

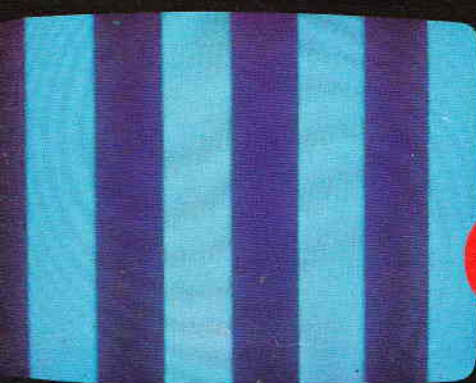

ELECTRONICS
TODAY INTERNATIONAL

AN ARGUS SPECIALIST PUBLICATION
DECEMBER 1991 £1.60



TESTCARD GENERATOR

**LAB
POWER
SUPPLY**
Use our free
board for this
project

**FREE
COPPER
CLAD
BOARD**
U.K. COPIES ONLY

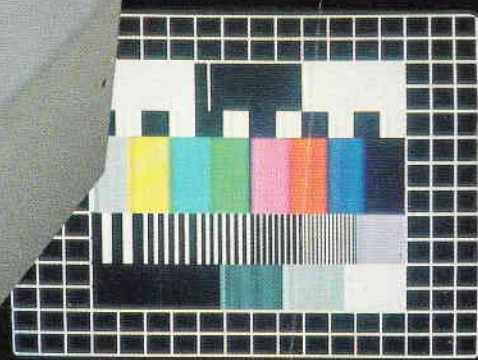

**NEGATIVE
FEEDBACK**
Improving
amplifier
performance

Creating accurate
colour patterns for TV
alignment



**OP-AMP
CHART**
A pull-out
pictorial guide
to op-amp
parameters

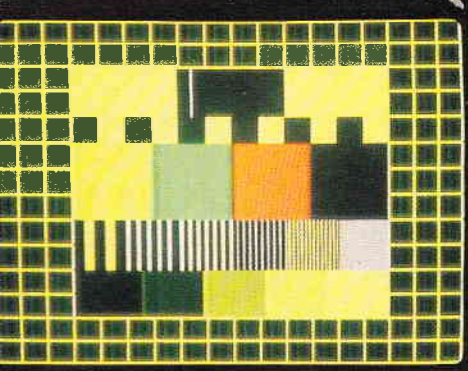

**HOW
TO MAKE
PCBs**
A home guide



9 770142 722016

12

OMP MOS-FET POWER AMPLIFIERS
HIGH POWER, TWO CHANNEL 19 INCH RACK

THOUSANDS PURCHASED BY PROFESSIONAL USERS



THE RENOWNED MXF SERIES OF POWER AMPLIFIERS
FOUR MODELS:- MXF200 (100W + 100W) MXF400 (200W + 200W)
MXF600 (300W + 300W) MXF900 (450W + 450W)
ALL POWER RATINGS R.M.S. INTO 4 OHMS, BOTH CHANNELS DRIVEN

FEATURES: * Independent power supplies with two toroidal transformers * Twin L.E.D. Vu meters * Level controls * Illuminated on/off switch * XLR connectors * Standard 775mV inputs * Open and short circuit proof * Latest Mos-Fets for stress free power delivery into virtually any load * High slew rate * Very low distortion * Aluminium cases * MXF600 & MXF900 fan cooled with D.C. loudspeaker and thermal protection.

USED THE WORLD OVER IN CLUBS, PUBS, CINEMAS, DISCOS ETC.

SIZES:- MXF200 W19"xH3 1/2" (2U)xD11"
MXF400 W19"xH5 1/4" (3U)xD12"
MXF600 W19"xH5 1/4" (3U)xD13"
MXF900 W19"xH5 1/4" (3U)xD14 1/2"

PRICES:- MXF200 £175.00 MXF400 £233.85
MXF600 £329.00 MXF900 £449.15
SPECIALIST CARRIER DEL. £12.50 EACH

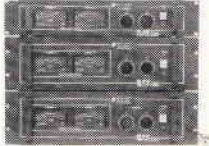

OMP VARISPEED TURNTABLE CHASSIS



* Manual arm * Steel chassis * Electronic speed control 33 & 45 R.P.M. * Vari pitch control * High torque servo driven DC motor * Transit screws * 12" die cast platter * Neon strobe * Calibrated balance weight * Removable head shell * 1/2" cartridge fixings * Cue lever * 220/240V 50/60Hz * 390x305mm * Supplied with mounting cut-out template.

PRICE £61.30 + £3.70 P&P

OPTIONAL MAGNETIC CARTRIDGES STANTON AL500mkII GOLDRING G950
PRICE £16.95 + 50P P&P PRICE £7.15 + 50P P&P

STEREO DISCO MIXER DJ6500

* WITH ECHO *

STEREO DISCO MIXER with 2 x 7 band L & R graphic equalisers with bar graph LED Vu meters. MANY OUTSTANDING FEATURES:- including Echo with repeat & speed control, DJ Mic with tone control & talk-over switch, 7 Channels with individual faders plus cross fade, Cue Headphone Monitor. Useful combination of the following inputs:- 3 turntables (mag), 3 mics, 5 Line for CD, Tape, Video etc.

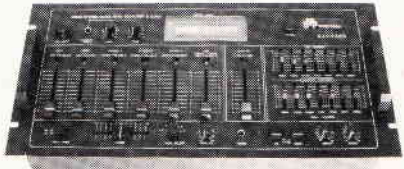

Price £134.99 + £5.00 P&P

SIZE: 482 x 240 x 120mm

PIEZO ELECTRIC TWEETERS - MOTOROLA

Join the Piezo revolution! The low dynamic mass (no voice coil) of a Piezo tweeter produces an improved transient response with a lower distortion level than ordinary dynamic tweeters. As a crossover is not required these units can be added to existing speaker systems of up to 100 Watts (more if two are put in series. FREE EXPLANATORY LEAFLETS ARE SUPPLIED WITH EACH TWEETER.

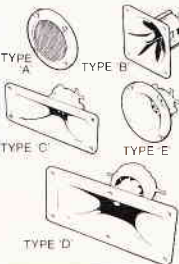

TYPE 'A' (KSN1036A) 3" round with protective wire mesh. Ideal for bookshelf and medium sized Hi-Fi speakers. Price £4.90 + 50p P&P.
TYPE 'B' (KSN1005A) 3 1/2" super horn for general purpose speakers, disco and P.A. systems etc. Price £5.99 + 50p P&P.
TYPE 'C' (KSN1016A) 2" x 5" wide dispersion horn for quality Hi-Fi systems and quality discos etc. Price £6.99 + 50p P&P.
TYPE 'D' (KSN1025A) 2" x 6" wide dispersion horn. Upper frequency response retained extending down to mid-range (2KHz). Suitable for high quality Hi-Fi systems and quality discos. Price £9.99 + 50p P&P.
TYPE 'E' (KSN1038A) 3 1/4" horn tweeter with attractive silver finish trim. Suitable for Hi-Fi monitor systems etc. Price £5.99 + 50p P&P.
LEVEL CONTROL Combines, on a recessed mounting plate, level control and cabinet input jack socket. 85x85mm. Price £4.10 + 50p P&P.

OMP LINNET LOUDSPEAKERS

THE VERY BEST IN QUALITY AND VALUE

Made especially to suit today's need for compactness with high output sound levels, finished in hard wearing black vinylite with protective corners, grille and carrying handle. Each unit incorporates a 12" driver plus high frequency horn for a full frequency range of 45Hz-20KHz. Both models are 8 Ohm impedance. Size: H20" x W15" x D12".

CHOICE OF TWO MODELS
POWER RATINGS QUOTED IN WATTS RMS FOR EACH CABINET

OMP 12-100WATTS (100dB) PRICE £163.50 PER PAIR
OMP 12-200WATTS (200dB) PRICE £214.55 PER PAIR

SPECIALIST CARRIER DEL. £12.50 PER PAIR



IN-CAR STEREO BOOSTER AMPS

THREE SUPERB HIGH POWER CAR STEREO BOOSTER AMPLIFIERS



PRICES: 150W £49.99 250W £99.99
400W £109.95 P&P £2.00 EACH

150 WATTS (75 + 75) Stereo, 150W Bridged Mono
250 WATTS (125 + 125) Stereo, 250W Bridged Mono
400 WATTS (200 + 200) Stereo, 400W Bridged Mono
ALL POWERS INTO 4 OHMS
Features:
* Stereo, bridgable mono * Choice of high & low level inputs * L & R level controls * Remote on-off * Speaker & thermal protection.

OMP MOS-FET POWER AMPLIFIER MODULES

SUPPLIED READY BUILT AND TESTED.

These modules now enjoy a world-wide reputation for quality, reliability and performance at a realistic price. Four models are available to suit the needs of the professional and hobby market i.e. Industry, Leisure, Instrumental and Hi-Fi etc. When comparing prices, NOTE that all models include toroidal power supply, integral heat sink, glass fibre P.C.B. and drive circuits to power a compatible Vu meter. All models are open and short circuit proof.

THOUSANDS OF MODULES PURCHASED BY PROFESSIONAL USERS

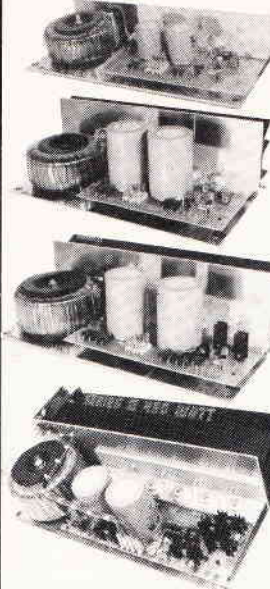

OMP/MF 100 Mos-Fet Output power 110 watts R.M.S. into 4 ohms, frequency response 1Hz - 100KHz -3dB, Damping Factor > 300, Slew Rate 45V/uS, T.H.D. typical 0.002%, Input Sensitivity 500mV, S.N.R. -110 dB, Size 300 x 123 x 60mm.
PRICE £40.85 + £3.50 P&P

OMP/MF 200 Mos-Fet Output power 200 watts R.M.S. into 4 ohms, frequency response 1Hz - 100KHz -3dB, Damping Factor > 300, Slew Rate 50V/uS, T.H.D. typical 0.001%, Input Sensitivity 500mV, S.N.R. -110 dB, Size 300 x 155 x 100mm.
PRICE £64.35 + £4.00 P&P

OMP/MF 300 Mos-Fet Output power 300 watts R.M.S. into 4 ohms, frequency response 1Hz - 100KHz -3dB, Damping Factor > 300, Slew Rate 60V/uS, T.H.D. typical 0.001%, Input Sensitivity 500mV, S.N.R. -110 dB, Size 330 x 175 x 100mm.
PRICE £81.75 + £5.00 P&P

OMP/MF 450 Mos-Fet Output power 450 watts R.M.S. into 4 ohms, frequency response 1Hz - 100KHz -3dB, Damping Factor > 300, Slew Rate 75V/uS, T.H.D. typical 0.001%, Input Sensitivity 500mV, S.N.R. -110 dB, Fan Cooled, D.C. Loudspeaker Protection, 2 Second Anti-Thump Delay. Size 385 x 210 x 105mm.
PRICE £132.85 + £5.00 P&P

NOTE: MOS-FET MODULES ARE AVAILABLE IN TWO VERSIONS: STANDARD - INPUT SENS 500mV, BAND WIDTH 100KHz. PEC (PROFESSIONAL EQUIPMENT COMPATIBLE) - INPUT SENS 775mV, BAND WIDTH 50KHz. ORDER STANDARD OR PEC.



VU METER Compatible with our four amplifiers detailed above. A very accurate visual display employing 11 L.E.D.s (7 green, 4 red) plus an additional on/off indicator. Sophisticated logic control for very fast rise and decay times. Tough moulded plastic case, with acrylic tinted front. Size 84 x 27 x 45mm.
PRICE £8.70 + 50p P&P

LOUDSPEAKERS

LARGE SELECTION OF SPECIALIST LOUDSPEAKERS AVAILABLE, INCLUDING CABINET FITTINGS, SPEAKER GRILLES, CROSS-OVERS AND HIGH POWER, HIGH FREQUENCY BULLETS AND HORNS, LARGE (A4) S.A.E. (50p STAMPED) FOR COMPLETE LIST.

P - From McKenzie Professional Series
S - From McKenzie Studio Series

McKENZIE - INSTRUMENTS, P.A., DISCO, ETC

- ALL MCKENZIE UNITS 8 OHMS IMPEDANCE**
- 8" 100 WATT P C8-100GP GEN. PURPOSE, LEAD GUITAR, EXCELLENT MID, DISCO. RES. FREQ. 80Hz, FREQ. RESP. TO 7KHz, SENS 96dB. PRICE £31.45 + £2.00 P&P
 - 10" 100WATT S C10-100GP GUITAR, VOICE, KEYBOARD, DISCO, EXCELLENT MID. RES. FREQ. 72Hz, FREQ. RESP. TO 6KHz, SENS 97dB. PRICE £38.89 + £2.50 P&P
 - 10" 200WATT S C10-200GP GUITAR, KEYB'D, DISCO, EXCELLENT HIGH POWER MID. RES. FREQ. 69Hz, FREQ. RESP. TO 5KHz, SENS 97dB. PRICE £53.21 + £2.50 P&P
 - 12" 100WATT P C12-100GP HIGH POWER GEN. PURPOSE, LEAD GUITAR, DISCO. RES. FREQ. 49Hz, FREQ. RESP. TO 7KHz, SENS 98dB. PRICE £40.35 + £3.50 P&P
 - 12" 100WATT P C12-100TC (TWIN CONE) HIGH POWER, WIDE RESPONSE, P.A., VOICE, DISCO. RES. FREQ. 45Hz, FREQ. RESP. TO 12KHz, SENS 97dB. PRICE £41.39 + £3.50 P&P
 - 12" 200WATT S C12-200B HIGH POWER BASS, KEYBOARDS, DISCO, P.A. RES. FREQ. 45Hz, FREQ. RESP. TO 5KHz, SENS 99dB. PRICE £71.91 + £3.50 P&P
 - 12" 300WATT S C12-300GP HIGH POWER BASS, LEAD GUITAR, KEYBOARDS, DISCO ETC. RES. FREQ. 49Hz, FREQ. RESP. TO 7KHz, SENS 100dB. PRICE £95.66 + £3.50 P&P
 - 15" 100WATT P C15-100BS BASS GUITAR, LOW FREQUENCY, P.A., DISCO. RES. FREQ. 40Hz, FREQ. RESP. TO 5KHz, SENS 98dB. PRICE £ 59.05 + £4.00 P&P
 - 15" 200WATT P C15-200BS VERY HIGH POWER BASS. RES. FREQ. 40Hz, FREQ. RESP. TO 3KHz, SENS 98dB. PRICE £80.57 + £4.00 P&P
 - 15" 250WATT S C15-250BS VERY HIGH POWER BASS. RES. FREQ. 39Hz, FREQ. RESP. TO 4KHz, SENS 99dB. PRICE £90.23 + £4.50 P&P
 - 15" 400WATT S C15-400BS VERY HIGH POWER, LOW FREQUENCY BASS. RES. FREQ. 40Hz, FREQ. RESP. TO 4 KHz, SENS 100dB. PRICE £105.46 + £4.50 P&P
 - 18" 500WATT S C18-500BS EXTREMELY HIGH POWER, LOW FREQUENCY BASS. RES. FREQ. 27Hz, FREQ. RESP. TO 2KHz, SENS. 98dB. PRICE £174.97 + £5.00 P&P

EARBENDERS:- HI-FI, STUDIO, IN-CAR, ETC

- ALL EARBENDER UNITS 8 OHMS** (Except EB8-50 & EB10-50 which are dual impedance tapped @ 4 & 8 ohm)
- BASS, SINGLE CONE, HIGH COMPLIANCE, ROLLED SURROUND 8" 50watt EB8-50 DUAL IMPEDENCE, TAPPED 4/8 OHM BASS, HI-FI, IN-CAR. PRICE £8.90 + £2.00 P&P
 - 10" 50WATT EB10-50 DUAL IMPEDENCE, TAPPED 4/8 OHM BASS, HI-FI, IN-CAR. PRICE £13.65 + £2.50 P&P
 - RES. FREQ. 40Hz, FREQ. RESP. TO 5KHz, SENS. 99dB.
 - 10" 100WATT EB10-100 BASS, HI-FI, STUDIO. PRICE £30.39 + £3.50 P&P
 - RES. FREQ. 35Hz, FREQ. RESP. TO 3KHz, SENS 96dB.
 - 12" 100WATT EB12-100 BASS, STUDIO, HI-FI, EXCELLENT DISCO. PRICE £42.12 + £3.50 P&P
 - RES. FREQ. 26Hz, FREQ. RESP. TO 3 KHz, SENS 93dB.
 - FULL RANGE TWIN CONE, HIGH COMPLIANCE, ROLLED SURROUND**
 - 5 1/2" 60WATT EB5-60TC (TWIN CONE) HI-FI, MULTI-ARRAY DISCO ETC. RES. FREQ. 63Hz, FREQ. RESP. TO 20KHz, SENS 92dB. PRICE £9.99 + £1.50 P&P
 - 6 1/2" 60WATT EB6-60TC (TWIN CONE) HI-FI, MULTI-ARRAY DISCO ETC. RES. FREQ. 38Hz, FREQ. RESP. TO 20KHz, SENS 94dB. PRICE £10.99 + 1.50 P&P
 - 8" 60WATT EB8-60TC (TWIN CONE) HI-FI, MULTI-ARRAY DISCO ETC. RES. FREQ. 40Hz, FREQ. RESP. TO 18KHz, SENS 89dB. PRICE £12.99 + £1.50 P&P
 - 10" 60WATT EB10-60TC (TWIN CONE) HI-FI, MULTI ARRAY DISCO ETC. RES. FREQ. 35Hz, FREQ. RESP. TO 12KHz, SENS 98dB. PRICE £16.49 + £2.00 P&P

TRANSMITTER HOBBY KITS

PROVEN TRANSMITTER DESIGNS INCLUDING GLASS FIBRE PRINTED CIRCUIT BOARD AND HIGH QUALITY COMPONENTS COMPLETE WITH CIRCUIT AND INSTRUCTIONS

- 3W TRANSMITTER 80-108MHz, VARICAP CONTROLLED PROFESSIONAL PERFORMANCE, RANGE UP TO 3 MILES, SIZE 38 x 123mm, SUPPLY 12V @ 0.5AMP. PRICE £14.85 + £1.00 P&P
- FM MICRO TRANSMITTER 100-108MHz, VARICAP TUNED, COMPLETE WITH VERY SENS FET MIC, RANGE 100-300m, SIZE 56 x 46mm, SUPPLY 9V BATTERY. PRICE £9.80 + £1.00 P&P



PHOTO: 3W FM TRANSMITTER

TREAT YOURSELF . . . TREAT A FRIEND!

Subscribe to
E.T.I. And
Choose One Of
These Superb Gifts
Absolutely FREE!

That's right take out a subscription to E.T.I. for either yourself or as a gift for a friend, and not only will we make sure its delivered to you each month at no extra charge*, but you or the recipient of your gift subscription can choose one of these superb gifts with the compliments of E.T.I.

Just fill in the coupon below and send it to the address given with a cheque, money order or credit card instructions to cover the cost of the subscription. Please also indicate in the space provided which option choice — 1 or 2 you would like.
We'll do the rest!

SUBSCRIPTION RATES

UK £19.20 POST FREE
Europe £24.10
Middle East £24.40
Far East £26.80
Rest of World £25.85
*UK only post free

Overseas rates include postage
Airmail rates upon request

TERMS AND CONDITIONS

This offer closes 30 December 1991 and is open to current ETI subscribers who wish to renew or extend their current subscription, but must do so using the order form provided. Please allow 28 days for receipt of gift.

To guarantee your gift before Christmas orders **MUST** be received by **FRIDAY 6TH DECEMBER 1991.**

CHOOSE YOUR GIFT FROM ...

OPTION 1 How many times do you wish you had a third hand to hold components together whilst soldering the joints? Helping hands, with gripper support and magnifying glass can help you perform this task with ease. Whether it is on the work-bench or out on site, this handy little jig can help you through the awkward moments in soldering. **WORTH £6.00**

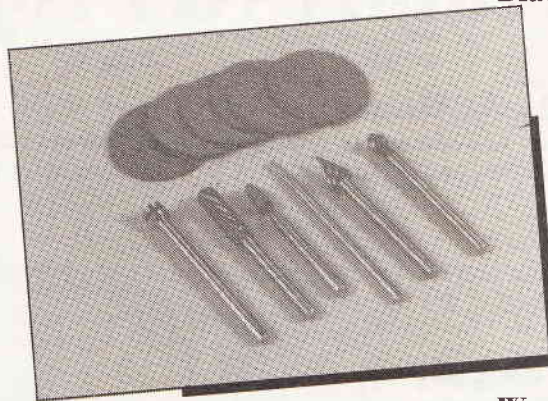
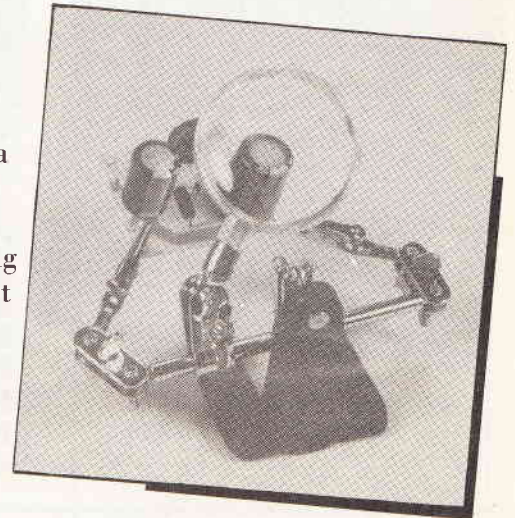

OPTION 2 The 12-piece Black & Decker Carving and Engraving kit is a must for any home constructor. The tools are ideal for enlarging and cleaning burred holes on PCBs and finishing-off front panel slots. The disc can be used for cutting square holes and shaping PCBs to fit into cabinet housings.

WORTH £10.00

Why not telephone or fax your subscription to us on:
TELEPHONE 0442 66551 EXT 210 (office hours only)
Please quote ETI/14. Fax: 0442 66998

- I would like to subscribe to ETI and receive a free gift
 I would like to send ETI gift subscription and free gift

My Name Recipient's Name

Address Address

.....

..... Post Code Post Code

.....

- New Subscriber Renewal New Subscriber Renewal
 OPTION 1 OPTION 2 OPTION 1 OPTION 2

Please commence with the issue

I enclose my cheque/P.O. for £..... payable to ASP or please debit my

Access/Visa

Signature..... Expiry.....

Please return to Subscription Department, Argus Specialist Publications, Argus House, Boundary Way, Hemel Hempstead, Herts. HP2 7ST.

ETI/14

Contents

DECEMBER '91

VOLUME 20 No 12

Regulars

Open Channel	6
News	7
News Stateside	11
Read/Write	12
Photocopy Service	14
PCB Service	15
PCB Foils	60
Classified Ads	63

Features & Projects

How To Make PCBs At Home	16
As we are giving away a free copper-clad board this month, Geoff Martin provides a basic but essential guide to the most cost effective way of producing a PCB of your own at home.	
The Nightfighter 4	20
Mike Meechan now moves on to the third rack module, the sound sensor switch in which any of your lighting displays can be zoned.	
Laboratory Power Supply	32
Andrew Armstrong constructs an indispensable workshop power supply using our free copper-clad board given away with this issue.	
Negative Feedback	36
Negative feedback is a very important parameter for amplifier performance. A P Stephenson provides the basics of a standard technique.	
An Op-amp Parameter Display Chart	40
Bryan Hart provides a visual alternative to some common op-amp parameters.	
Power On And Overload	46
Back to discrete component regulation with overload indication. A simple but effective project by J R Nowicki.	
Video Test Card And Test Pattern Generator	48
Paul Stenning produces an invaluable piece of service equipment for the alignment of colour tubes in TVs or monitors.	
Electromagnetism And Man	52
The evidence to support the idea that low frequency electromagnetic fields harms man has been difficult to come by. Douglas Clarkson reveals mans interaction with this very natural phenomena.	

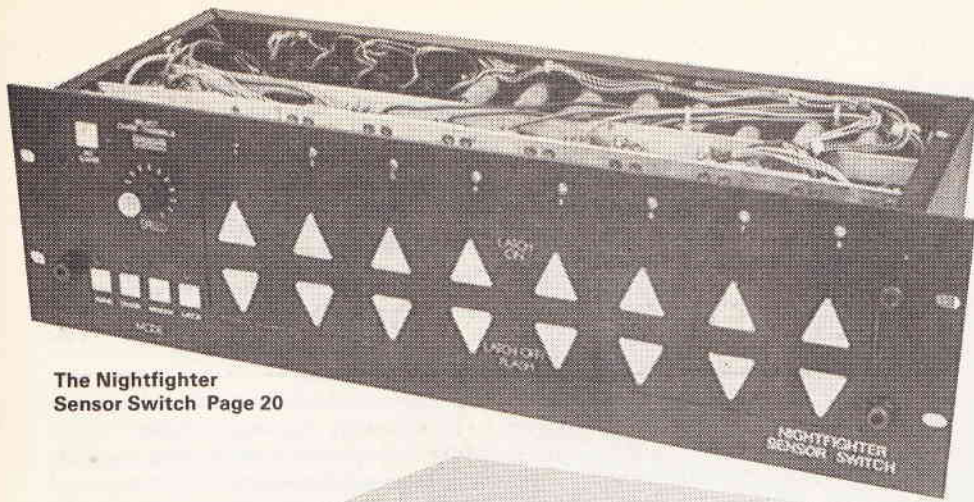

**The Nightfighter
Sensor Switch Page 20**



**Test Card and
Test Pattern Generator
Page 48**

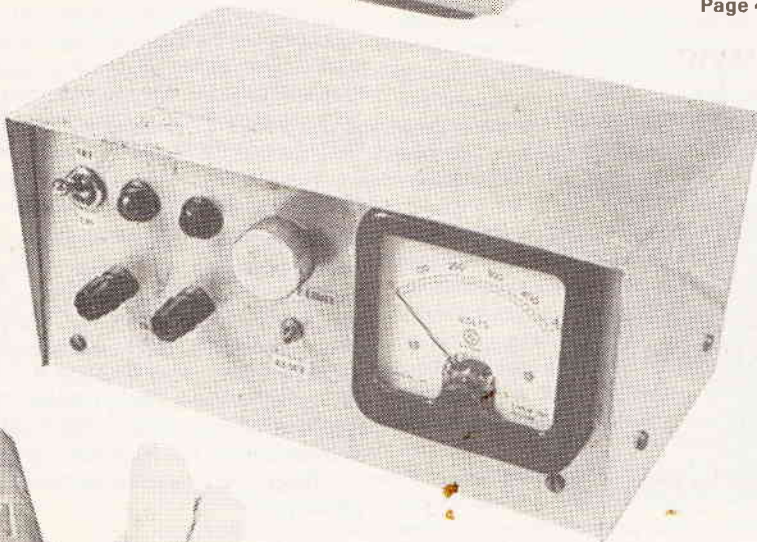

**Laboratory
Power Supply
Page 32**



**Making PCBs
at Home
Page 16**

**Power On and
Overload Indicator
Page 46**

Editorial

Changes to the school curriculum over the last few years to provide a broader learning base for our state children has been encouraged to keep abreast of developments in life. Sadly, as a lot of parents know and indeed children also know, the system lacks the resources and knowledgeable staff to take on some of the new subjects now on offer. A crucial area of concern is of course electronics coming as it does under the technology hat.

I predicted a few years ago, coming from education, that we editors 'in the business' would begin to see the following arrive on our desks:

Dear Sir,

I am a sixth/fifth-year pupil studying A level/GCSE technology etc... Please can you design/modify/send/help me in any circuits relating to...

As much as it is frustrating for the pupil in not getting the information from school, it is also frustrating for us in not being able to spend the time on such investigations. Our younger citizens are trying to learn from a very narrow academic foundation and if we are not careful it could end in rejection of the subject.

We all know the lack of investment into science and technology in Britain puts us in the bottom league for scientific development but this deep rooted problem finds itself reflected in our dichotomous education system, and in a way is self perpetuating. Breaking traditional 'safe' values and investing in new horizons is too much of a risk-taking adventure according to the 'old greys'. It would have a better chance with younger minds in positions of parliamentary power with a scientific background, something that is presently lacking.

Maybe the British Euro-child of tomorrow should receive their science and technology education across in mainland Europe where greater importance is placed on such matters. I'll pass on the practicalities of such a move but various exchanges in other areas have been operating for many years.

Now the bandwagon of environmental issues is truly underway it might seem opportune to get 'people power' onto making the importance of science a politically important issue.

Paul Freeman

OPEN CHANNEL



Why, oh why can't we (I use the term we loosely to mean *the whole world*) get our act together and stop doing things in a multitude of ways: duplicating research and development efforts; manufacturing many different types of products which all do the same thing; offering a whole range of goods all-but-a-smidgin identical in what they do; then expecting everyone to make a fortune and be happy?

It may be a bit naive and simplistic of me (and no doubt Her Majesty's current Government will tell me it is) but I'm sure the spirit of competitive materialism which has pervaded the UK over the last twelve years (and the rest of the world, for that matter) doesn't always produce the best results for us poor plebs who use the goods, services and products which are thrown at us. Don't get me wrong! I'm not saying competition isn't a good thing. Regular readers will know I argue for competition whenever competition is warranted.

But surely there has to be a case to answer when *too many* commodities are available in a given marketplace. In a simple example, take the town where I live. For argument's sake let's call it Mytown; a small University town of less than 50,000 residents. We've got a Macdonalds, a Wimpy, five pizza houses, umpteen Chinese takeaways, about ten curry houses and countless great British chippies. On top of this there must be well over twenty conventional sit-down-and-eat restaurants and dozens of pubs selling bar food. Unremarkably, there are almost weekly reports in our local rags about one or another eating outlet closing down due to lack of custom.

Now, as I say, I'm all for competition. But competition of this sort does no-one any good. No-one makes a good profit because sales averaged out between this lot don't add up to much. Customers don't see the real benefits of competition (that is, cheaper meals) because none of the eating outlets can afford to lower prices. Lower prices can only result if companies increase turnovers; and that can't happen because Mytown is a fixed size.

Where is all this relevant to electronics? Well, consider telepoint, that darling of the DTI which was to revolutionise personal communications. Two years ago, the Government thought we'd all be walking round with a telepoint 'phone in our pockets, briefcases or handbags by now. Then, all we need to do is to be within eyesight of a receiver/transmitter station and we can hook into the public telephone network whenever we want.

What happened? The DTI licenced four operators to do what two, or at most three, could easily do and so the system got out of hand. Handsets were too expensive, the four operators couldn't agree on a common standard, potential users couldn't be bothered, and operators started dropping like flies. Now there are only two operators left at the time of writing and the time is passed for the system. No-one wants it anymore, preferring to rely on real telephones or cellular carphones if they want to look cool.

Competition of this sort is self-defeating. It's happened in the computer business, of course. Larger companies take the lion's share of sales, while smaller fish are eaten or drown. Good ideas are stifled, prices remain high, customers are confused, fat cats get fat

ter. Yet still we don't learn.

Competitiveness should be monitored and controlled by governments. This way, consumers benefit by cheaper and better products and services, manufacturers and service providers benefit through increased profits, employees benefit by being in work. Chaotic competitiveness, unleashed and uncontrolled, is not a happy state of affairs.

The Big, Big Blue

Talking of large computer manufacturers, over the last few months IBM has been signing agreements with a number of companies worldwide, and it's interesting to speculate what it's all leading to.

These companies (including: Apple, Inmos, Motorola, Novell, Siemens and Wang) are all major players — if not leading players — in their own fields, and in one way or another have niches for themselves which even IBM has not yet been able to penetrate. Apple, for example, has its niche in graphics-orientated computer systems, Siemens niche is in communications, and so it goes on.

Is IBM looking to get a foothold in the few remaining corners of the computing market it doesn't already control? Is it wanting to be an even bigger blue whale in the sea of small fish it already controls? Are there going to be any small fish left at all in a few years, or is the big blue whale going to eat the remaining few all up?

DCC vs MD

It looks like Philips' digital compact cassette is going to win the impending war against Sony's mini-disc, simply because manufacturers want to make DCC and not MD. In alphabetical order, companies going to manufacturer DCC machines currently include: Bang & Olufsen, Blaupunkt, Grundig, Kenwood, Matsushita, Tandy, Thomson, Sanyo, Sharp, Sony (yes, that's right) and Yamaha. On the other hand, manufacturers who are to make MD machines are: Philips and Sony!

Maybe the impending war is really just a storm in a teacup.

Something To Be Nervous About

Siemens, Bull and Olivetti are going to produce a computer network, provisionally called the European Nervous System (don't blame me, I only report this rubbish!), which is to be pan-European and according to the European Commission's commissioner for research and development, Filippo Pandolfi, is essential to the future of the computer industry.

Of course it is. Building something like this will take years of research, years of development, and years of maintenance. It will cost millions upon millions of pounds and keep thousands if not millions of people in work. Companies throughout the continent will rush to use it, and be charged excessively high prices for the privilege.

Apparently IBM and Bull are in negotiations.

Apparently IBM and Olivetti are in negotiations. IBM and Siemens have already negotiated.

Keith Brindley

SATELLITE SOUND FROM B.K.

BK Electronics has announced the launch of the new Sub-Woofer Satellite System from Studio Power.

At £129.00, including VAT, for two satellite speakers and one bass bin, BK Electronics believes this price level to be the lowest in the UK for a true sub-woofer system.

The design is targetted towards the customer who would normally choose a small, traditional pair of loudspeakers and, for a

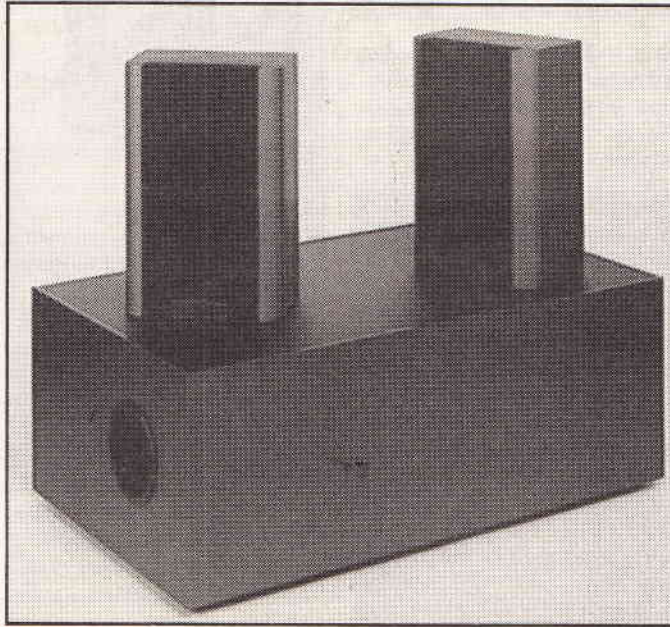

similar outlay, will be able to benefit from the addition of a single bass bin, giving a non-directional sub-bass sound, which may be hidden behind the sofa, curtains, or even under the coffee table! True stereo imagery is provided by the small satellite speakers.

All three units are finished in a deep grey, smooth metallic finish, with the satellites having contrasting black grilles.

The bass bin contains 2 x 6" bass units, in a push/pull configuration.

The satellite units each contain a 1" tweeter and a 3" mid-range unit. The system's power handling is 60 Watts RMS (90 Watts Peak Music Power).

The price, including VAT, is £129.00 plus £6.00 Postage and Packing, and is available from BK Electronics, Tel: (0702) 527527

LUCAS — DEVELOPING THE CAR OF THE FUTURE

Every year, 50,000 people are killed on the roads of the European Community. More are seriously injured. Both the European Commission and the various governments are committed to reducing these figures substantially. Lucas Automotive is playing a key role in developing safety-related technologies for improved safety and traffic efficiency, with other car component manufacturers throughout Europe, under the PROMETHEUS programme.

Two demonstration systems, developed by Lucas with Jaguar, cover Collision Avoidance and Autonomous Intelligent Cruise Control.

Collision Avoidance

As part of the PROMETHEUS programme, a team of engineers at the Lucas Advanced Engineering Centre in Solihull, UK., and other Lucas divisions, has been collaborating with major European companies, including Jaguar, to develop collision avoidance systems suitable for fitment to the majority of road vehicles.

The systems use various sensing methods — optical, infra-red and radar — to detect where the road is and the location of other objects (vehicles, people, stationary objects) that are likely to cross the path of the vehicle equipped with the system. The system then

assesses what threat these objects could represent and assists the driver in selecting the safest course of action.

There is an enormous amount of research and development to be done to achieve results. The driver has to learn to trust the system and not generate an unjustified sense of security. Indeed, the driver will remain responsible for the actions of his vehicle for the foreseeable future.

Machine systems have to be programmed to reliably detect hazards. They must also support, not distract or interfere with, the driver. For example, a system which automatically applied the brakes when the driver was trying to accelerate in order to overtake a hazard would increase the risk of a collision.

A single method of sensing is not capable of generating all the information necessary to produce an acceptable collision avoidance system.

Current work indicates that a vision system will be effective in good conditions but it will be necessary to use infra-red cameras before systems can operate in poor visibility or darkness.

The use of infra-red cameras was vividly demonstrated in the Gulf War but are extremely expensive. The Lucas collaboration with Pilkington, who are also participating in PROMETHEUS, will enable the company to benefit



from improvements in this area at the earliest opportunity.

Other methods being investigated include vehicle mounted video cameras and microwave radar systems.

Autonomous Intelligent Cruise Control

Whilst practical Collision Avoidance systems are a long term goal, there are spin-offs from that technology which can be applied to produce products in the medium term. The technologies associated with advanced sensors developed by Lucas Advanced Engineering Centre is being applied by the Lucas Chassis division in the development of an Intelligent Cruise Control system which provides the driver with

vehicle speed control in all traffic situations as well as enhancing passenger comfort and reducing driver fatigue. The system gives the driver the option of having the car automatically control its lateral position relative to the vehicle in front.

The Jaguar demonstration car has a prototype Lucas system using a millimetre wave radar sensor linked to electronically controlled actuators which maintain a set time interval of vehicle separation using automatic brake and throttle control. Development work is continuing aimed at providing the potential for improved tracking control under cornering conditions and further improvements in control algorithms that will refine the system even more.

THERMAL CUT-OUTS ENSURE OVERHEAT SAFETY

Thermal cut-outs, the latest new product from Quiller, provide a reliable method of isolating supply lines in applications where dangerous over-heating must be avoided.

Typically, the devices are installed in temperature sensitive areas of equipment — in-line with electrical supplies where they monitor the temperature. In the case of equipment failure, over-heating is accurately detected, based on a pre-determined cut-off temperature. At this point the device goes open circuit. Once 'blown' the component has to be replaced, after the problem has been rectified.

Application areas include the protection of fuel-pumps, transformer and battery pack systems, and in domestic appliances such as washing machines and irons.

Six ranges are available, with temperatures ranges from 60°C to 240°C. Maximum recommended operating currents range from 5A

to 25A, with voltage from 240V to 277V (AC resistive).

For further details, contact Quiller Limited, Tel: (0202) 417744.

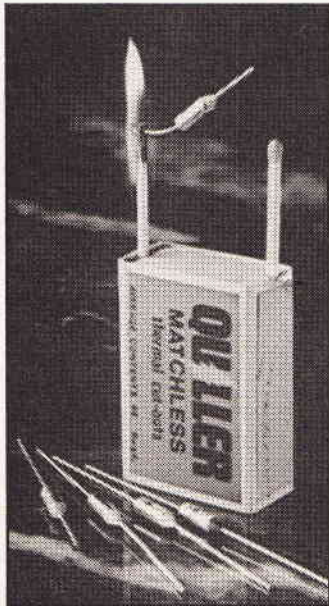

ADVANCED SOLDER PASTE



Fry's Metals has launched Aquatrak solder paste. It includes a formulation which helps avoid the use of organic cleaning solvents on circuit boards.

Aquatrak provides the overall performance of a rosin based paste, in a water soluble form, giving excellent cleaning results.

Residues left after soldering

are minimal and are removed by cleaning the circuits in water. They create no environmental hazard if they are washed into the main drainage system.

Aquatrak combines technically superior solder powder and flux for consistent bonding.

For further information contact Fry's Metals Limited, Tel: 081-665-6666.

MOBILE PHONE INDUSTRY TO LAUNCH ROAD SAFETY CAMPAIGN

The UK mobile phone industry, in conjunction with Douglas French MP, are seeking ways of promoting greater road safety amongst mobile phone users.

The campaign, was launched by the mobile phone industry's representative trade body the FCS at the national mobile communications exhibition at the Wembley Conference Centre. The FCS will seek to press mobile phone users who use their communication links whilst driving, to adopt more stringent safety methods while telephoning from their car.

In particular, the campaign will endeavour to persuade users of portable equipment to install properly approved car kits with hands free microphones and perhaps even the new generation voice activated systems. The object of the campaign is to eliminate the familiar scenes of drivers attempting to control their car whilst trying to tap out telephone numbers — an act which necessitates one, if not two, hands.

According to David Savage, Chairman of the Cellular Service Providers Committee within the FCS, and which represents the

major air time suppliers to over 95% of the country's cellular users:

"Whilst there is evidence to suggest that the correct and proper use of a mobile phone in a moving vehicle is no more dangerous than tuning the car radio the industry is concerned about the mis-use of hand-held portable telephones amongst its car driving subscriber base.

"The most potentially distracting action by any car driving user is that of manually dialling a number. This is clearly compounded when a portable is used by a driver

without an approved car kit.

"We will also be urging the manufacturers to reduce the cost of the necessary car kits to be proportionally more in line with the cost of handheld portable cellular telephones" he said.

Douglas French MP has long been an active campaigner for some form of legislation or safety guidelines to be introduced to eliminate the dangerous use of mobile phone equipment amongst car drivers.

NEW PROCESS TO REPLACE CFC 113 CLEANING AGENTS

Highly encouraging cleaning performance results have been achieved by ICI with a cleaning process the company has developed as a cost effective replacement for CFC 113 solvents in the electronics industry.

The new cleaning process, which has no potential to deplete

the ozone layer, uses a unique hydrocarbon alcohol formulation, called 'Evolve'. The formulation is specially developed to work in a novel multi-stage cleaning plant, which ICI has designed specially for use in flux removal applications.

Following customer trials, the

product and process will be introduced to the UK market in 1992.

The development of the new process is part of ICI's £100million overall CFC replacement programme. The benefits of the new process have been extensively assessed against a number of key production criteria. These

include high cleaning performance, inherent worker safety, ease of use, minimal process time, zero ozone depletion potential (ODP) and minimal overall environmental impact.

NO PROOF OF HEALTH RISKS FROM ELECTROMAGNETIC FIELD SAYS IEE

Fears over possible health risks from exposure to electromagnetic fields are greatly exaggerated, and have little basis in fact according to a report published today by the Institution of Electrical Engineers.

The IEE report comes in response to increasing concern over the possible biological effects of magnetic fields from overhead power cables, house wiring, electrical appliances and VDU's. Recent claims have attempted to link cancer, suicide, miscarriage and personality change to exposure to electromagnetic fields.

An IEE Working Party, chaired by Dr Tony Barker, Consultant

Medical Physicist, Sheffield Health Authority, spent a year studying reports of laboratory tests, and medical investigations from around the world. It's Report concludes that there is no evidence to show a firm link between exposure to low frequency electromagnetic fields and damage to health.

Public concern, the IEE report claims, has been fuelled by media sensationalism and had led to unnecessary alarm and widespread 'electrophobia' — the irrational fear of electromagnetic fields.

Epidemiological reports studied suggest a very slight increase in the risk of brain cancer and leukaemia for workers in some elec-

trical areas. However, they do not provide a definite connection with electric or magnetic field exposures and may be due to other occupational factors, such as exposure to solvents or other chemicals.

Laboratory studies reviewed by the IEE Working Party have also proved inconclusive. Most have been conducted on an ad hoc basis and have lacked independent confirmation. As a result, there is no widely accepted experiment which can demonstrate any biological effect of low level electromagnetic fields.

The report says there has been no national or international co-ordination of either medical or

laboratory experiments, nor is there any universally accepted technique for measuring levels of exposure to electromagnetic fields. Both issues, it claims, must be addressed before any definite conclusion can be reached.

Speaking on the IEE findings, Dr Tony Barker said, "The Working Party was faced with numerous fragmentary, isolated and often contradictory reports. At the present time we must conclude that there is insufficient evidence to make a health risk assessment, or indeed, even to determine whether there is any hazard to health from electromagnetic fields".

POWERFUL SCIENTIFIC CALCULATOR IC CARD FOR CASIO SF-9500 DIGITAL DIARY

The ES650 Powerful Scientific IC Card is one of two new IC Cards recently introduced by Casio for their top-range SF-9500 Digital Diary.

Plugging the ES650 Powerful Scientific into the SF-9500's expansion port, the Diary becomes a powerful programmable scientific calculator based closely on the Casio FX4500p, with all its functions plus a memory expanded almost fourfold to 4,095 steps.

The ES650 Powerful Scientific offers a selection of 112 scientific functions from basic arithmetic like fractions and percen-

tages to advanced integration, statistical and base-n calculations, and regression analysis. The ES650 also incorporates 128 scientific constants.

The Card's programming function enables multiple programs to be stored under their own filenames for recall.

Jump and sub-routine functions allow files to be linked together to conserve memory, while frequently used formulae can be stored in memory for one-touch recall.

The ES650 Powerful Scientific IC Card is priced at £49.99.

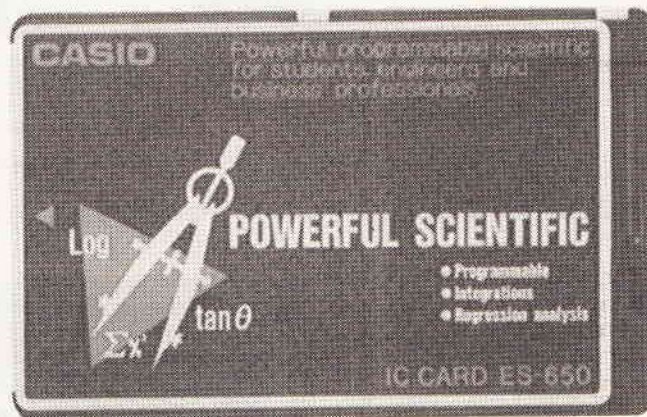

CAR ALARM WITH DIGITAL CODE

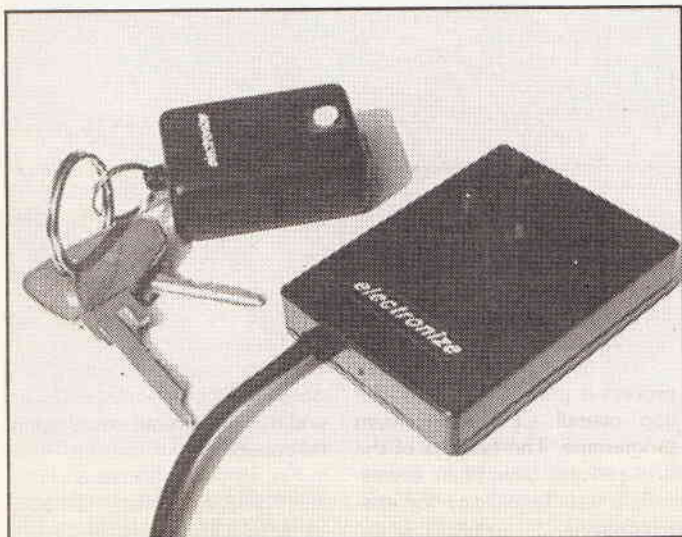

Two new products from Electronize, a key-ring transmitter and a dash top receiver, are said to offer high security, with a digitally encoded remote control for the company's existing alarms. With a range of 59,046 possible codes the user can set the code. This has advantages for fleet operators, who may want the same code for more than one vehicle, or people who want several key sets for one vehicle.

The transmitter uses a high power multiple pulse infra-red system to give a range up to 5 metres whilst making it difficult to 'crack' with electronic scanning devices. The low profile receiver is designed to sit in full view on top

of the dash. To warn off intruders, it has a high intensity red LED which flashes continuously when armed. A green light flashes once as the correct code switches off the alarm, so the owner always knows whether the alarm is on or off.

The transmitter and receiver are priced separately at £17.95 and £26.55 respectively. With an alarm and siren the complete coded system costs around £77 with D.I.Y. fitting. Self build parts kits are also available, bringing the system cost down to about £62.

For information contact: Electronize Design Tel: 021 308 5877.

PHONEPOINT SUSPENDS SERVICE

Phonepoint, the consortium comprising BT, France Telecom, Deutsche Bundespost Telekom, Nynex International and Northern Telecom Europe, is to suspend its telepoint oper-

ations with immediate effect.

The parties in the Consortium have taken this decision because of what they see as adverse market conditions for a telepoint service in the UK. However it is

hoped that a telepoint service may be made available by Phonepoint in the future should conditions become more favourable.

Phonepoint will be contacting all customers direct and will offer

them a full refund on equipment purchased from Phonepoint. In addition BT will offer an alternative option to upgrade customers to the Cellular service on favourable terms.

SMALLER LASER DIODE MODULES

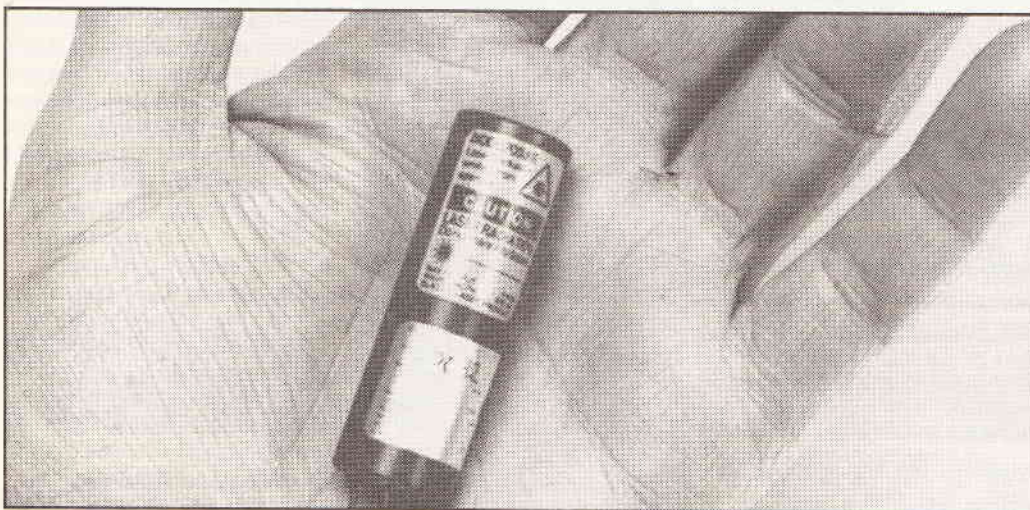

Compact visible laser diode modules in the Imatronic range now have an added modu-

lation option. Modulated versions offer 1kHz to 100kHz modulation with a 1 μ s rise time and can be

driven from any TTL compatible source. The small modules are suitable for replacing He:Ne

lasers giving the advantage of ruggedness.

An infra-red version operating at 820nm has been added to the range and packaged in the same compact 49 x 16mm diameter housing. Units in both ranges include all the focusing optics and require 4-5.25V DC to drive them.

The new IR diodes are available with outputs set to 1 or 3mW. Units operating in the visible spectrum from 660-685nm offer outputs of 0.5, 1, 2 or 3mW dependent on model. All units come as a complete package with two colour coded flying leads for the connection of DC power.

Contact: Lambda Photonics Ltd, Tel: (0582) 764334.

SILICON TRANSISTORS OUTPUT 40W AT 3.2GHz

Mitsubishi Electric is announcing the launch of its MTH301/302 S-band high output silicon transistors, putting silicon applications into the higher realms of 40W power output performance for 3.2GHz applications.

Silicon bipolar transistors are now replacing Klystron or travelling wave tube amplifiers through the demands for higher reliability and more compact designs. Furthermore, through more widespread demands to increase transmitting capacity in radio communications and radar, high frequency and high output are now essential.

To meet these increasing demands, Mitsubishi has developed its silicon bipolar transistors based on the company's developments in high frequency, high output transistors for radio receivers. The devices operate at 28V pulse, with a pulse width of 1ms and 50% duty cycle.

Output for the MTH301 is 16W, with a 40W output proclaimed for the MTH302, both at 3.2GHz and both with a collector

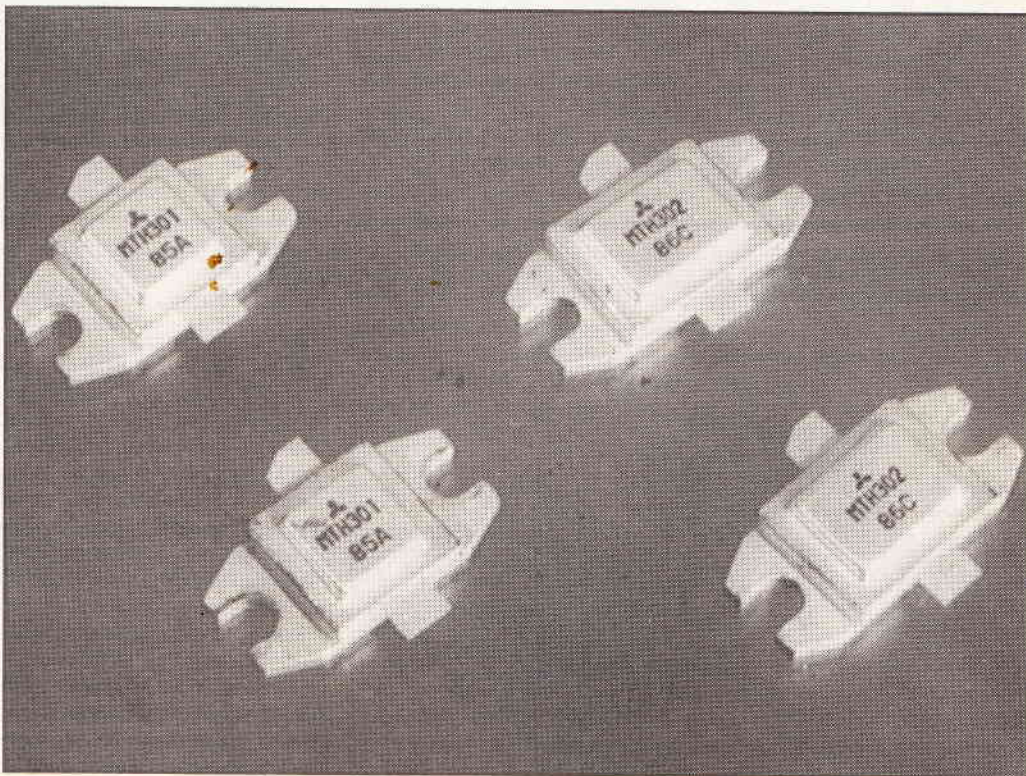

efficiency of 30%. The base ground design devices measure 20 x 16mm overall x 5.5mm high

for the MTH301 and 22 x 16mm overall x 5.5mm high for the MTH302.

For further information contact: Mitsubishi Electric UK Ltd, Tel: 0707-276 100.

stateside Integrated opto- electronic systems

Standard field-effect transistors could form the basis for integrated optoelectronic systems in an approach that integrates the FETs with asymmetric superlattices, according to scientists at AT&T Bell Laboratories.

The compound lattices are formed from alternating layers of indium gallium arsenide, indium

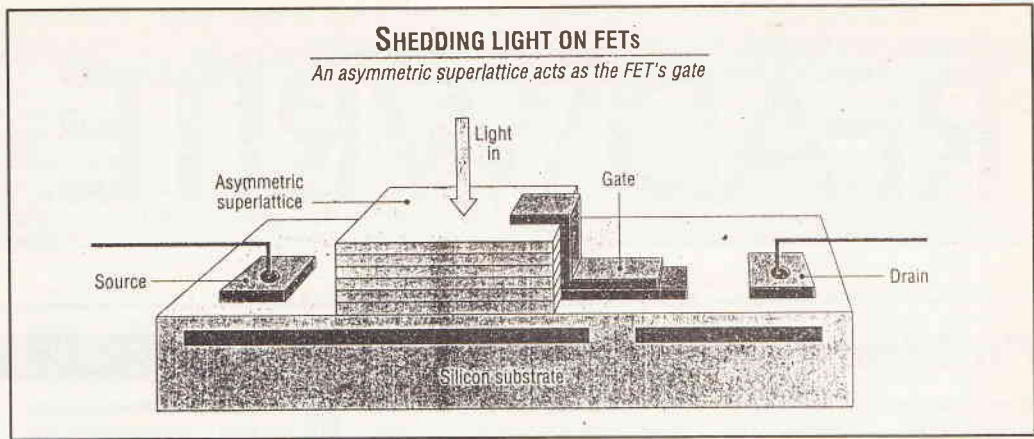

aluminium arsenide and indium phosphide and respond to light in the same way that capacitors respond to electric charge. Light stimulation causes the energy bands to tilt so that electrons and holes separate in each layer of the superlattice, storing the light energy in an electric field. Since FET gates operate as capacitors, the new superlattice could be easily integrated into the gate site of a standard FET, generating the same switching effect as an electronic gate. The result would be an

optically switched transistor that might be surprisingly easy to manufacture.

While many designs for phototransistors have been proposed and tried, the current design is unique in its direct integration into standard VLSI circuits.

"We have verified the operation of single FETs controlled by photonic gates, but the true test will be how well they integrate into actual circuits. The usefulness of this approach will be determined by the noise properties of the

devices when they are operating in specific circuits," said Serge Luryi of Bell. The superlattice can switch between charged and neutral states in only 2ps, and experiments with a superlattice combined with a state-of-the-art FET show switching speeds on the order of 200 Ps.

The fact that crystal defects actually enhance the operation of the new device may be a boon for practical applications.

Making 2-D holographic slices

An organic dye called protoporphyrin is enabling scientists at the University of Southern California to record images in precise time slices.

The new technique, called

'time-resolved holography,' lets researchers capture a specific two-dimensional slice from a three-dimensional image projection. The technique could be applied in medical imaging, where an image at a specific depth is required for analysis.

Conventional holograms encode an image as an interference pattern in photographic film. In place of the film, the scien-

tists dope the face of a polystyrene block with protoporphyrin. The surface is a plane of vibrating dye molecules, each with a slightly different resonant frequency. When light reflected from the object strikes the polystyrene, the protoporphyrin molecules absorb energy at their fundamental resonant frequency, preserving a brief frequency profile of the image.

Because the molecules con-

tinue to vibrate, light arriving slightly later can retune the frequency profile. By slightly delaying the reference beam pulse, an interference pattern is recorded at a specific time out of the total interval, during which reflected light arrives at the image plane. However, a permanent image requires continuous repetition of pulses timed at precisely the same instant.

Increasing current density of yttrium- barium- copper oxide

A method of improving the current-carrying ability of single crystals of the yttrium-barium-copper-oxide high-temperature superconductor has been developed by scientists from IBM's Thomas J. Watson Research Centre at Oak Ridge National Laboratory, Argonne National Laboratory, Ames Laboratory and Iowa University.

The superconductor is bom-

barded with tin ions, at 580, to introduce defects into the material's crystal structure in the form of columns, 20 atoms wide. The defects increase the maximum current by improving the 'pinning' phenomena — preventing the motion of magnetic field lines that would otherwise produce electrical resistance.

At 77 Kelvin, the critical current density was 450,000 amps/

cm² in a magnetic field of 1 Tesla. A proton-bombardment technique provides similar results, but only in low magnetic fields. The strength of the pinning and the values of the critical current density for these crystals are the largest ever observed in bulk Y-Ba-Cu-O at liquid-nitrogen temperatures in high magnetic fields. The critical current density also increases with the dosage of ion bombardment.

Liquid crystals

A new liquid-crystal switch activated by laser light may improve large area displays and optical memories. The effect has been demonstrated at Hercules Inc.'s Research Centre in an experiment with a slightly modified standard liquid-crystal cell.

Liquid-crystal cells are formed by sandwiching the liquid crystal between two glass plates coated with transparent polyimide which has microscopic grooves that cause the liquid-crystal molecules to line up in the same direction.

Molecules are switched into a different alignment with the application of electric or magnetic fields, depending on the type of liquid crystal. The Hercules ex-

periment is a simple variation on this method, where the polyimide is doped with a dye called diazodiamine. The dye causes a realignment of the liquid crystals when illuminated with laser light, and the effect is fully reversible. Illumination of the same area with light that is polarized at right angles to the original beam will realign the crystals and erase the image.

Laser-activated switching means that very small areas of microns or less can be switched, leading to applications such as adaptive optics. The Hercules researchers demonstrated the effect by writing a 10-micron-pitch diffraction grating in a liquid-crystal cell. The same technique could produce read/write holograms or dense read/write optical memories.

Problem Page

I am intrigued by the idea of being able to exercise while relaxing, as described in the box here from a mail order catalogue. Any idea how it works? I'm sure it must be possible to come up with a more affordable version. It might make an interesting project.

I have another problem. My car radio is a mid-eighties Ford 3-Waveband model. The FM reception is fine with the engine off, but sounds muffled when the engine is running (no interference, just as if someone has turned the treble right out). The medium and long wave are very strange - they give no reception at all to start with, but I have found that if I drive under high tension grid wires, it suddenly gives a crackle and bursts into life! The reception is then fine until the engine is turned off again. Then I have to look for more power lines to drive under to get it going again. I've had the radio out and apart on my test bench, where it seems to work fine. Put it back into the car and it is the same as before! I'm baffled. I could always buy another radio but I'd rather like to know what is going on - have you come across anything like it before?

**Gary Smith,
Heworth, York**

Firstly the Lean Machine, I can understand and suggest the mechanism but I'm not so sure about the concept. It sounds like a good old case of electrical nerve stimulation to twitch the muscles (remember Galvani and his frogs legs). A movement of muscle tissue expends energy and so on. Well this little box of tricks produces electrical pulses of varying frequency and amplitude to stimulate nerves via electrodes.

Believe it or not there is an established side to these machines and they are used for pain relief. If you have known a pregnant mother in labour then you might know about a 'TENS' machine. Electrodes are placed on the back either side of the spine and the pulsing nature of

the box sends messages to the brain to stimulate the production of endorphins, the bodies natural pain killing drugs. It's a non invasive way to dull pain. If ETI had appeared in Victorian times you might have seen adverts for various dangerous electrical therapies in air and in water!

As for sitting down to try to loose body fat, I've never heard so much nonsense - what's wrong with a walk or jog in fresh air!

Your other problem with the radio, the gremlins do seem to have crept in. From what you say it must have something to do with the car-body shell and/or aerial system being affected by the engine running. Is your car shell at the same potential as the negative terminal of the battery when the ignition switch is on? Do you have good aerial connections? Is your engine suppresor capacitor working? Will there ever be another radio like it? If listeners are tuned in to this hum of intrigue, why not write in and reveal all? - Ed.

Lean Machine now with 10 toning pads

While our old Learf Machine had eight toning pads, this new model has ten, meaning you can now effortlessly exercise up to five different muscle groups at once! Lie back and relax while the machine stimulates muscle activity and gently pulls your figure back into shape. It's especially good for firming thighs, tightening the waist and reshaping hips. New 'Soft-Start' facility ensures a gentle increase in the impulse before reaching full frequency. Lean Machine comes in a smart briefcase and is either mains-operated (240V AC) or, for complete portability, also runs on 6 HP2 batteries (not supplied). **10-pad Lean Machine £99.95.**

PCs

As a college lecturer in engineering I, along with the students, use PCs and associated peripherals a great deal. With respect to this, would it be possible to increase the number of projects you publish that are designed in the form of a standard 8-bit or 16-bit IBM PC expansion board.

Suggestions include:

- A Serial/IEEE convertor board. (This would allow the PC user access to the IEEE standard and easy instrumentation control. Further external devices could then be connected to this IEEE port allowing a great deal of potential expansion (for future ETI projects). A total of 16 devices, with their own addresses, could be connected in a daisy chain to a single expansion port of a PC!, all under software control.) Possible devices using the board could be:
- A voice recognition card.
- A burglar alarm with software monitoring.
- Robot control.
- Domestic environment control with software monitoring.

- An electronic lab - allowing computer control of experiments (very useful for practicals in GCSE).

- Shortwave radio under software control.

- A weather station where the computer monitors and records changes in temperature, pressure and humidity. (Could use this for psychic investigations for the brave of heart!)

I realise that many of these cards are available commercially (at high cost), but I think it would be more instructive to build these projects from scratch since this would not only save money, especially important in education establishments, but would provide a valuable insight into software control of hardware. I hope you can consider some of the ideas.

**Kevin Molby,
Leeds.**

We certainly will, ETI is open to anybody who has such a project for us to feature.

PCBs

Regarding Colin Long's letter (October), I use Easy PC, print out artwork (×1 scale) using a 9-pin dot matrix printer, and then have this photocopied onto acetate sheet at a cost of about 45 pence.

Using this method, I have produced a number of PCBs, both single and double sided, with enough detail to allow tracks to pass between IC pins easily.

As for the optical diffraction, if you arrange the artwork so that the toner side of the copy is in contact with the board during exposure, this is not a problem.

You may find that the copy is not sufficiently dark - experiment with the copier's contrast control and with exposure times to remedy this (or use a pen to darken

the tracks).

You will also discover that photocopiers tend to produce copies which are slightly 'stretched'. The actual difference in size between the original and the copy is very small, and is not a problem as component leads still reach the necessary pads. However, if the PCB is to be double sided, make sure both sides of the layout are stretched along the same axis!

Lastly, am I to understand from Paul Shlackman's article that the PIN number is stored on the cash-card itself? CSE Computer Studies taught me that the PIN isn't stored on the card!

**Daniel Brook,
Mill Hill, London.**

PCB Design To Prototype

I hope that I may be able to answer the question that Mr Carstens posed in the September issue of ETI. I am assuming that he wishes to produce the positives in house from EasyPC based on an IBM compatible, as I need to do when I am preparing a manuscript for publication. The positive is also used to produce the prototype PCB for testing and this again is done at home. The system I use has produced boards for both standard wired and surface mount components so I am quite happy that the output is reproducible and accurate on the 1:1 scale. The main problem is that output from a computer is not cheap by any means and the answer may not suit Mr Carstens.

The way I achieve the output is using a plotter with the necessary software in the PC. Whilst for paper output the choice of pen is simple, when you need to get the output on an acetate film then things get very difficult. A local analytical laboratory carried out some tests for me on the use of acetate film, drafting film (which is opaque) and on tracing paper. Only acetate film lets through

nearly 100% of the light that falls on it at the wavelength of the UV lamps in the exposure units. In the others it is about 1 to 2% so there is no choice but to use the glossy film.

The plotter that I use is the Roland DXY1100, the lowest cost version of the range but I suspect that any other plotter will do providing it will accept a pen of the only type that I find will work. Also the plotter must be able to draw accurately on the acetate sheet. The DXY1100 is good in this respect as the acetate is held firmly down on a baseplate and the pen is moved over it by the drive system. Plotters that grip the acetate and move it in one direction whilst the pen moves perpendicularly may have problems if the acetate slips in the drive.

The only pen/ink system that I can get to work consists of a 0.25mm tungsten carbide plotter drawing point with a cross groove and Staedtler 748 ink in black: Staedtler makes a high density black ink called 747 but every time I have tried to use it the ink dries too quickly and the drawing is destroyed by the pen blocking

and lifting one of the already drawn items. 748 ink does not seem to dry too quickly, but if you use it on a hot summer afternoon then you do get the same problem as with the 747 ink. Staedtler are well known world-wide so there should be no problem with getting the ink.

The pen comes from Dia-Nielsen a German company whose UK office is at Lonsto House, 1-3 Princes Lane, London N10 3LU. 01-444 7108 but they do not sell direct although they may be able to help with offices outside the UK. In Southern England where I live they can be obtained from Artworker Ltd and my local branch Artworker Southampton, Frobisher House, Nelson Gate, Southampton SO1 0GX holds them in stock. The type used is the F73142.

Flat tipped wet ink pens do not work as they cannot get enough ink onto the acetate film to get sufficient density into the tracks and pads, neither do ceramic tipped water based pens as the tracks end up as a line of dots. Overhead oil based pens should work but don't because the oil

based ink creeps before it dries and all the sharp edges disappear and closely drawn tracks merge into a large fussy blob.

The pen needs an adapter/ink supply unit to fit the plotter to be used. At just under £30 for the plotter point you can see that they are not a disposable item so you must also get hold of a cleaning kit and Rotring come to the rescue with their Pen Cleaning Unit which includes 10 sachets of special chemical to dissolve the remaining ink out of the pen once it has been washed quickly under the cold tap to remove the unused ink.

As I said it is not cheap but the system I use works well for me and gives the advantage that high quality drawings can be produced on paper as well.

**David Silvester,
Southampton.**

Some helpful tips from David. It seems to me that what is required is a clear plastic sheet with a matt surface and a roughness of paper. Only then will ink pens take to it easily. — Ed.

Video Niceties

We have received many replies to the video 'life' problem. From the letter, it became obvious that I do not have a home video and therefore had no cause to ask the same question. Here are a couple of replies.

With reference to the letter from M. P. Scotford in the Read/Write column of the October 1991 issue.

The answer to his video problem is quite simple (when you know), if the record prevention

tab is removed from the back of the tape (as with most pre-recorded tapes) the recorder will automatically play it as soon as it's inserted, whilst if the tab is in place the recorder will wait for you to press Play or Record or whatever. Some manufacturers make quite an issue of this in the manual calling it an Automatic Playback System or something!

If only all lives little problems could be solved that easily!

**Paul Stenning,
Hereford.**

With regard to Mr Scotford's letter concerning cash machines and video tape, I think I can throw some light on the latter. Video machines these days are very intelligent beasts. Whilst loading the tape against the heads, they have a quick look at what is recorded. Then they do a quick scan round the house and start to play the porno tapes just as ones wife/girlfriend/mother/lodger is about to walk into the room. This is all designed to cause maximum embarrassment to one-

self and the videos then sit there with a smug grin on their faces.

Seriously though, it is all to do with having the 'no record' tab broken off. If the video machine thinks the tape is a pre-recorded one, it tries to save you the bother of finding the remote control because it knows that you are probably the worse for drink anyway.

**Steve Marland,
Wigan.**

Millions of quality components
at lowest ever prices.

Plus Tools, Watches, Fancy Goods, Toys.
Mail order only. UK only.

All inclusive prices
NO post, or VAT etc to add on.

Write or phone for catalogue/clearance list.
At least 2,100 offers to amaze you.

Brian J Reed Electrical
6 Queensmead Avenue, East Ewell
Epsom, Surrey KT17 3EQ
Tel: 081-393 9055

MEGAPROM Program 2764/128/256/512/010/020 (1 Meg/2 Meg 28/32 pin) Hmos, Cmos, Nmos type Eproms. Attractively cased and supplied with power unit. Powerful operating software includes full screen Editor, extensive file handling (intel Hex, Binary, ASCII Hex), Byte/block or complete rom program/verification/editing. Fast algorithm 1K x 8 bit per 1.9 sec. Runs on IBM or compats via RS232 port (works on laptops) **£128.95**
MODEL 1 Supports Eprom types (2716-27512). Still available **£99.95**

PROG8751 Programs Microprocessor types 8751, 8752 NMOS, HMOS, CMOS. Same software specification as MEGAPROM with Encryption array and Lock bits programmable. Attractively cased with power supply. Runs on IBM PC and Compats via RS232 port **£99.95**

SIM8751 Simulates Microprocessors 8051/52 on IBM PC. Full control registers and memory. Label generated disassembly, program trace, go with break many more features. Supplied on 5.25 or 3.5 Disc **£99.95**



AUTO TRACKS V6 PCB Designer Produce professional printed circuit boards quickly and easily on your IBM PC/XT/AT or Amstrad 1640. Single/Double sided. Auto Routing, rats nest or point to point entry. Too many features to list here. SAE for further details **£59.95**

MICRO ENGINE Development board for MCS8031/51. Contains PLCC 8031, 24 pin Eprom socket, 6 meg Xtal, address latch IC and 18 pin IDC header output Ports 1 & 3. Ideal for stand alone control applications. Size 7cm x 4.5cm approx. Full screen Editor assembler for IBM PC/XT/AT (downloads code to printer port or disk) **£39.95**

EPROM/ROM EMULATOR Works on ANY computer with Centronics printer port. Emulates all ROMs from 1K (2758) to 32K (27258) over 50 types supported. Any file sent to printer port appears as ROM on target machine. Fast download. Ideal for MICRO ENGINE development **£59.95**

D.V.M. Module Brand new full spec 3 1/2 Digit Voltmeter Module. Large. 56 LED Display, FSR +/-200mv. Size 9cm x 5.5cm **£12.95**

ALL PRICES INCLUSIVE. SAE for further details
JOHN MORRISON (MICROS) Dept ETI.
4 REIN GARDENS, TINGLEY, WEST YORKSHIRE,
WF3 1JR. Telephone: 0532 537 507



MISSING ISSUES?

Then The Electronics Today International Back Issue Service May Be Able To Help

Back numbers of Electronics Today International cost cover price plus 60p postage and packing from Electronics Today International Back Numbers, Select Subscriptions, 5 River Park Estate, Berkhamsted, Herts HP4 1HL. Cheques should be made payable to Argus Specialist Publications.

Back issues are available for the previous twelve months only. As some issues are in very short supply, you should check availability on 0442 876661 so as to avoid disappointment.

ORDER YOUR COPY NOW - WHILE STOCKS LAST!



PHOTO-COPIES

Please supply photocopies of the following articles from ETI (complete in block capitals):

Month Year Page (if known)

Title

Month Year Page (if known)

Title

Month Year Page (if known)

Title

I enclose a cheque/postal order made out to ASP Ltd. to the value of £1.50 per photocopy ordered.

Total remittance £ Date

Name

Address

..... Postcode

Send the completed form and your remittance to:

ETI Photocopy Service
Argus House
Boundary Way
Hemel Hempstead
Herts HP2 7ST



ETI has been published for over 19 years and in this time a great many interesting and valuable projects and features have graced its pages. Although backnumbers are available for only the past 12 months issues we can supply photocopies of any individual article ever published in ETI.

Photocopies cost £1.50 per article regardless of their length. Please note that projects published over several issues must be ordered as a series of individual articles, each for £1.50.

PCB foil patterns (where published) and any errata are included with all photocopies as applicable.



PCB SERVICE

December

TELEPHONE
ORDERS
may be made on
(0442)
66551
ACCESS or VISA

- E9112-1 Nightfighter Sensor Switch Master Control (double sided) L
- E9112-2 Nightfighter Sensor Switch Channel Control (double sided) .. L
- E9112-3 Nightfighter Sensor Switch Sound Trigger H
- E9112-4 Nightfighter Connector Board F
- E9112-5 Nightfighter Sensor Switch PSU K
- E9112-6 Nightfighter 8-Channel Input Interface (double sided) P
- E9112-7 Power On and Overload Regulator P

PCBs for the remaining projects are available from the companies listed in Buylines.

Use the form or a photocopy for your order. Please fill out all parts of the form. Make sure you use the board reference numbers. This not only identifies the board but also tells you when the project was published. The first two numbers are the year, the next two are the month.

Terms are strictly payment with order. We cannot accept official orders but we can supply a proforma invoice if required. Such orders will not be processed until payment is received.

Price code	Price (inc. VAT)
C	£1.80
D	£2.50
E	£3.25
F	£4.00
G	£4.75
H	£5.50
J	£6.62
K	£7.20
L	£8.80
M	£10.60
N	£13.10
O	£15.80
P	£17.90
Q	£21.80
R	£23.90
S	£25.90
T	£29.00
U	£32.20
V	£35.80
W	£37.90
X	£40.70

- E9011-5 Four-track cassette recorder (Bias/erase oscillator board) K
- E9012-1 Infra Switch F
- E911-1 Remote Control - Main Board J
- E9101-2 Remote Control - Display Board H
- E9101-3 Remote Control Timeswitch - Transmit board E
- E9101-4 SBC Micro-Controller Board F
- E9101-5 SBC Practice Interface Board F
- E9101-6 5 in 1 Remote Sensing Switch E
- E9102-1 Remote Control Timeswitch - receiver board F
- E9102-2 Anti Theft Alarm (2 bds) H
- E9103-1 Ariennes Lights L
- E9103-2 64K EPROM Emulator N
- E9103-3 SSB Radio Receiver G
- E9103-4 Active Loudspeaker board H
- E9104-1 Testmeter Volts E
- E9104-2 Active Direct Injection Box F
- E9104-3 EPROM Eraser F
- E9104-4 Digital Tachometer F
- E9104-5 Radio Calibrator F
- E9105-1 Modulator Laser (2 boards) H
- E9105-2 Thyristor Tester F
- E9105-3 Frequency Plotter K
- E9106-1 Laser Receiver F
- E9106-2 Temperature Controller - Power Supply G
- E9107-1 Temperature Controller - Main Board K
- E9107-2 Temperature Controller - Probe PCB F
- E9107-3 The Foot Tapper - Volume Control (double sided) J
- E9107-4 The Consort Loudspeaker H
- E9108-1 Pulsed Width Train Controller E
- E9108-2 Model Speed Controller - Main Board F
- E9108-3 Model Speed Controller - Power Supply F
- E9109-1 Geiger Counter E
- E9109-2 Hemisync Waveform Generator Board G
- E9109-3 Hemisync Pulse Generator Board F
- E9109-4 Hemisync Power Supply Board C
- E9109-5 Nightfighter Main Processor Board O
- E9110-1 Freeze Alarm E
- E9110-2 Document Saver E
- E9110-3 Proto-type Designer J
- E9110-4 Nightfighter - Sound to Light (double sided) L
- E9110-5 Nightfighter - Ramp Generator Board F
- E9110-6 Nightfighter - Cyclic Crossfade (double sided) M
- E9110-7 Nightfighter - Strobe Board (double sided) J
- E9110-8 Nightfighter - 8 Channel Triac Board N
- E9111-1 Digital Code Lock L
- E9111-2 Switched Mode Power Supply E
- E9111-3 Nightfighter Mode Selection (double sided) J
- E9111-4 Nightfighter - Display Board (double sided) M
- E9111-5 Nightfighter - Bass Beat Trigger (double sided) L
- E9111-6 Nightfighter - Sequence Select (double sided) H
- E9111-7 Nightfighter - Master Controller PSU K
- E9111-8 Nightfighter - Output Switch (double sided) M

**TO: ETI PCB SERVICE, READERS' SERVICES,
ARGUS HOUSE, BOUNDARY WAY,
HEMEL HEMPSTEAD HP2 7ST**

Please supply:

Quantity	Ref. no.	Price Code	Price	Total Price

Post and packing £0.75

Total enclosed £

Please send my PCBs to: (BLOCK CAPITALS PLEASE)

Name

Address

..... **Postcode**

CHEQUES SHOULD BE MADE PAYABLE TO ASP Ltd.



Partly cleaned
copper-clad board

more frequently. I say replaced because nobody in their right minds would try to sharpen a 1mm diameter drill.

Now before you do anything else to any copper clad board, check the condition of the copper surface. If boards have been lying around for years they will have oxide on the surface and will therefore need cleaning. A clean and grease free surface is important to the processes which come later.

Highly recommended for ease of cleaning is the little block cleaners that look like an eraser. They contain abrasives in a silicon rubber base. Otherwise household abrasive powders, a cloth and water will do the job making sure not to get your finger prints on it. So even though your free PCB may look clean, it has to be shining bright.

Photosensitivity

To get any form of professional reproduction on the surface of the copper, it has to be firstly coated with a

Making PCBs at

A beginners guide to home produced PCBs by Geoff Martin.

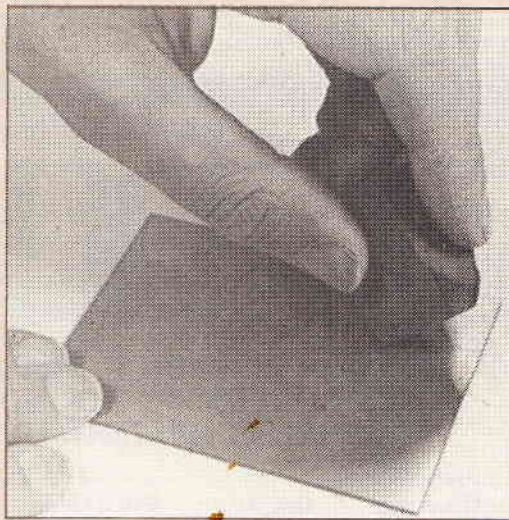

Cleaning board with block eraser

In response to demand, we present some information on making a printed circuit board at home. There are a variety of ways of achieving a 'one-off' or indeed a few PCBs for home use and this article sets about giving a few tips.

Board types

Copper-clad board is available in several varieties. The board presented free with this issue of ETI is of the SRBP type. It is a reinforced bonded paper with a thin copper sheet and should be strong enough for many purposes. It can be cut, filed and drilled very easily. The other common type of board is the fibre-glass one. Although more expensive it is more durable than the SRBP version. Double-sided copper clad boards are usually made from epoxy glass or fibre glass as it is usually known. The only small disadvantage to using fibre glass boards is that drill bits have to be replaced

photo-sensitive chemical. An important aspect here is that the coating should be even over the surface. That is why the photo-resist chemical is usually sold in an aerosol form for home use. Greater users of the chemical will buy the liquid in bulk containers and then spray on using some other form of airtreated spray. Aerosol cans of positive photo-resist are available from many component suppliers and if used regularly and moderately they will give good value for money.

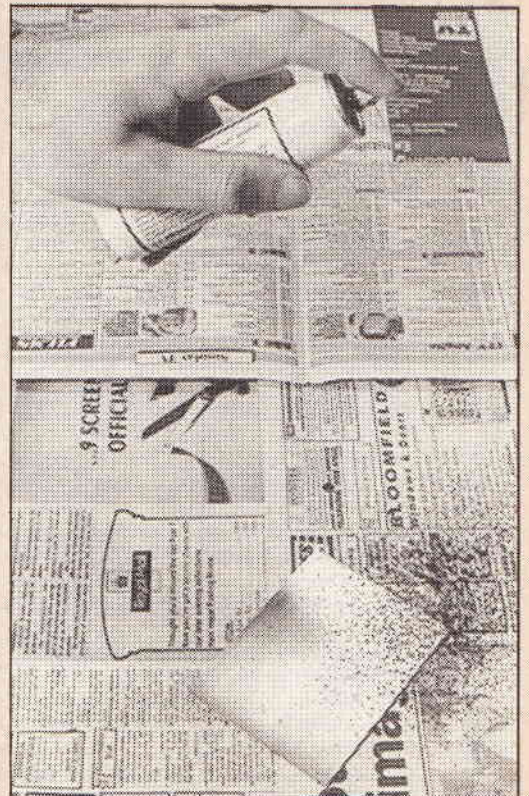

Spraying in a darkened room with an aerosol will give an even coating

PCBs

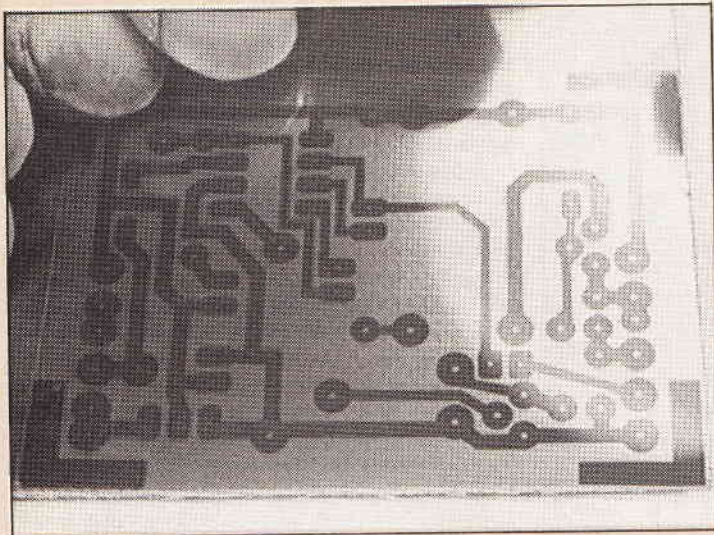

Placing foil on prepared board

expensive and less fun.

The next stage is to mask the surface with our foil. Details on the various ways to make foils will appear next month. Most foils either clear acetate sheet or photographic film will not adhere to the photosensitive surface and on these it is wise to have corner markers on the foil to align with the copper-clad board. Our free sticker foil given away with ETI next month will not suffer from any misalignment owing to adhesion. More about this next month.

IT IS ESSENTIAL THE COR-

Home

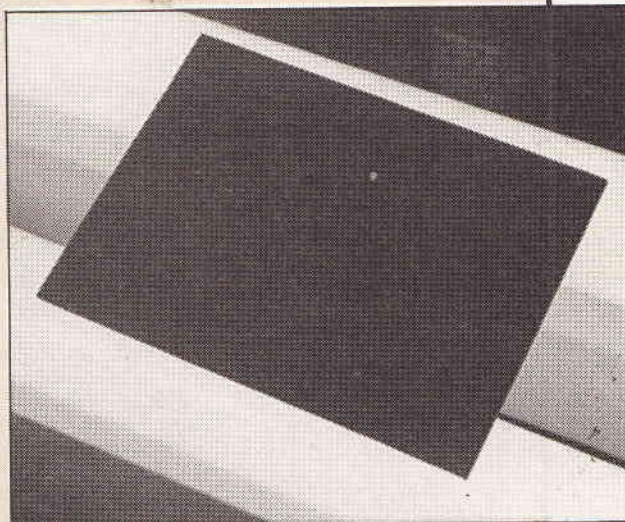

Exposing the board face down

RECT SIDE OF THE FOIL IS PLACED ON THE BOARD. . Not paying attention at this stage and proceeding to the etched board with the wrong side will result in a useless board and a few heated quotes about yourself like "You incompetant imbecile" or words to that effect. We only have to do it once!

As we have to expose it to some sort of light source it is well to consider the various ways at this stage. The most obvious is natural sunlight. It is bright



A UV exposure unit

To spray our clean board requires a darkened area with just enough light to see what you are spraying. It would also be wise to spray in a clean workshop area. Paper towels or old newspaper must be placed down first before spraying and it is advised that it is carried out in a ventilated but not draughty area as the smell is quite considerable.

The amount and the distance you spray comes with experience and very often overspraying is common. This results in excessive developing solution being used to remove exposed areas. As a rough guide spray at a distance of about 9 inches sweeping backwards and forwards until an even coating can be seen.

Drying time depends upon temperature and if the room happens to be in the high twenties Celcius it might take only 15-20mins to go tacky but a few hours to dry. If you have a small oven to hand the drying time is a matter of minutes. When handling the board make sure not to touch the surface. Using a pre-sensitised board instead of spraying is an easy option but is more

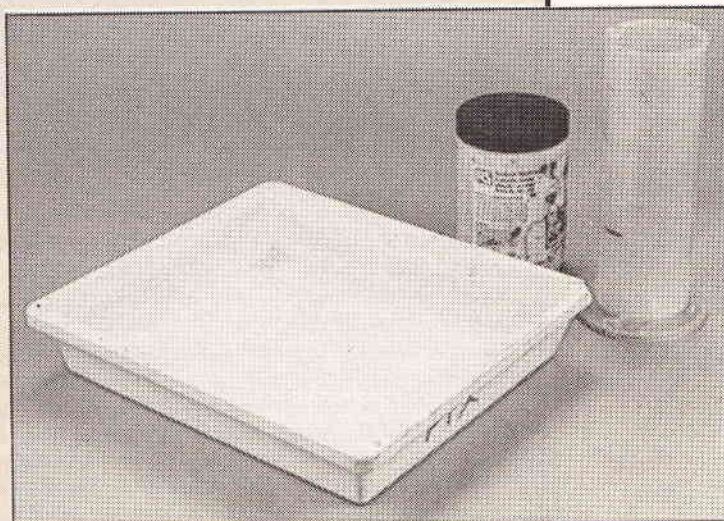

Materials for development

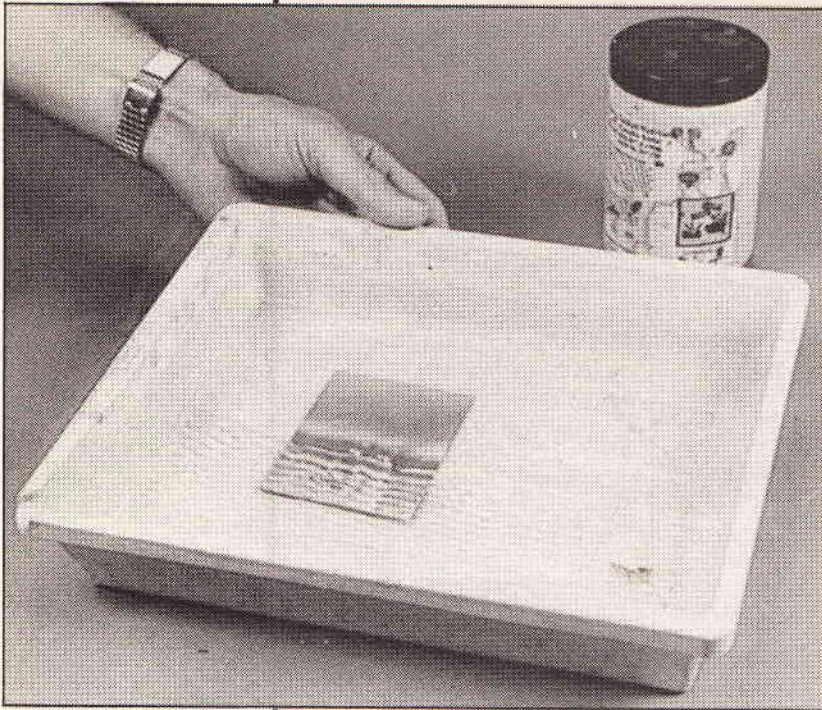

Developing the board

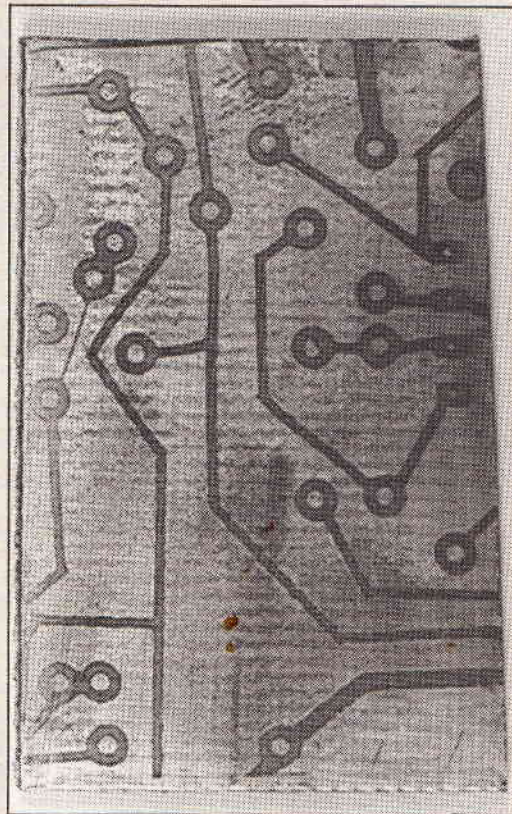

A developed but un-etched board

and when shining is uniform over the surface of the board. The disadvantage is the variable brightness owing to cloud and this gives an unknown exposure time. So the next thing to do is to turn to predictable artificial light. Using a single household light bulb suffers from the effect of giving uneven illumination over the board and hence uneven development. The next best thing is a reflector lamp like the sort in used in downlighters or at discos. Again the problem here is that they can only be used for small area boards. We need some way to spread the light. An ideal solution is to use a plastic Fresnel lens and place the lamp at the

focal point. This gives a flat surface to place the board on and provide an even illumination. Those who have access to an overhead projector can expose the board and film on the top where one normally puts the display. Exposure time will have to be experimented with but 5-10 mins may prove sufficient.

The standard but more expensive home method of exposure is the use of the UV timer box. This consists of an electronic timer and a couple of mini fluorescent UV tubes. The use of UV will speed up exposure time. The logic of this is in the Physics. UV wavelengths have a higher energy per photon to provide the chemical changes on the surface. The emitted radiation has to be contained in a box to protect your eyes.

Now we have exposed our board it needs to be developed. That means we have to remove the areas of photosensitive coating that has 'seen the light' so to speak. The liquid to do the job is a solution of Sodium Hydroxide or caustic soda. For convenience this chemical comes in pellet form and when transported through the postal system or by any other means has to be sealed from water. Moist Sodium Hydroxide can



Etching materials

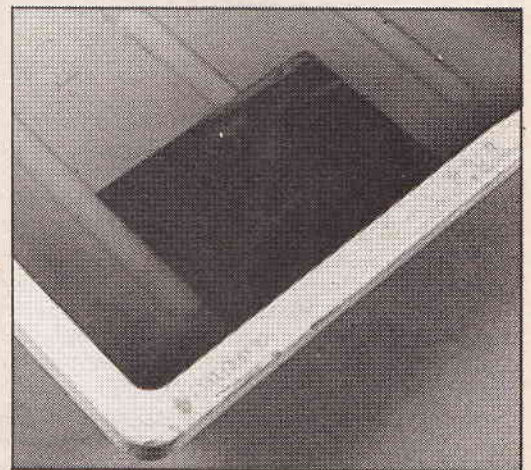

Etching board in orange solution of Ferric Chloride

be just as dangerous as acid spills, so it has to be handled with care. The concentration for the development of our board is a dilute solution (in the order of 7 grammes of pellets to 1 litre of water). You soon know

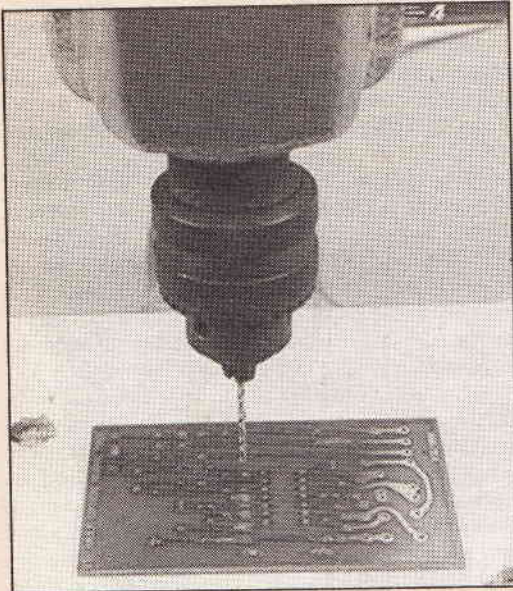

Drilling the holes with drill in stand



Using a 12V hand-drill

Etching Process

Various copper dissolving chemicals can be used but the most popular is Ferric Chloride crystals which turn the copper into copper ions in solution with a green colour of Copper Chloride. The main problem is one of etching time. But if we remember our chemistry from school, we can make good use of a rule of thumb that the rate of reaction doubles for every 10° rise in temperature. So hot Ferric Chloride solution will do the job much better. Find an old Pyrex glass beaker to heat it up in, not a metal container. It is well to leave the board in the hot etchant in a plastic tray for a few minutes to get the reaction going. Then it requires some form of agitation. This can be achieved by rocking the tray to and fro. A quicker method is to quickly pour the etching solution back into the glass beaker so the solution can be poured over the board tilting the tray and board at an angle of about 30-40 degrees. Hot etching solution moving at great speed over the surface will have the greatest impact.

If you want to spend money on etching tanks they are available. These will heat up the liquid and will also agitate the board or the solution. Some would even adopt ultra-sonic agitation.

Cleaning Up

When the last dregs of copper have been eaten away, it is time to remove and clean it up. Firstly wash away any traces of Ferric Chloride solution under a shallow tray of water. It is worth stating here that it is unwise to pour Ferric Chloride solution down the drains.

There are three ways to remove the photo-resist material on the copper trackwork. Firstly by an abrasive powder and pad or by using a stronger caustic soda solution than previously used for development or an organic solvent like Acetone.

The PCB should now be drilled ideally using a 12V modelling drill or a drill in a stand that can take a pin chuck. The hole sizes will vary according to the component lead diameter but a 0.8-1.0mm will be sufficient for most holes.

Finally an optional extra but sometimes worthwhile if the board is going to sit on the shelf, is the use of an aerosol lacquer. It protects the trackwork from oxidation and will take solder in the normal way.

Next month we look at making a foil pattern.

if it is too concentrated when you see all the photosensitive layer disappear from the copper. Developing the boards will require a tray, the best being one of the normal plastic photographic trays.

Assuming you have removed the foil and all is well, the board should be placed in the tray and rocked gently within the solution. Gradually you will see the outline of the trackwork appear. This is the most fascinating part of the process and has similar parallels to seeing a normal photographic picture appear in solution. This action has to take place in a room with a low level of light. If you happen to be a photographer the best place to be is in the darkroom illuminated by a safelight. Wait until the copper is visible on the exposed areas before removing. Wash under a tray of clean water and pad it dry with a paper towel.



Protecting the circuitry with a lacquer

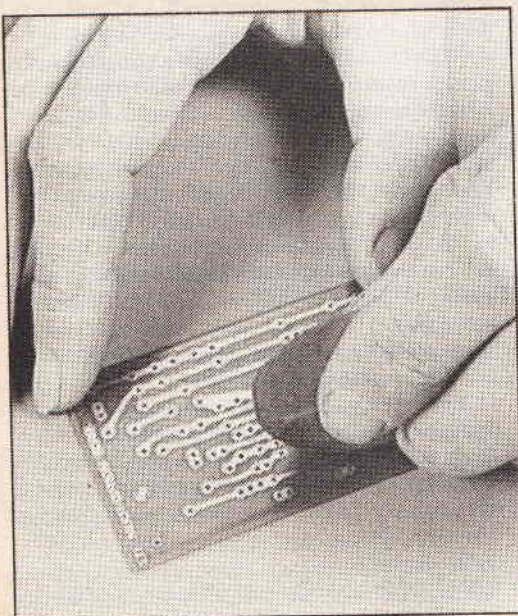

One way of cleaning the trackwork with abrasive



The Nightfighter

In this fourth part, Mike Meechan constructs a sensor switch to zone the light displays.

The final part of the series covers the Sensor Switch peripheral unit. Part 1, 2 and 3 showed the design and construction of the Master Controller and Dimming/Switch Packs respectively — this final featured unit interfaces between the two, allowing the operator to select, via a touch sensitive 'keyboard', which zones of lights are on at any one time. Some explanation of the terminology might be of interest to those readers not actively involved in nightclub lighting.

Almost all nightclubs — and some of the more upmarket mobile discos — will have more than one type of lighting effect fitted eg strobes, pinspots, neon, stage lights (Parcans), UV lamps, kinetic effects such as scanners (a sweeping searchlight effect) and perhaps even a laser. If all of the effects and lights were switched on all of the time, for one thing the venue would be flooded with hundreds of thousands of candelas of light and for another, the lightshow would have no dynamics or excitement whatsoever.

Instead, each effect is switched, sometimes using ordinary multi-gang lightswitches. We start to run into problems when we want to switch on or off something of more than two gangs eg a bank of four channel lighting. We can of course switch the Neutral line but that means the switch contacts handle the combined currents of all four channels (this switching of the Neutral can be used for special effects, some of which we'll discuss later) or alternatively we can allocate a separate controller for each bank/zone — of different lights. This, too, has its merits, but is obviously expensive and different zones will never be synchronised to each other. Better to have one Master and a number of slaves under central control, as in the Nightfighter system.

If the central control is now in the form of a touch sensitive keyboard, we can enable whole zones of lights very easily and in time with the music — playing the lights rather like a musical instrument.

We now have the design criteria for a touch switch. It should have the following features:

- Latch on/Latch off and Flash facility.
- Memory function allowing preselection of channels for next selection whilst present selection is still running.
- Inbuilt chaser with CHANNEL IN CHASE/OUT CHASE facility.

- Optional sound activation of chaser.
- Easily expandable up to 8 channels.
- Option of zero-switched mains outputs.

The basis of most touch switch designs is deceptively simple. The touch switch relies for its operation on the fact that it has a very high input impedance, this also being true of the CMOS gate input.

This high impedance (typically in excess of 100M), low capacitance combination means that only a very low charge is required to influence the voltage at the input. The human body itself acts as a reasonable aerial for the 50Hz hum fields radiated by the electrical mains distribution system, so that the contact between body(hand) and high impedance input can form the basis for the trigger for a switch.

HOW IT WORKS

CHANNEL BOARD

TP1 and TP2 are the LATCH ON and LATCH OFF touch panels respectively. R1 and R2 limit input current to IC1d, IC1e Schmitt inverter gates which have their inputs held at a voltage determined by the SENSITIVITY pot and R3 and R4. Touching either touch pad causes the associated inverter to output a 50Hz square wave which then clocks the relevant discrete retriggerable monostables formed from IC2b, IC3b and associated components, the Q outputs of these remaining high until the 50Hz input signal is removed, since C8 or C9 is discharged every time the Schmitt inverter output goes low, thus preventing the one-shot from resetting. Once this clock signal is removed, C8 can charge via R7 and the monostable resets. This signal is used to control bistables IC2a and IC3a depending on whether MEMORY, LATCH/FLASH or CHASE mode is selected. In LATCH/FLASH mode, TP1 sets and TP2 clears the bistable IC, this touchpad also forcing the output high for the duration of the touch. In this mode, the LED is made, (via gates of IC6, IC7c, IC4c and IC1a), to show green for channel ON and off for channel OFF.

In MEMORY mode, IC3a is implemented as a D-type latch with the data input controlled by the Q output of IC2a which is routed through IC4c. TP1 and TP2 set or clear the latch respectively. The MEMORY button on the Master Control Board is used to clock the data through the latch to the output. The LED in this mode is made to convey one of four states:

GREEN — channel ON.

FLASHING GREEN — channel presently OFF but will switch ON at next selection.

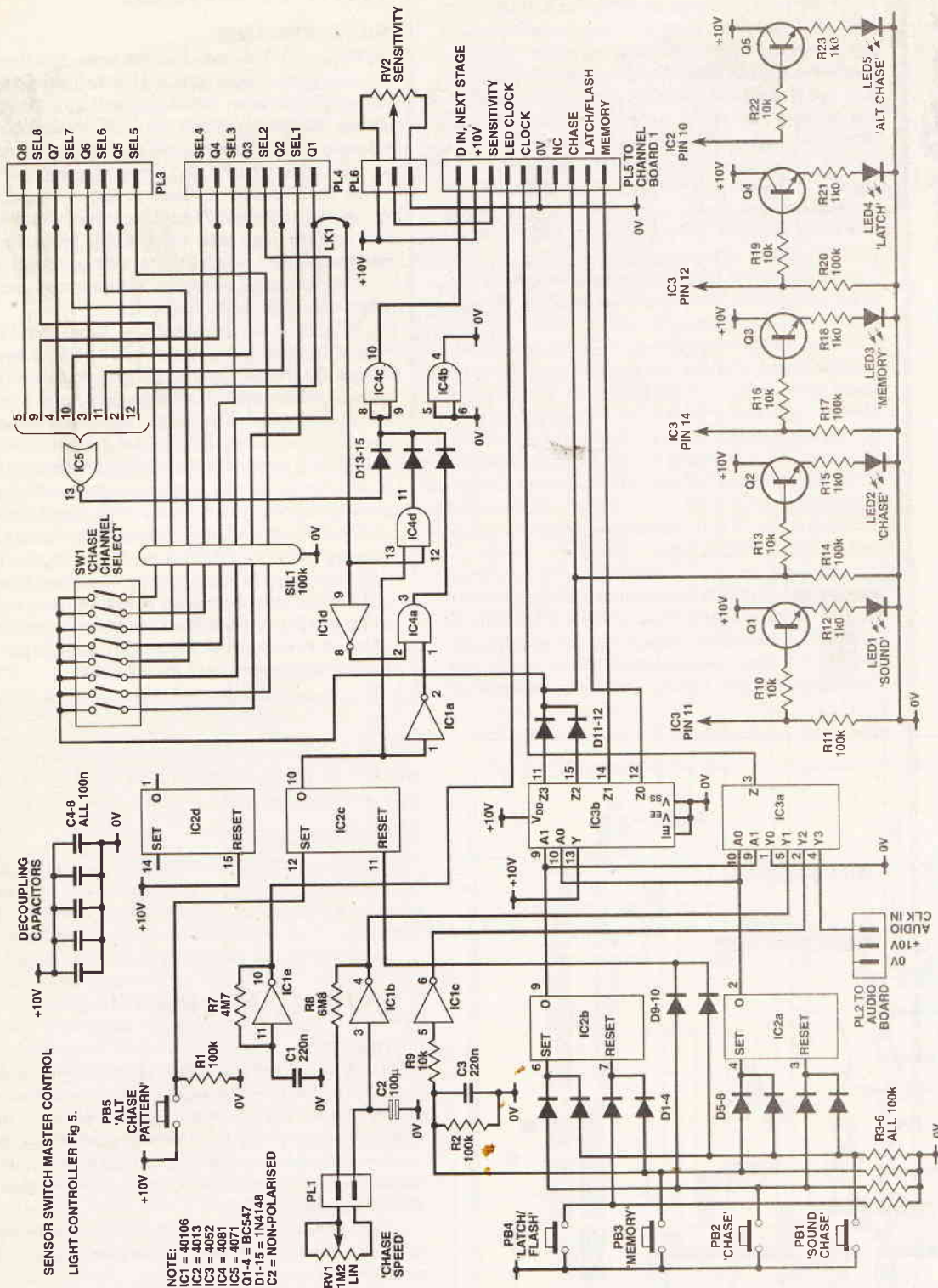

Fig.1 Sensor switch master control circuit

FLASHING RED — channel presently ON but will switch OFF at next selection.

LED OFF — channel presently OFF, no new selection.

The last mode, CHASE, cascades all of the latches on each channel board to form either a Johnson code or ring counter, depending on whether the Q or \bar{Q} output of the last stage is used as the code regenerating element.

The Q output of channel 1 bistable is used as the D input for channel 2, Q output of channel 2 used as the D input of channel 3 and so on and so forth. The CHASE CHANNEL SELECT switch, SW1 on the Master board, determines whether or not that particular channel is to be incorporated

into the chase sequence. If it is set to OFF, that channel operates as in LATCH/FLASH mode. If it is set to OFF, that channel operates as in LATCH/FLASH mode. If it is set to OFF, that channel operates as in LATCH/FLASH mode. If it is set to OFF, that channel operates as in LATCH/FLASH mode. If it is set to OFF, that channel operates as in LATCH/FLASH mode.

The LED shows GREEN — channel ON, RED — channel presently OFF but selected for CHASE routine and OFF, channel OFF and under manual LATCH/FLASH control.

Other gates on the board merely control the routing of the bistable input and output signals for the purposes of switching latch data, clock signals or the LED oscillator signal to the appropriate LED or gate input at the right time.

Some of the more sophisticated (and expensive) touch panels rely on change of capacitance at the input rather than change of voltage as in this design.

These types are inherently less prone to some of the problems associated with so-called inductive switching, such as spurious operation and liability to damage by static etc., and the capacitive design allows the switch to be sealed behind a waterproof membrane, thus protecting the delicate electronics from the ingress of beer, coffee etc. Unfortunately, the electronic implementation of this version calls for a reasonably complex circuit, too complex in fact to repeat four times on each channel board in addition to the other circuitry.

However, the simplicity and low cost of the featured design more than compensates for any compromises or shortcomings in its performance.

The design is implemented using one Master Control Board, one optional Sound Trigger Board (a pared down version of the Bass Beat Trigger in the Master Controller) and up to 8 Channel boards. Control signals from the Master Board are daisy-chained along to all of the channel boards. Outputs from each Channel board are fed back to the Master Control board and to a Connector board which then parallels connections to all low voltage rear panel connectors and a Triac Switching board if fitted.

The unit can be configured in one of three ways; as a low voltage control panel deriving its power from another unit (usually a Dimmer Pack fitted with an 18VA PSU), as a low voltage controller with integral 6VA PSU or as a controller with both low voltage and zero-switched mains outputs. The unit constructed will

HOW IT WORKS

MASTER CONTROL BOARD

The Master board selects mode of operation for the channel boards. PB1-4 each generate a unique two bit code from the Q outputs of IC2a, IC2b quad Set-Reset latches. The code addresses IC3a and IC3b, a dual analogue multiplexer/demultiplexer. IC3a is used as a multiplexer to select which of the three differently generated clock signals is routed to the CLOCK output pin on PL5. Clock signals can originate from the internal CHASE oscillator comprised of IC1b and associated components, from the MEMORY pushbutton (debounced by IC1c) or from the Sound Trigger board if fitted. IC3b is configured as a demultiplexer to switch one of four LED's on at the appropriate time.

IC1e is configured as a low frequency CMOS oscillator and is used to pulse the channel LED's when in standby mode.

The function of SW1 was explained in the Channel section. The Q output of each channel board is inputted via PL3 and PL4 to an 8-input NOR gate, IC5. LK1 is linked to whichever Q output has come from the last channel board fitted and will normally be connected to Position 1 when a full complement of channel boards is fitted. IC5 output is only high when all of its inputs are low ie when CHASE is first selected and so pre-loads the D input of the first channel selected for Chase as the first step of the sequence. This logic high is rippled through each of the selected stages until the last stage where upon it is fed back to the first stage D input via IC4a, D14 and IC4c. When ALT. CHASE is selected via PB5, IC2c is set, IC4a enabled and IC4d disabled so that the Q output of the last stage, inverted by IC1d, is now used as the D input of stage one. We now have a Johnson code or 'fill and empty' chase pattern. We can utilise this to create different chase patterns in the NORMAL chase mode as the ring counter will circulate however many logic ones there are present at the point in the ALT. CHASE where we change to NORMAL CHASE.

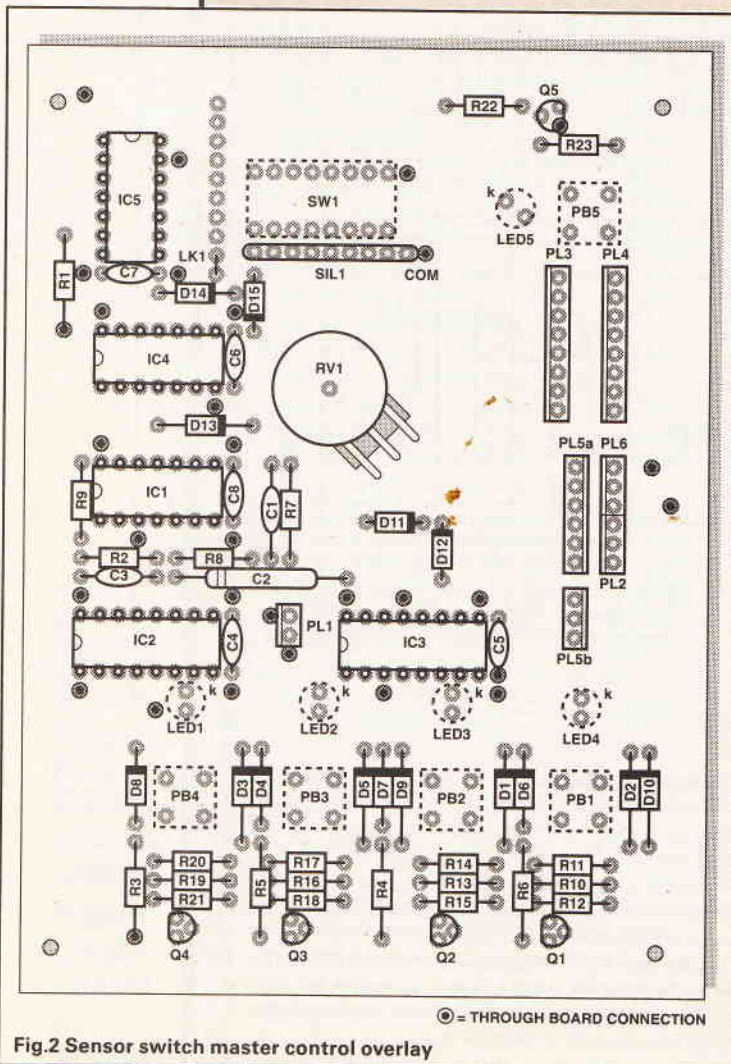

Fig.2 Sensor switch master control overlay

depend totally on individual requirements — the author's own unit features four channels of mains outputs and four of control.

Construction

The construction of this unit is probably the most difficult of all three featured as it required many interconnections, some involved metal-bashing and the careful crammung of many PCB's into a rigidly defined space.

If reasonable metalworking facilities are available to the reader then the casing is probably best home-constructed since most readily purchased enclosures of this ilk are rather large in depth dimensions, being anything up to 15" deep and more intended, one would think, for housing amplifiers, heavy duty PSU's and the Nightfighter controller. (However, since the prototype was first constructed, it has come to the attention of the author that one manufacturer of this type of enclosure now features cabinets of the size required — details are given in the Buylines section of this part of the series).

If it is intended that the Sensor Switch unit be vertically rack-mounted, cases of these sizes will provide no problems.

However it is envisaged that this unit be mounted horizontally or inclined at some angle, keyboard-style, where rear overhangs of these sorts of sizes may prove problematical.

If no facilities are available, most sheetmetal workshops will put the four or five bends required into a piece of aluminium for the price of a round of beers! ALL of the cutouts shown on the drilling diagram should be made unless the unit is to be completely without mains switching facilities. The triac mains outputs are wired, via rear panel mounted fuseholders to 6A IEC shuttered mains outlets. Colour coded and suitably rated wire should be used to connect between these fuseholders and the triac board PC terminals, looping the cable bunch from one end of the casing to the other as before. Parallel connections of these out-

PROJECT

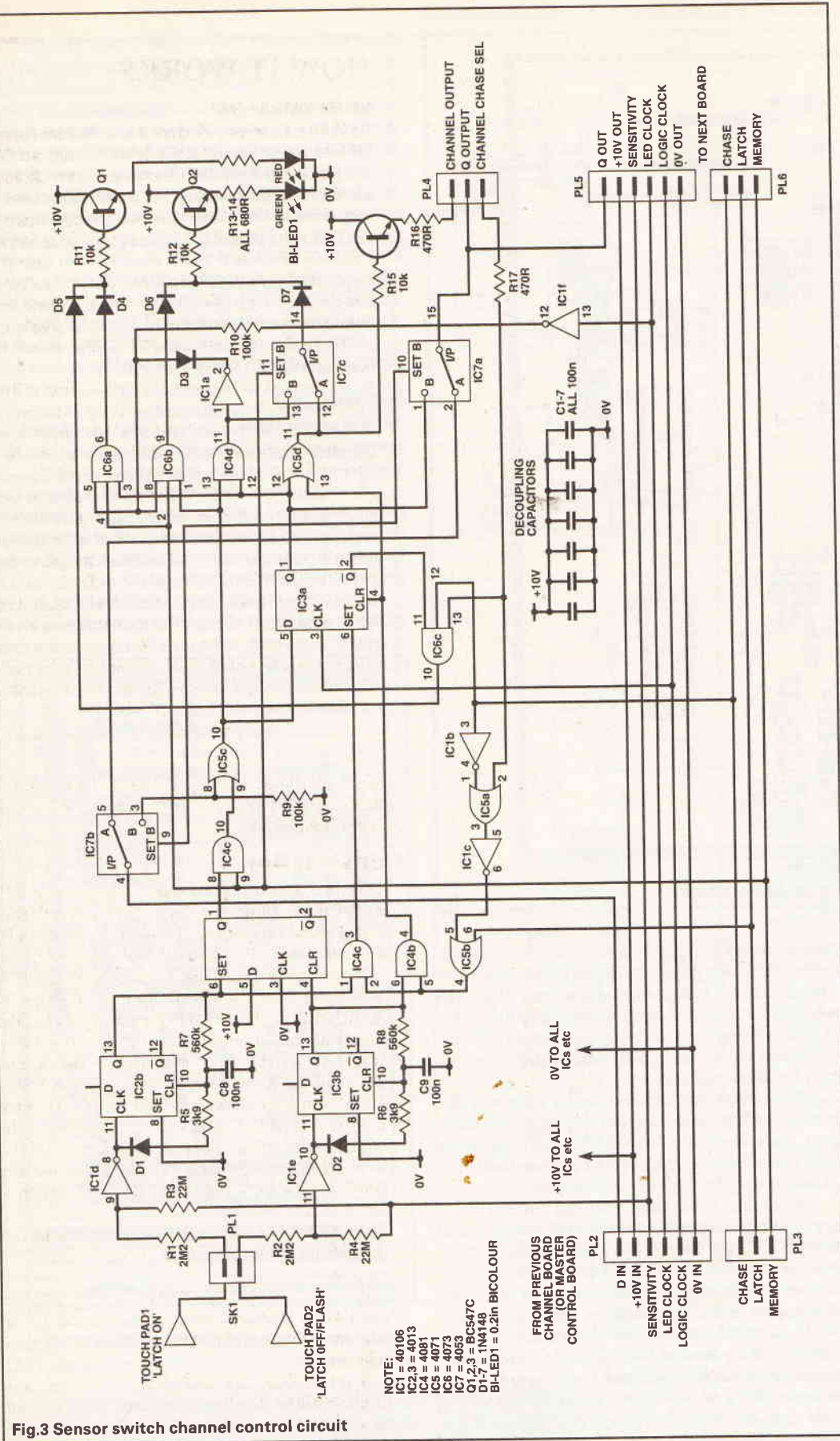

Fig.3 Sensor switch channel control circuit

puts are made to the Bulgin sockets, using the same pinouts as in Part 2. Each Neutral and Earth connection to these sockets should be wired individually to the Mains Input terminal block and neatly loomed and tie-wrapped, one earth connection being used to bond the chassis to Mains earth. All exposed mains connections should be sleeved and the fuseholders shrouded with

rubber boots.

Drilling and cutting of the front panel should be commenced at this stage. In the author's prototype, a large, rectangular cutout of size shown in the drilling details diagram was made. A piece of clear Perspex was then cut so that it was of exactly the right size to fit this cutout. A piece of sheet aluminium, very slightly

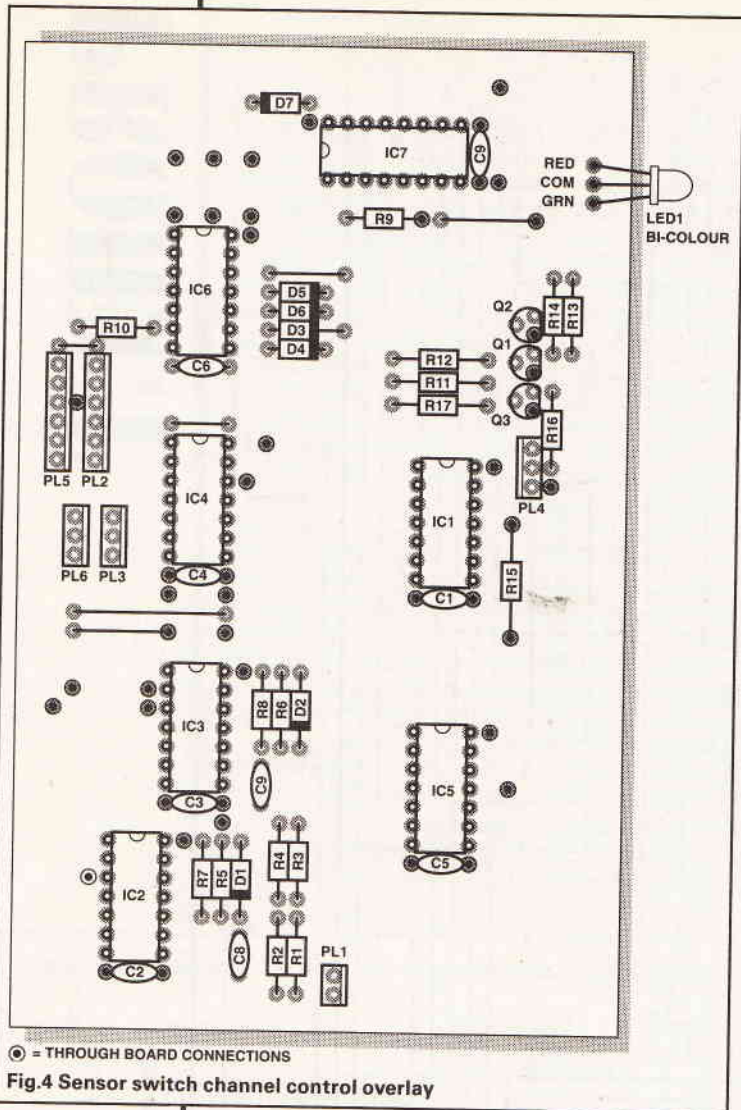

Fig.4 Sensor switch channel control overlay

larger all round than the Perspex was then cut. Holes for the touch pads were then drilled in both, the holes in the aluminium being of larger diameter. The touch pads are then mounted using insulating bushes, washers 6BA nuts and the whole assembly offered up to the front panel cutout and glued around the perimeter using Araldite or similar.

Connection between the touch pads and the channel board is made using Minicon plugs with short flying leads terminated with M3 solder tags. Each touch pad should be checked for complete insulation between it and the front panel metalwork.

All of the PCB's are mounted (in the time-honoured Nightfighter fashion) on $1/2" \times 1/8"$ aluminium bar fastened transversely inside the case. These strips are bolted on either side of the case to more aluminium strips running vertically inside the case. The photographs and diagrams show this more clearly. Should the unit be a powered version, the PSU and Switch board are mounted on a second set of centrally located transversely mounted bars, any cabling between front and rear panel being tucked neatly under or around the boards, depending on how many boards are fitted. Each Channel board is mounted at right angles to the front panel, being secured to the transverse mounting bars using 1cm wide strips of angle aluminium. Once again, a picture paints a thousand words and the diagrams show this far more eloquently.

Construction of the electronics is again very straight-forward, through-board pins, resistors and IC sockets being mounted first and the foil side compo-

nents (LED's, switches) mounted last. However, it should be noted that the very cramped layout of the channel board necessitated some slightly unorthodox design features, all decoupling capacitor legs being soldered on each side of the board and thus providing the ground connection for the adjacent IC concerned.

There is a requirement for eight, 3" long 6 way and 3 way plug to plug ribbon wire assemblies these providing connection between each of the channel boards and the Master, and also two rather unusual plug to plug assemblies which are shown in the diagram. Parallel connection between the rear panel CONTROL OUT D-type, triac board and each of the channel boards is made using a Connector PCB.

Finally, the optional Sound Trigger board is mounted piggy-back fashion on the Master board.

Setting up

The link on the Master board should be soldered into position such that it connects the Q output of the last channel to IC1 pin 9 (the other end of the link).

If the optional Bass Beat Board is fitted, the power supply and Audio Input connections are made via PL1. A short three way Minicon plug to plug connector is then used to provide power and the audio clock from PL2 to the Master board.

Should no Sound Trigger board be fitted, power supply connection is made directly from the PSU (or

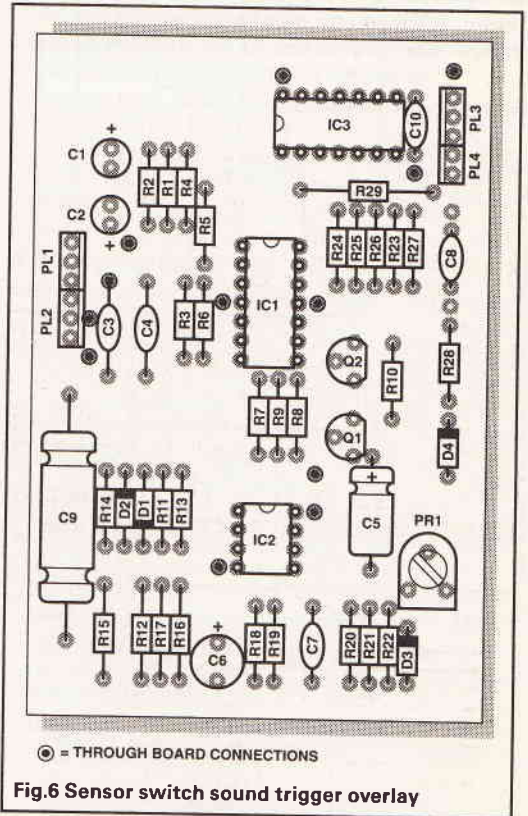

Fig.6 Sensor switch sound trigger overlay

the rear panel D-type if the unit is unpowered), no connection being made to the 10V terminal on the PSU board.

Mains input connections are made using a small piece of 30A terminal block which is mounted adjacent to the 20mm cable gland and behind the PSU.

Operation

Mains connection to the unit should be made using 13A cable or for powering from another unit, a 15 way D-type plug to socket lead should be constructed. It is left to the individual to devise some sort of splitter arrangement so that the channel outputs on pins 1 to 8 of the D-type are still readily accessible when using this

HOW IT WORKS

SOUND TRIGGER BOARD

This board is identical in all respects to the circuitry incorporated on the Master Controller Bass Beat Trigger for detection of the beat of the music. It differs only in that there is no oscillator section, no AGC wideband music section and that the Time Constant of the monostable section is much larger and is user variable via the front panel SPEED control.

approach. If ten core cable is used, the 0V connection should be made to the screen (braid) since this leaves the necessary two cores free for the plus and minus 10V connections. The unit which is being used as the remote power source will of course need to have the +10V and -10V connections made on the EXT. CONTROL OUT socket between pins 14 and 15 and the PSU plus and minus ten volt terminals.

The checking procedures for the triac and PSU boards follow exactly those given in parts 1 and 2 respectively.

Preset PR1 on the bass beat trigger board is adjusted for a voltage of 2.5V on pin 7 of IC2. Next, press each pushbutton in turn to ensure that its associated LED lights. Select LATCH/FLASH and verify that each of the touch pads on the upper row latches the relevant channel ON and that the lower touch pads turn the channel OFF or hold it ON for the duration of the touch. If there is no switching action or it is indeterminate, some adjustment of the SENSITIVITY pot may be necessary. The LED's on the triac board should be mimicking the front panel LED's.

Now clear all of the channels and select MEMORY. All of the LED's should be off. Run a finger along each of the upper LATCH ON pads and each LED should be flashing green. Pressing the MEMORY pushbutton again will cause the LED's to be a steady green and LED's on the triac board to be on. Pressing the MEMORY button again should have no discernible effect and all channels should remain on. Running a finger along the row of LATCH OFF touch pads will cause all of front panel LED's to flash red but the LED's on the triac board will remain unchanged.

Pressing the MEMORY button once more will switch all of the LED's, including the LED's on the triac board, off.

Ensure that all of the CHASE CHANNEL SELECT switches are in the ON position, turn the

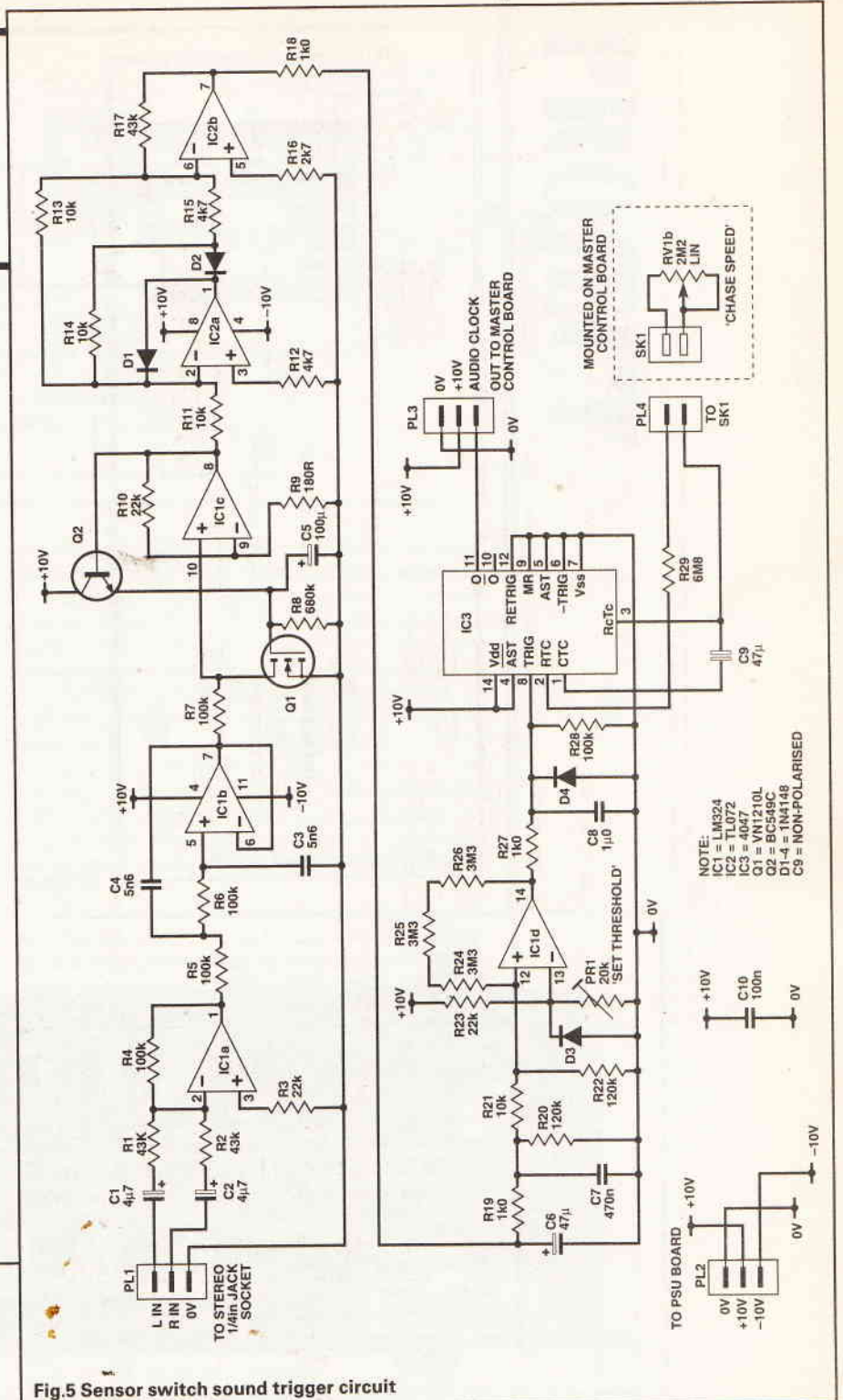

Fig. 5 Sensor switch sound trigger circuit

SPEED pot fully clockwise and press the CHASE button. All LED's will show red. After a short time, channel 1 LED should show green, then it should change to red whereupon channel 2 will show green and channel 1 again switches on. Now select ALT. CHASE and the chase routine will now be a fill and empty one, with channel 1, channel 2 etc all coming on sequentially until all channels are on. The channels will then sequentially switch off.

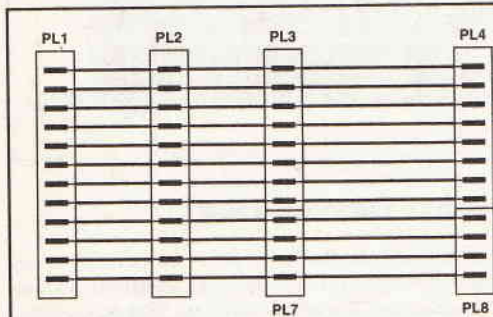
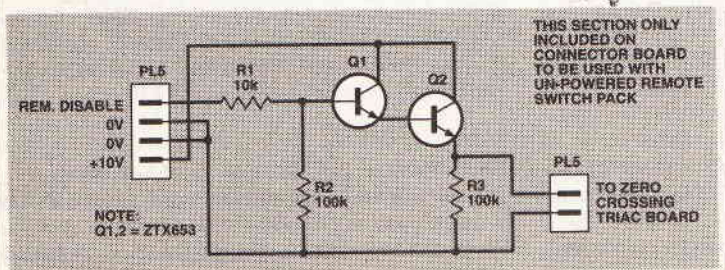

Fig. 7 Connector board circuit



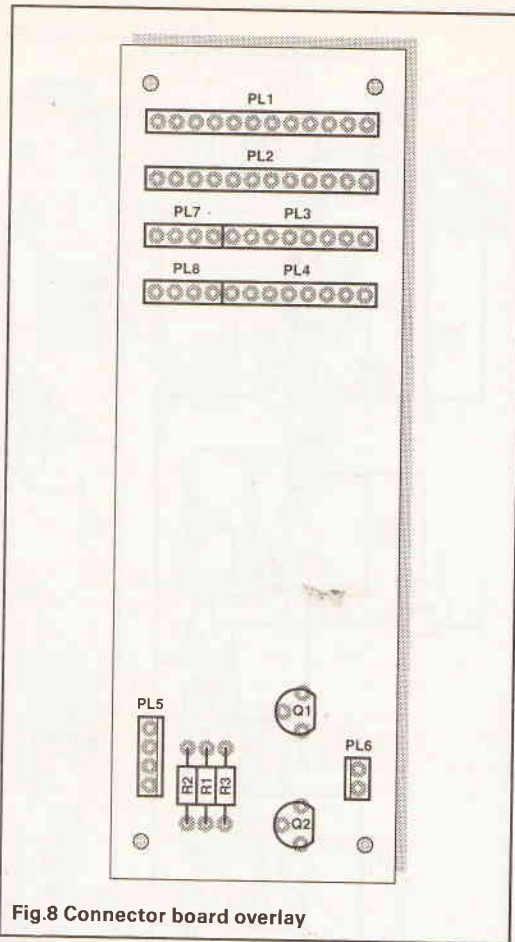

Fig. 8 Connector board overlay

tional. All that remains is to connect it to the other units in the Nightfighter range. Figure 14 shows some possible configurations and permutations of the Master Controller, Switch/Dimmer Packs and Sensor Switch.

Faultfinding

The PSU is of course the first port of call in this undesirable exercise. Much has been said already about the testing of this item and I won't bore you with further prose pertaining to it.

Next in line is the Master Control Board. Check that the correct voltages are reaching all of the IC's, that the bistables are toggling correctly when each of the buttons is pushed and that the multiplexer IC, once correctly addressed, is switching the correct output to input or vice versa. Checks for the Sound Trigger Board are as for the Bass Beat Trigger of the Master Controller. Once the Master board has been verified as working correctly, one can move on to any individual Channel boards which may be exhibiting problems. In the first instance, check that all of the Minicon socket-to-socket assemblies have been correctly fabricated and are plugged into the relevant sockets. Should faults persist at this stage, a wise investment might be a Logic Probe as further trouble-shooting involves tedious checking of individual logic levels on the pins of IC's. A comprehensive faultfinding guide for the dual channel board would consist in the main of reams of truth tables for each of the possible logic permutations. The one consolation for the reader is that it is statistically unlikely, but for a very foolish constructional error, that two channel boards will exhibit identical faults and that once one channel board is up and running, faultfinding can consist of comparing logic levels at identical points on good and faulty boards.

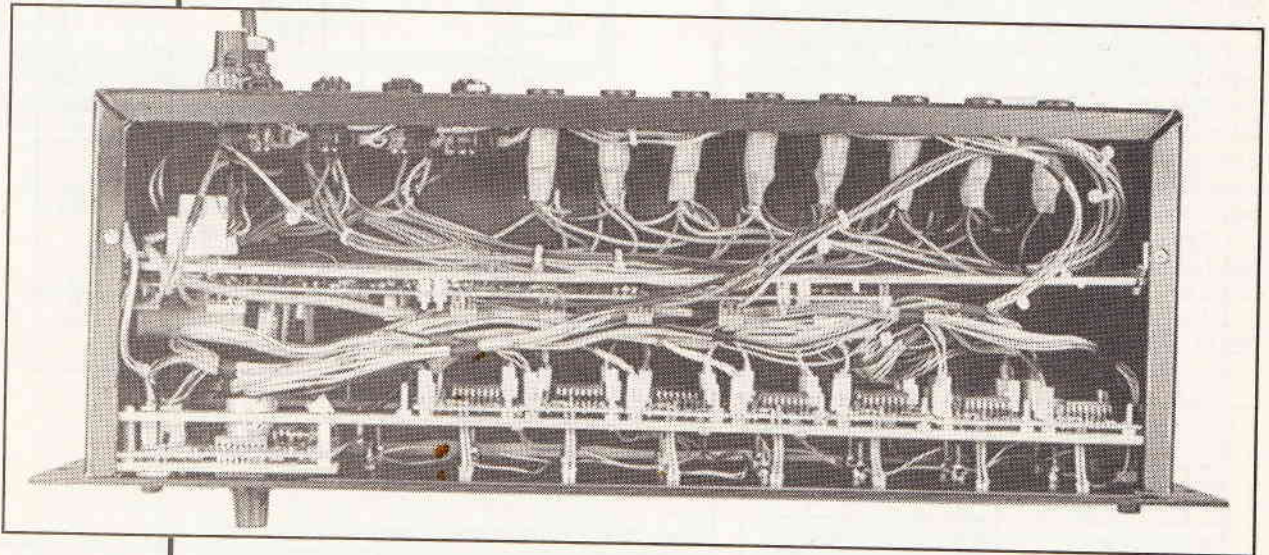

PROJECT

If we now revert to normal CHASE, the number of channels which are recycled in the routine (it was originally one) is determined by the number of channels which were on in ALT. CHASE at the time that we selected CHASE. This is useful for selecting chase routines of more than one channel. If a one channel chase is all that is required, either change modes when only one channel is on or select NORMAL as an intermediate mode and clear all channels before selecting normal CHASE. Finally verify that all of the channels can be switched in or out of the chase routine using the CHASE CHANNEL SELECT switches and that any so switched operate as in NORMAL mode. This facility should only be used infrequently as the CHASE CHANNEL SELECT switch has a very finite life (about 3000 operations).

The Sensor Switch is now fully set up and opera-

Further Development

As mentioned at the start of this section, there are some special effects to be had when we switch the Neutral connections as well as the Lives. Displays utilising this type of connection are known as Matrix displays. The Live connections are known as the X connections because they lie along the X-axis of the display and similarly the Neutrals are called the Y connections. To make the display chase along the Y axis ie a vertical column of lights sequencing along, we must switch all of the Neutrals on and chase the Lives. Similarly to chase along the X axis we must switch all of the Lives on and chase the Neutrals. We can do this using an 8-way triac board with four of the triacs switching Neutral and four switching Live. It would necessitate re-programming the EPROM such that the first forty pro-

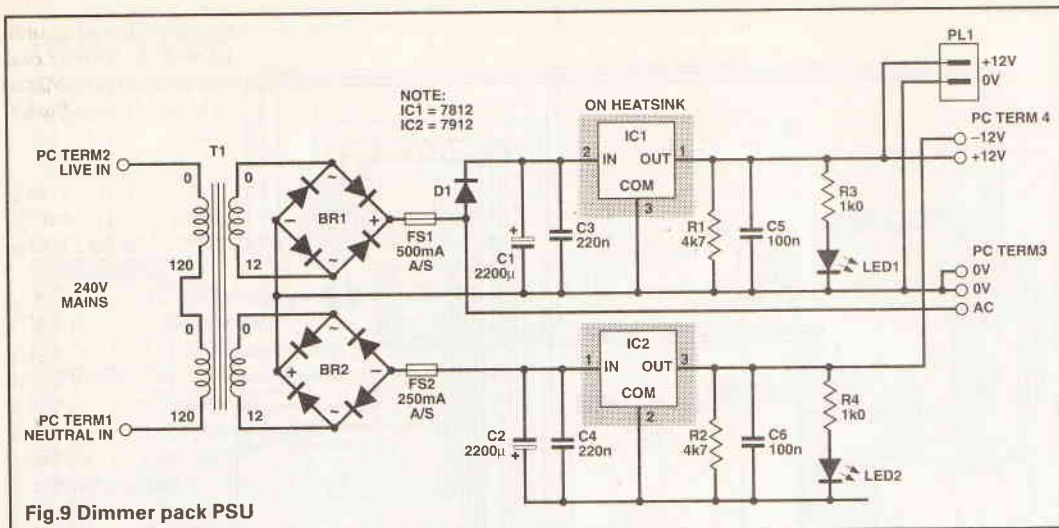

grams are on X-axis and the second forty on Y-axis. Thus toggling address line A10 would switch axes. Sample lines of EPROM addressed for a one lamp chase are given below.

X-axis chase starting at EPROM address 00, ie sequence No 1.

00 F1 F2 F4 F8 F1 F2 F4 F8 F1 F2 F4 F8 F1 F2 F4 F8

Y-axis chase starting at EPROM address 40,

40 1F 2F 4F 8F 1F 2F 4F 8F 1F 2F 4F 8F 1F 2F 4F 8F

The STROBE button could become the axis change pushbutton as it controls the A10 address line. D1 on the Output Mode board would need to be omitted so that the unit is no longer placed in Standby mode when PB4 is pushed, and the GO pushbutton would then select the other axis. EPROMS with contents suitable for a matrix-style display are available from the author, as is the EPROM necessary for the Master Controller. Any orders dispatched for the spe-

cial edition EPROM will be accompanied by more detailed wiring diagrams of the alterations required.

The triac boards can also be used to control voltages other than 240V mains because the triac supply is directly accessible via the 2.5mm tails. This is useful where we want to control low-voltage lamps eg 24V Tubelight without wishing to purchase four or eight 24V transformers. The triac supply is simply connected to the secondary side of a suitably rated 24V Transformer and the triac outputs will now be at 24V for direct connection to the lamps. These low voltage/high current outputs will be more susceptible to voltage drops caused by I^2R losses in connecting cables which should be kept as thick and as short as possible.

It is a sad fact that the cost of the actual electronics is far outstripped by the cost of hardware such as connectors, enclosures, knobs, switches etc.

The cost of the project could be reduced by using

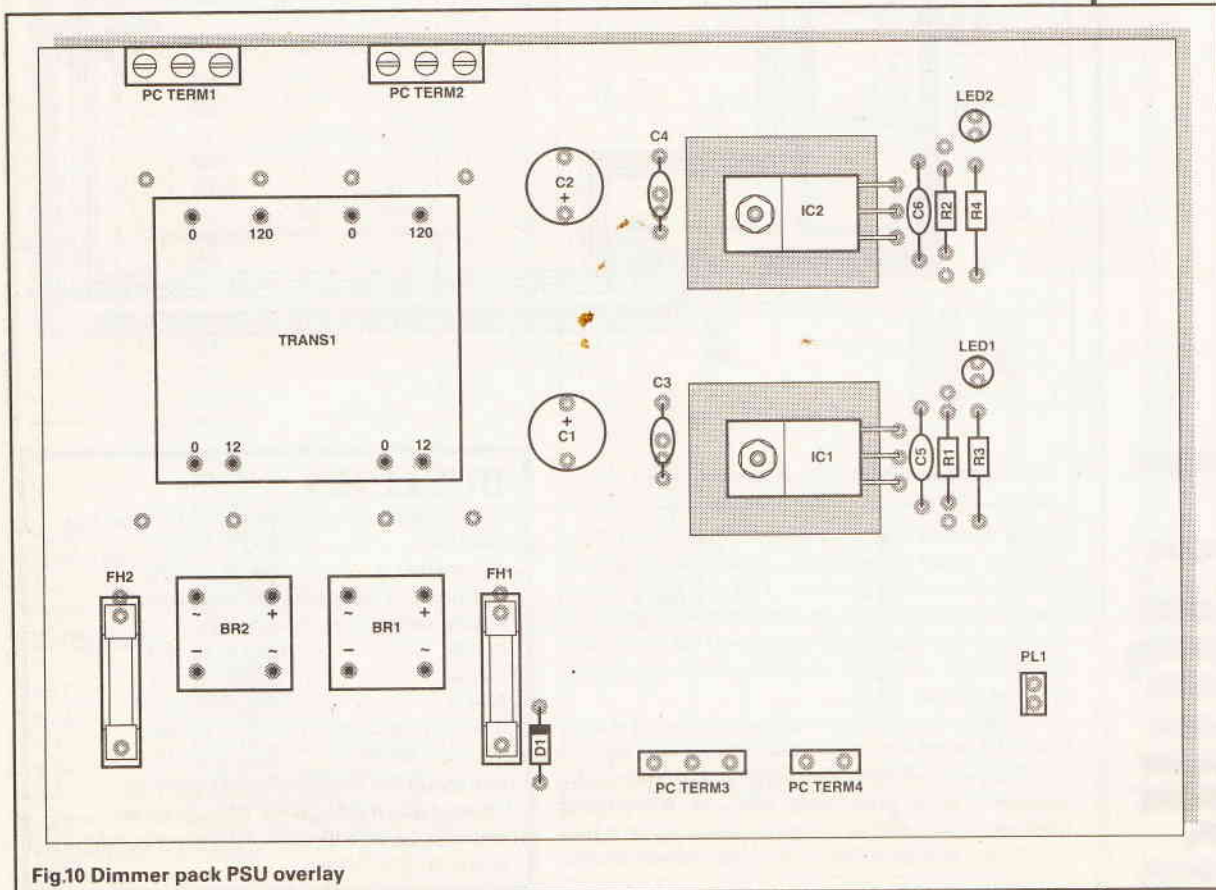

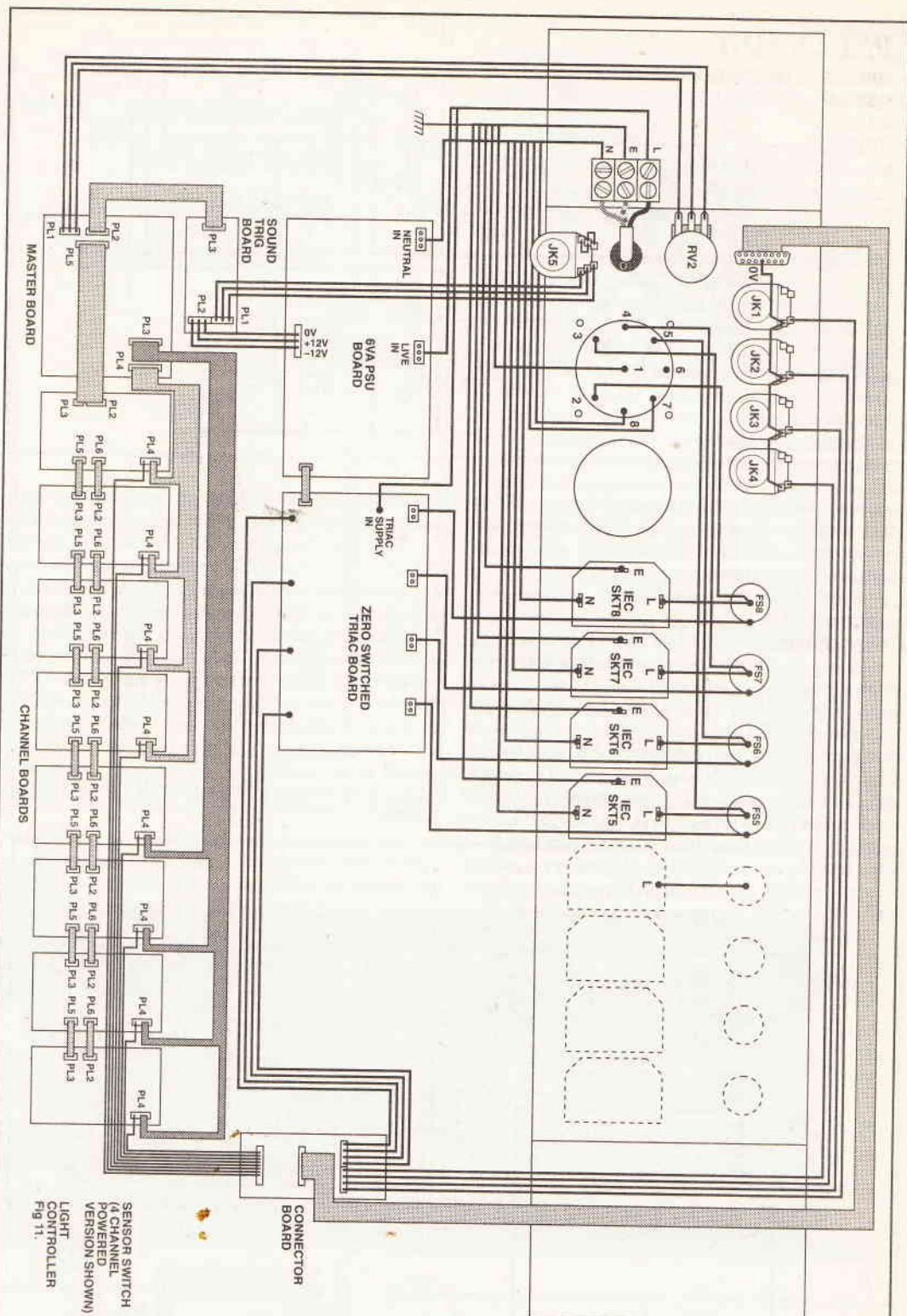

Fig.11 Interwiring diagram of sensor switch

less or cheaper mains connectors, hard-wiring all of the inter-board connections, chassis mounting fuseholders, less robust cases etc. This can prove to be a false economy as the units will be inherently less reliable, less professional-looking and the rig will take much longer to set-up, and dismantle when using terminal blocks.

Finally, the author is currently designing a stage lighting desk which will allow crossfades between two sets of presets, a memory facility for storing scene lighting levels, direct interfacing with the Nightfighter Dimmer packs, and an external control input which could be connected to the Nightfighter Master Controller.

BUYLINES

Keyboard switches (Alpha style) available from STC Components
 Switch Base (Stock No. 07352B)
 Alpha-style Keycap (Stock No. 028859C)
 Black anodised 19" front panels, plastic encapsulated PCB-mounting transformers from RS Components
 1U Panel (Stock No. 502 455)
 2U Panel (Stock No. 502 461)
 3U Panel (Stock No. 502 477)
 18 VA 12-0-12 Transformers (Stock No. 208 349)
 6 VA 12-0-12 Transformers (Stock No. 208 844)
 Touch pads, Minicon Connectors, Heatsinks, Opto-triacs, Interference Suppression Capacitors Toroidal Chokes and Miniature Pots all available from Maplin. Rack-mounting cases available from Rackz Products.

PARTS LIST

SENSOR SWITCH MASTER CONTROL

RESISTORS

R1,2,3,4,5,6,11, 14,17,20	100k
R7	4M7
R8	6M8
R9,10,13,16,19,22	10k
R12,15,18,21,23	1k
VR1	2M2 dual linear pot
VR2	1M linear pot
SIL1	100k SIL resistor array

CAPACITORS

C1,3	220n
C2	100µ non-polarised
C4-8	100n

SEMICONDUCTORS

IC1	40106
IC2	4043
IC3	4052
IC4	4081
IC5	4078
Q1-5	BC547C
D1-14	1N4148
LED1-4	0.1" yellow LED
LED5	0.1" green LED

MISCELLANEOUS

PB1-5	Click Switch & cap (Maplin FF87C, FF94C)
SW1	8-way DIL Switch (Maplin XX27E)
FL1	2-way Minicon plug
PL2,6	3-way Minicon plug
PL3,4	8-way Minicon plug
PL5	10-way Minicon plug
SK1	2-way Minicon socket-lead assy
SK2	3-way Minicon socket-socket assy
SK3,4	8-way Minicon socket to four 3-way and one 4-way socket assy (see text and diagrams)
SK5	10-way Minicon socket-socket assy
SK6	3-way Minicon socket-lead assy.
IC sockets to suit, PCB, veropins	

CHANNEL BOARD

RESISTORS

R1,2	2M2
R3,4	22M
R5,6	3k9
R7,8	560k
R9,10	100k
R11,12,15	10k
R13,14	680R
R16,17	470R

SEMICONDUCTORS

IC1	40106
IC2,3	4013
IC4	4081
IC5	4071
IC6	4073
IC7	4053
Q1-3	BC547C
D1-7	1N4148
BI-LED1	0.2" Tricolour LED

CAPACITORS

C1-7	100n disc ceramic
C8,9	100n polyester

MISCELLANEOUS

PL1	2-way Minicon plug
PL2,5	6-way Minicon plug
PL3,4,6	3-way Minicon plug
SK1	2-way Minicon socket-lead assy.
SK2	6-way Minicon socket-socket assy.
SK3	3-way Minicon socket-socket assy.
TP1-4	Triangular Touch Pads (Maplin HYO1B)
IC sockets to suit, PCB, Veropins.	

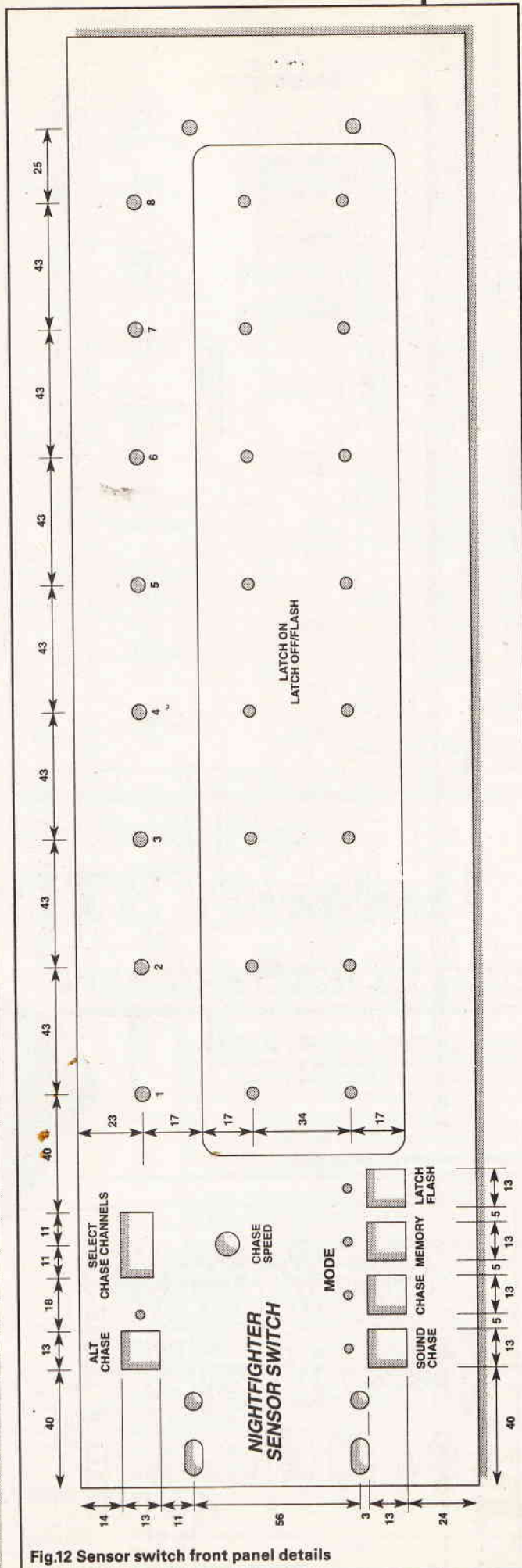

Fig.12 Sensor switch front panel details

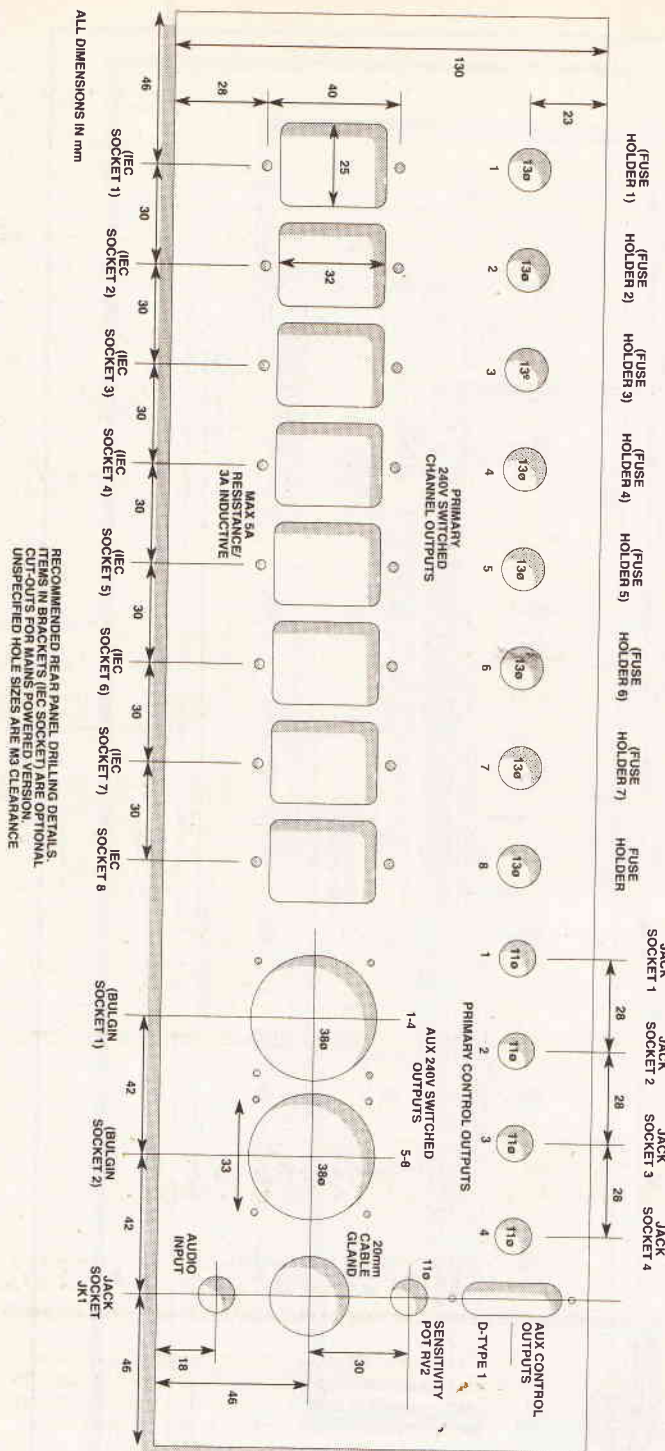

Fig.13 Sensor switch rear panel details

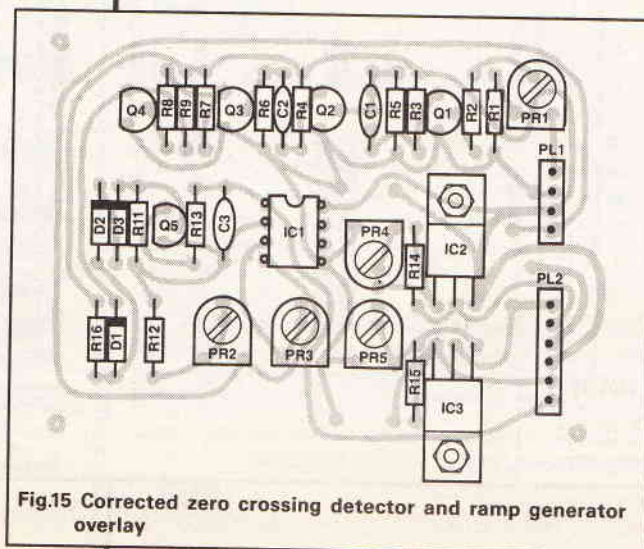

Fig.15 Corrected zero crossing detector and ramp generator overlay

SOUND TRIGGER BOARD

RESISTORS

R1,2,17	43k
R3,7,10,23	22k
R4,5,6,28	100k
R8	680k
R9	180R
R11,13,14,21	10k
R12,15	4k7
R16	2k7
R18,19,27	1k
R20,22	120k
R24-26	3M3
R29	6M8
PR1	20k horizontal preset

SEMICONDUCTORS

IC1	LM324
IC2	TL072
IC3	4047
Q1	VN1210L
Q2	BC549C
D1-4	1N4148

CAPACITORS

C1,2	4μ7 16V radial electrolytic
C3,4	5n6 polystyrene
C5	100μ 16v radial electrolytic
C6	47μ 16v radial electrolytic
C7	470n polyester
C8	1μ0 polyester
C9	47μ axial non-polarised electrolytic
C10	100n disc ceramic

MISCELLANEOUS

PL1-3	3-way Minicon plug
PL4	2-way Minicon plug
SK1	3-way Minicon socket/screened lead/stereo 1/4" jack socket assy
SK2	3-way Minicon socket to socket assy
SK3	3-way Minicon socket to flying lead assy
SK4	2-way Minicon socket to lead assy

MISCELLANEOUS TO COMPLETE SENSOR SWITCH

SK1	15-way D-type mounting socket
JK1-4	1/4" mono jack socket
JK5	1/4" switched stereo jack socket

3U black anodised front panel, matching case (see text), 6BA and M3 nuts, bolts, washers, solder tags, spacers, IEC 6A shuttered mains sockets to suit, Bulgin octal mains sockets to suit, 5x20mm panel mounting fuseholders to suit, 30A terminal block, 6A connecting wire of various colours, 20mm cable gland, 6VA PSU, Triac Switch board to suit, terminal block, mounting hardware as described in the text.

Error Round-up Part 1

Fig.2 PL2 'Bass Clock' is not connected to pin 9 'SW'. Pin 9 'SW' should be connected to IC15 pin 2 'A1'. IC18 and IC19 Pins 4 and 10 on both chips should be labelled 'IN' not Vdd0 and Vdd1 respectively. Vdd1 on IC's 18 and 19 is pin 16 and is connected to +5V. Vdd0 on IC's 18/19 is pin 1 and is connected to +10V. D4 is omitted from Main Processor Board Parts List and is 1N4148. PL5 Pin 9 should be labelled STROBE EN. Fig.3 C1,2 should be 100n disc.

Fig.7 Q3 FET, there should be no connection between gate and pin 3 of IC1d. Instead it should connect to the positive end of C6. The node of R34 and PR1 should connect to pin 13 IC2d.

Part 2

Fig.1 Q1-4 should be NPN transistors ie BC549. Fig.2 C2 should be 750p and PR4,5 are 5k presets. Fig.3 Wiper to RV101 should be labelled Point 2'. Fig.7 Board (0-12V) supply is made via PL2 as in circuit and point to left of Link 1 should be labelled To Triac Supply.

Fig.8 PR1 was wrongly positioned and without R1. See amended diagram Fig.15 left.

Part 3

Fig.2 C1 positive at lower end, C2 uppermost and C5 to the left. C11 should be aligned vertically under R42 and connecting to R44.

Fig.3 PB1-8 and PB1-6 (Fig.4) should be highlighted as being mounted on the other side of board.

Fig.4 Foil should be turned vertically to line up.

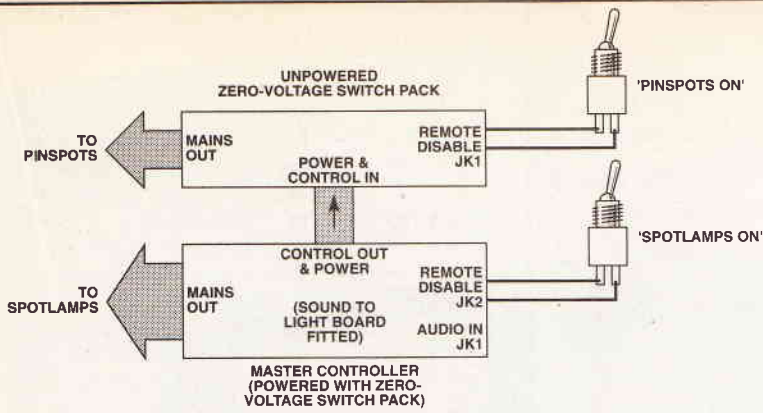

BASIC CONFIGURATION (SUITABLE FOR SMALL MOBILE)

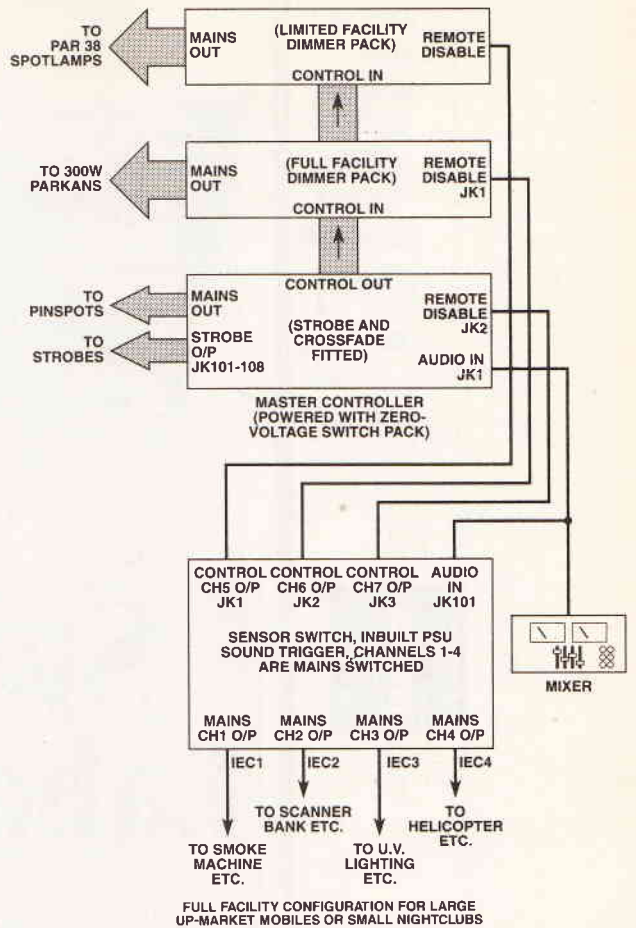

FULL FACILITY CONFIGURATION FOR LARGE UP-MARKET MOBILES OR SMALL NIGHTCLUBS

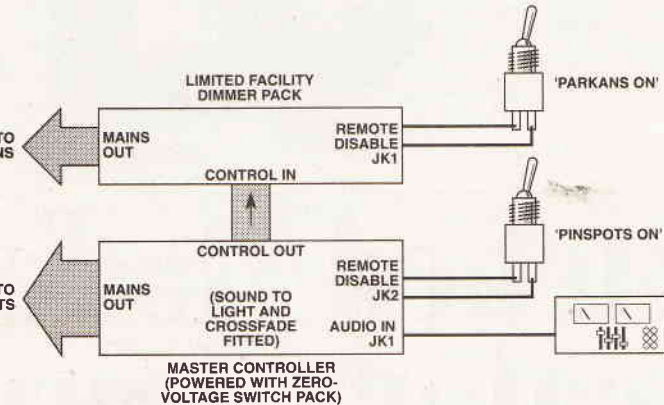

INTERMEDIATE CONFIGURATION (SUITABLE FOR LARGER MOBILE)

SCHEMATIC OF SEVERAL DIFFERENT SYSTEM CONFIGURATIONS FOR THE NIGHTFIGHTER UNITS

Fig.14 Schematic of possible configurations

DREMEL® USA *Christmas Reader Offer!*
MINIMITE™ Cordless

PCB PRECISION DRILL KIT

Perfect for all modelling, you can frill, sand, shape, grind, de-burr, clean, polish most materials around the house and car — even try your hand at light wood-carving with the accessories provided with this precision tool!

Just add a diamond burr from the full range of over 140 other Dremel accessories from model/hobby and toolshops nationwide to engrave glass, security mark valuables or add smaller collets to drill pcb holes down to 0.4mm.

5,000/10,000rpm motor runs on 4 alkaline or re-chargeable AA size batteries (batteries not included in kit)

MINIMITE DRILL KIT + ACCESSORIES £29.95 ROET/19
OPTIONAL 2 HOUR CHARGER + 4 NI-CAD BATTS £21.00 ROET/20

Please supply ROET/19 @ £29.95
 Please supply ROET/20 @ £21.00
 I enclose my cheque/P.O. for £..... made payable to ASP or
 please debit my Access/Visa

Signature Expiry

Name.....

Address.....

.....Post Code

Please allow 28 days for delivery U.K. only — overseas upon request.
 Please note the above information could be used for marketing purposes

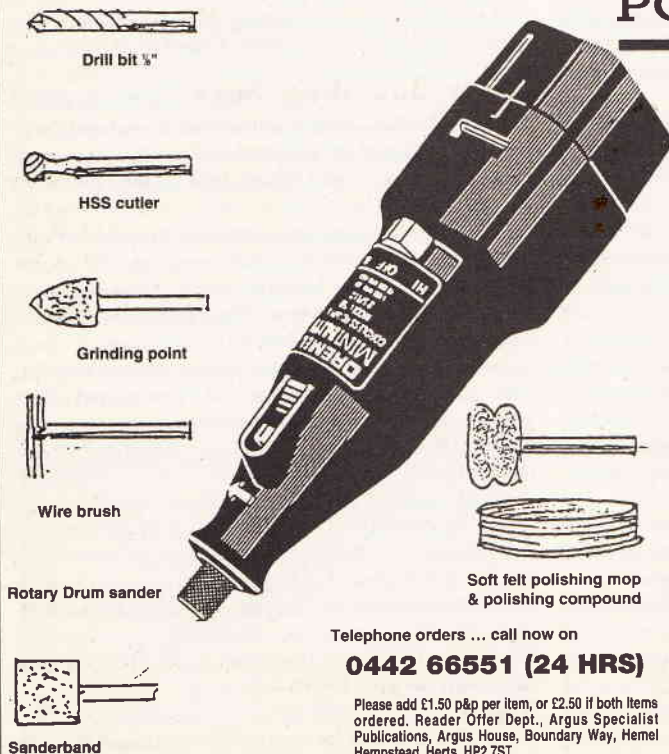

Telephone orders ... call now on
0442 66551 (24 HRS)

Please add £1.50 p&p per item, or £2.50 if both items ordered. Reader Offer Dept., Argus Specialist Publications, Argus House, Boundary Way, Hemel Hempstead, Herts. HP2 7ST

1

Switched Mode Laboratory Power Supply

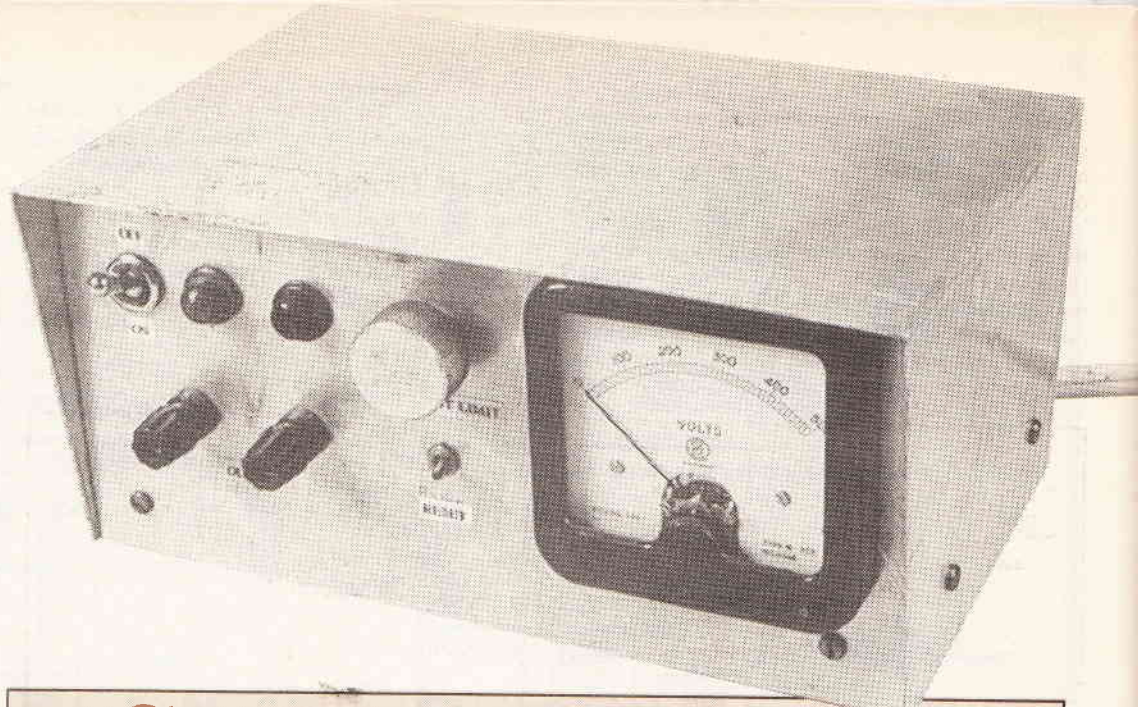

Andrew Armstrong constructs using our free copper-clad board and foil, an efficient bench supply.

PROJECT

Recently I used my old laboratory power supply to attempt to restore life to a nickel-cadmium battery which had failed in such a manner that it had an internal short circuit. What sometimes happens is that crystals of cadmium grow across the separator causing a short circuit. If the battery is charged at the time, a current will flow through the crystal and melt it back onto the plate.

What had happened in this case was that the battery had been left unused for too long, all its charge had leaked away and it had become short circuited. To attempt to restore it, I turned the voltage on the power supply well above the normal cell voltage for a NiCad, and proceeded to dab the power supply connections onto the NiCad in an attempt to melt the internal short circuit. Unfortunately, my power supply, which I built almost 20 years ago, gave way before the short circuit did. It would no doubt have been possible to delve into the Veroboard and messy soldering and carry out a repair, but I decided instead that this was an omen, and that it was time for me to start again from scratch and design a new power supply using up to date technology.

The current output at lower voltages had proved inadequate in the past, and was to some extent limited by thermal considerations. Therefore, I resolved to design and built a laboratory grade switched mode power supply which would be able to deliver at least 1 amp at 30 volts, 2 amps at 15 volts and, if possible, a maximum current of at least 5 amps at 5 volts.

The advantages of using switched mode technology are that little heatsinking is required, and that at currents below the maximum rating of the supply the

output power is more or less constant. It really is possible to supply much more current to the load than is drawn from the main reservoir capacitor.

Topology

I considered a number of different types of circuit for the job. My first decision was that I would use a conventional mains transformer to isolate the supply from the mains to avoid the difficulties of having to design a safe switching/isolation transformer. This decision simplified the design of the supply considerably, because a circuit topology employing a single storage inductor could be used.

My choices were then between the well known configurations of flyback, buck-boost (a kind of inverting flyback converter in which the output voltage can be above or below the input voltage), series buck regulator, or the less well known Cuk converter. One requirement from a laboratory power supply is that it shall provide a substantially noise-free output. The

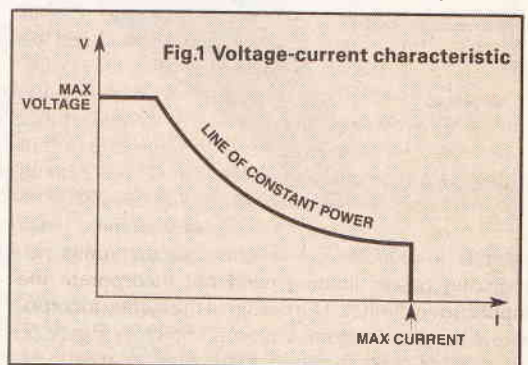

high ratio of peak current to average current in flyback converter designs makes low noise and ripple harder to achieve, so the first two configurations were ruled out.

The Cuk converter was a serious possibility. In theory it is possible to reduce both input and output ripple in a Cuk converter to zero, so that a very low output noise and ripple should be possible. Unfortunately the complexity of a Cuk converter is greater than that of other converter types, and the requirements for near-zero output ripple are difficult to achieve. The

tage regulator. The current limiter module is planned as a future project.

Circuit Design

When designing a buck regulator, one naturally thinks of the switching element in the positive line. The LT1070 does not readily lend itself to this, however, because its switching transistor is connected to the ground pin of the IC. It is possible to design a positive buck regulator using the LT1070, but because the operating current of the chip must flow continually in

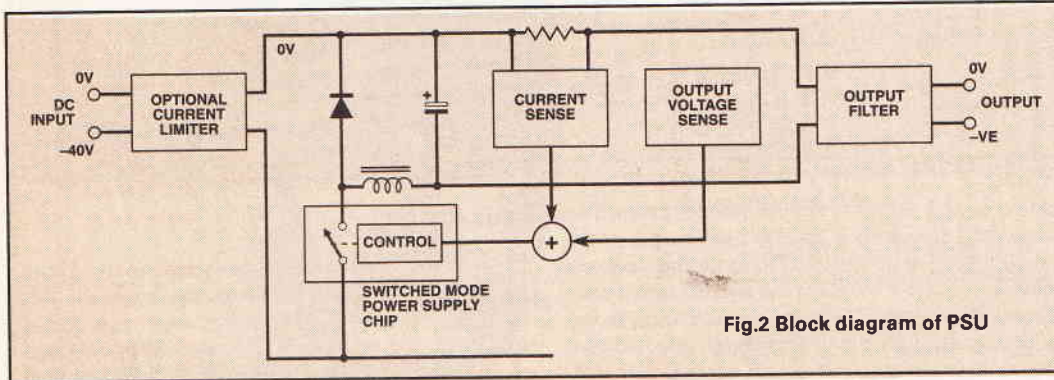

Fig.2 Block diagram of PSU

need for a replacement power supply precluded the use of a topology which is not yet widely known, and about which there is little conventional wisdom. Therefore the series buck topology was chosen.

The next requirement was to choose the detailed method of designing the power supply. Many approaches are possible; a completely discrete design might be tried, or a standard switched mode control IC might be used to control discrete circuitry. The reliability and precision demanded from a laboratory power supply precluded the use of a simple discrete design, so an integrated circuit was chosen.

After careful consideration, the LT1070 switched mode IC, which incorporates a switching element on chip, and which provides cycle by cycle switch current limiting, was chosen. This IC appears to offer the best characteristics suitable to a laboratory power supply, consistent with a reasonably simple circuit design. These include being proof against short circuits and overload, and providing accurate output control under a wide range of load conditions.

Constant Power

There are two approaches to avoiding overloading the mains transformer. One is to limit the output current of the unit to the maximum DC which can be supplied using the transformer with a bridge rectifier and reservoir capacitor. This has the disadvantage that at low output voltages only a fraction of the total available power is utilised. If power rather than current can be limited, then more current can be made available at lower output voltages. This power limit is of course subject to the maximum voltage available, and the maximum current which the regulator can control. An output current and voltage characteristic such as that shown in Figure. 1 would be the ideal. I considered the possibility of doing this entire control using the control loop of the switched mode regulator IC, but I decided that because power limiting can be provided by input current limiting (given a more or less constant output from the transformer) a separate current limiter circuit may be preferable. This would provide a useful extra short circuit protection for the power supply. It also permits a modular construction so that units not requiring power limiting need not incorporate the input current limiter. The design of the system incorporating the input current limiter is shown in Figure. 2, but this project is to produce the switched mode vol-

the output, this would not be suitable for any power supply in which the load can approach zero.

There is no good reason not to regulate in the negative supply, in which mode the LT1070 functions very well, so that is the approach taken in this design. The development circuit diagram which may be subject to minor modifications before part 2 next month, is shown in Figure. 3.

Starting at the input, a substantial electrolytic capacitor C1 is provided on the PCB to limit the need for substantial circulating currents off the board. A linear voltage regulator, IC1, is provided to supply the operating current for the LT1070, IC2. This is because the maximum voltage rating of the LT1070 for its power supply input is 40 volts, and a nominal 40V supply cannot be relied upon never to exceed 40 volts. Accordingly, a 35-volt regulated supply is supplied to IC2. The switch transistor of the LT1070 is rated at 60V, which is more than adequate to cope with variations in the DC input voltage.

The LT1070 is a current mode control chip which incorporates an internal oscillator whose frequency is set to approximately 40kHz by on-chip components. Internal circuitry monitors the current through the switch transistor, and it is this measured current which is fed back internally to adjust the mark:space ratio of the switch. External feedback adjusts the aiming point of the switch current rather than adjusting the mark:space ratio directly. This is what is meant by current mode control. Feedback loop stability is set by R3 and C3.

External feedback applied to the FB terminal and is compared internally with a 1.24V bandgap reference to generate an error voltage. In the design shown in Figure. 3, this input is protected from excessive voltage under fault conditions by the zener diode D1. R4 forms part of a potential divider referred to the output voltage. More about this later.

When the switch output is on, the negative supply is fed to the left-hand end of L1. When the switched current reaches the aiming point, the switch turns off and the input of L1 (connected to the Vsw terminal of IC2) rises to one diode drop above 0V, and the current in L1 starts to decline. Under most load conditions, the current in L1 exhibits triangular-shaped ripple but does not decline to zero. C4 substantially smooths this ripple, giving a more or less constant voltage.

The output current is fed through R5 to provide a

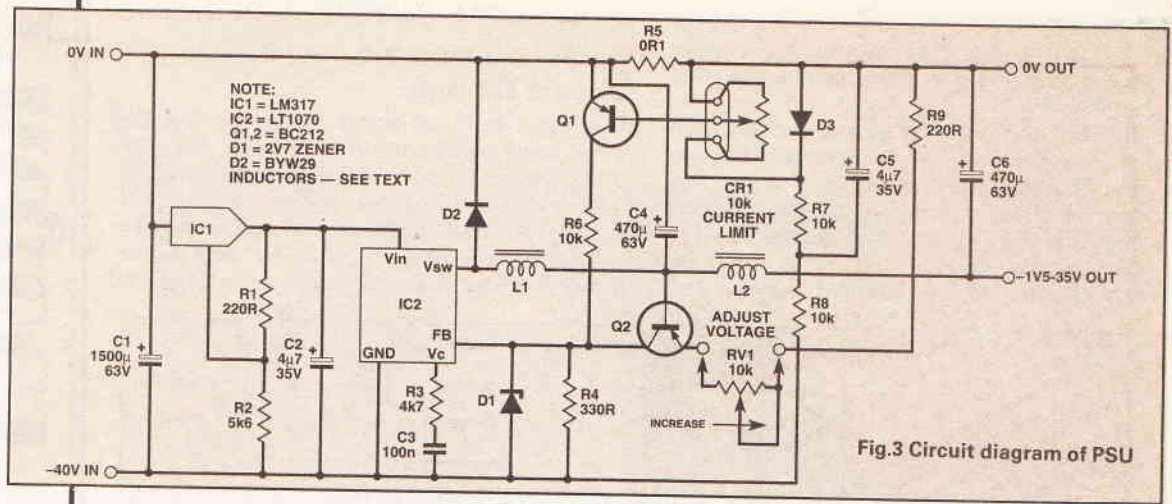
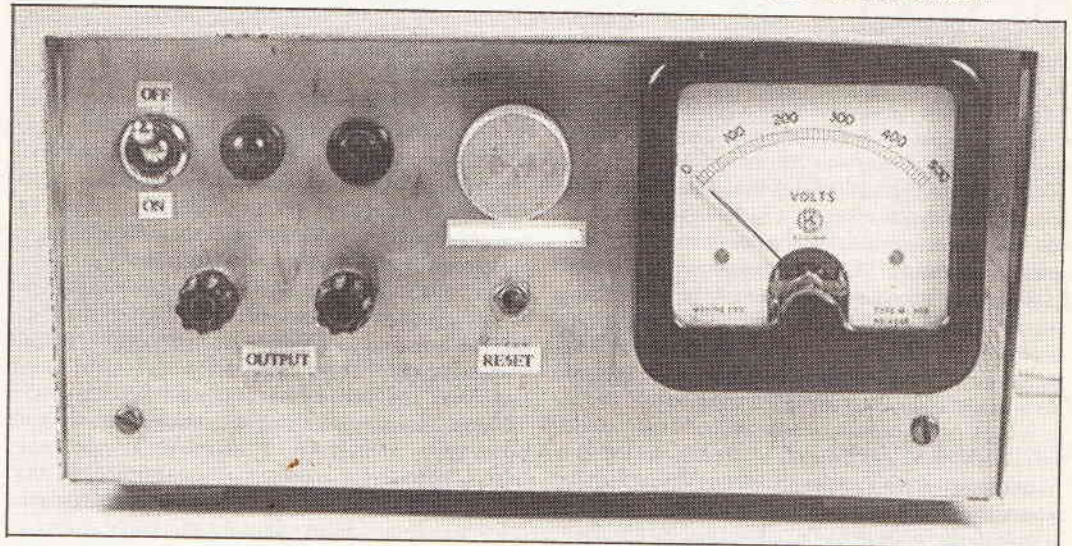

Fig.3 Circuit diagram of PSU

signal to use for variable output current limiting. The voltage drop across R5 is used to turn on Q1, which provides a positive current into R4 raising the feedback signal and therefore reducing the switch current aiming point. If the base of Q1 were simply connected to the output side of R5, then current limiting would take place at approximately 6A, which corresponds with 0.6V across the base/emitter junction Q1. This could be increased but not reduced by adjusting the current limit potentiometer. To compensate approximately for the base/emitter drop of Q1, a biasing diode D3 is supplied. The diode is forward-biased by means of a current flowing through R7 and R8. This current is made

Inductors

The inductors used in this power supply must be able to handle an average DC of 5A without either saturating or overheating. To keep the current ripple within bounds, the inductance of L1 should exceed 150 microhenries at no load to allow for the reduction of inductance that occurs even before saturation as current increases. L1 may be made by winding 50 turns of 1mm (or preferably 1.25mm) wire on a T104-40 core available from Cirkit - alternatively, a ready-made inductor available from Maplin (type JL73Q) may be used. L2 should consist of 30 turns wound on a Cirkit



substantially ripple-and noise-free by the addition of C5. This arrangement permits the current limit to be adjusted almost down to zero.

Voltage control

The feedback input of IC2 is referred to the negative supply, which is not either of the output supply connections. In order to refer the output voltage to the negative supply, Q2, R9 and the voltage adjustment potentiometer are used to inject a current into R4 proportional to the output voltage. Clearly the voltage across R9 and the potentiometer is less than the output voltage by the base-emitter junction of Q2. Because the base/emitter junction of a transistor is affected by temperature, the output voltage is also temperature dependent to some extent. This is only significant when the output voltage is low. The value of R9 is chosen so that the minimum output voltage is approximately 1.5V.

Because this is a laboratory power supply, extra output filtering to remove ripple and switching noise is provided to L2 and C6.

T94-40 core.

Initial experiments have shown that this filtering arrangement provides a very clean output, save that there are spikes at the switching frequency of a very short duration, and of approximately 20mV peak to peak amplitude symmetrical about the DC output voltage. The filtering does not completely remove the spikes, because there is stray capacitance between the input and the output of the inductors, while the capacitors C4 and C6 possess an unwanted equivalence series inductance and resistance. To make the output still cleaner, it is planned that a low value inductor and a ceramic or polyester capacitor are incorporated at the output terminals of the unit.

The use of a metal case, and a mains filter, should keep all radiated interference within the box, giving a supply as interference-free as a linear design.

Details of the final circuit design and construction will be provided next month. The PCB sticker provided free with next month's issue will be to the final design, which may differ slightly from the circuit shown in Figure 3.



ETI NEEDS YOU

This is your chance to be recognised as a creative technologist worldwide. Why not see your circuit designs in print and be the envy of your friends. We particularly require new ideas and designs in the following fields:

Audio design and music effects, applied electronics for use in the home and computing hardware.

No matter what the science or technology, just send us a brief description about the project you have built or are developing and we will give your ideas serious consideration. You never know who might be reading ETI when it appears, it may be developed on a commercial basis.

Send in your synopsis to ETI, Argus House, Boundary Way, Hemel Hempstead, Herts HP2 7ST.

CB CITIZENS' BAND

CITIZEN'S BAND is the only British CB magazine and covers a wide range of topics of interest to the newcomer and the experienced user. In each issue the latest equipment is reviewed, useful practical projects are detailed and all the national and international band news is featured. Of particular interest to overseas readers are the QSL pages, articles on shortwave listening, and reports on UHF CB.

Cover Price £1.60

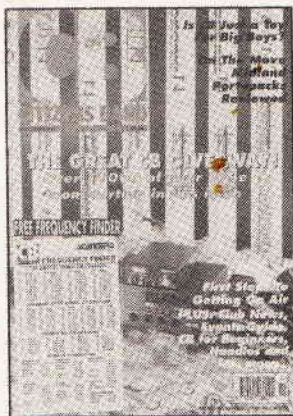

Published: 3rd Friday of each Month

Order
your copy
NOW!

Why not subscribe?
Telephone 0442 66551 ext 210
for further information



Give a choice this Christmas with an Argus Books Voucher!

Argus Books Vouchers are ideal gifts for modellers, whatever their specialist interests. By giving a Voucher, you don't have to worry whether you've picked the right book. The voucher will allow him or her to select the book of their choice!

Simply send in a cheque (or give us your credit card number) for £5, £10, £15, £20, or £25, and we will supply you with a voucher to the appropriate value. We will also include our most recent catalogue which contains full details on over 120 titles comprehensively covering R/C aircraft, boats, buggies, military, plastic and model engineering.

All you then have to do is send the voucher, plus details of the book(s) you require, to the address below and they will be sent to you within 14-21 days.

ARGUS BOOKS

**ARGUS BOOKS -
PUBLISHING FOR MODELLERS
AND HOBBYISTS.**

Please send me a voucher for the value of (please tick):
 £5 £10 £15 £20 £25

Please make cheques payable to Argus Books, and send to address below.

I enclose my remittance of £.....

Please charge my access/mastercard/barclaycard/visa

No. Signature

Expiry date Name

Address

ET11

Complete details and return form to:
 Voucher Offer, Argus Books, Boundary Way,
 Hemel Hempstead HP2 7ST.

ARGUS BOOKS

Negative Feedback

A P Stephenson looks at the standard ways of improving op-amp performance

Cheap voltage amplifier ICs with enormous gain have been with us long enough for them to be taken for granted. Except in certain specialised fields, the days of designing and building a voltage amplifier from discrete components to bump up some weak voltage, have long since gone. Instead, we simply bung in one of these off-the-shelf 'op-amps' and sit back — at least, that's the theory!

In practice, it is not quite so simple because the enormous gain and low cost have only been achieved by sacrificing stability and predictability. The gain (A) of an op-amp may be specified as 40,000 to 200,000 so a particular specimen, even of the same type number taken at random, could have a gain anywhere within these two extremes.

Apart from the actual gain variation, even the lower figure is probably far higher than required so something must be done to tame down the gain to some desired figure and to ensure that the tamed-down gain is predictable.

This is where feedback or, to be more precise, where negative feedback comes in. In fact, the design of a voltage amplifier using one or more op-amps is now reduced to the relatively straightforward problem of designing a suitable negative feedback system.

Although the above discussion has been primarily concerned with its effect on op-amps, feedback in some form or other pops up in various — and sometimes unexpected — areas of design so a sound knowledge of the underlying principles is essential.

Advantages of Negative Feedback

The most important design parameters of an amplifying system are:

- Voltage gain.
- Input resistance.
- Output resistance.
- Frequency bandwidth.
- Distortion.
- Noise.

The application of negative feedback to an amplifier will, in addition to lowering and stabilising the gain, increase the frequency bandwidth and reduce distortion. The signal to noise ratio is not improved but noise and hum in the output stage can be reduced.

A less obvious, although equally important, advantage is its ability to modify the input and output resistances of an amplifier. In short, gain is sacrificed in return for control over essential design parameters.

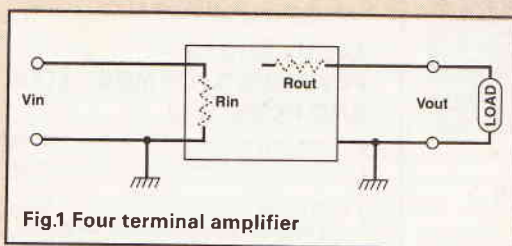

Fig.1 Four terminal amplifier

The Open-Loop gain (A)

Figure 1 shows any four-terminal amplifier which may, or may not, be an op-amp. The input signal, V_{in} , is amplified and appears as V_{out} . The ratio, V_{out}/V_{in} is defined as the open-loop gain. Thus:

$$A = V_{out}/V_{in}$$

The input resistance, R_{in} , is what the applied signal 'sees' and the output resistance, R_{out} , is what the final load 'sees' looking backwards into the amplifier output terminals.

The Feedback Fraction (B)

Feedback can be applied to any amplifier and consists of a network which taps off all or some fraction of the output and feeds it back to the input. The amount tapped off is defined as the Feedback Fraction, B.

Example: If one fifth of the output is tapped off, then $B = 0.2$

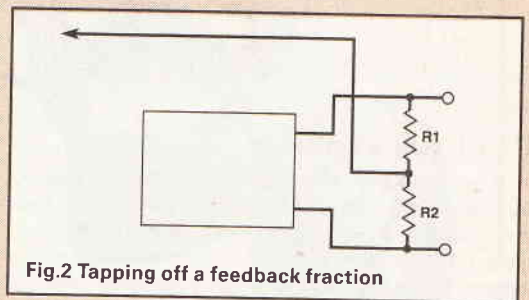

Fig.2 Tapping off a feedback fraction

Figure 2 shows how a simple divider network across the output can produce any desired value of B by suitable choice of resistors. This method of obtaining B is called voltage feedback. An alternative way of obtaining B, called current feedback, is treated later.

The General Feedback Equation

To simplify the discussion, the method of obtaining the feedback is not considered and the amplifier shown in Figure 3 is drawn with the input and output ground terminals omitted.

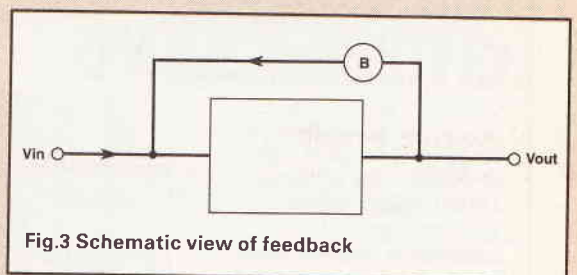

Fig.3 Schematic view of feedback

Since the voltage fed back is $B \times V_{out}$, the combined input to the amplifier, V_a , is given by:

$$V_a = V_{in} + BV_{out}$$

The black box has an open loop gain $A = V_{out}/V_a$ so,

$$V_a = V_{out}/A$$

These two equations allow V_a to be eliminated from the context to leave,

$$V_{out}/A = V_{in} + BV_{out}$$

A bit of algebraic juggling rearranges this into a more convenient form:

$$V_{out}/V_{in} = A/(1-BA)$$

The ratio, V_{out}/V_{in} is the new gain resulting from the application of feedback. It is called the Closed-Loop Gain, distinguished from the open-loop gain by the symbol A^1 . The final feedback equation becomes:

$$A^1 = A/(1-BA)$$

To summarise, an amplifier with open-loop gain A will have a closed loop gain of $A/(1-BA)$ when a fraction B of the output is fed back to the input.

OP-AMP

The Phase Relationship of B

The equation derived above has not taken into account the sign of B because of the need for a solution which catered for either positive or negative feedback.

In general, B should be written as a vector quantity, having the polar form, $B = |B| \angle \phi$

where |B| is the modulus and ϕ the phase angle or argument. The most frequently encountered values of ϕ are:

a) $\phi = 0^\circ$, in which case B is a simple positive fraction rendering the polar form superfluous.

b) $\phi = 180^\circ$, in which case, B is a simple negative fraction, again rendering the polar form superfluous. The general equation can therefore be split into two versions:

Positive feedback: $A^1 = A/(1-BA)$ (B is positive)

Negative feedback: $A^1 = A/(1+BA)$ (B is negative)

The term BA, sometimes called the loop gain, is important because it determines the quality of the feedback and is why the open-loop of an amplifier should be high.

Positive Feedback

This is considered first to get it out of the way. Note from the above positive feedback equation that the closed loop gain will be greater than the open-loop gain! Although this may seem an attractive way to increase the gain still further, it is seldom used in amplifiers because it is inherently unstable and will increase distortion instead of reducing it.

In the special case when $BA = 1$, the denominator would fall to zero and the closed loop gain would rise to infinity! An input signal would be quite redundant because the output would be an enlarged version of the input noise – in short, it would be oscillating.

It could be argued that positive feedback would be useful if there was not so much of it. To test this out, assume the open-loop gain is a modest 10,000. For AB to be less than 1, B must be less than $1/10,000$. This means that if the output is 10 volts, only one millivolt fed back will cause the amplifier to go over the top. It should be clear from all this that positive feedback, although having no worthwhile role in amplifiers, can still earn its keep in oscillator design.

Negative Feedback

The equation for negative feedback is repeated here for convenience:

$$A^1 = A/(1+BA)$$

Example 1: If $A = 1,000$ and $B = 1/100$ then $A^1 = 1,000/(1+10) = 1,000/11 = 90.9091$.

Example 2: If $A = 600$ and $B = 1/20$ then $A^1 = 600/(1+30) = 600/31 = 19.3548$

Example 3: If $A = 1,000$ and $B = 1$, then $A^1 = 1,000/(1001) = 0.9990$.

Example 4: If $A = 50,000$ and $B = 0.5$ then $A^1 = 50,000/(25,001) = 1.9999$

Four examples to explain such trivial arithmetic may seem excessive but they draw attention to a rather unexpected relationship between B and A^1 :

When A was 1,000 and B was $1/100$, A^1 was nearly 100.

When A was 600 and B was $1/20$, A^1 was nearly 20.

When A was 1,000 and B was 1, A^1 was nearly 1.

When A was 50,000 and B was 0.5, A^1 was nearly 2.

These figures suggest that in the above four cases, the approximate value of A^1 is $1/B$. To show that this is no coincidence, the negative feedback equation can be re-arranged into the following form:

$$\frac{1}{A^1 + B}$$

It follows that if $\frac{1}{A^1}$ is $\ll B$ (which it usually is) the equation can be simplified even further to the approximate form:

$$A^1 = \frac{1}{B}$$

This is a remarkable result! It shows that providing we have an amplifier with a reasonably large open loop gain, the closed loop gain is virtually independent of the amplifier!

Providing multifigure accuracy is not required, to know that B is 0.2 allows A^1 to be taken as 5 without working through the full equation or knowing anything much about the actual amplifier.

Examples:

If $B = 0.1$ then $A^1 = 10$

If $B = 0.01$ then $A^1 = 100$

If $B = 0.002$ then $A^1 = 500$

The following bit of arithmetic provides additional confirmation that the closed-loop gain depends very little on the open-loop gain:

If $A = 1000$, and $B = 1/10$, then according to the full feedback equation, $A^1 = A/(1+BA) = 1000/101 = 9.901$.

Now suppose, due to age or substitution of another specimen, A falls to 500 (half its previous value) then $A^1 = 500/51 = 9.804$.

Thus, even though A was halved, A^1 only changed from 9.901 to 9.804.

Distortion reduction

Transistors, providing they are correctly biased and are not overdriven, are reasonably linear amplifiers. That is to say, the output is a fairly authentic replica of the input. Nevertheless there is some distortion because the collector/base transfer function is slightly curved. An amplifier is judged, amongst other things, by the percentage harmonic distortion introduced.

Owners of cheap transistor radios, blaring out pop with the wick turned full up, seem to tolerate 15% or more distortion with a surprising degree of equanimity. In contrast, the distortion oozing out from one of those tall impressive looking 'music centres' will probably not exceed 1%. But any hifi system churning out Vivaldi with a distortion figure greater than 0.1% should blow its fuses with shame.

Negative feedback is a powerful weapon for combating distortion as can be seen by the following rough and ready rule:

Negative feedback reduces distortion in the same ratio as the gain is reduced.

Example: Assume an amplifier with an open-loop gain of 1,000 has a distortion figure of 10%. If feedback reduces the gain to 100, the distortion will fall to 1%.

The ability of negative feedback to reduce gain is easily understood but why it reduces distortion may not be so obvious. The following intuitive approach avoids a page full of algebra:

Assume a perfect signal enters the amplifier but, due to transistor imperfections, the output is distorted. The output will contain an enlarged version of the signal and an additional packet of unwanted harmonics that were not present at the input.

Because the feedback is negative, the actual input to the amplifier will be the difference between the signal and the feedback voltage. Because the feedback voltage contains the additional distortion components, the actual input to the amplifier must contain this distortion. But – and it is a big but – the input distortion is opposing the output distortion, so the overall effect is self-cancelling. Figure 4 shows some curves which may help in following the argument.

OP-AMP

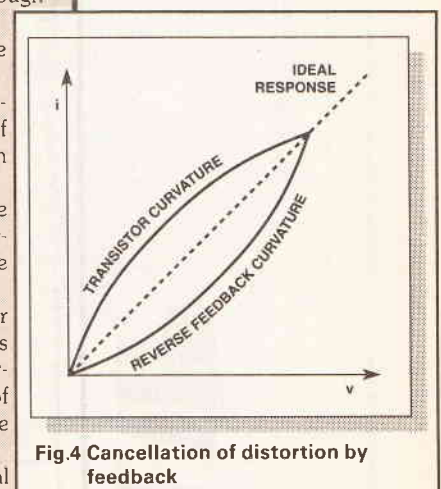

Fig.4 Cancellation of distortion by feedback

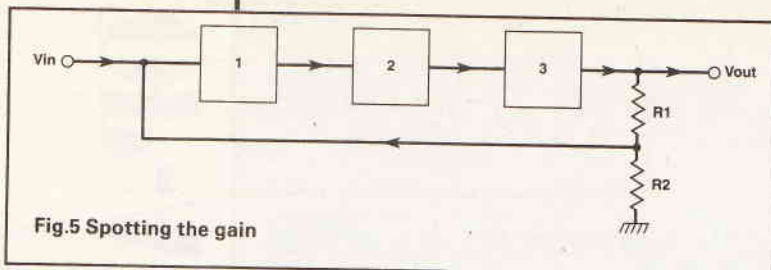

Fig. 5 Spotting the gain

Unravelling circuitry

Figure 5 shows a three stage amplifier circuit in block form with a two-resistor divider generating the feedback fraction. Although the actual amplifier circuit may be quite complex, the overall gain of the stage can quickly be traced by remembering it is, for all practical purposes, equal to $1/B$. The feedback fraction is clearly $R_2/(R_1 + R_2)$ so $1/B = (R_1 + R_2)/R_2$ which is indeed the closed loop gain. Once this feedback loop is spotted there is no need to worry about the individual gains or wade through complex circuit detail in order to calculate gain.

Example: If $R_1 = 9k$ and $R_2 = 1k$ then the total gain of the amplifier is $10k/1k = 10$.

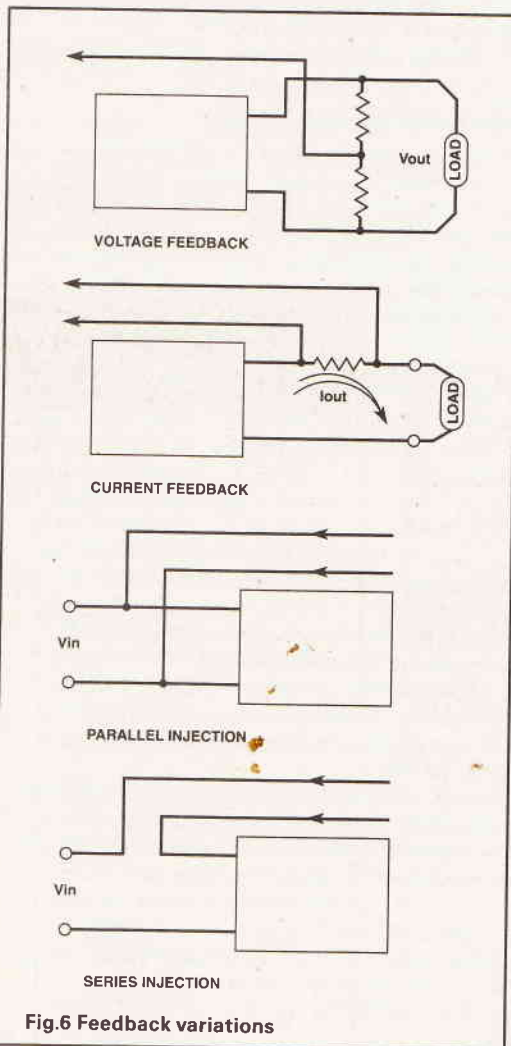

Fig. 6 Feedback variations

Feedback variations

Only the basic principles of negative feedback have so far been discussed but there are, in fact, two distinct categories of feedback (Figure 6):

- a) *Feedback type*
Voltage feedback lowers R_{out} .
Current feedback increases R_{out} .
- b) *Injection method*

Series injection increases R_{in} .
Parallel injection decreases R_{in} .

Output Resistance (R_{out})

Using voltage feedback

If the load demands more current, the tendency is for the output voltage to fall due to the increased voltage drop across the output resistance. But, because the feedback voltage is proportional to output voltage, this will drop as well causing the gain to rise. The rise in gain tends to offset the tendency of the output to fall so the effective R_{out} is reduced.

Using current feedback

If the load demands more current, again the tendency is for the output voltage to drop. However, the feedback voltage is proportional to the output current so the feedback voltage rises, the gain is reduced and so the output voltage falls even lower. The effective R_{out} is thus increased.

The Input Resistance (R_{in})

Series injection

The current which the amplifier demands from the input signal will now be less because the feedback voltage, V_{fb} and the input signal are in opposition. The amplifier input current is now $(V_{in} - V_{fb})/R_{in}$ instead of V_{in}/R_{in} so the effective R_{in} is increased.

Parallel injection

There is now an additional load across the input terminals. The greater the signal, the greater the feedback voltage so the input tends to drop still further. The effective R_{in} is therefore decreased.

How much is R_{in} and R_{out} changed?

To know that feedback can change R_{in} and R_{out} is all very well but it raises the question — by how much? Mathematics can, of course, provide the answer but the manipulations can become tedious. Providing a little accuracy is sacrificed, the following rough and ready rule is quite useful:

Change of R_{in} or R_{out} = ratio of open loop gain to closed loop gain

Example: Assume an amp has an R_{in} of $10k$ and R_{out} of $1k$ with an open loop gain of 100 .

If the closed loop gain is 20 (1.5th of its open loop value) the resistances will change by a factor of five. If voltage feedback is used with series injection, this will cause R_{in} to increase from $10k$ to $50k$ and R_{out} to decrease from $1k$ to $200R$.

It is worth mentioning at this point that amplifying voltages demands a high R_{in} and a low R_{out} so voltage feedback with series injection is indicated. Also amplifying currents demand a low R_{in} and a high R_{out} so current feedback with parallel injection is indicated.

Multiple Feedback Loops

Feedback is not always applied in one main loop from output back to input. There may in fact be intermediate loops within stages instead of, or in addition to, the main outside loop. Figure 7 shows one possible arrangement. To calculate the overall closed loop gain, proceed as follows:

1. First find A^1 for stage 1.
2. Find A^1 for stages 2 and 3.
3. Multiply the two results together to find the 'open loop' gain before the final loop is closed.
4. Find the final total closed loop gain.

Example: If A^1 of stage 1 is 10 , A^1 of stages 2 and 3 is 20 . The intermediate open loop gain is therefore $10 \times 20 = 200$. Assume the feedback fraction, B , is the main outside loop is 0.1 . The final closed loop gain is therefore $1/B = 1/0.1 = 10$.

It may seem that the intermediate loops are

superfluous because the above figures show that the final closed loop gain is dependant only on the outside loop. However the designer's reasons for the apparently useless inner loops may be due to R_{in} and R_{out} requirements rather than gain. It may be, for some reason, that the loop from stage 3 back to stage 2 has used series injection to lessen the load on stage 1 output.

It should be clear from all this that the ability of feedback to modify R_{in} and R_{out} is a powerful weapon in any designer's armament.

Instability

So far, the virtues of negative feedback have been rather over-stated so, to set the record straight, it is only fair to point out that too much of it can actually cause, instead of curing, instability! The trouble is due to certain circuit elements which have been so far ignored in the interests of simplicity. For example, it has been assumed that the phase angle of the feedback fraction was either zero or 180° . However, there will be several coupling capacitors and stray shunt capacitance in most amplifiers which, in conjunction with resistive elements, function as frequency, and therefore phase shift, filters. At extremes of frequency, either at the lower or the upper end of the band, the phase shift caused by each of them can approach 90° . In a multi-stage amplifier, these phase shifts can be cumulative and effect the phase angle of the feedback fraction. At the extreme frequencies of the band when large amounts of feedback are acting, the additional phase shift could swing the feedback angle from 180° right round to 360° . In this situation, the feedback becomes positive instead of negative so the amplifier, quite rightly, decides to change into an oscillator! Such a disaster can be prevented by either reducing the

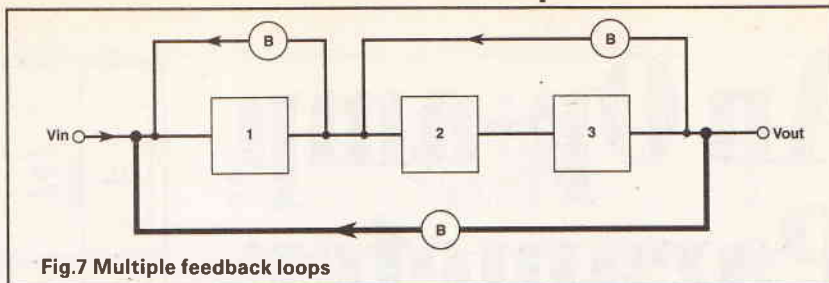

Fig.7 Multiple feedback loops

amount of feedback, or reducing the internal phase shifts in the amplifier. If the amplifier behaves itself over the expected frequency range when $B = 1$ (100% feedback) it can be given a complete bill of health.

Summary

1. Feedback is positive or negative according to whether the open-loop gain is increased or decreased.
2. Positive feedback is used in oscillators but hardly ever in amplifiers.
3. Negative feedback reduces the gain but in return:
 - a) ensures the gain is virtually independent of the internal amplifier parameters and
 - b) reduces distortion and
 - c) modifies R_{in} and R_{out} .
4. Providing open loop gain is high, closed loop gain is $1/B$ approximately.
5. Voltage feedback lowers R_{out} .
6. Current feedback increases R_{out} .
7. Series injection increases R_{in} .
8. Parallel injection decreases R_{in} .
9. The changes brought about by negative feedback are in the same ratio as the gain is reduced.
10. Too much negative feedback can sometimes cause instability.

HENRY'S

ELECTRONICS DISTRIBUTORS

QUANTITIES FROM STOCK

ADD 17 1/2% VAT
UK ONLY (PRICES CORRECT
AT SEPT 91)

ASK ABOUT OUR LOW LOW QUANTITY PRICES!

FANS



Axial Fans in stock
220/240V A/C
110/120V A/C,
12 volt and 24 volt
Various sizes From £4.00

SWITCH MODE POWER SUPPLIES

TYPE 1 OPEN CHASSIS TYPE

Output + 5 volt 8 amp, + 12 volt 0.5 amp,
- 12 volt 0.3 amp. 230-250V A/C Input
Size 7.7 x 4.2 x 1.9 ins

EX-UNITS **£2.55** Plus VAT etc. £2.00

TIMERS & RELAYS



All types of Relays,
Low Voltage, 110/240V
A/C DIL, OCTAL PLUG IN,
PCB Ecc Also 110 and
240V A/C timers.

MOTORS



Low voltage DC 3 volt,
6 volt, 9 volt and 12 volt
stocked

TYPE 2 ASTEC ENCLOSED METAL BOX



Three pin mains socket
input, on/off
switch. Output + 5 volt 3.75 amp,
+ 12 volt 1.5 amp, - 12 volt 0.4 amp,
115-230 V A/C Input Size 7.0 x 5.3 x 2.5 ins

BRAND NEW £11.02 Plus VAT
U.K. Carriage etc. £2.00

ALSO STOCKED Test Instruments

(UK's largest in stock
range) Public Address
Equipment, Hi-Fi and
Disco Speakers, Micro-
phones, Mixers, Security
Alarms, Doorphones,
Intercoms, CCTV Tools
and Components,
Accessories for TV,
Video, Hi-Fi, Telephones,
Audio and Computer.

Quantity Discounts - TYPE 2

5 + less	10 + less	20%
20 + less	50 + less	35%

U.K. Carriage etc. extra at cost

HENRY'S AUDIO ELECTRONICS

404 Edgware Road, London W2 1ED. Tel: 071-723 1008

- Open 6 days a week for callers and Telephone orders
- Trade, retail and export supplied
- Quantity Enquiries Tel: 071-258 1831
- FAX: 071-724 0322

ALL NEW COLOUR 350 PAGE CATALOGUE
Send 64 SAE (UK stamp £2.65)
Callers £2.00
Free to Trade/Education
(Written Request)

Peerless CC FORCE

 Wilmslow Audio's NEW range of speaker kits from Peerless.

This new range of four kits utilise CC technology drive units for optimum performance.

The kit contains all the cabinet components (accurately machined from smooth MDF for easy assembly).

Pictured here the Force 6, a large floor standing design.

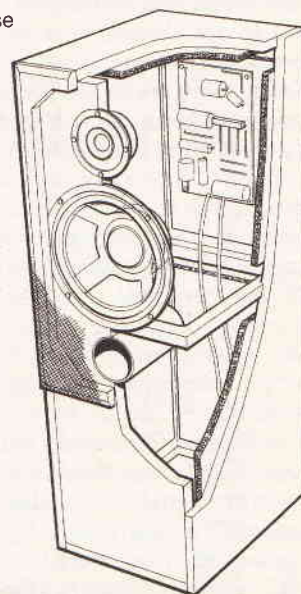

Dimensions:
800 x 275 x 335 mm
Response:
32 HZ - 20 KHZ
AMP Suitability: 30 - 120w
Impedence: 8 ohms

Price	carr./ins
Force 2 £167	£15 pr.
Force 4 £190	£15 pr.
Force 6 £210	£18 pr.
Force 8 £265	£18 pr.

All kits are available in Plus and Basic forms.

Wilmslow Audio

Wellington Close,
Parkgate Trading Estate
Knutsford, Cheshire
WA16 8DX
Tel: (0565) 650605
Fax: (0565) 650080

DIY Speaker catalogue £1.50
post free (export £3.50)



Telephone credit card
orders welcome



An Op-amp Parameter Display Chart

By Bryan Hart

The accompanying chart has been devised with two main objectives: to make the definition of Operational Amplifier parameters more appetizing and informative than is possible with the mere word-statements in textbooks and manuals; to produce as a pictorial check-list for assessing the likely effect of device parameters in a 'new' op-amp application. Most of the chart is self-explanatory, but bear in mind the following points.

The DC bias and peak-amplitude quantities are represented by upper case letters with upper case subscripts, if required. Thus V_{CC+} specifies the more positive of the two op-amp rail supplies. Small-signal quantities representing changes about bias conditions are shown by lower case letters with lower case subscripts, eg i_b for increment in bias current. The symbol Δ indicates a change that is not necessarily small.

Total instantaneous quantities are represented by a lower case symbol with an upper case subscript (eg v_G for signal generator output).

A given parameter is sometimes specified in manufacturers' data sheets and application notes by a variety of symbols. While it is not claimed that all possible choices have been exhausted, the common ones are listed in Column A.

Rail supplies are shown for reference in B1. However, V_{CC+} and V_{CC-} are omitted for clarity from Column B where they are not directly involved in parameter definition.

Column D shows straight line ('piece-wise linear') approximations to characteristics that are not always precisely linear. Any practical departure from linearity is only likely to affect critical, state-of-the-art, applications.

All the parameters are to some degree temperature-dependent but only those whose temperature sensitivity is likely to cause application problems are normally specified in data sheets by a temperature coefficient (TC). For an arbitrary parameter X, $TCX = \Delta X / \Delta T$ for a specified ΔT . Relevant TCs are shown as Related Parameters (RP) in the boxes of Column E.

Typical parameter data for the op-amp type 741 are listed in Column F because of the widespread popularity of this industry standard. The data refers to $V_{CC+} = +15v$, $V_{CC-} = -15v$, $T = 25^\circ C$, unless otherwise stated.

NGS means not generally specified.

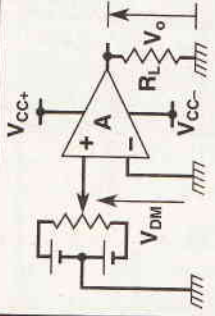
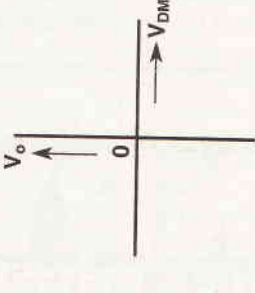
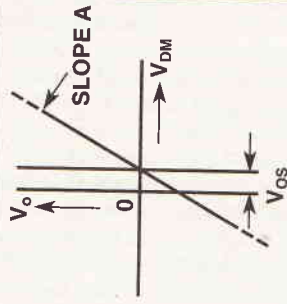
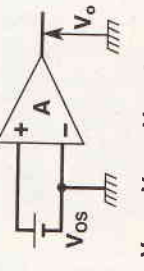
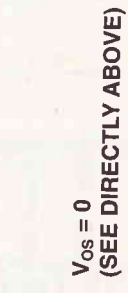

Since integrated amplifiers first became available over twenty-five years ago, special op-amps have been developed to optimize groups of related parameters, i.e. to produce characteristics resembling those in Column C. This helps to explain the wide variety of op-amps available. It is not possible, with current monolithic IC technology to optimize all parameters simultaneously.

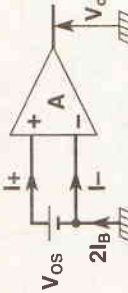
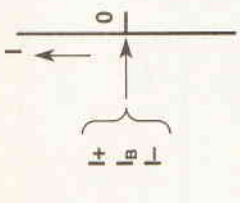
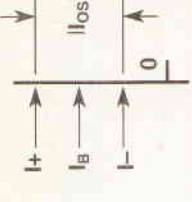
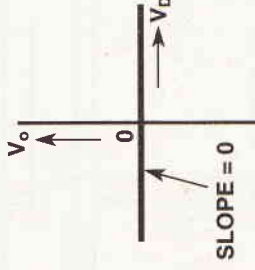
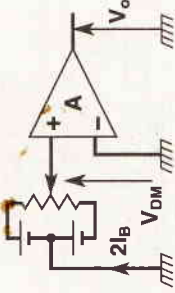
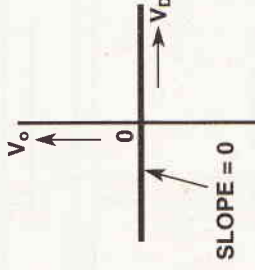
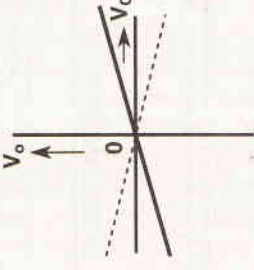
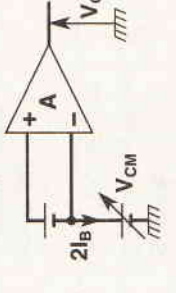
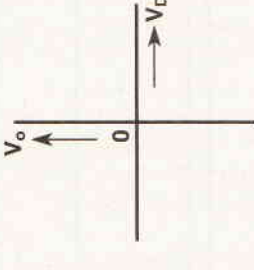
A	B	C	D	E	F
PARAMETERS & SYMBOL(S)	DEFINING CONDITIONS	IDEAL O.A.	IDEAL O.A.	COMMENTS	741
1 VOLTAGE GAIN $A, A_V, A_{VO}, A_{VOL}, A_D, A_{DM}, A_{VD}$	 <p>$A = \Delta V_O / \Delta V_{DM}$ for specified R_L (min)</p>			ALSO KNOWN AS: LARGE SIGNAL GAIN; DIFFERENTIAL GAIN; DC GAIN; OPEN-LOOP VOLTAGE GAIN.	200,000 OR, 200V/mV OR, 106dB FOR $R_L \geq 2k\Omega$
2 (INPUT) OFFSET VOLTAGE V_{OS}, V_{IO}, V_{IS}	 <p>$V_{DM} = V_{OS}; V_O = 0; R_L = \infty$</p>	 <p>$V_{OS} = 0$ (SEE DIRECTLY ABOVE)</p>	DEFINED ABOVE, 1D	SHOWN, ARBITRARILY, AS POSITIVE $ V_{OS} $, ONLY, SPECIFIED R.P. $TCV_{OS} = \Delta V_{OS} / \Delta T$	1mV N.G.S.

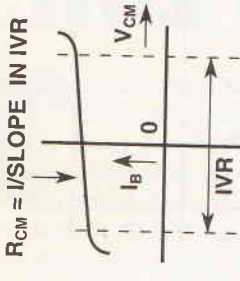
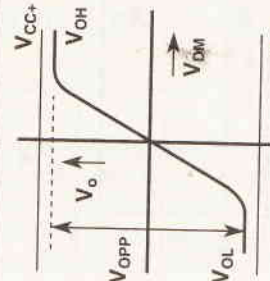
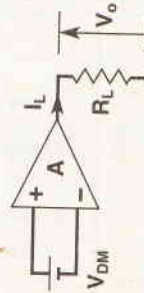
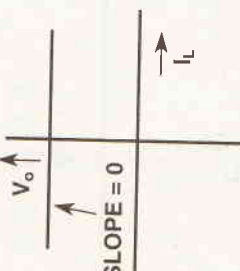
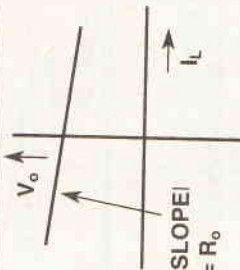
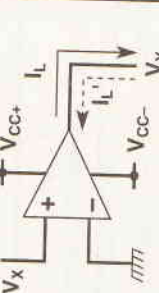
3	<p>INPUT (BIAS) CURRENT</p> <p>I_B, I_{B+}, I_{B-}</p>	 <p>V_{OS}</p> <p>$2I_B$</p> <p>$I_B = (I_+ + I_-)/2$</p> <p>$V_{DM} = V_{OS}; V_O = 0; R_L = \infty$</p>	 <p>0</p>	 <p>I_+ SHOWN GREATER THAN I_-, BUT COULD BE LESS</p>	<p>$I_B > 0$ FOR BIPOLAR TRANSISTOR O.A.s BUT CAN BE < 0 FOR F.E.T. O.A.s</p> <p>R.P. $TC_{I_B} = \Delta I_B / \Delta T$</p>	80nA
4	<p>INPUT OFFSET CURRENT</p> <p>I_{OS}, I_{OFFSET}</p>	<p>AS ABOVE, 3B.</p> <p>$I_{OS} = I_+ - I_-$</p>	 <p>SLOPE = 0</p>	<p>AS ABOVE, 3D</p>	<p>MAGNITUDE, ONLY, SPECIFIED TYPICALLY, $I_{OS} \sim I_B/5$</p> <p>R.P. $TC_{I_{OS}} = \Delta I_{OS} / \Delta T$</p>	20nA
5	<p>INPUT RESISTANCE (DIFFERENTIAL MODE)</p> <p>R_{IN}, R_{DM}, T_i</p>	 <p>$R_{DM} = \Delta V_{DM} / \Delta I_B$</p>	 <p>SLOPE = I / R_{DM}</p>	 <p>V_{CM}</p>	<p>R.P. INPUT IMPEDANCE, Z_i $Z_i = (V_{DM}/I_B)$ AND IS FREQUENCY DEPENDENT</p>	2M Ω
6	<p>COMMON-MODE (VOLTAGE) GAIN</p> <p>A_{CM}</p>	 <p>$V_{DM} = V_{OS}$ SO $V_O = 0$ FOR $V_{CM} = 0$</p> <p>$A_{CM} = \Delta V_O / \Delta V_{CM}$</p>	 <p>V_{CM}</p>	<p>AS ABOVE, AND 1B</p> <p>$\rho = A_{CM} / A_{DM}$ USUALLY EXPRESSED IN dB</p>	<p>A_{CM} CAN BE > 0 OR < 0. SIGN NOT IMPORTANT IN PRACTICE ONLY A_{CM}</p>	N.G.S. (BUT, CAN BE ESTIMATED FROM 1F AND 7F)
7	<p>COMMON-MODE REJECTION RATIO</p> <p>CMRR, ρ</p>	<p>AS ABOVE, AND 1B</p> <p>$\rho = A_{CM} / A_{DM}$ USUALLY EXPRESSED IN dB</p>	<p>∞</p>	<p>VALUE GIVEN IS FOR D.C. AND L.F. ρ IS FREQUENCY-DEPENDENT LIKE A_{DM} (SEE 15D)</p>	<p>N.G.S.</p>	90dB

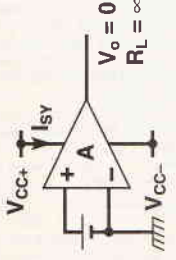
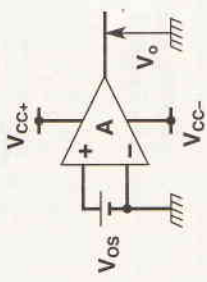
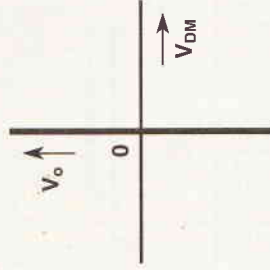
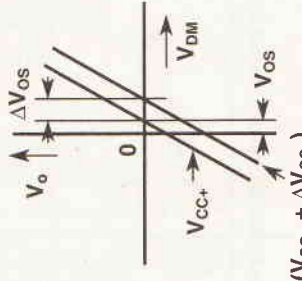
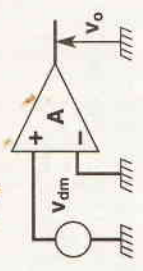
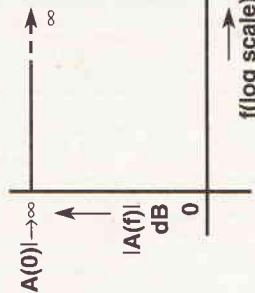
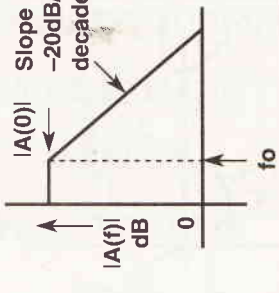
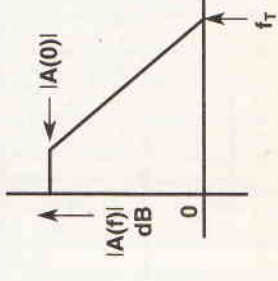
8	COMMON-MODE RANGE (INPUT VOLTAGE RANGE) IVR	SEE 6B INPUT RANGE FOR LINEAR OPERATION	∞	 <p>$R_{CM} = 1/\text{SLOPE IN IVR}$</p>	—	-13V → +13V
9	COMMON-MODE INPUT RESISTANCE R_{CM}	SEE 6B $R_{CM} = \Delta V_{CM} / \Delta I_B$	∞		R.P. $Z_{cm} = V_{cm} / i_b$	N.G.S. N.G.S.
10	OUTPUT VOLTAGE RANGE V_{OPP}	(SEE 1B) OUTPUT SWING, SYMMETRICAL ABOUT $V_o = 0$, BEFORE (QUOTED) DISTORTION OCCURS. R_L SPECIFIED	∞		POSITIVE AND NEGATIVE SATURATION LIMITS, V_{OH} , V_{OL} RESPECTIVELY, ARE APPROX 1V5 FROM POWER SUPPLY RAILS FOR BIPOLAR O.A.S	26V ($R_L = 2k\Omega$)
11	(OPEN-LOOP) OUTPUT RESISTANCE R_o	 <p>$R_o = \Delta V_o / \Delta I_L$ AT QUOTED V_o, I_L, IN OUTPUT VOLTAGE RANGE</p>	 <p>SLOPE = 0</p>	 <p> SLOPE = R_o</p>	PULSE MEASUREMENTS MINIMISE THERMAL EFFECTS	75 Ω ($V_o = 0V$)
12	SHORT-CIRCUIT OUTPUT CURRENT I_{sc}	 <p>$I_L \leq I_{sc}$ $V_X = V_{CC+}$ $-V_{CC-} \leq V_Y \leq 0$</p> <p>$I_L' \leq I_{sc}$ $V_X = V_{CC-}$ $V_{CC+} \leq V_Y \leq 0$</p>	∞		R.P. $P_{D(MAX)}$ (SEE 13E)	25mA

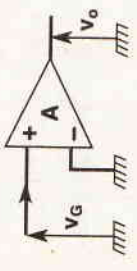
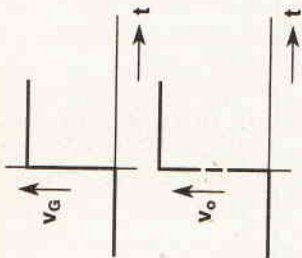
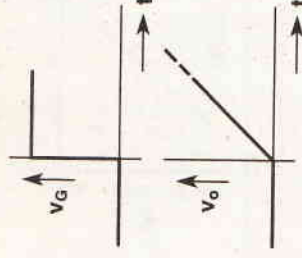
13	(TOTAL) POWER DISSIPATION P_D	 <p>V_{CC+}, V_{CC-}, V_o, I_{Sy}, $R_L = \infty$</p>	∞	$P_D = 2V_{CC+} I_{Sy}$ FOR $ V_{CC-} = V_{CC+} $	N.B. SPECIFIED FOR $V_o = 0, I_L = 0$ R.P. $P_{D(MAX)} \geq I_L V_{CC(MAX)} $	50mW 500mW ($\leq 55^\circ C$)
14	POWER SUPPLY REJECTION RATIO PSRR	 <p>V_{CC+}, V_{CC-}, V_o, V_{DM}</p> $PSRR = \Delta V_{CC+} / \Delta V_{OS} $		 <p>ΔV_{OS}, V_o, V_{CC+}, V_{CC-}, V_{DM}, V_{OS} ($V_{CC+} + \Delta V_{CC+}$)</p>	NORMALLY DEFINED FOR A SYMMETRICAL VARIATION IN V_{CC+} AND V_{CC-} R.P. POWER SUPPLY SENSITIVITY PSS $PSS = 1/PSRR$	90dB 30 μ V/V
15	FREQUENCY RESPONSE $A(f)$	 <p>V_{CC+}, V_{CC-}, V_o, V_{dm}</p> $ A(f) = V_o / V_{dm} $ $\angle A(f) = \angle V_o / \angle V_{dm}$	 <p>$A(0) \rightarrow \infty$, $A(f)$ dB, f (log scale)</p>	 <p>Slope -20dB/decade, $A(0)$, $A(f)$ dB, f_o</p>	← ASYMPTOTIC BODE GAIN PLOT FOR USUAL CASE OF A SINGLE POLE RESPONSE REALTED CURVE IS BODE PHASE PLOT	~10Hz
	SMALL SIGNAL BANDWIDTH; -3dB BANDWIDTH; OPEN-LOOP BANDWIDTH f_o	SEE ABOVE, 15B	∞	SEE ABOVE, 15D	APPLIES ONLY FOR SMALL AMPLITUDE SIGNALS. (SEE 17 FOR LARGE SIGNAL CASE)	~1MHz
	UNITY-GAIN OPEN-LOOP BANDWIDTH; UNITY-GAIN CROSSOVER FREQUENCY; GAIN-BANDWIDTH PRODUCT f_u, f_r, GBW	SEE ABOVE, 15B	∞	 <p>$A(0)$, $A(f)$ dB, f_T</p>	$f_r = A(0)f_o$, FOR SINGLE POLE RESPONSE	~1MHz

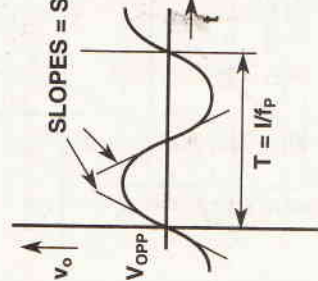
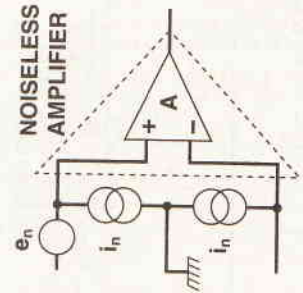
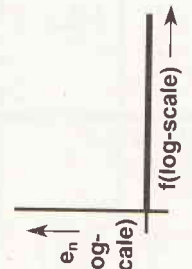
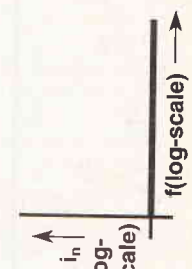
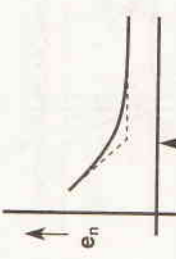
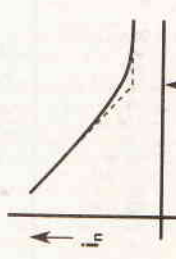
16	<p>SLEW(ING) RATE S, SR</p>	 <p>$S = \Delta v_O \Delta t_{MAX}$ FOR v_G 'LARGE' (e.g. 10V)</p>			<p>S APPLIES FOR FASTEST-GOING OUTPUT, POSITIVE-GOING OR NEGATIVE-GOING</p> <p>0V5/μs</p>	
17	<p>FULL-POWER BANDWIDTH: (FULL-POWER FREQUENCY; LARGE-SIGNAL BANDWIDTH) FPBW, f_p, f_{MP}</p>	 <p>SINEWAVE INPUT AMPLITUDE PRODUCES v_O (peak) = V_{OP} (SPECIFIED)</p>	<p>∞</p>		<p>N.G.S. (BUT) CALCULATE FROM S AND V_{OP}, ~6kHz FOR $V_O = 13V$</p>	
18	<p>INPUT NOISE VOLTAGE (SPECTRAL) DENSITY e_n (vs f)</p> <p>INPUT NOISE CURRENT (SPECTRAL) DENSITY i_n (vs f)</p>	 <p>NOISELESS AMPLIFIER</p>	 <p>e_n (log-scale) f (log-scale)</p>  <p>i_n (log-scale) f (log-scale)</p>	 <p>e_n f_{cc}</p>  <p>i_n f_{cc}</p>	<p>e_n IS r.m.s. NOISE VOLTAGE PER UNIT BANDWIDTH (1kHz) USUAL UNITS: nV/√Hz (f_{cc} = 'FLICKER' NOISE 'CORNER' FREQUENCY)</p> <p>N.G.S.</p>	<p>i_n IS r.m.s. NOISE CURRENT PER UNIT BANDWIDTH (1kHz) USUAL UNITS: pA/√Hz (f_{cc} = 'FLICKER' NOISE 'CORNER' FREQUENCY)</p> <p>N.G.S.</p>

UNIDEN SATELLITE RECEIVER Brand new units (model 8008) £60.00 ref 60P4Y also some 7007s also £60.00 ref 60P5Y

SPECTRUM +2 COMPUTER Built in data recorder, 128K, psu and manuals £59.00 ref 59P4Y

SPECTRUM +3 COMPUTER Built in disc drive, 128K, psu and manuals £79.00 ref 79P4Y

AMSTRAD CPC464 COMPUTER No manuals but only £79.00 ref 79P5Y

AMSTRAD CPC6128 COMPUTER Again no manuals but only £149.00 ref 149P4Y

AMSTRAD GT65 Green screen monitor £49.00 ref 49P4Y

AMSTRAD PORTABLE PC'S FROM £149 (PPC1512SD). £179 (PPC1512DD), £179 (PPC1640SD), £209 (PPC1640DD), MODEMS £30 EXTRA. NO MANUALS OR PSU.

AMSTRAD PC BARGAIN!!!!!! PC 1512DD COMPLETE WITH CGA COLOUR MONITOR, 2 DISC DRIVES, MANUALS ETC ONLY £249.00 REF 249P4Y

HIGH POWER CAR SPEAKERS. Stereo pair output 100w each. 4ohm impedance and consisting of 6 1/2" woofer 2" mid range and 1" tweeter. Ideal to work with the amplifier described above. Price per pair £30.00 Order ref 30P7Y

2KV 500 WATT TRANSFORMERS Suitable for high voltage experiments or as a spare for a microwave oven etc. 250v AC input. £10.00 ref 10P93Y

MICROWAVE CONTROL PANEL. Mains operated, with touch switches. Complete with 4 digit display, digital clock, and 2 relay outputs one for power and one for pulsed power (programmable). Ideal for all sorts of precision timer applications etc. £6.00 ref 6P18Y

FIBRE OPTIC CABLE. Stranded optical fibres sheathed in black PVC. Five metre length £7.00 ref 7P29Y

12V SOLAR CELL 200mA output ideal for trickle charging etc. 300 mm square. Our price £15.00 ref 15P42Y

PASSIVE INFRA-RED MOTION SENSOR. Complete with daylight sensor, adjustable lights on timer (8 secs -15 mins), 50' range with a 90 deg coverage. Manual override facility. Complete with wall brackets, bulb holders etc. Brand new and guaranteed. £25.00 ref 25P24Y

Pack of two PAR38 bulbs for above unit £12.00 ref 12P43Y

VIDEO SENDER UNIT Transmit both audio and video signals from either a video camera, video recorder or computer to any standard TV set within a 100' range! (tube TV to a spare channel). 12v DC op. £15.00 ref 15P39Y suitable mains adaptor £5.00 ref 5P191Y

FM TRANSMITTER housed in a standard working 13A adaptor (bug is mains driven). £26.00 ref 26P2Y

MINIATURE RADIO TRANSCEIVERS A pair of walkie talkies with a range of up to 2 Kilometres. Units measure 22x52x155mm. Complete with cases. £30.00 ref 30P12Y

FM CORDLESS MICROPHONE. Small hand held unit with a 500' range! 2 transmit power levels reqs PP3 battery. Tuneable to any FM receiver. Our price £15 ref 15P42AY

10 BAND COMMUNICATIONS RECEIVER. 7 short bands, FM, AM and LW DX/local switch, tuning eye/ mains or battery. Complete with shoulder strap and mains lead. NOW ONLY £19.00!! REF 19P14Y.

WHISPER 2000 LISTENING AID. Enables you to hear sounds that would otherwise be inaudible! Complete with headphones. Cased. £5.00 ref 5P179Y

CAR STEREO AND FM RADIO! Low cost stereo system giving 5 watts per channel. Signal to noise ratio better than 45db. wow and flutter less than .35%. Neg earth. £25.00 ref 25P21Y

LOW COST WALKIE TALKIES. Pair of battery operated units with a range of about 150'. Our price £8.00 a pair ref 8P50Y

7 CHANNEL GRAPHIC EQUALIZER plus a 60 watt power amp! 20-21KHZ 4-8R 12-14V DC negative earth. Cased. £25 ref 25P14Y

NICAD BATTERIES. Brand new top quality. 4 x AA's £4.00 ref 4P44Y. 2 x C's £4.00 ref 4P73Y, 4 x D's £9.00 ref 9P12Y, 1 x PP3 £6.00 ref 6P35Y

TOWERS. INTERNATIONAL TRANSISTOR SELECTOR GUIDE. The ultimate equivalent book. Latest edition £20.00 ref 20P32Y

CABLE TIES. 142mm x 3.2mm white nylon pack of 100 £3.00 ref 3P104Y. Bumper pack of 1,000 ties £14.00 ref 14P6Y

VIDEO AND AUDIO MONITORING SYSTEM



£99.00

Brand new units consisting of a camera, 14cm monitor, 70 metres of cable, AC adaptor, mounting bracket and owners manual. 240v AC or 12v DC operation complete with built in 2 way intercom. £99.00 ref 99P2Y

1991 CATALOGUE AVAILABLE NOW IF YOU DO NOT HAVE A COPY PLEASE REQUEST ONE WHEN ORDERING OR SEND US A 6"x9" SAE FOR A FREE COPY.

GEIGER COUNTER KIT. Complete with tube, PCB and all components to build a battery operated geiger counter. £39.00 ref 39P1Y

FM BUG KIT. New design with PCB embedded coil. Transmits to any FM radio. 9v battery req'd. £5.00 ref 5P158Y

FM BUG Built and tested superior 9v operation. £14.00 ref 14P3Y

COMPOSITE VIDEO KITS. These convert composite video into separate H sync, V sync and video. 12v DC. £8.00 ref 8P39Y

SINCLAIR C5 MOTORS 12v 29A (full load) 3300 rpm 6"x4" 1/4"

O/P shaft. New. £20.00 ref 20P22Y

As above but with fitted 4 to 1 inline reduction box (800rpm) and toothed nylon belt drive cog £40.00 ref 40P8Y

SINCLAIR C5 WHEELS! 3" or 16" dia including treaded tyre and inner tube. Wheels are black, spoked one piece poly carbonate. 13" wheel £6.00 ref 6P20Y, 16" wheel £6.00 ref 6P21Y

ELECTRONIC SPEED CONTROL KIT for c5 motor. PCB and all components to build a speed controller (0-95% of speed). Uses pulse width modulation. £17.00 ref 17P3Y

SOLAR POWERED NICAD CHARGER. Charges 4 AA nicads in 8 hours. Brand new and cased £6.00 ref 6P3.

**AT 286 MOTHERBOARD
640K RAM
UPGRADABLE TO 4M
AT CASE
AT POWER SUPPLY
AT KEYBOARD
MANUAL
NO I/O CARDS
£139**

JOYSTICKS Brand new with 2 fire buttons and suction feet these units can be modified for most computers by changing the connector etc. Price is 2 for £5.00 ref 5P174Y

GAS POWERED SOLDERING IRON AND BLOW TORCH Top quality tool with interchangeable heads and metal body. Fully adjustable, runs on lighter gas. £10.00 ref 10P130Y

ANSWER MACHINES BT approved remote message playback, intergal push button phone, power supply and tape. Exceptional value at £45.00 ref 45P2Y

CAR IONIZER KIT Improve the air in your car! clears smoke and helps to reduce fatigue. Case required. £12.00 ref 12P8Y

12 TO 220V INVERTER KITAS supplied it will handle up to about 15 watt 220v but with a larger transformer it will handle 80 watts. Basic kit £12.00 ref 12P17Y. Larger transformer £12.00 ref 12P41Y

VERO EASY WIRE PROTOTYPING SYSTEM Ideal for designing projects on etc. Complete with tools, wire and reusable board. Our price £6.00 ref 6P33Y

MICROWAVE TURNABLE MOTORS. Ideal for window displays etc. £5.00 ref 5P165Y

STC SWITCHED MODE POWER SUPPLY 220v or 110v input giving 5v at 2A, +24v at 0.25A, +12v at 0.15A and +90v at 0.4A £6.00 ref 6P59Y

HIGH RESOLUTION 12" AMBER MONITOR! 2v 1.5A Hercules compatible (TTL input) new and cased £22.00 ref 22P2Y

VGA PAPER WHITE MONO monitors new and cased 240v AC. £59.00 ref 59P4Y

25 WATT STEREO AMPLIFIER. c. STK043. With the addition of a handful of components you can build a 25 watt amplifier. £4.00 ref 4P69Y (Circuit dia included)

LINEAR POWER SUPPLY. Brand new 220v input +5 at 3A, +12 at 1A, -12 at 1A. Short circuit protected. £12.00 ref 12P21Y

MAINS FANS. Snail type construction. Approx 4"x5" mounted on a metal plate for easy fixing. New £5.00 5P166Y

POWERFUL IONIZER KIT. Generates 10 times more ions than commercial units! Complete kit including case £18.00 ref 18P2Y.

MINI RADIO MODULE Only 2" square with ferrite aerial and tuner. Superhet. Req's PP3 battery £1.00 ref BD716Y

HIGH RESOLUTION MONITOR! "s" black and white Philips tube in chassis made for OPD computer but may be suitable for others. £20.00 ref 20P26Y

BARGAIN NICADS AAA SIZE 200MAH 1.2V PACK OF 10 £4.00 REF 4P92Y, **PACK OF 100** £30.00 REF 30P16Y

CB CONVERTORS. Converts a car radio into an AM CB receiver. Cased with circuit diagram. £4.00 ref 4P48Y

FLOPPY DISCS. Pack of 15 31/2" D5DD £10.00 ref 10P88Y. Pack of 10 5 1/4" D5DD £5.00 ref 5P168Y.

BULL ELECTRICAL
250 PORTLAND ROAD HOVE SUSSEX
BN3 5QT TELEPHONE 0273 203500
MAIL ORDER TERMS: CASH PO OR CHEQUE
WITH ORDER PLUS £2.50 POST PLUS VAT.
PLEASE ALLOW 10-14 DAYS FOR DELIVERY

NEXT DAY DELIVERY £8.00

FAX 0273 23077

SONIC CONTROLLED MOTOR One click to start, two click to reverse direction, 3 click to stop! £3.00 each ref 3P137Y

FRESNEL MAGNIFYING LENS 83 x 52mm £1.00 ref BD827Y

LCD DISPLAY. 4 1/2 digits supplied with connection data £3.00 ref 3P77Y or 5 for £10.00 ref 10P78Y

ALARM TRANSMITTERS. No data available but nicely made complex transmitters 9v operation. £4.00 each ref 4P81Y

100M REEL OF WHITE BELL WIRE figure 8 pattern ideal for intercoms, door bells etc £3.00 a reel ref 3P107Y

TRANSMITTER RECEIVER SYSTEM Originally made for nurse call systems they consist of a pendant style transmitter and a receiver with telescopic aerial 12v. 80 different channels. £12.00 ref 12P26Y

CLAP LIGHT. This device turns on a lamp at a finger 'snap' etc. nicely cased with built in battery operated light. Ideal bedside light etc £4.00 each ref 4P82Y

ELECTRONIC DIPSTICK KIT. Contains all you need to build an electronic device to give a 10 level liquid indicator. £5.00 (ex case) ref 5P194Y

UNIVERSAL BATTERY CHARGER. Takes AA's, C's, D's and PP3 nicads. Holds up to 5 batteries at once. New and cased, mains operated. £6.00 ref 6P36Y

ONE THOUSAND CABLE TIES! 175mm x 2.4mm white nylon cable ties only £5.00 ref 5P181Y

PC MODEMS 1200/75 baud modems designed to plug into a PC complete with manual but no software £18.00 ref 18P12Y

ASTEC SWITCHED MODE POWER SUPPLY 80mm x 165mm (PCB size) gives +5 at 3.75A, +12 at 1.5A, -12 at 0.4A. Brand new £12.00 ref 12P39Y

VENTILATED CASE FOR ABOVE PSU with IEC filtered socket and power switch. £5.00 ref 5P190Y

IN CAR POWER SUPPLY. Plugs into cigar socket and gives 3.4, 5, 6, 7, 9, and 12v outputs at 800mA. Complete with universal spider plug. £5.00 ref 5P167Y

CUSTOMER RETURNED switched mode power supplies. Mixed type, good for spares or repair. £2.00 each ref 2P292Y

DRILL OPERATED PUMP. Fits any drill and is self priming. £3.00 ref 3P140Y

PERSONAL ATTACK ALARM. Complete with built in torch and vanity mirror. Pocket sized, req's 3 AA batteries. £3.00 ref 3P135Y

POWERFUL SOLAR CELL 1AMP .45 VOLT only £5.00 ref 5P192Y (other sizes available in catalogue)

SOLAR PROJECT KIT. Consists of a solar cell, special DC motor, plastic fan and turntables etc plus a 20 page book on solar energy! Price is £8.00 ref 8P51Y

RESISTOR PACK. 10 x 50 values (500 resistors) all 1/4 watt 2% metal film. £5.00 ref 5P170Y

CAPACITOR PACK 1.100 assorted non electrolytic capacitors £2.00 ref 2P286Y

CAPACITOR PACK 2. 40 assorted electrolytic capacitors £2.00 ref 2P287Y

QUICK CUPPA? 12v immersion heater with lead and cigar lighter plug £3.00 ref 3P92Y

LED PACK. 50 red leds, 50 green leds and 50 yellow leds all 5mm £8.00 ref 8P52Y

FERRARI TESTAROSSA. A true 2 channel radio controlled car with forward, reverse, 2 gears plus turbo Working headlights. £22.00 ref 22P6Y

ULTRASONIC WIRELESS ALARM SYSTEM two units, one a sensor which plugs into a 13A socket in the area you wish to protect. The other, a central alarm unit plugs into any other socket elsewhere in the building. When the sensor is triggered (by body movement etc) the alarm sounds. Adjustable sensitivity. Price per pair £20.00 ref 20P34Y. Additional sensors (max 5 per alarm unit) £11.00 ref 11P6Y

WASHING MACHINE PUMP. Mains operated new pump. Not self priming. £5.00 ref 5P18Y

IBM PRINTER LEAD. (D25 to centronics plug) 2 metre parallel. £5.00 ref 5P186Y

COPPER CLAD STRIP BOARD 17" x 4" of 1" pitch "vero" board. £4.00 a sheet ref 4P62Y or 2 sheets for £7.00 ref 7P22Y

STRIP BOARD CUTTING TOOL. £2.00 ref 2P352Y

3 1/2" disc drive. 720K capacity made by NEC £60.00 ref 60P2Y

TV LOUDSPEAKERS. 5 watt magnetically screened 4 ohm 55 x 125mm. £3.00 a pair ref 3P109Y

SPEAKER GRILLS set of 3 matching grills of different diameters. 2 packs for £2.00 (6 grills) ref 2P364Y

50 METRES OF MAINS CABLE £3.00 2 core black pre-cut in convenient 2 m lengths. Ideal for repairs and projects. ref 3P91

4 CORE SCREENED AUDIO CABLE 24 METRES £2.00 Pre-cut into convenient 1.2 m lengths. Ref 2P365Y

TWEETERS 2 1/4" DIA 8 ohm mounted on a smart metal plate for easy fixing £2.00 ref 2P366Y

COMPUTER MICE Originally made for Future PC's but can be adapted for other machines. Swiss made £8.00 ref 8P57Y. Atari ST conversion kit £2.00 ref 2P362Y

6 1/2" 20 WATT SPEAKER Built in tweeter 4 ohm £5.00 ref 5P205Y

5" X 3" 16 OHM SPEAKER 3 for £1.00! ref CD213Y

ADJUSTABLE SPEAKER BRACKETS Ideal for mounting speakers on internal or external corners, uneven surfaces etc. 2 for £5.00 ref 5P207Y

PIR LIGHT SWITCH Replaces a standard light switch in seconds. Light operates when anybody comes within detection range (4m) and stays on for an adjustable time (15 secs to 15 mins). Complete with daylight sensor. Unit also functions as a dimmer switch! 200 watt max. Not suitable for fluorescents. £14.00 ref 14P10Y

2 MEG DISC DRIVES 3 1/2" disc drives made by Sony housed in a 5 1/4" frame 1 2 meg formatted. £66.00 ref 66P1Y

CUSTOMER RETURNED 2 channel full function radio controlled cars only £8.00 ref 8P200Y

WINDUP SOLAR POWERED RADIO! FM/AM radio takes NICAD batteries complete with hand charger and solar panel 14P200Y

240 WATT RMS AMP KIT Stereo 30-0-30 psu required £40.00 ref 40P200Y

300 WATT RMS MONO AMP KIT £55.00 Psu required ref 55P200Y

ALARM PIR SENSORS Standard 12v alarm type sensor will interface to most alarm panels. £16.00 ref 16P200Y

ALARM PANELS 2 zone cased keypad entry, entry exit time delay etc. £18.00 ref 18P200Y

38MM CAMERAS Customer returned units with built in flash and 28mm lens 2 for £8.00 ref 8P200Y

STEAM ENGINE Standard Mamod 1332 engine with boiler piston etc £30 ref 30P200Y

Power On And Overload Indicators

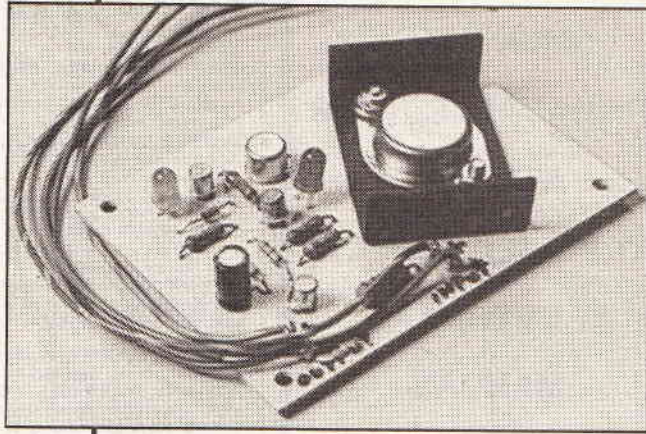

JR Nowicki reports on the discrete component side of regulation

Although discrete component regulators are considered to be out of date by many in the electronics world they still represent an attractive method of providing the supplies for a number of electronic equipment and experimental circuits. The basic regulator is shown in Figure 1. Its continued popularity in spite of the many integrated regulators readily available, stems from the design simplicity and the ease of construction for power supplies, which are often required for non standard voltage or current levels, for which standard integrated circuit regulators are not available.

Figure 1 shows a two transistor series regulator. The circuit consists of a zener diode reference Dz and a transistor comparator amplifier Q2 controlling the series transistor regulator Q1. This basic circuit suffers from the disadvantage that the output voltage is affected by the output current and input voltage variations, so the circuit has poor regulation. The regulation can be greatly improved by feeding the zener diode from the regulated output. This is achieved by connecting the resistor R1 to the emitter side of the series regulator transistor Q1 and replacing the resistor R2 by a constant current source as shown in Figure 2.

Figure 2 highlights an improved series regulator. Both circuits shown can easily be damaged by acciden-

tal overloads or short circuit and therefore a form of protection circuit is usually incorporated into the design. In addition to over current protection sometimes an over voltage protection is also included, but more often some kind of indication is required for power on and for overload condition. This can easily be fulfilled by the use of light emitting diodes (LEDs) as shown in Figure 3.

This circuit was designed to provide a constant output voltage of 5V at 500mA. The 2N3055 power transistor, Q1, is used as a series regulator together with a 2N3053 (or equivalent) transistor, Q2, connected as a darlington pair. The combination reduces the current on the control circuit and allows an LED to be used as a reference in place of a zener diode. The advantage of using an LED is that it can provide both, a good reference and at the same time it provides the power on indication. This function is performed by LED2, a green LED which provides a reference voltage of about 2V when operating at 12mA. The transistor Q4 is the usual comparator/error amplifier controlling the base current of the darlington pair. The transistor Q3 together with an LED1 and resistors R1 and R2 form the constant current feed for the series regulator. A red LED is used this time. The LED operates at about 150µA, therefore practically extinguished, nevertheless provides about 1.5V reference for the constant current transistor Q9.

The transistor Q5, diode D1 and the resistor R5 comprise the overload protection circuit. Finally, the resistor R3 together with LED1 provide an overload indication.

Normally, only the green LED is on when the power supply is in operation. Applying progressive overload the red LED begins to glow and the green LED is dimmed. Finally, as the progression to the short circuited output is complete the green LED turns off and the red LED is turned fully on. The short circuit current is approximately given by the base emitter saturation voltage $V_{be(sat)}/R5$, thus

$$I_{sc} = V_{be(sat)}/R5 = 0.7V/1R = 700mA$$

It is worth mentioning that the series transistor requires a heat sink since under the short circuit condition, with an input voltage of 10V there is about 7 watts power dissipation in the device. If the supply voltage is

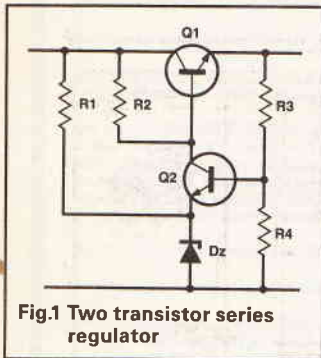

Fig.1 Two transistor series regulator

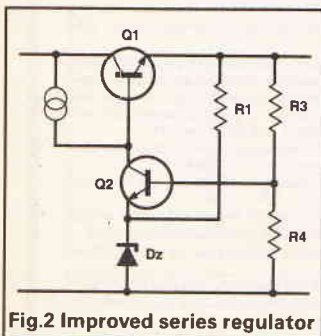

Fig.2 Improved series regulator

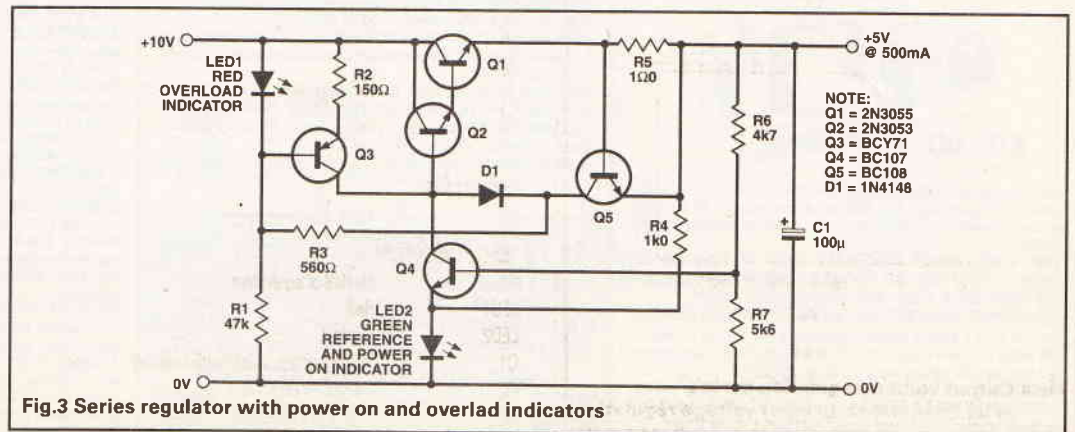

Fig.3 Series regulator with power on and overload indicators

increased to 20V the dissipation rises to 14 watts. Also, from the reliability point of view, the power rating of the load current monitoring resistor R5 should be of the order of 3W even though the maximum power dissipation is only about 0.5W.

The effectiveness of the LEDs as reference devices in regulator circuits is demonstrated in the load current (I_L) and input voltage (V_{in}) regulation curves shown in Figure 4a and 4b.

In order to enable an investigation of the circuit operation a printed circuit board artwork including the component layout are given in Figure 5.

A modified version of the series regulator circuit described above is shown in Figure 6. Here the comparator amplifier is in the form of a differential amplifier, transistors Q4(a) and Q4(b). The circuit has an advantage over the previous arrangement in that the reference diode current is kept constant and independent of the load current variations thus enabling further improvement in regulation for both the load current and the input voltage variations.

In addition to the above improvements the overload circuit is of the foldback type. The short circuit current is limited to approximately 100mA thus reducing the power dissipation in the series transistor under the overload condition.

Another variation of the series regulator incorporating power on and overload indicators is outlined in Figure 7. This time an op-amp is used as a comparator/error amplifier. This circuit was designed to provide an output voltage of 18V at a load current of 50mA.

Although the above circuits were designed for specific voltage and current levels the circuits can be easily modified for other voltages and currents. The output voltage can be adjusted by suitably altering the value of the resistor R6 and the current limit can be set by changing the value of the current monitoring resistor.

All the above circuits provide useful ideas for monitoring power on and overload protection which can be extended to include an indication of over voltage protection.

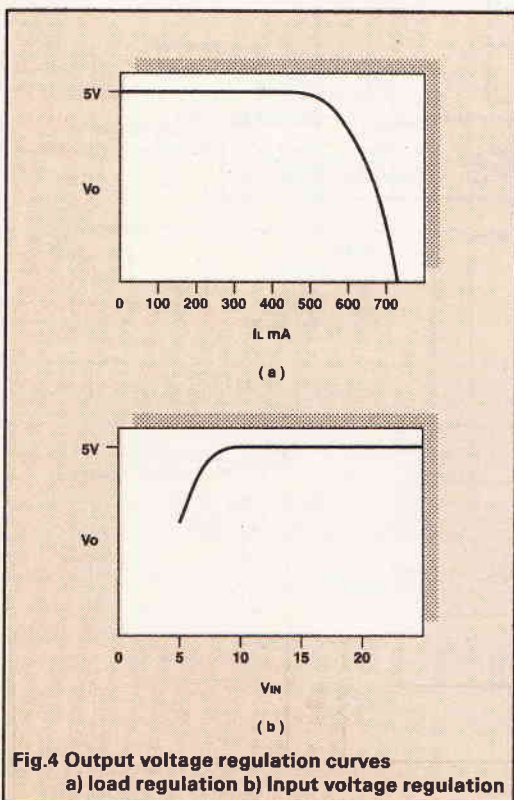

Fig.4 Output voltage regulation curves
a) load regulation b) Input voltage regulation

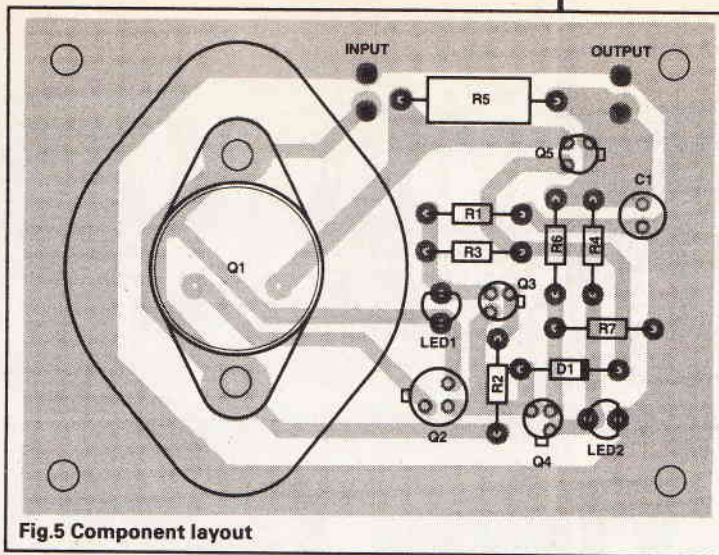

Fig.5 Component layout

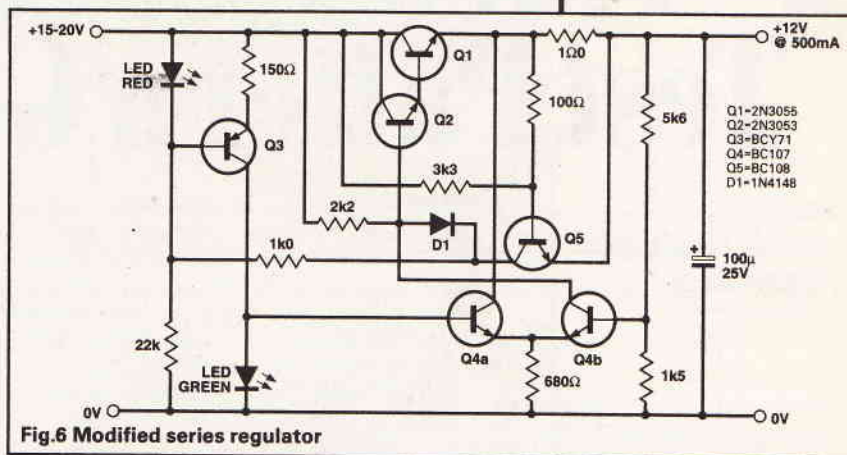

Fig.6 Modified series regulator

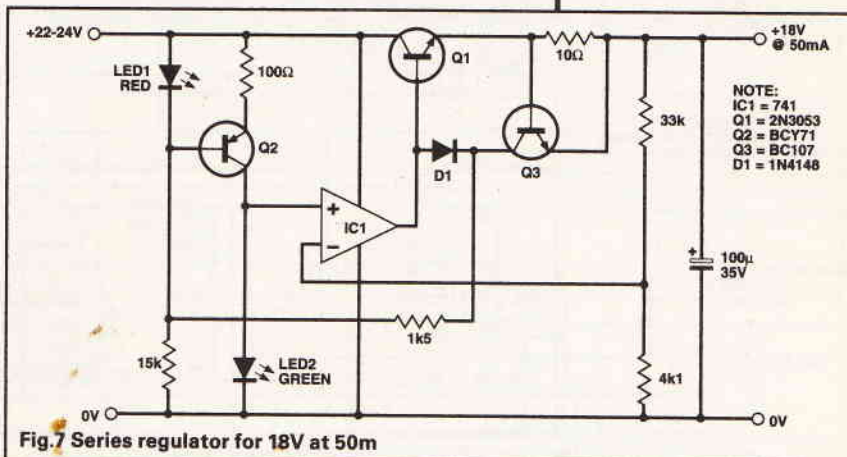

Fig.7 Series regulator for 18V at 50m

PARTSLIST

RESISTORS

R1	47k
R2	150R
R3	560R
R4	1k
R5	1R0,WW,3W
R6	4k7
R7	5k1

CAPACITORS

C1	100μ/16V Electrolytic
----	-----------------------

SEMICONDUCTORS

D1	1N4148 or equivalent
LED1	Red
LED2	Green
Q1	2N3055 or equivalent with heatsink
Q2	2N3053 or equivalent
Q3	BCY71 or equivalent
Q4	BC107 or equivalent
Q5	BC108 or equivalent

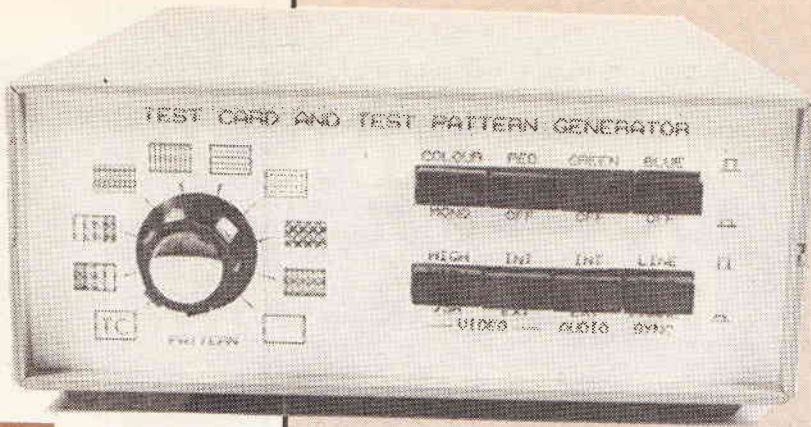

comprehensive is really required. The instrument featured here provides an impressive range of patterns including a full colour Test-Card, colour bars, cross-hatch, grey-scale, focus grip, colour purity patterns and more — for considerably less cost than a commercial unit of lower specification!

The unit also features a basic sine-wave audio oscillator, set at 800Hz. The audio oscillator, set at 800Hz. The audio and video outputs are available from the audio and video output sockets and, for more modern equipment, the SCART socket. An RF modulator is provided for connection to the aerial socket of UK standard Televisions and Video

1 Video Test Card And Test Pattern Generator

Paul Stenning introduces an invaluable aid to TV servicing.

There have been several designs of test pattern generators published in the past, invariably they produce the standard cross-hatch pattern, possibly horizontal and vertical lines, and may be a grey-scale. Most current designs are based around the ZNA234E monochrome test pattern generator IC.

This is adequate for monochrome (black and white) equipment, however for servicing colour televisions and video recorders, something a little more

Recorders (readers in other countries using the PAL standard may need to obtain a suitable type of modulator locally). The audio and video signals to the modulator are individually switchable to either the internally generated signals or to the external audio and video input and SCART sockets.

A Scope Trigger Output socket is provided to give reliable triggering on an oscilloscope when trying to view the video signals, the output from this can be switched to either line or frame sync.

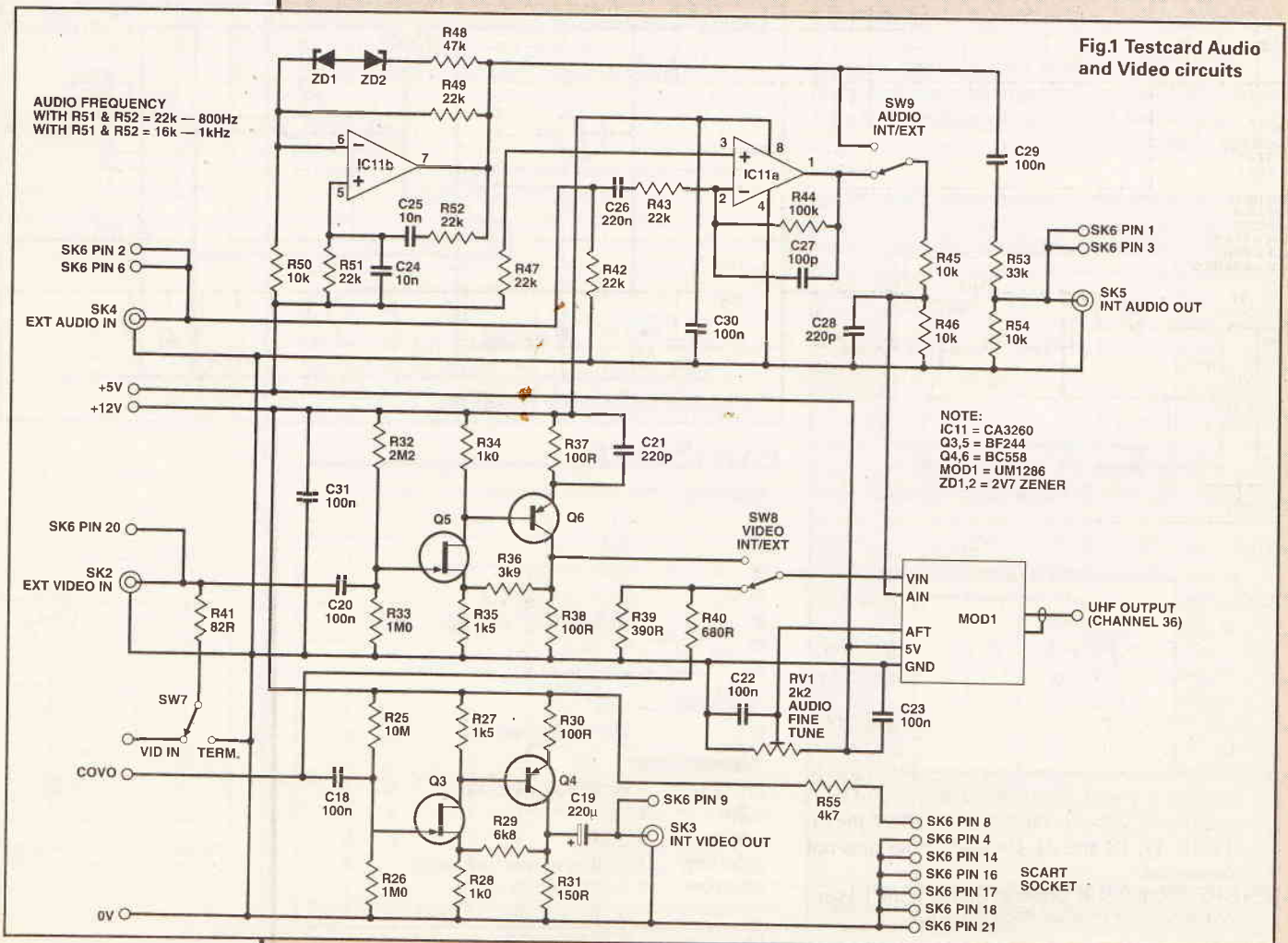

Fig.1 Testcard Audio and Video circuits

Features and Specifications

Test Card: Full colour Test-card featuring colour bars, grey scale (0%, 25%, 50%, 75% and 100%), frequency bars (0.5, 1.0, 1.25, 1.66, 2.5 and 5.0MHz), cross hatch, low frequency blocks and needle pulse.

Other Patterns: Colour bars 1 (black to white), Colours bars 2 (white to black), Cross hatch, Vertical lines, Horizontal lines, Dots, Focus grid, Blank raster, White raster.

Colour/Mono Switch: Removes chrominance (colour information) from Video signal, thereby converting colour bars to grey scale, and removing herringbone patterns.

Red/Green/Blue Switches: Completely remove information for that colour from video signal.

Internal Audio: 800 Hertz (nominal) Sine wave.

Scope Trig Output: 5V Pk-Pk at 10k, switchable Line or Frame.

Power Input: 240V AC 50Hz at 6VA or 11-13V DC at 120mA (see text).

The PAL colour encoder (IC9) is capable of producing 64 colours, however for this application only 10 are required. There are 2 data lines on IC9 for each of the 3 primary colours, labeled R0 and R1 for red, G0 and G1 for green and B0 and B1 for blue. Taking the red lines for example, if R0 only is high a fairly dark red (50% of maximum brightness) is produced, if R1 only is high, the colour is brighter (75% of maximum brightness), if R0 and R1 are both high the colour is maximum brightness (saturated, the same brightness as white), and if R0 and R1 are both low no red is produced. The same arrangement applied for the green and blue data lines. By applying various codes to the data lines, the primary colours can be mixed in various

PROJECT

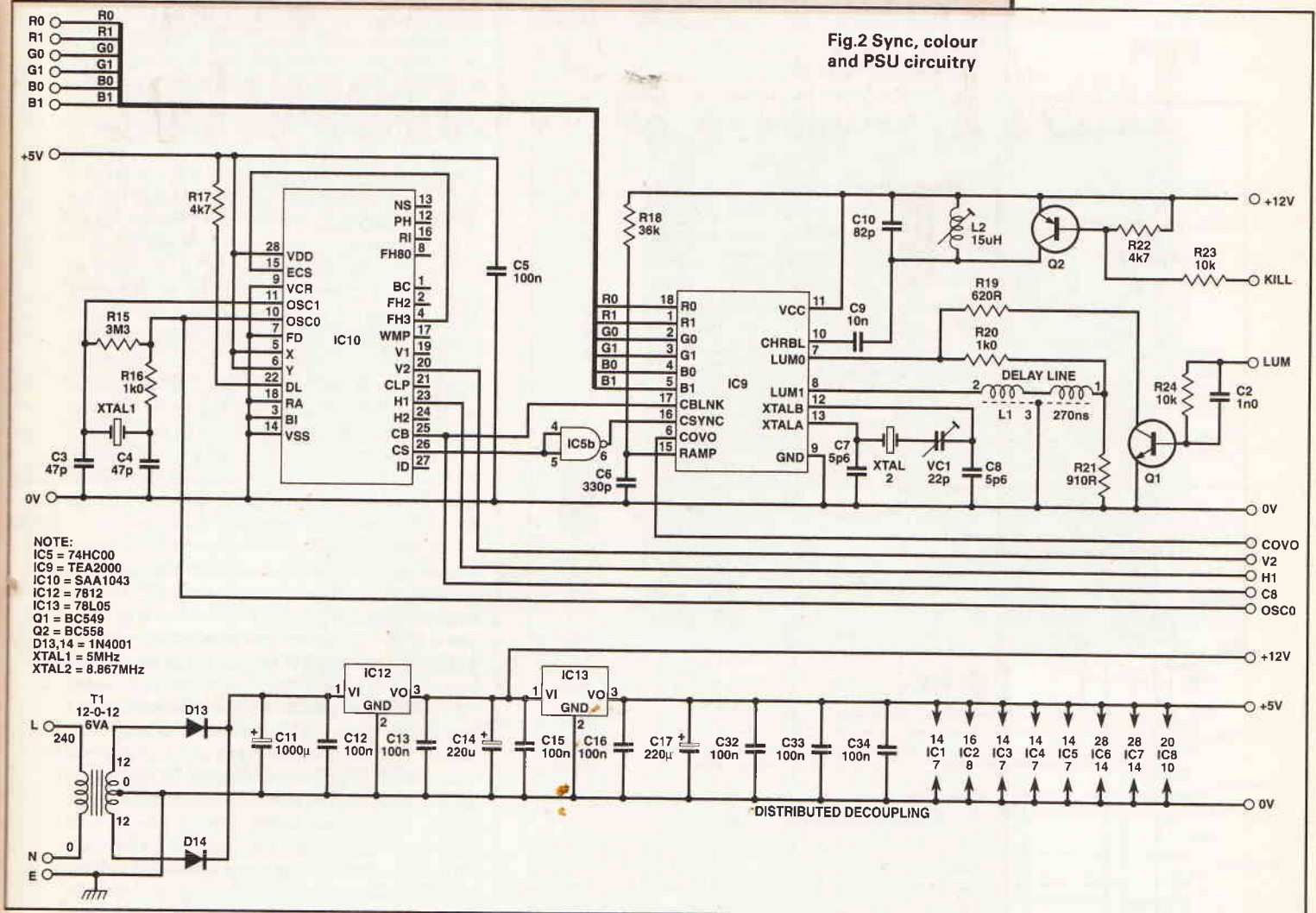

Video Out: 1V Pk-Pk PAL Composite video from pattern generator, BNC socket.

Audio Out: 500mV RMS, 800Hz Sine Wave, Phono socket.

Video In: 1V Pk-Pk PAL Composite video, Input Impedance 75R or 500k switchable, BNC Socket.

Audio In: 500mV RMS into 10k, Phono socket, 30Hz to 15kHz \pm 3dB.

SCART Socket: All signal levels as above. Pins 1 and 3, Audio out. Pins 2 and 6, Audio in. Pin 19, Video out. Pin 20, Video in. Pin 8, +12V via 4K7. Pins 4, 14, 16, 17, 18 and 21, Ground. Other pins not connected.

RF (UHF) Output: UK Channel 36 (591.5MHz) with 6MHz Sound Carrier. Phono socket.

combinations to produce an impressive range of colours.

The truth table below shows the codes required for the ten colours used in this application:

Colour	R0	R1	G0	G1	B0	B1
Black	0	0	0	0	0	0
Blue	0	0	0	0	0	1
Red	0	1	0	0	0	0
Green	0	0	0	1	0	0
Magenta	0	1	0	0	0	1
Cyan	0	0	0	1	0	1
Yellow	0	1	0	1	0	0
Dark Grey	1	0	1	0	1	0
Light Grey	0	1	0	1	0	1
White	1	1	1	1	1	1

From the above truth table it can be seen that all the colours except black, white and grey are used at the 75% brightness level, this level is chosen mainly because a good grey-scale is produced if the colour bar pattern is selected and the chrominance (colour information) is disabled. The logic levels on lines R0, C0 and B0 are always the same, these 3 lines therefore share one data line (D0) from the EPROMs, leaving more data lines available for other purposes, R1, G1 and B1 are connected to data lines D1, D2 and D3 respectively.

Unfortunately the TEA2000 (IC9) will only produce two shades of grey, 50% and 75%, for the test card an additional grey at 25% is required. This is achieved using Q1 and R19 to reduce the luminance signal level at the luminance delay line. This transistor is controlled by data line D4, when the 25% grey is required, the 50% grey is selected and D4 is taken high (a slight problem with this arrangement is that when the test card pattern is selected, and all three colours are switched off, a faint pattern will still be present,

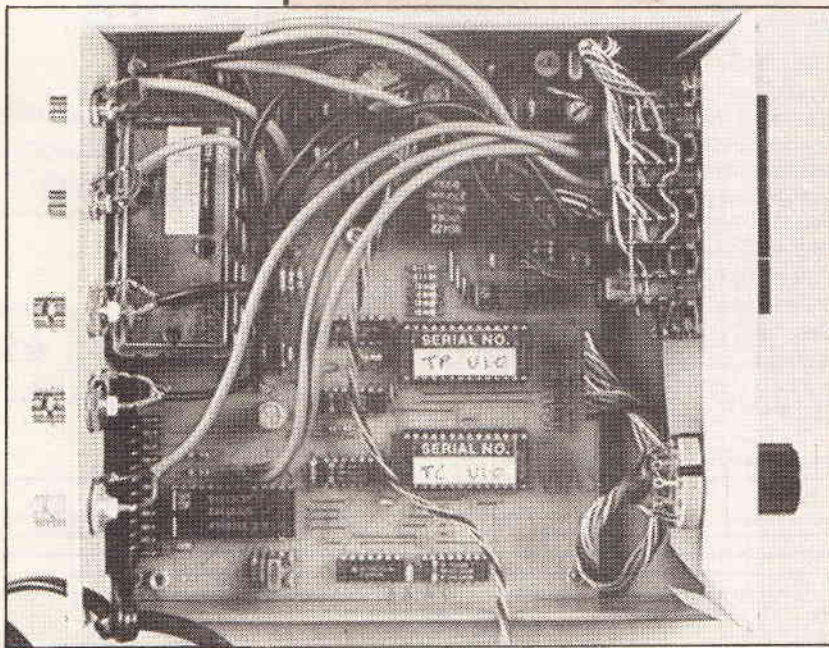

however since the instrument would never be used in this manner, it was not considered important).

The power supply uses a standard 12-0-12 volt centre tapped mains transformer, with full-wave rectification, giving about 17 volts DC across C11. This is regulated to 12 volts and 5 volts using two standard 3-pin regulator ICs (IC12 and IC13).

If required T1 could be removed, IC12 linked out, and the circuit powered from 12 volt (± 1 volt) batteries for portable use. Current consumption at 12 volts is about 120mA, so a small rechargeable sealed lead-acid battery would be a good choice. The maximum supply voltage for IC9 is 13.2 volts, so ensure this is never exceeded (disconnect the battery when charging).

Construction

All the components except the switches, sockets SK1 to SK5, mains transformer T1 and resistor R4 are mounted on the PCB. This is a single sided board, about 185 x 165mm in size, and will be available from the ETI PCB service next month. There are 45 links and it is advisable to fit these first, using tinned copper wire, about 24 SWG. The remaining components can then be fitted in the usual size order. Note that there are tracks between many of the IC pins so a fine tipped soldering iron and due care should be used. All the ICs except IC12 and IC13 (the regulators) should be fitted in sockets, and should not be inserted until the power

supply voltages have been checked — see Testing and Setting-up next month. Veropins may be used for the off-board connections if desired. Take care particularly when fitting the inductors, crystals and variable capacitor since they are easily damaged by rough handling and excessive heat. When fitting the modulator, ensure it is well down, then twist the mounting tags by about 45° and solder. Do not connect the wires from the modulator to the board until the power supply voltages have been checked.

The prototype was housed in a plastic case approximately 170 x 70 x 190mm, however this was

HOW IT WORKS

Most of the difficult work is done by IC9 (TEA2000), the PAL Colour Encoder IC, and surrounding circuitry (see Figure 2). This IC produces the luminance (brightness) and chrominance (colour) signals and combines them to form the PAL standard composite video output. The IC requires 6 bit colour data, giving a total of 64 possible colours; it also requires composite sync and blanking signals which are produced by IC10 (SAA1043), a Universal Sync Generator IC. Various other signals are obtained from IC10 for use as clock and timing signals for the remainder of the logic circuitry. The H1 and V2 signals from this IC go to SW1, which selects the signal to connect to SK1 (Scope Trig Socket) via R4. The colour data required by IC9 is stored in EPROMs IC6 & IC7. IC6 contains the data for the test card whilst IC7 contains the data for the other patterns.

The address lines of the EPROMs, IC6 & IC7 are controlled by two counter ICs, IC2 & IC3 (note that only one EPROM, either IC6 or IC7, is selected at any one time, depending on the position of SW2). The first counter, IC2 (74HC4040), is clocked by a 5MHz clock signal taken from the crystal (XH1) of IC10 (via IC1b); the counter is reset at the end of each scan line by the composite blanking signal (CB), also from IC10. This counter controls the EPROM address lines A0 to A7. During the non-blanked period of a scanned line (when CB is low) there are actually 258 clock pulses, so lines A0 to A7 count up from 0 to 256 (00h to 0 and 1 (00h and 01h) again. The fact that the first two "pixels" in each line are repeated again at the end of the line is of no consequence since this has been allowed for when planning the pattern data.

A second counter chip, IC3 (74HC4024), is normally clocked on each line by the composite blanking signal (via IC5a), and reset at the end of each frame by the V2 (Vertical Pulse 2) signal, also from IC10. Six output lines from IC3 control the remaining six address lines on IC6 (we will come to IC7 later), however since there are only six address lines this gives a maximum count of only 64 lines. Since there are about 280 visible lines per half frame (remember the 625 lines are made up over 2 frames), some means of obtaining the 280 lines is required. The obvious approach would have been to use larger EPROMs (more address lines), however these could be difficult to obtain and get programmed, and would make the unit more complex and expensive than planned. The Test-Car pattern has many sections where one line is repeated several times over, so the following arrangement was designed, where the same data in the EPROM could be used for several lines if required. If data line D7 goes high the rising edge resets another counter, IC4 (74HC4024), via C2 and R2. Output line Q5 of this IC goes low which switches the CB signal off of IC3 and on to IC4, via IC5a and IC1b. After 16 pulses on the CB line, line Q5 goes high again, switching the CB signal back onto IC3. Therefore if D7 is high during a picture line, that line is repeated 16 times. With careful pattern programming the 64 sets of line data produced the required full 280 line picture.

The above arrangement is fine for IC6, the Test-Card EPROM, which only contains one frame. IC7 on the other hand contains the data for 8 patterns. However these other patterns are made up of only 8 picture lines repeated several times over to make up the frame. Therefore only the lower 3 address lines from IC3 need to be connected to counter IC7, the upper 3 address lines from IC7 are connected to positions 2 to 8 of SW2 (Pattern Select), via diodes D3 to D11, which act as an 8 into 3 line binary decoder, in conjunction with pull-up resistors R6 to R8. Switch position 1 selects IC6 and disables IC7, giving the Test-card pattern.

The data line outputs of IC6 and IC7 are connected to an 8 bit D-type latch, IC8 (74HC574). This latch is clocked by the 5MHz clock via IC1c. The main purpose of this is to remove the effects of the propagation delays of

a little tight for comfort. Since the instrument is mains powered, a slightly larger earthed metal case would be more suitable. The PCB is mounted at the rear of the case, with cut-outs in the rear panel for the SCART socket and the UHF output socket on the modulator. The other sockets are also mounted on the rear panel.

All the switches are mounted on the front panel, a suitable legend for this will be featured next month. Switch SW2 is a rotary type, 1-pole 12-way, with the stop set at position 10 (note that no connection is made to pin 10, although position 10 is used). The other switches are the Japanese type latching

switches, and are mounted in two banks of four. The individual switch latches are left in place and the interlocking mechanism is not used.

Part 2 will feature more construction including the template for the front panel, the component overlay, the Parts List and an interwiring diagram.

IC2 and IC6/IC7, which would otherwise give rise to black vertical lines on the picture, particularly at points where several address lines are supposed to change state simultaneously. IC8 is also used to produce the 5MHz part of the frequency grating on the test-card. If line D6 is high the 5MHz clock signal is applied to the OE (Output Enable) pin of IC8, due to IC5c & IC5d. When this clock signal is high the outputs are disabled and are pulled low by resistors R11 to R14, when the clock is low the outputs are enabled and high due to D0 to D3 being high; thereby giving a 5MHz signal on all the colour data lines. The outputs of IC8 are also disabled (due to IC5c) when SW2 is in position 9, giving the Blank Raster pattern.

The colour data outputs of IC8 connect to IC9 via switches SW3 to SW5. These switches enable each of the primary colours to be switched on or off independently.

If switch SW6 (Colour/Mono) is closed, Q2 is turned on which removes the chrominance from the signal by effectively shorting out the chrominance filter circuit (L2 & C10) of IC9.

The composite video output from IC9 (COVO), is attenuated by R39 and R40, and fed to SW8 (the Int/Ext Video switch); it is also buffered by a video amplifier comprising of Q3, Q4 and surrounding circuitry, and fed to the Video Output socket (SK3), and pin 19 of the SCART socket (SK6). The external video input from SK2 or pin 20 of SK6 amplified by another similar video amplifier circuit, built around Q5 & Q6. The input impedance of this amplifier is about 500k, but can be reduced to about

75R by closing SW7. The output of this amplifier circuit, built around Q5 & Q6. The input impedance of this amplifier is about 500K, but can be reduced to about 75R by closing SW7. The output of this amplifier is also fed to SW8. Either the internal or external video, as selected by SW8, goes to the RF modulator MOD1.

The audio oscillator is built around IC11b and is a standard Wein Bridge circuit, with zener diodes used to control the negative feedback. The output is connected to SW9; and also attenuated to 500mV RMS (by R53 and R54), and fed to the Int Audio Out socket (SK5), and pins 1 & 3 of the SCART socket (SK6). The frequency is set to 800Hz, but can be changed to 1kHz if required by reducing R51 and R52 to 16K.

The External Audio input is amplified by IC11a. The gain is arranged such that a 500mV input gives the same drive to the modulator as the internal audio generator. The bandwidth is limited to 30Hz-15kHz by C26 and C27. The output also goes to SW9, IC11 is powered from the 12 volt supply, with the 5 volt supply used as the mid-rail. The outputs are about 8 volts peak-to-peak, centered at the 5 volt level. SW9 selects either the internal or external audio, and R45 & R46 reduce the level to about 4 volts peak to peak, centered at 2.5 volts, which is the correct level for the RF modulator, MOD1. C28 removes the small amount of 6MHz carrier signal that seems to come out of the modulator's audio input, and would otherwise find its way onto the Audio Output socket. RV1 is the 6MHz audio carrier fine tuning control.

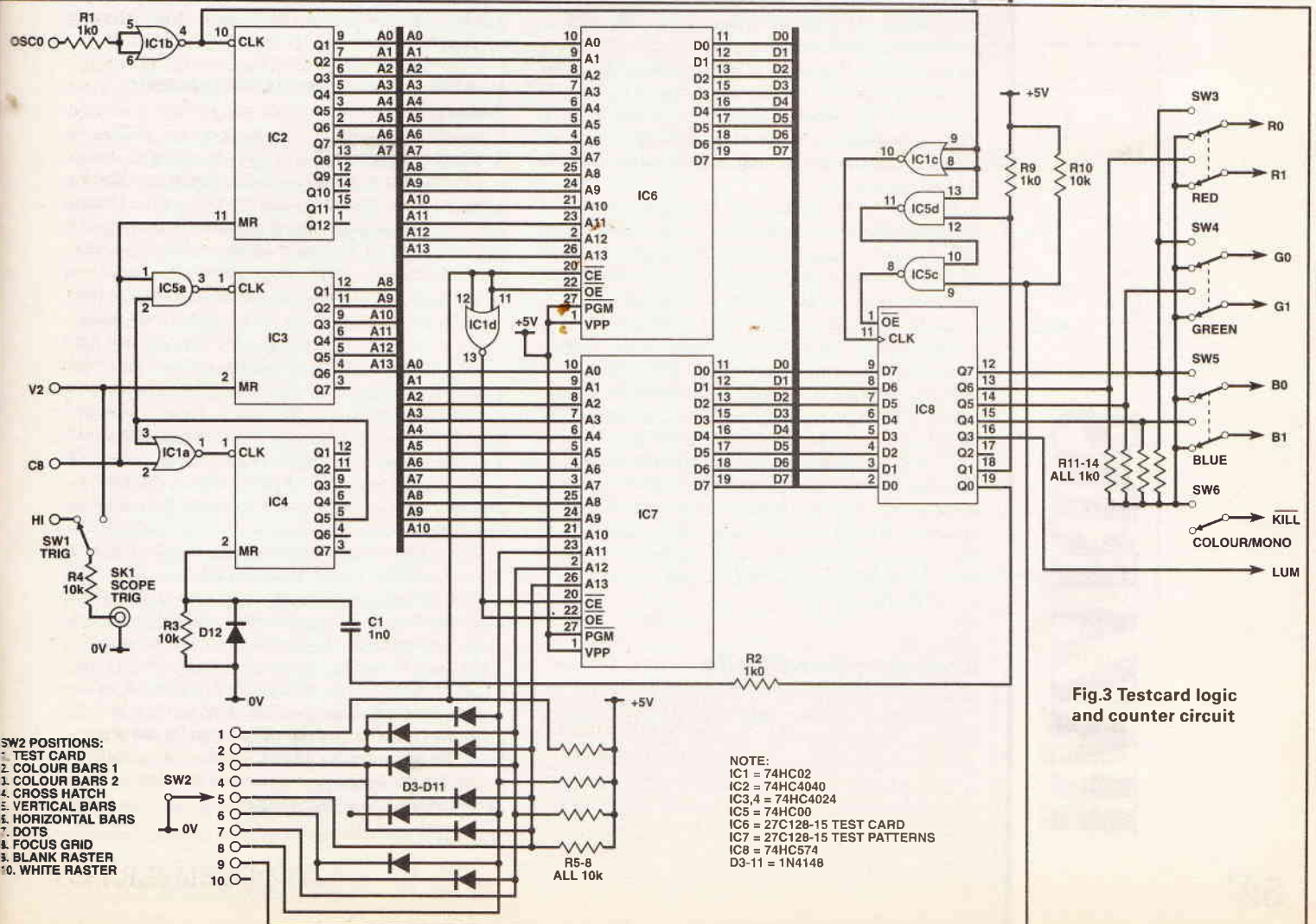

Fig.3 Testcard logic and counter circuit

Electromagnetism And Man

*How does natural electromagnetic radiation affect our existence?
Douglas Clarkson investigates.*

HAZARDS

As silicon technology forges forward at a never slackening pace and the electronic age forces greater and greater levels of dependence on its function, the true understanding of the interaction of electromagnetic fields on individuals is only beginning to dawn. In some ways, science has progressed along two directions – one that of acceptable science with its set of Nobel Laureates and another of workers not acknowledged to be part of 'acceptable' science. Gradually, a broad body of work in the evaluation of electric and magnetic fields on the population which previously has been ignored is acquiring increased respectability. One reason for this development is because horizons in the scientific community are generally expanding. Another factor can be identified in the development of measurement equipment to confirm effects and influences which previously remained undetectable.

Also, additional factors have been at work which have distorted open investigation of electromagnetic effects. The role of governments in presenting entrenched attitudes towards the possible effects of electric and magnetic fields from power lines can be identified almost the entire world over, with the exception possibly of the Soviet Union. In this scenario it is a government ploy to underestimate any possible risk to the community. There has also been a linked influence of military agencies to play down the possible risks associated with electro-magnetic radiation both in relation to direct exposure of military personnel and indirect exposure of the community living around military establishments.

There is no doubt that any developments in understanding of such effects have taken place in spite of this negating, damage limitation attitude. No doubt had appropriate resources been made available since, for example, World War II, then present understanding of electro-magnetic radiation and its effects would be considerably more advanced. Nevertheless, careful integration of diverse research themes, such as for example outlined in the landmark book 'Electromagnetic Man' written by Cyril Smith and Simon Best can bring to light a whole new perspective on such matters.

More importantly, the authors of the book make a reasonable case for considering and evaluating electromagnetic field interactions with man in a much broader context than traditionally undertaken. Mechanisms of interaction with the immune system and environmental pollutants are identified as especially relevant.

Limits to Sensitivity

While allergies to everything from house mites to E123 food additive can be demonstrated by, for example, skin allergy testing is there any awareness of the existence of so called 'electromagnetic allergies'? The work of Dr Jean Munro at her facility at Breakspear Hospital, Abbots Langley, Hertfordshire has demonstrated that such electric allergy sensitive patients do exist.

Measurements of the field signals which can be demonstrated to induce allergic reactions under controlled conditions provide a value of a lower limit of human sensitivity to electro-magnetic radiation.

Studies have shown that for specific sets of patients, such field strengths are of the same order of intensity as those radiated by commonplace electronic and electrical equipment such as televisions, PCs and microwave ovens. This is very much like saying that while the normal tolerance of say E123 food additive is 1mg per typical body weight, some people react adversely to 1 micro gram per typical body weight.

Such work indicates that mechanisms exist which cause the human body to be sensitive to very low levels of electromagnetic radiation and that specific levels which could be tolerated by some individuals would adversely affect others.

This work would seem to indicate that even such low level fields can produce an interaction in all individuals some individuals have a much lower level of tolerance for any changes thus initiated. The nature of the factor or factors which give rise to this lack of adaption to perturbation is unclear. Clearly in view of the increasing electromagnetic pollution in the environment, it is important to gain much better understanding of the relevant processes and mechanisms involved.

Testing and Electromagnetic Allergies

The process of testing for electromagnetic allergies at Dr Jean Munro's facility provides an interesting insight into the degree of skill required to adequately diagnose such conditions. It is of course necessary to isolate the patient as much as possible from stray electromagnetic interference and chemical allergens. Patients with electro-magnetic allergies demonstrate a range of sensitivities ranging from hyper sensitive to sensitive.

The basic method used is to establish an electromagnetic field around the patient using a standard signal generator and determine the patient's response. Initially the generator may even be positioned outside the clinical room where the patient is being observed if a particularly strong reaction is anticipated. Generally the tests commence at a frequency of around 1kHz and a gradual sweeping of frequencies is undertaken, with note being made of frequencies which bring about adverse patient response. Typically each frequency is monitored for 10 seconds to determine any reaction. This procedure might seem simple to undertake, however it is important that the patient is adequately screened from stray fields which could confuse the diagnostic process. A patient may, for example be discovered to be free from all symptoms at 8.4Hz, 450Hz, 4kHz, 25kHz, 350kHz, 20MHz, 320MHz and sensitive to all frequencies above 350MHz.

The surprising nature of her work is not that she has consistently been able to demonstrate electromagnetic allergies in patients but that no one has previously apparently been able to effectively demonstrate such effects.

Limitations on Scientific Curiosity

Such work indicates that all aspects of electromagnetic pollution should be investigated in a more open-minded way. The many benefits of the electronic age are here to stay though they should not be introduced at the expense of the general health of the population. Where emission levels can be reduced through expedient design and planning, then this is both relevant and sensible. Before the process of gaining a better insight into scientific understanding of such matters is undertaken, it is relevant to gain a perspective on social health matters by considering the vexed question of smoking and health.

It is understood all too well that smoking kills approximately one person every five minutes in the United Kingdom, yet companies are still allowed to promote and advertise their wares. This indicates two valid principles. Firstly, free market commercial enterprises, whatever the product they distribute and sell, will never volunteer to pack up their enterprises for the common collective good. They have generally to be coerced by legislation and will certainly try to muddy the waters of scientific debate. Secondly, governments can identify their own interests too closely in the maintenance of the status quo. They carry the notion that it is only by the fingers that they hold in the dyke of scientific curiosity in relation to environmental health that prevents the whole edifice of present economic structures tumbling down. This is a flawed approach to looking after the real interests of the population.

Back to Basics

The electro-magnetic spectrum covers a very broad range of wavelengths. It is quite appropriate to consider a photon of light energy, or a photon of infra red radiation interacting with matter on the basis of a bundle of energy being exchanged in the absorbing system. The photon can be considered to be associated with electric and magnetic fields which are 'bundled' within the small area of the photon. Moreover, the fields can be considered to be oscillating within the photon at the 'frequency' of the radiation. For a photon of green light this frequency is of the order of 10^{15} Hz. Also, where such photons are radiated in a random, haphazard way from a radiating surface such as a glowing filament, the phases and orientations of the fields within each photon will be random. It is relevant to consider what the fields would look like if a snapshot could be taken of them.

It is known that the E and B fields are at right angles to each other as shown in Figure 1. The photon can be imagined to be a region within which a 'bubble' of such fields is oscillating. Can any estimations be made of what the fields are within the photon? Introducing some very approximate calculations assuming:

i) the energy of the photon of green light is contained in a volume of diameter equal to the wavelength of the radiation.

ii) the formula for energy can be taken to be taken to be: $0.5 \epsilon_0 E^2$ where ϵ_0 is the permittivity of free space and E is the Maximum electric field vector.

This gives a value of E of about 8×10^5 volts per metre 'in the eye of the photon' as it were. This is perhaps an unconventional way of considering electromagnetic radiation. It does indicate in a simplistic way that as photon energies increase and their wavelength becomes shorter and the energy more localised, then the values of the E and B fields in the photon increase sharply.

Conversely, as the wavelength increases the E fields associated with a specific photon will decrease but they will occupy a greater volume, assuming this is comparable with the wavelength of the radiation.

What this analysis indicates is that there are two factors involved in how electromagnetic radiation interacts with the human body. One will be relevant to individual photon events and the other will be relative to the ability of the organism to tolerate any given level of electromagnetic interaction. Table 1 indicates the notional photon flux from a 1 watt electromagnetic generator unit.

Type of Radiation	Wavelength	Number photons per second
Ultra violet	300nm	1.5×10^{18}
Infra red	$3.0 \mu\text{m}$	1.5×10^{19}
Radar	3cm	1.5×10^{23}
Radio frequency	3 metre	1.5×10^{25}
Radio frequency	30 metres	1.5×10^{26}

Table 1: Photon numbers produced by specific radiation types for 1 Joule of energy.

Distance from power line (metres)	Value of field (micro Tesla)
10	20
20	10
40	5
50	4
100	2

Table 2: Variation of value of magnetic field value (peak) as a function of distance from power line for a line carrying 1000 Amps current.

This indicates that with increasing wavelength the number of quanta equivalent to a specific amount of electromagnetic radiation also increases. This is what gives a longer wavelength EM radiation its more definitive 'wave' properties — there are more 'photons' to aggregate up to a probabilistic wave front. In this situation it is possible to detect the localised E and B fields of the electromagnetic radiation.

Electro-magnetic Pollution

Most of the public awareness of electro-magnetic pollution has centred on the controversy regarding overhead power lines where they are erected close to or in some cases over populated areas. Directly under the lines an electric field amplitude of 10kV/m and a magnetic field amplitude in the region of 20 micro Tesla would be expected. At a distance of 100 metres, these values would be expected to fall to less than 1000V/m and less than 2 micro Tesla. A typical fluorescent tube should glow in the dark when it is subjected to a field of 2.8kV/metre. The current through the tube should be in the region of a few hundred micro amps.

A typical power line will consist of lines at a voltage of 400,000V and carrying up to around 5000 Amps maximum current. The magnetic element, which seems to be that component most implicated in EM pollution of this type, varies according to the cur-

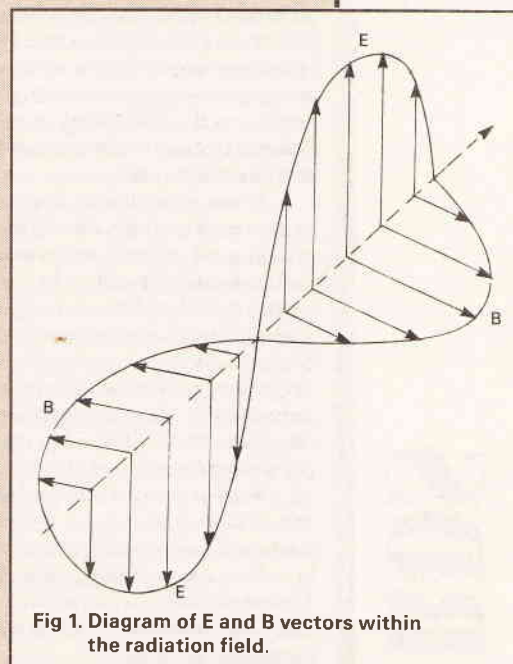

Fig 1. Diagram of E and B vectors within the radiation field.

HAZARDS

rent being carried along a specific line according to the equation:

$$B = \frac{\mu_0 i}{2\pi r}$$

where μ_0 is the permeability constant $4\pi \times 10^{-7}$, i is the current in Amps and r is the radius from a long straight wire in meters. Table 2 indicates the variation in field with distance r from a conductor carrying 1000 amps using this equation.

This field value, however, can be modified by patterns of current flowing in parallel supply lines on the pylon. Also, the size of the magnetic field amplitude can be expected to vary with the current transmitted along the line. Under conditions of light loading the current may be set at around 100 Amps while at peak demand times it could increase by a factor of ten. Thus a single measurement in the vicinity of a pylon in the middle of summer could vary significantly from the value obtained during a cold spell in the middle of winter.

One feature of such power distribution fields is that they are largely coherent as they interact with individuals, while the fields of discrete items such as domestic appliances is not uniform. Researchers indicate that such coherent fields are likely to have more of an effect than incoherent ones, multiplying the associated risk factors by as much as three.

One feature which is seldom mentioned in connection with power lines is the presence of harmonics on the distribution lines, usually in the magnetic field signal. A common harmonic frequency is that of 300Hz though the harmonic spectrum usually extends above 3kHz. Sometimes this so called corona effect can be heard on a car radio as a vehicle drives under a power line. In studies of EM pollution from power lines, it is relevant therefore not to ignore such harmonic effects.

Estimating Power Line Risks

The saga of the uptake of ionising radiation in the form of X-rays and Radium is estimated to have cost around 500 lives of its early users and developers. Dose limits of such ionising radiation have progressively been reduced as additional information has come to light. So too with non-ionising electromagnetic radiation, 'official' levels of safe values are likely to be reduced as additional information comes to light.

If asked, a UK based Power Distribution company would probably not set a safe upper limit of environmental exposure from power lines. Everything would be safe, no questions asked. A well read consultant in EM pollution would probably indicate that he would tolerate an exposure value of 15nT or 0.015 micro Tesla. This value would typically be observed for dwellings greater than 200 metres from the power distribution line. The EM consultant would also conclude that higher levels of exposure would be associated with increasing cancer risk. A value of 1 micro Tesla (approximately 70 times the 'safe' level) would, for example, be considered to be associated with an increased cancer risk ratio of 23.

A member of the public would find it difficult to identify 'expert' opinion in this subject area and is likely to be targeted by conflicting sources of information and attitudes of belief.

The World Health Organisation which dealt specifically with Environmental Health Criteria for Extremely Low Frequency (ELF) Fields made a relatively cautious assessment of the situation in 1984:

It is not possible from present knowledge to make a definite statement about the safety or hazard associated with long term exposure to sinusoidal electric fields in the range 1-10kV/m. In the absence of specific evidence of particular risk or disease syndromes associated with such exposure, and in view

of experimental findings on the biological effects of exposure, it is recommended that efforts be made to limit exposure, particularly for members of the general population, to levels as low as can be reasonably achieved. (WHO, 1984, p18).

It is quite clear that the sense of this directive implies that high voltage power lines should be routed so as to minimise the exposure of EM pollution to the public. It specifically does not say, however, that all is well, there is no need to worry, which has been the view consistently presented by the Power Distribution companies.

A subsequent report in 1987 by the International Radiological Protection Agency and the World Health Organisation on static and time varying ELF magnetic fields indicated that 'significant biological effects' could only be detected at levels around 5000 micro Tesla. More significantly, however, it was indicated that 'the suspected carcinogenic effects of ELF magnetic fields occur at 0.1 to 1 micro Tesla at more than a 1000 times lower'. Basically what the report is saying is that existing studies indicate risk factors have been demonstrated for the lower field values around 0.1 micro Tesla but that larger studies need to be taken to provide a more comprehensive picture before radically lower levels of exposure are recommended.

In the United Kingdom, the National Radiological Protection Board (NRPB) proposed levels of continuous 50Hz exposure of 2.6kV/m and 174 micro Tesla for a proposed standard in 1986 which has subsequently been published.

A factor of 10 between two sets of safety criteria is a matter of after dinner discussion, but a factor of a 1000 is not a topic for polite conversation.

It is relevant to note that various states in the USA have introduced their own legislation for the introduction of high voltage power lines. This action was undertaken when it was perceived that the process of updating national and international standards to take account of new research findings was excessively slow. In Florida, for example, the field levels at the edge of the 'right of way' under the line (where no buildings would be sited) the electric field limit was set at 1.5kV/m and the magnetic field limit at 5 micro Tesla under maximum operating condition. A typical width of right of way under power transmission lines was set at 190 feet.

It is obvious, that real progress in determining a true picture requires extensive research initiatives. There seems a reluctance on the part of governments to resource adequately any meaningful research programmes. This can only delay the resolution of the problem of Extremely Low Frequency fields.

The CEBG announced in 1988 that it was initiating a £500,000 research programme to study EMF bio-effects. Areas to be investigated include an independent epidemiological study of all new diagnosed childhood cancer cases in England and Wales in relation to patterns of EMF exposure. Other more significant research initiatives are being undertaken in the USA. This work will hopefully provide additional information regarding safe exposure limits in years to come.

The Fishpond Scenario

The authors of *Electromagnetic Man* became significantly involved in investigating persistent reports of adverse health effects caused by overhead power lines at Fishpond in Dorset in England. What unfolded from 1973 when such problems came to be experienced by the local inhabitants has acted like a catalyst to muster public opinion and more importantly collect scientific evidence against the siting of high power lines through populated areas.

More importantly, the effect of such electromagnetic pollution in association with other environmen-

tal pollutants such as pesticides has been suggested as an area which needs significant additional investigation. It is suspected that such other environmental pollutants can act to decrease the body's tolerance to such ELF fields and hence trigger carcinogenic effects at much lower levels. The use of pesticides has increased in the USA from an estimated 200,000lb in 1950 to 4,000,000,000lb in 1986, though in this period the percentage loss of crops to pests has doubled. Many researchers indicate that it may be essential to investigate ELF field interactions in association with other environmental factors.

Fishpond is a small village with around 30 people in permanent residence. By 1987 a selection of 23 reports of 'non-specific' health problems had come to light, the most serious of which included four heart attack deaths, two of which could be described as 'sudden' or unexpected and two of which related to a history of heart trouble which apparently became more severe after moving to the village. The set of 'non-specific' problems also included three cancers and various conditions such as dizziness, loss of muscle strength when outside, cataracts, severely swollen limbs, sleeplessness and blackouts.

Specific incidents such as blackouts, disorientation and dizziness were also observed immediately after the lines at Fishponds were (without the knowledge of the inhabitants) uprated from 275kV to 345kV.

The authors of *Electromagnetic Man* keep an open mind on whether the Fishpond episode is an isolated episode in chronic ELF field pollution aggravated by specific local problems or if it is representative of what is taking place over large tracts of populated areas overhung by power lines. It shows the significance of the case cannot be ignored.

More General Exposure Patterns

While individuals are exposed to electromagnetic fields from a range of sources, it is estimated that about 80% of domestic exposure is due to overhead and underground power lines with the remainder being made up by domestic appliances. The table below indicates the typical magnetic field values for a TV and a microwave oven at different distances.

Item	at 3cm	at 30cm	at 1 metre
TV	2.5-50 μ T	0.04 to 0.2 μ T	0.01 to 0.15 μ T
microwave oven	75-100 μ T	4 to 8 μ T	0.25 to 0.6 μ T

In electric distribution, the currents of three phase systems are essentially balanced so that the magnetic field component is largely cancelled out. Also, the small finite field around a balanced system will decrease according to an inverse square rule while the field around an unbalanced wire will only decrease according to the inverse of the distance. This emphasises the importance of ensuring that wiring systems are installed to minimise any imbalance of currents.

Typical 'domestic' ELF field exposure can now be readily measured using specific hand held meters costing a few hundred pounds. Remote from overhead or underground power lines, the fields would be expected to vary considerably in the domestic environment. Measurements in high rise flats can indicate that the degree of balancing of currents can vary considerably between ground and upper floors. One set of measurements, for example, indicated a peak ground floor value of 0.4 μ T and a peak top floor value of 0.015 μ T — a ratio of approximately 13.

An investigation of cases of suicide and depression by a Dr. F. Perry in Leeds provided evidence to link such clinical conditions to exposure to ELF fields. In high rise flats, there appeared to be higher incidence of

depression and suicide at ground floor levels.

It has been pointed out, however, that fields in bedrooms are more significant due to the greater amount of time spent there. It is not unheard of on the continent for beds to be located within rooms in positions to specifically minimise ELF exposure. Consultants in EM pollution would probably NOT use an electric blanket.

Occupational Exposure

Occupational exposure in the form of working with computing equipment is assuming increased importance primarily because the use of such equipment is becoming so widespread. 'Officially' according to UK based NRPB, computer equipment such as VDUs present no hazards and can be considered safe. A range of studies have indicated that the problem needs further examination with regard to exposure limits. It is difficult to often remove other environmental/occupational factors from such analyses. Within the EEC it is hoped to initiate legislation to harmonise the levels of exposure within member states. It is relevant to draw states. It is relevant to draw attention to the very real possibility of individuals having electromagnetic allergies. Levels of EM exposure which could be tolerated by most of the population would be problematic for this sub-group of the population.

Researchers also indicate that in assessing exposure risks from VDUs, often exposure from the sides and rear of such equipment could be significantly higher than from the front, so that apparent levels of exposure would depend significantly on layout of staff and equipment within a specific installation.

Enter The Military

The cat and mouse game centering on bombarding the American Embassy in Moscow with microwaves has been public knowledge since 1972 even though the American intelligence were aware of the bombardment since 1953. Also it was only since 1976 that defensive screens were installed to protect embassy staff. One embarrassment for the American authorities was that the level of the radiation was significantly below 'official' levels for safe exposure. While a notional 10mW/cm² was considered to provide a measure of safety, the Moscow Embassy radiation was about 5 micro Watts/cm², during the period January 1973 to August 1975. The 'hostile' radiation was in fact at level a factor of 2000 lower than Western safety limits. Additional beams came into play from August 1975 though when the defensive screens were installed the level of the bombarding radiation fell to about 2 micro Watts/cm². Subsequently in January 1979 the radiation essentially ceased though was detected briefly in 1983. Subsequently from March 1988 a much weaker higher frequency band around 10GHz has been detected.

A range of studies were initiated to try to determine the nature of any health risk. In response to public pressure, the most detailed medical review of all staff posted to the Moscow embassy during the time of bombardment was undertaken in 1976. Its findings showed that the incidence of disease was indeed higher in specific categories. It is relevant also to note that three ambassadors posted to Moscow subsequently died of cancer.

The general body of opinion is that the radiation was deliberately used to undermine the health of the embassy staff and in particular that of the Ambassador since the beam was centred on his office. Yet there still seems to be missing pieces to the puzzle. Was in fact the presence of microwaves a red herring and the health problems were caused by an additional subversive agent as yet unannounced or undetected?

Clearly detailed information of the subversive use

of EM radiation such as microwaves is not for the public domain in the West or in the East. There is no doubt that considerable investigation is undertaken in the world's R&D community into possible military applications of electromagnetic radiation. This was at its height during the Cold War but it is continuing at a significant pace. The bulk of this work will never be made public. The secret nature of this work covers the distinct areas of general technological function and also the potential health hazards of such systems to users or targeted individuals.

Conclusion and Summary

With the approach of the end of the 20th century, an understanding of the electromagnetic nature of man and the interaction with electromagnetic fields is finally being achieved is manifestly untrue. This rather disappointing state of affairs has largely come about

by restrictions on research into the adverse effects of electromagnetic radiation on individuals.

Recently, many more interesting lines of investigation are being unearthed which as yet have been scarcely researched. Developments in sensor technology have tended to increase the nature and scope of research to be undertaken. This expansion is also tending to link in concepts already identified by practitioners of Alternative medicine such as acupuncture, colour therapy, and in particular homeopathy to name but a few. It seems likely the mechanistic model of the human individual is too restrictive to allow a satisfactory model to be determined.

The 1990's have proved so far to be an interesting decade. Old empires of political thought can crumble if pushed hard enough. Is our view of electromagnetic radiation and its effect on the individual likely to suffer a similar fate?

OMNI ELECTRONICS

174 Dalkeith Road, Edinburgh EH16 5DX · 031 667 2611

Do you have your copy yet?

A COMPREHENSIVE RANGE WITH SERVICE SECOND TO NONE
OUR MUCH EXPANDED, BETTER ILLUSTRATED CATALOGUE WILL COST £1.50 — TO INCLUDE VOUCHERS TO USE AGAINST FUTURE PURCHASES. TO RECEIVE A COPY, PLEASE SEND YOUR REMITTANCE WITH YOUR NAME, ADDRESS AND TELEPHONE NUMBER REQUESTING A COPY OF THE 1990/91 OMNI CATALOGUE.

Open: Monday-Thursday 9.15-6.00
Friday 9.15-5.00 Saturday 9.30-5.00



TEST EQUIPMENT MAINTENANCE AND TECHNICAL CONSULTANCY

Service manuals
 Spare parts
 Comprehensive repair service including complete instrument refurbishment at highly competitive rates

We support scientific, commercial and industrial equipment manufactured by over 100 different companies
 New and second-hand test equipment also available at competitive prices
 Components, valves and miscellaneous items

Hesing Technology ^{HT}

41 Bushmead Road, Eaton Socon, St. Neots, Cambs PE19 3BT
Telephone and fax: (0480) 214488

BINDERS

Keep your copies in first class condition

Keep your collection of ETI

in mint condition with these specially commissioned binders. The price is just £6.95 which includes postage and packing.

How to order

Send cheque/P.O. to A.S.P. BINDERS OFFERS, Argus House, Boundary Way, Hemel Hempstead, HP2 7ST

TELEPHONE ORDERS (24 HRS) 0442 66551
OFFER CLOSSES 28 DECEMBER 1991

(0442) 66551



Please supply ETI BINDERS @ £6.95 each inc. p&p
Special Christmas Offer — Buy 2 and SAVE 20%

Please supply 2 ETI BINDERS @ £11.12 each inc. p&p

Total £..... (Please make cheques/postal orders payable to A.S.P.)

NAME

ADDRESS

Or debit my Expiry

ACCESS/VISA Signature.....

Please allow 28 days for delivery OFFERS CLOSSES 28/12/91

JOBSEARCH UK

The nationwide careers guide



NEW!

Select your next job from the region of your choice!

Looking for a job?

Whether out of work

or wanting a

change — don't

give up or lose hope

JOBSEARCH UK — thousands of

jobs and career opportunities

updated every fortnight

classified by job type and UK region

FORTNIGHTLY AT LEADING NEWSAGENTS 95p

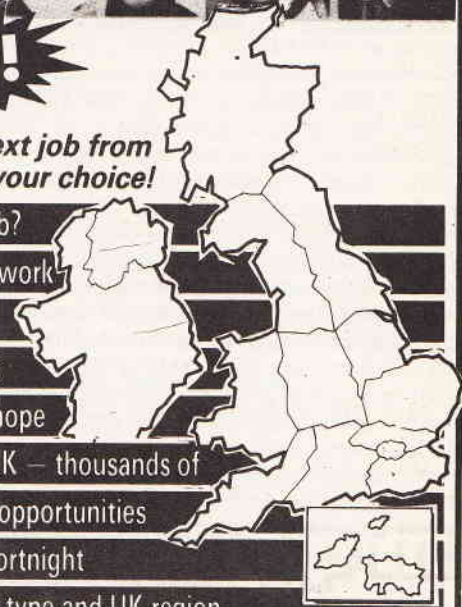

The ONE STOP Component Shop



NEW CATALOGUE AVAILABLE NOW!

▶ **Massive Stocks**

▶ **Old & New Technology**

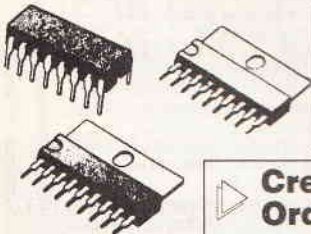
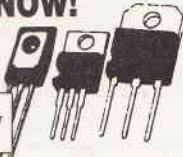

▶ **Latest Japanese Semi-conductors & Transistors Available**

▶ **Credit Card Telephone Orders a Speciality**

CRICKLEWOOD ELECTRONICS



Tel: 081 4520161 & 081 4500995
40 Cricklewood Broadway, London NW2 3ET
 Fax: 081 2081441 - Telex: 914977 CRICKEL G

8051 DEVELOPMENT LOW COST MICROCONTROLLER FOR ONLY £39

- 36 I/O lines
- High speed 16mm² CPU
- TTL level serial port
- RAM/ROM supplied
- Hexloader supplied in ROM
- Full manual/diagram
- 64-way expansion socket

QASM assembler also available

For more information ask for Extension 2360

— **MEC MICROSYSTEMS** —

Mountbatten House, Fairacres, Windsor, Berkshire SL4 4LE
 Tel: 0753 857181 Fax: 0753 860696

EPROM PROGRAMMER OR UNIVERSAL PROGRAMMING SYSTEM FOR YOUR PC? From Low Cost EPROM PROGRAMMER

The Model 160 programs virtually every EPROM and costs £195 + VAT

To UNIVERSAL PROGRAMMING SYSTEM

The Model 200AP programs EPROMs, serial and parallel EEPROMs, Flash memories, Micro-processors and controllers, PALs, GALs and Bipolar PROMs and costs £345 + VAT (adapters where required from £75).

This includes all the 8751 and 8748 families, the PIC micro-controllers, Z8s and EPROM Emulators. Nearly 900 devices in all.



New devices are constantly being added - ask if you want any programmable device added to our list.

All our programmers are designed, manufactured and supported by us in the UK.

Programming times are faster than most of our competitors, e.g. using the parallel port of your PC they program 2764s in 4 seconds and take less than one minute to blank check, program and verify 1 Megabit Flash Memories (and this time includes download time).

We also sell Gang Programmers, EPROM Emulators and Erasers and a universal cross-assembler for IBM PCs and compatibles.

Write or phone today for Free Information Pack:
Phone: (0666) 825146 Fax: (0666) 825141



MOP ELECTRONICS LTD., PARK ROAD CENTRE, MALMESBURY, WILTSHIRE, SN16 0BX UK

Scandinavian distributor:	Digitron A/S, Alesund, Norway	Phone 071-45 890 Fax 071-45 453
German distributor:	Synatron GmbH, Grasbrunn B.	Phone 089/4602071 Fax 089/4605661



SURVEILLANCE PROFESSIONAL QUALITY KITS

A range of high quality kits as supplied to leading UK security companies, all in-house designed and produced, not to be confused with cheap imports. All kits come fully documented with concise assembly and setting-up details, fibreglass PCB and all components. All transmitters are fully tuneable and can be monitored on a normal VHF radio or tuned higher for greater security. Build-up service available if required.

- MTX** Micro-miniature audio transmitter. 17mm×17mm. 9V operation. 100m range **£13.45**
- VT500** Hi-power audio transmitter. 250mW output. 20mm×40mm. 9-12V operation. 2-3000m range **£16.45**
- VXT** Voice activated transmitter. Variable sensitivity. 20mm×67mm. 9V operation. 1000m range **£19.45**
- SCRX** Sub-carrier scrambled audio transmitter. Cannot be monitored without decoder fitted to radio. 20mm×67mm. 9V operation. 1000m range **£22.95**
- SCDM** Sub-carrier decoder unit for monitoring SCRX. Connects to radio earphone socket. Provides output for headphones. 32mm×70mm. 9-12V operation **£22.95**
- HVX40** Mains powered audio transmitter. Connects directly to 240v AC supply. 30mm×35mm. 500m range **£19.45**
- XT89** Crystal controlled audio transmitter. High performance. 100mW output. Supplied with xtal for 108MHz. Others available to 116MHz. 85mm×28mm. 9V operation. 2-3000m range... **£37.95**
- QTX180** Narrow band FM crystal controlled audio transmitter. 180MHz frequency. Requires Scanner receiver or our QRX180 kit (see Cat) 20mm×67mm. 9V operation. 1000m range **£40.95**
- TKX900** Tracker/Beeper transmitter. Transmits continuous stream of audio pulses. Variable tone and rate. Powerful 200mW output. 63mm×25mm. 9V operation. 2-3000m range **£22.95**
- ATR2** Micro size telephone recording interface. Connects between telephone lines (anywhere) and cassette recorder. Tape switches automatically with use of phone. All conversations recorded. Powered from line. 10mm×35mm..... **£13.45**
- TLX700** Micro miniature telephone transmitter. Connects to line (anywhere) switches on and off with phone use. All conversations transmitted. 20mm×20mm. Powered from line. 1000m range **£13.45**
- CD600** Professional bug detector/locator. Variable sensitivity. Multicolour bar graph readout of signal strength with variable rate beeper. Second mode AUDIO CONFIRM distinguishes between localised bug transmission and normal legitimate signal such as pagers, cellular etc. 70mm×100mm. 9V operation **£50.95**

UK customers please send cheques. PO's or registered cash. Please add £1.50 per order for P&P. Goods despatched ASAP allowing for cheque clearance. Overseas customers send sterling bank draft or Eurocheque and add £5.00 per order for shipment. Credit card orders accepted on 0827 714476. Trade enquiries welcome.

Send 2x1st class stamps for the new 1991 Catalogue



THE WORKSHOPS
 95 MAIN RD. BAXTERLEY
 NR. ATHERSTONE
 WARCS CV9 2LE



0827 714476

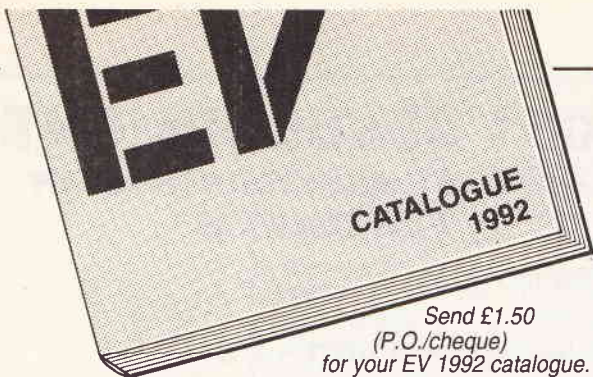

Send £1.50
(P.O./cheque)
for your EV 1992 catalogue.
Includes £1.50 voucher spendable on
orders upwards of £10.

The CATALOGUE

120 pages, A4. Expertly presented and illustrated.
Easily referred to. Packed with valuable information.

The COMPONENTS

As wide a choice as you could wish —
semiconductors, surface mounting, opto-electronics,
Rs & Cs, etc. etc. Top quality; fairly priced.

The SUPPLIERS

Siemens, Boss, Cliff, Omeg, Lorlin, R.S, Uniross —
to our top quality standards.

The SERVICE

Prompt, personal with customer satisfaction
guaranteed. Access/Visa facilities

Electro/alue

28 (B) St. Jude's Road, Englefield Green, Egham, Surrey TW20 0HB
Phone - 0784 433603 Fax - 0784 435216

electronize CAR ALARM KITS

MICRO-PRESSURE CAR ALARM

This new type of alarm is triggered by a unique pressure sensing system. As any vehicle door is opened air is drawn out, causing a minute drop in air pressure. A sensor detects this sudden pressure change and sets off the alarm. An electronic filter, tuned to only 3Hz., and adjustable sensitivity avoid false alarms whilst an arrangement of timers provide automatic operation.

- ☆ Operates on all doors and tailgate - no switches needed.
- ☆ Automatically armed 40 seconds after leaving vehicle.
- ☆ 10 second entry delay with audible warning. (0.5 second available.)
- ☆ Sounds horn or siren Intermittently for 30 seconds - then re-arms.
- ☆ Easy fitting - only 3 wires to connect - no holes to drill.
- ☆ Controlled by Ignition switch, hidden switch or coded remote control. (The optional siren and coded remote control are supplied separately.)

MICRO-PRESSURE ALARM Parts kit £15.95 Assembled £22.35

NEW CODED IR REMOTE CONTROL

Our latest addition allows control of our alarms from outside the vehicle. Both transmitter and receiver use a chip designed specially for car security systems with 59,046 code combinations. You can even set your own code, with several vehicles on the same code or several transmitters for one vehicle if required.

- ☆ High security, customer selected, 24 bit code.
- ☆ Key-ring transmitter with long life miniature alkaline battery.
- ☆ High power infra-red emitter with range up to 5 metres.
- ☆ Low profile dash top receiver/decoder.
- ☆ Flashing high Intensity red L.E.D. warns off Intruders.
- ☆ Green L.E.D. shows alarm is off.

Use the coded transmitter and receiver with our Micro-Pressure or Volt Drop alarm to form a coded remote controlled system.

CODE TRANSMITTER Parts kit £13.95 Assembled £17.95
CODE RECEIVER Parts kit £21.35 Assembled £26.55

Also available :-

VOLT DROP CAR ALARM Parts kit £14.90 Assembled £20.95
120dB PIEZO SIREN Assembled £11.95
MICRO-PRESSURE TRIGGER Parts kit £10.95 Assembled £14.95
EXTENDED CDI IGNITION Parts kit £22.75 Assembled £28.45

All the above include cable, connectors and clear easy to follow instructions.
All kits include case, PCB, everything down to the last washer, even solder.
All prices now include post, packing and VAT on U.K. orders. Same prices apply to all European countries. For delivery outside Europe please add £3.

Telephone orders accepted with VISA or ACCESS payment.
Order direct (please quote ref. ETC) or send for more details from :-

ELECTRONIZE DESIGN

Tel. 021 308 5877

2 Hillside Road, Four Oaks, Sutton Coldfield, B74 4DQ

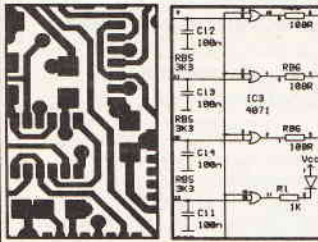
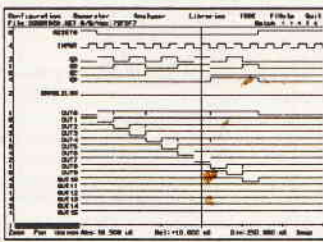
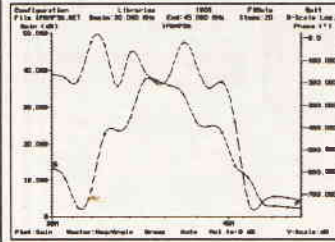
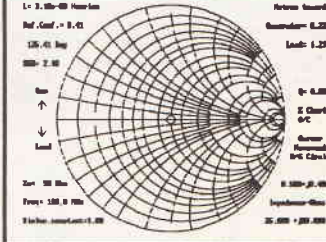
PCB & SCHEMATIC CAD	DIGITAL SIMULATION	ANALOGUE SIMULATION	SMITH CHART CAD
EASY-PC £98	PULSAR £195	ANALYSER III £195	Z-MATCH II £195
			
<ul style="list-style-type: none"> ● Design Single sided, Double sided and Multilayer boards. ● Provides Surface Mount support. ● Standard output includes Dot Matrix / Laser / Inkjet printers, Pen Plotters, Photo-plotters and NC Drill. ● Award Winning EASY-PC is in use in over 8000 installations in 50 Countries World-Wide. ● Runs on PC/XT/AT/286/386 with Herc, CGA, EGA, VGA. ● Superbly Easy to use. ● Not Copy Protected. 	<ul style="list-style-type: none"> ● At last! A full featured Digital Circuit Simulator for less than £1000! ● Pulsar allows you to test your logic designs without the need for expensive test equipment. ● Catch glitches down to a pico second per week! ● Includes 4000 Series CMOS and 74LS Libraries. ● Runs on PC/XT/AT/286/386/486 with EGA or VGA. Hard disk recommended. ● Not Copy protected. 	<ul style="list-style-type: none"> ● NEW powerful ANALYSER III has full graphical output. ● Handles R's, L's, C's, BJT's, FET's, OP-amp's, Tapped and untapped Transformers, and Microstrip and Co-axial Transmission Lines. ● Calculates Input and Output Impedances, Gain and Group Delay. ● Covers 0.001 Hz to >10GHz ● Runs on PC/XT/AT/286/386/486 with EGA or VGA. ● Not Copy protected. 	<ul style="list-style-type: none"> ● Z-MATCH II takes the drudgery out of RF matching problems and includes many more features than the standard Smith Chart. ● Provides quick accurate solutions to many matching problems using transmission line transformers, stubs, discrete components etc.etc.. ● Supplied with comprehensive user instructions including many worked examples. ● Runs on PC/XT/AT/386/486, CGA, EGA, VGA ● Not Copy Protected

For full information please
Phone, Fax or Write.

Number One Systems Ltd.
The Electronics CAD Specialists



See us at Desk-Top CAD
Stand 137, 5-7 Nov.

REF: ETI, HARDING WAY, SOMERSHAM ROAD, ST.IVES, HUNTINGDON, CAMBS, PE17 4WR, ENGLAND.
Telephone: 0480 61778 (7 lines) Fax: 0480 494042 International: +44-480-61778 Fax: +44-480-494042

ACCESS, AMEX, MASTERCARD, VISA Welcome.

Surplus always wanted for cash!

THE ORIGINAL SURPLUS WONDERLAND!

Surplus always wanted for cash!

BBC Model B APM Board

£100 CASH FOR THE MOST NOVEL DEMONSTRATABLE APPLICATION!

WIN £100 CASH!

BBC Model B type computer on a board. A major purchase allows us to offer you the PROFESSIONAL version of the BBC computer at a parts only price. Used as a front end graphics system on large networked systems the architecture of the BBC board has so many similarities to the regular BBC model B that we are sure that with a bit of experimentation and ingenuity many useful applications will be found for this board! It is supplied complete with a connector panel which brings all the I/O to 'D' and BNC type connectors - all you have to do is provide +5 and ±12V DC. The APM consists of a single PCB with most major IC's socketed. The IC's are too numerous to list but include a 6502, RAM and an SAA5050 teletext chip. Three 27128 EPROMs contain the custom operating system on which we have no data. On application of DC power the system boots and provides diagnostic information on the video output. On board DIP switches and jumpers select the ECONET address and enable the four extra EPROM sockets for user software. Appx. dims: main board 13" x 10". I/O board 14" x 3". Supplied tested with circuit diagram, data and competition entry form.

Only £29.95 or 2 for £53 (B)

MONITORS

MONOCHROME MONITORS

THIS MONTH'S SPECIAL!

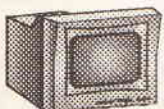

There has never been a deal like this one! Brand spanking new & boxed monitors from NEC, normally selling at about £140! These are over-engineered for ultra reliability. 9" green screen composite input with etched non-glare screen plus switchable high/low impedance input and output for daisy-chaining. 3 front controls and 6 at rear. Standard BNC sockets. Beautiful high contrast screen and attractive case with carrying ledge. Perfect as a main or backup monitor and for quantity users!

£39.95 each (D) or 5 for £185 (G)

CALL FOR DISCOUNTS ON HIGHER QUANTITIES!

COLOUR MONITORS

Decca 16" 80 budget range colour monitor. Features a PIL tube, beautiful leak style case and guaranteed 80 colour resolution, features usually seen only on colour monitors costing 3 times our price! Ready to connect to most computers or video outputs. 75Ω composite input with integral audio amp & speaker. Fully tested surplus, sold in little or hardly used condition with 90 day full RTB guarantee. Ideal for use with video recorder or our Telexbox ST, and other audio visual uses. **£99 (E) 3/£275 (G)**

20", 22" and 26" AV SPECIALS

Superbly made UK manufacture. PIL all solid state colour monitors, complete with composite video & sound inputs. Attractive leak style case. Perfect for Schools, Shops, Disco, Clubs. In EXCELLENT little used condition with full 90 day guarantee. **20"....£135 22"....£155 26"....£185 (F)**

CALL FOR PRICING ON NTSC VERSIONS!

HI-DEFINITION COLOUR MONITORS

Brand new 12" multiinput high definition colour monitors by Microvitek. Nice tight 0.31" dot pitch for superb clarity and modern metal black box styling. Operates from any 15.625 khz sync RGB video source, with either individual H & V syncs such as CGA IBM PC's or RGB analog with composite sync such as Atari, Commodore Amiga, Acorn Archimedes & BBC. Measures only 14" x 12" square. Free data sheet including connection information. Will also function as quality TV with our RGB Telexbox.



Only £145 (E)

Brand new Centronic 14" monitor for IBM PC and compatibles at a lower than ever price! Completely CGA equivalent. Hi-res Mitsubishi 0.42 dot pitch giving 669 x 507 pixels. Big 28 Mhz bandwidth. A super monitor in attractive style moulded case. Full 90 day guarantee.

Only £129 (E)

NEC CGA IBM-PC compatible. High quality ex-equipment fully tested with a 90 day guarantee. In an attractive two tone ribbed grey plastic case measuring 15" x 13" x 12". A terrific purchase enables us to pass these on at only.... **£79 (E)**

V22 1200 BAUD MODEMS

Master Systems 2/12 microprocessor controlled V22 full duplex 1200 baud modem. Fully BT approved unit, provides standard V22 high speed data comm, which at 120 cps, can save your phone bill and connect time by a staggering 75%! Ultra slim 45 mm high. Full featured with LED status indicators and remote error diagnostics. Sync or Async use; speech or data switching; built in 240v mains supply and 2 wire connection to BT. Units are in used but good condition. Fully tested prior despatch, with data and a full 90 day guarantee. What more can you ask for - and at this price!!

ONLY £69 (D)

LARGE QUANTITIES OF OSCILLOSCOPES AND TEST GEAR ALWAYS AVAILABLE - CALL NOW!

IBM KEYBOARD DEALS

A replacement or backup keyboard, switchable for IBM PC, PC-XT or PC-AT. LED's for Caps, Scroll & Num Locks. Standard 84 keyboard layout. Made by NCR for the English & US markets. Absolutely standard. Brand new & boxed with manual and key template for user slogans on the function keys. Attractive beige, grey and cream finish, with the usual retractable legs underneath. A generous length of curly cord, terminating in the standard 5 pin DIN plug. A beautiful clean piece of manufacturer's surplus. What a deal! **£39 (B) 5/£175 (D)**

Brand new and boxed 84 key PC/XT type keyboards in standard IBM grey with very attractive mottled finish and "clicky" solid feel keys. 10 function keys on side. English layout and £ sign. Green LEDs for Caps, Scroll & Num locks. **£29.95 (B) 5/£135 (D)**

CALL FOR DISCOUNTS ON HIGHER QUANTITIES!

FLOPPY DISK DRIVES BARGAINS GALORE!

NEW 5¼ Inch from £29.95!

Massive purchases of standard 5¼" drives enables us to present prime product at industry beating low prices! All units (unless stated) are removed from often brand new equipment and are fully tested, aligned and shipped to you with a 90 day guarantee and operate from +5 & +12vdc, are of standard size and accept the standard 34 way connector.

TANDON TM100-2A IBM compatible DS **£39.95 (C)**
CANON, TEC etc. DS half height. State 40 or 80T **£79.00 (C)**
TEAC FD-55-F. 40-80 DS half height. BRAND NEW **£79.00 (C)**

Specials!

TEAC FD-55 half height series in your choice of 40 track double sided 360k or 80 track double sided 720k. Ex-equipment fully tested in excellent condition with 90 day warranty. Order TE-36 for 360k **£29.95 (C)** or TE-72 for 720k **£39.95 (C)**

CHOOSE YOUR 8 INCH!

Shugart 800/801 SS refurbished & tested **£150.00 (E)**
Shugart 851 double sided refurbished & tested **£225.00 (E)**
Mitsubishi M2994-63 double sided switchable hard or soft sectors. BRAND NEW **£250.00 (E)**

SPECIAL OFFERS!!

Dual 8" drives with 2 megabyte capacity housed in a smart case with built in power supply **Only £499.00 (F)**
Ideal as exterior drives!

End of line purchase scoop! Brand new NEC D2246 8" 85 megabyte of hard disk storage! Full CPU control and industry standard SMD interface. Ultra high speed transfer and access time leaves the good old ST506 interface standing. In mint condition and comes complete with manual. Only **£399 (E)**

AFFORDABLE 10 Mb WINCHESTERS

A fantastic deal - 10mb (formatted) Winchester for £39.95! Tandon TM502 full height ST506 interface. Use it as a second hard drive on your present driver card or as a starter into Winchester land - see the driver card listed below. In excellent used condition, guaranteed for 90 days. **£39.95 (C)**
Hard disk driver card, complete with cables ready to plug into your PC or compatible. Supports two Winchesters. **£29.95 (A)**

No Break Uninterruptable PSU's

Brand new and boxed 230 volts uninterruptable power supplies from Densel. Model MUK 0565-AUAF is 0.5 kva and MUD 1085-AHBH is 1 kva. Both have sealed lead acid batteries. MUK are internal, MUD has them in a matching case. Times from interrupt are 5 and 15 minutes respectively. Complete with full operation manuals. **MUK.....£249 (F) MUD.....£525 (G)**

RECHARGEABLE BATTERIES

LEAD ACID

Maintenance free sealed long life. Type A300.

12 volts 12 volts 3 amp/hours **£13.95 (A)**
6 volts 6 volts 3 amp/hours **£ 9.95 (A)**
12 volts Centre tapped 1.8 amp hours. RFE. **£ 5.95 (A)**
12 volts 12 volts 38 amp hours. 7-1/2" x 6" S. RFE. **£35.00 (B)**

EXTRA HI-CAPACITY NICKEL CADMIUM

Super high capacity Chloride Alcad 12 volts refillable type XL1.5. Electrolyte is readily available Potassium Hydroxide. In banks of 10 cells per 8"H x 24" x 5.5"D wooden case. Each cell measures 8"H x 1.75" x 4"D. Can be easily separated. Ideal for all standby power applications. Ex MoD, like new. **£49.95 (E)**

SPECIAL INTEREST

Newton Derby frequency changer 3 phase 50hz to 3 phase 400hz. 15 kva output. As new. **£2900**
Trio 0-18 vdc bench PSU. 30 amps. New **£ 470**
Fujitsu M3041 600 LPM band printer **£2950**
DEC LS/02 CPU board **£ 150**
Rhode & Schwarz SBUF TV test transmitter 25-1000mhz. Complete with SBTf2 Modulator **£650**
Calcomp 1036 large drum 3 pen plotter **£ 375**
Thurley LA 160B logic analyser **£ 950**
1.5kw 115v 60hz power source **£ 875**
Tektronix R140 NTSC TV test signal standard. **£ 650**
Sony KTX 1000 Videotext system - brand new **£ 225**
ADDS 2020 VDU terminals - brand new **£2000**
Sekonic SD 150H 18 channel Hybrid recorder **£ 250**
Trend 1-9-1 Data transmission test set **£ 350**
Kenwood DA-3501 CD tester, laser pickup simulator

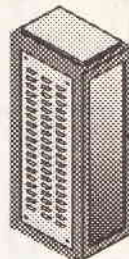

Superb Quality 6 foot 40u 19" Rack Cabinets

Massive Reductions
Virtually New, Ultra Smart!
Less Than Half Price!

Top quality 19" rack cabinets made in UK by Optima Enclosures Ltd. Units feature designer, smoked acrylic lockable front door, full height lockable half louvered back door and removable side panels. Fully adjustable internal fixing struts, ready punched for any configuration of equipment mounting plus ready mounted integral 12 way 13 amp socket switched mains distribution strip make these racks some of the most versatile we have ever sold. Racks may be stacked side by side and therefore require only two side panels or stand singly. Overall dimensions are 77-1/2"H x 32-1/2"D x 22"W. Order as:

Rack 1 Complete with removable side panels.....**£275.00 (G)**
Rack 2 Less side panels.....**£145.00 (G)**

POWER SUPPLIES

Power One SPL200-5200P 200 watt (250 w peak). Semi open frame giving +5v 35a, -5v 1.5a, +12v 4a (8a peak), -12v 1.5a, +24v 4a (6a peak). All outputs fully regulated with over voltage protection on the +5v output. AC input selectable for 110/240 vac. Dims 13" x 5" x 2.5". Fully guaranteed RFE. **£95.00 (B)**

Power One SPL130. 130 watts. Selectable for 12v (4A) or 24 v (2A). 5v @ 20A, ± 12v @ 1.5A. Switch mode. New. **£59.95 (B)**
Astec AC-8151 40 watts. Switch mode. +5v @ 2.5a, +12v @ 2a, -12v @ 0.1a. 6-1/4" x 4" x 1-3/4". New **£19.95 (B)**
Greendale 19AB0E 60 watts switch mode. +5v @ 6a, +12v @ 1a, +15v @ 1a. RFE and fully tested. 11 x 20 x 5.5cms. **£24.95 (C)**
Conver AC130. 130 watt hi-grade VDE spec. Switch mode. +5v @ 15a, -5v @ 1a, +12v @ 6a, 27 x 12.5 x 6.5cms. New. **£49.95 (C)**

Boshert 13090. Switch mode. Ideal for drives & system. +5v @ 6a, +12v @ 2.5a, -12v @ 0.5a, -5v @ 0.5a. **£29.95 (B)**
Farnell G6/40A. Switch mode. 5v @ 40a. Encased **£95.00 (C)**

COOLING FANS

Please specify 110 or 240 volts for AC fans.

3 inch AC 1/2" thick **£ 8.50 (B)**
3 1/2 inch AC ETRI slirmin. Only 1" thick. **£ 9.95 (B)**
3 1/2 inch AC 230 v 8 watts. Only 3/4" thick **£12.95 (A)**
4 inch AC 110/240v 1/2" thick. **£10.95 (B)**
10 inch AC round. 3 1/2" thick. Rotron 110v **£10.95 (B)**
10 inch As above but 230 volts **£24.95 (B)**
60 mm DC 1" thick. No. 812 for 6/12v. 814 24v. **£15.95 (A)**
80 mm DC 5 v. Papst 8105G 4w. 38mm. RFE. **£19.95 (A)**
92 mm DC 12v. 18 mm thick. **£14.95 (A)**
4 inch DC 12v. 12w 1 1/2" thick **£12.50 (B)**
4 inch DC 24v 8w. 1" thick. **£14.50 (B)**

THE AMAZING TELEBOX!

Converts your colour monitor into a

QUALITY COLOUR TVII

TV SOUND & VIDEO TUNER!



Brand new high quality, fully cased, 7 channel UHF PAL TV tuner system. Unit simply connects to your TV aerial socket and colour video monitor turning same into a fabulous colour TV. Don't worry if your monitor doesn't have sound, the TELEBOX even has an integral audio amp for driving a speaker plus an auxiliary output for headphones or Hi Fi system etc. Many other features: LED Status indicator, Smart moulded case, Mains powered, Built to BS safety specs. Many other uses for TV sound or video etc. Supplied BRAND NEW with full 1 year guarantee.

Telexbox ST for composite video input monitors.....**£32.95 (B)**
Telexbox ST as ST but with integral speaker.....**£36.50 (B)**
Telexbox RGB for analogue RGB monitors.....**£68.95 (B)**
RGB Telexbox also suitable for IBM multisync monitors with RGB analog and composite sync. Overseas versions VHF & UHF call. SECAM / NTSC not available.

BRAND NEW PRINTERS

TEC Starwriter Model FP1500-25 daisywheel printer renowned for its reliability. Diablo type print mechanism gives superb registration and quality. On board microprocessor gives full Diablo/Quime command capability. Serial RS-232C with full handshake. Bidirectional 25 cps, switchable 10 or 12 pitch, 136 cpl in Pica, 163 in Elite. Friction or tractor feed. Full ASCII including £ sign. Font and ribbon Diablo compatible.....**£199 (E)**
DED DPG21 miniature ball point pen printer/plotter mechanism with full 40 characters per line. Complete with data sheet which includes circuit diagrams for simple driver electronics.....**£49 (B)**
Centronics 150 series. Always known for their reliability in continuous use - real workhorses in any environment. Fast 150 cps with 4 fonts and choice of interfaces at a fantastic price!
159-4 Serial up to 9.5" paper, fan fold tractor.....**£ 99.00 (E)**
150-4 Serial up to 9.5" paper, tractor, roll or s/sheet.....**£129.00 (E)**
152-2 parallel up to 14.5" paper, tractor or s/sheet.....**£149.00 (E)**

CALL FOR THE MANY OTHERS IN STOCK.

VISIT OUR SHOP FOR BARGAINS

DISPLAY

MAIL ORDER & OFFICES
Open Mon-Fri 9.00-5.30
Dept ET, 32 Biggin Way,
Upper Norwood,
London SE19 3XF.

LONDON SHOP
100's of bargains!
Open Mon-Sat 9-5.30
215 Whitehorse Lane,
South Norwood,
London, SE25.

DISTEL © The Original
Free dial-up database!
1000's of items+info On Line
V21, V22 & V22 bis
081-679-1888

ALL ENQUIRIES
081-679-4414
Fax- 081-679-1927
Telex- 894502



-ELECTRONICS-

All prices for UK Mainland. UK customers add 17.5% VAT to TOTAL order amount. Minimum order £10. PO orders from Government, Universities, Schools & Local Authorities welcome - minimum account order £25. Carriage charges (A)=£2.00, (B)=£5.50, (C)=£8.50, (D)=£11.50, (E)=£14.00 (F)=£18.00 (G)=Call. All goods supplied subject to our standard Conditions of Sale and unless otherwise stated guaranteed for 90 days. All guarantees on a return to base basis. We reserve the right to change prices & specifications without prior notice. Orders accepted subject to stock. Quotations willingly given for higher quantities than those stated. Bulk surplus always required for cash.

PCB Foil

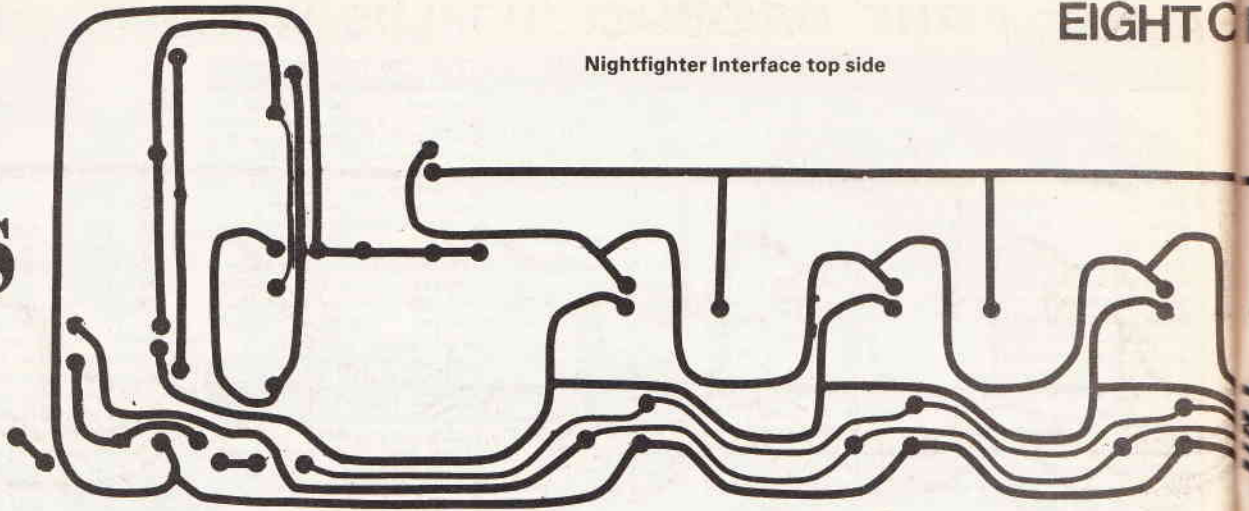

Nightfighter Interface top side

Nightfighter Eight Channel Input Interface (solder side)

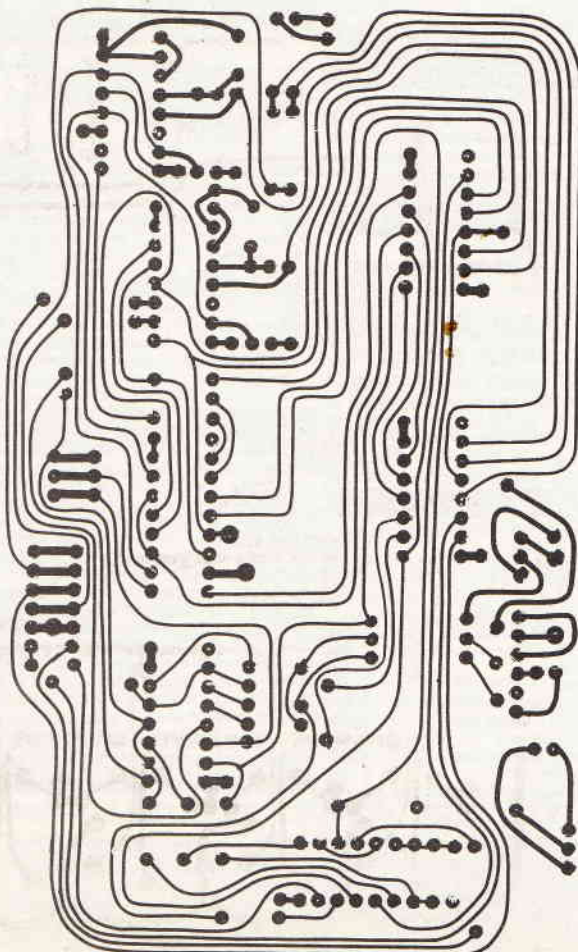
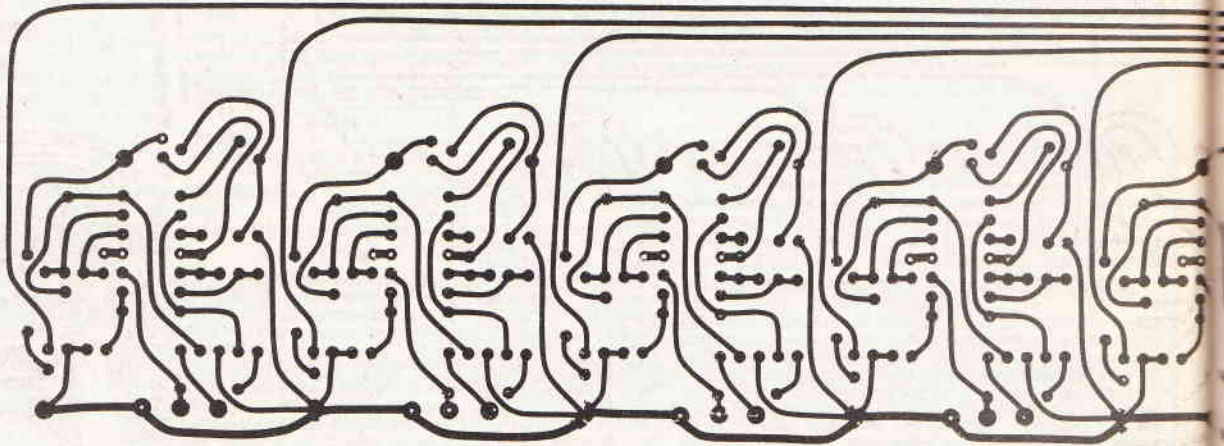

solder side

Nightfighter Sensor Switch Channel Board

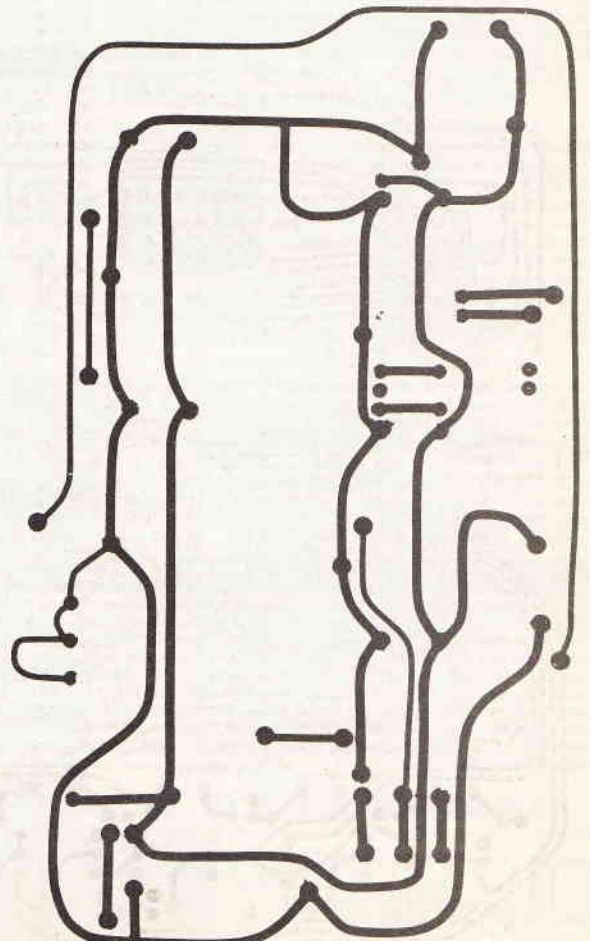

top side

CHANNEL INPUT INTERFACE

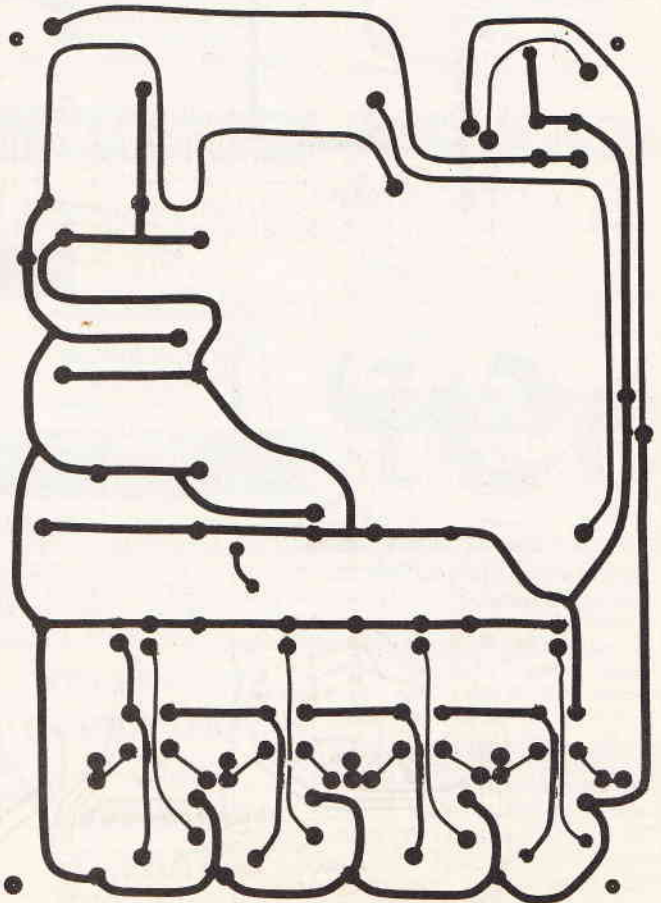
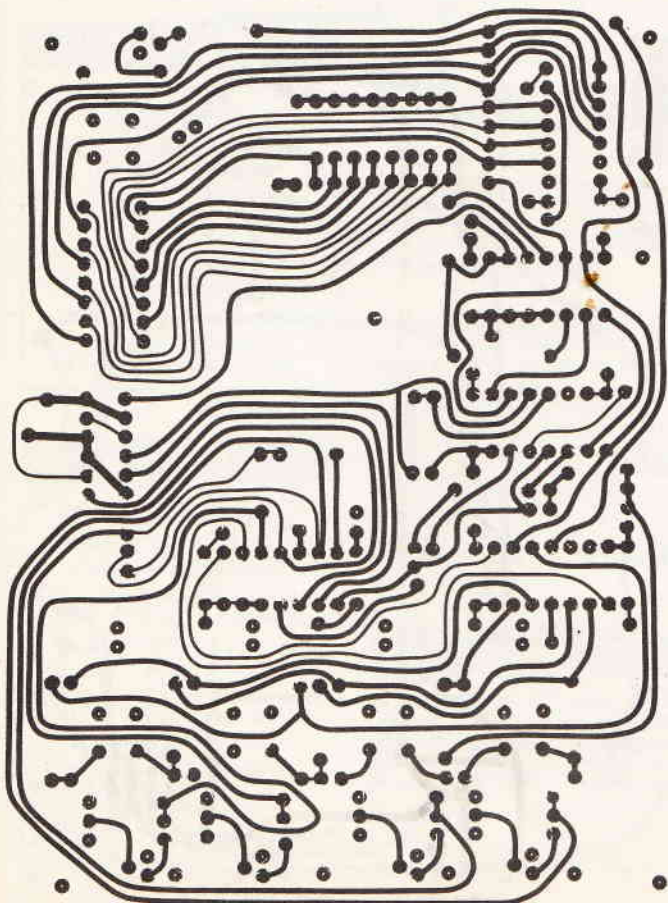
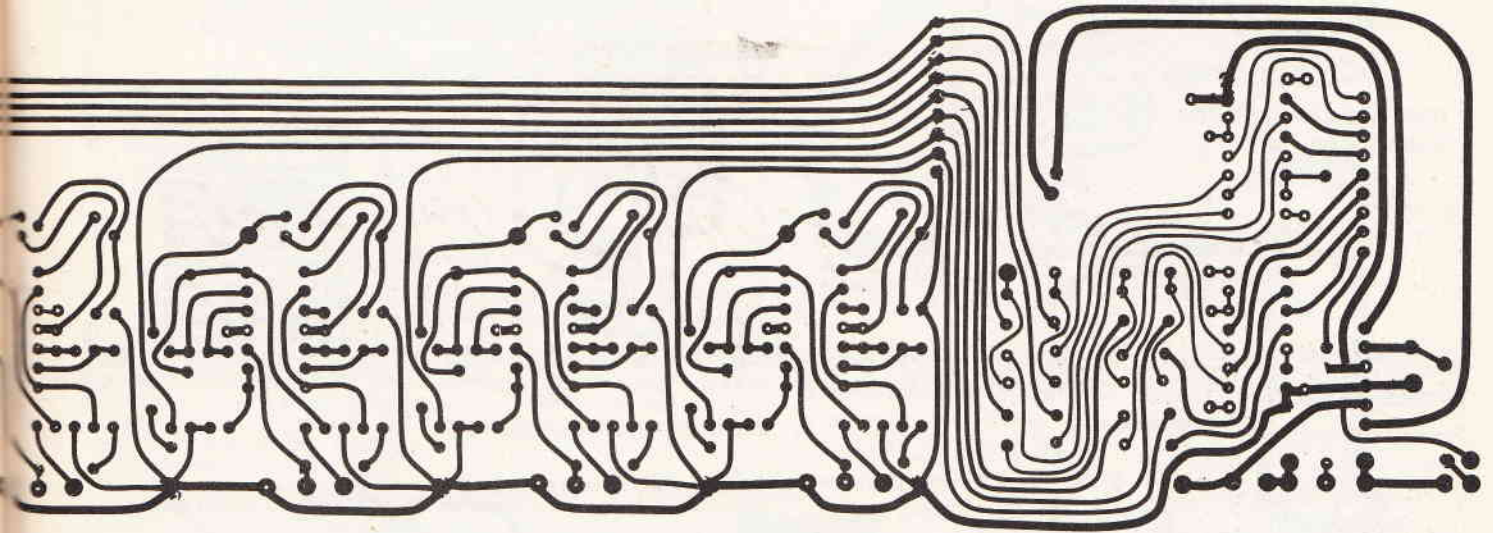
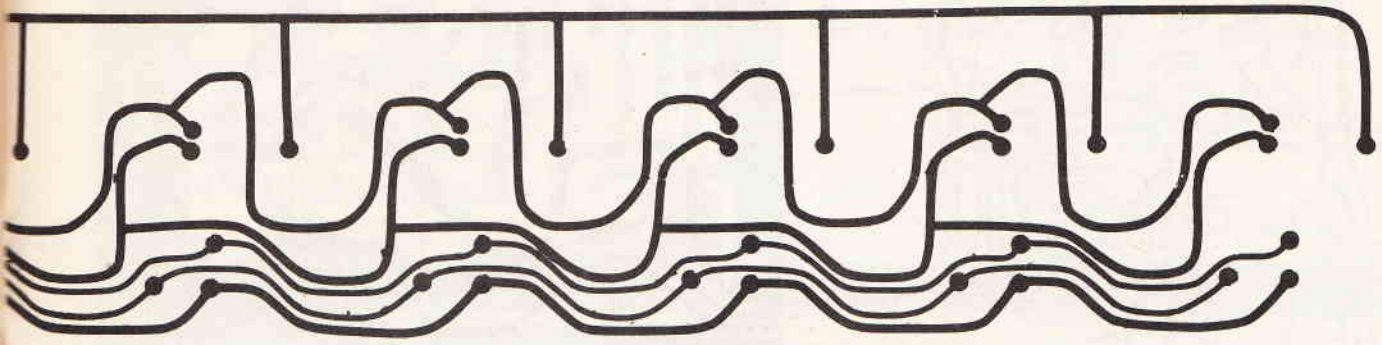

solder side

top side

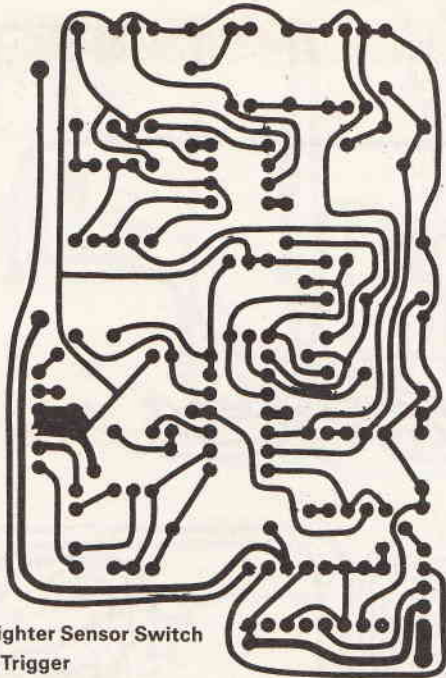

Nightfighter Sensor Switch
Sound Trigger

solder side

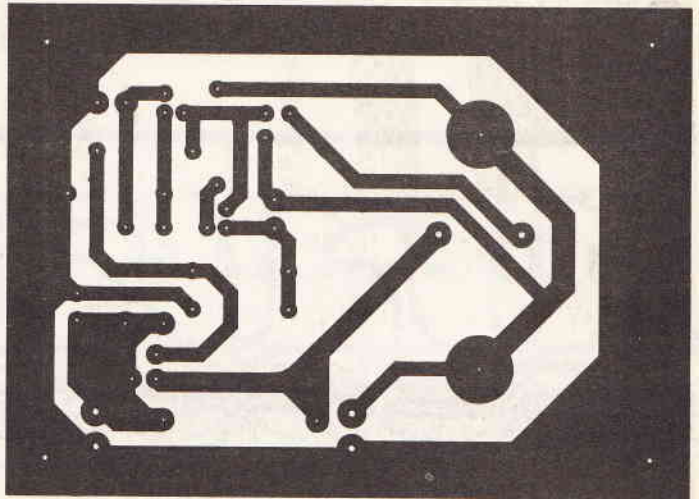

Power On and Overload Foil

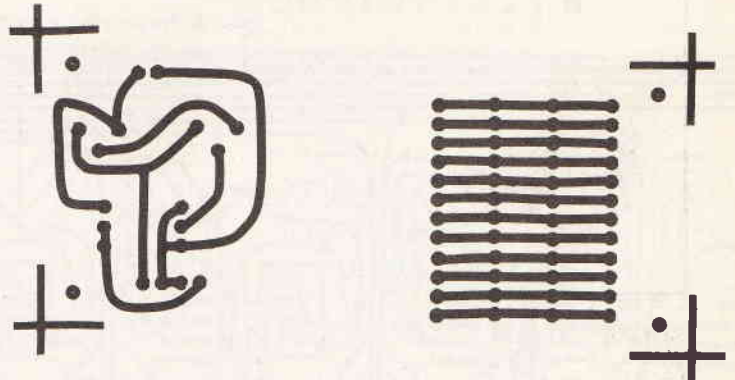

Nightfighter Connector Board

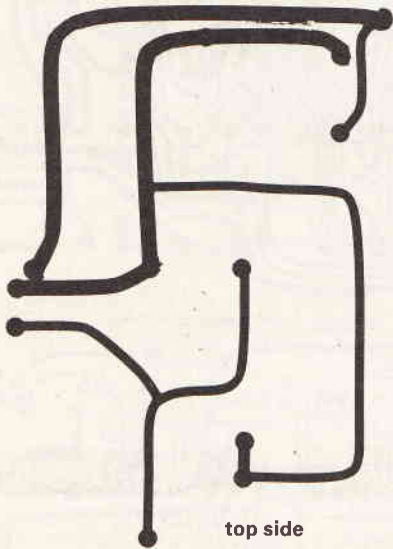

top side

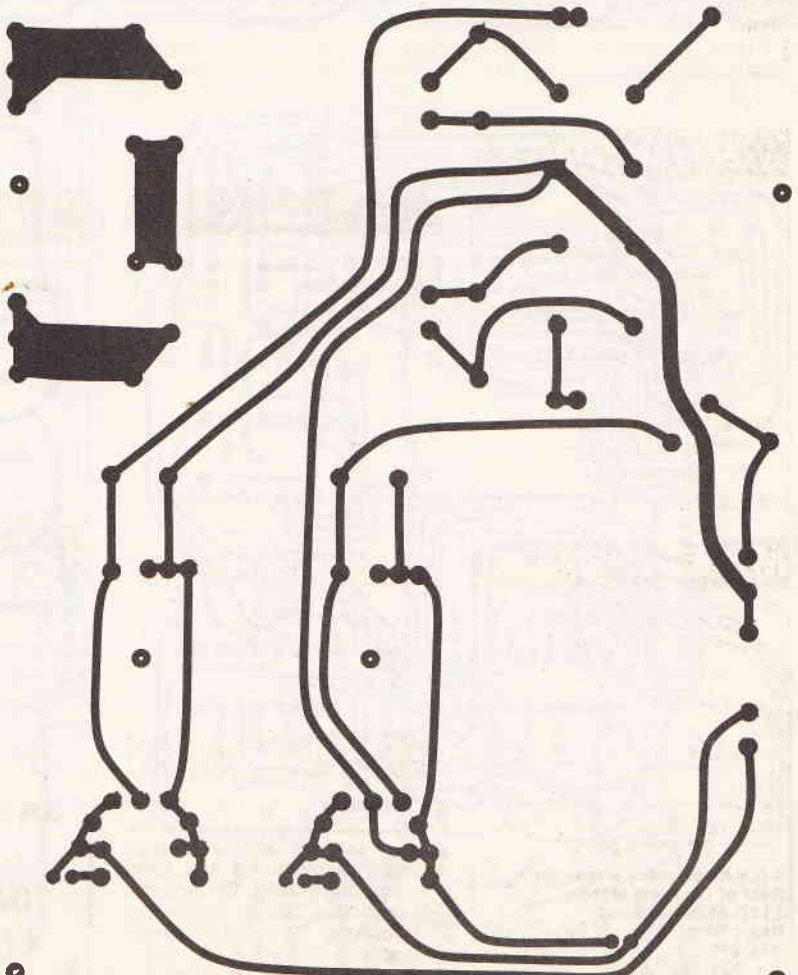

Nightfighter Sensor Switch PSU



Hybrid audio Pre-amp Nov 91

The text makes passing references to IC1, a regulator. This was included in an initial design but not included in the final design for the power supply. It should therefore be ignored.

Arrows from C2 and C13 in Fig.1 should be ignored. A take-off wire in Fig.2 labelled D4a should go to the indicator LED, LED 1. The foil was not printed on the foil pages as the author wanted to retain the rights to the design.

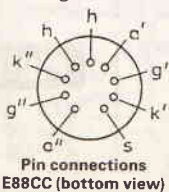

Pin connections
E88CC (bottom view)

ETI

ELECTRONICS

TODAY INTERNATIONAL



CLASSIFIED

James Trott
0442 66551 Ext 252

Send your requirements to:
ETI Classified Department, ASP, Argus House,
Boundary Way, Hemel Hempstead, HP2 7ST.

Lineage: 60p per word (+VAT) (minimum 15 words)
Semi display: (minimum 2.5cms)
£15.00 per single column centimetre (+VAT) per insertion
Electromart £24.00 per insertion (+VAT)

Ring for information on series bookings/discounts.
All advertisements in this section must be prepaid.
Advertisements are accepted subject to the terms and conditions
printed on the advertisement rate card (available on request).

FOR SALE

PARTRIDGE ELECTRONICS

- ◆ Two Mic. Inputs - Line Input
- ◆ Auto - Manual Control
- ◆ D.T.M.F. or L.D. Dialing



OUTSIDE BROADCAST UNIT

EASY TO CARRY

FLIGHT CASE

BROADCAST OVER

STANDARD PHONE NETWORK

REPORTER Model T26



UNIT D
318 HIGH ROAD
BENFLEET
ESSEX SS7 5HB
TELEPHONE: 0268 793381

PRINTED CIRCUIT BOARDS
Prototype boards made from your own design packages send your disc with HPGL file for plotting and a quote for prototypes for multiple runs. Accept 51" and 31" high density or low. Plotting services from £2.00 per plot. Film work produced and PCB's to requirements. Artwork design service. We can produce a design from your schematic. Some designs are not practical. Minimum basic charge for 1 off PCB, £15.00. This would depend entirely on the complexity of the board, from your artwork. Artwork preferably looking from component or solder side needed. A1, 2-1 or 1-1. Kits and boards from stock for many projects. Send S.A.E. for new catalogue out Sept 1st. Ring 021-366 6047 for further information.
Badger Boards, 1180 Aldridge Road, Great Barr, Birmingham B44 8PE. Please mention the magazine advert when making contact.

SOLAR PANELS 100mm x 60mm 2.5V 0.2Wp £1.40. 6 for £8. 12" x 6" 12V or 6V 1.4Wp £8.50. 12" x 12" 12V 3Wp £15.00. 36" x 12" 12V 5-6Wp £23.50. Prices include U.K. P&P. Larger mounted panels available. Orders to Bob Keyes GW4 IED. 4 Glanmor Crescent, Newport, Gwent, NP9 8AX.

BIG LONG LIST of Kits, Disk Drives, LCD Displays, Printers etc. Phone Jim on (0252) 518538.

PCB CAD USERS. High contrast artwork transparencies produced from your computer printout. For details + free sample, send see to SB Electronics, 10 Peacock Crescent, Clifton, Nottingham NG11 8EP.

WANTED

Turn your surplus transistors, ICs etc. into cash. Immediate settlement. We also welcome the opportunity to quote for complete factory clearance.

Contact:
COLES HARDING & CO.
103 South Brink
Wisbech, Cambs.

NOW ESTABLISHED OVER 15 YEARS

Tel: 0945 584188
Fax Number: 0945 588844

KITS

CONSORT SPEAKER KIT as July '91 E.T.I. £188 inclusive. All parts available separately. Memex Electronics Ltd. 1 Icknield Close, Ickleford, Hitchin, Herts SG5 3TD.

NEW VHF MICROTRANSMITTER KIT tuneable 80-135MHz, 500 metre range, sensitive electret microphone, high quality PCB, SPECIAL OFFER complete kit ONLY £5.95, assembled and ready to use £9.95 post free. Access/Visa order telephone 021-411 1821. Cheques/P.O.s to: Quantek Electronics Ltd, Kits Dept (ETI), 45A Station Road, Northfield, Birmingham B31 3TE. S.A.E. for details of this and other kits.

PLANS

ELECTRONIC PLANS, laser designs, solar and wind generators, high voltage teslas, surveillance devices, pyrotechnics and computer graphics tablet. 150 projects. For catalogue. SAE to Plancentre Publications, Unit 7, Old Wharf Industrial Estate, Dymock Road, Ledbury, Herefordshire, HR8 2HS.

ELECTRONIC COMPONENTS

RF & General Purpose electronic components for constructors projects. Our mail order catalogue shows it. Send 75p for your copy now.

£3.00 of discount vouchers supplied.

Or call us today for the parts you need, or ask about kits for your magazine project.

J.A.B Electronic Components
Rear of Queslett Motors
1180 Aldridge Road
Great Barr, Birmingham
B44 8PE
Tel: 021-366 6928

SERVICE MANUALS

SERVICE MANUALS

Available for most equipment

TV's, Video's, Test, Audio etc →

Write or phone for quote

MAURITRON (HRT),
8 CHERRY TREE ROAD,
CHINNOR, OXON OX9 4QY
TEL (0844) 51694 FAX (0844) 52554

ARTICLES WANTED

WANTED

Receivers, Transmitters, Test Equipment, Components, Cable and Electronic. Scrap. Boxes, PCB's Plugs and Sockets, Computers, Edge Connectors.

TOP PRICES PAID FOR ALL TYPES OF ELECTRONICS EQUIPMENT
A.R. Sinclair, Electronics,
Stockholders, 2 Normans Lane,
Rabley Heath, Welwyn, Herts AL6 9TQ.
Telephone: 0438 812 193
Mobile: 0860214302. Fax: 0438 812 387

LASER DIODES

DMM's and Logic Probes from £7.50 Visible laser diodes plus optics.

Send SAE:

Access Pacific Ltd
Kymbrook School House,
Kimbolton Road, Keysoe,
Bedford MK44 2HH
Tel: 0230 62695

HELP WANTED

WANTED — help on design of programmer for Mars coin mechs. Complete confidentiality and good reward for success. Phone Mark on 081-693 8200.

TELEPHONE JAMES TROTT ON

0442-66551 FOR RATES

EMPLOYMENT

SERIOUS about your future employment? Jobsearch UK is a newspaper with thousands of opportunities for every trade and profession throughout the United Kingdom. Published fortnightly through all leading newsagents. Subscription details, telephone 0753 532041.

VIDEO

DISCOVER, on video, the exciting world of clay shooting! A. J. 'Smoker' Smith, twice World Champion clay shot, takes you round a typical shoot and gives invaluable hints, tips and advice on this fast-growing sport. Available for £24.95, postage free, from Dept. AJ, Argus Books, Argus House, Boundary Way, Hemel Hempstead, Herts HP2 7ST. Tel: (0442) 66551, Ext. 203.

MISCELLANEOUS

KITS, plans, etc. for surveillance, protection (sonic and HV), "007" gear. Send 2 x 22p stamps. For list ACE(TI), 53 Woodland Way, Burntwood, Staffs.

NEW NEW NEW

DISCO LIGHTING KITS

RING 0902 23275 FOR YOUR BROCHURE NOW

PROBABLY THE MOST PRACTICAL RANGE OF DISCO LIGHTING CONTROLLERS TO BE MADE AVAILABLE TO THE KIT BUILDER

NORTECH electronic

98 School Street Wolverhampton

SCOPES

MENDASCOPE LTD

REPAIR & RECALIBRATE OSCILLOSCOPES ALL MAKES AND MODELS NATIONWIDE COLLECTION & DELIVERY

FREE ESTIMATES

Llangollen, Clwyd, N. Wales LL20 7PB
PHONE: 069 172 597

MANUFACTURERS ORIGINAL SPARES

COMPONENTS for TV • Video • Audio • Computer

WE CAN SUPPLY A VAST RANGE FOR MANY MAKES — WRITE (encl SAE please) OR PHONE 0452 526883 FOR A 'PRICE & AVAILABILITY' ON YOUR REQUIREMENTS

VIDEO BELT KITS		COMPUTER SPARES	
AMSTRAD VCR 4800/4700/5200	£3 19	AMSTRAD/SINCLAIR	£30 85
JVC HR3300/3330/3680	£2 79	PEG101A (PC1640)	£20 83
THORN 8800 to 8922	£2 79	40010 Li Array	£23 83
VIDEO PINCH ROLLERS		PCW #016 Serv. Manual	£13 89
AMSTRAD VCR 4500/4800 Mod Kit	£8 17	CPC 464 Serv. Manual	£8 49
JVC Above models	£5 17	AY98912	£5 74
SHARP VC381/386/388/390	£5 87	TEA2000	£4 49
THORN 3V0309/16/22/23/24	£5 17	ULAS0001E	£16 77
TV SERVICE MANUALS		UL476310/40056	£11 89
AMSTRAD CTY 1400	£9 95	ZX8302 (CL)	£10 75
BINATONE 01/9771	£8 99	ZX8401	£7 94
PHILIPS KT4K40 CHASSIS	£10 00	Spec + 2 ROM	£18 99
SEMICONDUCTORS		Spec 48K ROM	£8 63
TBA330 £1 14 UPC1378H	£2 45	Spec 48K Spaker	£1 49
TBA610P £1 40 ZTX213	£0 28	Spec 48K Membrane	£4 50
TD41001B £2 66 ZTX650	£0 49	Spec 48K Membrane	£7 99
OTHER ITEMS		+128K Membrane	£1 18
UNIBOSS #B989F Fast Charger for AAA AA (encl PP3) S. offer	£5 49	4 way Edge Conn	£3 36
4 core telephone cable perim	£0 15	QL Membrane	£7 85
Plug in TONE RINGER	£5 90		

This is just a small sample of stock Catalogue 50p. Chq/Stamps/3xIRC's. MAIL ORDER ONLY Please add 85p (UK) P&P but not VAT. All items subject to availability — Prices can change without notice.

MARAPET (ETI)
1 HORNBEAM WEWS GLOUCESTER GL2 0UE
Telephone: 526883

SPECIAL OFFERS

VARIABLE VOLTAGE TRANSFORMERS

	Price	P&P
INPUT 220/240V AC 50/60 OUTPUT 0-260V		
0.5KVA 2.5 amp max	£29.00	£3.75
	(£38.48 inc VAT)	
1KVA 5 amp max	£37.40	£4.25
	(48.94 inc VAT)	
2KVA 10 amp max	£54.00	£5.48
	(£69.89 inc VAT)	
3KVA 15 amp max	£71.50	£6.24
	(£91.34 inc VAT)	
5KVA 25 amp max	£126.50	
	(Carriage on request)	

Buy direct from the Importers. Keenest prices in the country

COMPREHENSIVE RANGE OF TRANSFORMERS-LT-ISOLATION & AUTO
(110-240V Auto transfer either cased with american socket and mains lead or open frame type. Available for immediate delivery.

	Price	P&P
4ft 40 watt £10.44 (parts only)	£12.27	inc VAT
2ft 20 watt £7.44 + £1.25 p&p	£10.21	inc VAT
13in 10 watt £5.90 + 75p p&p	£7.70	inc VAT
12in 8 watt £4.80 + 75p p&p	£6.52	inc VAT
9in 6 watt £3.96 + 50p p&p	£5.24	inc VAT
6in 4 watt £3.96 + 50p p&p	£5.24	inc VAT

230V AC BALLAST KIT
For either 6in, 9in or 12in tubes £5.50 + 55p p&p (£7.11 inc VAT)
For 13in tubes £8.00 + 75p p&p (£9.93 inc VAT)

400 WATT UV LAMP
Only £34.00 + £2.50 p&p (£42.89 inc VAT)
175 WATT SELF BALLASTED BLACK LIGHT MERCURY BULBS
Available with BC or ES fitting. Price inc VAT & p&p £20.27



12 VOLT BILGE PUMPS

Buy direct from the Importers
500 GPH 15R head 9 amp £16.36
1750 GPH 15H head 9 amp £26.05
PRICES INCLUDE P&P & VAT



EPROM ERASURE KIT
Build your own EPROM ERASURE for a fraction of the price of a made up unit. Kit of parts less case includes: 12 in 8 watt 2537 Argon Tube Ballast unit, pair of bi-pin leads, neon indicator, on/off switch, safety microswitch and circuit £14.00 + £2.00 p&p (£16.80 inc VAT)

SUPER HY-LIGHT STROBE KIT
Designed for Disco, Theatrical use, etc.
Approx 16 pulses. Adjustable speed £48.00 + £2.00 p&p (£58.75 inc VAT)
Lens and reflector £22.00 + £2.00 p&p (£26.20 inc VAT)
SAE for further details including Hy-Light and industrial Strobe kits

"BOFFINS SPECIAL" — UNIQUE OFFER

Surplus Precision Medical Unit, internally in excellent condition. Designed primarily to eject a precise controllable amount of fluid from a medical syringe (latter not supplied). Contains the following removable components: Dual Micro Processor Boards and EPROMS Escap Precision 12V DC Motor with 300 1 Gear Box and optical encoder coupled to a precision threaded drive mechanism. Mains supply with 12 x 15V Ni-Cad AA cells back-up LCD Digital read-out 17mm high with legends. Audible warning.
These are sold for the dismantling of the exceptional quality components. Regret no Circuits available. Ridiculously low price £16.00 + £4.00 p&p (£23.50 inc VAT).

WIDE RANGE OF XENON FLASHLIGHTS

GIANT BLOWER EXTRACTOR UNIT
Twin output centrifugal blower. 1 HP. 240V AC motor. Output approx 3800 c.f.m. Size: Length 100cm. Height 27cm. Depth 26cm. Fixing plate 1106 x 33cm. Price £125 + VAT. Ex-warehouse.

TORIN CENTRIFUGAL BLOWER
230V AC 2.800 RPM 0.9 amp. 130mm diameter. Impeller outlet 63 x 37mm. Overall size 195 x 160 x 150mm long. Price £17.90 + £2.50 p&p (£23.50 inc VAT).

SOLID STATE EHT UNIT
Input 230/240V AC. Output approx 15KV. Producing 10mm spark. Built-in 10 sec timer. Easily modified for 20 sec. 30 sec to continuous. Designed for boiler ignition. Dozens of uses in the field of physics and electronics, eg supplying neon or argon tubes etc. Price less case £8.50 + £1.00 p&p (£11.16 inc VAT) NMS

GEARED MOTORS
71 RPM 20lb inch torque reversible 115V AC input including capacitor and transformer for 240V AC operation. Price inc VAT & p&p £23.50.

HEAVY DUTY MOTOR
Crouzet 115/230V AC heavy duty 11RP motor. Anticlockwise type B2/015 Size 68mm diameter x 55mm long. Shaft 6mm diameter x 20mm long. Price inc VAT & p&p £18.85.

RHEOSTAT
50W 2 ohm 5 amp ceramic power rheostat price inc VAT & p&p £10.61.

MICROSWITCH
Pye 15 amp changeover lever microswitch Type S171. Brand new price 5 for £7.05 inc VAT & p&p

NMS = NEW MANUF SURPLUS
R&T = RECONDITIONED AND TESTED

SERVICE TRADING CO (E.T.I.)



Showroom open Monday - Friday

57 BRIDGEMAN ROAD, CHISWICK, LONDON W4 5BB

081-995 1560

ACCOUNT CUSTOMERS MIN. ORDER £10



Ample Parking Space

SHERWOOD Data Systems

... The single board computer people

The Archer



- | 2 serial ports | 4 counter timers | 32 digital I/O lines |
|-----------------|------------------|------------------------|
| 4 memory slots | Battery Backup | Expansion bus |
| Watchdog timer | | Powerfail interrupt |
| Options | | |
| Debug Monitor | Desk top case | On board mains psu |
| Option Switches | ROMable basic | Various daughter cards |

Sherwood Data Systems Ltd.,

Tel: 0494 464264

ETI

ELECTRONICS TODAY INTERNATIONAL

EDITORIAL

Editor Paul Freeman

CREATIVE

Art Editor Peter Kirby

Designer Iain Houston

Technical illustration Jerry Fowler

Photography Manny Cefai

ADVERTISEMENT SALES

Advertisement Manager

Mark Linacre

Advertisement Sales

Michele Donovan

Advertisement Copy Control

Marie Quilter

MANAGEMENT

Managing Director

Terry Patisson

Circulation & Promotions Manager

Debra Stupple

Production Manager

Tony Dowdeswell

Group Editor

Stuart Cooke

ISSN
0142-7229

ABC

Member of the
Audit Bureau
of Circulation

ETI is normally published on the first Friday in the month preceding the cover date. The contents of this publication including all articles, designs, plans, drawings and programs and all copyright and other intellectual property rights therein belong to Argus Specialist Publications. All rights conferred by the Law of Copyright and other intellectual property rights and by virtue of international copyright conventions are specifically reserved to Argus Specialist Publications and any reproduction requires the prior written consent of the Company © 1990 Argus Specialist Publications. All reasonable care is taken in the preparation of the magazine contents, but the publishers cannot be held legally responsible for errors. Where mistakes do occur, a correction will normally be published as soon as possible afterwards. All prices and data contained in advertisements are accepted by us in good faith as correct at the time of going to press. Neither the advertisers nor the publishers can be held responsible, however, for any variations affecting price or availability which may occur after the publication has closed for press.

● Subscription rates — UK: £19.20. Europe: £24.10. Middle East: £24.40. Far East: £26.80. Rest: £25.85 or US\$48.00.

Published by Argus Specialist Publications, Argus House, Boundary Way, Hemel Hempstead HP2 7ST. Tel: (0442) 66551. UK newstrade distribution by SM Distribution Ltd., 6 Leigham Court Road, London SW16 2PG. Tel: 081-677 8111. Overseas and non-newstrade sales by Magazine Sales Department, Argus House, Boundary Way, Hemel Hempstead, HP2 7ST. Tel: (0442) 66551. Subscriptions by Select Subscriptions Ltd., 5 River Park Estate, Berkhamsted, Herts HP4 1HL. Tel: (0442) 876661. US subscriptions by Wise Owl Worldwide Publications, 4314 West 238th Street, Torrance, CA90505 USA. Tel: (213) 3756258. Typesetting and origination by Project 3 Filmsetters, Whitstable. Printed by Wiltshire Ltd, Bristol.



Argus House, Boundary Way,
Hemel Hempstead HP2 7ST
Tel: (0442) 66551 Fax: (0442) 66998

NEXT MONTH

Next month we will have arrived at the Christmas issue once again and another free gift, a PCB sticker foil for you to experiment with. An article tells you how to use your free gift and how to make foils. *

We can offer the ultimate in enlarger timers if you are a photographic boffin. It could even turn the kettle on to make the tea.

To put you in the festive mood why not try making our LED Star project for the christmas tree. It's an ideal way to get rid of all those surplus LEDs.

We continue with the Test-Card Generator a versatile tool for the TV serviceman and a laboratory power supply which uses our free foil pattern.

On the theory side we start a new series on audio mixing desks. Also we cover Star-delta transforms and we continue in our course on Test-gear basics postponed from this month.

The Christmas issue of ETI will find its way on to the newsstand on December 6th.

The above articles are in preparation but circumstances may prevent publication

LAST MONTH

The November issue contained articles on:

Digital pulse transmission
Waves and Particles
The final part on Back to basics
Test-gear basics Part 1
The Nightfighter Part 3
Hybrid Audio Pre-amp
Switched-mode power supply

A limited number of back issues are available from Select Subscriptions (Address shown in column to the left).

ADVERTISERS' INDEX

BK ELECTRONICS	IFC	MAPLIN ELECTRONICS	OBC
CRICKLEWOOD ELECTRONICS .	57	MEC MICRO	57
DISPLAY ELECTRONICS	59	MQP	57
ELECTRONIZE DESIGN	58	NUMBER ONE SYSTEMS	58
ELECTROVALUE	58	OMNI ELECTRONICS	56
HENRYS ELECTRONICS	39	RADIO & TV COMPONENTS	IBC
HESING TECHNOLOGY	56	REED ELECTRONICS	13
JOHN MORRISON	13	SUMA ELECTRONICS	57
J&N BULL	45	WILMSLOW AUDIO	39

2 x 220 watt MOSFET AMPLIFIER

A top-of-the-range performer that will satisfy the most demanding audio enthusiast. If you're looking for an amplifier to power your subwoofer, the **SPARKOMATIC** is all you'll need! Highly sophisticated MOS-FET technology dramatically extends frequency response, separate input sensitivity controls, built-in protection circuitry for overheat and short circuit with l.e.d. indication, output power: 2 x 220 watt maximum and 2 x 110 watt at 0.1% THD. Bridged 440 watt mono maximum and 220 watt mono at 0.5% THD.



£164.50 plus £3.50 P&P

100 watt x 4 CLASS A AMPLIFIER FOR CARS

Delivers 4 x 100 watt into 4 woofers or with the aid of its built in active cross over delivers 200 watt of Bass via sub-woofer output and 2 x 100 watt range into 2 speakers; thus giving you all the power you require to make even traffic jams a positive pleasure. SPECIFICATION 4 x 100W (4Ω), 2 X 200W Bridged, THD 0.6%, S/N RATIO: 7 90db, RESPONSE 10Hz-50KHz, LOW PASS FILTER SWITCHED 75Hz 150Hz, INPUT 4 x PHONO 100-3 Volts, INPUT 4 HIGH LEVEL 20KΩ, SIZE 240mm x 50mm x 400mm.

£118.50 postage £4.50

75 watt x 2 CLASS A AMPLIFIER FOR CARS

Small but powerful, high efficiency amplifier, suitable for a number of hidden mounting locations. Easy connection through phono and high level input capability. SPECIFICATION 2 x 75 watt 4Ω, 1 x 150 watt Bridged, THD 0.190, S/N RATIO: 7.85 dB, RESPONSE 20Hz-30KHz, INPUTS: 2 X PHONO 100mV-3 VOLT 2 X HIGH LEVEL 2 X 20KΩ, SIZE 240mm X 50mm X 140mm.

£48.50 postage £3.50

11 BAND COMPONENT GRAPHIC EQUALIZER FOR CARS



This neat unit connects between the line output of your car stereo and your power amplifiers so you are able to adjust the sound as in a studio compensating for soft furnishing and sound reflections from glass, also it has a sub-woofer output to drive a separate amplifier for that extra deep bass sound. FEATURES: 2 channel inputs 4 channel outputs via phono sockets, CD input via 3.5mm jack 11 band graphic. SPECIFICATION RANGE 20Hz-60KHz THD 0.05%, S/N RATIO 85dB, EQ FREQUENCIES 60Hz, 120Hz, 250Hz, 380 Hz, 500 Hz, 750 Hz, 1 KHz, 2KHz, 4KHz, 8KHz, 16KHz (Boost out of = 12 dB) SIZE 178mm x 25mm x 140mm.

£32.70 postage £1.80.

EMINENCE 4Ω PROFESSIONAL USA MADE IN CAR CHASSIS SPEAKERS

All units are fitted with big magnets "Nomex" voice coils NOT ALUMINIUM, "Nomex" is very light and can stand extremely high temperatures, this feature makes for high efficiency and long lasting quality of sound.

VEB 12" 200W Max	Range 50Hz-3KHz	£34.40
VEB 8" 300W Max	Range 45Hz-3KHz	£39.35
V10 10" 400W Max	Range 33Hz-4KHz	£44.45
V12 12" 400W Max	Range 35Hz-3KHz	£45.95
BOSS 15" 800W Max	Range 35Hz-4KHz	£79.90
KING 18" 1200W Max	Range 20Hz-1KHz P.O.A.	

Postage **£3.85** per speaker.

AUDAX JBL 40-100 watt CAR TWEETERS

These state of the art advanced technology, high performance 10 mm dome tweeters are Ferrofluid coded and are active horn-loaded for high dispersion of sound with very low distortions. Ideal for tuning up your dull sounding in-car system. SPECIFICATION IMP40 40 watts at 5KHz, 100 watt at 10KHz, MAGNET, SIZE 5mm x 30mm, VOICE COIL SIZE 10.5mm EFFICIENCY 92.8 dB, 5k, SIZE 51mm x 51mm x 16.5mm. RECOMMENDED.

1st ORDER CROSSOVER, VALUE 1.5uf-2.2uf supplied. **£7.50 pair plus 90p post.**

MAIL ORDER £1 BARGAIN PACKS BUY 20 GET 1 FREE Please state pack(s) required

No.	Qty. per pack	Description
BP015B	1	30W dome tweeter. Size 90x66mil JAPAN made
BP017	3	33000µF 16V d.c. electrolytic high quality computer grade UK made
BP019	20	20 ceramic trimmers
BP020	4	Tuning capacitors, 2 gang dielectric a.m. type
BP021	10	3 position, 8 tag slide switch 3 amp rated 125V a.c. made in USA
BP022	5	Push-button switches, push on push off, 2 pole changeover. PC mount JAPAN made
BP023	6	2 pole 2 way rotary switch
BP024	2	2 Right angle, PCB mounting rotary switch, 4 pole, 3 way rotary switch UK made by LORLIN
BP025	4	3 pole, 3 way miniature rotary switch with one extra position off (open frame YAXLEY type)
BP026	4	4 pole, 2 way rotary switch UK made by LORLIN
BP027	30	Mixed control knobs
BP029	6	Stereo rotary potentiometers
BP030	2	10k wire wound double precision potentiometers UK made
BP032	4	UHF varicap tuner heads, unboxed and untested UK made by PHILIPS
BP033	2	FM stereo decoder modules with diagram UK made by PHILIPS
BP033A	4	6" x 3" High grade Ferrite rod UK made
BP034	3	AM IF modules with diagram PHILIPS UK MADE
BP034A	2	AM-FM tuner head modules. UK made by Mullard
BP034B	1	Hi-Fi stereo pre-amp module inputs for CD, tuner, tape, magnetic cartridge with diagram. UK made by MULLARD
BP035	6	All metal co-axial aerial plugs
BP036	6	Fuse holders, panel mounting 20mm type
BP038	20	5 pin din, 180° chassis socket
BP039	6	Double phono sockets, Paxolin mounted
BP041	3	2.8m lengths of 3 core 5 amp mains flex
BP042	2	Large VU meters JAPAN made
BP043	30	4V miniature bulbs, wire ended, new untested
BP044	2	Sonotone stereo crystal cartridge with 78 and LP styl JAPAN made
BP045A	2	Mono Cassette Record and play heads
BP046A	2	606 Mains transformers, PCB mounting. Size 42x33x35
BP047A	1	25V DC 150mA mains adaptor in black plastic case with flying input and output leads new units made for famous sound mixer manufacturer. Size 80x55x47
BP049	10	OC44 transistors. Remove paint from top and it becomes a photo-electric cell (ORP 12). UK made by MULLARD
BP050	30	Low signal transistors n.p.n., p.n.p. types
BP051	6	14 watt output transistors. 3 complimentary pairs in TO66 case. (Ideal replacement for AD161 and 162s)
BP052A	1	Tape deck pre-amp IC with record/replay switching No LM1818 with diagram
BP053	5	5 watt audio ICs. No TBA800 (ATEZ)
BP054	10	Motor speed control ICs, as used with most cassette and record player motors
BP055	1	Digital DVM meter I.C. made by PLESSEY as used by THANDAR with diagram
BP056	4	7 segment 0.3 LED display (red)
BP057	8	Bridge rectifiers, 1 amp, 24V
BP058	200	Assorted carbon resistors
BP059	1	Power supply PCB with 30V 4V/A transformer MC7818CT IC & bridge rectifier. Size 4" x 2 1/2"
BP061	5	6.35mm Mono jack plugs
BP063	5	6.35mm stereo switched jack sockets
BP064	12	Coax chassis mount sockets
BP065	1	3mtr Euro-mains lead with chassis socket

Postage **£3 per order**

ROADSTAR OF SWITZERLAND. QUALITY 13cm 40 watt CAR SPEAKERS. Fitted with dual polypropylene cone and foam rubber surround. Large 70mm magnet for good bass and treble response. Supplied complete with grills, fixing screws and cable.

OFFER PRICE £11.70 pair

They weigh nearly 1.5kg, Postage £3.15 each

2 pairs for £22 POST PAID UK ONLY

UNDER 1/2 PRICE OFFER

AUSTIN ROVER MINI MAYFAIR. 15 watt POD SPEAKERS. Moulded in a black housing for vertical or horizontal use. Fitted with a good mains 10cm speaker.

£4.95 pair plus £3 pp or

2 pairs for £10.50 post paid UK only

BSR STEREO RECORD PLAYER DECK

Manual auto operation, 3 speed (78, 45, 33%), 240V operation. unused but store soiled.

£10.50 ea P&P £3.75 2 for £18.00 P&P £3.75

RADIO AND TV COMPONENTS ACTON LTD
323 EDGWARE ROAD LONDON W2 1BN

MAIL ORDER TERMS. POSTAL ORDERS and/or CHEQUES with orders. Next monthly accounts to Schools, Colleges and P.L.C. only. ACCESS VISA Phone orders between 9.30-12pm please. Overseas readers write for quote on delivery.

Phone 071 723 8432 or 081 992 8430

323 Edgware Road, London W2 1BN. Closed Sun

AMPHONIC 125 + 125 POWER AMPLIFIER



125 watt per channel stereo power amplifier with independent volume controls, professional 19" rack mount and silent running cooling fan for extra reliability.
Output power..... 125W RMS max. per channel
Output impedance..... 4 to 16 ohms (max power into 4 ohms)
Sensitivity..... 450V at 22k ohms
Protection..... Electronic short-circuit and fuses
Power..... 220-240V a.c. 50Hz
Chassis dim..... 435 x 125 x 280mm
£170 + £7.00 pp

30 + 30 WATT AMPLIFIER KIT



An easy to build amplifier with a good specification. All the components are mounted on the single PCB which is already punched and back-printed.

- 30W x 2 (DIN 4 ohm)
 - CD/Aux, tape 1, tape II, tuner and phono inputs.
 - Separate treble and bass.
 - Headphone jack.
- Size (H.W.D.) 74 x 400 x 195mm.
Kit enclosed: case, PCB, all components, scale and knobs **£40.00 + £3.50 pp.**
(Featured project in *Everyday Electronics*, April 1989 issue). Reprint Free with kit.

MULTIBAND RADIO

VHF 54-176MHz + AM CB BANDS 1-80

Listen to: AIR TRAFFIC CONTROL,

AIRCRAFT, RADAR,

PUBLIC UTILITIES,

RADIO AMATEURS AND

MANY MANY MORE

SQUELCH CONTROL

AERIAL

£17.95
POSTAGE
£2.85

ROSS PUSH BUTTON RADIO

Mains and battery operated. High quality VHF/FM. Medium and Long Wave reception.

6 push button selected preset stations.

Fully retractable telescopic aerial

Headphone/earphone jack socket.

Size 230H x 150W x 65D

Ref. RE-5500

Brand new.

Listed price over £30.00

OFFER £15.00

+ £2.80 pp

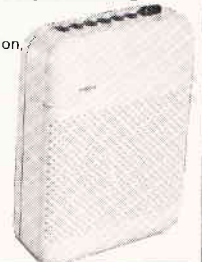

VIDEO SENDER

With this handy unit you can transmit the output of your home video, video camera or satellite equipment over-the-air to a receiving television within a range of 100ft. Simply connect the video and audio output of your equipment into this unit and a 10-13.8V dc power supply extra **£3.75** size 122 x 70 x 21mm

£11.50 + £2 pp

VHF RADIO TRANSMITTERS

100mW mini bug. Built on a neat little fibre glass pcb with condenser mic. Fully tunable over the FM band. 9V DC

£5.75 + £0.90 pp

2 Watt transmitter kit, supplied with fibre glass pcb, all components, diagrams, ready for you to build. 12-24V DC.

£7.50 + £0.70 pp

25 Watt Transmitter kit. Fully tuneable over the FM band. Kit comprises double sided pcb diagrams and all components, including heat sink.

Supply voltage 12-18V DC. **£67 + £1 pp**

Transmitters listed on this page are not licensable in the UK.

SPECIAL OFFER

DTMF TONE DIALLER

Suitable for remote control of telephone answering machines, videos, appliances etc. requiring DTMF signals over telephone lines.

£8.95

Please add 75p p&p when ordering



Please add 2.2% to all our prices due to the increase of the VAT rate to 17.5%

1992 BUYER'S GUIDE TO ELECTRONIC COMPONENTS

Maplin

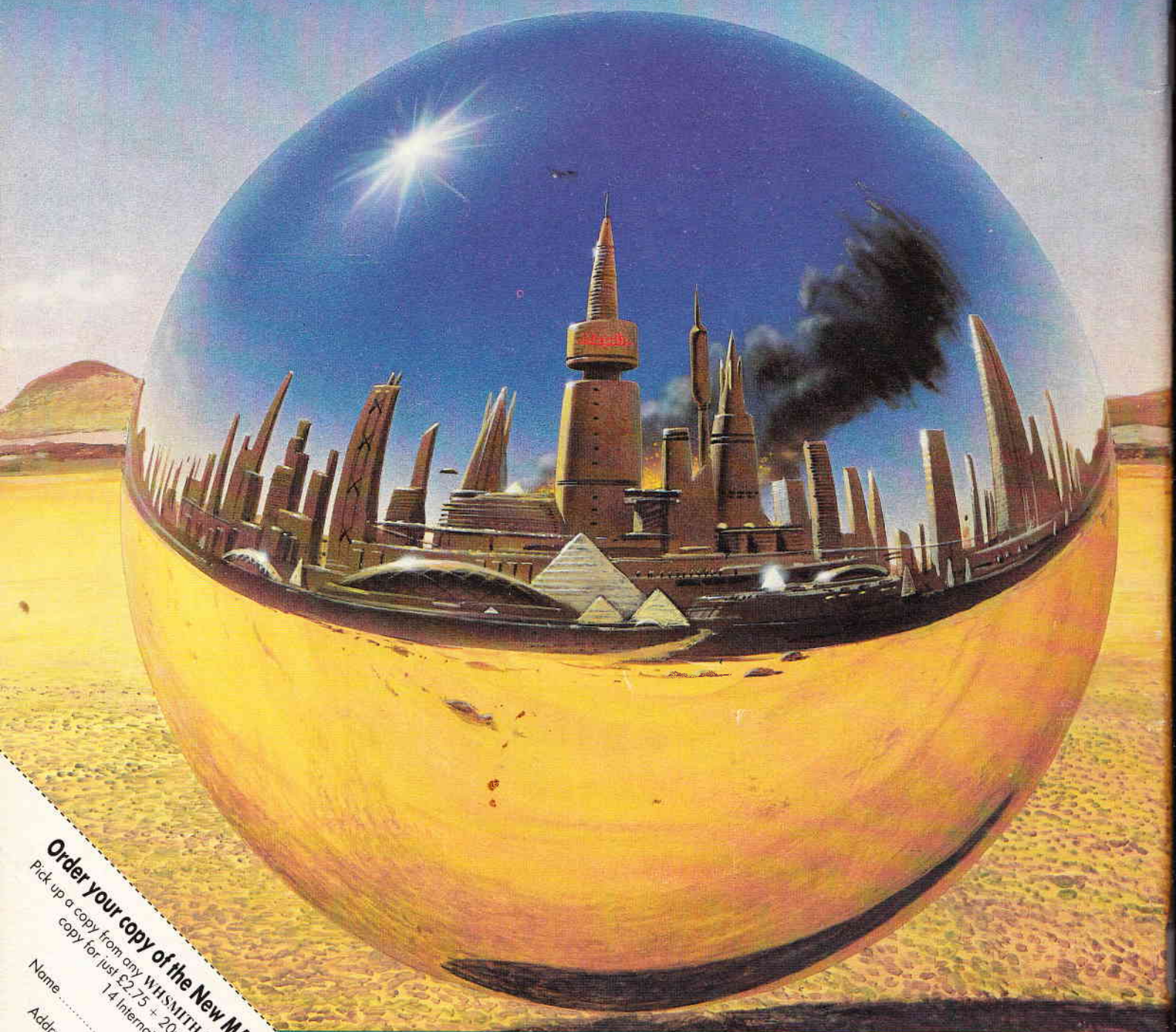

Order your copy of the New MAPLIN Catalogue on sale NOW!
Pick up a copy from any WHSMITH for just £2.75 or post this coupon now to receive your copy for just £2.75 + 20p p&p. If you live outside the UK send £4.85 or 14 International Reply Coupons. I enclose £2.95.

Name
Address
Post Code

Send to Maplin Electronics,
P.O. Box 3, Rayleigh,
Essex SS6 8LR.
E192

Over 600 product packed pages with
more than 600 brand new products.
On sale now, only £2.75

Available from all branches of WHSMITH and
Maplin shops nationwide. Hundreds of new products
at super low prices!