

WIN  
PRIZES  
WORTH \$4000

Australia's

Top Selling Electronics Magazine

# Electronics Australia

NDD

WITH ETI OCTOBER 1991  
Aust\* \$4.95  
NZ \$6.50 incl GST

**BUILD A CAR ALARM  
THAT'S REALLY LOW IN COST  
AND EASY TO INSTALL**

**PROFESSOR YAGI:  
THE MAN WHO POINTED  
OUR ANTENNAS  
IN THE RIGHT DIRECTION**



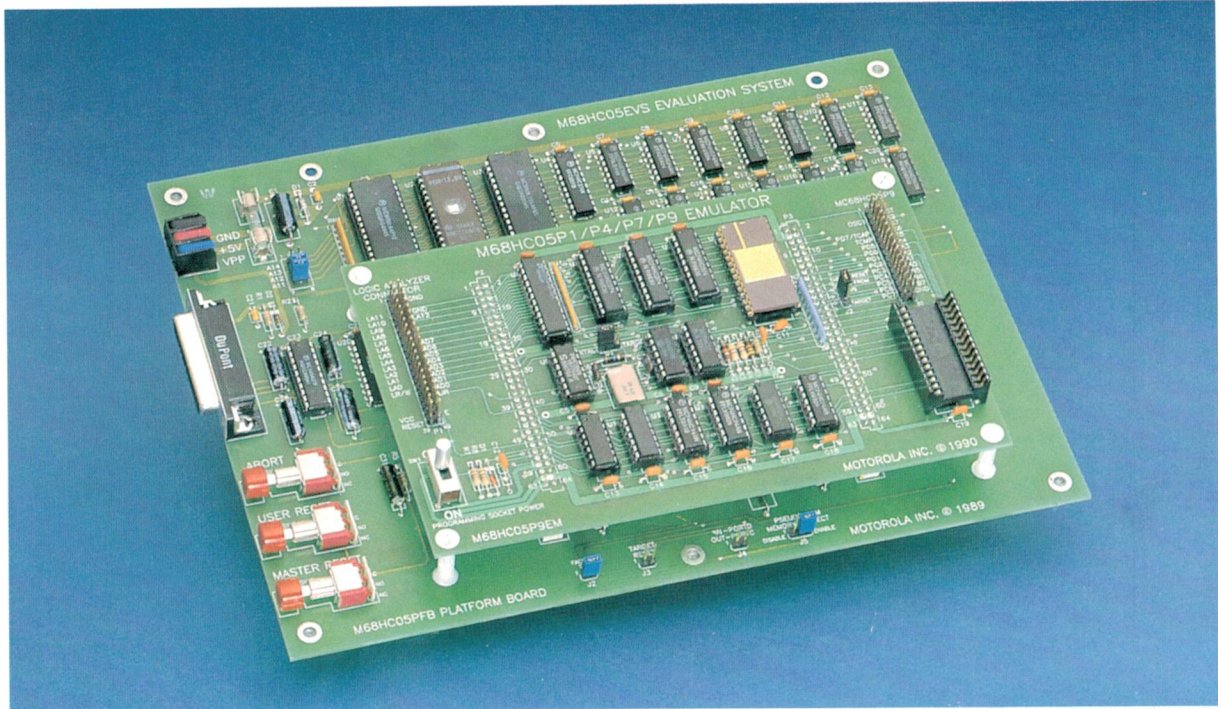
# IS THIS THE BEST STEREO CASSETTE DECK EVER MADE?

Registered by Australia Post - Publication No. NBP 0240





# The complete evaluation system for Motorola MCUs for much less than you'd expect.



The M68HC05 EVS Evaluation System provides designers with debugging and emulation facilities for the M68HC05 P and J families of Motorola MCUs. Main features of the EVS include:

- On board debugging monitor
- On line Assembler/Disassembler
- S-Record downloading capability
- 32K pseudo ROM for user code
- OTP/Eprom MCU programmer
- In Circuit Emulation capability
- Logic Analyser connector
- Very Low Cost (<<\$1000)

The M68HC05 family of 8 bit MCUs consist of a CPU surrounded by a mix of modular peripherals. The available peripherals include A/D converters, PWM, 16 bit timers, Watchdogs, Asynchronous and Synchronous serial, hi-drive ports, memory types include up to, 16K EPROM, 256 bytes EEPROM, 400 bytes RAM.

As the peripheral combination is determined by customer demand, the resulting devices are termed CSICs (Customer Specific Integrated Circuits). The EVS caters for the many possible combinations of peripherals by incorporating a small personality board to tailor the main board for a particular series. This reduces EVS design costs and therefore end product cost.

The EVS joins the existing range of EVM Evaluation Modules. The range now offers emulation capabilities for the M68HC05, M68HC11, M68HC16, M68000, M68300 AND DSP families of MCUs.

Please contact Veltek for pricing details  
and technical information.



**■** Solutions Through Superior Technology

READER INFO NO. 1

**VICTORIA**  
VELTEK PTY LTD  
22 Harker St, Burwood Vic 3125  
Ph. (03) 808 7511 Fax (03) 808 5473

**NEW SOUTH WALES**  
VELTEK PTY LTD  
Suite 12, 50 Great North Rd, Five Dock NSW 2045  
Ph. (02) 713 4100 Fax (02) 712 3605

**SOUTH AUSTRALIA**  
VELTEK (S.A.) PTY LTD  
1st Floor, 176 Gilles St, Adelaide SA 5000  
Ph. (08) 232 3922 Fax (08) 232 3929

**WESTERN AUSTRALIA**  
VELTEK (W.A.) PTY LTD  
Unit 5, 64-66 Kent St, Cannington WA 6107  
Ph. (09) 351 9420 Fax (09) 351 9324



# Electronics Australia

WITH  
**eti**

Volume 53, No.10

October 1991

AUSTRALIA'S LARGEST SELLING ELECTRONICS MAGAZINE — ESTABLISHED IN 1922

## Philips releases portable full-VHS VCR/CTV combo



Philips claims its new PVR200 is the first full VHS personal colour TV/VCR combination on the market. It features a high resolution, fast response 100mm active-matrix LCD screen, automatic station search plus the ability to replay either PAL or SECAM tapes. (See page 6)

## Low cost 'space bus'



One of the things preventing greater use of satellites for communications and broadcasting is the sheer cost of placing them in orbit. Lockheed believes its new F-SAT vehicle solves this problem — see page 18.

## On the cover

Pioneer's new top-of-the-line CT-93 stereo cassette deck could well be the best analog cassette recorder ever made, with truly outstanding performance rivalling the new DAT machines. See Louis Challis' detailed test report, beginning on page 8. (Picture by John Fryz)

## Video and Audio

- 6 WHAT'S NEW IN VIDEO & AUDIO *The latest products...*
- 8 THE CHALLIS REPORT: *Pioneer's CT-93 cassette deck — the best ever?*

## Features

- 18 LOCKHEED'S F-SAT: *Low cost space 'bus' for launching satellites*
- 22 MOFFAT'S MADHOUSE *Taking stock of computers...*
- 26 FEW IN NUMBER, BUT VERY ENTHUSIASTIC *Egypt's radio amateurs*
- 50 WHEN I THINK BACK... *Hidetsugu Yagi: Pioneer of directional antenna design*
- 83 OATLEY/EA 'ANYTHING GOES' CONTEST: *Win prizes worth over \$4000!*

## Projects and Technical

- 30 LONGER LIFE FOR NICADS — 1 *How they work, why they can fail*
- 40 THE SERVICEMAN *Problems with manuals, customers and myself as well*
- 44 LISTENING POST II GETS S-VGA, VGA/EGA *Improved fax pic quality...*
- 56 CIRCUIT & DESIGN IDEAS *Automatic light switch, low dropout regulator*
- 58 BUDGET CAR ALARM MK2 *Improved version of a very popular design*
- 64 VARIATIONS ON THE 18V/1A BENCH SUPPLY *30V/1A, 18V/2A versions*
- 70 EXPERIMENTING WITH ELECTRONICS — 3 *Making your siren wail*
- 78 MINI NIGHT VIEWER *Smaller, cheaper and easier to build than ever!*
- 86 VINTAGE RADIO *The Philips 2510 'tin trunk' receiver*

## Professional Electronics

- 100 NEWS HIGHLIGHTS *Maglev system uses ceramic superconductors*
- 104 SOFTWARE CALCULATOR FOR ELECTRONICS *Runs on PCs*
- 106 PC-BASED CIRCUIT SIMULATORS — 4 *Device models and modelling aids*
- 114 NEW PRODUCTS *Multilayer PCB shorts locator, extended life relay*
- 118 SOLID STATE UPDATE *Halogen lamp dimmer, 'Super HEMT' transistor*
- 120 DSE RE-RELEASES KIT FOR TV RF SM *Parts supply problems solved...*
- 122 SILICON VALLEY NEWSLETTER *IBM etches, deposits single silicon atoms*
- 124 LOCALLY MADE EPROM PROGRAMMER *Driven from a standard PC*
- 126 COMPUTER NEWS & NEW PRODUCTS *Continuous laser printer, A/D card*

## Columns and Comments

- 4 LETTERS TO THE EDITOR *TAFE problems, praise for Basic Electronics*
- 5 EDITORIAL VIEWPOINT *Why we need to encourage hobby experimenters*
- 14 FORUM *PAL vs sundry assorted MACS — our original correspondent replies...*
- 90 SHORTWAVE LISTENING *Preparing a reception report*
- 92 INFORMATION CENTRE *A veritable hornet's nest — electromagnetic fields*
- 98 AMATEUR RADIO NEWS *WIA to administer amateur radio licence exams*

## Departments

- 24 BOOK REVIEWS
- 96 EA CROSSWORD, HISTORY
- 97 MARKETPLACE
- 130 DIRECTORY OF SUPPLIERS
- 130 ADVERTISING INDEX
- 43 NOTES AND ERRATA



**MANAGING EDITOR**  
Jamieson Rowe, B.A., B.Sc., SMIREE, VK2ZLO

**PRODUCTION EDITOR**  
Milli Godden

**TECHNICAL EDITOR**  
Rob Evans, CET (RMIT)

**FEATURES EDITOR**  
Peter Murtagh, B.Sc., Dip.Ed.

**TECHNICAL CONSULTANT**  
Peter Phillips, B.ED., Dip.Ed., ECC

**SECRETARY**  
Ana Marie Zamora

**ADVERTISING MANAGER**  
Selwyn Sayers

**CONTRIBUTORS**  
Neville Williams, FIREE, VK2XV  
Jim Lawler, MITETIA  
Arthur Cushen, MBE  
Tom Moffat, VK7TM  
Peter Lankshear

**DRAFTING**  
Karen Rowlands

**GRAPHICS DESIGNER**  
Clive Davis

**PRODUCTION**  
Mal Burgess

**ADVERTISING PRODUCTION**  
Anthony Macarounas

**CIRCULATION MANAGER**  
Michael Prior

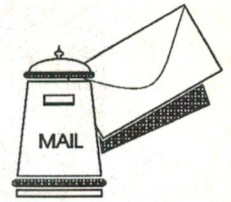
**PUBLISHER**  
Michael Hannan

**HEAD OFFICE**  
**EDITORIAL**  
180 Bourke Road, Alexandria, NSW 2015  
P.O. Box 199, Alexandria 2015  
Fax number: (02) 693 6613  
Subscription enquiries: phone (02) 693 9517  
Book Shop enquiries: phone (02) 693 4113  
Reader Services: see last page of magazine  
**ADVERTISING:** phone (02) 693 9734

**INTERSTATE ADVERTISING OFFICES**  
**Melbourne:** 504 Princes Highway, Noble Park, Vic 3174. Phone: (03) 795 3666, Fax No: (03) 701 1534, Nikki Roche  
**Brisbane:** 26 Chermiside Street, Newstead, Qld 4006. Phone: (07) 854 1119, Fax No: (07) 252 3692, Bernie Summers  
**Adelaide:** 98 Jervois Street, Torrensville, SA 5031. Phone: (08) 352 8666, Fax No: (08) 352 6033, Mike Mullins  
**Perth:** Allen & Associates, 54 Havelock Street, West Perth, WA 6005. Phone: (09) 321 2998, Fax (09) 321 2940, Tony Allen  
**New Zealand:** 63-73 View Road, Auckland, New Zealand. Phone: (09) 443 0954, Fax No: (09) 443 1326, Gordon Marr  
**United Kingdom:** John Fairfax & Sons (Aust), 12 Norwich Street, London, EC4A 1BH. Phone: (71) 353 9321, Fax: (71) 583 0348  
**Asia:** Headway Media Services Ltd, Room 2101, Causeway Bay Centre, 15-23 Sugar Street, Hong Kong. Phone: 516 8002, Fax: (862) 890 4811, Adrian Batten

**ELECTRONICS AUSTRALIA** is published monthly by Federal Publishing Company, a partnership of General Newspapers Pty Ltd.  
**A.C.N. 000 117 322**  
Double Bay Newspapers Pty Ltd.  
**A.C.N. 000 237 598**  
and Brehmer Fairfax Pty Ltd.  
**A.C.N. 008 629 767**  
180 Bourke Road, Alexandria, NSW 2015.  
Copyright © 1989 by Federal Publishing Company, Sydney. All rights reserved.  
No part of this publication may be reproduced in any way without written permission from the Publisher or Managing Editor.  
Typeset and printed by Hannanprint, 140 Bourke Road, Alexandria, NSW for Federal Publishing Company.  
Distributed by Newsagents Direct Distribution Pty Ltd, 150 Bourke Road, Alexandria NSW 2015. (02) 693 4141.  
The Australian Publication emblem on the front cover of this magazine is there to proudly signify that the editorial content in this publication is largely produced and edited in Australia, and that most of the advertisements herein are the products and services available within Australia.  
**ISSN 1036-0212**  
\*Recommended & maximum Australian retail price.

# LETTERS TO THE EDITOR



## Basic Electronics - 1

Being a middle aged youngster who still has an inquisitive mind, I decided about two years ago, when an electrical appliance 'died' to ask "what is electricity, what makes it work and how all those thingamajigs work inside various appliances?"

I went to the library, read many of my own reference books (bought for my children), and found a wealth of information but with my Year 8 education, I had a problem coping with the physics and advanced concepts of electronics.

Then I stumbled across *EA* at the newsagents — thought to myself 'In like Flynn now', but was honestly still out of my depth. Until the start of the Basic Electronics articles, which has shown me how to understand what is happening to the 'thingamajigs' once voltage is flowing in circuits.

I constructed the regulated power supply from the mains up (Basic Electronics - 9) and when completed, it was put into operation. It actually worked — Boy, that is some feeling you get. I am also doing a correspondence course for Basic Electronics, to further my understanding of a subject in which I am now an ardent student.

I would like to say, Sir, that without Peter Phillips' articles there are a lot of things that I would not understand properly. One only hopes that there are many out there in the community who are taking advantage of this wonderful series and hands on experience being preferable to amateur hobbyist's like me, through your magazine.

Thank you very much for making my adopted hobby so much more enjoyable.

Ray Marsh,  
Hastings, VIC.

## Basic Electronics - 2

I am writing in response to the recent letter by P.G. of Frankston VIC, in the May 1991 issue which criticises Peter Phillips' 'Basic Electronics' series.

Please correct me if I'm wrong, as I am of the impression that the series is titled BASIC ELECTRONICS and is written for the few who read this magazine that aren't qualified electronics engineers and have a great desire to learn. I am such a

person and I find Mr Phillips' style of writing easy to understand. Mr Phillips makes it perfectly clear in his writing that he may omit at times some of the more precise and technical equations in the interests of clarity.

I found P.G.'s explanation quite confusing. It leaves me wondering how he would have explained volts, amps and resistance. It is my hope that P.G. does not try his hand at writing a similar article, as I feel it would leave more readers confused than enlightened.

Peter, please keep up the high standard of writing as you have at least one avid student. My only criticism is sometimes having to wait two months for the next chapter.

Bob Sorich,  
Thornbury, VIC.

## Memory lane...

A letter in your May 1991 issue from Sam Howlett prompted me to write too, as Mr Howlett has stirred some of my own memories.

August this year will mark 15 years of reading your magazine and (its opposition at the time) Electronics Today. At the time I was 12, my brother just younger and between us we managed to buy each magazine as it came out as well as from time to time, extort money from parents to build some of the projects — mainly the small ones, although there is still a 20MHz frequency counter and a 40/40 amp in regular use, all of which were built in my school days.

I still have every issue from August 1976, reaching the point where I'm going to have to get them microfilmed to reclaim the space. What changes we've seen over the last decade and a half! It's interesting to look back and see how the magazine has changed to suit our continually changing hobby and market trends.

I remember reading the articles on microprocessors and trying to figure out a way of building something like the 'Baby 2650' or the 'Mini Scamp'. I wonder if anybody still uses theirs? What also of the DREAM 6800, the Super-80 and one more I think I've forgotten? I still have a Microbee, although these days, an 80486PC gets a lot more use.

It's refreshing to see the Amateur



Radio projects gaining space again, and presenting designs that at least rival commercial products.

Regrets? A couple, you (probably very wisely) never presented a major robot, even at the height of the microprocessor fever. I've always wanted to build one, and I figure that I would rely on your designs, not try and follow half-baked ideas from overseas. Secondly, I'm not sure I'm too pleased with the new format, but then I'm just being picky...

To Mr Howlett, hang in there. It IS possible to make a good living out of electronics and related fields. I can trace my career path back to an avid reading of these magazines. The understanding I gained from the projects and their descriptions served as a helpful background. They however, cannot replace a formal education.

To the staff of *EA* (with *ETI*) congratulations of your efforts at putting together what must regularly be one of the best general electronics magazines available anywhere, and I look forward to the next fifteen years.

Christopher F. Moran, MD  
Emergent Technology,  
Canberra, ACT

## TAFE problems

Further to your editorial in the May issue, I have a friend who teaches computer science at a large Victorian TAFE college. Last year she mentioned that there are three administrators for every teacher on campus. After getting my breath back, I asked what these administrators do. She said "We don't know — they just walk around carrying files."

On Saturday, my wife purchased a small amount of ribbon. The shop assistant came up with an amount double that of my wife's mental approximation, so she queried it. The assistant got huffy and said that the calculator must be right. My wife suggested that she calculate it mentally — the assistant said she did not know how, despite being a college student. Ultimately, my wife's mental arithmetic proved to be very close!

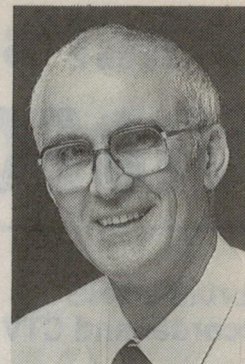
I share your concern for the direction that our education system is taking.

Peter Blackmore, CTS  
Camberwell, VIC.

## DROP US A LINE!

Feel free to send us a letter to the Editor. If it's clearly expressed and on a topic of interest, chances are we'll publish it. — but we reserve the right to edit those that are over long.

# EDITORIAL VIEWPOINT



## Why we need to encourage hobby experimenters

It seems our politicians, bureaucrats, industrialists and professional organisations have finally noticed that most of today's young people are shying away from science and engineering. And they're worried — or at least, they profess to be.

In my opinion they jolly well should be worried, even if they're not. Australia is already much weaker in many areas of high technology than 'developing' countries like Taiwan and Korea, and without a new generation of young scientists and engineers we'll slip even further behind.

There are no doubt many reasons why science and engineering are low on our youngsters' list of priorities. I'm sure the fact that lawyers, economists, tax accountants and stockbrokers have considerably higher status and remuneration must have a strong deterrent effect, for a start. I suspect that 'hard' science and engineering are also not getting the emphasis and encouragement they once were, in our secondary schools — perhaps because today's teachers were themselves turned away from these subjects during their own training, due to the influence of the environmental movement.

But perhaps *another* factor responsible for this trend, evident not only among young people but older people as well, is the lower interest nowadays in hobby experimenting. Not just in areas such as electronics, but also in other related fields.

When I was a teenager in the 1950's, there was a tremendous interest in experimenting. Most of us dabbled in amateur chemistry, photography, astronomy, and of course electronics. I don't know how many old radios I pulled apart, to use the parts for amplifiers and other projects — including my first TV set (built from an *R, TV & H* design).

Not all of the experimenters went into science or engineering, to be sure. But many did, and somehow they seemed to be better for it — keener, more energetic and with a better 'feel' for how to tackle things. Some of my former schoolmates are now top scientists and engineers with the CSIRO or industry.

Somehow I can't help but believe that the decline in hobby experimenting is at least a factor in the trend away from science and engineering as professions.

The ironic thing is that for anyone with even a modicum of intellectual curiosity, there are surely few areas that are intrinsically more fascinating or satisfying. Finding out how things work, the physical laws that make them tick — and then applying those laws to solve problems and create improved products or technology — what could be more interesting?

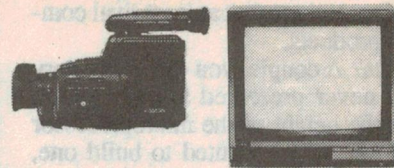
Here at *Electronics Australia* we're still trying to do our bit, to encourage people of all ages to try experimenting with electronics. We run as many construction projects as we can, at varying levels of complexity, along with other articles intended to help newcomers see how interesting electronics can be.

But we're especially keen to encourage *young* people — because we know that from today's young hobby experimenters will come tomorrow's scientists and engineers. And Australia will need as many of these as we can get — make no mistake.

**Jim Rowe**



# What's New in VIDEO and AUDIO



## Portable VHS recorder and CTV

The new Philips PVR200 'personal video' combines a full-size VHS HQ video recorder deck with a colour TV receiver, in a very compact portable package measuring only 262 x 230 x 98mm, and weighing less than 3kg.

Claimed to be the first full VHS personal colour TV/VCR combination on the market, the PVR200 features an active-matrix colour LCD screen 100mm on the diagonal. The LCD panel offers high resolution and fast response, for 'smear free' display of moving images. The receiver section is capable of multi-standard reception (PAL-BG-I, SECAM L, L') on both VHF and UHF, and has automatic station search, channel memory and auto fine tune.

It has 100mW of audio output, and can drive either the internal speaker or two sets of headphones.

The VCR section of the set can operate in either PAL or SECAM mode and has direct audio and video connectors for use with separate cameras, monitors and other VCRs.

These also allow the PVR200 to be used as a portable colour video monitor. The VCR has a programmable recording timer and also a sleep timer, as well as on-screen displays. The PVR200 is powered from an internally-housed rechargeable battery pack (typical capacity two hours of operation), but can also be operated from 240V AC or 12V DC. The mains adaptor is also a charger for the battery pack.

Recommended retail price of the PVR200 is \$2499.

## Toshiba introduces MUSE compatible

Toshiba Corporation has developed a new wide screen EDTV (Extended Definition television) set for the Japanese market, which can receive Hi-Vision (high-definition broadcasting system developed by NHK) broadcasts and show them in the conventional NTSC format, as well as receive EDTV Clear Vision broadcasts.

The new model (36H-ED1), named 'Bazooka Wide', features a 36" wide type screen with a 9 x 16 aspect ratio, the same as in Hi-Vision receivers. Priced at 1.2 million yen, marketing in Japan is scheduled to start on November 1, 1991. HDTV signals have a wider bandwidth than conventional TV signals. They have to be compressed at source, and TV sets require a special tuner to receive the signal. Japan's 'Hi-Vision' HDTV system uses the MUSE (Multiple Sub-Nyquist Sampling Encoding) compression technology developed by the Japan Broadcasting Corporation (NHK).

To receive NHK's experimental Hi-Vision broadcasts, conventional TV sets have, until now, required a separate MUSE-NTSC converter that can transform MUSE signals to conventional NTSC signals.

The 'Bazooka Wide' has a built-in MUSE-NTSC converter and provides a compact one-unit receiving system that enjoys a considerable price advantage over HDTV receivers. The new TV can also receive 'Clear Vision' broadcasting, as EDTV broadcasting is known in Japan. The EDTV standard provides higher picture resolution than conventional broadcasting, while maintaining compatibility with current broadcasting standards such as NTSC. Major commercial broadcasting companies in Japan began EDTV transmissions in August 1989.

## New 68cm, 78cm CTV's from Panasonic

Panasonic claims to have created a totally new television called 'THE ONE'.

The set uses a superflat, black picture tube which enables the screen to be





30% flatter than previous models, reducing reflection and providing a wider field of vision.

The 'super black' pigment used in the glass is said to allow a 46% improvement in contrast for sharp, bright images. **THE ONE** is also said to provide a 20% focusing improvement in the centre of the screen and 15% around the edges.

Panasonic's 'Dome Sound' system has been improved to deliver a richer, more powerful sound from a small surface area. Concealed speakers are just part of the sculptured, compact design.

While screen sizes are large at 68 and 78cm, the cabinets are smaller than those usually found on big TVs.

The 68cm set has NTSC playback while the 78cm has World 21-system reception. Users can play back NTSC media such as laser discs, video recorders and cameras as well as receive a broadcast in almost any country around the world (TX-33V2X only).

Both sets provide a complete set of AV terminals and are also fitted with a Teletext facility.

## BASF to make new B&O tapes

BASF has been chosen by leading Danish hifi equipment manufacturer Bang & Olufsen to produce an exclusive B&O brand of audio cassette.

Production is already underway on a new all-black Chrome Maxima II audio cassette, tailor-made to Bang & Olufsen's precise designer requirements. And following a successful trip to BASF's manufacturing plant in Willstätt by Bang & Olufsen's product managers, work is in progress on a joint Hifi-Pro cassette video project for the Danish equipment manufacturer.

## BTS, Kodak to develop HDTV telecine

Broadcast Television Systems (BTS) and Eastman Kodak company are to jointly develop and market a high performance CCD HDTV telecine.

The partnership will bring together BTS's expertise in designing, manufacturing and marketing telecine equipment and Kodak's film scanning and CCD sensor technology.

BTS has already completed a CCD HDTV telecine research project within the EUREKA EU95 programme. It is expected that limited quantities of the new HDTV telecine will become available in 1992.

"Both companies have already made significant progress towards the

## 'New look' ME preamps

ME Sound's premium range of Australian-made preamplifiers have a new look. ME's advanced technology, 'cost no object' remote controlled design the ME 35 has spawned the first evidence of 'trickle down technology', with other models now also featuring a new front panel assembly and control knobs.

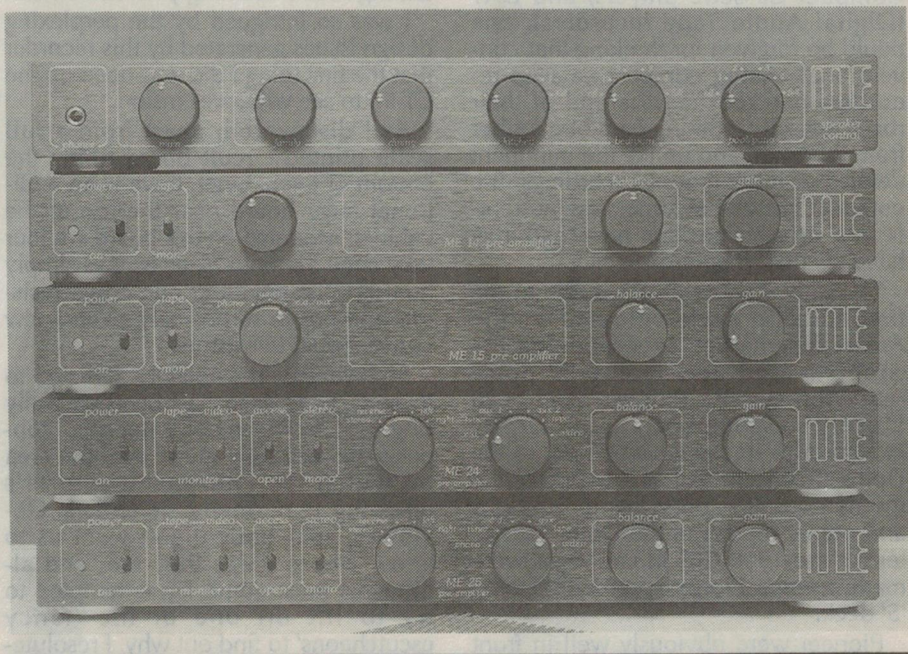
The new panel is now 8.2mm thick — over double the panel thickness of its predecessor. This new panel gives the ME equipment the same appearance and 'quality' image evident on higher priced imported competitive products.

The control knobs are very different too, with a genuine 24K gold-plated pin, inserted into the full length of a profiled cavity along the side of each knob.

Whilst a minor detail, the knobs used are of the highest quality and add an air of elegance not previously seen in ME's preamps.

The best news of all is that the normal ME updating system allows this upgrade to be incorporated into all previous products. Existing owners on the ME database are being advised of the details, along with the next significant upgrade option — for remote gain control. This is a motor-driven version of the already well accredited laser-trimmed Alps control in current preamps. ME owners who have changed addresses, without keeping ME informed will miss out on the special pricing that will be offered for updates.

For further information call ME Sound on (065) 50 2254.



development of experimental CCD HDTV telecines based on independent research," says Dr Pieter A van Dalem, president of BTS. "By combining our efforts, we can bring a superior product to the marketplace faster."

## Very different speaker from B&W

The latest addition to the B&W range of loudspeakers dubbed 'SOLID', is very different from the rectangular boxes we've come to expect from loudspeaker manufacturers. It's housed in a compact multi-radiused, two part polypropylene enclosure with intrinsic damping.

SOLID is a reflex loaded design, with a bass response well maintained down to 70Hz — which is further extended to

around 50Hz when wall mounted. Wall mounting itself is easily accomplished, as the integrated stand doubles as an adjustable wall bracket.

Above average sensitivity (90dB for 2.83V) makes the need for high power amplification unnecessary, although should it be required the safe handling limit is a staggering 150 watts.

A protection device is fitted as standard, reducing the input level should safe limits be exceeded. Magnetic shielding makes the unit suitable for use close to video monitors.

SOLID is available in two tone grey, all black or all white finish. While B&W's Australian distributor Convoy International does not set the suggested selling price, it believes SOLID will sell for around \$699pr. ■



# PIONEER'S CT-93 STEREO CASSETTE DECK

This month, Louis Challis has been testing the first Pioneer cassette deck to incorporate the new Dolby 'S' noise reduction system — along with quite a few other new enhancements. He was certainly impressed, classing it as the most impressive cassette deck he's ever tested:

With all the talk of DCC (Digital Compact Cassette players) and DAT (Digital Audio Tape recorders), one could be forgiven for thinking that conventional analog compact cassette recorders had reached the end of their road. Actually, nothing could be further from the truth, and unlike the imminent demise of microgroove recordings, the compact cassette recorders are currently in a stronger position now than they have ever been before.

The new Pioneer CT-93 is one of the first cassette decks released on the Australian market, incorporating the sophisticated new Dolby 'S' noise reduction system. Pioneer have been closely associated with Dolby Laboratories in the development of the Dolby 'S' system and as it happens, the momentous first press demonstrations and public release of the Dolby 'S' system at the 1990 CES in Las Vegas were made using a Pioneer prototype Dolby 'S' deck.

Pioneer were obviously well in front of most of their competitors, and as I half expected, they had every intention of staying well in front of the rest of the pack when the time came to release their production recorders.

The CT-93 is an advanced and well conceived three-head compact cassette deck, which is simply loaded with innovative features designed to make your mouth water — and thereby induce you to put your hand in your pocket in the dealer's showroom.

With a selling price that is almost on a par with the cheapest DAT recorders and in view of the not-too-distant release of DCC, one could again be forgiven for viewing this release with some scepticism. Who could possibly want to spend \$1,699 on a compact cassette recorder, at this point of time?

Well frankly, as this review unfolds, you will discover that there are many

good and practical reasons for entertaining such a seemingly heretical view.

I was so intrigued by the perplexing design issues generated by this recorder that the first thing I did was open up the CT-93 to see what was inside.

As I discovered, apart from a full scale printed circuit board filling the bottom of the cabinet, there is an additional large board near the top of the cabinet. Mounted on this board are four very large 52-pin IC's, as well as simply hoards of capacitors, numerous resistors and not so surprisingly, even a few conventional transistors.

My eye was immediately attracted to these IC's, as each had been carefully disguised by means of a polished copper plate, carefully glued over the area on which the chip manufacturer's labelling is normally stencilled. Obviously, somebody didn't want us to know whose chips they are, and although I must admit I was tempted to try to lift off one of the 'fancy escutcheons' to find out why, I resolutely resisted the temptation.

Amongst the other design and construction features that caught my eye were the extensive use of heavily copper-plated metalwork (which is claimed to reduce stray electrical currents, and which most probably does) and the use of honeycomb pressings in the metal chassis to stiffen it (which also most probably does).

A more significant development which could be observed is the natty simple and effective vibration isolation techniques which have been incorporated in the unit's 'reference cassette drive' mechanism.

As my measurements subsequently confirmed, these have provided what is clearly a 'state of the art' advancement in terms of reduced 'wow' and 'flutter', and puts this compact cassette recorder on a par with my professional Kudelski

Nagra reel-to-reel recorders. Although not readily visible, the reference cassette drive incorporates a number of neat and innovative improvements in terms of fundamental cassette recorder design technology.

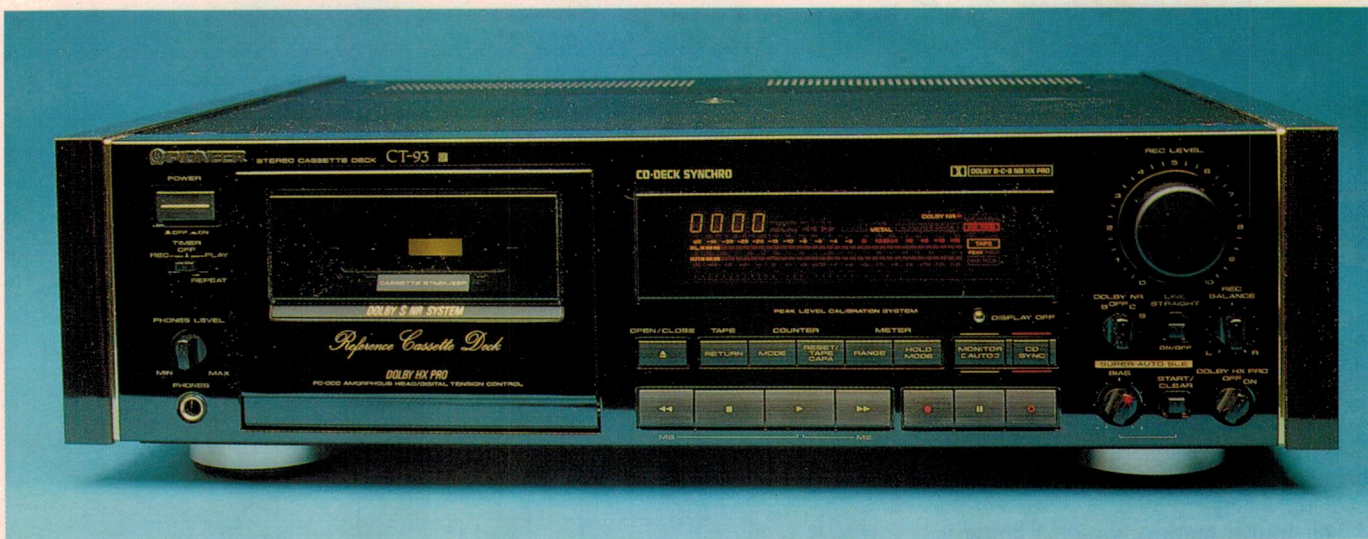
The most important of these is Pioneer's revelation that by reducing the operating pressure applied by the standard cassette pressure pad to the running tape, there is a consequent dramatic reduction in the level of random cyclical perturbations imposed in the movement of the thin tape as it passes over the heads. By displacing that pressure pad a minuscule distance away from the tape, but still close enough to maintain tape contact with the heads, the reduced pressure lowers the level of friction and simultaneously the minute tape vibrations, which cause the audible and measurable tape flutter...

By introducing concurrent improvements in the isolation system of the tape motor and tape drive, supplemented by dramatic improvements in the motor drive system to the flywheel and the take-up spool motor control, they have achieved comparable reductions in the level of the wow. And please forgive the play on words, but WOW — is that effective!

(So effective, that within 12 months most of the competition will probably be emulating Pioneer's technological advances, and will undoubtedly be claiming them as their own.)

The CT-93 exhibits loads of other attractive and eye-catching features, the most dramatic of which is the 'Super Auto BLE' automated tape optimisation function, which I consider to be the most positive advancement in cassette recorder design since Nakamichi released their 'state of the art' Dragon recorder some four to five years ago. I was so impressed by the Dragon that I





bought one, and as happy as I have been with my Dragon, I have come to the view that the CT-93 surpasses it in terms of absolute performance — and quite frankly also in terms of its 'user friendly' features.

What is 'Super Auto BLE', you ask? Well to my mind, this feature by itself is the *piece de resistance* of the CT-93. It offers — at the touch of a single button — simultaneous optimisation of the level of high frequency bias, recording sensitivity level as well as setting both mid-band (3kHz) and high frequency (15kHz) equalisation, with each of the four settings being independently and sequentially adjusted by microprocessor control — provided of course that the Auto BLE function switch is momentarily pressed prior to the start of normal recording.

When compared with the more time-consuming and laborious adjustments required to achieve a lesser number of enhancements on my Nakamichi Dragon (which tend to discourage the rest of my family from optimising tape performance), this is to me almost too

good to be true. What I noted with even more interest was that the range of bias settings offered are equivalent to 130 incremental steps; the level setting offers 32 level steps; the mid-band equalisation offers 16 steps of adjustment; whilst the high frequency (15kHz) equalisation incorporates three steps of adjustment.

For people wanting to achieve the best possible performance from a cassette tape, it is obviously not much use spending additional funds on a tape recorder with the new Dolby 'S' noise reduction system if you aren't going to optimise the other equally critical performance parameters.

But of course, the 'Auto BLE' is only the start of the readily visible special features that this deck incorporates.

The next thing that you notice is that it also incorporates 'switch selectable' Dolby HX PRO, to extract even more useful signal bandwidth when the input signals are close to the saturation limits of the tape that you are using. This is a real plus, and Pioneer is the first manufacturer to give you the optional

selection capability. Of course, the deck also incorporates both the Dolby 'B' and 'C' noise reduction systems — although I believe that, once you get used to Dolby 'S', you are only likely to want to use these other options when replaying older prerecorded tapes.

There are a number of other features which are obvious winners. The first of these is the 'CD deck Synchro' recording capability, which only really becomes feasible if you are using a matching Pioneer CD player which provides a 'CD-Deck Synchro' jack. When your CD player does incorporate the 'CD-Deck Synchro', then fully automatic cassette tape recording is possible with an unparalleled degree of convenience.

In like manner to the Auto BLE function the CD-Deck Synchro offers the convenience of one-button recording, with a single button on the cassette deck controlling the starting and progression of the cassette player and the CD player. So you can avoid all those nasty and finicky little problems which all of us have experienced, when attempting to correctly synchronise the operation of two pieces of interconnected equipment which seem to have minds of their own.

To make this task even easier, the CT-93 incorporates a *peak level calibration system* which allows you to progressively and constantly monitor the highest peak levels on any section — or if you should choose, all of a CD, a cassette, or even a record player's input signal, to facilitate optimum adjustment of recording level. This facilitates production of tape recordings with optimum signal to noise characteristics, and potentially the lowest possible level of high level harmonic distortion.

The third feature which I found attractive is the *digital tension control*. This controls the torque applied to the



Along with the usual stereo in and out connectors, the Pioneer CT-93 rear panel has a multiplex filter switch, sockets for remote control and a further socket for the CD deck synchronisation feature.



## Challis Report

tape take-up reel, using a microprocessor to vary the reel motor's operating characteristics. This adapts to the diameter of the tape wound on that reel and sets the torque to a predetermined level of tape tension — thereby improving tape spooling uniformity.

This feature has multiple advantages, and is one of the critical factors influencing the deck's wow and flutter figures, which are well in front of those provided by any competing compact cassette recorder I have yet reviewed. It helps to place its performance almost on a par with the latest generation of DAT recorders.

The fourth feature, which I know is now standard fare for DAT recorders, is the ATLC (Automatic Tape Loose Canceller), which automatically takes up tape looseness, as soon as the cassette well door is closed on your newly-loaded cassette.

With features like these, one can readily produce amateur recorded tapes that are markedly superior to those produced by previous generations of cassette recorders — and more significantly, markedly superior to any prerecorded cassette tapes that you can buy.

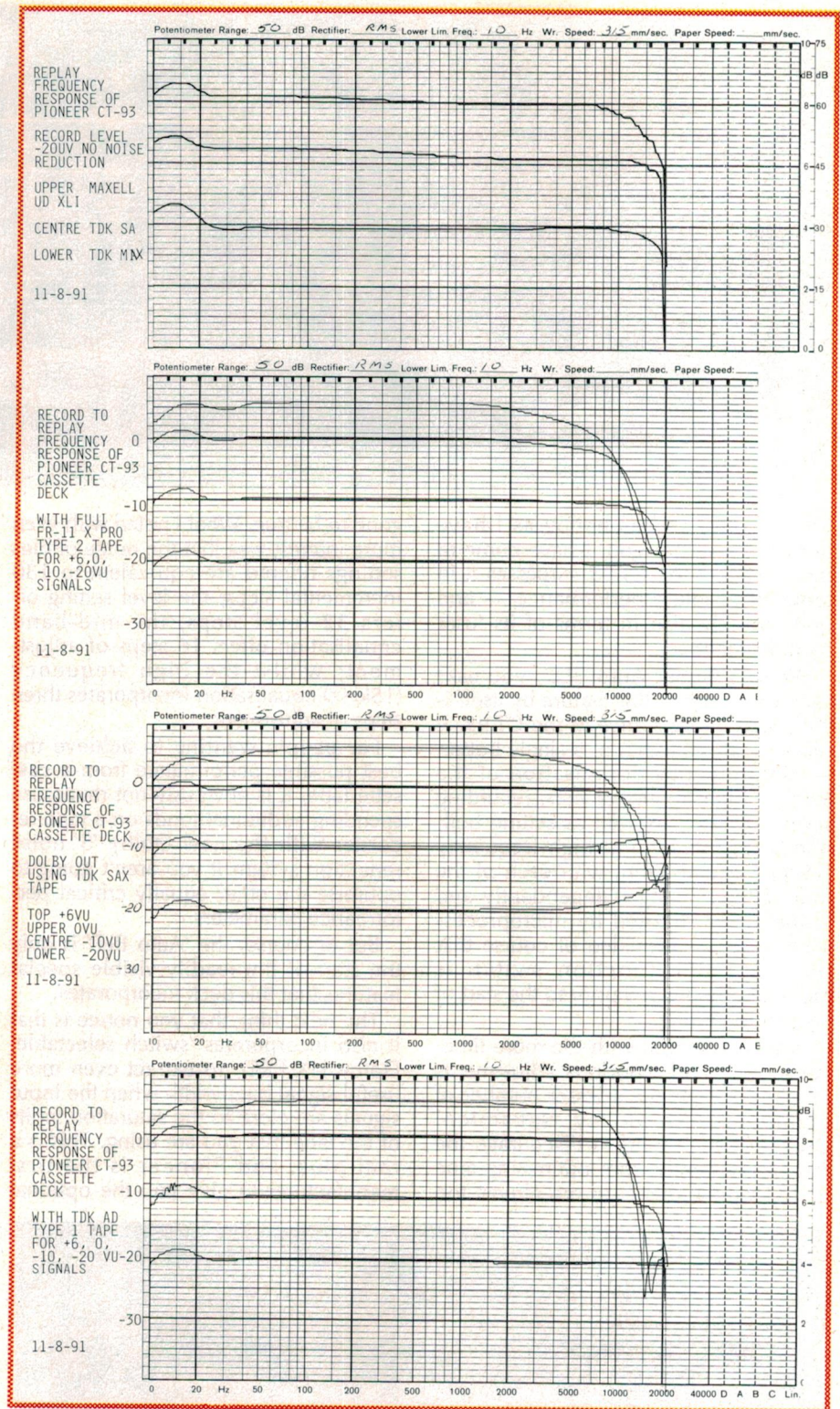
The frontal appearance of the CT-93 is black and does not really shine until the power switch at the top left hand corner is activated. Below this is the timer switch, and directly below at the bottom is a stereo headphone socket with its own small volume control immediately above.

To the right is the motorised cassette well lid, which smoothly electrically opens up when the Open-Close button is pressed.

The primary controls are laid out in two neat rows below the fluorescent display, with the large main controls at the bottom of the deck and the less frequently used switch controls located in the row above.

The seven main controls in the bottom row are Fast Rewind, Stop, Play, Fast Forward, Record, Pause and Record Mute. Some additional comment is really needed for three of these controls, as the Fast Forward and Fast Rewind switches have been given additional functions in conjunction with Record Mute.

If the Record Mute function has been correctly selected and used when a new tape is produced, then it will have four-second breaks between each of the track selections. You can then key in the number of tracks you want to advance or back-track (from the track on which you are currently located), by



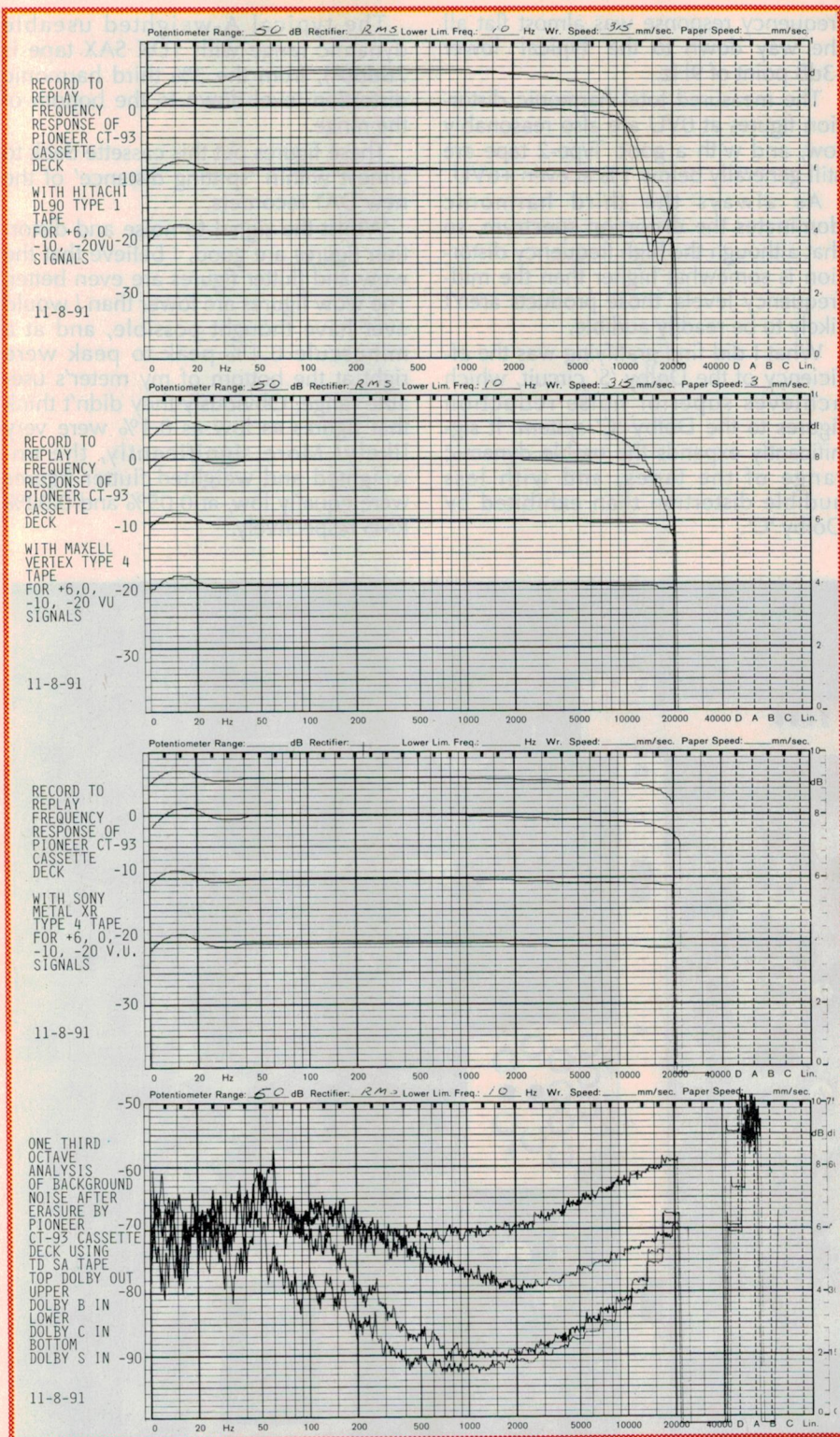
**Four of the performance curves for the Pioneer CT-93 deck, as measured by Louis Challis. At top are the replay response curves with three different kinds of tape, while the lower curves show record/replay response curves at different recording levels, for three different tape formulations.**

repeatedly pressing either the Fast Forward or Rewind switches the appropriate number of times. That's precisely where the tape transport will then shuttle the tape (subject to no keying errors), and if you press Play

before (or even after) you get to the required track, the deck will automatically enter into the play mode.

The other controls on the front of the deck include a tape counter zero button (which also provides Fast Forward





At top are three further sets of record/replay curves, while the lowest plot shows tape noise level after erasure, with the various Dolby noise reduction options.

or Rewind to the selected 0000 position), a counter mode button which provides normal tape counter, time counter, or remaining time counter (in similar manner to the functions provided on most CD players), and a Reset/Tape capacity counter to reset the

counter indication to either a numerical value or indication of the correct time value of tape remaining on the cassette — providing it is correctly configured.

The adjacent two pushbuttons control the level range meter, the first of which provides wide range from -30 to

+12VU, or from -3 to +12VU for an expanded view of the top of the recording range. When these are used in conjunction with the Hold Mode function switch, the level meter will hold the peak level during an indeterminate section of recording, and which may then be cancelled by pressing the button a second time.

Adjacent to this is the Monitor (Auto) switch, which is selected to monitor either the source level or recorded tape level using the replay heads.

The last of the controls in this grouping is the CD Deck Synchro recording button, about which I will have more to say later.

Other minor switches include a Display Off button, a manual bias adjustment control, recording balance controls for setting left-right channel balance, and a Line Straight switch, which disconnects the recording balance controls.

On the back of the recorder are conventional line input and output coaxial unbalanced sockets, a multiplex filter on/off switch, three sockets for CD Deck Synchro and small tip and sleeve control sockets to suit a Pioneer remote control system.

## Performance tests

The objective performance assessment of the CT-93 proved to be a most rewarding task, as all of the test results exceeded the manufacturer's published claims.

I was particularly keen to evaluate the replay responses using our standard TDK test tapes. The results were generally good (particularly when it is accepted that there are always some differences between the azimuth alignment of the original laboratory recorder and the specific machine's head alignment).

The Type-1 tape provided a replay response that was +3dB from 10Hz to 12kHz, which was fair but not all that exciting. By contrast, both the Type-2 and Type-3 tapes provided far more gratifying results, with the -3dB points extending out to beyond 18kHz, which I believe is particularly good.

If those results were good, then without exception the record to replay frequency responses were even better. All of the tapes tested, from Type-1 to Type-4, provided frequency bandwidths of beyond 21kHz at the -20VU level. As you will note by examining these level recordings, the responses were all remarkably flat, which is directly attributable to the efficiency of the Super Auto BLE circuitry. Not only did this conveniently and rapidly optimise the recording characteristics of the cassette



## Challis Report

recorder each and every time, but the results were the best I have seen from any cassette recorder (irrespective of the tape that was used).

With Type-1 and Type-2 tapes there wasn't much to choose between them, but with Type-4 tapes the frequency response extends out to beyond the claimed 23kHz, and Sony Metal XR achieves an astounding 24.2kHz bandwidth.

I doubt that this result could be readily bettered by any other cassette recorder on the market (and certainly not by any DAT recorder).

If the high frequency response is good, it's worthwhile noting that with the exception of a single bump, the low

frequency response was almost flat all the way down to the typical lower -3dB point of 9Hz.

The measured total harmonic distortion figures at 0VU are also reasonably low, and with a good Type-2 tape are still generally below 1% at even +6VU.

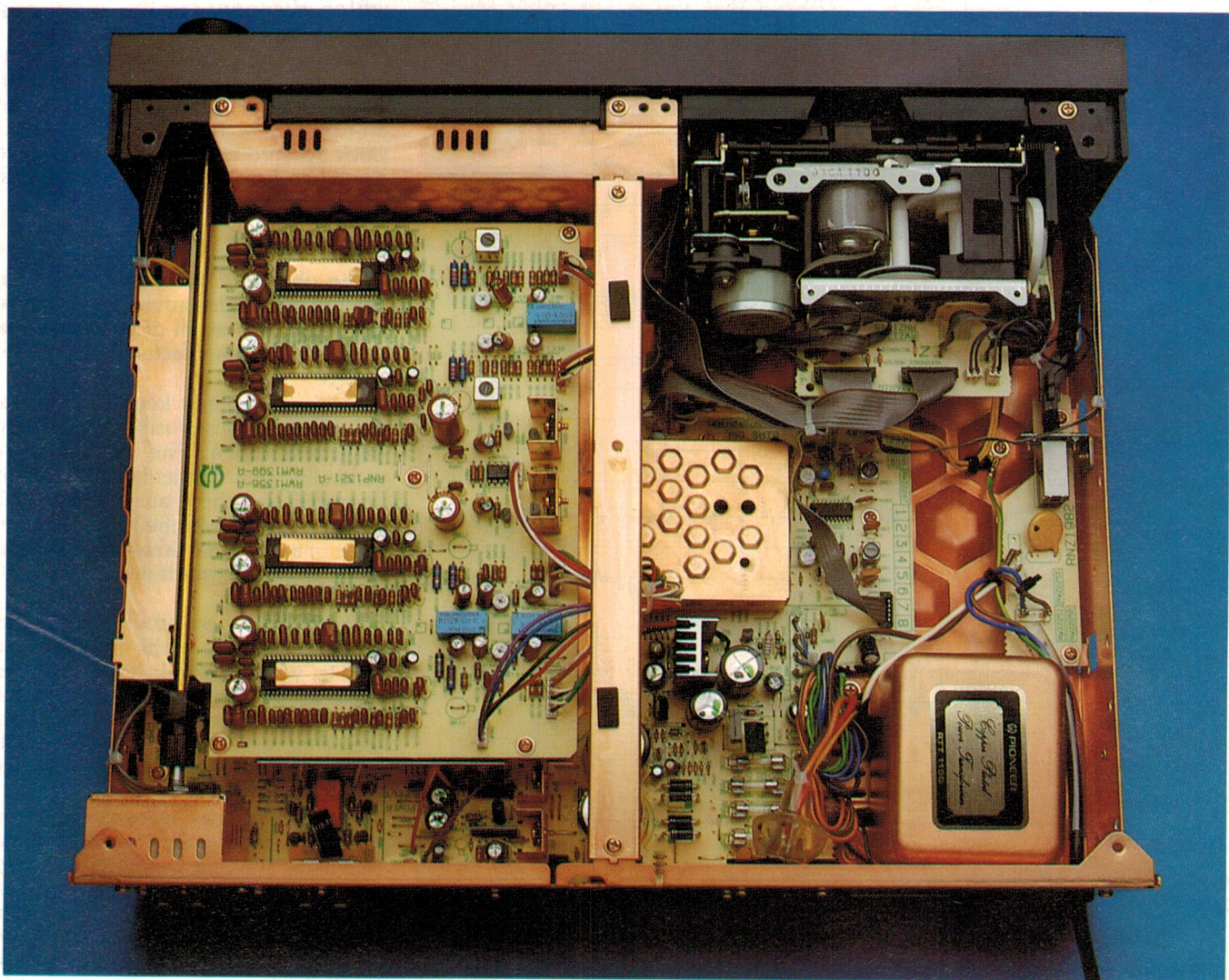
As always the third harmonic dominates the distortion spectrum, so that although the high frequency distortion is somewhat higher than the mid-frequency levels, those products aren't likely to be readily audible.

What I did find gratifying was the efficiency of the Dolby 'S' circuit, which achieves superior noise reduction figures to the Dolby 'C' system. It significantly expands the usable dynamic range of the tapes, and with less audible distortion than exhibited by Dolby 'C'.

The typical A-weighted useable dynamic range with TDK SAX tape is 78dB(A), from the 3% third harmonic distortion level down to the bottom of the range.

These figures put this cassette deck to almost within 'spitting distance' of the new DAT recorders.

Whilst the signal to noise and distortion figures are good, I believe that the wow and flutter figures are even better. The wow figures are lower than I would ever have thought possible, and at a minuscule 0.1% peak to peak were right at the bottom of my meter's useable range. Obviously they didn't think that figures as low as 0.1% were very likely! More significantly, the unweighted and weighted flutter figures were equally low, at 0.05% and 0.02% RMS respectively.



**Inside the Pioneer CT-93. Virtually all of the exposed metal work is heavily copper plated, which Pioneer claims reduces stray electrical currents. Visible at upper right is the tape transport, which incorporates a number of dramatic new enhancements. The four large 52 pin ICs visible down the left hand side are presumably involved in the recorder's comprehensive audio processing.**



## MEASURED PERFORMANCE OF PIONEER CT-93 CASSETTE DECK

Serial Number LE 26000 46N

### Record to Replay Frequency Response at -20VU

Tape	Dolby	Lower -3dB Point	Upper -3dB Point
TDK AD90	Out	8.7Hz	20.4kHz
Hitachi DL 90	Out	8.9Hz	21.2kHz
TDK SAX	Out	9.0Hz	21.0kHz
Fuji FR-11 XPRO	Out	8.6Hz	21.0kHz
Sony Metal XR	Out	8.7Hz	24.2kHz
Maxwell Metal Vertex	Out	8.8Hz	23.8kHz

**Speed Accuracy** +0.2%

**Wow and Flutter**

Wow	Average Unweighted	0.1% P-P
Flutter	Weighted	0.05% RMS
		0.02% RMS

### Harmonic Distortion

Tape	TDK SAX	100Hz dB	1kHz dB	6.3kHz dB
0VU	2nd	-63	-65	-57.8
	3rd	-45.5	-50.7	-39.3
	4th	-70.5	-71.1	-60.0
	5th	-67.9	-65.1	-
	THD	0.53%	0.29%	1.1%
-6VU	2nd	-64.0	-65.0	-59.5
	3rd	-53.0	-57.1	-45.9
	4th	-72.0	-69.8	-58.7
	5th	-71.9	-70.0	-
	THD	0.23%	0.16%	0.54%

### Maximum Input Level

(For 3% third harmonic distortion at 33Hz)

Tape TDK SAX 8vu

### Dynamic Range

(Relative to 3% third harmonic distortion level)

Tape	TDK SAX	Dolby Out	58.5dB(Lin)	67.0dB(A)
		Dolby 'S' In	63.0dB(Lin)	78.0dB(A)

### Erasure Ratio

(For 333Hz signal recorded at 0VU)

Tape TDK AD -82dB

Even the speed accuracy of this recorder is good, being only 0.2% high.

### Listening tests

Well pleased by the excellent test performance exhibited by the deck, I took it home and coupled it up to Pioneer PD7700 CD player — which I had requested from Pioneer to evaluate the CD Deck Synchro recording capabilities.

I took a new disc, the *Gipsy Kings* Columbia 468648.2, which contains 12 sequential tracks, which would have required my continuous attention had I

attempted to record it in the time-honoured manner. Not so now; I just ran the disc through for the first half of track one, to correctly set the recording level using the Peak Level Calibration capability.

Then Presto! by firstly pressing the Stop buttons on both the CD player and the cassette recorder, all I had to do was press the CD Sync button and go on with my work.

Everything else was done automatically, including the provision of four-second blank spaces between each of the tracks.

The quality of the recording with Dolby 'S' selected was almost indistinguishable from the original, and I am well satisfied that all the claims made for Dolby 'S' have been vindicated.

I next took a pre-recorded Dolby 'S' cassette tape entitled *Loom*, produced by Lucas Films, on which side one has been encoded in Dolby 'B' and side two contains the same program encoded with Dolby 'S'.

The results of this comparative assessment were worth the trouble, for they show quite positively that Dolby 'S' has overcome the microphone pumping and low frequency disturbances which are an aural feature of the Dolby 'B' and 'C' noise reduction systems.

I next played two pre-recorded cassette tapes with Rampas/Kudo playing two flutes with the Salzburg Mozart Orchestra. They played selections from Mozart, Cimarosa, Vivaldi and Stamitz (Sony Classical No ST 45 930).

Although this is claimed to be a digital recording using Dolby 'B' encoding, there is a trace of pumping distortion at some points in the recorded flute content, and these characteristics really do call for Dolby 'S' encoding to provide fidelity approaching that of a CD player. The recording is nonetheless superb, and a worthy addition to any collection.

For comparison purposes I then played a pre-recorded cassette tape with Cho-Liang Lin on the violin and Esa-Pekka Salonen conducting the Swedish Radio Symphony Orchestra, in a superb rendition of Sibelius' *Concerto for Violin and Orchestra in D Minor*, Op.47 (CBS MT 44548).

This cassette is also recorded with Dolby 'B' encoding, yet the violin provides no trace of the close mic pumping action displayed by the flute in the previous cassette.

It was with some reluctance that I parted with the CT-93, for this is unquestionably the latest and the greatest compact cassette recorder to be marketed in this country.

With performance as good as this, unless DCC is marketed at a substantially lower price, it will be hard pressed to usurp the venerable compact cassette — which can now hold its head up high, as its performance is 'at the top of the class'.

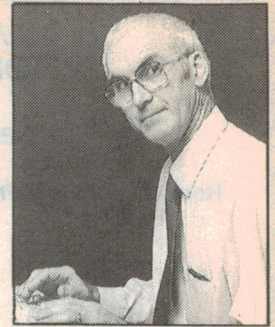
The CT-93 cassette deck measures 457 x 136 x 370mm (W x H x D), and weighs 10.8 kg. As noted earlier, it has a recommended retail price of \$1699.

Further information is available from Pioneer dealers, or direct from Pioneer Electronics Australia at 178-184 Boundary Road, Braeside 3195; phone (03) 580 9911. ■



# FORUM

Conducted by Jim Rowe



## **PAL vs. sundry assorted MACs, etc: our original correspondent replies...**

I thought we'd given the subject of satellite TV transmission systems pretty fair coverage, in the April, July and August columns, but it simply won't go away. I'm beginning to wish I hadn't made any comment on the subject, back in the January issue's editorial — I really started something!

As I sit down to prepare this month's column, there hasn't been time for anyone to respond to my piece in the last issue about compact fluorescent lamps. There have been a number of letters offering comments on the subject of FM stereo decoding, so we'll obviously have to deal with this again shortly. But I've also had a long letter from Keith Walters, the chap from Lane Cove in NSW whose letter really began the discussion of satellite television transmission systems, back in the April issue (but in response to my January editorial).

Keith obviously feels that some of the later correspondents have 'done him wrong', misinterpreting things he wrote and generally putting words in his mouth that he says he didn't write. So in fairness, I guess we'd better give him an opportunity to clear the air. His letter is quite long, but I'm reproducing it here in full so he can't accuse me of censorship:

*I have just purchased my copy of the July issue of EA, and read the letters of your three correspondents re the 'MAC' issue.*

*I have no complaint with Mr Gardiner's letter, but in the case of Messrs Thiele and Demkiw, it would have been nice if the two of them had done me the same courtesy, (i.e., actually READ mine) before rushing into print!*

*I'll deal with Mr Thiele's onslaught first:*

*First of all, I've never heard of the gentleman, but then I've never been directly involved in the Sydney broadcast TV scene, fraternity or whatever you want to call it.*

*So, the only personal assessment that I can make of his credibility in this field, has to be that derived from the contents of his letter. And I found THAT to be a mixture of (to use his own words): 'fact, ignorance, bombast, wishful thinking', and, (for want of a better term), hallucination!*

*'Bombast' was an interesting choice of word. I looked it up in the dictionary: 'high-sounding and often insincere words...' it said. That's what I thought it meant.*

*Well, I'm not sure exactly what he's on about there, but at least I don't resort to pompous turns of phrase like: 'so grotesque and contrary to my own experience...' or: 'You treated his nonsense far too gently, Jim.'*

*Technically, the first part of his letter (up to 'MAC solves problem') is sound enough, his explanation of the benefits of MAC transmission re signal-to-noise etc., being quite in order. (Originally, my first letter contained a similar explanation, but I deleted it to save space).*

*After that, he seems to lose the plot, and the 'hallucinations' set in. Because Mr Thiele seems to have put an enormous amount of vitriol into debunking a number of statements that I didn't actually make...*

*For example, I never said: 'There will always be some loss of quality in transcoding between PAL and Components and that therefore studios ought to stay all-composite PAL.' What I actually said was: 'If at any stage... the signal has to be converted to composite video... and then subsequently re-converted to component form, most of the benefits of component operation are completely negated.'*

*I stand by that statement, and I'm certainly not alone in this.*

*Again: 'Mr Walters says that the Betacam format is dead.' No I didn't! I said nothing of the %\$#@+&\* kind! Somewhat condensed, what I essentially DID say was: 'The concept of converting all our existing composite studios to all-component operation, based around component video recorders, (such as MII, SP Betacam or the digital D-1 formats), has fallen flat on its face.'*

*Just to explain to your readers,*

*Betacam is a component recording format introduced by Sony in the early 1980s, originally intended for 'camcorder' field operation. It uses modified Betamax cassettes, run at about nine times normal speed, with separate heads to record the luminance and chrominance signals. Betacam was seen as a major breakthrough, allowing high quality recordings to be made on a relatively cheap and lightweight VCR. The catch was that this could only be done if the signals were still available in component form, but this is not a problem in a camcorder setup.*

*Later, Matsushita introduced a similar, but more advanced system, called MII, with the idea of also using studio MII machines as a replacement for the much more expensive 'One Inch' C-format composite recorders, the then (and still current), industry standard. The idea was that the same tape format would be used right through the entire system, which on the face of it, made a lot of sense.*

*Sony subsequently introduced 'SP' (Superior Performance) Betacam, with similar performance specifications to MII. Although less sophisticated than MII, SP Betacam had the advantage of a fair degree of compatibility with the well established original Betacam system.*

*At about the same time, Sony also introduced the D-1 digital component format, as the 'Rolls Royce' of video recording systems. It certainly is capable of impressive results, but sales have been disappointing, partly for the reasons of incompatibility, and also because they're horrendously expensive machines!*

*SP Betacam and to a lesser extent, MII, are still alive and well in the broadcast marketplace, but mainly as a portable origination medium. For serious broadcast work, the studio machines are still mostly restricted to use as playback machines, for editing the 'wild' footage*





onto 1" tape. Because, (contrary to what Mr Thiele claims), most video engineers soon realized that component recorders and existing composite production equipment **JUST DON'T MIX**. Every time the composite signal had to go onto tape, it would have to be decoded back to its components, and then re-encoded on playback. A couple of generations of this and the picture becomes very soft. And the customers **DO** notice!

Admittedly, there are high quality decoders available that can reduce such degradation to a minimum, but these are very expensive. Any financial advantage obtained by buying the cheaper component recorders is substantially offset by the cost of the decoder required. Their use is usually restricted to situations where transcoding is unavoidable, such as the video effects machines Mr Thiele mentions.

Some TV stations do use 'Betacart' machines for handling commercials, but the deterioration in quality is quite noticeable, particularly by advertisers paying big bucks to have their product promoted. For this reason, the new D-2 based digital composite cart machines are proving very popular, despite the considerable extra cost involved.

So, as I said in my original letter: on

balance, the general consensus in the broadcast industry was that the small improvement in quality obtained from all-component operation could not justify the enormous expense (and inconvenience) involved in converting to it.

I was **NOT**, as Mr Thiele implies, just expressing my ignorant opinion here, either—I was simply describing the situation the **WAY IT IS**. Composite equipment is currently selling as well as it ever did.

Now we get to the weird bits... Right at the start of my original letter, I actually SAID: 'Now, there is no argument that (all-component operation from source to TV set) would provide the best possible picture quality,' and: 'A few European TV networks, recently started from scratch, have in fact adopted this approach.' So what was all that waffle about the 'newly installed' equipment in the 'English commercial station'? Was this meant to prove me wrong?

I totally **AGREE** that if you are going to start up a new facility from scratch, (and you can afford it), it makes a lot of sense to install all-component equipment, but **ONLY** if your 'upstream' video sources are going to be largely in component form. This will indeed be the case in a self-contained production centre, of the type Mr Thiele has described.

Unfortunately, in the vast majority of existing studio situations, it is simply **NOT** the case. Like it or not, most of the video material available today is released in composite form on 1" tape. Even studios that use D-2 digital composite VTRs for the actual production often do this. They have to — it's the industry distribution standard, the way the old 5-1/4" 360K floppy disks are for the computer industry.

And here's an interesting little snippet: at the last Olympic games, the official video recording format was Matsushita's MII component system, using both camcorders and studio machines. At the **NEXT** Olympics it's going to be — wait for it—Matsushita's 'D-3' format, which is a compact digital **COMPOSITE** format, using 1/2" tape! How the wheel turns...

There's been an enormous amount of interest in D-3, and I certainly wish them the best of luck with it. At last, they've produced something new that the industry can actually use!

Mr Thiele's statement: 'But any intelligent engineer knows that (cumulative loss of quality) is a matter of proportion. In assessing the feasibility of a system, he first finds out how much degradation each link produces, and then makes sure



that on any path the sum of inevitable degradations does not rise above a perceptible — or even, if that cannot be avoided — an 'acceptable' level' ...is a masterpiece of the 'bleedin' obvious'! Basically, what he's saying is: 'To avoid excessive degradation of the signal, you should avoid doing things that might degrade it'!

And that's exactly why 'intelligent engineers' have been reluctant to introduce component VTR into existing composite environments!

As for the digital effects machines he mentions, they certainly DO introduce noticeable degradation, but this is usually disguised by the dynamic (and usually transient) nature of the effect. And in case he hasn't noticed, such effects went out of fashion years ago. Most of those horrendously expensive machines have turned out to be white elephants. I suspect the only reason they're used at all these days is in a pathetic attempt to convince the accountants that they weren't a waste of money!

Now to the matter of the 'soft' SBS transmissions. First of all, let me say that SBS is by far my favourite TV network, and I think they do a remarkable job considering their limited budget. It doesn't particularly worry me if they've had to cut a few corners here and there — I'd still watch it even if they had to go to air from VHS tapes.

I'm perfectly well aware that the Sydney transmissions are derived from the studio's composite video output. However, I used to live in Brisbane, where the signals ARE derived from the AUSSAT BMAC link. The picture softness was very noticeable on all programmes there — and on the ABC too.

In fact, one of the incidental advantages I saw in moving to Sydney was that the SBS pictures there should be as good as those seen on the other channels! Alas, when I got here, the only major difference I could see was that the 'live to air' shots (mainly of newsreaders) seemed to be sharper, but not much else.

On closer examination, the only programmes that seem to retain their sharpness are the ones originally done in English, and thus not requiring subtitles. So I imagine that they must add the subtitles with some sort of component-based editing system. I'm not knocking SBS itself — I just wanted to provide a convenient example of multiple transcoding degradation.

Mr Thiele says he hasn't noticed that the pictures are sometimes 'soft'. Well, I

don't know how old he is, but someone who was writing letters to EA forty years ago must be getting on a bit — is he ABSOLUTELY sure he can really tell the difference?

This might sound like a cheap shot, but I'm quite serious — most TV servicemen will be able to relate stories of intractable 'focus problems', actually due to customers who refuse to admit that their eyesight might be failing! ('Set OK — customer needs adjustment'). And, unfortunately, it's not always just a matter of new glasses, either.

Now can I say something about the 'who invented MAC?' business. First of all, I never said Scientific Atlanta 'invented' the MAC system; I said they 'developed' it, which is a quite different thing.

Mr Demkiw is quite correct when he says the idea is quite old. In fact it dates back to the early 1950s, before the NTSC system was devised. Separate transmission of the colour difference signals had been proposed, but the brilliance of the NTSC system (and its descendants) was that it retained full compatibility with the existing monochrome system.

Time Division Multiplexing (TDM) techniques (such as MAC), only became practical in the early 1980s, with the emergence of affordable digital and CCD technologies. As I stated in my original letter, the technique used is a fairly obvious one, but its practical implementation required the development of a number of specialised ICs — a costly undertaking. So it's rather amusing that Mr Thiele first insists that MAC was a European 'invention' after all, and then he says:

'When Australia decided that MAC was the only possibility for the satellite HACBSS service, Digital Video Systems through Scientific Atlanta was the only possible source of production equipment...' To me, 'developed', in this sense, means turning a basic idea into an operating system, and from the above statement, it would seem that Scientific Atlanta were the first to do so.

What I HADN'T realized was how incompatible the European MAC systems were with ours. I guess it didn't occur to me that the Powers-That-Be would be so inept as to saddle us with a 'bastardized' system that's used nowhere else in the world. (So much for getting us out of the PAL/NTSC/SECAM muddle...)

I'd assumed that at least the video part of the European MAC standards would be the same as ours, and that the other differences would be minor modifications to suit European conditions. I

thought the 'European developed' tag was just manufacturer's hype!

One of the few points I can agree on with Mr Thiele is that MAC WAS originally devised as a means of improving transmission quality. However, like you, Mr Rowe, I believe that had very little to do with 'Australia's' decision to suddenly adopt the BMAC system, just when private operators were making noises about wanting to run satellite pay-TV systems.

It seems somewhat suspicious that 'Australia' 'happened' to choose the most expensive system available, with receiving equipment available from only one manufacturer, at an exorbitant price. As far as I knew, the 'C' band PAL HACBSS network was working quite well, before it was shut down. Obviously what they really wanted was a captive audience, equipped with receivers that could only pick up what they allowed them to pick up.

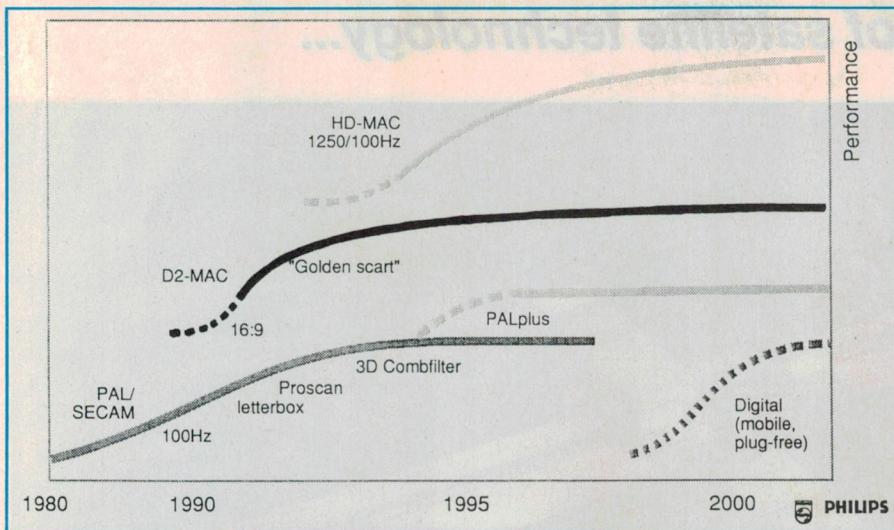
To finish up, I'd like to reply to a couple of Mr Demkiw's other points. In his section '2' he claims that compatibility with PAL is 'illusory' in a satellite broadcasting situation. Yes, Mr Demkiw, I'm sure that EA's readers are aware that you can't directly pick up satellite TV transmissions on an ordinary TV set! However, a PAL (or NTSC) satellite receiving system is still vastly simpler in operation than a MAC one.

For all systems, the basic setup consists of a dish, the dish mounted 'front end' electronics, and the IF/detector unit, which most users refer to as 'the receiver'. The receivers use the standard superheterodyne principle, with the RF amp, oscillator and mixer stages mounted at the focal point of the dish. The FM IF signal is fed down a coaxial cable to the receiver, where it is amplified and then demodulated to composite video, via relatively simple and inexpensive circuitry. In most cases, the sound appears as an FM subcarrier superimposed on the video signal, (much the way it does at the video detector of an ordinary TV set). A second (usually tuneable) FM detector is used to extract the sound. Some transmissions do have the sound digitally encoded as Mr Demkiw suggests, but certainly not all of them.

A MAC receiver has to have the same video circuitry, PLUS a MAC decoder and digital sound processor. And these AREN'T cheap. The last time I looked, a BMAC receiver unit, (without the dish or head end electronics) was about 10 times the price of the equivalent part of an ordinary receiver. And with the licensing so neatly tied up, there's little chance of competition bringing the price down.

As I understand it, at least part of the





**A graph showing the Eureka 95 Group's expectations for the various TV technologies planned for Europe, against time. (Courtesy Philips)**

reason for British Sky TV's decision to use PAL was the uncertain supply situation for the essential ICs required. As described above, straight PAL receivers are relatively simple devices made out of readily available components — virtually identical, in fact, to those made for the booming NTSC market.

I don't think it was so much a matter of 'more' profitability, rather it was a matter of profitability full stop!

As for 'compatibility' and sets with SCART connectors: This is completely irrelevant as far as I am concerned. Every Plessey B-MAC receiver I've ever seen had a composite video output available, and that's all I've ever seen anybody use! (This is not to say that NOBODY uses the component outputs, but it doesn't seem all that important to most users).

According to a recent issue of *New Scientist*, there are approximately 1+ million PAL satellite receivers installed already in Britain, with about 100,000 new ones being installed each month. There are another million or so in continental Europe, mostly in Holland and Germany. (All this since February 1989). Not bad for such an excrementally inferior system!

Would the ABC care to quote figures for B-MAC receiver penetration in the Australian rural market?

Just how fussy is the general public about picture quality anyway? Well, total sales of home VCRs (VHS and Beta) are rapidly approaching the half-billion mark — an incredible achievement for a product that was introduced less than 15 years ago. Yet the vast majority of them boast a useable luminance bandwidth falling somewhat short of 3MHz, with video noise and distortion performance

far below broadcast PAL and NTSC standards. Yet the consuming public love them!

As far as I'm concerned, the whole MAC fiasco (and HDTV too, for that matter) is just one big boondoggle — an unholy alliance of manufacturers' vested interests, power-hungry bureaucrats and busybody engineers with anal-retentive tendencies!

It's about time we exploded this can of worms (Yuk).

Well, Keith, I hope you feel better with that little lot off your chest(?). You can't say we haven't given you every opportunity to clarify your position, and to answer your critics. I don't think we'll ask you to clarify whom you had in mind with that last shot about engineers with anal-retentive tendencies, though — it sounds a little too close to home!

I don't want to prolong this particular discussion much longer, because I suspect many of our readers are now losing interest in it. Also I think it's unnecessary to comment on most of the points that Keith Walters makes in this last letter, as they've now been discussed fairly thoroughly by both himself and the other correspondents. But I would like to offer a couple of general comments.

First of all, I note from a recent article in *New Scientist* that the Europeans now seem to have reached a general agreement to move towards D2-MAC for satellite TV broadcasting, and also look set to move on to the HD-MAC system for transmission of compatible HDTV, planned to begin in earnest around 1998. This will have a 16:9 aspect ratio, and 1250/50Hz (or 100Hz) pictures.

Even British Sky Broadcasting has apparently agreed to swing over to parallel transmission of D2-MAC along with

their existing PAL, by 1994 — providing someone else pays for the additional transmission facilities!

Peter Ketelaar, an expert from the 'Eureka 95' group responsible for much of the development of this system recently visited Australia, and along with other members of the technical press I was invited to meet him and learn of the current state of play. It was interesting to note that his Group's strategy will apparently be to push the standard definition 16:9 format first, via the 'PAL-Plus' enhanced PAL system, and then move on to full-scale promotion of D2-MAC and finally HD-MAC. They don't see true digital TV or HDTV as likely to become commercially viable until around 2005, even though no-one seems to doubt that this will probably be the 'ultimate' transmission system for both terrestrial and satellite broadcasting.

One of the things that did emerge from our talks with Mr Ketelaar is that regardless of the reasons for the choice of B-MAC for Australia's satellite TV transmission, we may well find ourselves out on a proverbial limb if we stick with it. Although B-MAC is apparently being used in the USA and elsewhere for private networking and secure distribution of programme material, we seem to be almost on our own when it comes to use of it for domestic DBS. Certainly much of Europe seems to be committing itself to D2-MAC...

It looks as if our Federal Government still doesn't want to address itself to Pay-TV and DBS, apart from the latter's existing and very restricted use for HACBSS and RCTS. Presumably this is due to pressure from the existing commercial TV broadcasters, who are undoubtedly having a hard time. But when our authorities do finally get around to planning for the future, perhaps very careful thought should be given to the idea of phasing out B-MAC, and swinging over to D2-MAC.

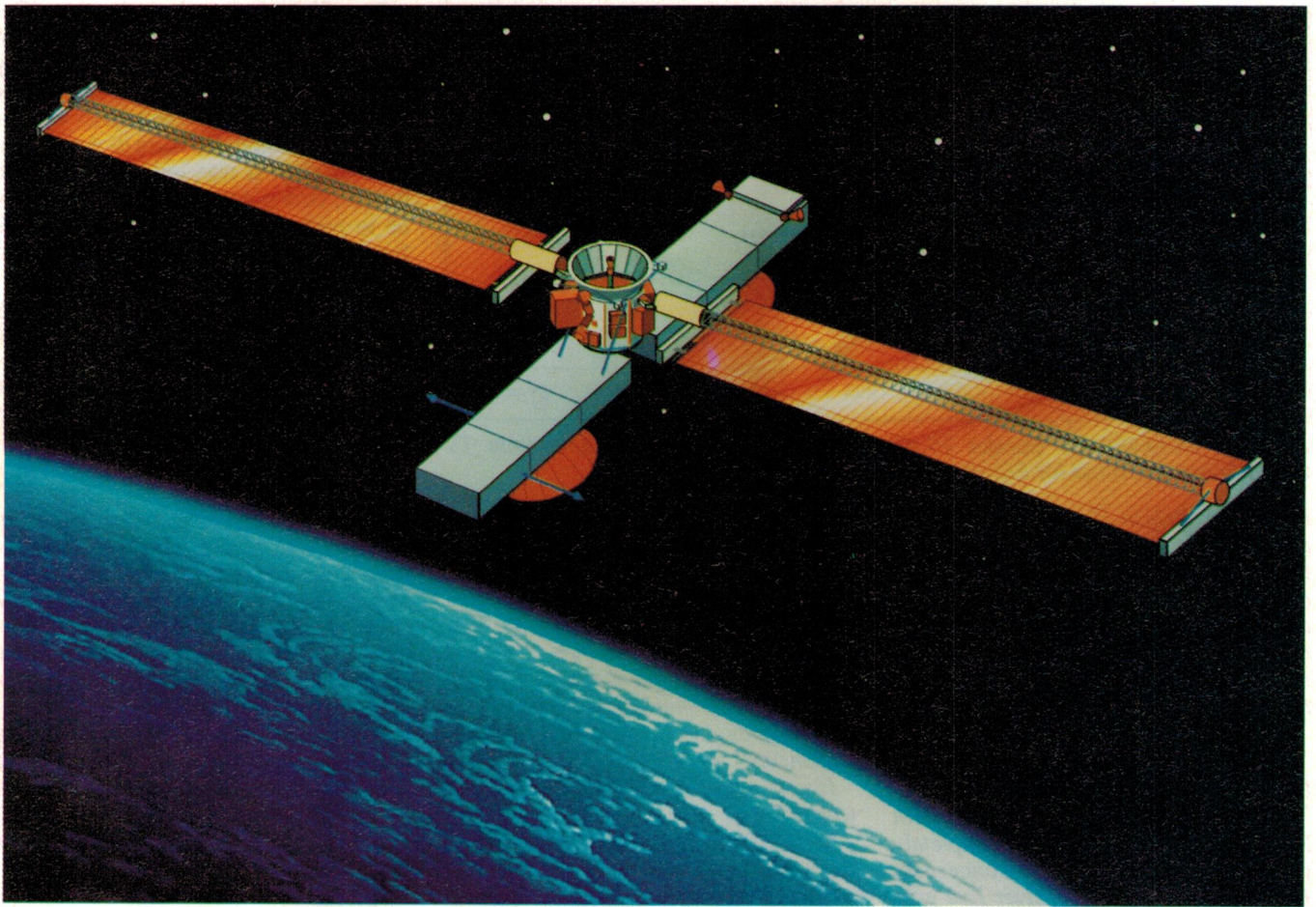
Such a change might well save us all a lot of hassle and money, in the future. But if the change is ever going to be made, the only time it would really be feasible would be before Pay-TV and DBS begins in earnest — i.e., while we still have a relatively small number of viewers committed to B-MAC.

Yes, I know D2-MAC doesn't provide for as many radio channels as B-MAC. But that shouldn't be a major stumbling block, now that digital audio broadcasting or 'DAB' is galloping towards us...

And with those few comments, I think we'll leave the subject for a while. Next month we'll return to FM stereo decoding, and I hope you'll join us. ■



*Lowering the cost of satellite technology...*



# LOCKHEED'S F-SAT: LOW COST SPACECRAFT BUS

One of the hurdles to greater use of satellites for improved communications and broadcasting is the sheer cost of putting a satellite in orbit. Based on its extensive experience in this area with the larger *Agna* vehicles, Lockheed believes it has the answer to lower costs — with its new lightweight modular F-Sat 'spacecraft bus' system.

by **GARY TURNER** Manager, F-Sat Program, Lockheed Missiles & Space Company

According to the recent study 'Affordable Spacecraft,' by the US Office of Technology Assessment (OTA), the cost of procuring a pound of satellite system (payload and bus) ranges from a minimum of US\$230,000 to more than US\$1 million, including amortised development costs.

These two elements, in about equal

proportion, typically represent well over half the cost of a space system. Lockheed's goal with F-Sat is to offer spacecraft bus services for payloads with a fraction of the costs currently being incurred.

Many missions consist of only one or two flights, and although payloads must necessarily change from one mission to

the next, the same is not true for the spacecraft bus, which supplies services (attitude control, power, propulsion, data management, command, and control) to those payloads.

In today's environment, it is not reasonable to expect our customers to go to the expense of developing a new bus for each mission, when the limited



resources can be better used in obtaining and applying the payload data. Lockheed therefore sees the need for development of a low-cost, multiple-mission bus and has established a dedicated project team to design and produce it.

With F-Sat, we are targeting the medium size satellite market, where a number of mission payloads are predicted to be deployed in the 1990s employing Delta II/Atlas II-class satellites (1350-4000kg, or 3000-9000lb.) These missions range from the Defense Meteorological Satellite Program (DMSP) and Air Force radar missions to flight experiments such as P-91B, NASA Mission to Planet Earth missions, and Commercial Development of Space initiatives.

In addition, scaled down (for budget reasons), missions such as Space Surveillance and Tracking System (SSTS) and Polar Platform could be added to this list, resulting in a large potential market for a low-cost satellite bus of this type.

As the developer and operator of more than 300 'standard' Agenas, Lockheed is fully aware that there is no such thing as a completely standard bus. However, we feel confident, based on our analysis of upcoming mission requirements, that an average commonality from one mission to the next of at least 75% is an achievable goal for a well thought out system.

This level of commonality, coupled with an efficient system for adapting the remaining 25% to specific mission needs, can be expected to result in major cost savings to our customers.

### What is F-Sat?

The F-Sat structure is an all aluminium construction, designed for ease of manufacture and assembly. The propulsion module, which forms the lower end of the spacecraft, is assembled as a unit including tank, valves, plumbing and thrusters.

It is then assembled to the main structure, which contains mounting provisions for the rest of the hardware.

The propellant management system is patterned after Lockheed's Inmarsat/Eurostar/Orion system — all titanium, with a proven surface tension type propellant management device for long life service with no moving parts.

It is capable of storing up to 450kg (1000lb) of hydrazine, but can operate at fractional loadings, if necessary.

The attitude control system consists of two star trackers, an inertial reference unit, and four momentum wheels

capable of three sigma  $0.01^\circ$  attitude knowledge and  $0.02^\circ$  attitude control.

The basic solar array package can be as large as  $46m^2$  (500ft<sup>2</sup>), providing more than twice the power output capability of competing buses.

This is based on our projection that future missions in this class, such as radars, microgravity experiments, and multiple experiment payloads, will require higher power levels than current projections indicate.

Current projections are biased by what the mission planners feel may be available, rather than what is possible with lightweight power system technology. With two nickel hydrogen batteries (with room for a third), average power output is 1.2kW at a conservative 15% depth of discharge or 2.4kW at 30%, which is well within the demonstrated

life for low earth orbit missions of up to five years.

Another area of the bus that has been designed for excess capacity based on our projections of future needs is in the Integrated Electronics System. We feel that there will be major increases in demand for onboard data processing and autonomy. We expect this added capability to more than pay for itself in the long run by:

- Reducing demands on ground station control
- Providing self test features that will decrease ground test equipment costs
- Providing data processing services to the payloads, thus reducing their costs
- Reducing the cost of ground data processing.

The selected system includes a central



*Technicians integrate components of an F-Sat mockup. The F-Sat bus design will feature simple aluminium construction, a high degree of access to components plus the ability to handle very high (2kW+) power demand.*



## Lockheed's Bus

integrated electronics box, incorporating a set of computer cards employing the GVSC 1750A processor developed by the Air Force for its SDI programs. Delivery of the first cards was expected in April 1991, in time for incorporation into our qualification unit.

The system speed of four million instructions per second is over twice our user's projected need employing ADA computer language.

The internal bus architecture provides easy expansion through the use of spare card slots. A novel packaging technique allows access to the cards at the vehicle without box removal.

### The keys to low cost

It is difficult under any circumstances to run a low cost, streamlined, fast turn-around development and production operation in our large systems oriented aerospace environment.

It is even more difficult within a highly structured, highly regulated space system or aircraft prime contractor organisation.

We would be discouraged about our changes for success, were it not for the

existence of a number of examples at Lockheed where it has been done.

The most obvious example is the famous Lockheed Aircraft 'Skunk Works' but there are other examples within the Space Systems organisations such as the Earth Sensor line of business, which supplies sensors to most of our commercial communications satellites (all GE communication satellites,

### About the author

Gary Turner is Manager of the F-Sat Program, Space Systems Division, Lockheed Missiles and Space Company, Inc.

Turner received his bachelor's degree with high honours in mechanical engineering from the University of Hartford in 1957, and his master's degree in mechanical engineering from the University of Connecticut in 1959.

During five years at Pratt & Whitney in East Hartford, Connecticut, he worked on nuclear powerplant design, and was one of the original design team on the SNAP-50 nuclear-electric space power system.

He joined Lockheed in 1963, and was appointed Manager of Electrical Power Systems in 1970, where he led the development of their basic lightweight solar array technology. This effort culminated in the Solar Array Flight Experiment which flew on STS 41-D in late 1984, and later led to the present Space Station Freedom solar array. For this work, he was awarded the AIAA Space Power Award in 1986. He is an Associate Fellow in the AIAA, a past member of the AIAA Space Power Committee, and a present member of the International Astronautics Federation Power Committee.

Intelsat V, Intelsat VII) in a highly competitive fixed price environment; likewise for the Arabsat, Eurostar, Inmarsat, Orion, and Lockstar propellant management systems, which won against highly subsidised international competition.

In government systems, the Solar Array Flight Experiment — the largest deployable structure ever flown — cost a total of US\$8.5 million, starting with a blank piece of paper.

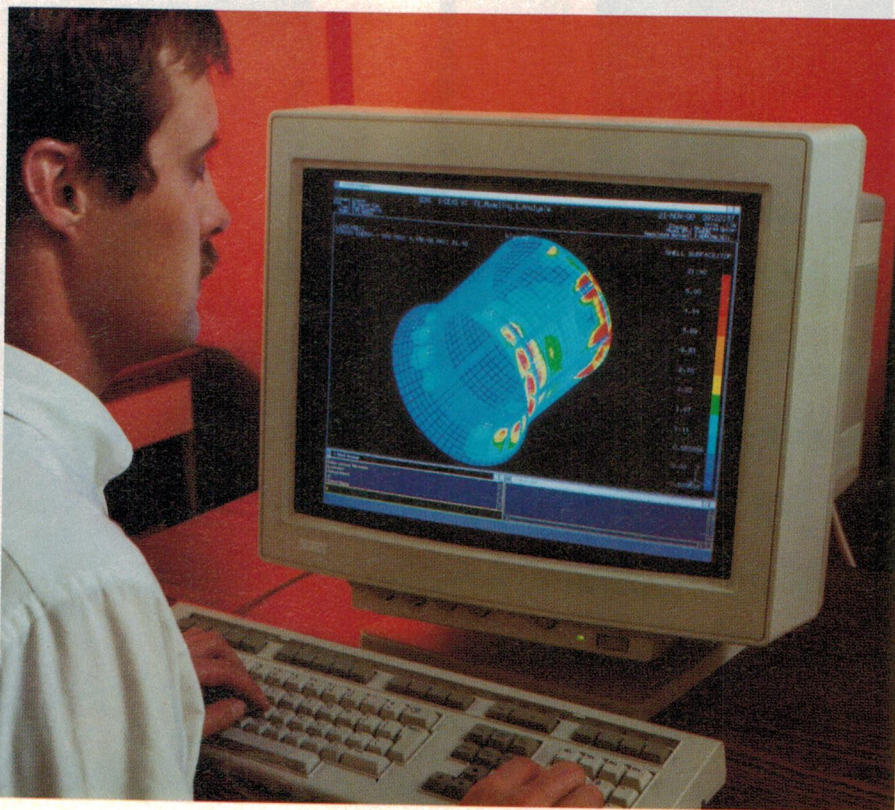
This cost included ground demonstration testing, redirection to a flight configuration and subsequent 90% redesign, flight integration, post flight support, and post flight data analysis.

Our intention is to learn from what we did right on these successful projects and build a 'company within a company' that can apply the same principles to the F-Sat project. The key elements in any successful operation are effective organisation, tools, and people.

Our organisational approach has been to co-locate all related functions — program office, engineering, manufacturing, procurement, and quality assurance — in one facility.

The organisation is highly horizontal in nature, with greatly expanded individual responsibility and authority (in our view, these two words should never be used separately in making assignments. We've therefore coined a new word — 'respority').

Our operating goal is to reduce the number of people between the designer or originator of an idea and the craftsman who produces it to zero. This involves eliminating the non-value-added functions from the project. They



The F-Sat Program will be the first across-the-board user of the newly developed Computer Integrated Engineering and Manufacturing (CIEM) system (shown above) and the Lockheed Software Engineering Environment (LSEE).



are quite easily recognised by the verbs that describe them — 'review', 'coordinate', 'monitor', etc. Our rule of thumb: 'If you can't do it, you shouldn't review it, and if you can do it, why don't you?'

The key to success, as always, is in the people. Here we rate attitude much ahead of aptitude. Stew Leonard, the successful Connecticut retailer cited by Tom Peters, said it well: "We rate attitude from 1 to 10, and then only keep the 10's. We don't want the others around us." Lockheed's Kelly Johnson in 1965 phrased the same thing somewhat more bluntly — "Pick a few good people and drown the rest."

Given that there's no truly 'standard' spacecraft, the speed and efficiency with which we can make the necessary 25 or 30% changes from one mission to the next becomes a vital part of the cost equation. The key to success here is the effectiveness of our hardware and software design tools as well as the skill of the people using them.

F-Sat is baselining the use of the new SSD Computer Integrated Engineering and Manufacturing (CIEM) system, which includes a set of 3-D hardware design and analysis packages, communicating with the Computer-Augmented Design and Manufacturing (CADAM) drafting tool set.

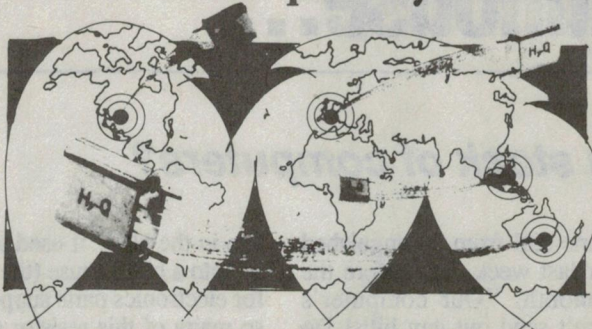
We find that these tools greatly improve original design efficiency and transition to manufacturing, but even more important are the efficiency savings in later change implementation and control.

The same is true, only more so, for software, where we expect the highest change cost to occur from mission to mission — and the percentage is increasing. In software, partly because of lack of proper software management and documentation tools, it is not uncommon for 100% new software to be written from one project to the next, even when such commonality should exist. Here we intend to use the Lockheed Software Engineering Environment (LSEE) software management and development tool set. We will be the first across-the-board user of LSEE, a small added risk for potentially large gain.

The F-Sat approach is not for everyone. Large bureaucracies exist to reduce the risk of individual errors. Some customers will be more comfortable in that type of environment, and will insist on it. For the others — and we are banking on their number growing — we are attempting to offer an alternative. ■

# WORLDWIDE

... the choice is crystal clear when you want custom made quartz crystals FAST!



"THE AUSTRALIAN COMPANY" — the choice is crystal clear

## Hy-Q International

Be it a Jumbo Jet or a local courier Hy-Q appreciate that stand down time represents lost revenue — so we have tailored our operation for efficient, fast service as a world leader in crystal technology with our bases on four continents... in Australia, Singapore, Great Britain, USA... we have the resources and technology to unequivocally guarantee our quality and service. Hy-Q also manufacture and stock Crystal Filters, DiI Oscillators, MPU Crystals, Clock Crystals, SPXO and TCXO Oscillators etc.

1 ROSELLA STREET, FRANKSTON,  
VICTORIA 3199  
(P.O. BOX 256, FRANKSTON)  
TELEPHONE: (03) 783 9611  
FAX: (03) 783 9703

**EXPRESS!!!**  
Our special emergency service slips into overdrive to despatch within \*six hours in special circumstances — 24 hours for others.  
Normal despatch for custom quality crystals is ten working days.  
\*Providing order received before 10am.

READER INFO NO. 2

## DAVID HALL ELECTRONICS

### Computer Disks

	Pkt 10
5.25" DSDD ..	\$5.95
5.25" DSHD ..	\$10.95
3.5" MF2DD ...	\$9.80
3.5" MF2HD ..	\$19.95

### Video Belts

### Cassette Belts

### Turntable Belts

### NOW STOCKED:

Full Range of  
K and W Heat sinks

### FM Bug Kits

- Voyager & PC board ..... 9.20
- PC board only ..... 1.50
- A surface-mounted bug that fits on top of a 9v battery.
- Ultima & PC board ..... \$12.50
- PC board only ..... 2.50
- See issue 15 or Security Devices. Our 1km bug. Requires LED Power Meter for peaking.
- Telemite MkII & PC board ... 7.45
- PC board only ..... 1.50
- See More FM Bugs! This model is attached to the phone lines. Has good audio pick-up.
- Amoeba & PC ..... 9.40
- PC board only ..... 1.40
- See More FM Bugs! A 400m room bug with tank circuit output. A very good performer.
- The ANT & PC ..... 8.50
- PC board only ..... 1.15
- See FM Bug book 1. A stable 200m room bug that fits into a Tic Tac box.
- Beetle MkII & PC ..... 13.45
- PC board only ..... 1.30
- See More FM bugs! An upgraded guitar transmitter with adjustable input sensitivity.
- Field Strength Meter & PC .. 8.70
- PC board only ..... 2.50
- Used to measure the output power of our bugs.
- Security Devices ..... 3.40

FULL RANGE OF ALTRONIC AND TALKING ELECTRONICS KITS INCLUDING FM BUGS

### MAIL ORDERS

For goods value up to: Add postage:	
\$10-\$24	\$4.00
\$25-\$49	\$5.00
\$50-\$99	\$6.50
\$100-over	\$8.00

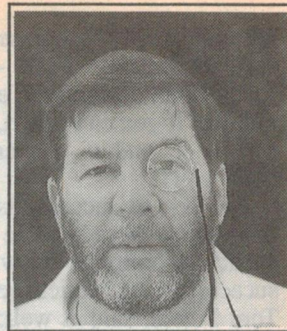
**DAVID HALL ELECTRONICS**  
3/376 KINGSTON RD,  
SLACKS CREEK 4127  
Ph (07) 808 2777  
Fax (07) 209 2623

READER INFO NO. 3



# Moffat's Madhouse...

by TOM MOFFAT



## Taking stock of computers?

I got a phone call from an anguished parts supplier last week, just before the end of the month. "Our computer's down! We can't send out any bills! Do you think you could get all your invoices from the last month and add them up and send in the money? Sorry about that..."

Oh dear. Just because of one cranky computer, that poor fellow had to ring every customer and ask them to work out their own bills, manually. What a waste of time for the customers, and an embarrassment for the supplier.

Unfortunately I couldn't help out with this exercise. I had bought several hundreds of dollars worth of resistors and capacitors and other bits and pieces for the Listening Post II project. I'd counted each one, each bag of 100 capacitors or 500 transistors, and then entered them into my own computer.

This keeps a running count of how many parts have been received, and subtracts the appropriate number from 'stock' as each kit is prepared. What it *doesn't* do is record which parts arrived in which month, and which have been paid for. That was supposed to be the job of the supplier's computer.

The idea of the computer at my end is to eliminate paperwork completely. Once the parts are counted against the number on the invoice, the invoice goes into the waste paper bin, later to do service lighting the wood heater or to make paper airplanes or something. The paperless office, that's me!

The supplier's entire billing system is based on the one computer. My stock system is based on another computer. If his computer goes down he's effectively out of business — no cash flow.

If mine goes down, well, I've got three different versions of the inventory system running on three different IBM-PC's; an XT, an AT, and a laptop. They're all kept up to date so if one goes kerflooie (the AT's in hospital at the moment for a system board transplant) I can still work from one of the others.

Computers! Is this progress? When I first got into the electronics game years

ago in the USA, it used to be possible to go into a parts house (the American term for electronics parts suppliers) and select so many of this resistor and so many of that capacitor and this connector and that tube (valve!), and the guy behind the counter would get out this floppy sort of book with several carbon copies.

He would then remove from behind his ear this wooden stick with a black thing down the centre and WRITE what you'd bought, upon the little book in front of him. He would then tear off one of the carbon copies and give it to you, and you would either intone "charge it", or swap it for some of the paper folding stuff in your back pocket.

If the book ran out of pages, or if the pencil broke, there would be spares nearby. These old-time parts houses could never be put out of business, even for a few minutes, by the breakdown of one piece of equipment.

When I moved to Australia over 20 years ago, the same 'parts house' system seemed to be alive and well. I remember you could walk into Radio Parts in Melbourne and they seemed to stock EVERYTHING. There appeared to be about 20 counter staff all working at once, and you could ask any one of them for a '6AQ5' and they immediately knew you were after a valve. If you were fortunate enough to be invited 'out the back' you'd see a giant warehouse, with row after row of shelves with every possible electronic device IN STOCK. Back at the counter they still worked with the books of carbon copies and pencils behind the ear.

### Computers hit Tassie

Tasmania has always been a leader in the computer field, in such areas as setting up one of the earliest inter-school computer networks for the use of students. It seems computerisation of the shop counter got an early start here as well. Back in the mid 1970's there were three or four major wholesale 'parts houses' competing against each other. But the computer had well and truly

sunk its fangs in, and when you arrived at the counter you were always greeted by a long queue.

Somewhere down in the bowels of the building there would be some kind of minicomputer with an 'expert' to run it. The only output from the computer seemed to be piles and piles of printouts of numbers. These sheets were inserted, several hundred at a time, into binders. The binders were placed on the counter out front, and were henceforth known as 'the book'.

If you wanted to buy something, the counterman would look up your 6AQ5 valve in 'the book' to determine that its computer number was something like '110A35VBS035823'. Out the back, the bin wasn't labelled with '6AQ5' and the price; instead, it would say '110A35VBS035823' and that's what the counterman would look for.

Once he found the '110A35VBS035823' the counterman would bring it back and then laboriously write the computer number on the sales docket. The process would then be repeated for the next part you required. You can imagine how long this took if you needed, say, 20 items.

A benefit of this, from the supplier's point of view, was that the counterman didn't have to know anything about electronic parts, as long as he could read the computer numbers. So unskilled people could be hired as counter staff, at a considerable saving in wage costs.

One glorious old Hobart establishment was a combination hardware, electrical trades, electronic parts, and automotive parts supplier. They were also into things like kitchenware and clothes, possibly a hangover from the 1920's when stores had to be all things to all people.

The store even had one of those little trolley systems for your money, zipping it to a central cashier's office so the counter staff didn't even have to know how to make change.

That place was living in the past (in the most complimentary meaning of the term), so it must have been a shock when computerisation hit. It wasn't un-



common to go in asking for a bag of 10k resistors and end up with a Holden radiator hose.

For a few short years 'the book' system flourished, infecting all the 'trade' electronic parts houses and the 'trade' hardware suppliers. I was working for Motorola Communications at the time, and any major two-way base station installation meant at least a couple of days doing the rounds and waiting in the never-ending queues to collect some toggle bolts here, some mains flex there, some coax connectors somewhere else.

I remember I once had a tower half erected and badly needed a couple of 2" wood screws to secure a bracket. I quickly found them at a trade-only hardware place, priced at 12 cents each. There was a gigantic queue, so I jumped in and asked one of the counter men if I could just leave 24 cents and run, to finish my tower job before the wind came up.

"No mate, gotta put them through the computer". I tried bribery: "What say I leave a dollar and you keep what's left over."

"No mate, still gotta go through the computer". What about shoplifting: just put the two screws in my pocket and exit? Do they send you to jail for pinching two screws?

I finally decided to combine bribery with shoplifting. I caught the counterman's eye and then tossed the dollar into the bin the screws had come from and shot out the door. There was never a word said about it after that, so it must have worked.

As I said, the 'book' computerisation system didn't last too long, thankfully. It's interesting to note that many of the businesses that indulged in it no longer exist. For several years after they went there was only one 'trade' parts house in Hobart, but a few months ago another one opened, giving some much-needed competition.

## Counter terminals

The dreaded 'book' is long gone. Both these electronic suppliers now have computer terminals right out at the counter. There's none of this thumbing through sheet after sheet of computer printouts. They just type in the part number as WE know it, such as 'BC547' for a transistor, and the computer comes back with how much it costs and how many are in stock. When your order is finished a printer goes 'zip-zip' a few times and out comes a nice invoice showing just what you've bought and what it's cost you. These are the things that make such good paper airplanes.

The shop's computer also subtracts what you bought from its running stock count, so the counterman can ask it "How many BC547's are left" and the computer will know. And with such tight control of numbers, suppliers can operate with much lower stock levels. This is a real blessing for suppliers at a time of recession, where every item of stock attracts big interest payments.

The computer and its stored information make it easy to predict potential sales of each individual item, based on previous sales over the past year or so. But this feature can go badly haywire with disastrous results for the poor slob needing the parts.

When the Listening Post II project first got rolling, I ordered enough bits to make up the first 50 kits. This went pretty well until we came to the 78L05 voltage regulator IC's — simple little transistor-shaped chips I'd been using off and on in projects for years. It seems other designers aren't as enamoured of these regulators as I am, so there hadn't been any recent sales of them.

Consequently the computer at one parts house didn't bother to stock them at all. The computer at the other place had decreed that only 15 should be stocked in Hobart, and another 15 at their Launceston office. I snapped up the 15 in Hobart and asked for the ones in Launceston to be sent down as well. The next day 10 turned up, not 15 (obviously specially ordered for someone else — no sales, huh?). I grabbed them. The following day my 15 turned up, so I grabbed them too.

## Cleaned 'em out

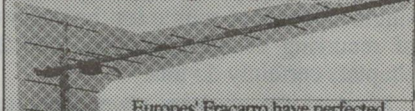
This means that over three days, it was possible to clean out a whole state of its supplies of 78L05's, partly by short-circuiting some other guy's delivery. Think of it — the whole state! And not by some high-flying major electronics manufacturer. No, little High-Tech Tasmania did it, my tiny manufacturing company that operates mostly from the top of the dining room table.

The Tasmanian suppliers immediately tried to replenish their supplies, only to discover the big importers on the mainland had been ignoring 78L05's as well. So for a few weeks, a lot of Listening Post orders were delayed for the want of a simple little chip worth less than a dollar. Had all the Tasmanian suppliers been willing to collectively invest \$100 in stocking 100 of the 78L05's, everybody could have been happy. But then again, if they stocked 'enough' of everything in the midst of a recession, they'd probably all go broke.

It makes one wonder if trade-only 'parts houses' are now redundant. When I order a big heap of stuff, like 700 100k resistors and 200 0.1uF capacitors, I'm told "they'll be here in a week". They generally are, but the point is that they're not held in stock locally.

The parts supplier just passes my order on to his own supplier, and tacks his margin on as the parts come back the other way. If the stuff isn't held in stock locally, why can't I just order it from interstate myself? Yeah, that idea might bear some looking into... ■

## 60,000,000 aerials later.



...Europes' Fracarro have perfected their television antenna designs to maximise gain, whilst keeping cost to a minimum. UHF Yagis from \$19\*, 4 element Phased Arrays at \$29\*, plus a huge range of quality diplexers, amplifiers, & filters. \*plus sales tax.

Request our introductory brochure today!  
Limited stockist opportunities available.

Peter C. Lacey Services Pty. Ltd. ACN006893438  
74 Fulton Rd. Mount Eliza 3930 Tel:03 787 2077

READER INFO NO. 4

## ACE SUPER BARGAINS

101 KEYBOARD	\$85
3.5 1.44MB DISK DRIVE & KIT	\$129
5.25 FLOPPY DISK DRIVE	\$123
CASE W/200W PS & LED DISP	\$180
HARD DISK 40MB VC W/CARD	\$395
MOUSE WITH MAT PIC	\$47
PRINTER I/O CARD	\$23
VGA MONITOR	\$556
DATA DIARY, EDIT SCROLL ETC	\$59
DOS V5.0 MICROSOFT	\$129
SIMM RAM MODULES 256Kx9	\$39
TV GAME SET WITH GUN	\$160
DUAL POWER CALCULATOR	\$12
VGA CARD W/512K	\$195
HARD DISK 80MB VC CARD	\$599
HARD DISK 100MB & CARD	\$825
MANY MORE SUPER BARGAINS JUST RING	

ACETRONICS

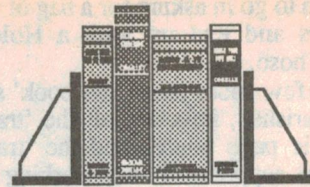
02 645 1241 Fax: 02 644 2862

CREDIT CARDS WELCOME - MONEY BACK GUARANTEE

READER INFO NO. 5



# NEW BOOKS



## Electronics Packaging

**HANDBOOK OF ELECTRONICS PACKAGING DESIGN AND ENGINEERING**, by Bernard S. Matisoff. Second edition, published by Van Nostrand Reinhold, 1990. Hard cover, 240 x 160mm, 656 pages. ISBN 0-442-26502-6.

This handbook contains a huge amount of detailed, technical information. The aim of the book is to provide a reference source for use in the packaging design of electronics equipment and to provide a single convenient source for the solution of recurring design problems. The 26 chapters certainly do this.

Most of the chapters cover technical areas like: fabrication processes, mechanical fasteners, heat transfer, shock and vibration design, material plating, wire and cabling, materials and processes, selection of plastics and RFI protection.

Other chapters cover various procedures: project planning, electronic pack-

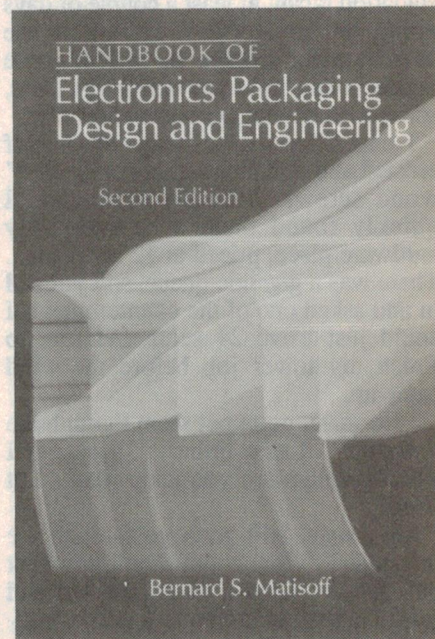
aging design and preferred materials for packaging. The human element is covered in human factors engineering (designing for easy of access and use based on people's preferred line of vision, movement, etc.), and a comprehensive chapter on safety.

Finally, there are useful tables of data: commonly used equations, formulae for calculating simple stress, and all types of conversion factors.

Appendix A contains reference tables and figures for all areas from wire gauges to different types of bolts. Appendix B, entitled 'Terminology', explains the meanings of hundreds of technical terms (79 pages) associated with the electronic industry.

I feel that the book succeeds very well in its stated intention. It provides, in one convenient reference book, the data needed by busy designers and engineers in their daily design tasks.

The review copy came from Van Nostrand Reinhold, 480 La Trobe Street, Melbourne 3000. (P.M.)

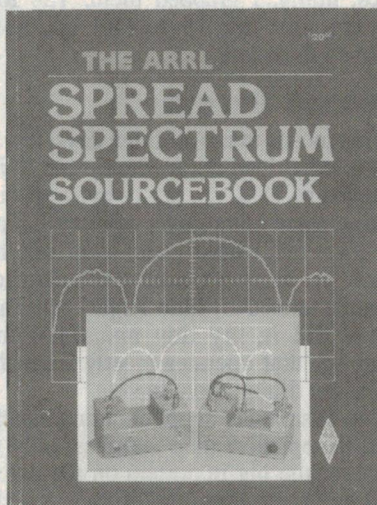


## Spread spectrum radio for amateurs

**THE ARRL SPREAD SPECTRUM SOURCEBOOK**, edited by Andre Kesteloot and Charles L. Hutchinson. Published by The American Radio Relay League, 1991. Soft cover, 275 x 205 x 20mm. ISBN 0-87259-317-7. Recommended retail price \$40.00.

The US Amateur Radio Research and Development Corporation (AMRAD) Newsletter of June 1980 stated, "There is some interest at the FCC in amateur radio experimentation in wideband modulation schemes, or spread spectrum". Official approval for experimentation was given in 1986, and since then, a group of experimenters has developed theoretical and practical systems for spread spectrum (SS) communications. This book consists of articles, papers and government reports that document the process whereby amateur SS progressed from the drawing board to the airwaves.

SS systems employ radio-frequency bandwidths that greatly exceed the bandwidth necessary to convey the mes-



sage. These bandwidths generally run from 10 to 100 times the information rate. By spreading the power over a wide band, the amount of energy in any particular frequency is very much smaller than for conventional narrow-band modulation techniques. The SS signal may even be below the noise level.

Coding sequences are used by SS sys-

tems to modulate and demodulate the transmissions. Receivers without the code cannot demodulate the encoded SS signal and will be highly immune to interference from it. Changing the code to another sequence effectively creates a new 'channel' on which a private conversation can take place.

The book contains very detailed accounts of the development of US amateur SS transmissions. It explains how the progress of solid state technology made amateur SS feasible, allowing the generation and deciphering of the modulating codes.

I found particularly interesting the descriptions of the early experiments which were conducted to overcome the problems of synchronisation and interference to conventional broadcasters. Spread spectrum theory and projects — it is all covered in this book. It seems that SS could offer amateurs a great chance for innovative experimentation.

The review copy came from Stewart Electronic Components, PO Box 281, Oakleigh 3166. It is available by mail order from this address. (P.M.) ■



# Low-cost maintenance tools.



Tek TSG 100 Series Test Signal Generators are proof you don't have to pay a lot to get a valuable tool for video service. Each one offers the performance you'd expect from much higher priced generators. Plus the signals and features you need to meet equipment maintenance requirements. All in a compact, lightweight package.

The TSG 131 is a multiformat solution for testing and servicing Betacam®, MII,

S-VHS, Hi-8 and PAL formats. The TSG 121 supports S-VHS, Hi-8 and PAL formats. And the TSG 111 is the choice for PAL-only applications. NTSC versions are also available.

Get the full story and a product demonstration from your Tek representative. We think you'll agree: low-cost, hard-working TSG 100 Series Test Signal Generators are some of the most productive maintenance tools you'll ever get your hands on!



**Tektronix**  
COMMITTED TO EXCELLENCE

READER INFO NO. 6

For more information, contact Head Office: 80 Waterloo Rd, North Ryde, NSW 2113  
Sydney (02) 888 7066, Melbourne (03) 836 3355, Brisbane (07) 394 1155  
Adelaide (08) 223 2811, Canberra (062) 51 6111, Perth (09) 242 4688, Toll free (008) 023 342



## *A look at ham radio in Egypt:*

# FEW IN NUMBER, BUT VERY ENTHUSIASTIC

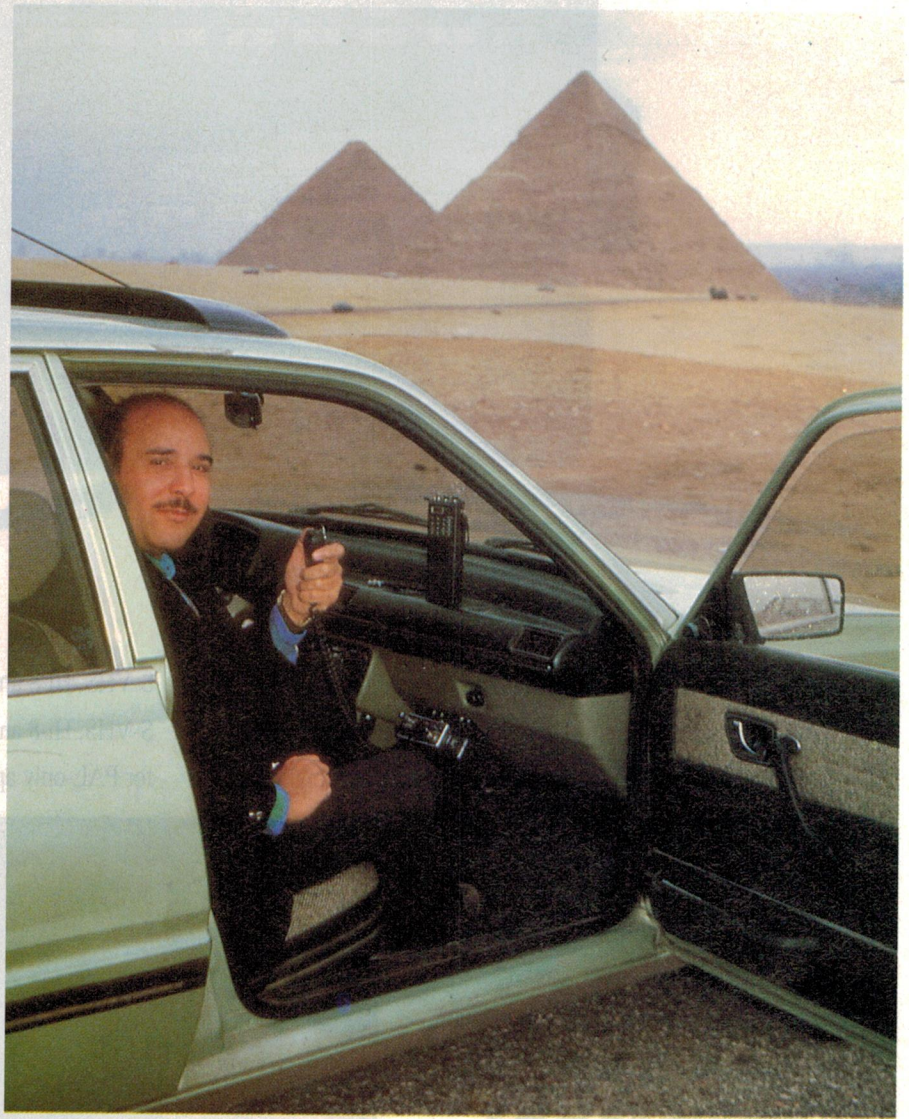
Australian radio amateur Tom King, VK2ATJ is very fortunate — as a travel writer, he often gets to visit many of those esoteric parts of the world that other hams can only contact by radio! He was recently able to visit Egypt, and was fascinated to meet some of that country's small but enthusiastic ham population. Here's his report, which shows that compared with Egypt, Australia's radio amateurs have a dream run...

In a dusty display case in an easily overlooked corner of Cairo's massive Egyptian Museum is a leather box containing a number of suspended and isolated copper strips. While this almost prehistoric relic cannot in any way be compared to the museum's magnificent gold and jewelled treasures of King Tut, just contemplating that the ancient Egyptians could have invented the first battery stimulated my imagination into creating a flurry of 'radio active' visions.

In my mind's eye I could picture a 1n 5/8-wavelength whip the back of a horse drawn chariot, and a 20m monoband beam sprouting from the apex of the Great Pyramid. I couldn't quite visualise the earliest transmitter, but knew that it just must have been 'rock bound' with the chief operator ("handle here is 'Pharaoh'") pounding brass during breaks from short wars with the Nubians — or long evenings with Cleopatra!

While the occurrence of such situations and scenes is highly dubious, one thing is certain: King Tut was about 3000 years too early to have joined the first Royal Egyptian Amateur Radio Club or to make use of its SU1CR (Cairo Radio) station facilities.

Although founded back in 1934 there are still a few 'G' callsign holders living in the United Kingdom today who were active members of that radio club during their stay in Egypt. (One of them is the President of the Radio Society of Great Britain). This was the time that the country larger in size than South Australia was ruled by King Farouk. The hobby flourished for nearly two decades during his reign.



*The first 2m mobile operator in Egypt, Ezzat SU1ER is a strong voice in Egypt's still small amateur radio community.*



The first setback came in 1952 when the then President of the Egyptian Republic, Gamal Nasser, overthrew the monarchy and stopped all amateur radio activity claiming his action was 'in the interest of national security'.

The order was overturned the following year, however, with the issuance of 'Decision #40 of 1953 for the purpose of installing radio equipment for technical and scientific tests'.

Issued by the Transportation Minister, it set out 20 points needed to be followed by those applying for an amateur licence, taking the examination and operating an amateur radio station.

Although this is an officially gazetted document, virtually all government bureaucrats and in excess of 99.9% of Egypt's 55 million people, do not know that amateur radio is legal or realise that the Wireless Division, Ministry of Communication, issues four different grades of licence — all valid for a year — so that even schoolchildren can easily become radio operators.

## Amateur radio grades

The four grades of licence available are:

1. A code speed of 16WPM is required along with a pass in electronics theory and rules and regulations. Grade 1 licence holders can operate on all bands and use all modes with a power of 250 watts.
2. A code speed of 12wpm is required along with a pass in the same exam. Grade 2 licence holders can operate on all bands and use all modes with a maximum of 50 watts.
3. Just a five wpm code speed and a pass in a basic exam is required. Grade 3 licence holders can operate on all bands, but are limited to 30 watts of SSB/CW on the HF bands and 10 watts on the low VHF bands.
4. The same exam conditions apply here as for grade 3, but the grade 4 licence holder is limited to 10 watts on CW in the HF bands and 10 watts on the low VHF bands.

No fixed date is set for the government-administered amateur radio examination which is held in Cairo. An applicant is given a specific day to sit for the exam only at the time the application is accepted.

Since late 1987, however, there haven't been widespread applications or examinations. A significant number of suitably qualified Egyptians are prepared to take the exam, but are not prepared to pay an application fee temporarily set by mistake!

The bottleneck situation occurred when an overly zealous junior



Providing many with their first Egyptian contact is Fathy, SU1FN.

bureaucrat felt that the privilege to become an amateur should be worth E£200 (about A\$80). Before that locals only had to submit E£20 with their application fee!

The yearly renewal for a licence remains at E£20 per year — per piece of amateur radio equipment! Again this is a practice not seen in any other country. As are restrictions on exchanging, moving and even owning radio equipment.

Obviously the government official on duty who arbitrarily set the exorbitant application fee did not realise that no country in the world charges such a high amount to public service minded amateurs, and that many countries encourage their amateur population by not charging any fees at all.

Understandably the Egypt Amateur Radio Society (EARS) has made a highly justified complaint to the Arab Republic of Egypt's National Telecommunications Organisation (ARENTO) stating that no application fee should be charged (or, at most, only a minimal amount to cover administrative time for processing the paperwork) — citing the non-commercial, non-business nature of amateur radio.

They also pointed out the hobby's beneficial aspects, including its positive implications for Egypt, which is considered the most technically advanced country in the Arab world.

When such a crippling and restrictive financial barrier is lifted, as must happen, those passing the relevant exam in Cairo will join a very small group of

just 24 licenced Egyptian amateurs. All live in Cairo except for Tarek, SU2TA of Alexandria, the first ever Egyptian station in the historic Mediterranean city. When in Egypt, Saudi Arabia's Prince Talal operates with his call sign SU1UN.

Despite the small number of Egyptian amateurs, the situation in the republic is somewhat more prosperous than can be found in its immediate African neighbours. Libya does not have regular authorised amateur activity. Sudan has but three hams, including Sid, the very AMTOR-active, ST2SA of Khartoum. And only a few foreigners are on the air from Djibouti. The situation in Ethiopia changes, but currently there is little activity.

## Support from EARS

Egypt's level of amateur activity is due mainly to the enthusiastic efforts of the devoted members of EARS. But it also helps immeasurably to have at least one senior government official interested and favourably disposed to amateur radio.

In Egypt that important individual is Eng. Mahmoud M.S. El Nemr, the Head of the International Telecom Sector, the government department responsible for administering the amateur radio exam.

I had a meeting with Mr Nemr, in which we discussed the importance of encouraging the development of amateur radio — which would, in turn, stimulate the growth of the electronics and communications industries in Egypt. During our meeting the influen-



## Egyptian Hams

tial official said he personally hoped that the number of amateurs would increase. "Would he be one to join the hobby?" I asked. "No, the level of work related commitments is just too great", he said.

The amateur radio movement in Egypt will undoubtedly continue to grow even, if its progress is only measured in terms of a handful of new callsigns every few years. This figure would be greatly increased if only a few relatively simple issues could be satisfactorily resolved.

First and foremost is the establishment of suitably equipped club premises. For many years, EARS meetings were held on a rotating basis in a member's home. An increase in membership numbers and the need for more space in which to conduct electronics and code classes created problems, which were generally solved in early 1988 with the acquisition of a room on the 13th floor of the Wireless Officers Club in Ramses Square. SU1AH, Ahmed and the Chairman of the Officers Club, Mr Zakaria Shahat were instrumental in securing a dedicated meeting room.

### Club station

While radio meetings are occasionally held on the first Saturday of the month, amateur operations are not yet authorised even though an application for HF and VHF activities along with a request for the callsign SU1ARS has

long been held by ARENTO. When permission is granted EARS will have a major problem with equipping Egypt's first club station with radio gear, as well as with instructional supplies for training students.

Assistance could be obtained more easily if EARS had a high profile patron like Susan Mubarek, wife of the President of the Arab Republic of Egypt.

Her husband could easily become an amateur himself, as he is the holder of a radio operator's licence obtained when he was a pilot. Mrs Mubarek is already heavily involved with youth and community activities, and would be the ideal individual for the role of Patron of the Egypt Amateur Radio Society.

One individual who would be most grateful if Egypt's first lady did become involved with the hobby is Saad Sayed Adul Maguid, Inspector of English for the New Valley Governate in El Kharga, an oasis southwest of Cairo. Apart from his contact with schools throughout a vast desert area, Mr Maguid is trying to get boy scouts in this isolated and rural area involved with amateur radio. The problem is training materials and equipment.

Amateur radio equipment is not sold in Egypt but it's available in neighbouring Israel, as a result it's very difficult for any newcomer to obtain books or set up a suitable station.

While it's not yet economically viable for any Egyptian electronics entrepreneur to begin manufacturing amateur radio kits or modules, this could be a possibility in the future. A more likely solution involves making a few correc-

tive 'pen marks' on an official document.

Permission to personally import amateur radio equipment can be granted only by ARENTO. But it is a time consuming exercise, requiring a number of forms and payment of a totally unrealistic 200% rate of duty! Yet if a computer enthusiast wants to import equipment, paperwork is far simpler and the duty level is just 5%. (Perhaps this abnormality will be adjusted when government officials understand that amateur radio is a frequent training ground for those proceeding to careers requiring computer skills!)

### Duty free equipment

Even when the duty on amateur radio equipment is reduced to the level of computer equipment, or better yet abolished altogether, most Egyptians would still not be able to afford a new HF transceiver. (The average annual income in the country is US\$700 OR A\$910).

With a number of amateurs already licenced but without equipment, and more equipment-less amateurs to be licenced after the application fee fiasco is resolved, the equipment situation is very critical. Amateurs in any country could play an instrumental role in assisting with donations of usable equipment or used equipment for sale at very reasonable rates. But even then Egyptian amateurs will have to complete a mountain of paperwork and pay an astronomical rate of duty.

Working to change such restrictive legislation and excessive duty has been one interest of EARS. Egypt's sole 'voice' for amateur radio operations became stronger on November 16 1987 when EARS' officials were notified of the Society's acceptance as a full member of the International Amateur Radio Union.

This influential organisation is noted for its dedication in assisting developing countries to cultivate amateur radio as a national resource.

### Office bearers

Currently the officers for EARS are:  
President SU1ER, Ezzat  
Vice President SU1AH, Ahmed  
IARU Liaison Officer SU1ER, Ezzat  
Secretary/Newsletter  
Editor SU1HN, Hamed  
Treasurer SU1FN, Fathy  
2m Officer SU1FK, Hosni  
Awards Manager SU1BA, Bass

Apart from these officers, EARS has established an education wing with SU1AH as CW trainer, SU1s HK and



Hosni, SU1HK, and daughters SU1MK, Magda (left) and SU1NK, Manal, are Egypt's most active VHF family.

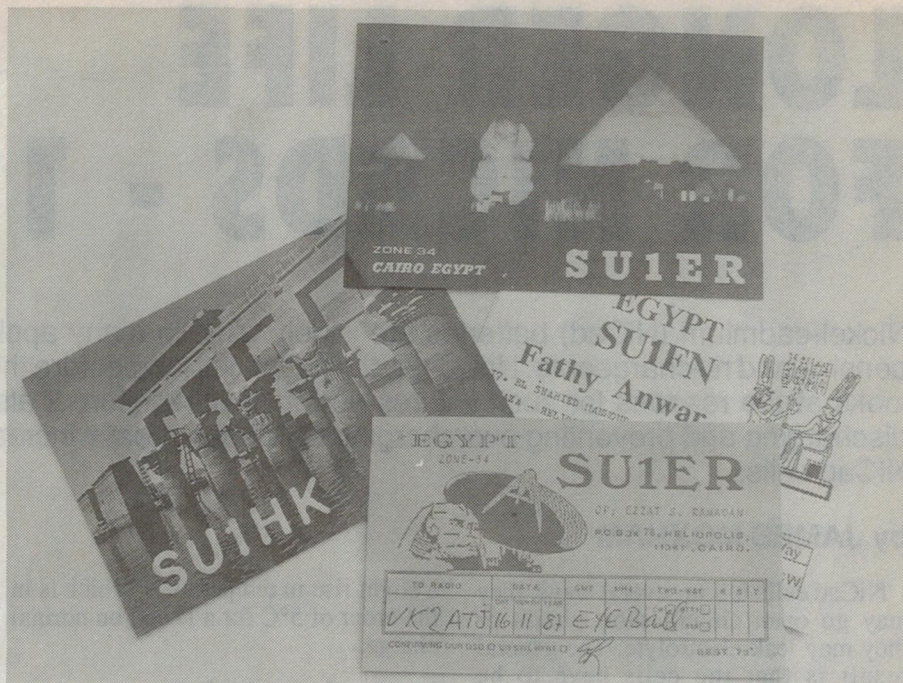


FN as instructors in electronics and SU1ER as course coordinator. As well, SU1ER is the society liaison officer responsible for dealing with licencing and other regulatory matters within Egypt. Despite a full time engineering job and dual voluntary duties with EARS, Ezzat SU1ER, is one of the more active amateurs in Egypt. From his suburban home, Ezzat operates one of the country's more sophisticated amateur stations. He was the first to obtain permission for mobile VHF operations. Along with SU1s HK, FN, CR, DZ and AL, he is active on AWTOR (14.076 Mailbox) and Packet (14.072MHz). Ezzat's three daughters, Sali, SU1SR, Rehab, SU1RR and Magi, SU1MR are also licenced amateurs.

During seven months of Iraqi occupation in Kuwait, SU1ER was in contact with 9K2DZ. From behind a false wall in the basement of his Kuwait City home, Abdul Jabbar Marfi — who holds the Egyptian callsign SU1DZ — secretly sent messages to Ezzat about the welfare of Egyptians in Kuwait. Ezzat regularly checks into the European DX Net (14.245MHz at 0800Z, Saturdays) to provide stations with an Egyptian contact and to talk to OE6EEG, the Egyptian-born Dr Salim; the Arabian Net (14.250MHz at 0600Z, Fridays) and the daily DX Family Hour Net (21.345MHz at 1830Z).

Newcomers to the Nets often barrage Ezzat with a number of common questions, which receive the following answers:

- Egyptian amateurs do not have QSL managers and there is no QSL bureau. Send cards direct via the call book address.
- There are no /SU call signs issued for visitors. Anyone using such a callsign is an illegal operator.
- SU3 callsigns have never been issued for Sinai operations.
- All correspondence is to be sent via SU1ER, PO Box 78, Heliopolis, Cairo 11341, Egypt.
- The address of the Egypt Amateur Radio Society is Floor 13, Flat 10, Ramses Building, No 6 Ramses Square, Cairo, Egypt; telephone 754 827.
- Published every two or three months more or less, is the club newsletter *Egyptian Echos*. Copies will be posted to any interested amateur who supplies an SASE to Hamed SU1HN, PO Box 1578, Alf Maskan, Cairo, Egypt.
- Another active ham is SU4FN. Fathy has provided many radio enthusiasts with their first CW or phone contact, as well as that all-important first SU1



**These QSL cards confirm contacts with Egypt's most active amateurs.**

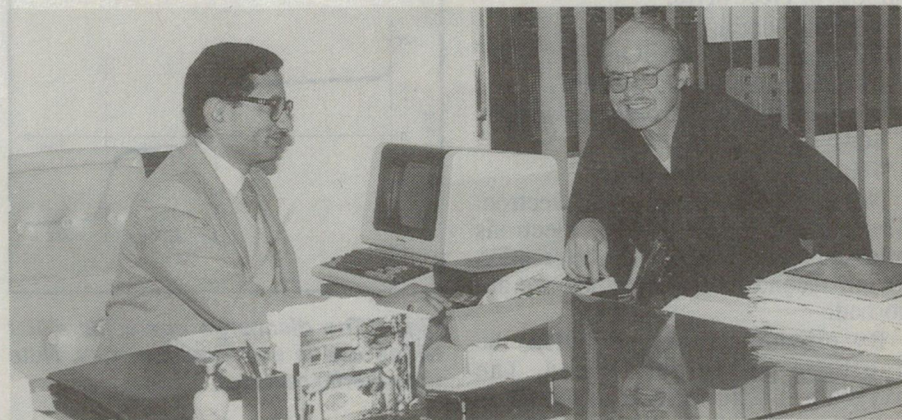
QSL. While his wife does not join in with amateur activities, both of Fathy's sons plan to obtain licences. SU1FN is also very fond of digital communications, with packet being his favourite.

The QSL cards of Hosni, SU1FK are also in demand, but for a different reason. SU1HK is a keen 2M FM operator. Encouraged by his wife Magda and daughters, SU1NK, Manal and SU1MK, Magda, Hosni has the very best hilltop QTH in an otherwise flat Cairo. Sited some 250m above sea level in the rock-rich hills which the Pharaohs quarried for their pyramids, this enthusiast has worked nearly a dozen countries on VHF including Malta; Turkey; Kuwait; a mobile station in Greece, as well as the Athens repeater; Israel (it's 500km to the

145.775MHz Tel Aviv repeater, which is frequently accessible); Lebanon and the R4 repeater in Jordan. Another frequent entry in the SU1HK log book is the R2 repeater in Cyprus, a 145.650-MHz machine some 600km away. Most recent were 2m SSB and FM contacts with Italy, and a 150mW simplex contact with the Greek Island of Rhodes. As no repeater exists in Cairo, Hosni, like the dozen other active 1m operators in the capital hopes that King Hussain, JY1, will be instrumental in setting up a high-sited repeater at Aqaba in the far south of Jordan — which could be accessed from Cairo.

Because of the vast expanse needed to house Cairo's exploding population (Africa's largest city has some 13 mil-

*Continued on page 95*



**Mr Mahmoud M.S. Nemr, Head of the International Telecom Sector and author Tom King, VK2ATJ (right) discuss some of the problems and potential facing amateurs in Egypt.**



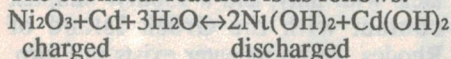
# LONGER LIFE FOR NICADS - 1

Nickel-cadmium (NiCad) batteries are widely used in many applications, because they are inexpensive and re-chargeable. However, they often fail long before their rated 400 charges. This article looks at the reasons for such failures and their prevention. It also gives some simple circuits for discharging and preventing overcharging which can greatly increase the useful life and capacity of NiCad cells.

by JAMES MOXHAM

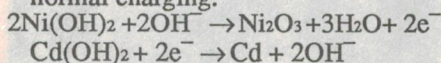
NiCad cells fail in several ways: they may go open circuit, short circuit or they may leak electrolyte. The general result is that the cells have to be thrown away. To understand why they fail, the basic chemical reactions need to be understood.

A NiCad cell can be thought of as two plates with an electrolyte-soaked separator in between. The positive plate is an oxide of nickel,  $\text{Ni}_2\text{O}_3$ ; the negative plate is cadmium and the electrolyte is potassium hydroxide. The chemical reaction is as follows:

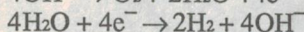
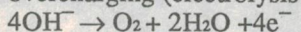


The difference from other rechargeable cells such as lead-acid and nickel-iron types is the reaction during overcharging. In unsealed cells, the large excess of electrolyte means that the charging energy can be dissipated by the electrolysis of water. The water is periodically replaced. In NiCad cells there is very little water, so a reaction is required which effectively results in no loss of electrolyte.

normal charging:

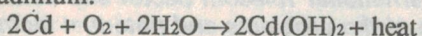


overcharging (electrolysis of water):



Note:  $\text{e}^-$  = the charge on an electron. The current is the flow of electrons released by the first half of the reaction to the second half where they are absorbed.

By providing excess  $\text{Cd}(\text{OH})_2$ , the hydrogen gas is not formed. The oxygen gas diffuses back to the negative electrode where it reacts with the cadmium:



The overcharging can be detected by

a slight rise in temperature, which is in the order of  $5^\circ\text{C}$  for a D cell on normal charge.

## Loss of electrolyte

NiCad cells often fail from loss of electrolyte. In order for the oxygen to diffuse between the plates, the gap between them is made as small as possible. This means that there is very little electrolyte present in the cell compared with an unsealed type of cell. Since water is actually part of the chemical reaction, it follows that a loss of a very small amount of water results in a large loss in capacity. Such water loss can occur when a reverse polarity is applied to a cell.

Apart from accidentally charging cells back-to-front, reverse-charging occurs most often to the first cell in a battery to go flat. When this happens, the current flowing through the flat cell from the other cells effectively reverse-charging it so that its polarity

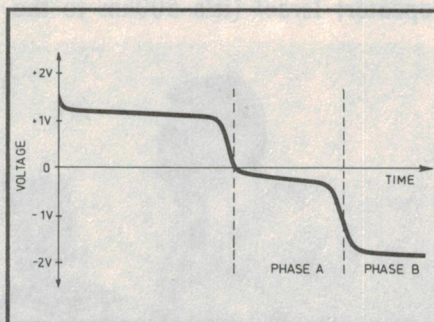


Fig.1: The discharge curve for a flat NiCad cell in series with others. Note the polarity reversal.

is reversed. The discharge curve for such a cell is shown in Fig.1.

Electrolyte decomposition occurs during phase A and phase B, resulting

in permanent loss of capacity. Oxygen is formed during phase A, where any extra cadmium is being converted to cadmium hydroxide. In phase B, hydrogen is also formed. The process is also a vicious circle; on the next discharge this cell is more likely to go flat first, losing even more electrolyte. The result is a battery with one cell that will not work at all.

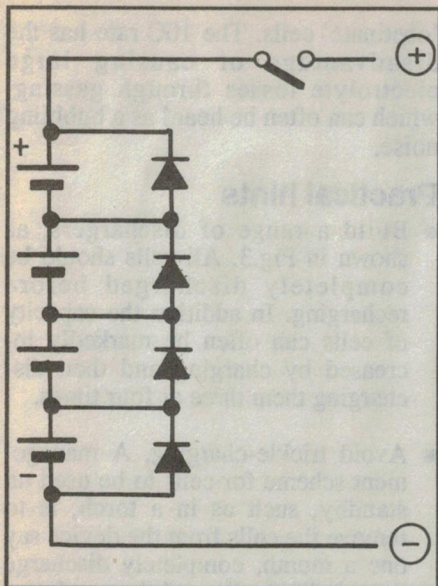
There are several solutions to the problem. One can provide a low voltage cutout mechanism, that stops discharge before reverse charging can occur. Another solution is to only use one cell and step the voltage up using an inverter circuit. A third option is to provide reverse protection diodes in the configuration shown in Fig.2. Unfortunately this provides only partial protection, because most diodes have forward voltage drops of about 0.6V. The cells are held in phase A, but this still results in electrolyte loss after the cadmium runs out. Schottky diodes have the lowest forward voltage drop and work best at currents greater than 0.5A, but they still only delay destruction of the cell and can cost as much as the cell itself.

## Incorrect charging

The rate at which oxygen recombination during overcharge can proceed is dependent amongst other things on the amount of extra cadmium present, and on the ambient temperature. The designed rate for standard cells is  $C/10$  at  $20^\circ\text{C}$ , where  $C$  is the capacity in ampere hours (Ah). Overcharging currents higher than this will result in a buildup in gas pressure until the safety valve opens, resulting in electrolyte loss.

Another point to watch is that at





**Fig.2: Reverse protection diodes can be fitted across each series-connected cell to prevent polarity reversal.**

lower temperatures the oxygen recombination process becomes much slower. Since cells are often charged in outbuildings for safety reasons, it is possible to damage cells even at the standard charging rate. Manufacturers recommend 0.1C charging to be done between +10 and +30°C.

## Degradation

As well as damaging the cell by loss of electrolyte, they are also damaged by the degradation of the plates and separator. Due to the dangers of overcharging, it is tempting to think that a trickle charge over a long period is the best solution.

Unfortunately this can cause another mode of failure, known as dendrite formation. Under some circumstances during charging, the cadmium can be deposited in the form of dendrites, which are miniature tree-like formations. If these grow long enough, they can actually provide a short circuit between the plates. Because dendrites grow during charging, it is possible for a bridge to be formed partway through the charge, diverting further charging current through the dendrite.

On discharge, this cell goes flat much too quickly and is said to have lost capacity.

Eventually one cannot get any charge at all into the cell, and it is thrown away. The conditions that favour dendrite growth appear to be gentle cycles of charging and discharging, and prolonged periods of overcharging.

Another problem associated with

prolonged overcharging is degradation of the separator between the plates. The separator material is usually fibrous polypropylene or nylon, and is attacked by the oxygen diffusing between the plates during overcharge. This attack can be made worse by the high pressures and temperatures associated with high current.

To avoid these problems, charging should be terminated shortly after the oxygen recombination phase has begun. There is no cure for a damaged separator, but techniques for dealing with dendrites are dealt with later in the article.

## Electrolyte creepage

This seems to be a problem with only some brands, and manifests itself as a furry white deposit on the top of the cell.

The culprit is the highly reactive potassium hydroxide electrolyte, which can leak past the seal at the top of the cell.

This is then converted to the less reactive potassium carbonate, on contact with atmospheric carbon dioxide. Both compounds attack metal, leading to poor electrical contact with battery holders.

The best cure is to avoid purchasing that particular brand again. I have used some cheap brand cells that have never shown this problem, whereas all six cells of one more expensive brand leaked electrolyte before they were discarded.

## Charging

Nicad cells have a very low internal resistance which is of the order of 0.01 ohms for the sintered plate variety and thus must be charged from a constant current source. There are four different charge rates: trickle, normal, fast and ultrafast.

Trickle charge is used when the cells are only needed occasionally but always have to be charged — for example, in emergency lighting systems. A charge rate of 0.01C will compensate for self-discharge, whereas a rate of 0.02 to 0.05C will also charge the cells. Rates over 0.06C are not recommended for indefinite periods.

The normal (overnight) rate is 0.1C for 14 hours. After this time all cells should have gone into the oxygen regeneration stage, at which time charging should be terminated. At this rate the maximum permissible charge time is 30 days.

Fast charging from 0.3C to 1C is possible, provided that the cells are

prevented from overcharging. This is commonly done by measuring the increase in temperature associated with overcharging, or by a timeout mechanism.

Measurement of the voltage rise across the cell cannot be used to detect the overcharged state.

Ultra fast charging at rates of up to 20C is often used by model plane and boat enthusiasts. Special techniques are required for this.

Many NiCad charging circuits have been published in the past, but most seem either to be too complicated or costly. Several circuits that use only a handful of components and can be wired up on a simple tag strip, will be given in the second of these articles.

## Discharging

It is often quoted that NiCads tend to lose capacity if they are never completely discharged. This is known as 'shallow discharge memory' and can be rectified by 3-4 charge/discharge cycles.

Another problem can occur if cells are always discharged in combination — as in a battery, e.g., the 9V NiCad. In this situation, it is inevitable that some cells will go flat before others do. If the cells are then discharged together, this means that some cells spend more time in the oxygen regeneration stage, reducing their life expectancy.

For both these reasons, cells should be individually discharged before recharging. The best and cheapest way to do this is to discharge each cell through a resistor. This not only prevents the possibility of reverse-charging, but also ensures that the cells are completely discharged before recharging. Fig.3 shows the appropriate circuit and a possible arrangement.

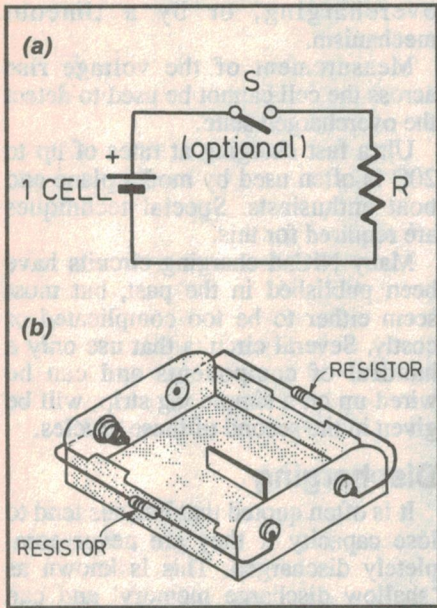
The maximum continuous rate of discharge is 2C, or briefly 4C. The limitation to discharge currents is the temperature of the cell which should not exceed 50°C.

The resistor values given assume the cell has an average voltage of 1.2V and 90% of rated capacity. Discharging at 0.5C, the process will take 2 hours.

The rate of discharge is a compromise between having to wait for the cells to discharge, and overheating. I chose an arbitrary rate of 0.5C which will discharge a completely charged cell in just under two hours. If the resistors are mounted where they can be felt this gives an indication of when the cells have discharged.



# NiCad Life



**Fig.3:** A simple system to allow individual discharging of each NiCad cell. Values for resistor R are shown in the table below.

SIZE	CAPACITY	RESISTOR
AAA	180mAh	15 ohm, 0.25W
AA	450mAh	5.6 0.5W
C	1.2Ah	2.2 1W
D	1.2Ah	2.2 1W
D	4.0Ah	0.68 2W

One characteristic of NiCad cells that should be noted here is self-discharge, which occurs even if the cells are not being used. Figures vary but typical values are a 35% loss of capacity in 30 days at 20°C. A cell can completely discharge itself in six months.

## Voltage monitoring

As mentioned previously, one of the quickest ways to destroy a NiCad is to reverse charge it, as may happen to the first cell in a stack to go flat. One way around this is to monitor the voltage of the complete stack or group of cells, and provide a warning when one cell is discharged.

## Rejuvenating 'dead' cells

Dendrite formation as discussed earlier, is a very common failure in NiCad cells, resulting in 'lost capacity'. The fault is often first noticed at the end of a discharge, where one cell will measure zero volts across it even when

the load is removed. At the end of charging at the 0.1C rate, the cell will still measure zero. Cells such as this can generally be rejuvenated using the method outlined below. It is not suitable for rejuvenating cells that are open circuit; these have most likely lost electrolyte, from either leakage or excessive current in either direction. First apply the normal 0.1C rate and measure the voltage across the cell. Don't worry if nothing happens, but arrange to be able to supply a charge of about 2C.

Apply this in bursts and note the voltage the cell settles to, in between. This will probably be zero at first but the cell should soon come 'unstuck'. Continue charging for a few minutes, but work in bursts to ensure the cell does not overheat. The cell should not be allowed to get anywhere near full charge. Next discharge the cell through a low value resistor (e.g., 0.5 ohm, 5W).

The theory behind this treatment is that the heavy charge will melt any dendrite causing short circuits, whilst depositing cadmium metal on the plate to give a usable charge.

The heavy discharge will then oxidise any remaining dendrites first, because these will offer a lower resistance path than the electrolyte.

The cell should then be recharged at the normal 0.1C rate, and should hopefully go through to the oxygen regeneration stage.

This can be checked by discharging the cell at 2C or so for about a minute, and noting the voltage it settles to after a further minute. If this is significantly lower, say 50mV, then the cell has reached overcharge.

The cell should then be left on low current (say 0.6C) for a further 24 hours. This is because the most effective dendrite removal occurs when the cells are on overcharge.

The dissolved oxygen diffusing across from the nickel plate tends to attack the dendrites first, dissolving the cadmium and re-depositing it on the cadmium electrode. Overcharging, whilst generally harmful, in this situation is beneficial to the cell.

The cell should then be cycled through three or four alternate charge/discharge cycles, before being returned to the stack.

Readers who look up reference 10 will find charge/discharge rates of 10C specified, instead of the 2C used here.

I have found the lower rate seems to be just as successful as the high rate, with the exception of a few very

'obstinate' cells. The 10C rate has the disadvantage of causing large electrolyte losses through gassing, which can often be heard as a bubbling noise.

## Practical hints

- Build a range of dischargers, as shown in Fig.3. All cells should be completely discharged before recharging. In addition the capacity of cells can often be markedly increased by charging and then discharging them three or four times.
- Avoid trickle-charging. A management scheme for cells to be used on standby, such as in a torch, is to remove the cells from the device say one a month, completely discharge them individually and then recharge them.
- Use alkali cells if the device is only used intermittently. This includes TV remote controllers and almost all 9V battery powered devices. NiCads should only really be used if you are replacing ordinary cells more than about once a month.
- Avoid using the 9V rechargeable battery. Most brands only give 7.2 volts, they are expensive and if one cell fails then the whole battery has to be thrown away.
- Build low battery indicators into devices if this is possible. Avoiding reverse-charging greatly prolongs the useful life of cells.
- Don't persistently overcharge cells. If you keep forgetting to turn them off, consider using a timer circuit. Alternatively use an alarm clock as a reminder.
- Avoid charging at rates greater than 0.1C, without some form of cutout mechanism to prevent overcharging.

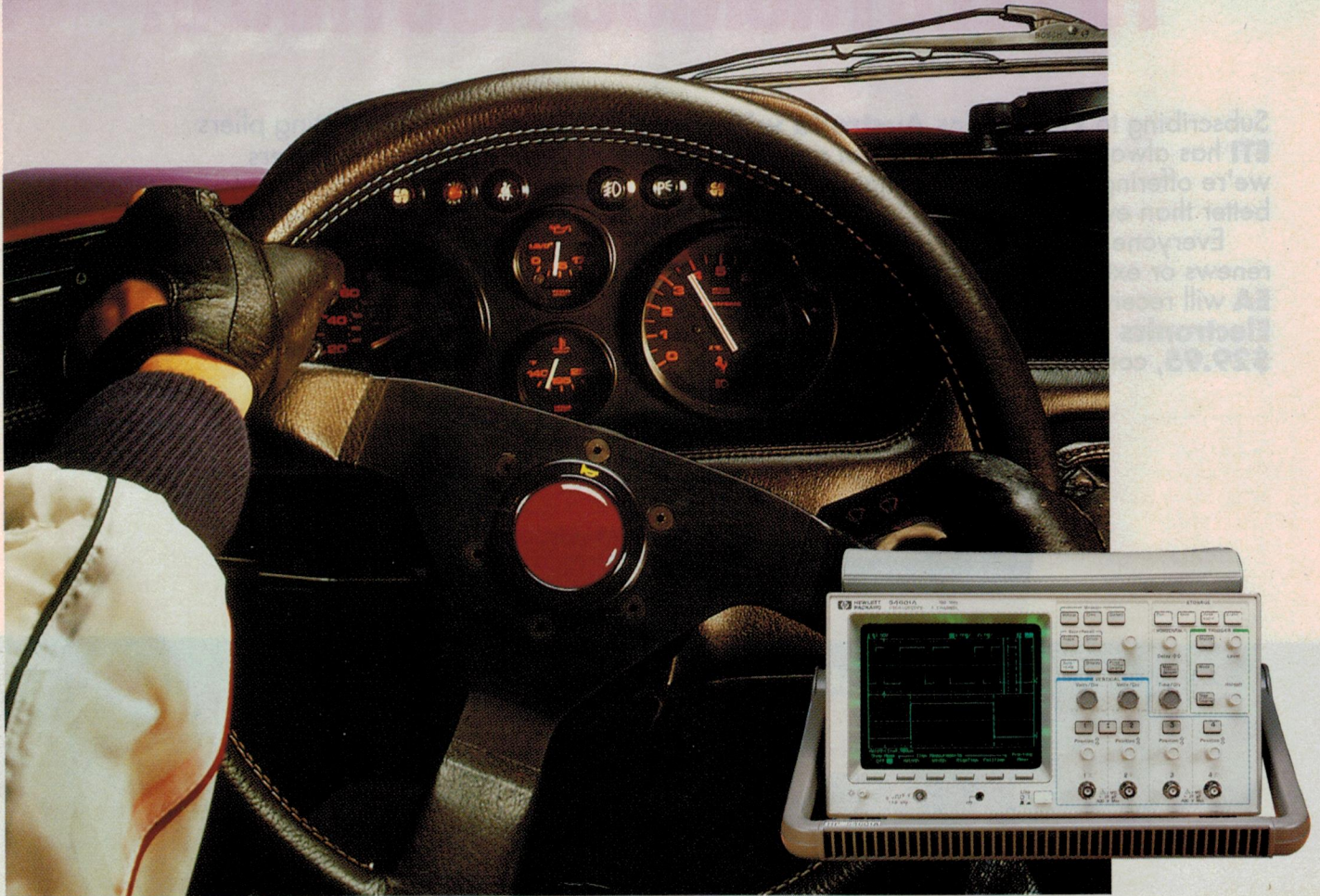
Using these few simple 'management rules' the useful capacity and life of NiCad cells can be greatly increased, resulting in further savings and increased reliability.

The second of these articles will describe the design and construction of various charging circuits and low battery indicators. Also included will be a circuit for a dendrite-suppression charger using periodic current reversal. A list of useful references will be given as well.

(To be continued) ■



# You'll like the feeling of our new digital troubleshooting scope.



**Now there's a 100 MHz digital scope that handles just like analog.**

Digital oscilloscopes have certain advantages that are hard to overlook. But for troubleshooting, many engineers still prefer analog scopes. Simply because they like the way they handle.

The HP 54600 changes that. It *looks* like a 100 MHz analog scope. All primary functions are controlled directly with dedicated knobs. And it *feels* like one. The display responds

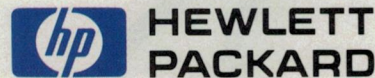
instantly to the slightest control change.

But when it comes to troubleshooting, the HP 54600's digital performance leaves analog and hybrid scopes far behind. At millisecond sweep speeds, the display doesn't even flicker. Low-rep-rate signals are easy to see without a hood.

It has all the advantages that only a true digital scope can provide. Like storage, high accuracy, pretrigger viewing, hard copy output, and programming. And since it's one

of HP's basic instruments the HP 54600 gives you all this performance at a very affordable price.

So if you like the feel of analog control, you'll like the way our new digital scope handles troubleshooting. To find out more call the Customer Information Centre on 008 033 821 or Melbourne 272 2555.



A Better Way.



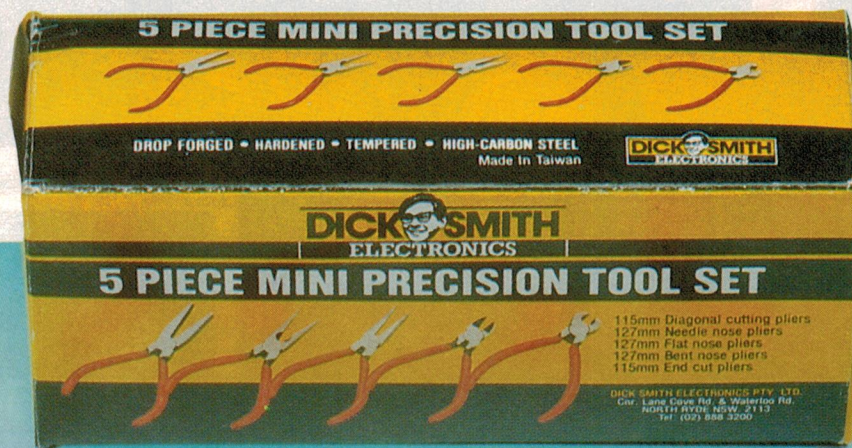
# THIS PRECISION PLIER SET IS YOURS FREE WHEN YOU SUBSCRIBE TO ELECTRONICS AUSTRALIA

Subscribing to **Electronics Australia with ETI** has always had its benefits, but right now we're offering a super bonus, that makes it even better than ever.

Everyone who takes out a subscription, renews or extends their existing subscription to **EA** will receive free, this **Dick Smith Electronics** precision tool set valued at **\$29.95**, consisting of

- 115mm Diagonal cutting pliers
- 127mm Needle nose pliers
- 127mm Flat nose pliers
- 127mm Bent nose pliers
- 115mm End at pliers

So subscribe or renew now for only \$47 (12 issues) to receive this great gift and save over 20% on the cover price.



**HURRY THIS GREAT OFFER ENDS 2ND OCTOBER, 1991**



## AUSTRALIA'S CHEAPEST DISK PRICES

ALL PRICES PER PKT/BOX OF TEN

### MEMOREX DISKS

1-9 Boxes		10+	1-9 Boxes		10+
3 1/2"DD	\$19.95	\$18.95	5 1/4"DD	\$14.95	\$12.95
3 1/2"HD	\$45.95	\$42.95	5 1/4"HD	\$23.95	\$22.95



### VERBATIM DATALIFE

1-9		10+
3 1/2"DD	\$28.50	\$27.95
3 1/2"HD	\$53.50	\$52.50
5 1/4"DD	\$22.95	\$21.95
5 1/4"HD	\$27.95	\$26.95



### VERBATIM VALUELIFE

1-9 Boxes		10+
3 1/2" DD	\$23.95	\$22.95
3 1/2" HD	\$39.95	\$37.95
5 1/4" DD	\$12.95	\$11.95
5 1/4" HD	\$19.95	\$18.95

### HARD DISK DRIVES TO SUIT EVERYONE!

#### 42 MEG HARD DISK FOR XT

28ms ACCESS WITH IDE/FDD CONTROLLER FAST STEPPER.....\$549

#### 42 MEG HARD DISK FOR AT

28 ms ACCESS WITH IDE/FDD CONTROLLER FAST STEPPER.....\$395

#### 43 MEG VOICE COIL HARD DISK

17ms ACCESS WITH IDE/FDD CONTROLLER VOICE COIL.....\$449 2 YEAR WARRANTY

#### 85 MEG HARD DISK FOR AT

18 ms ACCESS WITH IDE/FDD CONTROLLER VOICE COIL.....\$595 2 YEAR WARRANTY

#### 126 MEG HARD DISK FOR AT

16ms ACCESS WITH IDE/FDD CONTROLLER VOICE COIL.....\$895 2 YEAR WARRANTY

#### 200 MEG HARD DISK FOR AT

12ms ACCESS WITH IDE/FDD CONTROLLER VOICE COIL.....\$1,449 2 YEAR WARRANTY

All Hard Disk capacities are formatted. IDE/FDD drives are already low level formatted so you only have to "F DISK" to high level format them. Please note you need DOS 4.01 to format these to their maximum capacity as drive "C" or otherwise you will have to partition as "C", "D", "E", etc. if you have an earlier version of DOS

**DOS 5.0 NOW AVAILABLE. ONLY \$129.00**



### ROD IRVING ELECTRONICS

CITY: 48 A'BECKETT ST, MELBOURNE  
NORTHCOE: 425 HIGH ST, NORTHCOE  
SYDNEY: 74 PARRAMATTA RD, STANMORE  
MAIL ORDER: 56 RENVER RD, CLAYTON

PH: (03) 663 6151  
PH: (03) 489 8866  
PH: (02) 519 3134  
PH: (03) 543 7877

FAX: (03) 639 1641  
FAX: AS PHONE.  
FAX: (02) 519 3868  
FAX: (03) 543 2648

All sales tax exempt orders and wholesale inquiries to:  
RITRONICS WHOLESALE  
56 Renver Road, Clayton  
Phone: (03) 543 2166 (3 lines)  
Fax: (03) 543 2648

Errors and omissions excepted  
Prices and specifications subject to change  
IBM, PC, XT, AT are registered trademarks of International Business Machines. Apple is a registered trademark. Denotes registered trademarks of their respective owners.

3.5"DD from 79¢

FREE DELIVERY OVER \$100

### "NO BRAND"

BOXES OF 10 DISKS LIFETIME WARRANTY



	1-9	10+	50+	100+	500+
5 1/4"DS/DD	\$4.95	\$4.85	\$4.75	\$4.60	\$4.50
5 1/4"DS/HD	\$10.50	\$9.90	\$9.75	\$9.50	\$8.90
3 1/2"DS/DD	\$9.25	\$8.95	\$8.75	\$8.50	\$7.90
3 1/2"DS/HD	\$18.95	\$18.50	\$18.00	\$17.50	\$16.50

### RAINBOW DISKS

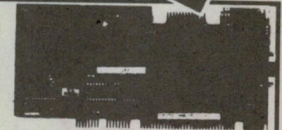
5 DIFFERENT COLOURS OR 1 SINGLE COLOUR!  
10 DS/DD  
COMES WITH A FREE PLASTIC DISK BOX!  
**ONLY \$8.95**  
10+.....\$7.95



### VGA GRAPHICS CARD (0 to 1 MEG)

This new VGA Graphics Adapter works with your IBM PC/XT, PC/AT or compatible system and high-resolution colour monitor to bring you sharp resolution, splendid colour and functions far beyond the VGA standard. Nothing surpasses the VGA Graphics Adapter when it comes to high resolution graphics! This card has the ability to produce 256 colours out of 256K in both 640 x 400 and 1024 x 768 resolutions. Other features of this card include: • Dip Switches • DB-15 connector. For analog monitors • DB-9 connector. For TTL monitors • Video BIOS: Basic Input/Output System • TVGA 8900Chip: VGA Graphics Chip • Edge connector: For IBMPC/XT, PC/AT and compatibles • Video DRAM: up to 1MB • Uses 44256-80 chips • Feature connector: For special applications

X18072 VGA CARD 16 BIT NO RAM (EXP TO 1M).....	\$199
X18073 VGA CARD 16 BIT 250K (EXP TO 1M).....	\$229
X18074 VGA CARD 16 BIT 512K (EXP TO 1M).....	\$269
X18076 VGA CARD 16 BIT (1 MEG).....	\$299



### SAVE UP TO AN INCREDIBLE \$900 ON MATH CO-PROCESSORS THIS MONTH!!!!

80287XL..replaces 80287-6 80287-8 80287-10.....	\$295
80387DX-33.....	\$595
80387SX-16.....	\$450
80387SX-20.....	\$495



### GENISCAN GS-4500

The best solution for desktop publishing with OCR software.

The GS-4500 is a hand held scanner that can transfer graphic images such as photographs, drawings, text, and clip art directly to your computer screen. It is capable of scanning up to 105mm in 2 different modes. Letter or photo. It also has a resolution control switch to select the amount of brightness to be used, and can also control the amount of colour shade. The scan width and contrast are software adjustable. The letter mode scans in black and white. This mode can be used for artwork and scanning text to a text file. The file can then be converted to word and text processor readable form through the use of the OCR System's ReadRight Optical Character Recognition software. The Photo mode is used to scan graphic material in 4 different shades of grey.

X19935.....\$299.00

WOW AN OCR SCANNER FOR \$299.00



### 3 1/2" DRIVE KIT. Y.E DATA 3.5" 1.44/720/360 DRIVE

- 5 1/4" Mounting bracket
- Power supply adapter
- Cable adapter
- Floppy disk controller card which controls 1.44/720/360 drives

Complete instructions to install a 3.5" in your existing computer. Enjoy the higher density & easy handling of 3.5" floppy diskettes! C11915.....\$295





MAIL ORDER  
HOTLINE  
008 33 5757

# RITRON QUALITY RITRON POWER

## RITRON

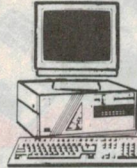
### 286-16



80286-12 CPU  
1 MEG RAM EXPANDABLE TO 4 MEG  
16Mhz LANDMARK SPEED TEST  
1.2M JAPANESE BRAND F.D.D  
42M HARD DISK DRIVE 28ms ACCESS  
101 EXTENDED "CLICK" KEYBOARD  
JAPANESE KEYBOARD SWITCHES  
MINI CASE & 200W POWER SUPPLY  
SUPA VGA COLOUR MONITOR (1024 x 768 res)  
SERIAL, PARALLEL, GAME PORT  
3 YEAR "AUSTRALIAN" PARTS & LABOUR WARRANTY  
256K VGA CARD. DOS 5.00 IBM\* COMPATIBLE  
SPREADSHEET, WORDPROCESSOR & DATABASE  
SOFTWARE INCLUDED.  
**ASSEMBLED & TESTED IN AUSTRALIA**  
**\$1,499** TAX INC.  
**\$1,350** TAX EX

## RITRON

### 286-21



80286-16 CPU  
1 MEG RAM EXPANDABLE TO 4 MEG  
21Mhz LANDMARK SPEED TEST  
1.2M JAPANESE BRAND F.D.D  
42M HARD DISK DRIVE 28ms ACCESS  
101 EXTENDED "CLICK" KEYBOARD  
JAPANESE KEYBOARD SWITCHES  
MINI CASE & 200W POWER SUPPLY  
SUPA VGA COLOUR MONITOR (1024 x 768 Res)  
2 SERIAL, PARALLEL, GAME PORTS  
3 YEAR "AUSTRALIAN" PARTS & LABOUR WARRANTY  
256K VGA CARD. DOS 5.00 IBM\* COMPATIBLE  
SPREADSHEET, WORDPROCESSOR & DATABASE  
SOFTWARE INCLUDED.  
**ASSEMBLED & TESTED IN AUSTRALIA**  
**\$1,549** TAX INC.  
**\$1,395** TAX EX.

## RITRON

### 386SX-21



80386SX-16 CPU  
42 MEG 28ms HARD DRIVE  
1.2 MEG 5 1/4" DISK DRIVE  
1MEG RAM ext to 4 MEG  
SUPA VGA COLOUR MONITOR (1024 x 768 Resolution)  
SERIAL, PARALLEL, JOYSTICK PORTS  
MINI CASE & 200W POWER SUPPLY  
101 KEYBOARD WITH DOS 5.00  
256K VGA CARD. IBM\* COMPATIBLE  
3 YEAR AUSTRALIA PARTS & LABOUR WARRANTY  
SPREADSHEET, WORDPROCESSOR & DATABASE  
SOFTWARE INCLUDED.  
**ASSEMBLED & TESTED IN AUSTRALIA.**  
**\$1,849** TAX INC.  
**\$1,695** TAX EX.

## RITRON

### 386SX-27



80386SX-20 CPU  
1 MEG RAM EXP TO 4 MEG  
27Mhz LANDMARK SPEED TEST  
1.2M JAPANESE F.D.D. 256K VGA CARD  
42M HARD DISK DRIVE, 28ms ACCESS  
101 EXTENDED "CLICK" KEYBOARD  
MINI CASE & 200W POWER SUPPLY  
SUPA VGA COLOUR MONITOR (1024 x 768 Resolution)  
SERIAL PARALLEL GAMES PORTS  
3 YEAR "AUSTRALIAN" PARTS & LABOUR WARRANTY  
DOS 5.00 IBM\* COMPATIBLE  
SPREADSHEET, WORDPROCESSOR & DATABASE  
SOFTWARE INCLUDED.  
\* SHAREWARE SOFTWARE  
**ASSEMBLED & TESTED IN AUSTRALIA.**  
**\$1,899** TAX INC.  
**\$1,710** TAX EX

## RITRON EXECUTIVE

### 386-57



80386-32 CPU 128K CACHE ON BOARD MEMORY  
1 MEG RAM EXP TO 16 MEG  
57Mhz LANDMARK SPEED TEST  
42 MEG HARD DISK 28ms ACCESS TIME  
1.2M JAPANESE BRAND F.D.D  
101 EXTENDED "CLICK" KEYBOARD  
SERIAL PARALLEL GAMES PORTS  
SUPA VGA COLOUR MONITOR (1024 x 768 Resolution)  
MINI CASE & 200W POWER SUPPLY  
256K VGA CARD (256 COLOURS)  
DOS 5.00 IBM\* COMPATIBLE  
3 YEAR "AUSTRALIAN" PARTS & LABOUR WARRANTY  
SPREADSHEET, WORDPROCESSOR & DATABASE  
SOFTWARE INCLUDED.  
\*SHAREWARE SOFTWARE  
**ASSEMBLED & TESTED IN AUSTRALIA.**  
**\$2,295** TAX INC.  
**\$2,065** TAX EX

## RITRON EXECUTIVE

### 386-57



80386-40 CPU 128K CACHE ON BOARD MEMORY  
1 MEG RAM EXP TO 16 MEG  
57Mhz LANDMARK SPEED TEST  
85 MEG HARD DISK 18ms ACCESS TIME  
1.2M JAPANESE BRAND F.D.D DOS 5.00  
101 EXTENDED "CLICK" KEYBOARD  
SERIAL, PARALLEL, GAMES PORTS 512K VGA CARD  
SUPA VGA COLOUR MONITOR (1024 x 768 Resolution)  
MINI CASE & 200W POWER SUPPLY  
3 YEAR "AUSTRALIAN" PARTS & LABOUR WARRANTY  
SPREADSHEET, WORDPROCESSOR & DATABASE  
SOFTWARE INCLUDED. \*SHAREWARE SOFTWARE  
**ASSEMBLED & TESTED IN AUSTRALIA.**  
**\$2,495** TAX INC. **WITH 200 MEG DRIVE**  
**\$2,250** TAX EX. **\$3,395** TAX INC.  
**\$2,895** TAX EX.

## RITRON EXECUTIVE

### 486-75



80486SX-20 CPU 64K CACHE ON BOARD MEMORY  
1 MEG RAM EXP TO 32 MEG  
75Mhz LANDMARK SPEED TEST  
43 MEG HARD DISK 18ms ACCESS TIME  
1.2M JAPANESE BRAND F.D.D DOS 5.00  
101 EXTENDED "CLICK" KEYBOARD  
SERIAL, PARALLEL, GAMES PORTS, 1MEG VGA CARD  
SUPA VGA COLOUR MONITOR (1024 x 768 Resolution)  
MINI CASE & 200W POWER SUPPLY  
3 YEAR "AUSTRALIAN" PARTS & LABOUR WARRANTY  
SPREADSHEET, WORDPROCESSOR & DATABASE  
SOFTWARE INCLUDED. \*SHAREWARE SOFTWARE  
**ASSEMBLED & TESTED IN AUSTRALIA.**  
**\$2,995** TAX INC. **WITH 200 MEG DRIVE**  
**\$2,795** TAX EX. **\$3,895** TAX INC.  
**\$3,695** TAX EX.

## RITRON EXECUTIVE

### 486-115



80486-25 CPU  
ON BOARD CACHE. 1 MEG OF RAM  
115Mhz LANDMARK SPEED TEST  
43 MEG HARD DISK 12ms ACCESS TIME  
1.2M JAPANESE BRAND F.D.D  
3.5" 1.44M JAPANESE BRAND F.D.D  
101 EXTENDED "CLICK" KEYBOARD  
SERIAL, PARALLEL, GAMES PORTS  
1 MEG VGA CARD DOS 5.0 IBM\* COMPATIBLE  
VGA COLOUR MONITOR (1024 x 768 Resolution)  
MINI CASE & 200W POWER SUPPLY  
3 YEAR "AUSTRALIAN" PARTS & LABOUR WARRANTY  
SPREADSHEET, WORDPROCESSOR & DATABASE SOFTWARE.  
**WITH 200 MEG DRIVE**  
**\$3,445** TAX INC. **\$4,395** TAX INC.  
**\$3,195** TAX EX. **\$4,095** TAX EX

## RITRON EXECUTIVE

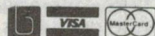
### 486-157



80486-33 CPU ON BOARD CACHE. 4 MEG OF RAM  
157Mhz LANDMARK SPEED TEST  
200 MEG HARD DISK 12ms ACCESS TIME  
1.2M JAPANESE BRAND F.D.D  
3.5" 1.44M JAPANESE BRAND F.D.D  
101 EXTENDED "CLICK" KEYBOARD  
SERIAL, PARALLEL, GAMES PORTS  
1 MEG VGA CARD DOS 5.0 IBM\* COMPATIBLE  
VGA COLOUR MONITOR (1024 x 768 Resolution)  
TOWER CASE & 220W POWER SUPPLY  
3 YEAR "AUSTRALIAN" PARTS & LABOUR WARRANTY  
SPREADSHEET, WORDPROCESSOR & DATABASE SOFTWARE.  
**ASSEMBLED & TESTED IN AUSTRALIA.**  
**IDEAL CAD MACHINE!**  
**\$4,695** TAX INC.  
**\$4,350** TAX EX.

## ROD IRVING ELECTRONICS Est. 1977.

MAIL ORDER HOTLINE: 008 33 57 57. (ORDERS ONLY) ENQUIRES: (03) 543 7877  
HEAD OFFICE: 56 RENVER RD, CLAYTON. PH: (03) 543 2166. FAX (03) 543 2648  
CITY 48 A'BECKETT ST. MELBOURNE. PH. 663 6351 / 639 1640. FAX: 639 1641.  
NORTHCOTE 425 HIGH ST. NORTHCOTE, PH. 489 8866. FAX: 489 8131.  
SYDNEY: 74 PARRAMATTA RD, STANMORE. PH: (02) 519 3134. FAX: (02) 519 3868  
ACN: 005 428 437



### Postage rates

\$1 - \$9.99.....\$3.00  
\$10 - \$24.99...\$3.50  
\$25 - \$49.99...\$4.50  
\$50 - \$99.99...\$6.00  
\$100 - \$199...\$7.00  
\$200 - \$500...FREE  
\$500 PLUS...FREE

These postage rates are basic postage only up to 5Kg. Road freight, bulky & fragile items will be charged at different rates

All sales tax exempt orders to : RITRONICS WHOLESALE  
56 Renver Rd, Clayton, Victoria.  
Ph: (03) 543 2166 Fax: (03) 543 2648  
**MAIL ORDER & CORRESPONDENCE**  
P.O BOX 620, CLAYTON, VICTORIA. 3168.

Errors & omissions excepted. Prices & specifications subject to change. \*IBM, PC, XT, AT, are registered trademarks of International Business Machines.



# ☆☆☆ GREAT RANGE! GREAT PRICE! ☆☆☆

# ROD IRVING ELECTRONICS

MAIL ORDER HOTLINE: 008 33 5757

## MONITOR MOVER ARM

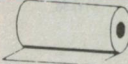


Position your monitor exactly where you want

- Maximise desk space!
- Solid steel structure
- Span 33cm
- Tray 30cm (tilting +/- 15)
- Desk clamp range 3cm -7.5cm
- Maximum load 50 kg

C21079.....\$199

## FAX ROLLS



	1-9	10+
C20092	\$9.95	\$9.50
Size: 210 x 11.5 x 30m		
C20094	\$9.95	\$9.50
Size: 210 x 25.4 x 50m		
C20096	\$19.95	\$17.95
Size: 210 x 25.4 x 100m		
C20098	\$9.95	\$9.50
Size: 216 x 25.4 x 30m		
C20100	\$11.95	\$11.50
Size: 216 x 24.4 x 50m		
C20102	\$9.95	\$9.50

## RIBBONS



**PRINTER RIBBONS TO SUIT:**

- CP80, SX80, DP80, BX100, BX100, MB100,

	1-9	10+
C22036	\$19.95	\$17.95
• MX80, FX80, RX80, FX800, MX70, MX80, LX800.		
C22031	\$16.95	\$15.25
• MX100, FX100, RX100, LQ1000		
C22002	\$19.95	\$17.95
• LX80		
C22003	\$12.95	\$11.95
• C10H 8510 - 1550		
C22051	\$13.95	\$12.50
NATIONAL PANASONIC KXM10 PRINTER RIBBON		
C22034	\$19.95	

## IBM PRINTER LEADS



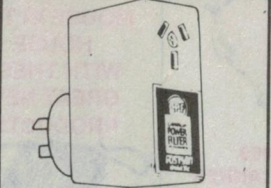
- SUITS IBM\* PC/XT, COMPATIBLES
- 25 PIN "D" PLUG (COMPUTER END) TO CENTRONICS 36 PIN PLUG.
- 1.8 meters
- P19029.....\$14.95
- 3 metres
- P19030.....\$19.95
- 10 metres
- P19034.....\$39.95

## CHECK OUT OUR HUGE RANGE OF PRINTERS ON SPECIAL!

Head	No. of col.	Draft	Speed	No. Fonts	Price
LX-400	9 pin	80	180cps	3	\$289
LQ-400	24 pin	80	180cps	3	\$489
LX-850	9 pin	80	180cps	3	\$395
LQ-850	24 pin	80	264cps	3	\$950
LQ-1050	24 pin	80	264cps	6	\$1050
LQ-550	24 pin	80	150cps	3	\$625
LQ-1010	24 pin	136	180cps	4	\$795
OKI 172	9 pin	80	180cps	3	\$275
OKI 380	24 pin	80	180cps	3	\$650
200-GX*	9 pin	80	213cps	5 colour	\$479
GSX 140*	24 pin	80	192cps	6 colour	\$779

LASER PRINTERS	
OL400 LASER PRINTER	4 PAGES / MIN 25 FONTS..... \$1499
OL800 LASER PRINTER	8 PAGES / MIN 36 FONTS..... \$2,495
OL840 POSTSCRIPT LASER PRINTER	8 PAGES / MIN 35 FONTS..... \$4,295



## CPF CONTINUOUS POWER FILTER SPIKE ARRESTOR

The Fortron CPF Filtered Electronic Spike Protector provides a protective electronic barrier for microcomputers, printers, telephone systems and modems electronic typewriters, audio and stereo systems and other sensitive electronic equipment.

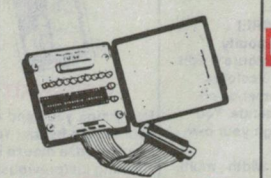
The CPF provides protection from dangerous electrical spikes that can cause anything from obvious damage (like immediate equipment failure) to less obvious harm that can drastically shorten a system's life.

CPF's superior circuitry design and semiconductor technology responds instantly to any potentially damaging over-voltage, ensuring safe trouble-free operation.

Additionally, CPF's filtering capability helps eliminate troublesome and annoying interference, general hash created by small motors, fluorescent lamps, and the like that threaten the performance and shorten equipment life of unprotected electronic components.

**SPECIFICATIONS:**  
 Electrical rating: 220-260 volts (AC) 50Hz 10 Amp  
 Spike/RFI Protection: 4 500 amps for 20m/second pulses  
 Maximum clamping voltage: 275V differential mode

Cat X10088 ..... \$69.95

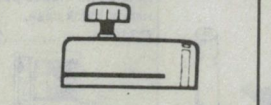


## RS232 BREAK OUT BOX

A simple way of monitoring RS232 interface lead activity. Interface powered, pocket size for circuit testing, monitoring and patching. 10 signal powered LED's and 2 spares. 24 switches enables you to break out circuits or reconfigure and patch any or all the 24 active positions.

**SPECIFICATIONS:**  
 Connectors: DB25 plug on 80mm ribbon cable and DB25 socket  
 Indicators: Tricolour LED's for TD, RD, RTS, CTS, DSR, CD, TC, RC, DTR, (E)TC  
 Jumper Wires: 20 tinned end pieces  
 Power: Interface power  
 Enclosure: Black, high impact plastic  
 Dimensions: 85 x 95 x 30mm

X15700 ..... \$99.95



## DISK NOTCHER

Converts 5 1/4" single sided floppy disks to double sided, by placing an appropriate notch in the floppy disk jacket.

C21070..... \$7.95

## COMPUTER CASES

**NEW TOWER CASE!**  
 Give your computer that professional look.

X11105.....\$199  
 Power supply to suit (220W)

X11102.....\$199

**Both for \$295**

**MINI TOWER CASE**  
 200 x 415 x 330mm with 200w power supply

X11100.....\$325

**RITRON EXECUTIVE CASE**  
 X11089  
 Includes power supply.....\$195

**TOP OF THE RANGE AT EXECUTIVE CASE**  
 For 386 & 486 systems  
 Includes power supply

X11101.....\$320

## POWER SUPPLIES

**POWER SUPPLY FOR IBM\*, PC/XT\*, & COMPATIBLES**  
 DC OUTPUT: +5/13A -5 0.5A  
 +12V /4.5 -12 V 0.5A

X11096.....\$139

**200W SWITCH MODE POWER SUPPLY FOR IBM\*, AT\* & COMPATIBLES**  
 DC OUTPUT: +5/16A -5.0.5A  
 +12V/4.5 -12V /5A -12.0.5A

X11097.....\$149

**UV EPROM ERASER**  
 It will erase up to 9 x 24 pin devices in complete safety, in about 40 minutes (less time for less chips)

- Chip drawer has conductive foam pad
- Mains powered
- High UV intensity at chip surface ensures EPROMs are thoroughly erased

**Without timer**  
 X14950.....\$99

**With built-in timer**  
 X14955.....\$169

## KEYBOARDS

**IBM\*, XT\*, TYPE 84 KEY KEYBOARD**

X12020.....\$109

**IBM COMPATIBLE EXTENDED KEYBOARD (101 KEYS)**

X12022.....\$99

**101 KEY TRACKBALL KEYBOARD**  
 Keyboard & mouse in one

X12030.....\$199.95

**KEYBOARD STORAGE DRAWER**

C21083.....\$84.95

**MINI VACUUM CLEANER**

C21087.....\$14.95

**KEYBOARD COVERS**  
 C21089 84 KEY.....\$4.50  
 C21088 101 KEY.....\$5.95

## DISK BOXES

100 x 5 1/4" ECLIPSE	
C16042	\$11.95
40 x 3 1/2" ECLIPSE	
C16040	\$8.99
120 x 3 1/2" LOCKABLE	
C16039	\$21.95
100 x 5 1/4" LOCKABLE	
C16020	\$13.95
50 x 5 1/4" LOCKABLE	
C16025	\$11.95
120 x 5 1/4" LOCKABLE	
C16028	\$19.95

## PRINTER SWITCHES

RS232-2 WAY	\$39
RS232-4 WAY	\$69
RS232-X OVER	\$29
RS232-2 WAY AUTO	\$69
CENTRONICS 2 WAY	\$49
CENTRONICS X OVER	\$69
CENTRONICS 2way auto	\$79
CENTRONICS 4 WAY	\$69

## PRINTER STANDS

ENCLOSED PRINTER STAND	
C21055	\$39.00
DELUX PRINTER STAND	
C21058	\$89.00
WIRE PRINTER STAND	
C21054	\$24.95
C21056	\$34.95

## MICE

**WITTY MOUSE**  
 EVER POPULAR, LOW BUDGET!  
 FREE MOUSE DRIVER & POP UP MENU SOFTWARE!

X19950.....\$49.95

**QUICK MOUSE**  
 Microsoft Compatible  
 FREE mouse house & mouse mat Plus FREE pop up menu software

X19955.....\$69.95

**SUPER BUS MOUSE 2**  
 DESIGNED TO FIT THE PALM OF YOUR HAND!  
 GREAT FOR SAVING A SERIAL PORT!  
 2 FREE TELEPAINT DISKS!

X19951.....\$119

**TOUCH MOUSE**  
 "A Stationary Breakthrough"  
 Use your finger instead of your mouse. Great for saving space. Ideal for laptops

X19960 . SAVE \$60 ... \$69

**MICROSOFT MOUSE**  
 The top of the range!  
 Supports hundreds of applications.  
 FREE MICROSOFT PAINTBRUSH SOFTWARE  
 BRINGS YOUR COMPUTER TO LIFE.

X19958.....\$159

## IBM\* CARDS

XT HD CONTROLLER	\$129
AT HD CONTROLLER	\$149
RS232/SERIAL CLOCK	\$49
MONO COLOUR CARD	\$76
MULTI I/O	\$99
VOICE MAIL	\$199
PRINTER CARD	\$29
EGA CARD	\$149
DIAGNOSTIC	\$795
TTL/PRINTER	\$89
RAM 2M AT EXT/EXP.	\$225
8M AT EXT/EXP.	\$325
FAX CARD	\$595
4 PORT SERIAL	\$129
2 WAY FDD CONT (360K)	\$39
RS232/SERIAL CARD	\$39
GAMES CARD	\$29
AT S/P/G 2 S/P/G	\$49
4 WAY FDD CONT. (360-1.44M)	\$129
2 WAY FDD CONT. (360-1.44M)	\$80
CLOCK CARD	\$39
SMART DRIVE ADAPTER IDE/FDC	\$49
SMART DRIVE ADAPTER IDE I/O FDC	\$89
VGA CARD 16 BIT NO RAM	\$199
VGA CARD 16 BIT 250K	\$229
VGA CARD 16 BIT 512K	\$269
VGA CARD 16 BIT (1 MEG)	\$299
VGA CARD 8 BIT 256K	\$139

PLEASE QUOTE THIS AD FOR THESE PRICES Errors & Omissions excepted



## FIVE CHANNEL SPECIAL EFFECTS MIXER

A console or freestanding mixer with 8 inbuilt special effects. Designed for both DJ and studio use. The following inputs are provided: 2 x turntables - 4 x line inputs - 2 x low impedance microphones. Eight special effects: siren, telephone, machine gun, bombing, shooting, ambulance, thunder, laser. Other features: bass & treble control, Headphone Cue monitoring, CH1 to CH2 cross fader, mic talkover switch, master volume level control and left & right LED VU meters.



A12013.....\$299.00

## VIDEOCAM / VCR AUDIO MIXER

A professional audio mixer designed for the serious home video movie maker through to the home video camera user. Background music and effects can be faded in and out to existing video tape sound tracks. Ideal for weddings, family, sporting and other recordings.

- Input for a video camera, VCR, CD, tape, tuner, auxiliary and turntable.
- Mic panpots - Mic faders - Turntable faders - VU meters - Mono/stereo switches - CD/Tape fader & more.



A12004.....\$169.00

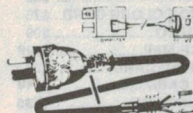


## SURGE/SPIKE SAFETY PLUG

Stand alone  
3 pin plug

Plugs into socket adjacent to the equipment that you want to protect. All outlets on a power board can be protected by inserting the Triangle Surge/Spike Plug into any of the free outlets. Green safety neon glows when power is on. Approval No. V88029 Total energy rating: 225 Joules (10/1000us) Protection level: 275V Nominal, 475V Peak. Response Time: Better than 10 nanoseconds. Automatic reset.

X10060.....\$25.00



## SURGE/SPIKE SAFETY CORD SET

3 pin MAINS plug to  
3 pin IEC plug

Plugs directly into your equipment and replaces your existing cord-set. Clear moulded plugs at both ends with green safety neons that glow when power is on. Approval Numbers: V88029, V900297, V85006. Total Energy Rating: 225 Joules (10/1000us) Protection level: 275V Nominal, 475V Peak. Response Time: Better than 10 nanoseconds. Automatic reset.

X10080.....\$39.50



## THE BUTTON SPIKE PROTECTOR

Surges and spikes are caused not only by lightning strikes and load switching but also by other equipment being switched on and off such as fluorescent lights, electric motors, fridge freezers, air conditioners, etc.

For effective protection such spikes must be stopped before they reach your equipment. Simply plug The Button into an outlet and it will protect all equipment plugged into adjacent outlets on the same branch circuit. The Button employs unique metal oxide varistor technology and will dissipate 150 joules of electrical energy (nearly twice that of comparable surge arresters).

**SPECIFICATIONS:**  
Voltage: 240V Nominal  
Total Energy Rating: 150 joules  
Response Time: 10ns  
Protection Level: 350V peak

X10061.....\$42.95



## MAGIC STAGE

A working bench for your Mouse.

- High quality ABS plastic and anti-static rubberised top
- Stationary holder
- Includes pull-out shelf for Mouse
- Dimensions: 280 x 260 x 25mm
- Fits over keyboard

C21080 On special was \$24.95 Now.....\$14.95



## SURGE BUSTER

6 PROTECTED POWER OUTLETS Ideal for protecting personal computers, video equipment, colour TVs, amplifiers, tuners, graphic equalisers, CD players etc

**SPECIFICATIONS:**  
• Electrical rating: 240V AC, 50Hz, 10A  
• 3 x Metal Oxide Varistors (MOV)  
• Maximum clamping Voltage: each MOV: 710 volts at 50 amps  
• Response time: Less than 25 Nanoseconds.

X10086.....\$69.95

## QuickShot joysticks

Quick Shot offers the most complete selection of video game controllers in the market. Models are available to suit all the most popular video game machines and just about any playing style.



QS-123 WARRIOR 5 IBM COMPATIBLE (15 PIN)  
C14208.....\$59.95  
APPLE & IBM COMPATIBLE (9 & 15 PIN CONNECTORS)  
C14211.....\$62.95



QS113PC IBM PACK INCLUDING JOYSTICK ADAPTOR CARD (15 PIN)  
C14216.....\$59.95



QS-123 PC IBM PACK INCLUDING JOYSTICK ADAPTOR CARD (15 PIN)  
C14217.....\$74.95



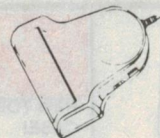
QS-129/F SPACEAGE CONTROL NINTENDO & MULTISYSTEM COMPATIBLE (7 OR 9 PIN)  
C14214.....\$39.95



QS-130/F DELUX DIGITAL NINTENDO & MULTISYSTEM COMPATIBLE (7 & 9 PIN)  
C14209.....\$39.95



QS-131 NEW BASIC ATARI / COMMODORE -9 PIN  
C14218.....\$19.95



## HS-3000 HANDY SCANNER

INCLUDES FREE SOFTWARE! PC PAINT BRUSH & IMAGE TOOL

- Wide 4.13" (105mm) Scan width
- 100/200/300/400 switchable DPI resolution
- Four encoded modes: B/W and three half tone patterns.
- Thirty-two shades of grey.
- Built in scanner view window for accurate scanner placement.

X19945.....\$269



## GENI SCAN COLOUR SCANNER

The GS-C105 Colour scanner scans any colour or black & white image into your IBM PC AT, PS-2 or compatible system without loss of hue.

**FREE SOFTWARE!**  
Draw shapes, modify objects alter colours & edit a palette of 256 colours using the commands on your pop-up menu. You can even design your own font type size.

- 105mm scan width, multi scan up to 300mm
- 64 shade levels

X19930.....\$895



## DUST COVER

Keep your computer and accessories free of dust and grime while not in use

- XT\* Cover Set C21066.....\$14.95
- AT\* Cover Set C21068.....\$16.95



## HEAD CLEANER DISKS

It only takes a minute amount of dust, dirt or magnetic oxide particles on your drive heads to cause problems: errors, downtime or an expensive service call. Regular use of a head cleaner will keep your drive free of trouble causing dirt and help keep your system up and running. These disk cleaners are simple to use, and include cleaning solution and instructions.

- 3 1/2" C12560.....\$6.95
- 5 1/4" C12555.....\$4.95

## HAVE THE CUTEST MOUSE IN THE HOUSE WITH THESE GREAT NEW PRODUCTS!



## MOUSE COVER

Be the first in your office to have a mouse that every one will want use. This cute little mouse cover puts a bit of fun and colour onto your desk while keeping your mouse free of dust!

C21069.....\$7.95



## MOUSE CLEANING KIT

Keep dust and dirt from damaging your mouse with this handy mouse cleaning kit. This special rounded tool will find its way into all the hard to get at places. The kit also comes with cleaning fluid and 5 soft cloths to keep your mouse spotless!

C21071.....\$9.95



## MOUSE KIT

Everything you need to keep your mouse happy! You get a mouse pad, a mouse holder, a cleaning kit (previously described) and a cute little mouse cover.

C21072.....\$16.95



## MOUSE GIFT SET

Here it is! The ultimate mouse kit. You get the cute little mouse pad, a mouse holder, a cleaning kit with the rounded tool & 5 cloths, the mouse house and mouse pad all in a handy black case.

C21074.....\$19.95



## COMPUTER CLEANING KIT

To gain optimum performance and prevent damage to valuable disks, this cleaning kit has all you need to keep your computer in top notch performance. Anti-static cleaning pads, cleaning swabs, cleaning solution, 5 1/4" & 3 1/2" cleaning diskettes.

C21077.....\$19.95

## VIDEO ACCESSORIES



## VHS VIDEO HEAD CLEANERS

New "wet dry wet" system cleans and dries all parts which come into contact with the magnetic tape. Fluid is applied directly on to cloth cleaning tape prior to use. It uses clean tape for each cleaning operation. Low drag for use in sensitive mechanisms.

A11456.....\$16.95



## VIDEO / AUDIO TRANSMITTER

A small compact unit that allows transmission of video & audio signals (RF) to any TV set or VCR within range of 30 metres. Ideal for watching videos in the bedroom or kitchen without having to move the entire VCR or having long extension leads running through the house. Can also be used as a transmitter for a video camera. With power on/off switch audio and video leads and supplied with an AC adaptor.

A16150 Normally, \$95.95 NOW ONLY.....\$84.95

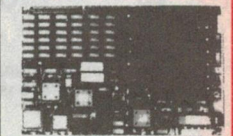
## AUDIO ACCESSORIES



COMPACT DISC CASES Packet of 3 standard replacement compact disk cases.

A10030.....\$6.99

## CHECK OUT THIS MONTHS MOTHERBOARD SPECIALS



286-12/16.....\$179  
286-16/21.....\$199  
386SX-20/27.....\$495  
386-33 WITH 128K CACHE...\$995



MAIL ORDER HOTLINE  
008 335757  
(TOLL FREE)  
LOCAL: 543 7877



# ROD IRVING ELECTRONICS - No.1 FOR COMPONENTS

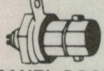
# ROD IRVING ELECTRONICS

MAIL ORDER HOTLINE: 008 33 5757

## BNC PLUGS AND SOCKETS



**BNC MALE PLUG**  
1-9 10-99 100+  
P10514 \$2.50 \$2.25 \$1.50



**BNC PANEL SOCKET**  
1-9 10+ 100+  
P10516 \$2.50 \$2.25 \$1.50



**BNC CRIMP PLUG**  
1-9 10-99 100+  
P10530 \$3.95 \$3.75 \$3.00



**BNC SOLDERLESS TWIST ON PLUG**  
1-9 10-99 100+  
P10531 \$3.50 \$3.25 \$3.00

## CANNON PLUGS AND SOCKETS



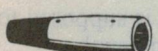
**CANNON TYPE 3 PIN CHASSIS MALE**  
1-9 10-99 100+  
P10962 \$3.50 \$2.95 \$2.50



**CANNON TYPE 3 PIN LINE FEMALE**  
1-9 10-99 100+  
P10964 \$3.95 \$3.50 \$2.90

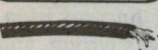


**CANNON TYPE 3 PIN CHASSIS FEMALE**  
1-9 10-99 100+  
P10966 \$4.95 \$4.50 \$3.50



**CANNON TYPE 3 PIN LINE MALE**  
1-9 10-99 100+  
P10960 \$4.50 \$3.50 \$2.50

## COMPUTER CABLES



• Six conductor shielded computer interface cable.  
W12670 • C1C6 6 con.  
1-9M 10M+ 100M+  
\$1.30M \$1.10M \$1.00M  
W12672 • C1C9 9 con.  
1-9M 10M+ 100M+  
\$1.60M \$1.50M \$1.20M  
W12674 • C1C12 12 con.  
1-9M 10M+ 100M+  
\$2.50M \$2.20M \$1.90M  
W12676 • C1C16 16 con.  
1-9M 10M+ 100M+  
\$3.50M \$3.20M \$2.50M  
W12678 • C1C25 25 con.  
1-9M 10M+ 100M+  
\$3.90M \$3.40M \$3.00M

## LEDS



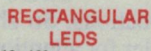
**QUALITY 3mm LEDS**  
1-9 10-99 100+  
Z10140(R) \$0.15 \$0.12 \$0.10  
Z10141(G) \$0.20 \$0.18 \$0.15  
Z10143(Y) \$0.20 \$0.18 \$0.15  
Z10145(O) \$0.20 \$0.18 \$0.15



**QUALITY 5mm LEDS**  
Z10150(R) \$0.15 \$0.12 \$0.10  
Z10151(G) \$0.25 \$0.20 \$0.18  
Z10152(Y) \$0.25 \$0.20 \$0.18



**FLASHING LEDS**  
RED 5mm 1-9 10+  
Z10159 \$1.10 \$1.00



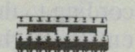
**RECTANGULAR LEDS**  
1-9 10+ 100+  
RED 20¢ 15¢ 12¢  
GREEN 20¢ 15¢ 12¢  
YELLOW 20¢ 15¢ 12¢  
ORANGE 20¢ 15¢ 12¢

## IC SOCKETS



**LOW PROFILE IC SOCKETS**  
Save a small fortune on these "Direct Import" low profile IC sockets! PCB mounting solder tall. All tin plated phosphor bronze or beryllium and dual wipe for reliability.

1-9 10+ 100+  
P10550 8 pin 15¢ 12¢ 10¢  
P10560 14pin 20¢ 18¢ 15¢  
P10565 16pin 20¢ 18¢ 16¢  
P10567 18pin 30¢ 25¢ 22¢  
P10568 20pin 35¢ 30¢ 25¢  
P10569 22pin 35¢ 30¢ 26¢  
P10570 24pin 35¢ 30¢ 26¢  
P10572 28pin 45¢ 35¢ 30¢  
P10575 40pin 45¢ 40¢ 35¢



**WIRE WRAP IC SOCKETS**  
These quality 3 level wire wrap sockets are tin plated phosphor bronze.

P10579 8pin \$1.50 \$1.40  
P10580 14pin \$1.85 \$1.70  
P10585 16pin \$1.95 \$1.80  
P10587 18pin \$1.95 \$1.80  
P10590 20pin \$2.95 \$2.75  
P10592 22pin \$2.95 \$2.70  
P10594 24pin \$3.95 \$3.50  
P10596 28pin \$3.95 \$3.50  
P10598 40pin \$4.95 \$4.50



**ELECTRET MIC INSERTS**  
With pins for easy board insertion. C10170  
1-9 10-99 100+  
\$1.20 \$1.00 \$0.90

## ULTRASONIC TRANSDUCERS

Designed to transmit at 40kHz (L 19990) & receive at 40kHz (L19991) without to 20V I/P on the transmitter. These units can't be heard so are ideal for TV remote controls, water level detectors, burglar alarms, motion detectors & information carriers as they can be either pulsed or used in a continuous wave mode.  
Transmitter 1-9 10+  
L19990.....\$2.95 \$1.95  
Receiver  
L19991.....\$2.95 \$1.95

## IDC PLUGS & SOCKETS

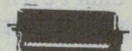
WOW! FROM \$1.00



**D TYPE IDC PLUGS**  
1-9 10+ 100+  
• DE9P 9pin plug  
P12166 \$1.50 \$1.20 \$1.00  
• DA15P 15pin plug  
P12168 \$1.50 \$1.20 \$1.00  
• DB25P 25 pin plug  
P12170 \$4.50 \$3.95 \$3.50



**D TYPE IDC SOCKETS**  
1-9 10+ 100+  
• DE9S 9 pin socket  
P12167 \$1.50 \$1.20 \$1.00  
• DA15S 15 pin socket  
P12169 \$1.50 \$1.20 \$1.00  
• DB25S 15 pin socket  
P12171 \$4.50 \$3.95 \$3.50



**IDC CENTRONICS 36 WAY PLUG & SOCKET**  
1-9 10+ 100+  
• Plug P12200 \$3.95 \$3.00 \$2.95  
• Socket P12201 \$3.95 \$3.00 \$2.95



**VOLTAGE REGULATORS BARGAINS**  
Description 1-9 10+  
7805UC \$0.50 \$0.45  
7812UC \$0.50 \$0.45  
7815UC \$0.50 \$0.45  
7905UC \$0.60 \$0.55  
7912UC \$0.60 \$0.55  
7915UC \$0.60 \$0.55  
78L05 \$0.40 \$0.30  
78L12 \$0.40 \$0.30  
LM324 \$1.00 \$0.90  
555 \$0.40 \$0.38  
741 \$0.50 \$0.45

## WE HAVE EXPANDED OUR COMPUTER LEAD RANGE!

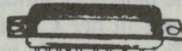


PLEASE RING TO CHECK AS NEW LINES ARRIVE DAILY.  
NULL MODEM CABLE M/F.....\$19.95  
NULL MODEM CABLE M/M.....\$19.95  
MONITOR EXTENSION LEAD  
15 PIN HIGH DENSITY \$29.95  
DB9 M/M 5.0 METRE.....\$29.95  
DB9 M/F 5.0 METRE.....\$29.95

## AT SERIAL CABLES

DB25M/DB9F 2.0 METRE.....\$19.95  
DB25F/DB9M 2.0 METRE.....\$19.95  
DB25M/M 10.0 METRE.....\$39.95  
DB25M/F 10.0 METRE.....\$39.95  
DB25F/F 10.0 METRE.....\$39.95

## DB25 CONNECTORS



**DB25 CONNECTOR SPECIALS**  
1-9 10+  
P10880 DE9P \$1.00 \$0.80  
P10885 DE9S \$1.00 \$0.70  
P10891 DA15S \$1.00 \$0.70  
P10892 DA15C \$1.00 \$0.90  
P10895 DA15S \$1.00 \$0.80  
P10892 DB25C \$1.00 \$0.80  
P10904 DB25P \$1.00 \$0.80  
P10905 DB25S \$1.00 \$0.80

## ECONOMY TRANSFORMER



1-9 10+  
2155 240V 6-15V 1A  
M12155.....\$8.95 \$7.95  
2156 240V 6-15V A2  
M12156.....\$13.95 \$12.95  
2851 240V 12-6V CT 250mA  
M12851.....\$4.95 \$4.50  
6672 240V 15 30vc 1A tapped  
M16672.....\$12.95 \$11.95

## FANS



**12V DC FANS**  
80 x 80 x 25.4mm  
12V DC. 1.7 Watt 0.14 Amp  
T12469.....\$16.95  
10+ fans, only \$16.95  
**FANS**  
Quality fans for use in power amps, computer hotspot cooling etc. Anywhere you need plenty of air.  
240V 4 5/8" T12461..\$16.95  
115V 4 5/8" T12463..\$16.95  
240V 3 1/2" T12465..\$16.95  
115V 3 1/2" T12467..\$16.95  
10+ fans (mixed) Only \$14.95.

## NEW SWITCH BOXES

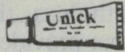
**9 PIN D SWITCH BOXES**  
2 WAY.....\$59.95  
4 WAY.....\$69.95  
**MONITOR & KEYBOARD SWITCH BOXES**  
only \$69.50

## NICADS



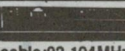
Save a fortune on expensive throw away batteries with these quality Nicads and Rechargers!  
Size AA 450mAH  
1-9 10+ 100+  
\$2.95 \$2.75 \$2.50  
Size C 12 A H  
\$9.95 \$9.50 \$8.95  
Size D 12 A H  
\$9.95 \$9.50 \$8.95

## HEATSINK COMPOUND



Heatsink compound is applied to the base and mounting studs of transistors & diodes. It maintains a positive heatsink seal that improves heat transfer from the device to the heatsink, thus increasing overall efficiency.  
H11800 ..10g...\$2.00  
H11810.150g..\$29.95

## WIRELESS MICROPHONE



Tunable:92-104MHz  
Freq response: 50-15kHz  
Range: over 300 feet in open field.  
A10450.....\$24.95

## PANEL METERS



We have a great range of panel meters at great prices!  
Q10500 MU45 0-1mA \$9.95  
Q10502 MU45 50/50uA \$9.95  
Q10504 MU45 0-100uA \$9.95  
Q10533 MU52E 0-5uA \$12.95  
Q10538 MU65 0-50uA \$12.95  
Q10540 MU65 0-1mA \$12.95  
Q10550 MU650-100uA\$12.95  
Q10560 MU650-20V \$12.95

## MOSFET SPECIALS



1-9 10+  
2SJ49 \$9.50 \$8.00  
2SJ56 \$10.00 \$9.50  
2SK134 \$8.50 \$8.00  
2SK176 \$9.50 \$8.90

## TOGGLE SWITCHES



1-9 10+  
S11010 S.P.D.T \$1.20 \$1.10  
S11020 D.P.D.T \$1.30 \$1.20

## ROD IRVING ELECTRONICS

MELBOURNE: 48 A'Beckett St. Ph: (03) 663 6151.  
Computer sales: Ph 639 1640  
NORTHCOTE: 425 High St. Ph: (03) 489 8866  
SYDNEY: 74 Paramatta Rd. Stanmore. N.S.W.  
Ph: (02) 519 3134

MAIL ORDER: 56 Renver Rd, Clayton Vic, 3168.  
Ph: (03) 543 7877

Mail Order Hotline: Ph: 008 33 5757.  
All sales tax exempt orders & wholesale inquires to: RITRONICS WHOLESAL, 56 Renver Rd, Clayton, 3168.

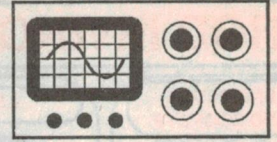
Ph. (03) 543 2166. (3 lines) Fax: (03) 543 2648.  
MAIL ORDER & CORRESPONDENCE  
P.O. BOX 620, CLAYTON, VICTORIA, 3168.

Errors & omissions excepted. Prices & specifications subject to change. IBM®, PC®, XT®, AT®, are registered trademarks of International Business Machines.

\*Apple is a trademark of Apple Corporation.



# THE SERVICEMAN



## Problems with manuals, customers and models that haven't changed in millenia!

The servicing jobs that I mostly write about in this column are basically the 'dogs' — the ones that present a lot more difficulty, or take a lot more time to solve, than most of the day to day work. Quite often they're also the jobs that working service techs like myself lose money on, as a result, although I can at least recoup something by writing about them! Of course every so often, a month passes when I don't have any 'dogs' to write about...

Contrary to what you might imagine from reading these pages, the life of a service technician is not made up of endless satisfaction at completing complex jobs. Ninety percent of the work is utterly boring; the most exciting event being the 'ding' as the cash drawer opens, to accept another payment from a satisfied customer. The complicated jobs that reach these pages comprise less than one job in five hundred or more 'routine' fixes, in my experience.

Nevertheless, there are occasional events that provide a little change from routine. While not important enough to make a story for these pages, these small items have still warranted the recording of details in the hope that one day they could be told to an interested audience.

It so happens that this month I don't have any 'BIG' stories on hand, so I have gathered up a number of these

'little' ones for your entertainment. I hope you enjoy them.

The first one is not quite a servicing story, but it just might have been.

### Manuals, manuals...

The lady was almost in tears when she brought in her CD player. She told me that it was only six weeks old, yet it had been back for service four times and still it wouldn't work properly.

I found that a bit hard to believe, since I know the people concerned and I am sure that they would not return a warranty job while there was any chance of a fault being still present. When she had calmed down a bit, I got the full details of her problem.

The player was a Pye model CDR3000. It's a bottom of the range model, selling for under \$200, but the lady said she had chosen it because of its 'No Frills' presentation. She didn't even want a remote control, but got one just the same.

For the first couple of weeks the machine gave her no trouble and she may never have realised she had a problem, if she had not wanted to play just three tracks from the centre of a disc.

It was easy enough to select the first of the three tracks, then let the machine play the next two in sequence. But it didn't switch off there, and kept on playing to the end of the disc.

It was here that she realised just what the 'Program Play' function was for. It wasn't a feature she had looked for, but it was on the machine so she decided to use it.

She tried following the instructions in the user manual, but the machine insisted in starting to play immediately, and from the first track. There was no way that she could find to make it follow

instructions. So she took it back to the retailer for attention. As I mentioned earlier, it went backwards and forwards four times and the lady could get no satisfaction from anyone.

I have looked after her television and video recorder for years, so she came to me as much for advice as for anything else. I set the machine up on the bench and went through the procedures laid down in the manual. The instructions are to:

- (1) press STOP.
- (2) press PLAY/PAUSE.
- (3) press SKIP > to select required track, press PROGRAM.
- (4) press SKIP < to select required track, press PROGRAM,
- (5) etc. for all required tracks.

Pressing CALL will display the set program for confirmation, and pressing PROGRAM PLAY will start playing the programmed sequence.

At least, that is what it is supposed to do, according to the user manual.

I went through it all twice, just to make sure, but there was no doubt about it. The machine would not follow instructions and it began playing from track one as soon as the programming sequence was started.

I was about to agree with the lady that she had a fault, when I had an idea. What if the user manual was wrong, and a quite different sequence of controls was needed? It wouldn't be the first time that a user manual was incorrect.

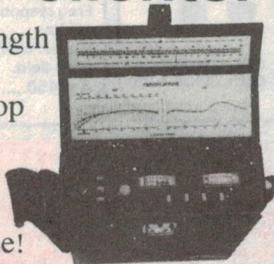
So I sat there for a few minutes, considering the purpose of the various buttons on the front panel and their relation to the instructions. Then I got to work.

It seemed to me that the second instruction, to press PLAY/PAUSE, looked out of place.

There was nothing ahead of that to tell

## Delight your clients.

Sadelta  
TC400  
field strength  
meter.  
Deliver top  
reception  
first  
time,  
every time!



Ask your trade stockist for a copy of  
Jim Rowe's review, from E. A. June '90.

Peter C. Lacey Services Pty. Ltd. ACN006893438  
74 Fulton Rd. Mount Eliza 3930 Tel:03 787 2077

READER INFO NO. 7





the machine that a programming sequence was to follow, so it did what it was told and began to play, from track 1!

I wondered what would happen if we omitted that second instruction. And that's all there was to it. Without that **PRESS PLAY** instruction, the machine operated exactly as it should do.

There was only one other puzzling matter. In the programming sequence, the use of the **SKIP** buttons to select track numbers is shown as alternately < and >. There seems to be no reason for this. The user can skip up or down continuously, in either direction, without affecting the program selection in any way.

The user manual is written in reasonably good English, but it was printed in Korea, so that might explain the reason for such a mistake.

But it does point up the absurdity of returning products to the retailer when service is required. That unit might have gone back and forth for ever, with the salesman never thinking to bring the owner and the serviceman together for a proper discussion.

And finally, although the old maxim goes 'When in doubt, read the manual!', it doesn't help at all if the manual keeps taking you round in wrong circles. The best way of coping with modern technology is to ask for help from someone who's already 'been there, done that'!

### Customers, customers...

There are times when I feel really 'put upon' by some of my customers. They demand immediate satisfaction and never hesitate to tell me how I overcharge them (in their opinion).

Yet there are other times when I feel just the reverse. My normal commercial

approach to some customers leaves me feeling about as big as sixpence and miserable with it.

Like today. The phone rang and a gentlemanly voice asked if I would call at his home to fix his video recorder.

I told him all about the cost of house calls, the cost of running a vehicle, the loss of time on the road, etc., etc. All of it justified, of course, and all chargeable.

I explained that nowadays I only did housecalls for large television sets which could not reasonably be brought in to the workshop. All other items should be brought in, to save me time and the customer money.

It was this last comment that made the difference, in this case, and the caller said he would make some arrangement to get the video into the workshop.

I forgot about the matter for an hour or so, but later in the day a car pulled up outside and the driver asked if I would be good enough to get the video out of the boot.

It was then that I realised that the driver had no legs! And there was simply no way he could carry the video out to the car, put it in the boot, and then bring it into my workshop. As I said earlier, I felt as big as sixpence. To make matters even more embarrassing for me, there were two elderly ladies in the car with him. I learned that they were his wife and sister-in-law, and *they* had carried the video out to the car between them, and had loaded it into the boot. And I've got the cheek to complain when I have difficulty lifting a TV onto the bench, or holding a screwdriver in an awkward position!

I'm only a few years off being an elderly citizen myself, so I had better look to how I approach these folk. They might ask for more than the usual consideration, but as often as not they deserve it!

### Troubles, troubles...

All the same with certain other customers it's easy to get into trouble — even when you do the right thing by them, you can still get abused.

This set arrived while I was out, so I didn't see who brought it in. I guess it might have been Mrs Customer, but it doesn't really matter.

It was a Philips portable colour TV, a model CT2020 if I recall correctly. The complaint was that it had a black line down the picture which had all the appearances of a ghost.

It wasn't a ghost though. It was quite easy to find a dried out electrolytic capacitor, and replacing that produced a first class picture.

I made a slight adjustment to the gray scale, replaced the cabinet back, then wiped the cabinet over with a damp cloth to remove years of grime from cigarette smoke.

Finally, I folded the telescopic antennas and pressed them back into their recesses in the cabinet. I have a horror of breaking antennas while waiting for customers to call for their sets. It usually happens that the ones I break are the ones that are most difficult or expensive to replace!

The set was only on the shelf for a day or two when Mr Customer called to pick it up. I took it down off the shelf and pushed it toward him.

He took on the appearance of the proverbial Stunned Mullet. "That's not my TV!" he exclaimed. I checked the name on the docket and told him that it was indeed his set.

"No it ain't!" he shouted. "Mine was different to that!" I asked him how his was different, but he couldn't explain. It was just 'different', that's all.

A moment later Mrs Customer came in, to see what the delay was. He shouted at her that I was trying to pass off someone else's telly. She demanded to know how he knew.

"Well", he said, "it was a different colour to start with. And ours had a different antenna!"

I found it easy to explain the colour — the set was now back to its original hue. I told them about the brown stain from cigarette smoke and was even able to find a small bit of cabinet that I had missed with my cleaning cloth.

The antenna was not so easy to explain because I had certainly not altered this in any way. He solved the problem





## THE SERVICEMAN

when he mentioned that his set "...had rabbit ears, and this one doesn't have any." Then the penny dropped.

I pulled the ears up from their recessed position, then deployed them in much the same way that they had been when the set came in.

"Yes", he said, "that's what my set was like, but that is still not mine. The ears on mine wouldn't fold up like that!"

That was when Mrs Customer took over. She gave him a thump on the ear that made his eyes rattle. "Stupid Prat!" she shouted. "How would YOU know what the set was like! You never touch the thing, and you even get the kids to change channels for you!"

She paid the bill and took the set while he walked out, thoroughly cowed, but still muttering about it not being his set. I don't think I'll see him again.

### Still more customers...

Here's another story about how one can get into trouble without doing anything.

A few weeks ago a customer brought in a Thorn 9007, with a problem so minor that I can't remember now just what it was. When he picked up the set, he mentioned that his ancient video recorder had finally packed it in, and he was going to buy a new one. He asked my advice as to what brand he should get. I always steer clear of answering this kind of question. No matter what brand I suggest, it will always turn out to be the wrong one for that customer.

There is just one bit of advice I give to all such enquiries. I suggest that they refuse to take any machine that cannot be operated without the remote control. Some people are impressed with the bland, no buttons, facade of the 'all remote' machines. But what happens when the remote control batteries go flat?

Or worse still, suppose you lose or tread on the remote control. Without a complete set of buttons on the machine itself, it's just so much worthless junk. (And for some machines you can no longer get replacement remote controls, either!)

Now back to the story. The customer took his TV and my advice, and I heard nothing for two or three weeks. Then he was back, demanding to know what I had done to his TV. When pressed for details, he complained that he had his new video, but couldn't get it to work with the Thorn. And more importantly,

he now couldn't watch SBS on the UHF band.

I asked what sort of video he had bought, and he told me that he had selected a Philips. He didn't know the model number, but he was able to tell me that it had a UHF output and that the Thorn would no longer work on UHF.

I knew with certainty that I had not done anything to the tuner when the set had been in the workshop, so all I could suggest was that he bring it back so I could have a look at the problem.

The moment I took the cover off the back of the set, I knew what the trouble was. I quizzed the owner about his old video, and about how he watched SBS. It turned out that the old machine had a VHF output, and he had really been watching SBS on VHF through the recorder, even though the Thorn was supposed to have a UHF tuner.

He wouldn't admit to his mistake, even when I was able to show him that another set in the workshop was displaying good SBS signals, while his had no response from one end of the dial to the other. It took a lot of explaining, but I eventually got through to him.

When these Thorns, and the equivalent AWA models, were delivered, they were fitted for 'all VHF' reception. The UHF tuner was fitted in the control head, but was not connected.

The set was designed so that the UHF B+ was switched on when the VHF selector was in the Channel 5 position. However, as delivered, the tuner was fitted with a normal Channel 5 biscuit so that the set would tune that channel in any area where it was operating.

So that the set could tune UHF, if and when that service became available, a special UHF biscuit was provided and was attached to the inside of the cabinet, along with a leaflet advising the serviceman how to go about fitting it to the tuner. The original VHF biscuit had to be removed and replaced by the UHF biscuit.

In this case, the UHF biscuit was still tightly sealed in its plastic bag and neatly stapled in place. The set had never been converted, and the owner had never watched SBS directly off air — only via his VCR.

Oddly though, he insisted that he had always had trouble trying to line up the set's rotary UHF tuner on channel 28, because there are only a few numbers on the dial, and 28 is not among them. Little did he realise that he could have turned the TV's UHF knob forever, without making the slightest difference to the setting of the video tuner!

That was one job that ended satisfac-

torily. I fitted the UHF biscuit and checked that SBS could now be tuned on the TV. The customer was finally convinced that he was mistaken, but for a time it was touch and go. He was going to do all kinds of nasty things to me before I calmed him down.

It just goes to show that you can get into all kinds of trouble, without doing anything!

### Digital hi-jinks

I was among a group of electronics technicians who recently had a conducted tour of the local television station. The Chief Engineer was quite proud of his equipment, and took no end of trouble to show us everything and to answer every question.

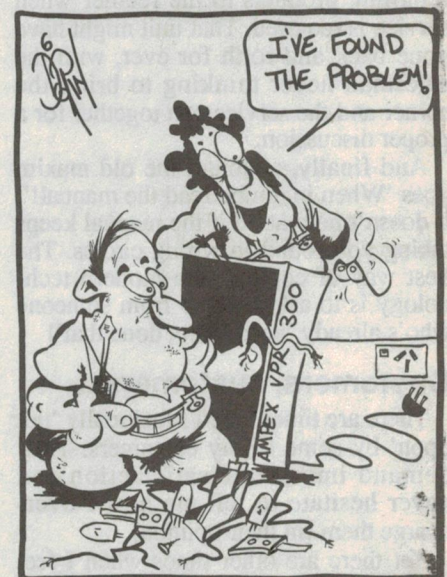
The last thing we looked at, and the highlight of the tour, was their new Ampex VPR300 digital video cassette recorder.

It seems that cassette convenience has now invaded the professional field, and apparently open reel machines are no longer being produced for the broadcast market.

This particular machine is mechanically amazing in the way it can accept different size cassettes, automatically changing its geometry according to the cassette being offered.

Naturally, we quizzed the Chief Engineer about servicing this very sophisticated machine. He acknowledged that it was expected to be a headache when things start to go wrong.

For the time being, servicing will be to board level only. It may get down to component level later, but that remains to be seen. In the meantime, the machine has a comprehensive self-diagnostic sys-





## Fault of the Month

### Sharp VCR model VC386

**SYMPTOM:** Tape was running fast, as though the machine was in speed search mode. The picture was reasonably stable, but showed three or four noise bars. The audio was not muted, and sounded like Donald Duck.

**CURE:** Plug NB (left-hand plug at rear of deck) was not pushed in fully. This plug carries all of the capstan drive and servo information, and with the plug misplaced one vital piece of information was not being referred to the capstan control circuits.

*This information is supplied by courtesy of the Tasmanian Branch of The Electronics Technicians' Institute of Australia (TETIA). Contributions should be sent to J. Lawler, 16 Adina Street, Geilston Bay, Tasmania 7015.*

tem that reduces down time to an absolute minimum.

There was one aspect of this machine that the visiting technicians found to be close to miraculous — its error correcting capability. It's common knowledge that most digital equipment, such as CD players, have a built-in error correction facility. It's less well known just how effective these facilities are, because we never know how many errors the system has had to deal with.

The new Ampex VPR300 professional VCR has an extremely effective error correction system — just how effective was graphically demonstrated by our guide. The new machine has a four head drum spinning at 6000rpm — four times as fast as the drum in a domestic VCR. The output from each head is brought out of the drum on separate miniature coax cables, and enters the signal processing section via miniature coax plugs.

With the machine replaying a demonstration tape made in the studios earlier that day, our guide removed one of the four head leads. The picture on the high definition monitor didn't change. The error corrector was obviously easily able to cope with the loss of 25% of the signal information. He then removed a second head from the system. Still the picture didn't change, although it was now suffering from a 50% loss of data.

Finally, removal of a third head lead did upset the picture, although the distortions appeared only in narrow bands across parts of the picture. Quite obviously, the error correction circuits in this amazing machine are able to cope with the loss of something more than 50% of the video information on the tape.

The problem is, for those of us who will have to service this kind of equip-

ment, how do you tell that there is something wrong with such a machine, which can so clearly compensate for quite dramatic faults?

As in this demonstration, two of the video heads could be worn out or broken, or their respective pre-amps could be unserviceable and no one would ever know! Or at least, that's what you'd expect.

In fact, the self-diagnosis system mentioned earlier would tell the maintenance technician that there was something wrong. But that's the only thing that would warn him. The picture on screen gives absolutely no sign of the breakdown.

Some top-of-the-line domestic VCRs now feature digital signal processing, and as time passes digital techniques will appear in more and more models. If the error correction circuits in those domestic models is anything like that in the new Ampex VPR300, then service techs will have headaches the likes of which they have never suffered before.

## More on manuals

And to end this month's column, here's an anecdote about a different kind of servicing.

I had to see my Doctor recently, because of trouble with one of my feet. He began by treating me for gout, but when the normal treatment for that complaint didn't work, he tried another so called 'cure'. But that didn't work either.

This went on for several weeks, and I was starting to get a bit annoyed. I made a comment to the effect that I was beginning to know how my customers feel when I take a long time to complete their repairs.

This prompted him to try a different tack, along the lines that I might have suffered an injury rather than an illness. But as he was a bit out of touch with the anatomy of the foot, he felt that he had better refer to his 'service manual'.

This turned out to be a large, profusely illustrated book, bound in leather and gold stamped on the cover and spine. I commented that it was a very different publication to the service manuals I used and that it looked to be very old.

At that, he admitted that he had a big advantage over me, because the models he worked on hadn't been changed for thousands of years! In fact, his anatomy text book was printed in 1850 something and was still quite up to date.

I'd like to find a service manual for an 1852 model video recorder. That really would be something to see!

Cheers for now. I'll be with you again next month. ■

## HIFI:

### An Introduction

All you need to know about hifi — past, present and future, now available in our new book.

Just \$4.95 from our local newsagent or write to:

The Book Shop  
Federal Publishing Co  
PO Box 199,  
Alexandria, NSW 2015

## NOTES AND ERRATA

Fig.1 in 'Experimenting with Electronics - project 2' (Flashing LEDs, EA September 1991) has the connections between the transistor bases and capacitors reversed.

B1 should connect to C2 and B2 to C1 (not B1 to C1 and B2 to C2 as shown). The correct pattern is shown in this month's project 3 where the circuit is re-used. The error is only on the strip-board version.

### SPEECH PROCESSOR FOR TRANSCEIVERS (September 1991):

Some constructors may wish to disable the 'over' tone feature via a front panel switch. If this is the case, simply wire a SPOT switch across the oscillator (IC2d) capacitor C13 — when the contacts are closed the oscillator will not run, and the 'over' tone is not transmitted.

### IMPROVED SERIAL I/O INTERFACE FOR PCs (July 1991):

The correct type number for the UART used is AY-3-1015D. This was shown incorrectly in the schematic diagram on page 61, the overlay diagram on page 62 and in the parts list on page 64. ■

## At Last! The Missing Link in Audio Service



The Audio Interface links all your test equipment with the units being serviced — from Walkmans to whopper amps. Power measurement (3 inputs) 800 watts per ch. Inputs/outputs duplicated on rear panel.

No more temporary hook-ups. Just one lead in, one lead out. Flick a switch, turn a knob, it's there! Saves frustration, time, and money. An investment in productivity at \$1495

Kingsley Electronics (03) 583 4020.  
17 Blackburn Drive, Cheltenham, 3192.

READER INFO NO. 8



# S-VGA, VGA/EGA fax pics for Listening Post II

There's been a tremendous response to Tom Moffat's improved low cost 'Listening Post' hardware/software package, designed to convert a PC into a terminal for receiving radiifax, RTTY and Morse. But some people still weren't happy — they wanted even *better* resolution for fax images, to take advantage of their EGA, VGA and S-VGA cards. This took a little longer, but Tom's done it...

When we reviewed the new Listening Post II back in the January issue, we were most impressed. Considering its low cost and apparent simplicity, it gave surprisingly good results and was very easy to drive. Obviously a lot of *EA* readers liked the idea too, because Tom tells us he's sold over 400 of the kits, and received many calls from delighted users.

In January the design only offered modest 'CGA' resolution, which Tom thought would be enough for most users. But even then, there were a few customers who weren't happy — they had 'Hercules' or 'HGA' graphics adaptors, and since the radiifax images were only in monochrome anyway, they

wanted to be able to run the LPII setup on their machine.

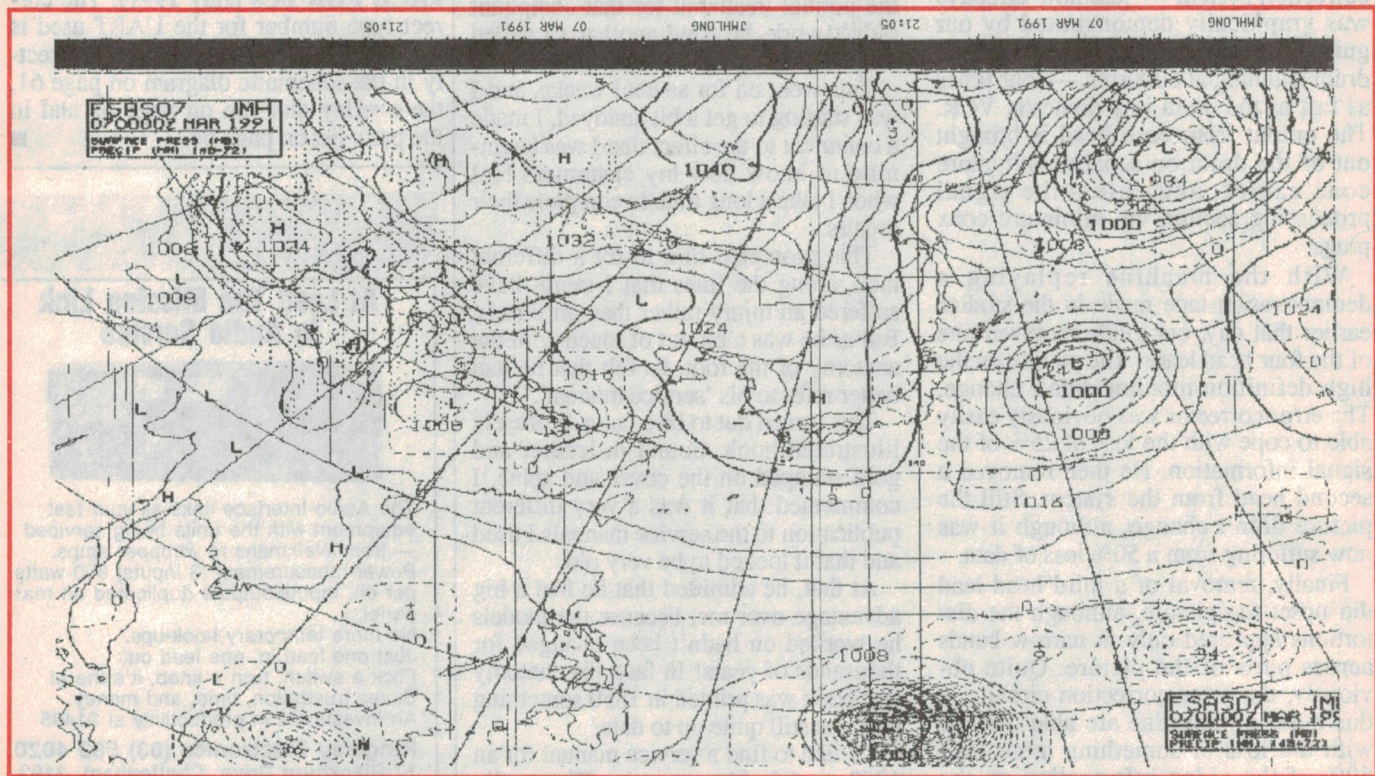
This posed a bit of a problem, because HGA cards use rather different scanning rates to CGA. Still, Tom found a way to adapt the LPII system fairly cheaply, by changing the crystal in the reference oscillator and making a couple of other minor mods. Thus we were able to announce in the April issue that he was able to provide an HGA version of the kit, and also an HGA upgrade. The new version not only ran on HGA boards, but provided somewhat higher resolution than the original.

But there were *still* a few unhappy would-be users of the LPII. If he could produce a higher-resolution HGA ver-

sion, what about a similar one to give higher-res images with EGA and VGA cards? Not an unreasonable request, of course, as there are now quite a lot of these cards around.

So Tom sat down to work out a version to run on the more advanced colour cards, and a couple of months ago he achieved success. In fact not only did he produce an EGA/VGA version of the kit, but a 'Super-VGA' version as well! That should provide a version for just about *everybody*, surely...

Actually because of the family relationship between the scanning rates for CGA, EGA and VGA, Tom has now been able to rationalise the kit into just three versions: one for CGA/EGA/VGA,



An example of the kind of printout that can be achieved using the new VGA version of Tom Moffat's Listening Post II software, as printed out on an Epson compatible — and then reduced to 50% to fit on our page. The file concerned is a 'long' image from the Japanese weather fax station JMH.



one for HGA and the third for Super-VGA. The combined CGA/EGA/VGA kit comes with a single crystal for the decoder board, but three sets of alternative software on the floppy disk to suit the three different display cards/modes. The other two versions each have a single set of software (and different crystals).

To summarise, then, there's now a choice of five different fax display formats: 640 x 200 (CGA), 640 x 350 (EGA), 720 x 348 (HGA), 640 x 480 (VGA) and 800 x 600 (S-VGA). And each one comes with a matching pair of printer drivers, to suit either Itoh or Epson printers and give printed images of the same resolution.

We haven't seen the S-VGA version as yet, but Tom very kindly sent us an upgrade kit for the CGA/EGA/VGA version — a floppy disk with the new software, and a replacement crystal (5242.88MHz) for the decoder board. After swapping over the crystals we fired everything up and tried it out, with both the EGA and VGA software in turn.

The results are even more impressive than before, particularly with the VGA software — and with a matching VGA and monitor, of course!

The screen pictures are particularly clean and sharp, while the printed im-

ages have much better resolution than before (see sample). We like the way that Tom has modified the SHOW program to make it scroll down a long fax image, too. With the Itoh print driver you can apparently have it print out long images in a single continuous operation as well, although we only have access to Epson-compatible dot matrix printers — and (Murphy's Law) the Epson driver doesn't offer this feature. Still, it's fairly easy to have it print out a long file in screen-size blocks, and tape them together.

On the whole, we found the new CGA/EGA/VGA version a big improvement over the original, and it makes LPII even more attractive than ever. 'On yer, Tom! Perhaps we could see how the S-VGA version works sometime too — that should be *really* impressive.

All three improved versions of the LPII kit apparently sell for \$63 each with the software on a 5.25" disk, or \$66 each with a 3.5" disk. Upgrades to any of the new versions sell for \$39 each, with a post/packing charge of \$7 for all versions and upgrades.

As before the only way you can get the Listening Post II is by mail order from High Tech Tasmania, 39 Piling Drive, Fern Tree, Tasmania 7054. (J.R.)

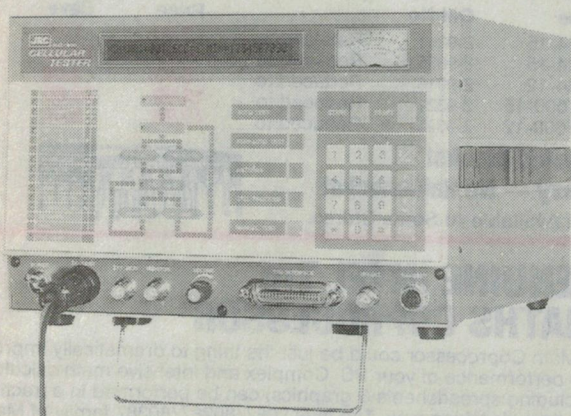
## CORRECTION

Following the publication in our September 1991 issue of a review of the Icom IC-24 handheld transceiver, Icom Australia has requested that we clarify the following points:

1. Although the article heading refers to the IC-24AT, which is the Australian version of this transceiver, the tested unit was in fact a modified IC-24. This is the domestic Japanese version.
2. Andrews Communications is not an authorised Icom Australia dealer, and products sold by that firm do not carry any warranty from Icom Australia. Icom Australia does not condone modifications and can give no guarantee for units that have been modified, when they are repaired.
3. The IC-24AT does in fact have 15kHz tuning steps. It also has 50kHz steps, in addition to those stated in the review.
4. The IC-W2 is again a domestic Japanese transceiver. The correct Australian version is the ICW2A. The IC-W2 cannot be modified on 2m to cover the Australian frequency range, nor to function in duplex mode.
5. Contrary to an impression that may have been given by the review, domestic Japanese radios are generally not suitable for Australian use. This is often also the case with models marketed in the US, Europe and South-East Asia. All new Icom models released in 1991 cannot be modified for correct operation in Australia, and this will shortly also apply to existing models. Intending buyers should therefore be warned.

# JRC CELLULAR TESTER NJZ-900A

JRC Japan Radio Co., Ltd.



## A New Powerful Tester for Field Service of Mobile Telephones.

### MAJOR TESTING FACILITIES

- (1) AUTO TEST  
Comprehensive, fully automatic testing of RF and Audio parameters giving both GO/NO-GO judgement and full results.
- (2) SEMI-AUTO TEST  
Continuous testing of a specific mode for trouble shooting.
- (3) ANTENNA  
Troubleshooting of an antenna and cable.
- (4) CALL PROCESS  
Full call process simulation and testing, including speech mode.
- (5) MANUAL TEST  
Provides access to signal generator, frequency counter, power meter etc for general purpose testing.

### FUNCTIONS

- Fully automatic testing and simple operation • Go/no-go judgement • 32-character LCD for monitoring test data, desired test parameters and message errors • Call process testing between mobile radio and cell site • Registration • Paging • Origination • Handoff • Release • Speech testing • General purpose tester capability in the MANUAL TEST mode; • RF power tester • Frequency counter • Deviation meter • RF signal generator • SINAD meter • Distortion meter • Audio level meter • VSWR meter • DC volt meter • IEEE-IB interface • Portable design • DC operation (13.8V) • Optional printer (IEEE-IB)

ASSOCIATED  
CALIBRATION  
LABORATORIES

Level 5, 499 St. Kilda Road, Melbourne 3004  
Tel: (03) 820 3044 Fax: (03) 820 3720

ACLEAO03



Every PC User's Guide To... **Faster, More Efficient Computing!**



# THE ONE MINUTE MEMORY MANAGER

This one's a must for every computer user! The One Minute Memory Manager is the most comprehensive guide to exploiting the memory potential on every PC and compatible computer. It's straight-forward, easy to follow and explains why memory is important, how and when to install more, and how to wring the most out of your computers existing memory.

You'll learn how to manage your computer's memory for greater speed, efficiency and the ability to run programs simultaneously. What's more, there are many helpful tips, advice and techniques demonstrating how to conserve memory when working with popular software programs such as Lotus 1-2-3, WordPerfect, NetWare, dBase... and much more!

Cat B-6097

**\$39<sup>95</sup>**

**Get the most from your PC!**

## 2Mb MEMORY UPGRADE

Get the most out of your computer system with these extra value memory upgrades. Just the thing for Windows applications, multitasking, etc. These 1Mb x 9-80ns SIMMS Memory Module Packs come with 2 x 1Mb boards. They're easy to fit and can have your PC working to greater efficiency in no time at all.

Cat X-1022

**Exceptional Value! \$199**

## FOR EXPERIMENTERS

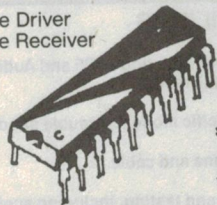
### Description

2732A 4K x 8 EPROM  
27C64 8K x 8 EPROM  
8250-B Serial Port IC  
Max 232 RS232 Tx/Rx IC  
AY-3-1015D UART  
DS1488/RS232C Quad Line Driver  
DS1489/RS232C Quad Line Receiver  
NEC V20-8 CPU

### Cat No.

Z-9209 **15.95**  
Z-9350 **7.95**  
Z-9221 **19.95**  
Z-5369 **12.95**  
Z-9115 **19.95**  
Z-5370 **1.95**  
Z-5371 **1.95**  
Z-9110 **29.95**

**Value Plus!**



### Sensational Savings

## D/RAM MEMORY CLEARANCE — Up To 60% OFF!

Hurry in, or you'll miss out on these fantastic savings on D/RAMS! This is a genuine Clearance Sale and stocks are strictly limited... so if you're after memory upgrades, don't stand there thinking about it for too long.... or they'll all be gone.

Type	Cat No.		Price	Save
4164-15	Z-9311	Reduced to	<b>2.95</b>	<b>1.00</b>
4464-15	Z-9335	Reduced to	<b>4.95</b>	<b>10.00</b>
4464-12	Z-9316	Reduced to	<b>5.95</b>	<b>4.00</b>
511000-15	Z-9321	Reduced to	<b>18.95</b>	<b>36.05</b>
511000-12	Z-9322	Reduced to	<b>19.95</b>	<b>5.00</b>

### Limited Stocks!

**Sorry — No Rainchecks!**

Not Available At Some Stores.



## GENUINE INTEL Tm MATHS COPROCESSOR

A Math Coprocessor could be just the thing to dramatically improve the performance of your PC. Complex and intensive math calculations (including spreadsheets & graphics) can be performed in a fraction of the time it's taking now. The Intel 8087/80287/80387 family of Math Coprocessors work with hundreds of PC software packages and they are quick and easy to install. We carry a comprehensive range including the 386SX series. Before you buy anywhere else... check out our competitive prices!

Available On Order  
Through Your Nearest Store.



# DICK SMITH ELECTRONICS

### MAJOR DICK SMITH ELECTRONICS AUTHORISED STOCKISTS:

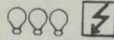
**NSW:** ARMIDALE: New England Electronics 711655 BALLINA: Ballina Electronics 867022 BEGA: OZTECH Electronics 923933 BOWRAL: F.R.H. Electrical 611000 BROKEN HILL: Hobbies & Electronics 884098 COOTAMUNDRA: Cootamundra Music & Lite 422561 COFFS HARBOUR: Coffs Harbour Electronics 525884 DENILIQUIN: Deni Electronics 813672 DUBBO: Chris's Hi Fi 828711 FORSTER: Forster Village Electronics 545006 GRAFTON: Repairs & Spares 421911 GRIFFITH: Miatronics 624534 INVERELL: Inverell Electronics 221821 KEMPSEY: P&L Leonard 631134 LEETON: Leeton Audiotronic 532800 LIGHTNING RIDGE: Cycle & Sound 290579 LITHGOW: Douroy Photographics 513173 LISMORE: Decro Electronic Services 214137 MOREE: Moree Electronics 522091 MUDGEE: Headware 723895 NARRABRI: Namoi Computer Service 922274 NELSON BAY: Nelson Bay Elect & Hobbies 813685 NOWRA: Nowra Electronics 210722 PARKES: Strad Music Ctr 823366 PORT MACQUARIE: Hastings Computer Service 834574 RICHMOND: Silicon Crafts 784101 TAREE: Brads Electronics 526603 WAGGA WAGGA: Phillips Electronics 216558 WELLINGTON: Wellington Service 452325 WINDOR: Silicon Crafts 776722 YASS: Warrington Electrical 261116 YOUNG: Keith Donges Electronics 821279 **VIC:** BAIRNSDALE: LH & LM Crawford 525677 COLAC: Colac Electronics 312847 MILDURA: Pullman Auto Pro 232682 SHEPPARTON: Andrew Guyatt Electronics 219497 SWAN HILL: Nyah District TV Service 329303 TRARALGON: Traralgon Electronics 741699 WARRAGUL: Roylaine 234255 WARRNAMBOOL: Korot St Elec Services 627417 **QLD:** AYR: Delta Electrix 831566 BUNDABERG: Bob Elkin Electronics 521785 CALOUNDRA: Electro-mart 918533 DYSART: Dysart Videotronics 582107 INGHAM: Masons Electronics 763188 INNISFAIR: Innisfail Hi-Fi 612014 MACKAY: Stevens Electronics 511723 MARYBOROUGH: Keller Electronics 214559 NAMBOUR: Nambour Electronics Shop 411604 PIALBA: Keller Electronics 283749 STANTHORPE Granite Belt Communications 813333 **TAS:** BURNIE: Electronic City 314760 DEVONPORT: Al Electronics 248322 **SA:** MT GAMBIER: Hutchesson's Communication Ctr 250400 PORT LINCOLN: Basshams TV & Comp World 822788 WHYALLA: Eyre Electronics 454764 **WA:** ALBANY: Micro Electronics 412077 BUNBURY: Micro Electronics 216222 GERALDTON: Batavia Lighting & Electrical 211278 KALGOORLIE: Today's Electronics 215212 KARRATHA: Daves Ocitronic 854836 MANDRAH: Micro Electronics 5812206 PORT HEDLAND: Ivan Tomek the Elect 732551



# KITS GUARANTEED QUALITY



## 30V VARIABLE POWER SUPPLY



A one amp, fully metered, power supply that's ideal for technicians, designers or hobbyists. It's adjustable up to 30 volts 1 amp with full overload protection and features a current limit LED. It's a full form kit & comes with a sturdy case, all components, PCB & front panel label.

Cat K-3475 ETI 11/82

Was \$99

Now Only \$79<sup>95</sup>

Until Sold Out!



## Cost Effective! BARGAIN BENCHTOP POWER SUPPLY



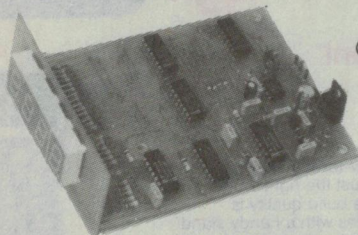
A versatile benchtop power supply that takes a practical approach to what's really required... and comes up with a money saving solution. Features include 2.5 to 18V variable output voltage, switchable current limiting (30mA & 1.2A), switchable voltage and current metering..... and it's all in a compact package. Full form kit is supplied with all components, case and pre-punched silk screened front panel.

Cat K-3202

EA 8/91



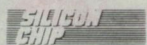
Only \$89<sup>95</sup>



## Suitable for 4, 6 & 8 Cylinder Cars! DIGITAL TACHOMETER

Watching the rev count on your car is a sure way to maximize efficiency and engine life. This low cost digital tachometer is certainly the way to go. It's relatively easy to build and it's designed to work with all ignition systems and with 4, 6, & 8 cylinder motors. Short form kit comes with LED display, all components and PCB.

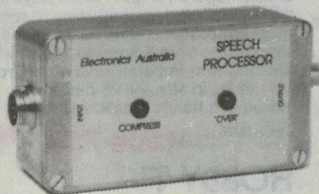
Cat K-3241



8/91



\$39<sup>95</sup>



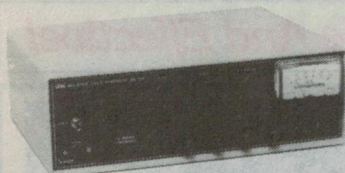
## Increase Your 'Talk Power' SPEECH PROCESSOR FOR TRANSCEIVERS



The very effective and successful method for controlling the dynamic range of speech through your transceiver. This simple device fits between the microphone and transceiver acting as a form of compressor so your speech level at the other end is as clear as possible. As a bonus, it automatically generates a 'beep' each time the PTT button is released. Comes as a full form kit with all components, PCB, die-case box and front panel label.

Cat K-6002

EA 9/91 \$39<sup>95</sup>



## It's Back! TV FIELD STRENGTH METER



By popular demand! Technicians, antenna installers, anyone who deals with FM/TV antenna installations will find this kit invaluable. This Field Strength Meter is the easy way to solve antenna position problems. It's battery operated (with charging circuit) or it can be powered by an external DC source (9 - 14V). You can even use it to convert a video monitor into a TV set. Full form kit comes with all components, PCB, case and pre-punched, silk screened front panel. Battery not included.

Cat K-6329

EA 8/88 \$199

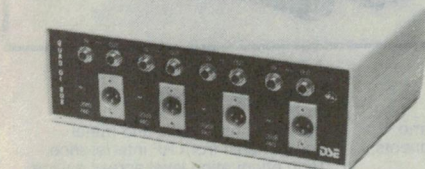
## Added Insulation for Extra Safety!

## FAN SPEED CONTROLLER

Warmer weather is fast approaching, so while you're thinking about dusting off the old fan you might like to make it more effective by building this Fan Speed Controller. It's easy to build and comes as a full form kit with PCB, all components, plastic case with pre-punched & silk screened front panel, plug and socket and a plastic pot so there's maximum insulation for added safety.

Cat K-3086

EA 7/91 \$39<sup>95</sup>



## QUAD 'DI' BOX



At last, a practical solution to the problems confronting stage and studio performers needing to connect several devices to a mixing box! This mains powered (requires M-9527 plug pack) Quad 'DI' box kit has significant advantages over battery powered versions and will replace up to four separate direct injection (DI) boxes... at a fraction of the cost. It's easy to build and comes with all components, PCB, case and silk screened & pre-punched front and pre-punched rear panels.

Cat K-5012

EA 6/91 \$79<sup>95</sup>



Mains — Kits marked with this symbol involve mains power wiring. Take extreme care when working with this equipment.

Degree Of Simplicity

Simple

Intermediate

Detailed

# DICK SMITH ELECTRONICS





# TOOLS & SERVICE AIDS

To make your job... a little easier!

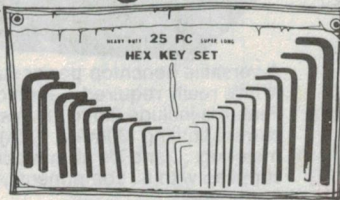
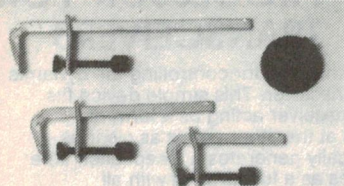


## HOBBY 'G' CLAMP SET

Three handy 'G' clamps that are perfect for most hobby work, model making, etc. All fit the 30mm (diam.) magnetic base supplied. Sizes include 40mm x 35mm, 30mm x 30mm & 20mm x 25mm.

Cat T-4755

**\$5<sup>95</sup>**



## 25 PIECE ALLEN KEY SET

This set is a must for any toolbox. It contains a superb range of Allen Keys in both metric and imperial sizes to suit most applications. Short-arm Metric key sizes range from 1.5mm to 10mm while the long-arm Imperial keys range from 1/16" to 3/8" in size. All 25 pieces are stored in a handy plastic wallet.

Cat T-5085

**Value Plus! \$9<sup>95</sup>**

## HOBBY 'F' CLAMP SET

Just like a spare set of hands for the workbench or toolbox. Three sizes: 20 x 120mm, 20 x 80mm & 20 x 40mm. All three clamps fit to the 38mm magnetic base included in pack.

Cat T-4750

**\$5<sup>95</sup>**

## Bargain Priced! ECONOMY PENCIL BLOWTORCH

It's incredibly convenient and ideal for heatsink work, silver solder, gold, silver, brazing, glass work, etc. The Butane Pencil Blowtorch fits easily in the pocket (it's not much bigger than a pen) and it's powered by butane gas (the same as they use in cigarette lighters, etc). A great idea for site-work and it's super value as well!

Cat T-1380

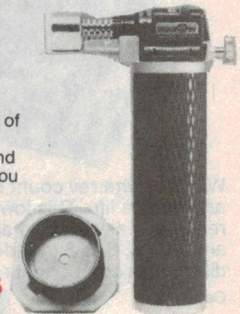
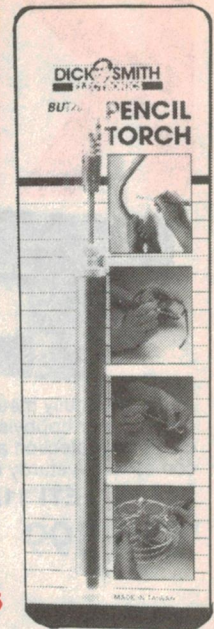
**\$15<sup>95</sup>**

## Electronic Ignition! BLOW-TORCH WITH STAND

It's new! This high power blow-torch has a fully adjustable flame so you get just the right amount of heat... where you want it. The build quality is exceptionally high and it comes with a handy stand which allows you to keep both hands free while you get on with the job.

Cat T-1390

**Only \$49<sup>95</sup>**



## ELECTROLUBE

## SERVICE AIDS Safe And Effective!

### PCB CLEANER

To remove contamination from PCBs before soldering and remove flux residue afterwards. Handy also as a degreaser. 500g spray.

Cat N-1105

**\$19<sup>95</sup>**

**Special Introductory Offer!**

### ELECTRONIC CLEANING SOLVENT

Now's the time to stock up on cleaning solvent with this great introductory offer! For this month only you can pick up a huge 400ml can of cleaning solvent at a price that's too good to pass up. This fast acting solvent is suitable for cleaning live components, leaves no residue and is non-corrosive.

200ml Spray. Cat N-1100

**\$11.95**

**Introductory Special!**

### AIR DUSTER

The ideal way to clean inaccessible or delicate parts... with high pressure gas. Includes pressure control valve. 400ml spray.

Cat N-1150

**\$27<sup>95</sup>**

### PERMAGARD

A penetrating lubricant which displaces moisture. Use it to protect tools and components from corrosion, free seized parts and minimize wear. 200ml spray.

Cat N-1120

**\$10<sup>95</sup>**

### CONTACT CLEANER LUBRICANT

Improves electrical contact, suppresses arcing, cleans and lubricates contacts to help reduce wear. fantastic for keeping pots clean and silent. 300g spray.

Cat N-1115

**\$16<sup>95</sup>**

### SPRAY FREEZER

Non-corrosive refrigerant for rapidly cooling small components in live circuits. The ideal way to detect faulty solder joints and overheated components. 450g spray.

Cat N-1110

**\$24<sup>95</sup>**

### TAPE HEAD CLEANER

An efficient cleaner for magnetic tape heads in audio, video and computer equipment. Will not harm plastic or rubber. 150g spray.

Cat N-1155

**\$9<sup>95</sup>**

### CLEAR PROTECTIVE LACQUER

A protective coating for printed circuit boards to keep-out harmful salts and moisture. Coating can be soldered through. 200ml spray.

Cat N-1130

**\$14<sup>95</sup>**



### HEAT TRANSFER COMPOUND

For efficient and reliable thermo coupling of electronic components and heatsinks. 22g syringe.

Cat N-1200

**\$8<sup>95</sup>**

### NICKEL SCREENING COMPOUND

Protects both plastic and metal components from RF interference. High attenuation level across a wide frequency range. 450g spray.

Cat N-1135

**\$44<sup>95</sup>**



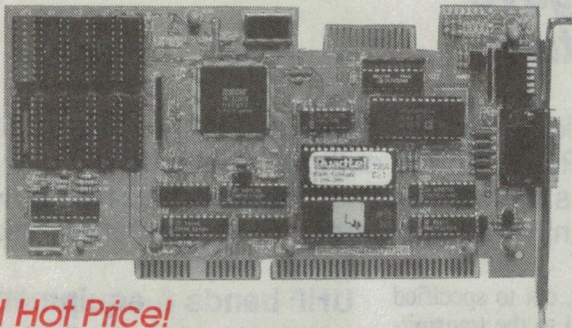


**COLOUR**

**SUPER**

**VGA**

**RESOLUTION**



*Red Hot Price!*

## SUPER VGA GRAPHICS ADAPTOR

More colours, higher resolution and faster screen loading! This super fast, Super VGA adaptor will bring that boring old computer display to life. With an incredible 256 colours and an astounding 1024 x 768 pixels resolution (that's sharp!)... or perhaps 768 x 1024 pixels resolution for when you're working on Desktop Publishing applications, etc.

This has to be one of the best value Super VGA graphics adaptors available. It's easy to fit to just about any IBM compatible (XT or AT) and, it comes with a huge 1Mb RAM on board! Just look at these features.....

- Super Fast
- 1Mb of DRAM
- 16-Bit (can also be used on XT's)
- Video modes compatible with all standard IBM modes
- Plus Super VGA!
- Up to 1024 x 768 pixels in 256 COLOURS
- 7 Selectable display modes
- Text modes include....
  - 80 column 25, 30, 43 & 60 rows
  - 132 column 25, 30, 43 & 60 rows
- Comes with drivers for a huge range of the most popular software!

It looks incredible! Just imagine what it would be like to see an image on your computer screen that was so sharp, so clear, so finely detailed that it looked just like a photograph... with the Super VGA adaptor, that's just what you can get.

Cat X-2001

**Outstanding Value! \$199**

Some stock lines may not be available at all stores.

**DICK SMITH**

**ELECTRONICS**

**PHONES**

**TOYS & LEARNING**

**SECURITY**

**AUDIO**

**COMMUNICATIONS**

**COMPUTERS**

**HOME ELECTRICALS**

## Want The Best Computer Display? VGA COLOUR MONITOR

When you're working, or playing, on your computer, the monitor is the vital link.... why would you settle for anything but the best? This superb Digor 30cm VGA Multisync Colour Monitor is capable of displaying VGA and Super VGA screens in 256 vivid colours! It's beautifully designed with controls conveniently located on the front of the monitor and a swivel base which gives you the freedom to adjust the monitor for the best, most comfortable viewing angle possible. And it comes complete with cable to suit IBM compatibles.

Cat X-2414

**A Fantastic Buy! \$499**

## MONITOR EXTENSION CABLE

Like to put your screen on the desk and away from your CPU? This bargain priced monitor extension cable makes it possible.

Cat X-2603

**YES!**

**Just \$9<sup>95</sup>**

You'll find a full range of ready made computer cables available at your nearest store.

### DS XPRESS PHONE & MAILORDER SERVICE

Outside Sydney (FREE Call) 008 22 6610 Sydney And Enquiries - 888 2105

FAX: (02) 805 1986 or write to DS XPRESS, PO BOX 321 N/R/DYE NSW 2113

All Major Credit Cards Accepted. O/Nite Courier Available.

**24 HOUR DESPATCH OF ALL ORDERS**

**NSW** • Albury 21 8399 • Bankstown Square 707 4888 • Blacktown 671 7722 • Brookvale 905 0441 • Bondi 387 1444 • Campbelltown 27 2199 • Chatswood Chase 411 1955 • Chullora 642 8922 • Gore Hill 439 5311 • Gosford 25 0235 • Hornsby 477 6633 • Hurstville 580 8622 • Kotara 56 2092 • Liverpool 600 9888 • Maitland 33 7866 • Miranda 525 2722 • Newcastle 61 1896 • North Ryde 878 3855 • Parramatta 689 2188 • Penrith 32 3400 • Railway Square 211 3777 • Sydney City 267 9111 • Tamworth 66 1711 • Wollongong 28 3800 **ACT** • Belconnen (06) 253 1785 • Fyshwick 80 4944 **VIC** • Ballarat 31 5433 • Bendigo 43 0388 • Box Hill 890 0699 • Coburg 383 4455 • Dandenong 794 9377 • East Brighton 592 2366 • Essendon 379 7444 • Footscray 689 2055 • Frankston 783 9144 • Geelong 232 7111 • Melbourne City 399 Elizabeth St 326 6088 & 246 Bourke St 639 0396 • Richmond 428 1614 • Ringwood 879 5338 • Springvale 547 0522 **QLD** • Brisbane City 229 9377 • Buranda 391 6233 • Cairns 311 515 • Chermerside 359 6255 • Redbank 288 5599 • Rockhampton 27 9644 • Southport 32 9033 • Toowoomba 38 4300 • Townsville 72 5722 • Underwood 341 0844 **SA** • Adelaide City 223 4122 • Beverley 347 1900 • Elizabeth 255 6099 • Enfield 260 6088 • St. Marys 277 8977 **WA** • Cannington 451 8666 • Fremantle 335 9733 • Perth City 481 3261 • Midland 250 1460 • Northbridge 328 6944 **TAS** • Hobart 31 0800 **NT** • Stuart Park 81 1977

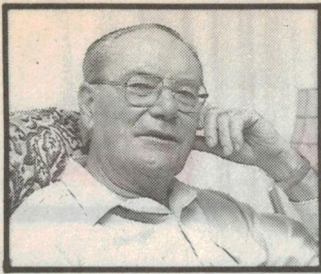
ORDER BY PHONE OUTSIDE SYDNEY (008) 226610 FREE CALL — SYDNEY AREA 888 2105

**YOUR EIGHT SPECIALTY STORES IN ONE**

DICK SMITH (WHOLESALE) PTY LTD ACN 000 908 716

B1197/PB





# When I Think Back...

by Neville Williams

## Hidetsugu Yagi: A pioneer who gave radio antennas a sense of direction

Look up the word 'Yagi' in almost any book on radio communications, and you will be told that it refers to directional antennas of a particular kind. Rarely do the authors have much to say about the Japanese inventor, whose memory it perpetuates. So who was he, and why does his name now occupy such a conspicuous place in the predominantly 'western' jargon of modern electronics?

In my younger days, it took a while to catch up with the idea of designing wireless/radio antennas to have specific properties — beyond, perhaps, the broad assumption that big was beautiful! In fact, we didn't even talk about antennas.

In the bush, we put up 'aerials', signifying 100-odd feet of stranded copper wire suspended by insulators 30 feet or so above ground. There was nothing very scientific about the design, the physical details depending mainly on the space and resources available to each individual set owner.

For sure, we used to argue about insulators of one kind and another, or which way an aerial should face — but at the end of the day, there seemed little to choose between them.

Later, when I came to live and work in the suburbs, I found that aerials had been scaled down to a few pathetic yards of insulated bell wire draped from the chimney to an outhouse, or simply tacked to the picture rail around the living room.

Dictated by expediency, the chief requirements were ease of erection, and their ability to bring in the full complement of local stations.

Then, around 1936, I experienced the first faint nibbles by the hypothetical amateur radio 'bug' — as evidenced from the fact that I bought a copy of the 1936 ARRL *Radio Amateur's Handbook*, which I still have.

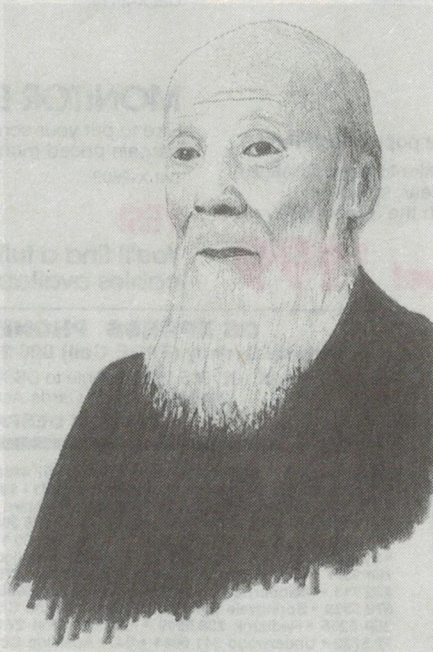
The emphasis in those days was on long distance HF (high frequency) communication on the 80, 40 and 20-metre 'ham' bands and for such a purpose, I discovered, aerials could no longer be random lengths of wire — long or short.

They needed to be erected out of doors

in an approved manner, cut to specified dimensions and coupled to the transmitter and receiver in a particular way.

In the amateur world, there were grounded antennas, Hertz antennas, doublets and zeppelins, centre fed, end-fed and so on.

They were all subject to mathematical calculation, and exhibited predictable directional properties and effective 'gain'. I was face to face with what the technical fraternity commonly refers to as 'antennas', designed for specific roles.



**Fig.1: We haven't been able to obtain an original photo of Professor Yagi, but this artist's sketch is a good likeness.**

### UHF bands & equipment

The 1936 ARRL *Handbook* also included special chapters on so-called 'UHF' receivers and transmitters. But the designs were still relatively primitive and the associated discussion of UHF antennas was, at best, sketchy and concluded thus:

*'A final firm suggestion is that a directive array should be used for UHF working wherever possible. Using a directive array is an exceedingly inexpensive way of getting a substantial increase in effective transmitted power'.*

Logically, one would have expected to find reasonable coverage in the handbook of the very practical Yagi-style VHF/UHF directional beams that had been developed and documented in Japan some 10 years before. Instead, I found one lone and non-committal reference to them, amounting to less than a half-column.

It would seem that, while the ARRL editorial team was aware of the generalities of directional UHF arrays, they hadn't got around to much in the way of what we might now visualise as practical UHF antenna 'plumbing', using off-the-shelf aluminium rods and tubing.

In Australia, about this same time (pre-1936) the then-technical editor of *EA's* predecessor *Wireless Weekly* John Moyle, and a number of fellow amateurs were spending periodic weekends setting up 5-metre equipment on mountain outcrops south and west of Sydney, to identify accessible vantage points for UHF communication. In the process, contacts had been made over up to about 200km. That they were using resonant rod antennas goes without saying, but it is unclear



whether they had made much use, either, of directional arrays with Yagi-style reflectors and directors.

Three years on, a report in what was then *Radio & Hobbies* for June 1939 indicates that by then, 5-metre amateur activities were on the increase around Sydney and Melbourne, and in Western Australia. It mentions that increasing use was being made of (unspecified) directional antennas, mostly vertically polarised.

Again, the August '39 issue of *R&H* carried a report of a 'sensational contact' on five metres between an amateur station in England and another in Italy.

The British station was said to be using a four-element horizontal beam, comprising a driven element, a reflector and two directors. While it would almost certainly have been a Yagi-based parasitic array, the term still didn't make it into the text.

## Wartime technology

World War II put an abrupt end to such activities, but a lot of amateurs (Editor John Moyle included) ended up in the armed forces and exposed to antennas of all shapes and sizes, among them — ironically — Yagi-based arrays.

After the war, when the affairs of *Radio & Hobbies* were restored to some semblance of normality, we found ourselves besieged by amateurs keen to get back on the air. We also found truckloads of surplus VHF and UHF equipment and miles of high quality coaxial cable. There was a powerful urge to adapt both the equipment and the techniques developed during the war to post-war amateur communication.

Up-dated information was also available from post-war textbooks — as, for example, the diagram in Fig.2 from the 1948 edition of the *ARRL Handbook*, showing at a glance the essential dimensions for a 4-element 50MHz Yagi beam. The active element depicted is a folded dipole with the two parallel rods/tubes scaled in diameter to provide a suitable feedpoint for a 300-ohm feedline. In the postwar years, Yagi beams rapidly assumed a special fascination for mechanically minded amateurs, especially when appropriate rotational mechanism and/or other hardware could be 'scrounged' cheaply ex-disposals.

I vividly recall picking up a bundle of 1-1/4" (32mm) tubular duralumin struts, apparently discarded by the De Havilland workshops, from a scrap heap near Sydney's wartime Bankstown aerodrome.

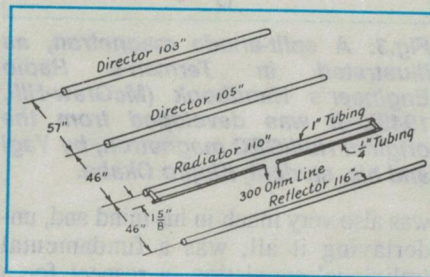
I also remember Ron Bell of RCS

Radio, ever on the lookout for an eye-catching product, making available 360° glass compass scales for use in back-lit wall displays of beam direction, when using ex-disposals 'Selsyn' motors for driving a makeshift antenna rotator. The Selsyn motors in turn could be bought for a proverbial song from firms like Ace Radio.

No less to the point, it didn't take a genius to calculate a half-wavelength at the desired operating frequency and reduce it by about 5% for the driven element. Or to work to the original length for a reflector, or knock off a further 5% or so for the director(s).

Graphs and tables were also available, postwar, to help determine appropriate element spacing, estimate feedpoint impedance and work out how to reconcile it with the available feed cable.

Whether or not we stopped to think



**Fig.2: Diagram of a Yagi array for the 50MHz amateur band, from the 1948 ARRL Handbook. Construction of the beam and provision of a rotatable mounting mast made an interesting challenge, rewarded by more and stronger signals.**

about it at the time, Yagi's pioneering research dating back into the mid-1920's had added immensely to the fun of being a postwar amateur, particularly on frequencies from 28MHz up.

I recall embarking upon such exercises with considerable zeal and subsequently, along with John Moyle, keeping regular 6-metre 'scheds' with amateurs in Canberra and in Young, the latter 270km away, on the far side of the Great Dividing Range. That done, we turned our attention to the 2-metre (144MHz) band, with 'stacked' Yagi beams to make the best of our still rather makeshift transmitters and receivers.

I well remember numerous debates about beam design in the *R&H* office with John Moyle, another amateur Maurice Findlay, and Raymond Howe who had specialised in antenna design in the RAAF.

The debates were to take a new turn a little later, when we became involved in commercial VHF 2-way radio systems for the *Sydney Sun* newspaper and the

*Sydney Morning Herald*, owned by our then parent company.

## A certain awkwardness

But, on the presumption that confession is good for the soul, I must admit to a certain diffidence about using the term 'Yagi' in such discussions. Over the years, I had grown accustomed to the many 'western' names in electronic jargon — Ampere, Baird, Boyle, Crookes, Edison, Faraday, Fleming, Galvani and so on through the alphabet to Volta and Wheatstone. What was Yagi doing in such auspicious company? With one letter in the index all to himself?

Could it be that the early tardiness in taking on board the Yagi research and terminology was a akin to my own attitude?

Racist? Undoubtedly! But, since those far-off days, I've spent decades trying to rationalise the attitudes originally nurtured in a country school, where we were encouraged to be proud of our British heritage, of the many red areas in the wall map, and of the invincible British navy that 'rules the waves'; a school where we made 'big deal' out of Wattle Day and a weekly flag ceremony; an environment where we felt openly curious about — and condescendingly sorry for — people who were neither British nor white. How fortunate we were to be both, in this great land of the free!

Years later, it fell to my lot to lead a party of *EA* readers on a 'Technitour' to Osaka in Japan, via Hong Kong and Taiwan, for 'Expo 70'. On that tour, many of us experienced for the first time what it was like to mingle, as foreigners, with other races in their own environment. I especially remember touring around the city of Osaka and noticing primary and secondary school-children on class excursions, uniformly immaculate in both dress and behaviour. How very different from my own scruffy, bare-footed, noisy schooldays!

Outside tertiary training centres, we came upon rows of motor scooters draped with the rider's helmet, gloves and goggles — with obviously no fear of them being 'pinched'. Unbelievable!

And outside many homes, with no room elsewhere for greenery, the occupants had arranged their cherished potplants on the footpath — with no fear that they would be despoiled by local yobbos!

Very obviously, and for whatever reason, the inhabitants of Osaka were unconsciously demonstrating a standard of civic honesty and conduct that



## WHEN I THINK BACK

shamed our own British/Australian cities.

### Yagi, the man

Only recently have I learned that Professor Hidetsugu Yagi, pioneer of the antenna configuration that bears his name, was born in that same city of Osaka, to a family that had a long and distinguished history in the area. As such, he had good reason to take as much pride in his heritage as we do in ours. So who was Yagi and how did his name get to be included in our technical jargon?

For a detailed answer to that question, I am indebted primarily to W.A. Atherton for his article in the venerable British magazine *Electronics & Wireless World*, for January 1989. He, in turn, acknowledges the assistance of Professor S. Adachi of Tohoku University, and of a Mr and Mrs J. Loftus who helped in translating the Japanese text. As already noted, other publications to hand deal variously with Yagi antennas, but make only the briefest reference — if any — to the inventor.

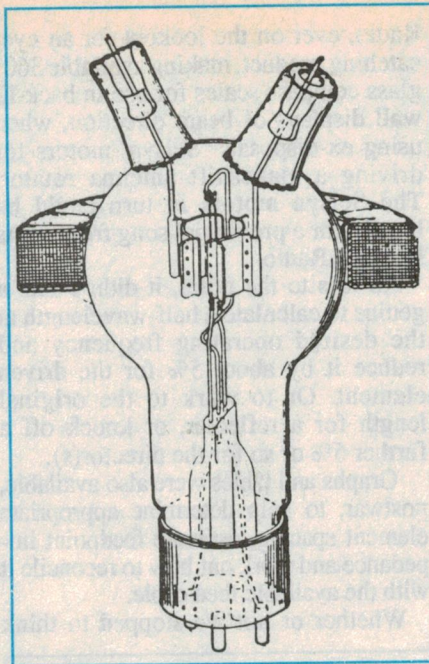
Well then, Hidetsugu Yagi was born on January 28 in 1886, one year before Heinrich Hertz' historic demonstration of generating, propagating and detecting radio waves. He was the second son in a family which, for generations, had held responsible positions under the contemporary shogun — hereditary commanders of the Japanese army, whose authority, for centuries, rivalled that of the Emperor.

When his older brother 'lost face' by dealing in stocks and shares (considered at the time to be little better than gambling), Hidetsugu became, to all intents and purposes, the eldest son in his family.

By conviction an idealist and a socialist, he was elected at one stage to the upper legislative house, roughly equivalent to Britain's House of Lords. It soon became evident, however, that his ideas were incompatible with those of his peers and he deliberately withdrew from traditional politics, preferring to air his views in print.

Yagi was, in fact, a prolific writer in newspapers and popular magazines, as well as in scientific journals. His wide-ranging interests covered working conditions and labour relations, society and its attitude to science, and the ends towards which he believed scientific research should logically be directed.

Communication by electrical means



**Fig.3: A split-anode magnetron, as illustrated in Terman's *Radio Engineer's Handbook* (McGraw-Hill, 1943). It was developed from the original Hull/GEC magnetron, by Yagi and his student, Kinjiro Okabe.**

was also very much in his mind and, underlaying it all, was a fundamental 'religious' conviction, a respect for a power beyond that of mere mortals.

### Academic, lecturer

Back to his technical career, Yagi had graduated from the Tokyo Imperial University (now Tokyo University) at the age of 24, and became a teacher at the Sendai Engineering High School. Some 200 miles north of Tokyo, Sendai was a city in its own right with a population of a million or so people.

Four years later, the Ministry of Education sent him abroad to further his studies — a fairly common practice at that time. He found himself at the University of Dresden, involved in the broad study of resonance under Heinrich Barkhausen.

In due course (1919) Barkhausen was to go down in history as the discoverer of the magnetic domain effect, but in 1914 he was much more concerned with the generation of continuous electromagnetic (Hertzian) waves produced by arcs — a subject in which Yagi himself already had a longstanding interest. It so happened that Yagi was on a study tour of Austria, Switzerland and Italy when the Great War broke out, and instead of returning to Germany, he decided to abandon his study notes and make his way direct to England.

There, he made himself known to the

famous J.A. Fleming, by then 65 years of age and Professor of electrical engineering at the University College, London.

Having been Marconi's engineering consultant for his historic work around the turn of the century, and as inventor of the thermionic diode valve, Fleming was a world authority on the technology of wireless communication.

Short of students at the time, he warmly welcomed the young Japanese graduate and readily agreed to monitor his already extensive studies in the subject. After a time with Fleming, Yagi moved on to the USA for a brief stay at Harvard University, before returning to Japan in 1916 to resume his teaching career.

Shortly afterwards, the Sendai High School was merged with the Tohoku Imperial University as the new Faculty of Engineering and, two years later (1921) Yagi received his doctorate. Historically, he is still acknowledged as one of the prominent figures whose original and creative research helped to establish the traditions and the reputation of the University's Engineering Department.

### Modern electronics

Already well versed in the established electrical methods of producing continuous electromagnetic waves, Yagi's concepts took a quantum leap when a Japanese naval officer, returning from the USA, told him of the magnetron tube which had recently been invented by Albert Hull in the Research Laboratories of GEC (the General Electric Co) in New York.

Yagi seized the first chance to incorporate the magnetron into his own work and by 1927, one of his research students, Kinjiro Okabe, not only managed to produce oscillations with a wavelength of a few tens of centimetres, but obtained increased power levels with the invention of the split-anode magnetron (Fig.3).

Another of his research students, Shintaro Uda (see panel) supplemented this work by performing experiments under Yagi's supervision, which led to the development of directional antennas based on a 'wave canal' created by a series of self-resonant 'passive' (or 'parasitic') directors placed in front of the driven element.

The combination of the split-anode magnetron and the beam array proved a major contribution to the technology of UHF communication, and brought the Japanese research to the attention of western engineers.

In western literature, the hallmark paper is: H.Yagi, 'Beam transmission of ultra-short waves', in *Proceedings of the*



IRE (USA) Vol.16, No.6, pages 715-741, June 1928. It was later reprinted in *Proc. IEEE*, Vol.72, 634-645, May 1984.

The paper was in two parts, Part 1 dealing with performance of the Yagi-da antenna system at wavelengths of approximately 4.4 metres and 2.5 metres. By accident or design, these had direct implications for amateurs using the 5-metre and 2-metre bands.

Part 2 covered the generation of centimetre waves by split-anode magnetrons — on 8, 12, 19 and 40cm — with credit being given to GEC for the original magnetron and to Okabe and Uda for their respective and very considerable contributions to the research. While much of the presentation had already been published in Japan, Yagi promised that future publications on the subject would appear in English.

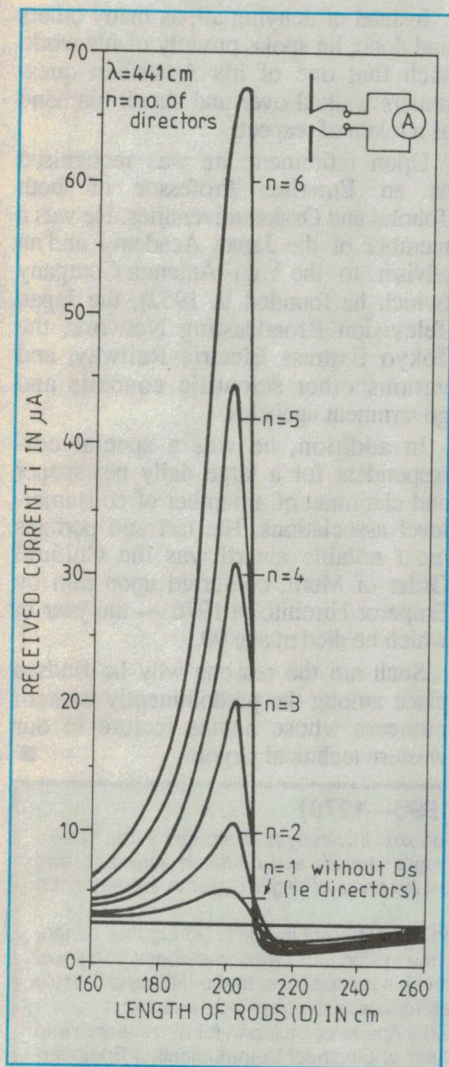


Fig.4: Curves from Yagi's paper to the IRE (USA), showing the relationship between received signal current and the number of directors in an experimental beam.

## Yagi fundamentals

In presenting an overview of the Yagi-Uda antenna, Yagi emphasised that metal rods (or tubes) of a finite length have a natural frequency of resonance, which can be used to take advantage of their natural directivity and/or their ability to act as reflectors or directors of energy in particular circumstances.

In a typical array, a triangle of three or five rods of appropriate length and spacing, behind and parallel to the driven element, could form a 'trigonal reflector' and concentrate the transmitted energy in a forward direction. Further elements cut to size and ranged in front of — and parallel to — the driven element would constitute a 'wave canal', further concentrating the frontal beam.

Some 22 figures in part 1 of the presentation illustrated the role of reflectors and directors, the effect of varying the number and spacing of elements, antenna height, polarisation and so on. It was noted that the findings were complementary for both transmitting and receiving — in one case as an effective power gain, in the other a similar improvement in effective sensitivity. Typical diagrams (Figs.4 and 5) show respectively the increase in received signal current with the addition of successive directors, and the gain and directivity of a complex array using one reflector and 20 directors.

Presentation of the papers prompted vigorous discussion, with J.H. Dellinger, Chief of the Radio Division of the US Bureau of Standards, rating the paper as one that was destined to become a classic in technical literature.

But despite the explicit nature of the presentation and its obvious relevance to amateur band communication, there appeared to be little immediate response by amateur station operators to the Yagi-Uda concept. In his comprehensive *Radio Handbook* (20th edition, 1975, Howard W.Sams & Co, Indiana USA), William Orr observes that the Yagi-Uda beam system was invented and publicised in Japan in 1926, and introduced into the USA via the IRE in 1928. Yet he notes that it was not until 1935 that it found any significant application in the amateur ranks, which accords with my own impression of the situation, as mentioned earlier.

## Widely used post war

However, based on post-war experience, Orr was assuring his readers (in 1975) that: 'No other antenna exists which can compare, size for size, with

the power gain and directional characteristics of the parasitic array'.

He goes on to discuss the properties of two-element and multi-element beams for the HF bands, along with derivatives such as stacked Yagis, loaded (shortened) elements and multi-band versions. Even the cubical quad finds a place in the scheme of things as an opened-out folded dipole, associated with similarly configured parasitic quad directors.

In a separate chapter on VHF and UHF antennas, the Yagi configuration features prominently in handyman 'back-yard' arrays, for use on amateur bands from 50MHz up or for the reception of satellite signals. Much the same applies to other postwar textbooks covering amateur or other communications.

However, if there was ever any doubt that Yagi had 'arrived' post war, one need only scan the rooftops in any western environment to note the proliferation of television antennas. A few use multiple elements connected to the downlead, but the majority are derivatives of the Yagi formula, with one element — or one for each band — connected to the downlead and most of the others serving as parasitic reflectors or directors.

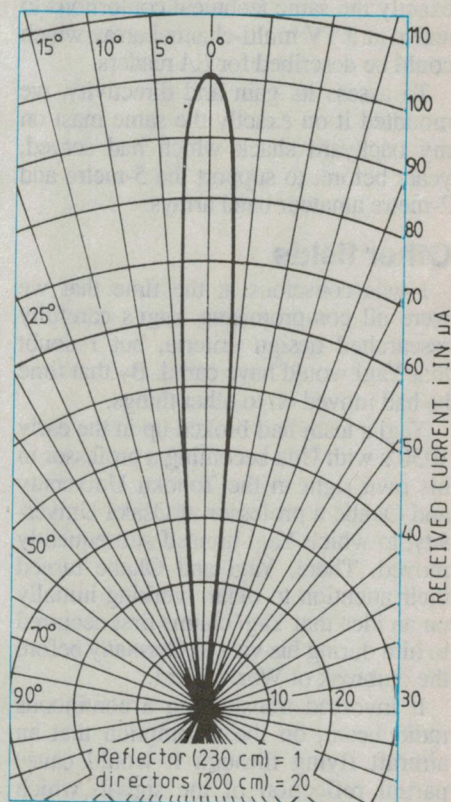


Fig.5: Another typical curve from Yagi's IRE paper, based on experimental work by Uda, showing the directivity pattern of an array involving one reflector and twenty directors.



## WHEN I THINK BACK

Over the years, television engineers worldwide have contorted the Yagi-Uda concept to achieve their own objectives. They have worked out the classical dimensions to suit the centre of the appropriate band, used folded dipoles for the active elements, stretched the reflectors and foreshortened the directors — in an attempt to cover more stations while still retaining some semblance of signal gain and directivity.

In Australia, they have pulled technical tricks by using long driven elements to function as simple dipoles for low-band VHF TV channels, and coaxed those same dipoles to function in harmonic mode for the high-band channels.

They have used separate long and short active elements to cover the low-end and high-end channels, coupling them both to the same downlead in a way which will hopefully prevent one from being adversely affected by the presence of the other.

But why do I keep saying 'they'? With the willing co-operation of my one-time editorial offside, Phil Walson, I remember setting aside the precision of the Yagi-Uda approach and going through exactly the same technical contortions to arrive at a TV multi-channel array which could be described for *EA* readers.

To assess its gain and directivity, we mounted it on exactly the same mast on my backyard shack which had served, years before, to support the 5-metre and 2-metre amateur band arrays.

### Other fields

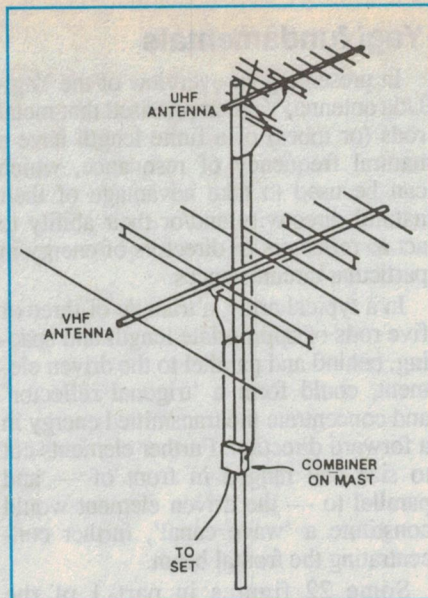
I was conscious at the time that we were all compromising Yagi's carefully researched design criteria, but I doubt that Yagi would have cared. By that time he had moved on to other things.

Yagi's team had broken up in the early 1930's with Uda becoming a professor in his own right in the Tohoku University and Okabe a professor at Osaka University, to which Yagi himself subsequently moved. There, Yagi and Okabe turned their attention to radar, working initially on an idea that Yagi claims first occurred to him during his visit to Germany before the outbreak of World War I.

It involved transmitting a continuous radio beam, on the assumption that an aircraft flying through it would cause partial reflection of the signal, which could hopefully be discerned by Doppler techniques.

Working on this system around 1936, Okabe is credited with having invented the first Japanese radar system.

The longest wartime continuous-beam



**Fig.6:** Reprinted from the April 1986 issue of *EA*, this diagram shows a UHF TV Yagi at the top with folded dipole and trigonal reflector. Below is a composite Yagi with two sets of elements for the low-end and high-end VHF bands.

system actually set up by the Japanese reached from Japan to Taiwan — a distance of 650 miles — near enough to 1000km. (See R.I. Wilkinson, 'Short Survey of Japanese Radar', in *Electrical Engineering* Aug/Sept. 1946, 370-377 and Oct. 1946, 455-463). In concentrating on a continuous beam, rather than time multiplexed pulsed transmission and reception, they had selected the wrong technology.

However, as the man nominally in charge of Japanese civilian fundamental research, Yagi bitterly criticised the Japanese High Command for their piecemeal approach to electronic research. The army and navy had policies of their own, but neither attached much importance to radar research.

Each saw radar as an essentially defensive measure, which would have little

relevance to a future war in which they expected always to be on the offensive. This time Yagi was right but, ironically, his own home was firebombed in 1945 and much of the research data he had assembled over the preceding 30 years went up in flames along with it.

With hindsight, it is interesting to speculate what the scenario might have been, had the brilliant team of Yagi and Okabe received the backing of the Japanese High Command in the mid 1930's. Britain, perchance, might not have entered the war with such a commanding lead in radar research.

At the end of hostilities, Hidetsugu Yagi was questioned by the Allied War Commission about the scientific research he had undertaken during the war. His answer: "I did my best for my country. I did my best to defeat the Americans!"

Instead of denying all, as many others had done, he spoke proudly of his work, such that one of his American questioners walked over and shook his hand as a token of respect.

Upon retirement, he was recognised as an Emeritus Professor of both Tohoku and Osaka universities. He was a member of the Japan Academy and an adviser to the Yagi Antenna Company (which he founded in 1952), the Japan Television Broadcasting Network, the Tokyo Express Electric Railway, and various other scientific councils and government agencies.

In addition, he was a special correspondent for a large daily newspaper and chairman of a number of consumer-level associations. His last and perhaps most notable award was the Cultural Order of Merit, conferred upon him by Emperor Hirohito in 1976 — the year in which he died at age 90.

Such are the reasons why he finds a place among the predominantly western pioneers whose names feature in our western technical jargon. ■

### Shintaro Uda (1896—1976)

Ten years younger than Yagi, Uda attended Tohoku University as a student in the 1920's while Yagi was lecturing there. He served as Yagi's student and research assistant, and performed many of the experiments which formed the basis of Yagi's paper to the American IRE in 1928.

Uda gained his bachelor's degree in 1924 and his doctorate in 1931. During that period, he wrote nine papers in Japan on the beam antenna system, and was co-author with Yagi of a number of others. Yagi acknowledged this fact in his presentation to the IRE, and his role is sometimes marked in technical literature by references to the Yagi-Uda antenna.

In 1932, Uda received an award from the Imperial Academy of Japan for his research into microwaves and, in 1936, was appointed Professor of Electrical Communication Engineering at Tohoku University. In the period 1955-58 he served also as a UNESCO expert at the National Physical Laboratory in New Delhi, India.

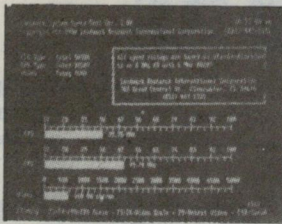
Uda retired in 1960, becoming Professor Emeritus at Tohoku, but was thereafter appointed as a professor at the Yokohama University. He died in 1976, the same year as his one-time mentor.



## SPEED TEST YOUR PC

You've seen the Landmark Speed Rating advertised by many major PC manufacturers, now you can have

your own copy of the **Landmark System Speed Test™**. Accurately measure CPU, math, and video speeds to make an informed purchasing decision, determine the best PC for the job or make just win some bets in the office on whose PC is really faster! Includes the Landmark AT CMOS RAM Setup program to update your system configuration on-the-fly.



## THE 5 MINUTE SOLUTION TO FLOPPY DRIVE FAILURE

With **Alignit™** you can clean, diagnose, and align your floppy drives in minutes without a scope. Patented technology requires only a screwdriver to perform ANSI-accurate alignments (.3 mil).

Alignit is ideal for corporate users with 2 or more PCs because it includes a "GOLD STANDARD" feature so you can align all your PCs to the same in-house standard, guaranteeing that all your floppies are perfectly interchangeable between PCs.

80% of all floppy drive failures can be fixed with Alignit so don't replace your drive, save time and money instead.

Includes dual size floppies, (both high and low density) and no-mess pre-lubricated cleaning diskettes (both sizes) good for 180 uses. Replacements and single drive size versions available. For all PCs and compatibles.

## HARD CORE TESTING FOR PROFESSIONALS

Landmark/SuperSoft **Service Diagnostics™** is ideal for professionals requiring the most exhaustive diagnostic test capabilities. Each module is CPU specific, including PC, XT, AT, 386/486, and PS/2. Since 1981 major manufacturers like Wang, Xerox, Prime, Sony, DEC, NEC, and NCR have relied on Service Diagnostics to tackle their toughest operating problems.

Intended for professional service and repair technicians, Service Diagnostics is also easy to use for the novice. Clear, concise on-line help and intuitive menus make finding system problems a breeze. Tests all CPUs, math chips, all memory, floppy, fixed and non-standard disk drives, standard/non-standard printers, system board, video, com ports and all keyboards. Utilities include low-level reformat, log bad sectors, edit bad sector table; the partition editor allows you to set up multiple partitions; back-up program transfers hard disk image on unformatted floppies and allows for restore after reformat.

Ideal for UNIX and other operating systems, the self-booting version doesn't require DOS. The manual offers troubleshooting tips to the component level. Also available in a complete Kit including; all CPU specific software, dual size floppy alignment software (see Alignit), and PC/XT & AT ROM POSTs. **Winner of the PC Magazine Editor's Choice Award in August 1990.**

## PC WON'T BOOT? THEN JUST KICKSTART IT!

Don't replace your motherboard, don't call service, use **KickStart™**. When serious hardware problems occur, nothing gets you up and running as fast. KickStart 2 measures power within 2.5% on all four voltages, shows Power-On Self-Test (POST) failure codes, and features on-board ROM-based diagnostics allowing you to determine and remedy the problem quickly, easily, and inexpensively!

Built-in serial and parallel I/O allows for testing via modem, or simply logging results to a remote terminal, printer or laptop. You can configure your own test routines and store them in KickStart 2's battery backed-up CMOS RAM saving valuable setup time. Includes serial and parallel loopback plugs and Landmark JumpStart AT ROM BIOS for testing PCs that don't issue POST codes. KickStart 2 tests your system regardless of O/S (even UNIX).

On-board switches, LEDs, and digital displays allow complete control over testing in systems lacking video or disk (ideal for motherboard or system burn-in).

KickStart 2 is the ultimate SECURITY CARD too! With both supervisor and user levels of password protection, you can prevent unauthorized use of your PC and accidental running of destructive tests.

*"KickStart 2 system diagnostics board helps users check out virtually every aspect of a PC's hardware system... the board is a worthy investment for computer maintenance." David Claiborne, PC Week - December 24, 1990.*

## HOW TO DEBUG A DEAD PC

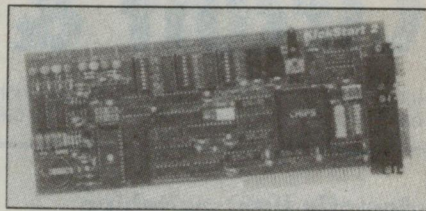
Need an inexpensive solution for dead or problematic PCs and motherboards? Try **KickStart 1™** or **JumpStart ROM POST™**, two quick and easy to use debugging tools.

KickStart 1 test card shows power status on all four voltages and binary PORT 80 Power-On Self-Test codes. The manual translates error codes for easy failed circuit isolation.

JumpStart ROM POST is a plug-in chip designed to replace your motherboard BIOS for testing purposes. Tests include CPU register and logic, 8087 math coprocessor, 8253 timer, 8237 DMA controller, 8259 interrupt controller, parity error and memory refresh logic, erroneous maskable/non-maskable interrupt detection, display adapter (MDA, CGA, EGA), keyboard, keyboard controller, floppy controller, drive A: read Base memory at normal & slow refresh rates, and POST checksum. Display of motherboard switch configuration.



*"SuperSoft's Service Diagnostics: The Kit is a technicians dream, with all the tools necessary to accurately analyze all phases of computer operations... it is well worth its performance potential." Bill O'Brien, PC Magazine - August, 1990.*



KickStart 2 is ideal for permanent installation. It eliminates the need for an I/O card, provides remote and on-site diagnostic capabilities for quick repair time and offers a solid hardware based solution to unauthorized access with impenetrable password protection.

## SLASH DOWNTIME AND OPERATING PROBLEMS

With **PC Probe™** you'll save time and money when your PC starts acting up. In one easy-to-use package you get Diagnostics, Benchmarks, Performance Enhancement Utilities, and System Information. Combined, this arsenal of tools will keep your system up and running at peak performance and remove the mystery about what's inside.

PC Probe diagnostic testing quickly isolates the source of hardware problems, even locating bad RAM chips. It tests system board, RAM, video, keyboard, com ports, floppy drive, hard drive, Ethernet card and more. Run PC Probe tests in batch mode or single pass, remote or on-site.

PC Probe allows you to increase your hard drive data transfer rate by determining optimum interleaving and changing it, prevent catastrophic data loss by performing data revitalization, reformat the hard drive, run external programs, display and edit CMOS RAM on-the-fly, prevent accidental hard drive data destruction with passwords, diagnose problems with device drivers installed.

The 200 page on-line manual has built-in table of contents, topic/text search, and troubleshooting tips. PC Probe comes with dual size floppies and 9 & 25 pin serial/parallel port loopback plugs. For PC XT, AT, 386, 486 and compatibles using DOS 2.0 or higher.

## CONFUSED BY TECHNICAL COMPUTER JARGON?

Finally, with a single keystroke, you can define virtually every computer term known in a matter of seconds. This award-winning, easy-to-use utility, defines over 4200 computer terms and concepts for you without having to leave the program you're in.

**The Computer Glossary™** (a software version of the best-selling book by Alan Freedman) installs as an application or hot-key accessed TSR. The definitions are written in concise, standard English. Plus, The Computer Glossary provides colorful industry "backgrounders" fascinating to the beginner and expert alike.

Get the most out of your software, manuals and computer magazines, buy The Computer Glossary and become a true POWER USER. Runs under DOS or MS-DOS 2.0, or later, with 32K of RAM and 1.4 MB of hard disk space on IBM PC, XT, AT PS/2 and compatible computers.



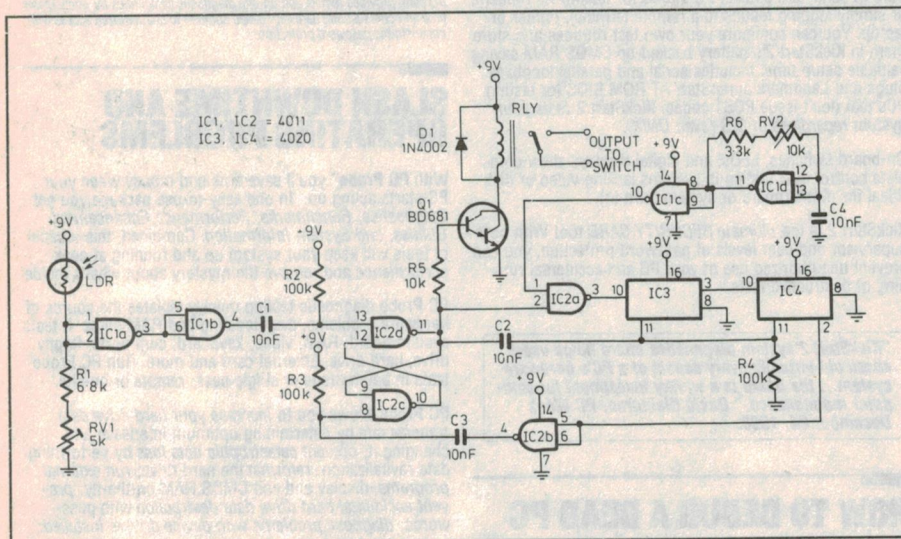
**Interworld Electronics & Computer Industries (Aust) Pty Ltd**  
1G Eskay Road, Oakleigh South, Vic 3167  
Tel: (03) 563-7066  
Fax: (03) 563-7337



# Circuit & Design Ideas

Interesting circuit ideas from readers and technical literature. While this material has been checked as far as possible for feasibility, the circuits have not been built and tested by us. We therefore cannot accept responsibility, enter into correspondence or provide further information.

## Automatic light switching



This circuit was designed to replace those timing units that will only switch plug-in loads such as lamps. Such units will not allow you to control external house lighting, and require continual adjustments in spring and autumn so that you don't have the lights on while daylight abounds.

Stage one is a light detector, based on IC1a and IC1b. As the light reaching the LDR decreases, its resistance and the voltage drop across it increases. When the input voltage of IC1a drops low enough, output at pin 3 goes high — causing the output at pin 4 to go low.

The light detector will cause no further effective change until the input to IC1a has first gone high and then low again. The correct positioning of LDR by RV1 means that this re-triggering should not occur until next evening.

Stage two comprises a flipflop made of IC2c and IC2d. The low from pin 4 is converted to a brief pulse by C1 and R2, which triggers the flipflop. Pin 11 goes high, and remains in this state until the timing/counting sequence is completed.

While pin 11 is high, the Darlington transistor Q1 powers the relay. The closed contacts of the relay bridge across the light switch and turn the exterior lights on. Diode D1 protects Q1

from the back EMF of the relay as it turns off. Stage three comprises an oscillator, IC1c and IC1d, and two 14-bit binary counters, IC3 and IC4.

When the relay is not switched on, the clock signal is isolated from the counter by the low on pin 2 of IC2a, and the reset pins 11 of both IC3 and IC4 are held low by R4. When the output of the flipflop changes, these ICs are reset through C2 and counting begins.

This counting will continue, at a rate determined by the oscillator frequency, until it has cycled through its 27 binary stages, after which pin 2 of IC4 will go high.

This high is inverted by IC2b and converted to a pulse by C3, which resets the flipflop and turns off the output. To achieve the desired time range of 2-7 hours, the oscillator frequency needs to vary from 18kHz (2 hours) to 5kHz (7 hours).

The extreme settings of RV2 provide 5.1-20.7kHz resulting in a range of 1hr 50min to 7hr 16min.

Power for the circuit is optional. The 9V, 100mA can be provided by a small plugpack, or a regulated supply derived from the 240V lighting supply, provided proper care is taken.

A.R. Lyons,  
Oakhurst, NSW

\$40

## 'Lightning meter' for SWLs

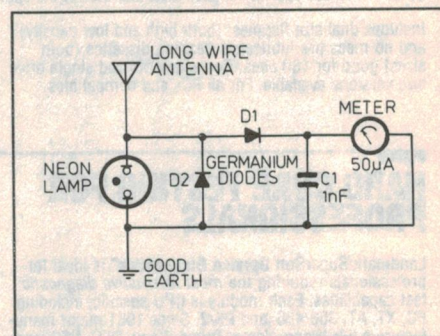
There is an old saying that lightning never strikes twice in the same place. Probably there's nothing left to hit the second time! However, this circuit allows you to get as close as I would ever dare to the fireworks display in the sky.

The circuit is simply an antenna current monitor, or a crystal set with a meter, depending on how you look at it. The antenna picks up radio energy, is rectified by the diodes and then fed to the meter for display.

The neon lamp is to offer some protection to the circuit in case of a nearby strike. The antenna needs to be 10 or 20 metres of wire — just like the one you use for listening to shortwave broadcasts.

As a storm approaches, the needle of the meter will begin to flick with each lightning zap, the movement being proportional to its intensity and proximity. As the storm moves into about a 1-2km radius, the needle will be thumping into the stop on the far side of the scale.

The distance (in kilometres) to the lightning source is calculated by divid-



ing the number of seconds between the zap and the sound of the thunder by three.

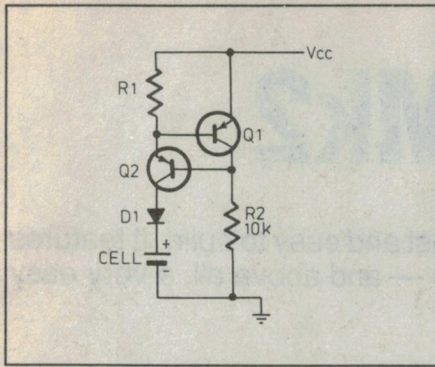
In a cloud-to-earth strike, current flows twice along the path of the strike — indicated by two pulses on the needle. And if you live near a radio station, you will probably always have a small reading on the meter because your circuit picks up some of the transmitter's power.

Alex Eades,  
Katoomba, NSW

\$30



## Constant current charger



In order to effectively charge NiCad batteries, a constant current source is required. This notes shows how to construct specific chargers for individual cells. In order to get a constant current through transistor Q2 to charge the cell, a fixed voltage source is needed to control its base current. Instead of using a diode (or pair of diodes), transistor Q1 is provided. It works like an amplified diode, as often used in push-pull amplifiers.

Select Q1. It can be any general purpose transistor (e.g. D467) which has a  $V_{BE}$  of approximately 0.7V. Using manufacturers' data sheets, select the charging current ( $I_{ch}$ ) for the NiCad, and determine the value of R1 from the equation:

$$R1 = V_{BE(Q1)} / I_{ch}$$

Now select Q2. This transistor must be able to cope with the charging current even when the cell is fully discharged. Its power dissipation is given by:

$$P = (V_{Q2 \text{ emitter}} - V_{D1 \text{ anode}}) \times I_{ch}$$

You can assume that V at D1 anode is 1.5V, for the worst case. Finally, select a suitable low forward-voltage-drop diode. A schottky diode is recommended. Note that in this circuit, the  $V_{BE}$  of Q1 across R1 sets the output current, independent of  $V_{cc}$ .

Ranjit Singh,

Kuala Lumpur, Malaysia

\$40

## Low-dropout voltage regulator

This regulator was designed to power instrumentation with 5V DC from a supply which varied over a range of 6-12 volts.

It consists of a commonly available three-terminal regulator with a PNP pass transistor.

The transistor has a minimum gain of 50 and a collector current of 1A. The LEDs act as two low voltage (about 1.9V each) zener diodes in series.

The regulator IC will maintain a volt-

## Sound effects generator

This sound effects generator can be used in many ways, for example, as a musical doorbell, or hooked up to a 10W amplifier as a Colonel Bogie car horn! The circuit consists of two 555s and a 4017 decade counter. The first 555 (IC1) is connected as an astable multivibrator to provide clock pulses for the 4017. Capacitor C1 will determine the frequency. It can be any value greater than 22nF — if less, it is too fast for the 4017. Varying the value can vary the sound from a zipper gun to a melody. The clock pulses are sent to pin 14 of IC2, a decade counter. On the

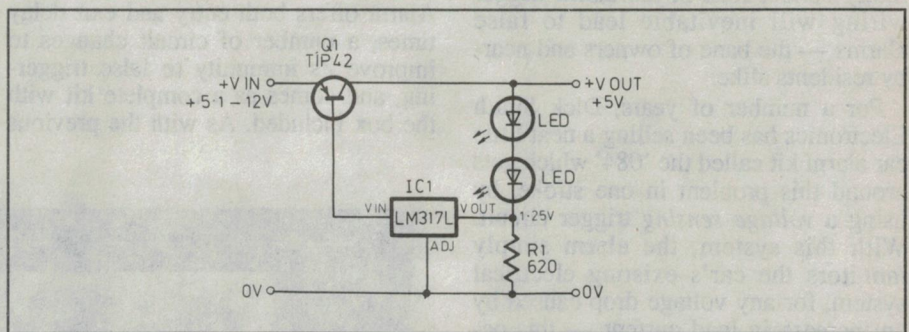
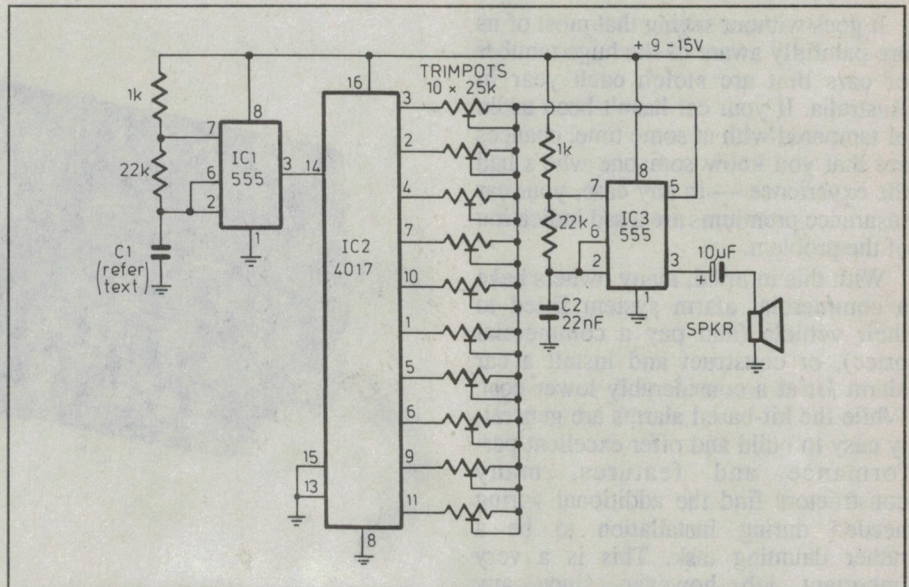
diagram all 10 outputs have been used, providing a 10 note tune. If you wish to use less notes, disconnect the reset pin 15 from the ground and connect it to the first unused output pin.

The trimpots connected to the output pins set the frequencies of the notes. Calibrate these with C1 at 100uF. IC3 is the final stage of the circuit and is connected similarly to IC1. The only difference is that its frequency is changed by the input to the control voltage at pin 5. The output goes to a loudspeaker via an output capacitor C2.

Ben Buxton,

Edgecliff, NSW

\$35



age of 1.25V across the 620 ohm resistor R1 at all times, so  $V_{OUT}$  is about 5V.

With no load on the output, virtually all the current through resistor R1 is via the LEDs, since the regulator contribution, which is effectively the base current of Q1, is only 1/50 of the current flowing through the LEDs. If a load is connected, the output  $V_{OUT}$  will tend to drop, and this will cause a large current change through the LEDs since they act as zeners. The regulator will make up the extra current via its  $V_{IN}$  terminal, which in turn will drive the PNP tran-

sistor and allow it to restore the output to its original value. Circuit performance is very good with operation down to an input of approximately 5.1V. The LEDs also act as a load monitor since they are at maximum brightness with no load and nearly off at full load. The circuit is also short-circuit proof. Other output voltages can be obtained by substituting the LEDs with other zeners, or by using the LM317 in its adjustable configuration.

H.F. Nissink,

Lindisfarne, Tas

\$35



## Construction project:

# Budget Car Alarm Mk2

Here's a simple but extremely effective car alarm that's both low in cost and easy to build. It features voltage sensing, both entry and exit delays, a flashing warning LED — and above all, a very easy installation method.

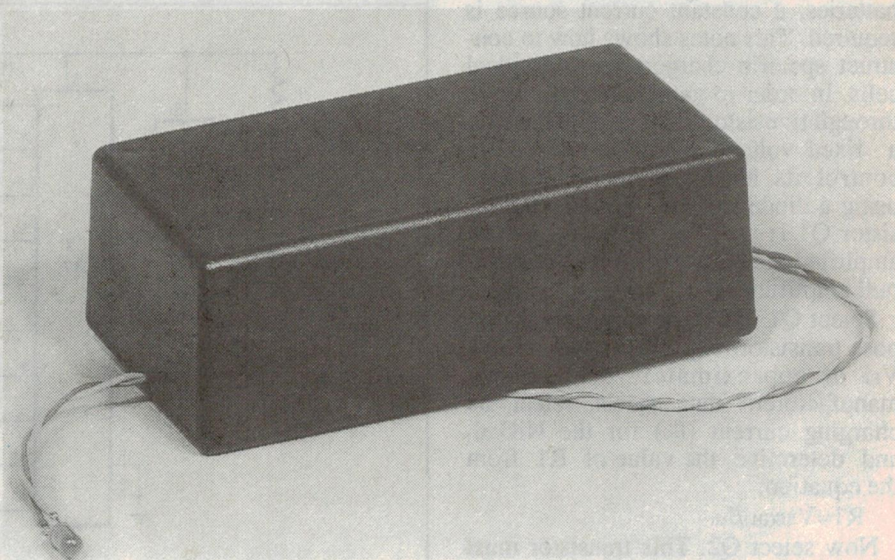
by **ROB EVANS**

It goes without saying that most of us are painfully aware of the huge number of cars that are stolen each year in Australia. If your car hasn't been taken or tampered with at some time, chances are that you know someone who's had the experience — in any case, your car insurance premiums are a sad indication of the problem.

With this in mind, many owners have a commercial alarm system fitted to their vehicle (and pay a commercial price), or construct and install a car alarm *kit* at a considerably lower cost. While the kit-based alarms are generally easy to build and offer excellent performance and features, many constructors find the additional wiring needed during installation to be a rather daunting task. This is a very important job however, since any faulty connections in the alarm trigger wiring will inevitably lead to false alarms — the bane of owners and nearby residents alike.

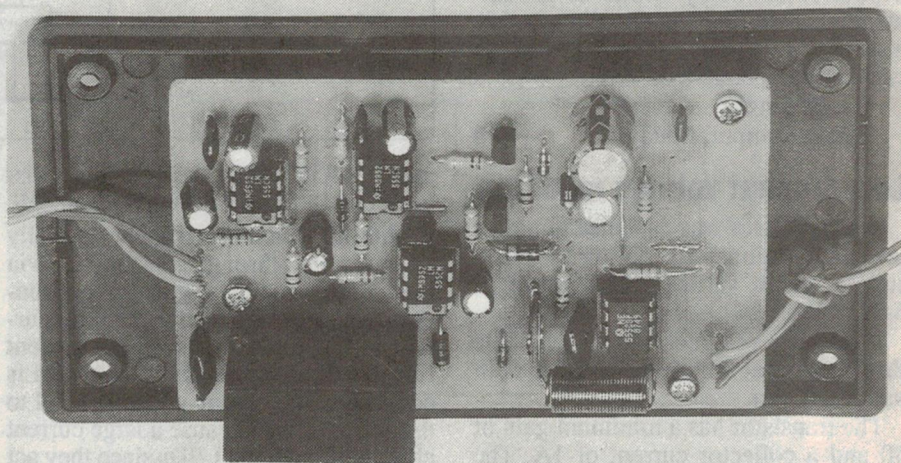
For a number of years, Dick Smith Electronics has been selling a neat little car alarm kit called the '084' which gets around this problem in one stroke, by using a *voltage sensing* trigger circuit. With this system, the alarm simply monitors the car's existing electrical system, for any voltage drop caused by an increase in load current — this occurs when even a low-powered bulb is activated, such as the interior dome lamp in response to a opening door. So in effect, the alarm's trigger wiring is already in place, and the installation procedure is just a matter of connecting the 12V source and the wires to activate the horn or siren.

While the original '084' design has proved to be a very popular kit since it was described in *ETI's Project Electronics* book around 1977, those energetic people at DSE have now updated the circuit to offer more features, at only a moderate increase in kit price.



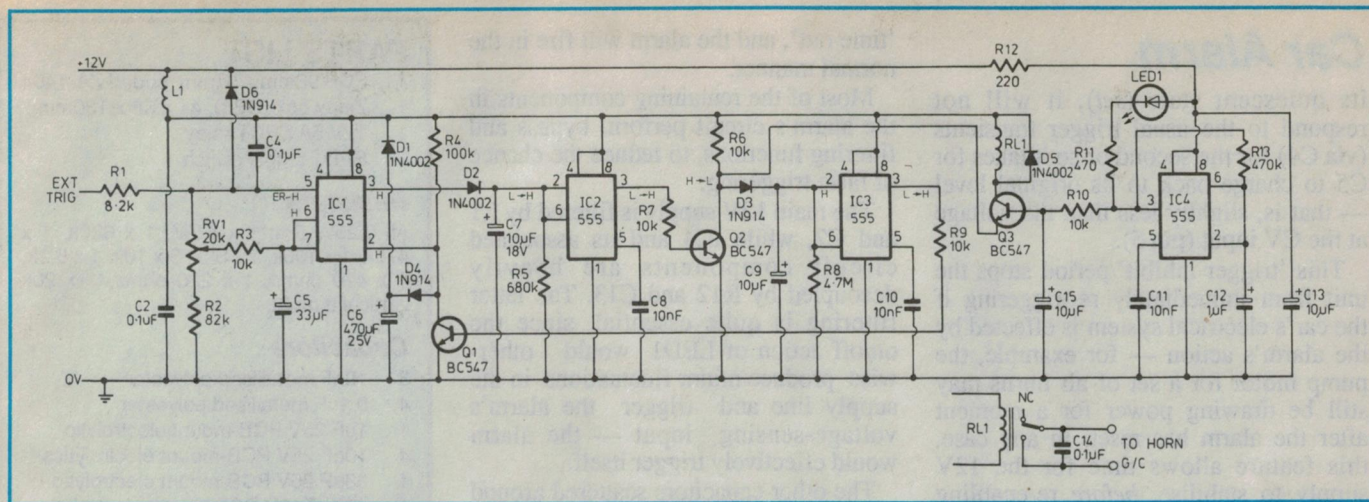
The new '084 Mk2' Budget Car Alarm offers both entry and exit delay times, a number of circuit changes to improve its immunity to false triggering, and comes as a complete kit with the box included. As with the previous

design, it also offers the convenient voltage sensing trigger circuit, automatic reset (after around 50 seconds), a flashing warning indicator LED, provision for an external trigger input (boot, bonnet, etc), and a straightforward



**An inside view of the completed alarm. As you can see, only a modest number of components are used, despite the circuit's many features.**





The circuit makes very effective use of four standard 555 timer chips. IC1 detects and latches the alarm trigger, IC2 and IC3 provide the entry and alarm time delay periods respectively, and IC4 supplies a pulsed signal for the warning lamp and output relay.

ward construction and installation method.

As it turns out, DSE is able to offer the complete new kit at only \$32.95 — which represents excellent value in effective car security. So for those who aren't keen to go through the more complicated installation procedure required by the more elaborate alarms, the new Budget Car Alarm Mk2 is an ideal choice.

Since DSE have totally re-designed the printed circuit board (PCB) to accommodate the alarm's new features, the PCB pattern is now proprietary to DSE, and other firms are not able to sell it. Individual constructors are of course free to etch their own PCB from the published circuit, and build the alarm from the ground up. However, most of us find it convenient simply to buy a complete kit, and put it together with a minimum of trouble.

Needless to say, a kit of all the parts needed to complete the Budget Car Alarm Mk2 is available from your nearest DSE store. It's priced at \$32.95 as mentioned above, and is designated K-4310.

## How it works

While the new alarm's circuit may look a little complex, its actual operation is really quite straightforward — particularly if you have a reasonable idea of how the 555 timer chip functions (see box 'The 555 precision timer').

As can be seen from the schematic diagram, the circuit uses a total of four 555's to perform the timing and sensing operations needed for the alarm's various features. The trigger sensing, entry delay, alarm sounding period, and

relay/LED action are controlled by the circuits based around IC1, IC2, IC3 and IC4 respectively.

Starting at the trigger sensing section, we can follow through each stage of the alarm's operation in a sequential manner. The trigger circuit is formed around IC1, which has its inputs arranged so that the voltage at the 555's threshold pin (6) is compared with that of the control voltage terminal (pin 5), and has its internal flip-flop in a normally set condition (that is, the output at pin 3 is high).

Since the voltage at pin 6 is derived by the voltage divider formed by RV1 and R2, it will be at a slightly lower level than that of pin 5 — which is nominally  $2/3V_{cc}$ , or in this case around 8 volts. Any rapid voltage drop in the car's wiring will be passed directly to pin 5 via C4, while pin 6 will remain at its existing level due to the filtering action of R3 and C5. This causes IC1 to change states (reset), driving its output (pin 3) to a low level. The alarm has now been triggered...

This action then reverse biases D2 — since C7 was previously charged to a high level from IC1's output — allowing C7 to discharge towards ground potential via R5.

This falling level is monitored by both the trigger and threshold inputs of IC2, which effectively functions as an inverting Schmitt trigger — that is, its output will drive low when the input(s) are above about 8V ( $2/3V_{cc}$ ), and drive high for an input level below 4V ( $1/3V_{cc}$ ). Consequently, after a delay of around nine seconds (the entry delay time) IC2's output will go high, biasing Q2 hard-on via R7.

The collector of Q2 then falls to a low

level, which both reverse biases D3, and also provides a path to ground for the emitter of Q3 — which in turn energises the alarm relay (more of this later). Since C9 was previously charged to high level via D3 and R6, it will now slowly discharge via R8 until IC3 changes state.

IC3 is connected in the same Schmitt trigger-type configuration as IC2, which means that after a delay period of about 50 seconds (the alarm sounding period) its output will switch to a high level, driving Q1 into saturation via R9.

Q1 is arranged to reset the alarm after the delay period generated by IC3. Since the collector of Q1 is connected to the trigger input of IC1 (pin 2), and is normally held at a high level by R4, IC1 will be forced back into its set state when Q1 is turned on. The output of IC1 (pin 3) then returns to its normal high level, C7 is charged via D2, IC2 turns Q2 off, Q3 de-energises RL1 and the alarm stops sounding. The action of Q2 also allows R6 to rapidly charge C9, and the output of IC3 consequently returns to its low level. This overall reset sequence takes about 100ms to occur.

Note that IC1's discharge terminal (pin 7) is also connected to the trigger reference voltage at C5, as well as the threshold input (pin 6). This means that when IC1 has changed to its reset condition in response to an alarm trigger, C5 is held discharged via pin 7 until the 555 is set again by the action of Q1 (that is, the alarm has finished sounding). When this occurs, the 555's internal discharge transistor is turned off, allowing C5 to slowly charge to its normal potential via R3.

Therefore, even though IC1 is back in



## Car Alarm

its quiescent state (*set*), it will not respond to the usual trigger transients (via C4) for the second or so it takes for C5 to charge back to its original level — that is, slightly less than the voltage at the CV input (pin 5).

This 'trigger inhibit' period stops the unit from immediately re-triggering if the car's electrical system is effected by the alarm's action — for example, the pump motor for a set of air horns may still be drawing power for a moment after the alarm has reset. In any case, this feature allows time for the 12V supply to stabilise, *before* re-enabling the alarm's trigger function.

The final section of the circuit based around IC4 drives the warning indicator light LED1, and provides the on/off drive signal for RL1.

This 555 is configured in a standard astable mode running at around 1Hz, with its output (pin 3) driving both LED1 via current limiting resistor R11, and the base of Q3 via R10.

When the alarm has been triggered causing the emitter of Q3 to be grounded via Q2, RL1 is then energised and de-energised in sympathy with the signal from IC4. As you would expect, LED1 runs continuously at the 1Hz rate.

RL1's contacts (as shown at the bottom of the schematic) are used to connect power to the car's horn, siren or other warning device. While the relay's contacts should be robust enough to cope with any likely load, C14 has been included to help quell any serious arcing produced when switching high-current inductive loads.

The alarm's exit delay time is controlled by the action of R4 and C6 at the trigger input (pin 2) of IC1 — in effect, it behaves as a power-on reset circuit. When power is first applied to the alarm, C6 is in a discharged state and presents a low voltage level to IC1's trigger input, forcing the 555 into the required *set* condition.

If a alarm trigger pulse is encountered at pin 5 under these conditions (when pin 2 is low) the 555 will flip into its *reset* condition, but only for the duration of the pulse, since it will be immediately *set* again by the low level at the trigger input. In other words, IC1 cannot *latch* into its reset condition and ultimately fire the alarm — so in effect, the trigger pulses are ignored.

Once the voltage at C6 rises above about 4 volts (1/3Vcc) however, the 555 will stay in its reset state when a trigger pulse occurs, the entry delay circuit will

'time out', and the alarm will fire in the normal manner.

Most of the remaining components in the alarm's circuit perform bypass and filtering functions, to reduce the chance of false triggering.

The main 12V supply is filtered by L1 and C2, while IC4 and its associated circuit components are heavily decoupled by R12 and C13. The latter filtering is quite essential, since the on/off action of LED1 would otherwise produce minor fluctuations in the supply line and trigger the alarm's voltage-sensing input — the alarm would effectively trigger itself.

The other capacitors scattered around the circuit provide extra filtering at potentially sensitive points, and again help to ensure that the circuit is stable under all conditions.

You may also notice that R1 is connected to the main triggering point at IC1 (pin 5), so that a low level at the external trigger point (that is, connecting it to ground) will also *set* IC1 and ultimately sound the alarm.

## Construction

The budget alarm is really quite simple to build, and should be up and running in a short time. All of the components (except the indicator LED) fit onto one small printed circuit board (PCB) measuring 92 x 57mm, and coded ZA-1404.

Commence construction by installing all of the lower profile components, and work your way through to the larger items, ending in the relay. Take particular care with the orientation of any polarised components, such as the 555 ICs (which all face in the same direction), diodes, and electrolytic capacitors — refer to the component overlay at all

## PARTS LIST

- 1 PCB 92mm x 57mm, coded ZA-1404
- 1 Zippy box (UB3), 41 x 68 x 130mm
- 1 12V 5A SPDT relay
- 1 SPDT toggle switch

## Resistors

All 0.25W 5%: 1 x 4.7M, 1 x 680k, 1 x 470k, 1 x 100k, 1 x 82k, 5 x 10k, 1 x 8.2k, 1 x 470 ohms, 1 x 220 ohms, 1 x 20k vertical trimpot.

## Capacitors

- 3 10nF metallised polyester
- 4 0.1µF metallised polyester
- 1 1µF 25V PCB-mount electrolytic
- 4 10µF 25V PCB-mount electrolytics
- 1 33µF 25V PCB-mount electrolytic
- 1 470µF 16V PCB-mount electrolytics

## Semiconductors

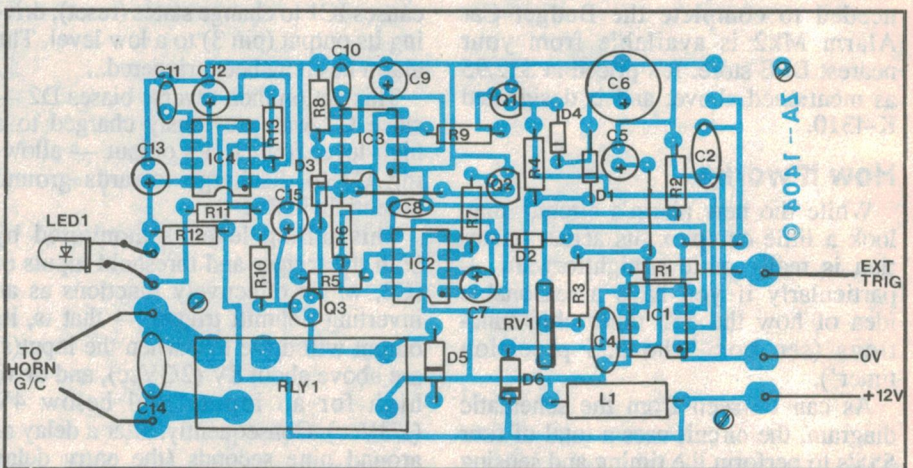
- 4 555 timer ICs
- 3 BC547 NPN transistors
- 1 5mm red LED
- 2 1N914 diodes
- 3 1N4002 diode

## Miscellaneous

Short length of 26B&S enamelled copper wire; hookup wire; 8-pin IC sockets (optional); PCB spacers with captive screws; PCB pins, solder etc.

times. The coil L1 is made by winding about 30 turns of 26 B&S enamelled copper wire around a 6mm (1/4") round former — the shank of a drill bit is quite suitable. Remove the former, and *thoroughly* scrape off the enamel coating from the ends of the wire, so that reliable solder connections can be made to the PCB pads.

Finally, install PCB pins (a total of seven) in all of the external connection pads, and connect suitable lengths of wire to each wiring point as shown in the component overlay — the actual



**Follow this component overlay diagram at all times during the construction procedure. Note how few external connections are needed to wire the alarm into a vehicle.**



## The 555 precision timer

The ubiquitous 555 timer chip is a low-cost, rugged, and above all, truly versatile device. With the addition of only a few components, it can perform a wide range of timing applications with impressive accuracy — just as its name implies. However, by changing the manner in which it's connected to the surrounding circuitry, the 555 can also be made to function as a flip-flop, a Schmitt trigger, a pulse modulator, an audio amplifier (see *EA* February 1980), and a host of other circuit 'building blocks'.

The main reason for this versatility is that the 555 has quite defined characteristics, and a number of its pins are connected to the key points in its internal circuitry. As can be seen from Fig.1, the 555's circuit is based around two voltage comparators (labeled '1' and '2') and an R-S flip-flop — comparator 1 drives the flip-flop's reset (R) input, while comparator 2 feeds the set (S) input.

Considering comparator 1 for the moment, we can see that the non-inverting input is connected to the chip's 'threshold' pin, while the remaining inverting input is hardwired to point X in the voltage divider formed by RA, RB and RC. Since these resistors are of equal value, point X will be at a voltage level of  $2/3V_{cc}$ , which sets the reference point for comparator 1. So as the voltage level at the threshold pin passes through  $2/3V_{cc}$ , the comparator's output will change state.

Comparator 2 is connected in a similar manner, except that in this case its non-inverting input is connected to a voltage reference set to only  $1/3V_{cc}$  (point Y). Therefore, as the voltage at the 555's trigger input falls below  $1/3V_{cc}$ , comparator 2's output will drive to a high level causing the flip-flop to set — as you would expect, any further action at the trigger input will be ignored, since the flip-flop is already in a set state.

To reset the flip-flop, the voltage at the threshold input must be raised above  $2/3V_{cc}$ , where the output of comparator 1 will drive high. Since the flip-flop's Q-bar

output is connected to an inverting output amplifier (as shown), a reset condition will ultimately cause a low level at the 555's main output (pin 3) — conversely, a set state holds this output at a high level. This main output by the way, can sink or source currents as high as 200mA, which is quite an advantage in some circuits.

An NPN transistor (QD) is shown in Fig.1 to represent the discharge facility offered by the 555 chip. When the flip-flop is in its reset condition, its Q-bar output turns this transistor hard on, allowing an external capacitor to be discharged to ground via the collector connection at pin 7.

The chip also has a master reset option as shown connected to pin 4, which as you would expect, resets the flip-flop regardless of the state of other inputs. Also, since the threshold input (comparator 1) controls the flip-flop's reset (R) input, it will always take priority over the set action of the trigger input — just as with any other R-S flip-flop.

In practice, this means that if the threshold pin is at a high level and the trigger input is low (that is, the flip-flop has both its R and S inputs activated), the 555 will remain in a reset state — in short, the threshold (reset) input overrides the trigger (set) input.

The 555's remaining pin, labeled 'control voltage' (pin 5), is connected directly to the 'X' reference point at comparator 1's inverting input. This allows the voltage at this point to be manipulated by external circuitry, so as to trim or fine-tune the comparator's changeover points. When the 555 is used in straightforward timing applications for example, the control voltage input can be used to alter the timing period 'on the fly', for a variety of modulation effects.

So all in all, there's plenty of scope for customising the way in which a 555 operates in a circuit. While most of us are probably familiar with its standard monostable and astable arrangements, there are a number of other configurations (both simpler and more complex) which make efficient use of this versatile little chip.

length of each wire will depend upon the distances involved in your particular installation. Then screw the completed PCB to the lid of the case (via small spacers) as shown in the associated shots, and the alarm is ready to go.

## Testing & installation

Ideally, the alarm should be tested before it is installed in the car, since access may be rather difficult once the unit is in place. The most convenient method is to place the alarm on the car's front seat, and connect its power wires to a normally active 12V source — that is, one that is not switched via the ignition key.

Wait a moment, then operate (say) the courtesy light and check that the relay starts activating after the entry delay period. If the alarm doesn't respond, try adjusting RV1 until reliable triggering is achieved.

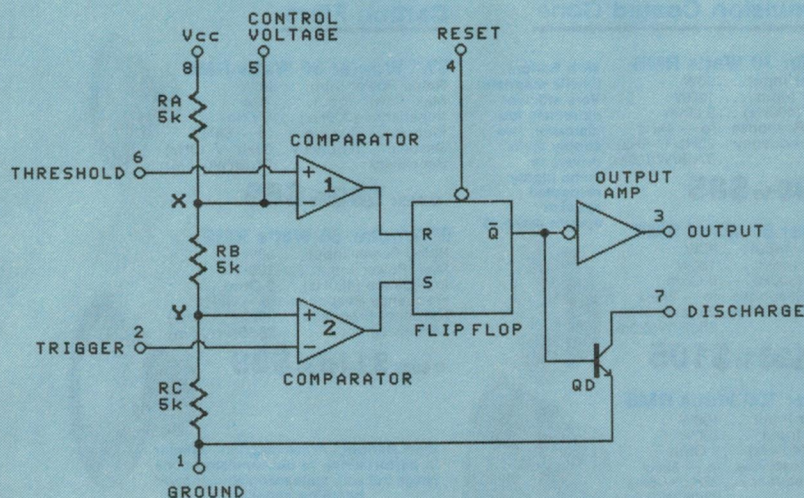
Don't adjust this control for too high a sensitivity however, as this may cause false triggering. Once you are happy with the alarm's operation, the unit can be mounted in some hidden position (under the dash is the usual).

The warning LED is installed in a very visible location, the 'horn' wires connected to the horn relay, and the power wires reliably joined to the car's active wiring via a hidden on/off switch. This connection point should be well 'down stream' from the car's battery, where any local electrical activity causes the most voltage deviation. If desired the alarm's external trigger wire can be connected to ground-switching boot or bonnet switches, so that these normally unprotected areas will also trigger the alarm.

Of course, fitting a courtesy light and switch to the boot or bonnet will avoid the need to use the external trigger feature (and install extra wiring), since the voltage transients produced by the additional lamps will then trigger the alarm's voltage-sensing circuit.

By the way, if you find that the alarm's existing delay times don't suit your particular needs, they can be adjusted by simply scaling the relevant RC combinations. For example, the run time (or sounding period) can be reduced by just decreasing the value of R8.

In a similar manner, the exit time, entry time, and flasher/relay pulsing rate can be changed by altering the values of R4/C6, R5/C7 and R13/C12 respectively — in fact, you should only need to adjust the value of the relevant resistor to cause a reasonable change in delay time. ■







## FREE CALCULATORS - AMAZING OPPORTUNITY

An American Industrialist once remarked "I believe that half of our advertising is ineffective - the trouble is, we don't know which half!" Well - as the year draws to a close we've decided to conduct a survey on our advertising i.e. to see where our advt's are noticed most. So when you see this notice simply ring us Toll Free on 008 999 007, advising us which magazine you saw the advt and we'll be delighted to send you absolutely without charge one of our fantastic X 2110 Desk Calculators - there is no obligation - you do not need to make any purchase. (Limit one per customer).



## Sensational Value On UHF Alarm Systems

### Main Control Receiver

The main control receiver runs on 240V AC with a 12V 1.2Ah battery for emergency backup. The range between the transmitters and the receiver is normally 80 metres in open space.

**Features:** • Wireless reception of external and internal sensors & detectors • Selectable home or away modes for selecting internal or external arming or just external to allow movement inside the building • Built in piezo electric siren gives different signals to indicate different functions • Sends signal down power line to activate remote siren • Programmable arm/disarm switch buttons

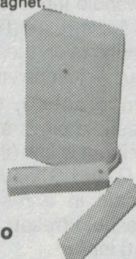
### Passive Infra Red Movement Detector

Ideal for the lounge/room, family room or hallways. Mounts up on the wall or bookshelf. Detects movement within an area of 9 x 9m.



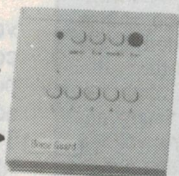
### Remote Reed Switch

This consists of an enclosed reed switch and transmitter with a magnet.



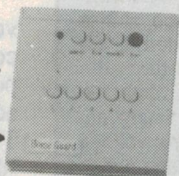
### Remote Piezo Alarm

This unit is a line carrier receiver, ie. plugs into 240V AC and receives signal through AC line.



### Front Door Remote Keypad

This handy unit virtually duplicates the function of the main control unit but at a more convenient location, ie. just inside the front or rear door etc. System can be armed or disarmed without the need to go to the main control unit.



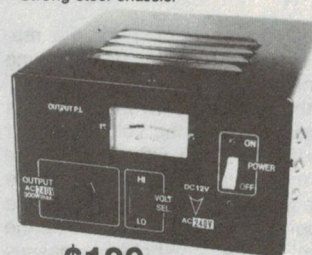
## 300 Watt Inverter

Go anywhere 240V mains power from your car battery with this fantastic 12V DC to AC inverter.

This compact inverter will power lights, power tools, electric shavers, radios etc. A must for farming, camping, mining, boating and wherever 240V power isn't available.

### Features:

- Complete with over current circuit breaker
- Fused 240V output
- Built in panel meter to monitor output voltage
- Strong steel chassis.



M 8120 **\$199.00**

## Superb Dome Tweeter Bargain of 1991 Less Than 1/2 Price!

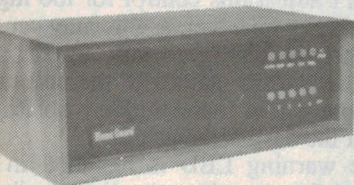
Dome Tweeter With Ferro Fluid 60 Watt Max. Power. Silky smooth frequency response 1.5Hz to 20kHz. Wide angle dispersion. Massive power handling capacity. Diam. 94mm. High spectrum. Purity. Incredible low price!



C 3012 **\$29.50**

This Month **\$12.00**

10 up **\$10.00**



**Requires no wiring which makes it a cinch to install. Do it yourself and save on installation and over 50% off regular prices.**

### SYSTEM 1

**Includes:**  
1 x Main Controller  
3 x Remote Reed Switches  
1 x Remote PIR Movement Detector  
1 x Remote Keypad  
1 x Remote Siren  
Plus 4 Bonus Large Alarm Warning Stickers  
**This Month Only \$399**  
NORMALLY **\$865**

### SYSTEM 2

**Includes:**  
1 x Main Controller  
3 x Remote Reed Switches  
Plus 4 Bonus Large Alarm Warning Stickers  
**This Month Only \$249**  
NORMALLY **\$515**

### SYSTEM 3

**Includes:**  
1 x Main Controller  
1 x Remote Reed Switch  
1 x Remote PIR Movement Detector  
1 x Remote Keypad  
Plus 4 Bonus Large Alarm Warning Stickers  
**This Month Only \$299**  
NORMALLY **\$630**

## Quality Speaker Bargains — Up to 30% Off

### Polypropylene

#### 10" Woofer 60 Watts RMS

Rated Power Input... 60W  
Max. Power Input... 100W  
Impedance (300Hz) ... 8 Ohm  
Frequency Response .fo — 4kHz  
Resonant Frequency .45Hz(+/-9Hz)  
Sensitivity ..... 98dB/W(0.5m)

**Excellent base register performance**

C 3065 ~~\$69.00~~ **\$60**

#### 12" Woofer 100 Watts RMS

Rated Power Input... 100W  
Max. Power Input... 150W  
Impedance (200Hz) ... 8 Ohm  
Frequency Response .fo — 3kHz  
Resonant Frequency .30Hz(+/-6Hz)  
Sensitivity ..... 98dB/W(0.5m)

C 3070 ~~\$99.00~~ **\$85**

#### 15" Woofer 120 Watts RMS

Rated Power Input... 120W  
Max. Power Input... 200W  
Impedance (200Hz) ... 8 Ohm  
Frequency Response .fo — 15kHz  
Resonant Frequency .25Hz(+/-5Hz)  
Sensitivity ..... 98dB/W(0.5m)

C 3075 ~~\$129.00~~ **\$95**



### Poly Emulsion Coated Cone

#### 10" Woofer 80 Watts RMS

Rated Power Input... 80W  
Max. Power Input... 130W  
Impedance (400Hz) ... 8 Ohm  
Frequency Response .fo — 4kHz  
Resonant Frequency .28Hz(+/-5Hz)  
Sensitivity ..... 97dB/W(0.5m)

C 3026 ~~\$99.95~~ **\$85**

#### 12" Woofer 80 Watts RMS

Rated Power Input... 80W  
Max. Power Input... 160W  
Impedance (300Hz) ... 8 Ohm  
Frequency Response .fo — 3kHz  
Resonant Frequency .25Hz(+/-5Hz)  
Sensitivity ..... 98dB/W(0.5m)

C 3030 ~~\$125.00~~ **\$105**

#### 15" Woofer 100 Watts RMS

Rated Power Input... 100W  
Max. Power Input... 200W  
Impedance (400Hz) ... 8 Ohm  
Frequency Response .fo — 3kHz  
Resonant Frequency .25Hz(+/-5Hz)  
Sensitivity ..... 98dB/W(0.5m)

C 3032 ~~\$235.00~~ **\$169**

**With Barium Ferrite magnets. Very efficient - extremely low distortion (we supply these drivers to some highly respected speaker makers)**



### Carbon Fibre

#### 6 1/2" Woofer 30 Watts RMS

Rated Power Input... 30W  
Max. Power Input... 70W  
Impedance (300Hz) ... 8 Ohm  
Frequency Response .fo — 6kHz  
Resonant Frequency .65Hz(+/-13Hz)  
Sensitivity ..... 97dB/W(0.5m)

C 3034 ~~\$82.55~~ **\$69**

#### 8" Woofer 60 Watts RMS

Rated Power Input... 60W  
Max. Power Input... 100W  
Impedance (400Hz) ... 8 Ohm  
Frequency Response .fo — 5kHz  
Resonant Frequency .50Hz(+/-10Hz)  
Sensitivity ..... 98dB/W(0.5m)

C 3036 ~~\$115.55~~ **\$89**

**With Barium Ferrite magnets. Similar in performance to our emulsion cone range but with quite astonishing power handling capacity**

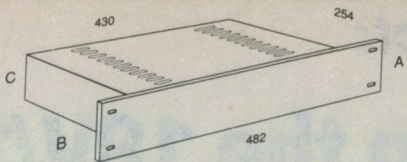




## Rack Cases

### Features:

- Raw aluminium, black or natural anodised finish
- These beautifully crafted rack cabinet boxes will give your equipment a really 1st class appearance
- Aluminium construction with removable top and bottom steel cover panels
- All dimensions conforms to the International Standard
- Ventilated lid
- Deluxe finish front panel
- Individually cartoned
- Supplied in Flat Pack Form - Easily assembled in minutes.



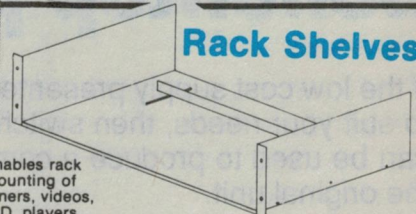
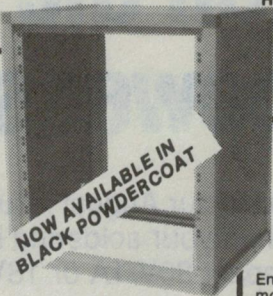
Cat No.	Unit Height	A	B	C	Finish	Ea.
H 5011	1U	44	32	38	Raw Alum.	\$59.95
H 5012	2U	88	76	79	Raw Alum.	\$78.95
H 5013	3U	132	54	122	Raw Alum.	\$82.95
H 5021	1U	44	32	38	Nat Anod.	\$85.95
H 5022	2U	88	76	79	Nat Anod.	\$82.95
H 5023	3U	132	54	122	Nat Anod.	\$89.95
H 5031	1U	44	32	38	Blk Anod.	\$85.95
H 5032	2U	88	76	79	Blk Anod.	\$82.95
H 5033	3U	132	54	122	Blk Anod.	\$89.95

• REVOLUTIONARY NEW EXTRUDED DESIGN ELIMINATES THE NEED FOR VISIBLE BOLTHEADS THROUGH THE FRONT PANEL

## Australian Designed and Manufactured Professional Series Modular Rack Frames

Suitable for home or commercial use, these fantastic rack frames are durable strong, good looking, light weight and easy to assemble. The frames are available in either Natural Anodised aluminium or Black Powder Coat aluminium and the side panels in Electric Blue or Black Powder Coat finish.

Ideal for use in home Hi-Fi systems, Professional Audio installations, Band Gigs, Computer Patch panel etc.



Enables rack mounting of tuners, videos, C.D. players, amplifiers etc. which normally can't be rack mounted. Supplied in flat pack form - easily assembled in minutes. Available in black only.

STOP PRESS - NOW AVAILABLE IN 2 & 4 UNIT SIZES!

H 5352	2 Unit (88mm)	\$49.95
H 5353	3 Unit (132mm)	\$49.95
H 5354	4 Unit (176mm)	\$55.95

Were	Now	Were	Now		
H 5204	\$139	\$125	H 5304	\$139	\$125
H 5205	\$40	\$44	H 5305	\$40	\$44
H 5206	\$149	\$135	H 5306	\$149	\$135
H 5207	\$45	\$49	H 5307	\$45	\$49
H 5212	\$189	\$152	H 5312	\$189	\$152
H 5213	\$89	\$80	H 5313	\$89	\$80
H 5218	\$89	\$170	H 5318	\$89	\$170
H 5219	\$110	\$99	H 5319	\$110	\$99
H 5230	\$229	\$205	H 5330	\$229	\$205
H 5231	\$159	\$143	H 5331	\$159	\$143
H 5238	\$289	\$242	H 5338	\$289	\$242
H 5239	\$195	\$175	H 5339	\$195	\$175

## Great Value Altronics Kits

### Sub-Woofers Adaptor

Get an amazing bass improvement from your stereo system. This fantastic adaptor simply "samples" your stereo amp output and provides a single channel output to feed a separate sub-woofer amp.

K 5560 \$29.95

M 9020 12V AC Adaptor To Suit \$16.95



### Universal High Power Amplifier Module

K 5140 \$69.00

All components, including output transistors mount on a single PCB. Suitable for high quality guitar amp, public address or in a high fidelity stereo amplifier. Kit includes angled heatsink bracket, main heatsink and unlike other kit suppliers, the in-built Polyswitch for loudspeaker protection.



### Door Minder

This project will sense a door opening in a large or small room and will sound a two-tone chime. It does not have to be anywhere near the doorway as it uses an ingenious sensor to detect the pressure change caused when the door opens.

K 1915 \$45.00

This Month \$29.00



### Beat Triggered Strobe

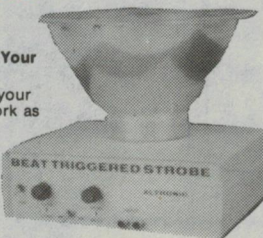
Add Some Life To Your Next Party

Flashes in time to your music. Will also work as normal strobe.

K 5790 \$79.95

K 5795 Two Tube

Option \$16.50



### Speech Synthesizer

Here is a self contained Speech Synthesizer that does not require a computer to control it. It can be connected to almost any appliance, vehicle or home remote control system to let you know when the kettle has switched off, the doors are locked or the water in the radiator is boiling. Blank Eprom included.

K 9500 \$95.00

This Month Only \$85.00

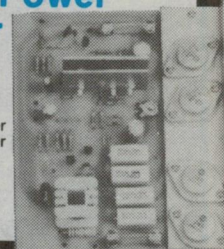
K 9502 Pre-Programmed Eprom \$20.00



### Playmaster Pro Series 1 Power Amplifier Module

Fantastic for use in Juke boxes, amplifier racks (multi-amplifier setups) discos etc.

K 5170 \$85.00



# ALTRONICS

174 Roe St. PERTH W.A. 6000 Phone (09) 328 2199  
PHONE ORDER TOLL FREE 008 999 007  
MAIL ORDER C/- P.O. Box 8350 Perth Stirling St. W.A. 6849

STANDARD DELIVERY & PACKING CHARGE \$5.50 to 1Kg, \$8 1Kg-5Kg.  
AUSTRALIA WIDE - Via Australia Post allow approx 7 days for delivery.  
OVERNIGHT JETSERVICE Up to 3Kg is \$10.00, 3Kg to 5Kg is \$28.00. Overnight Jetservice Courier for delivery next day Country areas please allow additional 24-48 hours.

WA COUNTRY ALBANY BP Electronics (098) 412681 Micro Electronics (098) 412077 BUNBURY Micro Electronics (097) 216222 ESPERANCE Esperance Communications (090) 713344 KALGOORLIE Todays Electronics (090) 215212 MANDURAH Lance Rock Retravision (09) 535 1246 Micro Electronics (09) 5812206 PORT HEDLAND Ivan Tomek Electronics (091) 732531 ROCKINGHAM TV Joe's (09) 5271806 NT ALICE SPRINGS Farmer Electronics (089) 522388 DARWIN Venronics (089) 853 622 VIC All Electronic Components (03) 6623506 The Electronic Component Shop (03) 6706474 BORONIA Ray Cross Electronics (03) 7622422 CHELTENHAM Talking Electronics (03) 5842386 CROYDON Truscott Electronics (03) 7233860 PRESTON Preston Electronics (08) 4840191 COUNTRY BAIRNSDALE LH & LM Crawford (051) 525677 BALLARAT Ballarat Electronics (053) 311947 BENDIGO KC Johnson (054) 411411 MILDURA McWilliam Electronics (050) 236410 QLD Delsound PL (07) 8396155 NEWSTEAD ECQ Electronics (07) 2541153 WEST END B.A.S. Audiotronics (07) 8447566 WOODRIDGE David Hall Electronics (07) 8082777 MAROOCHYDORE MALS Electronics (074) 436119 MARYBOROUGH Keller Electronics (071) 214559 PIALBA Keller Electronics (071) 283749 ROCKHAMPTON Access Electronics (East St.) (079) 221058 TOWNVILLE Super Solex (077) 724466 SA Force Electronics (08) 2125505 BRIGHTON Force Electronics (08) 3770512 CHRISTIES BEACH Force Electronics (08) 3823366 FINDON Force Electronics (08) 3471188 HOLDEN HILL Force Electronics (08) 2617088 LONSDALE Force Electronics (08) 3260901 ENFIELD Aztronics (08) 3496340 COUNTRY WHYALLA Eyre Electronics (086) 454764 TAS HOBART George Harvey (002) 342233 LAUNCESTON George Harvey (003) 316533 NSW David Reid Electronics (02) 2671385 SOUTH Sheridan Electronics (02) 2817727 SMITHFIELD Chantronics (02) 6097218 COUNTRY COFFS HARBOUR Coffs Harbour Electronics (066) 525684 NEWCASTLE Novocastrian Elect. Supplies (049) 621358 WARNERS BAY Vilec Distributors (049) 489405 WINDSOR M & E Elect. and Communications (045) 775935 WOLLONGONG Newtek Electronics (042) 271620.

HEAVY HEAVY SERVICE - All orders of 10Kgs or more must travel Express Road - Please allow 7 days for delivery. \$12.00 to 10Kgs. \$15.00 over 10Kgs.

INSURANCE - As with virtually every other Australian supplier, we send goods at consignees risk. Should you require comprehensive insurance cover against loss or damage please add \$1.00 per \$100 of order value (minimum charge \$1). When phone ordering please request "Insurance".

TOLL FREE PHONE ORDER - Bankcard, Visa, Mastercard Holders can phone order toll free up to 6pm Eastern Standard Time. Remember with our Overnight Jetservice we deliver next day.

ALTRONICS RESELLERS- Chances are there is an Altronics Reseller right near you - check this list or phone us for details of the nearest dealer.

Blue Ribbon Dealers are highlighted with a ■ These dealers generally carry a comprehensive range of Altronics products and kits or we'll order any required item for you.



## Construction project:

# Variations on the 18V/1A benchtop power supply

If the low cost supply presented in our August issue didn't quite offer the current or voltage ratings to suit your needs, then switch on your soldering iron! Here we'll show you how the same design can be used to produce a compact 30V/1A or 18V/2A supply, which offers the same features as the original unit.

by **ROB EVANS**

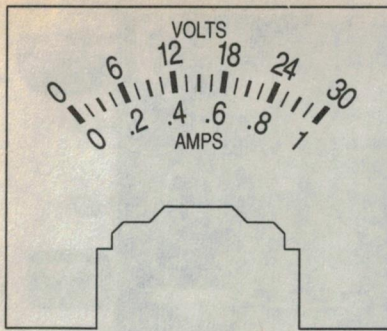
As discussed in the latter stages of the August '91 article, the 18V/1A benchtop supply's circuit and printed circuit board (PCB) were designed with increased output capabilities in mind.

A number of components are more robust than was really needed, and the PCB layout has sufficient space to allow larger, higher rated components to be installed where required. In short, it was

ready for more ambitious configurations. The first step to increasing the supply's output ratings is to install a larger power transformer, which has the current or voltage capability to suit the final







Here is the meter scale artwork for the 18V/1A alternative version of the power supply.

design's desired range. The original 18V/1A supply used the 15VAC/1A secondary winding of a 2155-type transformer (15VA), which ultimately defined the unit's maximum output current and voltage — this transformer was chosen as a balance between cost and power capability, and suited the design quite nicely. As it happens, the next larger size in the common transformer range (30VA) offers either double the current capability (the 2156 type), or twice the voltage rating (the 6672 type).

When these two transformers were first proposed as the basis of the up-rated supplies, it was assumed that a bigger (and more expensive) case would be needed to house their larger dimensions — the 2155 has a height of around 50mm, while both the 2156 and 6672 need a vertical space of about 58mm. However a certain tenacious editor

	18V/2A Version	30V/1A Version
T1	2156-type	6672-type
D1 to D4	1N5404	1N4002
C1 and C2	4700uF 25V	2200uF 50V (see text)
R2	2.2k	OMIT
R8 and R9	1.2/1.2 ohms (see text)	1 ohm
R11	1.8k	12k
C6	47uF 25V	47uF 35V
R5	680 ohms	390 ohms

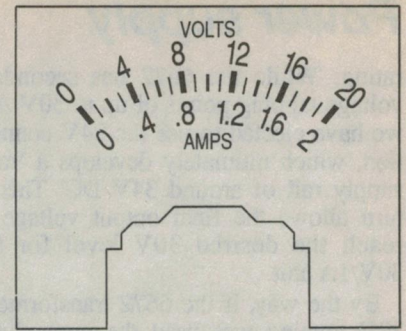
Fig.1: Use this table to choose the components for each version of the supply — the parts of interest are noted by an asterisk (\*) on the schematic diagram.

quickly proved that with a little creative box modification (more of this later), the same low-cost instrument case used for the original supply could also be used with both of the larger transformers.

The end result is that we have nearly doubled the supply's maximum output power without increasing its size, and adding very little to the overall cost.

As you have probably already gathered, the 2156-type transformer has been used to power the 18V/2A supply shown at the bottom of the lead picture, while the 6672-type is fitted to the 30V/1A unit shown on top (note the meter scales of each version).

Both supplies offer the same high performance as the earlier 18V/1A unit, can



And this is the meter scale artwork for the 18V/2A version of the power supply.

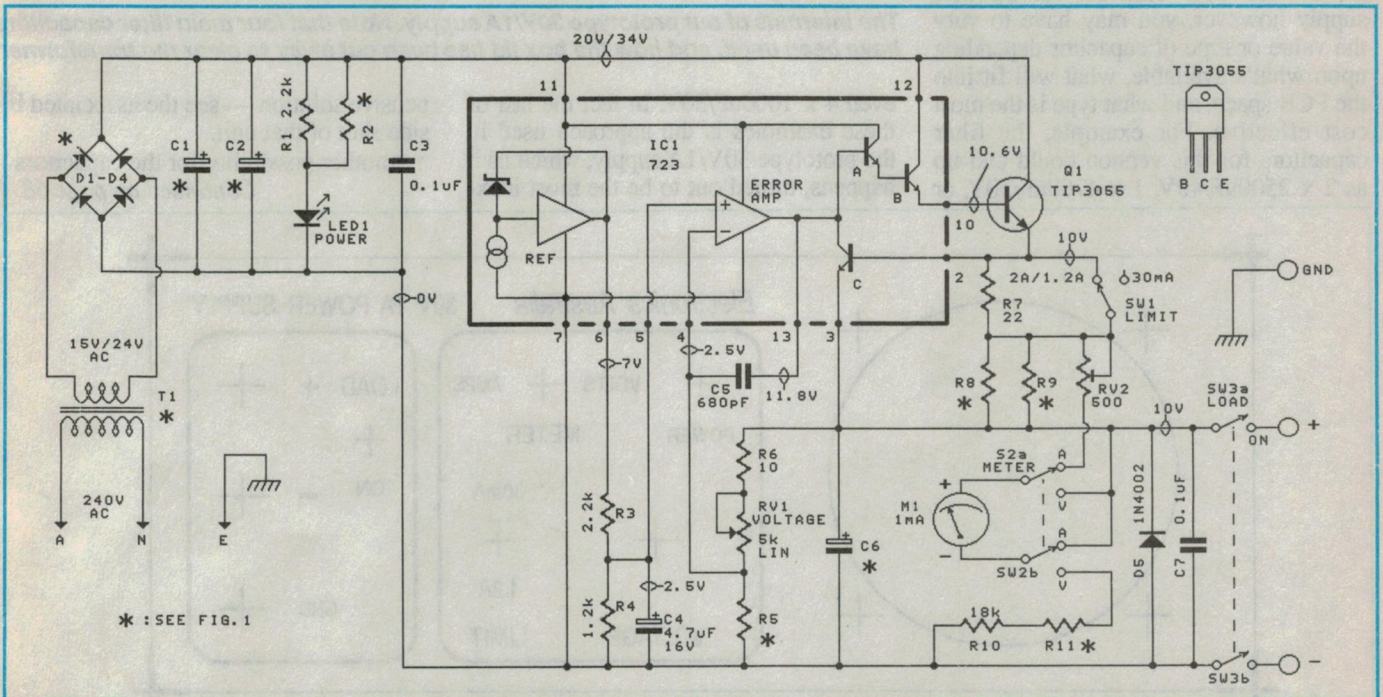
still be built with simple construction techniques, and use virtually the same basic parts.

### Circuit changes

The original circuit needs to be altered at eight or so different points, as detailed in the table shown in Fig.1.

The various components included in the table directly refer to those shown on the schematic diagram, which as you would expect, are not shown with matching values. While the supply's circuit operation is really quite straightforward, it may be worth referring back to the August '91 article at this point, so as to help you understand why the various alterations are required.

The most obvious change is the power transformer, which as discussed above, will increase the supply's current (using the 2156-type) or voltage (6672-type)



This is the schematic, showing the components that need to be changed. Fig.1 above, gives the components and values for each version of the benchtop power supply.



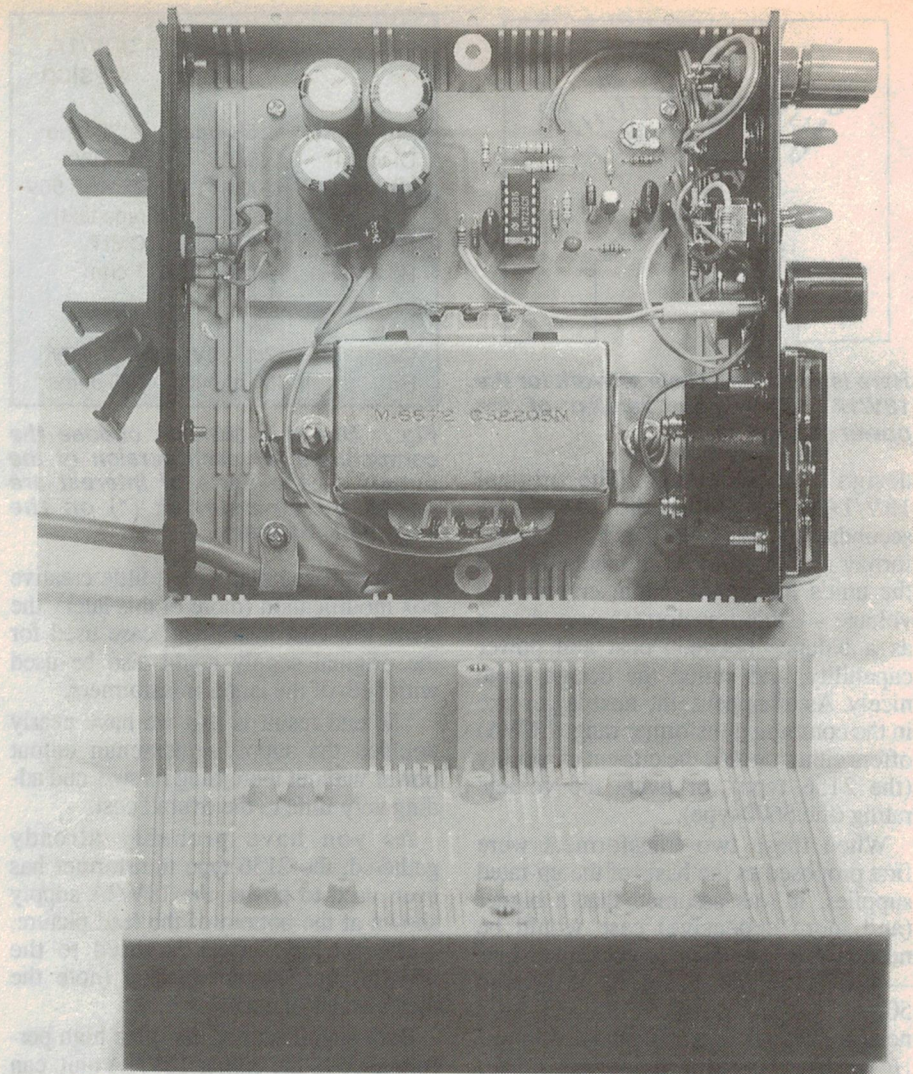
## Power supply

rating. While the 6672 has secondary voltage tapping points of up to 30V AC, we have elected to use the 24V connection, which ultimately develops a 'raw' supply rail of around 34V DC. This in turn allows the final output voltage to reach the desired 30V level for the 30V/1A unit.

By the way, if the 6672 transformer's 30V tapping was used the unregulated DC supply rail would have reached around 43V, which exceeds 723 regulator chip's maximum supply rating of 40V. Similarly the 27.5V tapping would produce a 39V rail, which is still too close for comfort. The 2156-type transformer for the 18V/2A supply simply connects in the same way as the original 2155-type unit, since their secondary voltages are the same.

Next, the four rectifier diodes (D1 to D4) have been changed to 1N4504-types (which have a 3A rating) to handle the increased current in the 18V/2A version, while the 30V/1A supply uses the same 1N4002 diodes as the original unit. However, the associated filter capacitors (C1 and C2) must be larger in both versions, since the supply rail is now delivering substantially more energy than in the original circuit.

The 4700uF 25V capacitors specified for the 18V/2A version are quite readily available and should neatly fit into the allocated PCB space. When it comes to the 2200uF 50V units for the 30V/1A supply however, you may have to vary the value or type of capacitor depending upon what's available, what will fit into the PCB space, and what type is the most cost effective. For example, the filter capacitors for this version could end up as 2 x 2500uF/40V, 1 x 4700uF/50V, or

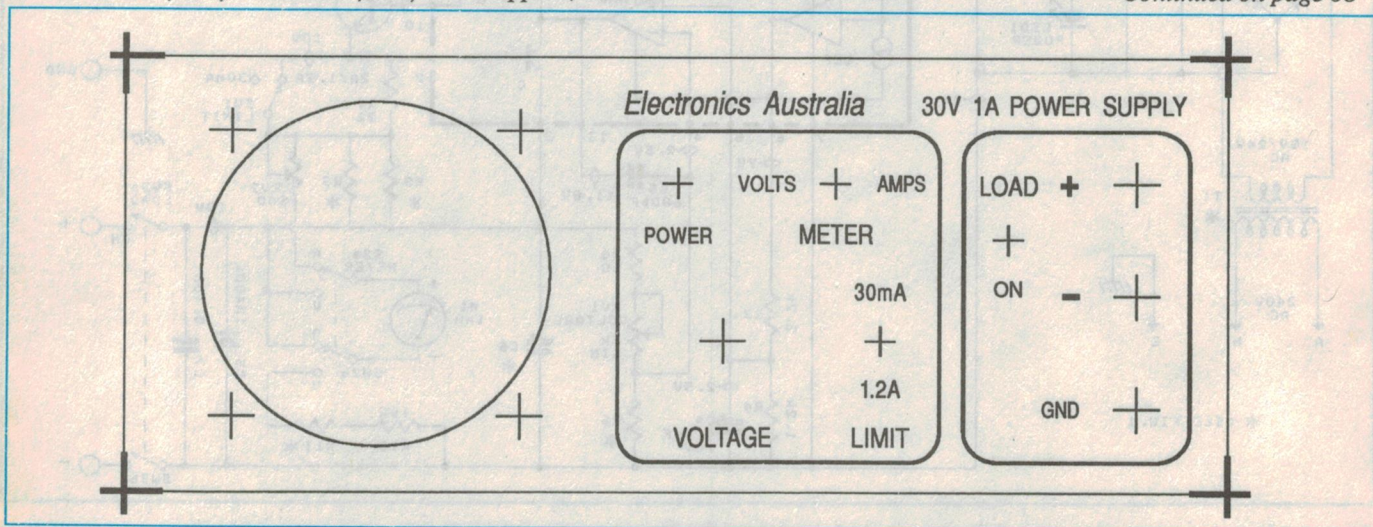


*The internals of our prototype 30V/1A supply. Note that four main filter capacitors have been used, and how the box lid has been cut away to clear the transformer.*

even 4 x 1000uF/50V. In fact the last of these examples is the approach used in the prototype 30V/1A supply, which as it happens, turned out to be the most inex-

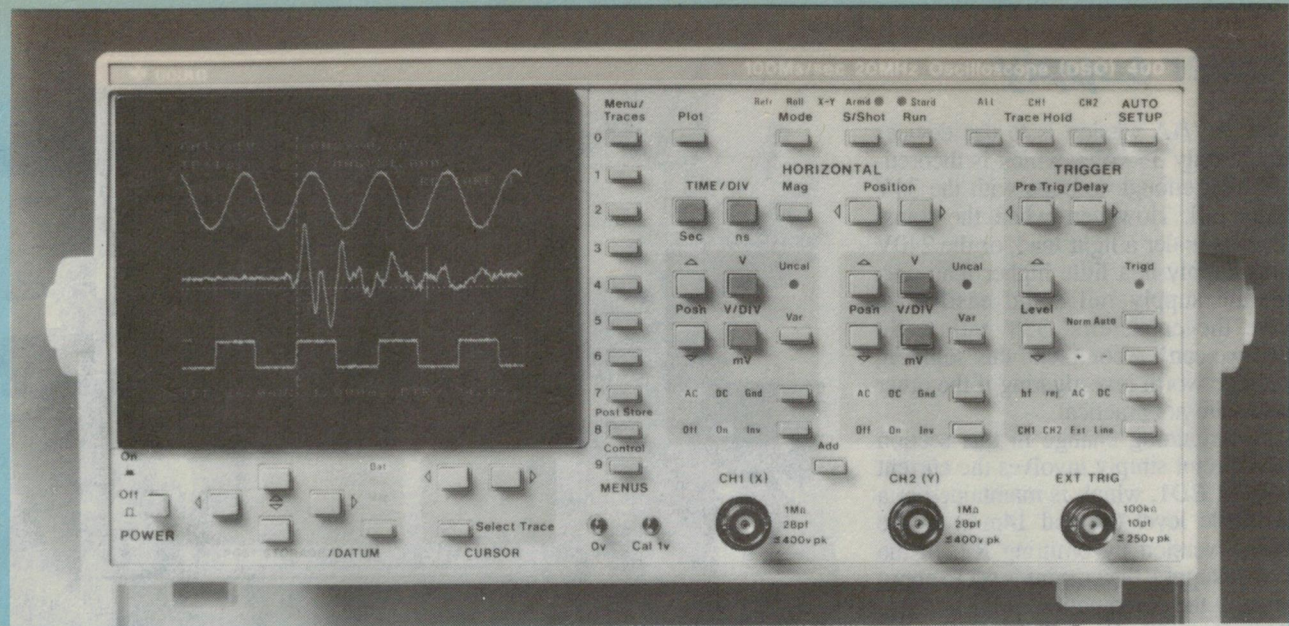
pensive solution — see the associated inside shot of that unit.

Another possibility for the capacitors  
*Continued on page 68*



*And here is the front panel artwork for the 30V 1A version of the power supply.*





# Gould 400 Series - 100Msamples/sec performance to 8bits, 10nS resolution...and you can take one with you from just \$3995\*

The Gould 400 Series offers the ultimate price to performance ratio in digital scope technology...all in an instrument that weighs just 5.5kg. 12-33Vdc operation enables you to capture high speed transient signals in almost any environment - on oil rigs, in the outback, even up a power pole - and take the data back to the lab for analysis.

**Model 420** has an internal colour plotter with real time clock and a wider range of waveform processing functions:

#### Cursor Measurements

Voltage and Time  
Peak to Peak  
Max - Min  
Risetime (falltime)  
Overshoot (Preshoot)  
Pulse width  
Frequency, Period, Duty Cycle  
RMS  
Area

#### Trace Manipulation

Filter (6 frequency steps)  
Invert  
Integrate

#### Trace Arithmetic

Add  
Subtract  
Multiply  
Limits Testing and Persistence.

**Model 450** offers all the capabilities of the 420 but with an extended bandwidth of 50MHz and ETS to 5ns/div (x10mag). Just check the basic spec alongside and call us to arrange a demonstration.



READER INFO NO. 11

## ELMEASCO Instruments Pty. Ltd.

#### NEW SOUTH WALES

18 Hilly Street,  
MORTLAKE  
P.O. Box 30, CONCORD  
NSW 2137  
Tel: (02) 736 2888  
Telex: AA25887  
Fax: (02) 736 3005

#### VICTORIA

12 Maroondah Highway,  
RINGWOOD  
P.O. Box 623, RINGWOOD  
VIC 3134  
Tel: (03) 879 2322  
Telex: AA30418  
Fax: (03) 870 8972

#### QUEENSLAND

192 Evans Road,  
SALISBURY  
P.O. Box 274 SALISBURY  
QLD 4107  
Tel: (07) 875 1444  
Fax: (07) 277 3753

#### SOUTH AUSTRALIA

241 Churchill Road,  
PROSPECT  
P.O. Box 154 PROSPECT  
SA 5082  
Tel: (08) 344 9000  
Telex: AA87519  
Fax: (08) 269 6411

#### W. AUSTRALIA

32 Teddington Road,  
VICTORIA PARK,  
W.A. 6100  
Tel: (09) 470 1855  
Fax: (09) 470 3173

#### Basic Model 400 Specifications

##### Vertical Deflection

Bandwidth: dc to 20MHz (-3dB)  
Sensitivity: 2mV/div to 5V/div in 1-2-5 sequence

##### Horizontal Deflection

Transient Capture Sweep Rate: 500ns/div to 50s/div. 28 ranges in 1-2-5 sequence

Repetitive Sampling Sweep Rate: 200, 100ns/div

Delayed Sweep Range: 20ns to 5000s

Display Modes: Refreshed, Roll, Interpolation, Single trace, Dual trace, Single Shot, Hold All, Hold Ch1, Hold Ch2, Hold Ref.

##### Acquisition System

Max Sample Rate: 100MSamples/s on each channel

Vertical Resolution: 8 bits

Record Length: 500 words/channel

Acquisition Modes: Normal, X-Y, Average, Peak Detection

Waveform Memories: 3 non-volatile

##### Screen Measurements

Cursors can be assigned to a trace and measurements made with respect to the datums

$\Delta T$  and  $\Delta V$  displayed on screen

Trigger level indicated on screen

Readout indicates instrument settings

Arrow for off-screen indication

##### Interface (RS423)

Baud Rate: 75 to 9600baud

Data Bits: 8 (no parity)

Digital Plotter Output: HGPL format via RS423 interface

\* Gould 400 Series prices are from \$3995 ex tax, subject to change without notice

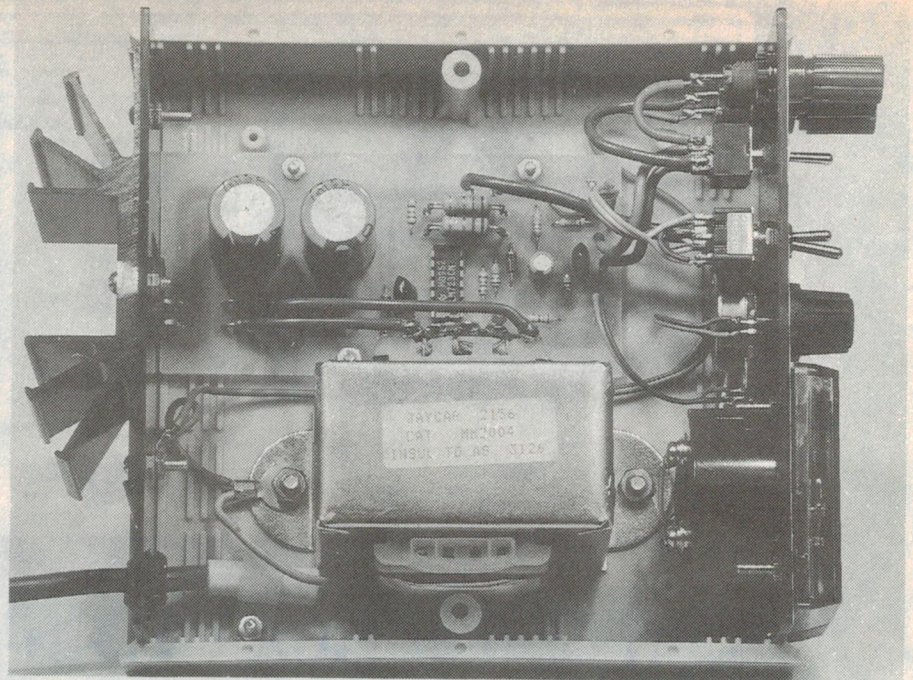


## Power supply

in the 30V/1A version is to use devices rated at only 35 volts, which is theoretically high enough to cope with the 34V supply rail. However, when the transformer is under a light load, or the 240V mains supply is a little higher than normal, the supply rail could easily rise above the capacitors' 35V rating. So while we can't recommend this solution, it may be worth investigating if the other options are not practical.

The remaining change in this section of the circuit simply involves the current level in LED1, which is maintained at a reasonable level (around 14mA) in the 30V/1A version by omitting R2. In the 18V/2A supply, the current is set to about 16mA by the combination of R1 and R2. Since we want the 30V/1A supply to have a maximum current limit of around 1.2 amps (as in the original 18V/1A version), R8 and R9 both have specified values of 1 ohm — this gives a total resistance of 0.5 ohms for IC1's current sensing transistor 'C'. The 18V/2A supply however, requires a total resistance of 0.3 ohms, to cause the circuit to shut down at around 2 amps. As it turns out, the most practical way to obtain this resistance is to install *four* 1.2 ohm resistors in parallel — that is, one parallel pair (0.6 ohms) for R8, and another pair in place of R9.

Next on the agenda is the meter voltage multiplier resistors R10 and R11, and the output filtering capacitor C6. To ensure that the meter will have a full scale voltage reading to match each version's range (30V and 20V), R11 is selected to maintain a 1mA current through the meter in both cases (12k and 1.8k respectively). Since C6 is across the supply's main output, it must have a voltage rating



An inside view of the 18V/2A version of the supply. As you can see, the 2156-type transformer is readily available from Jaycar stores.

of at least 30V for the 30V/1A version, and more than 18V for the 18V/2A supply — in fact, a 47uF 35V electrolytic takes up little PCB space, and would suit both versions.

The two alternative values for R5 are needed to define the supply's maximum output voltage, as set by the voltage adjustment potentiometer RV1. When R5 is reduced from 680 ohms to 390 ohms, the maximum gain of IC1's internal error amplifier is increased by a factor of about 1.5. This in turn means that the reference voltage at pin 5 of IC1 will be amplified by a greater amount, which ultimately drives the supply's output to around 30V when RV1 is at its maximum resistance.

So that's about it, for the changes be-

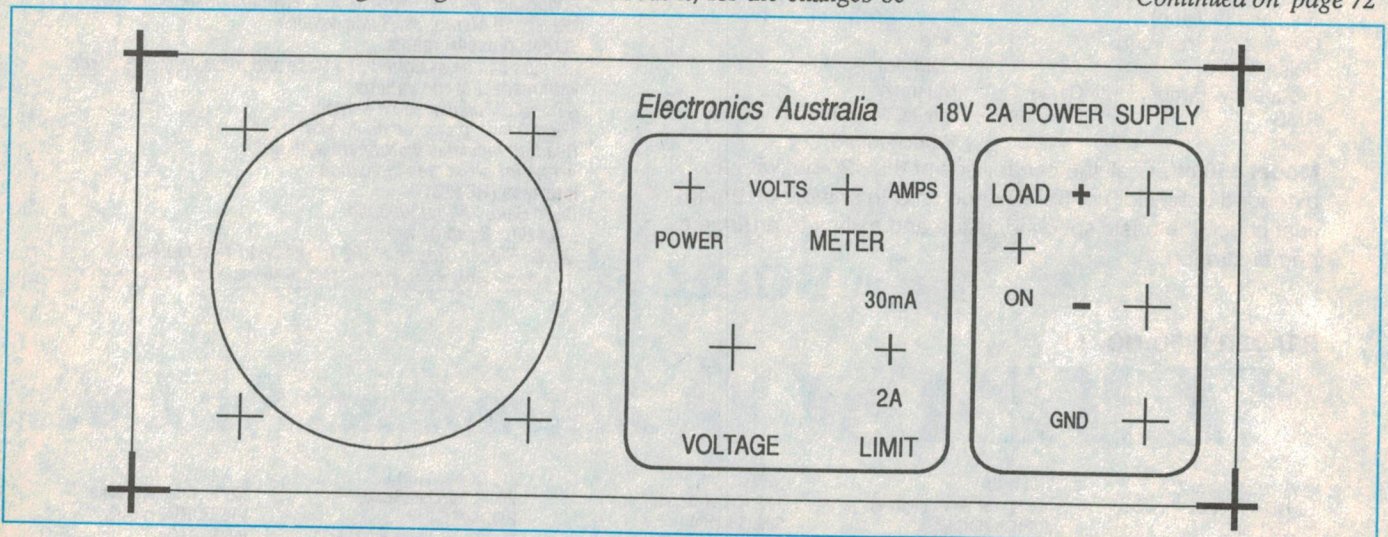
tween each version of the basic supply. If you find that your own needs are slightly different than those described above, it should be quite a simple matter to tailor the circuit accordingly.

### Construction

The construction procedure for both versions of the supply is virtually identical that of the 18V/1A unit, as described in the August issue. The only significant exceptions are the way in which the filter capacitors and current limit resistors are mounted in the 30V/1A and 18V/2A supplies respectively.

How the filter capacitors are best mounted on the PCB in the 30V/1A unit

*Continued on page 72*



Shown here is the front panel for the 18V/2A power supply, for those who would like to make their own.

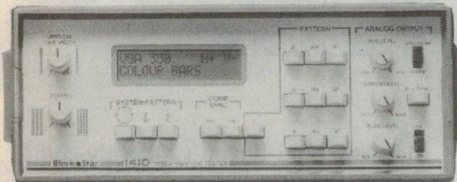


# OBIAT<sup>PTY LTD</sup> YOUR ONE STOP DISTRIBUTOR OF TEST & MEASURING INSTRUMENTS

## New Black★Star Video Monitor Tester 1410

- Checks MDA, CGA, EGA, Hercules, PGA, VGA, SVGA, 8514A, XGA and TV formats
- Microprocessor controlled
- Intelligent alpha-numeric display
- Analog RGB, TTL-IRGB, Secondary RGB, Horizontal/Vertical/Composite syncs
- Colour Bars, Test Card, Crosshatch, Dots, Ramp, Focus, Horizontal Lines, Vertical Lines, Raster and Checkerboard
- Full control over output signals
- 15.625 to 48.5kHz Line Frequencies
- 49.9 to 87Hz Frame Frequencies
- Inverse Video
- Separate Analog and TTL Outputs
- 1V and 0.7V Video
- Easy Connection via 9-way and 15-way 'D' and BNC Connectors

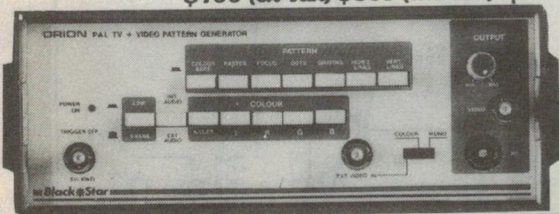
**\$1155.00 ex tax \$1328.00 inc tax**



## Orion PAL TV/Video Pattern Generator

- Tests TV, VCR, Monitors etc
- PAL B, D, G, H, I, K
- RF, Composite Video and IRGB Outputs
- Separate or Mixed Syncs
- Trigger Output
- Colour Bars, Greyscale, Crosshatch, Dots, Lines, Focus, Purity etc.
- Over 50 pattern combinations
- 1V or TTL IRGB
- 5.5, 6.0 and 6.5MHz Sound Carriers
- Internal/External Sound
- Mains Operated

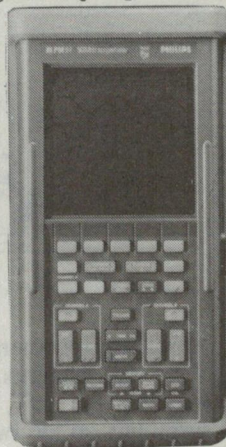
**\$755 (ex tax) \$869 (inc tax)**



## Its a 50MHz Bandwidth Digital Storage Scope plus...

- 25MS/s 2 channel digital storage
- 8-bit, 25 levels/div vert. resolution
- 7ns rise time, 40ns glitch capture
- 10ns/div to 5s/div timebase
- Store 8 waveforms (95 & 97) and 10 set-ups (97)
- Measuring cursors (95 & 97)
- "Auto-Set" automatic set-up of parameters, e.g. volts/div, time per div and triggering for any input signal

**FLUKE**



**PHILIPS**

## Fluke Upgrades 70 Series... Adds to Range... Lowers Some Prices!

It's hard to improve on a classic multimeter, but Fluke has risen to the challenge!

Three new multimeters - Top-of-the-line Fluke 79 and 29 offer capacitance, frequency, fast 63-segment bar graph and other features plus entry level Model 70 delivers unparalleled Fluke quality and safety.

Models 73, 75, 77, 21 and 23 are all upgraded - all now have Touch-Hold™



**FLUKE**

### Accuracy Comparison

Range	70	73	75(21)	77(23)	79(29)
Vdc	0.5%+1	0.4%+1	0.4%+1	0.3%+1	0.3%+1
Vac	2.0%+2	2.0%+2	2.0%+2	2.0%+2	1.0%+2
Ohms	0.5%+1	0.5%+1	0.5%+1	0.5%+1	0.4%+1
Adc	NA	1.5%+2	1.5%+2	1.5%+2	0.5%+2
Aac	NA	2.5%+2	2.5%+2	2.5%+2	1.5%+2
Frequency	NA	NA	NA	NA	0.01%+1
Price (ex tax)	\$125	\$175	\$260	\$295	\$350
Price (inc tax)	\$146	\$203	\$302	\$343	\$406

Ask for our **FREE 16 page Shortform Catalogue**

Special account facilities available for Education and Government Departments  
Express delivery throughout Australia and South Pacific

Detailed brochures and specifications available. We are factory trained to advise on your requirements for general purpose Test & Measuring Instruments

**OBIAT PTY LTD**

129 Queen Street, Beaconsfield P.O.Box 37 Beaconsfield NSW 2014  
Tel : (02) 698 4776 Telex : AA71958 Fax : (02) 699 9170  
QLD : Elmac Agencies, Tel (07) 356 2699, Fax (07) 356 0456





# Experimenting with Electronics...

by PETER MURTAGH

## 3 — Automatic wailing siren

This month's project is not really a new circuit — it shows how to link our first two projects together. We will use the flashing LEDs circuit (project 2) to replace the pushbutton on the siren circuit (project 1) so that the siren 'wails' by itself.

The purpose of the pushbutton in Project No.1 was to connect and disconnect the supply voltage from capacitor C3 (note that the siren components have been re-labelled on this month's schematic diagram).

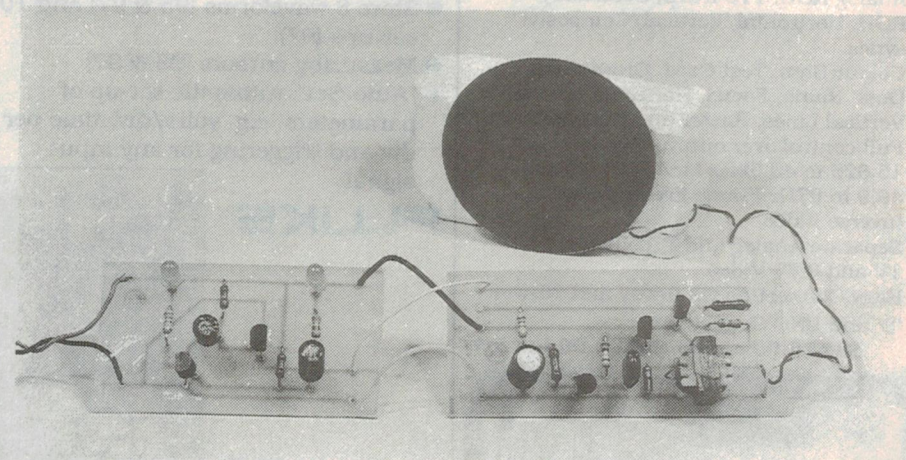
This causes the siren to wail, because its frequency is affected by this voltage. So instead of manually switching the supply on and off, we will connect the siren to the collector of one of the transistors in the flasher flipflop. This will achieve the same effect, but this time automatically.

If the flasher operates too quickly, then the sound frequency from the siren will build up too quickly — this will spoil the effect.

Likewise, if the flasher is too slow, then the sound will switch off completely for a short time rather than just die down.

### Construction

If you have already built projects 1 and 2, you only have to add transistor Q3 and the two resistors R5 and R6 to



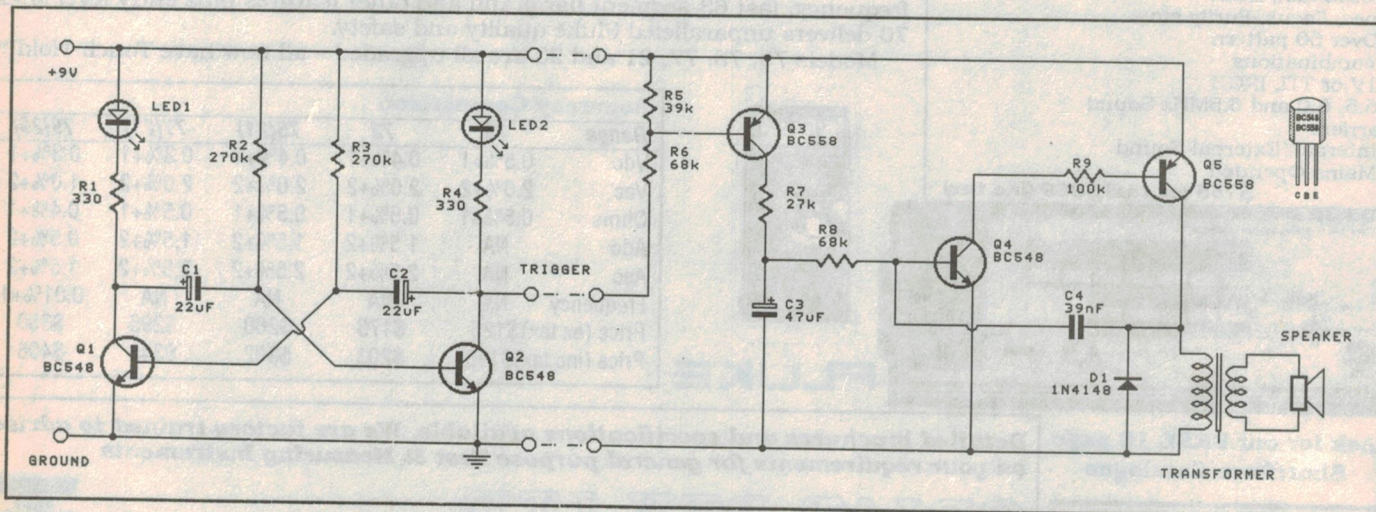
link them together. After adding these three components, solder wire loops between the +9V, ground and trigger terminals on the two boards (as shown in the photo).

The +9V and GND loops mean that only one battery is required to power both circuits. The battery cannot be seen in the photo, but it is connected to the wires at the far left.

In case you haven't already built the first two projects, then we have repeated the physical layout designs for them (in both strip-board and PCB format).

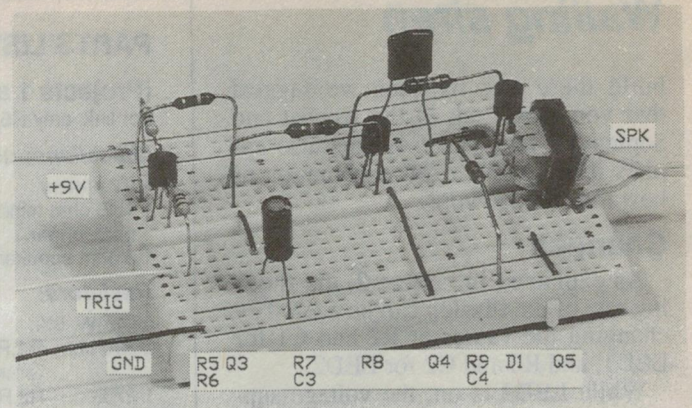
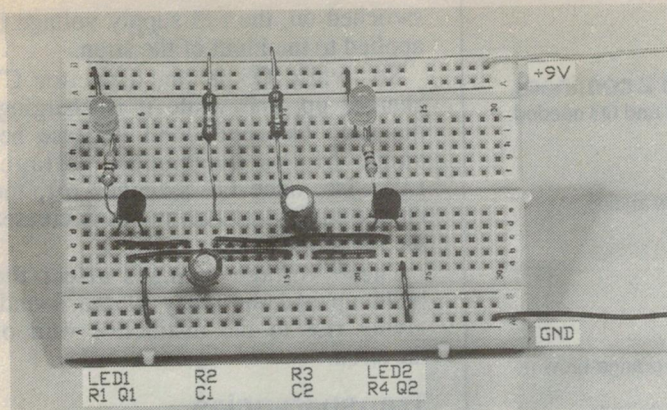
The photos also show you where to place the components if you have decided to build the circuits on a breadboard.

If you require extra details on how to



The schematic diagram showing the flashing LEDs on the left and the siren on the right. Transistor Q3 is turned on and off by the flasher and this causes the siren to wail.





The photos show the breadboard positioning of each component for the two circuits. Refer to the schematic diagram for more detail of which joins to which. The photo does not show the 'trigger' output from the flasher. It plugs into hole 21a, which is below the collector (left lead) of transistor Q2.

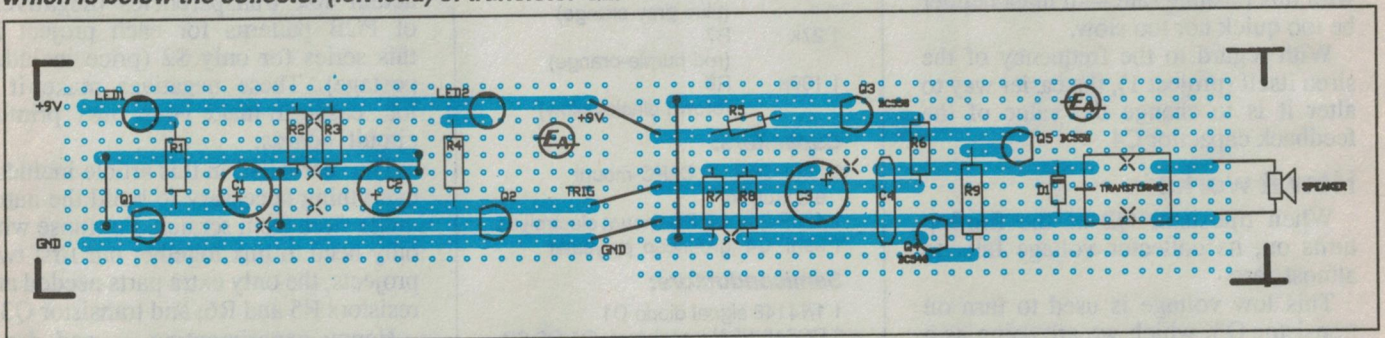


Fig.1: How to position the components using strip-board. The Xs show where the strips must be broken. Note the connecting wires between the two sections.

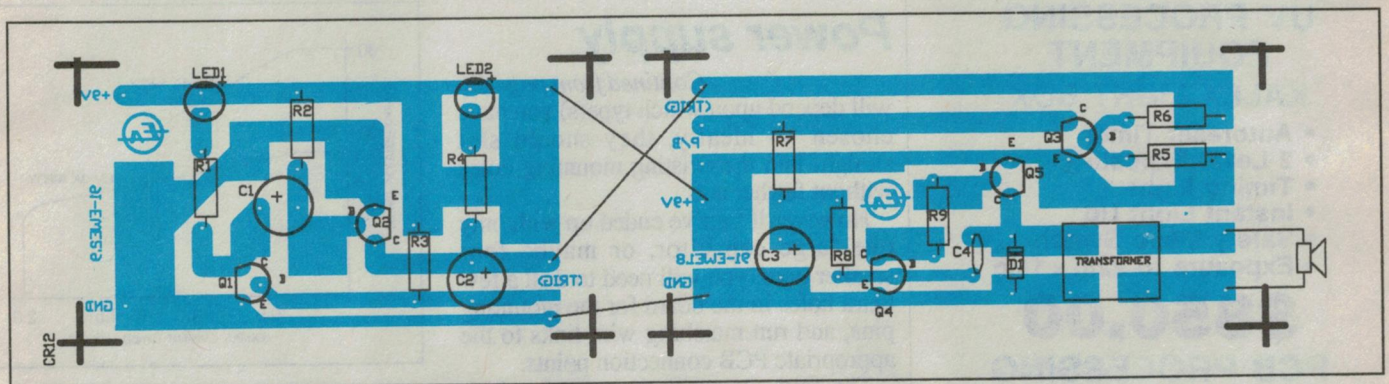
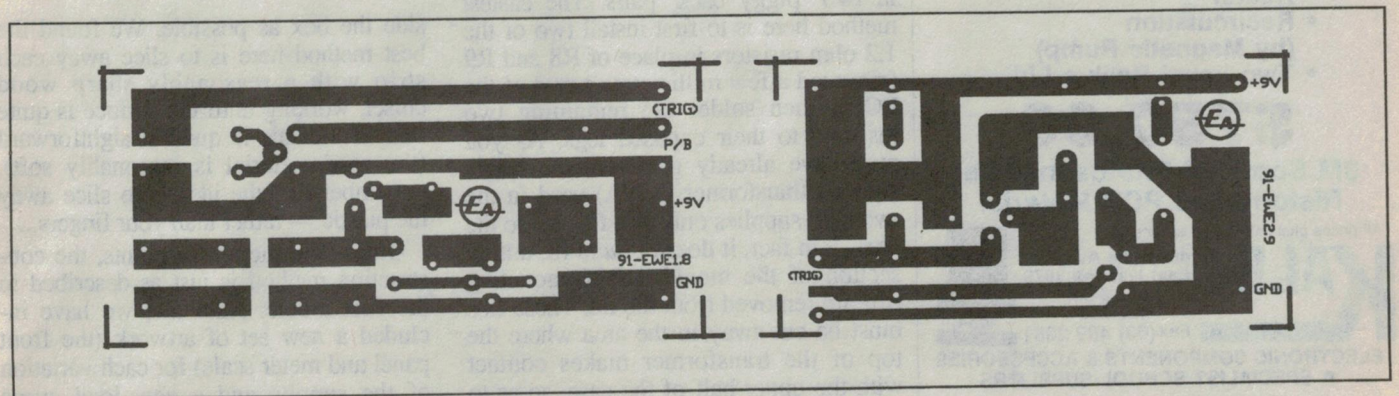


Fig.2: The layout for the printed circuit board. Note that in each of Figs.1 and 2 the battery connects to the left hand end at '+9V' and 'GND', while the speaker connects at the far right.



Shown here are the full size PCB patterns for those who like to make their own boards.



## Wailing siren

build these circuits, then we suggest that you look back to the August and September issues of *EA*. This also applies if you want a full explanation of how the circuits work.

### Changes

As explained in project 2, the flashing rate of the flipflop can be altered by changing the values of R2 and C1 for LED1, and R3 and C2 for LED2.

While LED2 is on, the voltage supplied to the siren is increasing; while LED1 is on, this voltage is decreasing. But as mentioned above, take care with this flashing rate — it must neither be too quick nor too slow.

With regard to the frequency of the siren itself (project 1), the easier way to alter it is to change the value of the feedback capacitor C4.

### How it works

When transistor Q2 of the flipflop turns on, its collector voltage falls to almost zero.

This low voltage is used to turn on transistor Q3, which we are using as a simple switch to replace the pushbutton in the original siren circuit. With Q3

### PARTS LIST

#### (Projects 1 and 2 comined)

For link, only R5,R6 and Q3 needed.

#### Miscellaneous:

- 1 9V battery
- 1 1k/8 ohm miniature audio transformer
- 1 8 ohm speaker

#### Resistors:

- All 1/4W, 5%:
- 2 330 ohm R1,R4 (orange-orange-brown)
  - 1 270k R2,R3 (red-purple-yellow)
  - 1 39k R5 (orange-white-orange)
  - 2 68k R6,R8 (blue-grey-orange)
  - 1 27k R7 (red-purple-orange)
  - 1 100k R9 (brown-black-yellow)

#### Capacitors:

- 2 22uF 25V C1,C2PC-mount electrolytic
- 1 47uF 25V C3 PC-mount electrolytic
- 1 39nF C4 "greencap" polyester

#### Semiconductors:

- 1 1N4148 signal diode D1
- 3 BC548 NPN transistors Q1,Q2,Q4
- 2 BC558 PNP transistors Q3,Q5

switched on, the full supply voltage is applied to the input of the siren.

So, while Q3 is on, capacitor C3 charges up, and while it is charging, the siren frequency will increase because of the increasing voltage. Likewise, once Q3 switches off, the charge on C3 leaks away and decreases the siren frequency.

These voltage changes affect the build up and die away of the sound, giving rise to the distinctive wail of the siren.

### Transparencies

A reminder that *EA's* reader services will continue to offer high contrast, actual size transparencies (negatives) of PCB patterns for each project in this series for only \$2 (price includes postage). These negatives make it a lot easier to make your own printed circuit boards.

The 'parts list' in this article includes everything necessary to build the automatic siren from scratch. For those who only need to link together our first two projects, the only extra parts needed are resistors R5 and R6, and transistor Q3.

Happy experimenting — and don't forget to send us your ideas for future circuits. ■

## UV PROCESSING EQUIPMENT

### KALEX LIGHT BOX

- Autoreset Timer
- 2 Level Exposure
- Timing Light
- Instant Light Up
- Safety Micro Switch
- Exposure to 22in x 11in

# \$850.00

## PCB PROCESSING KALEX ETCH TANK

- Two Compartment
- Heater
- Recirculation (by Magnetic Pump)
- Two Level Rack • Lid

# \$750.00

### 3M Scotchal Photosensitive Riston 3400 PCB Material

All prices plus sales tax if applicable

# KALEX

40 Wallis Ave  
East Ivanhoe 3079  
(03) 497 3422  
497 3034

Fax (03) 499 2381



ELECTRONIC COMPONENTS & ACCESSORIES

- SPECIALIST SCHOOL SUPPLIERS

READER INFO NO. 13

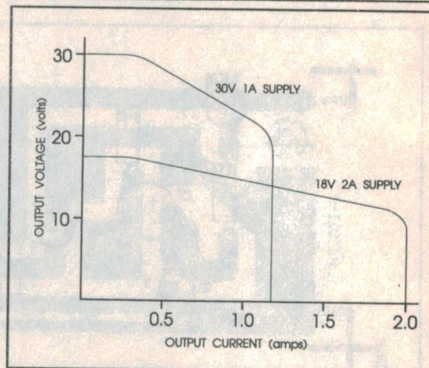
## Power supply

Continued from page 68

will depend upon which type(s) you have chosen — ideally, they should slot straight into the existing mounting holes without further ado.

However if you've ended up with only one large capacitor, or maybe four smaller ones, you will need to drill a few extra holes in the board for the mounting pins, and run matching wire links to the appropriate PCB connection points.

The four current limit resistors which are installed in place of R8 and R9 on the 18V/2A supply will need to be arranged in two 'piggy back' pairs. The easiest method here is to first install two of the 1.2 ohm resistors in place of R8 and R9 (mounted a few millimetres proud of the PCB), then solder the remaining two resistors to their exposed legs. As you may have already gathered, the larger style of transformer (30VA) used in the two new supplies only just fits inside the box — in fact, it doesn't quite fit, until a section of the moulded PCB-mounting ribs are removed from the lid. These ribs must be cut away in the area where the top of the transformer makes contact with the upper half of the case, so as to provide as much free vertical space in-



Performance curves for both new versions of the supply, showing the voltage and current limits.

side the box as possible. We found the best method here is to slice away each strip with a reasonably sharp wood chisel, working until the surface is quite flat. While this is quite straightforward (the case material is reasonably soft), remember that the idea is to slice away the plastic — rather than your fingers...

Other than the above points, the construction method is just as described in the first article. Note that we have included a new set of artwork (the front panel and meter scale) for each variation of the supply, and a new load curve showing the output range of both units. ■



# THE ELECTRONIC COMPONENTS SHOP

THE ELECTRONIC COMPONENTS SHOP

FREE  
PACK & POST  
ON ORDERS  
OVER  
\$200



**NO BRAND  
CHEAPER THAN BEFORE**  
(ALL PRICES PER 10 DISKS)

5.25	DS/DD	\$4.95
5.25	DS/HD	\$10.50
3.50	DS/DD	\$9.75
3.50	DS/HD	\$19.50

**MAIL ORDER  
HOT LINE  
008 335901**



**CERTIFIED  
100% ERROR FREE**

DATALIFE  
(ALL PRICES PER 10 DISKS)

5.25	DS/DD	\$18.00
5.25	DS/HD	\$24.95
3.50	DS/DD	\$25.80
3.50	DS/HD	\$48.80

## DYNAMIC RAM CHIPS



DESCRIPTION	1.9	10+
4164-10 (64K X 1)	\$3.50	\$3.00
4464-10 (64K X 4)	\$3.60	\$3.20
41256-08 (256K X 1)	\$3.20	\$2.80
44256-08 (256K X 4)	\$10.95	\$9.95
411000-08 (1 MEG X 1)	\$10.95	\$9.95
1 MEG X 9 SIM SIP	\$99.00	\$95.00

## ENERGY SAVING FLUORO

Why keep paying electricity bills for inefficient lighting. Standard globes use too much power through generated heat where fluoros turn all their energy into light saving you up to 80% of your electricity bills. Fluoros globes lasts up to 6 times longer than standard globes literally paying for themselves while you use them. All 5000K light range and guaranteed.

7WB:7W	Bayonet	\$14.95
11WB:11W	Bayonet	\$15.95
15WB:15W	Bayonet	\$16.95
15WE:15W	Screw-in	\$16.95
FB11W:11W	Bayonet (Ball)	\$19.95
BB11W:11W	Bayonet (Lrg.)	\$19.95

## QUALITY JAPANESE BRAND FLOPPY DRIVES

5.25" 360K .....\$130  
5.25" 1.2M.....\$129

3.5 Auto Switch  
720K/1.44M  
Inc.5.25 Bracket  
\$125

Call or Write to us  
for our complete  
range of computer  
products

## FANTASTIC

**Complete  
Computer Systems**  
286-16 .....\$1440  
386SX16 ...\$1750  
386DX25C \$2050  
386DX33C \$2250  
Above Includes:  
1M Ram  
1.2 or 1,44MB FDD  
40 MB HDD  
512K VGA Card  
Super VGA Monitor  
101 Keyboard  
25, 1P,1G Ports  
case & power  
supply

### 74HC

DESCRIPTION	1-9	10+
74HC00	\$0.75	\$0.85
74HC02	\$0.75	\$0.85
74HC04	\$0.75	\$0.85
74HC08	\$0.75	\$0.85
74HC10	\$0.75	\$0.85
74HC14	\$1.50	\$1.40
74HC20	\$0.85	\$0.80
74HC30	\$0.60	\$0.50
74HC32	\$0.80	\$0.75
74HC42	\$1.20	\$1.10
74HC73	\$1.20	\$1.15
74HC74	\$0.75	\$0.85
74HC75	\$1.20	\$1.10
74HC76	\$1.10	\$1.05
74HC85	\$1.40	\$1.30
74HC86	\$1.10	\$1.00
74HC123	\$1.30	\$1.15
74HC125	\$1.20	\$1.10
74HC173	\$1.20	\$1.10
74HC174	\$0.90	\$0.80
74HC221	\$1.45	\$1.35
74HC240	\$1.10	\$1.00
74HC244	\$1.10	\$1.00
74HC245	\$1.10	\$1.00
74HC273	\$1.20	\$1.10
74HC365	\$1.20	\$1.10
74HC373	\$1.20	\$1.10
74HC374	\$1.20	\$1.00

## \* HARD DRIVE \* SPECIALS

Lower prices  
all inc. IDE con.

40M	17MS	\$375
52M	9MS*	\$495
80M	17MS	\$545
105M	9MS*	\$725
120M	17MS	\$725
200	14MS	\$1295

\*Effective access time  
with 32K on-board  
cache

## CMOS

DESCRIPTION	1-9	10+
4001B	\$0.25	\$0.20
4011B	\$0.25	\$0.20
4013B	\$0.25	\$0.20
4016B	\$0.40	\$0.30
4026B	\$0.90	\$0.80
4042B	\$0.50	\$0.45
4044B	\$0.80	\$0.75
4049B	\$0.50	\$0.45
4053B	\$0.80	\$0.75
4060B	\$0.70	\$0.65
4069B	\$0.40	\$0.35
4071B	\$0.40	\$0.35
4081B	\$0.40	\$0.35
4093B	\$0.85	\$0.80

## EPROMS & RAMS

2716	.....	\$9.95
2732A	.....	\$7.50
27C32	.....	\$11.50
2764	.....	\$6.50
27C64	.....	\$7.00
27128	.....	\$7.50
27C128	.....	\$8.00
27256	.....	\$8.50
27C256	.....	\$9.00
27512	.....	\$12.50
276512	.....	\$13.50
27C1001	.....	\$23.50
6116	.....	\$4.50
6264	.....	\$9.50
62256	.....	\$17.50
628128	.....	\$60.00

## 6800 MICRO

DESCRIPTION	1-9	10+
6809P	.....	\$10.50 \$9.50
6809EP	.....	\$9.50 \$8.50
6821	.....	\$5.50 \$4.50
6850	.....	\$3.50 \$3.00

## Z80

DESCRIPTION	1-9	10+
Z80ACPU	.....	\$3.00 \$2.50
Z80BCPU	.....	\$4.50 \$4.00
Z80CCPU	.....	\$6.50 \$6.00
Z80API0	.....	\$3.00 \$2.50
Z80BP10	.....	\$4.50 \$4.50
Z80CP10	.....	\$6.50 \$6.00

## \$\$ SAVE \$\$

**BABY AT FLIP TOP CASE &  
200W P/SUPPLY  
\$180**

## VOLTAGE REGULATOR

### BARGAINS

DESCRIPTION	1-9	10+
7805UC	.....	\$0.50 \$0.45
7815UC	.....	\$0.50 \$0.45
7905UC	.....	\$0.60 \$0.55
7912UC	.....	\$0.60 \$0.55
7915UC	.....	\$0.60 \$0.55
LM317T	.....	\$1.00 \$0.90
LM337T	.....	\$2.10 \$2.00
LM723PC	.....	\$0.80 \$0.75
L296	.....	\$10.50 \$9.50

## DIODES

DESCRIPTION	1-9	10+
IN4148	.....	\$0.04 \$0.03
IN914	.....	\$0.05 \$0.04
IN4004	.....	\$0.05 \$0.04
IN5404	.....	\$0.15 \$0.12
IN5408	.....	\$0.25 \$0.21

## BRIDGES

DESCRIPTION	1-9	10+
W04	.....	\$0.45 \$0.40
BR64	.....	
6A 400V	.....	\$1.50 \$1.30
BR104	.....	
10A 400V	.....	\$1.80 \$1.50
BR354	.....	
35A 400V	.....	\$3.90 \$3.00

## MAXELL® BATTERIES FOR WATCHES AND CALCULATORS

### ALKALINE, SILVER OXIDE

LR 43 (PK 2)	3.95	SR 726W	2.25
LR 44 (PK 2)	3.95	SR 726SW	2.25
SR 41W	1.25	SR 731SW	2.50
SR 43C	3.95	SR 920SW	2.95
SR 44C	3.95	SR 927W	2.25
SR 5215W	3.95	SR 927SW	3.40
SR 5275W	2.95	SR 936SW	2.95
SR 6165W	2.95	SR 1120C	2.40
SR 6215W	2.50	SR 1120SW	2.95
SR 6265W	2.95	SR 1130C	2.40
SR 7165W	2.95	SR 1130SW	2.95
SR 721W	2.25	XR 11630W	7.80
SR 721SW	2.50		

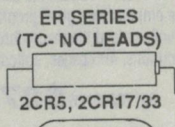
### LITHIUM

BR 2316W	4.95	CR 16165W	3.25
BR 2320W	4.95	CR 2016C	3.25
CR 1025W	3.25	CR 2025C	3.25
CR 1220W	3.25	CR 2032C	3.25

## BATTERIES FOR CAMERAS, COMPUTERS

### SUPER LITHIUM

ER 3	3.6V	ER 10/28	3.6V
ER 3s		ER 17/33	3.6
ER 3s /TC	3.6V	ER 17/50	3.6V
ER 6	3.5	2 CR5	6V
ER 6C	3.6V	2 CR17/33	6V
ER 6C/TC	3.6V	750 mA H	18.75
		750 mA H	18.50



2 AH 19.90  
1.9 AH 19.90

**WE CAN CROSS  
REFERENCE  
MOST MAJOR  
BRAND  
BATTERIES.**

## QUALITY IC SOCKETS

DESCRIPTION	1-9	10+
8 pin	.....	.20 .15
14 pin	.....	.25 .20
16 pin	.....	.30 .25
18 pin	.....	.35 .30
20 pin	.....	.40 .35
24 pin	.....	.50 .45
28 pin	.....	.55 .50
40 pin	.....	.60 .55

**FREE  
T.E.C.S. WHOLESALE  
PRICE LIST-  
SEND BUSINESS CARD**

**ALL SALES EXEMPT  
ORDERS AND  
WHOLESALE  
ENQUIRIES TO:  
T.E.C.S P/L  
1ST FLOOR 289  
LATROBE ST  
MELBOURNE 3000  
PHONE: (03) 670 6474  
FAX: (03) 670 6006**

## THE ELECTRONIC COMPONENTS SHOP

**SHOP TRADING HOURS:**  
Mon-Thurs 8.30-5.30  
Friday 8.30-8.00  
Saturday 9.00-3.00

**MAIL ORDER  
289 LATROBE ST  
MELBOURNE 3000  
Tel: (03) 602 3499  
TOLL FREE  
CREDIT CARD ORDERS  
008 335901**

POSTAGE RATES	
\$1-\$9.99	\$3.00
\$10-\$24.99	\$3.50
\$25-\$49.99	\$4.50
\$50-\$99.99	\$5.50
\$100-\$199	\$6.00
\$200+	FREE

# THE ELECTRONIC COMPONENTS SHOP



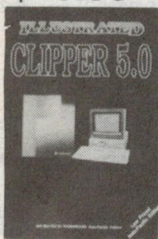
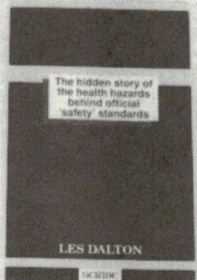
# MORE NEW BOOKS FROM JAYCAR

## RADIATION EXPOSURES

By Les Dalton

As reviewed by Electronics Australia, August 1991, a very interesting book. This book spells out clearly and simply what we have done to ourselves by creating a complex artificial radiation environment. We are now dependent on an ever-increasing array of radiation-emitting equipment and materials; and on safety standards which are continually turning out to be inadequate. These radiations are invisible and not easily identified with health effects. But recent research, which is uncovering a range of health risks, is being disputed, blocked and played down by radiation-emitting industries and health authorities. In this book you will learn about the realities of our new electromagnetic environment and of the nuclear age. 265 pages, softcover 223 x 150mm. Cal BC-1130

**\$19.95**



## ILLUSTRATED CLIPPER 5.0

John Mueller

This handy reference-tutorial provides everything you need to know about creating programs using Clipper. Hands-on activities and dozens of examples, including fully tested source code, introduce the user to the creation of generic code while emphasising good program structure. Step-by-step instructions lead the reader through the creation of fully functional programs, 495 pages, softcover 155 x 226mm

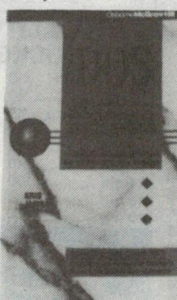
Cal BM-2126 **\$27.95**

## DOS - THE POCKET REFERENCE

2nd edition by Kris Jamsa.

This outstanding best seller has been fully revised and expanded to cover all versions of DOS - including DOS version 5. You will find complete descriptions, easy to follow examples and time saving tips for every DOS command. This book now has a special lay-flat binding so it will stay open on your computer table while you type in the command. This handy memory jogger is a must for all MS-DOS and PC DOS users. 218 pages, softcover 202 x 117mm. Cal BT-1330

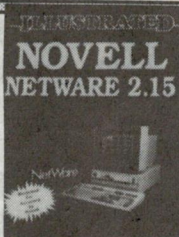
**\$22.95**



## PRACTICAL ELECTRONIC CIRCUITS

This book describes 25 different projects to build and there are some beauties. They include versatile regulated power supply, doorbell, running lights, NiCad charger, multimeter, electronic cricket, organ, slow rising sirens, burglar alarm, musical car horn, warbler, clap switch, solder iron temp control, insect killer, hargraph VU meter, power supplies, etc. 58 pages, 138 x 208mm. Cal BM-2465

**\$6.95**



## ILLUSTRATED NOVEL NETWORK 2.15

Timothy K McDonald

This book explores the features, limitations and options involved in selecting the ideal hardware/software combinations and installing a customised network. All computer users who inter-face with a Novell Netware should have this book at their fingertips. It is a must for Novell Netware trainers and system administrators. Software configuration and installation are described in a straightforward, easy to follow format. This use of each command is illustrated with examples that can be entered at the workstation. Command mistakes are pinpointed and error messages are explained. Appendices provide concise information on terms, troubleshooting and exercises. 245 pages, softcover 228 x 154mm.

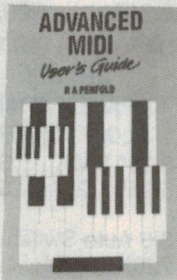
Cal BM-2124 **\$19.95**

## ADVANCED MIDI USERS GUIDE

By R A Penfold

This book is for those who wish to go beyond very basic slaving and sequencer setups, and who wish to exploit MIDI to the full. Anything within reason can be accomplished using MIDI - this book tells you how. • Explains all the MIDI messages • Routing MIDI signals in simple to advanced systems • Covers the use of system exclusive messages • Explains how to troubleshoot when things go wrong • Shows how to use MIDI pedals and other gadgets • Explains MIDI time codes and synchronising with non-MIDI gear • Useful appendices. 179 pages, softcover 137 x 216mm. Cal BP-1228

**\$22.95**



## UPGRADING PC'S MADE EASY

By Bud and Alex Aaron

Have you ever wished your PC was faster, more powerful or had greater capabilities. This book tells you: • Why and when to upgrade your PC • What your options are • How to do the upgrading yourself • How to maintain and trouble shoot. By following the clear explanations and practical illustrations you'll be able to: • Increase memory • Boost processing power and speed • Install floppy and hard disc drives • Add peripherals like a mouse, printer or scanner • Replace and maintain your power supply. If you want to enhance your IBM compatible PC, XT, AT or PS/2, then this is the book. 459 pages, soft cover 185 x 232mm.

Cal BT-1328 **\$49.95**

## PIR MADNESS

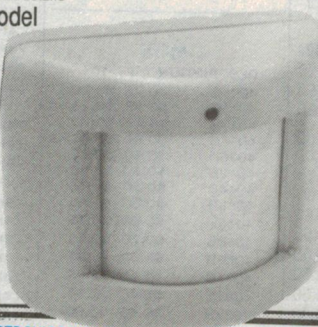
See catalogue for full details

Economy model

Cal LA-5017

**Was \$59.95**  
**NOW \$45**

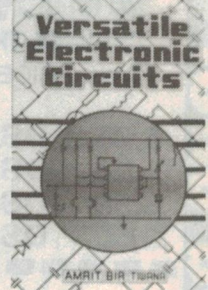
**SAVE \$14.95**



## VERSATILE ELECTRONIC CIRCUITS

This book presents a collections of over 60 electronic circuits for the hobbyist. These include 10 band equalisers, 60 watt stereo systems, microlevellers, memory doorbells, melody doorbells, digital clocks and locks, dynamic moving displays, timers, digital test gear, video games, computer add ons, TV boosters, object counters, battery chargers, digital LCD DPM's, low cost test gear, emergency lighting systems, earthquake alarms plus a lot more. 188 pages, 138 x 208mm. Cal BM-2468

**\$12.95**



## 555 TIMER AND ITS APPLICATIONS

The 555 Timer IC is probably the most used IC in the world. It will give an accurate timing range of micro seconds to hours. This book describes the functions and operation of the 555, then explains 21 projects to build using the IC. Some of these include photo timer, touch plate controller, car wiper control, car lights turn off, flashers, generators, delayed auto power on and off, NiCad charger, frequency divider, light operated relay, etc. An ideal book for the electronic hobbyist and experimenter. 43 pages, 138 x 208mm.

Cal BM-2466 **\$4.95**



## BUILD YOUR OWN INTERCOMS

Intercoms are an important part of the business person's day to day life. This book covers types of intercoms describing two stage intercoms, sub stations, low power intercoms, IC intercoms, privacy intercoms and more. 44 pages, 138 x 208mm

Cal BM-2467 **\$4.95**



## UNDERSTANDING AUTOMATION SYSTEMS

By N Schmitt and R Farwell

Another in the understanding series which we can offer you at about 1/3rd normal price. This book is about robots that provide products that weigh tons to machines that automatically place electronic parts to an accuracy of thousands of a millimetre. This book discusses basic types of control, system technics, programming, robots etc. 276 pages, softcover 227 x 178mm. Cal BM-2417

**\$12.95** **SAVE \$20**



## DELUXE TERMINATOR

See catalogue for full details

Economy model

Cal LA-5022

**Normally \$119**  
**NOW \$95**

**SAVE \$24**





# SCOPE PROGRAMMABLE ALARM PANEL MADNESS

Unbelievable scoop purchase of top quality alarm panels. Jaycar has purchased the importers entire stock of SCOPE brand state of the art programmable alarm panels.

## 6 Sector control panel

This alarm panel has 6 separate sectors plus 6 x 24 hour sectors. The features and facilities this panel has is simply amazing, the manual lists 51 separate facilities that can be programmed, some of these include:

- when standard alarm zones are required, no programming is required
- permanent memory hold up facility
- separate timed exit, entry and PA circuits
- any zone can be timed (0-99 secs) as an exit/entry
- final door set
- digital communicator outputs, arm/disarm, alarm, personal attack, fire/tamper
- these can be inverted
- hand over zones, programmable on any zone
- isolate facility (except PA, fire and tampers)
- soak test (on any zone)
- operator memory stores 8 events
- siren test (tests all sirens for 10 seconds)
- will drive a combination of sirens, piezo
- zone pairing
- key terminal - 6 options
- automatic reset - 10 options
- end of line resistors programmable on any alarm zones
- pulse count on all zones

**NEW**

**SAVE ABOUT \$200**

This alarm has a digital 7 segment display on the panel to show sector conditions and system information. There is also a 12 digit keypad on the front. Each unit is supplied with a 114 page installation/service manual and an operating manual which covers about everything you will ever need to know.

### Specifications:

Operating voltage - 16-18V AC	Quiescent current consumption - 125mA
Output voltage - 13.6 V DC	Power output max current - 1A DC
Stand by battery - up to 6.5 Ah	No of sectors - 6 x burglary
End of the line resistor - 1KΩ	Sector loop current - 1mA
Sector de-bounce time - 300 m sec	Key switch input - programmable for either latching or pulse input
Size - control box 330 x 255 x 82mm	Exit time - prog 0-99 secs
Entry time - prog 0-99 secs	
Siren time - prog 1-10 min	

<b>Power supply to suite 16V AC</b>	<b>Cat MP-3021</b>	<b>\$22.50</b>
<b>Gel battery to suit 1.2Ah</b>	<b>Cat SB-2480</b>	<b>\$26.50</b>

Cat LA-5180

**ONLY \$199.50**

Also available without case for \$129.50 Cat LA-5182

## Remote key pad

Intelligent remote keypad to program and arm/disarm the system, 7 segment readout. You can use up to three per panel.

Cat LA-5183 **Special price \$59.95**

**BELOW WHOLESALE**

## Scope 6/30 12 sector panel

Ideal for warehouses, factories and large houses. This 'state of the art' alarm panel has 12 sectors plus 5 tamper zones. The features and programming functions are similar to the smaller unit. The scope 6.30 is controlled lby a separate digital keypad with an alpha/numeric LCD display. We supply two of these with each unit (one for the front door and one for the back door). The unit is housed in a metal box measuring 355W x 290H x 120D.

This can be hidden away as all access is done via the keypads. When standard and tamper zones are required all zones are end of line resistor supervised and can also be programmed so that both tamper and arm circuits can use the same cable pair. 114 page installation/service manual and operating instructions supplied.

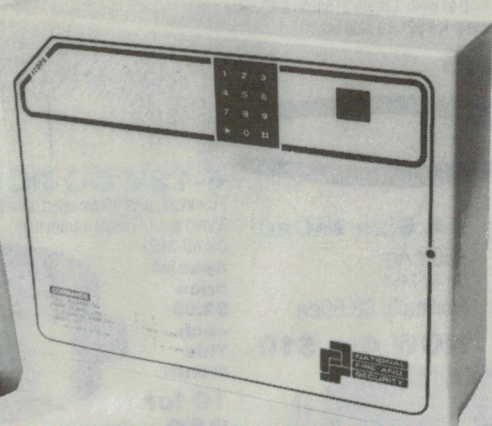
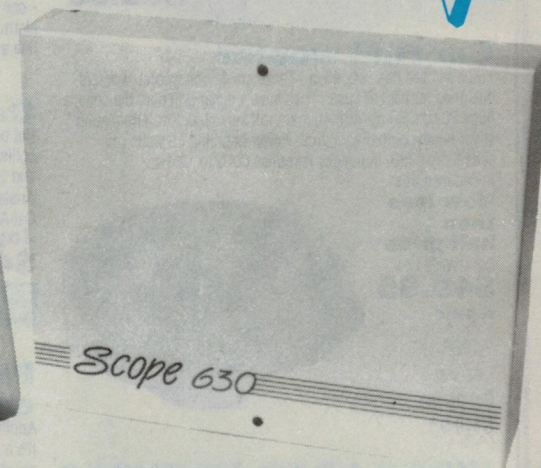
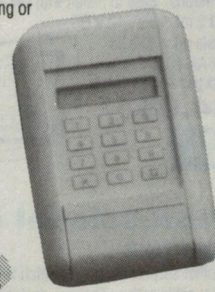
### Specifications:

Operating voltage - 16-18V AC  
 Operating current - 150mA  
 End line resistor - 1K  
 Current de-bounce time - 200m sec  
 Output voltage - 13.65V DC  
 Memory type - Eprom programmed through keypad  
 Keypads - LCD with alph/numeric characters  
**Plug pack to suit - 16V AC**  
**Back up battery to suit 12V 6.5Ah**  
 Supplied with two keypads  
 Cat LA-5185

Cat MP-3021 **\$22.50**  
 Cat SB-2486 **\$43.50**

**BELOW WHOLESALE**

**ONLY \$599**



## Teleguard VP3 Security System

This is an ideal alarm system for home units and small houses. Its easy to operate and install. Simply screw the unit on the wall. It has an inbuilt PIR (range up to 15m) as well as a 12V rechargeable 700mA gel battery. The unit requires 12V DC to charge the battery, a power supply can be plugged in permanently or for 10 hours when the power light flashes (approx every 2 weeks). It has an inbuilt 115dB piezo screamer, and wow is it loud, as well as a 12V output socket for an external piezo of required.

Once the unit is switched on by the keyswitch they keys are then hidden and normal day to day on/off operation is by two RF transmitter key fobs.

This is a well engineered alarm system, it is easy to use and install and it works very well. Its made in Italy and there is only a limited quantity.

Cat LA-5140

**ONLY \$179.50**

**240V power adaptor to suit 12V DC 300mA** Cat MP-3006 **\$15.95**



## GEL BATTERY MADNESS

We have purchased a large quantity of National brand gel batteries. Stock up now at these crazy low prices. Some well below normal wholesale prices.

<b>6 Volt 8Ah</b>	Cat SB-2478	<b>Only \$16.95</b>
<b>12 Volt 2.4Ah</b>	Cat SB-2483	<b>Only \$29.95</b>
<b>12 Volt 24Ah</b>	Cat SB-2492	<b>Only \$99.95</b>
		(wholesale price \$132)
<b>12 Volt 38Ah</b>	Cat SB-2495	<b>Only \$149.95</b>
		(Wholesale price \$228)



## NEW SMALL PHILIPS DOME TWEETER

AD11800/T8

A new addition to our range of quality dome tweeters. Ideal for small bookshelf speakers, or to give a new lease of life on an old system by replacing the old tweeters. Looks exactly like the AD11610, except it is smaller. Textile dome. Made in Belgium.



**Specifications:**

- System power 80 watts RMS
- Frequency response 3300-20,000 Hz
- Resonant frequency 1700Hz
- Magnet Weight 60 grams
- Voice coil diameter 25mm

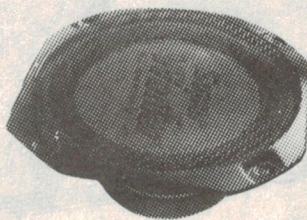
**Dimensions:**  
From one side to the other 74mm.  
Mounting holes - diagonal 83mm.  
Cut out 65mm

Cat CT-2013  
**\$22.95**

## Car HiFi woofer

You don't see this very often. These are 8" honeycomb woofers designed for car HiFi use. They have a metal grill over the cone, a huge 20 oz (.57kg) magnet, foam roll surround, black frame and silver honeycomb diaphragm. Power handling 35 watts rms, sensitivity 93dB, frequency response 60Hz to 12kHz, impedance 4Ω.

**Now less than half price**  
Cat CW-2117  
**\$49.95**  
a pair



1988  
Arista  
Cat price  
\$119.95

## VIDEO LEAD MADNESS

Length 1.5ml

Cat		Was	Now
AV-6512	BNC → PL259	<b>\$8.95</b>	<b>\$2</b>
AV-6514	PL259 → PL259	<b>\$7.95</b>	<b>\$2</b>
AV-6516	PL259 → RCA	<b>\$5.95</b>	<b>\$2</b>



## GUITAR SPEAKER SALE

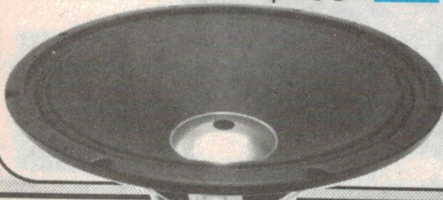
12" 200W RMS Cat CG-2381

Normally \$159 **OCT \$129** **SAVE \$30**



15" 150W RMS Cat CG-2382

Normally \$129 **OCT \$109** **SAVE \$20**



## Car alarm breakthrough Moss Hyper-Frequency Radar Interior Movement Detector

**NEW**



The new moss MS-712 projects a completely harmless 2-45 gigahertz hyper frequency energy field inside your car that will detect the slightest intrusion. This system is unaffected by air turbulence or temperature fluctuations and eliminates false alarms. It can be used with the windows or sun-roof partially open, and is ideal for all soft-top vehicles. The latest technology and variable range adjustment allow you to set the energy field precisely to suit your own requirements. The unit is ultra compact measuring only 85(L) x 55(W) x 221(H)mm. FREE VIDEO - This unit is supplied with a VHS instructional video as well as all wiring and fittings. The unit has three wires to connect - one to earth, one to positive which is only available when the alarm is on, an one trigger wire. 12 months warranty and a help line available.

Cat LA-8922 **\$99.95**

## Car stop light

Put one of these on your rear parcel shelf and avoid rear end collisions. Easy to install with self adhesive rubber mounting and 2 mt cable. 12 V DC.

Arista price \$13.35  
Cat AA-2085  
**Jaycar price \$4.95**

**SAVE 67%**



## Professional cable cutter

Another surplus stock buy which will save you heaps. This time it's a cable cutter. They are designed to cut copper and aluminium cable up to 38 sq mm. They will slice through cable with the greatest of ease and strip as well. Length 215mm (8 1/2"). Every toolbox needs one. Trade price \$21.89 plus tax. Cat TH-1823

**Jaycar price \$9.95**



## D Size NiCad

1.2AH current  
Cat SB-2460

Normally \$6.95  
**NOW \$5**

## AA Size NiCad

450mAh  
Cat SB-2452

Normally \$3.50ea  
**NOW 4 for \$10**



## SUBWOOFER SPECIALS

**8"**

Cat CW-2150  
Normally \$99.50

**October \$69.50**

**SAVE \$30**

**10"**

Cat CW-2152  
Normally \$129.50

**October \$99.50**

**SAVE \$30**

## 6-12V DC PCMT BUZZER

PC mount, pins 15mm apart, size 28mm diameter, mounting holes 35mm apart. Height 14mm high.

Cat AB-3460

**Special price \$2.95 each**  
**This month 10 for \$10**



## Speaker mounting screws

At last you can now buy black philips head chipboard screws to mount your speakers from Jaycar. These are very difficult to obtain. Two sizes available.

Large No. 10 x 30mm Ideal for woofers

Pkt 20 Cat HP-0624 **\$3.50**

Pkt 200 Cat HP-0626 **\$27.50**

Large No. 6 x 15mm Ideal for tweeters, midranges, crossovers

Pkt 20 Cat HP-0620 **\$2.95**

Pkt 200 Cat HP-0622 **\$22.95**

**NEW**



## UHF ANTENNA PRICES SLASHED

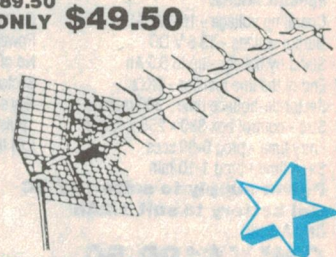
We were sick and tired of paying too much for antennas. We have found our own supplier and can now reduce the prices by up to 45%. But don't worry, the new ones are imported but so were the ones they replaced. New everyday low prices. Wholesale enquiries: phone (02) 747-2022.

## 43 Element

Specs - Gain: 13dB, Channels: 21-69, Frequ: 470-862MHz, Boom: 20mm square, Overall length: 1234mm, Finish: elements and boom anodised.

Cat LT-3181  
Was \$89.50  
**NOW ONLY \$49.50**

**SAVE 45%**

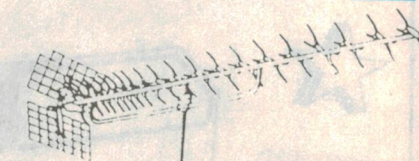


## 91 Element

Specs - Gain: 15-19dB, Channels: 21-69, Frequency: 470-862MHz, Boom: 20mm square, Overall length 2214mm, Finish: elements and boom anodised.

Cat LT-3182  
Was \$139  
**NOW ONLY \$79.50**

**SAVE 43%**



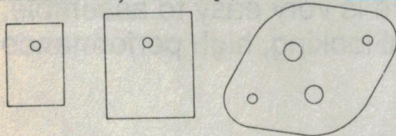


## Transistor washers that don't require silicon grease

### Silicon impregnated rubber washers

At last you can stop using messy silicon grease. These washers are made from silicon rubber and are effective as mica and grease. Avoid mica washers that crack, avoid run off, speed production assembly time. Three sizes available including the new T03P size as well as T03 and T0220. Physical properties:  
 Colour - grey Tensile strength - 40kg/cm<sup>2</sup>  
 Elongation - 80% Dielectric breakdown voltage - 4000/0.3mm  
 Co-efficient of thermal conduction - 2.4 x 10<sup>-4</sup>  
 Flammability class - 94V-0/0.3mm  
 Dimensional stability - 0.2% change /0.3mm

**NEW**



Type	Pack qty	Price	Cat
T03	20	\$6.95	HP-1150
T03	100	\$23.95	HP-1151
T0220	20	\$2.50	HP-1155
T0220	100	\$8.95	HP-1156
T03-P	20	\$4.50	HP-1160
T03-P	100	\$14.95	HP-1161

(Size 25 x 20mm)

## BUSHES

Now available, separate bags of bushes to suit the new silicon impregnated rubber washers and mica washers

T0220	Pkl 100	\$8.95	Cat HP-1166
T03	Pkl 100	\$9.95	Cat HP-1168

## TELECOM POWER SUPPLY BARGAIN

This is a quality power supply! It is 240V primary to 48V DC at 1.5A and 75V AC 50Hz at 6VA. It is housed in a large metal enclosure measuring 300(L) x 140(W) x 100(H)mm. It incorporates two transformers, fuseholder and spare fuse, 2 x 2500uf 63V can electros, rectifier board and two large voltage resistors. The inputs and outputs are all screw terminal strips. These would have cost Telecom a fortune to be made. Due to the enormous weight - we must ask mail order customers to add an extra \$5 on top of normal p & p charges.  
 Cat MP-3032



Grab one now at this crazy price  
**ONLY \$35 each**

## STUDIO 3-55L SPEAKER KIT

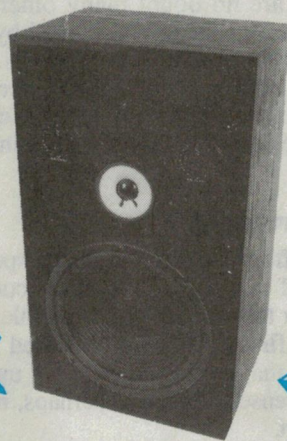
Refer Silicon Chip 1991. At last, a high quality speaker kit at a very reasonable price using quality components. Jaycar and Silicon Chip proudly announce the 3-55L 3 way speaker kit. The kit incorporates the magnavox 12W, 12" woofer, sealed 5" midrange driver and the fabulous Phillips AD11610/T8 dome tweeter. Power handling is 80 watts programme. Drop into any Jaycar store for a demonstration (not Concord). The kit is available in two parts. Part one includes the drivers, crossovers, terminals, ladders, innerbond, screws, cable etc. Part two includes the two fully build black cabinets with all holes cut and speaker grill fitted.

**Part 1:**  
**Speakers etc** Cat CS-2480 **\$279**

**Part 2:**  
**Cabinets** Cat CS-2482 **\$250**

**TOTAL \$529**

**BUY BOTH TOGETHER FOR ONLY \$499**



## LOW COST 18V 1A BENCHTOP SUPPLY KIT

Ref: EA August 1991  
 This economy priced power supply features:  
 • variable output voltage from 2.5 to 18V  
 • switchable current limiting  
 • both voltage and current metering.  
 The Jaycar kit includes PCB, all specified components, Scotchcal panel and meter scale.

Cat. KA-1736 **\$79.95**

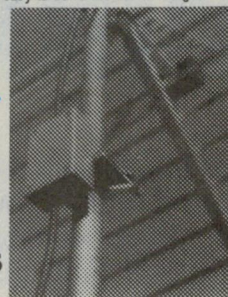


## NEW KITS

### MASTHEAD AMPLIFIER

Refer Silicon Chip Aug 91.

This masthead amplifier kit is easy to build install. It will give around 18dB of gain from 40MHz to 1GHz which is right across the UHF and VHF bands plus FM band (88-108MHz) as well. The Jaycar kit includes the special 24V AC power supply. Beware of other kits which don't supply this. Also includes PCB, jiffy box, mast clamp, OM 350 and all specified components.  
 Cat KC-5097 **\$44.95**



### DIGITAL TACHO KIT

Refer Silicon Chip Aug 91.

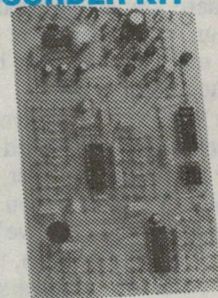
This LED digital tachometer features a 4 digit readout that indicates from 0 - 9900 RPM. It works from Kettering to Hall Effect systems and with 4, 6 and 8 cylinder cars. The Jaycar kit is a short form version, everything is supplied except the box and front panel - as we feel many constructors will want to mount it in the dash.  
 Cat KC-5098 **\$34.95**



### PC VOICE RECORDER KIT

Refer Silicon Chip Aug 91.

Can record messages up to 20 seconds long. Store them on hard or floppy disc and then replay them when you wish. The Jaycar kit includes all specified components except the pluggack and zippy box. The software is available from Silicon Chip.  
 Cat KC-5099 **\$32.95**



### Speech processor kit for transceivers

Refer EA Sept 91. Increase your talk power. Connects in line with existing mic, and acts as a preamp, compressor and speech filler. It so automatically generates a "beep" each time the press to talk button is short form kit. Includes PCB, mic socket, relay and all specified components. No box supplied.  
 Cat KA-1737 **\$29.95**



**HEAD OFFICE**  
 115 Parramatta Road Concord 2137  
**Telephone (02) 747 2022**  
**FAX (02) 744 0767**

POST & PACKING	
\$10 - \$24.99	\$ 3.75
\$25 - \$49.99	\$ 4.50
\$50 - \$99.99	\$ 6.50
OVER \$100	\$8.00

**MAIL ORDERS**  
 P.O. Box 185 Concord 2137  
**ROAD FREIGHT ANYWHERE IN AUSTRALIA**  
 (up to 20kg) **\$13.50**

**MAIL ORDER VIA ☎**  
**FREE CALL - FOR ORDERS ONLY (008) 022 888**  
**HOTLINE (02) 747 1888**



**SYDNEY - CITY** 117 York St. (02) 267 1614 - Mon-Fri 8.30 - 5.30 Thurs 8.30 pm - Sat 9 - 1  
**PARRAMATTA** 355 Church St (Cnr. Victoria Rd) (02) 683 3377 Mon-Fri 9 - 5.30 Thurs 8.30 pm - Sat 9 - 4pm Sunday 10am - 4pm  
**CONCORD** 115 Parramatta Rd Cnr Lloyd George Av (02) 745 3077 - Mon-Fri 8.30 - 5.30 - Sat 9.00 - 12  
**BANKSTOWN** 363 Hume Highway Cnr Meredith St (02) 709 2822 Mon-Fri 9 - 5.30 Thurs 8.30 pm - Sat 9 - 4  
**GORE HILL** 188 Pacific Hwy (Cnr. Bellevue Ave) (02) 439 4799 - Mon-Fri 9 - 5.30 Thurs 8.30 - Sat 9 - 4pm

**BURANDA QLD** 144 Logan Rd (07) 393 0777 - Mon-Fri 9 - 5.30 Thurs 8.30 - Sat 9 - 4  
**COBURG VIC** 266 Sydney Road (03) 384 1811 - Mon-Fri 9 - 5.30 Fri 8.30 - Sat 9 - 4  
**MELBOURNE-CITY** Shop 2, 45 A'Beckett St City (03) 663 2030 Mon-Fri 9 - 5.30 Fri 8.30 - Sat 9 - 2  
**SPRINGVALE VIC** 887-889 Springvale Road Mulgrave (03) 547 1022 Nr Cnr. Dandenong Road Mon-Fri 9 - 5.30 Fri 8.30 - Sat 9 - 2  
**ADELAIDE S.A.** 190 Wright Street (Cnr Selby Street) (08) 231 7355 Mon-Fri 9 - 5.30 Fri 8.30 - Sat 9 - 12



## Construction Project:

# MINI NIGHT VIEWER

Look into the night and see all sorts of hidden wonders with our new, smaller, simpler, and cheaper Infrared Night Viewer. The electronics is compact and simple, the case is very easy to assemble, and a kit is available complete with lenses. The result is a professional looking, high performance instrument previously unavailable to hobbyists.

by BRANCO JUSTIC and PETER PHILLIPS

Regular readers might remember the very first IR Night Viewer project, published in *EA* May 1990. Its popularity was overwhelming, and Oatley Electronics responded by presenting a re-designed case, which we described in September 1990.

Since then, further developments have taken place, culminating in the design described in this article.

There are several features in the new design, particularly the size of the case. The unit is now a truly handheld device, as the photos show.

In Fig.2, we've shown how the revised electronics has allowed the case design described in September 1990 to be made smaller. In fact, if you like this design better than the case we're describing in this article (see Fig.1), then build it, but to smaller dimensions. Oatley Electronics can supply details.

Perhaps the most surprising thing of all about the Night Viewer is the uses people have found for it. As we previously described, the infrared night viewer was originally developed for military applications. Here the uses were intended for surveillance, targeting and other less peaceful applications.

But now that these tubes have become available to the general market (in limited quantities), hobbyists and other interested people have found just how useful a night viewer can be.

For example, wild life enthusiasts can pursue their hobby in the night, by observing nocturnal animals and birds. Farmers use it for similar reasons, but to protect their livestock.

A night viewer opens up new possibilities for photographers; fire fighters can also detect hot spots in fires that appear to be totally extinguished.

Detecting infrared light has applications in science and in electronics. In

particular, those involved in security use a night viewer to see in the dark, for obvious reasons.

There are no doubt many other applications for this device, limited by the imagination of the user. And it's this amazing interest in the night viewer that has prompted Oatley Electronics to refine the design to that described in this article.

### The lenses

Apart from the smaller size, a special feature of this project is that the correct lenses for the tube are also available.

In the first article, we described how to adapt magnifying glasses for use as the two lenses. Primitive perhaps, but a good start.

In the revised case, as presented in September 1990, we showed how a camera lens could be used. However, two lenses are required: one to focus the image onto the IR tube, and another to

view the image on the screen of the tube. The camera lens was used to focus the image onto the tube, but to allow the image to be viewed a magnifying glass was employed. Since that time, Oatley Electronics have sourced IR tubes that come with the correct precision lenses. These lenses and the IR tubes were manufactured in the mid to late 1960's for use in tanks.

According to those who know, the quality of the two lenses is incredible. The imaging lens contains seven individual lenses and gives a field of view of around 30°. It also includes an infrared filter, totally integrated into the assembly.

Both lenses have a fine thread machined around their body, which allows excellent focusing adjustment. The mount for both lenses is a metal ring with a matching, internal thread. Fixing the lenses to the case of the viewer is therefore greatly simplified.

### PARTS LIST

#### Resistors

All 1/4W, 5% unless otherwise stated:  
R1 22k  
R2,3 10k  
R4,5,6 10M, 1/2W high voltage

#### Capacitors

C1 100uF electrolytic  
C2 0.1uF 400V polyester  
C3 10nF 3kV ceramic  
C4-11 680pF 3kV ceramic

#### Semiconductors

D1 1N4148 signal diode  
D2 1N4007 1A diode  
D3-11 BY509 high voltage diode  
Q1 2N2219 NPN transistor  
Q2 C106D SCR

#### Miscellaneous

BWB448 IR tube and lenses to suit;  
2 x NE2 neon lamps;  
oscillator transformer;

trigger transformer;  
2 x PCBs, 53mm round coded  
OE30NWa and OE30NWb;  
50mm SWV 45° joiner;  
3 x 50mm SWV end caps;  
130mm length 50mm SWV pipe;  
9V battery clip;  
insulated plastic switch;  
screws, nuts, hookup wire.  
*A kit of parts for this project is available from:*  
Oatley Electronics  
5 Lansdowne Parade,  
Oatley West, NSW 2223.  
Phone (02) 579 4985  
Postal address (mail orders):  
PO Box 89, Oatley West NSW 2223.  
Complete kit for IR viewer described in article: \$299  
Kit with Philips tube (used, no lenses): \$389  
Kit with other tube types (check for details): \$150 - \$250  
Post and pack charges \$5





In some instances, constructors might want to use a camera lens as the imaging lens. The advantage here is that the infrared filter integral in the supplied imaging lens is avoided.

This filter tends to lower the sensitivity of the unit to visible light, which is fine if you are using an infrared torch. However, some users may want to use the viewer in low light conditions without an infrared torch, and fitting a camera lens will give a greater sensitivity.

However, the case of the viewer needs to be slightly longer. Details will be

provided on request by Oatley Electronics.

If you intend taking photographs using the viewer, an additional lens is required to allow the camera to focus onto the screen of the IR tube.

This is necessary to permit focusing over the very short distance between the camera and the screen of the tube. Again Oatley Electronics can provide details.

### The IR tube

As the photo of Fig.3 shows, IR tubes come in various shapes and sizes. The tube used in the prototype has the type

number BWB448 and is the tube described in this article. Other suitable tubes, also shown in the photo, are the 6032 and the 6032A.

The other type of tube shown is made by Philips and is available in limited quantities. This tube features fibre optic coupling which increases its overall sensitivity, allowing it to produce useful images under starlight as well as infrared conditions.

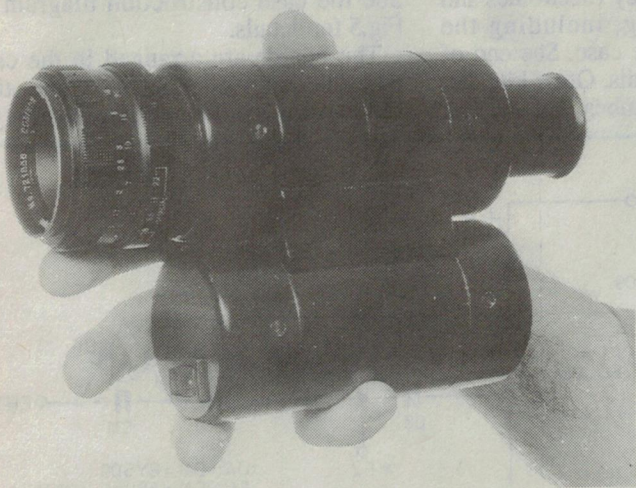
This tube is prefocussed, and therefore doesn't need a focus voltage. However it is more expensive due to its more complex construction.

Where necessary, Oatley Electronics will supply details on any electrical or mechanical differences required to accommodate different tube types.

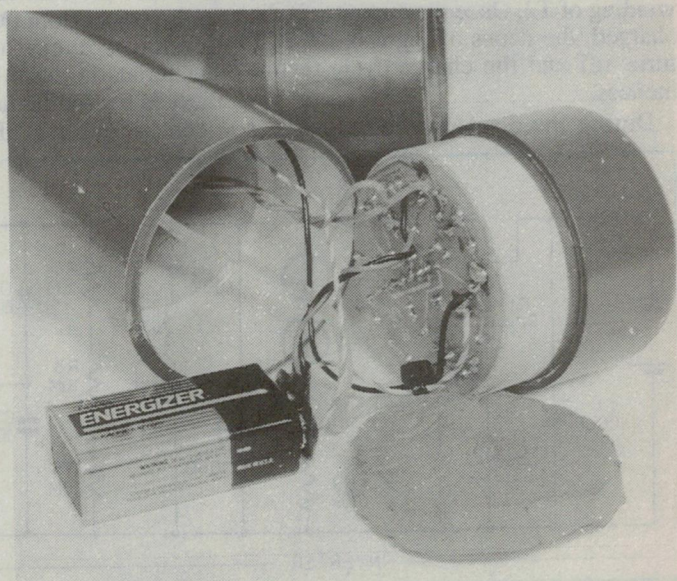
After all, IR tubes are not easily obtained, and when stocks of one type are exhausted, another may have to be substituted. Incidentally, there are a few important points to note about IR tubes. Because of their sensitivity and sophisticated construction, they can be damaged if certain precautions are not taken.

Apart from the obvious need to handle an IR tube with care, you should note the following points:

1. Don't reverse the polarity of the applied voltage. Otherwise, the tube might lose gain, and background illumination may also be introduced.
2. All IR tubes have a number of glass to metal seals (up to 10). If one of these is broken, the tube will lose its vacuum and become useless.
3. Don't expose the tube to high levels of light, especially with power applied.



**Fig.2:** This shot shows a construction virtually identical to that described in September 1990. The difference is the size! Compare it to that shown in the September article. This is not the case being described here, as the new case is even simpler and smaller.



The electronics fit into the case as shown in this photograph.



# Night Viewer

## The electronics

An IR tube requires an EHT voltage to operate. Ideally this voltage needs to be held constant, and should be in the range of 10kV to 16kV.

A voltage of 12kV gives excellent performance and is the value provided by the circuit. As well, a focus voltage of between 1.5kV to 3kV is required, depending on the tube type. The BWB448 tube requires 1.5kV.

The circuit, shown in Fig.4, operates from a 9V battery and is much simpler than the circuit presented in the original article described in May 1990. However, the principle of operation is much the same. The circuit has three basic sections: the inverter, the converter and the voltage multiplier.

The inverter section is a ringing choke type oscillator, and comprises transformer T1, R1, D1, and transistor Q1. Resistor R1 provides bias current to allow the oscillator to start, and also supplies feedback to maintain oscillation. Diode D1 protects the base-emitter junction of Q1. The oscillator operates at around 1.5kHz, and the resulting AC voltage at the primary of T1 is stepped up by the secondary of this transformer. This voltage is rectified by diode D2 and charges C2 via the primary (low resistance winding) of T2.

When the voltage across C2 exceeds the breakdown voltage of the two series-connected neon lamps NE1 and NE2 (around 150V), the neons turn on. This triggers the SCR (Q2) and C2 is quickly discharged via the SCR and the primary winding of T2. Once the capacitor is discharged, the neons extinguish, the SCR turns off and the charge cycle recommences.

During the discharge cycle of C2, a

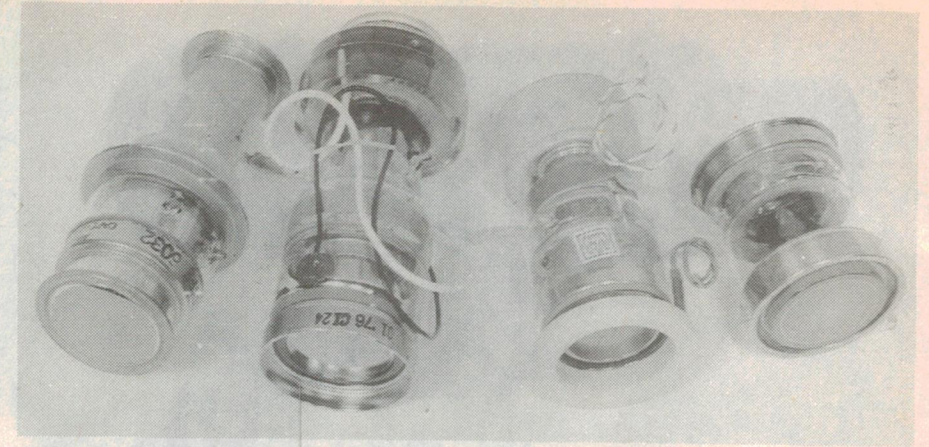


Fig.3: There are various IR tubes available, as shown in this photograph. The BWB448 tube, described in this article is shown in the centre. The 6032 and 6032A tubes on the left can also be used. The Philips fibre-optic coupled tube on the right has a greater sensitivity and doesn't need a focus voltage.

high voltage pulse (approximately 3kV) is produced at the secondary of T2. This voltage is rectified by the halfwave rectifier circuit of D3 and filter capacitor C3. The voltage across C3 is therefore around 1.5kV, which is used as the focus voltage for the IR tube. Resistors R4, R5 and R6 provide a load for the circuit and help maintain regulation.

The output of T2 is also applied to the multiplier circuit comprising diodes D4 to D11 and capacitors C4 to C11. The multiplier effectively quadruples the input voltage, giving an output of some 12kV. A focus voltage of 3kV is available across C8. The multiplier section is constructed on a separate PCB from the rest of the circuit.

## Construction

A complete kit of parts is available for this project from Oatley Electronics and contains everything, including the materials to make the case. See end of article for further details. Other kits that contain different IR tubes, but without

the lenses are also available. To avoid complicating things, we're only describing how to construct the viewer shown in the photo of Fig.1, but full details of other designs are available from Oatley Electronics.

Construction of the unit is in two parts: the electronics and the case. The electronics should be assembled and tested first.

## The electronics

The electronics comprises two small, circular PCBs. These are designed to fit in an end cap of the case, and the boards connect together with two wires.

Construction of the boards is simply a matter of following the layout diagram. One point to note is the need to file a small relief slot in the inverter PCB, for the anode lead from the multiplier PCB. See the case construction diagram of Fig.5 for details.

The boards are arranged in the case with the components facing each other and two wires of around 50mm in length

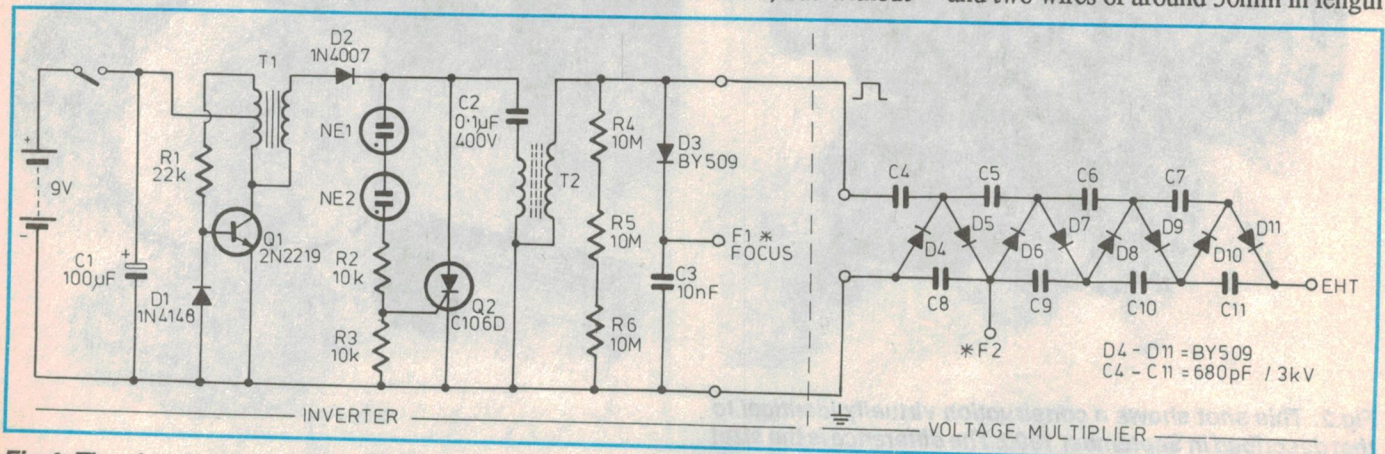
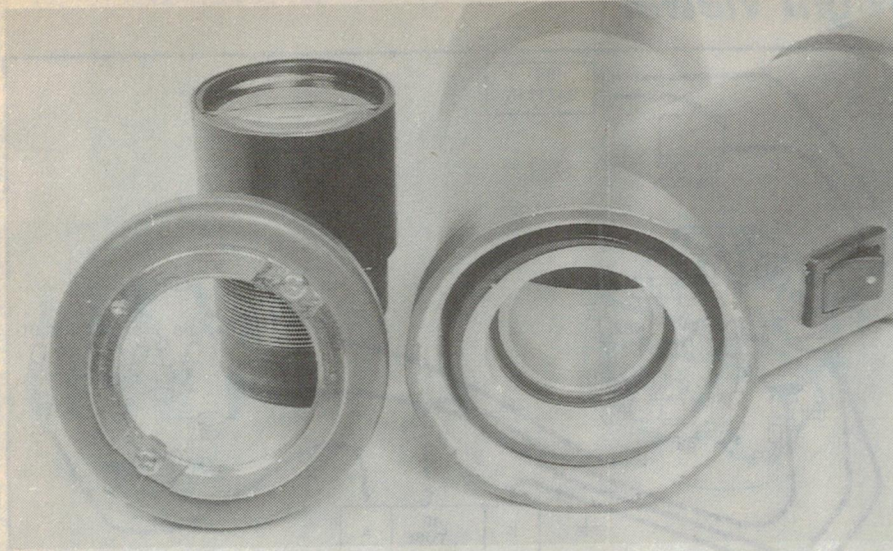


Fig.4: The circuit comprises three sections: an inverter to step up the DC input, a converter to produce 3kV and a multiplier to give the required 12kV. A focus voltage of 1.5kV is obtained across C3, and 3kV is available across C8.





**This photo shows the cathode end of the case and details of how the imaging lens is mounted.**

are required to interconnect them. The switch and battery connect to the track side of the inverter PCB as shown in Fig.5. Once you've assembled and connected the boards the electronics can be tested. Temporarily connect the tube, taking care not to stress the wires at their connection points at the tube.

Then lay everything on a sheet of material that has good insulating properties. For example use a sheet of perspex, thick plastic, polyurethane foam or glass. This is necessary to prevent high voltage leakage, as wood or similar materials can conduct electricity sufficiently to affect the regulation and operation of the multiplier.

Testing should be carried out in dim lighting, to prevent overloading and possible damage to the tube. Also, before applying power to the circuit, connect the earth of the circuit (negative terminal of the battery) to the mains earth. This prevents the entire circuit floating above earth and helps minimise the shock hazard. This is only necessary when the boards are outside the case. Note that although the current capability of the multiplier is very limited, a high voltage charge can remain in the multiplier capacitors after the power is turned off.

With power applied, check that the phosphor screen of the IR tube lights. Then check that a well focussed image is

obtained on the screen when an object is placed in direct contact with the front of the IR tube. You should also be able to see the neons flickering, indicating that the inverter section is working. Any faults are likely to be wiring errors, such as reversed diodes or other active components.

## The case

The case is made from 50mm PVC plumbing fittings and as the photos show, the end result is excellent. The diagram of Fig.5 shows constructional details of the case and the photos give views of both ends of the case.

Parts B, D and E are sections that need to be cut from a length of 50mm PVC pipe. Start by cutting these lengths from the pipe where B is 13mm, D is 23mm and E is 32mm.

Part A is made by cutting an end cap to an overall length of 12mm. Then cut a 37mm diameter hole in the centre of the cap. Place the supporting nut for the image lens over this hole and drill two 2.5mm holes through both the nut and the end cap. Locate the holes in the centre of the two recesses mounted on one side of the nut. These holes are for the 6BA metal screws used to hold the nut to the end cap.

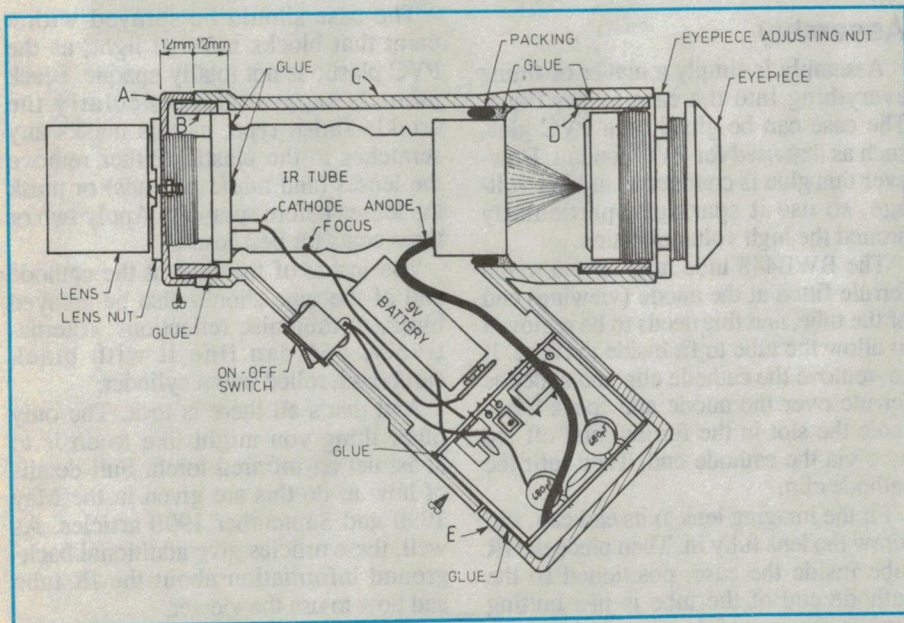
The eyepiece thread is a neat fit inside the pipe, and adjustment is made by rotating the nut to move the eyepiece as required. Next, cut a rectangular opening of 13mm by 19mm in the joiner for the on-off switch. The position is not critical, but it should be located similar to that shown in Fig.5. The switch is a press fit inside the opening.

The final step prior to assembly is to partially pot the multiplier in its end cap with a suitable potting compound. While not absolutely essential, this is recommended as a humid environment could cause high voltage leakage from the multiplier. Because the supply is designed to supply very low currents only, the slightest leakage can cause a reduction in the output voltage.

Various compounds can be used such as Araldite, a neutral cure silicone glue or other glues specified as being suitable for high voltage encapsulation.

Be careful not to use a silicone glue that is acidic cure. The tube should be marked as being *neutral* cure. There are specialised, two-part high voltage potting compounds available, but these are generally expensive. We used neutral cure silicone in the prototype.

If you use neutral cure silicone glue, be careful to keep the depth of the potting to layers of around 5 to 6mm. Greater depths take a long time to dry,



**Fig.5: The layout diagram. The connecting leads between the two boards should be around 50mm long. The anode lead to the IR tube is an EHT lead.**

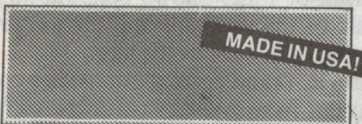


# SOLAR PANELS

**AT SUPER LOW PRICES**

**BRAND NEW, AMORPHOUS SILICON SOLAR PANELS, CONSTRUCTED ON IMPACT RESISTANT GLASS**

## 10 WATT-12 VOLT SOLAR PANEL



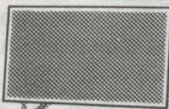
**MADE IN USA!**

For the more serious cost effective applications. This one will almost fully charge a fully discharged 12V-6.5AH get cell in one day! Minimum charging current into a 12V battery. 700mA. Voc: 16V (max) 20V. DIMENSIONS: 300mm X 900mm. **ONLY \$99**

Order Solar Panel: SP3 DELIVERY BY SKYROAD EXPRESS

## 2 WATT-12V SOLAR PANEL

Can charge 0-12V batteries at approx. 150mA. More than adequate for maintaining 12V batteries in cars and boats, or charging batteries in portable appliances.



**ONLY \$29**

Order Solar Panel: SP2 DELIVERY BY SKYROAD EXPRESS

## 1 WATT-6V SOLAR PANEL

Experimental delight! One of these panels will fully charge a 6V-500mA HR nicad battery pack in about 4 hours! You can also connect as many of these panels in series or parallel to produce the voltage and current required.

Voc: 8V (max) 10V  
Isc: 250mA (max) 300mA  
Order Solar Panel: SP1

**ONLY \$12** \$3 P&P



**VISIBLE LASER DIODE POINTER AT A SPECIAL PRICE**

Based on a "state of the art" 3mW visible red laser diode, and a matching heatsink/collimator assembly. The circuit even has provision for digital switching. Use them for pointers, sights, communications, security, etc. This kit includes the laser diode, collimator, PCB and components, and all the casing. Everything you need to make a complete pointer! **PRICE IS REDUCED BY OVER 20%!**

**\$179** + \$5 Cert P&P

**NEED A BATTERY TO CHARGE WITH YOUR PANEL?**

How about our BARGAIN PRICED brand new, industrial grade, 6.5AH sealed GEL batteries, at a fraction of their real value. Yes, 6.5 AMPERE HOURS! Use them in alarms, communications equipment, HE-NE laser power supplies, lighting, solar powered systems, etc. Excellent low temperature performance: 90% of full capacity at 0 deg C! Limited stock at

**ONLY \$34** Ea.  
DIMENSIONS: 150 X 95 X 65mm. Weight of one battery is 2.54kg.

**LASERS are not for kids: DANGER**

ANY OR AS MANY ITEMS DELIVERED BY SKYROAD EXPRESS TO YOUR DOOR: \$10

**OATLEY ELECTRONICS**

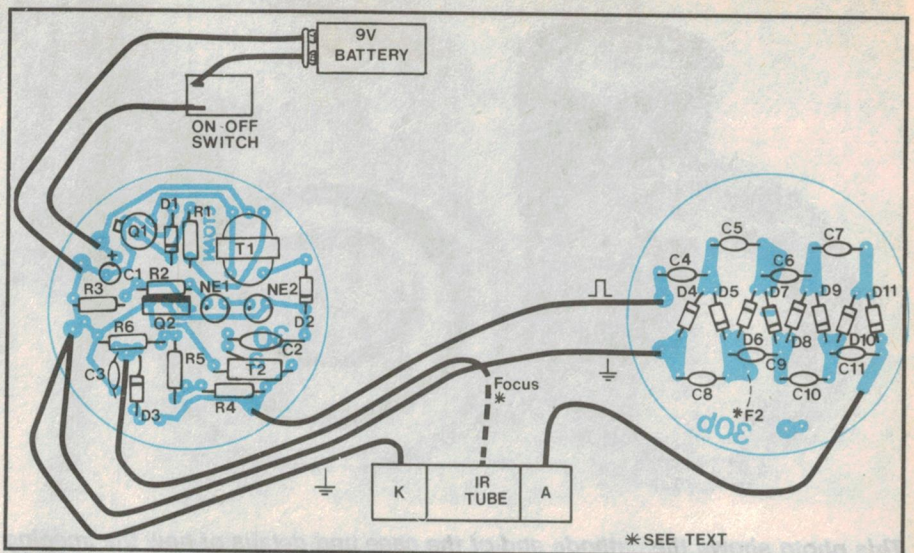
PO BOX 89, OATLEY, NSW 2223

Telephone: (02) 579 4985

Fax: (02) 570 7910

READER INFO NO. 14

# Night Viewer



Finally, here's the PCB overlay diagram, to help you in wiring up the Mini Infrared Night Viewer.

and anything over 1cm may not completely dry at all.

Make sure that both the multiplier assembly and the end cap are clean and dry before potting. Coat the track side of the multiplier board with the compound and allow it to dry. Make sure all solder joints are covered and that there is no exposed metal. Then lay a coating over the components. It is not necessary to completely enclose the components, but all bare wires and connections should be well coated. Then fit the coated PCB into the end cap and run some compound around the board to seal it in the end cap.

## Assembly

Assembly is simply a matter of fitting everything into the case as per Fig.5. The case can be glued with PVC glue, such as that used for PVC conduit. However this glue is conductive at high voltage, so use it sparingly, particularly around the high voltage section.

The BWB448 tube may have a nylon ferrule fitted at the anode (viewing) end of the tube, and this needs to be removed to allow the tube to fit inside the case. If so, remove the cathode clip and slide the ferrule over the anode and focus wires (note the slot in the ferrule) and off the tube via the cathode end. Then refit the cathode clip.

Fit the imaging lens to its end cap, and screw the lens fully in. Then place the IR tube inside the case, positioned so the cathode end of the tube is just butting against the rear of the lens. This step is important as it ensures that adjustment of the lens cannot damage the tube by

exerting pressure against the tube. Once the tube is located, fit packing (foam rubber or pieces of cardboard) around the tube to hold it in place inside the case. Small dabs of glue can be used to secure the tube, as shown in Fig.5.

The rest of the assembly is fairly obvious. Note that the anode lead passes through a relief slot filed in the inverter PCB. Foam rubber packing should be placed around the battery to prevent it touching exposed connections or the tube. The end cap assembly holding both PCBs is held to the case with a single screw, to allow access when changing the battery.

The case should be sprayed with a paint that blocks infrared light, as the PVC plastic is not totally opaque. Black paint is suggested, particularly the crinkle finish type, as this masks any scratches in the plastic. Either remove the lenses (and mask the ends) or mask the lenses before spraying. Apply two or three coats for best results.

The inside of the case at the cathode end of the tube should also be sprayed black, to minimise reflections. Alternatively, you can line it with black cardboard, rolled into a cylinder.

And that's all there is to it. The only other thing you might like to do is to construct an infrared torch. Full details of how to do this are given in the May 1990 and September 1990 articles. As well, these articles give additional background information about the IR tube and how to use the viewer.

Just remember not to expose the tube to high levels of light, particularly when the power is turned on.



# OATLEY ELECTRONICS-EA 'ANYTHING GOES' COMPETITION

Win some great prizes in our 'Anything Goes' competition! All you have to do is send in suggested applications for the Helium-Neon Laser project (September edition) OR the Night Viewer (October edition). We'll be awarding the prizes for the ideas that are most imaginative and useful. There are five major prizes and 40 runner-up prizes, with a total prize value of over \$4000!

There's no limit to the sort of entries you can submit — they can be complex or simple. For example, it might be an application in education, science, measurement, physics, entertainment, photography (which can include holography), surveying, home use and so on. Or you may have found a way of improving either of these projects. Anything goes, providing it's not proprietary and it's got something to do with lasers or night viewers!

## Here's what you can win:

- **FIRST PRIZE:** A fully constructed, very sensitive 'sub starlight' night viewer. These are not generally available and can produce useful images in light levels of around  $10^{-14}$  — virtual darkness. Also features an automatic light level control. (Value \$1595)
- **SECOND PRIZE:** A 7mW helium-neon gas laser head with a commercial mains power supply. A complete system that's ready to go. (Value \$520)
- **THIRD PRIZE:** A kit of parts for the night viewer as published in the October edition of EA. (Value \$299)
- **FOURTH PRIZE:** A 1mW laser head with a commercial laser supply that operates from 12V. (Value over \$259)



FIRST PRIZE

- **FIFTH PRIZE:** A laser kit comprising a 2mW laser head, with commercial mains power supply. (Value \$210)
- **PRIZES 6 to 25:** A complete kit of parts for the PIR alarm module as described in EA for May 1989. (Each kit worth \$47.85 — total prize value \$957).
- **PRIZES 26 to 45:** A complete kit of parts for the stereo VU meter as described in EA for June 1987. (Each kit worth \$14.90 — total prize value \$298).

SO 45 PEOPLE WILL WIN A PRIZE!

How's that for a competition for everyone? Total prize value is \$4138, simply for submitting an idea. Entries will be judged on their usefulness, originality and general appeal to other readers. All diagrams and written descriptions in your entry should be presented clearly. Ideally you will have proven your application and supplied sufficient information to allow us to publish details, for the benefit of other readers.

**To enter, simply send your entry to:**

'Anything Goes' Competition,  
Electronics Australia,  
PO Box 199,  
Alexandria, NSW 2015

**Competition closes 30th Nov. 1991.**

All winners will be advised by mail and results will be published in the February 1992 edition of *Electronics Australia*.

All prizes have been donated by:  
Oatley Electronics,  
5 Lansdowne Parade,  
Oatley West, NSW 2223.  
Phone (02) 579 4985  
Postal address (mail orders):  
PO Box 89, Oatley West NSW 2223.



SECOND PRIZE



## DATA & REFERENCE

### DIGITAL IC EQUIVALENTS AND PIN CONNECTIONS

**BP140** \$18.00  
Shows equivalents and pin connections of a popular user-orientated selection of European, American and Japanese digital ICs. Also includes details of packaging, families, functions, manufacturer and country of origin.

### LINEAR IC EQUIVALENTS AND PIN CONNECTIONS

**BP141** \$18.00  
Shows equivalents and pin connection of a popular user-orientated selection of European, American and Japanese linear ICs. Also includes details of function, manufacturer, and country of origin.

### POWER SELECTOR GUIDE

**BP235** \$16.00  
Covers power devices including Diodes, Thyristors, Triacs, FET's and Power transistors etc.

### ELECTRONIC HOBBYISTS HANDBOOK

**BP233** \$16.00  
Mr R.A. Penfold has used his vast knowledge of hobby electronics to provide a useful collection of data for the amateur electronics enthusiast, in a single source where it can be quickly and easily located.

### RADIO AND ELECTRONIC COLOUR CODES AND DATA CHART

**BP7** \$4.00  
Covers many colour codes in use throughout the world, for most radio and electronic components. Includes resistors, capacitors, transformers, field coils, fuses and battery leads, speakers etc.

### CHART OF RADIO, ELECTRONIC, SEMICONDUCTOR AND LOGIC SYMBOLS

**BP27** \$4.00  
Illustrates the common, and many of the not so common, radio and electronic, semiconductor and logic symbols that are used in books, magazines and instruction manuals etc., in most countries throughout the world.

## CIRCUITS & CONSTRUCTIONAL PROJECTS

### IC PROJECTS FOR BEGINNERS

**BP97** \$8.50  
Offers a range of simple projects based around a number of popular and inexpensive linear and digital integrated circuits. With most projects, complete layout and/or point to point wiring diagrams are included to help simplify construction.

### 30 SOLDERLESS BREADBOARD PROJECTS - BOOK 1

**BP107** \$11.00  
Each project, which is designed to be built on a "Verobloc" breadboard, is presented in similar fashion with a brief circuit description, circuit diagram, component layout diagram, components list and notes on construction and use where necessary. Wherever possible the components used are common to several projects.

### 30 SOLDERLESS BREADBOARD PROJECTS - BOOK 2

**BP113** \$6.50  
This book describes a variety of projects that can be built on plug-in breadboards using CMOS logic IC's. Each project contains a schematic, parts list and operational notes.

### POPULAR ELECTRONIC PROJECTS

**BP49** \$9.50  
Provides a collection of the most popular types of circuits

and projects covering a very wide range of interests, including Radio, Audio, Household and Test Equipment projects.

### HOW TO USE OP-AMPS

**BP88** \$11.00  
This book has been written as a designer's guide covering many operational amplifiers, serving both as a source book of circuits and a reference book for design calculations. The approach has been made as non-mathematical as possible and it is hoped, easily understandable by most readers, be they engineers or hobbyists.

### IC 555 PROJECTS

**BP44** \$9.50  
Every so often a device appears that is so useful that one wonders how life went on without it. The 555 timer is such a device. Included in this book are basic and general circuits, motorcar and model railway circuits, alarms and noise-makers as well as a section on the 556, 558 and 559 timers.

### 50 SIMPLE LED CIRCUITS

**BP42** \$6.00  
Contains 50 interesting and useful circuits and applications, covering many different branches of electronics, using one of the most inexpensive and freely available components - the light-emitting diode (LED). Also includes circuits for the 707 common anode display.

### 50 SIMPLE LED CIRCUITS - BOOK 2

**BP87** \$6.00  
A further range of uses for the simple LED which complements those shown in book number BP42.

### 50 PROJECTS USING RELAYS, SCRS AND TRIACS

**BP37** \$8.50  
Relays, silicon controlled rectifiers (SCR's) and bi-directional triodes (TRIAC's) have a wide range of applications in electronics. This book gives tried and practical working circuits which should present the minimum of difficulty for the enthusiast to construct.

### MINI-MATRIX BOARD PROJECTS

**BP99** \$6.50  
This book provides a selection of 20 useful and interesting circuits, all of which can be built on a mini-matrix board just 24 holes by 10 copper strips in size.

### REMOTE CONTROL HANDBOOK

**BP240** \$13.00  
Replaces our original book DP73 and is aimed at the electronics enthusiast who wishes to experiment with remote control in its many aspects and forms.

### MODEL RAILWAY PROJECTS

**BP95** \$8.50  
Provides a number of useful but reasonably simple projects for the model railway enthusiast to build. The projects covered include such things as controllers, signal and sound effects units, and to help simplify construction, stripboard layouts are provided for each project.

### ELECTRONIC PROJECTS FOR CARS AND BOATS

**BP94** \$9.50  
Describes fifteen fairly simple projects for use with a car and/or boat. Each project has an explanation of how the circuit works as well as constructional details including a stripboard layout.

### POWER SUPPLY PROJECTS

**BP 76** \$7.50  
Mains power supplies are an essential part of many electronic projects. This book gives a number of power supply designs, including simple unregulated types, fixed voltage regulated types, and variable-voltage stabilised designs, the latter being primarily intended for use as bench

supplies for the electronics workshop. The designs provided are all low-voltage types for semiconductor circuits.

### ELECTRONIC SECURITY DEVICES

**BP56** \$9.50  
This book, besides including both simple and more sophisticated burglar alarm circuits using light, infra-red and ultra-sonics, also includes many other types of circuit as well, such as gas and smoke detectors, flood alarms, doorphone and baby alarms, etc.

### PRACTICAL ELECTRONIC BUILDING BLOCKS-Book 1

**BP117** \$8.50

### PRACTICAL ELECTRONIC BUILDING BLOCKS-Book 2

**BP118** \$8.50

These books are designed to aid electronic enthusiasts who like to experiment with circuits and produce their own projects. The circuits for a number of building blocks are included in each book, and component values and type numbers are provided in each case. Where relevant, details of how to change the parameters of each circuit (voltage gain of amplifiers, cut-off frequencies of filters, etc.) are given so that they can be easily modified to suit individual requirements. No difficult mathematics is involved.

### HOW TO DESIGN ELECTRONIC PROJECTS

**BP127** \$9.00

The aim of this book is to help the reader to put together projects from standard building blocks with a minimum of trial and error, but without resorting to any advanced mathematics. Hints on designing circuit blocks to meet your special requirements where no "stock" design is available are also provided.

### HOW TO DESIGN AND MAKE YOUR OWN PCBs

**BP121** \$6.50

Chapter 1 deals with the simple methods of copying printed circuit board designs from magazines and books and covers all aspects of simple PCB construction as comprehensively as possible.

Chapter 2 covers photographic methods of producing PCB's and Chapter 3 deals with most aspects of designing your own printed circuit board layouts.

## S.W., AMATEUR RADIO & COMMUNICATIONS

### COMMUNICATION (Elements of Electronics-Book 5)

**BP89** \$11.00

A look at the electronic fundamentals over the whole of the communication scene. This book aims to teach the important elements of each branch of the subject in a style as interesting and practical as possible.

### AN INTRODUCTION TO AMATEUR RADIO

**BP257** \$11.00

Gets you started with the fascinating hobby that enthralls so many people the world over.

### INTERNATIONAL RADIO STATIONS GUIDE

**BP255** \$16.00

Totally revised and rewritten to replace the previous edition (BP155), this book contains considerably more information which is now divided into thirteen sections including: Listening to SW Radio, ITU Country Codes, Worldwide SW Stations, European, Middle East & N. African LW Stations, European, Near East & N. African MW Stations, Canadian MW Stations, USA MW Stations, Broadcasts in English, Programmes for DXer's & SW Listener, UK FM Station, Time Differences from GMT, Abbreviations, Wavelength/Frequency Conversion



## AERIALS

### AERIAL PROJECTS

**BP105** \$8.50

The subject of aerials is vast but in this book the author has considered practical aerial designs, including active, loop and ferrite aerials which give good performance and are relatively simple and inexpensive to build.

### 25 SIMPLE SHORTWAVE BROADCAST BAND AERIALS

**BP132** \$6.50

Fortunately good aerials can be erected at low cost, and for a small fractional part of the cost of your receiving equipment.

This book tells the story. A series of 25 aerials of many different types are covered, ranging from a simple dipole through helical designs to the multi-band umbrella.

### 25 SIMPLE INDOOR AND WINDOW AERIALS

**BP136** \$6.00

Written for those people who live in flats or have no gardens or other space-limiting restrictions which prevent them from constructing a conventional aerial system.

The 25 aerials included in this book have been especially designed, built and tested by Mr. Noll to be sure performers and give surprisingly good results considering their limited dimensions.

### 25 SIMPLE TROPICAL AND MW BAND AERIALS

**BP145** \$6.00

Shows you how to build 25 simple and inexpensive aerials for operation on the medium wave broadcast band and on the 60, 75, 90 and 120 metre tropical bands. Designs for the 49 metre band are included as well.

### AUDIO & HI-FI

#### DIGITAL AUDIO PROJECTS

**BP245** \$11.00

Contains practical details of how to construct a number of projects which fall into the "Digital Audio" category. They should be of interest to most audio and electronic music enthusiasts.

#### AN INTRODUCTION TO LOUDSPEAKERS AND ENCLOSURE DESIGN

**BP256** \$11.00

All you need to know about the theory and operation of loudspeakers and the various types of boxes they may be fitted into.

Also includes the complete design and constructional details of how to make an inexpensive but high quality enclosure called the "Kapellmeister".

#### AUDIO PROJECTS

**BP90** \$8.50

This book covers in detail the construction of a wide range of audio projects. The text has been divided into the following main sections: Pre-amplifiers and Mixers, Power Amplifiers, Tone Controls and Matching, Miscellaneous Projects.

All the projects are fairly simple to build and designed to assist the newcomer to the hobby.

#### AUDIO (Elements of Electronics-Book 6)

**BP111** \$13.00

Analysis of the sound wave and an explanation of acoustical quantities prepare the way. These are followed by a study of the mechanism of hearing and examination of the various sounds we hear. A look at room acoustics with a subsequent chapter on microphones and loudspeakers then sets the scene for the main chapter on audio systems, amplifiers, oscillators, disc and magnetic recording and electronic music.

#### AUDIO AMPLIFIER CONSTRUCTION

**BP122** \$9.00

The following practical designs are featured and include circuit diagram and description, Veroboard or PCB layout and any necessary constructional or setting-up notes.

Chapter 1 - Pre-amplifiers: versatile microphone type based on the NE5534; tape type using the LM3802; RIAA pre amp; simple guitar pre amp; ceramic or crystal pick-up type; active tone controls using a LF351; general purpose pre

amp.

Chapter 2 - Power amplifiers: simple low power battery type using a 2283 IC; 2 watt using the TBA820; 8 watt using the TDA2030; 16 watt 12 volt P.A. amplifiers; 20 watt using a MOSFET output stage; 100 watt DC coupled amplifier using four MOSFETs in the output stage.

#### CHOOSING AND USING YOUR HI-FI

**BP68** \$6.00

Provides the fundamental information necessary to make a satisfactory choice from the extensive range of hi-fi equipment now on the market.

Help is given to the reader in understanding the technical specifications of the equipment he is interested in buying.

## THEORY & CALCULATIONS

### FROM ATOMS TO AMPERES

**BP254** \$12.00

Explains in crystal clear terms the absolute fundamentals behind the whole of Electricity and Electronics. Really helps you to understand the basis of the subject, perhaps for the first time.

### FURTHER PRACTICAL ELECTRONICS CALCULATIONS AND FORMULAE

**BP144** \$16.00

Written in the same style as the first book (BP53) and with the same objectives in mind, this book is divided into the following fourteen sections: Electricity, Electrostatics, Electromagnetism, Complex numbers, Amplifiers, Signal Generation and Processing, Communication, Statistics, Reliability, Audio, Radio, Transmission Lines, Digital Logic and Power Supplies.

### THE SIMPLE ELECTRONIC CIRCUIT AND COMPONENTS

**BP62** \$12.00

### ALTERNATING CURRENT THEORY

**BP63** \$12.00

### SEMICONDUCTOR TECHNOLOGY

**BP64** \$12.00

The aim of this series of books is to provide an inexpensive introduction to modern electronics so that the reader will start on the right road by thoroughly understanding the fundamental principles involved.

BOOK 1: This book contains all the fundamental theory necessary to lead to a full understanding of the simple electronic circuit and its main components.

BOOK 2: This book continues with alternating current theory without which there can be no comprehension of speech, music, radio, television or even the electricity mains.

BOOK 3: Follows on semiconductor technology, leading up to transistors and integrated circuits.

## ELECT. & COMPUTER MUSIC

### ELECTRONIC MUSIC PROJECTS

**BP74** \$9.50

Provides the constructor with a number of practical circuits for the less complex items of electronic music equipment, including such things as fuzz box, waa-waa pedal, sustain unit, reverberation and phaser units, tremelo generator, etc.

### MUSICAL APPLICATIONS OF THE ATARI ST's

**BP246** \$12.95

The Atari ST's are fast becoming the first choice in computers for the electronic music enthusiast due to their relatively low cost and MIDI interface. The Penfolds show you how to make the most of these machines musically, with simple add-on circuits and program routines.

### COMPUTER MUSIC PROJECTS

**BP173** \$11.00

Shows some of the ways a home computer can be used to

good effect in the production of electronic music. Topics covered include sequencing and control via analogue and MIDI interfaces, computers as digital delay lines and sound generators for computer control.

### MORE ADVANCED MIDI PROJECTS

**BP247** \$11.00

Carries on where book BP182 left off by providing constructional details of some more advanced and sophisticated projects such as a mixer, merge unit and harmoniser etc.

### ELECTRONIC SYNTHESIZER CONSTRUCTION

**BP185** \$11.00

This book will enable a relative beginner to build, with the minimum of difficulty and at reasonably low cost a worthwhile mono-phonic synthesiser, and also learn a great deal about electronic music synthesis in the process.

## TV, VIDEO & SATELLITES

### AN INTRODUCTION TO SATELLITE TV.

**BP195** \$12.95

As a definitive introduction to the subject this book is presented on two levels. For the absolute beginner with no previous knowledge, the story is told as simply as it can be in the main text.

For the professional engineer, electronics enthusiast, student or others with technical backgrounds, there are numerous appendices backing up the main text with additional technical and scientific details, formulae, calculations and tables etc.

## FAULT-FINDING

### HOW TO GET YOUR ELECTRONIC PROJECTS WORKING

**BP110** \$8.50

We have all built circuits from magazines and books only to find that they did not work correctly, or at all, when first switched on. The aim of this book is to help the reader overcome just these problems by indicating how and where to start looking for many of the common faults that can occur when building up projects.

### AUDIO AMPLIFIER FAULT-FINDING CHART

**BP120** \$4.00

This chart will help the reader to trace most common faults that might occur in audio amplifiers. Across the top of the chart are two "starting" rectangles, viz Low/Distorted Sound Reproduction and No Sound Reproduction; after selecting the most appropriate one of these, the reader simply follows the arrows and carries out the suggested checks until the fault is located and rectified.

### GETTING THE MOST FROM YOUR MULTIMETER

**BP239** \$11.00

It is amazing just what you can check and test with a simple multimeter if you know what you are doing. This book tells the story, covering the basics and relative merits of analogue and digital instruments, component checking and dealing with circuit testing.

### MORE ADV. USES OF THE MULTIMETER

**BP265** \$12.00

A sequel to book BP239 showing the reader some more advanced and unusual applications of that humble test instrument - the simple multimeter.

### HOW TO USE OSCILLOSCOPES AND OTHER TEST EQUIPMENT

**BP267** \$12.00

Just as the title says, this book shows the hobbyist how to effectively use a number of pieces of electronic test equipment including the oscilloscope.

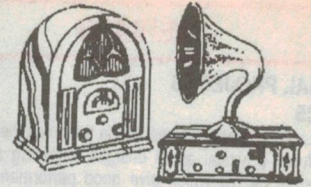
**SOLD OUT**

To order, simply fill in the coupon, remembering to include the code numbers and \$5.00 postage and handling. If the coupon is missing, write down the names, code numbers and prices of the books you require. Include your name, address, ph number, plus cheque, money order or credit card details (card type, card number, expiry date and signature) and send it all to Federal Publishing, Freepost No.3, P.O.Box 199 Alexandria, NSW 2015. Don't forget to sign all orders.



# Vintage Radio

by PETER LANKSHEAR



## The Philips 2510 receiver

Philips' first export model receiver, the 2510, was first produced in late 1929 and was one of the first Philips receivers sold in Australasia. Furthermore, it was one of only two Philips models to be sold in both Australia and New Zealand.

Its quality and unusual appearance make the Philips 2510 a justifiably popular receiver, and it has survived in surprisingly large numbers — many New Zealand collectors having more than one. As proof of Philips durability, some are still in working order despite being completely original.

The equivalent larger cased European model called the 2511 had some common features, but clearly the 2510 was a special design. Unlike practically all European receivers, it did not include a longwave band. It is remarkable that Philips bothered to develop a special export model, for what by European standards must have been a very small market.

Already many countries had import restrictions and tariffs to protect their homegrown receivers. It had become

necessary for Philips to look to remote countries like Australia and New Zealand, where broadcasting was established and most radios were still imported.

Philips were by 1929 already well known here for their valves and battery eliminators, and could assume that their receivers would sell easily. It has recently come to light that the 2510 was sold in Brazil, while Argentina and South Africa also had Philips branches and are likely to have sold the 2510 as well.

Philips must have considered these combined markets as having sufficient potential to make the development of a special model a viable proposition. Much of the development work and many of the components for the 2511 were used, however.

Whatever the rationale, the 2510 was

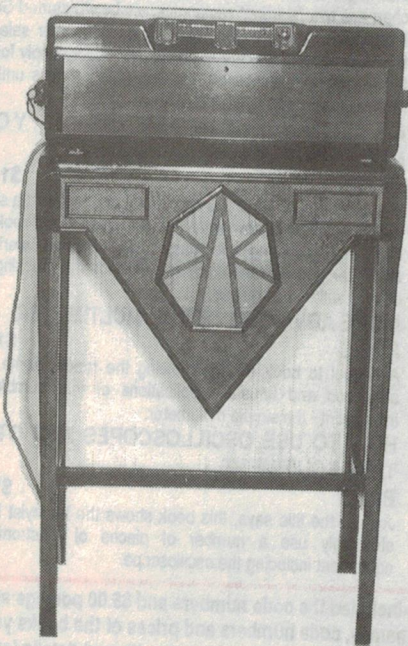
launched. Unfortunately, before production of the 2510 had run its course, Australia too joined the ranks of the protectionists.

This must have been quite a setback. One outcome was that Philips did not develop any more single band receivers — any exports to New Zealand being the standard models, by now being produced in an English Philips factory.

### Two versions

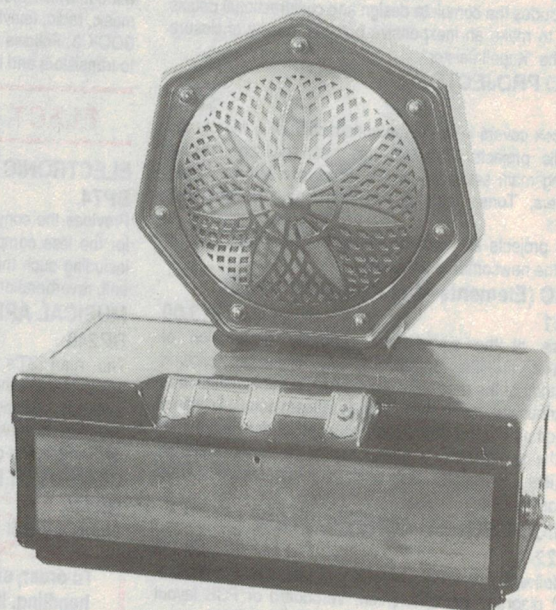
Despite the 2510 being in production for only a couple of years, there were two versions and several small variations as production progressed.

Although a database listing 40 receivers has been analysed, there is no firm relationship between dating and the sequence of serial numbers. Many receivers have, however, a date printed on one

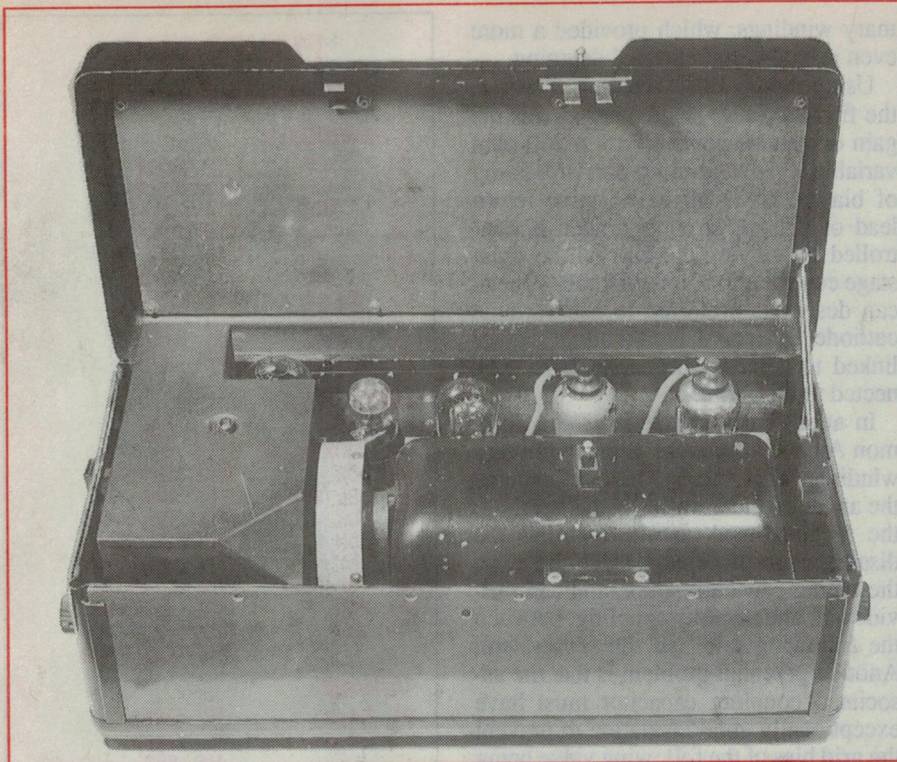


*Fig.1 (right): The 2510 was very popular when combined as shown here with the 'Sevenette' magnetic (moving iron) speaker.*

*Fig.2 (left): Another popular combination was the 2510 with the 'Consolette', a table of unusual design and incorporating an early 'permagnetic' moving coil loudspeaker.*







**Fig.3:** There's not a lot visible under the lid of the 2510. Here the valve shielding box has been removed, but the tuning capacitor is still hidden by its curved shield and the power supply by the protective box visible at the left.

of the bypass capacitors. One difference readily distinguishes the early version from later models: the main escutcheon plate in the early models has six stars, whereas later there was only a single star. Later still, the keyhole was given a metal surround.

A real mystery surrounds a few New

Zealand models with low serial numbers. Instead of the maker's plate being marked 'Made in Holland', the caption reads 'Assembled in N.Z.'. Leading one to speculate what for, and by whom?

Given the type of construction, and facilities available at the time, only very nominal assembly could have been un-

dertaken. There are no differences to distinguish the N.Z. version. Were there any Australian assembled models? If any reader knows of one, please let me know.

## US equivalents

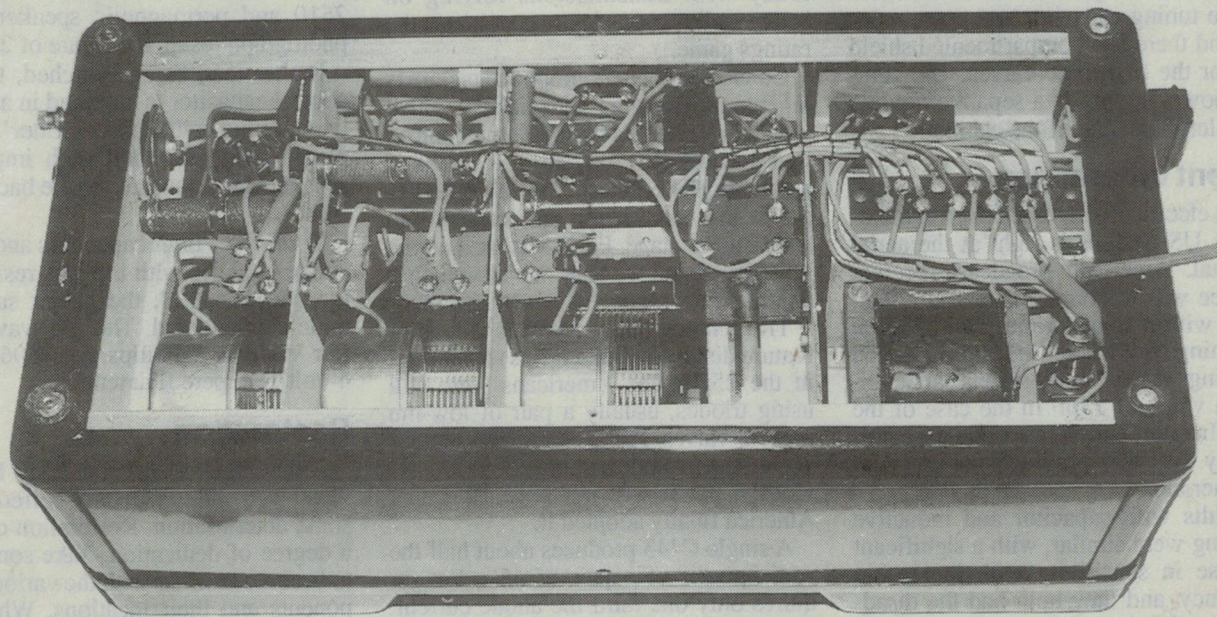
As a mains powered TRF in a 'chest' type cabinet with separate loudspeaker, and with two screen-grid RF amplifier stages, the 2510 was a European equivalent of familiar 1929/30 American receivers such as the Atwater Kents, Crosleys and Philcos. There are interesting design details, which illustrate some of the differences between contemporary American and European technology and construction.

Many 2510's were supplied with a 'Sevenette' free standing moving iron speaker, but an alternative was Philips' first permanent magnet moving coil speaker, the 'Permagnetic', available in some rather stylish cabinets designed by a Sydney architect. There was also the unusual 'Consolette', which consisted of a table to support the receiver and with the speaker mounted underneath.

## Side controls

Except for the on/off switch, there are no controls at the front of the receiver. Instead, tuning and volume controls are at the ends of the cabinet.

One odd feature has created a lot of speculation. There is a lock for the lid which, despite what is claimed in the instruction book, does not prevent unauthorised use of the receiver. All it does is to prevent access to the interior. It is



**Fig.4:** With the bottom panel removed, most of the wiring and components are accessible.



## VINTAGE RADIO

not necessary for safety — there is an automatic cut-out switch connected to the lid. One possibility is that this is a hangover from the model 2511's lock, which had a second position locking the wavechange and mains switches.

### Novel cabinet

The colloquial term 'tin trunk' for the 2510 is not really very appropriate. In fact, the case consists of a metal frame and panels of 'Vanherite', made from sheets of paper impregnated with thermosetting resin and cured under high compression. A printed wood grained pattern on the outer paper sheet provides a high gloss decorative finish. The removable panel on the underside of the cabinet, providing access to the wiring, is a feature which was to become common Philips practice.

Internal construction of the 2510 is quite different from the conventional chassis. Instead, the Philips format is more three dimensional, the entire assembly being carried in a very solid metal frame. At the rear is a row of valve sockets and many of the larger resistors, wound on glass tubing. To the front of the valve sockets is a beautifully made brass vaned three-gang tuning capacitor with an integral drum dial drive, and under this are three cylindrical cans — almost certainly containing toroidal tuning coils.

Shielding partitions across the frame provide mounting surfaces for smaller components. Separate covers are used for the tuning capacitor and power supply, and there is a compartmented shield box for the first three valves. The compact power supply is a separate module at the left hand end of the cabinet.

### Salient differences

One electrical difference from contemporary US designs is right at the aerial terminal. American broadcast receiver practice was to couple the aerial inductively with a small primary winding on the tuning coil, whereas Philips favoured coupling via a small series capacitor, with a value of 13pF in the case of the 2510. In later models, a second capacitor of only 4pF was provided for use with large aeri-als.

Results with capacitor and inductive coupling were similar, with a significant increase in sensitivity with increasing frequency, and they both had the disadvantage of detuning the input stage with changes of aerial. Later these methods were superseded by high impedance pri-

mary windings, which provided a more even response and minimal detuning.

Using a type E442 screen-grid valve, the first amplifier stage incorporates the gain or volume control R15, a 200-ohm variable resistor forming part of a string of bias resistors in the negative return lead of the power supply. Gain is controlled by varying the bias on the input stage control grid. Contemporary American designers preferred to use variable cathode bias or screen voltage, often linked to another variable resistor connected to the aerial.

In another divergence from the common American practice of using primary windings for RF coils, Philips connected the anode of the first RF stage directly to the second tuned circuit. This has the disadvantage of placing HT voltage on the tuning capacitor stator, and can provide an undesirable coupling between the following grid and the HT system. Another potential problem is that the associated coupling capacitor must have exceptionally good insulation to prevent the grid bias of the following valve being upset by the leakage of HT voltage.

In a similar manner, the anode of the second RF stage, another E442, is directly connected to the detector tuning coil.

### Traditional detector

The detector is a traditional grid-leak type — sensitive, but in 1929, already obsolescent in high quality broadcast receivers. Its chief disadvantage in this application is serious distortion at high modulation levels, a greater problem today with transmissions relying on heavy audio processing to compete in the ratings game.

Connection of a gramophone pickup is ingenious. Plugging the pickup, which would have had its own volume control, into the socket at the rear of the cabinet automatically connects the valve grid to a bias line, converting the detector into an amplifier stage. Early sets used a type E415 triode but for later models a higher amplification factor E424 was specified.

The pentode output valve is the major feature distinguishing Philips technology in the 2510. The Americans were still using triodes, usually a pair of low- $\mu$  type 45 valves. Philips engineers had invented the pentode a couple of years previously, but it was not until 1931 that America finally adopted it.

A single C443 produces about half the audio power of a pair of 45's, but requires only one third the anode current. By using the more sensitive and efficient pentode, Philips receivers saved one stage of amplification.

## PHILIPS 2510: Component values

### Capacitors

C1	5 $\mu$ F	C12	0.5 $\mu$ F
C2	4 $\mu$ F	C13	0.5 $\mu$ F
C3	1 $\mu$ F	C14	0.5 $\mu$ F
C4	2 $\mu$ F	C15	0.5 $\mu$ F
C5	1 $\mu$ F	C16	13pF
C6	1 $\mu$ F	C17	13pF
C7	550pF	C18	0.5 $\mu$ F
C8	1650pF	C19	0.5 $\mu$ F
C9	40pF	C20	0.5 $\mu$ F
C11	0.5 $\mu$ F	C27	(4pF)

### Resistors

R1	50k	R11	100k
R2	200k (100k)	R12	20k
R3	40k	R13	35 ohms
R4	38k (30k)	R14	100k
R5	50k	R15	200 ohms
R6	40k	R16	100 ohms
R7	2M	R17	50 ohms
R8	38k (30k)	R18	50 ohms
R9	2M	R19	225 ohms
R10	30k	R20	40k
		R21	50k (100k)

### Valves

V1	E442	V2	E442
V3	E415 or E424	V4	C443
		V5	506

Values in brackets are for 1931 models.  
Some sets do not have C14 or C20.

The output transformer has a tapped secondary winding connected to two sockets, L1 for high impedance moving iron speakers and L2 for connecting directly to voice coils.

Here is another puzzle. In a 1931 data sheet, the output transformer has a turns ratio calculated to make the L2 impedance a remarkably high 64 ohms. However, direct measurements on both the 2510 and permagnetic speaker in the photograph result in a figure of 28 ohms.

Rather than being switched, the tone control capacitor is mounted in a 'tapon' type of plug called a 'tone filter'. This is plugged into L1, and high impedance speakers are connected to the back of the filter.

With paper filter capacitors and a filter choke in series with the bias resistors in the negative lead, the power supply is quite conventional. The full wave rectifier valve is a Philips type 506 with a 4-volt 1-ampere filament.

### Restoration

Although as a class the 2510 has survived well, many will have suffered from some deterioration. Restoration calls for a degree of dedication. Take some time to become familiar with the various components and their locations. When you do start work, remember that **the valve top caps are the anodes, and have a high voltage on them!**

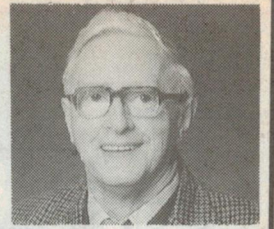






# SHORTWAVE LISTENING

by Arthur Cushen, MBE



## Preparing a reception report

This month we outline the five basic ingredients in a reception report, so that broadcasters can be given the details they seek. There is also some more interesting information of the work of the Red Cross, as well as news and information on other stations in various parts of the world.

International broadcasters are keen to hear from their audience worldwide, not only to indicate that listeners are tuned to the broadcast but also to enable them to confirm the quality of your reception.

In recent articles we have looked at various aspects of radio listening for the beginner. Recently we dealt with the SIO code and how to evaluate the strength of a signal. This month we are looking at the content of a reception report.

There are five basic ingredients in a reception report: the date, time, frequency, some programme information that can be verified, and some comments on reception conditions, signal strength and comparison to other broadcasters being heard in your area.

The date should be given in UTC (GMT) or the station's local time. Australia is 10 hours ahead of UTC and therefore in using the 24 hour clock system, when it is 10am in Sydney, it is midnight or 2400UTC. After that time, both Sydney time and UTC are the same day. This remains so until in Sydney it is past midnight — then the UTC day is still the previous day.

When writing the date it is advisable to spell out the month, as the US and some countries list the month before the day, so 10/6/91, the 10th of June, could also be the 6th of October. Therefore it is necessary to express the date in words.

The frequency should be given in kilohertz. If you have a keypad receiver with a display, this information is easy to obtain. If not some stations give the frequencies they are using at the commencement or end of their transmission.

The programme content should cover at least 15 minutes of information, including items such as news bulletins, the name of the news reader, musical numbers, the identification announcement of the station and other material which the station can identify as being from their programme log.

When listening to transcribed programmes supplied by other broadcasters or recordings which are not produced in the

station's studios, it is only necessary to name the title of the programme, as the exact contents would not be known to the broadcaster.

Later, when you come to listen to stations using a foreign language, such as broadcasts from the BBC or the Voice of America, you will find that they announce their station identification every hour or half hour. You will soon learn the familiar signals used by broadcasters so that, without listening to any spoken

programme, you will know the source of the signal.

When writing to stations in Latin American which are broadcasting in Spanish or Portuguese, there are publications available which give an excellent summary of the English text and the equivalent Spanish translation. Armed with a translation guide, you can write a very well presented letter in Spanish, though your knowledge of the language may not be great.

## AROUND THE WORLD

**BRAZIL:** The transmitters of Radio Braz at Brazilia are being used for a programme service called 'Radio Surinam International.' The transmissions are beamed to Surinam and heard on 17750kHz with English news at 1730UTC. The news generally consists of information about Surinam and then a bulletin of Caribbean news and information. Sign-off is at 1742, following a short announcement in Dutch and the Surinam national anthem.

**FRANCE:** Radio France International is using the facilities of Radio Beijing for a transmission in French to Australia at 1030-1130 on a frequency of 15285kHz. Radio France International has three daily broadcasts in English: at 1230-1300 9805, 11670kHz are the best of many frequencies; from 1400-1500 they use 11915, relayed via Beijing; while the transmission 1600-1700 is on 11705 and 12015kHz and these are relayed by Africa Number One in Gabon.

**GUAM:** The English broadcasts from KSDA are now heard at 2400 on 15610kHz, 0200 on 13720kHz Saturday-Sunday only; 1600 on 11980kHz; 1700 on 13720 kHz Saturday-Sunday only; and 2300 on 15610kHz.

**INDIA:** All India Radio Delhi broadcasting to Australia in English 1000-1100 on 15050, 15335, 17387, 17895, 21735kHz; 2045-2230 on 7412, 9910, 9950, 11620, 11715 and 15265kHz. There are two new frequencies now in use: 17895kHz replacing 17865kHz at 1000, and 9950kHz replacing 9665kHz at 2045.

**JAPAN:** Radio Japan, as well as broadcasting a Regional Service to the South Pacific 0900-1000 on 15270 and 17890kHz, has a General Service in three transmissions: 0500-0600 and 0700-0800 on 17890kHz, and 1900-1930 on 9640 and 11850kHz. The popular 'Radio Japan DX Corner' is heard on Sunday at 0930 on 11840 and 21610kHz, and at 2130 on 17890kHz.

**USSR:** Radio Alma Ata is another of the Soviet Republics heard with its own broadcasting service, and English is carried at 1630-1658 on 5915kHz. The broadcast consists of news about Kazakhstan as well as world news. Music is heard from 1648 to sign-off, when the full address is given and a request for reception reports is made.

**VATICAN:** The use of a new out-of-band frequency by Vatican Radio has been noted in the broadcast to Africa in English at 0500-0530. The channel is 11625kHz, and from 0530 the programme continues in Portuguese. We have only noted Vatican on one other out-of-band channel, 6248 kHz, which is used for reception of broadcasts in Europe.



A book series produced in the US under the title Language Lab, enables Spanish/English, Portugese/English, Indonesian/English and French/-English reports to be written.

In particular, when dealing with smaller stations in Latin American which have no staff with a knowledge of English, a letter in Spanish could result in them verifying your report.

### Better East/West relations

The ending of the Cold War and jamming has been beneficial to shortwave listeners. One of the latest outcomes has been a meeting in Prague, where broadcasting organisations from Eastern and Western Europe met in discussion for the first time in over 40 years.

The meetings were to work for better frequency usage and try to avoid interference from each others transmissions. In the past, Radio Moscow, a huge broadcasting organisation, has not cooperated to any degree with stations in Western Europe and this has caused interference on most frequencies.

The first meeting which was attended by 14 countries from Eastern Europe, from Ulan Bator across to Poland, was held in May. One of the early outcomes was a minor frequency adjustment between the BBC and Radio Moscow.

The BBC has been using 11955kHz, and suffering interference from Radio Moscow, and Moscow has been using 11835kHz, also used by the BBC. This type of negotiation, with a bit of give and take, is certain to be of benefit to shortwave listeners.

Already there has been a further meeting to plan the winter schedule for stations in Europe, and better coordination of frequency usage will result.

### Spain's world service

A 24 hour service in Spanish, to be operational by the end of the year, is the aim of the Spanish Foreign Radio in Madrid. Already broadcasting to most parts of the world in several languages including English, this entire Spanish transmission would be heard, not only direct from Spain, but from a new relay base in Costa Rica.

The installation near San Jose, Costa Rica consists of three 300kW transmitters. By October the station should be fully operational and early next year it will be

*This item was contributed by Arthur Cushen, 212 Earn St. Invercargill, New Zealand who would be pleased to supply additional information on medium and shortwave listening. All times are quoted in UTC (GMT) which is 10 hours behind Australian Eastern Standard Time.*

fully used. There will be a satellite link from the studios in Madrid to Costa Rica, and the transmissions will cover the southern parts of the United States and Mexico.

Then tests will be carried out to Central America and the Caribbean and later to South America. Costa Rica will benefit from the agreement by being able to make use of some time.

The engineers do not expect the transmitters to be able to reach the whole of South America and so a site in Northern Argentina or Chile is being looked at for another relay base. Plans are also underway to try and purchase air time on already established stations in South America, to relay some of the programmes. These transmissions in the main will be on mediumwave.

Spanish National Radio already has one overseas relay base on the Canary Islands, beaming programmes to Latin America, but in recent months the use of this facility has been reduced as the transmitters are old, and another site on the Canary Islands is being investigated.

Spanish National Radio is best received in the South Pacific with its English broadcast 0500-0600 on 9630kHz and it includes a special programme for shortwave listeners in the Monday transmission.

There is a special Spanish transmission to Australia daily 0500-0700 on 9650 and 11730kHz. Spanish National Radio already has an agreement with Radio Beijing to relay some of its programmes for reception in the Far East.

### Red Cross Activity

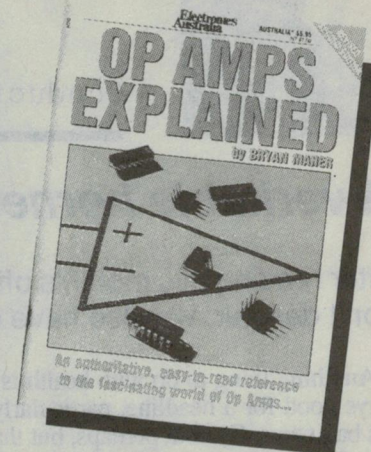
From its base in Geneva, the International Committee of the Red Cross operates its own broadcasting service and played a special role during the recent Gulf conflict.

The Red Cross started broadcasting towards the end of the Second World War. They were granted a frequency for their use in May 1945, when they commenced broadcasting names of prisoners of war as they were released.

Today the Red Cross still continues with its humanitarian message and they produce programmes twice a month in six languages. These programmes consist of on-the-spot reports of Red Cross activity worldwide, which help the 150 countries where there are Red Cross societies to keep in touch.

The Red Cross has no transmitters of its own but uses the frequency of 7210kHz for its regular broadcasts on a transmitter supplied by the Swiss PTT. The monthly broadcasts are carried worldwide without charge by Swiss Radio International. In the South Pacific, the broadcasts of the Red Cross are heard over Swiss Radio International from 0740-0757 on 9560, 13685, 17670 and 21695kHz. ■

## NOW AVAILABLE AGAIN!



The first edition proved very popular with students and hobbyists alike, and sold out. If you missed this revised second edition on the news stands, we still have limited stocks.

Available for \$5.95 (including postage and packing) from Federal Publishing Co Book Shop, P.O. Box 199, Alexandria, NSW 2015

# HELP US GET RID OF MS.



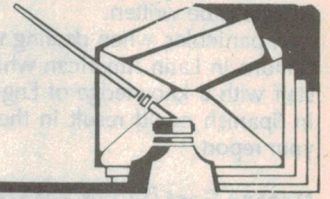
A cure could be only dollars away.

# MS





# Information centre



Conducted by Peter Phillips

## A veritable hornets' nest

After reading this month's offerings, you may be tempted to throw out your electric bed blanket. But don't despair, we also have quite a line-up of good ideas you might want to try.

Anything thing to do with health is always good for a headline, particularly if it's bad news. Cynical perhaps, but that's me. The main topic this month stems from a letter I presented in July, sent in by G.N. from Padstow NSW, and concerns the effects of living near a high voltage overhead power line. I've received quite a few letters on the topic, starting with this one, which I've had to shorten to fit into our available space:

### Overhead power lines

*The query from G.N. is likely to open a hornets' nest. I suspect you'll get a lot of mail from Victoria, where the Brunswick-Richmond Terminal power station issue is still topical. Unfortunately this is a political rather than a technical or medical issue, giving rise to emotions that tend to cloud the real issues. I know of several union officials, school teachers and at least one entertainer who claim great knowledge of the topic, though I doubt if they can even spell 'electromagnetic'.*

*There is quite a bit of literature on this subject, including the International Radiation Protection Authority's papers, such as IBN 0 7316 2370 3, available from the Australian Radiation Laboratory, Lower Plenty Road, Yallambie, Victoria. There's far too much content to include in this letter, so I'll make some relevant points:*

*Firstly, the study by Wertheimer and Leeper, 1979 that was used to beat the drum about the dangers of extremely low frequency electromagnetic fields has been discredited.*

*Quote 'Irrespective of reported findings, all authors who conducted health surveys of occupationally exposed populations agree that exposure to 5kV/metre fields is inconsequential.'*

*Quote 'To date, chronic low-level exposure to 50/60Hz fields has not been*

*established to increase the risk of contracting cancer. If it is established in the future, it would in all likelihood be an extremely weak carcinogen.'*

*Extremely low frequency voltage fields can interfere with cardiac pacemakers, but generally for other injurious effects the voltage field must be so strong that you get zapped first. (G.M., South Oakleigh Vic).*

The next contribution is not quite so positive. In fact it's downright scary, if you only read part of the report, sent by a reader who has this to say:

*There has already been a Royal Commission on the subject in NSW, in which Mr Justice Gibbs made an ambivalent finding. I am enclosing an article from the Medical Observer that has since lead to the establishment of a Victorian panel of investigation into the topic. (Dr A.W., Netherby SA).*

Space doesn't allow me to reprint the complete article, published in the *Medical Observer*, 26 April, 1991, so I'll pick out the salient points. The article starts 'New research commissioned by the Victorian Government has confirmed a likely link between overhead power lines and a two-fold increase in the rate of cancer in children'.

But how about this statement!

*In another revelation expected to have wider ramifications, the report also confirms that the electromagnetic radiation produced by power lines is also emitted in potentially dangerous levels by most domestic and industrial appliances.'*

According to the research conducted by the Melbourne University, 'Children exposed to magnetic radiation levels of 3 milliGauss (mG), the measure used to determine magnetic fields, are 2.1 times more likely to develop cancer than children living in lower magnetic fields'. The article continues that 'according to a survey of 47 homes conducted in 1987 by

the Health Department, most homes in metropolitan Melbourne have exposure levels of at least 3mG which can rise to as high as 30mG'. The report also states that typical overhead lines emit magnetic radiation at levels of between 0.7 and 30mG. High voltage overhead lines produce magnetic fields up to eight times stronger than this.

However Ian Gordon, the chief researcher from Melbourne University's statistical consulting centre adds 'that only an association between cancer and magnetic radiation had been found, not absolute proof of cause and effect...' and that 'the results are disturbing enough to warrant further research into the area, but not dire enough to force a radical response'.

From all this, if further research establishes a link, it is obvious that household appliances will need to be redesigned and overhead power lines relocated. The worst offenders are electric blankets, water beds and floor electric heating.

The next letter makes me feel better:

*I looked into the subject of overhead power line safety a couple of years back, when relatives were considering purchasing a house near one. The best material I could locate at the time was the proceedings of the 1988 IRPA Conference. I trust that it, or its later version is available in Sydney.*

The message I received from perusing the material is that if you are concerned about the effects of electromagnetic fields, then don't sleep on an electric blanket. Incidentally, they did buy the house, as the material allayed any fears they had. (P.G., Brisbane Qld).

Another letter takes up the topic of the effect of magnetic fields on heart pacemakers. The writer apparently was a pioneer in the field and a section of his letter states:

*In the case of 50Hz interfering signals,*



pacemakers are designed to recognise these and respond by switching themselves to a non-demand mode for the duration of the interfering signal, that is, they pace continuously.

I have not heard of a case of an overhead high voltage power line inducing sufficient 50Hz signal into an implanted cardiac pacemaker to cause fixed rate operation, but I feel the possibility cannot be discounted. (S.Y., Howick NZ)

From the above, it seems we have more to fear from an electric bed blanket than from overhead power lines, as current is the culprit rather than voltage. It's current that causes a magnetic field and, as our first correspondent points out a high voltage field will zap you before it performs other nasties. Evidently further research is currently under way, and hopefully someone might send me the findings so I can either scare everyone even more or put all our minds at rest. Phew!

So leaving that topic for now, here's a letter that I found particularly interesting as it can save you money:

### Re-inking ribbons

*This has to be the best idea since the bag to put sliced bread in! An acquaintance of mine was recently travelling in Phoenix, Arizona and happened to leaf through some local Atari User's Group newsletters. In one of them, a letter to the editor suggested that printer ribbons could be rejuvenated by spraying them with CRC 2-26 or CRC 5-56. The writer was at pains to point out that only CRC would do, and that WD40 and other similar sprays would only gum up the works.*

*As it happened I had a can of CRC 5-56 and some worn out ribbons for my Star NX1000 colour printer, both colour and black. It sounded too good to be true, but what did I have to lose? The ribbon cartridge prised apart easily enough, and I then gave the bunched-up ribbon a good squirt and snapped the case back together. I then used an electric screwdriver to wind it through a couple of times before trying it in the printer. Did it work?*

*Did it ever! The ribbon came up better than new. The printing was sharp and black, with just a little bit of smudging. I printed out about 20 pages using continuous stationery and the last page was as good as the first. The ink also seems to dry instantly, and there was no tendency for it to smear or mark the pages as they stacked on top of each other. Admittedly it smells like kerosene, but so does the morning paper.*

*Then I decided to try a colour ribbon.*

*The results were just as good — the colours came up bright and clear, with no sign of bleeding between each colour track. And a week later the ribbons are just as good, so the CRC doesn't dry out too quickly. The only minor problem was that my crude 're-inking' method hadn't evenly treated the ribbon.*

*I then decided to make a 'CRC re-inking' roller, using a foam hearing protector, which I obtained from a chemist. These earplugs are made from a highly compressible foam plastic and look like an overgrown cigarette filter, with a diameter of around 10mm. I used a 'Decidamp' brand, but there are other similar types on the market.*

*To make the roller, I punched a hole through the length of the foam using a 2mm nail and mounted the resulting roller on a piece of wood using a pin. Once again I used the battery screwdriver to wind the ribbon past the roller. A single squirt of CRC on the roller was more than enough to do one ribbon. Ideally, the ribbon needs to be just noticeably dampened, although my first attempt resulted in a saturated ribbon, which worked fine. (K.W., Lane Cove NSW).*

What a great idea! To prove it works, K.W. included a print sample of a 'before and after' ribbon, and typed his letter with a treated ribbon. Certainly the print was dark and clear and just as good as a new ribbon. As an additional point, K.W. states that the rejuvenated ribbons work best with the hammer impact set to its minimum. He also mentions that the treated ribbons don't give dots as sharply delineated as new ribbons, which he suggests is an advantage on NLQ text anyway. Thanks K.W., I'm sure the manufacturers of CRC 5-56 won't mind us printing this letter.

### Drill speed control

In the hope that the following idea is not patented, here's a letter from a contributor who recently needed to fix his two-speed electric drill. In the process he discovered how the speed change 'electronics' works:

*I have just completed repairing a two-speed 10mm capacity electric drill, which required a new switch. This gave me the opportunity to break open the old switch to see what constitutes an 'electronic switch', which is its classification according to the parts supplier. The switch had cost over \$30, so I wondered what was inside.*

*As it turns out, the 'electronic switch' contains a diode and a switch mechanism that has two positions: low-speed and full-speed. In the full-speed*

*position it seems that the diode is shorted and the 240V mains is applied directly to the motor. In the low-speed position the diode is in series with the motor. The mechanics of the switch are arranged so that when the speed control knob is in the low-speed position, the plunger can only travel a certain distance when squeezed by the operator. In the full-speed position, the plunger can travel its full distance, allowing different contacts to be operated.*

*Such an arrangement is ideal for a universal motor, as this type of motor can operate from AC or DC. When the diode is in series with the motor, half wave rectified DC is applied, otherwise it's AC. Naturally the speed regulation is not fantastic, particularly when running in low-speed mode. But with a two-speed gear change, you can have a total of four speeds of operation for the cost of a diode.*

*The switch was made in France and is apparently used in various brands of electric drill. A simple idea, and one that could be easily implemented in the form of a simple add on 'speed control' box so that any portable drill can have the benefits of dual speed. (B.H., Heathmont Vic).*

The interesting thing about this letter is the term 'electronic switch'. Obviously it is electronics in its most basic form, but one has to wonder at the ethics of such a classification. To me, 'electronic switch' conjures up images of triac control and all kinds of sophistication. But a series diode! Clever marketing, but perhaps slightly misleading.

Thanks B.H. for taking the trouble to write, and thanks also for sending me the dismembered switch. As it turns out, the circuit diagram of the switch showing its contact arrangement and the internal diode is imprinted on the case. The circuit confirms your diagnosis of the operation of the switch. The diode appears to be a 5A device, and the mechanics of the switch are certainly very basic.

### Battery problem

The next item came to me in the form of a phone call, from P.H. of Liverpool NSW, and concerns a rather interesting problem with an alkaline 9V battery and a wireless house alarm system. The alarm system has remote infrared sensors which are powered with 9V batteries, and a flat battery will trigger the alarm to warn the owner. The system also indicates which sensor has triggered the alarm.

Following a false alarm, P.H. checked his diary and found that the battery for



## INFORMATION CENTRE

the offending sensor was due for replacement. He purchased the recommended alkaline type (at around \$6.00) and duly installed it. Some few hours later the alarm triggered, again from the sensor with the new battery. Thinking the obvious, P.H. checked the battery voltage and confirmed it was correct at 9V. After another false alarm, again from the same sensor, P.H. decided that the sensor module must be faulty. After parting with around \$90 for a new one, he was not impressed when the false alarms continued.

Following an intuitive guess, P.H. decided to test the new battery with a load rather than with a voltmeter. It turned out that the brand new battery had a high resistance connection between two of its cells.

This particular type of battery consists of six size AAA cells connected in series, rather than the usual sandwich arrangement of flat cells. Each cell is connected with spot welded metal strips, and one of the welded connections was faulty. On an open-circuit test, such as with a voltmeter, the battery voltage was correct. Under load, the battery voltage fell to virtually zero. But given the usual reliability of these batteries, it's no wonder P.H. took the voltmeter reading as being sufficient evidence that the battery was OK.

Without mentioning the brand of the battery, it seems that the manufacturer's testing methods need overhauling as this simple problem should have been picked up. One to look out for!

### Hand dryers

While most of us are not in the business of manufacturing hand dryers, the next letter suggests how to improve their performance:

*I write to describe a simple modification to the hand dryers one sees in washrooms around the country. These units always seem to take at least a minute or so to reach their operating temperature, meaning users often need to queue for their turn. If the output air from the dryer is redirected back into the intake, the warm-up time is around five seconds, saving power and time.*

*If an internal feedback duct was to be installed, these dryers would then perform their task more efficiently. In fact some form of temperature control would probably be required to prevent overheating. The saving in electricity costs would be significant as would the reduced waiting time. (T.G., Crows Nest NSW).*

Since reading this letter I've been mentally redesigning the dryers we use. Maybe a duct with an opening to place one's hands in would serve the purpose, as an internal duct would rob the air flow. Whatever the method, the idea seems good to me.

It would be nice if the noise could be reduced as well, and maybe a more interesting 'set of instructions' to read while you stand drying your hands.

### Car aerials

In July a reader (D.A., of Findon SA) asked for information on the impedance of car aerials. It seems that my guess of 50 or 75 ohms was incorrect, as the next letter points out:

*Believe it or not, the characteristic impedance of a car antenna system is 135-150 ohms on FM! On AM the frequency is too low to matter and capacitive losses in the cable dominate. Older radios with an antenna trimmer for AM required approximately 27-75pF antenna to ground capacitance. If a long cable was used, a series capacitor was required to reduce the capacitance seen by the radio (antenna to ground is normally around 12pF and 135-ohm coax is approximately 34pF/metre).*

*Modern car radios with varactor tuners are not sensitive to antenna capacitance on AM, and a series capacitor is rarely needed. Some experimentation is usually required on a weak AM station to find the best compromise. On AM, the longer the antenna the better. On FM, the correct (resonant) length is about 1 metre on a car or 0.75 metre on a flat ground plane. Unless you are in a strong signal area, 135 ohm coax should be used to avoid reflections. Unfortunately, 135 ohm coax is not the easiest stuff to get hold of. I suggest you try Astronics in Dandenong (Vic), or buy a few car radio antenna extension cords from an auto shop to make up the necessary lead.*

*I hope this information is of use. (M.H., Mordialloc Vic).*

Thanks M.H., I'm sure this will interest many readers. Aerial design is a bit of a black art, but none more so than car aerials. For best performance it seems two aerials are required, one for AM (a long one) and another for FM.

The usual compromise of a telescopic antenna can therefore be improved in a fixed installation. I can see that my coat hanger (naturally its formed in the shape of a map of Australia) will have to go. All I want is for the 'aerial snappers' to move to new pastures, or to change their occupation.

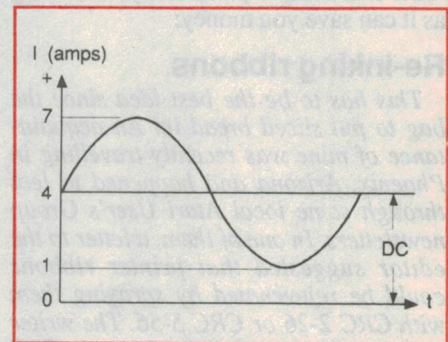
### What??

Here's a classic question that has been around for years. I haven't presented it, before as I have not really had a definitive answer. The question is posed by Graeme Madigan (MIE Aust) but it's the answer rather than the question that I'm most thankful for. Here's the question:

A 1F capacitor (C1) is charged to 100V. Thus the energy in C1, given by  $1/2CV^2$  is 5000J. This capacitor is now connected to another 1F capacitor (C2), which is initially uncharged. After connection, the voltages across C1 and C2 will be equal at 50V and the energy in each capacitor will be 1250J, making a total of 2500J. So where did the other 2500J go? Now just to make things a bit easier, we conduct this experiment in a tub of liquid helium at about 1ÉK.

### Answer to September's What??

The values are 4.25A and 4.25V. The waveform shows the current values from



which the DC and the AC power can be determined. These are 16W ( $I^2R$ ) and 4.5W respectively. The AC power can be determined in various ways such as  $V_p-p^2/8$  ohms. Adding these individual power values gives 20.5W. The RMS value of either the current or voltage is the square root of the total power, giving 4.25. (By the way, I've confirmed this answer with two other methods). ■

### NEW KITS RELEASED

Dick Smith Electronics has advised that it has released a kit for the following EA project:

**SPEECH PROCESSOR FOR TRANSCEIVERS** (September 1991): The DSE kit is for the processor exactly as described, including a diecast case. With the DSE catalog number K-6002, it is priced at \$39.95.

*NOTE: This information is published in good faith, from information supplied by the firms concerned. Electronics Australia cannot accept responsibility for errors or omissions.*



## 2m FM Transceiver — Recommended Mods

Dick Smith Electronics has supplied details of modifications recommended for the 2m FM Transceiver design we published in the January-April 1991 issues, to improve its performance. DSE's kits for the project already incorporate the mods, but details are presented here for the benefit of readers who may be 'rolling their own' from the published design.

For convenience, the modifications are grouped into a number of categories — those concerned with the design overall, and those concerned with specific circuit sections. Brief details of all mods follow...

### General points

1. It's recommended that all of the leads connecting to the mic socket are looped through an iron powder toroid (DSE cat. number L-1439), as many times as possible (typically two).
2. Similarly the DC power cable should be looped through another L-1439 toroid, on the outside of the case but as close as possible to the entry grommet. Protect with a sleeve of heat-shrink tubing.
3. Fit F8 ferrite beads (DSE L-1430) over each of the five PCB pins in the main board, which have wires connecting to the PA module: +13V, FWD, REV, T8V and ALC.
4. Similarly, fit L=1430 ferrite beads at the main board where each of the five wires from the mic socket are connected. In the case of the shielded mic cable and the PTT line, the beads can be fitted over the PCB pins. For the UP and DN lines, the beads must be fitted to the wires themselves, at the PCB end.
5. Loop the speaker leads through a small ferrite toroid (DSE L-1431) as many times as possible, at the main board end. Also loop them through a similar toroid at the speaker itself,

and again at the external speaker jack on the rear panel.

6. Fit 1nF ceramic capacitors between each of the following main board PCB pins and ground, underneath the main board: PTT, +13V, ALC, T8V (next to ALC), FWD, REV.

### RF section

1. It's recommended that you add a 1nF chip capacitor between the source of Q301 and ground, and another between gate 2 and ground. Both caps should be added on the component side of the board.
2. A 10pF NPO ceramic capacitor should be added in parallel with trimmer C323, and another of the same value in parallel with trimmer C328.
3. Capacitor C324 should be changed to an 82pF NPO ceramic (previously 33pF).
4. Capacitor C329 should be changed to a 68pF NPO ceramic (previously 22pF).
5. Coil L312 should be changed to 5.5 turns of 0.8mm ECC wire (previously 2.5T).
6. Capacitor C336, originally a 20pF trimmer, should be changed to a 22pF NPO ceramic.

### VCO/PLL section

1. Capacitor C408 should be changed to an 18pF NPO ceramic (previously 12pF).
2. Similarly C425 should be changed to an 18pF NPO ceramic (previously 47pF).

### Mic preamp

Capacitor C502 should be a 1.0uF monolithic (previously 0.1uF).

### ALC control

1. Resistor R614 should be changed to 4.7k (previously 10k).
2. Resistor R615 should be changed to 100k (previously 10k).

### PA module

1. On the PA module PCB, remove the short track linking the pads for the cathode end of D805, and the 'hot' end of C813.
2. Solder a 5082-2800 Schottky diode (DSE Z-3230) between the two pads identified in (1), with the cathode end of the diode connected to C813 and the REV PCB pin.
3. Solder a 1nF ceramic chip capacitor between the cathode of the diode added in (2) and ground, on the ground plane side of the PCB (i.e., in parallel with C813). ■

### HIFI:

#### An introduction

All you need to know about hifi — past, present and future, now available in our new book.

Just \$4.95 from our local newsagent or write to:

**The Book Shop**  
Federal Publishing Co  
PO Box 199,  
Alexandria, NSW 2015

## Egyptian Hams

*Continued from page 29*  
lion inhabitants) and the long time needed to travel between suburbs, 2m FM is used regularly to coordinate amateur activities. A daily Cairo Net is held on 145.275 or 145.375MHz at 1800 local. Cairo's amateurs who use low power 2m FM handhelds hope that the next step for their club will be the establishment of that much needed repeater. While far greater demands are currently being placed on foreign exchange resources the head of the PTT Mr El Nemr said that an application for

a repeater would be viewed favourably, but the amount of paperwork required to actually accept even a freely donated repeater would be unrealistic.

Instead of waiting for yet another administrative miracle, I took a lift to the top of the single structure in Cairo which would be the ideal site for any eventual 2m repeater. From the lofty 187m high, 68-storey Cairo Tower I was able to look out over a city which blends the old and new like no other.

Below I could see an entry to the new subway (Africa's first underground transport system) and some of the city's luxury hotels — which before the out-

break of Gulf hostilities accommodated up to two million visitors a year. Beyond, the centuries-old bargain filled Khan el Khalili Bazaar was visible in one direction and the eternal pyramids could easily be seen in the other.

Despite the vast research carried out on these structures, many mysteries remain. No one knows exactly how the pyramids were built. But for me another mystery continues to be more interesting. Did King Tut ever qualify for the 'WAP Award'? While no evidence can be found that he 'Worked all Pharaohs' the odd smile on the face of the Sphinx may offer some clue! ■



# 50 and 25 years ago...

'Electronics Australia' is one of the longest running technical publications in the world. We started as 'Wireless Weekly' in August 1922 and became 'Radio and Hobbies in Australia' in April 1939. The title was changed to 'Radio, Television and Hobbies' in February 1955 and finally, to 'Electronics

## October 1941

**Improved facsimile radio:** Heat generated inside invisibly inked paper by ultra-high frequency electric oscillations is the latest method for 'printing' newspapers and photographs by radio in the USA. In operation, the system picks up transmitted radio signals which correspond to the print on the paper being scanned. High frequency electric currents are generated, and these are modulated by the received radio signals. The modulated signals lead to a stylus and also to a rotating drum wrapped in 'pyro' paper which changes colour when heated. As the high frequency currents zip back and forth through the space between the stylus and drum, a pin-point of heat is generated in the paper. The whole paper is 'printed' by points of modulated heat.

**Methane gas:** The Commonwealth Geologist is investigating the possibility of using natural gas as a motor fuel and as a substitute for gas oil now used in the manufacture of coal gas.

He points out that supplies of methane gas from both operating and disused collieries in New South Wales seem to be inexhaustible, but it will be necessary to ensure that it can be extracted in sufficient quantities and that there is a supply of cylinders available to store the gas.

## October 1966

**Sun-powered motorway radio-phones:** A sun-powered telephone system, designed specially for motorway emergency call boxes, has been installed to cover 12 miles of a new motorway between Accra and Tema, in Ghana. The system is based on a fully transistorised radio telephone, and is believed to be the

first application of solar energy to a motorway emergency telephone system.

On the Ghana motorway, the system comprises five pairs of telephone boxes, each pair being situated at a two-mile interval, one each side of the carriageway. These give access to the Accra terminal toll booth.

The roadside stations are all powered by solar energy converters, the radio power output on this system being approximately 1/3W.

**Electronic vehicle detector:** A traffic actuated signal, incorporating the latest version of an electronic vehicle detector made by AWA, is now in operation in Maitland, NSW.

The new detector requires only a loop of wire buried about one inch below the roadway to detect and signal to the automatic controller the approach of vehicles towards an intersection.

The detector produces a 'signal' when each vehicle passes over the loop, while another version of it provides a constant 'signal' when a stationary vehicle is within the field of influence of its loop.

This new transistorised detector and modern electronic controller combine to make the signals now being installed in NSW among the most flexible and versatile in the world, AWA claims.

## EA CROSSWORD

### ACROSS

1. Degree of error. (8)
5. Similar products. (6)
10. Certain agreement in wave motion. (2,5).
11. Produce product with oxygen. (7)
12. Free from error. (4)
13. What potential does across a load. (5)
14. Term for one's Morse style. (4)
17. Electrical unit. (5)

### SOLUTION TO SEPTEMBER

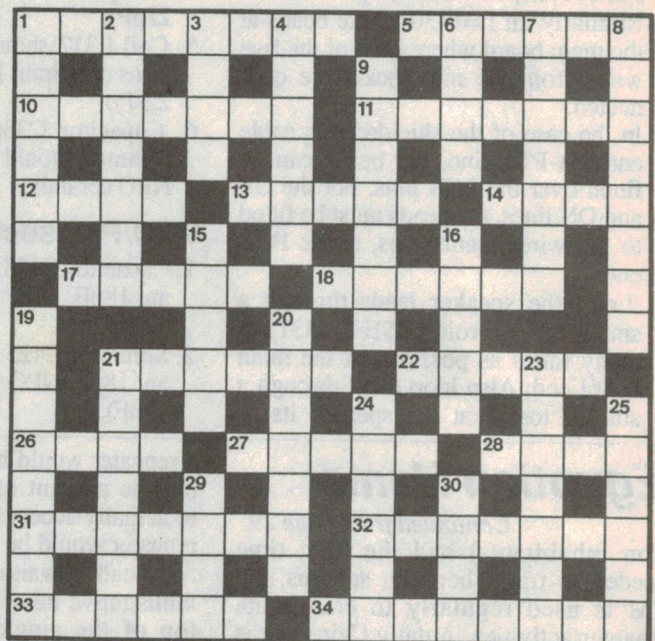
```

C A M C O R D E R   K A P P A
O   N   A   U   N   R   R
P L A N E T S   B I O N I C S
P   N   S   H   I   B   N   E
E M I T   L E A D S   S T U N
R   M   T   S   I   A   I
B A T H S   O U T M O D E D
G   T   E   R   M   B   I   E
E L E C T R E T   B E A M S
O   A   W   G   R   M   M
P R O M   G R O U P   H I F I
H   P   T   I   I   F   N   R
O N E S H O T   T R I G G E R
N   N   I   E   A   L   O
E P S O N   S C R A M B L E R
    
```

18. Retail agent. (6)
21. Double use of channel. (7)
22. Motor component. (5)
26. Significant time in sea navigation. (4)
27. Computer problem. (5)
28. Style of antenna. (4)
31. Type of valve. (7)
32. Warn of danger. (7)
33. Tests. (6)
34. Said of certain popular computers. (8).

### DOWN

1. Brand of electrical products. (6)
2. Unit of a spacecraft. (7)
3. Obtain data from a store. (4)
4. Removes data. (6)
6. Watch. (4)
7. Having more unwanted signals. (7)
8. Range of frequencies. (8)
9. Said of certain interactive circuits. (7)
15. Diagram showing related information. (5)
16. Prefix used for certain high frequencies. (5)



19. Sunspots produce — storms. (8)
20. Significant point in satellite's orbit. (7)
21. Unit expressing power of lens. (7)
23. Source of radio traffic. (7)
24. Tissue activated by electrical impulses. (6)
25. Information carrier. (6)
29. Quantity equivalent to energy. (4)
30. Problems in electrical circuits. (4)



# EA with ETI marketplace

## ADVERTISING RATES FOR THIS PAGE

**SMALL ADS:** The minimum acceptable size of 2 centimetres x one column costs only \$50. Other sizes up to a maximum of 10 centimetres are rated at \$30 a centimetre. **CLASSIFIEDS:** \$4 for 40 letters. Just count the letters divide by 40 and multiply by \$4, ROUND UP TO THE NEAREST WHOLE NUMBER. **CLOSING DATE:** Ads may be accepted up to the 10th of the month two months prior to issue date. **PAYMENT:** Please enclose payment with your advertisement. Address your letter to THE ADVERTISING PRODUCTION MANAGER, ELECTRONICS AUSTRALIA, PO BOX 199, ALEXANDRIA, NSW 2015. Fax: (02) 693 9997

### FOR SALE

**UNUSUAL BOOKS:** Fireworks, Locksmithing, Radar Invisibility, Surveillance, Unusual Chemistry and more. Send SASE for catalogue to: Vector Press, Dept. E, PO Box 434 Brighton SA 5048

**WEATHER FAX PROGRAMS:** For IBM XT/AT's \*\*\* "RADFAX2" is a high resolution, shortwave weatherfax, morse & RTTY receiving program. Needs CGA, SSBhf radio & RADFAX decoder. Also "RF2HERC", "RF2EGA" & "RF2VGA", same as RADFAX2 but suitable for Hercules, EGA & VGA cards respectively, \$35 \*\*\* "SATFAX" is a NOAA, Meteor & GMS weather satellite picture receiving program. Uses EGA or VGA modes. Needs EGA or VGA colour monitor and card + "WEATHER FAX" PC card \$45.\*\*\* All programs are on 5.25" or 3.5" disks (state which) + documentation, add \$3 postage. ONLY FROM M.DELAHUNTY, 42 Villiers St, New Farm 4005, QLD Ph: (07) 358 2785.

**AMIDON FERROMAGNETIC CORES:** FOR LF/HF/VHF/UHF applications. Send DL size SASE for data/price to RJ & US IMPORTS, BOX 431 KIAMA NSW 2533. Agencies at Geoff Wood Electronics, Sydney: Webb Electronics, Albury. Assoc TV Service, Hobart: Electronics Components, ACT: Truscott Electronics, Melbourne. T.V.

**YOKE EXCHANGE:** Prompt service. Refer transformer rewinds this page. Phone (065) 761 291 - Fax (065) 761 003

**SCANNERS:** Top quality Uniden, factory authorised dealer. Range from \$210.05 for 50XL, covers 10, 6, 270cm, 10 memories, ideal for amateur, to \$475.52 for 200XLT, 200ch, covers all major bands, including 800-900 MHz. Also the cheapest prices on antenna \$40.13. Post and Pack \$10 under \$250. Cash, Cheque and Credit card accepted. TopCom Radio Communication, P.O. Box 336, Greensborough, VIC, 3088. Ph: (03) 883 9535.

**VALVES:** Large stock of as new valves, all types, bargain prices. Send S.A.E. for price list or phone. 10% discount on 5 or more. Photon Electronics 1 Sandstone Place Marmion 6020 (09) 448 0861

**SELL:** three very old radios, comm. rec., Old valves, X-mittervalves, books, manuals, Parts, etc. all things old stuff (07) 3566 6052

**ELECTRONICS AUSTRALIA ISSUES:** 1958- 1987 and Electronics today International issues from commencement to 1987. Best offer Tel(Day) 02- 439 1488 (evening) 971 0535. Ask for Lewis

**2.8 MB BACKPACK EXTERNAL DISK DRIVE:** for PC/XT/AT/PS1/PS2/Etc. No internal connection. Runs off Compatible printer port. Printer still supported. Simple installation. Suit Laptops or any PC upgrade. 3.5" 2.8Mb drive accepts 1.4Mb and 720K disks. \$599. 5.25" 1.2Mb drive accepts 360K disks. \$499. Prices include Tax, postage and insurance. Don McKenzie 29 Ellesmere Cres Tullamarine 3043.

**FOSGATE:** Surround sound processor pro model 3601 with wired remote. Has 2 x 40W inbuilt amps for rear speakers. Various surround modes incl. dolby. \$450 freight paid. Tel (070) 553 409

### RE-INKING MACHINES

SAVE OR MAKE MONEY BY RE-INKING PRINTER RIBBONS. ELECTRIC MACHINES COMPLETE WITH ADAPTERS FOR MOST CARTRIDGES \$325. DEALERS ENQUIRIES WELCOME. Ribbon Recycles (Vic) (03) 862 1864 6 Church St Hawthorn

### FIX-A KIT

\$20 PER HOUR LABOUR

3 months warranty on repairs  
12 months warranty on construction.

Technical help.

### HYCAL ELECTRONICS

Design, manufacture, repair of electronic equipment  
(02) 633 5897

### KIT REPAIRS

electronic design service from conception to final artwork.  
Kits repaired from all magazines.  
Ring anytime 9am-9pm Mon-Sun.

**EEM Electronics**  
10 Bouverie Place, Epping, Vic. 3076  
(03) 401 1393

### WANTED

**WANTED MOTOR FOR AKAI GXC-39D CASSETTE DECK:** Advise condition and price to N.Mcpherson, Box 5647, GOLD Coast Mail Centre, 4217. Fax: (075) 38 1961. Phone (0750) 38 6700

**WANTED ANY OLD MICROPHONES:** made before 1960: For collector in Perth. John (09) 279 1234 85 Parker St. Bassendean 6054 WA

### TRANSFORMER REWINDS

ALL TYPES OF TRANSFORMER REWINDS

- \* REWOUND TO YOUR SPEC
- \* EXACT REPLACEMENT WINDING
- \* VINTAGE RADIO A SPECIALITY
- \* ALL ONE OF TYPES
- \* ALL QUOTES BY RETURN MAIL
- \* RAPID SERVICE

For price quote send details showing physical size & number of windings (or send unit, same will be returned to sender if quote not satisfactory)

### TRANSFORMER REWINDS

FREEPOST NO 7, PO Box 438, Singleton, NSW  
2330. Ph: (065) 761291 Fax: (065) 761003

### Old Reprinted Electrical Books

Build a 40,000 Volt Induction Coil .....	\$9
Electrical Designs (1901) .....	\$19
Short Wave Radio Manual (1930) .....	\$23
Shortwave Radio Quiz Book (1938) .....	\$9
High Power Wireless Equipment (1911) .....	\$16
High Frequency Apparatus (1916) .....	\$19
Build Short Wave Receivers (1932) .....	\$13
Vision By Radio (1925) .....	\$16
1936 Radio Data Book .....	\$12
How to Become a Radio Amateur (1930) .....	\$6
All About Aerials .....	\$5
Television (1938) .....	\$5
Shortwave Coil Data Book (1937) .....	\$5
1928 Radio Trouble-Shooting .....	\$24
Neon Signs (1935) .....	\$21
101 Short Wave Hook-Ups (1935) .....	\$14
Vacuum Tubes in Wireless's .....	\$21
Construction of Induction Coil .....	\$21
Tesla: Man Out of Time (biography) .....	\$22
Tesla Said, articles by Tesla 292pp .....	\$74
My Inventions by Nikola Tesla 111pp .....	\$27
Dr. Nikola Tesla - Complete Patents .....	\$93
Colorado Springs Notes 1899-1900 .....	\$133
Tesla Coil Secrets .....	\$13

Allow 15 weeks for delivery of some items., Payment can be made by cheque made out to Plough Book Sales, P.O. Box 14, Belmont, Vic. 3216, Phone (052) 66 1262



## EA with ETI Marketplace

**MY AUSTRALIAN DESIGNED:** low cost super fast Z80 micro-controller development system has gained acceptance already with educational institutions. Pop it on the end of any PC MSDOS or Z80 machine and away you go. Boards, EPROM, and 360K disk \$76 including postage for a short form kit. Gee, I wish I had this when I was a kid. For more info. Send a 43¢ stamp to Don McKenzie 29 Ellesmere Cres Tullamarine 3043

**IBM FORMAT:** 3.5" 720K Review/Info/Disk on the video cassette size MS-DOS Atari Portfolio Pocket PC. Thinking of buying one? This will help you make up your mind. You already own one! It contains Public Domain software for the Portfolio, discounted accessory listings and much more. Just \$5 or send a 43¢ stamp for more info to Don McKenzie 29 Ellesmere Cres Tullamarine 3043

**IBM COMPATIBLE COMPUTERS:** Computer Kits and Accessories button spike protector \$37 & 6 socket power boards with surge/spike protection \$49. Pack/Post \$3. Send for a free price list M.T.S.Electronics PO Box 1013 Taree NSW 2430 Phone (065) 531 296

### RCS RADIO PTY LTD

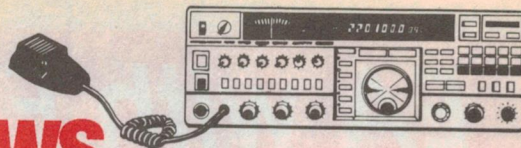
Established 1933  
IS THE ONLY COMPANY WHICH  
MANUFACTURES & SELLS EVERY PCB  
& FRONT PANEL  
published in EA & Silicon Chip.  
651 Forest Road, Bexley 2207  
AUSTRALIA  
RING (02) 587 3491 FOR INSTANT PRICES.

#### MACSERVICE

26 Fulton St. South Oakleigh, 3167  
Phone: (03) 562 9500 Fax: (03) 562 9615

**THIS MONTH!!!!!!** Quality used test instruments  
oscilloscopes  
TEKTRONIX 500MHz SYSTEM 7A19, 7A26, 7B80  
, 7B85, 7904 \$3,850  
400MHz SYTEM STORAGE 7834 \$4250.  
SPECTRUM ANALYSERS.  
HEWLETT PACKARD, 141T to 1250MHz AND  
TRACKING GENERATOR \$7,500  
AS ABOVE TO 110MHz \$5,250 TO 18 GHz \$9,500.  
OTHER  
HP 432A DC/10GHz POWER METER \$945  
WAVETEK SWEEP TO 1.2GHz \$950 NARCONI  
2955, 2957 1GHz COMS/CELL ANALYSER \$11,400  
HP FREQ COUNTER TO 3GHz \$1,250  
TEK 577/D1/177/178 CURVE TRACER \$5,400.  
THRU LINE POWER METER 1KW TO 500MHz 16  
RANGES \$900  
IMPACT LASER PRINTER CANON CX ENGINE  
HP EMU. \$600  
10GHz GUN DIODES \$25 MANY OTHER  
DEVICES AVAILABLE PLEASE ENQUIRE.  
VALVES, RF TRANSISTORS, SPECIAL TEST  
INSTRUMENTS...

# Amateur Radio News



## WIA to administer amateur exams

As reported in the August issue of *Amateur Radio*, negotiations between the WIA and DoTC have resulted in the WIA being granted permission to set and administer virtually all amateur radio examinations throughout Australia, as from October 1, 1991.

DoTC has decided to phase down further its involvement in the day to day running of the examinations, as from December 31, with the three month overlap period designed to allow an orderly changeover.

But after the change DoTC will still be responsible for granting exemptions, and also conducting examinations for disabled people. It will also be retaining responsibility for the standard and content of amateur radio examinations, and will be auditing the WIA's management of them from time to time.

The new arrangement is expected to solve many of the problems which have developed with the 'distributed devolvement' system that began in 1990.

## New antenna for MWRS 70cm repeater

The latest issue of Manly-Warringah Radio Society's newsletter reports that the Society's 70cm repeater on 438.175MHz has just received a new antenna, constructed by Peter VK2XJO.

The new antenna is a coaxial colinear, with eight half-wave sections made from 10mm hard-drawn copper tubing on a fibreglass mast.

Recent reports suggest that the new antenna is giving the repeater much better range than previously, with John VK2ZJJ reporting full quieting at his old QTH — where it was previously unreadable.

## VK2 interest in spread spectrum

According to Tim Mills, VK2ZTM, there is quite a bit of interest in spread-spectrum communications among NSW amateurs, and in forming a group to exchange information and experience in this area. Those interested are encouraged to contact either the VK2 Divisional office or Dave, VK2KFU.

## Warning on Icom IC-R7100's

Icom's latest wideband HF/VHF/UHF IC-R7100 receiver has aroused a lot of interest. Essentially an updated version of the IC-R7000, it is smaller (virtually the same size as the IC-R72A) and offers features like a built-in clock and expanded memory capacity: no less than 900 channels. This is quite apart from its basic appeal, of tuning all the way from 25MHz to 1999.9999MHz in steps as small as 100Hz.

But Bob Wiley, Icom's national marketing manager, warns that not all IC-R7100's available in Australia are the same. Apparently some of those being offered at especially attractive prices are sets made for the Japanese domestic market, and imported by dealers that Wiley describes as 'unauthorised'.

The problem with these receivers is that unlike the official model made for Australia, they don't tune continuously across the range.

There are in fact 10 gaps or 'breaks' which can't be tuned — some of which are as wide as 45MHz. And the receivers apparently can't be modified easily to tune through the breaks, so anyone buying one will be stuck with the broken coverage.

So that potential buyers can check, to ensure they're being offered a genuine full-coverage 'Aussie' model, here are the location of some of the main breaks in the Japanese domestic model:

271.0 - 275.0MHz

412.0 - 415.0MHz

810.0 - 834.0MHz

860.0 - 889.0MHz

915.0 - 960.0MHz

If you're offered a set that *won't* tune to these parts of the spectrum, odds are that it's one of the Japanese domestic models.

Bob Wiley also warns that some of the same dealers are also importing Japanese domestic model transceivers, which can be even more different from the genuine 'Aussie' models in terms of band coverage.

So the old maxim of *caveat emptor* applies — not all Icom transceivers and receivers are the same! ■



Electronics Australia's


# Professional Electronics

S ♦ U ♦ P ♦ P ♦ L ♦ E ♦ M ♦ E ♦ N ♦ T

**CIRCUIT SIMULATORS:  
DEVICE MODELS AND  
MODELLING AIDS**

**LOCALLY DESIGNED  
PC-DRIVEN  
EPROM PROGRAMMER**



 **NATIONAL  
INSTRUMENTS**<sup>®</sup>  
*The Software is the Instrument*<sup>®</sup>

**NEW NI INTERFACE KITS ALLOW  
USERS TO DEVELOP IEEE-488.2  
CONTROL PROGRAMS ON PCs, ATs,  
HP/APOLLO 9000 WORKSTATIONS**



# NEWS HIGHLIGHTS

## US PHONE FIRMS TESTING CDMA CELLULAR

Qualcomm Inc, San Diego-based developer of the new CDMA (code division multiple access) technology for cellular mobile phones, has announced that further companies on the North American continent are evaluating the technology. The firms are Bell Atlantic Mobile Systems, GTE Telecommunications Products and Services, and Toronto-based Bell Cellular.

CDMA is expected to provide a 20-fold increase in the call capacity of cellular systems, by using a binary coding scheme to spread signals over a wider portion of the spectrum.

Additional benefits include better voice quality, improved privacy, less interference due to better multipath resistance, fewer cell sites and a 'soft handoff' — resulting in fewer dropped calls.

Qualcomm has also signed a licensing agreement with Oki Telecom, a division of Oki America Inc., whereby Oki will develop and market mobile and portable cellular phones using CDMA technology.

## IBM CELEBRATES PC'S 10TH BIRTHDAY

IBM has celebrated the 10th anniversary of its Personal Computer, which was first released on the US market in 1981 — establishing a multi-billion dollar industry.

Personal computers didn't begin with the PC, but it certainly gave them respectability and paved the way for them to be accepted into the corporate environment. The original PC also set a record within IBM, as it took Don Estridge's team in Boca Raton, Florida only 12 months to complete its development from inception — faster than any product in the company's history.

Now, of course, the original PC is history. The company's latest model PS/2 model 90 and 95 XP486 machines perform at more than 50 times the speed of the 1981 model, have up to 1000 times the memory capacity (64MB) and can be fitted with 10,000 times the disk storage capacity (1.6GB).

IBM Australia's Wangaratta plant began assembling PCs in 1984, and now employs 88 people making the latest PS/2 machines.

## COMPACT GPS MARINE SATNAV

Local marine electronics firm GME Electrophone has released a compact satellite navigation unit which uses the GPS (Global Positioning System) — the same system which was used so effectively by the USA during the recent Gulf War.

The GME Pronav GPS 100 measures only 159 x 100 x 51mm, and runs on either rechargeable NiCad batteries or a

boat's 12V DC system. It comes complete with built-in antenna, and provides easy single-key memory storage for waypoint co-ordinate information.

Once this information is stored, the GPS 100 can also give automatic indication of the course from a current position to any desired waypoint — updating the information several times each second.

Accuracy is within about 15 metres.



## BBC PUSHES FOR DIGITAL RADIO

After a successful demonstration of digital audio broadcasting (DAB) during the Radio Academy's annual festival in Birmingham, the BBC is reported to be pressing the UK government to authorise a public DAB service on the VHF band.

During the Birmingham tests, low power conventional FM and DAB transmissions were made from a tall city building at around 200MHz.

A special bus was fitted with dual receivers, feeding multiple stereo head-

sets. Each observer on the bus could thereby compare the reception provided by the two systems, as the bus moved around the city, simply by selecting either set of signals with a switch.

The DAB signals were consistently of much higher quality, and allowed the bus to move over twice the distance from the city centre (25km vs 10km) before reception was unsatisfactory.

On the basis of the tests, BBC engineers believe that DAB will allow 12 stereo programmes to be broadcast within a 4MHz segment of the spectrum, using a network of low-powered transmitters.



## MAGLEV SYSTEM USES CERAMIC SUPERCONDUCTORS

Toshiba Corporation has announced the development of a magnetically levitated linear-motor propelled transport system based on ceramic superconductors. The experimental system uses the 'pinning effect' peculiar to high-temperature superconductivity, which occurs when ceramic superconductors are exposed to a magnetic field at around  $-196^{\circ}\text{C}$ , to achieve a floating height and load capacity sufficient for practical use.

As the technology operates even under conditions of zero gravity, the system has the potential to provide a future transport system for use in spacestations, as well as application in clean rooms.

The new system was developed at Toshiba's R&D Centre, where researchers have assembled a small 2.2 metre test track. The system has tested and run a linear motor carrier (180mm long, 120mm wide and 45mm high) at a speed of 25 metres a minute. Despite its small scale, the experimental track has proved the practical potential of the system, as the test vehicle is able to carry a load of up to 3kg — equal to twice its own weight.

When ceramic superconductors are cooled to  $-196^{\circ}\text{C}$ , in a magnetic field, their flux density (strength of magnetic field) becomes fixed, resulting in the 'pinning effect' that holds them in a constant, levitated position relative to the magnetic source.

Propulsion is attained by induction in the superconductors and the moving magnetic field of the primary coil of the linear motor.

The use of ceramic superconductors in the system achieves significant advantages, as their operating temperature of  $-196^{\circ}\text{C}$ , is much higher than the  $-269^{\circ}\text{C}$  of conventional metal superconductors — allowing the development of smaller refrigeration units and therefore systems.

The superconductors used in the new system are yttrium-based oxide manufactured using the QMC (Quench and Melt Growth) method and were developed by Nippon Steel Corporation.

Each has a diameter of 45mm and is 15mm thick. In the experimental system, four superconductors are installed at each corner of the vehicle.

## SECOND HUBBLE GYRO FAILS

A second stabilising gyroscope has failed on NASA's Hubble Space Telescope, after repeated malfunctioning. This leaves only four of the HST's six gyros operational — one more than the minimum needed for correct motion sensing and attitude stabilisation of the telescope.

The reason for the failures is not known at this stage. Made by Bendix, the gyros had each been tested for 20,000 hours before they were installed in the HST. The faults appear to be in the low voltage power supplies for the interfaces between the gyros and the control system computer.

The HST does have a second set of standby gyros, which can be swung into operation if more of the main set fail. However these would place the HST into a 'retrieval mode', in which it would not be capable of normal operation.

## ALTRONICS LOOKING FOR SALES REP

Perth-based importer and wholesaler Altronic Distributors is looking for an assistant for their NSW State Manager. The position would initially involve internal sales from the firm's Chatswood office, but there are excellent career prospects for the right person — who will need to be enthusiastic, self-motivated, have a good general knowledge of electronic components and possess a current driver's licence. The likely age group is 18-24.

Further information is available from Colin Fobister, on (02) 417 8938.

## CIMA ELECTRONICS CHANGES ADDRESS

Victoria-based CIMA Electronics has moved to 51 Chapman Street in North Blackburn, at the corner of Joseph Street. The new phone number is (03) 898 6744.

The company is offering a DSP Workshop, conducted by Alan Bradley of RMIT, from 13-15 November at its former premises of 3 Chester Street, Oakleigh. Fees for the workshop are \$650 per attendee, while those who attend will also be able to purchase a special DSP software package developed at RMIT, for the special price of \$150.

## VIRGIN PIONEERS AIRVISION SYSTEM

Virgin Atlantic Airways, the UK's second-largest international airline, is pioneering the Philips 'Airvision' system of in-flight audiovisual entertainment. The company's aircraft *Shady Lady* has been





## NEWS HIGHLIGHTS

equipped with the new system, which provides individual colour LCD screens for all passengers and a choice of six programme channels.

In Economy class the screens are fitted into the back of the seats, while in 'Upper' class larger screens are fitted into the centre consoles. Each passenger has individual control over programme selection, brightness and audio volume.

Virgin plans to have all of its 11 aircraft fitted with the Airvision system by the end of the 1992 northern hemisphere summer.

## HP & FORD DEVELOP IMPROVED CAR DIAGNOSIS

Microprocessor-controlled engine management systems have revolutionised the motor industry and dramatically boosted performance, but given auto service people a big headache. Happily Hewlett-Packard and Ford have now teamed up in the USA to develop a new Service Bay Diagnostic System, designed to help service technicians cope with the increasing sophistication.

The SBDS combines computer-driven service tools and diagnostic strategies with on-line service information, to guide the service tech to the source of trouble and also suggest the repair. A CD-ROM disk reader built into the mobile SBDS cart allows the tech to scan up to 50,000 pages of the latest service information, with text and graphics.

Because some engine problems can only be identified while driving the car, the SBDS also incorporates a portable vehicle analyser (PVA) which gathers data during the road tests and transfers it back into the SBDS computer afterwards.

## MOTOROLA BEGINS LOCAL TRUNK MFG

Motorola Australia has begun local assembly of its trunk radio systems. The assembly is taking place at Motorola headquarters in Mulgrave Victoria — replacing previous supplies from a plant in Malaysia.

While a basic 'chassis' is still coming from Malaysia, Australian operators are now assembling the customised refinements required by each purchaser. The system controller — the actual 'brain' of each trunking network — is also being locally assembled. Previously controllers were imported complete from the US.

"The advantage of this local assembly for Australia is that we are developing local expertise in the skilled work required for customised system assembly," market-

ing manager Martin Cahill says. "It means that we can find answers to any technology problems close to home."

Continuing improvements in technology and falling local production costs also meant that prices will continue to fall, Mr Cahill adds.

## SYDNEY TERMINAL FOR TASMAN 2

A significant step in the implementation of the Australia/New Zealand Tasman 2 optical fibre submarine system was taken recently with the installation of underground land cable between Bondi Beach and Paddington by system manufacturer Alcatel TCC.

Tasman 2 consists of 2083km of deep sea cable for laying along the seabed between Sydney and Auckland. In addition, the system includes 116km of armoured cable to protect against abrasion as it negotiates the continental shelf, and some 31km of land cable for connection to the land based terminals at either end.

In Sydney, the land-based terminal is housed at the OTC Limited international communications exchange in Oxford Street, Paddington.

Tasman 2 is due for completion in December 1991. It will be one of the first long haul systems in the world to operate at 1550 nanometres and to comprise three fibre pairs, each operating at 560Mbps. It will provide a carrying capacity of up to 100,000 simultaneous telephone conversa-

tions, compared with approximately 4000 on existing analog cables. Some 19 undersea repeaters at intervals of 120km will be used to maintain signal strength and clarity along the route.

The Tasman 2 system is being manufactured at Alcatel TCC's new \$100 million Port Botany facility. The purpose-built factory is the most modern in the world and was built on the deepsea harbour at Botany to provide easy access for ocean-going cable laying vessels. The land based terminals, power feed equipment and computerised supervisory system are being manufactured by Alcatel TCC in New Zealand.

## MULTI MAKING PCB'S FOR AUSTRIA

Multi Electronics has been awarded a \$250,000 contract to assemble printed circuit boards for Metasys GMBH, an Austrian manufacturer of dental equipment.

In a cooperative venture, Multi Electronics will produce the PCBs, sourcing all components and bare boards locally and exporting the finished products. Multi will also act as importer of other components of the Metasys Amalgam Separator, which is expected to become a standard fitout in dental surgeries throughout Australia in the 1990s.

Managing Director Jack Rutherford, when announcing the contract, said that the relationship fits perfectly into Multi's

## NEWS BRIEFS

- **Lako Vision** has been appointed as the Australian distributor of the Video Associates range of products, which includes the Microkey add-on boards for IBM PCs.
- The new **Data Professionals Expo** will run concurrently with the **Queensland Computer Expo** at the RNA Showgrounds in Brisbane from 2nd-5th October.
- **IRH Components** of Sydney will market in Australia the Dynasty range of batteries from Johnson Controls.
- The American Gentner Corporation, which specialises in broadcast and telephone audio processing systems, has appointed Sydney-based **Audio Engineers** as its exclusive Australian distributor.
- The Institute of Electrical and Electronic Engineers is hosting an international conference, **IEEE TENTCON '92**, on 'Computers, Communication and Automation towards the 21st Century'. Tutorials will be held on 9-10th, with the conference on 11-13th November, at the World Congress Centre in Melbourne. For more information, phone (03) 646 4122.
- David W. Powell has been elected as Managing Director and Chief Executive Officer of **3M Australia**. He replaces Vincent J. Ruane, who is now a Division Vice President at 3M headquarters in Minnesota, USA.
- **VSI Promark Electronics** has re-appointed Steve Weddell as State Manager of its West Australian branch. He has recently completed full-time university study.
- Akai has appointed **The P.A. People** of Sydney as its NSW and Canberra exclusive dealer for its range of professional audio products.
- **Computer '92**, the 8th International Computer Expo for Asia, will be held in Hong Kong on May 12-15th, 1992. For more information, phone (Hong Kong) 575 6333.



strategy of being both an exporter and a local supplier of PCB assemblies and security and environment control products.

Whilst the first contract is for \$250,000, the PCB assemblies over the next few years could increase substantially and the total market for the Amalgam Separator is over \$15 million.

## NEW COMPONENTS COMPANY IN SYDNEY

A management buyout by the staff of Allen-Bradley Components Division has resulted in the emergence of a new electronics company in Sydney's Castle Hill. The newly formed company Daktron Electronics, acquired the assets of the Electronic Component Division of Allen-Bradley on 29th April.

Operating out of brand new 2400sq ft complex in the rapidly growing Castle Hill Business Park, Daktron will offer a wide range of precision electronic components.

Commenting on the birth of the new company, General Manager David Kidsley said "My colleagues, George Harvey, David Kent and myself, are confident that with our modern premises and online computer system, we have the means and resolve to continue the high level of service that industry has come to expect when ordering precision electronic components.

Daktron's address is 33/7 Salisbury Road, Castle Hill 2154; phone (02) 899 3566.

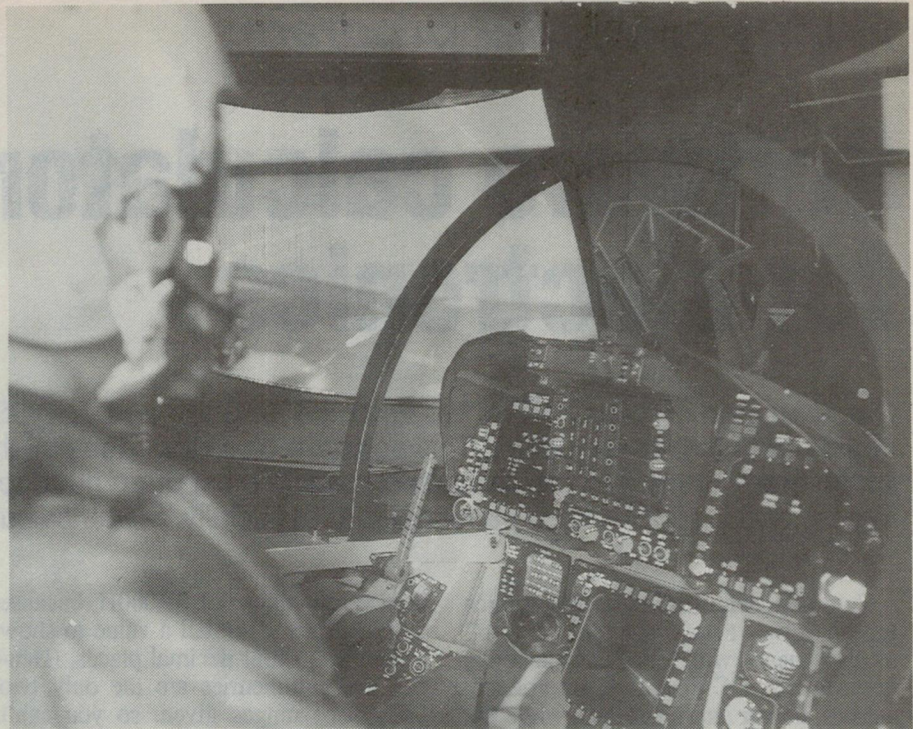
## CONFERENCE ON SMT

The Surface Mount and Circuit Board Association (SMCBA) Surface Mount '91 conference will feature a number of international and local speakers, who will cover issues critical to the Australian electronics industry.

Topics include advanced assembly techniques, design, printing, reflow and wave soldering, quality levels, plant layout, cleaning, static dissipation, directions in telecommunications and influences on manufacturing, rework and repair, finance, project management and training.

The conference will be held in Melbourne on October 17 and 18 and Sydney on October 22 and 23. In conjunction with the conference a display of products available will be mounted by a number of suppliers.

International speakers include Jim Baker of Hewlett Packard (USA) who will be covering project management issues in electronics assembly; Kevin Kucera of Siemens SMT (Singapore) who will present a paper on advanced assembly



*The RAAF is upgrading its operational flight simulators at Williamtown (NSW) and Tindal (NT) as part of a multi-million dollar programme to create a realistic simulated combat environment for its top F/A 18 Hornet fighter pilots. The hardware is being supplied by Hughes Training Inc, while the software has been designed by Computer Sciences of Australia.*

techniques; and Ian Fleck from Euro Dynamic Systems (Scotland) who is an expert in printing techniques. It is anticipated that at least three more speakers from overseas will present papers at the conference.

Further information is available from Dianne Hunt, Executive Officer of the SMCBA; phone (03) 569 6393.

## GERMANY SETS UP LARGEST GSM NETWORK

The largest digital DSM network to be introduced to date has gone into operation in Germany, on time. The Global System for Mobile Communications (GSM) network has been installed by Ericsson to move Germany into a new era of mobile telephony.

The network, D2, is operated by the private German telephone company, Mannesmann Mobilfunk. D2 is the first telephone network in Germany to be operated by a private company. Ericsson AXE mobile switches and more than 100 radio base stations provide coverage to Germany's main urban areas and larger cities, such as Berlin, Frankfurt, Dusseldorf and Hamburg.

Managing Director of Mannesmann Mobilfunk, Peter Mihatch, said the suc-

cessful start of GSM had been made possible by devoted work from all companies and people involved.

"Only 18 months after the D2 licence was awarded, the infrastructure was installed so that 15 industrial areas are now covered by the system," he said. The D2 network is to be extended to full national coverage. Mannesmann Mobilfunk plans to have 80% of the population of former West Germany covered by the end of 1992.

## NAVY BUYS 450 METRIX DMM'S

Elmeasco recently delivered some 450 Metrix Model MX-52 digital multimeters to the Royal Australian Navy.

The MX-52, one of the models in the 'ASYC' series, was chosen because of its many safety and performance features, reliability and functionality. ASYC, an acronym for Advanced Safety Concept, is the result of combining many safety features to provide an instrument to work accurately in difficult conditions without endangering the user.

The MX-52 purchased by the Navy has a 5000 count display with multi-mode bargraph, measures true RMS AC, dB and frequency. ■



## Handy computer program:

# Software calculator for electronics

Cam Dunstan of Q-Net NSW has written a program for MS-DOS PCs called COMS-CALC, which could prove to be very useful. This software calculator does all the ordinary, everyday calculations which electricians and electronic technicians most often need to make. The program is very easy to use, and would save you a lot of time, especially if such calculations are done quite often.

Common calculations in electronics fall into two categories: DC and AC measurements, with four basic quantities in each. The DC quantities are voltage, current, power and resistance, while the AC ones are frequency, capacitance, inductance and impedance. Because calculating AC quantities is more complicated, I suspect that this 'calculator' would prove to be more useful for the AC category.

When the program is run, a bright, colourful screen — complete with a small smiling face — displays your list of choices. Each two-member combination of the four DC and AC quantities is listed. Once you enter your two values, the program then calculates the other two quantities.

So if the DC values of 12V and 10A are entered, a resistance of 1.2 ohms and a power of 120W are calculated and displayed. Similarly, if you enter an AC frequency of 1MHz and an impedance of 8 ohms, then it gives the capacitance (0.0199uF) and the inductance (0.0013mH).

Another option on the menu is to calculate the length of an antenna, given the frequency. It displays the full wavelength, the length of 1/4 and 5/8 whips as well as the dipole. For all these lengths, adjusted (shorter) values are also given to allow for 10% end effects.

The 'set ranges' option allows you to choose the units in which you want to express your calculations. For the example given above, by selecting capacitance to be displayed in picofarads, your answer would be shown as 19,894pF instead of 0.0199uF.

If you use the program's default ranges (megahertz, microfarads, henries and ohms) with our above example of 1MHz and eight ohms, then you get an

inductance answer of 0.0000H, because 0.0013mH is too small a value to show in henries to four decimal places. (Henries and millihenries are the only two inductance ranges given, so you can't choose to have it displayed as 1.3uH.) The range must be set to millihenries to see the 0.0013 answer. So you need to know the ranges of units in which you are operating.

The actual calculations performed by the program are not very complicated, but if they need to be made regularly, then using this 'calculator' is certainly far easier than looking them up on a reactance-frequency chart — and certainly more accurate than such a chart's between-lines approximations.

So the program is very well presented on the screen, is easy to use and could be very useful.

There are a few areas, though, where I

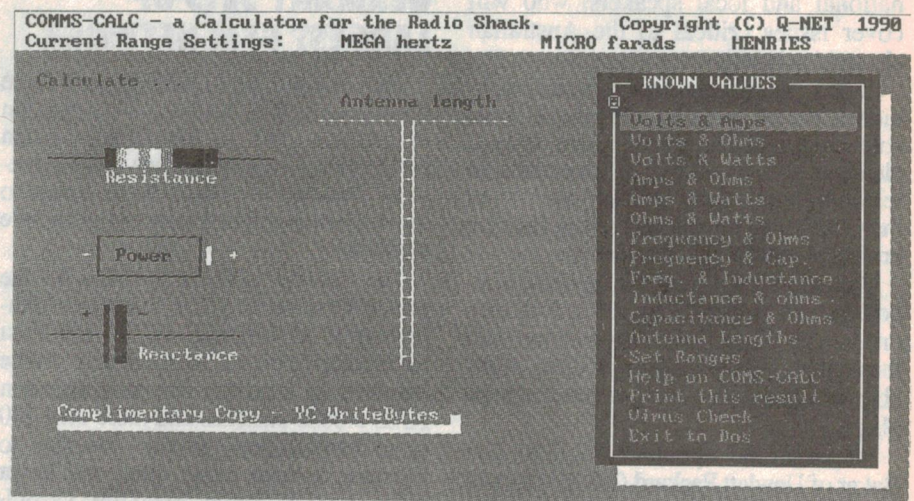
feel that the program could be improved. Take the above example where the inductance value was too small to register.

Once you realise that your selected range is wrong, you must then exit to the main menu, change the range, and then re-enter all your values.

And if you are half-way through a calculation, you have to complete it before you are able to exit. It would be better if the 'set ranges' could be accessed from within the chosen calculation, and the new answer automatically re-calculated.

Or at least if the program 'remembered' the last set of entries, then they could be re-entered as default values by simply pressing the 'enter' key. (At the moment, if you do just press 'enter', the program exits to DOS, and this means that you must re-enter any altered ranges.)

Also, the menu has a very large list of



The main menu of the COMSCALC program. Current range settings are displayed along the top of the screen, while the various combinations of known values are listed in the box at the left.



17 options. You can only make your choice by using the up/down-arrows, which can become tedious; but at least the up-arrow loops from first entry to last and the down-arrow from last to first.

Quicker selection could be made by the first letter (though at the moment too many choices start with the same letter for this to be practical), or selection by number. Or better still, clicking with a mouse.

The program does not use accepted conventions for its units. So we find MEGA hertz (the program's use of capital and small letters), MICRO farads and even MILLIE henries (sic), but we don't find nanofarads or microhenries in any form at all. Perhaps the capitals are only for emphasis?

As well, and only a minor point, entry headings are inconsistent. Some inputs are by units (e.g., amps = ) while others are by the electrical quantities (e.g., capacitance = ). I would be happier if all entries followed the same format.

For me to become a regular user of this program, I would require more flexibility with the 'set ranges' and its units. I like the idea of setting the range for the answer units, but I would prefer to be able to make entries with any of the common multipliers.

Perhaps the 'set range' values could be the default, requiring no units to be entered, but entries could also be made with the common multipliers (p,n,u,m,k,M) for each quantity — e.g., pF, mH, kHz etc. And I would like the answer to automatically adjust the set range if the calculated value is too small to be displayed.

The use of the 'esc' key to exit also needs minor modifications. It does not work after a calculation is started but not completed (a disadvantage); and when used to exit the 'set ranges' it appears to work — but the next time you try to select this option, it ignores you.

These are all possible improvements for a future version.

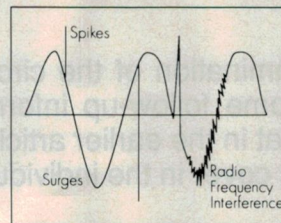
The program, as it stands, offers a very attractive screen format, with good colour and layout, and has the potential to be very useful for frequent calculations.

It is far easier to use than interpreting a reactance-frequency chart. For anyone making constant calculations of these commonly-used quantities, it would be \$25 well spent.

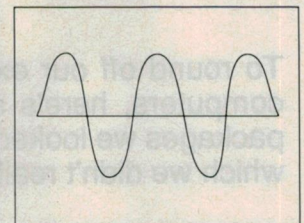
The review copy came from Q-NETT NSW, PO Box 942, Murwillumbah 2484. Copies are available from that address by direct mail order on either 3-1/2" or 5-1/4" disks. (P.M.) ■

# How do you get clean power?

Would you install a computer, a fax machine, telephone system or other electronic equipment to an A.C. supply looking like this?



Disturbed Power



Good Supply

Almost all electronic equipment requires clean power, totally free from disturbances. Install a Westinghouse Computer Protector with the following features to eliminate power supply disturbances.

- Heavy duty (up to 10A)
- Built in power surge limiter
- Two stage RFI filter
- Earth line choke
- Quickly installed
- Competitively priced
- Maintenance free
- Available ex stock



Available in all states.  
 VIC (03) 391 1300  
 NT (089) 84 4700  
 NSW (02) 545 1322  
 WA (09) 446 8844  
 QLD (07) 275 3188  
 SA (08) 212 6235 & (08) 23 8500



**WESTINGHOUSE BRAKE & SIGNAL COMPANY (AUSTRALIA) LIMITED**  
 Incorporated in New South Wales  
**SIGNAL DIVISION**  
 Postal Address:  
 P.O. Box 4,  
 Newport, VIC 3015  
 Phone (03) 391 1300  
 Fax (03) 391 6607  
 Stephenson Street,  
 Spotswood, Victoria

**DISTRIBUTOR ENQUIRIES WELCOME**

NCAA/WES/0234

READER INFO NO. 15

**MS**  
**Multiple Sclerosis.**



## PC-based Circuit Simulators - 4:

# UPGRADES, MODELS AND MODELLING

To round off our examination of the circuit simulator packages currently available for personal computers, here's some follow-up information on recent upgrades and enhancements to the packages we looked at in the earlier articles — plus a discussion of device models and modelling, which we didn't really cover in the individual package reviews.

by JIM ROWE

The original intention with these articles was to provide a basic idea of what circuit simulator programs do, and then simply review the three main simulators currently available. Although this has now been done, in the June, July and August articles, there still seem to be some aspects of these rather complex programs which were either not covered in the reviews, or not properly. Since the reviews were written, there have also been significant upgrades and enhancements to two of the packages, rendering some of the comments made in the reviews already out of date.

The idea of this follow-up article is to cover at least some of the aspects that were not discussed adequately in the earlier articles, together with news of the recent developments. Hopefully this will remedy the shortcomings and provide a reasonably satisfying picture of the current state of the art concerning PC-based simulators.

First of all, then, let's look at the upgrades that have appeared for a couple of the simulators, since we looked at them.

### PSPICE Schematics

With regard to *PSPICE*, the first package we reviewed, MicroSim has at last remedied what was probably the most important single criticism of their product: its lack of a dedicated schematic capture facility. No longer is it necessary to prepare your SPICE netlist and circuit file in 1960's fashion, because like the other two packages *PSPICE* now boasts its own integrated schematic program. Netlists are generated automatically, as you draw the circuit schematic on screen.

The new *PSPICE Schematics* program hasn't yet been released in Australia at

the time of writing, so we haven't had a chance to try it out. But from MicroSim's press release and some advertisements that have appeared in US magazines, it looks as if it should be quite impressive.

*PSPICE Schematics* appears to be an integrated 'front end' for the rest of the *PSPICE* package, allowing you to run simulations and look at the results using *PROBE*, by calling the other programs directly from within *Schematics* itself. And it's a friendly menu-driven program, having been written as a 'native' application for Microsoft's popular *Windows 3.0* environment. So it offers that environment's familiar and reasonably intuitive graphical interface, with pull-down menus, dialog boxes and multiple windowing.

Note, though, that since the new *Schematics* is a native *Windows 3.0* application, it can't be run directly from DOS. You must have *Windows* on your computer in order to run it — so if you don't have it already, that will be a further expense. This is not the case with either of the other simulators, both of which run directly under DOS, while still offering the same kind of schematic capture 'front end' facility.

*PSPICE Schematics* also needs 3MB of extended memory, with 4MB recommended. Presumably this includes the

requirements for *Windows 3.0* itself, but it's still a fairly hefty memory requirement.

Other features of the new program are an integrated symbol editor for creating and modifying device symbols, an 'electrical rule checker' which can be used to check the schematic before a simulation is run, auto-incrementing of device names and labels, and the ability to examine circuit voltages and currents using *Probe* by referring to device pins and net names, rather than node numbers.

No price is available for *PSPICE Schematics*, at the time of writing. It was planned for Australian release in late August.

### IsSPICE upgrade

The other significant upgrade to occur since the first reviews were written is to Intusoft's *IsSPICE* package, and in particular to the *PreSPICE* program, which provides a range of pre-simulation processing facilities, plus the device model libraries and a text editor for looking at and modifying the circuit files.

The newly-released version of *PreSPICE* (Version 3.0) offers an expanded model library, now with over 1000 SPICE models for devices including many new JEDEC and European transistors and diodes. As well as models

```
.MODEL MN4351 NMOS (LEVEL=1 VTO=2.1 KP=1.5M GAMMA=10.1U
+ PHI=.75 LAMBDA=3M RD=14 RS=14 IS=15F PB=.8 MJ=.46
+ CBD=7.94P CBS=9.53P CGSO=11.7N CGDO=9.75N CGBO=16.0N)
* -- Assumes default L=100U W=100U --
* 25 Volt .03 Amp 100 ohm Enh-Mode N-Channel MOS-FET 08-19-1990
*****
```

Fig. 1: An example of the kind of file used in SPICE to provide modelling data for a particular type of device — in this case an MN4351 N-channel MOS transistor. This kind of .MODEL file is used for basic or 'primitive' devices.



for things like zener, varactor and Schottky diodes, power MOSFETs and so on, there are also models for IGBTs, UJT and PUTs, fuses, switched-capacitor filter ICs, vacuum tubes, current feedback op-amps, Darlington transistors, dual-gate MOSFETs, voltage regulator ICs, ECL/MECL/CMOS/TTL logic gates, MOVs and even the ubiquitous 555 timer chip.

Including Intusoft's existing 'optional' libraries for RF transistors and op-amps (sold separately), this brings the total number of device models available from the firm up to over 1600 — all in unencrypted ASCII form and fully compatible with Berkeley SPICE 2G.6. Quite a few of the models are 'generic', too, in the sense that they accept parameter data from the user during entry, to allow modelling of many other devices not currently in the libraries. More about this later.

The other upgraded aspect of *PreSPICE* is that it now features a new version of the *IsEd* text editor, replacing the original and rather dated version. The new version provides the same 'Windows-like' graphical user interface that Intusoft introduced with the latest version of *IntuSCOPE* (V3.11), and can be driven using either the keyboard or the mouse.

It also allows you to view and edit multiple netlists and library files at once (up to 20 at a time!), and to edit files as large as 3MB. Another new feature is context-sensitive help, for both *PreSPICE* and *IsSPICE*.

In addition to the new editor, *PreSPICE* now also allows you to call *IsSPICE*, *SPICENet* and *IntuSCOPE* directly, giving it 'front end' capabilities like those provided by the firm's ICAPS shell.

At the time of writing, we've only been able to try out a 'preview' beta-test version of *PreSPICE* V3.0, with the new text editor functional, but only the SPICE netlist forms of the expanded libraries — i.e., without the matching schematic symbols. As far as the expanded libraries are concerned, we have thus only been able to scan them, and note the overall scope of the device models covered. Again, more about this shortly.

But the new editor itself looks to be a big improvement over the previous version. Basic viewing and editing of files is now very quick and convenient, thanks to the mouse-and-windows tools, and you can now perform nice functions such as cutting, copying and pasting chunks of text from one file to another, having the editor 'jump' to a marker 'tag' you've placed at a different point in the file

(handy for block moves), and searching through the files of a directory to find a string of text (like a particular device model). You can also perform DOS functions without leaving the program, like displaying directories and directory trees.

There's also the ability to vary the background and text colours inside different windows, and to select from a range of display fonts.

In short, the new *PreSPICE* looks to be a very worthwhile enhancement for the *IsSPICE* package.

The Australian price for the PC version of *PreSPICE* V3.0 is \$412, with an upgrade available for \$149 to those with the previous version. These prices include postage for prepaid orders, but \$10 should be added for credit card purchases.

By the way, a new version of Intusoft's *SPICENet* schematic capture program is apparently scheduled for release around the end of the year, with the same windows-like GUI used by *IntuSCOPE* V3.0 and the new *PreSPICE*. So before long, the complete package will be effectively integrated to the same extent as *Micro-Cap III*.

At about the same time, Intusoft is apparently also planning to release an upgraded version of *SPICEMod*, its modelling 'spreadsheet' program, with the ability to construct models for additional types of device.

And talking about device models and modelling, this was an aspect of simulators that we didn't really cover much in the first three articles. So let's try to remedy that omission, now.

```
.SUBCKT UA741 2 3 6 7 4
*
*      - IN + OUT VCC VEE
*
QNI1 10 2 13 QNI1
QNI2 12 3 13 QNI2
.MODEL QNI1 NPN(NF=1.5 BF=111 IS=8E-16 CJE=3PF)
.MODEL QNI2 NPN(NF=1.5 BF=144 IS=8.3E-16 CJE=3PF)
Q3 13 14 4 QN741
IEE 4 14 185NA
CCM 13 4 2.5PF
RCM 13 4 10MEG
RC1 11 10 1K
RC2 11 12 1K
CHF 10 12 55PF
D1 7 11 D741
RP 7 4 10K
GA 0 15 12 10 .9MMHO
GCM 0 15 13 0 6.3NMHOS
R2 15 0 100K
D2 15 0 D741 OFF
D3 0 15 D741 OFF
C2 15 16 30PF
GB 16 0 15 0 12.5
RO2 16 0 1000
D4 16 17 D741P OFF
EP 17 0 7 0 -1.8 1
D5 18 16 D741P OFF
EN 0 18 0 4 -2.3 1
.MODEL D741P D(RS=1M)
D6 19 16 D741
D7 16 20 D741
IRO 20 19 170UA
RR0 16 21 1MEG
Q4 7 19 21 QNO
Q5 4 20 21 QPO
.MODEL QNO NPN(BF=150 CJC=3P IS=1E-14)
.MODEL QPO PNP(BF=150 CJC=3P IS=1E-14)
L1 21 6 30UHY
RL1 21 6 1K
.MODEL D741 D(CJO=3PF)
.MODEL QN741 NPN
.ENDS
*****
```

**Fig.2: In comparison with the .MODEL data file used for basic devices, SPICE uses a more elaborate modelling file for more complex devices — known as a .SUBCKT file. As you can see, this is the file for a 741 op-amp.**



# Simulators

## Models & modelling

As we noted in the first of these articles, the whole validity and feasibility of carrying out computer simulations of real-world circuits depends upon the accuracy of the mathematical 'models' used to represent the various components, in those circuits. Hence the enormous amount of work that has been invested in simulators like SPICE, to make its internal device models as accurate as possible.

But a computer model of any type of electronic component is essentially just a set of equations, describing the electrical behaviour of that component — the relationships between its various input and output voltages and currents, under both static and dynamic conditions. And because many of these relationships vary in degree, between particular examples of each component, the mathematical equations generally have to include a significant number of scaling coefficients, linked with the behaviour parameters of the real-world devices.

So in order to simulate any particular example of a device, the simulation program needs to have not only the basic set of equations describing the behaviour of that type of device, but also the scaling coefficients for that particular example. For example to simulate a BC547 transistor, it needs not only the equations describing the general behaviour of a bipolar transistor, but also the particular coefficients for the BC547.

The mathematical equation 'models' for all of the basic types of device are usually built into the simulator program itself. In fact some simulators have multiple versions of the models for certain kinds of device, offering different 'levels' of modelling accuracy versus simulation speed (more accuracy usually means slower simulation).

But the coefficient data for each particular example of the devices is generally held separately, to allow the simulator to 'plug' it into the model when simulating that device.

The modelling coefficients for any particular example of a device can be worked out from its various performance parameters — gain, input and output resistances, internal capacitances, characteristic curves, breakdown voltages and so on.

And of course at least some of these parameters can generally be worked out from the manufacturer's data sheets, although not all data sheets provide enough

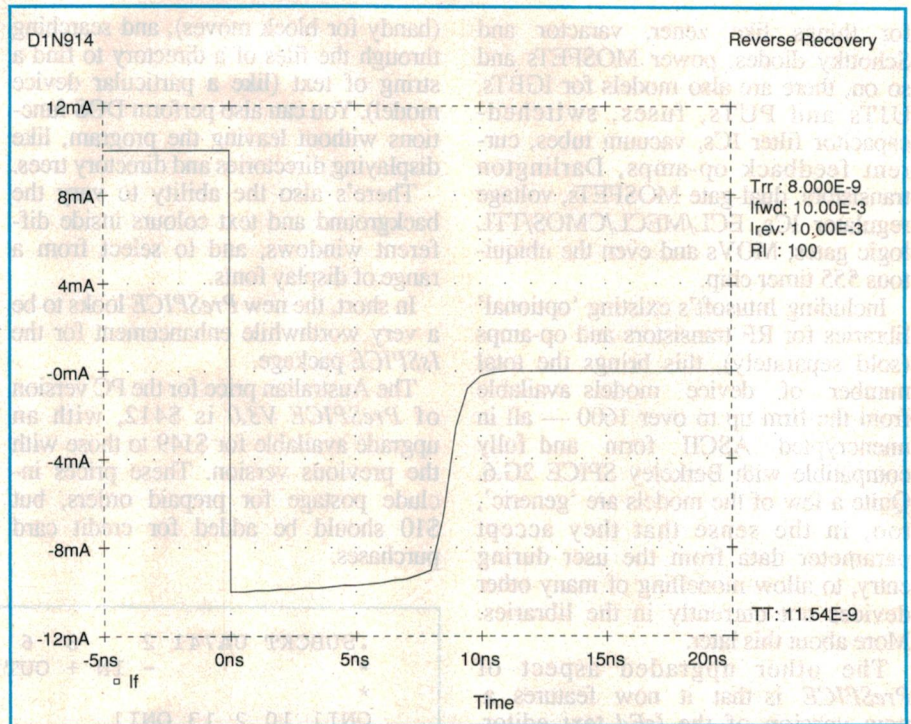


Fig.3: As part of its operation in helping you to produce device modelling data files from manufacturers' data sheets, PSPICE's modelling program PARTS.EXE allows you to plot the performance of the model. Here's an example.

of the necessary information. Often some of the key parameters concerned have to be measured, for a representative batch of devices, in order to allow calculation of the necessary modelling coefficients for that device.

A further complication arises with regard to more complex devices like op-amps and logic gates, which are really formed from a combination of basic devices — such as transistors, diodes, resistors, capacitors and so on. In short, they're essentially a subcircuit — a particular configuration of basic devices.

Generally the simulation programs don't include a full set of separate modelling equations for each of these complex devices. This would be wasteful, anyway — many of the equations

would be duplicating those already used for the basic devices themselves. Instead, simulators like SPICE are designed to accept more elaborate modelling data for these devices, containing a description of the actual subcircuit configuration as well as the modelling coefficients for the basic devices concerned.

SPICE simulators call each set of scaling coefficient data for a particular basic device a .MODEL file, while the more elaborate data files for 'subcircuit' devices are called .SUBCKT files. Examples of the two different kinds of files are shown in Figs.1 and 2, to show you what they look like.

As it happens, a number of electronic components which are still fairly 'basic' are generally also modelled as a

```
D:\PSPICE>type d1n914.mod
* D1N914 model created using Parts version 4.03 on 05/03/91 at 05:53
*
.model D1N914 D(Is=161.7E-21 Rs=0 Ikf=0 N=1 Xti=3 Eg=1.11 Cjo=4p M=.3333
+ Vj=.75 Fc=.5 Isr=8.267n Nr=2 Bv=100 Ibv=100u Tt=11.54n)

D:\PSPICE>type d1n4001.mod
* D1N4001 model created using Parts version 4.03 on 05/03/91 at 05:30
*
.model D1N4001 D(Is=46.61f Rs=.1561 Ikf=0 N=1 Xti=3 Eg=1.11 Cjo=1p M=.3333
+ Vj=.75 Fc=.5 Isr=2.454u Nr=2 Bv=100 Ibv=100u Tt=5n)
```

Fig.4: Here are the modelling data files for 1N914 and 1N4001 diodes, as produced by the author using PSPICE's parts modelling program PARTS.EXE.



```

SPICEMOD 1.4 ===== Bipolar Junction Transistor (Q) ===== 08-10-19
      .MODEL Name (MPSA06) = MPSA06 (Estimated Data)
      Type (GeNPN, GePNP, SiNPN, SiPNP) = SiNPN (Entered Data)
      Max. Collector-Emitter Voltage, VCEO = 80.000 V. <VAF>
      Max. Emitter-Base Voltage, VEBO = 4.000 V. <VAR>
      Max. Continuous Collector Current, IC = 0.500 A. (Scales all Values)
      Peak Current Gain, hFE = 220.238 <BF>
      High Current 50% HFE Point, IH = 0.300 A. <IKF>
      Low Current 50% HFE Point, IL = 0.300 mA. <ISE>
      Collector Saturation Voltage, VCE(SAT) = 0.140 V. <RE> (RC, RB)
      at IC = 0.500 A. (near max. current)
      Base-Emitter On Voltage, VBE(ON) = 0.653 V. <IS> (ISE)
      (at IB = IC/10) at IC = 0.020 A. (at IC(max) / 25)
      Max. Gain-Bandwidth Product, fT = 219.203 MHz. <TF>
      Storage Time at I(fTmax), ts = 0.325 us. <TR>
      Output Capacitance, COB = 8.000 pF. <CJC>
      at VCB = 5.000 V.
      Input Capacitance, CIB = 40.277 pF. <CJE>
      at VEB = 1.000 V. (Reverse Bias)
===== SPICE MODEL PARAMETERS: =====
.MODEL MPSA06 NPN (IS=50.7F NF=1 BF=286 VAF=160 IKF=.3
+ ISE=17.7P NE=2 BR=4 NR=1 VAR=16 IKR=.45 RE=.103 RB=.412
+ RC=41.2M XTB=1.5 CJE=53.2P CJC=15.6P TF=725P TR=138N)
* 80 Volt .5 Amp 219 MHz SiNPN Transistor 08-10-1991
<< TO PRINT PAGE, PRESS 'Shift-PrtSc', WHEN DONE, PRESS 'Enter' >>

```

**Fig.5: A screen dump showing the kind of entry screen provided by *IsSPICE's* modelling data spreadsheet *SPICEMod*. As the data values are keyed in, you can see the model parameters changing at the bottom of the screen.**

'subcircuit' configuration of basic devices. For example an SCR or triac is modelled as a suitable configuration of bipolar NPN and PNP junction transistors, while a dual-gate MOSFET is modelled as a series combination of individual single-gate MOSFETs. Similarly a Darlington 'transistor' is modelled as a subcircuit with a pair of individual bipolars in the appropriate configuration, along with any internal protection diodes, pulldown resistors etc.

Even components like transformers, crystals, lamps and switches tend to be modelled as subcircuits.

So in order to run a simulation of any particular circuit, a simulator program needs all of the modelling data for the devices concerned — both the .MODEL data for the basic devices, and the .SUBCKT data for the more complex devices.

Obviously the ideal situation, from the users' point of view, would be for the firms marketing simulation programs to provide this modelling data for all avail-

able devices. But with the enormous number of different devices available nowadays, this would obviously be an impossibility.

The next best thing would be if the device *manufacturers* provided the simulation data for each of their devices — just as they provide conventional performance data sheets. This is also probably a bit too much to hope for, although a number of firms who make op-amps and other ICs have recently started to provide SPICE modelling data on their particular devices (see box).

In the main, though, what has happened to date is that the firms marketing simulators have provided with them as much modelling data for specific devices as they have been able to gather together. This is provided in 'model libraries', either along with the simulator package itself, or made available separately for an additional cost. Hence MicroSim boasts that *PSPICE* comes with a library of modelling data for over 3500 analog and

```

.MODEL BC548 NPN (IS=3.76F NF=1 BF=329 VAF=98.5 IKF=.15
+ ISE=743F NE=2 BR=4 NR=1 VAR=20 IKR=.225 RE=.815 RB=3.26
+ RC=.326 XTB=1.5 CJE=10.6P CJC=6.01P TF=496P TR=61.8N)
* 30 Volt .1 Amp 320 MHz SiNPN Transistor 06-10-1991
*****
.MODEL BC558 PNP (IS=5.48F NF=1 BF=416 VAF=98.5 IKF=.1
+ ISE=2.31P NE=2 BR=4 NR=1 VAR=20 IKR=.15 RE=.715 RB=2.86
+ RC=.286 XTB=1.5 CJE=10.6P CJC=9.63P TF=794P TR=61.8N)
* 30 Volt .1 Amp 200 MHz SiPNP Transistor 06-10-1991
*****
.MODEL D1N914 D (IS=146P RS=.559 N=1.7 BV=99.9 IBV=100U
+ CJO=4P VJ=.75 M=.333 TT=5.76N)
* 100 Volt .075 Amp .004 us Si Diode 08-10-1991
*****

```

**Fig.6: Sample model data files produced by the author using *SPICEMod*, for BC548 and BC558 transistors, and also a 1N914 diode.**

1500 digital components, while as we've seen earlier the latest version of Intusoft's *IsSPICE* effectively comes with the data for over 1000 parts included in *PreSPICE V3.0's* libraries. Spectrum's *Micro-Cap III* comes with data for about 280 specific devices.

Note, however, that sheer size or 'number of devices' is not necessarily an accurate guide to the utility of these built-in modelling libraries. A significant proportion of the larger libraries tends to be data for simple devices such as diodes. A smaller library can actually provide data for almost as many useful devices, for typical day-to-day simulations.

Incidentally Intusoft can also supply an optional library with modelling data for RF transistors (currently 40 devices), and others with data on various vendors' op-amps. The latter data comes originally from device vendors such as Analog Devices/PMI, Harris, Comlinear, Linear Technology, Burr-Brown, Texas Instruments and Elantec. Data is available for over 500 different op-amps in all, varying from seven devices in the Comlinear library to 176 devices in the AD/PMI library. Intusoft apparently checks all of this vendor data for accuracy in SPICE simulation, and also adds suitable schematic symbols for use by its own *SPICENet* program.

All of the optional Intusoft model data libraries are available in Australia for \$32 each plus postage, and are available on either 5.25" or 3.5" floppy disk.

Needless to say, all of the simulator firms are adding modelling data for further devices to their libraries all the time, both to boost the utility and market appeal of their simulators, and also in response to requests from existing customers. But despite this, Murphy's Law still tends to operate: whenever you try to simulate any particular real-world circuit, there's a high probability that there won't be specific modelling data for at least one of its devices.

To get around this, the simulator firms have developed other ways to help you proceed. The most common approach is to provide a separate 'modelling' program, designed to help you generate the simulator modelling data for a particular device yourself, using parameters from the manufacturer's data sheets. MicroSim's modelling program for *PSPICE* is called *PARTS.EXE*, you may recall, while that for Intusoft's *IsSPICE* is called *SPICEMod*. The corresponding program for Spectrum's *Micro-Cap III* is called their Parameter Estimation Program, or 'PEP' for short.

We'll look a little more closely at these modelling programs shortly. But before



## Simulators

doing so, it's worth noting that Intusoft actually provides a *second* way to help the user run simulations involving devices for which there's currently no specific modelling data, quite apart from *SPICEMod*. This is by including in the *PreSPICE* libraries a set of 'generic template' device models. There are some 28 of these in all, at present, including generic bipolar and FET op-amps, NPN and PNP bipolars, a GaAsFET, an NPN power bipolar, high and low voltage zeners, an N-channel JFET, a quartz crystal and so on.

The idea is that when these generic models are called into a circuit schematic using *SPICENet*, the program recognises them as a 'blank template component', and prompts you to provide the basic parameters for your specific device — from the manufacturer's data sheet. It's rather like the procedure involved with one of the separate modelling programs, except that here it's carried out 'on the fly', during the annotation of your circuit schematic (and a separate device model is not saved for later use).

The data sheet parameter data required to 'fill in the blanks' of these generic device templates is usually quite modest. For example in the case of a diode, it's merely  $I_{max}$ ,  $V_{max}$  and  $T_{rr}$ ; for bipolar and FET op-amps, it's the input offset voltage and current, the input bias current, the gain bandwidth, the DC gain and the output slew rate.

These 'generic' models give *IsSPICE* the ability to run reasonably accurate simulations for literally thousands of devices, for which 'pre cooked' modelling data is not yet available. It's a very nice feature.

### Practical modelling

In my initial forays into the various simulator packages, I didn't have the opportunity to try out their different modelling programs. Since then, I've been able to remedy this omission. Here's a brief report on what I found.

First of all, I tried MicroSim's modeller *PARTS.EXE* (Version 4.03). As supplied normally with the full version of *PSPICE*, this has the ability to guide you in modelling six different types of device: diodes (signal/rectifier/zenner), BJTs (bipolar junction transistors), JFETs (small signal, general purpose), power MOSFETs, op-amps (bipolar or FET), and voltage comparators.

Unfortunately I could only try out the diode modelling option, because like the rest of the *PSPICE* 'evaluation version'

package sent for review, the matching version of *PARTS.EXE* had only this option activated. The remaining options were 'unavailable on evaluation copy'.

Still, at least I was able to try modelling a diode. I tried modelling both a 1N914 and a 1N4001, neither of which

available at the time. Assuming that the other options in the full *PARTS.EXE* are as easy to use as the diode option, it seems to be quite a handy and practical program. The only problem is likely to be getting enough parameter info from the manufacturer's data sheets — a difficulty by no means unique to this modelling program. In fact it applies to them all, essentially.

Next I moved to the *IsSPICE* package, and tried using its *SPICEMod* modelling program. Intusoft actually describes this as a 'modelling spreadsheet', which seems fairly appropriate as it works rather like one of these programs. For each device you get a column of parameter input 'cells', with adjacent text cells showing the parameter needed. As you feed in the value of that parameter value, its effect is seen to 'ripple down' into the device's *SPICE* model data shown at the bottom of the screen (Fig.5 gives a screen dump of the entry screen for a BJT).

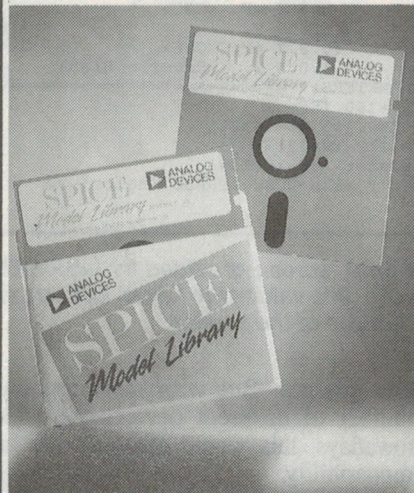
*SPICEMod* comes with a lot of inbuilt help, and also turns out to have an intriguing amount of inbuilt 'intelligence', whereby it can estimate many of the less significant modelling coefficients from the more significant ones, using algorithms based on a knowledge of physical device behaviour. This allows it not only to 'guess' these second-order coefficients, from your keyed-in primary parameters (great if you really can't find any values for the secondary ones), but also to check any values you may key in for the second-order parameters, against what it has estimated. If the two are wildly different, it will reject your value and replace it with its own estimate — prompting you to look deeper into the manufacturer's data, or dig up the data from another manufacturer...

Currently *SPICEMod* can help you model diodes, BJTs, power BJTs, Darlington transistors, JFETs, MOSFETs, and two levels of power MOSFET. I gather that the ability to model other devices such as IGBTs, SCRs, Triacs and op-amps is planned for the near future, along with the ability to plot test curves.

I was trying out *SPICEMod* before the arrival of the new upgrade for *PreSPICE*, with its enhanced model libraries, and the model libraries supplied with the earlier version didn't have many of the European-type bipolar transistors used here in Australia. So for the exercise, I tried using *SPICEMod* to produce model data for the popular BC548 and BC558, and again for the 1N914 diode.

This all turned out to be very straightforward, thanks to the program's spreadsheet approach and inbuilt

### SPICE Models for Analog Devices op-amps



Manufacturers of electronic devices have begun to supply *SPICE* modelling data for their devices, to assist users in running simulations. An example is well-known US specialised IC maker Analog Devices, which has recently made available this MS-DOS floppy disk library of *SPICE* model data for 176 of its op-amp devices. Available free from the firm's distributors, it should be available from NSD Australia, Locked Bag 9, Box Hill 3128.

was represented in the 'reduced' device data library provided with the evaluation version of *PSPICE*.

On the whole, I found *PARTS.EXE* quite friendly, leading me step by step through the process of obtaining the various parameters from the manufacturer's data. I also liked the way it allows you to display and print out plots of the 'electrical performance' of the device model, so that you can compare these with the manufacturer's curves. Fig.3 shows the plot for reverse recovery of the 1N914 model, for example, while Fig.4 shows the actual *SPICE* modelling data files produced for my two diodes. They're probably not very accurate, because I wasn't able to dig out all of the parameters that *PARTS.EXE* needed, from the data sheets



'intelligence'. The modelling data files I produced for the three devices are shown in Fig.6.

Finally, I turned to the *Micro-Cap III* package, and its modelling program *PEPEXE*. This turned out to be rather different from *Micro-Cap III* itself, with no ability to use a mouse — all functions are controlled from the keyboard, and are fairly limited (along with the on-line help).

*PEPEXE* is currently designed to allow you to 'estimate' *Micro-Cap III* model parameters for BJTs, MOSFETs, diodes, op-amps and JFETs. For each kind of device it presents a 'split screen', which shows a column of the various parameters needed for the simulation model on the left hand side, and another on the right hand side showing the items of data needed by *PEP* to produce them. Actually some of the data is used by *PEP* to work out the modelling parameters, while other items are transferred directly over because they correspond directly to the parameters concerned.

I tried using it to produce models for a BC548 and a 1N914, but found both of these extremely difficult. *PEP* seems to need a lot more device data than either *PARTS.EXE* or *SPICEMod*; some 68 items for a BJT, for example, and 29 for a diode. It isn't at all helpful in terms of the exact nature of the data it needs, either.

I found myself having to refer not only to the manufacturer's data sheets, but also back to the main *Micro-Cap III* manual to try and work out the significance of the various device model parameters. The *Micro-Cap III* manual isn't particularly helpful here in any case, so the whole job turned into something of a nightmare.

Frankly, I have to rate *PEPEXE* as a particularly unfriendly program, and one that's much less helpful in making device models than either *PARTS.EXE* or *SPICEMod*. Like the former it does have the ability of showing you a plot of the electrical behaviour of your device model, but this is little consolation when it seems to offer so little help in making up the model in the first place...

All things considered, I found *SPICEMod* easiest of the three to use, with *PARTS.EXE* almost as helpful and *PEPEXE* a rather distant third. A little surprising, in view of the friendliness of *Micro-Cap III*.

## Last resort

What do you do when you want to simulate a circuit, and there either isn't a model for one of the devices you're using, or no modelling data for a particular device — and the modelling pro-

gram can't help? Well, as a last resort you can always contact the local distributor of the simulator you're using, and seek help from the experts.

I tried this myself, when I wanted to simulate an RF preamp circuit I've been developing for a forthcoming project. It was using an MFE131 dual-gate MOSFET, and I wanted to try the effects of different kinds of output loading and coupling circuits, on the gain and bandwidth. The only problem was that at that stage, none of the simulators had any model for a dual-gate MOSFET — let alone the right data for an MFE131.

Having elected to try the simulation with *IsSPICE*, I tried contacting Intusoft's local distributor Peter Stein, of Speaker Technologies — to see what help he could provide.

Peter faxed over the request to Intusoft, and within a couple of days back came a complete *.SUBCKT* model for the MFE130, which was the nearest they could get. As you can see from Fig.7, it treats the dual-gate device as a series combination of two single-gate units, with their parameters carefully tailored to duplicate the behaviour of the MFE130.

Using this model I was able to use *IsSPICE* to run a series of simulations of my RF preamp circuit, and optimise its performance. And when I finally built up the circuit using 'real' components, the performance was very close indeed to that predicted by the simulation — I only had to make a slight alteration to the value of one component, the drain load peaking inductor.

In fact I'm told that it was my request which prompted Intusoft to add a range of dual-gate MOSFET models (including the MFE130) to the new *PreSPICE* libraries. None of the other simulators currently offer a model or data for these devices, by the way.

## Other new products

Before closing this roundup of the simulator scene, I should mention two

further new products that have become available since the first articles were written. One is a low-priced 'student version' of *Micro-Cap III*, the other a new book from Intusoft.

The student version of *Micro-Cap III* comes from the Addison-Wesley Publishing Company, and consists of an abbreviated version of the standard package together with a 192-page introductory manual specially for students and newcomers, written by Professor Martin Roden of California State University. It's apparently in wide use among US universities, with over 30,000 copies having been sold already.

The student version comes with most of the features of the standard package, but can only deal with circuits having a maximum of 30 nodes. It also has a smaller device library, lacks the MESFET and magnetic core models, and cannot drive a plotter (only Epson or HPLJ II printers), or perform Monte Carlo analysis. It also lacks the schematic symbol editor, *PEP* and the other utilities — but all remaining analysis functions are present, including DC, AC, transient and Fourier.

The introductory manual seems to be well written, and carefully goes through both the basic concepts of simulation, and the operation of *Micro-Cap III*.

In short, this student edition provides an excellent introductory package — not just for students, but I'd say for many others as well. Especially since it's priced at a very reasonable \$65 — much less than the evaluation version of any of the simulators. I gather it's now available from many of the larger bookstores, but if you have any difficulties, try contacting Addison-Wesley at the address given shortly.

The new book from Intusoft is titled *A SPICE Cookbook*, and has 225 pages discussing over 100 practical examples of circuit simulation covering a wide range of electronics — from power supplies to RF and microwaves, and including areas

```
.SUBCKT MFE130 1 2 3 4
*Connections Drain Gate2 Gate1 Source
*Dual Gate MOSFET
MD1 1 3 5 4 MFE130A
MD2 5 2 4 4 MFE130B
.MODEL MFE130A NMOS (LEVEL=1 VTO=-2.3 KP=10M GAMMA=2.18U
+ PHI=.75 LAMBDA=2.14M RD=14 RS=.1 IS=10.7F PB=.8 MJ=.46
+ CBD=9.76P CBS=11.7P CGSO=276P CGDO=230P CGBO=44.4N)
.MODEL MFE130B NMOS (LEVEL=1 VTO=-1.7 KP=16M GAMMA=14.20U
+ PHI=.75 LAMBDA=12.14M RD=.1 RS=14 IS=10.7F PB=.8 MJ=.46
+ CBD=9.76P CBS=11.7P CGSO=276P CGDO=230P CGBO=44.4N)
* 35 Volt .03 Amp 100 ohm N-Channel DG-MOS-FET 06-10-1991
.ENDS
*****
```

Fig.7: The model data file for an MFE130 dual-gate MOSFET, as supplied by Intusoft in response to a call for help by the author. As you can see, it's a *.SUBCKT* file, representing the device as a series-connected pair of single-gate devices.



## Simulators

such as amplifiers, filters and digital. It comes complete with a floppy disk giving *IsSPICE* circuit netlists, *SPICENet* schematic files, and SPICE compatible model data for all of the circuit examples covered in the book itself.

An important feature of the new book is that each circuit example is discussed in detail, with discussions of SPICE simulation techniques, device modelling considerations, syntax pitfalls, interpretation of output and so on.

In short, it's designed as a valuable introduction and reference to simulation with SPICE, and *IsSPICE* in particular. A *SPICE Cookbook* is priced in Australia at \$68, including the floppy disk (PC or Mac versions available), with postage included if a cheque is sent with your order. It's available from Speaker Technologies.

### Final comments

Now for just a few brief comments and corrections, before ending off.

In the *IsSPICE* review, I reported that there must be a way to have *IntuSCOPE* plot the gain of an amplifier, filter or similar circuit (i.e., output/input, in dB) — only at the time, I couldn't work out how. I've since discovered it's fairly easily done using the program's waveform calculator, after you've told *IntuSCOPE* to change its vertical axis to dB.

The waveform calculator is programmed in 'reverse Polish' fashion, that system beloved of boffins, but in this case it's fairly easy. To tell it to divide the output waveform (say 1) by the input waveform (say 2), you type in '2 w 1 w /', or click on the corresponding buttons of the on-screen 'calculator keypad'. The new gain waveform then appears, labelled '0'.

So it can be done, and fairly easily when you know how.

In my review of *Micro-Cap III*, I said that there might be a way to vary the effective power supply voltage for op-amp models, but I couldn't see how. I've since learned that you can do this by adjusting the 'Vmax' parameter, in the Level 2 op-amp model. The model's supply voltage is effectively set to +/-Vmax.

I also said that *Micro-Cap III* would only run a single analysis at a time, whereas I've been advised that it can run in a 'batch' mode, to perform a number of analyses at once. And finally I said that unlike the SPICE simulators, it didn't generate an output file, to permit further analysis. In fact it can be made to

The Student Edition of  
**MICRO-CAP III™**

An electronic circuit analysis program...  
adapted for education

3 1/2" format

1: Global settings  
2: Models  
3: Plotter setup  
4: Text setup  
5: Graphic setup

Addison-Wesley • Benjamin/Cummings

**Fig.8:** Addison-Wesley Publishing Co has released this new 'Student Edition' of the *Micro-Cap III* simulator. Selling for only \$65, it consists of a easy to read introductory book plus a 'stripped down' version of the simulator.

do so, I've learned, by selecting 'Save' in the run options. This can then be retrieved and examined later.

A final comment: as I noted in the first of these articles, SPICE was originally developed at the Berkeley campus of the University of California, and is actually a public-domain program. It turns out that copies of the source code for both the '2G6' and later '3D2' versions of SPICE are available from UCB for MS-DOS machines, for US\$150 and US\$250 respectively.

The source address is:

Industrial Liaison Program,  
Software Distribution Office,  
Engineering Research Labs,  
497 Cory Hall,  
University of California,  
Berkeley, CA 94702.  
(Phone (415) 643 6687).

And here are the local address details of the firms mentioned in this article:

#### **PSPICE:**

Technical Imports Australia,  
PO Box 927,  
Crows Nest 2065.  
Phone (02) 954 0248.

#### **IsSPICE, SPICE Cookbook:**

Speaker Technologies,  
PO Box 50,  
Dyers Crossing 2429.  
Phone (065) 50 2254.

#### **Micro-Cap III:**

David Spalding,  
45a Blackett Drive,  
Castle Hill 2154.  
Phone (02) 639 3507.

#### **Micro-Cap III Student Edition:**

Addison-Wesley Publishing Co.,  
6 Byfield Street,  
North Ryde, 2113.



# Escort Quality Reliability

3  
YEAR  
WARRANTY

Over 10 years of experience in Australia has proven Escort's quality and reliability in DMMs.

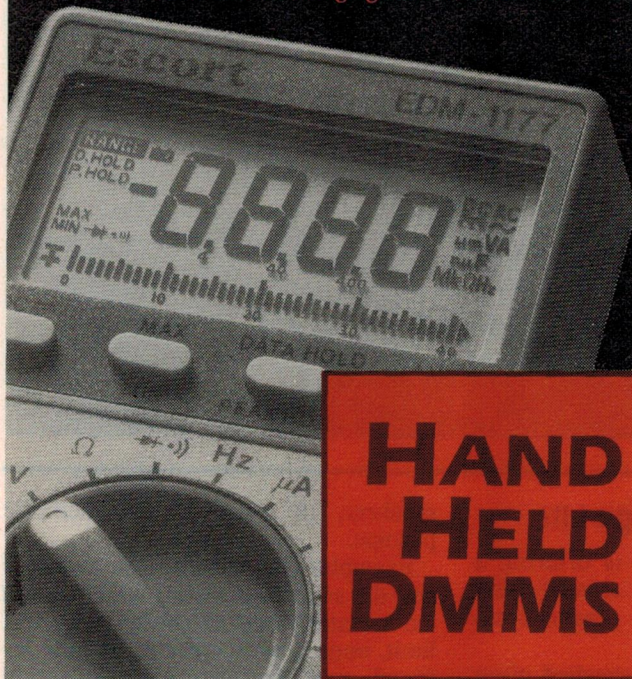
The Escort EDM-1100 series of Auto-Ranging, Bar Graph Digital Multimeters represent the best DMM value for money.

Measurement functions include voltage, current, capacitance, frequency, logic, diode, transistor and continuity testing, as well as Peak, Data and Range Hold, and Max and Min Memory.

**EDM-1133** 8 Auto-Ranging Functions \$132 EX TAX

**EDM-1155** 12 Auto-Ranging Functions \$155 EX TAX

**EDM-1177** 14 Auto-Ranging Functions \$205 EX TAX



**HAND  
HELD  
DMMs**

Distributed and Serviced by:

**EMONA INSTRUMENTS**

NSW: (02) 519 3933 QLD: (07) 397 7427  
and new VIC office, VIC: (03) 889 0427

ALSO AVAILABLE FROM:

NSW: David Reid (02) 267 1385 Geoff Wood (02) 427 1676  
Novocastrian (049) 62 1358 DGE (049) 69 4242 Hundell Eng  
(042) 74 0278 QLD: Colourview (07) 275 3188  
Access (079) 22 1058 Nortek (077) 79 8600  
VIC: RPG (03) 329 7888 WA: Hincos Eng (09) 244 2777  
SA: E.C. & E. (08) 232 0001 I.C.S. (08) 47 3688  
TAS: George Harvey (002) 34 2233 (003) 31 6533

READER INFO NO. 16

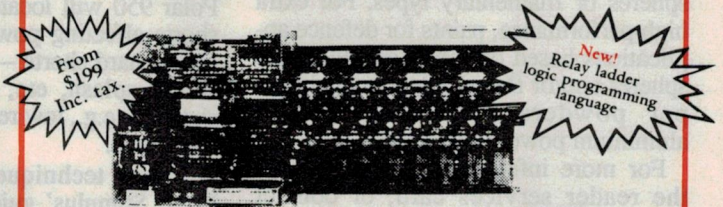


IN ANYONE'S LANGUAGE  
PROCON TECHNOLOGY  
LETS YOU TAKE CONTROL!

We manufacture a wide range of low-cost digital I/O boards. Each board features: 8 opto-isolated inputs (12/24/48V AC or DC), 8 relay outputs (switching up to 10 Amps at 250VAC), LEDs indicate I/O status and IBM-PC software is included. An industrial version with plug-in relays is also available.

The system features: External mounting (up to 30 metres from computer) operating through any IBM-PC bi-directional printer port and capable of expanding to 240 I/O.

Applications: Home or business security systems, process monitoring and control, laboratory automation, quality control testing, robot control and energy management.



From  
\$199  
Inc. tax.

New!  
Relay ladder  
logic programming  
language

**ASPA**  
AUSTRALIAN SOFTWARE PUBLISHERS ASSOCIATION

**PROCON**technology



Box 655, Mt. Waverley, VIC. 3149. TEL: (03) 807 5660  
9 Wendover Court FAX: (03) 543 3249

\* Yes! High-speed drivers are available for GWBASIC, QuickBASIC, TurboBASIC, TurboC, TurboC and TurboPascal. Our file I/O driver also allows many other programs and languages to be used. E.g. DBASE, Clipper, COBOL, FORTRAN, MODULA-2 etc.

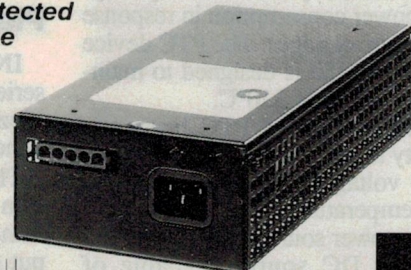
READER INFO NO. 17

## 120 WATT 48 VOLT Power Supply

AUSTEL APPROVED  
CCL No. A91/PS/0017

Low Cost  
Output 48V 2.5A  
Fully Protected  
Low Noise

MODEL:  
MPS2



**The high powered performer**  
Setec Pty. Ltd. 6 Holloway Drive, Bayswater, Vic. 3153 Australia  
Ph: (03) 762 5777 Fax: (03) 762 9197

READER INFO NO. 18



# NEW PRODUCTS

## EMI/RFI protection

Victorian company Specialised Industrial Spraying coats moulded plastic electronic components to reduce EMI/RFI and ESD.

EMI/RFI shielding coatings available include those based on nickel flakes, spheres or filamentary types. For extra high performance, paints for defence applications based on silver coated nickel spheres and/or flakes, silver coated copper powders and silver coated aluminium powders are used.

For more information, circle 243 on the reader services card, or contact Specialised Industrial Spraying, PO Box 747, Warragul 3820; phone (056) 23 2723.

## Temp controlled soldering iron

Dick Smith Electronics has released a low voltage, temperature controlled soldering iron (T-1950). The miniature, low cost iron is said to be ideal for hobbyist constructors.

A ceramic heater with a PTC (positive temperature coefficient) is embedded right in the tip of the iron, giving greater efficiency than other soldering irons where the heating mechanism is some distance from the tip.

The PTC provides accurate temperature control, high reliability, fast heat-up and quick response to changing thermal loads. It also prevents burn-out, as the tip will never overheat.

PTC heaters maintain essentially constant temperature by automatically varying their power consumption in response to temperature changes. The PTC device used in the T-1950 is designed to maintain a temperature of 310°C.

A further benefit of PTC heaters is their ability to operate from a wide range of supply voltages while maintaining a constant temperature.

Suitable power sources are any 12V to 18V AC or DC source, capable of delivering 6W continuously — e.g., any 12V car battery and most bench power supplies.

For more information circle 244 on the reader services coupon, or contact Dick Smith Electronics, PO Box 321, North Ryde 2113; phone (02) 888 3290.

## Multilayer PCB shorts locator

PCBs are becoming more complex as designers are incorporating multilayer board designs, densely packed components including surface mount and fine line tracks and power planes. The Polar 950 will locate shorts and partial shorts affecting power planes. This includes hard shorts — e.g., Etch defects, solder splash, etc, as well as partial shorts — e.g., low resistance decoupling capacitors.

A new technique called 'Vectored Plane Stimulus' guides the operator to

the fault using four directional arrows on the instrument's front panel. This technique is used for all types of shorts involving a plane.

A DC current probe measures PCB track current without breaking or cutting tracks — ideal for tracking multipath short currents.

The non contact probe will locate faults in backplanes, shorts in memory banks and generally where access to tracks is limited.

For more information circle 241 on the reader services coupon, or contact Emona Instruments, PO Box K720, Haymarket 2000; phone (02) 519 3933.



## Piezo sensor design kits

INTAQ International is offering a series of design kits for sensors using piezoelectric thin film plastic components.

The kits include both standard piezo film samples and a range of new thin-film piezo components. They have been put together to facilitate the development of specialised sensors within the following four basic market segments: industrial instrumentation; medical; computers; and consumer. There is a basic design kit and eight specialist kits.

The basic design kit (\$135) will demonstrate the use of INTAQ's piezo film sensors (PFS) as microphones,

speakers, IR detectors and acoustic pickups.

Examples of specialist kits available are: the switch kit (\$135) which shows the versatility and reliability of PFS in limit, impact, soft contact, wake-up, infrared, magnetic (reed) and snap action appliances, and the vibration sensor & accelerometer kit (\$402) which displays PFS as lightweight, flexible and highly sensitive to vibration inputs with excellent fidelity over a wide range of frequencies.

For more information circle 253 on the reader services coupon, or contact INTAQ International, Kyle House, 27 Macquarie Place, Sydney 2000; phone (02) 252 4055.



## PCB cleaner

A new and economical printed circuit board cleaner, Hycasol is non toxic, non flammable, and non conductive.

Unlike spray cleaners which can only be used once, it can be re-used many times. The solvent rapidly dissolves flux, grease, dirt and other contaminants. As well as cleaning printed circuit boards, it can be used to clean tape heads and connectors since it leaves no residue.

Jaycar Electronics has been appointed the sole retail and wholesale distributor for Hycasol.

For more information circle 245 on the reader services coupon, or contact Hycal Electronics, 4/62 Great Western Highway, Parramatta 2150; phone (02) 633 5477.

## Open board DC-DC converter

The 3T series of open board DC-DC converters help solve tough power system requirements inexpensively.

From a wide input range of 10V to 60V from a raw positive DC source, they provide a single adjustable output via a multiturn pot of either +4.5V to +30W at 12A, or +4.5V to +15V at 20A, or a negative output of -4.5V to -30V at 5A.

The 3T incorporate a variety of features such as parallel connecting for increased current output, and synchronising to allow users to integrate the 3Ts into a design which meets their specific demands — e.g., using three to produce outputs of +5V and 12V.

They also provide a constant current limit which is factory set but can be adjusted 10% if desired. This feature of constant current limit is ideal for designing battery chargers.

For more information circle 246 on the reader services coupon, or contact Amtex Electronics, 13 Avon Road, North Ryde 2113; phone (02) 805 0844.

## Accurate glue dispenser

EFD's new Glue Dispensing Station, Model 1000XLE, replaces manual methods of applying glues, pastes, solvents, lubricants, inks and greases and achieves double output without guesswork errors.

The compact workstation makes consistent dots or clean stripes of materials such as cyanoacrylate bonding, epoxy heatsink compounds, RTV, sealants, solder creams, solder marks and solvents.

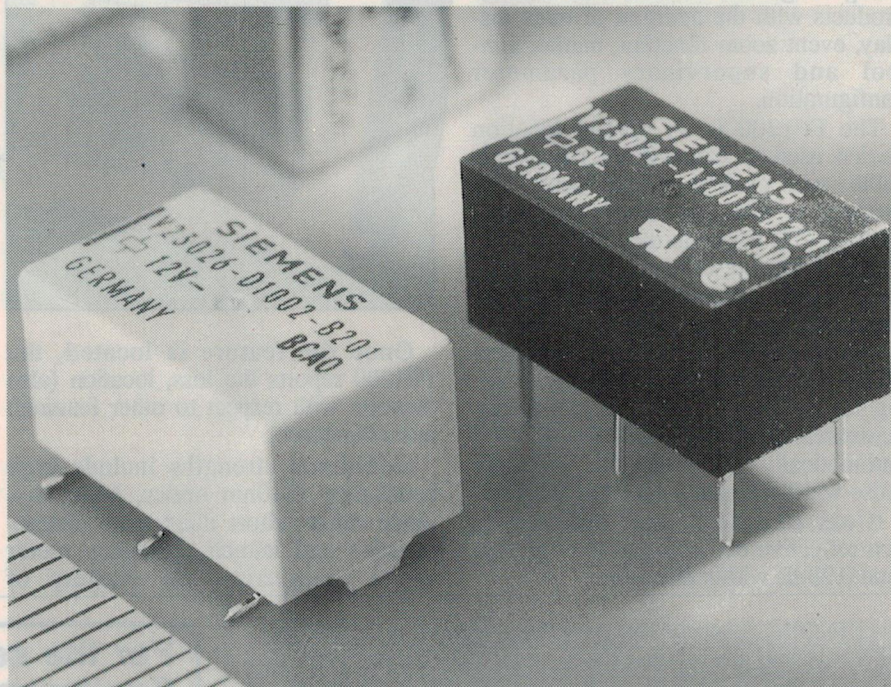
As a result, it significantly reduces product rejects and adhesive waste,

## Extended life relay

For its P1 miniature relay, Siemens now guarantees 10<sup>9</sup> operations. Even after one billion operations during life tests, scanning-electron microscope photographs revealed only very insignificant changes to the contact surface which gave no ground for fearing impairment of operation. The P1 miniature relay is produced under clean-room conditions, and the extremely large number

of operations is the result of the special sandwich contact coating design, for which a palladium-nickel alloy (PdNi) is first gold-plated and then rhodium-plated. But the P1 also owes its long life to the mechanical design with wear-free mounting of the centre spring.

For more information circle 247 on the reader services coupon, or contact Siemens Components, 544 Church Street, Richmond 3112; phone (03) 420 7308.



while increasing assembly output and eliminating mistakes due to excessive operator fatigue.

For more information circle 248 on the reader services coupon, or contact Electronic Development Sales, PO Box 822, Lane Cove 2066; phone (02) 418 6999.

## De solder tools

Scope Laboratories has recently doubled its range of solder suckers.

All of the models, mini size SR8 (foreground), mid size SR14 (centre) and the Jumbo SR27 (largest), plus the metal bodied SR10 (in hand) are available with static dissipative nozzles as an option.

For more information circle 242 on the reader services coupon or contact Scope Laboratories, PO Box 63, Niddrie 3042; phone (03) 338 1566.

## Decade resistance boxes

In teaching or laboratory demonstrating of electrical or electronics engineering principles, as well as in the normal

test/repair workshop situation, the availability of a reliable decade resistance box is desirable if not essential.

The **LEBCO 601 Six** is such an instrument, conveniently providing a selection from 1 to 1,111,110 ohms in 1 ohm steps.

Connections to the network (isolated from the metal case) are two gold-plated binding posts 25mm apart, accepting 4mm banana plugs.

The switch contacts are gold over silver plating and sockets at the junction of each decade enable the box to be used as a potential divider.

Maximum power ratings are: 1 watt/per resistor, 3 watts/decade and 10 watts total. The voltage limit is 300V, subject to dissipation limit restraints. Its stability is better than 0.1% p.a. in normal lab use and 0.2% after 2000 hours, at 0.5watts/resistor.

For more information circle 249 on the reader services coupon, or contact Applied Electro Systems, 5/17 Heatherdale Road, Ringwood 3134; phone (03) 872 4816.



## NEW PRODUCTS

### Optical fibre fault locator

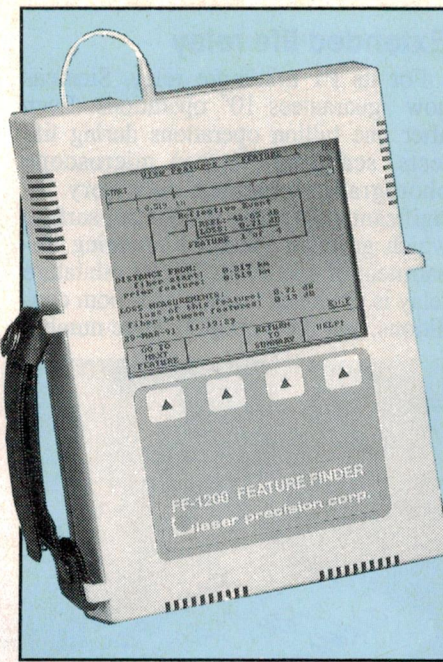
Laser Precision's latest Feature Finder, the FF1200 is claimed to be the most advanced high resolution handheld fibre optic fault location instrument available today.

It combines similar features to the existing long haul FF1000 and FF1100 products with the addition of trace display, event zoom function, marker control and supervisory parameter configuration.

The FF1200 is an optical location device used to characterise fibre optic cables with closely spaced events. The product is thus suited to fibre optic LAN, FTTH (Fibre to the home), CATV installation, commissioning, maintenance and catastrophic failure test applications.

The FF1200's single button operation eliminates the need for extensive training for the user. The technician simply depresses one button and the FF1200 automatically selects distance range and pulse width necessary for fibre analysis.

It can accurately locate reflective or non reflective events equal to or greater than 0.25dB within one metre.



Once the feature is located, the FF1200 reports the loss, location (also location with respect to other features) and reflectance.

Additional strengths include high resolution 1310nm optics, 64km distance range, short dead zone characteristics and launch efficiency meter which characterises the integrity of

the patchcord.

All these features are packaged within a lightweight, handheld portable, battery operated and rugged case.

For further information circle 270 on the reader service card or contact Vicom Australia, PO Box 366, South Melbourne 3205; phone (03) 690 3399.

### Tantalum dipped radial capacitors

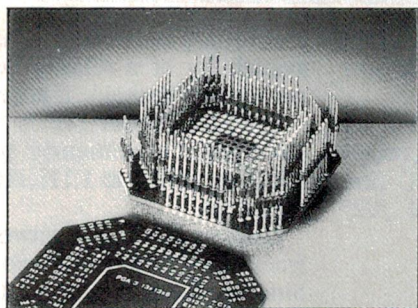
Kemet 'Ultradiip II' series miniature dipped solid tantalum capacitors provide the designer with the advantage of compactness plus low leakage and low loss performance characteristics for filtering, bypassing, coupling, blocking and RC timing circuits.

The series features a capacitance range from 0.1 to 680uF at voltages from 3 to 50V DC.

Solid tantalum devices exhibit no degradation failure mode during shelf storage and show a constantly decreasing failure rate during life tests.

They exhibit low DCL, ESR and impedance and have excellent temperature stability.

For more information, circle 250 on the reader services coupon, or contact Crusader Electronic Components, 73-81 Princes Highway, St Peters 2044; phone (02) 516 3855.



### Complete Line of Debug Tools

- Famous Bug Katcher™ makes it easy to attach test leads to ICs in LCC, PLCC, PGA, PQFP, and DIP packages.
- Eliminates need for noisy cables; reduces capacitance and inductance in your test set-up.
- You can also quickly isolate and reconnect sections of your socketed IC with our Bug Isolator.™ (All packages.)
- Quick turnaround on custom engineering services, if needed. For a free catalog, contact:

**COMPONENT SALES**  
P.O. Box 580 Tel: (03) 764 5199  
Bayswater Vic. 3153 Fax: (03) 764 5445

**ET**

## For the servicing of Electronic Equipment with SPECIALISED SCREWS.

Insert Bits available for:-

Torx®  
Torx Tamperproof®  
Spanner  
Phillips Security (Pin in head)  
Socket Security (Pin in head)  
Tri-Wing



Write for catalogue to:-



ENDEAVOUR

**ENDEAVOUR TOOLS PTY. LTD.**

31 Cleeland Rd.,  
South Oakleigh, Vic 3167

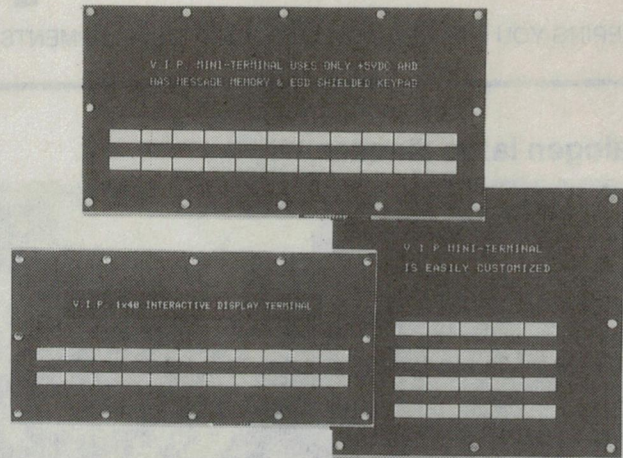
Ph: (03) 562 8266 Fax: (03) 562 8363



# MEASURING UP TO YOUR NEEDS WITH THE NEW I.E.E.

## V.I.P. TERMINAL

- Bright, easily read, vacuum fluorescent display
- Integrated keypad for operator response
- RS232 Interface
- 1 x 40, 2 x 20 and 2 x 40 versions available with 2x11 or 4x5 keypad
- Can store up to 128 messages for easy programming
- Single 5V DC supply
- Complete with filter and housing if required
- Applications include operator consoles, annunciator panels, industrial terminals, machine tools and many more.
- Other interactive displays available.



**CALL NOW FOR A DEMONSTRATION**

READER INFO NO. 21



### DAVIDSON

Measuring up to your needs

**MB & KJ DAVIDSON PTY. LTD.** (inc in Vic)

17 Roberna Street, Moorabbin Vic. 3189

Ph: (03) 555 7277 Fax: (03) 555 7956

Suite 1, 6th Floor, 10 Help St., Chatswood NSW 2067

Ph: (02) 410 9893

W.A. Henco Engineering (09) 244 2777

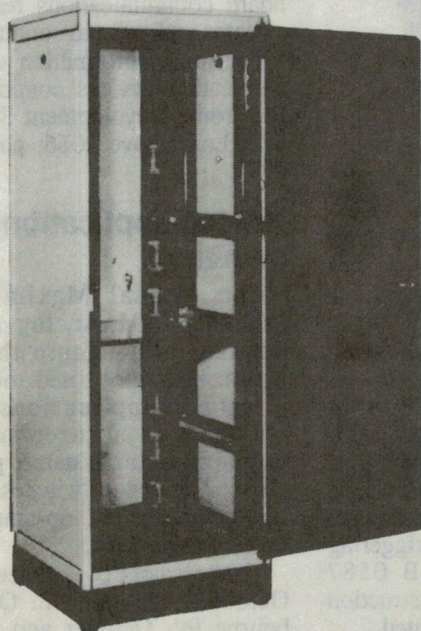
S.A. Graphic Electronic Industries (08) 365 1000

ACT/TAS/QLD M.B & K.J. Davidson (03) 555 7277



**AMALGEN**  
INDUSTRIES PTY. LTD.

# ELSTEEL



## 19 INCH RACKS

### Sturdy Modular Construction

The standard unit is complete and ready to use and comes with

- Rear door
- Flush side panels
- Bottom entry glands
- 100mm Plinth

#### Options

- Chassis Tray & Angles
- Slides
- 200mm Plinths
- Steel or perspex front doors
- Fan trays
- Lifting hardware
- Power Boards
- Rack mounted power supplies

READER INFO NO. 22



**AMALGEN**  
INDUSTRIES PTY. LTD.

N.S.W.-Amalgam  
Ph (02) 570 2855  
Fax (02) 580 5128

Vic.-B.I. Systems Pty Ltd  
Ph (03) 551 8911  
Fax (03) 551 8861

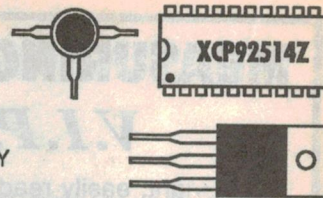
Ballarat-B.I. Systems Pty Ltd  
Ph: (053) 357 266  
Fax (053) 355 208

S.A.-Graphic Electronic  
Ph (08) 365 1000  
Fax (08) 365 1001

Qld.-B.I. Systems Pty Ltd  
Ph (07) 274 1600  
Fax (07) 274 1172



# Solid State Update



KEEPING YOU INFORMED ON THE LATEST DEVELOPMENTS IN SEMICONDUCTOR TECHNOLOGY

## Halogen lamp dimmer



Siemens has released a new dimmer circuit, the SLB 0587, which has the ability to electronically dim low voltage halogen lamps. The touch control obviates mechanical switches and extends lamp life by soft switch-on. Low voltage halogen lamps are finding increasing applications in shops and offices, and are also becoming popular in domestic use.

The SLB 0587 offers the well-known advantages of the SLB 0586A for normal incandescent lamps: control via touch keys from several points, high interference immunity, and a low requirement for peripheral components. In addition, it is suitable for the construction of control circuits for inductive loads — i.e., it can continuously vary the brightness of both conventional incan-

descent lamps as well as low voltage halogen lamps.

Increased attention has been paid to safety in the design of the SLB 0587, by a series of measures to avoid half-waves which produce a direct current. To this end, the trigger pulse is applied to the positive and negative half-waves, and if the first pulse does not trigger, the triac is retriggered. The new trigger pulse is not generated until after the zero transition of the triac current. If retriggering becomes frequent, the SLB 0587 switches the dimmer off and destruction of the transformer is thus prevented.

For more information circle 271 on the reader services coupon, or contact Siemens, 544 Church Street, Richmond 3121; phone (03) 420 7314.

## SuperHEMT transistor

The Fujitsu SuperHEMT transistor series consists of two devices which claim to have the lowest noise figure and highest gain of any production transistor to date. The devices, FHX15FA/LG/X and FHX16FA/LG/X, have typical noise figures of 0.55dB and 0.65dB, respectively, and an associated gain of 11.5dB at 12GHz, making them significantly more efficient than conventional HEMTs.

This performance is made possible by the sub-quarter micron gate structure and the introduction of a two dimensional gas layer of Indium Gallium Arsenide (InGaAs), providing superior electron mobility.

The SuperHEMT transistor was designed to have the same input-output impedances as the FHX04FA/LG/X and the FHX05FA/LG/X, and are thus drop-in compatible with existing HEMT circuit designs. The outstanding performance of the SuperHEMTs makes them a logical choice in DBS and TVRO receivers and should offer a significant advantage as HDTV becomes available. Other applications include satellite on-board communications receivers, radar systems and radio astronomy.

For more information circle 272 on the reader services coupon, or contact Electronic Development Sales, PO Box 822, Lane Cove 2066; phone (02) 418 6999.

## Analog applications seminar

The Annual Maxim Integrated Products 1991 Analog Applications Seminar will feature the following topics: high speed and low power 232 interface applications; low cost microprocessor supervisory circuits; data acquisition systems; power supply circuits' analogue switches & mux's; active filter design; op-amps; and high speed comparators.

The seminars commence in Perth 7th October, Adelaide 8th October, Melbourne 9th October and Sydney 15th October. Admission is free.

For more information contact Veltek, 22 Harker Street, Burwood 3125; phone (03) 808 7511.



## Ultra low noise preamp IC

Analog Devices' SSM-2017 is a low cost audio preamplifier featuring ultra low input noise which simplifies audio system design. This fully integrated microphone preamplifier replaces up to 20 passive components, four transistors and an op-amp. Housed in a space saving 8-pin mini-DIP, the SSM-2017 requires only one external gain set resistor, from which the designer can program gains from one to over 1000.

Applications include audio mix consoles, intercom/paging systems, digital audio systems, automotive differential gain stages and sonar equipment. Low input noise voltage of  $950\text{pV}\sqrt{\text{Hz}}$  (at 1kHz,  $G=1000$ ) permits high gain for low level signals without noise contribution from the amplifier. Total harmonic distortion is typically just 0.01% over the full audio range of 20Hz to 20kHz ( $G=100$ ), and output signals of 10Vrms can be driven into low load impedances without significant degradation of performance. Other features include 17V/ $\mu\text{s}$  slew rate, 1MHz gain bandwidth product ( $G=100$ ), and a sub-audio 1/f noise corner.

For more information, circle 275 on the reader services coupon, or contact NSD Australia, Locked Bag 9, Box Hill 3128; phone (03) 890 0970.

## 100MHz processor

Intel has announced a 1.2 million-transistor, 100MHz microprocessor. Based on the architecture of Intel's flagship 486 microprocessor, the high-speed CPU consists of a floating point unit and a combined instruction-and-data cache memory of 8Kbytes. The 100MHz microprocessor operates up to three times faster than current versions of the 33MHz 486 microprocessor, and measures less than half the size.

Submicron process technology enables the microprocessor to offer unprecedented device connectivity, density and performance. It incorporates aggressively scaled CMOS transistors, three metal layers, and planarised dielectric and tight metal pitch on all layers. The CPU also features salicided gates and source drains, as well as tungsten plug filled vias and contacts. New design methods and computer-aided design (CAD) tools were developed to reduce wire length, route three-metal layers more efficiently, and exploit other process features such as salicided source drains.

These elements provide the device with high packing density and high internal speed. While Intel has successful-

## Inline 40A rectifier bridge

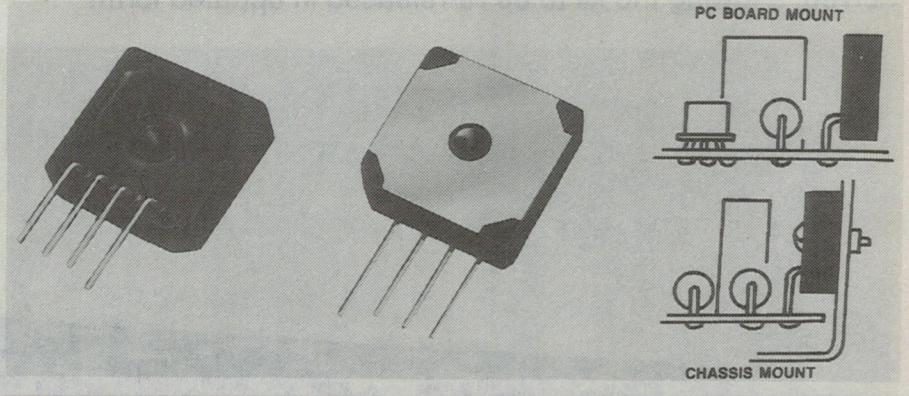
A new rectifier bridge design provides high current capacity with single, inline terminal placement. This allows space saving vertical mounting on crowded PC boards. The integral metal heatsink provides low thermal resistance, while the centre hole allows it to be mounted directly to a chassis or heatsink.

The FPIL series bridges are rated at 40 amperes, 50 to 1000 volts and up to 400

amperes surge. They are also available in recovery times to 50ns.

The rectifiers also offer other features such as avalanche characteristics, low reverse leakage and 2500 dielectric capability.

For more information circle 273 on the reader services coupon, or contact Westinghouse Industrial Products, PO Box 4, Newport 3015; phone (03) 391 1300.



ly fabricated and demonstrated the 100MHz microprocessor, the component is a technology demonstration vehicle at this point, not an actual product.

## Large LCD display

Oprex has released the DMC16188NY-LY, a 16 character by one line LCD display with a large character size of 14.54mm high x 6mm wide. This size makes them suitable for hand-held terminals and customer displays. Features include a wide viewing angle, single +5V supply voltage and LED backlighting provides the display with crisp and vivid viewing in a variety of ambient lighting conditions. As with all the firm's DMC series, the interface is via an 8-bit or 4-bit MPU, 192 alphabetical, numeral, symbol and special characters can be displayed by the built-in character generator.

For more information circle 277 on the reader service coupon or contact Amtex Electronics, 13 Avon Road, North Ryde 2113; phone (02) 805 0844.

## Line powered PR232C transceiver

The Dallas Semiconductor DS1275 line-powered RS232 transceiver is a CMOS device that provides a low power interface between RS232 signal levels and common CMOS/TTL levels. The transmitter employs a novel circuit which steals current from the receive RS232 signal when the signal is in a

negative state (marking). Since most serial communication parts remain in a negative state statistically, using the receive signal for negative power greatly reduces the DS1275's static power consumption.

For more information, circle 274 on the reader services coupon, or contact Veltex, 22 Harker Street, Burwood 3124; phone (03) 808 7511.

## Large CMOS gate array

Motorola's Application Specific Integrated Circuits (ASIC) division has introduced the H4C series array family. Using triple layer metal routing, the sub-micron CMOS array family combines densities up to 318,000 gates, with user configurable RAMs up to 256K bits for true system integration.

The H4C series transistors use a newly developed 0.7micron effective channel length process to achieve 180 picosecond speeds and a very low power dissipation (three microwatts/MHz/gate) for a CMOS array.

The series provides a novel phase-locked loop (PLL) solution to high speed chip-to-chip data transfer. By compensating for variations in chip-to-chip and intra-chip routing delays and process variations, the PLL synchronises on-chip storage elements with external system clocks.

For more information circle 276 on the reader services coupon or contact Motorola Australia, 673 Boronia Road, Wantirna 3152; phone (03) 887 0711. ■



# DSE re-releases kit for TV RSFM

Despite its popularity, Dick Smith Electronics had to withdraw the kit for its VHF/UHF Relative Field Strength Meter some time ago, due to component supply problems. But these have now been solved, allowing the kit to be re-released in updated form.



Back in the August 1988 issue, you may recall, we published the design for a VHF/UHF relative field strength meter. Designed by the R&D people at Dick Smith Electronics, it was intended for TV and FM antenna installers, service technicians or indeed anyone involved in antenna installation or receiver adjustment.

Features of the design included an optional internal 12V battery and power supply, allowing the unit to be operated on rooftops or up masts, away from mains power; coverage of low-band VHF (including FM), high-band VHF and UHF, in three bands; four preset tuning channels, which enabled it to be set up for the local transmissions in any particular area; a sensitivity of better than 10 $\mu$ V (20dB $\mu$ V), with 80dB of manual attenuation; both meter indication and an inbuilt speaker with volume control for audio monitoring; and a composite video output, allowing use of a

video monitor for picture quality comparisons.

Needless to say DSE marketed a kit for the project, and this became very popular — not surprising, in view of its many features.

But after a while, there were supply problems with a couple of the key components: the combination bandswitch/tuning pots used for preset tuning on the four memory channels, and the VHF/UHF front-end tuner module.

DSE was able to obtain a very similar VHF/UHF tuner module without much difficulty, but the bandswitch/tuning pots became almost impossible to obtain. The firm was therefore forced to take the kit off the market, until they could source a suitable replacement.

Finally, a couple of months ago, they were able to find a bandswitch/pot assembly that was electrically equivalent to the earlier unit.

But unfortunately it turned out to be

somewhat different physically, requiring a fairly significant re-design of the project's main PCB and front panel — Murphy's Law!

This re-design has now been done, however, and as a result DSE has been able to release the kit in its new form.

In terms of operation, performance and features the unit is the same as before, the only differences being that it now uses the new bandswitch/tuning pots and VHF/UHF front-end tuner module.

Needless to say the instruction manual supplied with the kit has been modified to cover the changes, and allows everything to be built just as easily as before.

The re-released kit has the catalog number K-6329, and sells for \$199 — making the assembled unit much cheaper than commercial field strength meters. It's available from all DSE stores, and also from selected resellers. (J.R.)



WOOD FOR CHIPS...WOOD FOR CHIPS...WOOD FOR CHIPS...WOOD FOR CHIPS...WOOD FOR CHIPS...WOOD FOR CHIPS...WOOD FOR CHIPS...WOOD

WOOD FOR CHIPS...WOOD FOR CHIPS...WOOD FOR CHIPS...WOOD FOR CHIPS...WOOD FOR CHIPS...WOOD FOR CHIPS...WOOD FOR CHIPS...WOOD

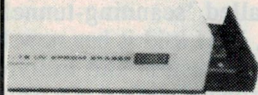
## EPROM SPECIAL

27C010-200 40pin Dual in Line  
1MB EPROM just  
**\$19.95 each**

## QUV-T8/N Industrial EPROM Eraser

- 125x200mm slid-out tray with anti-static pad
- UV indicator
- 7700 hour lamp life
- 15,000microwatt/sq cm intensity
- Safety interlock switch

**\$133.80 ex tax**  
**\$155.20 inc tax**



Don't forget we stock a full range of EPROMs and other microprocessor chips.

## SHOOTER Stand Alone EPROM/Micro Programmer

- Ideal for personal projects and small industrial users
- Works with any MS-DOS compatible PC or dumb terminal with serial port
- Copies and verifies in stand-alone mode
- Programs 2716-27512's including 'A' and CMOS
- Programs 8751/87C51 Micros with adapter
- Built-in debug firmware enables RAM editing and display with terminal
- Fast intelligent algorithms
- Built in RS232 port at 110, 300, 1200, 2400baud
- Uploads and downloads Intel hex, Motorola hex, ASCII hex or binary files

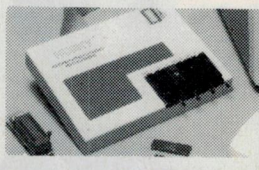
**\$680.00 ex tax,**  
**\$795.00 inc tax**



## HUSKY EPLD/EPROM/MICRO/GANG/SET Programmer

- Direct drive from PC via high speed parallel interface
- Four 32 pin ZIF sockets
- Programs in SET or GANG mode for up to 4 single EPROMs or 4 CMOS 20/24 pin EPLDs
- Completely software driven
- Optional adapters for single chip Micros, CMOS 20/24pin EPLDs and PLCC/PGA packaged devices
- Husky software is menu driven plus mouse or cursor
- Supports devices up to 2MB
- Software updates available

**\$776.25 ex tax**  
**\$906.00 inc tax**



## See Review in E.A. May

## SerialTest serial data analysis on your PC

This is an MS-DOS software and cabling package which offers sophisticated facilities at a fraction of the cost of dedicated hardware systems. SerialTest provides a window onto RS232 lines operating either passively or actively sending data or control signals to simulate either at DTE or DCE device. Triggers can be defined based on error conditions or data to initiate or terminate monitoring sequences.

**\$425 (\$395 ex tax)**

Send \$10 for a demo disk, refundable on purchase.

## Kikusui 40MHz 2 Channel Scope

- 5mV/div dc to 40MHz
- 20ns/div to 0.5s/div Main
- 0.2µs to 0.5ms/div Delayed
- Includes x1/x10 probes
- 2 year warranty

**LOS5041** **\$1372.50**  
**(\$1178.50 ex tax)**

## Fluke 70 Series II Multimeters in stock

Model 70 True Fluke quality for only **\$150 inc tax!**  
Model 75II 0.4%, 10A range, TouchHold™ etc **\$312 inc tax**

## ROLACASE Portable Storage Systems

- Ideal for vehicle storage
- Easily indexed
- Take with you to the job
- Static conductive to prevent damage to delicate components
- Ideal for mining, gas etc industry where extra safety is required
- High impact ABS
- Internal Dimensions 360x360x75mm
- Choice of two types - Blue, single compartment **\$57.20**
- Orange, divided into 20 compartments **\$64.95**
- Storage rack holds 3 cases, for vehicle or bench **\$155.00**



## INFRA-RED BARRIER KIT

- 15metre range
- 2 Outputs no/nc
- Fast response
- Mounting cases included
- Easy to align
- Low power drain - 12V/45mA
- Detects objects 10mm diameter

The ATM20 uses high frequency coding to minimise interference from sunlight etc. High power GaAlAs technology and low noise PIN diode.

Ideal for use in -  
Speed detection systems up to 999.9kph!  
Security  
Camera trigger for wildlife photos

Complete kit uses finest components, has comprehensive instructions and is complete down to terminal strips **\$58.20**  
We stock the full range of Professional AT&M Kits - Don't design your own - Send for our list and save a fortune!

## Save Problems and Cost with



## MEMOREX

### GENUINE PREMIUM GRADE DISKS

5 1/4	2S/2D	\$16.95 per 10
5 1/4	2S/HD	\$24.95 per 10
3 1/2	2S/2D	\$24.95 per 10
3 1/2	2S/HD	\$49.95 per 10

# APPA

## Why pay up to \$150 for a label?

Take a close look at APPA multimeters. Look familiar? That's because they're sold under different brand names. And that means you could pay a lot more than you need to. We've seen the top of the line model selling at around \$150 more than our price. So you're paying that much extra just for the brand label!

### Look at the features -

- Large high contrast display - The 96 and 98 have analog bar graphs too
- Colour coded input terminals and function switch for easy setting
- Probe storage clips built in for easy two handed measurements
- The 96 is water resistance for industrial use
- Shockproof for a drop of 1.5m!
- Built-in tilt stand
- Automatic power-off
- Meet IEC 348 Class II and UL1244 standards for safe operation

### Model 93

- 1999 count
- Large 20mm high contrast LCD readout
- 8 Functions - Vdc, Vac, Adc, Aac, Ohms, Diode, Frequency, Capacitance
- 0.5% dc accuracy **\$142.80**

### Ranges

Vdc 200mV, 2V, 20V, 200V, 1000V  
Vac 200mV, 2V, 20V, 200V, 750V  
Adc 200µA, 2mA, 20mA, 200mA, 2A, 20A  
Aac 200µA, 2mA, 20mA, 200mA, 2A, 20A  
Ohms 200Ω, 2kΩ, 20kΩ, 200kΩ, 2MΩ, 20MΩ  
Frequency 2kHz, 20kHz, 200kHz  
Capacitance 2nF, 20nF, 200nF, 2µF, 20µF

### Also available -

- Model 93T with transistor tester in place of 2A range **\$142.80**

### Model 96

- 3 1/2 digit plus 41 segment analog bar graph
- Autoranging or manual selection
- 6 functions - Vdc, Vac, Adc, Aac, Ohms, Diode
- Water resistant
- Data hold
- Memory offset

### Ranges

Vdc 200mV, 2V, 20V, 200V, 1000V  
Vac 200mV, 2V, 20V, 200V, 750V  
Adc 200µA, 2mA, 20mA, 200mA, 2A, 20A  
Aac 200µA, 2mA, 20mA, 200mA, 2A, 20A  
Ohms 200Ω, 2kΩ, 20kΩ, 200kΩ, 2MΩ, 20MΩ **\$166.80**

### Model 98

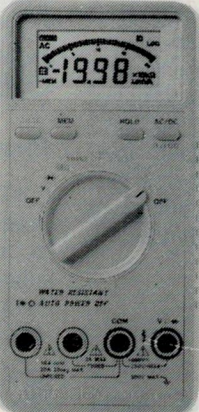
- 3 1/2 digit plus 41 segment analog bar graph
- Autoranging or manual selection
- 8 Functions - Vdc, Vac, Adc, Aac, Ohms, Diode, Frequency, Capacitance
- Data hold
- Memory offset

### Ranges

Vdc 200mV, 2V, 20V, 200V, 1000V  
Vac 200mV, 2V, 20V, 200V, 750V  
Adc 200µA, 2mA, 20mA, 200mA, 2A, 20A  
Aac 200µA, 2mA, 20mA, 200mA, 2A, 20A  
Ohms 200Ω, 2kΩ, 20kΩ, 200kΩ, 2MΩ, 20MΩ  
Frequency 2kHz, 20kHz, 200kHz  
Capacitance 2nF, 20nF, 200nF, 2µF, 20µF **\$214.80**

### Model 76 Component Tester

- Does the things your multimeter doesn't!
- Capacitance 200pF to 20µF
  - Resistance 200Ω to 20MΩ
  - Transistor hfe and Icco
  - Diode displays Vf at 1mA
  - LED displays Vf at 2Ma and 10mA
  - Battery tests 9V and 1.5V cells
  - SCR Pass/Fail test **\$142.80**



## Geoff Wood Electronics Pty Ltd (inc in N S W)

229 Burns Bay Road, (Corner Beatrice Street), Lane Cove West N S W

Mail Orders to - P O Box 671, Lane Cove N S W 2066

Telephone : (02) 428 4111 Fax : (02) 428 5198

8.30am to 5.00pm Monday to Friday. 8.00am to 12 noon Saturday

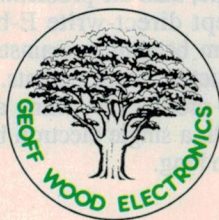
Mail Orders add \$5.00 min to cover postal charges

Next day delivery in Sydney add \$5.00

All prices INCLUDE sales tax unless stated otherwise

Tax Exemption Certificates accepted if the line value exceeds \$10.00

BANKCARD, MASTERCARD, VISA, CHEQUES or CASH cheerfully accepted.





# Silicon Valley NEWSLETTER



## Motorola dedicates \$500M fab plant

Motorola's newest and largest manufacturing facility, the US\$500 million MOS 11 wafer fabrication plant, has been formally dedicated. The facility is Motorola's largest single investment ever, and it has generated worldwide interest within the semiconductor industry due to its state-of-the-art technology.

US House of Representatives Majority Leader Richard Gephardt, in keynote remarks, said MOS 11 is an achievement not only for Motorola, but for America's efforts to compete globally.

Located at Motorola's Oak Hill site in Austin, Texas, MOS 11 has been designed to be the most advanced semiconductor manufacturing facility in the world. It is the only non-captive commercial 8" wafer fab in the United States.

Huge by industry standards, MOS 11 encompasses over 460,000 square feet. The facility houses a 70,000 square foot clean room which exceeds the industry's Class 1 standards for particle filtration by three times.

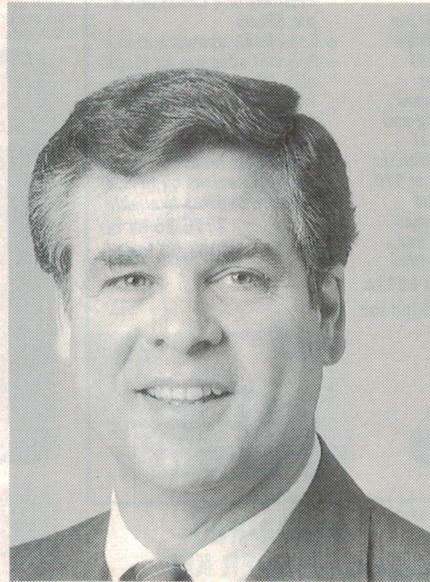
## \$1.4B contract to Lockheed, Pyramid

If the AT&T/NCR merger raised doubts over Pyramid Technology's future, the Mountain View company has landed one of the most lucrative sub-contracts in computer industry history.

AT&T has won the much sought-after US\$1.4 billion, seven year contract to update the computer system used by the US Internal Revenues Service. Much of the AT&T bid was based on computers AT&T has been buying from Pyramid, under an OEM contract.

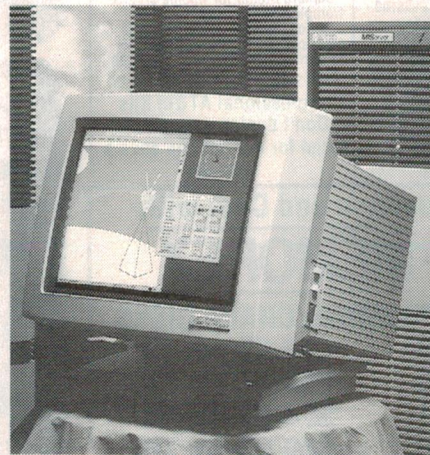
The deal calls for AT&T to install 3200 high performance Pyramid made computers, as well as some 50,000 workstations and networking products. Pyramid estimates its share of the contract will amount to more than US\$300 million over the next five years.

"We will ship more computers in this contract alone, than we have shipped in the entire history of the company", said an elated Pyramid executive, vice president Edward Scott.



*Pyramid's president, Richard Lussler*

AT&T along with Pyramid and Computer Sciences Corp, fought a hard battle to obtain the contract. Other bids were submitted by teams including IBM with Arix, and Lockheed with Hewlett-Packard.



*Pyramid Technology's new MIServer S Series system which uses industry-standard RISC processors from MIPS. Running the UNIX System V operating system, it is representative of the systems included in the IRS contract.*

## IBM etches, deposits silicon atoms

IBM engineers have moved a big step forward towards the development of single atom transistors and electronic circuits.

After demonstrating last year that individual Xenon atoms could be manipulated and placed in designed positions with a so-called 'scanning-tunnelling microscope', IBM said it has now been able to move clusters and individual silicon atoms on the surface of a wafer.

Potentially, this will set the stage for the development of single atom transistors and circuits with linewidths of a single string of conducting atoms.

Current state-of-the-art linewidths on 0.3 micron devices still measure about 500 atoms. Memory circuits built with so-called 'nanometrics' could store trillions of bits of data onto a single chip.

In a second breakthrough, IBM said its researchers had been able to perform the latest silicon atom etch and deposition experiments at room temperature. The earlier Xenon experiments had to be conducted at only 7° above absolute zero.

Now that they have been able to demonstrate two of the three critical steps in the semiconductor development process, IBM said it is confident it will also be able to achieve the third requirement — doping, the process that changes the electrical properties of specific sectors on the silicon wafer. In this case, the 'impurities' would have to be placed just as precisely atom by atom, as the silicon atoms which form the actual circuit.

It will be decades before the IBM research will find its way into the commercial market, even if IBM is able to build an actual working circuit within the next year. The main problem lies in building complex circuits fast enough when having to painstakingly move millions of individual atoms to specific locations.

The problem is similar, but far more complex in scope, than the problems that have so far kept direct-write E-beam lithography from becoming mainstream in volume production environments.

Here too, the process of writing all of the circuitry with a single electron beam simply takes too long.



Still, like direct-write E-beam, the IBM process could be introduced in very special market segments where cost and speed is no obstacle and production can be limited to only a few chips.

Those circuits, however would be so powerful a single, pinhead size chip could easily accommodate all of the circuitry found in a top-of-the-line Cray supercomputer, and would operate virtually at the speed of light.

## Grove blasts Bush's tech policy

In his keynote address at the opening of the first annual business leader symposium at the National Press Club in Washington DC, Intel chief Andrew Grove sharply criticised President Bush for his lack of vision and interest in a US industrial policy for the electronics industry.

While admiring Bush for his astute conduct in the Persian Gulf War, Grove said "In contrast, I am not nearly as impressed with the President's conduct of the government's activities having to do with the general field of electronics, specifically of information processing."

US companies in many industries have lost large chunks of global marketshare, Grove said. "We all know this is happening in steel, machine tools, and in automobiles. In semiconductors, US owned companies had a 57% share of the global market 10 years ago. Today that share is only 35%. In the case of equipment that we use, it was 75% in 1980. In 1990 it has shrunk to 47% in computers, it was 76% in 1980' by 1990 it had declined to 55%. Clearly we are losing marketshare, and we are losing it fast."

Grove said he was encouraged a few months ago, when the White House released a list of 22 technologies that should be nurtured as critical to national security, including microelectronics.

But a few days later the White House distanced itself from the report, saying it had been the opinion of the commission that made the study and didn't reflect White House policy.

"What the hell is that supposed to mean?" Grove said. He added that he is also viewing with alarm the increasing number of investments the Japanese are making in US high-tech firms.

"I am reminded of what happened in a related industry, consumer electronics — in the 1970s. We lost consumer electronics starting with the colour TV. If you walk through a consumer electronics store you simply cannot find any American-made product of any kind."

Now, Grove said the same companies

that bought up the consumer electronics hardware industry in the 1970s are buying up the consumer electronics software business as well, including movie studios such as Columbia Pictures (Sony), MCA (Mitsubishi) and CBS Records. "You only have to walk through a records store to see how prominent the Sony label has become on compact discs in a matter of months."

"It seems to me the cycle is about to be repeated in the information processing industry," Grove said, pointing out that the Japanese have pushed their marketshare of palmtop computers to 80%.

While some people believe the law of the survival of the fittest should be applied because consumers will benefit, Grove said that the industries the US is losing "represent the wealth-creating engine of the US well into the next century."

## IBM and Apple form alliance

In an historic agreement that could radically reshape the personal computer, workstation, microprocessor, operating system and application software markets, IBM and Apple Computer, have announced a historic far-reaching alliance that may well create the industry standard for personal computers and workstations for the mid-to-late 1990s.

Under the terms of the agreement:

- Apple and IBM have agreed on a single software and hardware platform for their next generation personal computers and workstations.
- The systems will be built around an advanced version of the IBM RS/6000 RISC microprocessor chip set.
- Motorola will develop an improved version of the IBM chip set and manufacture the chips for Apple, IBM and possibly other companies wishing to market compatible systems. Motorola is expected to integrate the current six-chip set into a two-chip set.
- IBM and Apple will set up a new jointly-owned company that will finish development of Apple's object-oriented programming based 'PINK' operating system. Apple will transfer the PINK technology it has been developing for five years, as well as some 100 software engineers involved in the project to the new company.

IBM will contribute an unspecified amount of money to the joint venture. In addition, it is expected that the new company will absorb the Patriot Systems joint venture between IBM and Mount View-based Metaphor Systems which

was working on OOP-based programming tools.

- Apple will licence its user-friendly Macintosh software technology to IBM, which will incorporate it into its workstations and mainframes.
- Apple and IBM will intensify ongoing efforts to enable Macintosh computers to easily communicate with IBM mainframe systems.
- IBM and Apple will jointly create and licence future multimedia software that will allow users to mix sound, data and video simply by pushing electronically displayed 'control panel' buttons on a computer screen.

The deal followed three weeks of intense negotiations between Apple and IBM. The powerful alliance between the world's two largest personal computer vendors is leaving much of the computer, semiconductor and software industries scrambling to determine how the alliance will affect their business and future strategy.

## Seagate lays off 1200 workers

Seagate has laid off some 1200 workers, as sluggish demand for personal computers is taking its toll on disk drive makers.

Industry analysts said the Seagate announcement was the first of a series of cutbacks expected to sweep through the drive industry. The industry's problems began during the first quarter but have worsened. Besides sluggish end-user demand, many drive makers are facing customers with excess inventories that had been built up during much of 1990 when drive makers raked in record sales.

Two companies that are not expected to suffer to the same degree as Seagate are Quantum and Connor Peripherals, both of Milpitas. Both companies have major long-term supply contracts with major companies such as Apple Computer (Quantum) and are assured more steady demand for their products.

Seagate in contrast depends heavily on unpredictable clone makers and the computer retail store market. But clone makers in particular suffer when overall demand for computers is weak, and customers are able to negotiate large volume discounts with brand name manufacturers.

Evidence of the trend showed up in the quarterly results released by Seagate and Connor this week. Whereas Seagate's earnings plunged from US\$29.7 million a year ago to just \$383,000 Connor was able to record a US\$26.8 million profit, essentially the same as a year ago. ■





# Locally made EPROM Programmer for PCs

JED Microprocessors, the Melbourne-based manufacturer of microprocessor based and related equipment, has produced a low cost and easy to use programmer for PROM and FLASH devices, driven from the parallel printer port of a standard PC. Here's a rundown on what it does and how it works, from the designer himself.

by **EDWIN SCHOELL** Managing Director, JED Microprocessors

The JED PC PROM programmer is a small box designed as a simple but flexible device for easy lab and field programming of EPROM and FLASH devices from any standard PC.

It is designed and built in Melbourne, and was produced as an aid to users of PROMs — from small microcontroller systems to the JED 386SX industrial PC (see page 116 of the July 1991 issue of *Electronics Australia*.) A range of low-cost PC-resident cross assemblers, disassemblers and simulators is available from JED to produce code for almost every microcontroller available in Australia, priced from \$90.

One of the most important things to note is that the JED programmer does *not* need any special boards plugged into the PC. Rather than use an I/O board which has to find a spare slot in the PC, and draw power from the PC system, the device simply plugs into the standard DB25 parallel printer port on the PC, and all communications takes place at high speed via that port.

Thus any PC compatible, from a humble XT to a fast 486 desktop, or any lap-top with a DB25 printer port, can use this system without any adjustments and without needing to open the lid and install cards.

The JED PROM programmer uses a 32-pin device socket, and is thus able to program JEDEC pinout devices with up to 1MB capacity (27C080). The lower limit is the bottom of the 28-pin range, i.e., 27C64 devices with 8K byte capacity.

Intel-format FLASH devices are also able to be both programmed AND erased on this system, as well.

There is no PROM type selection switch, as the programmer uses the automatic identifier mode (originated by Intel, and now used by most manufacturers). This is accessed by raising the A9 line to 12 volts and reading a



manufacturer's code from address 00000, along with a type number from address 00001. (Before using automatic mode, the user should check from a device data-sheet that this mode is supported. All Intel, National, TI, AMD, Signetics/Philips, Atmel and Microchip types are included and automatically set up, and new ones are added as they become available.

If a PROM does not support this mode, type and algorithm selection can be made safely from the screen). Fast programming algorithms vary from manufacturer to manufacturer, and the algorithm is selected automatically from the identifier as well.

## Software

A menu-driven system is supplied on disk. Users simply call up the *PPEXE* file, then use arrow keys (or an initial letter) to steer around the windows, naming files and specifying options as requested. These are saved to disk, so that next time the program is used, the defaults are recalled. A PROM can be programmed with very few keystrokes, because the sequence of PROM erase check, then program, then verify runs automatically.

(Optional printer port addresses are supported, so that if you do not want to disconnect the normal printer cable, a cheap printer interface card can be added and used for access.)

A bar graph marked 0 to 100% shows the action occurring as the blank check, programming and verify stages proceed.

PROM programming is always done from a binary image (a .BIN) file, which is created automatically when a source file of some other format is selected.

The main PROM programming routine

can load from (or save to) binary, Intel hex, Intel extended hex and Motorola S19, S28 and S37 formats.

## Utilities

To make it easier for users with a variety of file formats and PROM loading patterns, a number of JED-developed utilities are supplied with the system. These allow a blank PROM image of the correct length to be created on disk, and then add in one or more files with the correct offset into the file. The add-in files can come from variety of sources and have a variety of formats, and, for example, can add in a user program, a library, a compiled C program, a data table and some debug code into a PROM image.

Usually a simple batch file like the following (to combine font files) is created to do the job:

```
FIM fontbig.bin ffff
FAD fontmod.bin fontbig.bin
FAD -o8000 fonthigh.bin fontbig.bin
Utilities provided are:
```

*FIM.EXE*: This generates a blank image (fontbig.bin) of a PROM of the selected length (in this case, a 27C512, (64K bytes long, with top address FFFF hex).

*FAD.EXE*: This adds data files into the binary image created by *FIM.EXE*.

In the example, the first reads one binary file (fontmod.bin) and loads it from 0000 to 7FFF. The second FAD has an offset command (-o8000) and loads fonthigh.bin into addresses 8000 to FFFF. All supported file formats can be loaded into the image using FAD.

*FICON.EXE*: This can convert any supported format to and from a .BIN file.

*FSPLIT.EXE*: Splits a file into two

PROM images, allocating odd bytes to one file and even bytes to the other.

*FCKSUM.EXE*: Generates a two-byte (16-bit) checksum of a PROM, and (optionally) can place this in the last two bytes of the PROM image.

*PPD.EXE*: Users can add more PROM types and manufacturers to the internal tables by using this device-type editor. It allows selection of the algorithm.

## PROM editing

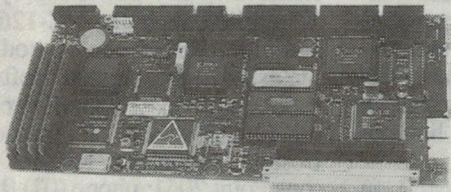
Existing PROMs can be read and saved on disk. The .BIN files can be examined byte by byte, and can be edited on screen, saved on disk, or used to program a new, modified device. PROM data can also be examined directly.

## Power supply

A 14-volt plug pack supplies power to the PROM programming system. No power is drawn from the PC. The interface to the PC has pullup resistors, so it is compatible with all TTL, CMOS and VLSI parallel-port driving logic. For portable programming applications, a NiCad battery pack is available which can run the unit for several hours — enough for over a hundred PROMs. The plug pack then can plug into the battery pack and charge it. The JED PC PROM Programmer system is a compact 155 x 90 x 37mm. The unit is supplied with a ribbon cable for the PC, the choice of a 3.5" or 5.25" floppy disc containing the software, and the plug pack power supply for a cost of \$300 plus 20% sales tax if applicable.

Further information is available from JED Microprocessors, Office 7, 5/7 Chandler Road, Boronia, Victoria 3155; phone (03) 762 3588. ■

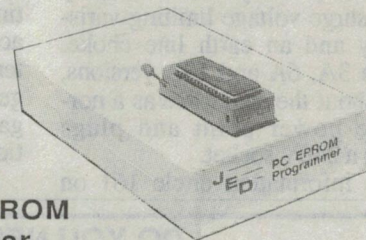
## Australian Computers & Peripherals from JED... Call for data sheets.



The JED 386SX embeddable single board computer can run with IDE and floppy disks, or from on-board RAM and PROM disk. It has Over 80 I/O lines for control tasks as well as standard PC I/O. Drawing only 4 watts, it runs off batteries and hides in sealed boxes in dusty or hot sites. It is priced at \$999 (25 off) which includes 2 Mbytes of RAM.

### JED Microprocessors Pty. Ltd.

Office 7, 5/7 Chandler Rd., Boronia, Vic. 3155. Phone: (03) 762 3588 Fax: (03) 762 9639



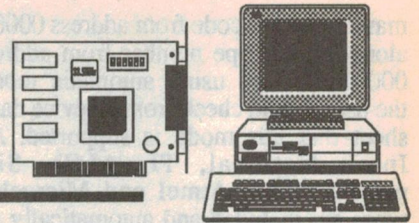
### \$300 PC PROM Programmer.

### Need to programme PROMs from your PC?

This little box simply plugs into your PC or Laptop's parallel printer port and reads, writes and edits PROMs from 64Kb to 8Mb. It does it quickly without needing any plug in cards.



# Computer News and New Products

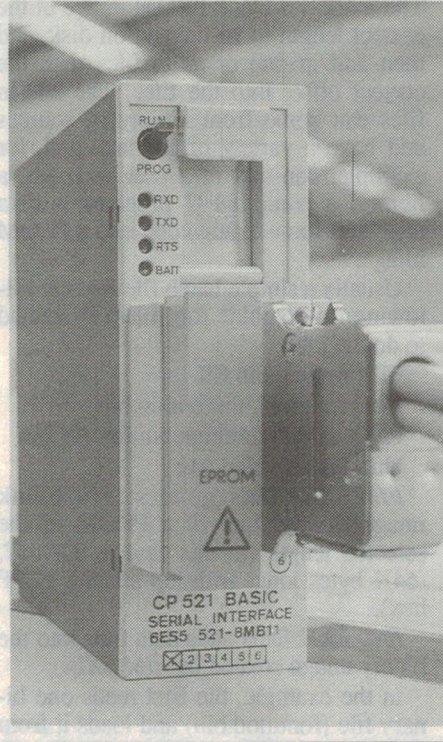


## Comms processor speaks Basic

The new 'CP 521 Basic' communications processor for S5-100U programmable controllers from Siemens is programmed in Basic. Typical areas of applications are: offloading complex arithmetic functions from the central processor, data dumping and processing, operator-process communication and monitoring. A monitor and printer can be plugged into the front connector.

There is an editor available on the CP 521. Siemens has expanded the Basic interpreter by special commands for data exchange with the CPU and with Simatic I/Os. The program is developed in the 32K byte module memory (RAM) and transferred to the submodule memory of the same size after testing. The module memory is then available as data memory for program processing.

For more information circle 165 on the reader services coupon or contact Siemens, 544 Church Street, Richmond 3121; phone (03) 426 7218.



the reader services coupon or contact APC Services, PO Box 584, Bayswater 3153; phone (03) 762 3000.

## Protel support

Quest International Computers has been appointed an authorised reseller of the Protel range of CAD products. Quest is also the exclusive distributors of the P-CAD product range from CADAM, in addition to developing its own inhouse products like the QED range of personal photoplotters for low cost artwork production.

For more information circle 164 on the reader service coupon or contact Quest, 1 Hamilton Place, Mount Waverley 3149; phone (03) 807 7444.

## Budget A/D card

The new PC-126 from Boston Technology is a low cost, fully featured A/D card for PC-XT/AT/386s and laptops.

It is a 12 bit, 16 channel A/D card capable of sampling rates of up to 50kHz with two 12-bit D/A channels and 16 digital I/O lines included on the card. The inputs and outputs have DIP-switch selectable ranges, with the inputs having a high impedance. Advanced triggering and clocking modes are integral to the card, as well as DIP switch selectable base address, to avoid bus contention. The card has been designed with laptop usage in mind and thus has a low power consumption. It can also be used in laptops which don't provide the standard +/-12V power supply rails.

Supplied with the PC-126 is driver software, driver source code and the Status 30 data acquisition software.

For more information circle 166 on the reader service coupon or contact Boston Technology, PO Box 415, Milsons Point 2061; phone (02) 955 4765.

## Power surge protection

The 'Computer Protector' from Westinghouse is designed to protect computer, fax, video and hifi equipment, as well as all other high tech microprocessor based equipment, from damaging power surges. It will almost completely remove AC mains interference.

The Protector incorporates four levels of protection: primary and secondary RFI filters, surge voltage limiting varistor circuitry and an earth line choke. Available in 3A, 6A and 10A versions, the unit is about the same size as a normal double power point and plugs directly into a 240V socket.

For more information circle 161 on

the reader services coupon or contact Westinghouse Industrial Products, PO Box 4, Newport 3015; phone (03) 391 1300.

## Upgraded control software

Version 2.0.3 of the Strawberry Tree Data Acquisition Workbench PC and control software has just been announced. Major additions include runtime versions with password controlled access, support for 24-pin printers, extended data buffers and hardware triggers, easier selection of analog output gain ranges and new command line options for trigger and buffer.

For more information circle 162 on

## DO YOU NEED A FAX MACHINE AND A MODEM?

GET IN THE PICTURE WITH THE MAESTRO 9600XR FAX /DATA MODEM \$399 Incl tax Telecom approved price includes Fax Software for either PC or Macintosh  
Send and Receive



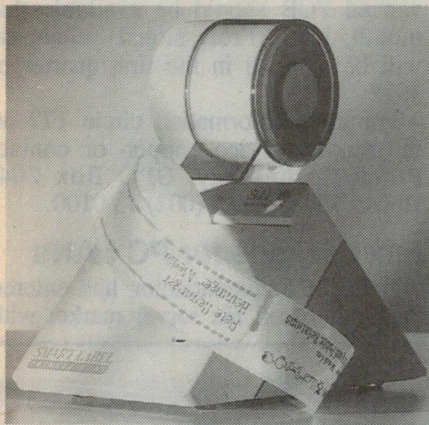
Also the MAESTRO 2400 XR Here's a fully-featured, Hayes compatible 1200 & 2400 bps full duplex modem for just 299 (inc. tax).

This modem uses the latest in DSP chip set Technology and microprocessor control, bringing you the future today.

Maestro Distributors - Calool St. South Kincumber, NSW 2256 Ph: (043) 68 2277 Fax (043) 68 2731



## Enhanced label printer



Seiko Instruments has produced an enhanced version of its Smart Label Printer, released only a year ago, called the SLP Plus. Its new features include checking the validity of an onscreen ad-

dress against Australia Post specifications, capturing it off the screen automatically, and printing it on a label. Because the SLP Plus printer can recognise text or ASCII files, it can produce labels from files in most word processors, databases and spreadsheets.

Running as a TSR or application on a PC, and as a Desk Accessory on the Apple Mac, the SLP Plus software becomes a desk tool running in conjunction with most application programs.

The earlier 71KB version has now been cut to 8KB of memory, with disk and expanded memory swapping as installation options.

The SLP Plus and software retails for \$472, excluding tax (\$510 including tax).

For more information circle 163 on the reader services coupon or contact Portable Computer Systems, 80 Arthur Street, North Sydney 2060; phone (02) 954 3411.

## Philips 20" hi-res monitor

The Philips CM5000 Hi-Resolution 20" (48cm) colour monitor is suitable for IBM PC/XT/AT/PS-2 computers, Mac II and SPARC workstation users. It will operate at any scan frequency from 30kHz to 64kHz.

With the latest dark glass non-glare electrostatic free surface picture tube, the CM5000 produces correctly sized displays for the three most commonly used formats. This allows users to move between applications, without the annoying re-adjustment of the picture height and width controls each time.

Video bandwidth of 110MHz and excellent convergence at both centre and corners of the picture are critical specifications of the CM5000 in achieving good picture quality.

This model is the latest 1280 x 1024 resolution addition to the Philips range of 'Brilliance' monitors.

For further information circle 167 on the reader service coupon or contact Philips Components, 34 Waterloo Road, North Ryde 2113; phone (02) 805 4455.

## 400dpi colour laser printer

The new Canon PS300 printer combines a 9" digital colour laser imaging system with an Adobe PostScript Interpreter to provide colour printing of computer generated images and text.

It has a copy speed of five pages a minute in full colour A4, accepts up to A3 size paper and has a high 400 dots per inch resolution for text and graphics.

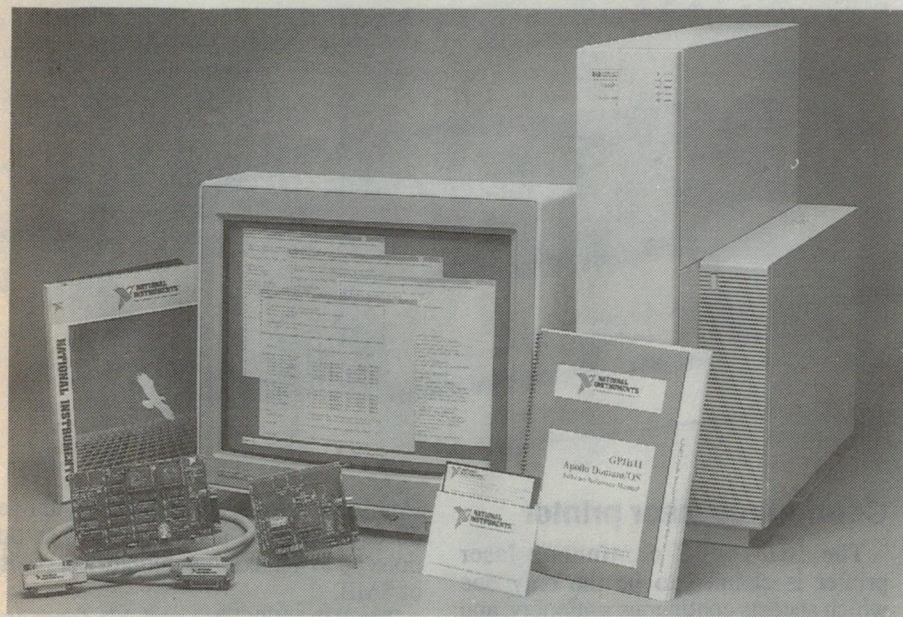
The PS300 is also a colour copier. Its editing and image manipulation capabilities facilitate layout positioning of graphics in colour newsletters, brochures, product literature and other presentation materials.

Advanced image recognition and black character enhancement features automatically differentiate colour photos and illustrations from text, and its photo mode and text mode respectively increase the sharpness of half tone gradations.

For more information circle 168 on the reader service coupon or contact Canon Australia, 1 Thomas Holt Drive, North Ryde 2113; phone (02) 805 2000.

## LEAP card/mic

ATI will shortly be introducing a hardware interface card and calibrated microphone combination which is designed to work with its acoustical software package, LEAP 4.1. This will make the system far more competitive with the well known MLSSA package since parameters needed by the LEAP



## GPIB interface kits for 9000 400 workstations

National Instruments Australia has announced two new interface kits that equip Hewlett-Packard HP/Apollo 9000 series 400 workstations as instrument controllers. The GPIB-A/AT and GPIB-A/PC kits include an IEEE-488.2 controller board and the enhanced IEEE-488.2 compatible AT-GPIB board, which uses the NAT4882 and Turbo488 custom chips to achieve maximum data transfer rates of 1MB/sec for both reads and writes. The GPIB-A/PC kit has the cost-effective GPIB-PCII/IIA board that uses the NAT4882 chip and transfers data at 400KB/sec.

The GPIB11 Domain/OS software includes a high speed driver, a C language interface, an interactive utility for debugging application programs, and a screen-oriented system configuration utility. The new driver is completely compatible with the National Instruments drivers available for Apollo DN3000 and DN4000 series workstations, so existing customers can easily upgrade to the new 9000 series 400 workstations without modifying existing programs.

For more information, circle 180 on the reader services coupon or contact National Instruments Australia, 1 Colin Avenue, Park Orchards 3114; phone (03) 879 9422.



## COMPUTER PRODUCTS

software can now be provided by the mic.

The LEAP card is referred to as an LMS card and comes in IBM format only. The condenser mic is calibrated to B&K 413 +/-0.5dB. Each mic and card is calibrated so that all measurements are absolute — no scaling or interpretation is required. Throughout the 10Hz-100kHz range there are 200 points per decade for detailed and accurate responses in terms of amplitude, phase and impedance.

The estimated price of the card/mic, subject to final confirmation, is \$1200 — around 1/3 the price of MLSSA.

For more information, circle 170 on the reader services coupon or contact Speaker Technologies, PO Box 50, Dyers Crossing 2429; phone (065) 50 2254.

### Protel for Windows

Protel Technology has announced their next generation PCB design system, 'Protel for Windows.'

The system consists of a PCB layout module available in two versions: Professional PCB and Advanced PCB with auto placement and autorouting;

# Forget our baby logger.

Unlike real babies, the DT 50 is cheap to run. Only 200  $\mu$ A in low power mode. Store up to 300,000 readings in a removeable memory card. You can forget it for over a year.

Whatever your data logging application, from ten channels to thousands, there is a Datalogger model that will turn problems into child's play.

Designed in Australia, used around the world. BMW (makers of toys for big boys) use Datalogger. So do Mercedes Benz, GM, Ford and Volvo.

But its not only car makers we help. If you'd like your data logging problems solved talk to us. The rest of the world does.



Data Electronics 46 Wadhurst Drive, Boronia 3155  
Tel (03) 801 1277. Fax: (03) 800 3241.

READER INFO NO. 26

and a schematic circuit design module: Professional Schematic.

Protel for Windows runs under Microsoft Windows version 3.0 or greater. It takes advantage of the 386 enhanced mode in Windows and hence uses the virtual memory capability provided. As a result the user can load boards of any size with no restrictions on the number of components, tracks and nets. It also supports the multiple document interface (MDIO) standard. This allows the user to load any number of boards simultaneously and to move

tracks, pads and components between designs. Professional PCB and Advanced PCB should be available this month, while Professional Schematic will be released in the first quarter of 1992.

For more information circle 172 on the reader service coupon or contact Protel Technology, GPO Box 204, Hobart 7001; phone (002) 73 0100.

### Fax package for PC LANs

National Semiconductor has entered the LAN-based fax server market with



### Continuous laser printer

The IBI 1600C continuous laser printer is claimed to be the only one which accepts continuous stationery, and to be totally flexible in both the length and width of the printed area.

Using adjustable sprockets, it can accommodate labels or forms from 89mm to 248mm wide and any length up to 560mm, making it suitable for a wide range of printing and labelling applications.

The print quality is 300 x 300 dots per inch with five-level density control, providing excellent resolution for text, graphics and bar codes. Resident bar-code fonts are Code 39, UPC, Code 128, MSI and Interleaved 2 of 5, with others including Codabar, Code 49, 16k, Code II, Postnet and EAN B/13 available as options.

Helvetica from 6 to 72 point and

Courier text fonts are standard, and over 60 others can be added onboard as options up to a maximum memory capacity of 8MB.

The IBI 1600C has scalable fonts and all matter may be printed in landscape or portrait, even on the same sheet. Print speed is equivalent to 16 300mm pages per minute, regardless of print density.

Centronics parallel and serial interfaces are provided as standard, with optional IBM connectivity via Twinax and Coax interfaces as options. Standard emulation is HP Laserjet II PCL, with optional Code V. Standard RAM of 2MB and font ROM of 2MB are both upgradeable up to a maximum of 8MB each.

Further information is available by circling 171 on the reader service card of by contacting Datacos, Unit A11, 4 Central Avenue, Thornleigh 2120; phone (02) 980 6711.



the introduction of EtherFax, a combined hardware and software system that allows PC LAN users to send and receive faxes. EtherFax is compatible with Novell NetWare, and features a fax server that manages all facsimile communications activities for all users on the network. EtherFax is a low cost solution because it requires only one fax board and a single, dedicated telephone line to serve up to 64 LAN users.

The system administrator, who can also be an EtherFax user, configures the fax server through software, sets up the fax environment, receives faxes and routes them to the appropriate LAN users. For file security, fax messages can be accessed only by the administration and the originating/receiving user.

EtherFax is G3 fax-compatible and operates at speeds as fast as 9600bps. The EtherFax host server must be an IBM PC AT or compatible computer, with 640kB of RAM and PC-DOS version 3.1, 3.3, 4.01 or any latest version.

For more information circle 174 on the reader service coupon or contact National Semiconductor, 16 Business Park Drive, Monash Business Park, Nottigham 3168; phone (03) 558 9999.

## Toshiba to make 3.5" 1GB HDD's

Toshiba America Information Systems Inc (TAIS), based in Irvine California, is to produce a family of large capacity hard disk drives (HDDs) for high performance multi-user computer systems and workstations, at a new manufacturing facility in San Jose, California.

TAIS is responsible for the process of research, production and marketing of new products, which have been developed by a team of American engineers in response to increasing demand for large capacity disk storage devices in the US market. The first of the new MK-430's to be mass produced at the new facility will be the MK-438FB one gigabyte class 3.5" Winchester disk drive. Using 8 platters to achieve a formatted capacity of 867MB, the drive features a 12.5ms average seek time, a disk data transfer rate of up to 25Mbps, up to 512KB of cache memory and a SCSI-2 bus transfer rate of 10MB/sec.

TAIS currently has samples of the new drive at major US OEMs for evaluation and integration. Samples are priced at US\$2295.

## FIBRE OPTICS FOR VIDEO

We supply systems for:

- CCTV Surveillance and Monitoring
- Video Conferencing
- Multichannel Applications
- Broadcast

All are manufactured and supported by

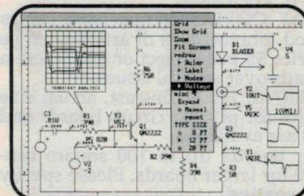
**OPTICAL  
SYSTEMS  
DESIGN**

2 /5 Vuko Place,  
Warriewood 2102  
PO Box 891 Mona Vale  
NSW Australia 2103  
Telephone: (02) 913 8540  
Facsimile: (02) 913 8735

READER INFO NO. 28

## Analog Circuit Simulation

Completely integrated CAE software from \$149



### SPICE NET

Schematic entry package for any SPICE simulator generates SPICE netlists, displays output waveforms and node voltages directly on the schematic.

ISpICE 1.41 \$149, the complete SPICE program, runs on all PC's.

ISpICE/386 \$579, The fastest PC based SPICE program available. Has virtually no memory limitations.

SPICE NET 2.0 \$443, a schematic editor for any SPICE simulator. Generates a complete Spice netlist.

INTUSCOPE 3.1 \$488, a graphics post processor that performs all the functions of a digital oscilloscope.

PRESPICE 3.0 \$413, Extensive Model libraries, Monte Carlo analysis and parameters sweeping and evaluation. - Update from version 2.1 to 3.0 \$149

A SPICE COOKBOOK + disk - NEW \$75 a collection of over 100 practical Spice examples encompassing a wide variety of disciplines - comes with disk (mac & PC versions)

Free 6 month Intusoft News Letter Subscription - a collection of the latest simulation topics including practical modeling, Spice news and unusual applications. To qualify, fax your business card or letter head.

### ICAP/2

The Complete Solution for your Analog Circuit Simulation Needs

Schematic Entry, Component Models, SPICE Simulation, Monte Carlo Analysis and Post Processing, only \$1335 Complete

ICAP/2 includes ISpICE1.41, SPICE NET, PRESPICE, and INTUSCOPE

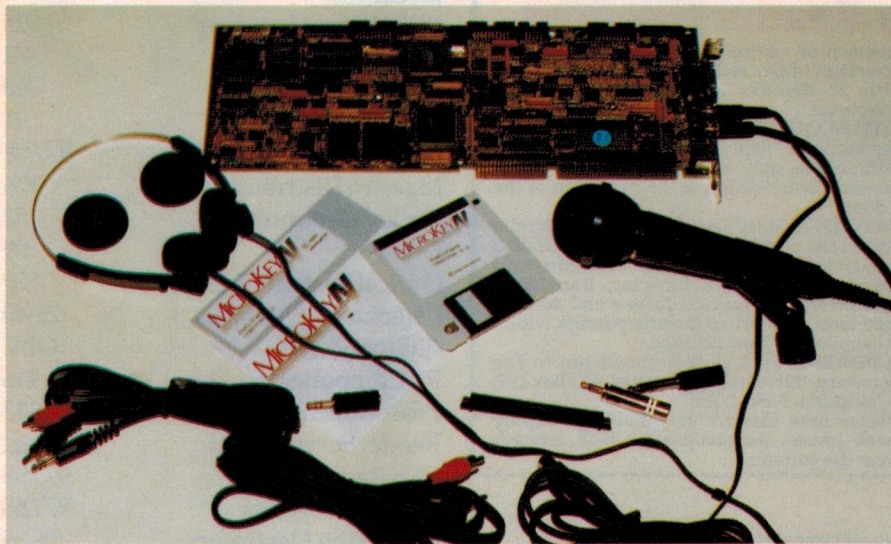
ICAP/3 - Schematic Entry, Component Models, Special 386 SPICE Simulator, Monte Carlo Analysis and Post Processing, The Most Powerful Analog Circuit Simulation Solution, only \$1771 Complete

ICAP/386 includes ISpICE/386, SPICE NET, PRESPICE, and INTUSCOPE

For detailed information, contact  
**SPEAKER TECHNOLOGIES**  
Phone 065 50 2254  
FAX 065 50 2341

**intusoft**

READER INFO NO. 29



## Audio card

The Microkey Audio Card provides audio for Harvard Graphics, Autodesk Animator, Lotus Freelance, Applause II, Microsoft Powerpoint, and in fact, any graphics package with a 'screen show' facility.

Any existing presentation can have the added dimension of audio without any programming, audio mixing or editing.

Once you have recorded your audio, simply integrate it with the presentation by assigning the audio file the same name as the graphic file you want it

to accompany. The Microkey Audio Software will then automatically link the two together, adding sound effects, music or a complete narration to your presentation.

The card requires a single 16-bit slot, and features selectable sampling rates of 8, 16 and 32kHz, thus allowing varying sound quality and corresponding hard disk consumption.

For more information circle 173 on the reader service coupon or contact Lako Vision, 1/45 Wellington Street, Windsor 3181; phone (03) 525 2788. ■







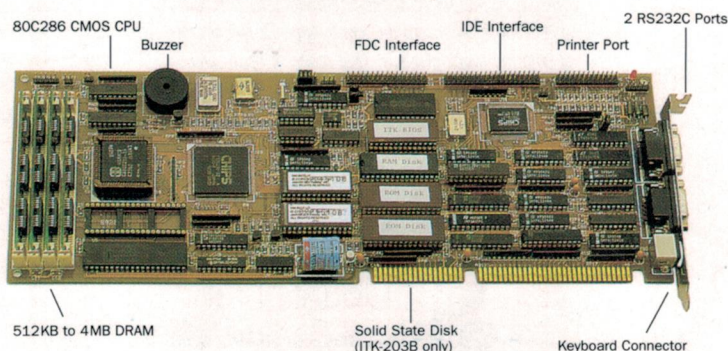
# Our range of industrial hardware is growing at extra ordinary speeds

We have the hardware you've been looking for, at the price you'll want to pay.

1

## ITK 203

Our new ITK 203 is the perfect embedded controller. It has two inbuilt Solid State disk drives which are exceptionally fast and allow operation up to 60 degrees Celsius. Drive A; is fully bootable and can hold up to 1Mb of program. Drive C; is a 128Kb battery backed Static Ram for holding of data. The ITK 203 is supplied with full documentation and all the S/W necessary to format the Solid State drives. Fully populated the ITK 203 draws less than 10 Watts.



2

## ITK 421

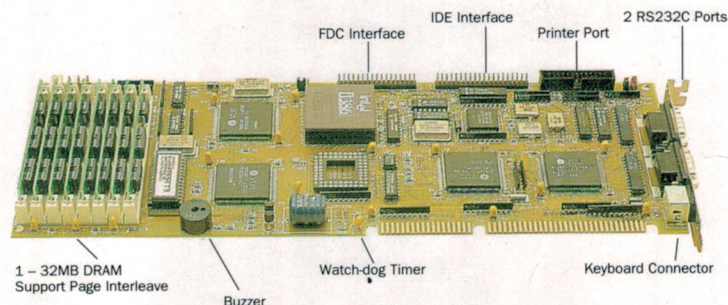
We are able to offer you the convenience of the ITK 203 as a ready to use 19 inch panel with inbuilt 9 inch VGA colour monitor. The two membrane keypads are decoded to provide a standard PC keyboard input. Add either the ITK 202 or ITK 203 for a complete industrial computer together with Solid State disk drives. Add other PC plug in boards such as data acquisition, digital I/O or Arcnet/ Ethernet – we have a good range to offer you.



3

## ITK 202

The new ITK 202 offers all the power of a full 80386DX at speeds of 25 or 33MHz but drawing less than 7.5 Watts of power and rated to 60 degrees Celsius. All normal functionality of a complete 386 machine is included on this board. A special feature is the Watchdog timer that allows for program restart should a power glitch or other problem occur. Add an ITK Solid State disk drive board if rotating media not suitable. We can supply passive backplanes from 4 to 18 slots and 19 inch and Shoe-box chassis are available.



READER INFO NO. 27

When your industry relies on fast, accurate and reliable data acquisition and process control, APC is your vital link – call your nearest APC office for further up to the minute information.

Adelaide  
Tel (08) 363 0400  
Fax (08) 363 1736

Melbourne  
Tel (03) 762 3000  
Fax (03) 761 1367

Sydney  
Tel (02) 810 2113  
Fax (02) 555 1048

Brisbane  
Tel (07) 374 2846  
Fax (07) 374 2749

Tasmania  
Tel (002) 71 8181  
Fax (002) 71 8185

**APC**

Automation & Process  
Control Services Pty Ltd



**FLUKE.**



**PHILIPS**

# Introducing ScopeMeter™

There's More Than One Reason to Reach for It

*In fact, there's every reason to reach for ScopeMeter. Because only ScopeMeter combines the expertise of Fluke and Philips to bring you a dual-channel digital scope along with everything you've come to expect from Fluke digital multimeters.*

*The result: an integrated scope-and-multimeter that lets you see a waveform and digital meter display at the same time from the same input. Or switch between high-precision Scope and Meter functions with the touch of a key. That makes it faster and easier than ever to capture, store and analyze precisely what you're looking for. At a price that looks good, too.*

*To get your hands on a ScopeMeter, contact your Philips sales office or your nearest authorized Philips/Fluke distributor.*



**Built to Take It**

- Completely sealed against water, dust and contaminants.
- EMI protected and measures up to 600 volts rms.
- Rugged construction with shock-resistant holster.
- Three-year warranty.

ScopeMeter  
Now there's only one to reach for

**Double Duty**

- Integrated 50 MHz digital storage scope and 3000-count (3-2/3 digit) multimeter.
- Precision Min/Max Record and 40 ns Glitch Capture make it easy to troubleshoot intermittent failures.
- Simultaneous waveform and digital display on a backlit screen you can read across the room.

- Runs on rechargeable NiCad Batteries, standard C-cells or the included line voltage adapter/battery charger.
- Adjustable tilt-stand comes in handy as a hanger, too.
- Compatible with a wide range of multimeter and scope accessories.

**Simply Easy**

- Intuitive front panel layout for simple, straightforward operation.
- Pop-up menus and five function keys for easy control.
- Autoset key automatically sets voltage, time and trigger functions.

**Goes Wherever You Go**



Be No. 1 with Fluke and Philips

For further information please contact your local Philips Test & Measurement Organisation:

**SYDNEY** (02) 888 0416

**MELBOURNE** (03) 881 3666

**PERTH** (09) 277 4199

**WELLINGTON** (04) 88 9788

**BRISBANE** (07) 844 0191

**ADELAIDE** (08) 348 2888

**AUCKLAND** (09) 89 4160



Our factory is ISO-9001 certified

**PHILIPS**

READER INFO NO. 30

