

# ELECTRONICS

## Australia

March, 1970



40¢

Digital instrument for home construction. (See page 62)

THE BIPOLAR TRANSISTOR • PREPARING FOR COLOUR TV  
COMPRESSED SPEECH • SIMPLE TRANSISTOR AMPLIFIERS

# Our cassette stereo starts where the others left off

National RS255S portable. It looks innocent enough, but it's quite a little earthquake kit. For a start, it pumps out 5 watts in a way that makes it sound like far more.

It's all solid state. It's dual power, battery-AC with instant changeover. It's all pushbutton, has fast forward and rewind. It has 4 inputs, 5 outputs, 1 DIN socket and 2 mikes. Frequency response is

40—12,000 HZ. There are 2 speakers in the recorder, and 1 in each of the detachable wing units. There's a little button that lets you play or record 2-track mono if you wish. National RS255S. It's the sort of machine that can bring out your power complex in a beautiful rush. If you send the coupon, we'll send you some more to gloat over . . .



## NATIONAL



TO HACO DISTRIBUTING AGENCIES PTY. LIMITED.  
57-69 ANZAC PARADE, KENSINGTON, NSW. 2033

I must know more about the NATIONAL RS255S portable stereo cassette recorder. Send me everything free.

NAME .....

ADDRESS .....

.....POSTCODE.....

Y689



# ELECTRONICS Australia

incorporating RADIO, TELEVISION and HOBBIES

ABC certified circulation in excess of 50,000

volume 31, number 12

**DIGITAL FREQUENCY METER:** *A full description of the 200KHz version of our new low cost DFM appears on page 62. Offering high performance combined with simplified construction, it would be ideal as a tutorial project.*

**SIMPLE AMPLIFIER CIRCUITS:** *Our younger readers will be interested in the article showing how to build a variety of amplifier circuits using oddment transistors. See page 83.*

**WHAT IS SQUEECH?** *It is a device for speeding up the rate of tape playback, but without altering pitch. The ingenious mechanism with which this is achieved is described in the article beginning on page 109.*

Editorial Office:  
12th Floor, 235-243 Jones Street,  
Broadway, Sydney, Australia.  
Phone 2-0944.

Postal Address:  
Box 2728, G.P.O., Sydney, 2001, Australia.

Advertising:  
Manager, Howard Jenkins  
Sydney Representative, Bill Summons.  
Office: 8th Floor, 235-243 Jones Street,  
Broadway, Sydney. Phone 2-0944.  
Melbourne Representative, Clarrie Levy.  
Office: 392 Little Collins Street,  
Melbourne, 3000. Phone 67-8131.

Circulation:  
Alan Parker, Manager.  
Office: 9th Floor, 235-243 Jones Street,  
Broadway, Sydney. Phone 2-0944.

Subscription Rates: See back page.

Representation:  
Melbourne—John Fairfax and Sons Ltd., 392 Little Collins Street, 3000. Phone 67-8131.  
Brisbane—Sungravure Pty. Ltd., 78 Elizabeth Street, 4000. Phone 2-6688.  
Adelaide—John Fairfax and Sons Ltd., 104 Currie Street, 5000. Phone 51-3502.  
Perth—Sungravure Pty. Ltd., 454 Murray Street, 6000. Phone 21-8217.  
Newcastle, N.S.W.—Associated Newspapers Ltd., 22 Bolton Street, 2300. Phone 2-3696.  
London—John Fairfax and Sons (Aust.) Ltd., Reuter Building, 85 Fleet Street.  
New York—The Sydney Morning Herald Ltd., 1501 Broadway, New York, N.Y., 10036.

Distribution:  
Distributed in N.S.W. by Sungravure Pty. Ltd., Jones Street, Broadway, Sydney, N.S.W.; in Victoria by Sungravure Pty. Ltd., 392 Little Collins Street, Melbourne; in South Australia by Sungravure Pty. Ltd., 104 Currie Street, Adelaide; in Western Australia by Western Press; in Queensland by Gordon and Gotch (A'sia) Ltd.; in New Zealand by Truth (N.Z.) Ltd.; in Tasmania by Davies Bros. Ltd., "Mercury," Hobart.

Copyright. All rights reserved.  
Devices or arrangements shown or described herein may embody patents. Information is furnished without responsibility for its use and without prejudice to patent rights.

## CONTENTS — MARCH, 1970

### features

- 3 Editorial — new units
- 10 The forces of nature
- 15 Computer graphics in engineering design
- 18 Automatic equipment tester
- 20 Post Office prepares for colour TV
- 23 Effect of bushfires on propagation
- 25 First Australian Faraday Lecture
- 97 Electroluminescence for visual displays
- 101 TECHNITOUR to Japan EXPO '70

### technical digest

- 27 Laser altimeter as calibrating tool
- 29 Simulated accident studies
- 31 Alternative reactors for Jervis Bay

### technical articles

- 40 Communications receiver, part 3
- 52 Fundamentals of solid state, chapter 10
- 62 200KHz digital frequency meter
- 77 Shunt-regulated power supply
- 83 Simple amplifiers for younger readers

### regular features

- 33 Scientific and industrial news
- 88 Serviceman
- 91 Radio: unofficial history
- 93 Forum
- 103 Reader built it
- 109 Audio topics—more words in less time
- 112 Record reviews—classical
- 116 Record reviews—devotional, popular, jazz
- 131 Trade reviews and releases.
- 141 Technical books and publications
- 145 Amateur band news and notes
- 156 Listening around the world
- 165 Answers to correspondents
- 172 Index to volume 31
- 175 Market place—classified advertisements
- 176 Index to advertisers
- 174 Notes and errata



# Now low cost, power rectification to 25 amps!\*

with "Miniwatt" BYX21L

Series Silicon Power Diodes made in Australia

BYX21L/200  
BYX21L/200R † 100 Piv

BYX21L/400  
BYX21L/400R † 200 Piv

25 AMP

(† Reverse Polarity Version)

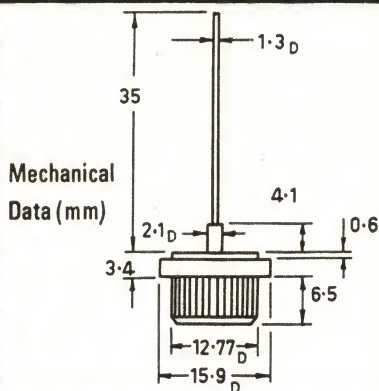

Clip

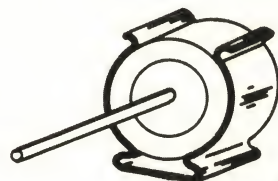

Solder

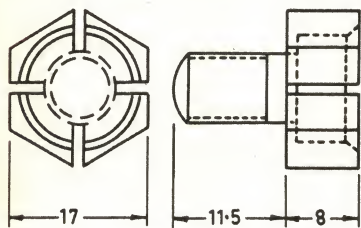
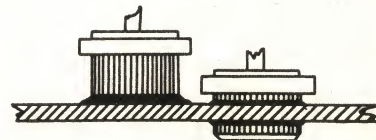

MTG Adaptor



Press

\* WITH SUITABLE HEATSINK

*"Miniwatt"*

electronics division of  
Philips Electrical Pty. Limited

Sydney • Melbourne • Brisbane •  
Adelaide • Perth • Canberra

**PHILIPS**

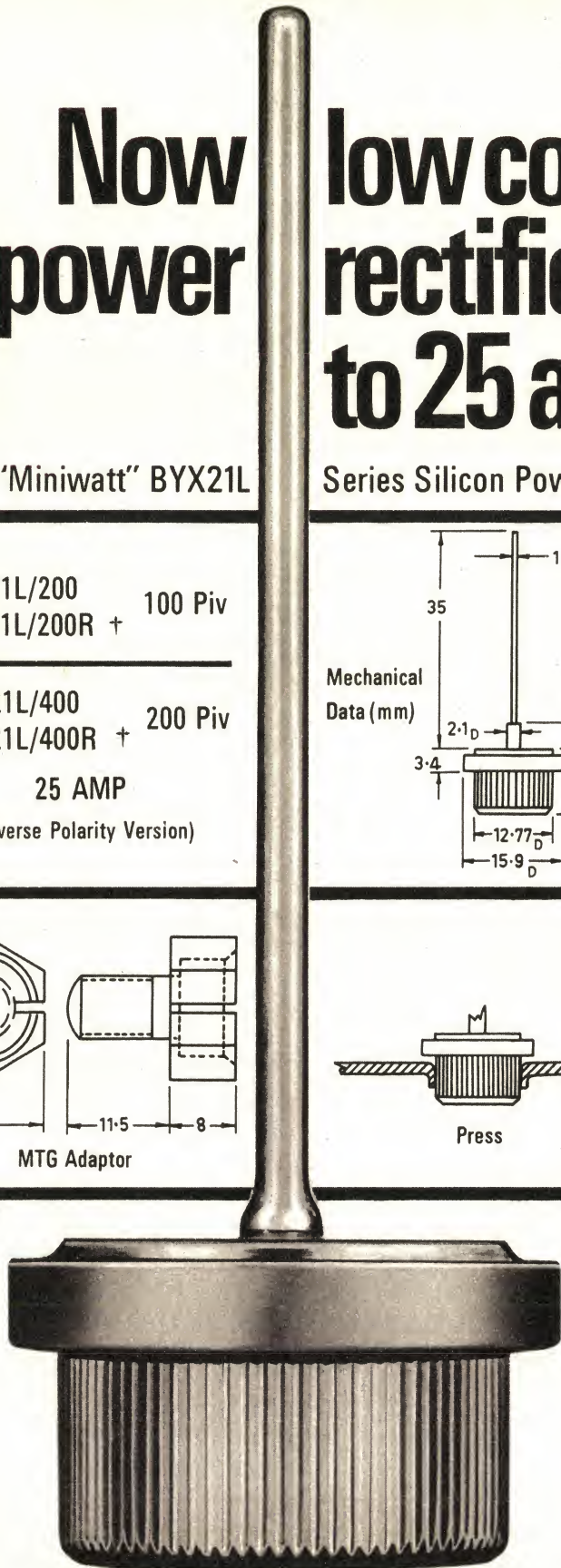



## EDITORIAL VIEWPOINT

by Neville Williams

### New units . . .

During the month, the Federal Government announced that Australia would convert to the Metric system of weights and measures during the next ten years. To the scientific and engineering community, this came as no surprise; in fact, most people involved in technical matters are quite accustomed to working in metric units.

Not unexpectedly, writers in the popular press have questioned the necessity for making the change, citing the complications and the cost of so doing: If feet, pounds and pints were good enough for our forebears, they should be good enough for us. If others prefer metres, litres and grams, that's their business — and their business entirely!

Unfortunately, it isn't as simple as that. Industrially and commercially, we are becoming progressively more involved with nations which either use the Metric System, or are in the process of adopting it. To cling to the present system and become the "odd man out" would be to impose a heavy liability on future international trade.

These matters apart, there is a lot of pressure from scientific and technological interests for rationalisation of units and standards on a world basis and adoption of the Metric System is part of this. Our present system has evolved from "standards" which were seemingly quite unrelated, one to the other, and as remote from science as the length of Henry VIII's right foot. It has since become clear that physical parameters are all fundamentally interdependent and the mathematical terms necessary to express their relationship reflect the disparity of the original units and standards.

The Metric System was born out of an attempt to rationalise standards, units, multiples and their relationship one to the other. In retrospect, it is to be lamented that the English-speaking nations saw fit to stay with the old conventions, only to be faced with the necessity for change in the 1970s.

In the intervening decades, conventions for measuring other physical quantities have been introduced, amended and rejected. This has compounded the problem so that, overall, there is a state of massive confusion in technical literature: A variety of measurement systems; different standards for the same units; different meanings for the same word; multipliers with a significance varying with context; literature ostensibly current but nevertheless obsolete.

To try to build a new, rational system around our present foot-pound-gallon and the other oddly related quantities would be plainly ridiculous. It would be equally ridiculous to envisage a dual system, with internationally recognised units for all scientific, engineering and technical applications (this of necessity) and traditional units for buying household needs.

I should hope that not too many of our readers will be found chanting: "I hate metres!"

### On the cover

*A view of the low frequency version of our new Digital Frequency Meter project, whose description appears in this issue (page 62). Developed by Technical Editor Jim Rowe, it combines up-to-the-minute circuitry and operating flexibility with straightforward construction and low cost. Spread before the instrument in the picture are some of the components which have made it possible: printed boards, integrated microcircuits, transistors and readout tubes.*

#### EDITOR

Neville Williams  
M.I.R.E.E. (Aust.)  
(VK2XV)

#### ASSISTANT EDITOR

Philip Watson  
A.M.I.R.E.E. (Aust.)  
(VK2ZPW)

#### TECHNICAL EDITOR

Jamieson Rowe  
B.A. (Sydney), B.Sc.  
(Technology, N.S.W.)  
M.I.R.E.E. (Aust.)  
(VK2ZLO)

#### TECHNICAL STAFF

Ian Pogson (VK2AZN)  
Harry Tyrer (VK2ZHH)  
Anthony Leo (VK2ZHK)  
John Horsfield  
Robert Flynn  
Leo Simpson  
Alan Nutt

ON SALE  
THE  
FIRST MONDAY  
OF EACH MONTH

# INSTROL HI-FI

the largest HI-FI showroom in Australia.

Proud  
to present  
the new

## Dual

## CTG 28

tape deck

### SPECIAL FEATURES:

1. Two tape speeds,  $7\frac{1}{2}$  ips and  $3\frac{1}{2}$  ips.
2. Brakes controlled by feeler lever directly from tape, providing constant tape tension and highest tape protection.
3. Four-digit tape index counter with instant-reset button.
4. Tape-end shut-off controlled by feeler lever.
5. Push-button control with mechanical interlock device, preventing errors in operation.
6. Dual stereo tapehead with hyperbolic contours, providing very good tapehead contact, necessary for drop-out-free playback.
7. Multi-play by direct switch.
8. Two level controls for individual or coupled stereo level selection.
9. Instant-stop button ("pause").
10. Recording-mode pilot light.
11. Two illuminated VU meters.
12. Two mixing inputs with microphone sensitivity for mono recordings.

### MODERN ENGINEERING:

The CTG 28 is built to four-track standards in accordance with the newest developments in magnetic sound recording.

Besides playback of prerecorded tapes, recordings in mono, stereo, and multi-play can be made. With hyperbolic contour tapeheads, modern silicon transistors in the electronic circuits and many other advanced features, optimum recording and playback quality are guaranteed. The newly developed tape drive is

Dual, the name synonymous with first class hi-fidelity turntables, now have produced the CTG 28 tape deck . . . a deck that is first class in styling and performance.

Featuring a natural walnut case with dust cover, Instrol are proud to display this deck, together with all other new Dual hi-fi equipment at their spacious showroom. The largest Dual display ever seen—at Instrol during March.

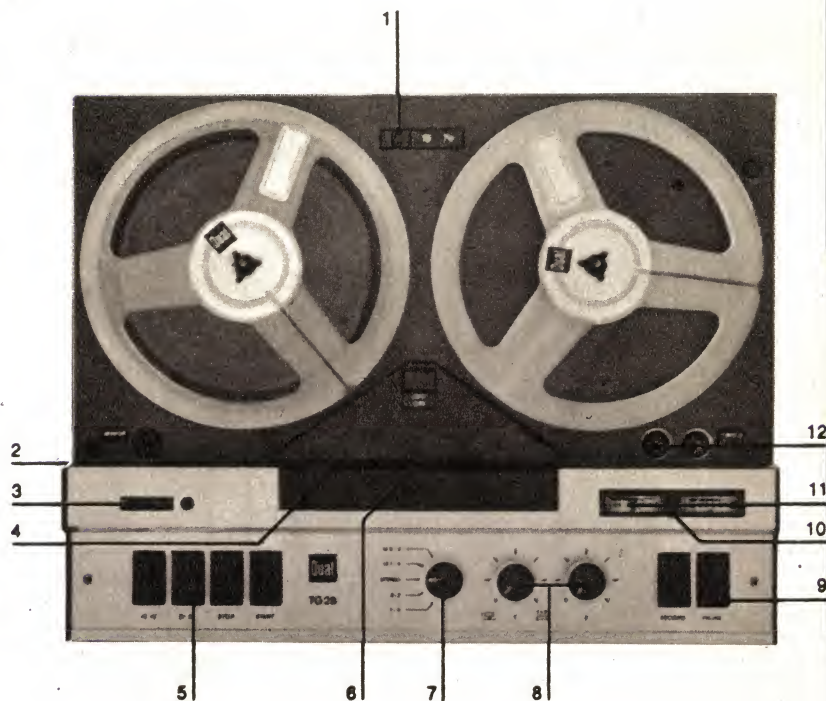

extraordinarily easy on tapes with the brakes controlled by feeler levers sensitive to tape tension. The unit operates on two speeds —  $7\frac{1}{2}$  ips for high-fidelity requirements and  $3\frac{1}{2}$  ips for less demanding requirements. Tape reels up to 7in diameter can be used. The electronics consist of a combination two-channel recording/playback pre-amplifier on printed circuits.

### FACILITIES FOR CONNECTIONS:

Amplifier, radio, record-player, mono and stereo microphones, headphones and tape recorder. Also auxiliary items such as slide synchronizer, telephone adapter and home movie sound coupler may be used. Microphone and headphone jacks are easily accessible on the front of the chassis.

# CENTRE

91a York St. (between King & Market St.)

## Easy to Assemble

### INSTROL CABINET KITS

MAKE YOUR OWN HI-FI FURNITURE FOR LITTLE MORE THAN HALF THE COST



**FREE**

**INSTROL CABINET CATALOGUE**

Post coupon, call, or phone for free fully illustrated Instrol hi-fi cabinet brochure. It includes full specifications and down to earth price details of all Instrol cabinet designs. (If writing please include postage stamp.)

Each kit is complete with all necessary timber parts, plus nails, screws, full, easy to follow instructions. Speaker enclosure kits are complete with acoustic inner-bond lining felt, and acoustic grille cloth. Equipment cabinet kits include hinges, knobs, catches, sliding stays, castors, slides, leg sets, etc. All timber parts precision cut, fit together smoothly . . . panels are best quality veneered in selected Teak or Queensland Maple. Instrol cabinet designs will cater for virtually any make of speaker, player, amplifier, and tapedeck. If required, all designs are available ready built and polished, but it's highly economical and much more fun to make your own.



**OUTSTANDING VALUE.** Combined amplifier/player cabinet. Model 75. Complete with friction stay-up perspex cover. Available kit of parts or built and polished.

**PRICE**

Kit of Parts, Teak . . . . .	\$28.50
Qld. Maple . . . . .	\$25.00
Built and Polished, Teak . . . . .	\$41.50
Qld. Maple or Walnut . . . . .	\$37.00

So easy, a child can manage it. The Instrol way — a new simplified method of assembly. A hammer, screwdriver, few hours of your time, and you can make for yourself a complete high quality hi-fi cabinet setting, fully professional in appearance.

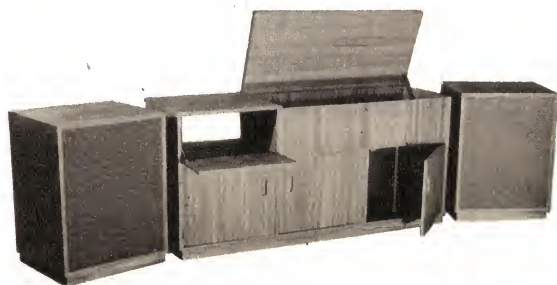

## INSTROL HI-FI CENTRE

91a York St. (between King & Market St.)  
SYDNEY, 2000

(opposite Rank Xerox Building)  
Phone 29-4258

for descriptive leaflet post coupon

Please include postage stamp.

Name \_\_\_\_\_

Address \_\_\_\_\_

Postcode \_\_\_\_\_

Instrol Cabinets       Hi-Fi Equipment

# ALMA MICROPHONES

**DM78:** Exceptional quality cardioid uni-directional dynamic microphone, for use in all stage and recordings, superb directional characteristics magnificently presented in its own black and red lined carrying case. Impedances: 50K and 600 $\Omega$  (switchable); Output Level: -75 db; Response: 30 CPS - 18 KCS; Cardioid (uni-directional); Weight: 13 ozs; Dimensions: 7 $\frac{1}{2}$ " x 2 $\frac{1}{4}$ "; Case: Black abs plastic, with gold plated wire mesh black fly-off cradle with gold plated fittings. On/off switch. 20 ft lead. List Price: \$76.00.

**NOTE**

\* 6 ft Florentine Bronze Floor stand with gold plated extension and locking height adj. available, for use with above model.

**DM47:** Highly efficient, cardioid, uni-directional dynamic microphone with excellent characteristics especially designed for all stage and recording use. Impedances 50K or 600 $\Omega$  or 50 $\Omega$ ; Output Level: -73db; Response: 40 CPS - 18 KCS; Cardioid (uni-directional); Dimensions: 5 $\frac{1}{2}$ " x 1 $\frac{3}{8}$ "; Weight: 18 ozs (incl. lead); Case: Black zinc diecast with chrome facings with on/off slide switch 20 ft lead; List Price: \$36.00.

**DM67:** Superb quality, cardioid uni-directional dynamic microphone, stable performance designed for stage and recordings. Impedances: 50K or 600 $\Omega$  or 50 $\Omega$ ; Output Level: -73db; Response: 40 CPS - 18 KCS; Cardioid (uni-directional); Dimensions: 5 $\frac{1}{2}$ " x 1 $\frac{3}{8}$ "; Weight: 7 $\frac{1}{2}$  ozs; Case: Precision moulded, aluminite zinc diecast, with satin chrome facings. Fly-off cradle, 20 ft lead, on/off switch. List Price: \$33.00.



DISTRIBUTED BY  
**GOLDRING**  
ENGINEERING  
(A'ASIA) PTY. LTD.

NEW SOUTH WALES  
443 Kent Street Sydney 2000 Tel 295802  
VICTORIA  
162 Pelham Street Carlton Victoria 3053 Tel 345105  
QUEENSLAND  
415 Adelaide Street Brisbane Queensland 4000 Tel 23247  
WESTERN AUSTRALIA  
32 Northwood St Leederville Western Australia 6007 Tel 84988  
SOUTH AUSTRALIA  
77 Wright Street Adelaide 5000 Tel 51-5117

GE:P548



# read what the experts have to say about the GOLDRING LENCO GL75

## PERCY WILSON

Manufactured by Goldring Manufacturing Company (GB) Ltd., 486-488 High Road, Leytonstone, London E11. Manufacturer's specifications: TURNTABLE: AC mains: 200/240 V. 50Hz. Mains switch fully click suppressed 4-pole constant velocity motor (15 VA). Continuously variable speed adjustment. Adjustable stops for 16, 33 1/3, 45 and 78 rpm. 9 lb. non-magnetic dynamically balanced turntable. Wow and flutter measured, according to DIN spec., 0.05%. Rumble measured, according to DIN spec., -60db. Speed variations  $\pm$  0.2% for 10% mains voltage change. Automatic disengagement of idler wheel. Dimensions: front to back: 13in. Side to side: 15 in. TRANSCRIPTION ARM: Pickup arm with counter-balance weight and bias compensation (anti-skating) adjustment. Knife-edge bearings. Stylus pressure adjustable from 0.5 to 5 grams., with sliding weight. Minimum stylus pressure 0.5 gram. Removable lightweight pickup headshell. Total length of pickup arm: 12.4 in. Tracking length (distance from pedestal to centre of turntable) 8.3 in. Overhang of stylus 0.675 in. Total adjustment for stylus position: 1/8 in. Offset angle: 23° 12'. Tracking error  $\pm$  0.8°. Can accommodate any cartridge. Hydraulic lowering device.

I have now had one of these transcription units on test for over six months; and some of my professional colleagues have made independent assessments which agree with mine. So, let me not beat about the bush, but declare my verdict straight away. This is, quite simply, that the GL75 is easily the best integrated turntable arm unit that the partnership between Goldring have yet produced.

This is, of course, a mouthful, for Goldring's products have long been known in the front rank. I have no hesitation in declaring that the GL75 is reckoned with in any company's circumstances, anywhere in the world. Having made that confession of not merely of faith, I must justify it by stating the results of my tests. In this I shall not just describe but give a clear and concise description that can be gleefully used in any specifications. I shall only comment on the performance.

First of all, I must refer to the features. This is the continuous variation of turntable speed and others who have perfect pitch, this is another turntable I know. It is secured by having a wheel which travels over the turntable. This idler wheel on a horizontal axis and its movement is such that it does not affect the motor's operation. It is a hasty and wrong conception of design in which the idler wheel is angled to the turntable rather than a design in which the idler wheel is parallel to the turntable.

In my tests I mounted the motor plate on stilts, as it were, above a rather thin motor board, which would resonate quite easily. I found the possibility of rumble all right, but I also found that the makers' recommendations had indicated the answer. In the first place, the motor plate must be mounted, as specified, on a motor board at least 3/4 inch thick. Do not on any account go below 3/4 inch. If the motor board in your cabinet is slimmer than this, then stick a sheet of Celotex to it so as to damp out any natural resonance. When suitable precautions are taken in mounting; such as the makers specify, the possibility of rumble is avoided. I have enlarged in this report on this possibility, because of the special vulnerability in a vertical drive as compared with a horizontal one; and to make it clear that the makers have safeguarded the position in their mounting instructions.

The second precaution to be taken, and this is vital, is that the motor should always be switched off and on at the switch on the motor plate and never at an independent switch. Otherwise the idler driving wheel would be left in contact with the turntable, and a tiny flat may be created on the rubber driving rim. In order to have accurate control of the turntable speed this rim has to

*Hi-Fi News*, February, 1969. Frank Jones

## MANUFACTURER'S SPECIFICATION.

Precision engineered transcription motor and arm. Turntable: Die-cast non-magnetic alloy dynamically balanced. Diameter: 12 1/2 in. Weight: 8-8 lb. Speeds: Infinitely variable between 30 and 36 r.p.m.; click-in stops for standard speeds including 16 2/3 r.p.m. Wow and flutter: 0.05% (DIN specification). Rumble: -60 dB. Speed stability: Within 0.2% for a 10% change in mains voltage; within 0.3% for pickup playing at 6 gm. Lowering device: hydraulic. PICKUP ARM: Lightweight type with decoupled counterweight and separate playing weight counterbalance. Stylus pressure: Infinitely variable between 0.5 gm, calibrated at 1 gm intervals. Total length: 12.4 in. Effective length: 8.3 in. Overhang: 0.675 in, adjustable up to 1/4 in. at the headshell. Offset angle: 23° 12'. Tracking error:  $\pm$  0.8°. Height: Adjustable. Dimensions: 15 x 13 x 2 1/2 in. (above baseplate) x 3 in. (below). Weight: 18.7 lb. GL75/P, on plinth with Perspex lid, as in photo.

Manufacturers: Goldring Manufacturing Co. Ltd., 486-488 High Road, London E.11



Despite its up-to-the-minute appearance the Goldring Lenco GL75 is the latest in a long line of turntables and playing desks from which started, as far as I can see, with the GL56—the first turntable reviewed in *Hi-Fi News* and basically the same as this machine. Since then we have seen an improved pickup arm and a more sensible layout (the GL56 had the pickup under the pickup in its own housing for some strange reason), a more massive turntable in its own housing with another, improved, motor and now the GL75 with its distinctive styling and a fine finish to go with it.

One of all these units is the motor and the unique drive mechanism. It has been reviewed on many pages, but many of the requirements for the layout of the motor requirements, so that the points will do no

supported by a robust motor mounted between the motor and the motor to isolate it from the motor. This motor is the most precise part of the unit, and runs so



DISTRIBUTED BY  
**GOLDRING**  
ENGINEERING (A'ASIA) PTY LTD

NSW 443 Kent St Sydney 2000 Tel 295802  
VIC 162 Pelham St Carlton 3053 Tel 345105  
QLD 415 Adelaide St Brisbane 4000 Tel 23247  
WA 32 Northwood St Leederville 6007 Tel 84988  
SA 77 Wright St Adelaide 5000 Tel 515117

SEND COUPON FOR FULL REVIEWS  
to 443 Kent Street Sydney 2000 Telephone 29 58 02

NAME .....

ADDRESS .....

POSTCODE .....

GE:P549

# A New Member of KENWOOD's Powerful



## 120-WATT SOLID STATE STEREO AMPLIFIER KA-4000

Introducing KENWOOD's KA-4000, the solid state stereo amplifier that's the right answer for your Hi-Fi problems. Here's 120 watts of IHF standard total music power—a power-packed instrument that's up to the most severe stereo task. Wide power bandwidth is another outstanding feature with 13 Hz to 30,000 Hz range. IM distortion is almost totally eliminated. The KA-4000 offers momentary silence with a lever type -20 dB quick response muting switch. This amazing stereo advance is further equipped with 2 dB step type tone controls and lever type high and low filter switches. The KA-4000 also has a blue light indicator for input selector switch. If you desire even more total stereo power, another member of the KENWOOD family, the KA-6000 has a booming 180 watts. If you need less power, KENWOOD's diversified range of instruments offers an amplifier with the output you need.



### BOOKSHELF TYPE 4-WAY 5 SPEAKER SYSTEM KL-60

- \* Mounted speakers: 12-inch, free-edge woofer · 1 (Bass)
- 6½ inch cone squawker · 1 (lower midrange)
- 4 inch cone squawker · 1 (higher midrange)
- Horn-type tweeter · 2 (Treble)
- \* Dimensions: 15"(W), 25½"(H), 11¼"(D).



### 40-WATT SOLID STATE STEREO AMPLIFIER TK-150U

- \* 5 pairs of input terminals for MAG, AUX 1, AUX 2, TAPE REC and TAPE PLAY.
- \* Damping factor: 40 (at 16 ohms), 20 (at 8 ohms)
- \* Dimensions: 10½"(W), 4¾"(H), 9¾"(D).



### 60-WATT SOLID STATE STEREO AMPLIFIER TK-25

- \* 2 sets of stereo speaker terminals and front panel speaker selector switch.
- \* Dimensions: 13"(W), 4¾"(H), 9¾"(D).

# Stereo Family



## 180-WATT SOLID STATE STEREO AMPLIFIER KA-6000

### Special Features of KA-6000

- \* Wide power bandwidth of 10Hz to 50,000Hz with very low IM distortion.
- \* Exclusive Low Level Phono Inputs for the Low Level Output Cartridges, the output of which is 2mV, 0.5mV, or 0.05mV.
- \* 2 pairs of MAG Input Terminals for 2 sets of record players.

*the sound approach to quality*



**KENWOOD**  
TRIO ELECTRONICS, INC.

6-5-1 CHOME, SHIBUYA, SHIBUYA-KU, TOKYO, JAPAN

*Sole Agent in Australia:* Jacoby, Mitchell & Co., Pty., Ltd. : Head office: 469-475 Kent Street, Sydney Tel: 26-2651 Melbourne: 15 Abbotsford Street Tel: 30-2491 Brisbane: 56 Edward Street Tel: 2-6467 Adelaide: 652 South Road, Glandore Tel: 53-6117 Perth: United Australia Co., Pty., Ltd. 435 Hay Street, Subiaco Tel: 8-4665 Tasmania: K. W. McCulloch Pty., Ltd. 57 George Street, Lounceston Tel: 25-322 Newcastle: Edmunds Moir & Co., Pty., Ltd. 18 Wood Street Tel: 61-4991  
*Distributor in New Zealand:* JOHN GILBERT & CO Tasman Buildings Anzac Ave Auckland C I

Ask for a catalogue or demonstration by your nearest dealer.



### 30-WATT FET SOLID STATE AM/FM STEREO RECEIVER TK-20U

- \* F.E.T. (Field Effect Transistor) 3 Gang Tuning Condenser frontend for superior sensitivity, image rejection and cross modulation ratio.
- \* Dimensions: 14 1/2" (W), 4 3/4" (H), 11 3/4" (D).

To: Jacoby Mitchell & Co., Pty., Ltd. EA  
469-475 Kent St., Sydney.

Send me information on KENWOOD RECEIVER, AMPLIFIERS, SPEAKERS & name of nearest KENWOOD retailer,

NAME: \_\_\_\_\_ AGE: \_\_\_\_\_

ADDRESS: \_\_\_\_\_



A massive solar flare, 160,000 miles high.

Physicists recognise four natural forces—gravitational, electrostatic, magnetic and nuclear. While the exact nature of these forces is still not fully understood, modern research has uncovered clues which may eventually explain the mutual attraction or repulsion which results.

by L. C. Debnam

One of the first things that any animal becomes aware of in life is the motion of objects. Man, as an animal, is able to perceive motion almost from the first instant his eyes are open, even before the shapes of objects become apparent. A moving object is easier to see than a stationary object and many animals instinctively remain motionless when they sense danger until either the danger has passed or they know that they have been detected.

Studies of the sciences have been aided throughout history by motion. The planets would not have been discovered by early man if they did not move with respect to the background of fixed stars, and subatomic particles, such as electrons, would be undetectable if they did not move.

Greek philosophers of the sixth to second centuries B.C. studied many of the abstract sciences to try to determine the logic behind the operations of nature. In their studies of motion they concluded that motion could be divided into two different types, "natural" motion and "unnatural" motion. Natural motion, i.e., motion due to nature, consisted of motion toward the Earth, as this required no effort on the part of man. Unnatural motion was motion in directions other than downward, as man had to supply effort to move an object or to keep it moving in these directions. Some idea of the concept of friction appears in their writings, as horizontal motion through the air was considered more natural than horizontal motion along the ground.

For nearly 2,000 years after the time of Aristotle (384-322 B.C.) the concepts of natural and unnatural motion were the only accepted scientific "explanations" of motion. Then, in 1687, Sir Isaac Newton published his now famous three "laws of motion" which may be applied to all motion. The most important of these laws was the first because it introduced a new concept into the ideas of motion. This may be freely translated from the original Latin to the form:

"An object will not change its motion unless it is acted upon by a force."

The second law of motion is the most useful, because it relates force to

mass and acceleration, and may be applied to the solution of practical problems, but the first law combined natural and unnatural motion into the single concept of motion and at the same time resolved problems of friction, effort (in the Greek meaning of the word) and the combined "natural-unnatural" motions.

To explain the "natural" motion of objects, these laws require that the Earth exert a force on all other objects so that such things are accelerated toward the ground; to determine this force, Newton's attention was directed to the Moon. The distance to the Moon was known to be about 250,000 miles (384,000 kilometres) and it moved in a circular path around the Earth once every 28 days, which meant that it moved around the Earth at a speed of about 2,300 miles per hour (3,650KM/hr). By the first law of motion the Moon would continue past the Earth in a straight line at its speed of 3,650KM/hr unless a force acted continuously to change its direction of motion and cause it to move in a circle. (When an object moves in a circle its direction of motion is continuously changing.)

Newton was able to determine that such a force would act toward the Earth and, by comparison with the gravitational acceleration of bodies near the surface of the Earth, he formulated the "Law of Universal Gravitation" which may be expressed as

$$F = G \frac{m_1 m_2}{r^2} \quad [1]$$

where F is the force of attraction between two bodies of masses  $m_1$  and  $m_2$  separated by a distance r. G is a constant known as the "Universal Gravitational Constant." With the aid of this equation the gravitational attraction between any two objects in the universe may be determined. As may be seen from this equation the more massive the bodies the greater is the attraction and the larger the separation distance the smaller is the attraction.

Gravitation is an attractive force which acts toward the centre of mass ("centre of gravity") of an object. The

force acts equally on both objects involved. In the case of the Earth and the Moon the Earth is attracted toward the Moon with as much force as the Moon is attracted toward the Earth. The movement of the Earth is not as great as the movement of the Moon because the Earth is more massive than the Moon, but this force causes the Earth to have a monthly 6,000-mile "wobble" or perturbation in its orbit around the Sun. A readily observable effect of the Moon's gravitational attraction on the Earth is the existence of ocean tides in which the waters are attracted toward the Moon and a lesser known effect is the "ground tide" in which the Earth itself is distorted about 9 inches (23cm) in a regular cycle with the ocean tides.

The Earth moves around the Sun in the same way that the Moon moves around the Earth. As the Sun is much more massive than the Earth, the Earth introduces only a small perturbation of about 560 miles (900KM) per year in the Sun. The most massive planet, Jupiter, introduces a perturbation of 1,970,000 miles (3 million KM) each 12 Earth years.



Sir Isaac Newton's laws of motion led directly to the formulation of the gravity theory.

# OF NATURE

During the preparation for the "Apollo" moon-landings, both manned and unmanned satellites were set into orbit about the moon. It was found that these Lunar Orbiter Satellites did not move at constant speeds in their orbits but travelled faster than they should have done in certain places, mainly over the comparatively flat "seas." Such perturbations in the satellite orbits indicate that generally under the "seas" are high mass concentrations, possibly — but not necessarily — deposits of heavy metals of meteoric origin.

The gravitational attraction of large masses has occasionally hindered Earth surveys. In surveying, a plumb-line is used to determine a vertical line. In most cases, the weight on the plumb line is attracted toward the centre of the Earth, thus the line points toward the Earth's centre. However, in India, the large mass of the Himalayan mountain chain is sufficient to pull a plumb-line away from the vertical and much of India and Pakistan is not properly surveyed. This phenomenon has been used to determine the positions of deposits of heavy metals in the ground.

The second natural force, static electricity, was a phenomenon of nature known to the Ancient Greeks. The earliest recorded observations are those made by Thales of Miletus (one of the original "seven sages") about 600 B.C. He noticed that when amber was rubbed with fur it would attract small pieces of chaff and straw. Systematic studies of this phenomenon were not made until about A.D. 1580 when William Gilbert, court physician to Queen Elizabeth I, performed experiments on this attractive force and published his results in a book entitled *De Magnete*. He named the phenomenon electricity from the Greek word *electron* (amber). About A.D. 1650, Otto Von Guericke, Burgomaster of Magdeburg, discovered that there was sometimes a force of re-

pulsion between electrified bodies. He proposed that there were two types of electricity, "resinous" and "vitreous."

In 1747 Benjamin Franklin introduced the terms "positive" (for vitreous) and "negative" (for resinous) electricity. Von Guericke had discovered that electric charges of different types attract each other, whereas electric charges of the same type repel each other.

In 1785 Charles Augustin Coulomb published the law of electric attraction and repulsion which bears his name. In modern terminology Coulomb's law is expressed as

$$F = \frac{1}{4\pi \epsilon_0} \frac{q_1 q_2}{r^2} \quad [2]$$

where  $F$  is the force of attraction or repulsion between two bodies with electric charges  $q_1$  and  $q_2$  separated by a distance  $r$  in a vacuum.  $\epsilon_0$  is a constant known as the permittivity of free space.

Although this law was first published by Coulomb it appears that Joseph Priestley and Henry Cavendish — British scientists — were aware of it before Coulomb.

The force given by equation [2] acts along a straight line between the two charges.

The importance of static electricity mainly lay in its development of "Dynamic electricity" until near the end of the 19th Century. At that time many scientists were investigating the properties of electrical discharges in gases — the forerunner to the modern fluorescent lamps and neon discharge lighting systems — and some of these noticed that when there was almost no gas in the discharge tube the end opposite the cathode sometimes glowed. This glow could be enhanced by coating the inside of the tube with zinc sulphide. This glow was presumed to be caused by "rays" emanating from the cathode and travelling in straight lines toward the anode.

In 1897 Sir Joseph John Thomson, who was to receive the 1906 Nobel Prize in Physics for his work, successfully determined the nature of cathode rays and showed that they are extremely small particles with a negative electric charge. These small particles were named **electrons** and were considered to be parts of atoms. Thomson also discovered the existence of particles emanating from the anode which have a charge equal to the charge of an electron but positive and a mass of 1,836 times the mass of an electron. These particles were named **protons**.

An atom was then assumed to consist of protons and electrons, and in 1911 the New Zealander Ernest Rutherford showed that the protons of an atom are concentrated at the centre in a nucleus and the electrons occupy positions apart from the nucleus.

If the forces of electricity had not been known, the study of the atom would not have been possible, as almost



*Lightning over Sydney—a spectacular display of one of Nature's forces.*

all knowledge of the interior of the atom has been obtained from the forces which act on charged particles directed into atoms. Even the particles used — normally electrons and protons — would not have been detected except for the electrical forces that they exert on larger particles.

One of the most common detectors of sub-atomic and atomic charged particles is the ionisation chamber in the form of a Geiger-Muller tube. Fundamentally this consists of a metal tube with a fine wire down the centre. This tube is enclosed in a glass envelope containing a gas such as argon at a pressure of about one-eighth atmospheric pressure. The tube and wire are connected to a DC supply of about 1,000 volts with the positive of the supply on the central wire. When a charged particle passes (usually at high speed) through the tube it can — due to electrostatic forces — dislodge electrons from the atoms of argon, leaving positively charged atoms ("positive ions") and free electrons in the tube. The free electrons are attracted toward the central positive wire and the positive ions are attracted toward the negative tube with the result that a momentary current flow occurs. This current pulse can then be detected, amplified and counted by normal electronic means.

Electrostatic forces are used in cathode ray tubes to control the speed and direction of motion of the electrons which impinge on the screen. For the formation of a picture on a television screen approximately  $10^{13}$  (one million million) electrons strike the screen each second, i.e., about 65 million electrons

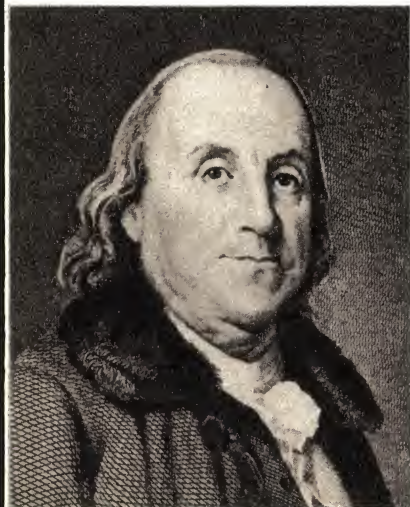

*Benjamin Franklin's early work on static electricity prepared the ground for later research.*

# your money buys more

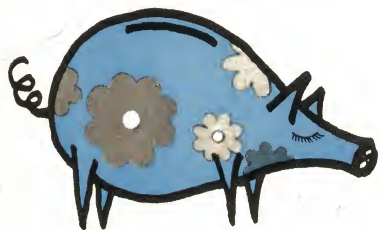

# when you choose a

## SCOPE

# soldering iron



Both irons are beautifully presented in a handy reusable plastic pouch-pack, complete with one spare tip and two spare elements.



### TRANSFORMER BY NATRONICS

Both operate on voltages from 2.5V to 6.3V A.C. or D.C. or from 240V A.C. mains through a NATRONIC Scope Transformer fitted with 6ft. 3-core flex and 3 pin mains plug.

Fully approved by electricity authorities APP. No. N/360/6894 - 5

**IRH**  
**COMPONENTS**  
 PTY. LIMITED

The Components Division of IRH Industries Limited

THE CRESCENT, KINGSGROVE, N.S.W. 2208. PHONE 50 0111 **IRH**

### INTERSTATE TELEPHONES

MELB. VIC.	489.1088	BRIS. QLD.	2.1391
HOB. TAS.	34.2811	PERTH W.A.	8.2271
LAUN. TAS.	22.844	ADEL. S.A.	23.1971

AVAILABLE FROM ALL MAJOR ELECTRICAL WHOLESALEERS AND HARDWARE STORES — THE FULL GUARANTEE APPLIES ONLY WHEN THE IRON IS USED WITH THE APPROVED 'SCOPE' TRANSFORMER. MANUFACTURED BY NATRONICS PTY. LTD.



SCOPE DELUXE



SCOPE STANDARD

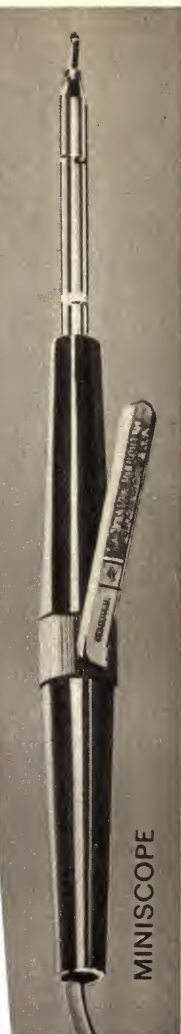

MINISCOPE

### ECONOMY

Consumes current only whilst in use. Scope De Luxe performs all the functions of other irons from 40 to 150 WATTS.

**MINISCOPE**—up to 75 WATTS.

### LABOUR SAVING

Fast warm-up — always ready, cuts wiping, retinning and filing of tips to a MINIMUM.

### VERSATILITY

Copes with all soldering jobs— from miniature components to large solder lugs. Can even be operated from a 6 volt car battery

### CONTROL

Temperature control at your finger tips. Heat only when, where and as much as needed.

### CONVENIENCE

Ideal for those almost inaccessible spots. No burning of adjacent insulation.

### SPEED

ONLY 5 to 6 seconds' initial heating up time from cold, then practically instantaneous.

### MINI WEIGHT

Scope De Luxe weighs only 3½ ozs. complete. Miniscope 1½

### GUARANTEE

Fully guaranteed with time tested dependability.

### SAFETY

Low voltage operation. Heat sensitive components protected.

### LESS MAINTENANCE

Longer tip life. NO expensive heating elements to replace. Maintenance without special tools. Spare tips and elements readily available from your Scope Distributor.

VOTED FIRST BY A HOST OF SATISFIED USERS.

Please Post — free illustrated SCOPE literature

NAME \_\_\_\_\_  
 ADDRESS \_\_\_\_\_  
 CITY \_\_\_\_\_ POSTCODE \_\_\_\_\_

are required for the formation of one line of a television picture. Each of these electrons has been accelerated from zero speed to about one-fifth of the speed of light (70,000KM or 44,000 miles per second) over the short distance of 14 inches (36 cm) in less than one-tenth of a picosecond by electrostatic forces. Such acceleration is impossible with gravitational forces or any man-made mechanical forces.

The third force of nature, known to man many centuries ago, is magnetic force. Fragments of magnetite (natural iron oxide) found near the ancient city of Magnes (the modern Manissa, near Smyrna) were found to point in a particular direction if freely suspended. As early as A.D. 120 it was known to the Chinese that an iron rod could be magnetised by rubbing it with magnetite. In the 12th century A.D., Alexander Neckham described a pivoted iron needle that was carried on ships to plot a course.

William Gilbert was the first to systematically study magnetism, as well as electricity, but he found no connection between the two phenomena although he did find that "like poles repel and unlike attract." Before Newtons time it was sometimes considered that gravity was a magnetic effect — but this raised the problem of non-magnetic materials being bound by gravity.

Although suggestions were made that electricity and magnetism might be related, it was not until 1818 that this was proven, when the Danish scientist Hans Christian Oersted observed that a compass needle was deflected when placed near a wire carrying an electric current. Twelve years later Michael Faraday and Joseph Henry independently discovered that movement of a magnet near a conductor produced an electric current in the conductor.

In 1820 Jean Baptiste Biot and Felix Savart measured the force between two current-carrying conductors and the equation for this force in a vacuum may be expressed in modern terminology by

$$F = \frac{\mu_0}{2\pi} \frac{I_1 I_2 \ell}{r} \quad [3]$$

where F is the force between two conductors of the length  $\ell$  separated by a distance r, carrying currents of  $I_1$  and  $I_2$  respectively. The constant  $\mu_0$  is known as the permeability of free space. This equation differs from equations [1] and [2] in two important respects. The first is that the source of magnetism (the currents) cannot be regarded as points, and the second is that the separation distance (r) is not squared in equation [3] so that magnetic forces may be detected over greater distances than electrostatic or gravitational forces.

If the old idea of "pole strength" for magnetic forces of permanent magnets is used however, where a "pole" is simply the collection of magnetic forces to a point source, equation [3] could be expressed in the form

$$F = K \frac{P_1 P_2}{r^2} \quad [4]$$

where K is a constant and  $P_1$  and  $P_2$  are two pole strengths separated by a distance r. This equation is very similar to equations [1] and [2].

## Some useful data

To compare the electrostatic and gravitational forces in the nucleus of a helium atom the following information is required.

mass of proton	$1.67 \times 10^{-27}$ kilogram
charge of proton	$1.6 \times 10^{-19}$ coulomb
diameter of nucleus	$2.4 \times 10^{-16}$ metre
$E_0$	$8.85 \times 10^{-12}$ coulomb <sup>2</sup> /(newton-metre <sup>2</sup> )
G	$6.67 \times 10^{-11}$ newton-metre <sup>2</sup> /kilogram <sup>2</sup>

The gravitational force of attraction between two protons in a helium nucleus is, by equation [1]

$$F = \frac{6.67 \times 10^{-11} \times 1.67 \times 10^{-27} \times 1.67 \times 10^{-27}}{2.4 \times 10^{-16} \times 2.4 \times 10^{-16}} \text{ newtons}$$

$$= 3.2 \times 10^{-33} \text{ newtons of force.}$$

The electrostatic repulsion is given by equation [2] as

$$F = \frac{1}{4\pi \times 8.85 \times 10^{-12}} \frac{1.6 \times 10^{-19} \times 1.6 \times 10^{-19}}{2.4 \times 10^{-16} \times 2.4 \times 10^{-16}} \text{ newtons}$$

$$= 4000 \text{ newtons of force.}$$

thus the electrostatic force of repulsion is about  $10^{36}$  times as great as the gravitational attraction.

One newton is approximately equal to the downward force exerted by 40z at the surface of the Earth.

Magnetic forces are now known to be caused by electric currents — even the "permanent" magnets obtaining their forces from inter-atomic currents. Although at first sight natural magnetic forces may appear to be very weak — as suggested by the Earth's magnetic field which has far less effect than gravitation — some natural magnetic forces are extremely powerful. Some of the most powerful natural magnetic forces observed have occurred on the Sun, which is composed of fast moving (high temperature) hydrogen and helium atoms. At the high temperature of the sun the gas atoms decompose by losing electrons to form positively charged ions, and the motions of such charged particles constitute electric currents which form gigantic magnetic fields.

These gigantic magnetic fields are thought to be the source of solar flares in which a globule of solar material some twenty thousand miles in diameter is accelerated away from the gravitational forces of the sun to a speed of seven hundred miles per second (1,000KM/sec) in less than two minutes. The energy release in such flares is a thousand million times as much as that of the atomic bomb exploded over Hiroshima in 1945.

During the International Geophysical Year of 1957-58, such flares occurred often. At one period, from late 1957 to late 1958, the Sun was observed to have two "North" poles — no "South" — existing at either of the poles. Such a phenomenon apparently occurs every eleven years, to some extent coinciding with the major sunspot and solar flare cycle, but magnetic measurements of the Sun have not been carried out for a long enough period to determine this with certainty.

It is known that throughout the galaxy, and probably the whole universe, space is not a perfect vacuum but contains between ten and one thousand atoms per cubic centimetre. Many of these atoms are ionised and are in motion, thus creating magnetic fields. These magnetic fields appear to be responsible for the spiral shape of the galaxy, which cannot be explained by gravitational forces.

Since the mid-1950s a new field of

physics — magnetohydrodynamics — has arisen from the study of charged particles and magnetic fields, and their interactions.

The fourth natural force which was unsuspected until the early years of the 20th century is nuclear force. The nucleus of an atom consists of protons and neutrons—the protons being positively charged particles and the neutrons uncharged particles. Electrons do not exist in the nucleus but are separate. The diameter of an atomic nucleus is known to be about one million millionth of an inch, so that this would be the greatest separation distance of the two protons in the nucleus of a helium atom. (For other atoms the separation distance would have to be less.)

By using this separation distance as r in equation (2), and the charge of each proton, the electrostatic repulsion force may be determined. As both protons are positively charged, the nucleus tends to break into separate protons. The mass of a proton is known, and as this is extremely small, it may be imagined that the gravitational attraction between protons is small—but the separation force due to electrostatic repulsion is about one-half ton. (See the data above for the mathematics of this calculation.) Consideration of these forces led to the belief in the existence of a short range "nuclear force" which would be required to hold the nucleus together against the electrostatic repulsion force.

To date no general equation such as the equations for gravitational, electrostatic and magnetic forces has been developed for the nuclear forces but the energy required to hold the nuclear particles together is generally considered to be obtained from a mass deficiency. This mass deficiency is a measurable quantity of most atomic nuclei and may be determined by adding the masses of the individual nuclear particles (protons and neutrons) of which the nucleus is composed and comparing this mass with the measured mass of the nucleus. It is found that the measured mass of the nucleus is LESS than the normal mass of the constituent particles, the difference being known as the mass deficiency. The energy can

(Continued on page 174)

# Here are the famous names in INSTRUMENTATION

*together with the standard of service to match*

A SELECTION FROM THE OUTSTANDING RANGE OF INSTRUMENTS AVAILABLE FROM JACOBY MITCHELL:

## ADVANCE



(Above) Advance OS25 Oscilloscope has vertical amplifier bandwidth from DC to 5 MHz with a max. sensitivity of 100 mV/cm on each channel. Time base gives sweep speeds from 1 sec/cm to 0.5  $\mu$ S/cm using switched and fine controls. Bright clear display on 5" helical PDA tube.

Tick for further details.



(Above) Advance TC9 Timer Counter is a 6-digit instrument capable of measuring frequencies up to 32 MHz with 0.1 Hz resolution. Freq. Measurement: 2 Hz to 32 MHz. Time Measurement: 1  $\mu$ S to 10 S in decade steps. Sensitivity: 3 position attenuator providing 10 mV, 100 mV, and 1 V RMS.

Tick for further details.



(Above) Advance TC11 & TC12 Timer Counters are designed to measure frequencies up to 15 MHz. TC11 has 4-digit display with 1 Hz resolution. TC12 has 5-digit display with 0.1 Hz resolution. Freq. Measurement: 2 Hz to 15 MHz. Time Measurements: TC11 10  $\mu$ S to 1 S, TC12 10  $\mu$ S to 10 S. Sensitivity: 10 mV, 100 mV and 1 V RMS.

Tick for further details.

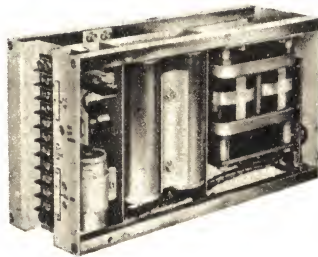

(Above) Advance PM Series Stabilised Modular Power Supplies are designed in modular form to be used as integral parts of other equipment, either singly or in multiples. Voltage Range 0-50 volts. Current capability 500 mA to 10 A. Fully transistorised, with silicon semi-conductors which permit operation up to +60°C.

Tick for further details.

## JAYEM



(Above) Jayem S100 Tr Multitester provides AC and DC measurements, also resistance, capacity and level. Also measures the more important parameters of transistors, both NPN and PNP types. DC 100,000 o.p.v. A 3" anti-parallax scale and sensitive 7.5  $\mu$ A meter. Shockproof suspension and full overload protection.

Tick for further details.



(Above) Jayem JM-01 Micromegmet is designed for the rapid and accurate testing of insulation resistance such as motors, generators, power-lines, etc., and for voltage detection and continuity checks. Rated voltage is 500 V and measuring range is 0.01-100 Megohms. Fully transistorised with 1 transistor and 4 diodes. Only 6" x 3 1/8" x 1 5/8", in soft leather carrying case with 1 pr. of test leads.

Tick for further details.

## KOVO



(Right) Kovo Megmet is a portable insulation tester for measuring insulation resistance of DC and AC mains, machines and appliances. The generator is driven by 2 sets of gears, the tooth wheels being of bronze and the pinions of steel. Models Available: Megmet 500 500 V, Resistance: 50 Kohms to 50 Megs; Megmet 1000 1000 V, Resistance: 100 Kohms to 100 Megs.

Tick for further details.

Tear this advertisement out and mail

Jacoby, Mitchell & Co. Pty. Ltd.  
Please send me details on instruments of which I have ticked applicable squares.

NAME.....

ADDRESS.....

POSTCODE.....



Distributed by—

# jacoby, mitchell & co. pty. ltd.

469-475 Kent Street, Sydney. 26-2651

MELBOURNE  
30-2491/2

ADELAIDE  
53-6117

BRISBANE  
2-6467

PERTH  
28-1102

LAUNCESTON  
2-5322



# Computer Graphics in Engineering Design

New storage and display techniques developed in the U.K. to allow direct access to computers by engineering staff will eliminate the administrative bottlenecks which occur when all computer work is channelled through computer operators.

By A. H. Thomas, B.Sc., M.I.E.E.

Since their earliest days, computers have been used in the solution of specific engineering problems; that is those problems which can be expressed in mathematical form (perhaps of great complexity) and are capable of solution, given the necessary data, by a continuous run of the computer without human intervention. The delays associated with the operation of most computer installations mean that several hours or tens of hours may elapse between the submission of a problem and the receipt of its solution by the engineer. Much, perhaps most, engineering design work is repetitive in nature, requiring several solutions of the same mathematical formulas with slightly different input data. This means that the total time required to complete a design is determined by the delays in the computing department rather than by the time needed for the designer to make the necessary decisions at each step in the procedure, or by the actual time needed for calculation by the computer.

Sometimes it is possible to incorporate the necessary repetitions in the computer program, where the choices involved are sufficiently predictable, for example in the design of transformers. In many cases, however, the judgment of the designer is needed at each stage. For instance, a choice between several possible courses of action may be needed, involving a logical procedure too complex to program or requiring value or aesthetic decisions. An example of this is the design of the interconnection patterns for printed-wiring boards or integrated circuits. Whereas it is relatively easy to program the computer to route most of the conductors, it is very difficult to make it route them all satisfactorily. The intervention of the designer simplifies the process greatly and makes use of a human skill not possessed by a computer, that of comprehending an overall pattern.

The efficient use of computers for engineering design thus requires that the designer has instant access in order to eliminate his waiting time. This can be provided simply by connecting a typewriter directly to the computer, so that the designer can feed in data, call up or feed in the appropriate program, and receive output in printed form. Since, however, a single designer would not occupy fully even the smallest computer because of the slow speed of the typewriter but principally because of the time needed for thought before calling for a calculation many terminals must be connected to the computer so that overall it is satisfactorily loaded.

Multi-access systems of this type are now becoming commonplace and are, of course, useful for other iterative procedures such as program writing and information retrieval.

An engineering designer does not, however, communicate only or even mainly by the printed word. He expresses his ideas in the form of drawings, so that the use of a tele-typewriter requires a translation into alphabetical and numerical form.

The computer output may sometimes best be expressed in the form of a graph or histogram rather than as a single numerical value or table of values. The designer will wish to study this and if necessary modify his original drawings and call for a recalculation.

A graph or drawing may, of course, be delivered by a computer using a mechanical plotting machine and if no further steps in the iterative design procedure are needed, this may be quite satisfactory, particularly where great precision in draughting is required. But when the designer wishes to alter the design and call for further work by the computer, he needs first to get the drawing from the computer quickly so that he is not kept waiting unproductively, and second to be able to modify the drawing directly or to specify new numerical values.

An engineering designer therefore requires a combined input and output de-

vice attached to the computer having this graphical and interactive capability. Such a device is the graphic display, in which the drawing and alphanumeric information are presented on a cathode-ray tube.

The high writing speed of a cathode-ray tube enables drawings to be presented rapidly, complete with all necessary annotation. Although the resolution-value of the screen limits the complexity and accuracy of the drawing that can be produced, it is possible to cause part only of a complex drawing to be displayed, either by scale-changing, to magnify a detail of particular interest, or by regarding the screen as a "window" through which any desired portion of a large drawing can be seen.

The designer must in the first place make his drawing on the cathode-ray tube. The position of the cathode-ray spot on the screen is controlled by the computer, and some means must be provided to allow it to be moved about by the designer. This can be done simply by typing appropriate x and y co-ordinate values on a keyboard connected to the computer, but unless great precision is needed this method is too slow.

More direct movement of the spot can be achieved by means of a tracker ball, in which the movements of a freely rotatable sphere are signalled to the computer and cause the spot to execute corresponding movements; a control column may be used in a similar fashion. An analogue of the screen may be set up consisting of a plate over which the movement of a stylus causes a corresponding movement of the spot.

The most commonly used device for moving the spot is the light-pen. This consists of a holder containing a photo-electric cell connected to the computer in such a way that the instant at which

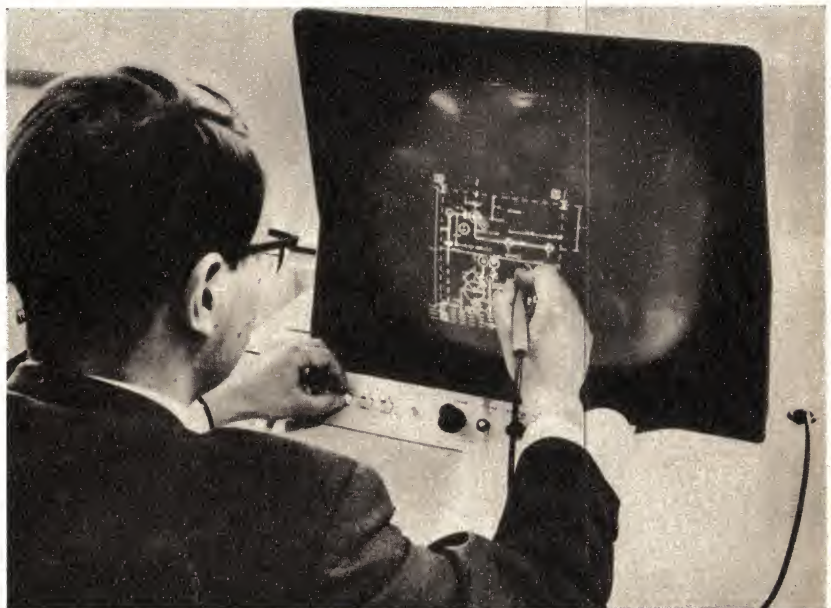

*Employing a light-pen for plotting design data on the display screen of an Elliot computer.*

# NO OTHER GENERATOR PROVIDES 0.1% DISTORTION PLUS THESE FEATURES FOR ONLY \$76 MODEL bwd 140A VERY LOW DISTORTION SINE & SQUARE WAVE GENERATOR.

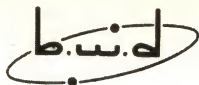

1Hz to 1MHz Sine or Square Wave. 2.5V RMS output.  
 < 0.1% distortion from 100Hz to 100kHz. < 0.5% from 5Hz to 1MHz.  
 < 5% calibration — typically 2%.

Output level within 3% over entire range.

10V p-p Square Wave.

< 250nSec risetime into 10K $\Omega$  and 100pf load.

Battery life, 800 hrs Sine Wave, 400 hrs Square Wave.

Battery version	model bwd 140A	\$76	Plus tax if applicable
AC version 100-260V	model bwd 140A/01	\$94	
AC/rechargeable battery	bwd 140A/02	\$120	



AVAILABLE  
 EX STOCK FROM  
**B.W.D. ELECTRONICS PTY. LTD.**  
 333 BURKE ROAD, GARDINER, VIC. PHONE 25 4425  
 127 BLUES POINT ROAD, NTH. SYDNEY, N.S.W. PHONE 929 7452  
 ALSO 23 1922 in S.A. 23 3847 in W.A. 51 5121 in QLD. AND 6 3581 in N.Z.

the spot is brightened by the beam is signalled. The x and y values then being supplied by the computer are the coordinates of the spot. By causing a more complex figure than a single spot to be drawn, such as a cross, and by having the aperture of the light-pen such that it can only view part of the figure, it is possible to cause the figure, or "tracking symbol," to follow movements of the pen across the screen.

A light-pen may thus be used to make drawings in two ways. In the first of these, the computer is caused to present on the tube a grid or matrix of spots. The light-pen is used to indicate two of these spots to the computer, which, on the pressing of a key on an associated keyboard, will cause a line to be drawn between the two spots. Proceeding in this way, a complete drawing may be built up; if the grid of spots is too coarse, a finer grid may be drawn locally in the area where greater precision is needed. Circles and arcs may be drawn by various methods, such as by indicating three points, by indicating one point and typing in the required radius on the keyboard, or by indicating the ends of an arc and typing in the radius.

In the second method, no grid of spots is presented. To draw a line, the light-pen is used to move the tracking symbol to the position required for one end of the line, then to that of the other end. Depression of appropriate keys causes a line to be drawn between the two points. Circles and arcs may be drawn in a similar way to that of the first method. This method is similar to freehand drawing, and it is possible for the computer to apply constraint such that, for example, lines can only be drawn horizontally or vertically.

Many drawings, particularly symbolic ones such as electronic circuit diagrams, contain repeated elements and repeated groups of elements. To save work, it is important for the designer to be able to draw a certain element once, to move it as a whole about the screen and cause it to be repeated as often as required. It should also be possible to combine certain elements into a group and then to treat the group as an element in itself which may be repeated as required. For convenience, it is desirable that it should be possible to invert elements or make mirror images of them and to expand or contract elements to different sizes.

Alteration of a drawing requires that it be possible to delete an element by pointing at it with the light-pen, without deleting other similar elements but at the same time deleting other associated elements, such as the wires connected to an electrical resistor or the dimension lines belonging to a group of holes. Further requirements are those mentioned above for windowing and scale-changing of the complete picture. Scale-changing may call for the deletion of detail too fine to be resolved on the screen.

The process of building up a picture and subsequently modifying it is thus complex and requires an elaborate system of storing the data in the computer. This is called the "data structure," and its design represents one of the most complex problems in the creation of graphical display systems.

A light-pen may be used, as mentioned earlier, for pointing at elements

BWD/7

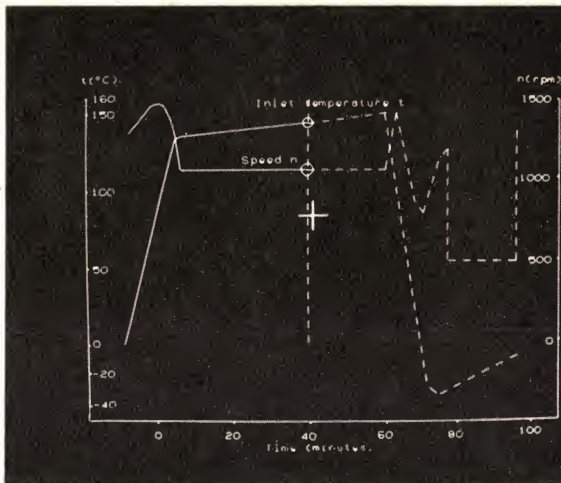
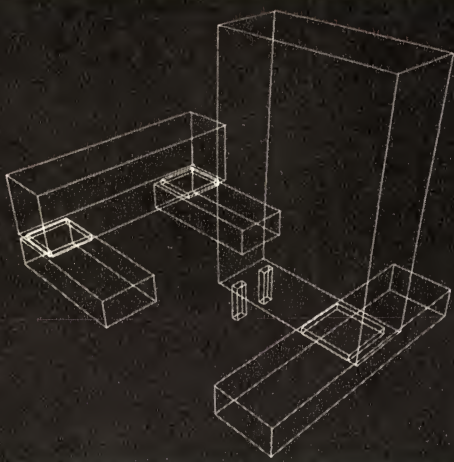

LEFT: A graphical display used to apply perspective to a furniture design drawing.

RIGHT: Visual display giving input and output characteristics of equipment under test.

of drawings which are to be deleted or amended. It may be used directly in its tracking mode to alter a picture by moving the ends of lines or the junction of groups of lines. In the pointing mode, it may be used as the "key" of a "keyboard" in which the "keys" are symbols or words in plain English displayed on the screen of the cathode-ray tube. In this way, an infinite number of key functions may be provided rather than the finite number available on a mechanical keyboard. This arrangement of "light buttons" is often preferred for convenience to the use of the keyboard for the insertion of numerical data, since it is not necessary for the designer to take his eyes from the screen or to attempt to operate the keyboard with his free hand.

Having made the drawing, the designer may call for a calculation to be carried out — perhaps of the stiffness of a structural member, the complex cross-section of which has been drawn, or of the electrical characteristics of a circuit of which the diagram has been drawn. An immediate answer may be presented to the designer, in the light of which he may if necessary modify the drawing and call for further calculations. These calculations, as are all other functions, are set in motion by depressing keys on the keyboard or selecting light-buttons with the light-pen.

The computer must be provided with the appropriate software to operate the display, cope with light-pen and keyboard outputs, establish the data structure and call up the appropriate routines to carry out the design calculations. The provision of adequate software and applications programs is the key to the achievement of a successful computer graphics system for computer-aided design.

The computer must have a store of sufficient size to hold the complete data structure relating to the task in hand, plus the programs and any data needed in the calculations. Since one designer cannot occupy a machine continuously, in order to load it economically it must be capable of carrying out other work while he is occupied in thought. This other work may be a background job or jobs of low priority run in the normal batch-processing mode, or it may be that of designers using other displays connected to the machine. This requires a further allocation of computer storage and the provision of

a backing store of the disc or drum type.

Most displays require that the picture be presented on the screen between 15 and 50 times/second, to avoid flicker. The repetition rate used is dependent on the type of phosphor employed. To avoid loading the computer with this surely repetitious task, a small buffer store is usually provided for the display which is cyclically read at the required rate. However, such a buffer is very like part of a computer and it is found useful to expand it into a small computer so that it can carry out some of the minor functions which would otherwise have to be performed by the main computer, such as handling signals from the light-pen and managing that part of the data structure corresponding to the portion of the total data structure visible on the screen. The main computer is then left to carry out calculations, to hold the major portion of the data structure and perhaps to hold common data files and common programs of use to more than one display.

When this is done, the transmission rate of data between the central computer and a display is reduced, and it therefore becomes easier to site the display remotely. Such remote siting is necessary in large organisations with a number of design offices, or for smaller organisations having their own displays but connected to a large, shared machine for major calculations and common data storage.

The concept thus emerges of a satellite system, consisting of a central computer of high capability and having substantial storage capacity, connected over private wires or the public telephone system to a number of satellites, each consisting of a small computer, display, light-pen and keyboard. Some systems of this kind are in operation, but no clear rules can yet be stated to indicate precisely what work should be done in the central and satellite computers and what rate of data transmission should be employed. Much depends on the relative economics of computers and data transmission.

Displays can be used for work outside the immediate design area; for example, information retrieval, stock control and the drawing and amendment of program evaluation and review technique (PERT) charts for project control. Some of these tasks do not need the capability of presenting drawings,

for example, stock control and much information retrieval work. Simpler displays having the ability only to present alphanumeric data may therefore be used. They are electronic versions of the tele-typewriter, having the advantage of high writing speed and noiseless operation but also the disadvantage of not providing a printed record, or "hard copy." This type of display, with an associated keyboard, has, however, enjoyed the greatest volume of sales, mainly in applications outside engineering design and particularly for airline seat booking.

Application of computer graphics to engineering design is still in an early stage of development. It is clear, however, that the technique is of great potential benefit, not necessarily, if at all, in design work of the highest creativity, but in helping with many of the routine design and drawing office tasks which are needed between the initial conception of a product and its readiness for production.

The ability of a display to provide two-way communication between designer and computer means that the designer can be guided through a complex, though routine, design procedure, and be given access to computation power or standard data just when he needs it. The main benefit of this is likely to accrue from the shortening of the design period, reduction in errors in procedure, and improved accuracy. It is also possible to generate component or material lists automatically, and for modifications of the design to be reflected immediately in amendment of these lists. Reduction in design time and eventually of cost means that a design can be prepared in response to a customer's inquiry which is both accurate and precisely costed, thus probably allowing a more competitive price to be quoted.

Pioneer work in industry and research establishments shows that computer graphics has an assured place in computer-aided design. Further development of the hardware and software, and of the techniques of application to practical problems, will ensure its eventual use throughout industry. ■

# 30,000 ELECTRONIC TESTS IN LESS THAN TWO MINUTES

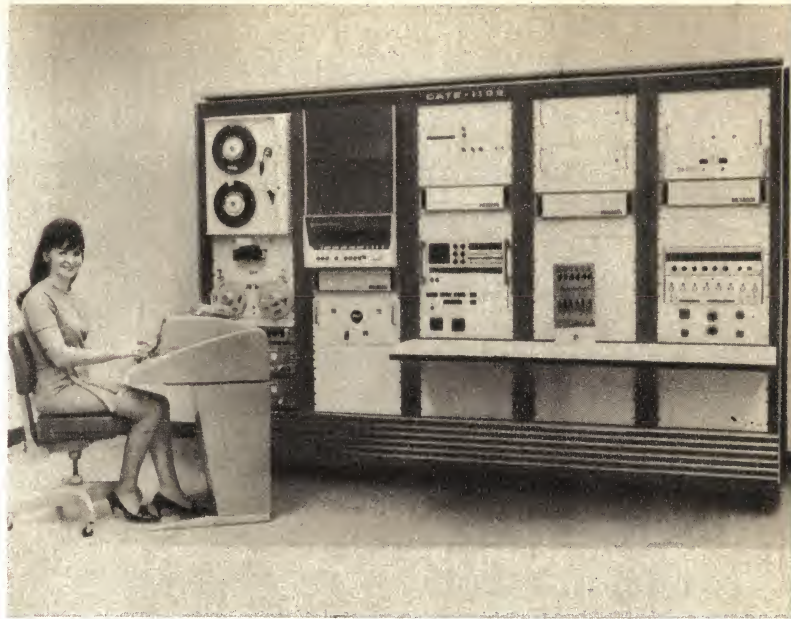

The CATE computer controlled equipment tester.

Fully automatic post-production testing of complex digital and analog electronic equipment can be carried out by computer controlled test systems developed in the U.S.A. by the Convair Division of General Dynamics. Up to 30,000 separate tests can be completed in one minute 50 seconds.

Called Convair Automatic Test Equipment (CATE), the new systems are controlled by Varian 620/i general-purpose computers with 16K memory which allow the single technician operator required by each system to initiate a test merely by typing in the part number of the item to be tested.

According to Electronics Group Engineer, B. A. Penners, the CATE systems now in operation at Convair each have testing capability of 10,000 units (ranging from electronic modules to rack-size systems) per month on a two-shift basis.

The requirement for automatic testing arose with the F-111 AGE logic modules. After evaluating the buy or build decision, Penners' group chose the latter course in order to achieve the following unique equipment characteristics:

1. a system totally under computer control;
2. internal loading and switching by computer controlled switching systems;
3. a universal adapter configuration to accommodate 550 or more types of modules and subsystems.

The CATE 1082 product was the first system developed with the above characteristics. It contains a general purpose integrated circuit digital computer and related peripheral devices, computer interface electronics for controlling the station, test stimuli sources, signal measurement and detection devices, an automatic matrix switching device, test loading devices, an adapter subsystem for the devices to be tested, and an extensive software package to fully utilise all hardware components.

The test set computer that supervises and controls all testing is a Varian 620/i with peripherals. The standard

test stimuli supplied are fixed loads, fixed voltage sources, programmable power supplies, addressable registers and flip-flops, and pulse lines. Signal measurement and detection devices include a 32-channel analog-to-digital converter, a pulse timer, addressable registers, and sense lines.

Subsequent requirements arising from the F111 AGE program dictated the need for a second (and more versatile) test system, designated CATE 1109. Like its logic-oriented predecessor, this nearly universal test system centres on the Varian 620/i minicomputer as a controlling element. In addition to duplicating the logic test capability of CATE 1082, the new system also fully utilises the capabilities of such versatile instruments as a waveform analyser, a pulse generator, a waveform generator, a volt-ratiometer, seven programmable power supplies, and others.

In spite of the impressive capabilities listed above, Penners feels that the system's real strength resides in a Convair designed switching system which allows simultaneous interconnection of any (or all) test instrument(s) to any part of the unit under test. Additionally, electrical loading for each UUT pin may be automatically set under program control.

Test programs are written in a simplified form of Fortran which can be learned easily in about two weeks with no prior programming experience required. An extensive software library reduces the test writer's task essentially to calling library sub-routines in the proper order. The test programmer is not required to understand digital computer hardware or system software to write complex and detailed test programs.

To start a test sequence, the operator types in the part number of the item to be tested on the teletypewriter key-

board. The resident portion of the supervisory program that is always in the computer interprets this request and searches the magnetic tape on which all test programs are stored. After the appropriate program is found, it is loaded into the computer and testing begins.

Each test begins with a confidence self-test of CATE 1109 or CATE 1082 before proceeding to the device being tested. During testing, messages may be printed which direct the operator to take some particular action, such as plugging in the unit to be tested and making an adjustment. The specific operator communication during any testing situation is determined by the test program. This communication will vary greatly from situation to situation. For example, in one large failure diagnostic application of CATE, the particular test number and test values which failed are printed out along with voltages occurring at all other test points at the time of failure.

This information is used in diagnosing the failure and determining corrective action. However, operator communication capability can take on any degree of complexity depending on how the test programmer designs his program.

The specifications for the CATE computers are:

- 1.8-microsecond memory cycle time.
- 16-bit word length.
- 16,384 words of core storage.
- Eight priority interrupt levels.
- Direct memory access.
- Single and double word instructions with direct, indirect, relative, and indexed addressing.

● Buffered interface controller allowing simultaneous computation and input/output.

Computer peripherals include a magnetic tape transport (25-ips. 556 or 800 bpi), teletype, and a 300 CPS paper tape reader. The entire CATE 1109 test system, excluding teletype console, measures 117 inches wide by 81 inches tall by 33 inches deep with a 68-inch-wide work shelf. The system requires no stringent environmental controls.

# BUY RIGHT... FROM ENCEL

## Compax Solid State Tuners

High quality, wide band A.M. tuner  
Output suits all amplifiers and tape  
recorders. Teak finished case is optional  
Outstanding value.

Price (with case and sales tax)

**\$49.50**



## Onkyo 8" Co-axial speakers.

Six powerful magnets . . .  
Unique performance.

Can any 8" speaker be worth \$36.50?  
Easily . . . when you see and hear the  
remarkable CX - 20D. Here at last is  
a total-performance 8" co-axial speaker  
with six magnets, a horn-type tweeter,  
an electrical crossover high compliance  
and unusually robust ribbed construction.  
Total weight is almost 8lb. and frequency  
response is 35-20,000 Hz. The response  
curve is substantially flat; from an engineering  
viewpoint the CX - 20D is superb in design  
and construction. The matching enclosure  
is easy to make and any handyman can  
make it from readily available materials.  
We want you to hear the CX-20D and  
make your own appraisal.

Price (including sales tax) **\$36.50**

## Tape Head Demagnetisers

Simply plug the tape head demagnetiser  
into any AC power point and pass  
over the heads. Takes only five seconds  
and can make a world of difference.  
Two models - single and double probe.

Price (including sales tax) **\$4.50**

## Comprehensive range of world famous Turntables at Australia's lowest prices.

B. S. R.	Compax	Connoisseur
Dual	Garrard	Goldring
J. H.	P. E.	Thorens.



## Lustré ST - 510 Tone Arm.

Tracks at less than 1gm.

Ballrace bearings. Head accepts all  
standard ½" cartridges. Fitted with  
out-rigger type bias adjustment . . .  
stylus pressure adjusted by counter-  
balance, finished in satin chrome and  
anodised aluminium.

Price (including sales tax) **\$19.50**

## ST - 510D.

As ST - 510 but fitted with tone arm  
lift. Hydraulic dampener ensures  
smooth, controlled operation, thus elim-  
inating risk of record damage.

Price (including sales tax) **\$24.50**

## Tape Recorders are lower priced at Encel.

Akai	Clarion	HMV
Kreisler	Miny	National
Revox	Sony	Tandberg
Toshiba	Truvox	Philips

Because of agreements with manufactur-  
ers we are unable to advertise our  
discount prices.

(Write for full price list)

## Write for price lists, full details and reviews of Encels' World Wide Range of Speakers.

Akai	Compax	Celestion
Derham	J. B. Lansing	Jantzen
K.E.F.	Kenwood	Lowther
Sansui	Sonics	Sony
Stentorian	Wharfedale	

## Encel Service Divisions. Sydney. Melbourne.

Staffed by fully qualified, highly ex-  
perienced technicians. Latest and  
most elaborate test equipment. Just  
another Encel customer service.

## Amplifiers

Australia's largest range  
Australia's lowest prices.

Akai	Compax	Kenwood
Lux	Radford	Rotel
Sansui	Sony	Sound

Write for specifications, prices, and  
reviews from world wide authoritative  
audio journals.

## New Dynamic Headphones

PML - D42. Will satisfy the most ex-  
acting professional demands for both  
stereo and mono listening. Most stable  
and reliable in operation due to the  
unique design of the diaphragm pres-  
sed integrally with the frame of the  
voice coil. Excellent ear contact and  
comfortable. Frequency response: 30-  
20,000 Hz. Power: 0.3 mV. Sound pres-  
sure level at 0.3 mV: 100dB.

Price (including sales tax) **\$19.50**

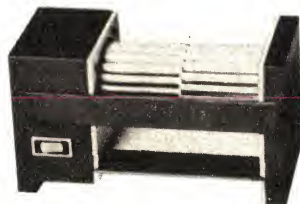

## Remarkable directional fan for desk or work bench.

This attractive fan was designed by a  
leading French designer. Sits on desk,  
or wall mounted. The unique directional  
control allows for air flow above the  
table . . . will not disturb papers  
or parts. Provision for deodorizing or  
perfuming air.

Price (including sales tax) **\$7.50**

## Trade-in Trade-up.

Let your old equipment in good work-  
ing order earn money for you. Bring in  
your tone arm, amplifier, tape recorder  
etc., for valuation when making a pur-  
chase. You could be surprised at the  
allowance Encel Electronics offers.

## Tapes

BASF and Philips low-noise tapes at  
Australia's lowest discount prices.  
Write, without obligation, for details.

# ENCCEL

**ELECTRONICS (STEREO) PTY. LTD.**

Head Office: 431 Bridge Rd., Richmond, Victoria. 3121. Tel. 42 3762.

Sydney Store: Ground Floor, 2SM Building. 257 Clarence Street, Sydney, N.S.W. 2000. Tel. 29 4563, 29 4564.

Australia's Greatest Hi-Fi Centre ■ Wholesalers ■ Trade-ins accepted ■ Terms

# POST OFFICE PREPARES

The advent of colour TV to Australia will require that the TV relay systems provided by the P.M.G.'s Department be capable of handling a much more complex signal than is needed for monochrome TV.

In February, 1969, the Postmaster-General, Mr Hulme, announced in the House of Representatives that the PAL (Phase Alternation Line) colour television system would be used when colour television transmissions were introduced in Australia.

The PAL system was recommended by the Australian Broadcasting Control Board after careful assessment of the relative advantages of the three main systems (NTSC, PAL and SECAM) now in use in other parts of the world.

The NTSC system was introduced in the U.S.A. early in 1953 following a recommendation of the National Television System Committee. A tribute was paid to the NTSC system by Dr W. Bruck of Telefunken, who was largely responsible for the development of the PAL system, when he stated in a lecture to members of the Institute of Electrical Engineers in London in 1965, that the NTSC system belongs to the outstanding physical and technical masterpieces of our century.

The PAL system is a variant of the NTSC system. The main virtue of the PAL variation is its ability to com-

pensate for some of the distortion which inevitably occurs between the studio where the signal is generated and the domestic colour television receiver picture displayed. The PAL system advantages and the significant improvements in circuit design and manufacturing, which have become possible largely through solid state devices, now promise that the colour television receivers for the coming Australian service will be many times more reliable and stable than the valve-operated receivers in use when the NTSC system was first operated.

The SECAM (sequential and memory) system is, like PAL, very tolerant of distortion in the transmission system. A choice between SECAM and PAL depends not only on an engineering evaluation, but also on a subjective comparison of both systems. A final subjective comparison by human observers is necessary because the PAL and SECAM systems differ in their characteristic errors which, therefore, cannot be related by objective measurements.

The television studio equipment, relay systems and transmitters of the present Australian black and white television service are now being evaluated in terms of their suitability for colour television. To allow time for the conversion of equipment and the production of colour television receivers, the Postmaster-General has also said that

18 months' notice would be given of the date of commencement of colour transmissions.

In the case of the P.M.G.'s Department, with its extensive network of video relays and national television transmitter stations throughout the Commonwealth, this 18-month period would not allow all the conversion, upgrading and installation of equipment which must be accomplished before the colour "on-air" date. Preparations must therefore commence as soon as possible if the work is to be completed within reasonable time. In fact, considerable work has already been done in preparation for the changeover.

This article does not include the difficulties applying specifically to television transmitters, which it is hoped will be covered by a subsequent article, but concentrates on the difficulties arising in relaying colour television signals.

Monochrome or black and white television signals contain two basic types of information. The first is synchronising information which sets the time pattern for the display. The second type of information provides the luminescence signal which controls the brightness of the cathode ray tube to provide the picture. Colour uses similar basic synchronising information, but includes two additional types of information. The first of these is the "colour burst" which is an addition to the synchronising information and which allows the extraction of the correct colour signal phase relationships at the receiver. The second is the "chrominance" signal—conveying information as to colour (hue) and intensity (saturation)—which is additional to the lumi-

Based on an article by R. W. Harnath, F.I.R.E.E. (Aust.), A.R.M.T.C. (Divisional Engineer, Long Line Equipment Section, P.M.G.'s Dept.)

## Convertible Colour TV Camera

A new monochrome broadcast TV camera which can be converted to colour at any time has been announced in the U.S.A. by Ampex Corporation.



The new camera, Model BC-210M, is designed for studio or outside broadcast use. It uses a single Plumbicon pickup tube, and is basically a one-tube version of the Ampex two Plumbicon colour camera Model BC-210. The BC-210M can be converted to full broadcast colour capability by the addition of a single colouring channel.

The BC-210 colour camera has a simple optical system which splits the visible spectrum into luminance for one of the tubes, and red-blue, in alternate fields, for the other, by means of a revolving two-colour filter wheel locked to vertical sync. The missing colour fields are replaced by using a 262-line delay in conjunction with field frequency switching. Each colour field is thus used twice, once as the original signal and once as a delayed signal. The three signals (red, blue and luminance) are then fed into a matrix in which green is obtained by subtracting appropriate proportions of blue and red from the luminance signal.

The BC-210M is expected to be used by small commercial stations and by educational networks which may want to convert to colour operation at a future date. When converted, the BC-210M performs identically with the BC-210.

# FOR COLOUR TV

nescence signal used in monochrome transmission.

To retain about the same overall frequency bandwidth for the colour signal as for the black and white, the colour information is carried in the high frequency end of the normal television signal, using two-phase amplitude modulation of a sub-carrier signal. As far as a black and white signal is concerned this added colour signal is a spurious signal. However, by choosing a sub-carrier frequency with a precise relationship to the line and field scanning frequencies of the television system, a fine spatially interleaved interference pattern is produced which, with the persistence of vision effect of the eye, has minimum visibility.

In the PAL system, the sub-carrier has a frequency of approximately 4.43MHz which, when modulated with colour information, produces side band signals at frequencies up to 1.3MHz above and below the carrier frequency.

This means that the energy distribution of a colour signal is very different to that of a monochrome signal, particularly at the high frequency end of the band, and also that the bandwidth requirement for a colour television signal is approximately 5.7MHz instead of the 5MHz commonly used for monochrome.

It should not be implied from this that a colour TV receiver needs to have a video bandwidth of 5.7MHz. In fact, this would not be practical, because the sound carrier occurs at 5.5MHz and transmitters and receivers are both designed so that the video bandwidth does not extend significantly beyond 5MHz for either black and white or colour. In the case of a colour signal, the full 1.3MHz lower sidebands from the chrominance sub-carrier (from 4.43MHz down to 3.13MHz) are transmitted but, of the upper sidebands, only the lower frequencies are transmitted, as permitted by the approximate 5MHz limitation.

Thus, the chrominance signal uses a vestigial sideband system, very similar to the vestigial sideband system used by the luminance or monochrome system. This means that both the transmitter and receiver response curves must be tailored to satisfy these requirements.

As far as relay systems are concerned, it is necessary to transmit the full 5.7MHz bandwidth, in order that the transmitter will be presented with a signal which is as nearly perfect as possible. Whatever tailoring is to be done must be done at the transmitter. Any attempt to do this within the relay network, when the transmitter is already designed to do the job, could result in serious complications and degradation of the picture quality.

There are two results arising from the need to accommodate the chrominance sub-carrier. The first is that response of video circuits above about 5MHz, which previously was relatively less significant than the lower frequency performance in terms of picture quality from the television receiver, now becomes highly significant.

The second is that caused by the

larger signal frequencies, due to the colour signal components, which require parts of television amplifiers and other equipment, where the high frequency load impedance is largely capacitive, to have a much greater power or volt-ampere capability to carry colour signal without distortion. For example, it can be shown that an amplifier which has a flat frequency response to 5MHz can be completely inadequate in handling this high frequency power requirement.

In order to ensure that the equalisation of relay equipment is adequate, a new test signal is being introduced. Monochrome transmission circuits were lined up using a 2T pulse and bar. The energy distribution of a 2T pulse falls off progressively above 2.5MHz and approaches zero at 5MHz, so that systems lined up using this signal can have significant equalisation errors above about 3MHz. The new test signal, in addition to 2T pulse and bar, incorporates a "20T" pulse, modulated with the colour sub-carrier frequency. The 20T pulse has exactly the same sine squared shape as the 2T pulse, but has 10 times the duration.

The extended duration 20T pulse provides heavier loading, and therefore a more exacting check, at the lower frequency end, while the colour sub-carrier provides a heavier loading and more exacting check of the high frequency end. The use of this combined signal gives an energy spectrum which is much more uniform over the whole band and thus provides critical testing of the equipment performance at all frequencies.

To test the capabilities of the transmission equipment for high frequency power performance, a method usually known as "differential gain and phase" testing is being introduced. This test uses the same sawtooth or staircase linearity testing waveform previously used for monochrome circuits, but in place of the 1MHz modulation frequency previously applied, uses the 4.43MHz colour sub-carrier frequency as a modulating signal. By means of a special receiving equipment which compares the phase of the colour burst and of the recovered modulated signal, it is possible to obtain information regarding the change of phase at this frequency which occurs when the information signal varies from black level to maximum. Differential gain is also measured by the same test gear, in a similar fashion to previous non-linear tests at 1MHz. These two factors are important because they change the "hue" and "saturation" of the observed colour signal from the original states impressed on the relay.

Most long distance radio relay systems have adequate bandwidth to cope with the 5.7MHz colour requirement, but the early types of cable video systems used in Australia cut off fairly sharply above 5MHz. To change the equalisation capabilities of these systems would be prohibitive in cost, and it will therefore be necessary to replace older equipment gradually with new equipment which has an intrinsic bandwidth exceeding 7MHz.

The reference to "old" and "new"



*The repeater station at Madden's Plains, south of Sydney, is typical of similar broadband repeaters all over Australia. These must be capable of handling the more complex signals when colour TV is introduced.*

cable video systems introduces an interesting sidelight into this overall story. Cable video systems, as distinct from "radio" or "carrier" systems, transmit video information directly, at the video frequencies. They are used for relatively "short haul" applications, as between a capital city terminal and a switching centre a few miles away, or from a switching centre to the TV studios. Repeaters are required every five or six miles and the maximum distance is normally limited to the use of a maximum of three repeaters.

The "old" cable video equipment used by the P.M.G.'s Department was imported and used valves. When this was due to be replaced the Department looked around for something more modern, using solid state techniques. It transpired that there was nothing offering on the world markets which would meet the Department's specifications, so the Department went ahead and developed its own equipment, in conjunction with a leading Australian manufacturer, and this equipment has subsequently been manufactured in quantity.

One benefit arising from the replacement of the older valve equipment is that the operating costs of the new equipment are very low. Also, the cost of providing no-break AC power for the older rack could exceed \$700 per annum, depending on the no-break plant being used. An additional advantage is the elimination of valve aging, which in the older equipment caused changes in the equalising characteristics thus requiring re-equalisation of the system at random intervals. (From "Telegen," December, 1969.)

# Give your designs the flexibility of these newest IC "Building Blocks"

For technical details, write to Amalgamated Wireless Valve Co. Pty. Ltd., Private Mail Bag, P.O. Ermington 2115 or Interstate Offices and Distributors.



AMALGAMATED WIRELESS VALVE CO. PTY. LTD

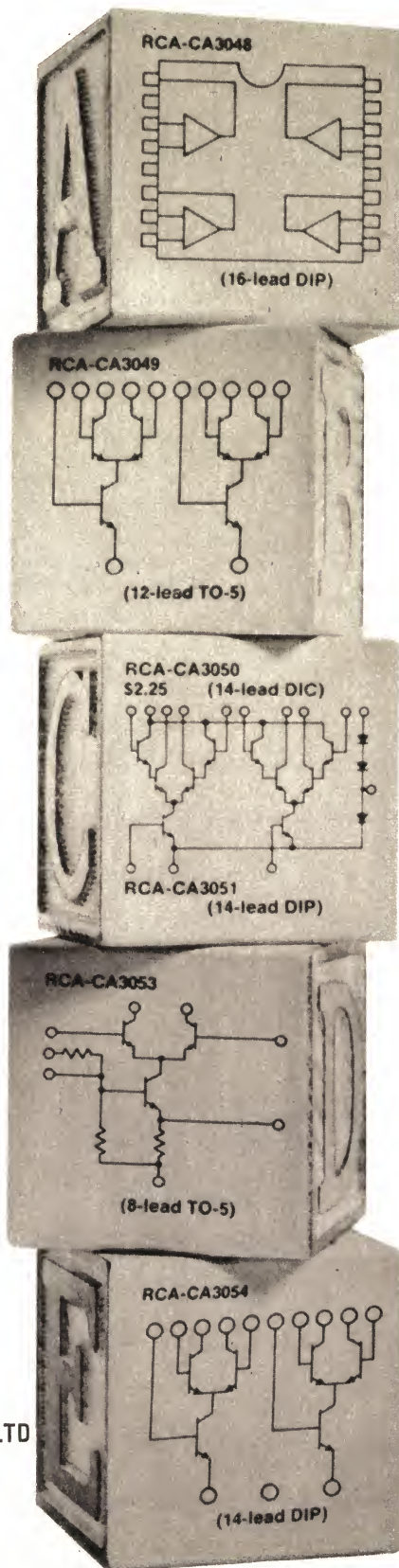

## 4 AC Amplifiers in a Package

Four independent AC amplifiers with 53 dB (min.) voltage gain per amplifier @ 10 kHz, for use to 300 kHz. For low-noise and general AC applications in industrial service.

## DC to 200 MHz Dual Diff Amp

Dual independent diff amps for low-power applications. Power gain 23 dB (typ.) @ 200 MHz; noise figure 4.6 dB (typ.) at 200 MHz. Wide application potential over the full military temperature range.

## Darlington-Connected Dual Differential Amplifier

Two Darlington-connected diff amps with diode bias string for low-power applications from DC to 20 MHz. CA3050 for full military temperature range; CA3051 for  $-25^{\circ}\text{C}$  to  $+85^{\circ}\text{C}$  operation. Both feature high impedance input, low bias current, low offset current.

## Economy Multi-Purpose Linear IC

New economy linear IC combining performance and versatility—at a new low in cost. 40 dB (typ.) cascode voltage gain @ 10.7 MHz, 30 dB (typ.) differential voltage gain @ 10.7 MHz. Recommended for IF and general-purpose applications. 6- or 12-V operation.

## 120 MHz Dual Diff Amp in 14-lead DIP

Matched diff amps with independently accessible inputs and outputs. Max. input offset voltage = 5 mV; max. collector current = 50 mA. Forward current transfer ratio ( $h_{fe}$ ) (typ.) = 110. For  $0^{\circ}$  to  $85^{\circ}\text{C}$  operation. Also available as CA3026 in TO-5 package for full military temperature range.



# Do Bushfires Impair Radio Communication?

Post Office researchers have reported that they have found no significant interference to radio transmission during recent investigations into the problems of radio communications during bushfire fighting.



The experiments were carried out during "Operation Euroka" in Queensland last October, and followed requests for an investigation into apparent radio failure during last summer's fatal fires at Lara, Victoria.

The Post Office Research Laboratories report says that the overall conclusion from the Euroka investigations was that fire-edge to fire-edge radio communications between mobile transceivers fitted to trucks, and fire-edge to base station communication were not affected significantly.

However, in other bushfires, different atmospheric conditions, different fuels and strong winds may produce substantially more severe temperature patterns to those experienced in the Euroka fire. It is therefore not impossible that the subrefractive conditions observed at Euroka could become more marked, and have significant effects on communication between a fire-edge vehicle and a distant base station with low aerials. Under such conditions, radio waves curve upwards, thus weakening signals received at a distant base.

The Post Office team's experiments covered the radio frequency bands used by bushfire fighting organisations and also the frequency bands used in the national trunk telephone microwave radio systems.

For the microwave measurements, special equipment was available, some of it produced by Standard Telephones and Cables Pty. Ltd., and the rest developed by the Post Office Research Laboratories.

However, there was no comparable equipment available for measuring HF and VHF and in the brief preparation time before Operation Euroka these units had to be made up from transceivers normally used for point-to-point communications by Post Office research field teams. They were assembled from Treager and S.T.C. mobile sets.

Collaborating with the Post Office team was a three-man team from the

University of N.S.W., led by Professor P. Angus-Leppan, of the University's Department of Surveying.

For the HF and VHF measurements, the Post Office team set up three units in a simulated bushfire fighting situation. There were two "near" stations, each 140 yards from the fire edge and transmitting a distance of 800 yards, including 500 yards across the flames. Aerials for these units were mobile "whips" on vehicles adjacent to instrumentation shelters.

Transmissions were also received at a "fire brigade base" station 15 miles away, with a Yagi aerial mounted on a 120ft tower and with long-wire vertical HF aerials run down from the tower summit.

Measurements at the trunk system frequency of 450MHz and 4,000MHz were made using transmit and receive aerials 25ft above the ground on masts beside the instrumentation shelters at the "near" stations. Transmit and receive aerials were also installed at the top of the mast at the remote station.

At the "near" receiving station, the vertical angle-of-arrival of the 4,000MHz signal was measured continuously.

The University of N.S.W. party made precision measurements across the fire testing optical refraction and range. Ranging was done with three MRA101

tellurometers, now a standard measuring instrument in precision surveying. These instruments measure the transmit time of 10GHz radio signals between "master" and "slave" units and had an accuracy of about half-a-centimetre at this range.

During the fire, the Post Office radio signal strengths varied slightly both above and below the levels before the fire was lit, but signal minima were rarely more than 5dB below the "pre-burn" levels. Averaged over the eight major attenuation measurements made (five on the short path, three on the long) the total range of signal variation was below 11dB. For the long path it was below 7dB.

The Post Office measurements of the angle-of-arrival showed a decrease at 4,000MHz — the apparent position of the transmitting aerial being lowered. This effect was more marked in the university measurements with tellurometers, which were employing a lower ray height across the flames.

A ray about 4ft above the piled timber showed a maximum range "shrinkage" of 5cm, due to an increase in radio wave velocity, while similar measurements at about nine feet above the timber showed no change at a time when the lower path appeared shortened by 3cm.

Brief tests were also made with a laser beam across the fire and first indications are that it could offer useful qualitative data on the degree of turbulence and on mean refraction (hence temperature gradients).

The six-man Post Office research team went into Operation Euroka at short notice, when it was learned that the Department of Supply was to conduct the experiment with 6,000 tons of bulldozed brigalow scrub to test fire patterns.

The Post Office saw it as a unique opportunity to study the effects of bushfires on radio propagation in circumstances wherein many aspects of fire and weather behaviour were being accurately measured simultaneously. ■

## Amateurs Please Note

The results obtained from "Operation Euroka" can only be regarded as inconclusive. The situation exists, therefore, where more data is required. Amateur operators may be able to provide such data, and thereby undertake a public service, by making observations during actual bushfire conditions of fluctuations in normal reception behaviour over paths they are accustomed to working.

Standard extrusions for every purpose



# heatsinks

Manufactured in Australia, these extrusions offer design engineers "off the shelf" heatsinks for most applications.

TYPE  
35 D  
45 D  
55 D  
65 D

STANDARD LENGTHS

2" 3" 4" 6"  
3" 4" 6"  
4" 6" 8"  
4" 6" 8"

FINISH  
Anodised  
Anodised  
Plain

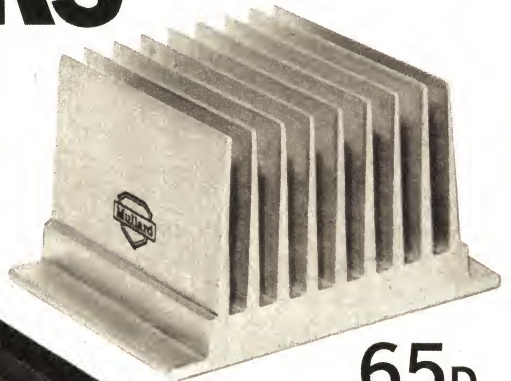

**65D**

For use with high power thyristors and silicon diodes under high peak current conditions.

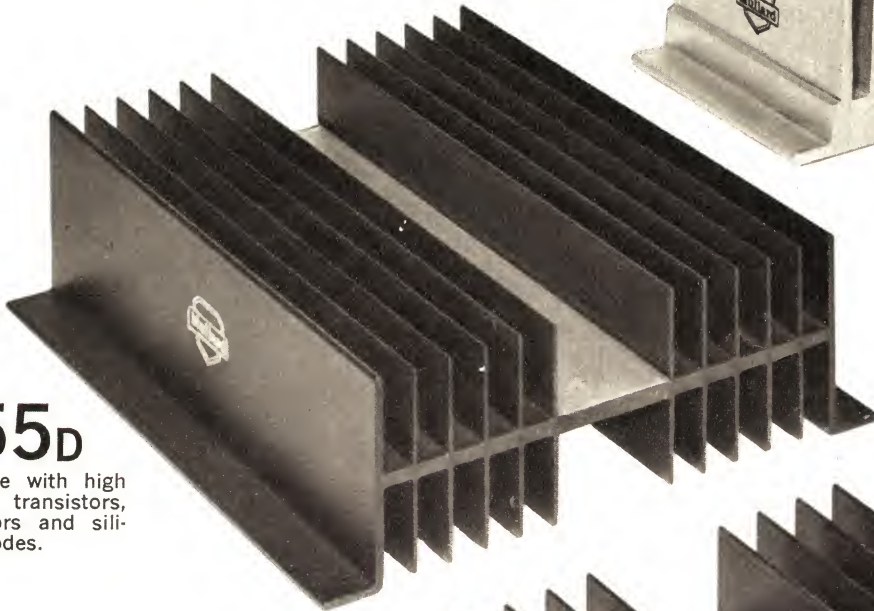

**55D**

For use with high power transistors, thyristors and silicon diodes.

**45D**

For use with medium power transistors, thyristors and silicon diodes.

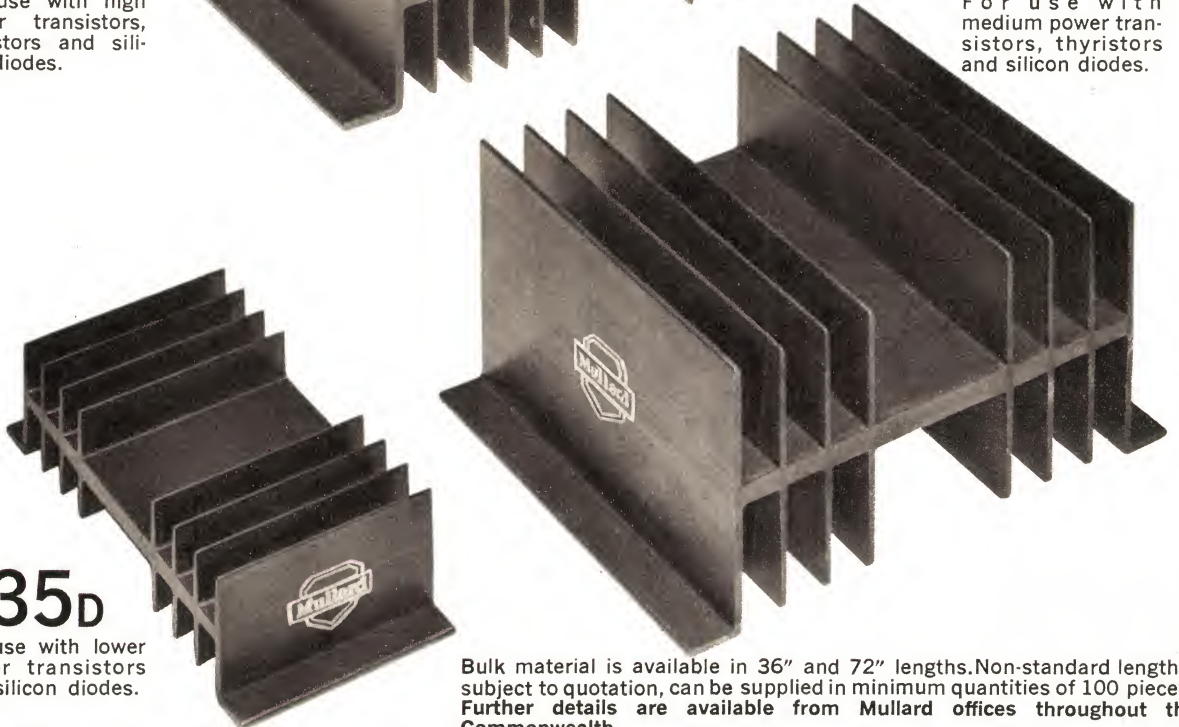

**35D**

For use with lower power transistors and silicon diodes.

Bulk material is available in 36" and 72" lengths. Non-standard lengths, subject to quotation, can be supplied in minimum quantities of 100 pieces. Further details are available from Mullard offices throughout the Commonwealth.



## Mullard-Australia Pty. Ltd.

35-43 Clarence Street, Sydney, N.S.W., 2000. Phone: 29 2006 • 123-129 Victoria Pde., Collingwood, VIC., 3066. Phone: 41 6644 • St. Paul's T'ce. and Light St., Bowen Hills, QLD., 4006. Phone: 51 5151 • 579 Murray St., Perth, W.A., 6000. Phone: 21 2561 • Medhurst Wholesale Ltd., Hobart, Launceston, Burnie, TASMANIA.

Associated with MULLARD LTD., LONDON

M235.

# FIRST AUSTRALIAN FARADAY LECTURE

The 1968-69 Faraday Lecture, entitled "Microelectronics," originally presented in U.K. by Mullard Ltd. for the Institution of Electrical Engineers, is to be staged in four Australian capital cities, during March, by the Institution of Radio and Electrical Engineers Australia.



Mr. Edward T. Emms, B.Sc.,  
C.Eng., F.I.E.E., A.R.C.S.,  
F.I.M.A.

The Faraday Lectures are an annual event in the U.K., organised by the Institution of Electrical Engineers. They are held to commemorate the great British physicist Michael Faraday, whose research into the principles of electromagnetic induction laid the foundations upon which the science of electrical engineering was subsequently built. Arrangements have now been completed for the I.R.E.E. Australia to present the 1968-69 lecture in Australia. The I.R.E.E. is the first body to sponsor a Faraday Lecture outside the U.K.

The 1968-69 lecture in the U.K. was delivered by Mr Peter Trier, director of research and development, Mullard Ltd. It was given 29 times in the U.K., in 12 major centres, to audiences totalling about 60,000. The Australian lectures will be given by Mr Edward T. Emms, who is head of the Mullard Central Applications Laboratory, and who was deputy lecturer for the U.K. presentations. He will be assisted by Mr David G. Dewdney, manager of the Mullard Electronics Centre in London.

The lecture has been most carefully prepared, and involved months of work by a team of planners in the U.K. In addition to numerous slides and film strips, which are used at every stage of the lecture to add visual impact, the lecturer is aided by elaborately mounted large-scale models, which are manipulated by a team of assistants.

The lecture begins with a brief historical survey of the techniques which predated the transistor revolution. Transistor theory is covered next, and in this section of the lecture use is made of an elaborate model using coloured balloons to represent electrons and "holes" which move about through the three sections of the model representing the emitter, base and collector. This is designed to show

the audience what really happens to electrons in transistor action, and how their wanderings can be controlled at will to provide not only current amplifiers, but also other solid state devices—switches, resistors, capacitors and diodes.

This section leads readily into the miniaturisation of electronic devices, the need for which is illustrated graphically by the complex circuitry associated with the flight deck of an airliner, a modern telephone exchange and a rocket launching. The planar technique is discussed, and its application to microcircuits techniques is shown with the aid of another large scale model, prepared in great detail, which allows the various stages of manufacture to be built up a step at a time. The last section of the lecture is concerned with the application of microcircuits to modern-day electronics, showing how they are already being used in computers and other complex equipments, and giving a glimpse into the future, when they will be used in everyday domestic equipment.

It should be obvious from the foregoing that the lecture is pitched at a popular rather than an engineering level. In fact, the subject matter has apparently been very carefully prepared to cater for the widest possible audience, and even those with little or no prior knowledge of the subject should have no difficulty in understanding the material presented. Accordingly, no restrictions have been placed on attendance.

Even those to whom the subject matter is not new should find the methods of presentation, involving special lighting effects and staging techniques, a most interesting spectacle. People in the electronics industry will also be present

with an opportunity to introduce their families and friends to the matters with which they are closely involved each day.

The lectures are to be presented in accordance with the following program:

**SYDNEY:** Friday, March 6, at 12 noon, 2.30 p.m. and 8 p.m., and Saturday, March 7, at 10 a.m., 2.30 p.m. and 8 p.m., in the Science Hall, University of N.S.W.

**MELBOURNE:** Tuesday, March 10, in the Storey Hall, Royal Melbourne Institute of Technology, at 11 a.m., 2 p.m. and 8 p.m.

**ADELAIDE:** Friday, March 13, in the Brookman Hall, South Australian Institute of Technology, at 10 a.m., 2 p.m. and 8 p.m.

**CANBERRA:** Wednesday, March 18, in the Canberra Theatre, at 10.30 a.m., 1.30 p.m. and 8 p.m.

In Sydney, arrangements for attendance can be made with Mr K. Knight, secretary of the Institution of Radio and Electronics Engineers, simply by phoning (27-1039). Similar arrangements will apply in Melbourne, where reservations can be made through Mr R. Crow, principal of the Royal Melbourne Institute of Technology (34-0234); in Canberra, Mrs Schultz, 44-361; and in Adelaide, Mr D. Cox, 233-866. ■

**RIGHT:** The nanosecond measurement model and experiment. Note that the two assistants are wearing dark clothing, deliberately chosen so that they are inconspicuous against the dark backcloth. The actual experiment apparatus is just below the hand of the assistant on the right.

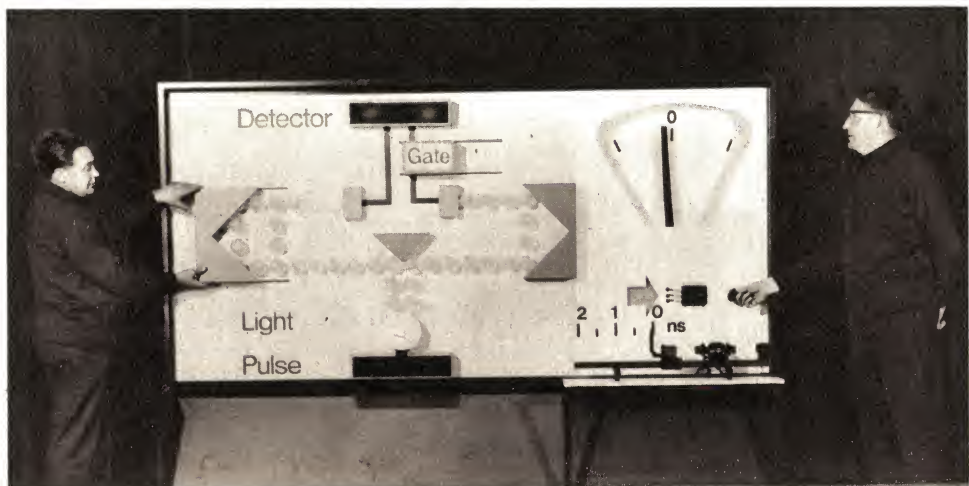



# This is the only projector your slides deserve

Do you fiddle with exposure, fuss over focus and then ruin all your results with fuzzy projection? It's not right! Your slides need a Paximat. Paximat needle sharpness is what they deserve. Only Paximat top quality optics will do justice to your slides.

Paximat 5000 & 3000 model projectors have Autofocus. A measuring beam adjusts the sharpness electronically. All you do is . . . insert the magazine, focus the first slide, set the interval timer (18, 15 or 30 secs.) and sit back.

Also changes slides manually and by remote control.

The 5000 model Paximat changes slides by radio control. A transmitter held in the palm of the hand changes slides forward and reverse over a distance of 18 ft.

With Paximat Automatic 35 mm projectors you can have the following accessories: condenser lens for super slides, lamp-economising switch, interchangeable lenses from 55 mm to 200 mm focal length and tape recorder synchroniser.

## *Paximat*

Select a Paximat projector from \$62.50.

5 models to choose from: Pico S, 1000, 1800, 2000, 3000, 5000.

See your camera store, department store, or chemist. Ask about the Paximat range of slide projectors.

Brochures from  
**Photimport Pty. Ltd.** Melbourne, Sydney, Brisbane, Adelaide, Perth.

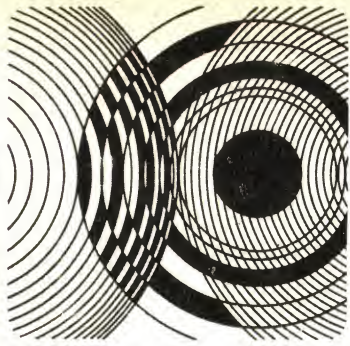

# TECHNICAL DIGEST

## Laser Altimeter used as calibrating tool

A pulsed laser altimeter developed in U.K. by Elliott Brothers (London) Ltd. will be used as a calibration tool for radio altimeters, which suffer from inaccuracies due to terrain penetration effects at radio frequencies.

It is not possible to use a laser equipment as a prime altimeter due to the degradation in performance under poor visibility conditions as a result of backscatter and attenuation of the laser energy. The equipment has been designed to operate in the environment of a combat aircraft and is at present undergoing acceptance trials in a Comet system in an altitude range of 15 to 2,000 feet and an accuracy of  $\pm 5$  feet or  $\pm 1\%$  whichever is the greater.

A block diagram of the system is shown in figure 1. The transmitter is mounted coaxially with the receiver to avoid parallax problems and make maximum use of the circular window area available in the trials aircraft.

The transmitter employs a gallium arsenide semiconductor laser diode which is mounted inside a vacuum Dewar flask and cooled to around 80°K. The vacuum envelope ensures low heat transfer from the outside of the Dewar to the cold laser, thus allowing high cooler efficiency and preventing mist-

ing of the Dewar exit window. It is necessary to operate at low temperatures in order to achieve a high laser efficiency — the quantum efficiency of the diode rises from 5% at room temperature to about 30% at 80°K. This high efficiency means that high peak laser output powers can be achieved with a reasonably low input current drive which can be generated by a practical drive circuit.

The laser requires a pulse drive current of 200A to achieve the maximum peak power output of 50W. The laser driver must further be capable of generating pulses of short rise time to achieve good accuracy of altitude measurement. These pulses are generated by discharging a low inductance capacitor bank, charged to 1KV, through a fast cold cathode switching tube. It is imperative in the design of this circuit that stray inductance is kept to a minimum if short duration, high current pulses are to be achieved. The circuit developed achieves a peak current of

200A, pulsewidth 30nS, and a pulse repetition frequency from 0 to 100 p.p.s.

The energy emitted from the laser diode is collimated by a transmitter lens of 6.5in (165mm) focus and 3.25in (82.5mm) aperture which produces a beam divergence of 6 by 2 mrad. The optical aberrations through the transmitter lens are minimised by the use of a four-element lens, the radii of curvature and the thickness of these elements being optimised to give minimum aberration. This optimisation was achieved with the aid of a computer program for ray tracing through the optics.

Energy emitted from the transmitter is reflected by the ground and collected by the receiver which takes the form of a Cassegrain telescope of 12 inches (30cm) aperture. After reflection by the primary and secondary mirror, the received light is brought to a focus at the field stop which defines the receiver field of view at 10 by 6 mrad. Light from the stop is then refocused on to a silicon photodiode of 2.5mm diameter.

The combination of the silicon photodiode detector and its associated pre-amplifier is designed to have a fast, low noise performance. The detector behaves as a current source and thus the pre-amplifier must have a low input impedance to achieve fast detection.

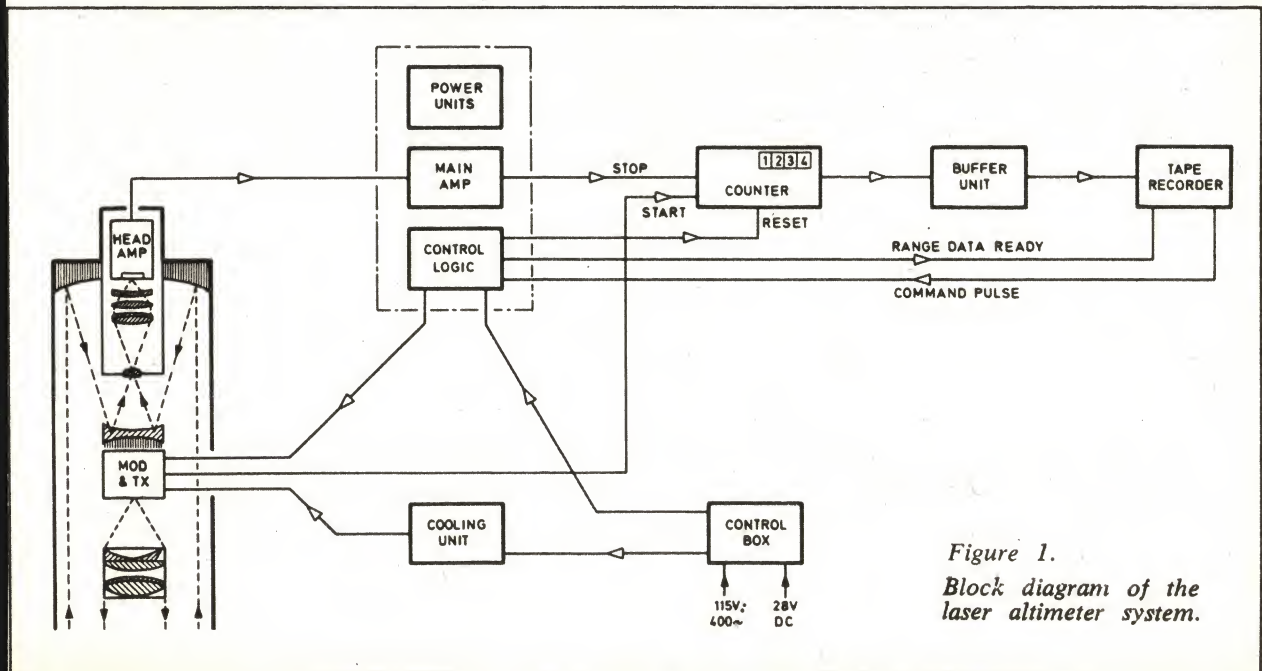

Figure 1.  
Block diagram of the laser altimeter system.

here is the one for the

# BIG SOUND

New Rola  
12U50 speaker  
with  
**50 watts  
RMS  
power!**

Now you can let them hear it — all of it. No need to keep it down — new Rola 12U50 is built for the big sound. It was developed specifically for the high power handling requirements of electric bass guitars. The 12U50 is a 12" speaker with all the power handling capacity you need — it is as tough as they come — and it bears the Rola label . . . your guarantee of quality and fidelity to the highest standards. It has been fully field tested under the most rigorous conditions.



#### Features

50 watts R.M.S. power handling over full range.  
Long, heavy gauge aluminium voice coil former for high thermal conductivity.  
Epoxycoated voice coil winding insulates coil against high temperatures generated at high power levels.  
Heavy duty voice coil connecting braids to prevent flexing fracture.  
Fully felted cone, with special rim treatment to provide large linear excursions without break up at high levels.

A leaflet detailing recommended Rola enclosures for 50 or 100 Watt systems is available on request. Complete Rola enclosures are also available.

**PLESSEY**  
**Rola**



Plessey Rola Pty Limited  
The Boulevard Richmond Victoria 3121  
Telephone 42 3921 Telex 30383  
NSW PO Box 2 Villawood 2163  
Telephone 72 0133

AR19

# COMPUTER-SIMULATED ACCIDENT STUDIES

**Cornell University's Aeronautical Laboratory (CAL) in the U.S.A. is conducting studies of road accidents using computer-simulated models representing various accident situations.**

A virtual-earth amplifier therefore represents an ideal choice, an operational amplifier being the most convenient form of this circuit. The optimum choice of input device is a low noise FET which provides the best noise performance and adequate speed of operation. The detector/pre-amplifier assembly achieves an equivalent input noise power of 50nW RMS at a bandwidth of 25MHz.

Output from the pre-amplifier is further amplified with a video amplifier which raises the voltage level to around 5V for driving the counter (see below). The amplifier gives a voltage gain of  $10^6$  and will deliver 8V into 50 ohms with a rise time of 10nS. This amplifier employs a common base input stage giving an input impedance of 50 ohms. The remainder of the amplifier consists of cascaded shunt feedback pairs and the low output impedance is provided by a double emitter follower.

The height accuracy required for the altimeter is  $\pm 5$  feet which dictates an accuracy of transit time measurement of approximately  $\pm 10$ nS. This may be achieved with a high speed counter/timer (i.e. around 100MHz) or by the use of an analogue technique where the height reached by an accurate ramp function is used as a measure of transit time. Available systems using the latter technique operate in a "search and lock" mode which prevents the tracking of rapid height changes. For the present application the digital approach was adopted and employs a high speed counter which has the necessary 10nS resolution. This provides a facility for height measurement each time the transmitter operates (i.e. integration over a number of pulses is not required) and will therefore readily follow step changes in height. The digital technique provides the further advantage of an ergonomic, high accuracy digital altitude display and a b.c.d. output suitable for driving computer interface equipment.

The counter is started by a sample from the transmitter current pulse and stopped by the returned signal pulse from the video amplifier. A counter clock frequency of 98.3312MHz is used which results in a readout in feet. The velocity of light under typical conditions is  $.983312 \times 10^9$  feet per second. Therefore, light travels 10 feet in 1 count and with the go and return path for the laser beam one count represents an altitude of 5 feet. The accuracy of the relationship, that one count equals 5 feet, depends on the stability of the crystal clock and the variation in the velocity of light. The clock is accurate to one part in  $10^7$  per day and likely atmospheric variations will only affect the velocity of light by one part in  $10^4$ . It is obvious that these errors are negligible in comparison with the allowed system accuracy. The counter resolution is  $\pm 1$  count which gives an altitude resolution of  $\pm 5$  feet.

The instrument also provides a BCD output which is used for feeding height information to the aircraft tape recorder. It is necessary to reset the counter on completion of each height measurement and this is provided by a reset pulse which is generated by auxiliary logic, synchronised to the altimeter transmitter pulse. The BCD output is reset to zero but the display has a memory such that the indication is only updated when the altitude changes. If

One project concerns a three-year study sponsored by the Bureau of Public Roads.

This study looks at the performance of the driver by simulating his possible courses of action in accident situations at intersections on the computer. The computer describes numerically and in detail the driver's processes of perception, decision-making and response as he passes through the intersection. By these means it can suggest techniques for training drivers, establishing traffic regulations and designing roads at intersections. Features are represented in the computer on a mathematical model, which reproduces in terms of equations and formulas the relevant characteristics of the vehicle, driver and highway.

The model deals with two simple cross-road intersections with stop signs or traffic light control. Fourteen characteristics of the intersection can be represented, including type of traffic control, road conditions, max. detection distance of the intersection and speed limits. Other factors which can be taken into consideration relating to the vehicle and the driver include the speed, acceleration and deceleration of the vehicle, the driver's braking tendencies, and braking response time.

The model can deal with a whole string of vehicles. Nonetheless it cannot completely simulate a real situation and certain limitations are imposed for the sake of simplicity. For example, all roads are two-lane, no overtaking, and no pedestrians, the intersection is on level ground and visibility is a constant. The model is, however, still being developed and may eventually be modified to incorporate some of these features.

The simulation of a particular incident involves the use of a number of routines, which together build up a picture of the relationship between the various factors involved.

The driver enters the central program when he is 600 feet from the intersection. At this stage his only concern is with the traffic ahead of him, and this situation continues until he observes the intersection. Once the driver detects the intersection, he slows down and prepares to pass through it. Here again, the distance and rate of deceleration are determined

by a number of variable factors. When the intersection is reached, the driver will stop, scan the road for other cars and proceed when it is clear.

The model has been validated from data gathered in laboratory experiments, investigations using real cars and drivers, and real-life observations at intersections.

In another CAL project a computer model is being used to study the causes and nature of accidents to pedestrians. The particular field of this study is the dynamics of the impact of the car on the pedestrian and is sponsored by the National Highway Safety Bureau.

The computer was used to simulate impact speeds of 5, 10 and 15mph under emergency braking conditions and of 20mph without braking, to define the trajectory of the "pedestrian" after impact. At 20mph the pedestrian somersaulted, hitting the bumper, the leading edge of the bonnet, the bonnet, windscreen and roof as he did so.

Although this is a preliminary study, results suggest that it can provide insight into the fundamental relationships involved in pedestrian collisions and thus lead to methods of reducing pedestrian accidents.

Another part of the research project was the behaviour of cars and their occupants in various accident situations.

The computer's results were produced in the form of animated cartoons, comparable to frames on motion-picture film. The time interval between frames could be varied, with a minimum in the region of 1/1000th of a second.

There are obvious advantages in using computer simulation for this work once its accuracy is satisfactorily established—notably the greatly reduced cost and the ease with which experiments can be repeated. ("Electronics Weekly," 10/12/69.)

*Computer simulated frames showing the body motions of a dummy in a collision. Compared with films of an actual crash, the computer results proved remarkably accurate.*



the counter exceeds its full count of 9995 feet without a receiver stop pulse being detected, then the counter automatically resets to zero to indicate "out of range." The counter gate cannot be opened and closed in an interval of less than 30nS and this prevents the counter being stopped by electrical or optical breakthrough from the transmitter to the receiver. The instrument was converted to operate from aircraft supplies.

The height measured by the laser altimeter, together with that simulta-

neously measured by the radio altimeter, is recorded on the aircraft tape recorder. The recorder is also provided with aircraft attitude information which is required to correct for the slant height measured by the laser system which is rigidly mounted to the airframe. These altitude measurements are synchronised with a photographic record of the terrain thus allowing a comparison between the altimeters under known conditions. ("Marconi Instrumentation," Vol. 12, No. 3).

# ADCOLA

## "M" SERIES PRECISION SOLDERING & DE-SOLDERING TOOLS

*"The soldered joint is the link between components in the most scientifically designed and developed apparatus the world has ever known. One faulty joint can upset the functioning of the apparatus."*

*"The first important decision in Radio or Electronics is the careful selection of a Precision Soldering Tool."*



FOUR "TRICLAD" TIP SIZES  
**M20 1 OZ. 1/8" DIA. TIP:** MICRO MINIATURE ELECTRONICS  
6 volt, 12 volt, 24 volt, 32 volt, AC/DC



FOUR "TRICLAD" TIP SIZES  
**M64 3 1/2 OZS. 3/16" DIA. TIP:** RADIO AND TV ASSEMBLY AND  
SERVICING  
230-250 volt and all lower voltage  
ranges AC/DC



TWELVE "TRICLAD" TIP SIZES  
**M207 4 OZS. 1/4" DIA. TIP:** RADIO AND TV SOLDERING AND DE-  
SOLDERING  
230-250 volt and all lower voltage  
ranges AC/DC

PRECISION MADE  
THOROUGHLY TESTED  
ACCURATELY CALIBRATED  
EASILY APPLIED  
EFFICIENT AND RELIABLE  
CORRECT TIP TEMPERATURE  
RIGHT TIP SIZE AND SHAPE  
LIGHT WEIGHT  
FINE BALANCE  
FINGERTIP GRIP  
SLIM BARREL  
CONSTANT OPERATION  
MAINS VOLTAGE APPROVED  
AVAILABLE ALL VOLT RANGES  
NO TRANSFORMER NECESSARY  
STANDARD IN R.A.N.  
STANDARD IN ARMY  
STANDARD IN R.A.A.F.  
STANDARD IN P.M.G.  
STANDARD IN COMPUTER FIRMS  
STANDARD IN SPACE TRACKING  
AUSTRALIAN MADE  
SERVICE IN ALL STATES.  
QUALITY GUARANTEED

# ADCOLA

Available from all Principal Radio and Electrical Components Suppliers  
Further information is available from:  
N.S.W.: Adcola Products Pty. Ltd., 17 Burwood Rd., Burwood, N.S.W. 747-1606  
S.A.: F. R. Mayfield Pty. Ltd., 11 Halifax Street, Adelaide. Tel.: 8-4131.  
QLD.: T. H. Martin Pty Ltd., 56-74 Edward Street, Brisbane. Tel.: 2-0555.  
W.A.: Everett Agency Pty. Ltd., 17 Northwood St., West Leederville. 6007. Tel. 8-4137  
ADCOLA PRODUCTS PTY. LIMITED, 22 FIRTH STREET, DONCASTER, VICTORIA. 3108.  
Tel.: 848-3777.





# ALTERNATIVES FOR THE JERVIS BAY ATOMIC POWER STATION

Overseas countries are vying for the contract to build Australia's first atomic power station to be located at Jervis Bay (130 miles south from Sydney). This article explains some of the alternatives available — the various systems from which the final choice will have to be made.

Current nuclear reactors can be conveniently classified under three headings, according to whether they use:

- Light water, heavy water or graphite for moderation.

- Gas, light water or heavy water as the coolant.

- Natural or enriched uranium for fuel.

In a nuclear power station's radioactive pile, atoms of the uranium isotope U235 are split by the impact of neutrons (nuclear particles carrying no electric charge), producing in the process more neutrons to carry on the chain reaction. The neutrons emerge at speeds of about 6,000 miles a second, too fast to carry on the reaction efficiently.

Their most efficient speed, as far as splitting lots of P235 nuclei is concerned, is about one mile a second. To slow them down to this speed, some material is needed to moderate their velocity — hence the term moderator. Graphite, water and beryllium are particularly good materials for this; and the first two are the most commonly used substances. The water can be ordinary tap water ("light water" in the trade) or a variant known as heavy water.

The ordinary hydrogen atom, the simplest element there is, consists of one proton in the nucleus and one electron circling around. In a rare isotope of hydrogen, the central proton is joined by a neutron to form heavy hydrogen (or deuterium). In ordinary water, perhaps one molecule in 5,000 has heavy hydrogen instead of ordinary hydrogen. And if these molecules are separated out (by a fairly expensive process) you have heavy water. If you don't want the expense of a heavy water plant, you can use light water — but at a price.

Heavy water soaks up just the right proportion of neutrons for a pile run on natural uranium — that is, one where the fuel rods contain only 0.7 percent of the fissile U235. Light water soaks up too much — to keep the pile going satisfactorily you have to step up the proportion of U235 by using enriched fuel.

The choice thus becomes natural uranium and expensive heavy water moderation, or enriched fuel with light water or some other relatively inexpensive moderator. The coolant is needed to transfer the heat from the pile to the actual generating part of the station.

The American General Electric reactor uses boiling light water as the moderator and also as the coolant, while the Westinghouse version uses pressurised light water (preventing boiling) to

take the heat to a heat exchanger for production of steam. Both are thus light water systems, using heavily enriched fuel. They are also on the low side as far as capital costs are concerned — \$100 million has been quoted as a rough estimate of the possible cost of an American 500 megawatt station at Jervis Bay.

Enrichment of uranium, for a pressurised light water 500MW station on high load factor (that is, running continuously) to about 3 per cent U235, would cost about \$2 million a year, if done in the U.S.

Very roughly, the total cost of enriched fuel runs out at one-third for the original uranium oxide, one-third for enrichment and one-third for processing into fuel elements. So the total cost of fuelling might be around \$6 million a year.

Britain over a number of years built 10 nuclear power stations using natural uranium fuel, graphite as the moderator and carbon dioxide as the coolant; these are the gas graphite stations. They now have an improved version known as the advanced gas cooler reactor, still using graphite and carbon dioxide, but with slightly enriched uranium fuel.

Work has also been going on in Britain on a prototype 100MW station using a hybrid system — heavy water moderation, to reduce the amount of fuel enrichment needed, light water as the coolant, and slightly enriched uranium as the fuel. This is the Steam Generating Heavy Water Reactor, or SGHWR.

The Australian Atomic Energy Commission had high hopes that this system could be modified to work on natural uranium, meeting the Commission's requirement of independent Australian nuclear fuel supplies. Twenty Australian experts spent two years in the U.K. working with the British on this prospect, but the results were disappointing. However, with the possibility that Australia might acquire access to the newer, much cheaper method of fuel enrichment known as the gas centrifuge ("Electronics Australia," August, 1969), British chances of putting the SGHWR into Jervis Bay have revived.

The package deal would be more economic than alternative proposals for natural uranium reactors — provided a series of reactors are built, this point needs underlining — if the enrichment technology is available and is acquired, then Australia will pretty well be committed to erecting a series of nuclear power stations to make economic use of the enrichment plant.

Unless, that is, export contracts for

the enriched fuel surplus can be negotiated — or military uses are found for the surplus production. It is a point to be looked at very carefully between March this year, when the official tenders are finally expected to be called, and September when, on present plans, the contract will be awarded.

Natural uranium reactors are possibly available from Canada, Siemens in West Germany, A.S.E.A. in Sweden and Gesell in France. However, only the Canadians and the West Germans have actually exported or contracted to export working systems. A 500MW nuclear station to the CANDU (for Canadian Deuterium Uranium) design could cost between \$125 million and \$150 million.

CANDU reactors use natural uranium and heavy water moderation, largely through historical accident. With two moderation systems available — heavy water and graphite — the U.K., France and Canada at the beginning of World War II got together as much heavy water as possible and carried it to safety in Canada.

The Canadians have stayed on that line of development since. They now have eight nuclear power stations using the CANDU system built or committed.

They include a 3,000MW station made up of four 750MW units for Ontario, and installations for India and Pakistan.

Australia would need about 500 short tons of heavy water to start off a CANDU reactor, for a cost estimated at \$22 million.

This assumes a price of \$22 a lb, compared with current prices of \$28.50 a lb, on the argument that increases in the supply of heavy water will bring down prices.

At current prices, it would cost \$28.5 million.

A natural uranium power station would need about eight tons of heavy water a year to make good operational losses, costing about \$350,000 a year.

The Canadians claim that the total cost of fuelling a CANDU reactor is one-half to one-third the fuelling cost of any other big commercial reactor in the world.

It will take a lot of savings on fuel over a long period of time to make up for the difference between just over \$50 million for a coal-fired unit and \$150 million as the upper limit for a CANDU nuclear reactor.

The relative advantage of the coal-fired stations lessens as you move away from the coalfields.

Either transmission lines lengthen, with resultant power losses, or coal has to be transported to a local power station for a cost which increases with distance.

For this reason, industrial centres in southern Australia look better prospects for nuclear power than do Queensland and N.S.W., which are well supplied with major black coal deposits. (Condensed from an article by Christopher Jay, "Financial Review," 7/1/70.) ■

**brand five**

magnetic recording tape

# DISCOUNT PRICES!

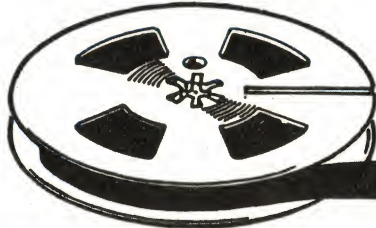

**AUSTRALIA'S  
BEST VALUE!**

from

## DIRECT TAPE DISTRIBUTORS

"BRAND 5"—unconditionally guaranteed and manufactured to highest USA professional standards. It's sensationally priced at half that of comparable tapes.

"BRAND 5" has high remanence iron oxide emulsion coated to highest grade Acetate or Mylar base material.

"BRAND 5" ensures unmatched results in high fidelity mono and stereo recordings, with certain protection against head wear, squeal and gumming of heads.

**OUR  
PRICE**

LENGTH	TYPE No.	DESCRIPTION & MIL. THICKNESS	NORMAL PRICE		
<b>7" REELS</b>					
1200'	15D7	1.5 ACETATE	6.60	3.00	
1800'	10D7	1.0 ACETATE	7.25	3.25	
1800'	10D7M	1.0 MYLAR	9.15	3.99	
2400'	5D7M	.5 MYLAR	10.40	4.75	
2400'	5D7MT	.5 TENSIL MYLAR	11.90	5.25	
3600'	5D7MS	.33 MYLAR	13.20	6.75	
<b>5½" REELS</b>					
1200'	10D57	1.0 ACETATE	5.50	2.55	
1200'	10D57M	1.0 MYLAR	6.00	2.95	
1800'	5D57M	.5 MYLAR	8.90	3.75	
<b>5" REELS</b>					
600'	15D5	1.5 ACETATE	3.40	1.80	
900'	10D5	1.0 ACETATE	4.15	1.98	
900'	10D5M	1.0 MYLAR	5.32	2.25	
1200'	5D5M	.5 MYLAR	6.95	2.50	
1200'	5D5MT	.5 TENSIL MYLAR	8.70	2.75	
1800'	5D5MS	.33 MYLAR	9.60	3.75	
<b>CORRESPONDENCE TAPES</b>					
<b>3½" REELS</b>					
900'	3D32MS	.33 MYLAR	3.90	1.95	
<b>3" REELS</b>					
150'	15D3	1.5 ACETATE	.95	.50	
225'	10D3	1.0 ACETATE	1.20	.65	
225'	10D3M	1.0 MYLAR	1.65	.70	
300'	5D3M	.5 MYLAR	1.95	.85	
600'	3D3MS	.33 MYLAR	3.30	1.60	
<b>CASSETTES</b>			C30	3.10	1.55
			C60	3.50	1.65
			C90	4.75	2.65

**SAVE  
over  
50%**

**SEND THIS COUPON WITH YOUR ORDER TODAY!**



### DIRECT TAPE DISTRIBUTORS

**BOX 3040, G.P.O. SYDNEY, N.S.W. 2001**

Please send me BRAND 5 Tape/s as per attached list.

I enclose \$..... covering purchase price  
PLUS Postage and Packing @ 10 cents per reel.  
Any surplus postage will be refunded.

NAME.....

ADDRESS.....

STATE..... CODE.....

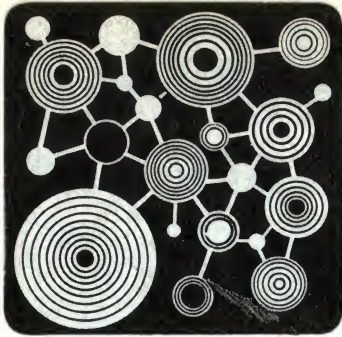

# SCIENTIFIC AND INDUSTRIAL NEWS

## Laser communications

Aerojet-General Corp., Calif., has been awarded a contract by the National Aeronautics and Space Administration (NASA) for the development of a laser communications experiment. It will be aboard NASA's Applications Technology Satellite-F (ATS-F) scheduled for launching from Cape Kennedy into a synchronous (stationary) orbit in 1971. Aerojet-General is required to develop the spacecraft laser equipment and ground equipment necessary to conduct laser communications experiments between the craft and a ground station. The system will require smaller antennas and may need less power and weight than is required for microwave systems.

In 1974 when ATS-G is launched, the experiment could be expanded to include spacecraft-to-spacecraft laser communications (teletype, voice, facsimile, colour TV and still photographs) between ATS-F and G spacecraft.

## UHF power diodes

An unexplained phenomenon in a solid-state device has been harnessed by RCA scientists to produce high power pulses of energy in the UHF band. The effect occurs in certain silicon avalanche diodes when they are placed in a circuit tuned to oscillate at frequencies lower than those at which the diodes are supposed to be able to oscillate. For reasons still not fully understood, when electrical pulses are now applied to the diodes, they abruptly enter an "anomalous mode" of operation and begin to produce microwave oscillations with powers and efficiencies comparable with electron tubes. Discovery of the anomalous mode and the development of the diodes is credited to a team of scientists in the RCA Microwave Research Laboratory headed by Dr Kern K. N. Chang.

By combining five PN diode junctions in one package, the team has succeeded in producing microwave pulses with peak powers above 1.2KW at frequencies up to 1GHz and with efficiencies above 25 per cent. Avalanching of the junctions is triggered by 130V pulses, but once microwave oscillations begin, 94V, 10A, 1μS pulses with 0.1 per cent duty cycle are used on each junction to achieve the 1.2KW output. Diode samples have been operated at the RCA laboratories without failure for more than 15,000 hours.

## Diagnosis by CCTV

A new medical use for closed-circuit television has been pioneered by the Department of Surgical Neurology of Edinburgh University and the Emergency Department of the Edinburgh Royal Infirmary. A television link, now operational, enables new patients at the infirmary to be examined by a specialist three miles away. If necessary, the specialist can direct the surgical staff to prepare an operation ready for his arrival. In this way, rapidly deteriorating conditions can be detected and treatment started with the maximum speed.

The new system was developed by Professor John Gillingham, neurosurgeon at Edinburgh Western General

## Heart/lung membrane

Research in the U.K. to design a heart/lung machine which is smaller, safer and more efficient than current machines has resulted in the development of a new membrane. Known as "Silestofilm," the rubber silicone membrane makes it possible to mimic the functions of the alveolar membrane within a living lung by eliminating the direct contact of oxygen and blood during oxygenation. The membrane's high permeability to oxygen and carbon dioxide makes it ideal for the type of machine under consideration. (Midland Silicones Ltd., Reading Bridge House, Reading, Berks., England.)

*A research worker positions a sample of the membrane on a manometer prior to testing its permeability to different gases.*

Hospital, together with the South-Eastern Regional Hospital Board, Scotland, and was engineered and installed by the Marconi Electro-Optical Systems Division. The Marconi V322A vidicon television camera in the Royal Infirmary accident unit is carried on a movable boom above the patient trolley, and has full facilities for panning, tilting and zooming. It can view the whole patient, or zoom in enough to inspect just one eye, as the specialist directs. The television signal is carried three miles from the Royal Infirmary to Professor Gillingham's office in the Western General Hospital by a GPO link. There is a permanent telephone link between the infirmary and Professor Gillingham's office on which he can be told of a new admission, direct the camera movements, or give instructions to prepare for an operation if necessary.

## Geological survey of Australia

Westinghouse Electric Corporation is to conduct a geological mapping survey of about 50,000 to 70,000 square miles in Australia and New Guinea using "Side Look Radar." (See "Electronics Australia," June, 1969, page 21.) The survey was due to begin in Western Australia early this year. Preparation of the radar mosaic maps and the geological interpretation of the maps will be done by the Automatic Operation of the Raytheon Company. Side look radar has been used to map 6,000 square miles of the Darien Province of the Republic of Panama, where the area is constantly covered by clouds making aerial photography impossible.

Westinghouse flew its specially equipped DC-6 aircraft to Australia to carry out the survey. The aircraft is a self-contained mapping unit. Every step of the process from the pulse transmission to film processing and evaluation is done aboard the plane by a highly skilled crew. Flying at 20,000 feet, the plane can map 1,500 square miles in an hour and can be used in adverse weather. The ability to rapidly collect images by day or night through all kinds of weather greatly shortens the initial exploration period for mineral and oil firms.





# HEAT EXCHANGERS

## FOR TRANSISTORS, DIODES, THYRISTORS

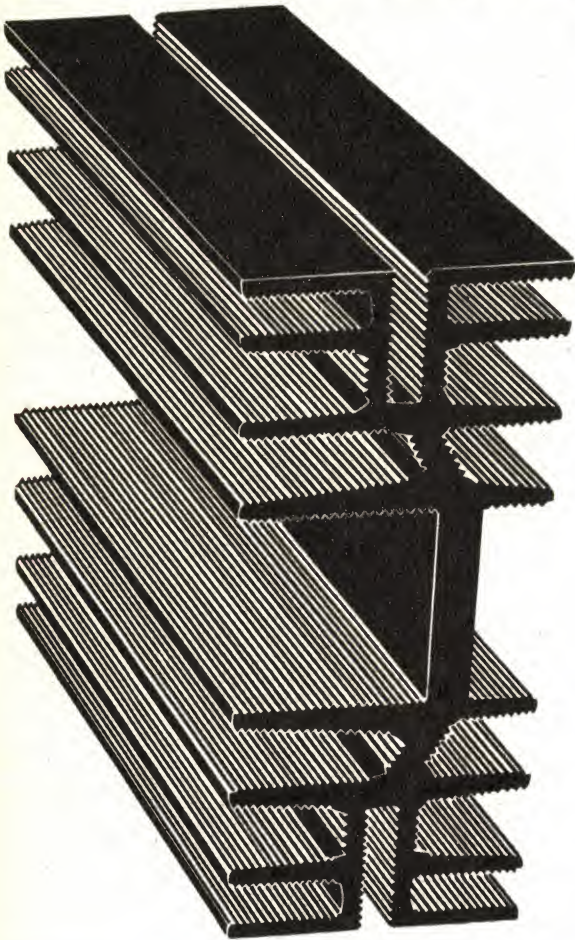

**NEW**



### MiniFin

**WITH**

**Hexafit mounting**

**FOR MEDIUM POWER**

**DIODES & THYRISTORS**

Hexafit, a new concept in mounting systems, is a unique feature of the new WF MiniFin. Although designed for 20 U.N.C., fluting allows any type threaded 1/4" bolt to be affixed in any of the six channels anywhere along its full length making easier, simpler mounting at **less cost**. No drilling or nuts are necessary. The bolts alone provide firm and rigid mounting.

The fluted surface allows high heat dissipation in compact profile. Offset mounting provides protection whilst the device is still accessible within the outline of the MiniFin.

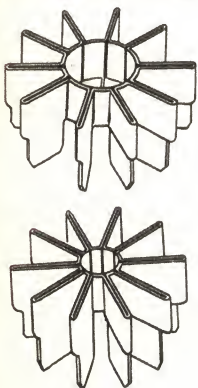

**TRANSISTOR**  
"Snap-on" Heat Exchangers

HE 101 fits JEDEC case styles to 18, 24, 28, 40, 44.  
HE 102 fits JEDEC case styles to 5, 9, 11, 12, 16, 26, 29, 33, 39, 42, 43, 45.  
HE 103 fits JEDEC case styles to 8, 38, 48.

Available ex stock



## WARBURTON FRANKI

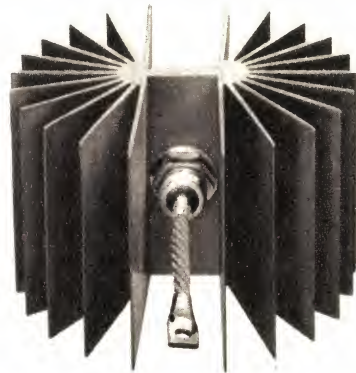

### FOR HIGH POWER DIODES & THYRISTORS

MULTIFIN EXTRUDED ALUMINIUM HEAT EXCHANGER enables FULL RATED OUTPUT to be obtained from a wide range of medium and high power semi-conductor devices WITHOUT THE USE OF COOLING FANS.

- MULTIFIN is available in:
- Plain lengths, cut to order
  - Anodised and machined lengths
  - Spot faced and drilled.
- ADELAIDE 56-7333; BRISBANE 51-5121; HOBART 2-1841; LAUNCESTON 31-3300; MELBOURNE 69-0151; MOUNT GAMBIER 2-3841; NEWCASTLE WEST 61-4183; PERTH 71-7744; SYDNEY 29-1111; WOLLONGONG 2-5444.

## Darwin booster station

The high power Radio Australia booster station established at Darwin commenced regular transmissions on December 20, 1969. This date marked the 30th anniversary of the inauguration of Radio Australia. The first transmissions emanated from Lyndhurst in Victoria on December 20, 1939. The three transmitters at Darwin are all rated at 250KW and all should be operating on full power by March, 1970. The Darwin station is located on Cox Peninsula, and was established at a cost of \$8 million. It picks up Radio Australia programs "off air" from Shepparton in Victoria, and retransmits them at greatly increased power to increase the effectiveness of Radio Australia transmissions to south-east and eastern Asia.

## Radio and TV expansion

A low-powered national television translator station is to be established on Mount Devlin, a ridge overlooking Collinsville in Queensland. The station will relay the programs of ABMQ at Mackay. It will use channel 11 with horizontal polarisation. It is hoped to have the station operating by the end of 1970, when it will provide an adequate service to the 2,000 residents of the town. The establishment of a commercial translator station is being considered.

A national broadcasting station to be established in north-west New South Wales will be located at Byrock between Nyngan and Bourke on the Mitchell Highway, about 79 miles north-west of Nyngan. It will operate with power of 10KW and use a directional aerial. It will take the regional third network programs of the A.B.C. It will provide a service to about 16,000 people in an area outside the service areas of 2CR Orange and 2NB Broken Hill. The station is expected to be operating within three years.

## Split screen CRT

Westinghouse Electric, of the U.S.A., has developed a cathode ray tube with a split screen — one part displays information in real time while the other displays information stored electronically by the tube. It thus combines the functions of a conventional CRT and a display storage

tube in a single device. Both areas of the tube can be used for continuous display, however, as the tube storage is done by an internal screen rather than by the persistence of a phosphor. The ratio of stored to non-stored area can be varied at the time of manufacture to suit the tube's application.

## Sounding rocket

A new type of sounding rocket for high-altitude geophysical research has been developed by Svenska Flygmotor, of Sweden. Called SR-1, the rocket can carry over 100lb of scientific instruments to a height of 120 miles. Main features of the unit are the hybrid rocket engine with superior handling characteristics and the attitude control system which radically decreases impact dispersion. In the SR-1 safety is ensured by the separation of the oxidiser from the fuel. The latter, developed by Flygmotor, has a high melting point, is smokeless, can be easily stored, and is easy and cheap to manufacture.

The attitude control system of the rocket removes the risk of descent anywhere but in the chosen area. Necessary side forces are generated by secondary injection of the liquid oxidiser in the supersonic part of the exit nozzle. The attitude - sensing device is a pneumatic floating-ball gyroscope, developed by the Swedish Defence Research Institute.

## Survey of WWV users

The National Bureau of Standards (N.B.S.) of the U.S.A. is considering changing the format of radio stations WWV and WWVH, two of four radio stations operated by the Bureau to provide accurate time and frequency information. N.B.S. is seeking the opinion of users on the present format and asking for suggested changes. A questionnaire has been sent to many users of the services, and information about the survey is broadcast on WWV once each hour. The questionnaire is on a machine-readable punch card, and participants punch out a "Yes," "No," or "No Opinion" in answer to 16 questions concerning the present format of the broadcasts. Additional comments are invited on a separate sheet of paper.

Station WWV has been transmitting standard radio frequencies on a regularly announced schedule since March, 1923.

## Versatile CCTV camera

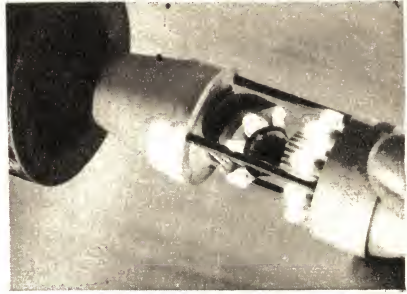

A closed-circuit television camera, no bigger than an electric torch and complete with its own miniature lighting set, has been developed in the U.K. It can be inserted into a 2½in diameter pipe (as shown) to examine a weld. For this it is fitted with a 90-degree viewing head, using a 45-degree mirror to see round a right angle corner. The head can be rotated by a remotely controlled miniature electric motor built into the camera viewing head. Pictures inside tubes of only ¼in diameter are possible using an introscope attachment. The range of screw-in attachments includes a waterproof head that can be operated at depths up to 500 feet for forward or right-angle viewing and fitted with quartz-iodine lighting. (Seer TV Surveys Ltd., Old Woking, Surrey, England.)

It first operated on the grounds of the Bureau in Washington, D.C. The station was moved several times, but remained in Washington until 1966, when it began broadcasting from its present location near Fort Collins, Colorado. Station WWVH began supplementing the services of WWV from Maui, Hawaii, in 1948. Both WWV and WWVH broadcast the same services on HF. N.B.S. also operates a LF and a VLF station (WWVB and WWVL) at the Fort Collins site.

All users of WWV who wish to receive the questionnaire should write to: WWV 1969, National Bureau of Standards, Boulder, Colo. 80302, U.S.A.

## W.A. radio and TV

A national television station and a national broadcasting station commenced operations recently in Western Australia. A television station to serve Geraldton began regular transmissions on December 8, 1969. A radio station to serve the Bunbury/Busselton area began transmissions on December 22, 1969. In the past 13 years, the Government and private enterprise between them have provided 140 TV stations throughout Australia.

The TV station at Geraldton, ABGW 6, is located on Moresby Range, seven miles north-east of Geraldton. It operates on 10KW of power, and takes its programs on relay from Perth over the recently installed coaxial cable system. The Bunbury/Busselton radio station, 6BS, operates on 2KW and covers not only the Bunbury/Busselton area, but also parts of the Margaret River/Augusta district, providing a service for about 26,000 people.

The commencement of television transmissions in the Kalgoorlie area, scheduled for December 29, was delayed due to last-minute equipment failures. The station, ABKW 6, is sited on Peter Hill, two miles north of Kalgoorlie. It will operate on 4KW and be beamed towards Kambalda and Coolgardie. It will take its programs from Perth via the completed section of the East-West microwave link.

## Computer service in Melbourne

The IBM Call/360 shared computer service (see "Electronics Australia," May, 1969, page 18) has been extended to Melbourne to provide an identical service to that previously operating in Sydney. Several terminals in Victoria were connected to the Sydney-based IBM System/360 Model 50, but the relatively high long-distance line costs restricted this

service. To handle the work load of terminals installed and planned in Victoria, IBM has installed a second System/360 Model 50 costing \$1.5 million in the company's data centre in St. Kilda in addition to the model which has been at the centre since February, 1967. (IBM Australia Ltd., Bradfield Highway and Kent Street, Sydney, 2000.)



The original IBM System/360 Model 50 installed at the IBM data centre in St. Kilda.

# Sansui

AMPLIFIERS ARE POPULAR BECAUSE THEY OFFER GREATER PERFORMANCE AT A MODERATE COST.

For over a quarter of a century Sansui has been Japan's leading manufacturer of high quality stereo amplifiers . . . today this progressive company is recognised as a leading *international* manufacturer. Over 75% of Sansui's total production sells rapidly on world markets — irrevocable proof of the acceptance of Sansui quality and reliability. *Simon Gray proudly presents three of Sansui's best selling high fidelity solid state stereo amplifiers.*

SANSUI MODEL  
**AU 222**  
— 46 WATTS

Using low noise silicon transistors throughout, the Model AU-222 features a frequency response of 20-30,000 Hz.  $\pm$  1dB. and a power output of 46 watts (music power). Input sensitivity suits magnetic cartridges at 2 mV. Performance of this compact stereo amplifier is quite outstanding and every desirable control is incorporated. List price is \$180 inc. sales tax.



SANSUI MODEL  
**AU 555**  
— 60 WATTS

Total music power is 60 watts and frequency response is 20-80,000 Hz  $\pm$  1 dB. Input sensitivity suits magnetic cartridges at 2 mV. Advanced circuitry is employed — low noise silicon transistors are used throughout. Controls are extremely flexible — audio quality is superb. List price is \$217 inc. sales tax.

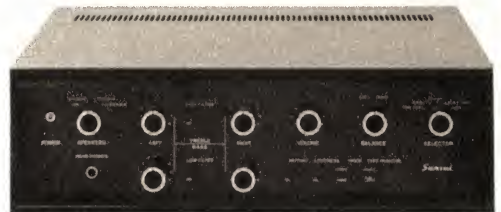

THE NEW  
SANSUI MODEL  
**AU 777A**  
— 70 WATTS

An extremely fine, all silicon transistor, stereo amplifier with a frequency response of 20-100,000 Hz  $\pm$  1 dB. at normal listening levels. Power output is 70 watts (music power) and input sensitivity suits magnetic cartridges at 2 mV. All desirable controls are incorporated. Price is \$321 inc. sales tax.



Every Sansui amplifier has many unique advanced features and offers flexibility and control unsurpassed in its price range. We invite you to see your nearest Sansui amplifier supplier and listen to these fine amplifiers. Ask for complete unabridged specifications. Examine the construction of Sansui equipment closely—engineering and electronics reflect Sansui's quality control in manufacture. Above all, listen. Hear the extraordinary difference Sansui quality makes!

SGS 10/69



Exclusive National Distributors (except W.A.):

**Simon Gray Pty Ltd.**

Head Office: 28 Elizabeth St., Melbourne Vic. Tel. 63 8101\*  
Sydney Office: 22 Ridge St., North Sydney, N.S.W. 929 6816  
Canberra Office: 31-33 London Circuit, Canberra City. A.C.T. Tel. 496050

INTERSTATE REPRESENTATIVES:

N.T.: Pfitzner's Music House, Smith Street, Darwin. Tel. 3801  
Q'land: Sydney G. Hughes, 154-158 Arthur St., New Farm, Brisbane. 58 1422  
S.A.: Eilco Sales Pty. Ltd., 7-9 Osmond Terrace, Norwood, S.A. Tel. 63 4844  
Tas.: K. W. McCulloch Pty. Ltd., 57 George Street, Launceston. Tel. 25322

## Visual approaches in bad visibility

A radar device that would enable pilots of Lockheed's L-1011 TriStar jetliner to "see" airport runways while landing in rain and fog has been successfully demonstrated in flight tests. The device, called an independent landing monitor (ILM), displays a realistic picture of the airport and runways on a screen in the cockpit. It is being developed by Texas Instruments Inc., of Dallas, Texas, to meet requirements for "new generation" wide-bodied jetliners, such as the TriStar, which will begin entering airline service late in 1971. It is claimed to be the first system permitting a pilot to visually monitor performance of an aircraft's automatic landing system during approach and touchdown under low visibility conditions.



The display screen of the Texas ILM system showing clearly a runway's image.

## Smog study in U.S.A.

Los Angeles is installing automated equipment to measure atmospheric pollution and weather conditions at 12 key sites once every 20 seconds. The system, designed by Litton Industries' Guidance and Control Systems Division, will automatically measure atmospheric changes and telemeter the information over telephone lines to Los Angeles County Air Pollution Control District. There it will be continuously analysed by computer and presented in instant pre-digested form to a control officer who will be able to issue public warnings if needed.

The system — Litton Industries Model 512 Quality Data Acquisition System — is designed for remotely measuring, telemetering, recording, processing and displaying information related to air and water quality parameters. The system achieves high reliability and ease of maintenance through the use of solid-state components and plug-in printed circuit boards. A typical monitoring program includes measurement of such phenomena as wind speed and direction, air temperature and concentration of sulphur dioxide, carbon monoxide, hydrocarbons, oxides of nitrogen and other contaminants. Output data is available for recording on magnetic tape, punched paper tape, typewritten page, visual displays or for connection to an external processor for subsequent data handling.

## The I.T.U. in 1969

The number of member countries of the International Telecommunication Union (I.T.U.) increased to 137 with the admission of Nauru (10 June, 1969) and Mauritius (30 July, 1969). The Study Groups of the International Consultative Committees held numerous meetings during the year. Among topics discussed were: the possible application of satellite techniques to direct broadcasting from satellites, to aeronautical and maritime navigation; traffic control communication; space communications; problems concerning standard frequency

and time broadcasts; and the possibility of standard time broadcasts based on an atomic standard. Further work was done to improve the standards for low cost sound and television receivers for use in new and developing countries. Work progressed on the preparation of a handbook to be used by monitoring stations in observing transmissions by all nations to check that they conform to the International Radio Regulations. The I.T.U. continued to assist in technical co-operation by sending experts to study special telecommunication problems, to train staff, and to operate some 15 training schools including an experimental earth station to train space radiocommunication specialists. Four seminars were held during 1969 on the following subjects: telecommunication management techniques; the improvement of sound and television broadcasting systems in Africa; recent progress in telecommunication techniques including the integration of satellite communications in the telecommunications network; telecommunication management techniques and network planning in Latin America.

Other sensing systems besides radar were evaluated for the TriStar's ILM, such as infra-red, low light level television, and image intensifiers. But radar appears to offer the best overall promise for overcoming restrictions imposed by bad weather, according to John Gorham, Lockheed's engineer in charge of TriStar flight guidance and controls.

Gorham emphasised that the ILM "is not intended in any way" to substitute for the TriStar's fail-operative automatic landing system, which will be a standard feature of the aircraft's avionics. The range of the display in clear weather is about five miles. Reduction in range caused by fog, rain or snow will be measured during flight tests. Lockheed's minimum ILM range requirement is two miles. Resolution of the display must be of such quality that a pilot can instantly recognise the runway, other airport features and any hazards in the approach and landing path. The ILM display will also show airport taxiways, permitting the pilot to taxi off the runway under low visibility conditions.

An ILM system, when fully developed by Texas Instruments and adopted by Lockheed, will be offered as an option to airlines ordering the TriStar. Lockheed believes the ILM's advantage for airlines will be to virtually eliminate costly go-arounds that could arise when jetliners begin landing at airports in poor visibility. Under such conditions, a pilot could misinterpret fleeting views of the ground in the final stages of landing and elect to circle the airport for another approach before touching down.

and time broadcasts; and the possibility of standard time broadcasts based on an atomic standard. Further work was done to improve the standards for low cost sound and television receivers for use in new and developing countries. Work progressed on the preparation of a handbook to be used by monitoring stations in observing transmissions by all nations to check that they conform to the International Radio Regulations. The I.T.U. continued to assist in technical co-operation by sending experts to study special telecommunication problems, to train staff, and to operate some 15 training schools including an experimental earth station to train space radiocommunication specialists. Four seminars were held during 1969 on the following subjects: telecommunication management techniques; the improvement of sound and television broadcasting systems in Africa; recent progress in telecommunication techniques including the integration of satellite communications in the telecommunications network; telecommunication management techniques and network planning in Latin America.

## Radio-telephone links

Areas up to 30 miles distant from Post Office telephone facilities can now be linked to the national telephone network by a simple and relatively inexpensive VHF radio-telephone link developed by Amalgamated Wireless (Australasia) Ltd. Following a year's testing of the new equipment under field conditions, the Australian Post Office has contracted to buy \$39,000 worth for installation in selected areas. (See "Electronics Australia," December, 1969, page 16.)

A.W.A. has also found considerable interest in South-East Asia and the Middle East, where earlier types of radio-phones have been supplied in quantity, often for use by industrial establishments in the outer suburbs of cities where there was no immediate prospect of normal telephone services becoming available.

## Electrical exhibition

Electrex '70, the 15th International Electrical Engineers' Exhibition, will be held in Earls Court, London, England, from April 8 to 15, 1970. The organising committee has announced a new award for Electrex '70. Formerly awards have been made for the best items in the industrial and domestic sections. Now a third award will be made for accessories. Among exhibits eligible for this section are switches, fuses, plugs, socket outlets, lampholders, ceiling roses, and other electrical accessories. During the exhibition, the British Electrical and Allied Manufacturers' Association is sponsoring a three-day International Conference on Electrical Insulation.

## Broadcasting convention

The third London International Broadcasting Convention, IBC '70, will take place from September 7 to 11, 1970, at Grosvenor House, Park Lane, London. It is sponsored by several professional bodies, including the Electronic Engineering Association, which is organising the exhibition aspects of the convention on behalf of the other sponsors.

The scope of IBC '70 takes in all aspects of television and sound broadcasting including: operational experience; receivers; studio design; propagation and service planning; origination equipment; recording; films; signal distribution, including wire relay; satellites; automation aspects of broadcasting; transmitters and transposers; aerials; digital techniques in broadcasting; technical management. All inquiries should be addressed to The Secretariat, International Broadcasting Convention, c/o I.E.E., Savoy Place, London W.C.2, England.

## Magnetospheric model

A magnetospheric model based on the theory of the interaction of the magnetised solar wind plasma with the earth's magnetic field was exhibited at a recent open day at the Science Research Council's Radio and Space Research Station in southern England. The line pattern is assumed to resemble the superposition of two simple vacuum fields namely a dipole field, corresponding to the earth's field, and an external uniform field corresponding to the interplanetary (solar wind) field.

The station's research program is concerned with the study of the propagation

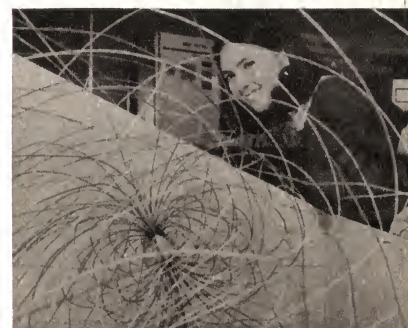

of radio waves and with related aspects of atmospheric physics and its application to the development of communications. Experimental and theoretical investigations include the effects of electromagnetic and particle radiation from the sun on the ionosphere and the influence of meteorological factors on the propagation of very short radio waves through the troposphere. Rockets and satellites are used as experimental tools; the station provides services for its own space science research groups and those elsewhere, notably in British universities. (Radio and Space Research Station, Ditton Park, Slough, Bucks., England.)

STOP RUST OUTDOORS 2 YEARS -- OR MORE!

# Lubricates Penetrates Stops Rust

DRY YOUR ELECTRICAL SYSTEMS  
with LPS — the NON-GREASY ONE

**STOPS  
Squeaks!**



LPS is NOT a paint, lacquer or a varnish, and will NOT damage paint, rubber, fabrics, plastics, or finishes.

## Displaces Moisture Fast!

### TECHNICAL INFORMATION

#### Physical Properties:

##### LPS I

Less than .0001 inch non-greasy molecular film with capillary action that spreads evenly and easily to seal out moisture at very low cost.

**Rust Inhibitor:** Protects all metals from rust and corrosion.

**Water Displacing Compound:** Dries out mechanical and electrical systems fast.

**Lubricant:** Lubricates even the most delicate mechanisms; non-gummy, non-sticky; does not pick up dust or dirt.

**Penetrant:** Penetrates to loosen frozen parts in seconds.

**Volume Resistivity per ASTM D-257;** Room temperature, ohm/cm;  $1.04 \times 10^{12}$

**Dielectric Constant per ASTM-877:**

**Dielectric Constant 2.14** Dissipation Factor: 0.02

**Dielectric Strength per ASTM D-150:**

**Breakdown Voltage 0.1 inch gap, 32,000 volts**

**Dielectric Strength volts/inch 320,000 volts**

**Flash Point (Dried Film)**

**Fire Point (Dried Film) 900 degrees F**

**TESTS AND RESULTS: 950 degrees F**

**Lawrence Hydrogen Embrittlement Test for Safety on High Tensile Strength Steels:** Passed. Certified safe within limits of Douglas Service Bulletin 13-1 and Boeing D6 17487.

**Mil Spec. C-16173D-Grade 3**

Passed

**Mil Spec. C-23411**

Passed

**Swiss Federal Government Testing Authority for Industry:** Passed 7 Day Rust Test for acid and salt water. Passed Weiland Machine Test for Lubricity as being superior to mineral oil plus additives.

LPS PRODUCTS CONFORM TO  
FEDERAL MIL SPECS  
C-23411 and/or C-16173D



LPS RESEARCH LABORATORIES, INC.  
2050 COTNER AVE. • LOS ANGELES, CALIF. 90025

## HOW LPS SAVES YOU TIME AND MONEY

1. LPS PROTECTS all metals from Rust & Corrosion.
2. LPS PENETRATES existing rust — stops it from spreading.
3. LPS DISPLACES moisture on metal—forms fine protective film
4. LPS LUBRICATES even the most delicate mechanisms at extreme temperatures.
5. LPS PENETRATES to free rust frozen parts, nuts, bolts, etc.
6. LPS PREVENTS equipment failures due to moisture (drives it out).
7. LPS LENGTHENS LIFE of electrical & electronic equipment—improves performance.
8. LPS RESTORES equipment damaged by water contamination & corrosion.
9. LPS PENETRATES AND PROTECTS plated and painted metal surfaces.
10. LPS PROTECTS metals from salt atmosphere, acid & caustic vapours.
11. LPS LOOSENS dirt, scale, minor rust spots & cleans metal surfaces.
12. LPS ELIMINATES squeaks where most everything else fails,

(SOLE AGENT)



**ZEPHYR PRODUCTS PTY. LTD.**

70 BATESFORD ROAD, CHADSTONE, VICTORIA—PHONE 56-7231

MANUFACTURERS OF RADIO & ELECTRICAL EQUIPMENT & COMPONENTS



## Yacht race communications

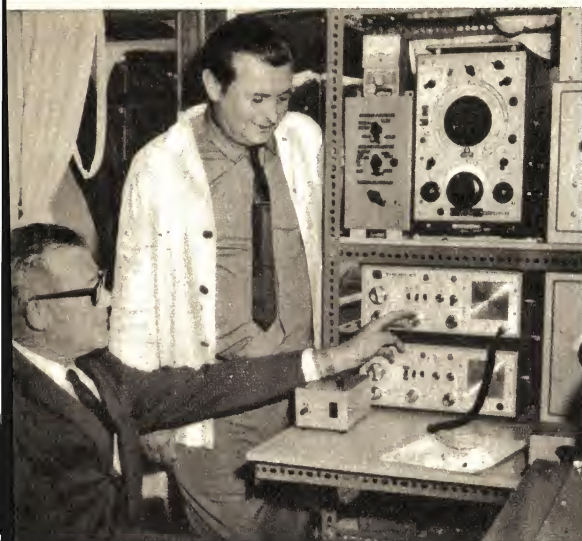

Mr R. Young, radio operator of the Cruising Yacht Club of Australia (left), and C.Y.C. assistant secretary, Mr D. Goode, with the A.W.A. communications equipment installed in the 75ft motor yacht Bali H'ai, the official radio relay ship which accompanied competitors in the 1969 Sydney-Hobart yacht race.

## Noise abatement

The Department of Civil Aviation will establish Airport Noise Abatement Committees in Sydney and Melbourne as a further step to help overcome present and future aircraft noise problems. The Committees will comprise representatives of C.A., local government, and the airlines, together with State Government representatives whenever they desire to be represented.

Terms of reference for the Committees include: informing the public on aircraft noise problems and the action being taken to alleviate the nuisance; maintaining a continuous liaison with airlines, community groups, and other interested authorities about possible noise nuisance to proposed housing and other community projects; discussing current aircraft noise problems and seeking satisfactory answers; acting as a clearing house for all specific noise nuisance complaints relevant to Mascot, Tullamarine and Essendon airports and co-ordinating resolution of complaints; recommending appropriate additional investigation and research into community noise problems associated with aircraft operations at these airports.

## Ergonomics conference

The Ergonomics Society of Australia and New Zealand is holding its Seventh Annual Conference at the University of New South Wales on August 13 and 14, 1970. The conference theme is Applied Ergonomics. Papers on selected topics from the fields of environmental studies, training and skills analysis, road safety, and ergonomics in medicine will be presented. People interested in attending or contributing papers to the conference are requested to write to the Conference Secretary at the following address: D. Goodridge, c/- School of Mechanical and Industrial Engineering, University of New South Wales, P.O. Box 1, Kensington, N.S.W. 2033.

## Spectroscopy courses

Analchem Consultants, in conjunction with Perkin-Elmer Pty. Ltd., are organising three-day training courses in atomic absorption spectroscopy, commencing in Sydney on April 6, 1970, and in Melbourne on April 27, 1970. The courses will cover both theory and practical work. Interested persons should contact Analchem Consultants, 18 Kendal Crescent, Collaroy Plateau, N.S.W. 2098, for further details or registration forms.

## Underwater rescue

The U.S. Navy is to have manipulating arms on its deep submersible emergency rescue vehicles. This will enable the rescue vehicles to pick up objects weighing up to 10lb, to remove mud and debris, to attach cables, and to cut lines. The 10ft-long arms were developed by Westinghouse for Lockheed, the prime contractor for the Navy's submersibles.

Movement of an arm is partly manual and partly programmed. Electronic controls, hydraulic actuators, and servo-valves cause the arm's six joints to rotate in a manner which ensures precise positioning. The arm may be jettisoned as a safety measure, separating at the shoulder joint. The arm's terminal device can also be

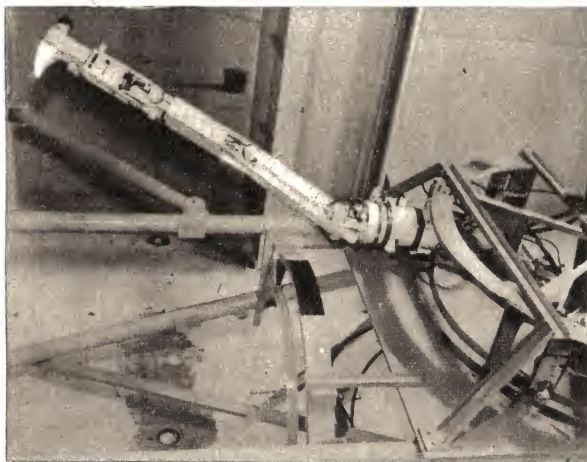

jettisoned. Stowing and unstowing of the arm is completely automatic. The bay into which the arm folds is out of the pilot's visual range.

*you may*  
**HEAR**  
*about*  
**QUAD**  
*now*  
**HEAR**  
**QUAD**  
*for yourself!*



If you have heard QUAD, you know what we are talking about. If you have only heard **about** QUAD let us at U.R.D. show you, tell you, demonstrate to you what Hi-Fi stereo is really all about.

Drop into our showroom and experience the sound of the best equipment in the world. Or send us the coupon below so we can post you a comprehensive brochure on QUAD giving you all the facts.

# URD

**UNITED RADIO  
DISTRIBUTORS PTY. LTD.**

**SHOP 32, ASH STREET,  
ANGEL ARCADE,  
SYDNEY.**

Telephone 28-3718, 28-3926.

Please forward me all available literature on QUAD.

Name .....

Address .....

..... State .....



## PART THREE

# Our New Communications Receiver

This is the third and final article describing our new receiver. It deals with the RF stages, the dial assembly, general assembly and inter-wiring, testing and alignment. In regard to the latter particular attention is given to the filter blocks in the IF system.

By Ian Pogson

Before proceeding with the description of the receiver, there are some errors which unfortunately crept into the parts list. We suggest that readers modify their parts list in accordance with the information given in Errata and Notes elsewhere in this issue.

The first mixer is assembled on a piece of tag board, with seven pairs of tags. As the layout is identical with that for the second mixer, we are not repeating the diagram. Sufficient details should be available in the under-chassis picture. The same comments and procedures as before apply for the transformers and the wiring of the diodes.

The RF amplifier components are mounted on two boards, each having 13 pairs of tags, and these in turn are fixed to a two bank, 2-pole 5-position rotary switch. Before proceeding with any further assembly, check the dimension between centres of the screws holding the switch decks. This should correspond approximately with the dimension between the third hole in from one end of the boards and the fifth hole in from the other end. More than likely, the holes on the boards will be a little too close together. These should be eased out to the right dimension with a slim taper file.

The four coils, L1, L2, L3 and L4, are mounted and terminated on one of the boards, according to the wiring diagram. The ends of the windings are terminated at convenient adjacent tags on the board. In the case of the lower frequency coils, which are wound with relatively fine wire, this is not enough to fix the coil securely to the board. This can be done simply by tying the toroid to the board with a piece of nylon or other suitable cord. While not so necessary with the coils wound with heavy wire, it is a good idea and en-

sures that they do not shift.

Next, the main component board is wired according to the diagram. Make sure that all the interconnecting wires are complete before any attempt is made to take the assembly of this board any further. The two capacitors in series with the tuning capacitor are not wired in at this stage.

The two boards, as assembled to this stage, are mounted on the end of the range selector switch and separated from each other and the switch with 1/4in-long spacers. The first step in assembly involves fitting the first pair of spacers to the rear ends of the two switch retaining screws. Generally, there is about 1-16in of thread protruding beyond the nuts. The screws used in MSP type H switches are 5BA and the threaded spacers which are readily available are 1-8in Whitworth. These dissimilar threads do not mate very well but, due to the short length of thread, it is possible to screw the spacers on, provided due care is taken. If you can substitute Whitworth screws, so much the better.

The board with the coils is mounted against the spacers at the end of the switch, with the coils away from the switch. The second board is spaced away from the coil board with the second pair of 1/4in spacers. Two round-head screws, 1-8in x 1/4in are used to secure the two boards to the spacers on the switch.

The assembly is now ready for the outstanding wiring and components. The various sections of the switch are used as follows. Only one section is used on the wafer nearest the clicker plate and this is used to switch the aerial into the primaries of the coils. The corresponding section on the other wafer switches the tuning capacitor to

the relevant series capacitors. The third section selects the top of the secondary of each coil. The wiring involves the interconnections between the various contacts on the switch and coils, together with the series capacitors. Where there is no series capacitor, a length of wire is substituted.

The dial system is the same as the one described for the 1967 All Wave series of receivers, but with a different scale. The basic movement is the planetary dual ratio unit, made by Jackson Bros., and distributed in Australia by Messrs Watkin Wynne Pty. Ltd. A backing plate, 6-3/8in x 3 1/2in, was made from 16 gauge aluminium sheet.

The dial scale is the same size as the backing plate and we used a piece of Formica board, one face finished in matt white. All lines are drawn with drawing instruments and Indian ink. Correct size photographic reproductions of the scale will be available through the Information Service, at 50c each. The alternative is to do the whole job yourself, along with the calibration which will be discussed later.

To add a finishing touch, we made up an escutcheon from a piece of 16 gauge aluminium. The outside dimensions are the same as the backing plate. The inside dimensions are 5 1/2in x 3-1/8in. The latter dimensions correspond with the cutout in the front panel, with four mounting holes also corresponding with holes in the front panel and backing plate. The escutcheon was given a coat of glossy black enamel.

This takes care of all the dial components, except the pointer. We made ours from a piece of 16 gauge copper wire, as follows. Take a piece of tinned copper wire, about 2 1/2in long. This is hammered flat, leaving about 1/4in round at one end. Use a hammer with a good smooth face and a hard, flat surface, such as part of a vyce. Use care and patience and keep hammering, not too hard, until a reasonably flat surface is obtained on one side. Turn the wire over and treat it in the same way. When the wire bends, it can be straightened, to allow the job to proceed properly.

Having done a reasonably good job

## CALIBRATIONS FOR ALL BANDS

up to this point, there will be undulations, due to uneven hammering. These are removed by carefully filing both flat faces. The edges can also be straightened up by a little filing. When you are satisfied with the finish, solder the round end to a small solder lug, with the pointer edge at right angles to the lug. Cut the pointer to length, with a 45-degree bevel and then give it a coat of black paint. The hole in the lug is used to fix the finished pointer to the movement, with one of the two screws supplied.

Although we did not fit a sheet of perspex over the dial, some readers may prefer to do so. A piece may be cut to the same outside dimensions as the escutcheon. The perspex is then fitted between the escutcheon and the front panel.

Assembly of the dial unit is quite simple but it is desirable to do it in a logical sequence. The movement is fixed to the back plate with two screws, using the holes adjacent to the 13/16in hole. Brass spacers can be used but this is not necessary. We used brass screws  $\frac{1}{4}$ in long and six nuts to give the right spacing. This method has the advantage that fine adjustment can be made to the spacing.

The backing plate is immediately behind the scale and the distance between the scale face and the back of the panel will need to be between  $\frac{1}{8}$ in and  $\frac{3}{16}$ in, according to space desired between the pointer and scale. One nut used as a spacer may be just insufficient and two nuts probably too much. A combination of one nut and one or more washers should give the desired spacing.

Push the four screws through the corners of the escutcheon and include the Perspex if used. The screws are then pushed through the corresponding holes in the front panel. Run a nut (with the washers) on to each screw. The nuts should not be tightened at this stage. Offer the back plate assembly over the four screws and tighten the nuts. Four more nuts behind the back plate hold the complete dial in place. Screw the pointer to the movement.

The dial which results is one which is capable of smooth, fine tuning control. This can be further improved by using a very large knob, which helps the vernier action.

As mentioned before, the dial movement is a dual ratio arrangement. This allows a quick transition from one end of the dial to the other, or to any desired point. The high ratio can then be used over a limited range, which is slightly less than one turn of the knob. Some readers may like this arrangement as it is. On the other hand, others may not like the rather heavy feel of the low ratio. This can be dispensed with permanently, leaving only the high ratio, by simply removing one of the two "dogs" which engage for the low ratio. In point of fact, we did alter ours by cutting off one of the dogs with a jeweller's saw. Travel across the dial is very little impeded by this change and feels rather better. Before making up your mind, remember that there is no turning back!

We are now in a position to undertake the final assembly. This is largely a matter of common sense, but it is possible to run into some traps, whereby an item already fixed has to be removed so that another item may be as-

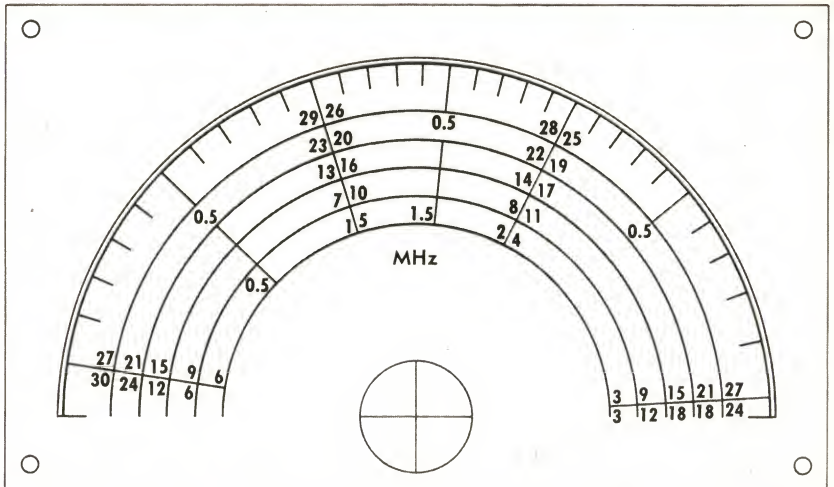

Dial calibrations provide for ten ranges, all of 3MHz. The smaller divisions are 100KHz apart. Any one range has all figures on one side only of each MHz division, i.e., all on the anti-clockwise side or all on the clockwise side. The lowest range (up to 3MHz) runs clockwise, the 3 to 6MHz range runs anti-clockwise (it being the tunable IF), and all the following ranges up to 18MHz run clockwise. The system crosses over at this point and all ranges from 18 to 30MHz run anti-clockwise. The 100KHz divisions on the outer radius apply to all ranges. Full size, glossy photographic reproductions of this scale are available through our Information Service for 50c, post free.

sembled. To avoid this as much as possible, here is a suggested order of assembly, with appropriate comments as we go along.

The main chassis partition should be among the first to be fixed, with grommets fitted to holes where leads are to be passed through. The single gang capacitor for the RF stage should be fitted next. Remember to provide a lead of hookup wire from the stator plates, running the lead through a hole immediately below the gang.

The front panel is next. This is held in place by the components which are fixed along the front skirt of the chassis. These include two toggle switches, pilot lamp, function switch, a bush for the extension spindle for the crystal selector switch, and the RF amplifier assembly. The crystal selector switch can also be fitted at this stage.

When screwing the power transformer in place, we suggest that you use  $\frac{5}{32}$ in Whitworth screws. We also stood the transformer feet off the chassis by placing an extra nut between the foot and the chassis. This reduces the transfer of heat from the transformer to the chassis. This is done to avoid undue chassis temperature rise, with less heat conduction to the oscillator coil in particular.

The rest of the major front end components, such as the crystal sockets, first mixer assembly and L5, may now be fitted together with the components along the back skirt of the chassis.

The tunable IF assembly and the 3-gang capacitor should be mounted in conjunction with each other, as screws for each are fairly close to the respective alternative item. Three leads from the stator plates of the gang should be provided, the input section lead being dropped through immediately below the lug on the gang. The other two leads

are brought through holes drilled about  $\frac{3}{8}$ in from the respective coil cans or L7 and L8. These two coils, with L6, may be mounted now. These may be followed by the noise silencer assembly, which is straightforward.

The filter block assembly, on its printed board, is mounted upside down, i.e., with the copper uppermost. This is to permit final adjustments during the alignment process. This is followed by the largest assembly of all, the IF amplifiers, AGC and BFO. However, before fixing it, we suggest that you decide which leads may be better soldered in place, to avoid an awkward situation later on.

The audio amplifier and power supply are the only remaining major items to be fixed under the chassis. These are stood off with  $\frac{1}{4}$ in diameter,  $\frac{1}{2}$ in long spacers. Flag heat sinks for the two output transistors and the AC128 — regulator transistor are held under the appropriate spacers.

Assuming that the dial has already been fitted to the front panel, as described earlier, the three potentiometers, meter and aerial capacitor may be fitted. The wiring board for the back of the meter may also be included.

The aerial capacitor, which is a 140pF maximum in the prototype, must be insulated from the panel. If the 140pF is not readily available, then one with a maximum of 100pF would do. The purpose of this capacitor is to afford control over the signal level into the receiver and so avoid blocking and cross-modulation on very strong signals.

On the other hand, it may sometimes be desirable to feed as much signal as possible into the receiver, particularly at the lower frequencies. A switch is shown across this capacitor in the main

## CHEST OF DRAWERS

Three types of Galvanised Chests measuring 17 $\frac{1}{2}$ in x 6 $\frac{3}{4}$ in x 11 $\frac{1}{2}$ in, containing 16 drawers, each measuring 6 $\frac{1}{2}$  x 3 $\frac{3}{4}$ in x 2 $\frac{1}{2}$ in.

- TYPE C.D.1. With 16 undivided drawers.
- TYPE C.D.2. With 16 triple compartment drawers.
- TYPE C.D.3. With 8 triple compartment drawers, and 8 undivided drawers.
- TYPE C.D.4. A 17 $\frac{1}{2}$ in x 11 $\frac{1}{2}$ in Galvanised Chest containing 4 full-length drawers each measuring 15 $\frac{3}{4}$ in x 6 $\frac{3}{4}$ in x 2 $\frac{1}{2}$ in.

The Chests are finished in blue hammertone stoving enamel, are complete with identification cards and packed in strong corrugated cartons. Provision is made for all units to be bolted together in tiers.

WRITE FOR FREE CATALOGUE AND PRICE LIST OF TOOL BOXES AND CHESTS OF DRAWERS.

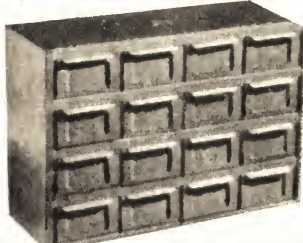

## COLOUR TELEVISION

With particular reference to the PAL system by G. N. PATCHETT  
This book now available  
**\$5.95**



## "PIPGRAS" HOLE PUNCHES

"PIPGRAS" Hole Punches are made from Alloy Tool Steel, and cut clean and accurate holes in sheet metal. They make a smooth, perfect hole without reaming or filing.

## SCREW TYPE, ROUND

Supplied with "UNBRAKO" High Tensile Socket Screws and Wrenches. Cut holes in sheet metal up to 18 gauge.

Type No.	Nominal Size	Actual Size	Water Pipe Size (I.D.)	Pilot Drill Size	Price Each
32.S	1/4in	0.507in	—	1/4in	\$2.17
40.S	3/8in	0.618in	1/4in	5/16in	\$2.17
48.S	1/2in	0.742in	3/8in	5/16in	\$2.80
56.S	3/4in	0.884in	1/2in	3/4in	\$3.80
64.S	1in	1.008in	—	3/4in	\$4.10
72.S	1 1/4in	1.133in	3/4in	3/4in	\$4.53
76.S	1 3/16in	1.172in	—	3/4in	\$4.53
80.S	1 1/4in	1.258in	—	3/4in	\$4.97
88.S	1 3/4in	1.382in	1in	7/16in	\$5.97

With Heat Treated, High Tensile Steel Hex. Head Bolt and Nut.

Cut holes in sheet metal up to 16 gauge.

96.S	1 1/2in	1.512in	—	9/16in	\$6.68
112.S	1 3/4in	1.762in	1 1/4in	9/16in	\$7.60
128.S	2in	2.014in	1 1/4in	9/16in	\$8.33

## BELLPHONE



Pick up the receiver and dial push number desired.

Large **\$13.50** per pair  
Small **\$10.12** per pair

## KALTRO SVC TV-RADIO REMOTE CONTROL LISTENER



This TV-Radio Remote Control Listener is a combination of an extension speaker and a remote control station to regulate the sound of both the TV, Radio, Phono, or Hi-Fi set and the speaker incorporated in the Listener itself. In addition, up to two earphones can be attached for listening to the sound of the TV, Radio, Phono, or Hi-Fi set without disturbing others around you. Unwanted commercials can be easily cut off by merely turning down the control of the TV-Radio Remote Control Listener. A modern designed plastic cabinet with easily adjustable fingertip controls ideal for use in home, office and business. Complete with earphone, 20ft of lead wire and installation instructions.

Price **\$8.75**

Trade enquiries  
prices available  
on application

★  
Free parking  
at Rhodes

★  
Phone:  
73-0211 Rhodes  
29-4451 City  
73-5586 Sat. Morning.

## THIS MONTH'S SPECIALS

Radar 1XR Power Supply **\$30.60**  
Radax 05XR Power Supply **\$20.40**  
Lapel Microphone X67 **\$00.90**  
Table Microphone BM3 **\$ 7.50**

## 8 WATT STEREO AMPLIFIER MODEL SA-80S



### SPECIFICATIONS

Output Power: 8 Watt, 4 Watts per channel.  
Frequency Response: 60 to 15,000 cps. plus or minus 1 db.  
Harmonic Distortion: Less than 3%.  
Hum and Noise: 52 db below rated output.  
Sensitivity: Phone (Crystal) 100mV 250K ohm.  
Tuner 100mV.  
Tube Complements: 12AX7x1. 30A5x2.  
1S151x1 (Silicon Rectifier).  
Dimensions: 5.1lb. 9 $\frac{1}{4}$ in x 6 $\frac{3}{4}$ in x 3in.

## BOOK SHELF TYPE SPEAKER SYSTEM MODEL SP-4S



Speaker: 4in. 8 ohms.  
Frequency Response: 70-13,000 cps.  
Sensitivity: 93dB.  
Power Input: 8W (Music Power).  
Cabinet Size: 9 $\frac{1}{2}$ in (H) x 6 $\frac{1}{4}$ in (W) x 5 $\frac{1}{2}$ in (D).  
Finish: Walnut lacquer.

## MODEL M6 FOUR CHANNEL TRANSISTORISED MICROPHONE MIXER



All four inputs accept standard two circuit Phone Plugs, while the output jack accepts a standard circuit Phone Pin Plug.

### SPECIFICATIONS:

● Input Impedance: "Hi" Impedance for Crystal Microphone, etc. ● Gain: Approximately 6 db. ● Maximum Input Signal: 1.5 volts. ● Maximum Output Signal: 2.5 volts. ● Output for Minimum Distortion: 2 volts. ● Hum: 0. ● Battery: 9 volts.

Mono **\$6.75** Stereo **\$9.75**

# GENERAL ACCESSORIES

(A DIVISION OF ELECTRONICS INDUSTRIES)

116-118 CLARENCE ST., SYDNEY 29-4451 443 CONCORD RD., RHODES 73-0211  
BOTH STORES OPEN SATURDAY MORNING FREE PARKING SPACE AT RHODES FOR CUSTOMERS

circuit diagram. This is to short out the capacitor for this condition. We provided the "switch" by applying a small bridge of solder across the outer ends of three of the rotor plates. When the capacitor is fully meshed the solder short circuits the rotor plates to the stators. This provides wide control over incoming signals, from the short-circuited position to the minimum capacitance position at the other end of the scale.

Having completed the major assembly, the remaining constructional task is to do the interwiring between units and add a few other items in the process. Most of the procedure will suggest itself at this stage but a few guiding comments may be of assistance.

In addition to the speaker outlet socket, which is the two-pin version of this line of miniature sockets, we have made optional provision for a five-pin

section of the switch is wired so that, on the STANDBY position, the leads are open, but are bridged in the RECEIVE position. Another section of the function switch is used to switch one lead of the mains to the primary of the power transformer. This is wired so that the mains lead is broken only in the OFF position, but bridged for both STANDBY and RECEIVE.

Although it may be a small point, the type of power transformer used may call for mention as to how it should be connected. Where there is one secondary winding of 12.6 volts, there is no problem. However, if there are two secondary windings of 6.3 volts each, they will be connected in series. In the case of two 12.6 volt windings, these should be connected in parallel, in the correct phase relationship.

The leads between the detector and the audio volume control are best run

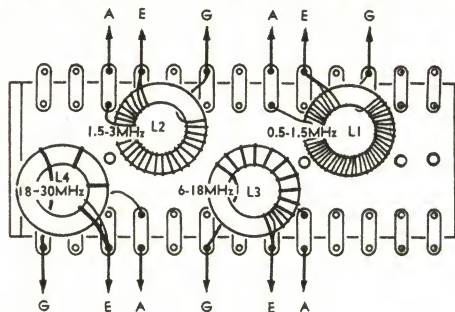

*This board is mounted nearest the switch and accommodates the four toroidal coils. The suggested terminations are clearly indicated and each coil should be firmly anchored, as mentioned in the text.*

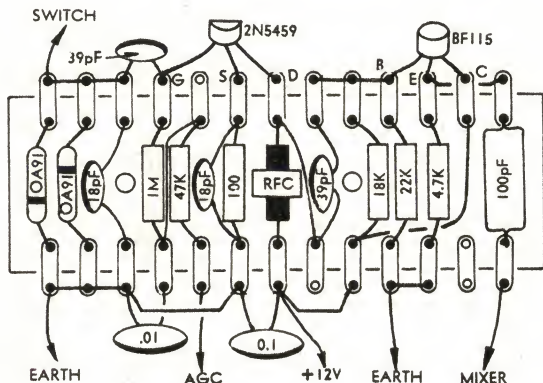

*This board which is stood off from the coil board, includes all other components for the RF amplifier. All wiring can be followed easily from this diagram.*

socket as an outlet for the 17.5 volts unregulated, 12 and 9 volts regulated, and earth. These voltages can be used for ancillary equipment associated with the receiver, provided the demand is within the current capabilities of each voltage.

A third socket, with four contacts, is reserved for any control leads which may need to be taken from the receiver, such as for muting. We have arranged a simple muting arrangement which breaks all the 12 volt supply to the receiver. The 12 volt lead from the power supply is terminated at one point on the socket. Another socket point is the feed point for all the 12 volt supply to the receiver. These two points may be taken externally to where contact may be made or broken, thereby activating or silencing the receiver.

So that this facility can also be controlled at the receiver, leads are taken from this socket to the function switch on the front panel. This is marked, OFF, STANDBY and RECEIVE. One

in shielded or coaxial cable (the light weight variety) to ensure that no hum problem arises from this source. We earthed the ends nearest the detector to a lug on the audio amplifier fixing screws. We also connected the coaxial shield lead to the case of the volume control. This point is also used as the earth connection for the S meter circuits, which are nearby.

The wiring of the two toggle switches on the front panel could be a little confusing and so we have drawn wiring diagrams for each. The selectivity switch presents no particular problem, but the SSB1, AM, SSB2 switch could take some working out. By following the wiring diagram, no troubles should arise.

The 14 volt indicator lamp on the front panel, should be wired directly across the 12.6 volt AC supply to the rectifiers.

Although the greater number of components for the tunable IF and VFO are on the assembly unit, in addition to

BUY RIGHT... FROM ENCEL

# SOUND

## solid state stereo amplifier

(AT AUSTRALIA'S  
LOWEST PRICES)

In every price range "Sound" amplifiers command respect... and a big share of the market. No wonder. More than adequate technical specifications... precise quality control in manufacture.



### SAQ-203

This compact model, so sensibly priced, is especially suitable for fitting into cabinets, bookshelves, etc. Frequency response: 30-20,000Hz. Input sensitivity 3mV. Output 14 watts RMS total. 18 low noise transistors... headphone/tape recorder jacks, attractive control panel.

Including sales tax **\$74.50**



### SAQ-505

Here is real value for money. Frequency response: 20-20,000 Hz plus/minus 1dB. Input sensitivity: 3 mV. Output: 50 watts RMS total. 20 low noise transistors. Tape/headphone jacks, tumbler switches control monitoring, volume, rumble. Every desirable feature.

Including sales tax **\$119.50**

### TRADE-IN

Yes Encel will be pleased to trade in your present equipment and thus Encel's prices (already the lowest in Australia) become even lower.

# ENCCEL

ELECTRONICS  
(STEREO) PTY. LTD.

Head Office:

431 Bridge Rd., Richmond, Vic. 3121. Tel. 42 3762.

Sydney Store: Ground Floor, 2SM Building,  
257 Clarence Street, Sydney, N.S.W. 2000.

Tel. 29 4563, 29 4564.

Wholesalers Trade-ins accepted Terms

Australia's Greatest Hi-Fi Centre



# BIG SOUND BIG SPEAKER

Pioneer lead the 'Pop' scene with the finest lead & bass guitar speakers



## 15" Guitar Speaker P-382

Voice Coil Impedance:	8 Ohms (P382B) or 15 Ohms (P382A).
Nominal Power:	60 watt.
Frequency Response:	60 - 5000 c/s.
Sensitivity:	103 db/watt.



## 12" Guitar Speaker 30-35Q

Voice Coil Impedance:	8 Ohms.
Nominal Power:	40 watt.
Frequency Response:	70/5000 c/s.
Sensitivity:	102 2db/watt.

Contact your State Office of **ASTRONICS AUSTRALASIA PTY. LTD.** (Sole Australian Agents, and a member of the Electronic Industries Limited Group of Companies) for your nearest dealer's address.

VIC: 161-173 Sturt St, South Melb. Phone 69 0300.  
 N.S.W.: 121 Crown St, E. Sydney. Phone 31 6721.  
 S.A.: 81-97 Flinders St, Adelaide. Phone 23 4022.  
 W.A.: 28 Belmont Ave, Belmont. Phone 65 4199.  
 TAS: 199 Collins St, Hobart. Phone 2 2711.  
 QLD: 50-54 Lt. Edward St, Brisbane. Phone 2 0271.



**PIONEER**

— THE BIGGEST SOUND AROUND

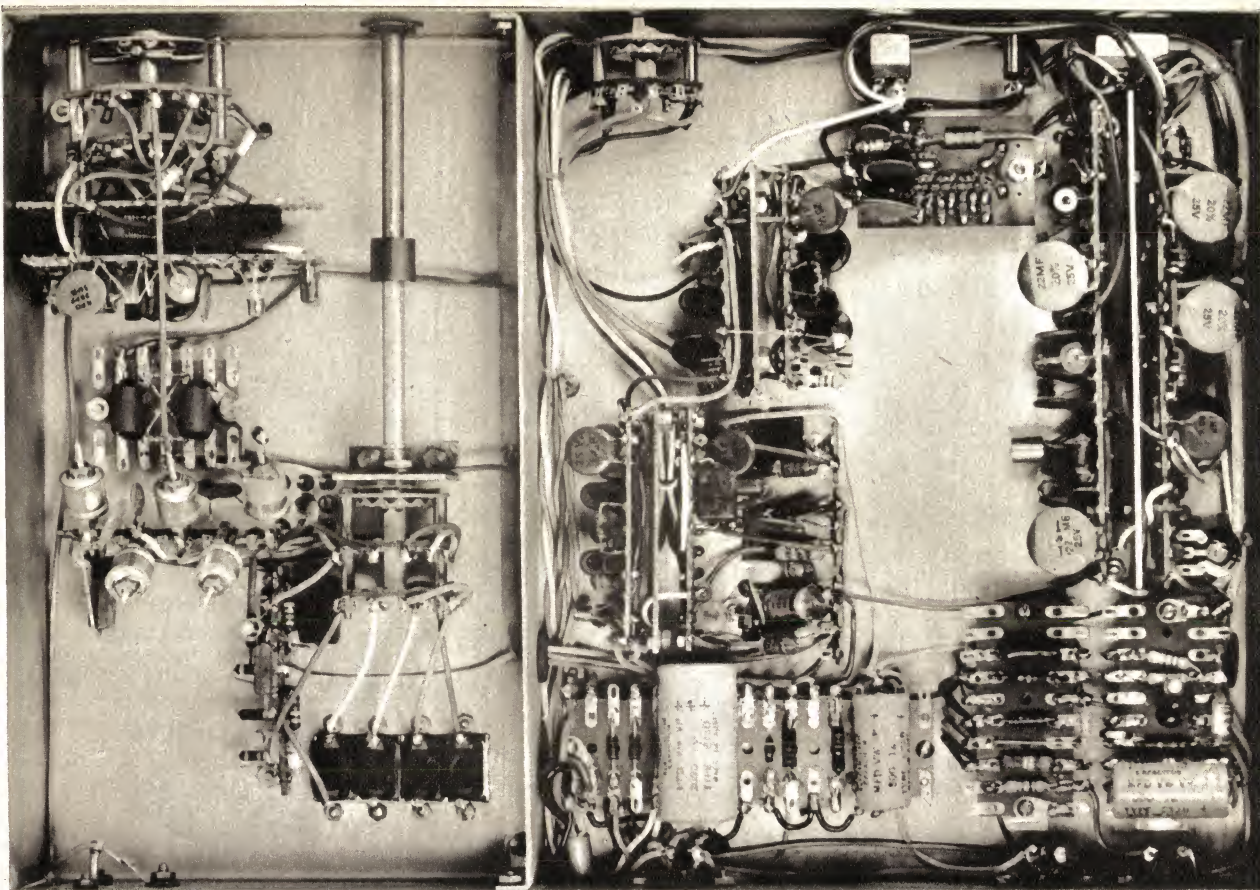

*Underchassis view showing the relative positions of the various modules which have been described in detail. At right of the partition are the power supply and audio amplifier at the bottom, the IF strip at the right, and the ceramic filter board at the top. To the left of the filter is the noise silencer, with the tunable IF just below it. Details of the front end, to the left of the partition, are shown in a separate picture on the next page.*

the three coils, there are a number of other components which are wired between tag strips and the coil lugs. A 2-tag strip is held under the oscillator coil screw, with 3-tag strips similarly mounted for the other two coils. Make sure that all wiring and components for the VFO are quite firm, to avoid instability due to vibration. All other leads should be kept as short as possible.

The crystal oscillator and amplifier-multiplier stages are so disposed as to keep leads as short as possible. The resistors and closely associated capacitors for both transistors are wired to a 10-tag strip and this is orientated so that it is conveniently located with respect to the switch, crystals, etc. This can be seen in the under-chassis picture.

Another 10-tag strip accommodates the five 3-30pF trimmers, and shunt capacitors where used, for tuning the amplifier-multiplier output. This tag strip is mounted at right angles to the other one, as may be seen in the photograph. One mounting foot of this tag strip, the one nearest the coil, is not used. We found it more convenient to cut it off and support the tag strip by soldering it directly to the earth lug of the coil.

Having completed the whole of the assembly and wiring, the receiver is all but finished, except for adjustments. Before carrying out the adjustments a careful check should be made of the whole wiring, to make sure that there are no omissions or errors. If all is well, switch on the power and check for any signs of distress. If none appears, we can proceed. First, make sure that the noise silencer is totally disabled, by turning off the switch on the silencer control. This is very important.

With no signals being fed into the

receiver, set the S meter to zero with the 1K tab pot. The first step of alignment is to tune L5 to 24MHz, 21MHz, 18MHz, 15MHz, 12MHz and 6MHz. Two methods may be readily used to obtain an indication of resonance. One is to use an RF probe with a VTVM, set to its lowest range. The probe is connected across the low impedance secondary of L5, which is the injection for the first mixer. This method has the disadvantage that it does not indicate the frequency of the output voltage.

The second method is to use a dip oscillator, set to its "wavemeter" position; i.e., the oscillator not working and the unit set to detect an RF field. This method gives a peak reading on the meter for tuning and it also gives the frequency of output. The choice is up to the resources of the reader. If you use a VTVM, connect the probe across the output winding and if you use a GDO, hold the coil close to the same lead from the coil to the mixer. The GDO will need to be set to the expected frequency each time.

Set the Tuning Range switch to 30-27 and set the dip oscillator to 24MHz. Adjust the slug in L5 for maximum deflection of the dip meter. If you are using a VTVM, tune for maximum deflection also. Set the Tuning Range switch to 27-24 and set the dip oscillator to 21MHz. Adjust the appro-

appropriate trimmer for maximum response. Set the Tuning Range switch progressively to 24-21, 21-18, 6-9 and 0.5-3 and adjust each trimmer in turn, for maximum response on 18MHz, 15MHz, 12MHz and 6MHz, respectively.

If it is not possible to adjust the slug or trimmer through the wanted frequency it may be necessary to make a small change in the value of the shunting capacitor. Inability to reach resonance at 24MHz, with the slug right out, would require that the 10pF capacitor be changed to 8.2pF. Once this slug is set it must not be touched when adjusting trimmers to the other frequencies.

The next job is to sweep align the IF strip, with the two filter blocks. Equipment needed is a sweep generator which sweeps 455KHz, and a CRO. These are set up in the usual way. A marker generator is not necessary, the object being to get the pass bands of the correct shape. Any deviation from the nominal frequency of 455KHz has to be accepted but will not amount to more than 1KHz or so anyway.

The AM detector of the receiver is used for this operation and its output may be taken from across the volume control, across the speaker voice coil, etc. and is fed to the CRO via a shielded lead. It should be noted that after the alignment of the IF strip no changes can be made to circuit values which could upset the pass-band shape.

# TRUSCOTT'S

## AUSTRALIA'S GREATEST MAIL ORDER TAPE RECORDER & HI-FI CENTRE

STOCKISTS OFF ALL LEADING BRANDS OF TAPE RECORDERS HI-FI EQUIPMENT, COMPONENT PARTS AND ACCESSORIES



### NEAT G30 TONE ARM

The G30, complete with lift-lowering device is a precision built tone arm, outstanding in appearance, and simple to mount, and use in any installation. The results obtainable are far beyond those usually expected from such a moderately priced tone arm. As with all NEAT tone arms, the G30 will accept all standard 1/2" mounting cartridges, including Ortofon and S.M.E. headshells without modification. REVIEWS from the "Gramophone" and "Electronics Australia" are available.

Price (Including Sales Tax) **\$24.00**

Other outstanding NEAT tone arms available include the G37 Static balance arm, and the revolutionary G32 "Gyrostat" professional arm. Send now for details and reviews.

### NEAT CARTRIDGES

V70—A top performance high quality moving magnet cartridge that out performs many more expensive cartridges. Input sensitivity 5mV. Frequency response 20-20,000Hz. Two models are available with replacement type diamond stylus. V70 with conical stylus — V70E with elliptical. When used with the NEAT G30 tone arm, an excellent low cost combination is obtained. Reviews from the "Gramophone" and "Electronics Australia" are available.

Price (Including Sales Tax) **\$11.25**

If elliptical stylus required add \$3.75.

V90—An economical moving magnet model for the budget conscious buyer. Input sensitivity 5mV. Frequency response 20-19,000Hz. Fitted with conical replacement type diamond stylus.

Price (Including Sales Tax) **\$8.50**

Other outstanding NEAT cartridges available include the V15 "Dynamagnet" and V60 "Induced" Magnet models, and the new V100 "Moving Coil" model complete with special transformers. Send now for details and reviews.

### ACOUSTIC SPEAKER GRILLE CLOTHS

Select your speaker grille cloth from the largest range in Australia. Over 60 top-grade cloths now available to choose from. Send now for samples and a very attractive T.M.Q.

### SPEAKER ENCLOSURE PADDING

Truscott's are the leading South Australian stockists of innerbond lining and Bonded Courteille filling. Ensure dust-free padding for your speaker enclosure. Send for a T.M.Q.

### SAVE YOUR RECORDS . . . USE THE UNIVERSAL LUSTRE TONE ARM LIFT



This beautifully finished and functional universal tone arm lift will fit all tone arms, the lowering action is pneumatically dampened and extremely smooth — risk of record damage may now be eliminated.

Price (Including Sales Tax) **\$8.50**

### ACCESSORIES

Microphones and Stands — Tapes and Spools — Splicing Kits — Record Care Accessories — Speaker Enclosure Acoustic Cloth and Inner Baffling — Headphones — Pre-packed Leads — Plugs and Connectors — Head Cleaning Kits — Pillow Phones — Bases and Covers, and Many Others.

### Fast Mail Order Service

When ordering, please give your full address printed in BLOCK LETTERS. All Truscott equipment is brand new and fully guaranteed. Sales tax is included in all quoted prices. All orders are despatched promptly. All prices quoted are Nett. Postage and freight extra. Note. T.M.Q.—Truscott Mail Order Quote.

### COMPONENT PARTS

Truscott's are stockists of all General Electronic components, including resistors, capacitors, plugs and sockets, solder, scope irons and spares, hook-up cables, valves, terminals, tag strips, matrix board, cambric spaghetti, fuses, chassis, grommets, solder lugs, alligator clips, valve sockets, D.I.M. connectors, TV connectors, battery savers, and also a large range of semi-conductors for all Japanese makes.

### HI-FI TRANSCRIPTION Turntable Combination

Consists of the one and only J.H. Synchronous Turntable, Neat G30 tone arm with lift-lowering device, Neat V70 Magnetic Cartridge, and hand finished oiled TEAK Wooden base with separate plexiglass dust cover.

Price (Including Sales Tax) **\$85.00**

If assembly required—add \$6.00.

### HEADPHONE JUNCTION BOX

Elega JB3 Stereo Headphone junction box with facilities for 2 sets of headphones. You can now add a headset to your amplifier even if it is not fitted with a headphone jack.

Price (Including Sales Tax) **\$4.50**



### STEREO HEADPHONES

A complete range of top brand HI FI Stereo Headphones is available. Price (Including Sales Tax) **\$7.50** from only . . . . .

Models available include:  
 Ashidavox ST11—8 ohm—20-18,000Hz \$11.50  
 Elega DR65C—8 ohm—30-15,000Hz \$19.50  
 Hosiden DH-03S—8 ohms—20-18,000Hz \$8.75  
 Elega DR65C—8 ohm—25-17,000Hz \$17.50  
 Kalfro DH-02S—8 ohm—20-12,000Hz \$7.50  
 Elega DR75C—10K—25-17,000Hz \$19.50

Choose your equipment from the following selection of top brands—and ask for a T.M.Q.

### TAPE RECORDERS

Alwa, Akai, BSR, Incls, Kriesler, National, Philips, Revox, Sony, Tandberg, Tesla, Thorn Atlas, Uher etc.

### TURNTABLES



BSR, Dual, Goldring, Lenco, JH, Labcraft, PE Thorens, etc.

### AMPLIFIERS

Akai, Compac, Cosmos, Kenwood, Leak, Linmark, Monarch, Sansul, Sony, etc.

### STONE ARMS AND CARTRIDGES



ADC, All Balance, Audio Technica, Decca, Dual Goldring, Neat, Ortofon, Shure, SME.

### SPEAKERS

Akai, Kenwood, KEF, Leak, MSP, Philips, Rola, Soundmaster, Soundwood, Sony, Tesla, Wharfedale.

### TUNERS

Compac, Sansul.

### DICTATION MACHINES

Agavox, Grundig, Philips.

### SLEEP LEARNING EQUIPMENT

All requirements for sleep learning equipment available including Pillow Speakers \$4.50, Endless loop tapes \$8.86, and Time Clocks \$25.00.



# TRUSCOTT ELECTRONICS

AUSTRALIA'S GREATEST TAPE RECORDER & HI-FI CENTRE  
 62-64 HINDMARSH SQ. ADELAIDE, 5000 Phone: 233024 233278



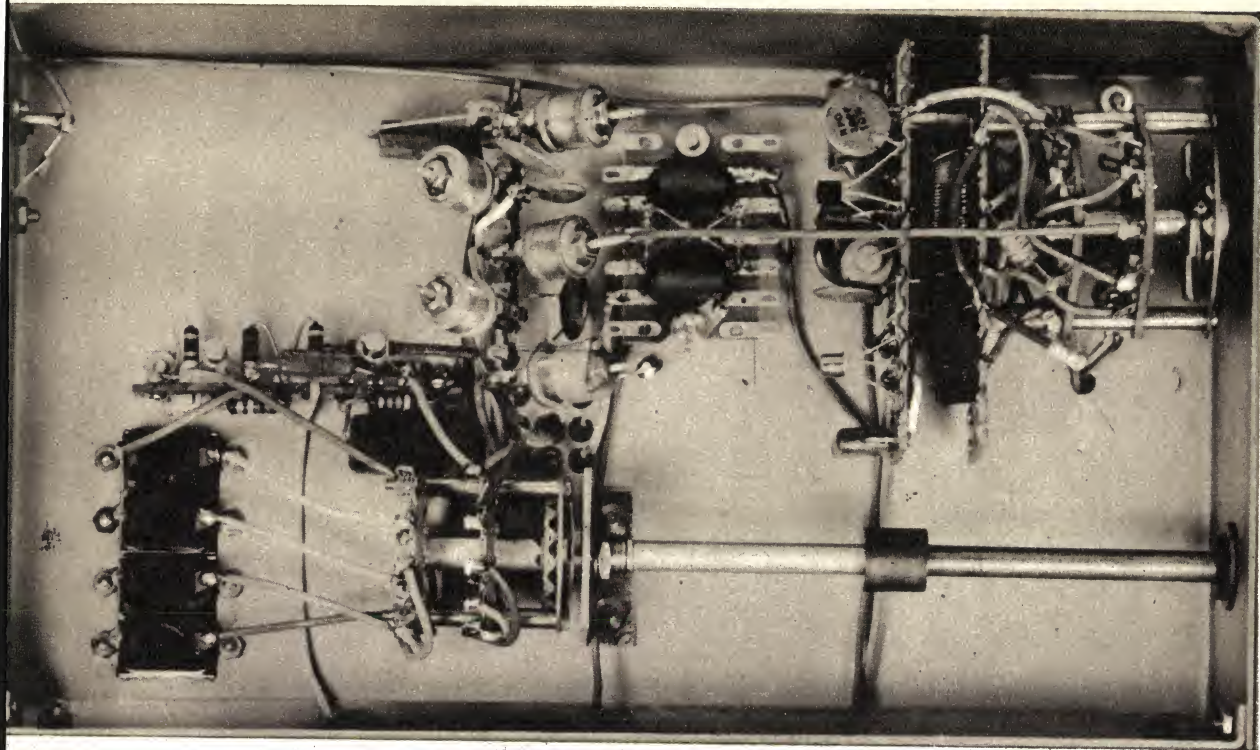

*Here are the layout details of the front end. The four crystals are at the left, with the switch immediately to the right. Above these two items are the oscillator and amplifier-multiplier tag strip and the trimmer tag strip. To the right of the trimmers is the ring mixer, with the RF amplifier assembly at the top right corner.*

If changes are made in the future, the alignment should also be checked and adjusted if necessary.

We suggest disposing of the broad position first, involving the single SFD-55B, as this is the simplest. Feed the output of the sweep generator into the base of the silencer amplifier. Adjust the level of the display on the screen to convenient size and make sure that there is not so much signal being fed into the system as to cause overload anywhere along the line. This could look like an ideal curve but is not the true story.

In all probability the display on the screen will look "lopsided." The technique is to use resistors and capacitors of various sizes to make exploratory checks. The resistor values will normally range between about 10K and 1K, and the capacitors from about 22pF to 100pF or more. Start with either a capacitor or a resistor of any value in the above range. Connect it between chassis and pin 1 or 2 of the resonator in the filter block, and note the effect on the screen. Careful observation, together with a few tests, will indicate the correct value of resistor or capacitor, and the terminal to which it must be connected, to give the best pass-band shape.

Note that at no time should the two resonators used for interstage coupling be subject to any of these adjustments.

More than likely, a resistor will give the best result. In some cases it may be necessary to connect a resistor or capacitor to both pins. We had one case where it was necessary to connect a 6.8K resistor and a 100pF capacitor, in parallel, from one pin to chassis, with a second resistor of 12K from the other pin to chassis. This was an extreme case.

Now switch to the sharp filter position, which brings in the block of four SFD-455B filters. It may be necessary to readjust the gain of the CRO vertical amplifier. The same principles apply as before, but the procedure is some-

what more involved in that there are many more combinations possible. However, this may sound worse than it really is in practice. Proceed as before, with a resistor or capacitor from each of pins 1 and 2 to chassis, and note the effect.

At this point, a certain amount of guesswork as well as judgment must be applied. Connect the component which

looks most promising, in that it results in an improved, if not a correct, pass band shape. If improvement is still called for, proceed as before. More than likely, a component will be found which gives the final correction. If not, connect the most promising component into circuit and proceed along the same lines. When the final pass band is achieved, all the corrective components

## CAPACITIVE DISCHARGE

# IGNITION SYSTEM

the MARK TEN, a U.S.A. topseller. In kitset form, only \$47.00.

Ideal for ALL gasoline engines on CARS, TRUCKS and BOATS.

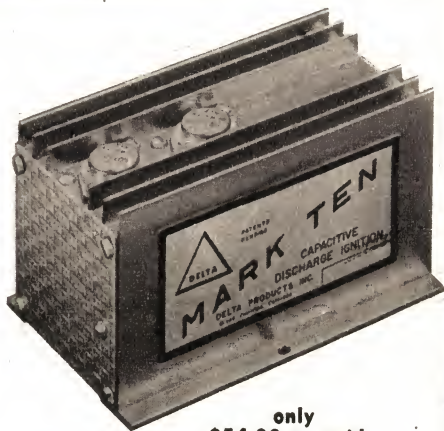

only \$54.00 p. paid

**A MUST for Every Sports or Modified Engine**  
**SOME OF THE BENEFITS YOU CAN EXPECT . . .**

- Dramatic increase in Acceleration
- Improved Gasoline Mileage.
- General Performance.
- Longer Plugs and Points Life.
- Instant Start in All Weather.
- Virtually eliminates Ignition Tuneups.

For further details, write to: **TASTRADE SUPPLIES**  
**P.O. BOX 159, RIVERWOOD, 2210.**

For further information please refer to the Nov., 69 issue of E.A.  
When ordering state 6/12 volt +VE or -VE earth system.



THE MARK OF  
DISTINCTION

TYPE NO.	NOM. WATTS	PRIMARY IMPEDANCE (OHMS)	SECONDARY IMP. (OHMS)	MTG.	H.	W.	L.	
OPM1A	5	7000, 5000	S.E. 15, 8, 3.7, 2	W	2 1/4	2 3/4	2 3/4	MEDIUM FIDELITY 40-30000 CPS ± 2 db.  ( ) Impedance in brackets indicate screen taps available.
OPM19A	5	7000, 5000	S.E. 500, 250, 166, 100	W	2 1/4	2 3/4	2 3/4	
OPM20A	5	10000, 8000	S.E. 15, 8, 3.7, 2	W	2 1/4	2 3/4	2 3/4	
OPM2A	7	10000	P.P. 15, 8, 3.7, 2	W	2 1/4	2 3/4	2 3/4	
OPM3A	10	4000, 2500	S.E. 15, 8, 3.7, 2	VC	3 1/4	2 3/4	2 1/2	
OPM4A	10	4000, 2500	S.E. 500, 250, 166, 100	VC	3 1/4	2 3/4	2 1/2	
OPM5A	15	5000, 3000	P.P. 15, 8, 3.7, 2	VC	3 1/4	2 3/4	2 1/2	
OPM6A	15	5000, 3000	P.P. 500, 250, 166, 100	VC	3 1/4	2 3/4	2 1/2	
OPM7A	15	(10000) 8000, 7000	P.P. 15, 8, 3.7, 2	VC	3 1/4	2 3/4	3 3/4	
OPM8A	15	(10000) 8000, 7000	P.P. 500, 250, 166, 100	VC	3 1/4	2 3/4	3 3/4	
OPM10A	25	(8000) 6600	P.P. 15, 8, 3.7, 2	VC	3 1/4	2 3/4	3 1/2	
OPM9A	25	(8000) 6600	P.P. 500, 250, 166, 100	VC	3 1/4	2 3/4	3 1/2	
OPM14A	35	(8000) 6600	P.P. 15, 8, 3.7, 2	VC	4 1/4	3 3/4	3 3/4	
OPM11A	35	(8000) 6600	P.P. 500, 250, 166, 100	VC	4 1/4	3 3/4	3 3/4	
OPM13A	55	3500	P.P. 15, 8, 3.7, 2	VC	4 1/4	3 3/4	3 3/4	
OPM12A	55	3500	P.P. 500, 250, 166, 100	VC	4 1/4	3 3/4	3 3/4	
OPM21A	100	(4500)	P.P. 500, 281, 125, 31	VC	4 1/4	3 3/4	4 1/4	
OPM16A	10	500	15, 8, 3.7, 2	W	2 1/4	2 3/4	2 3/4	LINE TO VOICE COIL 40-30000 CPS ± 2 db.
OPM18A	25	500	15, 8, 3.7, 2	VC	3 1/4	2 3/4	3	
OP412	7	9000 + Screen Taps	P.P. 15, 7.5, 3.7, 2.	W	2 1/2	2 3/4	3	MULLARD STEREO PLAYMASTER UNITS
OP308/15	12	8000, 6000	P.P. 15, 3.75	VC	4 1/4	3 3/4	3 1/2	HI-FI FOR MULLARD 5-10 AMPLIFIER
OP308/8.4	12	8000, 6000	P.P. 8.4, 2.1	VC	4 1/4	3 3/4	3 1/2	
OP301/15	12	8000 + Screen Taps	P.P. 15, 3.75	VC	4 1/4	3 3/4	3 1/2	ULTRA-LINEAR
OP301/8.4	12	8000 + Screen Taps	P.P. 8.4, 2.1	VC	4 1/4	3 3/4	3 1/2	
OP312/15	25	6600 + Screen Taps	P.P. 15, 3.75	VC	5	4	3 3/4	
OP312/8.4	25	6600 + Screen Taps	P.P. 8.4, 2.1	VC	5	4	3 3/4	
OP387/15	12	8000 + Screen Taps	P.P. 15, 3.75	VC	3 1/2	3	3	For 6BQ5's (EL84's)
OP387/8.4	12	8000 + Screen Taps	P.P. 8.4, 2.1	VC	3 1/2	3	3	
OP447/15	12	8000 + Screen Taps	P.P. 15, 3.75	VC	3 1/2	3	3	For 6GW8's (ECL86's)
OP447/8.4	12	8000 + Screen Taps	P.P. 8.4, 2.1	VC	3 1/2	3	3	
OP499/500	60	4000	P.P. 500	W	2 1/2	4 1/2	3	PHILIPS 60 WATT AMPLIFIER (6CA7's) (EL34's)
OP499/15	60	4000	P.P. 15	W	2 1/2	4 1/2	3	
OP499/8.4	60	4000	P.P. 8.4	W	2 1/2	4 1/2	3	
OP541	40	3300	15, 8, 3.7	VC	4 1/4	3 3/4	3 3/4	GUITAR AMPLIFIER ELECTRONICS AUSTRALIA
OP542	60	2600	15, 8, 3.7	VC	4 1/4	3 3/4	3 3/4	
OPS10K3	5	10000	S.E. 3		HEIGHT			SPEAKER TRANSFORMERS
OPS7K3	5	7000	S.E. 3		1-3/16			
OPS5K3	5	5000	S.E. 3		WIDTH 1-3/16			
OPS10K15	5	10000	S.E. 15		LENGTH 1-1/2			
OPS7K15	5	7000	S.E. 15		MOUNTING			
OPS5K15	5	5000	S.E. 15		CENTRES 2"			

## FERGUSON TRANSFORMERS PTY. LTD.

331 HIGH STREET, CHATSWOOD, N.S.W. • P.O. BOX 301, CHATSWOOD, 2067.  
TELEPHONE 40-0261 (8 LINES) • TELEGRAMS: "FERTRAN."

INTERSTATE AGENTS:

TASMANIA:  
Associated Agencies Pty. Ltd.,  
25 Barrack Street,  
Hobart, 7000.  
Phone: 2-1843.

A.C.T.:  
Errol Nazer Pty. Ltd.,  
84 Barrier Street,  
Fyshwick, 2600.  
Phone: 9-0325.

QUEENSLAND:  
Keith Percy & Co. Pty. Ltd.,  
Waterloo Street,  
Newstead, 4006.  
Phone: 51-5461.

WESTERN AUSTRALIA:  
Athol M. Hill,  
613 Wellington Street,  
Perth, 6000.  
Phone: 21-7861.

SOUTH AUSTRALIA:  
Wm. M. Mathew Pty. Ltd.,  
12 French Street,  
Adelaide, 5000.  
Phone: 23-6202.

VICTORIA:  
Ferguson Transformers Pty. Ltd.,  
181-183 Hawke Street,  
West Melbourne, 3003.  
Phone: 329-6415.

are wired permanently to the copper side of the board.

This description may give the impression that the task is a tedious one. This is not the case and the correct shape can normally be obtained in a shorter time than it has taken to write the detailed instructions!

The next adjustment is to introduce the correct amount of attenuation at the output of the broad filter, so that when switching from broad to sharp, there is no change in gain. This can be done readily, with the sweep still set up. Adjust the low value resistor (shown as 150 ohms) to a value which equalises the gain.

Using the sweep setup the BFO can be set, at least approximately, to the correct frequency on each side of the pass band of the sharp position. Assuming a capacitor of 68pF or so across the 1mH inductor, switch on the BFO and see where the centre frequency lies. A good place to start is at about the bend near the bottom of the pass band. Adjust the capacitor to give this result. Now add another capacitor, 100pF or perhaps more, across the capacitor just decided. The new value should shift the BFO centre frequency to the corresponding point on the other side. These positions may be subject to some change under listening conditions. This completes the sweep alignment.

Turn the tunable IF capacitor to its fully meshed position. Set the dial pointer so that it coincides with the scale horizontal base line. On our dial scales the 3MHz point will be already marked in, about 5-32in above the base line. The 6MHz point, on our scale, is about 3-8in above the base line at the other end of the scale. If you are making your own scale, these two points should be fixed at this stage.

Set the RF Band and Tuning Range switches to 3-6MHz. Set the dial pointer precisely to 3MHz. Feed in a signal from a signal generator, or other source, at precisely 3MHz. Adjust the slug in the oscillator coil, L8, until the signal gives maximum deflection on the S meter. Adjust the slugs in coils L6 and L7 for maximum response on the S meter. If necessary, reduce the generator input level so that the S meter does not reach full scale.

Set the dial pointer to precisely 6MHz and the generator to the same frequency. Adjust the trimmer on the oscillator section of the gang until the signal gives maximum response on the S meter. Peak up both of the other two trimmers on the gang. Return to the 3MHz point and repeat the process, as it will be found that the position will have shifted a little. The 6MHz point must be checked and this process must be repeated until both the 3MHz and 6MHz points are in the correct positions.

We are now in a position to do the rather exacting job of calibrating the dial. Fortunately, it is only necessary to calibrate from 3-6MHz, the rest of the ranges will automatically come in their right positions, assuming that the crystals are on frequency. A reliable source of accurate frequencies over the 3-6MHz range is required, the final result being only as good as the original reference. Signal generators are usually quite good, but they often are a little off calibration and this will be carried over to the new dial. If you have a source of 1MHz and/or 100KHz spot frequencies from crystals, then these

should be used. The alternative is to use the best available.

With the 3 and 6MHz points already set, the 4 and 5MHz points should be marked in next. Then it is a good idea to mark in the 500KHz points. This done, it is an easy matter to set and mark in the 100KHz points in between. Mark these points first in pencil, then in ink or other permanent fashion.

Set the dial pointer to 6MHz and set the RF Band switch to 6-18MHz and the Tuning Range switch to 9-12MHz. Feed a signal into the aerial terminal at

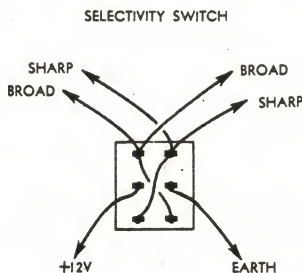

The selectivity switch is wired according to this diagram.

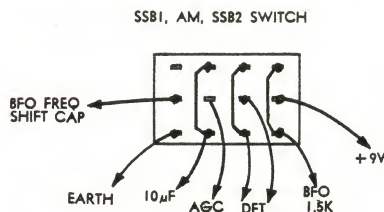

This is how the AM-SSB switch should be wired.

9MHz and make any necessary adjustment to the trimmer across L6.

Disable the BFO by removing the 9 volt lead from the 6.8K resistor. Switch to either SSB1 or SSB2 and with the generator set as before, switch on the modulation. Adjust the 100K potentiometer on the product detector for a null in the modulation. Restore the 9 volt lead and the alignment is complete.

Having completed your receiver and attached an aerial to it, a little practice will soon help in mastering the controls. Perhaps a short lesson would be in order.

Set the Tuning Range and RF Band switches to the positions which include the wanted frequency. Tune the wanted station on the dial and peak up the signal with the RF Tune control. Due to economy in design, it is possible to adjust the RF Tune control to another frequency than that of the wanted signal, thereby reducing its strength and possibly favouring an interfering signal. This situation should be avoided.

When a signal is tuned in the aerial capacitor should normally be set towards "max" so that a relatively large amount of signal is fed into the receiver. However, very strong signals could cause overloading, and this control should be turned back until the problem disappears. The higher the received frequency, the further towards "min" will this control have to be set. When trying to receive a medium strength or weak signal in the presence of a very strong adjacent one, the strong signal may cross-modulate the wanted one. Again, the aerial capacitor should be set towards "min," until the problem is resolved.

Generally, the noise silencer will be set to the disabled, or completely off position. This is essential when receiving very strong signals, or even when receiving lower strength signals in the presence of a very strong adjacent signal. The reason for this is that the silencer is fitted before the sharp selectivity of the receiver and the strong signal, even with the silencer control operative but turned well back, can be suicidal. In short, the strong signal can turn off the gate and nothing is allowed through.

Under conditions where it is desired to receive a medium to weak signal, in the presence of noise, the Noise Silencer control should be advanced to a point where the noise is reduced or eliminated. The limiting point comes where the peaks of the wanted signal modulation are clipped off. The control should be backed off to avoid this condition. Noise silencing is often complete in the presence of impulse noise, but the effectiveness against hiss and similar overlapping noise is limited.

When receiving SSB signals, the detector must be set to either SSB1 or SSB2. As the heterodyning crystals in the front end are used for injection both above and below the frequency of the incoming signal, it is not possible to mark the switch in the more conventional manner as USB and LSB. For any particular band the correct position may be quickly determined on a trial and error basis.

So there it is. We have set out to produce a receiver which would give a reasonably high performance, at a modest cost. We think we have succeeded and we hope you like it.

Before even completing this series of articles we have been asked for sensitivity and signal-to-noise ratio figures. So far, all we can say is that the internal noise is extremely low, giving a practical sensitivity which is very good. There are three main factors contributing to the low noise; the FET RF amplifier, the ring mixer, and the high "Q" of the RF coils. We have attempted to measure the signal-to-noise ratio but all the figures obtained so far appear to be "too good to be true." Until we can double check our equipment, or have the measurement made by an independent organisation, we would prefer not to quote them. ■

## SERVICE

BILL TURNBULL offers you service on Hi Fidelity equipment tape Recorders, Communication Receivers and Electronic Test Equipment.

25 years experience  
All work guaranteed

BILL TURNBULL  
11 ELLALONG ROAD,  
CREMORNE, N.S.W. 90 4825

**SILICON CONTROLLED RECTIFIERS.**

Item	Symbol	2SF 101	2SF 102	2SF 104	2SF 106	2SF 108	2SF 656	2SF 657	2S 658	Unit	
		°Non Rep. P.R.V.	$V_{R\ surge}$	75	150	300	400	500	75		150
°Rep. P.R.V.	$V_{RM}$	50	100	200	300	400	50	100	200	V	
°Rep. PK. Fwd. Blocking Voltage	$V_{FOM}$	50	100	200	300	400	50	100	200	V	
Avg. Rect. Current	$I_o$	200( $T_a=50^\circ C$ )			300( $T_a=25^\circ C$ )			470 r.m.s.			mA



**SILICON CONTROL RECTIFIERS.**

Item	Symbol	2SF 660	2SF 661	2SF 662	2SF 664	Unit
Non Rep. P.F.V.	$V_{F\ surge}$	75	150	300	600	V
Non Rep. P.R.V.	$V_{RM}$	75	150	300	600	V
Rep. Pk-Fwd. Blocking Voltage	$V_{FOM}$	50	100	200	400	V
Repetitive P.R.V.	$V_{RM}$	50	100	200	400	V
Avg. Rectified Current	$I_o$	6.3( $T_c=50^\circ C$ )		3.5( $T_a=50^\circ C$ )FN11 H.Sink		A
PK 1 cycle surge	$I_{surge}$			10Ar.m.s.		A
				50		A



**BIDIRECTIONAL THYRISTER.**

ITEM	Symbol	AC06BR	AC06DR	AC10BR	AC10DR	UNIT	REMARKS
Peak Block Voltage	$V_{BLM}$	200	400	200	400	V	
Conduction RMS Current	$I_{RMS}$	6		10		A	$T_c=75^\circ C$ or $T_a=40^\circ C$ With FN12 H.Sink
Surge Current	$I_{surge}$	50		80		A	1 Phase, 1 Cycle
Peak Gate Current	$V_{GM}$			$\pm 10$		V	
Peak Gate Current	$I_{GM}$			$\pm 3.0$		A	
Peak Gate Power	$P_{GM}$			5.0		W	
Avg. Gate Power	$P_{GAV}$			0.5		W	
Junct. Temp.	$T_j$			100		°C	
Storage Temp.	$T_{stg}$			$-25 \sim +100$		°C	
Stud Torque	—	30		35		kg cm	

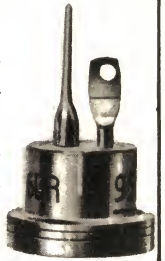

**PLANAR TYPE UNIUNCTION TRANSISTOR.**

ITEM	Symbol	2SH16 2SH17	Condition
Power Dissipation	P	200	mW
Emitter Rev. Voltage	$V_{B2E}$	30	V
Interbase Voltage	$V_{BB}$	25	V
Peak Emitter Current	$I_{EM}$	1	A
Emitter Current	$I_E$	50	mA
Junction Temp.	$T_j$	$-20 \sim +125$	°C
Storage Temp.	$T_{stg}$	$-20 \sim +125$	°C



**TRIGGERING DIAC.**

ITEM	Symbol	V413	Specification			UNIT
			MIN.	Typ.	MAX.	
Breakover Voltage		$V_{BO1}(V_{BO2})$	26	—	40	V
B/Over Voltage Symmetry		$\Delta V_{BO}(I_{BO1}-I_{BO2})$	—	—	3.5	V
B/Over Current Symmetry		$I_{BO1}(I_{BO2})$	—	—	200	$\mu A$
B/Over Voltage T/C			—	0.1	—	%/°C
Peak Output Voltage		$V_P$	4.5	—	—	V

For more details and free brochures fill in the coupon:  
Please send me information on

.....  
 NAME.....  
 COMPANY.....  
 ADDRESS.....  
 .....POSTCODE.....

Standard Telephones & Cables Pty. Limited  
Moorebank Avenue, Liverpool, N.S.W. 2170





**O.K. So STC  
have lots of SCR's  
and diodes  
Now tell me something  
specific about them.**

Here's the gen:

STC have huge stocks of NEC diodes and SCR's ready for immediate delivery. And here's what you want to know about our most popular models. Call or fill in the coupon for further details.

Call or Telex (collect) your order to STC Components Division.

Phone

Sydney 602-1314, 602-1329, 602-1369;

Melbourne 480-1255; Brisbane 47-4311;

Adelaide 51-3731; Perth 21-6461.

Or Telex Sydney 20328.

# Fundamentals of SOLID STATE



## Chapter 10

by Jamieson Rowe

The bipolar transistor — NPN and PNP forms — basic configuration — equilibrium conditions — collector-emitter bias alone — the effect of forward emitter-base bias — minority carrier injection — base diffusion, and collection — the device as a power amplifier — factors affecting the gain — the gain factors alpha and beta — characteristic curves — the common base characteristic — the common emitter characteristic.

Let us now turn our attention to a fourth basic semiconductor device, one whose development in fact marked one of the most important milestones in the history of the electronics industry: the bipolar transistor.

Although in earlier chapters we have examined other "transistor" devices such as the unijunction and the FET prior to the present introduction of the bipolar transistor, this order of presentation has been arranged by the author mainly in an effort to assist the reader by dealing with concepts and devices in a logical and progressive manner. In consequence, the presentation order is quite unrelated to the chronological order in which the devices made their appearance.

Actually the bipolar transistor was the first practical transistor device to be developed. The first crude working model was built in December, 1947, at the Bell Telephone Laboratories by physicists William Shockley, John Bardeen and Walter Brattain, and announced in the "New York Times" of July 1, 1948. This despite the theoretical proposition of the FET device some 20 years earlier, as noted previously in chapter 8.

In fact the name "transistor" was coined by Bell Labs expressly for the bipolar device. It was intended to describe the operation of the device, being a contraction of the words "Transfer" and "resistor." However, although the term "transistor" is still widely used to signify the bipolar device in particular, it has also become widely used as a generic name applied to any three-element semiconductor device capable of power amplification. The result has been ambiguity, and accordingly it has become common practice to use the term "bipolar transistor" to signify the specific device. For this reason the latter term will be that used in the present and subsequent chapters.

Basically, the bipolar transistor consists of a device having three functional semiconductor regions. The three regions are arranged such that there are two adjacent and approximately parallel P-N junctions, sharing one of the three regions as a thin common region. Naturally this means that the unshared or "outer" regions of the device must both be of similar semiconductor type,

because they will both be of opposite type to the shared common region.

From this definition and from the somewhat schematic representations shown in figure 10.1 it may be seen that, like the unijunction and the FET, bipolar transistors may be constructed in either of two complementary forms. One form is that having an "NPN" configuration, in which the shared common region is of P-type material while the outer regions are of N-type material. The other or "PNP" form has the converse arrangement.

As one might well expect from previous chapters, both varieties of the device operate in virtually identical fashion except that the polarities of operating voltages and currents are opposite, and the roles played by the various current carriers are reversed. In the case of the NPN variety, conduction band electrons play the major part in

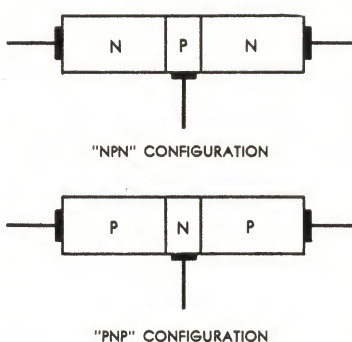

Figure 10.1

device operation, whereas with the PNP variety it is valence band holes which play the major role.

Because they operate in virtually identical fashion, the performance of NPN and PNP bipolar transistors of the same semiconductor material and geometry is almost identical. It is true, however, that there are subtle differences in performance due to such theoretical factors as the differing mobilities of electrons and holes. It is also true that there are practical manufacturing problems which tend to make it harder to achieve some aspects of device performance with one form compared with the other.

Despite these factors, at the present state of the semiconductor art there are many types of bipolar transistor which are available in NPN and PNP versions sufficiently comparable in performance to be virtually interchangeable in a large number of applications. The appropriate power supply polarities must be provided in each case, of course.

Although the foregoing might seem to suggest that one form of the device could perhaps be adopted for universal use, and the other virtually ignored, there are a number of reasons why this is not done. One is that there are many applications in which a particular combination of circuit configuration and power supply polarity strongly favours one form compared with the other. Broadly speaking, there are as many such applications favouring one form as there are favouring the other, so that in general it is both convenient and economical to have devices available in both forms.

A further reason is that in critical applications demanding high performance in terms of certain parameters, one device form can offer distinct advantages compared with the other as a result of the subtle differences between the two noted above. An example is in UHF power amplifiers, where NPN devices tend to be more attractive largely as a result of the higher mobility of electrons relative to that of holes. In other cases PNP devices may be more attractive.

There is also the important reason that with both varieties of the device available, it becomes possible to produce novel and highly efficient circuitry which employs both types of device and exploits their complementary behaviour. This is a very worthwhile and dramatic advantage which the bipolar transistor and other semiconductor devices, such as the unijunction and the FET, offer in comparison with the thermionic valve.

As with the other semiconductor devices which we have examined in previous chapters, the bipolar transistor may be fabricated from a variety of semiconductor materials; although to date only germanium and silicon have been used to any appreciable extent. Germanium was used for the first devices developed, and for those first marketed, and is still used to a small extent for very high current switching devices and very high frequency amplifiers. However, the great majority of bipolar transistors now manufactured and used are fabricated from silicon, largely because of the superior leakage behaviour and high temperature performance offered by this material.

Because of the similarity between the NPN and PNP forms of the bipolar

transistor, it is really only necessary to consider one form when examining the fundamentals of device operation. Once the basic concepts of device operation are grasped with respect to one form, the operation of the other form may be deduced simply by exchanging the roles of the current carriers, and reversing the polarities of all voltages and currents.

In the treatment which follows, the PNP form of the device is used as the basis for discussion, primarily to assist the reader in becoming more familiar with the behaviour of holes as current carriers. However, upon completion of the chapter the reader may care to deduce for himself the corresponding picture of NPN device operation, in order to test and reinforce his understanding.

An elementary PNP bipolar transistor is shown in figure 10.2 (a). It may be seen that the thin central N-type region shared by, and between the two P-N junctions, is called the base (B), while the two outer P-type regions are called the emitter (E) and collector (C).

The same names are used for the corresponding regions of the NPN variety of the device. In both cases the term "base" refers to the thin central region, which is lightly doped, while the terms "emitter" and "collector" refer respectively to the heavily and lightly doped end regions. The significance of these terms should become apparent later in this chapter.

Superficially, as may be seen, the bipolar device consists basically of two P-N junctions arranged in a "back-to-back" or inverse series configuration, with the common connection brought out as the base electrode. From this the reader might be led to infer that its behaviour would be very similar to that of a pair of simple P-N diodes connected in a similar manner. However this is only true in a very limited sense indeed.

If one simply ignores either of the two device junctions and its associated P-type region, and proceeds to examine the behaviour of the remaining junction alone, then that behaviour will in general be identical with that of a normal P-N diode. The results of such a test will be the same for either junction, so that in this rather artificial and limited sense the device is in fact equivalent to a pair of simple diodes connected back-to-back. Yet almost the only practical significance of this fact is that it may be used as the basis of simple tests for device damage.

Of far greater significance is the fact that as soon as both junctions are permitted to play an effective part in determining device behaviour, its behaviour tends to depart quite markedly from that of a pair of simple diodes. And the reason for this is that the thin base region shared by both junctions causes a significant interaction between the two.

It is, in fact, this interaction between the behaviour of the two junctions which is responsible for virtually all of the highly useful properties of the bipolar transistor, and which therefore we must proceed to examine in some detail. But before we do so, it may be worthwhile for the reader to refresh his understanding of P-N junction behaviour by referring to the diagrams of figure 10.2 (b) and (c).

Figure 10.2 (b) shows the energy level diagram corresponding to the equilibrium condition of the elementary tran-

sistor shown in (a). As before, the equilibrium situation represented is that which applies with zero external bias applied to the device electrodes, and is thus the dynamic balance reached between the "internal" carrier movements due to the opposing mechanisms of diffusion and drift. The average carrier energy level or Fermi level ( $E_f$ ) is constant throughout the material.

As part of the equilibrium, depletion layers are formed in the vicinity of

"up-hill" slope of the nearest junction.

Similarly the majority carriers (electrons) in the base region effectively "see" themselves at the bottom of a potential "valley" in the centre of the device, as may be seen if the diagram is viewed upside-down. In order to pass from the base to either of the two other regions, in the equilibrium situation, these carriers must surmount the "up-hill" potential slope of the junction concerned.

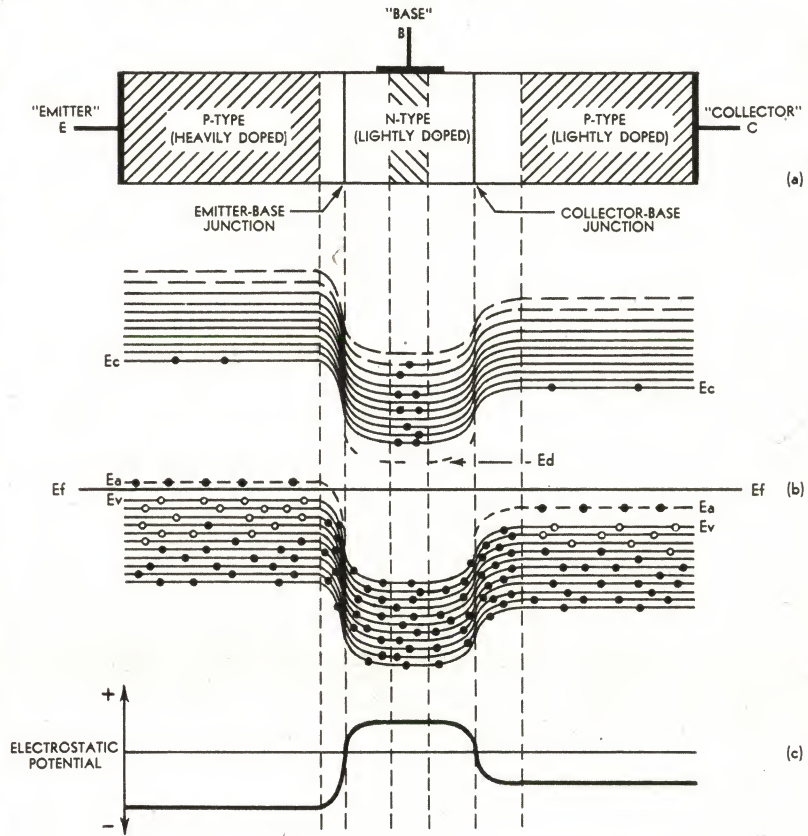

Figure 10.2

each junction, extending into the material on either side to a degree inversely proportional to the doping levels. Drift fields are set up across the depletion layers, as before, with the P-type side of the depletion layers acquiring a negative charge, and the N-type side a positive charge. This produces a distribution of electrostatic potential throughout the device, of the shape shown in figure 10.2 (c).

From previous chapters, the reader may be able to recognise that this potential distribution has two important implications regarding the movement of current carriers within the device.

One important implication is that, in the equilibrium situation, both P-N junctions of the device represent potential barriers to the MAJORITY CARRIERS in each of the three semiconductor regions.

Hence the majority carriers (holes) in both the emitter and collector regions of the PNP device shown effectively "see" the base region as a potential "mountain" separating these two regions, this "mountain" having the cross-section suggested by the curve of figure 10.2 (c) viewed normally. In order to pass from one P-type region to the other under equilibrium conditions, such carriers must first surmount the

In short, then, any flow of majority current carriers across the device junctions constitutes a movement of these carriers in opposition to a depletion layer potential barrier. It may be recalled from chapter 4 that this type of majority carrier flow is normally known as a diffusion current.

The second important implication of the diagram of figure 10.2 (c) is really the converse of the first. In the same equilibrium situation, both P-N junctions of the device represent "downhill" potential slopes to the MINORITY CARRIERS in each of the three device regions.

Hence in the PNP device shown, minority carrier holes in the base region "see" themselves at the top of a relatively high potential "plateau," and can "roll down" a potential slope into the emitter or collector regions if they diffuse into the depletion layer region of the appropriate junction. Similarly, minority carrier electrons in the emitter and collector regions "see" the base region as a narrow "gorge" running between the two outer regions, and can accordingly roll into the base if they diffuse into the appropriate depletion layer.

Minority carrier flow across the junctions of the device may thus be de-

# PRINTED CIRCUIT BOARD EDGE CONNECTORS

## DUO-TYNE

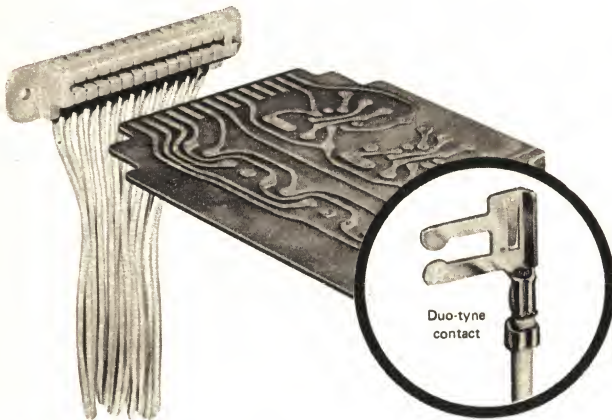

Material - Polypropylene.

Housings with mounting holes				Housings without mounting holes				Both Type Housings available in 9 colours	
*No. of Positions	Part No.	A in.	B in.	C in.	*No. of Positions	Part No.	D in.		E in.
5	151626	1.696	.726	.936	5	151635	.936	.726	
9	151628	2.320	1.350	1.560	9	151637	1.560	1.350	
12	151629	2.788	1.818	2.028	12	151638	2.028	1.818	
15	151631	3.256	2.286	2.496	15	151640	2.496	2.286	
Board thickness .070 - .055 in.									
* Other sizes available on request.									

DUO-TYNE flag connector for appliance, entertainment, automotive industry applications. Available in a multitude of sizes.

### FEATURES

- \* Excellent low cost commercial application.
- \* Contacts rated to 7.5 amperes.
- \* Contact spacing .156 in.
- \* Excellent vibration resistance.
- \* Available in 9 colours.
- \* Gold and tin-plated contacts.

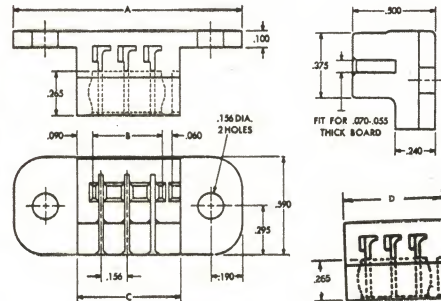

### CONTACTS AND TOOLING

Wire Range	Part No. Strip Form	Part No. Loose Piece	Insulation Range in.	Finish	Hand Tool	Extraction Tool
22-18	60215-4	66088-2	.060 - .090	Tin	90027	810992-1
26-22	66149-4	66150-2	.035 - .055	Tin	90094	810992-1

## AMP-LEAF



HOUSING AND DIMENSIONS IN.												
*No. of Dual Positions	No. of Housings Part No.	Housing Material	A	B	C	D	E	F	G	H	J	K
15	480110-5	Phenolic	3.182	2.854	2.621	2.506	2.376	.350	.700	.250	.466	.187
	480110-2	Dial. Ph.	3.187	2.859	2.625	2.510	2.380	.350	.700	.250	.466	.187
18	480133-5	Phenolic	3.650	3.400	3.088	2.948	2.843	.375	.700	.155	.406	.156
	480133-2	Dial. Ph.	3.656	3.406	3.093	2.953	2.848	.375	.700	.155	.406	.156
22	480142-3	Phenolic	4.274	4.025	3.754	3.591	3.466	.350	.700	.250	.456	.125
	480142-2	Dial. Ph.	4.281	4.031	3.760	3.596	3.472	.350	.700	.250	.456	.125
Board thickness .070 - .055 in.										* Other sizes available on request.		

Contacts available in continuous strip for high speed applications, via AMP-ELECTRIC bench press, or in loose piece for hand tool application. Solder contacts available for small and proto-type applications.

### FEATURES

- \* Excellent performance to most exacting requirements.
- \* Low card insertion force.
- \* Contact ratings is 5 amperes.
- \* Contact spacings .156 in.
- \* Housings materials phenolic or diallyl phthalate.

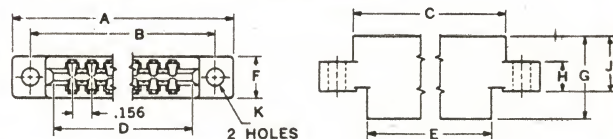

### CONTACTS AND TOOLING

Part No. Strip Form	Part No. Loose Piece	Wire Range	Insulation Double Wire	Insulation Single Wire	Range in.	Finish	Hand Tool
42702-3	42839-3	26 - 22			.050 - .064	Gold/Standard	90028
42717-3	42840-3	22 - 18	.120 max		.055 - .080	Gold/Standard	90028
		66067*	two 16 max.			Gold/Standard	

\* Solder Tab Contact

Inter Control Keying Plug Part No. 582501-1  
Contact Extraction Tool Part No. 465195-1 for 15-22 Pos.  
Contact Extraction Tool Part No. 465195-2 for 18 Pos.

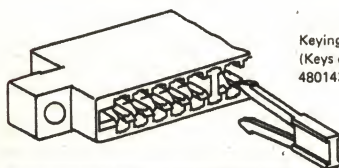

Keying Plug  
(Keys on foil tab)  
480143-1 for 1/16in. board thickness



Retaining Spring  
Material Beryllium Copper  
42973-2 Plain finish

# AUSTRALIAN AMP PTY. LIMITED

43 CARNARVON STREET, AUBURN, N.S.W. 2144. P.O. BOX 78, AUBURN. TELEPHONE 648 1724.

### BRANCHES:

#### VICTORIA

116 Bank Street,  
South Melbourne, Victoria 3000.  
Telephone: 69-4946

#### QUEENSLAND

17 Wicklow Street, Kangaroo Point,  
Brisbane, Queensland 4169.  
Telephone: 91-5051

### DISTRIBUTORS:

#### SOUTH AUSTRALIA

R. G. Pank (Electrical) Pty. Ltd.,  
230 Pank Street,  
Adelaide, South Australia 5000.

#### WESTERN AUSTRALIA

Simon Holman & Co. Pty. Ltd  
10-12 Southport Street,  
Leederville, Perth, Western Australia 6007.



scribed as drift currents, as they represent a carrier flow influenced by and in the direction of the "inbuilt" electric field across each junction depletion layer.

From previous chapters it may be recalled that the only minority carriers present in a doped semiconductor region under equilibrium conditions are those generated by the "intrinsic" excitation mechanism. Hence in the bipolar transistor for the equilibrium conditions, the minority carrier drift currents moving "down" each depletion layer potential slope will be at a very low level, and saturated in the sense that they are determined almost completely by the number of carriers produced by excitation.

Since by definition there can be no net current flow in a device in the equilibrium condition, the foregoing implies that the majority carrier diffusion currents moving in opposition to the minority carrier currents, or "up" each depletion layer slope, must also be at a very low level.

Thus while there are currents flowing across both junctions of the bipolar transistor in the equilibrium situation, as an integral part of the equilibrium, these currents are quite small and consist in both cases of equal and opposite majority and minority carrier currents. In this respect the bipolar transistor does not differ from the other junctions semiconductor devices examined in earlier chapters.

It is hoped that the foregoing review of the equilibrium condition of the device has assisted the reader in refreshing his understanding of basic P-N junction behaviour. Now let us turn to consider what happens when the equilibrium of the bipolar transistor is disturbed by the application of external bias voltages.

If one connects a DC bias voltage between the emitter and collector electrodes of the device of figure 10.2, of either polarity, only a very small current is found to flow. This is perhaps not surprising, because in this case we are effectively connecting the external bias across both junctions in series, and for either polarity of the bias one of the junctions will be reverse biased.

The internal situation of the device will, in fact, be only slightly different from that for equilibrium. The depletion layer of the reverse biased junction will widen to correspond to the increased electric field across it. This in turn will cause a small net current to flow, as there will be a reduction in the majority carrier diffusion currents while the minority carrier drift currents will remain fixed at their saturation values.

The small current which flows through the reverse-biased junction will cause a very small voltage drop to appear across the other junction, which will naturally be forward biased. Accordingly the depletion layer of this junction will narrow very slightly, and its majority carrier diffusion currents will increase to correspond to the small net current flow.

It may be seen that when a single external DC bias is connected between the collector and emitter electrodes of a bipolar transistor, the device behaviour for both applied polarities is basically very similar to that of a normal P-N junction diode when reverse biased.

However the small current which flows through the device in this situation is actually slightly greater than the reverse bias current of a normal P-N diode, or of either device junction alone. And although the difference in current levels is only slight, it is of great significance, for it provides the key to the really interesting and unique aspects of bipolar transistor operation.

The alert reader may have already noticed an interesting fact about the small current which we have seen to flow through the device when biased between emitter and collector. This is that the current which does flow effectively "changes its nature" during its passage through the device, even though its magnitude necessarily remains constant. When passing

a P-N junction, of necessity they undergo a reversal in terms of population statistics — simply because the majority/minority roles in each type of semiconductor material are the opposite of those in the other type.

Hence a carrier initially belonging to the majority population of one region will automatically become a minority carrier when it crosses a junction into a region of opposite type; and vice-versa.

Perhaps the most obvious implication of this, in the case of our foregoing biased transistor, is that the minority carrier currents flowing across the reverse-biased junction actually consist of the same types of carrier moving in the same directions as the majority carrier currents flowing across the forward-biased junction. Only the "labels" ap-

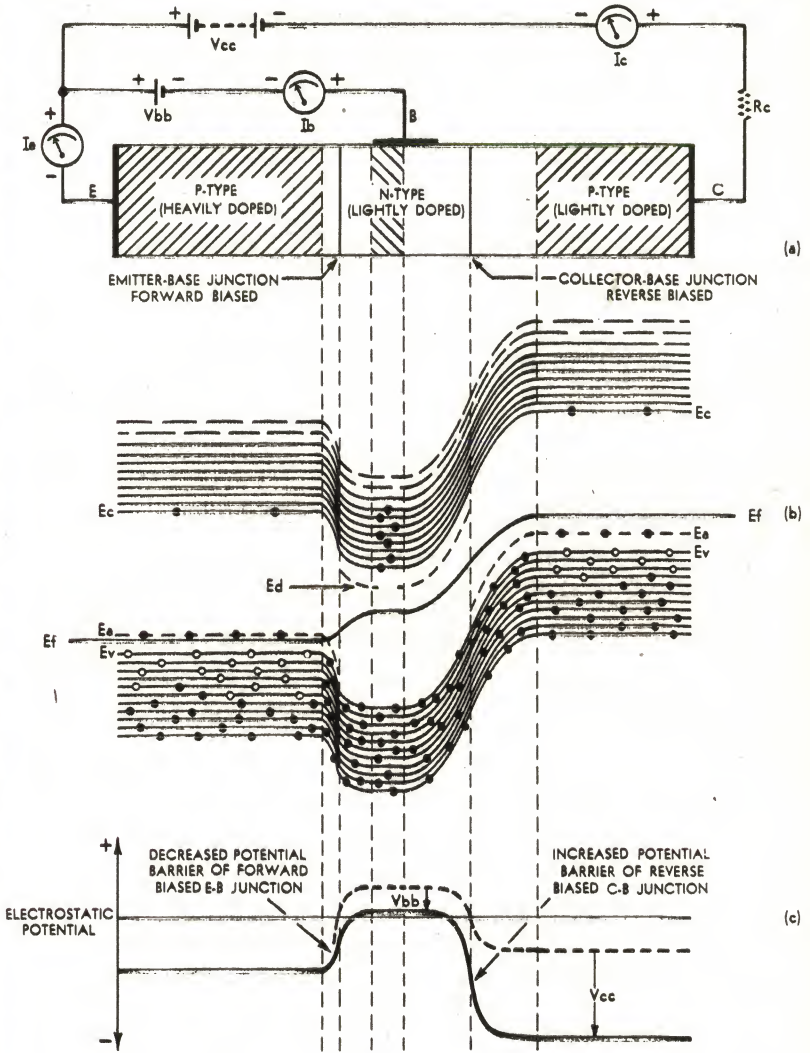

Figure 10.3

plied to the carriers change, in other words. This should clear up the apparent contradiction.

However, a second and more important implication is that those majority carriers (holes) which diffuse across the forward-biased junction into the base region will naturally then become minority carriers in that region, boosting the minority carrier population of the base above its normal level. And because the base region is relatively thin, many of these additional minority carrier holes will be able to diffuse across to the depletion layer of the re-

verse-biased junction, we saw it to consist of drift currents derived from the minority carrier populations of the two adjacent regions; yet when it passes through the depletion layer of the forward-biased junction it then consists of diffusion currents derived from the adjacent majority carrier populations.

At first sight this may seem not only confusing, but downright contradictory. Yet the explanation is really quite simple: when carriers move from one semiconductor region to another across

# Only Philips PM2400 has both automatic AC/DC selection and automatic polarity indication.

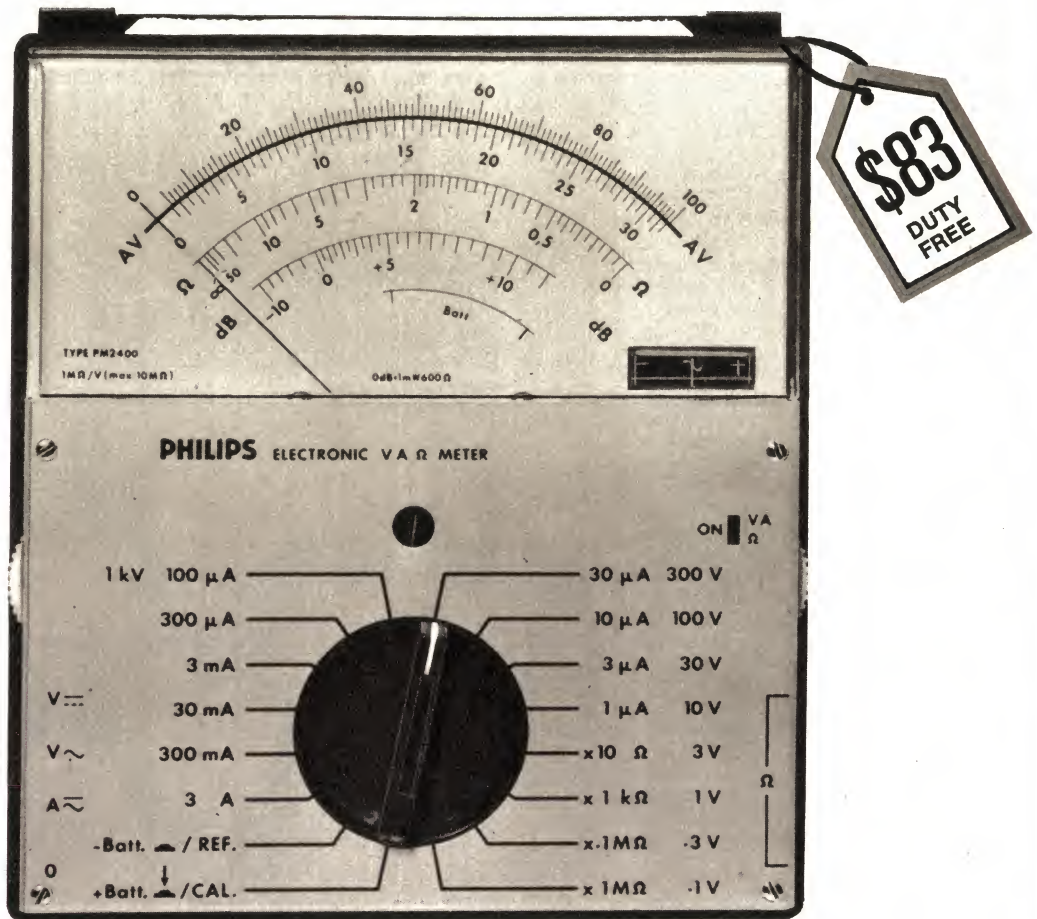

- 42 ranges for resistance AC/DC current and voltage measurements
- One linear scale for both voltages and currents
- Monoknob range selection
- Built-in calibration facility
- Overload protected
- All Solid State construction

The PM2400 is a compact multimeter combining the excellent input features of electronic instruments with the versatility of universal meters. Its specifications match those of more expensive equipment. Simpler, more accurate readings are obtained from the wide scale, knife-edged pointer and a special shadow-free meter

cover which allows light to reach the scale from more than one direction. Solid State Circuitry minimises current consumption, allowing accurate measurements for at least 1000 hours on a set of batteries.

For complete information, contact Philips Electrical Pty. Limited, 69-79 Clarence Street, Sydney 2000, or your nearest Philips Office.

## PHILIPS



test and measuring instruments

38-8777

verse-biased junction before their passage can be interrupted by a recombination with a majority carrier electron.

Naturally those holes which do reach the reverse-biased junction depletion layer will be "grabbed" by the electric field of the latter and will accordingly drift into the far P-type region. The minority carrier hole current of the reverse-biased junction will thus be boosted to a value greater than its normal saturated value, and this explains why the net current passed by the device is higher than that of a normal reverse-biased junction.

The mechanism just described may be seen to involve a novel type of interaction between the two junctions of the device: the current passed by one junction in the reverse-biased state is increased significantly from its "normal" saturated value as a result of excess minority carriers injected into the narrow base region by the forward-bias of the adjacent junction.

This is, in fact, the precise "interaction" mechanism which is responsible for the really important behaviour of the bipolar transistor, and to which reference was made earlier. The ability of one forward biased junction to influence the conduction of the other reverse-biased junction gives the device the ability to perform power amplification, although of a slightly different type to that of the thermionic valve or the field effect transistor.

In figure 10.3(a) is shown an elementary PNP transistor with external bias voltages applied to it, in a fashion which should help in understanding how the device is capable of amplification.

One of the applied voltages, that labelled "Vcc," may be seen to correspond to the collector-emitter bias which we have just considered in the foregoing discussion. With this bias applied alone, as we have seen, the device will draw only a small current slightly larger than the current drawn by a reverse-biased P-N junction. We might thus expect the meter measuring collector current  $I_c$  to register only a current of this low order.

The other bias voltage applied to the device is labeled "Vbb," and may be seen to be applied between the base and emitter with a polarity which forward biases the base-emitter junction. Superficially one might therefore expect a considerable current flow to be registered by both the meter measuring base current  $I_b$  and that measuring emitter current  $I_e$ .

Perhaps surprisingly, this is not quite what is found. The meter in the emitter lead is certainly found to register an appreciable current, as expected. However, the meter in the base lead is found to register only a small fraction of the emitter current, while instead the meter in the collector lead is found to register virtually the same current as the emitter meter, despite the reverse bias on the collector-base junction!

The reason for this behaviour is simply that the majority carrier hole current passed by the forward biased base-emitter junction "injects" excess minority carrier holes into the base, as before. Because of the narrowness of the base region, a major proportion of these holes are able to reach the depletion layer of the reverse biased collector-base junction before being stopped by recombination with a majority

carrier electron. Those which do reach the second junction will naturally "roll down" the potential gradient into the collector.

As the emitter region is relatively heavily doped whereas the base region is quite lightly doped, the majority carrier diffusion current passed by the emitter-base junction consists mainly of holes moving from emitter to base rather than electrons moving from base to emitter. Also the light doping in the base region results in a relatively low population of majority carrier electrons in the base, so that most of the minority carrier holes injected from the emitter escape recombination and do actual-

rent (and hence low power) conditions at the base of the device can thus be arranged to cause large changes in both the voltage and current levels at the collector. From this it may be seen that the bipolar transistor is capable of providing appreciable power amplification.

It should now be fairly clear why the names "emitter" and "collector" are used for the two end regions of the bipolar device. The name "emitter" is surely quite appropriate for the region concerned, which does effectively emit or inject carriers into the base region. Similarly the name "collector" is quite appropriate also, for the region concerned does effectively collect those of

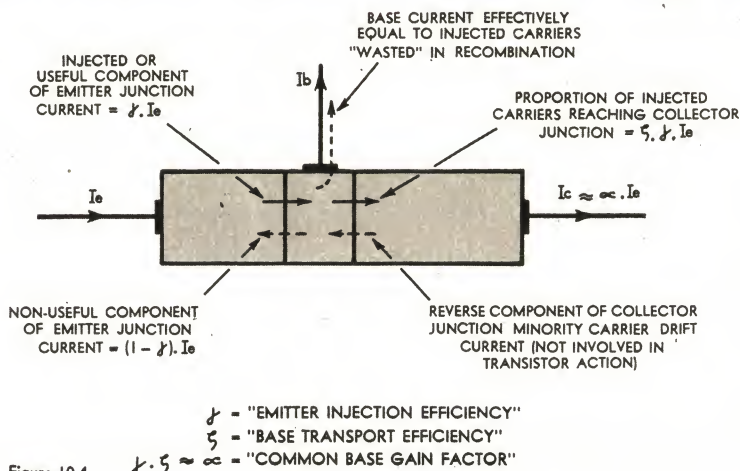

Figure 10.4

ly end up in the collector region. This explains why the emitter and collector currents are almost equal.

The base current is actually equal to the slight difference between the two, because in effect it consists only of the small number of electrons necessary to replace those majority carrier electrons in the base region which do actually meet and recombine with an injected hole. This accordingly explains why the base current is very small.

From the foregoing it may be seen that the operation of the bipolar transistor is basically a combination of three simple processes: injection, diffusion and collection. The forward-biased emitter-base junction injects minority carriers into the base, whereupon these carriers diffuse away through the base, because of the localised concentration. Those which manage to reach the reverse biased collector-base junction without recombining with a majority carrier are then collected by that junction.

The effect of forward bias  $V_{bb}$  applied across the base-emitter junction, then, is to cause a marked increase in the current flowing through the reverse biased collector-base junction. And as one might expect, the increase in collector current is highly dependent upon the magnitude of the applied base-emitter bias. In fact only a small bias  $V_{bb}$  is found sufficient to produce quite a large collector current  $I_c$ , and relatively small variations in  $V_{bb}$  tend to produce large variations in  $I_c$ .

As the collector-base junction is reverse-biased, the collector supply voltage  $V_{cc}$  may be considerably larger than  $V_{bb}$ . This allows a fairly large load resistor  $R_c$  to be connected in series with the collector, as shown. Changes in the low voltage/low cur-

rent the injected carriers which diffuse across the base region.

The name "base" is applied to the central region of the device largely as a historical carry-over from the very first type of bipolar transistor, the long obsolete "point contact" variety. With this type of transistor the base region did in fact form the physical base of the functional device. However, with most modern forms of the bipolar transistor this is not the case, and the term "base" is merely a conventional label.

At this point the reader may find it worthwhile to examine the diagrams of figure 10.3 (b) and (c), which show respectively the energy band diagram and electrostatic potential distributions for the biased transistor of figure 10.3 (a). Comparison of these diagrams with the corresponding diagrams for the equilibrium situation, given in figure 10.2, may help in clarifying the foregoing discussion.

As we have seen, the base current of a biased bipolar transistor consists basically of the small number of electrons necessary to replace those majority carriers in the base region "absorbed" by recombination with injected minority carriers. As such, it is numerically equal to the difference between the emitter and collector currents. From this it follows that the larger can be made the fraction of emitter current reaching the collector, the smaller will be the base current and the higher the potential amplification of the device.

Naturally one factor which has an important effect on the proportion of emitter current reaching the collector is the actual composition of the emitter junction current. From the foregoing discussion, it should be fairly clear that it is only the component of emitter current which consists of carriers moving from emitter to base which plays a part

# It's a *Now* world!

Remember when you could only have one type of wire wound resistor?

*Now* you have the choice of **FIVE** styles



1. Vitreous coated Wire wound  
1.5 to 14 watts.



2. Tubular, fixed and adjustable Wire wound 3 to 200 watts with "Pyrosil" coating.



3. Flat Wire wound with "Pyrosil" coating 20 to 75 watts.



4. Ceramic case Wire wound Fireproof inorganic construction 5 to 15 watts.

## *Now* another **IRC** first, **NEW ASW SERIES**

Axial weldable leads

Low T.C. close tolerance winding

Pyrosil coating

Welded Termination

ASW Series  
2w - 5w - 7w and 10w

Supersedes the old fashioned AA/AB "Radio" type wire wound resistors.

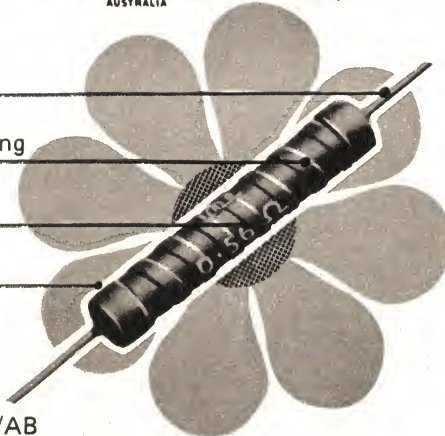

**IRH**  
**COMPONENTS**  
**PTY. LIMITED**

The Components Division of  
IRH Industries Limited

**IRH** THE CRESCENT, KINGSGROVE, N.S.W. 2208. PHONE 50 011

INTERSTATE TELEPHONES

MELB. VIC. 489.1088 BRIS. QLD. 2.1391  
HOB. TAS. 34.2811 PERTH W.A. 8.2271  
LAUN. TAS. 22.844 ADEL. S.A. 23.1971

Check your literature file is up to date on the complete IRC Resistors range

in the operation of the device; the component which consists of carriers moving in the opposite direction plays no useful part.

It is for this reason that the ratio between the emitter and base impurity doping levels is made very high, ensuring that the emitter junction current consists almost entirely of carriers moving from emitter to base. In the PNP transistor, as we have seen, these carriers are holes; conversely in the case of the NPN transistor they are electrons. The ratio of the emitter-to-base component of emitter current to the total emitter current is known as the **emitter injection efficiency or ratio**, which term the reader may recall was also used in chapter 7, in connection with the unijunction.

Apart from the emitter injection ratio, a second important factor governing device amplification is the number of minority carriers injected into the base which are able to diffuse through to the collector junction depletion layer without meeting with a majority carrier and "falling by the wayside" due to recombination. Expressed as a proportion of the total injected carriers, this is known as the **base transport efficiency**.

It is to ensure a high base transport efficiency that the base region is made very narrow; the shorter the distance which the minority carriers must travel through the base, the lower the likelihood of recombination. The base transport efficiency is also improved by making the impurity doping level of the base as low as possible, to ensure a relatively small population of base region majority carriers.

The schematic diagram of figure 10.4 may help the reader to visualise the significance of the emitter injection efficiency and base transport efficiency factors in terms of basic device operation.

It is possible to express the amplification action of the bipolar transistor in terms of two different gain factors, both of which are actually current increment ratios. One of these, and the earliest to be used, is called  $\alpha$  (alpha), and is simply an expression of the ratio between collector and emitter currents, in terms of changes or small increments:

$$\alpha = \frac{dI_c}{dI_e} \quad (dV_{cb}=0) \quad \dots (10.1)$$

Here "dIe" is a small change in emitter current, "dIc" is the corresponding change in collector current, and the expression in brackets specifies that the collector-base voltage is defined as constant.

Fairly obviously alpha is always less than one, because the collector current is always less than the emitter current. In fact alpha is a fraction which approaches unity asymptotically as the amplification increases: a very low gain device may have an alpha of 0.91, while a very high gain device might have an alpha of 0.998.

The numerical values of alpha for practical devices tend to be restricted to the range between these two examples, and are progressively cramped for increasing orders of amplification. Because of this it is usually more convenient to use the second gain factor called alternatively  $\beta$  (beta) or hfe.

Beta is simply the device amplification expressed as the ratio between collector

and base currents, again in terms of small increments:

$$\beta = \frac{dI_c}{dI_b} \quad (dV_{ce}=0) \quad \dots (10.2)$$

Here "dIb" means a small change in base current, "dIc" again means the corresponding change in collector current, and the expression in brackets has a similar meaning to that in (10.1).

Naturally since  $I_b$  is simply the difference between  $I_e$  and  $I_c$ , alpha and beta have a fixed relationship to

tor characteristic, which in this case displays the amplification behaviour of the device in terms of the relationship between collector current and voltage for various values of emitter current. As may be seen, this is known as the **common base characteristic**.

Perhaps the first thing which the reader may note from the diagram is that the major portion of each curve in the characteristic "family" is almost horizontal, at a collector current value which corresponds in each case to a fraction alpha of the emitter current

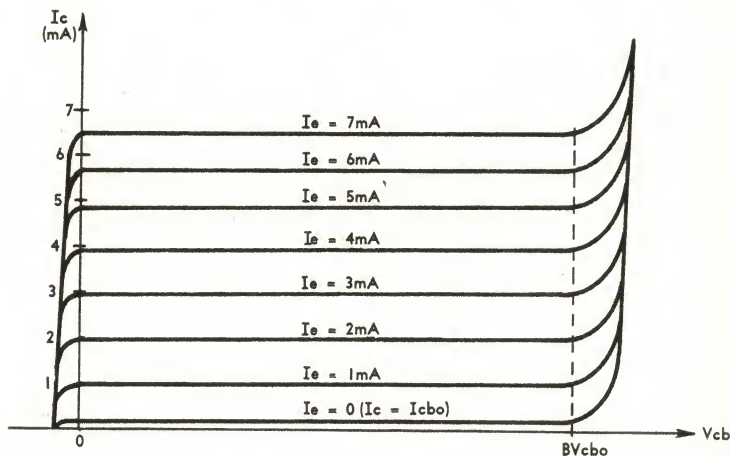

Figure 10.5 "COMMON BASE CHARACTERISTIC"

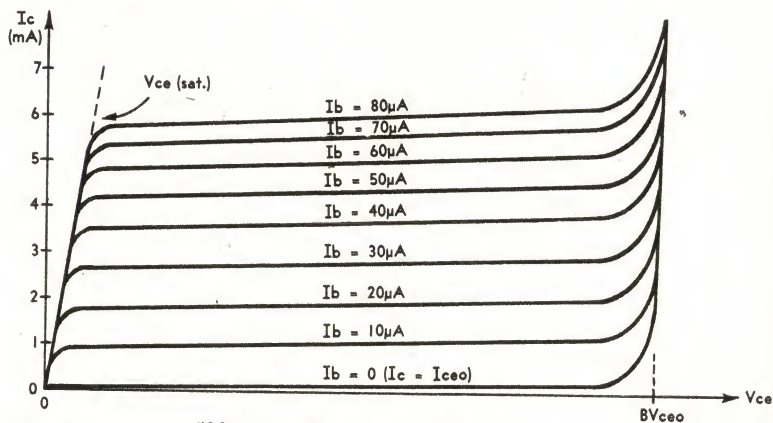

Figure 10.6 "COMMON EMITTER CHARACTERISTIC"

one another. A short calculation reveals that the relationship is as follows:

$$\beta = \frac{\alpha}{1 - \alpha} \quad \dots (10.3)$$

Beta normally has a value somewhat greater than unity, and does not become cramped at high orders of amplification. For example, devices having alpha values of 0.91 and 0.998 quoted above would have corresponding beta values of 10 and 500 respectively. The reader may care to work these out for himself using equation 10.3.

Just as there are two different gain factors which may be used to express the amplification action of the bipolar transistor, there are also two main ways of representing the behaviour of such a device in terms of graphical characteristics. These will now be briefly examined.

Figure 10.5 illustrates one of the two main types of bipolar transistor collec-

tor characteristic. The curves thus bear a strong resemblance to those of the FET and the thermionic pentode valve, and indicate that like these devices the bipolar transistor has a relatively high output resistance.

The curves have this basic shape because the injection-diffusion-collection mechanism which we have seen to be responsible for device operation is basically almost independent of the magnitude of collector voltage. As long as the collector-base junction is not forward biased, its depletion layer is capable of "collecting" virtually all of the injected carriers which diffuse across the base. The collector current which flows as a result of forward emitter-base bias is thus effectively "saturated."

If the collector-base junction is in fact forward biased, normal device operation does naturally cease. This explains why the curves of figure 10.5 drop down sharply on the left-hand side. All curves in the family fall to

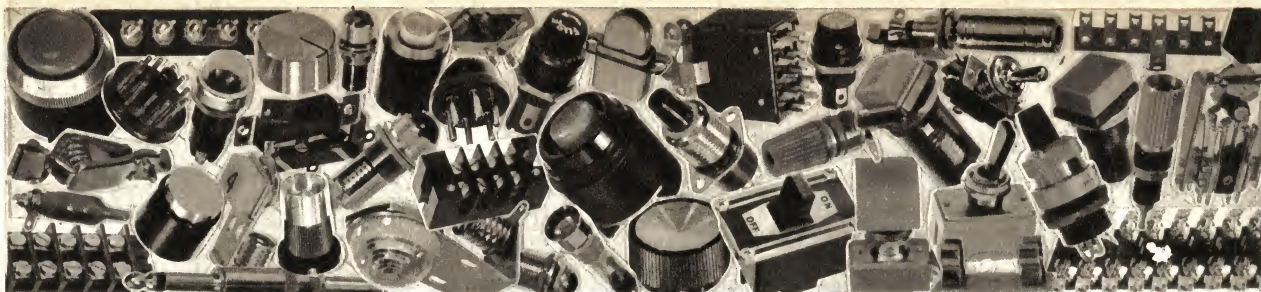

Like being proud of their Kangaroo, Sato's large variety of electrical parts is the favorite choice by Australians. Your inquiries are welcome.

# SATO PARTS

**SATO PARTS CO., LTD.** HEAD OFFICE: EBISU, SHIBUYA-KU, TOKYO, JAPAN TEL: (442) 8506~8  
BANK ACCOUNT: MITSUBISHI BANK

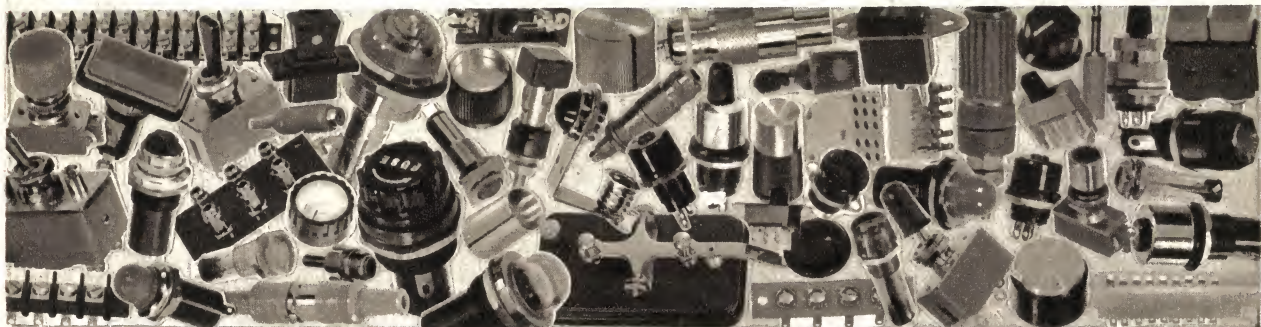

## A vast range of SATO Parts

- For manufacturers
- For TV
- For radio
- For instruments
- For amplifiers
- For kitset builders
- For sound equipment
- For industry
- For stereo equipment
- For educational purposes
- For electronics
- For tape recorders

Distributed by



## GENERAL ACCESSORIES

(A DIVISION OF ELECTRONICS INDUSTRIES)

116-118 CLARENCE STREET, SYDNEY 443 CONCORD ROAD, RHODES — 73-0211  
BOTH STORES OPEN SATURDAY MORNING

zero current when the forward collector-base bias has been increased to approximately 0.3V for germanium, or 0.6V for silicon.

The other limit to the "pentode" region of device operation occurs when the reverse bias on the collector-emitter junction is increased to the point where this junction enters avalanche breakdown. As with any other P-N junction, the current then increases rapidly due to avalanche carrier collision. Normal device operation again ceases, and the device enters a high dissipation mode of operation. The collector-base voltage at which avalanche begins is called the **collector-base breakdown voltage**, symbolised  $BV_{cbo}$ .

In the "common base" configuration in which the curves of figure 10.5 are measured, the collector-base junction is biased by a voltage applied directly between collector and base ( $V_{cb}$ ). Because of this, the device does not amplify its own reverse bias current when the external base-emitter bias is zero ( $I_e = 0$ ). The lowest of the curves therefore corresponds to the "normal" reverse bias current of the collector-base junction, known as the **collector-base saturation current** ( $I_{cbo}$ ).

It may be noted that the curves of figure 10.5 actually slope upward slightly in the direction of increasing collector voltage. The reason for this is that as the collector-base voltage is increased, the depletion layer of the collector-base junction naturally widens, and this reduces the effective thickness of the base. The amplification therefore increases slightly, due to lower carrier recombination and increased base transport efficiency.

A further point to note is that although the curves for low values of emitter current are spaced apart by almost exactly the same intervals of collector current, those for higher values become cramped together. In other words, the amplification action of the bipolar transistor droops at high values of emitter and collector current.

The primary reason for this is that at high current levels the emitter injection efficiency of the device tends to fall as a result of the large number of minority carriers present in the base region. In effect, the number of minority carriers becomes so great that the emitter-base diffusion current component tends to fall, the base-emitter component rising to compensate.

The other main type of collector characteristic used for the bipolar transistor is that known as the **common emitter characteristic**, illustrated in figure 10.6. As may be seen, this displays the amplification action of the device in terms of the relationship between collector current and voltage for various base currents.

The common emitter curves are rather similar to those for the common base configuration, as may be seen, the main difference being that the value of base current corresponding to each curve is very much smaller than the value of emitter current. In effect, the common-emitter curves display beta, whereas the common base curves display alpha.

The curves may be seen to have a more pronounced slope than those of the common-base characteristic, and this is again due to the reduction of the effective base thickness as the collector-base junction depletion layer extends with increasing collector voltage.

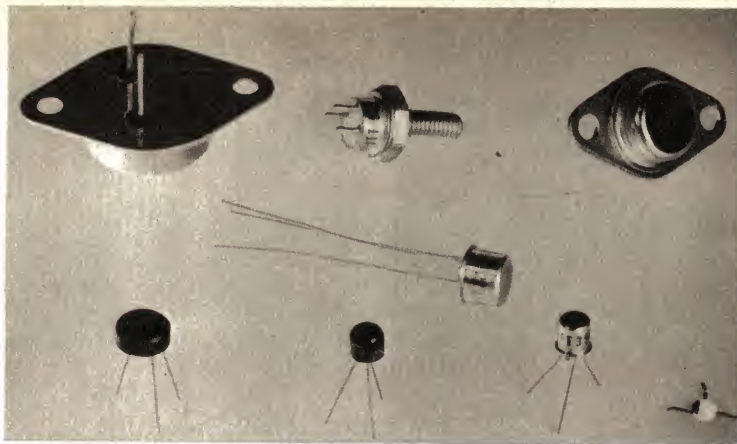

*An array of modern silicon transistors, reproduced approximately actual size. The largest device, when bolted to a suitable heatsink, is capable of dissipating up to 120 watts. The smallest shown is a sub-miniature type for VHF use, capable of dissipating only a few tens of milliwatts.*

The effect is more dramatic in this case merely because beta is a more sensitive indicator of the amplification mechanism.

As before, the curves may be seen to cramp together at higher collector current levels, indicating the droop in amplification due to falling emitter injection efficiency. Again the effect appears more marked in this case, due to the greater sensitivity of beta as an indicator of the device amplification mechanism.

When the curves of figure 10.6 are measured, the collector bias voltage is applied between collector and emitter as shown in figure 10.3. As we saw earlier, this allows the device to amplify its own reverse bias current even when no external forward bias is applied to the base-emitter junction.

As a result the lowest ( $I_b=0$ ) curve of the family in this case represents a collector current level somewhat greater than the normal reverse bias current of the collector-base junction. Known as the **collector-emitter saturation current** ( $I_{ceo}$ ), it is actually very close in value to  $I_{cbo}$  multiplied by beta.

Whereas the curves of the common base characteristic maintained their value of collector current down to zero collector voltage  $V_{cb}$ , the curves of the common emitter characteristic may be seen to fall away at a low value of collector voltage, the value rising slightly with collector current. The reason for this is that because the collector bias voltage is applied between collector and emitter, it cannot be reduced below a certain value without effectively forward-biasing the collector-base junction.

Naturally when the latter occurs collector action falls, so that collector current drops as soon as the effective collector junction voltage reverses.

The voltage level at which the collector current of the device begins to fall is known as the **collector saturation voltage**, symbolised  $V_{ce(sat)}$ . The slight rise in this voltage with collector current results from the reduction in effective collector junction voltage due to resistive voltage drop in the relatively high resistivity collector and base material.

As before the collector bias voltage of the device cannot be increased indefinitely, for at a certain voltage avalanche breakdown occurs and the device current rises sharply. The avalanche breakdown of a bipolar transistor in the common emitter configuration occurs at the **collector-emitter breakdown voltage**, symbolised  $BV_{ceo}$ .

Because the device amplifies its own leakage current in this configuration, the amplification and avalanche effects are cumulative and this generally causes  $BV_{ceo}$  to be somewhat lower than the collector-base breakdown voltage  $BV_{cbo}$ .

At this stage of our discussion of the bipolar transistor it is hoped that the reader has gained a reasonably clear and satisfying concept of basic device operation. If this is not so, a glance back through the chapter may be advisable, as the concepts which have been presented are quite important and will be necessary for an adequate understanding of the following chapters.

## SUGGESTED FURTHER READING

- BURFORD, W. B., and VERNER, H. G., **Semiconductor Junctions and Devices**, 1965. McGraw-Hill Book Company, New York.
- CLEARY, J. F. (Ed.) **General Electric Transistor Manual**, 7th Edition, 1964. General Electric Company, Syracuse, New York.
- PHILLIPS, A. B., **Transistor Engineering**, 1962. McGraw-Hill Book Company, New York.
- SHIVE, J. N., **Physics of Solid State Electronics**, 1966. Charles E. Merrill Books, Inc., Columbus, Ohio.
- SURINA, T., and HERRICK, C., **Semiconductor Electronics**, 1964. Holt Rinehart and Winston, Inc., New York.
- Also "The Transistor: Two Decades of Progress," a special review section in **Electronics**, V.41, No. 4, February 19, 1968.

# A low cost 200KHz Digital Frequency Meter

The "low frequency" version of our new digital counter design. It uses the same counting section as the high frequency version yet to be described, so that it can measure to beyond 40MHz if an external timebase is used. Integrated microcircuits and printed wiring boards make assembly quite straightforward.

by Jamieson Rowe

Taking advantage of modern components and circuit techniques, the basic digital counter-frequency meter described in this article offers a high standard of performance at a very modest cost. It provides the facility for making rapid, unambiguous frequency measurements and event counts of high accuracy and resolution. As a result it should be very suitable for use in equipment servicing, production testing, research and development, and by amateur radio operators.

It may also be of interest to universities and technical colleges, both as a means of providing low-cost digital frequency meters for student use, and also as a constructional project for engineering and science students. The design would be well suited for the latter application, as it combines low cost and ease of construction with the use of modern integrated microcircuits and printed wiring boards.

The design uses solid-state devices throughout, with the exception of the gas-discharge tubes used for numerical readout display. It uses a total of 29 microcircuits, 8 discrete transistors, 9 diodes and a silicon rectifier bridge. The digital microcircuits used include devices of the RTL, DTL and ECL variety, and together represent some 525 functional transistor elements and 34 functional diode elements. This may give some idea of the order of wiring simplification and cost reduction which has been made possible with microcircuits.

The instrument has a counter consisting of three full decades plus single digit over-range, and is also fitted with overflow detection and indication. The readout display is via side-viewing, gas-discharge display tubes for the full decades, together with a matching neon lamp for the over-range "1." Counter capacity is 1,999, giving a display resolution of .05 per cent.

Three frequency measurement ranges are provided, together with an "events counting" range and an "external timebase" range. The frequency ranges are nominally 0-2KHz, 0-20KHz and 0-200KHz.

The limitation of the self-contained frequency range of the instrument to 200KHz arises from the fact that this version of our DFM design uses a low cost mains-derived timebase system. A 50Hz signal from the power mains is doubled in a modified full-wave rectifier circuit, and then fed to a flip-flop divider chain to provide timebase frequencies of 100Hz, 10Hz and 1Hz.

This system offers a considerable cost saving compared with a crystal oscillator and divider chain, and it is for this reason that we have adopted it for the low frequency version of the design. However, as 100Hz is the highest frequency which may be easily derived from the 50Hz AC mains, this means that 10mS is the shortest internal gating time available for frequency measurement.

A further consequence of the use of mains-derived timebase signals is that the measurement accuracy of the instrument for the ranges concerned is quite modest—typically only in the order of 0.5-1 per cent. However, it is

believed that there are many applications in which this limitation and that of restricted frequency range will be outweighed by the low cost and freedom from reading ambiguity provided by the instrument.

The frequency response of the input signal shaping, gating and counter sections of the instrument is considerably better than the figure of 200KHz which corresponds to maximum capacity of the counter for a 10mS gating time. In fact, these sections will typically be capable of operating reliably to beyond 40MHz, as they are identical with the corresponding sections of the high frequency version.

All that is necessary in order to realise this "latent" frequency performance is to supply the instrument with the appropriate higher frequency timebase signals. These may be supplied from any suitable source of stable reference signals having a peak-to-peak output of about 3-4 volts. A suitable source would be the "Solid State Crystal Calibrator" described by the author in the September, 1969, issue. The selected timebase signal from such a



## SPECIFICATIONS

A low cost digital frequency meter employing integrated microcircuits and gas-discharge readout tubes. The readout display provides three full decades plus single digit over-range. A panel lamp indicates counter overflow.

Basic frequency range of the instrument is 200KHz, but this is limited not by counter response but by the limitations of the internal mains-derived timebase. The response of the counter itself extends to beyond 40MHz, and this range may be realised if an external timebase is used.

The three internal frequency ranges cover 0-2KHz, 0-20KHz and 0-200KHz. An "events" position permits manual control of the counter gate for event counting. External gate control for this mode is also possible using a +3V/0 logic convention. Similarly an external timebase may be used for extended range measurements and frequency ratio measurements.

Two internal sampling rates are provided, 5 per second and 1 per 4 seconds, together with a manual sample facility and provision for external sampling input (+3V/0 convention).

Input impedance of the instrument is approximately 2K ohms, with an input sensitivity of approximately 30mV P-P up to 200KHz rising to better than 300mV P-P at 40MHz. The input sensitivity is adjustable and the input circuitry is protected from overload damage for inputs up to 100V peak-to-peak.

Power consumption of the instrument is approximately 40 watts.



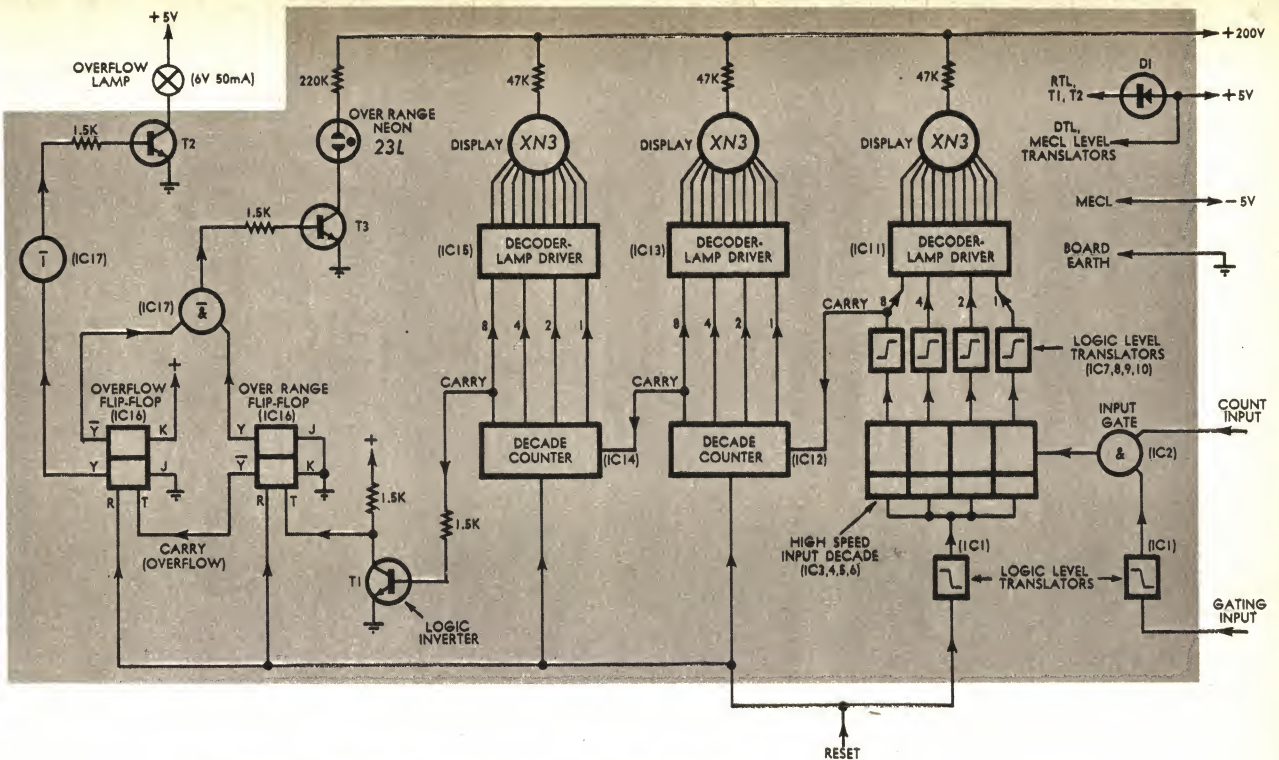

**DIGITAL FREQUENCY METER - COUNTER BOARD**

GREY OVERPRINT INDICATES PRINTED WIRING BOARD (69/410)

Figure 1

source is simply fed to a connector provided at the rear of the counter, and the function switch turned to the "external timebase" position.

Naturally the accuracy of the instrument when used with an external timebase source will be somewhat greater than with the internal mains-derived timebase signals. When the September, 1969, calibrator is used, for example, the accuracy will be in the order of .01% or better depending upon the care taken in standardising the calibrator, and upon the resolution of the effective range involved.

The same rear connector and function switch position used for higher frequency measurements may also be used to enable the instrument to perform frequency ratio measurements, or measurements in special units. Thus, by using appropriate timebase signals, it is possible to arrange the instrument to measure an unknown frequency in terms of a ratio to a known frequency, or to express a pulse rate in terms of beats per minute, firings per revolution, etc.

In the "events count" mode the instrument will perform normal counting, the gate being controlled by a manual pushbutton on the front panel. An indicator lamp is provided to display the "gate open" condition. The logic circuitry is arranged so that the first depression of the button following instrument reset will open the gate, while the second depression will close it. Further depressions have no effect until the instrument is reset, ensuring that readings are quite unambiguous. The input pulses counted in this mode may have any repetition rate up to 40MHz.

Remote command events counting is also possible, using the "external timebase" facilities. In this case a push-button and bounce-suppression circuit

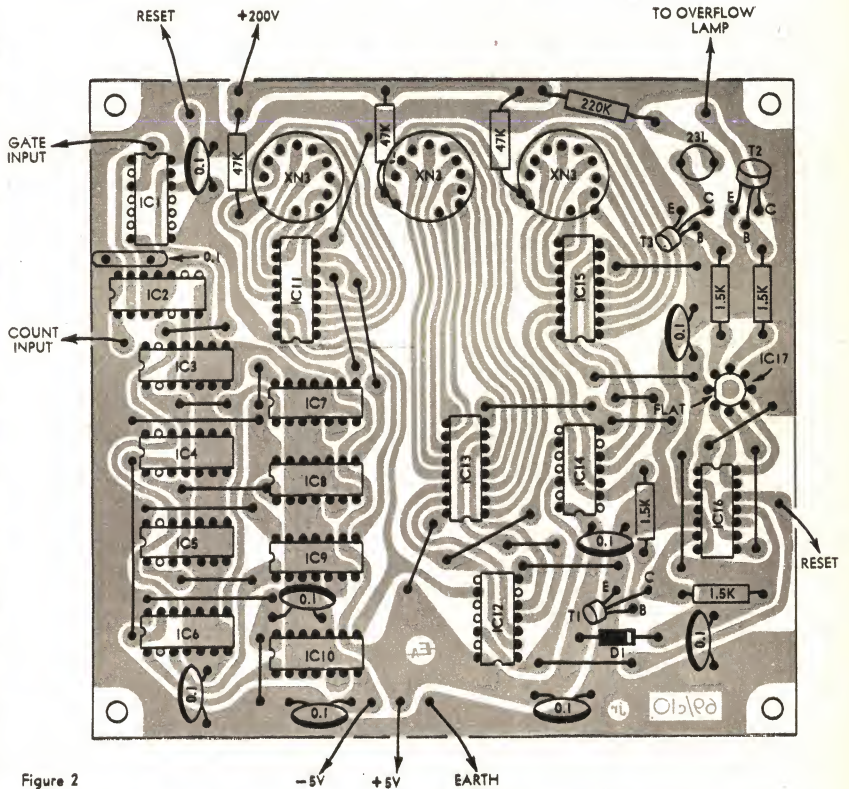

Figure 2

would merely take the place of the external timebase generator to which reference was made earlier.

Naturally for convenient remote command operation a remote reset facility is also necessary, and provision has been made for this also. The instrument in fact provides four sampling modes; two automatic recycling modes, in which measurements are made at 5 per second and 1-every-4 seconds, respectively, a "manual" mode allowing reset when required using a second

push-button on the front panel, and the "external" mode in which reset is initiated by a +3V/0V pulse applied to a rear panel connector.

The two internal sampling modes employ reset pulses of 5Hz and 0.25Hz repetition rates, which are derived from the mains timebase system. This obviates the cost of an independent free-running sampling generator, and involves only a slight restriction in terms of operating flexibility. The lower rate must be used for the 2KHz

world famous



pushbuttons  
now made  
locally

to get the pressing problems of top quality  
and immediate availability right off  
the launchpad



49 colour combinations available ex stock.  
Featuring Silver contacts 1 N/O or 1 N/C  
with 250V/0.7A rating. Screw or quick  
connect termination. Shown actual size.



**E. S. RUBIN & CO.  
PTY. LTD.**

73 Whiting Street, Artarmon, N.S.W. 2064.  
Telephone: 439 2333. Telex: 21175 • 6 Kemp  
Street, Woodville, South Australia 5011.  
Telephone: 45 3579. Telex: 82529  
• 138 Berkeley Street, Carlton, Victoria 3053.  
Telephone: 34 6469. Telex: 30948  
• Queensland—Telephone: 74 097. Western  
Australia—Telephone: 21 7861.

and 20KHz internal ranges because of the gating times used for these ranges; however, either sampling rate may be used for the 200KHz internal range and for higher ranges employing external timebases.

The input sensitivity of the instrument is better than 30mV P-P between about 100Hz and 3MHz, falling to better than 300mV P-P at 10Hz and 40MHz. The sensitivity may be reduced if necessary, for the measurement of signals in the presence of noise. Input impedance is approximately 2K ohms.

Overload protection is incorporated into the input circuitry, and the instrument is thus able to accept signals up to approximately 100V peak-to-peak without damage.

Apart from the power supply wiring, all of the circuitry of the instrument is mounted on printed wiring boards. This simplifies the construction considerably, so that, despite its relative complexity, the instrument should be capable of being constructed rapidly, easily and with confidence even by those with little experience of equipment construction.

There are three wiring boards, the largest of which supports the complete counting section including decoding and readout display. A smaller board, mounted beneath the counter board, provides the mains-derived timebase frequencies, while the smallest board mounts behind the input connector and main front panel controls and supports the input shaping, gating logic and reset circuitry.

The logic/circuit diagram of the counter board is shown in figure 1. As may be seen, it includes some 17 microcircuits, three discrete transistors, three numerical indicator tubes, a neon lamp and a handful of minor components.

Input signal gating for the counter is performed on the counter board itself, by microcircuit IC2. As the counter gate must be capable of operation at the highest input frequency handled by the instrument, a high speed ECL-type device is used. The device is actually a Motorola MECL, type MC1004.

As the devices used on the input board to generate the gating signal are saturated-logic RTL devices, the actual gating signal fed to the counter board has the corresponding logic convention. Because of this a "logic level translator" is used to convert this signal into one compatible with the ECL gate device. The translation function is performed by one half of IC1, a Motorola type MC1017.

The first decade of the counter itself must also be capable of operating at the maximum input frequency handled by the instrument, and for this reason high-speed ECL devices are again used in this section. The decade consists of four Motorola type MC1013 flip-flops, which have a rated maximum toggle frequency of 70MHz minimum. These devices are shown on figure 1 as ICs 3, 4, 5 and 6.

The second and third decades of the instrument handle somewhat lower maximum frequencies than the input decade, and for this reason these decades use devices of lower frequency capability. The devices which are used in this case are type CuL 9958, from

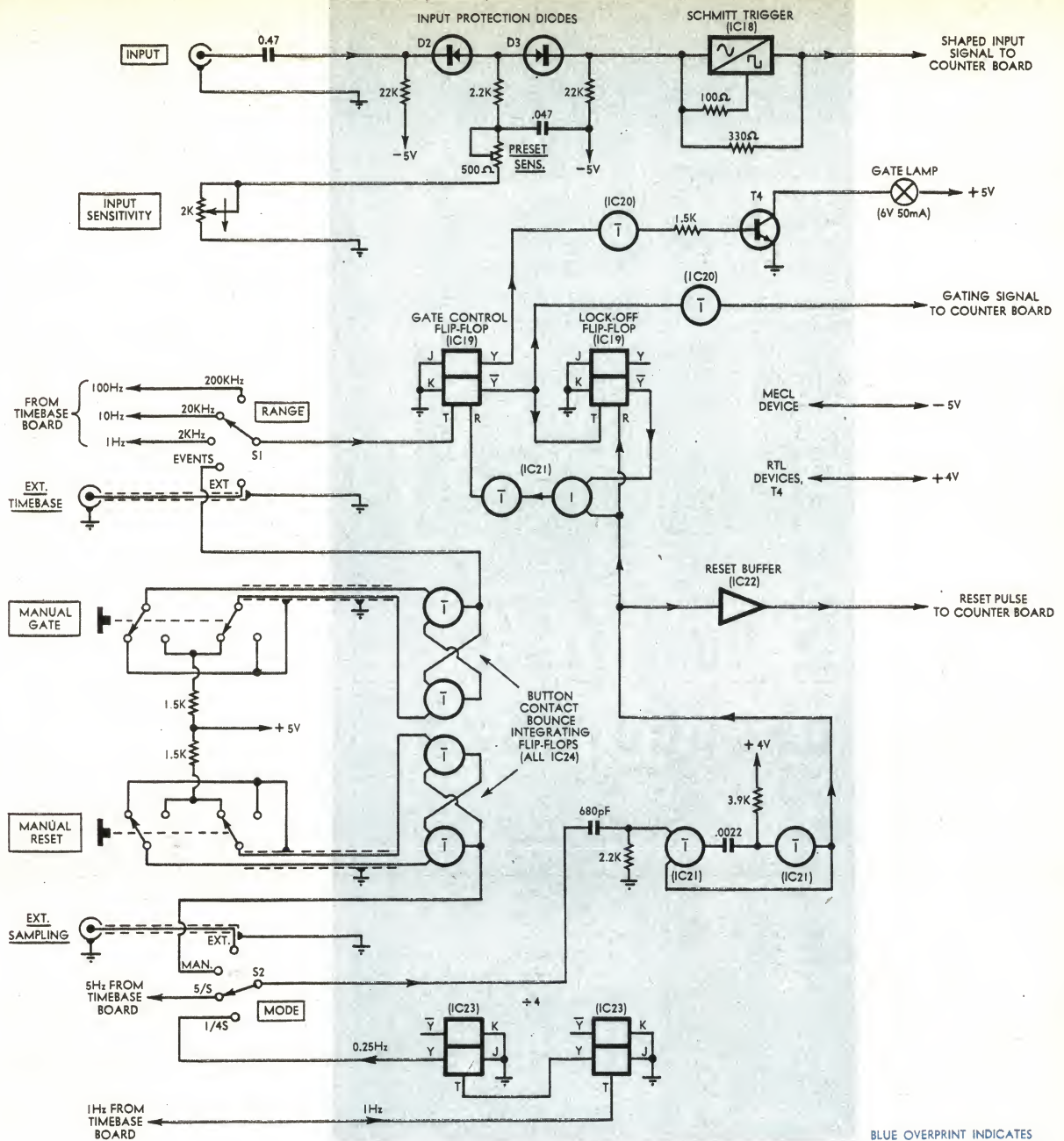

BLUE OVERPRINT INDICATES PRINTED WIRING BOARD (69/c11)

EA 200kHz DIGITAL FREQUENCY METER—INPUT BOARD

Figure 3

the Fairchild "Counting Micrologic" range. Each device is a complete decade counter (IC12, IC14), containing four flip-flops and associated feedback gating, and operating in 8421 BCD code.

The outputs of each of the three counting decades is decoded into decimal notation and prepared for application to the numerical readout tubes by devices IC11, IC13 and IC15. These are combined decoder/lamp driver devices type CuL9960, again from the Fairchild range.

As the decoder/lamp driver devices employ DTL circuitry, logic level translators must be used between IC11 and the ECL flip-flops of the first counting decade. The devices used in these positions (ICs 7, 8, 9, 10) are Motorola type MC1018, which are expressly designed for ECL/saturated logic translation. Device IC10 also acts as a level translator for the carry-over to the DTL device IC12.

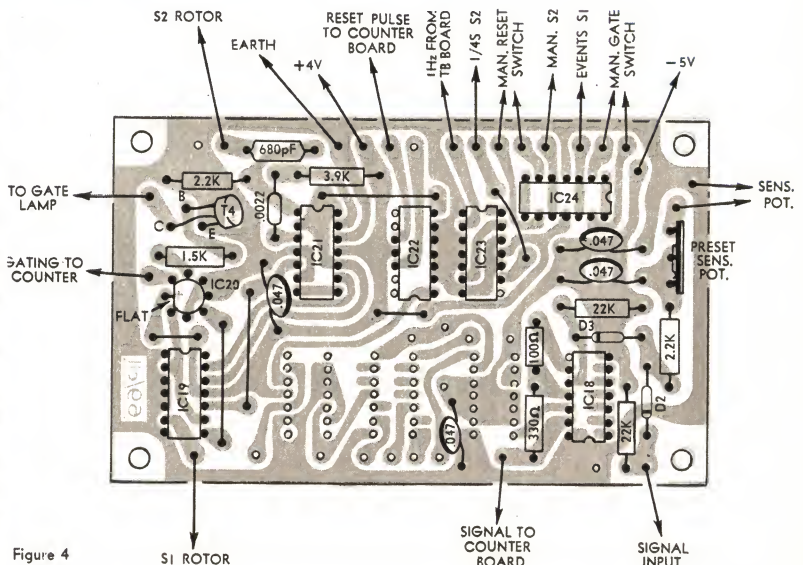

Figure 4

The OS25 has set new standards for a low-cost, dual-trace oscilloscope. It is rugged, simple to operate and maintain and is attractively styled. Triggering facilities are unusually comprehensive for a low-cost instrument of this type and include internal triggering from either channel.

This oscilloscope has a vertical amplifier bandwidth from DC to 5 MHz with a maximum sensitivity of 100 mV/cm on each channel. The time base gives sweep speeds from 1 sec/cm to 0.5  $\mu$ S/cm using switched and fine controls. The operating mode best suited to the time base speed is automatically selected by the time base range switch; beam switching for the two slowest speeds and alternate sweep for the four highest speeds.

A bright clear display is obtained on a 5-inch helical PDA tube operating at a potential of 3 kV overall.

## 5 MHz Dual-Trace Oscilloscope OS25



Exclusive Australian Distributors for...

**ADVANCE INSTRUMENTS**

**jacoby, mitchell**  
**& co. pty. ltd.**      **26-2651**  
**469-475 kent street, sydney**

MELBOURNE    30-2491  
 ADELAIDE      53-6117  
 BRISBANE      2-6467  
 PERTH          28-1102  
 LAUNCESTON   2-5322



JM/14-68

The numerical readout tubes used in the instrument are low-cost side-viewing types from the English "Hivac" range. Designated type XN3, they provide easily read numerals some 14mm high, and are intended for printed wiring board mounting. The tubes are available via trade suppliers from the Imported Components Division of Plessey Ducon Pty. Ltd.

Counter over-range is performed by one half of IC16, which is a Motorola type MC790P dual J-K flip-flop. Carry-over from IC14 to the over-range flip-flop is taken via an inverter transistor T1, which is necessary because although the DTL device IC14 and the RTL device IC16 both use similar logic levels, they employ opposite logic conventions.

Readout for the over-range is performed by a neon lamp, driven by transistor T3. The neon lamp used is a special type having long electrodes,

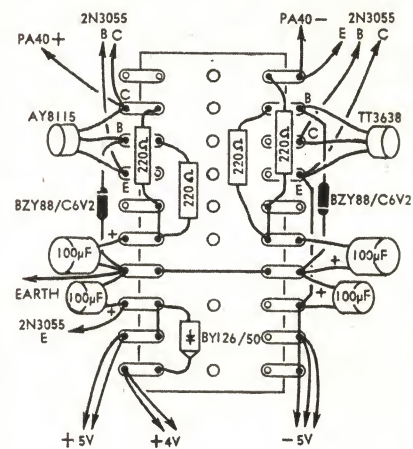

Figure 6

thus matching the numerals of the full decades. It is a Hivac type 23L, and is also available from Plessey Ducon Pty. Ltd.

Overflow detection is performed by the second flip-flop of IC16. The output of the flip-flop is fed via an inverter element to transistor T2, which drives the 6V/50mA panel indicator lamp. The inverter element is formed by half of IC17, which is a Fairchild type FuL914 dual gate.

The second half of IC17 is used as a NAND or inhibitor gate which prevents the over-range neon from operating when the counter has overflowed. This has been done to avoid ambiguity and prevent reading errors.

As may be seen, reset signals are applied to all three counting decades and also to both the over-range and overflow flip-flops. As the reset signals fed to the counter board have saturated logic levels, a level translator is used to feed the ECL input decade devices. The translator uses the second half of IC1.

Figure 2 shows the component placement and additional wiring on the counter board. Assembly of this board should be a simple and straightforward operation if this diagram is used in conjunction with figure 1.

The logic/circuit diagram for the input board is shown in figure 3. In the present version of the counter design seven microcircuits are mounted on this board, together with



# The pocket priced sound maker

## monarch

The Monarch SA-400 is a deluxe integrated solid state stereo amplifier with luxurious walnut veneer cover. Flexible and compact, it has an ample power output of 10 Watts continuous per channel to the speakers. Includes Phono (both magnetic and ceramic), Tuner and Auxiliary Input, Tape-In and Tape-Out for tape recording, playback or monitoring.



The Monarch SA500/W amplifier — a deluxe solid state unit. Versatile and compact, it provides an



ample output of 34 watts continuous power, to the speakers. Includes Phono, Tuner and Auxiliary Input and Tape-Out for tape recording. Smoothly styled in a handsome walnut veneer cover. Careful selection of high-quality components in these amplifiers ensures trouble-free operation in the Monarch tradition of fine quality.

ample output of 34 watts continuous power, to the speakers. Includes Phono, Tuner and Auxiliary Input and Tape-Out for tape recording. Smoothly styled in a handsome walnut veneer cover. Careful selection of high-quality components in these amplifiers ensures

### MONARCH 500/W

**\$129**  
R.R.P.

#### FACILITIES

**Front Panel:** Selector—Aux; Tuner; Phono; Mono-Stereo Volume • Bass • Treble • Loudness • High Filter • Low Filter • Power • Phone Jack

**Rear Panel:** Input—Mag; Ceramic; Tuner; Tape; Tape Output • Speaker Terminals • AC Output • AC Fuse • Speaker Fuse

#### SPECIFICATIONS

**Output Power:** 42 Watts Total Music Power (IHF) into 8 ohms • 17½ Watts RMS each channel into 8 ohms.

**Harmonic Distortion:** Less than .9%

**Frequency Response:** 20-20,000 Hz + 1 DB

**Channel Separation:** Over 50 DB

**Hum and Noise:** Over 55 DB

**Loudness:** 50 Hz + 10 DB; 10,000 Hz + 4 DB

**Tone Controls:** Bass 50 Hz + 10 DB; —12 DB; Treble 10,000 Hz + 10 DB —12 DB

**Low Filter:** 50 Hz —10 DB

**High Filter:** 10,000 Hz —10 DB

**Input Sensitivity:** Mag. 3MV at 1KHZ. Tuner 150MV at 1KHZ. X'tal 150MV at 1KHZ. Aux. 150MV at 1KHZ.

**Power Supply:** 240 Volt A.C.

**Dimensions:** D — 10", W — 14½", H — 5".

### MONARCH S.A.400

**\$105**  
R.R.P.

#### FACILITIES

**Front Panel:** Selector—Aux; Tuner; X'tal; Phono • Volume • Balance • Treble • Bass • Loudness • Mode-Stereo • Mono • Tape Monitor • Power • Phone Jack • High Filter

**Rear Panel:** Input—Mag; X'tal; Tuner; Aux; Tape-Input; Tape-Output • Speaker Terminal • AC Output • AC Fuse • Speaker Fuses.

#### SPECIFICATIONS

**Output Power:** 28 Watts Total Music Power (IHF) into 8 ohms • 10 Watts RMS each channel into 8 ohms.

**Harmonic Distortion:** Less than 1%

**Frequency Response:** 30-20,000 Hz

**Channel Separation:** Over 50 DB

**Hum and Noise:** Over 60 DB

**Loudness:** 50 Hz + 10 DB; 10,000 Hz + 4 DB

**Tone Control:** Bass 50 Hz + 12 DB —12 DB; Treble 10,000 Hz + 12 DB —12 DB

**Scratch Filter:** 10,000 Hz — 10 DB

**Input Sensitivity:** Mag 3MV at 1KHZ. Tuner 150MV at 1KHZ. Aux 150MV at 1KHZ. X'tal 150MV at 1KHZ

**Power Supply:** 240 Volt A.C.

**Dimensions:** D — 9½", H — 3½", W — 13½".

Australian Distributors:

# W.C. Wedderspoon

SHOWROOM: 193 CLARENCE STREET, SYDNEY. 29-6681

AVAILABLE FROM ALL HI-FI SPECIALISTS IN ALL STATES

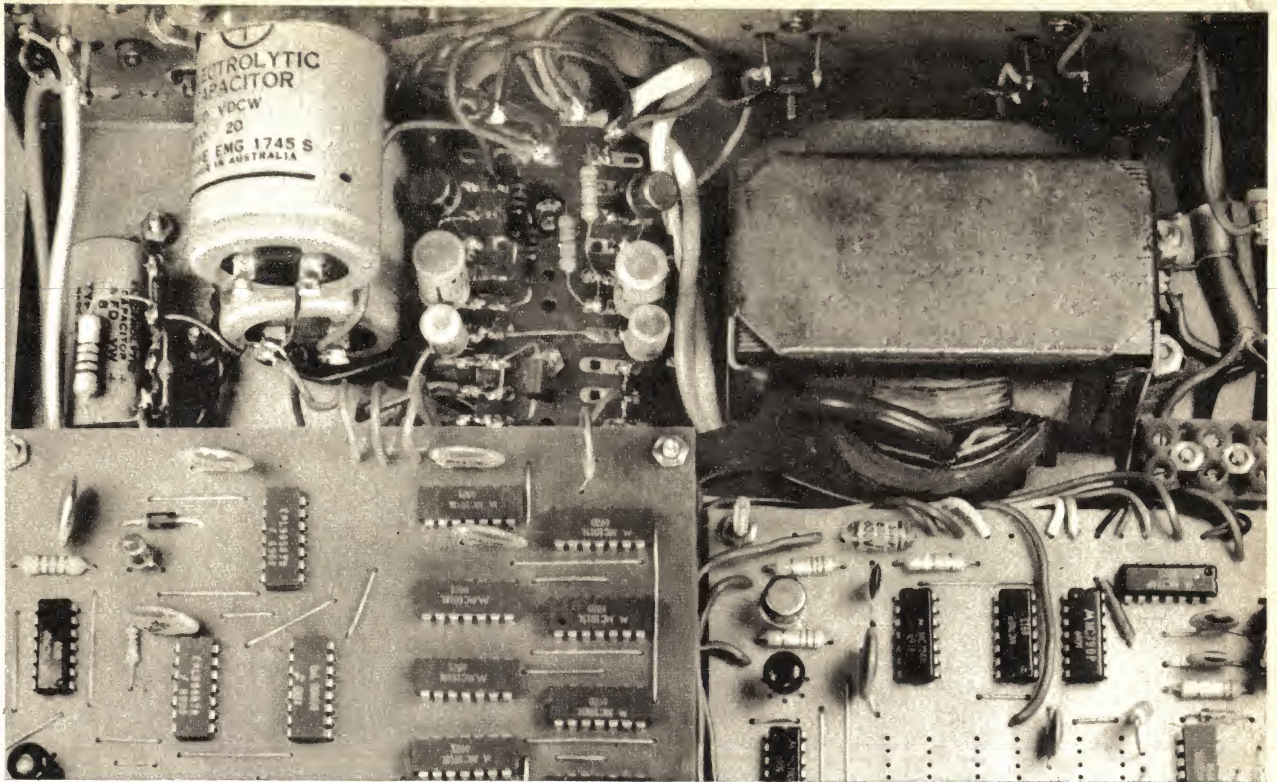

Above is a view of the interior of the instrument, looking from overhead and towards the rear. Visible are the power supply components, and part of the counter and input boards. At left is a view of the rear of the case.

allow the gate control flip-flop to be reset, along with the lock-off flip-flop, by the normal instrument reset pulses. It is therefore the latter pulses which act as the "sampling command" pulses in the instrument; each reset pulse not only resets the elements of the counter, but also primes the gate control circuitry to allow a new measurement to be taken.

Shaping of the reset/sampling pulses is performed by the remaining two gates of IC21, which are connected in a monostable or "one-shot" configuration. The output from the monostable is fed directly to the gate control logic, and through a buffer amplifier (IC22) to the counter board. Device IC22 is a Motorola type MC788P dual non-inverting buffer.

Selection of the reset/sampling signal source is performed by the mode switch S2. This selects one of four signals: (a) a 0.25Hz signal derived from the 1Hz timebase signal by the two flip-flops of IC23 (MC790P), giving a slow sampling rate; (b) a 5Hz signal taken from the timebase board, giving a faster sampling rate; (c) a "manual" signal generated by means of a front-panel "reset" button, with spurious bounce components removed by an integrating flip-flop using two elements of IC24 (MC724P); or (d) an external reset/sampling source.

The signal selected by S2 is differentiated before being fed to the monostable, to ensure correct operation regardless of the duration of the selected signal. Any signal having a pulse width greater than about 100ns is

thus quite suitable for use as an external reset source.

The second front-panel pushbutton and the remaining elements of IC24 are used to generate manual gating signals for the "events" counting function.

The placement of components and interconnection wiring for the input board of the instrument is shown in figure 4, and again it should be a fairly simple matter to assemble and interconnect the board using this diagram in conjunction with the circuit/logic diagram of figure 3. Note, however, that the board provides for integrated microcircuits and interconnections which are not used in this version of the instrument.

The remaining sections of the instrument to be described are the power supply and the mains-derived timebase. The circuit/logic diagram for these sections is shown in figure 5.

The power supply section of the instrument is fairly conventional. A simple half-wave rectifier circuit using a 150V/20mA transformer secondary winding is used to provide approximately 200V at low current for the readout display tubes, while a full-wave bridge rectifier circuit using a centre-tapped 12.6V/4A winding is used to provide supplies of +5V, +4V and -5V for the various microcircuits.

The low-voltage bridge rectifier is a single-package silicon unit, type PA40, by Electronic Devices Inc., of New York. It is available either directly or



## SONY TC120

Proudly presents this professional cassette recorder. Now even running, jumping, walking wherever you are with the Sony TC 120 featuring new handsome styling with built-in electret condenser microphone, which has remarkable 25ft radius pick up. Resettable tape counter, external AC/DC operation, or self-contained batteries.

Ideal for schools, lecture halls, business conventions, etc.

Available now from:

**VICTOR'S HI-FI CENTRE**

77 WENTWORTH AVE.,  
CNR. ELIZABETH STREET,  
SYDNEY.

61-2967.

61-6031

Full range of Kenwood amplifiers on display.

# INSTROL ELECTRONICS

## Everything for hobbyist and technician

### PLAYMASTER KITS STEREO AMPLIFIERS

(postage \$1.80 extra)



Playmaster No. 3	\$60.50
Playmaster No. 4	\$83.50
Playmaster No. 10	\$106.15
Playmaster No. 113	\$64.60
Playmaster No. 115	\$96.80
115 Magnetic Preamp	\$10.50
Playmaster No. 118	\$89.60
118 Magnetic Preamp	\$16.15
E.A. 3 plus 3	\$43.50
E.A. 10 plus 10	\$62.75
Playmaster 124 gram	\$67.70
Playmaster No. 128	\$99.40

### CONTROL UNITS

(postage \$1.20 extra)

Playmaster No. 112	\$44.00
—Preamp "A"	\$9.00
—Preamp "B" or "D"	\$6.00
—Preamp "C"	\$9.00
Playmaster No. 120	\$44.40
Playmaster No. 127	\$49.85

### TAPE ADAPTOR

(postage \$1.80 extra)

Playmaster No 119	\$87.03
-------------------	---------

### MISCELLANEOUS

(postage \$1.20 extra)



### KEYLESS ORGAN

(Electronics Aust. January 1969)

Playmaster 111 tuner	\$39.00
111 Power Supply	\$9.40
111 Whistle Filter	\$7.80
Fuzz Box (Aug. 67)	\$12.95
Musicolour (post. \$1.80)	\$46.05
Keyless Organ	\$35.10

### GUITAR AMPLIFIERS

(postage \$1.80 extra)

Playmaster No 116	\$84.35
Playmaster No 117	\$92.30

### PRINTED CIRCUITS

(extra 20c postage and packing)

Playmaster No 110	\$3.20
Playmaster 112, 65/P12A	\$2.50
65/P12B	\$2.50
Playmaster No. 113	\$3.00
No. 115 Crystal preamp	\$2.00
Magnetic preamp	\$1.60
Left channel	\$1.60
Right channel	\$1.60
Playmaster No. 119	\$2.50
Playmaster No. 120	\$2.50
Playmaster No. 123	\$3.20
No. 124 amplifier	\$2.50
Tuner	\$2.50
Playmaster No. 125	\$2.50
Playmaster No. 127	\$2.50
Playmaster No. 128	\$2.50
each	\$2.50
Powered loudspeaker (9-69)	\$1.25
Magnetic preamp (10-65)	\$2.50
Musicolour	\$2.50
Stereo three plus three	\$2.50
Stereo 10 plus 10	\$2.50
Keyless Organ (gold)	\$5.00
Keyless Organ (nickel)	\$3.50
F.E.T. Voltmeter	\$2.30
Blank 4 x 2, 3 x 3 or 4 x 3	.20
Blank 6 x 3	.25
Blank 6 x 4	.30
Blank 6 x 6	.45
Blank 12 x 3	.50
Blank 9 x 6	.60
Etching kit	\$1.15

### PLASTIC INSTRUMENT CASES

6 x 3 x 2 (post. 20c)	\$1.32
5 x 2 1/2 x 1 1/2 (post. 25c)	.75

### LABELS

(post. 20c, reg'n 25c extra)

Playmaster No. 2	\$2.00
Playmaster No. 3	\$2.00
Playmaster No. 4	\$2.00
Control Unit No. 9	\$2.00
Control Unit No. 10	\$2.00
Playmaster No. 102-103	\$2.80
Playmaster No. 104	\$2.00
Playmaster No. 105	\$2.00
Playmaster No. 106	\$2.80
Playmaster No. 107	\$2.80
Playmaster No. 108	\$2.80
Playmaster No. 110	\$4.00
Playmaster No. 111	\$2.80
Playmaster No. 112	\$2.00
Playmaster No. 114	\$2.80
Playmaster No. 115	\$2.00
Playmaster No. 116	\$2.80
Playmaster No. 117	\$2.80
Playmaster No. 118	\$2.80
Playmaster No. 119	\$3.40
Playmaster No. 120	\$2.00
Playmaster No. 123	\$2.80
Playmaster No. 124	\$2.00
Playmaster No. 125	\$4.50
Playmaster No. 127	\$2.00
Stereo 3 plus 3	\$2.00
Stereo 10 plus 10	\$2.00
Musicolour	\$2.00
Fuzz Box	\$1.20



### METALWORK

Write in for free catalogue on INSTROL high-quality metalwork and chassis for "Electronics Australia" designs.

### TOOLS

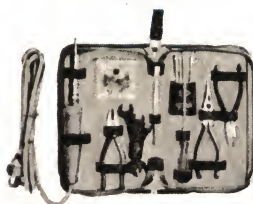

Instrol Tool Kit (\$1 post.)	\$12.50
Adel hand nibbler (30c post.)	\$5.75
Chassis Punch Set 5RB (\$1 post.)	\$7.00
Adcola M64 Sold. Iron (30c post.)	\$6.50
Craftsman 30W Iron (30c post.)	\$4.20

### DIECAST INSTRUMENT CASES

4 1/2 x 3 x 1 (post. 20c)	\$2.19
4 1/2 x 3 x 2 (post 35c)	\$2.76
6 1/2 x 4 1/2 x 2 (post. 60c)	\$3.81

### HOWARD SAMS BOOKS

(add 15c packing and postage)

Using Scopes In Transistor Circuits	\$5.45
Troubleshooting With The Oscilloscope	\$3.40
Know Your Oscilloscope	\$3.40
101 Ways To Use Your Oscilloscope	\$4.05
101 More Ways To Use Your Scope In TV	\$4.05
A.B.C.s Of Transistors	\$3.20
101 Ways To Use Your Signal Generator	\$4.03
Radio Receiver Servicing	\$5.18
TV Diagnosis And Repair	\$2.25
Transistor Substitution Handbook	\$3.05
Many Other Titles	

# INSTROL ELECTRONICS CENTRE

91a York St. (between  
King & Market St.)

PHONE 29-4258 SYDNEY N.S.W. 2000

for descriptive leaflet post coupon

<input type="checkbox"/> Playmaster	Please include postage stamp.
<input type="checkbox"/> Toolkit	Name .....
<input type="checkbox"/> Microphone	Address .....
<input type="checkbox"/> Metalwork	Postcode .....
<input type="checkbox"/> Technical Books	
<input type="checkbox"/> Capstan Cabinets	



via trade suppliers from Watkin Wynne Pty. Ltd., who act on behalf of Australian General Electric Pty. Ltd., the importers. Watkin Wynne are also able to supply the transient-protected A14M diode used in the 200V supply.

The reservoir capacitors for the low-voltage supplies are bracket-mounted 3000uF units, this value being necessary because of the appreciable current drain. These and the other capacitors used in the prototype power supply were kindly supplied by Plessey Ducon Pty. Ltd. Readers may order similar units from this firm, through their usual trade supplier.

Both the positive and negative out-

The diodes are connected to the ends of the low-voltage transformer secondary in such a way that they perform full-wave rectification.

No reservoir capacitor is used at the output of the rectifier, the idea being that it is the 100Hz ripple component in the output which is shaped and used to produce the highest timebase signal. The small filtering components used are arranged only to attenuate higher order components, and to prevent malfunction due to mains transients.

Shaping of the 100Hz component from the rectifier is performed by the elements of IC28, which is an MC724 quadruple gate. Two of the elements

derive the 10Hz, 5Hz and 1Hz timebase signals.

Each of the two divider decades used employs two MC790P dual J-K flip-flop devices, connected in the minimum-device configuration used in the author's Crystal Calibrator (September, 1969).

The main advantage of the mains-derived timebase system is economy, as noted earlier; only five microcircuits are involved, and no quartz crystal is required. The disadvantages are that the highest readily obtainable timebase frequency is 100Hz, limiting the self-contained frequency range of the instrument, and that the short-term frequency stability of the power mains restricts measurement accuracy using the internal timebase signals to about 0.5—1 per cent.

For a low cost general-purpose LF instrument of the type involved here, these disadvantages are probably not great. However, for higher frequency measurements and for more critical applications, it is generally necessary to employ a more pretentious timebase system. For this reason the high frequency version of the design to be described in the third article uses a quartz crystal timebase divider system.

To assist constructors in wiring the power supply and timebase sections of the instrument, we have prepared wiring diagrams for the power supply resistor panel and the timebase board. These are shown in figures 6 and 7 respectively.

Physically the new instrument is housed in a simple low-cost metal case which is identical in style and external dimensions to that of our "10-Plus-10 Stereo Amplifier." The prototype case was kindly supplied by Heating Systems Pty. Ltd., who should be able to supply drilled and punched cases and front panels soon after this article appears.

As may be seen from the photographs, the front of the

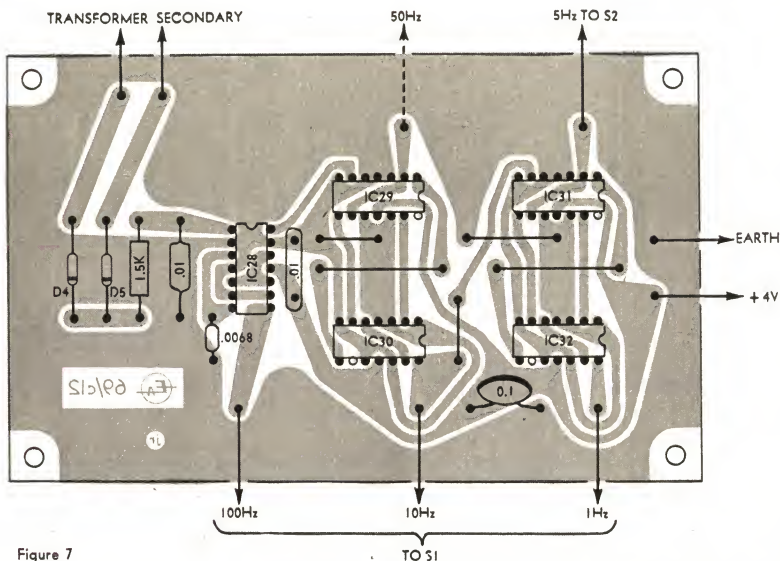

Figure 7

puts of the low voltage power supply are stabilised by means of simple series regulator circuits. The regulators are very similar, and use BZY88/C6V2 nominal 6.2V zener diodes in conjunction with BDY20/2N3055 series regulator transistors. The main difference between the two is that in the positive supply an AY8115 or 40408 device is used in conjunction with the main transistor in a Darlington or "super-alpha" pair, for high current gain, whereas in the negative supply the reversed polarities require the use of a "complementary compound" configuration using a TT3638 PNP device.

The -5V output from the supply is used for the ECL devices on the counting board, and for IC18 on the input board. The +5V supply is used for the DTL devices on the counting board, for the level translation ECL devices, and for the front panel pilot lamps. As the +5V supply would cause excessive dissipation if applied to the RTL devices, a simple series-diode system is used to derive approximately +4V for these devices.

The power transformer used for the instrument is a rather special type, combining a low-current high voltage secondary with a high-current low voltage winding. The prototype transformer was kindly supplied by Ferguson Transformers Pty. Ltd., from whom similar units may be ordered via trade suppliers. The type number which has been assigned to the unit is PF 3144.

The mains-derived timebase system may be seen to be a simple one, using only five microcircuits, two diodes and three minor components.

perform squaring, while the remaining two act as buffers. One of the latter provides the 100Hz timebase signal which passes to the range switch S1; the other provides the signal for the frequency divider elements used to

## DURATONE HI-FI

BRITISH amplifiers — direct imports save money.  
Unit 1 18 plus 18 wts rms into 8 ohms. THD at 6 wts rms 0.1%; 5 inputs; teak case.

**Price \$139.00**

Unit 2 As above; 25 plus 25 wts rms; THD 0.25 wts to 18 wts rms 0.1%

**Price \$169.00**

Unit 3 12 plus 12 wts rms; THD 0.01% at 1/2 watt (normal listening level) teak case.

**Price \$175.00**

Check our low prices on Sony Kenwood J. H. Silcron Wharfedale Goodmans Quad Tandberg B & O KEF etc. etc.

Mail Order P.O. Box 125  
CURTIN, A.C.T.

Phone Canberra  
81-2549

**CT 500/P MULTIMETER**

6 DC Voltage Ranges: 0 - 5000V  
 5 AC Voltage Ranges: 0 - 1000V  
 4 DC Current Ranges: 0 - 500mA  
 4 Resistance Ranges: 0 - 12M  
 Sensitivity: DC 20,000 ohms per Volt,  
 AC 10,000 ohms per Volt

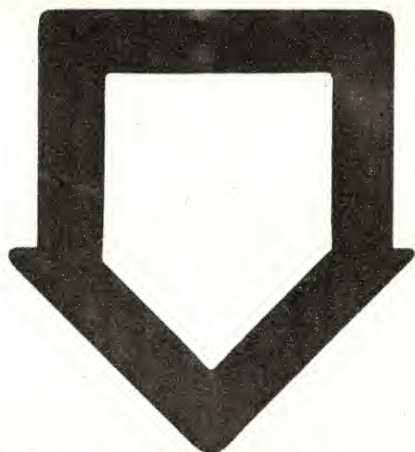

**200H MULTIMETER**

6 DC Voltage Ranges: 0 - 2500V  
 5 AC Voltage Ranges: 0 - 1000V  
 3 DC Current: 0 - 250mA  
 Resistance: 0 - 6K, 6M  
 Capacitance: 10pF - 0.1MFD  
 Sensitivity: DC 20,000 ohms per Volt  
 AC 10,000 ohms per Volt

**MEASURE UP TO A  
 MULTIMETER FROM  
 GENERAL ACCESSORIES  
 THE METER SPECIALISTS**

SERVING THE RADIO & ELECTRICAL INDUSTRY THROUGHOUT AUSTRALIA.

DIVISION OF ELECTRONIC INDUSTRIES LIMITED.

N.S.W. 443 CONCORD ROAD, CONCORD WEST. Phone: 73 0211  
 W.A. 46 MILLIGAN STREET, PERTH. Phone: 21 2501  
 TAS. 199 COLLINS STREET, HOBART. Phone: 2 2711  
 QLD. 50 LITTLE EDWARD STREET, BRISBANE. Phone: 2 3093  
 S.A. 81 FLINDERS STREET, ADELAIDE. Phone: 23 4022  
 VIC. 153 STURT STREET, SOUTH MELBOURNE. Phone: 69 0300

**CT 330 MULTIMETER**

8 DC Voltage Ranges: 0 - 6000V  
 5 AC Voltage Ranges: 0 - 1200V  
 4 DC Current: 0 - 600mA  
 4 Resistance: 0 - 60Meg Ohms  
 Capacitance: 50pF - 0.2MFD  
 Sensitivity: DC 20,000 ohms per volt, AC  
 10,000 ohms/volt

**CT 330/P With Diode Protection**



**C 1000 MINIMULTIMETER**

4 AC Voltage Ranges: 0 - 1000V  
 4 DC Voltage Ranges: 0 - 1000V  
 2 DC Current: 0 - 100mA  
 Resistance: 0 - 150K Ohms  
 Sensitivity: 1000 ohms per Volt AC, DC



**OL 64D MULTITESTER**

**\*Measuring Range**  
 8 DC Voltage Ranges: 0 - 5000V at 20 Ohms/V  
 4 AC Voltage Ranges: 0 - 1000V  
 5 DC Current Ranges: 0 - 10A  
 4 Resistance Ranges: 0 - 40 meg Ohms  
 Capacitance: 250pF - 0.02µF  
 Inductance: 0 - 5000H  
 Sensitivity: 20,000 ohms per Volt DC  
 8,000 ohms per Volt DC

instrument is fitted with an escutcheon plate having a rectangular window for the readout display. The window is provided with an optical filter made from orange-tinted "Perspex" sheet, the later being bolted to and behind the front panel proper by means of countersunk-head screws hidden behind the escutcheon.

Beneath the display window on the front panel are mounted the mains pilot, gate indicator and overflow lamps, and below these again the mains switch, manual gating button and

the power transformer, behind the range switch S1 and the sensitivity pot. The mains-derived timebase board is mounted alongside this board to the left, behind the mains switch, push-buttons and mode switch S2. The counter board is mounted above the timebase board, supported by long screws in a position such that the numerals of the readout tubes are centrally placed behind the display window.

Construction of the instrument should present few problems even for

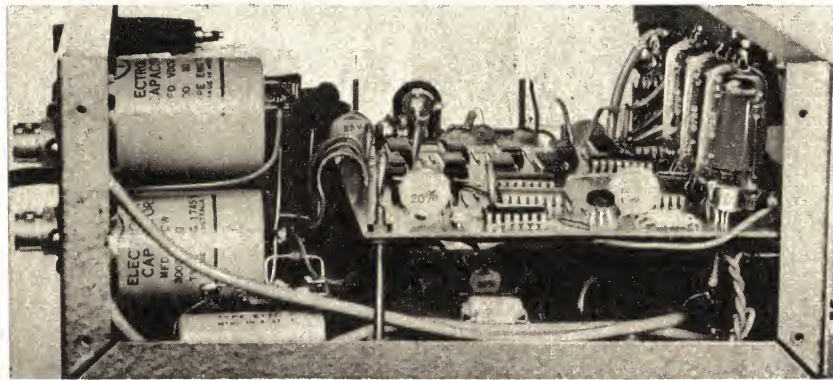

A view taken from the left-hand side of the case, with the cover removed. The timebase board may be seen beneath the counter board.

manual reset button. Adjacent to these is the mode switch, S2.

The pilot lamps, mains switch and manual pushbuttons are all miniature types. The pilot lamps are Japanese "Sato" components, and may be ordered via trade suppliers from either I.R.H. Components Ltd. or the Imported Components Division of Plessey Ducon Pty. Ltd. The mains pilot has a green bezel, while the other two have red bezels.

The mains switch and pushbuttons are from the Japanese "NKK" range, and may also be ordered via trade suppliers from I.R.H. Components Limited. The mains switch is coded type S-2012, while the buttons are coded type SB-2061.

To the right of the display window on the front panel are the range switch S1 and the sensitivity control, in that order. Mounted centrally between these controls is the input connector, completing the front panel fittings.

Mounted on the exterior of the case rear are the mains cord entry and the power fuse-holder, the two power supply regulator transistors (insulated by mica washers), and at the far right the two connectors for external timebase and external sampling input. The silicon rectifier bridge and 3000uF reservoir capacitors are mounted on the rear of the case also, but are inside.

The power transformer is mounted near the rear of the case, adjacent to the regulator transistors. Between the transformer and the reservoir capacitors is a 10-lug section of miniature resistor panel, and this is used to support the minor components of the low voltage power supply. The few components of the high voltage supply are mounted on a 4-lug tagstrip on the other side of the reservoir capacitors, near the rear-panel connectors.

The input circuitry wiring board is mounted immediately to the front of

the relatively inexperienced constructor. The component placement on the printed wiring boards is shown in the diagrams, as are also the board interconnections and most of the "hand" wiring. However, there are a few minor points regarding which it may be worthwhile to present the following brief comments.

### HIGH FREQUENCY VERSION NOW COUNTS TO 70MHz

While preparing the present DFM article for publication, the author has been carrying out further development on the high frequency version of the design. As a result of this further development, the frequency range of the HF version has been almost doubled. When this version is described shortly, therefore, it will be presented not as the 40MHz instrument predicted earlier, but as an instrument capable of making reliable measurements to beyond 70MHz.

A soldering iron having a small, well-tinned bit is recommended for making the soldered joints to the printed wiring boards, as this will allow the joints to be made without risk of bridging between conductors. The joints should be made rapidly, particularly those involving microcircuits and other semiconductor components, to prevent damage due to overheating.

The flying leads of the numerical indicator tubes and over-range neon should be bent very carefully to line up with the holes in the counter board, to prevent strain on the glass envelope.

Note that the correct orientation for the 14-pin and 16-pin microcircuits is shown in the wiring diagrams by a small hemispherical indentation on the device symbol. It will be found that each device has a similar indentation

# PLAN YOUR FUTURE

CHOOSE a career in the field of ELECTRONICS\* — the Nation's most progressive and fastest expanding industry.

✱ Advancement in this modern science demands technical ability, a sound knowledge of basic principles and applications.

YOU can master the subject by training at the MARCONI SCHOOL and be ready to grasp the opportunities that occur in the three fundamental branches of Radio-technology.

# KNOW WHERE YOU'RE GOING

## A = APPLIED SERVICING

Comprehensive training in the maintenance and repair of radio and television receivers offers substantial rewards to competent technicians. Marconi School training covers all aspects of radio and television receiver circuit applications, practical exercises in fault finding and alignment procedures.

## B = BROADCASTING

A thorough and practical grounding is available to students in broadcasting transmitter performance standards and maintenance techniques, with individual instruction in station operation and studio control and testing.

## C = COMMUNICATIONS

Combines all the foregoing, together with radio aids to navigation, mobile telephony, marine service application and international wireless telegraph regulations, qualifying the successful student for the Commonwealth Government Certificate of Proficiency and the Marconi School Diploma in Radiotechnology.

Classes are conducted at 21 Pier Street, Sydney (at the foot of Goulburn Street).

Daily: 9.30 a.m. to 4.30 p.m.

Evenings: 6 p.m. to 8.30 p.m.

or by Home-Study Courses (except practical instruction on equipment).

# STUDY NOW

Send for training syllabus. There is no obligation.

NAME.....  
ADDRESS.....

the MARCONI SCHOOL of wireless

G.P.O. Box 2516, Sydney

A Service of Amalgamated Wireless (Australasia) Ltd.

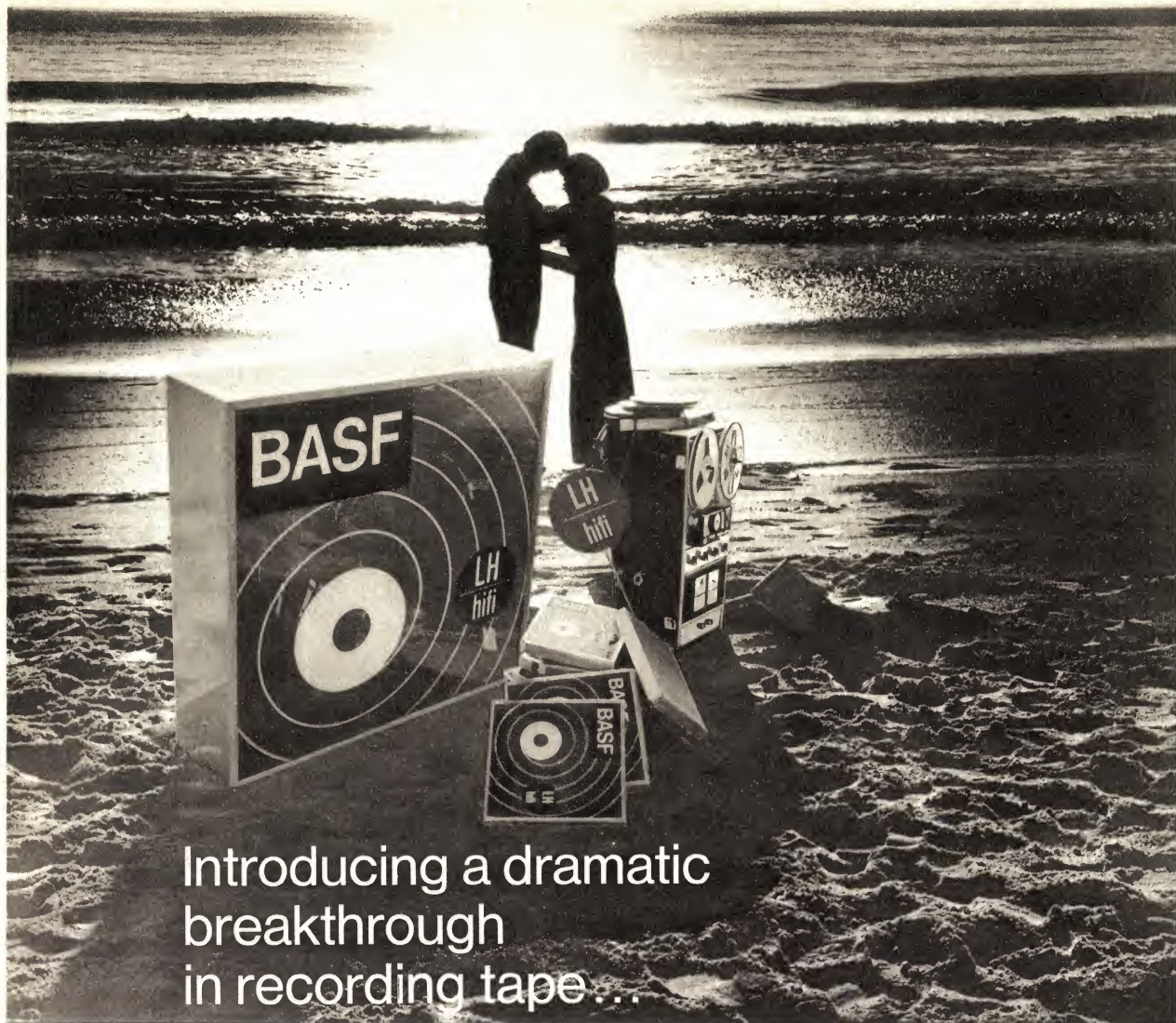

Introducing a dramatic  
breakthrough  
in recording tape...

## BASF low noise-high output.

BASF LH Magnetic Recording Tape is the world's only tape which combines ultra-low noise with a significant increase in output level across the entire audio spectrum. Other "low-noise" tapes simply do not have this increased output level.

By decreasing the basic tape noise, and increasing sensitivity BASF engineers have achieved a dramatic improvement in signal-to-noise ratio (Dynamic range) of as much as 8db over other quality tapes on the market. This means that recorders can reproduce sounds, from the faintest whisper to a booming crescendo, with more clarity, realism and less distortion than ever before.

BASF Low noise-High output magnetic recording tape — "the beginning of a new recording revolution."

**MAURICE CHAPMAN & CO. PTY. LTD.,**



276 Castlereagh Street,  
Sydney, N.S.W., 2000.  
Phone: 61 9881

## FREQUENCY METER PARTS LIST

### COUNTER BOARD

#### SEMICONDUCTORS

IC1: Motorola MC1017.  
 IC2: Motorola MC1004.  
 IC3, 4, 5, 6: MC1013.  
 IC7, 8, 9, 10: MC1018.  
 IC11, 13, 15: Fairchild CuL9960.  
 IC12, 14: Fairchild CuL9958.  
 IC16: Motorola MC790P.  
 IC17: Fairchild FuL914.  
 T1: 2N3565, BC108, TT3565,  
 or TT108.  
 T2: 2N3569, or TT3569.  
 T3: 2N3568, SE7001, or BSX21.  
 Diode D1: EM401, BY126/50, etc.

#### REMAINING COMPONENTS

1 Printed board, code 69/d10.  
 3 XN3 numerical indicator tubes.  
 1 23L long-electrode neon tube.  
 4 1.5K  $\frac{1}{2}$  watt resistors.  
 3 47K  $\frac{1}{2}$  watt resistors.  
 1 220K  $\frac{1}{2}$  watt resistor.  
 9 0.1uF 25V ceramic capacitors.

### INPUT BOARD

#### SEMICONDUCTORS

IC18: Motorola MC1035.  
 IC19, IC23: Motorola MC790P.  
 IC20: Fairchild FuL914.  
 IC21, IC24: Motorola MC724P.  
 IC22: Motorola MC788P.  
 T4: 2N3569, or TT3569.  
 Diodes D2, D3: OA91 or similar.

#### REMAINING COMPONENTS

1 Printed board, code 69/c11.  
 1 100 ohm  $\frac{1}{2}$  watt resistor.  
 1 330 ohm  $\frac{1}{2}$  watt resistor.  
 1 1.5K  $\frac{1}{2}$  watt resistor.  
 2 2.2K  $\frac{1}{2}$  watt resistors.  
 1 3.9K  $\frac{1}{2}$  watt resistor.  
 2 22K  $\frac{1}{2}$  watt resistors.  
 1 500 ohm tab pot (board mounting).  
 1 680pF polystyrene capacitor.  
 1 .0022uF 30V mylar, polyester or polystyrene.  
 5 .047uF 25V ceramic capacitors.

### TIMEBASE BOARD

#### SEMICONDUCTORS

IC28: Motorola MC724P.  
 IC29, IC30, IC31, IC32: Motorola MC790P.  
 Diodes D4, D5: OA91 or similar.

#### REMAINING COMPONENTS

1 Printed board, 69/c12.  
 1 1.5K  $\frac{1}{2}$  watt resistor.

1 .0068uF polystyrene capacitor.  
 1 .01uF 30V mylar, polyester or polystyrene.  
 2 0.1uF 25V ceramic capacitor.

### CASE & POWER SUPPLY

1 Case 10 $\frac{1}{2}$ in x 8 $\frac{1}{2}$ in x 4in, with front escutcheon plate.  
 1 Power transformer, 240V to 12.6V CT at 4A, 150V at 20mA.  
 1 Rotary switch, 1 pole 5 positions.  
 1 Rotary switch, 1 pole 4 positions.  
 1 Mains fuseholder with 1A cartridge.  
 3 Co-axial panel connectors.  
 3 Miniature 6V/50mA lamp bezels (see text).  
 2 Miniature pushbuttons (see text).  
 1 Miniature SPDT toggle switch (see text).

#### SEMICONDUCTORS

1 A14M, 1N5061 or similar silicon diode.  
 1 EM400, BY126/50 or similar silicon diode.  
 1 PA40 silicon bridge rectifier (8A).  
 2 Nominal 6.2V zener diodes, BZY88/C6V2 or similar.  
 2 2N3055, BDY20 or similar NPN power transistors.  
 1 AY8115, 40408 or similar NPN power transistor.  
 1 TT3638 or similar PNP power transistor.

#### RESISTORS

4 220 ohm  $\frac{1}{2}$  watt.  
 2 1.5K  $\frac{1}{2}$  watt.  
 1 150K 1 watt.  
 1 2K linear carbon pot.

#### CAPACITORS

1 0.47uF 400V polyester.  
 1 8uF 250VW electro.  
 2 100uF 6VW electro.  
 2 100uF 10VW electro.  
 2 3000uF 10VW chassis mounting electro.

#### MISCELLANEOUS

2 large instrument knobs, 1 small knob; 10-lug section of miniature resistor panel; 4-lug tagstrip; 3-segment length of "B-B" connector panel; 4 $\frac{1}{2}$ in x 1 $\frac{1}{2}$ in piece of orange tinted acrylic sheet (1/8in) for display window filter; grommet for mains cord (3/8in); mains cord and plug; cord clamp; mounting screws, nuts, lock washers, power transistor mounting hardware, connecting wire, solder, etc.

at one end of the package. The round 8-pin devices have a flat or coloured line whose orientation is indicated in the diagrams.

Note also that there are two reset signal inputs to the counter board, the two being joined by a long link of insulated hookup wire.

The mains cord should be securely clamped to the case floor, after entry via a suitably grommetted hole, using a "C" clamp. This will prevent strain on the connections. The connections themselves are best made using a 3-segment length of "B-B" connector strip, which may be mounted to the right of the power transformer.

Signal interconnections between the various boards should be made in standard insulated hookup wire, and arranged to be as short and as direct

as possible. Shielded leads need only be used for the connections to the two rear-panel connectors.

And finally, take care when mounting the two power supply regulator transistors to ensure that the device cases are properly insulated electrically from the instrument case. Use the standard mica insulating washers, with a smear of silicone grease on each side for thermal continuity, and fit the usual fibre or plastic sleeves to the mounting bolts. It is a wise precaution to check the insulation with an ohm-meter when the device is mounted, to prevent possible damage when power is applied.

There is only one adjustment to be made upon completion of the counter, after which it should be ready for immediate use. The adjustment

(Continued on page 174)

# approved & accepted

by leading manufacturers and  
Government Departments.

## ELNA

### Electronic Components

- Electrolytic Capacitors
- Polyester Capacitors
- Carbon Potentiometers

Australia's largest selling imported capacitors are produced by one of the world's major components manufacturers.

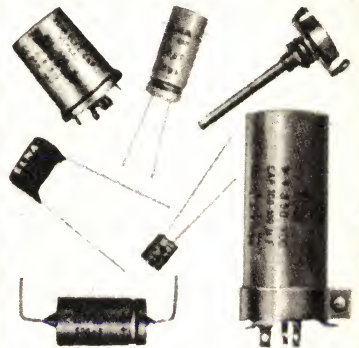

Write or phone for  
illustrated brochure

## SOANAR ELECTRONICS

PTY LTD

A. & R.-Soanar Group Company.

VIC.: 45 Lexton Rd, Box Hill. 89 7323.  
 NSW: 82 Carlton Cres. Summer Hill.  
 798 6999.  
 QLD: R. A. Venn Pty Ltd, Valley. 51 5421.  
 SA: Scott Thompson Pty Ltd, Adelaide.  
 23 2261.  
 WA: Everett Agency Pty Ltd, West Leederville. 8 4137.



# A SYMPHONY ORCHESTRA IN YOUR LOUNGE...

(AND ROOM FOR YOU TOO.)

YOU MAY NOT HAVE A ROOM THE SIZE OF CARNEGIE HALL BUT YOU  
CAN REPRODUCE CONCERT HALL SOUND AND CLARITY WITH PIONEER



The PIONEER AX330 amplifier

The PIONEER AX330 is an imported, solid state tuner amplifier for the quality conscious, thrifty Audiophile! The AX330 is a high quality unit for those who don't have a living room the size of Carnegie Hall — but want Concert Hall clarity and purest sound reproduction.

NOW AVAILABLE FROM YOUR DEALER.

Contact your State Office of **ASTRONICS AUSTRALASIA PTY. LTD.** (Sole Australian Agents, and a member of the Electronic Industries Limited Group of Companies) for your nearest dealer's address.

VIC: 161-173 Sturt St. Sth. Melb. Phone 69 0300.  
N.S.W.: 121 Crown St. E. Sydney. Phone 31 6721.  
S.A.: 81-97 Flinders St, Adelaide, Phone 23 4022.  
W.A.: 28 Belmont Ave, Belmont. Phone 65 4199.  
TAS: 199 Collins St, Hobart. Phone 2 2711.  
QLD: 50-54 Lt. Edward St, Brisbane. Phone 2 0271.



**PIONEER**

— FOR PURE SOUND

# A shunt-regulated power supply

In January, 1969, we described a small variable power supply which was economical and burnout-proof. In this article, we describe a modified version featuring a high degree of regulation and low ripple output, yet economical to build.

By LEO SIMPSON



This power supply offers a degree of performance intermediate between that of the simple supply mentioned above and the high performance, 0-30V supply described in September, 1968. It is easy to build and, as mentioned above, is proof against all normal abuse, making it suitable not only for "one-off" construction by the experimenter or servicemen but also for multiple construction for use in teaching institutions and development laboratories.

The performance of the unit is as follows: Output voltage is adjustable from 3V to over 20V; available load current at 3V is around 900mA, dropping to about 150mA at 20V. The output is highly regulated up to the point where current limiting occurs; in the middle of the voltage range it is better than 1 per cent for currents in excess of 500mA. Output ripple and noise is low, ranging from 20 to 40mV peak-to-peak, depending on load current and voltage setting. The accompanying diagram shows the performance which can be expected at the different voltage settings.

While the circuit diagram of the supply shows a total of five transistors, the operation of the unit is quite simple. The heart of the circuit is an active voltage divider circuit consisting of two 6.8 ohm resistors in series and a shunt element, a Darlington pair consisting of transistors T4 and T5.

The voltage divider is, in fact, a shunt regulator circuit. Reference to figure 1 will clarify the explanation. Notice that, whereas with conventional series regulator circuits the adjustable element is in series with the load, in the case of shunt regulator circuits and adjustable element is in parallel with the load.

The adjustable element can be likened to a zener diode with an adjustable breakdown voltage. The "zener diode" begins to conduct when the supply voltage rises above a certain point and in so doing, effectively limits any further voltage rise to a few per cent. The breakdown effect will not cause any damage provided the internal power dissipation is kept within limits. The series resistance limits the current drain so that over-dissipation in the shunt element and other power supply components is prevented.

For those readers not familiar with the operation of a Darlington pair reference to figure 2 will help. The two transistors are interconnected as shown and can be treated as a three-terminal "black box" which operates as a single composite transistor. The current gain of this composite transistor is approxi-

in contrast with that of the more usual circuit, in which the transistor is connected as the series divider element. In such circuits the transistor dissipation rises with load current, and special precautions must be taken if the transistor is not to be ruined by excessive current on short-circuit.

One disadvantage of the shunt regulated supply is that, for a given voltage setting, the power consumption will be more or less constant, regardless of whether a load is connected to the external circuit or not. This means that these supplies tend to be wasteful of power when lightly loaded. For small supplies such as this one, however, this is of no consequence.

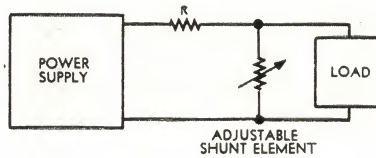

Figure 1

Figure 1: Illustrating the principle of an adjustable shunt-regulated power supply.

mately equal to the product of the current gains of the individual transistors. The effective "breakdown" voltage of the Darlington pair shunt element is determined by the bias voltage on the input, i.e., the base of the Darlington pair.

A major advantage of the shunt regulator configuration is that the regulating element, in this case the Darlington pair, is protected from damage due to short-circuit loads.

Because the output terminals are connected across the Darlington pair (disregard the diode for the moment) any load connected to the terminals is effectively in parallel with the Darlington pair (the adjustable shunt element) as is shown in figure 1. The current drawn by the load, therefore, is subtracted from that which is otherwise drawn by the Darlington pair, to maintain a given output voltage. Thus, the greater the load current the less the dissipation in the shunt regulator element. If the output terminals are short-circuited, the shunt regulating element is effectively removed from the circuit. The rectifier is then presented with the heavy but not unduly embarrassing load consisting of the series divider resistors.

It should be appreciated that the foregoing state of affairs is somewhat

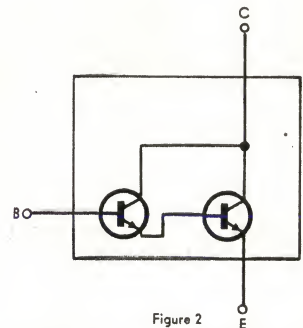

Figure 2

Figure 2: The Darlington pair configuration, in which two transistors operate as a single, composite transistor.

Although the shunt element is protected by the basic circuit configuration against over-dissipation due to excessive loading, it is also desirable to protect it against voltages generated externally. The situation can arise where two supplies are used in series, and, if a connection is made in error, damage can occur. For this reason we have connected a diode in series with the output to prevent any current flowing back into the supply. The diode will also protect the supply against positive voltage spikes generated by inductive loads.

As stated above, the "Darlington pair" is the shunt element. It will have an effective current gain, Beta, ap-

# COSMICAR LENSES

FOR CLOSED CIRCUIT TELEVISION & 16mm CAMERAS



ZOOM LENS  
f1.5 22.90mm



f1.9 12.5mm  
wide angle

- 'C' mount
- Focusing and Iris
- Top Japanese Quality

	Tax included	
WIDE ANGLE f1.9 12.5mm	.....	\$50.97
WIDE ANGLE f1.4 12.5mm	.....	\$78.04
NORMAL ANGLE f1.9 25mm	.....	\$24.36
NORMAL ANGLE f1.4 25mm	.....	\$37.08
LONG FOCUS f1.9 50mm	.....	\$38.59
LONG FOCUS f1.4 50mm	.....	\$59.95

LONG FOCUS f1.4 75mm	.....	\$35.48
LONG FOCUS f1.4 75mm	.....	\$75.71
TELEPHOTO f2.8 135mm	.....	\$64.72
ZOOM f2.8 20-55mm	.....	\$119.63
ZOOM f1.5 22-90mm	.....	\$323.71
ZOOM f1.5 22-90mm ALSO AVAILABLE AS A MOTORISED AND REMOTE CONTROLLED MODEL		

★ Trade enquiries.      ★ Tax free quotes      ★ Send for brochure showing full specifications.

## HALOGEN LIGHTING FOR PHOTOGRAPHIC & TV STUDIOS

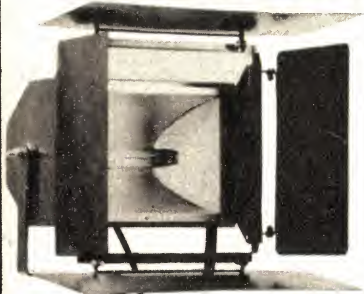

BROAD BEAM LAMP

A strong floodlight, 80 deg., 1000 watt, 7in Phillips Quartz Iodine Halogen lamp equivalent to 4 photofloods, lasts 2,000 hours at 3,200 deg. K. Lamp head \$37.25, Heavy duty stand \$21.75. Lamp \$10.50. Barn door \$22.45. All prices plus Tax.



NARROW BEAM LAMP

Beam 55 deg. with 800 watt 4-11/16" long lamp. One stop stronger than broad beam. Light and portable. Heat-insulated handle, fully tiltable. Lamp head \$29.95, Stand \$21.75. Barn doors \$13.90. G.E. lamp 250 hours \$13.50, Jap. Ushio lamp \$7.80. All prices plus tax.

Send for special Brochure.

## JOB TANKS AND SPIRALS



No. 35F— Tank and Spiral. \$7.37  
Dayload— 35mm, \$15.33  
Automat— 35mm, \$15.33  
No. 16/35—2 x 16mm or 35mm \$7.64  
No. 110—35mm (20) or 127 or 120 \$5.74

No. 160— 35mm or 2 x 127 or 2 x 120 \$7.64  
No. 160D—2 x 35mm or 2 x 127 or 2 x 120 \$8.62  
No. 16/160D—16mm or 2 x 25mm or 2 x 127 or 2 x 120 \$8.62  
Reporter—5 x 35mm or 4 x 127 or 3 x 120 \$18.66

## MACBRO FLAT BED

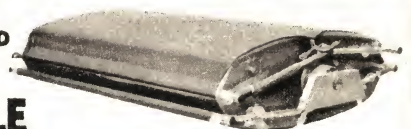

## DOUBLE SIDE GLAZERS & STAINLESS STEEL SHEETS

TOP QUALITY GLAZERS OF MODERN DESIGN

Flatbed Glazers  
14" x 10" Double Sided \$34.50 plus tax.  
20" x 16" Double Sided \$54.55 plus tax.

Glazing Sheets 14" x 10" Stainless Steel \$3.80.  
20" x 15" Stainless Steel, \$5.83.

## FAMOUS ACUFINE & DIAFINE FILM DEVELOPERS



ACUFINE — For high resolution and finest grain. A maximum acutance, ultra fine grain film developer combining optimum quality with the highest effective speeds currently available with single solution developers. For instance ASA 125/FP3 Film is indexed at ASA 250 with Acufine development of 3 1/2 minutes at 70 deg. temperature.

PRICE: Quart \$1.16, Gallon \$4.12 (Post Free). DIAFINE (Two-bath): For Highest speeds and widest latitude. Usable over a wide temperature range with one developing time for all films. Fast, medium and slow films can now be developed simultaneously without adjustment in developing time. Produces greatest effective speeds as indicated by the exposure index of 200 ASA for Ilford Pan F, normally rated at 50 ASA.

PRICE: Quart \$3.52, gallon \$9.96 (post free).



## SAKULITE S-2 ELECTRONIC FLASH

- Ideal battery flash.
- Low Cost.
- ONLY \$13.95.
- Flash factor on Kodachrome 28.

- 30 Joules.
- Works from 2 Penlight cells.
- Wide removable diffuser.

# WAGNERS



524 FLINDERS ST., MELB. 3000      62-3114  
43 ELIZABETH ST., MELB.      62-3114  
CHADSTONE SHOPPING CENTRE.      56-5814

WAGNERS for everything photographic







switch which shorts out one resistor. The slide switch simultaneously inserts a 12K resistor in series with the potentiometer so that the output voltage cannot be set lower than 10 volts, thus ensuring that the internal dissipation of the supply is limited.

Externally, the effect of the slide switch is to provide a second ("HI") range in which additional current is available, but only for the range of voltages between 10 and 20 volts.

As with the normal or "LO" range, an output short-circuit on the "HI" range effectively removes the Darling-ton pair from the circuit. However, the current load on the bridge rectifier and transformer is around 1.6 amps which will cause damage if the short is maintained for sufficient time. For this reason we have provided a 1 amp fuse to protect the transformer and bridge rectifier against overheating. The fuse will probably not "blow" if a short circuit is applied on the "LO" range as the current is limited to 1 amp.

An output voltmeter is provided, to permit convenient adjustment and monitoring of supply output during operation. The meter used in the prototype is an economy 3-inch rectangular type of Japanese manufacture, designated type VP-2A and having a standard 0-1mA/100 ohms characteristic. We removed the original 0-1 scale markings with a typewriter eraser and replaced them with an appropriate 0-20V numbering.

Neither side of the basic supply is internally connected to the case or mains earth, but rather, a third "earth" output terminal is provided to permit either

output polarity to be tied to earth if and when required. This approach offers complete flexibility, at no sacrifice in performance and at an additional cost of only a few cents.

As may be seen from the photographs, the supply is constructed in a sloping front case which is convenient for bench-top operation. The case was originally designed for the economy supply published in January, 1969. It measures 5in x 5in x 5in and has a

wrap-over front panel. The case and printed front panel of the prototype was made by Heating Systems Pty. Ltd. and most kit suppliers would have similar cases already in stock.

The output voltmeter is mounted at the top of the sloping case panel, with the output potentiometer beneath it and the fuse and range switch mounted to the left and right of the latter, respectively. The three output terminals are mounted at the lower front of the case,

## PARTS LIST

- 1 Sloping Front Case, 5 x 5 x 5in, to suit economy power supply described in January, 1969.
- 1 Power transformer, 15V at 1 amp DC (A&R 2155 or equivalent).
- 1 3in rectangular meter, 0-1mA/100 ohms.
- 1 DPDT slider switch.
- 1 5K (lin.) potentiometer with switch.
- 1 16-lug section of miniature resistor panel.
- 1 11-lug section of miniature resistor panel.
- 3 screw terminals — red, green, black.
- 1 1-amp cartridge fuse and holder.

### SEMICONDUCTORS

- 1 40250, 2N3054, silicon NPN power transistor.
- 1 40408, 2N3053, TT801 silicon NPN transistor.
- 1 2N3638, TT800 silicon PNP transistor.
- 2 BC108, 2N3565 silicon NPN transistors.

- 1 MBI silicon bridge rectifier (or 4 1-amp diodes).
- 1 BZY88/C3V3 zener diode.
- 1 A15A or equivalent high-current diode.

### RESISTORS

- ( $\frac{1}{2}$ -watt unless specified.)
- 1 x 220K, 1 x 22K, 1 x 12K, 1 x 1.5K, 1 x 1K, 3 x 680 ohms, 1 x 220 ohms, 1 x 180 ohms, 2 x 6.8 ohms/10 watt.

### CAPACITORS

- (higher voltage ratings may be used)
- 1 2000uF/25VW electrolytic.
  - 1 500uF/12VW electrolytic.
  - 1 1uF/100VW polyester or metalised polyester.
  - 1 1800pF polyester or polystyrene (low voltage).

### SUNDRIES

- 1 knob, spacers, screws, nuts, mains cord and plug, mains cord clamp, 1 grommet, 1 handle, rubber feet, connecting wire, solder, solder lugs.

# Homecrafts FOR RADIO PARTS

289 Elizabeth St. Melbourne. Phone 60 1442

## TRANSISTORISED CALLING AND TALKBACK SYSTEMS

### BATTERY OPERATED

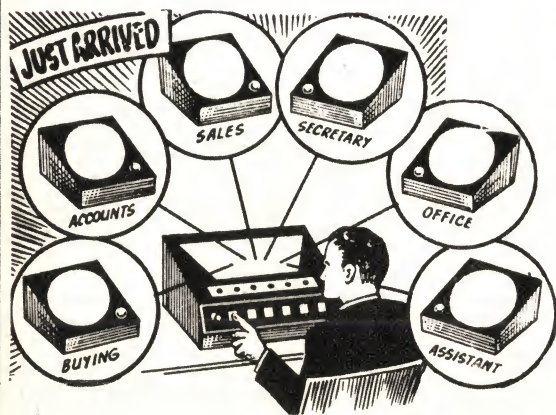

### Table or Wall Mounting

FOR USE IN OFFICE, FACTORY, HOME, BABY MINDING, FRONT DOOR, ETC.

- 2 Station — 1 Master, 1 Slave, 1 x 9v Batt., from ... \$9.00
  - 3 Station — 1 Master, 2 Slaves, 1 x 9V Batt., from ... \$15.00
  - 4 Station — 1 Master, 3 Slaves, 1 x 9V Batt., from ... \$19.00
  - 7 Station — 1 Master, 6 Slaves, 6 x Torch Batts. ... \$36.00
- All prices include Batteries, Cable and Instructions, etc. Postage extra.
- 3 Station — All Master Telephone type, 2 x Torch Batts. ... \$30.00
- Suitable 5-core Cable 250 yds AC Adaptors suitable for all types of Inter-coms. ... \$6.90

TRANSISTOR AERIALS		
5in extends to	39in	\$1.40
6in extends to	46in	\$1.70
6in extends to	32in	\$1.00
6in extends to	28in	\$1.00
7in extends to	39in	\$1.20
9in extends to	39in	\$1.95
6in extends to	4ft 6in	\$1.80
7in extends to	5ft 8in	\$3.00

Plus Post 15c.

CRYSTAL SET BUILDERS		
Coils	80c	Tunings Conds. \$2.00
Diodes	35c	Terms . . . . . Ea. 12c
Headphones	\$2.50	Plus postage.

TAPE RECORDER ACCESSORIES		
2 1/2in Spools	30c	Tape
3in Spools	35c	5 1/4in x 1,200ft
5in Spools	40c	Tape
5 1/4in Spools	70c	7in x 1,800ft
7in Spools	50c	Tape
2 1/2in x 100ft		5in Plastic Tape, boxes
Tape	60c	7in Plastic Tape, boxes
2 1/2in x 300ft		
Tape	\$1.40	
3in x 600ft		

Plus Postage 20c.  
See us for Tape Recorder Patch Cords. Adaptors, etc.

STEREO PLUGS AND JACKS		
Metal Plugs	95c	Bakelite ext. sockets
Bakelite	70c	Chassis Jacks

Plus Postage 10c.

Capacitor Substitution Box, 1,000 VV	\$5.00
Resistor Substitution Box, 1 Watt.	
Plus Post, 20c	\$4.50

Michigan/Collard — Four Track Rec./Play Heads	\$21.50
Michigan/Collard — Twin Track Erase Heads	\$3.00
Michigan/Collard — Four Track Erase Heads	\$8.50

## MAIL ORDER SPECIALISTS

with the earth terminal in the centre to allow convenient linking of either output terminal when required.

The power transistor is mounted on the outside of the upper rear of the case. Although the transistor body is connected internally to the collector and must therefore be isolated electrically from the earthed case, for efficient cooling of the device the two must be closely coupled thermally so that the case can act as a heatsink. To achieve this the lacquer finish of the case is removed from the area immediately beneath the transistor, and the mica insulating washer supplied with

The power transformer used in the prototype was made by A. and R., type 2155. Any similar power transformer with a 15V secondary at 1 amp DC will be quite suitable. The transformer is mounted with the primary winding lugs nearest to the cord entry, so that the mains wiring is kept as far as possible from the low voltage circuitry. The mains cord enters via a grommetted hole in the rear of the case, then between the transformer stack and side of the case and finally terminated at the switch/pot. It is anchored by a clamp, which is held by the same screw which retains one of the transformer lugs and

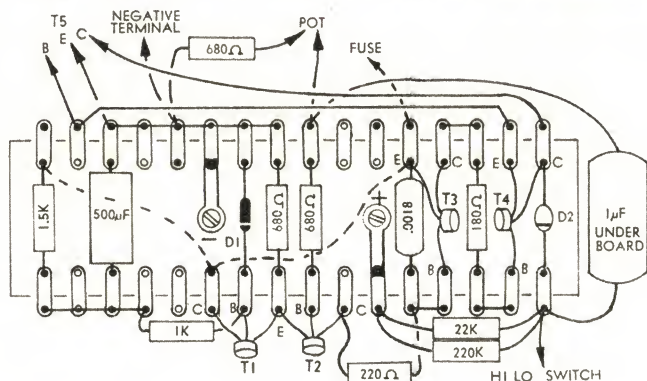

The layout of components on the tagboard mounted on the rear of the meter movement. Note that the 1uF capacitor is actually underneath the tagboard. Compare with photo on page 79.

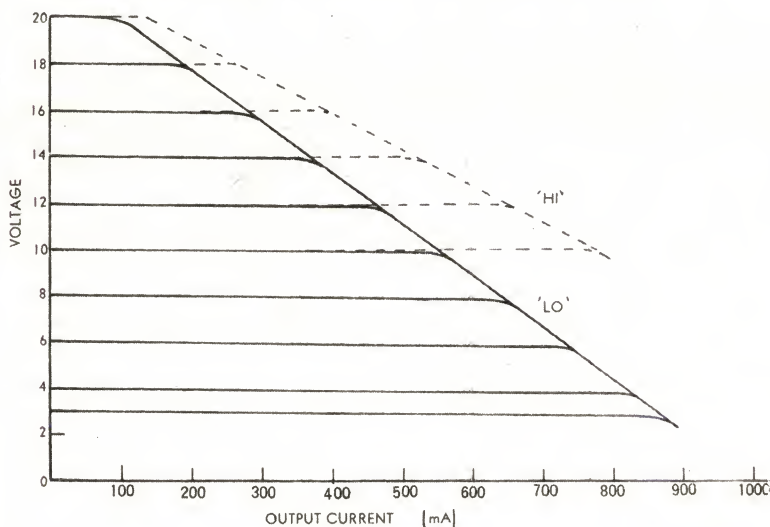

Diagram showing the degree of regulation to be expected at different voltage settings. Ripple and noise output will range from 20 to 40mV peak-to-peak, depending on the load and voltage setting.

the device is coated with the usual silicone grease.

If 40250 or 2N3054 transistors are not easily obtainable at the time you wish to build this unit the much higher rated (though only slightly more expensive) type 2N3055/BDY20 may be substituted, although it requires different mounting holes. At the time of writing, both 2N3054 and 2N3055 transistors are in good supply.

Although the interior of the case is quite small, it is not unduly crowded with the layout we have employed. We recommend that the layout shown in the wiring diagram and accompanying photograph be followed closely to make construction as straightforward as possible.

a solder lug to terminate the mains cord earth. The earth wire is also connected to the front panel earth terminal.

The bridge rectifier we used was silicon type, MB1, made by I.T.T. However, it may be more economical to use four individual 1 amp diodes and these can easily be accommodated. The voltage rating is not critical — any of the currently available 1 amp silicon diodes has sufficient voltage rating.

The bridge rectifier, 2000uF electrolytic capacitor and the two 6.8 ohm/10 watt resistors are accommodated on an 11-tag section of miniature resistor panel. It is important that the resistors are kept as far away

(Continued on page 171)

## up to ten times longer life



MAXELL Alkaline Dry Cell — this unique new design concept features high capacity and durability that surpasses the performance of the world's top dry cell batteries. The construction of the Maxell Alkaline Dry Cell differs greatly from conventional types of carbon ZINC cells. However, the Maxell Alkaline cells can be used where you normally use a carbon ZINC cell. MAXELL ALKALINE CELLS are especially suitable where there is a demand for increased current, combined with durability and little voltage drop. Even near the end of the cell life the discharge capacity is large and stabilized.

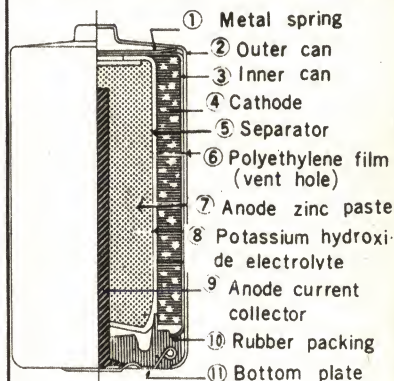

Exclusive new construction minimises leakage. Double cans are used and rubber sealing with the unique spring safety device. (see diagram)

Interior drying is prevented by hermetic sealing, therefore long storage periods are possible (over two years). Even then Maxell Alkaline cells are in the same condition as when they left the production line. These cells will withstand severe temperature changes. Rigid tests have shown extremely stabilized capacities from the low temperature of -4F to the high temperature of 150F at which temperatures dry cells would fail to operate satisfactorily.

Prices:

AM1 ..... 75c  
AM2 ..... 50c  
AM3 ..... 40c

Trade enquiries to  
TASMANEX PTY. LTD.  
376 Pittwater Road, Harbord 2096

# SOFT LANDING

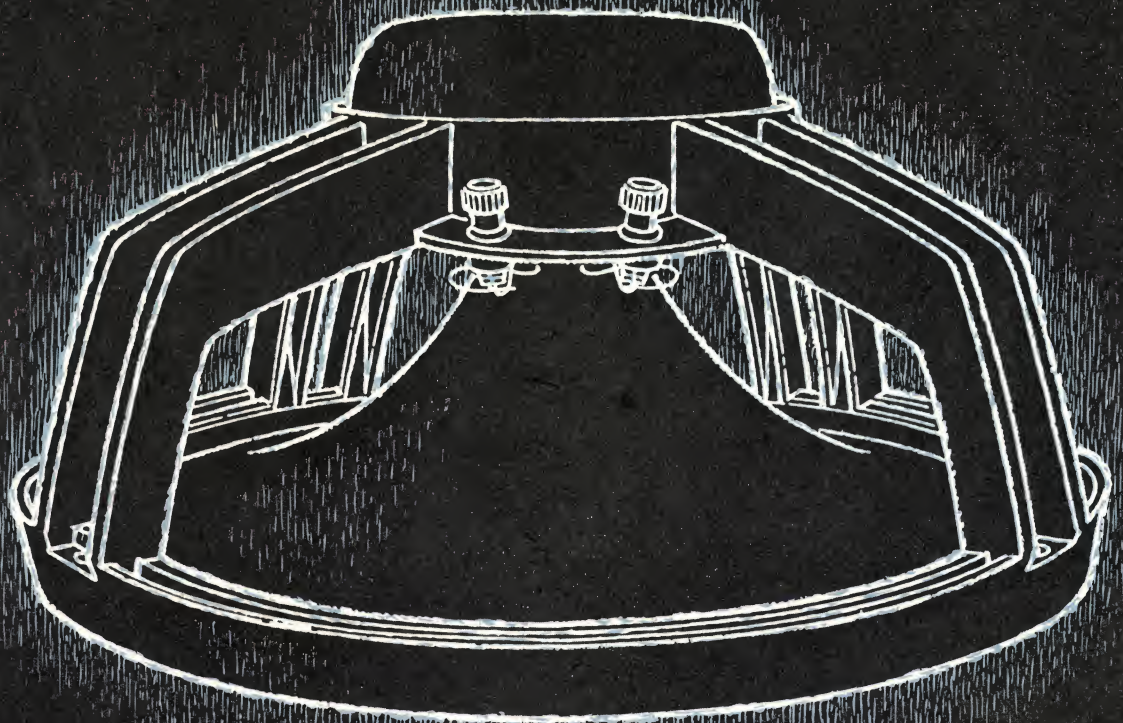

## NEW FIFTEEN INCH LOUDSPEAKER TYPES 15VAC/15VBC

The latest touchdown in the MSP range of Hi-Flux speakers fulfils a requirement where high power handling and quality reproduction of bass frequencies are of prime importance. It features a nominal 35 Hz resonance and this coupled with an exponential cone form allows smooth frequency coverage from 30 Hz to 6 kHz when used in a suitable enclosure. The use of a 2 inch diameter voice coil and heavy duty ceramic magnet ensures optimum efficiency; the design of cone rim and suspension coupled with voice-coil magnet design provides linear cone excursion to the specified limit of power handling capability.



47 YORK STREET SYDNEY 2 0233 .

MANUFACTURERS SPECIAL PRODUCTS PTY LTD

ADELAIDE  
51 0111

BRISBANE  
31 0341

HOBART  
3 3836

LAUNCESTON  
2 1804

MELBOURNE  
67 9161

PERTH  
28 3425

SYDNEY  
533 1277 & 29 7031

An instructional article for our younger readers:

# SIMPLE TRANSISTOR AMPLIFIER CIRCUITS

In this article for our younger readers we present a series of amplifier circuits and answer some of the questions which arise out of the design of such circuits.

By Leo Simpson

Many of our novice readers have written to us over the past years asking for simple transistor amplifier circuits, preferably using particular transistors that they had in their possession. These requests have generally been hard to fulfil as the transistor types mentioned have often differed from those in our simple amplifier designs. As much as we would like to assist, we are not in the position to design circuits for individual readers.

Recently, however, we reviewed the situation and decided that one way in which we could help would be to present an article showing readers how to construct simple amplifiers using general-purpose transistors. The article could at the same time show readers the basic principles to be followed in order to achieve the best performance from typical oddment transistors. This is, in fact, that article.

Possibly, the first point to be considered when visualising a versatile amplifier circuit is the DC supply voltage. This must be selected so that the various voltage, current and wattage ratings of all components will not be exceeded under any conditions of operation. Other factors to be considered at the same time are the value of the external load on the output transistor (loudspeaker or phones, etc.) and the required power output.

We decided upon 6 volts as the most useful "all-purpose" supply voltage for the following reasons:

Firstly, it is low enough so that all transistors likely to be used will be operating within their voltage ratings.

Secondly, it provides a reasonable voltage swing across the load (reasonable power output) without an excessive IR drop (wattage) across the semiconductors; if we had decided upon 3 volts, for example, the usual 1-volt "saturation" voltage (minimum voltage drop) across most silicon transistors would leave only 2 volts peak-to-peak as the maximum obtainable signal across the load, resulting in very limited power output.

Thirdly, and perhaps most importantly from the schoolboy experimenter's view, 6 volts can be obtained readily from two 3-volt cycle batteries, and these can be relied upon to last quite a long time.

In the case of the first four circuits to be discussed, the output load is intended to be headphones, of either the 2,000-ohm magnetic variety of the high impedance crystal types. We decided upon this because many of the requests for simple circuits have mentioned that headphones were to be used. Methods of connecting low impedance (typically 8-ohm) earphones will be discussed later in the article.

Having decided upon the supply volt-

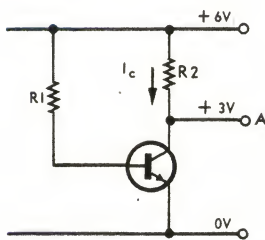

Figure 1

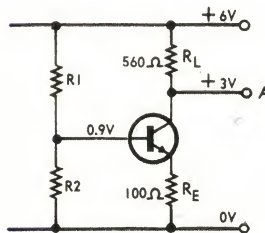

Figure 2

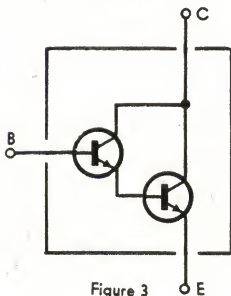

Figure 3

age and external load for an amplifier stage, the next consideration is the zero signal current; this is dependent on the collector resistor, in the case of the circuits discussed here, and on the biasing. Having selected a given value of collector load resistor, the bias must be set so as to obtain the maximum output voltage "swing" before clipping the signal waveform. Engineers like to call this composite voltage-current-bias setting the "DC working point."

Referring now to figure 1, let us consider one method of setting the bias and consequently the zero signal current, which is commonly encountered in beginners' circuits. In this case, the bias must be set so that the voltage at point A is equal to half the supply voltage, this condition giving the maximum output voltage excursion, or "swing."

Plainly enough, the voltage at point A will be dependent on the collector current flowing through the load resistor R2. In turn, the collector current will be equal to the product of the base current (flowing through R1) and the current gain, or Beta, of the transistor. (Beta is approximately equal to the ra-

tio of collector current to base current). By varying R1 and thus the base current, the DC voltage at point A can be set. The transistor is then said to be "current biased."

While superficially a simple system, current biasing has certain serious disadvantages. The first is that no two transistors will have exactly the same Beta and so the DC working point has to be set up for each individual transistor. A second disadvantage is that the Beta of many transistors tends to vary with temperature. This means that a DC working point set on a cold day (by current biasing) would be off the mark on a hot day or after the transistor had generated its own internal heat.

The third and most serious disadvantage of all is that with this biasing system transistors will amplify their own collector-base leakage current and this (leakage) is very dependent on temperature. Some improvement in the stability of the DC working point can be obtained by using an emitter resistor but, in general, methods other than current biasing are to be preferred.

The most common method of biasing an amplifier stage is shown in figure 2. The two major features of the circuit are that there is a voltage divider which holds the base to a fixed voltage (instead of letting it "float" as in figure 1) and an emitter resistor, incorporated to improve temperature stability. This emitter resistor ideally should be as high in value as possible to obtain the best stability, but in practice it should not be made so high that there is excessive voltage drop — and consequent power loss — across it. Generally, 0.5 volt is a suitable figure across the emitter resistor.

Now, for transistors which have a reasonably high Beta for all temperatures likely to be experienced, the collector current may be considered to be equal to the emitter current. Since we have selected 560 ohms as a suitable value of collector resistor and the desired voltage at point A is 3 volts, the collector current will be approximately 5 milliamps, therefore the emitter resistor can appropriately be 100 ohms. In fact, the desired collector current is obtained by setting the DC voltage drop across the emitter resistor and this is done, in turn, by setting the base voltage.

For collector current to flow the transistor must be forward biased. In general, a forward-biased semiconductor junction has a voltage drop across it which is fairly constant for current variations of two or three to one. For silicon transistors this voltage will be approximately 0.6V and for germanium types it will be approximately 0.25V. An average figure applicable to all transistors is 0.4V. Thus, to bias the transistor correctly, we would arrange for the base voltage to be 0.4V above the emitter voltage. Hence, the voltage divider consisting of R1 and R2 is selected to give a base voltage of 0.9V.

The values of the voltage divider resistors are selected so that variations in

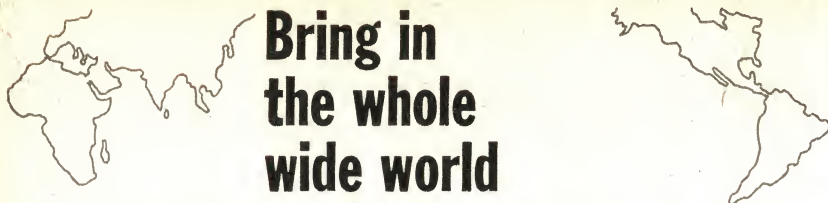

Bring in  
the whole  
wide world

REALISTICALLY

with the

**REALISTIC** <sup>DX</sup>150  
Communications Receiver



Transistorised.  
All solid  
state

4 Bands  
.535 to 30 MHC  
(includes Broadcast)

240V AC  
or 12V DC  
operation

This is the BIG performance set that obsolesces tube receivers . . . a professional-looking set that appeals to amateurs and short wave listeners alike. The DX 150 gives long-range, world-wide realistic reception on 4 bands, including Broadcast. Fully transistorised—all solid state—no warm-up delays; the DX 150 will run on dry cells if current fails or is not available; will operate from a car's cigarette lighter or any 12V DC service. A 240V AC power supply is also built in. Over 30 semi-conductors—product detector for SSB/CW, plus fast and slow AVC—variable pitch BFO—illuminated electrical bandspread, fully calibrated for amateur bands—cascade RF stage—ANL for RF and AF—zener stabilised—OTL audio—illuminated "S" meter—built-in monitor speaker plus front panel jack for external (optional) matching speaker.

Realistic Performance

Realistic Price

**\$229.50**

Attractive silver extruded front panel, solid metal knobs, grey metal cabinet, size 14½" x 9½" x 6½".

CONSULT YOUR LOCAL RADIO DEALER, OR

MAIL THIS COUPON *today*

Please forward free illustrated literature and specifications on Realistic

Name .....

Address .....



(A unit of Jacoby Mitchell Holdings Ltd.)  
376 EASTERN VALLEY WAY, ROSEVILLE, 2069.  
Cables and Telegraphic Address: 'WESTELEC.'  
Sydney. Phone: 40 1212

the base current of the transistor will have little effect on the base voltage. Note that the effects of leakage current also have to be taken into account. In this respect germanium transistors are worse, as they have much higher leakage currents than silicon devices. In taking these facts into account, it is customary to arrange that the voltage divider resistors pass a current roughly 10 times that of the base bias current, in the case of germanium transistors. Somewhat lower current values can be used in conjunction with silicon transistors.

Thus, in figure 2, if the transistor had a Beta of 40 and the collector current was 5 milliamps, the base bias current would be 125 microamps. Thus, 1 milliamp would be a suitable current for the voltage divider resistors. Using Ohm's law, R2 would equal 1K and R1 would equal 5.6K to give a base voltage of 0.9V and a current slightly less than 1 milliamp through the resistors. Note that any error occurring due to our assumption of 0.4V as being the forward voltage drop for a semiconductor junction will generally be "swamped" by the error in selection of resistors from the 10 per cent preferred value range.

One can check the accuracy of the resistor selection by measuring the voltage at point A. If necessary, it can be adjusted by varying one or other of the resistors in the voltage divider.

We have seen that the method of biasing shown in figure 2 provides a DC working point which is relatively free from the effects of temperature and which does not have to be varied to suit individual transistors. Thus, we have a circuit with predictable characteristics, but one which has the disadvantages of slightly higher current drain (through the voltage divider resistors) and lower input impedance than the circuit shown in figure 1 which is current biased.

Note that, in the case of figure 2 we have shown an NPN transistor. All the above calculations can be applied to circuits using PNP transistors, but the polarities of all voltages in the circuits must be reversed.

Figure 3 illustrates a more complex configuration known as a Darlington pair configuration, in which two transistors (both either PNP or NPN) are interconnected as shown. They operate effectively as one composite transistor with a Beta equal to the product of the Betas of the two individual transistors. It is important to grasp this concept of the two transistors acting as one with a very high Beta.

An advantage of the Darlington pair configuration is that it offers, in a simple circuit, higher gain than could be obtained from two separate, capacitively coupled transistor stages of the type shown in figure 2. Another advantage is that it enables a higher input impedance to be obtained, especially when the output load is placed in the emitter circuit.

Figure 4 shows a practical amplifier using a Darlington pair configuration. Any general-purpose germanium PNP transistors, excepting high power types, can be pressed into service. Note that the Darlington pair is biased in the way shown in figure 2 (voltage divider) except that the voltage drop from the base to the emitter of the composite transistor is 0.8 volts instead of 0.4 volts since it has two forward biased

# Typical "oddment" circuits

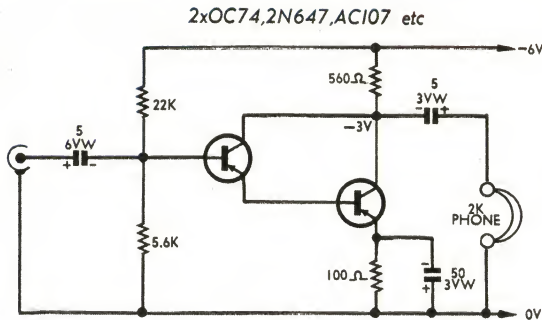

Figure 4

base-emitter junctions. Note that we have been deliberately conservative in specifying relatively low values for the voltage divider resistors, in spite of the fact that the bias current will be very small. This is to allow for the effects of high leakage current in possibly old, oddment germanium transistors. Much higher values could be specified if low leakage silicon transistors were to be used.

The 100-ohm emitter resistor is "bypassed" with a 50uF electrolytic capacitor to eliminate gain reduction due to emitter degeneration. If the emitter resistor is not shunted with a capacitor, the output signal voltage due to fluctuating collector current appearing at the collector of the Darlington pair, will appear with reduced amplitude across the emitter resistor. This, in turn, will counteract the signal input voltage appearing between base and emitter and thus cause a reduction in voltage gain. By connecting a capacitor across the resistor, as shown, the signal voltage appearing across the resistor is minimised and gain reduction avoided.

The value of the bypass capacitor

emitter degeneration to provide a high input impedance. Input impedance is approximately 500K and the typical voltage gain will be 5 times, regardless of the Betas of the particular transistors used. The emitter resistor may be bypassed to obtain a substantial increase in voltage gain but this will reduce the input impedance to approximately 50K.

Figure 6 is a direct-coupled "complementary" configuration using a PNP and an NPN transistor; the latter can be either germanium or silicon. Note that the biasing arrangement is essentially an extension of the method shown in figure 2. The voltage divider at the input determines the current flow through the first transistor and thus the voltage at its collector. This collector voltage then determines the current flow through the second transistor and hence the voltage at its collector.

The voltage gain can be varied by the negative feedback which is controlled by the size of the 100-ohm resistor. With the 100-ohm resistor in circuit the gain will be approximately 16 times. Reducing the resistor to zero will

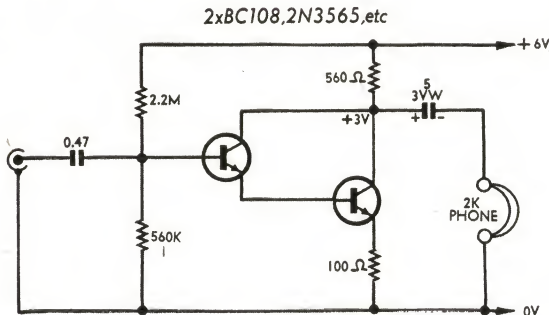

Figure 5

selected must be such that its impedance is low for the lowest signal frequency to be handled.

The circuit in figure 4 has an input impedance of something less than 5K. Current drain is 5mA and the typical voltage gain to be expected is at least 40 with general-purpose germanium transistors. The gain can be reduced to a value of approximately 5 by omitting the bypass capacitor.

The circuit in figure 5 is basically similar to figure 4, except that we have specified silicon transistors, which, as we have already mentioned, can be expected to have a much lower leakage than germanium types. PNP transistors may be used merely by reversing the polarity of the supply voltage and the electrolytic output coupling capacitor. Note that we have not bypassed the emitter resistor. This is to make use of

eliminate the negative feedback and maximum gain will result. This will typically be 125 times for the transistors we have specified. By manipulating negative feedback one can thus design for a desired order of gain.

Figure 7 is another direct coupled configuration. Here, the circuit uses DC feedback to the base of T1 to establish the DC working point. In this case the gain can be varied by the setting of the potentiometer, which isolates the 100uF capacitor to a greater or lesser extent from the 680-ohm emitter resistor. An equivalent effect can be obtained by replacing the potentiometer with fixed resistors which add up to 10K but provide a suitable fixed tapping point.

All the above circuits are suitable for use with 2000-ohm dynamic headphones or the high impedance crystal

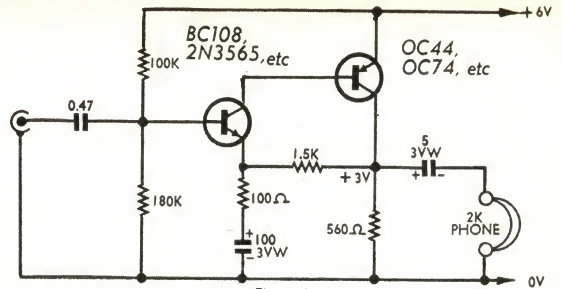

Figure 6

type. Low impedance types, such as the 8-ohm variety supplied with transistor radios cannot be used directly, because the output impedance of the amplifier stages we have described is too high.

The circuits can be used with low impedance phones if a suitable step-down transformer is coupled to the output, via the 5uF electrolytic capacitor. The transformer could be almost any type

## NEW EQUIPMENT CABINETS



**MODEL 154.** With lift-up lid over player. Sliding door in front of amplifier compartment. Large storage space with four separators. Size 36in wide, 17½in deep, 31in high.

Made and Polished, maple, walnut or teak . . . . .	\$65.00
Packing . . . . .	\$2.20
Kit of Parts, maple . . . . .	\$36.50
Teak extra, kits only . . . . .	\$6.50
Packing . . . . .	\$1.40

New Player Platform model 175 is 16in x 14in x 3½in. Price \$7.50 for maple or walnut. Kit of parts \$4.00. Teak, 50c extra. Perspex cover, 3½in or 5½in high, \$8.20 and \$1.50 extra if required hinged. Please specify cut out required.



### MODEL 186

New Player Cabinet model 186 is 10in high, 16in wide, 16½in deep and 5½in above shelf. Finished with tinted perspex top. Price \$22.00 for maple or walnut or teak. Kit of parts, \$13.50. Teak, \$1.00 extra (kits only). Height of this model can be increased to take various amplifiers. Tailored cut out. Ask for quotation. F.O.R. Packing \$1.

Write for Catalogue and Player Guide

## H. B. RADIO SALES

105 Catherine Street,  
Leichhardt, Sydney.  
Telephone: 56-5580.



## Sub-Miniature switches

The best the World can offer

TYPE	MODEL	CIRCUIT	250 V.A.C. RATING	CIRCUIT ARRANGEMENT
ROTARY	MRY-106	1 POLE	1A	1-6 USABLE POSITIONS
	MRX-108	1 POLE	1A	1-8 USABLE POSITIONS
	MRX-204	2 POLE	1A	1-4 USABLE POSITIONS
	MRX-402	4 POLE	1A	2 POSITION
TOGGLE	S-2012	SPDT	5A	ON-ON
	S-2013	SPDT	2A	ON-OFF-ON
	S-2022	DPDT	5A	ON-ON
	S-2023	DPDT	3A	ON-OFF-ON
	S-2025	DPDT	3A	ON-MOM ON
	S-2042	4PDT	5A	ON-ON
	S-2043	4PDT	3A	ON-OFF-ON
PUSH BUTTON	SB-2011	SPDT	2A	ON-ON (MOMENTARY)
	SB-2061	DPDT	3A	ON-ON (MOMENTARY)
	SB-2065	SPDT	2A	ON-ON (DOUBLE ACTION)
	SB-2085	DPDT	3A	ON-ON (DOUBLE ACTION)
SEE SAW	SW-3012	SPDT	3A	ON-ON
LAMP LIGHTED	MLB-2061*	DPDT	3A	ON-ON (MOMENTARY)
	MLB-2085*	DPDT	3A	ON-ON (DOUBLE ACTION)

\*THE MLB SERIES OF LAMPLIGHTED SWITCHES ARE AVAILABLE WITH RED, GREEN AND TRANSPARENT BUTTONS. THE LAMP VOLTAGES AVAILABLE ARE:— 6V, 12V, 18V, AND 24V.

**POST TODAY**

Please supply Sub-Miniature and Standard switch catalogue.

NAME.....

ADDRESS.....

**IRH**  
**COMPONENTS**  
**PTY. LIMITED**

A Subsidiary of IRH Industries Limited

THE CRESCENT,  
KINGSGROVE,  
N.S.W. 2208,  
TEL. 50 0111

IRH 692 R

— a 6.3V heater transformer would be almost ideal. The 240V winding would be connected to the output of the amplifier while the phones are connected across the low voltage winding.

None of the amplifiers so far discussed has sufficient power output for use with loudspeakers. The circuit in figure 8 represents a novel and economical way of obtaining sound from a loudspeaker. It has one major drawback — DC flows through the loudspeaker voice coil. Normally, loudspeakers should not have DC flowing through them, as the current causes a fixed deflection in one direction and thus restricts the cone excursion in one direction more than the other; this could result in distortion on loud signals. If one is prepared to risk some deterioration in quality, the arrangement is a handy one to keep in mind.

The circuit is again a Darlington pair configuration. T2 should be a power transistor. The current flowing through the loudspeaker should be kept to a minimum consistent with power output, otherwise the cone excursion will be excessive and the power dissipation in the voice coil may cause an undesirable temperature rise. For these reasons and considering the battery drain, the impedance of the loudspeaker should not be less than 15 ohms and the drop across the loudspeaker should not be more than 3 volts. If higher impedance types are on hand they may be used provided the DC working point is adjusted to 3 volts, as shown, to ensure adequate signal excursion. The voltage at the collector can be adjusted upwards by decreasing the 1K resistor, and vice versa.

Note that the power transistor does not need to be mounted on a heatsink, as, at most, it will only be required to dissipate 600 milliwatts of power.

Note also that the available power output with this amplifier is strictly limited because of the limitation on current flowing through the loudspeaker, and the current which can reasonably be drawn from dry cells.

Finally, in figure 9 we have shown an economical, complementary-symmetry amplifier with an output power of 300 milliwatts into an 8-ohm speaker. It represents the most economical method of providing this order of power, both in terms of component cost and battery consumption. Particular transistors have been specified and it is not intended as a circuit in which oddment transistors can be substituted.

Note that loudspeakers with an impedance higher than 8 ohms may be used with a consequent reduction in power output and current drain. Current drain with an 8-ohm loudspeaker is 100mA at full power and a mere 1mA at no signal.

The operation of the amplifier is as follows: The input transistor is a high-gain silicon NPN type functioning as a common-emitter amplifier stage. Following the input transistor is a silicon PNP transistor which performs further voltage amplification and also acts as the driver for the two output transistors. The output transistors are a complementary germanium pair, AC127/AC128.

Complementary-symmetry operation has the advantage of achieving the phase-splitting which is necessary for class-B operation push-pull operation in the output pair itself. Class-B operation implies that the output transistors are



biased so that they draw very little current under quiescent conditions, the current rising with signal level. For those not familiar with phase-splitting in complementary-symmetry amplifiers the principle is as follows:

Suppose, initially, that the signal from the collector of the driver transistor is positive-going, so that both output transistor bases are driven positive.

ter of the input transistor. The degree of feedback is determined by the value of the 270-ohm resistor. Decreasing the resistor increases the gain and vice versa. The low frequency response of the amplifier is determined mainly by the value of the 16µF capacitor in series with the 270-ohm resistor and also by the size of the output coupling capacitor.

2xOC74,2N647,AC107, etc

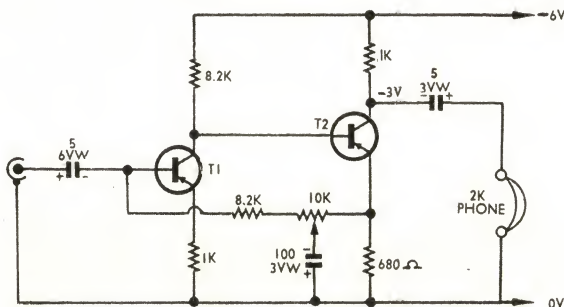

Figure 7

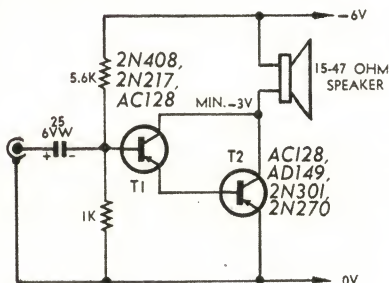

Figure 8

Because all stages in the amplifier are direct coupled, the voltage at the junction of the output transistor emitters is determined by the ratio of the voltage divider resistors at the input. Normally, there should be no need to adjust this voltage, unless the supply voltage is changed.

The last feature of note in this amplifier is the low value of quiescent current necessary to reduce "cross-over" distortion to acceptable limits. Cross-over distortion is visually apparent on an oscilloscope as a "nick" in

BC108, 2N3565 BC158, 2N3638

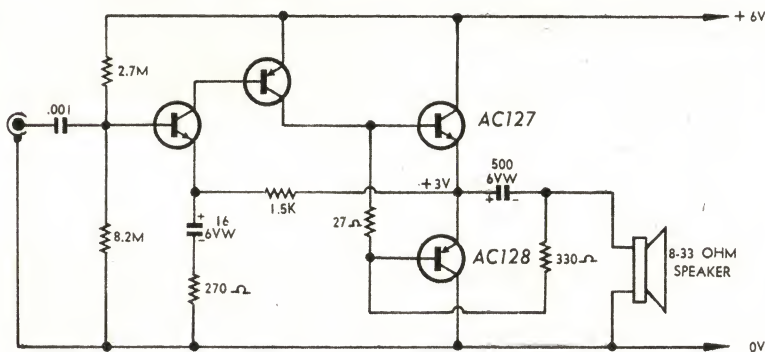

Figure 9

This will cause the upper (NPN) transistor to conduct and "charge up" the output coupling capacitor via the loudspeaker load, the lower (PNP) transistor meanwhile is turned off. During the following half-cycle, as the signal becomes negative with respect to the junction of the two emitters, the upper transistor turns off while the lower one conducts and discharges the output coupling capacitor through the loudspeaker load.

Class-B operation is thus achieved, with positive-going half-cycles being supplied to the loudspeaker from the positive supply rail and the negative-going half-cycles being supplied by the subsequent discharge of the output coupling capacitor.

Negative AC and negative DC feedback is applied from the junction of the output transistor emitters to the emit-

ter of the input transistor. The degree of feedback is determined by the value of the 270-ohm resistor. Decreasing the resistor increases the gain and vice versa. The low frequency response of the amplifier is determined mainly by the value of the 16µF capacitor in series with the 270-ohm resistor and also by the size of the output coupling capacitor.

In this case, both output transistors are slightly forward biased by the voltage divider formed by the 330-ohm and 27-ohm resistors to give a quiescent current of approximately 1mA. This low current means that the usual temperature stabilisation components such as emitter resistors and thermistors can be omitted.

## PRACTICAL NIGHT CLASS TRAINING for Careers in Radio, T.V. & Electronics

Trained technicians are wanted urgently. It's in your hands to train NOW for a successful future.

A.R.T.C. Practical Night Classes (established nearly 40 years) provide individual practical workshop training.

- Commence at any time.
- No previous knowledge required.
- Proceed at your own pace.
- Modern technical electronic training.
- New Australians welcome, the COURSE is specially simplified.
- Low in cost and you pay for the COURSE not the time taken.

College open for enquiries Monday-Friday 9 a.m. to 5 p.m. and until 7 p.m. on Monday and Thursday nights.



POST COUPON FOR FREE BOOK

'Careers in Radio, T.V. & Electronics'

Name .....

Address .....

AUSTRALIAN RADIO & TELEVISION COLLEGE Pty.Ltd.  
E.S. & A. Bank Building, cnr.  
Broadway & City Rd.,  
BROADWAY. (opp. Grace Bros.)  
Phone: 211-4224

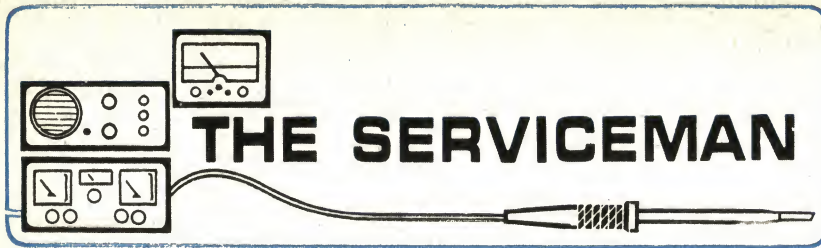

# THE SERVICEMAN

the good lady that there was indeed a peculiar pattern on the screen and that they had every right to complain about it.

With the set tuned back to an active channel, the mark was virtually invisible most of the time — which was the reason I had missed it at first encounter. Only by looking carefully at mid-grey areas which happened to coincide with segments of the circle could one see anything unusual.

That was until the picture faded through a blank grey screen into the next scene: then the circle was plain indeed.

Had it been a normal service situation, I would have advised the customer to forget it; the mark detracted so little from the value of the picture.

But this wasn't a normal service situation. The people concerned had paid for a new receiver and they had every right to expect a picture tube free from obvious peculiarities.

In exchange for my service fee, I duly rang the store which had supplied the receiver and explained to the departmental head what I had observed. To give him his due, once convinced, he had no hesitation in promising to send out a serviceman forthwith, with a replacement tube.

What had caused the circle on the screen I could only guess.

During manufacture, the envelope of the picture tube is partly filled with water and the phosphor powder is poured into the water. It then slowly settles on to the inside of the screen face. The water is then carefully poured off ("Decanted," they call it) and the surface dried with warm air.

Possibly something had interrupted the process in the case of this particular tube and left a slight stain or discontinuity in the density of the phosphor around a small pool of water. Either that, or a pool of water on a previous occasion had left a ring of contamination on the inside of the glass, which had affected the phosphor.

Or was there a colouration in the glass itself?

That the tube had passed through all the inspections, right into the customer's home, is probably explained by the fact that such inspections are normally carried out from close up, in front of the tube. And from this position, the mark was simply not apparent.

Why, I haven't a clue. I only know that that's the way it was. Furthermore, the serviceman who effected the replacement rang me next day to compare notes and to seek mutual assurance that neither of us was mad!

I did suggest that he make sure to attach a note to the tube explaining why it was rejected; otherwise someone back at the picture tube store will want to know: "What the heck is supposed to be wrong with this perfectly good tube?"

The very next job, somewhat remote from my usual haunts, involved a new stereo system, which was reported to be anything but satisfactory.

From the message, I had mental visions of a large, and expensive system and a rather critical owner getting upset about something that fell short of perfection. It turned out to be a new system, to be sure, but it was a quite unpretentious one with two smallish loudspeakers that could be demounted

## Round circles and square eyes!

Servicemen, like everybody else, have those crazy days when the most unlikely things seem to happen in quick succession. I had just such a day a few weeks back.

It started out normally enough with a message to go to a particular address and have a look at a television set which was supposed to have "a peculiar pattern on the screen."

Perhaps I tempted fate by thinking to myself that most television sets suffered from peculiar patterns on the screen for most of the time. Patterns in the likeness of politicians, for example.

When I duly arrived at the address, I found to my discomfort that the real purpose of my visit was to provide an independent opinion in a dispute between customer and supplier. I certainly had no wish to become the "meat in a sandwich" but, since I was at the address, with a service fee at stake, I had little choice but to go along with the situation.

The lady of the house explained that they had recently bought a new 25-inch television set from one of the major stores in Sydney. They had noticed, however, that there was a round ring on the screen about the size of a plate. When they rang the store and complained, the department manager had said that he had never heard of such a thing and he felt that they must have seen a reflection in the tube face of something else in the room. After all, the set had been checked before it left the store and checked again after installation; nobody had seen anything amiss.

After a further complaint, the manager had sent out a serviceman who, as fate would have it, turned up late one afternoon when only a couple of the older children were home. The serviceman had had a good look at the set and pronounced it as perfect. As far as the store was concerned, the matter had ended there.

My job was to look at the set and, presumably, verify the owner's observation.

Since there seemed to be no obvious alternative, I walked over and switched the set on, to be greeted, shortly afterwards, by a seemingly perfect picture: plenty of brightness all over, good contrast, no smear, no ghosts and, as far as I could see with the naked eye, no peculiar patterns either!

I could only say as much.

At this, the lady of the house sug-

gested that I turn the selector to channel 14 which, on this set, is a blank channel. Naturally enough, I was greeted with a perfectly plain raster on the screen. I didn't need to be a sage to realise that switching to the blank channel was supposed to show up the peculiar pattern to best advantage.

However, as I kneeled in front of the screen, I peered in vain for any sign of pattern or mark or imperfection. The tube looked exactly what it was supposed to be — a new and healthy 25-inch specimen.

Again I said as much.

"Now come back here," said the lady of the house, and I did so without any particular enthusiasm.

And blow me down. There it was: As plain as you couldn't wish for — a darker, yellow brown line, about a half-



"You realise, of course, there's a slight additional charge for these fringe-area calls?" "PF Reporter."

inch wide and describing an almost perfect circle about nine inches in diameter in the centre of the screen.

As I moved towards the screen again, the line seemed to disappear till, from about a foot away, I could only just make it out because I knew what to look for and where.

But, even from close up if the screen was viewed obliquely, the circle was quite obvious.

Naturally, I had to accept the evidence of my own eyes and agree with

from the main cabinet and placed somewhat further apart.

And far from the trouble being subtle, it was a case of one channel being very obviously weak and distorted.

This could have been due to anything from the pickup cartridge onwards but my first step was to swap the two loudspeaker plugs over and try again. Since distortion still issued from the same loudspeaker, it seemed pretty clear that the loudspeaker itself was at fault.

While it was natural to suspect that the voice coil was fouling in the gap, I have also known somewhat similar behaviour to be caused by a dry joint between the lead from the voice coil and the tagstrip on the housing.

With this in mind, I switched the system off, unscrewed the rather frail rear cover from the loudspeaker cabinet and undid the four screws holding the loudspeaker in place.

My next — and quite automatic — action was to raise the loudspeaker to my ear, with a thumb on opposite edges of the cone, to note whether I could hear a scraping noise as I moved the cone gently back and forth.

But I didn't get that far. Quietly, but very plainly, I was greeted by a voice

ed them off, they went off and stayed off. They didn't keep on working in any roundabout fashion!

To round off this month's instalment, here is a story passed on to me by the Editor and submitted by P.E. of Como, N.S.W. He writes as follows:

Repairing a radio receiver is like solving a mystery story, with the serviceman playing the role of detective. He collects facts, makes deductions and follows up clues, until the villain of the piece, a faulty resistor or other component is unmasked. This case was no exception.

Diffidently the owner produced an

early portable receiver of local manufacture.

"Some weeks ago I dropped it," he explained, "and since then the volume has been weak and there seems to be more background noise than usual." As an afterthought, he added, "And the volume control squeaks!"

My first thought was that the ferrite aerial rod had broken. Removing the back of the case showed that this had indeed happened, but on some previous occasion, it had been repaired fairly effectively with a piece of plastic tubing and some kind of adhesive. The battery voltage and current draw were

## ORYX SOLDER SUCKER



### CASE HISTORIES

*Yes our "Serviceman" will be happy to include in his columns items contributed by readers, such as the story featured overleaf. The material must be authentic — NOT fictional. It should be supported by mention of equipment, make and model (if possible and not for publication), voltage and current readings and a careful account of symptoms, diagnosis and corrective procedures. A contribution fee will be paid for items used.*

that I recognised instantly as emanating from one of our local broadcast stations.

I must have forgotten to turn the set off! But no, it was off all right; and it was still turned to "Phono" where I had left it.

Then I suddenly realised where I was: off the beaten track, as I said, and only a mile or so from the particular transmitter.

Apparently, signal was penetrating the circuits of the amplifier through the power wiring or loudspeaker leads and was being rectified by one or other of the junctions in one or other of the output transistors.

Switched on, the equipment was a regular stereogram. Switched off, it was behaving like a crystal set!

Not that this schizophrenic behaviour had any bearing on the original complaint. As far as I could see, the loudspeaker connections were perfectly sound and the trouble was simply a warped or off-centre voice coil.

Since the unsought sound could be heard only when close to the loudspeaker, I saw no reason to get involved trying to eliminate it, but I imagine that, a bit closer to the transmitting aerial, it might have been too loud to ignore.

As an old-timer, I can chalk up one more thing to be said for valves. They never acted like this. When you switch-

A new device introduced by Oryx, this de-soldering tool makes it easy to remove excess solder from circuit boards, from plated-through holes, and from terminals, etc. Consisting of a miniature Oryx iron to melt the solder, and an attached suction bulb and a reservoir for the removed solder, the unit is small and light enough to be used easily with one hand. It has its own built-in stand, so it can simply be put down on the bench between operations. Operating on very low voltage for greatest safety, it requires only 18 watts at 6, 12 or 24 volts AC or DC, or 25 watts at 12 or 24 volts AC or DC. Highly efficient and precision-made throughout, the unit is extremely effective for use on the

production line, by servicemen, by test technicians, and in prototype and breadboarding activities. The solder reservoir is stainless steel, easily cleaned; the suction tip is heavily chrome plated so that solder will not adhere. The unit Model SS-18-6V is furnished complete with an Oryx 18 watt, 6 volt miniature soldering iron, ready for operation from a suitable 6 volt transformer or other 6 volt source. For higher temperature operation, the 6 volt iron may be removed, and any of the following Oryx models used in its place — Model 12-6, 12 or 24 volt AC or DC, or an Oryx 25 watt, 12 or 24 volt AC or DC, both used in conjunction with an Oryx de-soldering adaptor.

For further particulars please contact your nearest distributor:



47 YORK STREET SYDNEY 2 0233

MANUFACTURERS SPECIAL PRODUCTS PTY LTD

ADELAIDE	BRISBANE	HOBART	LAUNCESTON	MELBOURNE	PERTH	SYDNEY
51 0111	31 0341	34 3836	2 1804	67 9161	28 3425	533 1277 & 29 7031

*Introducing  
The "New Look"  
"J.H." Synchronous  
Turntable*



Like its predecessor, this turntable is still the closest approach to spinning a record on air. **It revolves to perfection silently and constantly**—two apparently simple attainments which, nevertheless, involve 10 years of manufacturing know-how.

Even the most fastidious audio enthusiasts agree that this instrument is compatible with the finest stereo components. Although now considerably more sophisticated in styling the price of the "J.H." manual model is still a mere —

**\$36**

**\$36**

**\$36**

A speed change will shortly be available as an optional extra.

(The pickup arm depicted in the illustration is a masterpiece of British engineering — the "Transcriptor" fluid-damped hydraulic arm.)

**J. H. REPRODUCERS CO.**

293 HUNTINGDALE ROAD, CHADSTONE, VICTORIA. 3148

TELEPHONE: 277-3066

Exclusive Australian Agents for — ADC Cartridges and Amplifiers, Kef speakers, J. H./G. H. Unipoise Pickup Arms, Pritchard Arms, TRANSCRIPTOR TURNTABLES and the popular J.H. Synchronous Turntable.

## RADIO: Unofficial history

When a certain commercial radio station in Brisbane acquired a new manager, the staff were left in no doubt that things were in for a change. "Efficiency" was the keynote, and as anybody who did not look as though he was essential to the enterprise soon found himself out of a job, the place fairly hummed with activity. Even the musicians became unusually industrious! New program ideas were tried, and the upshot of all this was entirely satisfactory to the station owners—the costs were down and the ratings were up.

One of the aims of the new-look station was to be first with the news. The "with-it" image had to be sustained wherever possible, and one of the dodges used to be first off the mark was to get public figures to record suitable speeches in advance against the eventuality of the sudden death of prominent world figures. Within minutes of the news being received of the death of such a figure, the announcement could be made, the speeches played over, and suitable devotional music played as a mark of respect. The value of such preparation will be appreciated by those who have had to interrupt a comedy program for such an announcement, only to find that they have nothing suitable to put to air.

Reflecting the new efficiency policy, superbly edited recordings were made on disc, and a selection of sacred music set aside against the day when the emergency arose.

(Readers are invited to submit contributions to "RADIO: Unofficial History" and a publication fee will be paid for those used. Stories must be humorous and they must be true. Letters must be signed and the locale of the story indicated as a mark of good faith. The Editor reserves the right to re-phrase contributions as necessary to preserve uniformity of style.

next measured as a routine procedure and found to be normal.

Checking the reception of the local stations proved to be inconclusive. The gain was noticeably below par and the background hiss above normal, but the set was still working. In fact, it looked like a case of "general debility" which can consume a lot of time and components to restore the original performance. Turning off the volume control switch reminded me of the third fault. At the moment the switch contacts opened the speaker emitted a small "squeak."

A quick look at the circuit diagram showed that it was a conventional 7-transistor line-up. A mixer-oscillator, two IF stages and a diode detector, followed by an audio amplifier, audio driver and push-pull output.

The audio amplifier and the front end were de-coupled from the driver and output stages by a 220-ohm resistor and an 80uF electrolytic capacitor. If this capacitor had dried out, it could possibly explain the loss of gain and the tendency towards audio instability. However, bridging it with a new 100uF microfarad capacitor only changed the pitch of the "squeak" when the switch was turned off.

Before consigning this receiver to the shelf marked "Curly Ones" for more mature consideration, I decided to run over it with a multivibrator signal injector. Starting from the output stage I worked my way back towards the converter. All was normal until the 2uF capacitor coupling the volume control to the audio amplifier was reached. Applying the signal injector to the output

One day, the planning paid off. A much loved and respected member of the Royal Family passed away, the news arriving in the middle of a soap opera. The program was cut, and the appropriate disc having been retrieved from the stock of prepared speeches, it was placed on the turntable and put to air as per the standing instructions.

But where was the set of sacred music discs? Nobody knew, and they certainly were not where they should have been. In this emergency, everybody from the cleaner and cook to the program and technical staff joined in the search, knowing that they had only a few minutes to find the missing discs before the recorded speeches ended. In the meantime, the recorded voices of the public figures were lamenting the untimely death of the British Prime Minister, Phones rang furiously, but in vain; nobody could spare the time to answer them in the general panic occasioned by the search for the missing discs.

But there were a few red faces later, when listeners began to inquire about the sudden and entirely unexpected death of the Prime Minister, who, as it happened, was remarkably fit. Like Mark Twain, the report of his death was "greatly exaggerated."

In the inevitable "inquest," the truth came out. The right disc had been handed to the panel operator, but he had played the wrong side! (C. D., Sherwood, Qld.)

side of this capacitor gave a strong signal from the speaker, whilst applying to the input side gave very little. The villain of this story had been exposed—a partially open coupling capacitor.

Replacing this coupling capacitor cured all three faults. The volume increased, the background hiss became almost inaudible and the "squeak" disappeared. Presumably the additional loading of the volume control and diode detector circuits fixed the second two faults.

In retrospect, I had seriously to doubt the client's account of what had happened. Quite possibly, the performance of the receiver had been deteriorating over a long period, as the electrolytic coupling capacitor gradually dried out. It was only when he dropped the set and became apprehensive about the damage it might have suffered, that the owner realised that the set was performing poorly.

On the other hand, the capacitor could have suffered damage in the fall by one of the connections tearing loose internally.

As for the hiss, this would be more noticeable, anyway, in an old set, with the audio gain control turned abnormally high to make up for the lossy coupling to the front end. The squeak would indicate that the audio end was either unstable, or on the verge of instability with the coupling circuit almost open: this could have added to the noise.

But, typically, I had to forget about the "ifs" and the "might be's" and press on with the next job. The main thing was that the receiver had been fixed. □

## Regulated Power Supply BATTERY ELIMINATOR

### SPECIALLY FOR LARGER BATTERY OPERATED TAPE RECORDERS



#### TYPE PS104

Designed primarily for Tape Recorders where a regulated voltage supply is necessary to prevent speed variation with load changes. A versatile power supply with a range of output voltages making it ideal for design, testing and repair of Transistor Radios, Amplifiers, Record Players, Test Equipment, etc. It is also eminently suitable for use in Schools, Universities, Government Departments and Industry.

#### SPECIFICATIONS

Input Voltage	240 Volts, 50 Hz.
Output Voltage	4.5V, 6V, 7.5V, 9V or 12V D.C. by Selector plug. Max Current 0.5A
Protection	Electronic Overload Protection.
Regulation	Approx. 10% on 12V Range
Ripple	Approx. 5% on all other Ranges Less than 100 mV R.M.S. under all conditions.
Circuitry	All silicon solid state.
Size	4 ins. wide by 2 1/2 ins. high x 5 1/2 ins. deep
Weight	2 lbs. 7 ozs.
Approval	Approved by Electric Supply Authorities

Manufactured by

## A. & R. ELECTRONIC EQUIPMENT

COMPANY PTY. LTD.,

42-46 LEXTON ROAD,  
BOX HILL, VIC., 3128.

Phones 89-0238, 89-0239.

#### AGENTS IN ALL STATES

N.S.W. SOANER ELECTRONICS PTY. LTD.  
82 Carlton Cres., Summer Hill. Ph. 798-6999.  
QLD. R. A. VENN PTY. LTD.  
71-73 Doggett St., Valley, Bris. Ph. 51-5421.  
S.A. SCOTT THOMPSON PTY. LTD.  
93 Gilles St., Adelaide. Phone 23-2261.  
W.A. EVERETT AGENCY PTY. LTD.  
17 Northwood St., W. Leederville. Ph. 8-4137.

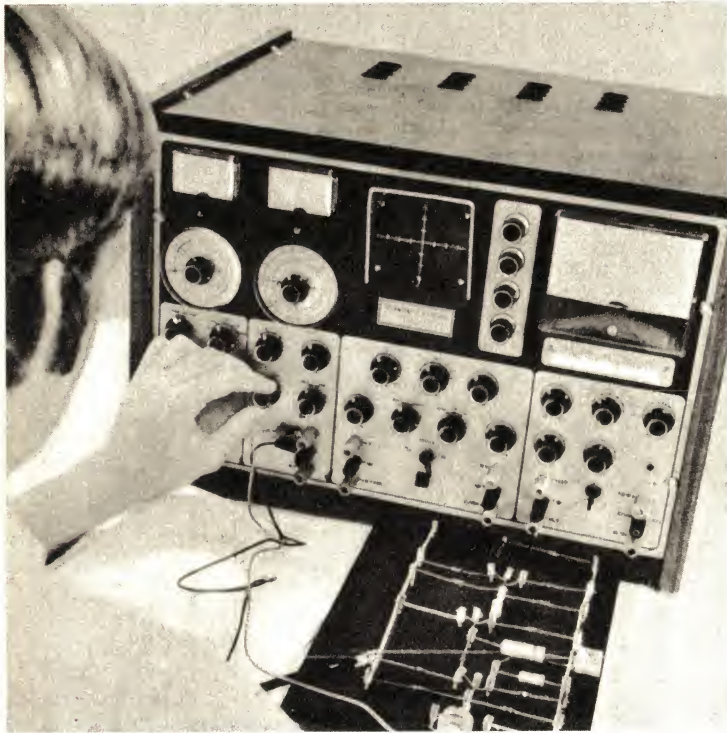

# Now YOU can enter The Wonderful World of Electronics with **TECHNIPAC**

Here's a truly unique electronics training program. It combines the theory and practical application of Electronics in a simple, logical and effective manner. We call it the TECHNIPAC System.

The TECHNIPAC System is new to you, but it is the result of 30 years' experience training people in technical fields. It isn't all study, either. It includes more than 400 actual experiments and the assembly of a first-class testing console, the TECMARK II, shown above.

The training program consists of 26 separate TECHNIPACS. There is no contract to sign. You order and pay for each Technipac only when you are ready for it.

Send for the free illustrated brochure, "Electronics, Technipac and You." We *guarantee* that no salesman will call on you.

**Post this coupon  
Today To:**

**Technical Training International**

75 Archer St,  
Chatswood. NSW 2067

**To: Technipac Systems Division  
Technical Training International**  
P.O. Box 328 Chatswood. NSW 2067

Please send me the free brochure,  
"Electronics, Technipac and You."  
I understand no salesman will call.

Name: \_\_\_\_\_ Age: \_\_\_\_\_

Street: \_\_\_\_\_

City: \_\_\_\_\_

State: \_\_\_\_\_ Postcode: \_\_\_\_\_

E A



# FORUM

## Program lines and microwave links

When we sit down each evening to listen to the radio or to watch our favourite television program, we may possibly associate it with the Australian Broadcasting Commission, or a particular commercial station. Very rarely does one stop to think that behind the distribution of radio and television programs is a vast network of lines and radio links provided by the Australian Post Office.

### Conducted by the Editor

Responsible for this introduction is a letter to hand from Mr E. J. Wilkinson, Assistant Director-General (Radio), Australian Post Office Headquarters, Melbourne. He writes as follows:

Dear Sir,—“I refer to the lists of broadcasting and television stations operating throughout Australia and the Territory of Papua/New Guinea, which were published on pages 108-111 of the January, 1970, issue of Electronics Australia. In view of the popularity of the lists and the many uses to which they are put, I trust you will allow me to make an observation concerning the national broadcasting and television transmitting stations.

“From a study of the notes accompanying the tables of stations, all your readers may not appreciate the involvement of the Australian Post Office in providing and operating these stations. Under the direction of the Federal Minister concerned (the Postmaster-General) responsibility for the national services in Australia is vested in three Commonwealth Authorities:

- Australian Broadcasting Control Board: Planning, standards, overall control.

- Australian Broadcasting Commission: Programs and establishment and operation of studio technical facilities.

- Australian Post Office: Establishment and operation of transmitting plant and program relay facilities.

“These responsibilities cover medium and short-wave stations and also apply to the operation of the National Broadcasting Service in the Territory of Papua/New Guinea.

“I would stress that there is very close and friendly co-operation between the three bodies and my desire in setting out the separate responsibilities is merely to draw attention to the Post Office role, not to emphasise it. Especially have I in mind the large number of Post Office technical

staff who help to bring national sound and television programs to the homes of your readers. Many of these are living and working in remote and lonely parts of the Commonwealth or Papua/New Guinea, and the majority are keen readers of Electronics Australia.”

Yours faithfully,  
E. J. Wilkinson.

Changing the subject, a letter on this page draws attention to the mounting problem posed by SCR devices, as seen by a New Zealand reader.

In fact, we did make a specific point about bi-directional thyristors in last month's editorial but our correspondent could not have known this when he penned the letter. The important difference is that we referred to the interference in only general terms; our correspondent is much more specific. He works in a situation where there is a concentration of SCRs and where

## SCR controllers

Dear Sir,

As a regular reader of your journal I wish to express my appreciation of it and to pose a problem which may be suitable for mention in “Forum.”

I would like to ask whether you have heard any mention of trouble from SCR power controllers in the form of AF interference on the mains and into telephone circuits.

In the laboratory where I am working, we have several SCR-controlled ovens, adding up to about 10KW, all told. If one of these is on, the interference is noticeable through the intercom system. If they are all on, the intercom is all but unusable. To a lesser degree, the trouble is also apparent in the telephone circuits.

I gather that this kind of interference on the mains also causes the supply authorities some trouble, as it

the interference is sufficient to make its presence felt in a very definite way.

To be sure, one must reasonably ask whether all practical steps have been taken to suppress interference from the oven controllers, even if only to minimise the trouble as distinct from eliminating it altogether. Have the controllers been fitted with optimised capacitors and/or inductors? Are they encased in adequate metal boxes, suitably earthed? Has the wiring been run in earthed metal conduit rather than the now usual plastic variety? These are the kinds of precautions we suggested in our recent “Musicolour” unit, knowing that they would limit interference to a level where it would at least be non-obvious.

In saying this, we are not seeking to set ourselves apart from anyone else. We would welcome legislation to control electrical interference. If that makes it necessary for our staff's vehicles to be checked for interference and our projects to conform to certain radiation standards, yet to be set, that's just part of the deal.

As for SCR interference upsetting control devices operated by the electricity supply authorities, that's the biggest laugh of all! Cynically, I see it as almost a recommendation for using SCRs by the thousand, for control tones themselves are a blight on our peace of mind.

Within a couple of days of writing the February editorial, I had occasion to attend the funeral of an esteemed friend. As something like 200 people sat in the church listening quietly to

can trigger hotwater systems, etc., in some instances.

It seems to me that the action of these controllers is to produce a whole string of harmonics of 50Hz right up into the RF region.

I know of no practical method of filtering or of stopping this interference. It is as pernicious as control tones superimposed on the lines by the supply authorities but it is potentially more troublesome. Certainly, due to the very low cost of SCR devices, the situation is rapidly worsening.

In our case, there are few, if any, ovens available having other type controllers. New Zealand's D.S.I.R. are investigating the problem but have not yet evolved any practical solution. Have you or any of your readers heard of any?

—R.S. (Wellington, N.Z.).

WORLD'S BEST RECORD-PLAYING EQUIPMENT AVAILABLE AT RECORDED MUSIC SALON. WE ARE SOLE AGENTS FOR AUSTRALIA FOR: ARMSTRONG, ENGLAND, AMPLIFIERS, TUNER AMPLIFIERS; JORDAN WATTS, ENGLAND, LOUDSPEAKERS; EMPIRE, U.S.A., CARTRIDGES, TURNTABLES, LOUDSPEAKERS; HARMAN KARDON, U.S.A., AMPLIFIERS, LOUDSPEAKERS, MUSIC CENTRES; SCHAUB-LORENZ, GERMANY, AMPLIFIERS, TUNERS, LOUDSPEAKERS, TAPE RECORDERS, TELEVISION; ERA, FRANCE, TURNTABLES, AMPLIFIERS, MUSIC CENTRES, LOUDSPEAKERS.

**ARMSTRONG 521 AND 526:** Power output 25 watts per channel into 8 ohms, 15 watts per channel into 15 ohms, 30 watts per channel into 4 ohms. Power bandwidth: 20-25,000 Hz. Total Harmonic Distortion: Less than 0.5 per cent for ALL power levels up to 25 watts output and ALL frequencies throughout the audio range. It is possible to quote a much lower distortion figure by selecting a particular frequency at a particular power output but this, on its own, is misleading. In this amplifier, for example, total harmonic distortion at 1 kHz at 15 watts output into 8 ohms is typically 0.1 per cent. Crosstalk: Never worse than minus 40 dB at any frequency and at any level of output. Channel Matching: Each channel plus or minus 1 dB to the other. Hum and Noise: Related to 25 watts output, better than minus 70 dB on tape playback, minus 60 dB on Radio and minus 55 dB on Pickup inputs with volume control at maximum. Power amplifier only, i.e., volume control at minimum is minus 87 dB.

**UNIT 1:** Armstrong 526 complete with 2 Empire 2000 loudspeakers, ERA Mark III turntable, belt-driven, which tracks the Empire 1000 ZE cartridge at 1/10th of a gram frequency response is 1 dB from 20-20,000 Hz, overall frequency response 4 to 40,000 Hz. Output voltage 5 mv per channel.



The same with Armstrong 521, the same as the 526, but without the tuner:

LESS . . . . . \$240.00  
The same with Armstrong 226 tuner/amplifier, 10 watts per channel, frequency response 30-20,000 cycles plus or minus 1 dB, less than 1/2 per cent distortion at 8 RMS per channel.

**UNIT 2:** Armstrong 227, technical specifications the same as for 226—10 watts per channel, etc., ERA Mark IV turntable, belt-driven, hydraulically controlled lowering device, complete on base as illustrated, Decca Derram diamond needle cartridge, with 2 Jordan Watts loudspeakers.



**UNIT 3:** Nord Mende Model 8001/T tape recorder with Dual 1210 turntable complete with cartridge, 2 Schaub-Lorenz beautifully designed speaker systems.

**UNIT 4:** Schaub-Lorenz Model 3000 tuner/amplifier, short-wave broadcasts, AM/FM, fully transistorised, 15 watts per channel, suitable for magnetic pick-up input, Empire 808 Cartridge. Dual 1210 turntable complete with Heko 10in base and tweeter loudspeakers without boxes.



**UNIT 5:** 2 Leak Mini Sandwich loudspeakers, Kenwood 250 amplifier, Akai 4000 tape deck. The same with Armstrong 521 amplifier.

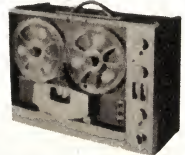

**UNIT 6:** Ampex 2163, world's best tape recorder, records and plays back in two directions, the heads are guaranteed for 10,000 hours or three years, whichever is sooner. Retail Price \$665. Our Price with two Jordan Watts loudspeakers, frequency range from 20-20,000 cycles.

The same with Nord Mende 8001/T 3 motor professional tape recorder:



**UNIT 7:** PE 34 belt-driven turntable, Empire 888E cartridge, frequency response from 10-30,000 Hz, output voltage 8 mv per channel, with Schaub-Lorenz Model 4000 tuner/amplifier, 25 watts per channel from 20-30,000 cycles, 2 Harman Kardon HK 40 loudspeakers complete in cabinets.



**UNIT 8:** Harman Kardon SC 1510 music Centre, power output: 25 watts, 1 HF (50 watts E.I.A. peak), Frequency Response: Plus or minus 1.5 db 18-30,000 Hz at 1 watt. Harmonic Distortion: Less than 1 per cent. Inter-modulation Distortion: 0.25 per cent at 1 watt. Harman Kardon SC 1510 fully transistorised compact unit, complete with 2 HK 10 loudspeakers.

## The cartridge designed for checking test records The new Empire 1000ZE—stereo calibration standard



Made in U.S.A.

Each 1000 ZE cartridge is individually calibrated to have a flat frequency response within plus or minus 1 DB from 20-20,000 Hz. There are no electrical or mechanical resonant peaks and total IM distortion at the standard 3.54 cm/sec groove velocity does not exceed .05 per cent at any frequency within the full spectrum. Stereo separation is better than 35 DB at 1 KC and remains at least 25 DB or better all the way out to 20,000 Hz. Overall frequency response 4 to 40,000 Hz. Output voltage 5 mv per channel. The calibration standard 1000 ZE stereo cartridge was designed to provide professional users, such as recording studios, radio stations, scientific and engineering laboratories, as well as serious audio-philites with the ideal standard for record playback evaluation. The 1000 ZE tracks effectively at stylus forces as low as 1 gram and never subjects the disc, whether it is vinyl pressing or master lacquer, to any visible wear or groove deformation. In high performance pickup arms (for example the Empire 990) operation stylus pressures below 1 gram may be used with most recordings. The Empire cartridge is the finest stereo-mono cartridge ever developed. Assembled under carefully controlled conditions, the Empire cartridge is inspected at each phase of its manufacture. Experienced, skilled American workmanship and design are responsible for its superior performance. The stereo performance of the Empire cartridge sets a new standard in listening quality. The Empire cartridge gives new meaning to the word "compatible." For, in playing monophonic records, it outperforms the finest monophonic cartridges previously available.

### MONOPHONIC USE:

To use the Empire cartridge in monophonic high fidelity systems, make the same physical installation as described for stereo, and connect the two G pins to each other, and the L and R pins to each other.

### OPERATION OF THE EMPIRE CARTRIDGE:

The design of the Empire cartridge is based on the induced field design lies in the extremely light and flexible stylus assembly. The Stylus, a precision polished diamond tip, is moved by ripples in the side at the same time moving a small conical element attached to the changes in magnetic field gated by the moving cone. The direction whether the resulting sound will come from one channel or the other; the amount of movement determines the loudness of the sound.

"Moving Magnetic Cone" principle. The superiority of this type of permits. The Empire cartridge works in the following manner. The record groove. The movement swings the stylus lever from side to side at the movement of the movement of the conical element by the stylus determines other; the amount of movement determines the loudness of the sound.

### FACTS ABOUT THE ELLIPTICAL STYLUS:

The elliptical stylus bi-radial dimensions (ex. 2 x .7 mil) on axis permits the smaller .2 mil radius to provide far greater groove resolution, especially on inner grooves. This produces a marked improvement in high frequency responses of the cartridge system. Tracing distortion is lowered to a minimum allowing for greater stereo separation. Monophonic recordings exhibit unusual clarity of sound. The above is accomplished without the disadvantages of small stylus tip radius on spherical diamonds. The larger axis prevents the stylus from bottoming in the stereo or mono groove while effectively tracking as though it were a small radius diamond. The Empire 1000 ZE Stereo Calibration Standard is priced in the U.S.A. at \$99.95. Our price in Australia: \$100.00. Sole Agents for Australia: RECORDED MUSIC SALON.

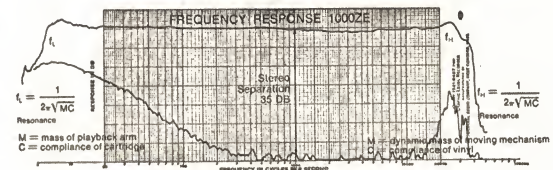

We attend with special care to Mail Orders and Wholesale Enquiries

# RECORDED MUSIC SALON

23 COLLINS STREET,  
MELBOURNE 3000.

C. PINCZEWSKI

TRUE FIDELITY

Telephone 63-6257



words of tribute, the atmosphere was shattered by a protracted series of 1000Hz tones reproduced through the amplifier system.

If ever I felt hostile about the practice it was then. I can only hope that last month's editorial and the workshop on interference to which it referred will start the ball rolling for some action on this whole vexed question.

Speaking about being hostile, a number of readers have expressed themselves as such, from time to time, since we adopted the term Hertz in place of cycles per second. They described the change in terms such as untimely, unnecessary, undesirable, deplorable, snobbish, etc. And choosing to ignore the real reason why Hertz emerged as an international term, they forecast that we would have to reverse our decision in due course. Some even tried to press us into leading a crusade to have the word rejected by the World's technical Press.

If we had ever been tempted to do anything like this—and we certainly weren't—any chance of us dropping the term Hertz would have disappeared with the recent announcement by the Federal Government of a changeover to the metric system of weights and measures.

Very plainly, as a nation, we are supporting the principle of uniform international scientific and engineering standards. Hertz happens to be a part of it.

As a piece of counter propaganda to those whose letters have been featured from time to time, I thought you might like to read one which arrived recently from a correspondent in South Australia.

Dear Sir,

As a migrant from the Continent. I have read with much amusement the various arguments regarding the "new" terminology. I simply cannot understand why people find fault with Hertz instead of cycles-per-second or, for that matter, Celsius degrees instead of Fahrenheit. The time is now in sight when these people will have another thing to get ulcers about: metric weights and measures.

In my opinion, the move comes none too soon, as Australia, in many ways is backward, if not archaic. Mind you, we are not alone in this respect but that is no excuse.

To get back to all that fuss about Hertz, etc., I had to "unlearn" what I had been taught and get used to your standards and it was not all that hard. I am not a genius, or anything approaching one, and I cannot really see what the fuss is all about.

I am not 40 yet but, brother, have I seen some changes? It's impossible to stop the world. A lot of people need to pull their socks up and get on with the job. This country might then get somewhere.

V. S. (Whyalla, S.A.).

Having re-read the letter, I can only hope that V.S. is a big bloke. You need to be, when you express yourself in this uninhibited fashion!

From a reader in Melbourne comes a letter enclosing a clipping from a

suburban newspaper. It tells of a new type of shoe which, in warm weather, will ensure that the wearer does not suffer from hot feet. On the contrary, he or she will have among "the coolest feet in Australia."

Knowing how cold one's feet can get, at times, in Australia, I'm not sure that I would be in the market for shoes which carried such a promise. But the chance of shedding at least a few degrees would certainly be welcome at times.

The interesting thing is that the article blames the problem of overheated feet on to static electricity. Get rid of this, and down comes the temperature. I quote:

"Basic principle of the Stat-E-Con sole, as its name implies, is to earth the static electricity which normally builds up in the body, resulting in the hot-foot condition, which has come as a by-product of today's widely used synthetic soles."

Commenting on this, our correspondent (H.P., East Malvern) says:

"This may not be a field in which I am particularly well informed but I fail to see how the presence or absence of a static charge on a person's feet could affect their temperature and comfort. In any case, it would appear that, the moment the person touched any earthed object with any part of their body, the charge would be dissipated anyway."

I'm afraid I must express agreement with these sentiments. To be sure, certain plastic soles can produce considerable discomfort on hot days and sandals with a minimum of "upper" are no exception. But I would have to be convinced that it is not simply a matter of thermal insulation and the lack of means by which heat from that very hard working area of skin can dissipate.

Increase the thermal conductivity of the soles by any convenient means and I imagine that the discomfort would diminish immediately.

I have no way of knowing whether the Stat-E-Con soles exhibit increased thermal conductivity as well as electrical conductivity, or whether only the latter. But, if static electricity is entirely to blame for hot feet then an alternative method of cooling them would be to use a metal walking stick or trail a chain, as some car drivers used to do.

On this basis, Dickens' famous character, the Ghost of Jacob Marley, must have had quite frigid feet.

In saying this, I am not discounting the possible significance of anti-static soles in surgery and other situations where static charges could produce unexpected sparks, leading to involuntary movement and even ignition of volatile gases. But that is quite a different thing from hot feet.

Come to think of it, I could do with a pair of anti-static trousers. Time and again I slide across the front seat of my car and receive a "belt" as I touch the door-handle.

And wouldn't it be curious if conductive trousers turned out to be the answer to the proverbial "hot seat"? ■

# JEMCO

The reliable multimeter backed by dependable service since 1959.

NEW model

US-105, 50,000 o/v \$30  
US-100, 20,000 o/v \$25



- Overload Protected, Shockproof
- Polarity Reversing switch.
- 200 Megohm US.105 (50 MO US-100) Resistance Range Rx1/x10/x100/x1K/x10K

DC volt: 0.25/1/2.5/10/50/250/1000.

AC volt: 2.5/10/50/250/1000.

DC Current: 50UA, 1/25/500 mA, 10A

AC current: 10A.

5-7/8 x 4-1/8 x 1-7/8 inches.

Robust workshop model MT-216 \$11.40 2000 o/v.



DC/AC volt: 10/50/250/500/1000.

DC current: 500UA 25/500mA

Resistance: 1 Meg Rx10/x100/x1K.

Decibels: -20 plus/minus 36dB 2 ranges.

Capacitance: 0.001—0.1UF.

Inductance 20—1000H.

5-3/8 x 3 1/2 x 1-5/8 inches.

Quality pocket meter MT-114 \$8.80 4000 o/v, leather case \$2.



DC/AC volt: 10/50/250/500/1000.

DC current: 250UA 10/250mA.

Resistance: 20K/2Meg

Decibel: -20—22, 20—36.

4 1/2 x 3 1/2 x 1 1/2 inches.

All prices plus 15 per cent Sales Tax. Please disregard prices in Feb. advt. Available ex stock from leading merchants or sole Australian distributors.

## INDEVA PTY. LTD.

24 Bellevue Rd., Bellevue Hill, 2023.

Telephone Sydney 36-4401.

Melbourne 81-2908.

Brisbane 27-336. Adelaide 67-2246.

Name .....

Address .....

Mail this coupon for details.

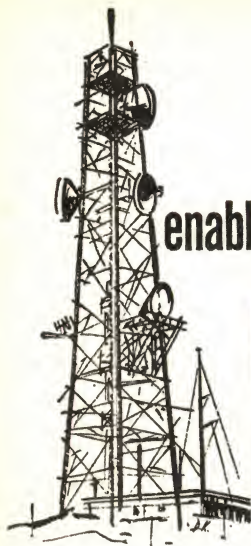

# ALLIED CAPACITORS

specialised facilities and years of experience  
enable Allied to design and manufacture for your specific needs



- Ceramics
- Plastic Film
- Electrolytics
- Silvered Mica
- Potentiometers
- Paper Capacitors
- Connectors
- Switches
- Trimmers
- Centralab Packaged Electronics



**ALLIED CAPACITORS PTY. LIMITED**



Distributed by  A Hawker Siddeley Company  
Ferris Bros. Pty. Limited, 752 Pittwater Rd.  
Brookvale, N.S.W. 2100. Ph. 93-0221 (10 lines)

Write for catalogue and service information to  
Allied Capacitors Pty. Limited,  
752 Pittwater Rd., Brookvale, N.S.W. 2100.

NAME.....PHONE.....

ADDRESS.....

EA.....POSTCODE.....

FB4211/69

????? does NASA and the world's leading professionals, radio stations  
etc. use

because the NEW BREED styled UHER  
prof. portable range of tape recorders are  
the most successful ever available.



4 speeds—2 or 4 track stereo—4 way power  
supply—40-20,000 cps, 6½lb.

BE SURE, USE

**UHER**

Your NEXT Choice

by

**ATRAM PTY. LTD.**

Sole Australian Importer and General Agent.  
5 McLaren Street, North Sydney. 92-4177

MADE IN W. GERMANY

Now every Amateur and Enthusiast can have  
**ACTION and SOUND**

with

**UHER BANDRECORDER**

RANGE: 4000 Report L—the most successful reporter model.  
4200/4400 Stereo—the world's smallest hi-fi stereo  
recorder.

1000 Pilot—the world's most advanced and compact  
lip-synch-recorder.

Available in All States from Franchised UHER Agents

N.S.W.: John Border Photographics Pty. Ltd.  
175 Liverpool St./403 George St.  
Sydney. Tel.: 26-1106.  
N.S.W.: Milverson Sound Centre,  
791 Pacific Highway, Chatswood.  
Tel.: 41-4365.  
N.S.W.: Glen Dor Camera Centre,  
43 The Corso, Manly.  
Tel.: 92-2709.  
N.S.W.: Camera & Taperocorder Industries  
Pty. Ltd., Piccadilly Centre, Wol-  
longong. Tel.: 2-5525.

A.C.T.: Canberra Sound and Recording Service,  
109 Majura Ave., Dickson.  
Tel.: 47-7980.  
QLD.: A. E. Harrold Pty. Ltd.,  
123-125 Charlotte St., Brisbane.  
Tel.: 31-3081.  
VIC.: Atram Pty. Ltd.,  
1 Corr St., Moorabbin. Tel.: 95-5633.  
VIC.: Klapp Electronics Pty. Ltd.,  
224 Chapel St., Prahran.  
Tel.: 51-4653.

VIC.: Photosound Pty. Ltd.,  
7 Cookson St., Camberwell.  
Tel.: 82-7042.  
S.A.: Kallin Distributors (Wholesale)  
Pty. Ltd., 140 Gawler Place, Adelaide.  
Tel.: 23-6055 (11 lines).  
W.A.: Alberts TV and Hi-Fi Centre Pty. Ltd.,  
282 Hay St., Perth. Tel.: 21-5004.  
N.T.: N.T. Musical and Electrical (W/S)  
Pty. Ltd., 54 Cavanagh St., Darwin.  
Tel.: 3072.

# ELECTROLUMINESCENCE . . .

## principles of semiconductor and phosphor techniques

Electroluminescent devices under development in the U.K. are expected to eventually be widely used in both the technical and domestic spheres. One likely use is as a flat picture display for TV receivers.

By ARON VECHT

Everyday electronic equipment conveys information of ever-increasing complexity to us. In almost all cases this is done by some visual signal (usually an electrical message converted into a light signal). These signals range from a simple on/off, indicated by a single lamp, to a complete picture, that may contain about a quarter of a million dots of light. There is therefore, a continuous demand for better light sources that can effectively display the required information.

In the past, simple incandescent (or neon) lamps were used as single indicators, while the cathode ray tube could convey more complicated information. Both these devices have the disadvantages of bulk and a fairly limited life. The conversion to light of electricity is indirect; in one case, the process occurs via heat, while the other makes use of the action of an electron beam on a powder phosphor layer. However, the conversion of the energy is inefficient, ranging from 1-20 per cent.

Ideally we require a robust, flat, efficient source of light which has a long life. Such a lamp should convert the electrical signal directly into light. This process is termed electroluminescence. The stage of research and development has now been reached where two types of lamps of considerable promise have been made. These lamps, that are now becoming available, have been developed from two very different areas of research.

The first is a direct outcome of semiconductor technology and an extension of the detailed investigation of the elements silicon and germanium to compounds such as silicon carbide and gallium arsenide. The lamps in this group

are junction devices, the light being emitted at the junction of P and N type semiconductors.

The second is a development of research on the materials that convert the electron beam energy in the cathode ray tube into light. Such materials are usually applied to the cathode ray screens as powders and are termed phosphors. One of the most efficient phosphor systems used in the past is based on zinc and cadmium sulphides. When they are prepared to a high degree of purity, doped with copper or silver impurities and treated in a special way, the required phosphor properties are obtained. If some of these phosphors are placed inside a capacitor with at least one transparent electrode, light can also be obtained directly by the application of an AC field. The phosphors have now been considerably modified and the light sources produced using this technology may be called powder electroluminescent cells.

In devices where only small areas of illumination are needed or where long life is essential, junctions made from silicon carbide or gallium arsenide and related compounds are being used on an ever increasing scale. Unfortunately, unless technology changes a great deal, these devices will remain expensive, as they are produced from perfect single crystals which can only be grown to a certain size.

Such devices, however, have the advantage of a long operating life. Thus, where the labour cost of dismantling apparatus is high they will replace conventional bulbs. Further applications are for very small light sources and in electronic equipment that requires light emitting devices to switch rapidly. Junction devices that can be switched on or off in nanoseconds (a nanose-

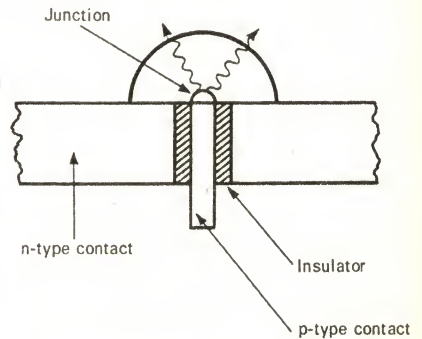

Simplified diagram of a junction electroluminescent device. The emission area is about 1 sq. mm.



Simple DCEL letter display, photographed from its own illumination. The letters can be obtained either by evaporating the back electrode through a mask, or, as in the example illustrated, by photo-etching the transparent electrode.

cond is a thousand-millionth of a second) can now be produced.

The problem with gallium arsenide lamps and lamps made from related compounds, was primarily the colour of the light produced. Efficient light sources can be made that emit in the infra-red but efficiency falls off a lot as light emission in the visible region is obtained. Originally it was thought that

**RIGHT:** A hundred dot cross matrix photographed from its own illumination. Each dot is a discrete electroluminescent cell, separately powered.

**FAR RIGHT:** Showing how a cross matrix can be used for a number display, by selection of the appropriate contacts to illuminate the desired dots. (Photographed from its own illumination.)

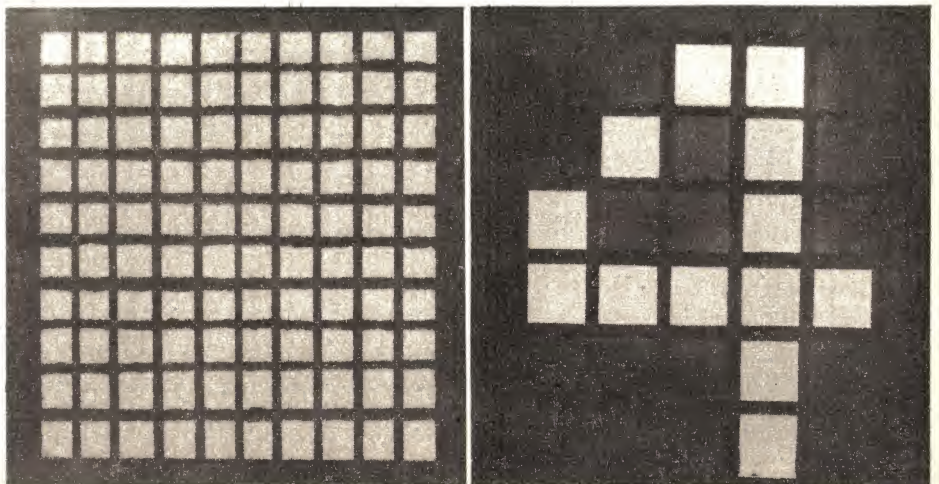

# At last a high fidelity Cassette Stereo

It took Teac years of research to develop a compact stereo cassette recorder with the same high quality record and playback as available in reel to reel stereo tape decks. Their success was the A-20 cassette stereo deck — \$209.50 Aust. The A-20 features a 4-pole hysteresis synchronous motor, Dual VU meters, all silicon-transistorised pre-amplifiers, and uni-directional stereo microphone. This cassette stereo tape deck was made to match the Teac AS-200 integrated amplifier (120 watt RMS continuous power output and wide dynamic range. Frequency response 20-80,000 Hz — \$389 Aust.), and Teac LS-350 3-way 3-speaker system (full 12" woofer, easily handles 40 watts — \$154 Aust.), but can be easily connected to any quality equipment to give you the convenience of cassette, and the quality of reel to reel tape.

## Specifications:

- 2 heads
- 4 track, 2 channel stereo
- Frequency response 60 to 10,000 Hz
- Wow and flutter less than 0.2%
- Tape speed 1 $\frac{7}{8}$  i.p.s.
- C-60, C-90, or C-120 tape
- Size 9 $\frac{3}{4}$ " x 10" x 4 $\frac{1}{4}$ "

## AUSTRALIAN MUSICAL INDUSTRIES PTY. LTD.

155 Gladstone St., Sth. Melb., Vic., 3205.  
Phone 69 7281. Telegrams AMUS Melb.

# TEAC®



### RETAIL ENQUIRIES:

**VIC.:** Brashs Pty. Ltd. 63 6701  
Melbourne & Suburbs  
Suttons Pty. Ltd. 60 1201  
Melbourne & Country  
Stereo Sound Systems Pty. Ltd.  
Ringwood 870 4961  
Southern Sound  
Moorabbin 97 7245

**N.S.W.:** Convoy International Pty. Ltd.  
Sydney 29 6475

**S.A.:** Ern Smith & Co. Ltd.  
Adelaide 51 6351

**W.A.:** Albert TV & Hi-Fi Centre Pty. Ltd.  
Perth 21 5004

**TAS.:** B.B.C. Radio Centre Pty. Ltd.  
Burnie 31 4415  
Wills & Co. (1954) Pty. Ltd.  
Launceston 2 4641

**QLD.:** Brisbane Agencies Audio Centre  
Brisbane 2 6931  
King & King  
Brisbane 2 7760

such light sources would not be used much, but two methods have been introduced which overcome this problem. Firstly, methods have been developed for growing single crystals of materials that emit in the green part of the spectrum. Best results are being obtained by the growth of solid solutions of two compounds producing a material still showing reasonable efficiency in emitting visible light. An example of this is graded growth gallium arsenide phosphide which gives a useful red-emitting device. Alternatively, new materials have been developed that can convert infra-red light to the visible part of the spectrum. Such materials, can simply be coated on the windows of infra-red emitting gallium arsenide lamps, producing green light.

But for large area displays covering thousands of square cm another approach is required and powder electroluminescent cells can be employed. These are cheap to make and can basically be considered as a painted layer between two electrodes. At one time it looked as if such devices could only be employed at fairly high voltages (over 100) using AC supplies. More recently,

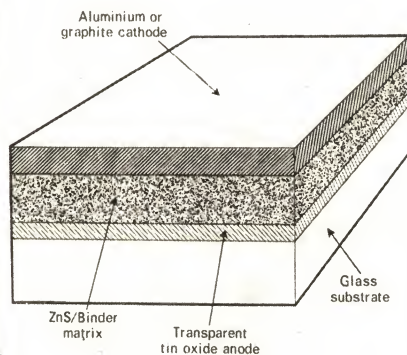

*The general arrangement of elements in a powder electroluminescent cell for DC. The surface area may vary from as small as one hundredth of a square millimetre to thousands of square centimetres.*

it has been shown that this is not the case and that low voltage (30V) direct current panels can be produced.

A major problem that remains to be solved is the maintenance of these large area panels. Early experiments indicated that direct current electroluminescent (DCEL) lamps were merely scientific curiosities that emitted light for only a few minutes. Although light emissions lasting about a thousand hours can now be achieved, this is not quite good enough. A light output which lasts for five to ten thousand hours is needed and will probably be obtained.

The light emission from the DCEL lamps is yellow-orange, this colour being obtained by adding a manganese impurity to the phosphor. This is a most useful colour, as it corresponds to the part of the spectrum to which the eye is very sensitive. Further work is now being done to obtain useful green and blue emissions. This has recently been done by replacing the manganese impurities by traces of rare earth ele-

ments and green and blue lamps have been produced. Although the development of these phosphors is at a very early stage, rare earth activated materials will increase the range of colours that will eventually be obtained from DCEL lamps.

So far, only the powder phosphor systems, where the phosphor powder is incorporated in a binder, have been described. Zinc sulphide and related compounds can be evaporated and the deposited thin film, after suitable treatment, shows similar electrical and optical properties to those observed in powders of these materials. This is different from gallium arsenide and its related compounds which can only be used in single crystal form.

Thin films of zinc sulphide activated with manganese and copper can be made to electroluminesce. Up to now, the properties of such films have not matched the performance of powder phosphors. When the light emitting pro-

cesses are better understood, evaporated devices may well perform better and ultimately replace the powder devices. Thin films can be prepared very cheaply and research workers are after large area devices compatible with solid state technology.

The potential of these devices appears to be enormous. Such lamps will certainly find wide application for digital readout and illumination devices in a great many electronic equipments, and when other problems of storage and address have been solved, electroluminescent lamps may be used in flat picture displays to replace cathode ray tubes in television systems. In a much wider field, they could be used in situations where large areas of uniform illumination are required. Exit signs, notice boards and clock faces can be directly illuminated by them, and the low voltage DC application immediately indicates their use in car dash boards and similar situations.

**BUY RIGHT... FROM ENCEL**

## SONICS

**HIGH PERFORMANCE SPEAKER SYSTEM  
AT AUSTRALIA'S LOWEST PRICES**

### FOUR FROM THE SONICS RANGE

**AS-69E Compact** (18 $\frac{3}{8}$ " x 12 $\frac{3}{8}$ " x 5 $\frac{1}{4}$ "") yet fitted with a bass/mid range speaker and a separate tweeter. Comes in hand finished teak/walnut enclosure.

Price (including sales tax) **\$27.50.**

**AS-303:** This magnificent system, in hand finished teak or walnut enclosures, features three speakers with a 3 way crossover network: a 12" woofer (with long throw voice coil), 6 $\frac{1}{2}$ " mid range speaker, and a horn type tweeter. AS-303 handles 15 watts (RMS) plus; and produces high quality colouration free sound over wide frequencies. Size 25" x 14 $\frac{3}{4}$ " x 11."

Price (including sales tax) **\$69.50.**

**AS-61.** This Slimline speaker (21 $\frac{3}{8}$ " x 17 $\frac{3}{4}$ " x 4 $\frac{3}{8}$ "") features four bass mid range speakers and a separate tweeter. In teak/walnut — with detachable legs. Encels' low price for this tremendously popular model includes sales tax.

**\$39.50.**

**AS-330:** Top of the "Sonics" range. This 3 way system features 5 speakers, 12" woofer, a pair of 6 $\frac{1}{2}$ " mid-range speakers and two exponential tweeters. Frequency response 30-20,000 Hz; with smooth sound provided for by the carefully selected crossover frequencies. Hand finished in teak/walnut and most attractive; incorporating a fret grill; 15 $\frac{3}{8}$ " x 26" x 11 $\frac{5}{8}$ ."

Price (including sales tax) **\$98.50**

### ALSO FROM SONICS

Stereo Headphones from \$9.50.

**HS-304** . . . comfortable, fatigue-free personal listening.

Price (including sales tax) **\$12.50**

**HS 303** . . . low impedance stereo headphones. Frequency response 20-15,000 Hz.

Price (including sales tax) **\$9.50.**

**All Sonics stereo headphones have foam rubber ear-pads.**

# ENCCEL

**ELECTRONICS (STEREO) PTY. LTD.**

Head Office: 431 Bridge Rd., Richmond, Victoria. 3121. Tel. 42 3762.

Sydney Store: Ground Floor, 25M Building, 257 Clarence Street, Sydney, N.S.W. 2000. Tel. 29 4563, 29 4564.

Australia's Greatest Hi-Fi Centre ■ Wholesalers ■ Trade-ins accepted ■ Terms

Now distributed in Australia by  
**MAGNA-TECHTRONICS (AUST.) PTY. LTD.**

# **ELAC** MIRACORD

**\*World's top-rated automatic changers  
and components**

( \*U.S. CONSUMER REPORT AND U.S. STEREO REVIEW)

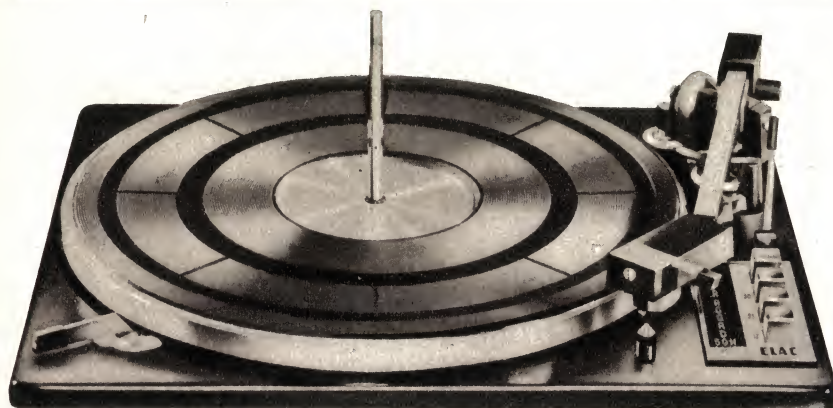

## **MIRACORD 50 H**

Made for the connoisseurs—the Elac Miracord 50 H four-speed transcription turntable. Incorporates operating and control facilities of unrivalled flexibility . . . highest precision action.

- Hysteresis synchronous motor (Papst outer rotor).
- 12 inch precision-balanced turntable.
- Stylus overhang adjustment.
- Dynamically balanced arm that tracks to  $\frac{1}{2}$  gram.
- Push-button control.
- Automatic changer mechanism.
- Piston-damped cueing device.
- Effective antiskate.
- Metal cam (no plastic).

### **ELAC Hi Fi Stereo Magnetic CARTRIDGES**

**STS 244-17**  
**STS 244-E elliptical**  
**STS 344-17**  
**STS 344-E elliptical**  
**STS 444-12**  
**STS 444-E elliptical**

### **DEALERS INVITED IN ALL STATES**

Application can be made now to Magna-Techtronics for selling world-famous Elac products.

**MAGNA-TECHTRONICS (AUST.) PTY. LTD.,**  
Box 314, P.O., Crows Nest 2065. Phone 439 1651.  
*Ask for Stan Bankowski, Manager, Acoustics Div.,  
and enjoy personalised attention.*

*Like more facts on Elac Miracord Turntables? Mail this coupon to our Box No. for free literature.*

Name.....

Address.....

..... P.C. ....

MS49XFFM

Come with us  
to EXPO '70  
on the first

**20 DAYS OF  
EXCITEMENT  
AND EDUCATION  
FOR ONLY \$1069**

**BASIC TOUR ITINERARY**

Fri., June 26: Interstate passengers fly to Sydney by T.A.A./Ansett.

Fri., June 26: Depart Sydney 11.45 a.m. by B.O.A.C. VC10 jet for Hong Kong and The New Hong Kong Hotel. (Perth passengers fly via Singapore. Passengers from Brisbane, Darwin, Port Moresby fly direct to Hong Kong. New Zealand passengers via Sydney.)

Sat., June 27: Morning at leisure. Afternoon flight to Taipei, thence to the President Hotel.

Sun., June 28: Sightseeing Taipei.

Mon., June 29: Morning technical tour at Taipei. Afternoon to Tokyo.

Tues., June 30: Tokyo, technical and sightseeing tour.

Wed., July 1: Leisure day in Tokyo.

**THURS., JULY 2 to FRI, JULY 10:** Depart Tokyo for an exclusive and action-packed 9-day tour of spectacular Japan, including two complete days at the EXPO '70 site, Senri Hills.

Sat., July 11: Morning flight from Osaka to Hong Kong.

Sun., July 12: Harbour cruise, Hong Kong.

Mon., July 13: Leisure, Hong Kong.

Tues., July 14: Duty-free shopping. Evening flight to Sydney.

Wed., July 15: Arrive Sydney 6.50 a.m. (Perth passengers return via Singapore. Passengers from Port Moresby, Darwin and Brisbane fly home direct. New Zealand passengers return via Sydney. Other interstate passengers fly home by T.A.A./Ansett.)

# TECHNITOUR\*

Arranged by "ELECTRONICS Australia"



**ALL-INCLUSIVE TOUR COSTS**

(Fares and schedules are subject to alteration.)

From SYDNEY	\$1069	BRISBANE	\$1056
MELBOURNE	\$1114	DARWIN	\$980
HOBART	\$1156	WELLINGTON	\$1166
ADELAIDE	\$1156	AUCKLAND	\$1166
PERTH	\$1053	CHRISTCHURCH	\$1166
CANBERRA	\$1090	PT. MORESBY	\$969

Single-room supplement \$95

For only \$262 more than the normal economy class return air fare, you will enjoy:

- A fantastic 20-day tour of interest to our readers and their families.
- First-class, air-conditioned hotels.
- First-class transport in coaches, trains, steamers.
- The finest food in world-class restaurants.
- Travelling companions who share similar interests.
- English speaking escort in each country.
- Participation in EXPO '70.

Our "TECHNITOUR" price includes your economy class air fare, first-class accommodation in twin-bedded rooms, all meals, sightseeing, transfers to and from airports, gratuities, tipping, local tours, 44lb of free baggage allowance, entrance tickets to EXPO—in fact everything except items of a personal nature, such as duty-free shopping, drinks and cigarettes, laundry and items not specified in the amazingly comprehensive itinerary.

\* The word "TECHNITOUR" has been registered by "ELECTRONICS Australia."

## TECHNITOUR — JAPAN, EXPO '70 JUNE 26 — JULY 15, 1970

Tick appropriate square

- I wish to reserve a place in the "Electronics Australia" TECHNITOUR of Japan and EXPO '70 for ..... person(s). Enclosed is a ..... (cheque, etc.) for \$..... (Deposit required is \$100 per person.)
- I am interested in the abovementioned tour. Please forward details of itinerary, conditions, etc. by return mail.

Name (please print) .....

Number, Street, etc. ....

Town or City .....

Postcode ..... Country .....

Fill in this coupon and mail to:  
TECHNITOUR TO EXPO '70  
"Electronics Australia"  
G.P.O. Box 4601  
SYDNEY 2001  
AUSTRALIA

Hurry with your application, because reader response has been immediate and there is a limit on the number of people we can accommodate.

# TAPE DECK

# Dual

# TG28

## HIGH FIDELITY

## STEREO



ASK FOR A CATALOGUE OR DEMONSTRATION BY YOUR NEAREST DEALER

## FRED A. FALK (SALES) PTY. LTD.

28 KING STREET, ROCKDALE, N.S.W. — PHONE 599-3722

**Distributors:**

N.S.W.—All leading Electrical Houses.

VIC.—Radio Parts & Electrical Houses.

QLD.—Ron Jones P/L, 7-9 Merton Rd., Sth. Brisbane.

S.A.—Truscott Electronics & all leading Electrical Houses

W.A.—Athol M. Hill, 613 Wellington St., Perth.

TAS.—All leading Electrical Houses.





# A READER BUILT IT

## Parlour Game—Another Version\*

Although this is yet another version of the electronic game described on previous occasions, it offers some novel features. One is the method of displaying the "machine's move" instructions, and another a means to vary the machine's "program" when the players learn how to beat it.

The submitted circuit was evolved after reading your articles on "Switchcraft." (Radio Television and Hobbies, November, 1959). The idea is not new but readers may welcome a switching circuit which can be used to entertain one's friends.

To play the game 14 switches are turned down in sequence from left to right. The player and the box take it in turn to move, turning down one, two, or three switches at each move, as they please. Each tries to leave the last move to the other. When it is the box's turn to move the player presses the switch, S18 and then, on the box's behalf, turns down the switches over which a light appears. It is then the player's turn again.

The switches S15, 16, and 17 are used to vary the circuit when someone beats the box, so that he cannot win again by making the same moves.

I purchased 18 obsolete lever keys from the post office for 5c each. Switches S1 to S14 are two-position types. Most of them need to provide three change-over functions (the "a" "b," and "c" functions shown on the circuit) and two, S6 and S10, need four such functions ("d"). These switches are normally set in the horizontal position (the position represented on the circuit) and pushed down to represent the various "moves." Switches S15 to S17 are three-position types, and S18 is a spring return type.

I mounted the switches in a wooden

frame, arranged in two rows. From S1 to S14 makes up the top row and S15 to S18 are spaced out to make the bottom row. There is a 7/16in hole above each switch S1 to S14 to accommodate a 6.3V globe. These were purchased cheaply at a chain store. The unit's total cost was under \$2. (L. A. S.)

\* This circuit was submitted by a reader some time ago, and since it may no longer be appropriate to publish the name and address as supplied, we have used initials only. If the reader concerned cares to contact us, we shall be pleased to arrange payment for the item.

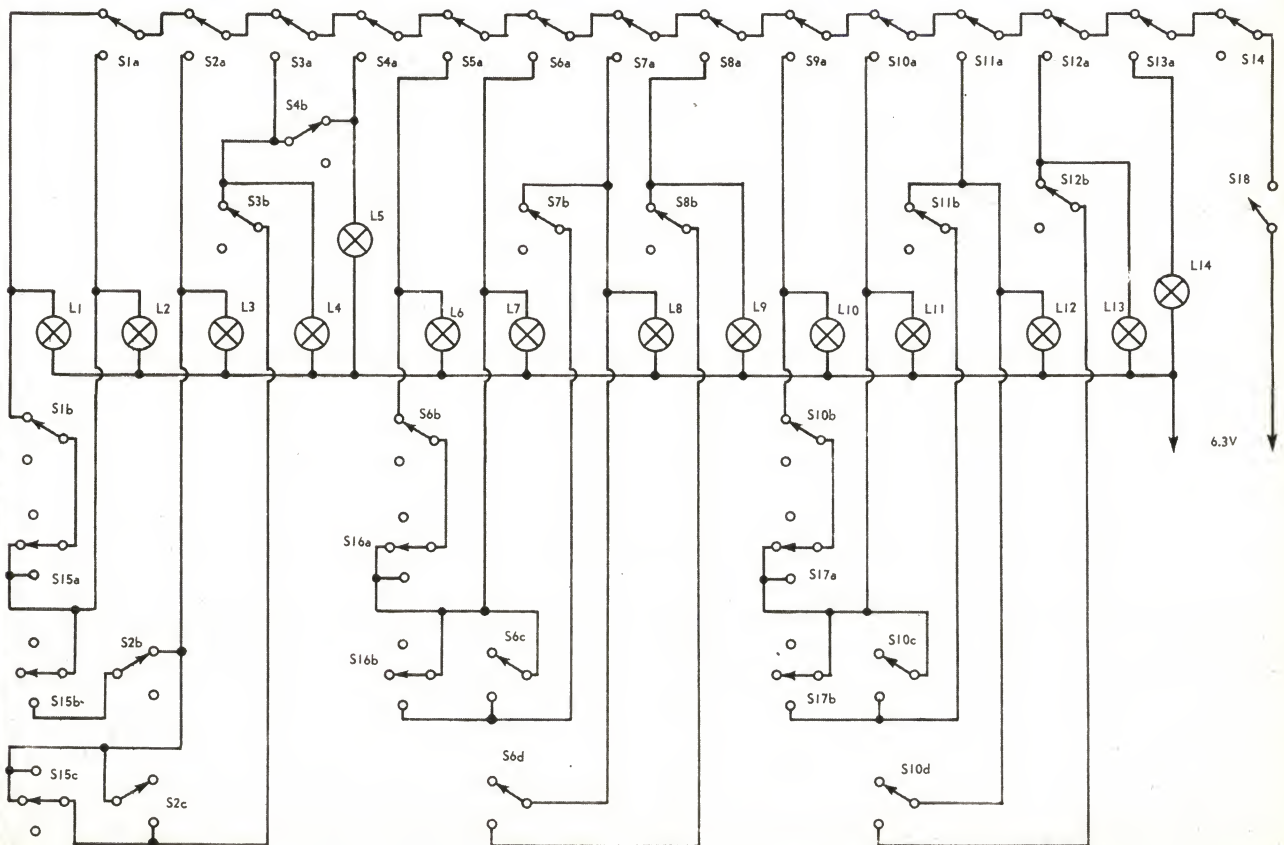

# MACRON

# ELECTRONICS PTY. LTD.

RECOMMENDS



## SPEAKER ENCLOSURES



## SPEAKERS

### 2-WAY AIR-SUSPENSION SYSTEMS

MODEL No.	IMPEDANCE [ $\Omega$ ]	FREQ. RANGE [c/s]	INPUT [W]	SPEAKERS [mm]	DIMENSIONS [mm]
<b>FCS-104</b>	8	95~20,000	8	100(W), 85(T)	250H×158W×173D
<b>FCS-200</b>	8	60~20,000	40	200(W), 50(T)	530H×294W×240D
<b>FCS-207</b>	8	45~20,000	30	200(W), 50(T)	540H×295W×220D
<b>FCS-208</b>	8	70~20,000	30	200(W), 50(T)	480H×280W×200D
<b>FCS-250</b>	8	50~20,000	30	250(W), 80(T)	597H×321W×300D

### COMPACT SPEAKER SYSTEMS

MODEL No.	IMPEDANCE [ $\Omega$ ]	FREQ. RANGE [c/s]	INPUT [W]	SPEAKER [mm]	DIMENSIONS [mm]
<b>BF-103S</b>	8	110~18,000	8	100(FULL-RANG)	320H×200W×174D
<b>BF-163S</b>	8	60~16,000	10	160(FULL-RANG)	384H×240W×174D
<b>BF-203S</b>	8	45~16,000	15	200(FULL-RANG)	477H×298W×254D

### FULL-RANGE SPEAKERS

DIAMETER [mm] [in.]	MODEL No.	V.C. IMP. [ $\Omega$ ]	RESONANT FREQ.( $f_0$ ) [c/s]	FREQ. RANGE [c/s]	SENSITIVITY [dB]	MAX. INPUT [W]
100 4	<b>FE-103</b>	8/16	65~95	$f_0$ ~18,000	96	10
160 6½	<b>FE-163</b>	8/16	40~60	$f_0$ ~20,000	98	10
200 8	<b>FE-203</b>	8/16	35~55	$f_0$ ~16,000	100	15
200 8	<b>FE-201</b>	8/16	60~90	$f_0$ ~16,000	100	8

### WOOFERS

DIAMETER [mm] [in.]	MODEL No.	V.C. IMP. [ $\Omega$ ]	RESONANT FREQ.( $f_0$ ) [c/s]	FREQ. RANGE [c/s]	SENSITIVITY [dB]	MAX. INPUT [W]
160 6½	<b>FW-162</b>	8/16	40~60	$f_0$ ~3,000	95*	30
200 8	<b>FW-202</b>	8/16	25~35	$f_0$ ~2,000	97	45

W.A. D. K. Northover,  
1 Dunvegan Road,  
Applecross, 6153.  
TAS.: Nichols Radio,  
91 Wellington Street,  
Launceston, 7250.

N.S.W.: Jacoby Mitchell,  
469-475 Kent Street,  
Sydney, 2000.  
VIC.: Macron Electronics,  
70 Batesford Road,  
Chadstone, 3148.

S.A.: Nell Muller,  
8 Arthur Street,  
Unley, 5061.  
QLD.: T. H. Martin,  
56 Edward Street,  
Brisbane, 4000.

Homecrafts T.A.S.  
Astor House,  
199 Collins Street,  
Hobart, Tas., 7000.

## A READER BUILT IT . . . continued

### Improved Burglar Alarm

Those readers interested in burglar alarms may care to add this circuit suggestion to their files. It is aimed at getting the ultimate life from the system's batteries.

In the October, 1969, edition of "Electronics Australia" (page 99) there was featured a transistorised burglar alarm. In this the writer states that the current drain of the system is about 1.5mA and that the service life of the batteries should be almost as long as the shelf life. Having little else to do at the time I immediately proceeded to carry this idea to its logical conclusion, i.e., no current drain until operated.

Reference to the original circuit shows that the 1.5mA was flowing through the 5.6K biasing resistor and while increasing the value of this would give some improvement, it is a compromise at best. For this reason I replaced the passive biasing network with an active one, as shown.

With this configuration the non-operate current is the Icbo (collector current when emitter current is zero) of T1, normally 10-20uA. Operation of the circuit depends on the Icco (collector current when base current is zero) which flows when the base circuit is opened by any of the door or window contacts. This provides forward bias for T2, in place of the forward bias provided by the 5.6K resistor in the original circuit.

Note that only a germanium type transistor can be used for T1, as the

bias current required to turn on T2 will normally be higher than that which can be provided by a silicon type.

Using this circuit, the batteries should now have a service life which

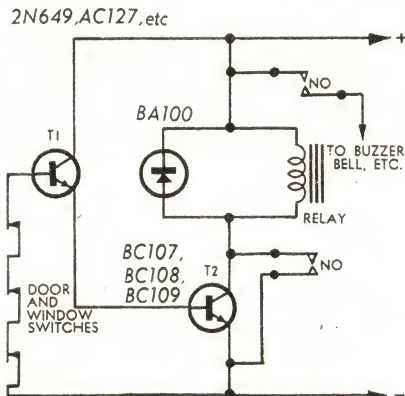

really is equal to the shelf life. Admittedly, the improvement may be somewhat academic, and the circuit was originally designed more as an exercise than anything else. However, the basic idea may appeal to some readers. (Submitted by: B. J. Robertson, 23 Stanley Terrace, Christies Beach, S.A. 5165.)

### Faster Etching Hint

Readers who make their own printed wiring boards may like to try this simple idea to speed up the etching process.

I have found that when etching a printed circuit board it takes a long time and a lot of ferric chloride to etch away a small amount of copper.

By soldering a wire to the copper on the board and connecting the other end of the wire to a carbon rod, immersed in the bath, a cell is formed. The carbon can be salvaged from an old battery. The wire connecting to the copper board will need to be painted with resist to prevent it from being etched along with the copper pattern.

This will speed up the etching process without the need to use more etchant. (Submitted by: G.H., Bendigo, Vic. 3550)

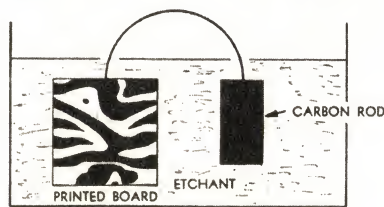

### OLD COMPONENTS

Like most other hobbyists with more enthusiasm than money, I have collected a lot of old wiring parts — particularly resistors and capacitors. Recently I managed to borrow an LRC bridge and found to my dismay that many of the old paper capacitors and even a few of the mica capacitors were leaky and off value. A lot of the resistors had gone high.

The bad ones I threw out but I marked the poor ones with a spot of lacquer with the idea of using them where they would still do. Checking old parts is not only likely to save trouble but it is a good technical exercise. (C.D., Orange, N.S.W.)

(Editor's Footnote: "Reader Built It" projects are published for the general interest of experimenters and as a source of ideas. Based on readers' contributions, they have not been tested in our laboratory and we cannot accept responsibility for them.)

# LAFAYETTE

OF U.S.A.

1970 CATALOGUE NO. 700  
JUST OFF THE PRESS!

SEND FOR YOUR COPY NOW!



Latest Releases!  
Best Bargains!  
**496**  
Pages

GUIDE TO  
EVERYTHING  
IN ELECTRONICS

- ★ AMATEUR RADIO
- ★ TEST INSTRUMENTS
- ★ STEREO/HI-FI EQUIPMENT
- ★ 27MHz 2-WAY RADIO
- ★ COMPONENTS

**THOUSANDS OF INTERESTING ITEMS.** The 1970 catalogue of Lafayette Radio Electronics Corporation of U.S.A. details 1,000s of items of interest to the amateur, technician, hi-fi enthusiast, experimenter, hobbyist, engineer, student, serviceman . . . fully illustrated. Many items are available from Australian stocks—list included—others are available for shipment from the U.S.A. Many exclusive LAFAYETTE lines, not available elsewhere, are featured.

The small charge for the catalogue is to cover import duty, postage, etc., and will be refunded on receipt of an order for \$25 or more.

Mail Coupon below or write.

**LAFAYETTE ELECTRONICS,**  
Division of Electron Tube  
Distributors Pty. Ltd.,  
94 HIGH STREET,  
ST. KILDA, VIC., 3182.

Please send me Catalogue 700. I enclose Chq./P.O. for \$2.50, which is refundable with my first order for \$25.

NAME: .....

ADDRESS: .....

..... State ..... P./Code .....

**MA75**  
Top of the BSR range. Features 11" die-cast turntable and clip-in cartridge holder.



**MA70**  
Favourite of sound enthusiasts all over the world.



**MA65**  
Engineered to the same high standards as the others and incorporating many of their features.



**MA55**  
The BSR MA55 provides an economical unit packed with BSR features.



## 4 GREAT BSR TURNTABLE UNITS

MODEL	TURNTABLE 11" dia.		MOTOR		POWER SUPPLY	PICK-UP ARM							STUB SUPPLIED	SWITCH 'POP' FILTER	RECORD CAPACITY	TURNTABLE SPEED	CARRIDGES
	Pressed	Cast	2 Pole	4 Pole	240V 50 cycle	Dual Voltage	Low Mass Tubular aluminium	Counterbalanced	Cue/ Pause Lever	Automatic lock	Bias compensator	Stylus pressure Adjuster					
MA75		•		•	•	•	•	•	•	•	•	•	•	•	•	•	Any Standard mono or stereo cartridge can be fitted.  Up to eight 7", 10" or 12" diameter records with manual selection of record size.
MA70	•			•	•	•	•	•	•	•	•	•	•	•	•	•	
MA65	•		•		•	•	•	•	•	•	•	•	•	•	•	•	
MA55	•		•		•	•	•	•	•	•	•	•	•	•	•	•	



**BSR (A'Asia) Pty. Ltd.**

Monarch Works Industrial Estate.  
St. Marys N.S.W.  
Phone: 623-0375



**WHOLESALE DISTRIBUTORS**

Goldring Engineering (A'Asia) Pty. Ltd.,  
N.S.W.: 443 Kent St., Sydney, 2000. 29-1275  
VIC.: 162 Pelham St., Carlton, Vic. 3053. 67-1197  
QLD.: 415 Adelaide St., Brisbane, Qld. 4000. 2-3247  
W.A.: 32 Northwood St., Perth, W.A. 6007. 8-4988  
S.A.: 77 Wright St., Adelaide, 5000. 51-5117

BSR-P106



Model 500 with ceramic cartridge . . . \$103  
 Model 500 with 800H Magnetic cartridge . . . \$114  
 - Model 600 with CI/ST4 cartridge . . . \$114  
 Model 600 with 800H Magnetic cartridge . . . \$125

# The only triple tested total turntables. BSR McDonald.

Every BSR McDonald automatic turntable is precision made and tested in Great Britain to the most exacting specification. Upon arrival in Australia, every model is unpacked, tested and assembled in the total turntable concept, then re-tested again under actual playing conditions. That's why BSR service calls are the lowest in the

industry – and perhaps that also explains why BSR sells more turntables than anyone else in the world.

The BSR McDonald 500 and 600 are complete modular units ready for use. Each unit has an ebony polystyrene base, smoke tinted dust cover, mains and audio leads – the only complete, packaged, factory tested units.

## Features such as

- Dynamic anti-skate control applies continuously corrected compensation at all groove diameters.
- Cueing and pause control lever allows for exact positioning of stylus on record and permits you to interrupt listening and reposition to same groove.
- Micrometer stylus pressure adjustment permits 1/3 gram settings from 0 to 6 grams.
- Automatic lock on tone arm after last record is played.
- Dynamically balanced 4-pole

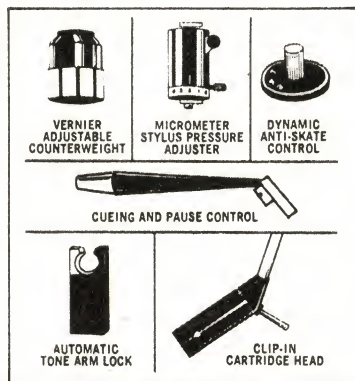

induction motor has high torque, constant speed design – assuring minimum rumble and wow.

- Tubular aluminium tone arm is perfectly counter-balanced both horizontally and vertically.
- Resiliently mounted, coarse and fine vernier adjustable counterweight.
- Tone arm is jam-proof even if it is held during the cycling operation.
- Clip-in cartridge holder, provides universal mounting and quick change. (Optional).



BSR A'Asia Pty Ltd  
 Southern Section Industrial Estate  
 St Marys New South Wales  
 Telephones 6230375 and 6230376

Wholesale Distributors Goldring Engineering (A'Asia) Pty Ltd New South Wales 443 Kent Street Sydney 2000 Telephone 29-5802/3/4 Victoria 162 Pelham Street Carlton 3053 Telephone 34-5105 Queensland 415 Adelaide Street Brisbane 4000 Telephone 2-3247 Western Australia 32 Northwood Street Leederville 6007 Telephone 84-988 South Australia 77 Wright Street Adelaide 5000 Telephone 51-5117 BSR:P 104



# the magnificent world

## Model X-360



**Model X-360**

**PROFESSIONAL STEREO TAPE RECORDER—X-360**  
 \*4 heads, 3 motors \*4 track stereo/monaural recording and playback \*4 tape speeds (1½, 3½, 7½ and 15 ips) \*3 speeds main motor \*CROSS-FIELD HEAD \*50 watt solid state amplifier \*Automatic volume control (Comput-O-matic) \*Automatic continuous reverse (Reverse-O-matic) \*Automatic dust minder \*Magnetic brake for motors \*Matching speaker: SW-160 (.4 way, 60 watt input).



**Model X-330**

**10½" REEL MULTI-PURPOSE STEREO TAPE RECORDER—X-330**  
 \*Program minder (Automatic continuous reverse) \*Sensing tape continuous reverse \*Manual reverse \*CROSS-FIELD HEAD \*3 speed motor for capstan drive \*Magnetic brake \*Enabling to use 10½" reel \*4-track stereo/monaural recording and playback \*3 speeds, 4 heads \*40W all silicon transistorized amplifier \*24 hours continuous Hi-Fi stereo playback capacity at 1½ ips (7,200 feet tape) \*12 hours continuous Hi-Fi stereo recording capacity (total 24 hours) at 1½ ips (7,200 feet tape) \*Matching speaker: SW-150 (3 way, 40 watt input)

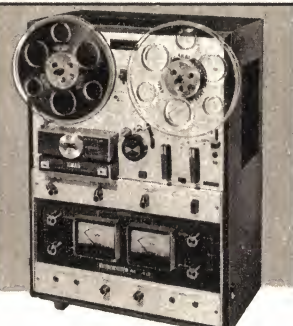

**Model M-10**

**THREE MOTORS AUTO. REVERSE TAPE RECORDER—M-10**  
 \*CROSS-FIELD HEAD \*3 motors \*Sensing tape continuous reverse (Auto. reverse) \*Manual reverse \*3 speeds, 3 heads \*3 speed capstan drive motor \*Automatic stop/shut off \*Automatic pinch wheel release \*Automatic lever release \*4 track stereo/monaural recording and playback \*40W music power solid state amplifier with two integrated circuits \*Fine vinyl leather or wooden cabinet \*Matching speaker, SW-125 (3 way, 30 watt input).

Prove it by the sound!  
 ..... prove it with

# AKAI®

AKAI AUSTRALIA PTY. LTD.: 276 Castle-  
 reagh St., Sydney, N.S.W./146 Burwood  
 Rd., Hawthorn, VICTORIA/399 Montague  
 Rd., West End, Brisbane, QUEENSLAND/8  
 Arthur St., Unley, S.A./579 Murray St.,  
 Perth, W.A. **HOME CRAFTS:** Petrie St.,  
 Canberra, A.C.T. **J.B. YOUNG:** Giles St.,  
 Kingston, A.C.T.

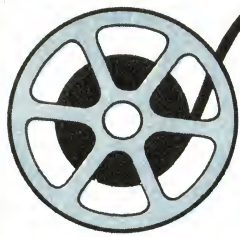

# AUDIO TOPICS



## SQUEECH — HOW TO GET MORE WORDS INTO LESS TIME

Squeech means "squeezed speech" — and the word is formed by dropping out a few letters of the original expression and then joining up the rest. In a way, this is something like the manner in which the effect is created, as the following explanation will show.

By Jorma Hyppia

The ability to speak fast, yet accurately and with clarity, is a skill which few people possess. Some people carefully cultivate this skill, such as news readers and radio commentators, but the average person who does not have such incentives as the forenamed seldom acquires the skill. Yet in many spheres of professional and commercial activity, such a skill would be a decided asset. Basically, this would mean the ability to impart more information within a given time.

Most people are never likely to acquire the ability to speak rapidly yet intelligibly, so a speech recording device which allows playback with adjustable speed, yet without affecting pitch of the original voice, looks very interesting. When this device also has the ability to slow down speech as well while retaining the original pitch, it looks doubly interesting.

As any tape recorder user knows, it is a simple matter to speed up recorded sound—you simply play it back at a higher speed than that at which it was recorded. But this speedup is achieved only with the sacrifice of intelligibility; with every doubling of playback speed, the pitch of the sound is raised a full octave. Unfortunately, this can make the deep voice of a basso profundo sound like the chattering of a cartoon chipmunk.

The problem, then, is to increase the playback speed without changing the pitch. One way to do this is by programming a computer to scan pre-recorded speech material and compress it. This method is now used only in compressed speech research because of the high cost; the tedious programming that is required costs about \$900 per minute.

At present, the more practical means

of compressing speech is by utilising a mechanic-electronic device called a Rate Changer. Such equipment is already on the market. It costs several thousands of dollars, but it's a far cheaper solution because it can quickly compress pre-recorded tapes without the elaborate programming required for computers.

The first rate changer—called an acoustical pitch and tempo regulator—was invented by a German scientist, the late Anton Springer, in the early 1950s. His original TeleNorm equipment was later improved and is now manufactured by Eltro Automation of Heidelberg, West Germany.

The secret of the Eltro Rate Changer lies in a unique application of a fairly common recording component, a rotating playback head. An ordinary tape recorder has a stationary head with a single sensing gap. If a pre-recorded tape moves across this fixed head at varying speed, pitch changes will occur. But if a multi-gap rotating head is substituted for the fixed head, the tape can be speeded up (or slowed down). Constant tape-to-head-velocity is maintained by rotating the head in the proper direction at the proper speed. So long as the tape-to-head velocity remains constant, pitch stays unchanged.

Figure 1 shows the ingenious mechanism used to maintain this constant

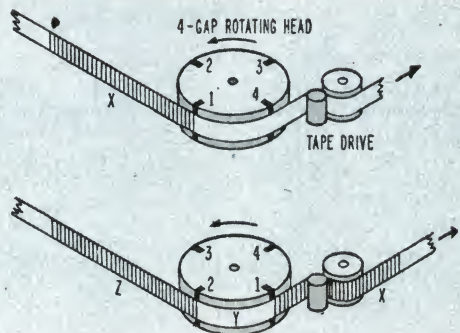
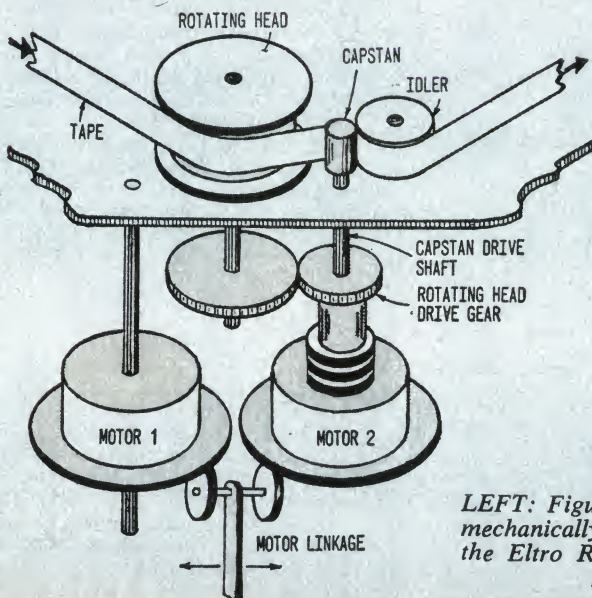

Figure 2. The rotating head of the Rate Changer. The way in which this arrangement leaves out segments of the tape when scanning, to produce compression, is explained in the text

LEFT: Figure 1. This diagram shows the arrangement of two mechanically linked motors and rotating tape head which allow the Eltro Rate Changer to increase or reduce tape playback speed while maintaining constant pitch.

# LEADER TEST INSTRUMENTS



## LSG-11 is still the most efficient, budget-priced signal generator....that's why it's the most popular!

The LEADER LSG-11 is a general purpose signal generator having features which make it most useful in testing, checking and experimenting with radio and audio frequency circuits. Calibration accuracy is  $\pm 1\%$  below 30Mc. This feature permits easy alignment and checking of tuned circuits, IF amplifiers, etc. Wide frequency range: 120Kc to 390Mc. Stable Colpitts oscillator with buffer stage. Two audio modulation frequencies. Provision for quartz crystal. Clear scales for frequency calibration. Compact and rugged construction. Attractive heavy steel cabinet.

### Specifications:

Frequency range:	120Kc - 130Mc on fundamentals
Calibrated Harmonics:	120 - 390Mc
R.F. Output:	0 - 100,000 $\mu$ V, adjustable (120Kc - 38Mc)
Modulation Frequencies:	400 and 1,000cps, A.F. Output adjustable
Crystal Oscillator:	1 Mc to 15 Mc
Tube Complement:	1-12BH7 1-6AR5
Accessory:	1-75 ohm Cable
Power Supply:	AC 50/60 cps: 100V, 115V or 230V as specified: 13VA approx.
Size and Weight:	27.5 x 19 x 11.5 cm; 2.75 kg (10 $\frac{3}{4}$ " x 7 $\frac{1}{2}$ " x 4 $\frac{1}{2}$ " (6.1 lbs.))

Sole Australian Representatives:

**ASTRONICS AUSTRALASIA PTY. LTD.**  
(ALL STATES)

AVAILABLE FROM ALL GOOD RADIO TRADE HOUSES.

speed ratio between the tape and the head. The velocity of the capstan that drives the tape and that of the rotating head are held in exact synchronisation by means of an electric field lock achieved by using two mechanically linked AC motors.

Motor 1 has a fixed speed of 900-rpm angular velocity, which is equivalent to 15ips linear velocity, the normal tape speed. This motor is coupled to Motor 2 by means of a sliding clutch-like linkage consisting of two rubber-tyred wheels engaging discs attached to the rotors of the motors.

Motor 2 is of synchronous type having four-pole construction and a speed of 900rpm. An important design aspect is the freedom of the field or stator section of the motor to rotate around the rotor. This field section is coupled to the rotating head by means of two gears.

When the linkage is set at its 100 per cent position, Motor 1 drives the rotor of Motor 2 at a speed of 900rpm; the rotor shaft in turn drives the capstan at the same speed. Since 900rpm is the normal synchronous velocity of Motor 2, its field section remains stationary during the 100 per cent setting.

Now, if the control knob is moved to shift the linkage so as to increase the rotor speed of Motor 2, the field section of Motor 2 will move just enough to compensate for the speed-up and maintain a rotor-to-field synchronisation of 900rpm. In so doing, the field section moves the gears, thus transmitting the same compensating movement to the rotating playback head.

The speed of Motor 2 can be varied continuously from 450rpm to a maximum of nearly 1800rpm; this means that the tape transport speed is variable from about half to double the normal speed of 15ips. In other words, there's a range extending from 7 $\frac{1}{2}$ ips to 30ips tape speed.

No matter what the actual tape speed may be within this range, the electrical field lock maintains a constant 15ips velocity between the tape and playback head. As a result, the pitch of the recorded sound remains unaffected by tape speed changes.

The foregoing discussion explains how constant pitch is maintained. But this does not yet explain why compression and expansion take place.

Let us take compression first. The principle used is a well known one, in which small segments of information are left out during a re-recording process. This is how it is done.

The tape to be treated is loaded on to the normal recorder, but instead of being fed to the head and feed mechanism of the recorder, it is fed to the Rate Changer, where it is sensed by the rotating head. Figure 2 shows how the segments of information are omitted.

The top diagram shows the starting position as the tape begins to move from left to right, with the head rotating in the same direction (counter-clockwise). Gap 1 is just coming into position to sense the shaded section of tape marked X. By the time the head has rotated a quarter turn, section X has been sensed and has moved to the position shown in the lower drawing.

Just as gap 1 moves away from the tape and becomes temporarily ineffective, gap 2 begins to sense the next shaded section marked Z. Note



that an intermediate section, Y, cannot be sensed by either gap. Gap 1 is moving away from the tape, and gap 2 cannot catch up with section Y. Two important consequences result: (1) the sound information on section Y is eliminated, and (2) the playing time represented by section Y is also eliminated (this occurs because the instant that the last sound on section X has been sensed, re-recording of section Z begins).

What has happened is that a small amount of time compression has been achieved by sacrificing a small amount of recorded information. This process is repeated again and again throughout the length of the tape; the accumulated small time compressions, interspersed throughout the tape, add up to a large overall reduction in the total playback time.

Does this chopping out of bits of sound information create distortions in

Speech compression now appears to be of primary interest in terms of potential applications. However, speech expansion also has uses. In this case the playing time is lengthened without introducing pitch changes.

The Eltro does this with equal ease when the control knob is properly adjusted. Basically, expansion is created in much the same way as is compression except that the tape velocity is made slower than the relative playback velocity, hence the head gaps tend to catch up with tape segments already scanned once. Instead of eliminating information bits, the head now replays bits periodically.

Frequency of these replays depends on the way the instrument is adjusted. The highest, limiting expansion of 200% is achieved when each bit (13.35mm segment) is reproduced twice before the head goes on to the next bit. This condition yields a tape that re-

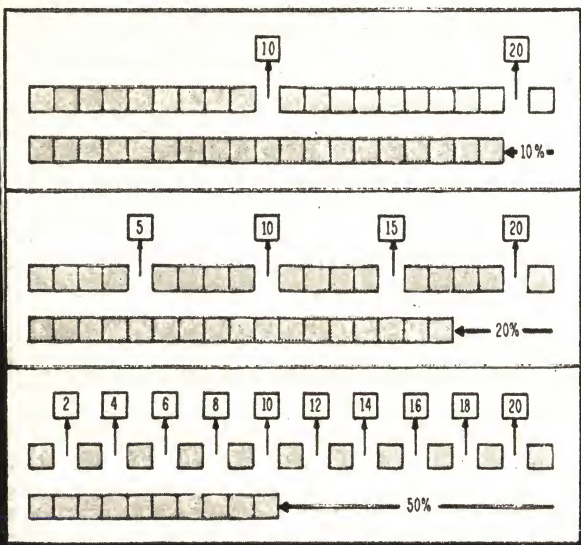

*A better idea of the operation of the Rate Changer may be gained by studying these three diagrams. In each diagram, a section of tape is shown divided into 21 segments. Deleting sections 10 and 20 (top) results in 10 per cent compression; deleting sections 5, 10, 15 and 20 (centre) results in 20 per cent compression . . . and so on.*

the compressed sound? None that you can perceive with the ear. Reason is that each deleted segment is kept shorter than 35 milliseconds, and this is threshold sound duration that the human ear is just able to perceive. This perception phenomenon is known as the Haas Effect.

The diagrams in figure 3 show 10%, 20%, and 50% degrees of compression. The middle row in each section of the diagram represents a length of tape divided into 21 blocks; each block represents a tape segment that is 13.35 millimetres in length. At a 15ips tape speed, this length of tape represents 64.68 milliseconds of playing time, a period slightly shorter than threshold perceptual time of 35 milliseconds. This length is automatically measured out by the playback equipment because it is equal to the gap-to-gap distance of the rotating head.

If the Eltro Changer's control knob is adjusted so that there is a 10% increase of the tape velocity (about 16.5ips), every tenth bit of sound information on the tape is eliminated. This results in a time compression of 10%. If the tape speed is increased by 20% (to about 18ips), every fifth bit is removed to achieve a 20% time compression. Finally if the tape speed is doubled to 30ips, every second bit is removed, and the total playing time is chopped in half.

quires twice as much playback time as the original recording. To obtain lesser degrees of expansion, the system is adjusted so that fewer information bits are reproduced twice.

Business and industry may find uses for squeech—for management training purposes, for indoctrination of salesmen, for review of board meetings or sales meetings, for scanning client conferences. And consider the harassed secretary or typist who must cope with the dictation of a fast-talking boss. If the employer's dictation is slowed down, the typist is likely to make fewer mistakes when transcribing the material. On the other hand, speeded up recordings might be just the thing for testing the proficiencies of secretarial applicants.

There are many other potential applications for squeech. One more might be mentioned, if only because it is so unusual. Squeech may solve a particularly vexing problem in deep sea exploration. (See "Electronics Australia," December, 1969, page 29.) The addition of helium to the breathing atmosphere of divers hampers telephone communications because the gas causes a pitch increase in the voices of the divers. This pitch increase greatly reduces intelligibility. However, a Rate Changer could be used to restore such off-pitch speech to normalcy without in any way deteriorating the sound quality. (By arrangement with "Radio-TV Experimenter.")

# JBL



## THE JBL SA660 SOLID STATE AMPLIFIER

The exclusive JBL T-Circuit (Pat. Pending) maintains precise control over the associated loudspeaker systems all the way down to zero cycles.

60 watts continuous RMS power per channel with less than 0.2 per cent harmonic distortion at any frequency from 20 to 20,000 cps, both channels operating. IM distortion less than 0.2 per cent at 120 watts or any power level. Noise 85db below rated output from high level inputs, 72db from low level inputs.

Like all JBL Electronic products, the SA660 is designed and manufactured by JBL personnel in JBL's own electronic facilities.

37 silicon transistors plus 23 silicon diodes used throughout, short circuit proof, open circuit proof, overload proof, 5 1/16in x 6 13/16in x 13 1/2in.



## JBL LANCER 77

A highly sophisticated system, in which virtually all of the speaker panel is utilised as direct radiating area. It combines the LE10A low frequency driver with the PR10 passive radiator, which crosses over at 2500 cps through the L X 4-2 dividing network to a high-frequency direct radiator. The combination gives a seamless purity of overall sound. 14in x 23 1/2in x 11 1/2in. deep.

**ALDERSONS CAMERA &  
HI-FI CENTRE**  
NEWTON BUILDING,  
THE KINGSWAY,  
CARINGBAH  
TELEPHONE 524-9023

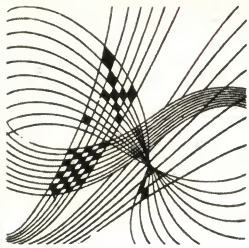

## CLASSICAL RECORDINGS

Reviewed by Julian Russell

**AVANT GARDE**—Compositions by Koueg, Pongracz, Riehn, Zimmermann, Cage, Schnebel, Gruppo Nuova Consonanza, Kagel and Stockhausen. Set of six discs. Deutsche Grammophon Stereo 643/541-6.

All but dedicated admirers of often way-out contemporary music will find little to interest them in the first three reviews this month. But I feel that this is no reason why they should not be included, though I do not intend to act as a missionary for the school just for the sake of being thought "in the groove." I find some of it impressive, an occasional piece moving, and others totally incomprehensible. But the six discs might also provide the merely curious with some idea of what some contemporary composers are doing, if not a very clear picture of where they are going.

Because Stockhausen is the best known of the composers contributing to this DG set, I shall start with his disc which offers on one side "Mixture" for orchestra, sine-wave generators and ring modulators (version for small orchestra), and on the reverse "Telemusic." The "tele" in "Telemusic" means far distant, not music for television. In it you will hear clicks, bangs, flutters, whistling glissandi, timpani and other notes, notably some clear bell tones, all produced in the Studio for Electronics Music, NHK, Tokyo, Japan. Some of it sounds genuinely Asian and calls up memories at times of the old Parlophone 78 set of Eastern Music. There is one curious sequence that sounds like a gutter overflowing in the rain. And there are frequent repetitions of a sustained note.

There are also some enchanting effects like fairy tambourines, and some notes so high that they are barely on the threshold of audibility. There is even a noise that sounds like a steam locomotive and, in another section, curious disembodied voices. Again you occasionally hear what sounds like the static and distortion in a badly received radio program, but the superb quality of the recording makes it obvious that this is the effect Stockhausen intended and not the result of bad engineering. Many of the electronically produced sounds are now pretty familiar to students of this school, but they are indubitably put together by a master craftsman. I feel that I might even grow to like it.

"Mixture" starts like Honegger's "Pacific 231," a famous echoic piece of the 1920s. There are also sounds produced by standard musical instru-

ments, their timbres in many cases changed by the use of electronic filters. It all sounds to me — though I must stress that mine is an untutored opinion — very like the "musique concrete" of the past decade. I cannot say that I was moved by either work, but I was certainly disturbed enough to encourage their repetition.

"Improvisations" by the Gruppo Nuova Consonanza can perhaps best be described by a quotation from the sleeve annotations. "To unite composition and interpretation, which have hitherto always been separate functions in traditional European musical practice, in a simultaneous creative act, is the declared aim . . . of the group. The musicians alternate between various instruments in diverse formations . . . A lively mind and personal modesty in all those taking part are absolutely vital if a group of composers are to work together successfully."

The "improvisations" are controlled by rehearsals of spontaneously produced sounds which are taped and afterward altered either directly or by the addition of new sounds. The notes go on to state that "all the pieces . . . are authentic 'life' improvisations which have not been edited." They originated in the Experimental Electronic Studio, Rome. The first piece is titled "E poi?" which translated means "And then?" or "After that?" and is, I think, used as a quotation from the concluding bars of Iago's "Credo" in Verdi's "Otello." The music consists for the most part of single notes delivered by different instruments, or alternatively, very brief phrases. The result often resembles the fragmentation of the Post-Webern school.

Another piece is called "Quasiraga" and is reminiscent of sitars played at impossible speed with stenographic clicking taking the place of the accompanying tabla. Indeed, it has a genuine raga effect in long, slowly increasing climaxes.

A third piece, "Light Music," according to the sleeve notes, receives its stimulus from jazz, though I found this difficult to detect.

"Ancora un Trio" consists of a very strange series of short notes produced by a trumpet, some of them sounding for all the world like hiccups. There is an occasional longer phrase not unlike something from Stravinsky's "sacre du Printemps."

A "Credo" begins with a sound like a large jet plane passing overhead and goes on to low growls.

There are interjections by male speaking voices with here and there a phrase that sounds like Italian double talk. There is even a fragment of a march as it might be played by a village band. I can only say that there was nothing I either liked or admired in the whole recital, if it can be called that.

I found nothing to attract me in Kagel's "Hallelujah," either. And I found no enlightenment in the annotations which state that "Kagel's compositorial (sic) techniques are often secretly based on Jewish theology: musical analysis can occasionally trace analogies to, for instance, the 49 stages of meaning in the explanation of every place in the Torah as taught by talmudic tradition." It is a choral piece which opens with some rhythmic figures reminiscent of Stravinsky's "Les Noces" but soon introduces some cat-like miaowing and descending glissandi like expiring old men. A solo voice now and again uses the "speech-song" technique exploited by Schonberg in his "Pierrot Lunaire" but I found the whole exercise extremely depressing.

American John Cage is represented on one disc by his "Atlas Eclipticalis" for one to 98 orchestral players (86 possible parts) and his "Winter Music" for one to 20 pianists. To refer to the sleeve notes again "the parts of Atlas Eclipticalis are transcriptions of stellar constellations made legible in the form of notes. There is no score and thus no regulated combination of instruments: what is apparently intended is the cosmos as a model of anarchy. . . . The conductor accordingly has no commanding function but merely indicates the passing time. The musicians are to read the circular movements of his arms as rotating second-hands."

"Winter Music" consists of 20 pages which can be played by one pianist or distributed between two and 20. In the recording, five pianists play different pages simultaneously. I find it quite impossible to take such a travesty of music seriously. On the same disc, Schnebel's "Glossolalia" (the medical term for the scriptural "speaking in tongues") has several voices speaking and muttering in German, their inflections rising and falling in pitch, sometimes in solo, sometimes together. There are a few shrieks, and groans, too, and it might be interesting if delivered in an English translation. I did catch one English phrase which goes: "After this cue beginning 20 seconds madly." This piece, too, offers nothing which, to me, can be described as music.

Bernd Zimmermann is given a disc to himself on which one work is a "ballet blanc" called "Presence" and the other "Intercommunication." The first is a trio for the classical combination of violin, cello and piano. The second a duo for cello and piano. The ballet has a plot which brings together the unlikely combination of Cervantes' "Don Quixote," Joyce's "Molly Bloom," and someone called "Roi Ubu," conceived by Alfred Jarry. Each character is represented by one of the three instruments and quotations from Strauss' "Don Quixote," Prokofiev's 7th Piano Sonata and Stockhausen's "Zeitmesse" are easily recognised by those who know the works. Between these stable points the music is, in comparison to most of the other pieces in the set,

played by instruments whose tone can be immediately recognised. And much of it is what might be described as valid music, though of course, atonal and polyrhythmic. The quotations supply what might be called wayside stations in a journey into the unknown.

I found "Intercommunication" one of the most fascinating pieces in the whole set. Although the solo cello produces some unusual sounds in the way of timbres, I found myself not only interested but to some degree in sympathy with the strangely static mood of the whole piece. This, I am quite certain, I could grow to like.

The sixth and last disc — at present they cannot be bought separately but will be available in that form later this year — features more electronic music by Gottfried Konig which slides up and down, flutters and often sounds like an uncoiled chaff-cutter. The first item is called "Terminus"; the second, "Green Function," is much the same, with the addition of a sound like a toneless alarm clock going off.

"Phonothese" is a little more musical and often has an attractive fragility. "Chants de Malador" has long periods of silence and almost inaudible sounds interrupted by great explosions of noise. One extraordinary effect sounds as though it was produced by a hail storm of steel ballbearings.

Well, there they are. And the listening to and writing about them has been one of the most onerous chores I have undertaken for a long time. But one compensation was the magnificent quality and engineering of the whole set.

★ ★ ★

MESSIAEN—Cinq Rechants,

XENAKIS—Nuits.

PENDERECKI—Stabat Mater.

Soloists of the French Radio and Television Choirs conducted by Marcel Couraud. Record Society Stereo S/6323.

Admirers of Messiaen — and I add here that I am one, to indicate that I am not opposed to the whole of the avant garde movement—should have no difficulty with his contribution to this disc. It is written for 12 solo vocalists who sing some vague French phrases about Tristan and Isolde and other famous lovers interspersed with a strange language invented by Messiaen himself. Since the melodic line often has a strong Asian flavour, these weird words might be taken as imitating Hindu without the use of its actual vocabulary. But however odd this may read the result is indubitably musical and the third song in the cycle, a soprano vocalise over a hummed accompaniment, is as lovely as anything I have heard for many years. Messiaen wrote the sleeve notes, too, and these should go a long way to explaining to newcomers what the music is about and how it was conceived and constructed.

Xenakis, too, should need no introduction to anyone even interested in contemporary music. He has been much played in Australia during recent years and is fast growing in popularity among coterie audiences. His piece is dedicated to political prisoners in present-day Greece and evokes a nightmare picture of the terrors of a concentration camp, even to having yelping jackals prowling about outside. No praise

# NEW SANSUI 600 L

## Short wave Tuner Amplifier

at the lowest price in town

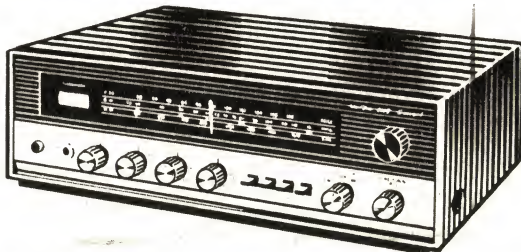

At last! A Short wave Tuner Amplifier unlike any multi band you've ever seen before. Here's a receiver of the finest quality at a price you would normally pay for the amplifier on its own.

- Four Short wave bands
- 60 watt I.H.F.
- Modern sliding controls
- Fine tuning
- 1.8 MHz to 26.5 MHz.

### ANOTHER NEW RELEASE

## SANSUI 300E STEREO TUNER-AMPLIFIER WITH SHORT WAVE SECTION

keenly priced  
below  
**\$250**

The Sansui 300 E is solid state 3 band AM/FM stereo tuner amplifier with short wave section. Unparalleled performance and dramatic styling.

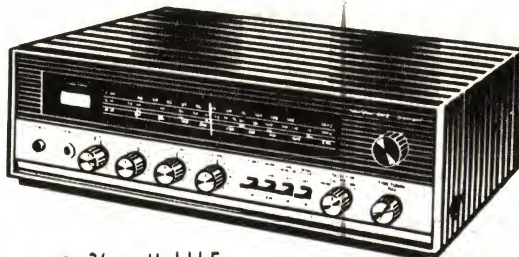

- 36 watt I.H.F.
- 25-30,000 Hz at ± 2db.

### JUST ARRIVED!

Revolutionary new  
Hi-Fi Head Phones  
by Telefunken

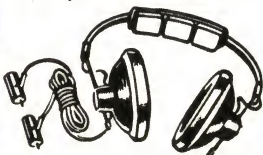

Now — the most comfortable fit ever with exclusive fluid buffered earpieces and head padding. Complete with continental type plugs and exclusive adaptor lead for your stereo outlet. 20-20,000Hz at .5 p.c. harmonic distortion. Come in and hear them for a new experience.

### THIS MONTH'S SPECIAL

CEC TURNTABLES  
Near Half Price

CEC. A bargain that comes once in a life time. Top quality semi-automatic turntable with high quality Magnetic Cartridge, self returning precision Tone arm. Reduced price — now \$70.

### Grille Cloth Galore

New patterns constantly being added, ask for a sample. Also B.A.F. Wadding for proper sound packing of your speaker enclosures.

● Laybys ● Terms available ● Mail orders supplied

**MASTERSOUND SALES PTY. LIMITED**  
400 KENT STREET,  
SYDNEY. 29-1527

AE02/102

BUY RIGHT... FROM ENCEL

# GRACE

Top Performance  
matched Tone arms  
and Stereo Cartridges

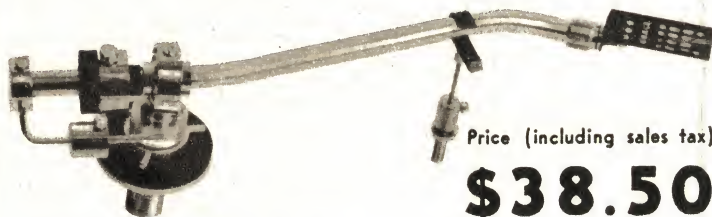

Price (including sales tax)

**\$38.50**

## TONE ARMS G545

This, the newest of the Grace tone arms, is fast becoming the most popular. Tracks down to 0.25 gm. Gimbale type gyroscopic bearing. Ultra light weight cartridge shell. Sub-weight adjustment sets stylus pressures from 0-3 gms.

Price (including sales tax) **\$38.50**

## TONE ARM G520L

Similar to G 545, but shorter (8.07" stylus to pivot), allowing for use with compact equipment, or where space is at a premium, but without sacrificing quality.

Price (including sales tax) **\$29.50**

## CARTRIDGES

Model F8C. Frequency response: 15-25,000 Hz-1dB, output 5mV. Stylus pressure: 1/2 to 1 1/2 gms. Cross talk: less than 30dB at 1 Hz. Tip mass 0.55 mgm. Stylus: Elliptical (0.2 x 0.8mm). Comment: Performance is quite outstanding.

Price (including sales tax) **\$49.50**

Model F8L. Output 5mV. Frequency response 20-20,000 Hz. ± 2dB Stylus: Elliptical diamond (0.2mm x 0.8mm). Cross talk less than-30dB at 1Hz. Stylus pressure: 1/2 to 2 1/2 gms. Total weight: 6.5 gms. Comment: A cartridge of truly professional standard.

Price (including sales tax) **\$39.50**

## Model F 8 M



Model F8M. Output 7mV. Frequency response 20-20,000 Hz ± 2dB Stylus: Elliptical diamond (0.2 mm x 0.8 mm). Cross talk less than - 30dB at 1Hz. Stylus pressure: 1/2 to 2 1/2 gms. Total weight: 6.5 gms. Comment: A cartridge of truly professional standard.

Price (including sales tax) **\$39.50**

could be too high for the manner in which the singers present this inordinately difficult music which takes emotional tension to what must be close to the point of ultimate tolerance. The whole is a wonderful technical accomplishment by composer and performers.

Since Penderecki later incorporated his "Stabat Mater" into his great "St. Luke's Passion," it will be well known already to the many admirers of that exciting oratorio. The "Stabat Mater" consists of six strophes expressing alternately pain and faith in a manner that cannot fail to make an immediate impact on any sympathetic listener. Some of the music is in Gregorian form, some modelled on the later polyphonic school, and some half-spoken. All of it is eloquent and the recording and performance faultless.

★ ★ ★

**LULLY — Pieces de Symphonie. English Chamber Orchestra conducted by Raymond Leppard. Record Society S/6322.**

Those who think of Lully only in terms of tinkling spinets will be surprised at what is on offer here. There are triumphal marches complete with trumpet trills on high notes, as brilliant as one could wish, though redolent at the same time of Louis XIV formality. There is an impressive Chaconne and some entrancing slumber pieces. Among the 18 pieces, most of them brief, you will recognise Lully as a greatly gifted melodist. He was also one of the founders of what has since developed into a modern symphony orchestra. His orchestration, though tending at times to be formal, sometimes surprises with a remarkably subtle effect. Rhythmic sprightliness is not neglected (Air for Dancing from Bellerophon) nor humor either (Entrance of Polyphemus from Acis and Galatea).

The English Chamber Orchestra is admirably conducted from a mostly inaudible harpsichord by Raymond Leppard, but except for this I have nothing but praise for the whole production. Eminently pleasing.

★ ★ ★

**WERDER — String Quartet No. 4; Music for Clarinet and String Quartet. Austral String Quartet. Donald Westlake (clarinet). EMI Stereo OASD7553.**

Felix Werder was one of our first Australian contemporary composers to win recognition not only in Australia but also overseas. Indeed the string quartet on this disc was dedicated to the Pascal and taken with them back to Europe where it received performances over the French radio. By the way, the Pascal cut the work for their performances. The version offered here is one abridged by the composer in 1963. The work in its original form was finished in May, 1955.

Werder is not as way out as some of his slightly younger Australian contemporaries and I have long thought him to be a romantic at heart. However, he has managed to rid himself almost completely of romantic tendencies—not at all a fault in my mind. His music, even as early as the quartet, is characterised by the unbending logic of a Max Reger and it would not be difficult to imagine Reger writing similar music had he lived during the present period. And

# ENCCEL

ELECTRONICS (STEREO) PTY. LTD.

Head Office: 431 Bridge Rd., Richmond, Victoria. 3121. Tel. 42 3762

Sydney Store: Ground Floor, 2SM Building, 257 Clarence Street, Sydney, N.S.W. 2000. Tel. 29 4563, 29 4564.

Australia's Greatest Hi-Fi Centre ■ Wholesalers ■ Trade-ins accepted ■ Terms

since Reger is today held in such little esteem, I hasten to add that I mean no disrespect to Werder by my comparison. It must not be forgotten that Reger, like Werder, had his deeply lyrical moments.

The Music for Clarinet and Strings dates from as recently as 1965. Its chief interest to me centred on the eloquent playing of the clarinet part by Donald Westlake. Another feature I found quite entrancing is a scherzo of unusual delicacy from this fundamentally serious composer. The disc was produced by EMI (Australia) in association with the APRA Music Foundation and is a credit to all concerned in its making. It is well worth a place in the record library of anyone interested in contemporary music of the more accessible kind. Without having corresponded with Werder, I imagine he must be very happy about the way he has been served here.

★ ★ ★

**HAYDN — Cello Concerto in D Major.**

**MONN — Cello Concerto in G Minor.** Jacqueline du Pre (cello) and the London Symphony Orchestra conducted by Sir John Barbirolli. E.M.I. Stereo OASD 2466.

I have enjoyed Miss du Pre's previous recordings so much — as well as her splendid TV biography — that I was really cast down with disappointment at this new release of hers. The Haydn has an absolutely lacklustre first movement in which the composer's line is pulled about inexcusably to suit the soloist. Admittedly the remaining movements are a little better but by no means what one would have expected from this artist. It would be a great pity if this unusually gifted young cellist were to develop an idiosyncratic style to the detriment of the compositions she plays.

I met Monn's G Minor Concerto here for the first time and have little desire to renew its acquaintance. I thought I might have found some interest in the harpsichord continuo played by Australian Valda Aveling, especially as her part is based on one written by Schonberg. Alas, she was, as I wrote about Leppard in the Lully, hardly ever audible. I am afraid that I can find almost nothing to recommend about this disc.

★ ★ ★

**ENGLISH MUSIC FOR STRINGS —** Chacony in G Minor (Purcell); Introduction and Allegro (Elgar); Simple Symphony (Britten); Two Aquarelles (Delius); Sir Roger de Coverley (Bridge). English Chamber Orchestra conducted by Benjamin Britten. Decca Stereo SXLA6405.

This is a delightful recital. The English Chamber Orchestra is right at the head of all similar combinations and under Britten's impeccable direction is well-nigh incomparable. Britten has a sure sense of style no matter what he conducts. He is stately in the Purcell "Chacony," warmly appreciative of the Edwardian comfort of Elgar's "Introduction and Allegro." Since the playing space on both sides is well filled, I suppose it was economically necessary to include these two pieces in the same key on the one side. However, since all the bands are separated by

generous divisions there is nothing to prevent you playing the pieces in whatever order you like. At any rate my comment about the keys of these two works does not alter the fact that Britten's is, I think, the best performance of the Elgar I have ever heard. The fact that he lingers rather more than is usual over the slow section serves only, in my opinion, to contrast the mood of the Allegro when he reaches it. And while I am writing about the Elgar I must offer special thanks to the members of quartet who join the orchestra in this item.

On the reverse side is Britten's delicious Simple Symphony, based, by the way, on pieces he wrote as a child. Here, at a slightly later date, they are put together with every evidence of master craftsmanship. If you want to sample an example of the orchestra's superb playing, try the pizzicato Scherzo movement and pay attention to the constantly varying dynamics. The two Delius fragments were arranged by the composer's faithful amanuensis Eric Fenby. They are tender fragments and caressed with a lover's touch by Britten and his orchestra. The recital ends with a novelty — to me, at any rate — Frank Bridge's ingenious and exhilarating free fantasia on the old dance tune Sir Roger de Coverly. Don't miss this beautiful record.

## In Brief . . .

**MOZART — Symphonies Nos. 1, 2, 3, 4 and 5.** London Philharmonic conducted by Erich Leinsdorf. World Record Club Stereo S/4637.

This disc has little to recommend it other than the interest it might provoke in works seldom or never heard in the concert hall. The symphonies themselves are of varying merit from movement to movement. The engineering is far from good and the playing coarse and sometimes downright impatient. Its club price is the only strong point in its favour.

★ ★ ★

**MOZART — Symphony No. 31 (Paris), No. 35 (Haffner), No. 32 in G (K. 318).** Stuttgart Classical Philharmonie conducted by Karl Munchinger. Decca Stereo SXL6402.

This, too, is not out of the top drawer. The orchestra, which is new to me, produces only a commonplace reading under Munchinger, notably in the absence of any really pianissimo playing. This means a deadening lack of dynamic variation and a general atmosphere of monotony. These are not very early works, as are those reviewed on the previous disc, and are worthy of a much better performance. Sound is only average.

★ ★ ★

**RAMIREZ — Misa Criolla; Seven South American Folk Songs.** Los Huanca Hua. World Record Club Stereo S/4605.

I can recommend this disc warmly to all those in search of sane novelty. Although none of the voices is trained in the European sense of the word there is no doubting the fervour and expressiveness of the chorus. It is, in fact, a breathtaking choir. Occasional falsetto notes from male singers and the gen-

eral rhythmic treatment give it all a strong South American flavour. The singers have an infallibly sense of pitch and phrasing. Without disrespect, I think it would be true to describe this exciting form of the Mass as a Mass for dancing. And this applies especially to the Gloria. The seven folk songs on the reverse side are all admirable examples of this art. Some of them sound unusually modern with the big beat and "Yeh, yeh, yeh" sound of pop music of the last decade. But I enjoyed every bar.

★ ★ ★

**LOWE — Ballads.** Dietrich Fischer-Dieskau (baritone); Jorg Demus (piano), Deutsche Grammophon Stereo 139416.

The songs of this 19th century German romantic are seldom heard nowadays except for an occasional performance at vocal recitals. But they are all eminently pleasing, if sometimes a little sentimental. But Fischer-Dieskau's fine sense of style goes far to counteract this tendency. They range from the heroic to the humorous and except for a rare high note that seems to suggest tiredness are admirably sung and beautifully accompanied. Well worth the attention of lovers of the middle European romantic school. □

## RADIO ENTHUSIASTS

Learn amateur radio in your spare time.

Whatever your interests are in amateur radio, there's a Stott Radio course for you. Easy to follow. Practical. Modern. Guidance all the way by top-flight radio engineers.

### Radio For Amateurs Course:

Learn the exciting skills of building modern radio receivers. Learn about the latest advances in electronics, design, construction and operation. Let Stott's show you how.

### Amateur Operator's Certificate Course:

Broadcasting is fascinating. Stott's offer an entirely new course that enables you to sit for the Amateur Operator's Certificate of Proficiency examinations with complete confidence. Get full details now.

POST THIS COUPON TODAY

**Stotts** 

TECHNICAL CORRESPONDENCE COLLEGE

159 Flinders Lane, Melbourne, 3000  
383 George St., Sydney, 2000  
290 Adelaide St., Brisbane, 4000  
45 Gilles St., Adelaide, 5000  
89 St. George's Terrace, Perth, 6000

Please send me, free and without obligation, full details of your courses in Radio for Amateurs.

Mr, Mrs, Miss .....

Address .....

Age .....

No sales representative will call

EA 370

STC 112



# VARIETY FARE

By HARRY TYRER, FORBES CAMERON, NEVILLE WILLIAMS

## Devotional recordings

**STORIES FROM THE BIBLE IN SONG.** By Father Leo Watt, O.F.M. Sung by the Choir of St. Augustine's College, Brookvale, N.S.W. Directed by Father Patrick Fahey, O.S.A. Stereo, Festival SFL-933623. Also in mono FL-33623.

Interest: Australian choir, songs.  
Performance: Well done, lads!  
Quality: Clean, well balanced.  
Stereo: Normal.

Saint Augustine's College at Brookvale, N.S.W., is run by the Augustinian Fathers. The College Choir, which I would judge to number about 50 boys, provides an excellent example of what can be accomplished by careful training of a group of schoolchildren — and this is undoubtedly one of the points of interest about the album.

Their performance is of such an order to have warranted instrumental support by George Golla on guitar, Reg Robinson on bass and Errol Scarlett on piano — a professional contribution that has added much to the final sound.

Of added interest is the fact that all the songs are the work of a 31-year-old Franciscan priest, Newcastle-born Father Leo Watt. Slanted somewhat towards folk-style, they describe episodes from the lives of well-known Bible characters: Moses, Jonah, Ruth, Elias, Job, Daniel, Joshua, David — actually twelve tracks in all, playing for about 30 minutes.

The music itself is bright and pleasant, in its class, but the words from fifty young throats don't fare quite as well. You can make out the themes — provided you know them beforehand. But I imagine that most people, who would be interested in a record such as this, would have heard the stories many times.

In short, if the contents appeal, you can buy with confidence. (W.N.W.)

★ ★ ★

**SUNDAY WITH THE KING FAMILY.** With the Alvino Rey Orchestra conducted by Ralph Carmichael. Compatible stereo, Light Records LS-5514-LP. (Available from Sacred Productions Australia, 181 Clarence Street, Sydney, and other capitals).

Interest: Gifted family group.  
Performance: First class.  
Quality: Excellent.  
Stereo: Nicely spread.

For those who may need an introduction to "America's most beloved Chorus," the jacket carries a coded picture of the eight King brothers and sis-

ters, grouped with their husbands, wives and children. Blessed with much more than the usual collective talent, the 39-strong group can perform as a full choir, or break up into smaller male, female, and mixed groups — with an odd solo or narration for extra measure.

On this album the various groupings are used to provide a variation in sound, complementing that provided, anyhow, by Ralph Carmichael's arrangements. The result is that, in a program which involves 22 familiar hymns, playing for 45 minutes or more, the sound does not become wearisome; perhaps we should add the phrase "to those who would normally buy this type of album."

As one might guess from the title, the hymns are those which one would expect to hear any Sunday in any one of the thousands of non-conformist churches throughout the world. Space does not permit their listing but, be assured, you'll know them.

A well-produced, generous program,

which will bring endless pleasure to those who enjoy the old hymns. (W.N.W.)

★ ★ ★

**THAT OLD TIME RELIGION.** The 130-voice Amen Choir. Directed by John Gustafson. Arrangements by Ralph Carmichael. Compatible stereo, Light Records LS-5519-LP (From Sacred Recordings Australia, 181 Clarence Street, Sydney, and other capitals).

Interest: Bright choral singing.  
Performance: Exhilarating.  
Quality: Clean, well balanced.  
Stereo: Beautifully spread.

In the field of sacred music, choirs are so numerous that they need to be better than merely good to make a reviewer sit up and take notice. This album did just that.

The choir is first rate, with such a well-blended, forward sound that it is hard to realise that it is 130 strong. The direction is good, the instrumental touches are well integrated and, back of it all, the arrangements by Ralph Carmichael are outstanding.

Mind you, a program composed largely of Negro spirituals lends itself to musical development. The 12 track titles are: Old Time Religion — Stand By Me—What A Friend We Have In Jesus — Swing Down Chariot— Lead Me Gently Home— Down By The Riverside — Battle Hymn Of The Republic — One Of These Days— Just A Closer Walk— Near The Cross — Deep River — Bound For The Promised Land.

Clean, well-balanced sound and a playing time of 36 minutes round off an album which I would heartily recommend. (W.N.W.)

## Instrumental, Vocal and Humour . . .

**RIMSKY-KORSAKOV'S GREATEST HITS.** Various orchestras and conductors. C.B.S. stereo SBR 235347.

Interest: Tuneful classics.  
Performance: Mostly satisfactory.  
Quality: Good sound, some tape hiss.  
Stereo: Normal.

For those who follow these reviews regularly, I need only say that this latest release in the C.B.S. "Greatest Hits" series of famous composers is very much "the mixture as before." The orchestras are the same, the treatment is the same — the tunes are different. In this case, the producers had the advantage of being able to choose from the works of a composer whose gift for melody and orchestration are second to none. The results are a feast of glorious melody: The Flight of the Bumblebee — The Young Prince and the Young Princess from "Scheherzade"—Procession of the Nobles from "Mlada" — Hymn to the Sun from "Le Coq D'or — Dance of the Tumblers from "The Snow Maiden" — Song of India from "Sadko" — The Sea and Sinbad's Ship from "Scheherzade" — Canto Gitano and Fandango Asturiano from "Capriccio Espagnol."

The orchestra/conductor combinations are the Philadelphia/Ormandy, The New York Phil-

harmonic/Bernstein, and the Columbia Symphony/Kostelanetz — all excellent bodies of players. While I am not entirely happy about some aspects of the performances (I like the two pieces conducted by Kostelanetz to be rather more "dolce" for example) I feel there is little point in going too deeply into such matters. These discs will give considerable pleasure to those who are becoming interested in the classics, and I feel this is their main purpose. On the technical side, the sound quality is of good standard, but there is noticeable tape hiss in some tracks. (H.A.T.)

★ ★ ★

**PASTORAL SYMPHONY, No. 6 in F.** (Beethoven). The Pittsburgh Symphony Orchestra, conducted by William Steinberg. Music For Pleasure, compatible stereo MFP-A9027.

Interest: Economy classic.  
Performance: Satisfactory.  
Quality: Very good.  
Stereo: Normal.

For those seeking a cheap recording of Beethoven's popular "Pastoral" symphony, here is a perfectly respectable performance for \$1.99. Although presumably a few years old, the sound quality is of excellent standard. As for the performance, this may not please those who have certain views about

how this work should go. Steinberg starts off rather fast, giving the impression that he has not entirely shaken off the habit of city bustle on his arrival in the country, but settles down to leisurely enjoyment in the slow movement, which is as calm and pastoral as one could wish. The bucolic festivities of the third movement are lively enough, the storm movement is appropriately noisy, and the shepherd's tune appropriately devotional. Good value. (H.A.T.)

★ ★ ★

**SYMPHONIC POEMS.** The Pines of Rome — The Fountains of Rome — The Birds. (Respighi.) The London Symphony Orchestra conducted by Istvan Kertesz. Decca (E.M.I.) stereo SXL 6401.

Interest: Program music.  
Performance: Fine.  
Quality: Excellent.  
Stereo: Excellent.

The provision of Respighi's three most popular works on one disc represents excellent value for money, and as far as I know, it is the first time it has been done. It does entail a turnover in the middle of "The Birds" and although this is inconvenient, it is inevitable. This is a fine performance, in which the climaxes are brilliantly realised — in this respect, it is superior to the New Philharmonia/de Burgos recording reviewed recently. However, those who have already bought that recording need not feel too badly about it. In the slower section, the languishing beauty projected by the Philharmonia players is not realised to the same extent by the London Symphony. Whether you buy one or the other will depend, I imagine, in your preference for the fill items. Personally, I feel the "Birds" suite is a better fill than the Stravinsky pieces offered in the Philharmonia recording. (H.A.T.)

★ ★ ★

**MUSIC OF THE DANCE.** Ballet Classics. Stereo, Calendar SR66-9663.

Interest: As per title.  
Performance: Good, average.  
Quality: Clean but lacking somewhat in bass.  
Stereo: Not outstanding.

From the Swiss Elite catalogue, this album comes in a decorative but singularly uninformative jacket listing the track titles only, but with no mention of the composer, the orchestra (or orchestras) featured, the conductor(s) or the venue. One can only guess that the orchestra is one or more of those featured frequently by Elite — the Viennese Promenade, or the Vienna National Opera Orchestra.

The bass is "wooden" rather than ponderous and the spread is not expansive but the sound is nevertheless quite clean and, at the Calendar price, will represent good value to those to whom the music appeals.

The excerpts featured are: Hungarian Dance No. 5 (Brahms) — Slavonic Dances No. 5 and 6 (Dvorak) — Ballet Music from "Coppelia" (Delibes) — Hungarian Dance No. 6 (Brahms) — Slavonic Dances No. 7 and 8 (Dvorak) — Ballet Music from "Carmen" (Bizet) — Polovtsian Dances from "Prince Igor" (Borodin-Korsakov-Glazounov).

Playing time for the disc is just over the 40 minutes. (W.N.W.)

# New From England!

## B & W (MODEL DM3)

### Professional Monitor Loud Speakers

Here—now—is performance at its very best. DM3 Loud Speakers give effortless listening with a delicacy seldom achieved.

Smooth, extended frequency response, superior power handling capabilities, low distortion and much else besides. Here is a true high fidelity producer.

**Brief specifications:**

Size 28½" x 15½" x 11½".

Weight: 53lb.

Power Handling: 15 Watts R.M.S. throughout frequency range. Frequency Response: Better than plus or minus 5db 40Hz-2500Hz.

Impedance: Nominal 8-ohms.

Individual performance curve with each unit. For use where no compromise performance is required.

Write for literature and "Arrow Quote."

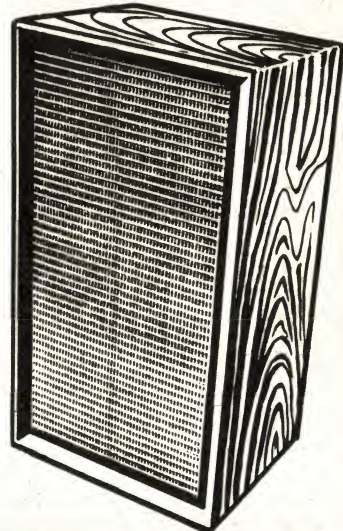

### Just arrived! New shipment of famous TD 150 Turntables



"A handsome unit, the TD-150AB Mark II (illustrated) is also a ruggedly built machine and a top-flight performer. The usual measurements were made at Nationwide Consumer Testing Institute Inc. (a subsidiary of United States Testing Company Inc.) Rumble as per the NAB standard (of 1.4 cm/sec to 100Hz was a very low —40db and of course completely inaudible. Wow and flutter were clocked at 0.07% and 0.05% respectively, and are of no significance in listening. The arm had no measurable resonance at all, which is outstanding. Speed accuracy was good, measured at 1.95% fast for the 33-rpm setting and 0.9% fast for the 45-rpm setting. Speed was unaffected by line voltage changes. Tracking ability of the arm was on a par with the best." (American "High Fidelity" Magazine.)

- Top performance
- Easy operation
- Modern slim line
- Best protection of your records.

3 Models available as follows:

- TD150 Turntable only — \$104.00
- TD 150A Turntable with TPI3 arm \$125.00
- TD 150AB Mark 2 Turntable with arm and base \$140.00

Write for literature and "Arrow Quote"

Prices subject to change without notice.

**AE** **ARROW ELECTRONICS** 342 Kent St. SYDNEY  
NOW AT 29-6731

Opposite 2UW between KING & MARKET Sts.

# LITTLE SHORT OF REVOLUTIONARY

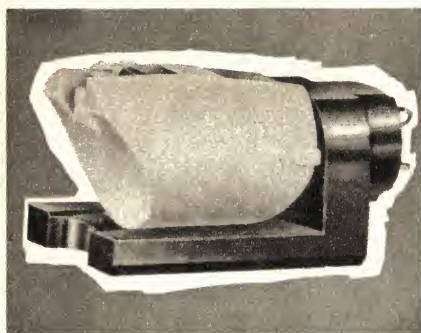

# DECCA Deram

MICROGROOVE "CERAMIC" CARTRIDGE  
fitted with diamond stylus  
for stereo or mono microgroove records

Micrographs of a groove recorded with a 10 KHz signal taken from three copies of a Decca stereo frequency test record SXL 2057.

UNPLAYED MICROGROOVE



AFTER ONLY 1 PLAYING  
with a good, average-priced  
cartridge. Arrows show damage

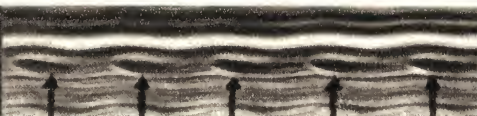

NO DAMAGE AFTER 250  
PLAYINGS with Decca Deram.



## THE DECCA DERAM DOES LESS DAMAGE AFTER 250 PLAYINGS THAN THE AVERAGE CARTRIDGE DOES AFTER ONLY ONE

The Decca Deram has a tip mass of 0.6 milligramme; its compliance is  $9 \times 10^{-9}$  cms/dyne (lateral) and  $5 \times 10^{-9}$  cms/dyne (vertical); tracking weight 2.5 gms.; frequency response  $\pm 3$ dBs 18Hz to 18KHz. Output 50MV/CM/Sec.

Retail Price  
**\$12.60**

Sole Australian Agent:

### BRITISH MERCHANDISING PTY. LTD.

Shaw House 49-51 York St., Sydney, N.S.W. Telephones 29.1571 (3 lines)

THE BEST OF CARMEN DRAGON, Vol. 2. The Capitol Symphony Orchestra, conducted by Carmen Dragon. Capitol (E.M.I.) stereo SP 8687.

Interest: Mainly non-classical.  
Performance: Pleasing style.  
Quality: Very good.  
Stereo: Normal.

The aim of Carmen Dragon for many years has apparently been to present fine melodies, whatever their origin, in full orchestral dress, presumably for the benefit of those who are not normally listeners to the classics. This second selection from earlier recordings illustrates this fact well, since no less than eight of the 12 tracks are arrangements of traditional and popular songs: All Through the Night — Jeannie with the Light Brown Hair — Home on the Range — Black is the Colour of My True Love's Hair — Lady of Spain — Rule Britannia — The Wide Missouri — America the Beautiful. The other four tracks are the ever popular Prelude to "Carmen"; the lively, and in America universally known, reel "Turkey in the Straw"; the dreamy Debussy number "En Bateau" which I cannot imagine anybody disliking, whatever their musical taste; and one of the finest of Italian traditional melodies, "Carnival of Venice."

It should not be too difficult for any prospective purchaser to make up their minds about the merits of this selection. If it suits your taste, the arrangements and performance are both highly competent, and the technical side is up to standard — clean sound, good stereo spread and silent surfaces on the review copy. (H.A.T.)

★ ★ ★

ON THE BEAUTIFUL BLUE DANUBE. The New York Philharmonic Orchestra, conducted by Leonard Bernstein. C.B.S. stereo SBR 235339.

Interest: Strauss waltzes.  
Performance: Unconvincing.  
Quality: Excellent.  
Stereo: Normal.

Performances of Strauss waltzes, by large orchestras, and without cuts, are very much to my liking, and I am always glad to have for review a disc such as this, in which five of the most popular waltzes are presented in full orchestral dress—in fact, as Viennese tone poems. Side one has "Blue Danube" and "Emperor" waltzes; side 2 has "Vienna Blood," "Artist's Life" and "Voices of Spring." So far, so good — but what of the performance.

Nobody will dispute the status of the New York Philharmonic and its present conductor, Leonard Bernstein, or deny that they are able to present very impressive performances of great orchestral works — but Johann Strauss! Hardly their cup of tea, I thought, when this disc arrived. The tautness which has been a notable feature of the orchestra's performances, and the driving energy of Bernstein's conducting, hardly seem suited to the relaxed atmosphere and gaiety of Strauss' music — and so it turned out. I was determined to approach this disc with an open mind, but with the best will in the world, I cannot approve this performance wholeheartedly. True, the standard of individual performers, the quality of tone, and the lush recorded sound leave nothing to be desired, but



the atmosphere achieved by the Vienna Philharmonic, for example, and the special lilt which they impart to the accompaniment, is missing. With so many competitive versions available, it is difficult to recommend this one. (H.A.T.)

★ ★ ★  
**POMP AND CIRCUMSTANCE.** New York Philharmonic conducted by Leonard Bernstein. C.B.S. stereo SBR 235331.

Interest: Orchestral marches.  
 Performance: Appropriately rousing.  
 Quality: Excellent.  
 Stereo: Well spread.

I find the New York Philharmonic and Bernstein much better suited to the type of rousing fare presented here. In addition to Elgar's "Pomp and Circumstance March No. 1," from which the disc takes its title, there are: March of the Toreadors from "Carmen" (Bizet) — War March of the Priests from "Athalie" (Mendelssohn) — Fest March from "Tannhauser" (Wagner) — Coronation March from "The Prophets" (Meyerbeer) — Procession of the Sardars (Ippolitov-Ivanov) — Rakoczy March (Berlioz). This is extrovert music of the kind which Bernstein revels in and the orchestra obviously finds it

more to its taste than Strauss. The orchestral tone is superb, and I must particularly mention the cellos in the glorious second subject in the Elgar piece (the "Land of Hope and Glory" tune). The sound quality is of the highest standard. (H.A.T.)

★ ★ ★  
**BATTLE OF BRITAIN.** Original soundtrack recording. Music composed and conducted by Ron Goodwin. "Battle of the Air" composed by Sir William Walton and conducted by Malcolm Arnold. United Artists (Festival) stereo SUAL-993,586. Available in mono.

Interest: For filmgoers.  
 Performance: Robust.  
 Quality: Excellent.  
 Stereo: Normal.

The producers of this film epic must have been disappointed that Sir William Walton could not be prevailed upon to write the whole score, with the result that the prolific Ron Goodwin got the task. Mr Goodwin churns out film scores the way Mozart churned out German Dances — to order, and delivery guaranteed before the date required. If the results are not memorable, the scores do what they are required to do. If they do not survive as works of art, well, they were not intended to be

## Moog synthesizer — classics and rock

**THE WELL TEMPERED SYNTHESIZER.** More electronic performances by Walter Carlos on the Moog Synthesizer. C.B.S. stereo SBR 235351.

Interest: "Switched On" sequel.  
 Performance: Fascinating.  
 Quality: The best.  
 Stereo: Excellent.

In view of the great success of "Switched on Bach" it was inevitable that there should be a sequel. Other companies have attempted to cash in on the interest generated by Walter Carlos' first Moog Synthesizer disc, and I have dutifully listened to some of them, but have had to report in lukewarm terms. Here I have no hesitation in resorting again to superlatives. Once again, Carlos has restricted his work to the baroque period, the music of which somehow sounds entirely appropriate when recreated in this medium. The music consists of four Scarlatti sonatas; the Fourth Brandenburg Concerto of Bach; the Bouree, Air and Allegro Deciso form Handel's "Water Music", and two works by Monteverdi — "Orfeo" suite and "Domine Ad Adjuvandum."

Of these, the Scarlatti pieces came over the best. I thought the treatment brilliant, and touched with a real beauty. The Handel pieces, particularly the Air, seemed to me the weakest part of the disc. The Bach work is perhaps not quite so successful as in the first disc, but extremely interesting just the same. Of the Monteverdi pieces, the "Domine Ad Adjuvandum" is the more interesting, since Carlos has tried to create choral effects, which are slightly startling on first hearing, but entirely fascinating. A worthy sequel to the first success, which I feel sure will find almost equal favour with those who found "Switched on Bach" an enjoyable experience. The sound quality is of the highest order, and the spread of sounds

across the stereo spectrum add greatly to one's enjoyment. (H.A.T.)

★ ★ ★  
**SWITCHED-ON ROCK.** The Moog Machine. Stereo, CBS SBP-233730.

Interest: Moog in another mood.  
 Performance: Lots of know-how, skill.  
 Quality: No "accidental" noise, or distortion.

As one of the older generation, I would not presume to pass judgment on this as rock in its own right, but I imagine that, beat notwithstanding, much of the sound will be too gimmicked to gain automatic acceptance by the top-40 crowd.

On the other hand, this very gimmickry, both in the main theme and the sonic goings-on in the background will commend itself to those who are partial to the psychedelic.

"Switched-on Bach" went over well because it was framed on a familiar structure. So is this album, in the sense that the sound rests on a foundation of rhythm expertly laid down by Leon Rix on drums.

But drums or no drums, I must concede the industry, the patience, the skill — and the inspiration under aseptic conditions — which allowed the rest of the team to build up the sound one finger at a time, adding it phrase by phrase to the 16-track tape.

I almost forgot the track titles: Spinning Wheel — Jumpin' Jack Flash — The 59th Street Bridge Song — Get Back — Yummy, Yummy, Yummy — The Weight — Time of the Season — Aquarius — Let The Sunshine In — You Keep Me Hangin' On — Hey Jude.

If you want an opposite number for your "Switched-on Bach" this could be it. Or maybe you just like the idea of helectronic hep! (W.N.W.)

★ Now you can own the

# SONIC BOOM

OF 1970

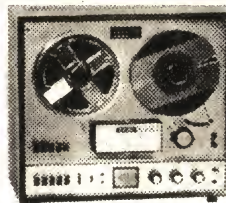

Look what 'Stereo Review' says about the TEAC A-1200 TAPE DECK

"There's no doubt that it can meet the standards of the most critical listener... One of the best features of the TEAC A-1200U is its price. We have never tested a recorder at this price level that could match the A-1200U. It's only real competition would seem to come from the \$500-and-up class of recorders."

The TEAC Corporation usually makes Studio Sound Equipment. Their new units for the discriminating listener are causing a "Sonic Boom" all over the world. Now for the first time Convoy Technocentre brings you this exciting new Hi-Fi equipment and at a price that most can afford.

**ADD THE SUPERB TEAC CASSETTE, PLAY-RECORD DECK. FULL HI-FI SOUND STANDARDS!**



★ Separate Sound Level Control; Four Independent control switches for right and left channels of input and output  
 ★ Editing Control; Pause Button  
 ★ Dual VU Meter ★ Two TEAC Techno-Built Precision Heads, equals the best from professional quality open-reel machines ★ 4-Pole Hysteresis Synchronous Motor ★ Cardoid Stereo Microphone ★ Headphone Monitoring  
 ★ 3-Digit Pushbutton-Reset Index.

## CONSULT THE SOUND EXPERTS

HEAR... COMPARE... REVOX, PIONEER, SONY, SANSUI, GOODMAN, LEAK, ELAC, DUAL, EVERY LEADING SOUND UNIT DANISH PEERLESS SPEAKERS.

If you want the newest, most value for money, discover what you save by selecting one of the proved and guaranteed Sound Systems from the Convoy Technocentre from \$200 to \$2,000. Terms available. Expert Hi-Fi service.

# Convoy

FOR SOUND SATISFACTION

TECHNOCENTRE  
 449 KENT STREET,  
 SYDNEY. 29-6475

# LEAK HI-FI

## Craftmanship & Quality

In a world of ever rising prices Leak (Aust) Pty. Ltd. through increased production efficiency and plant modernization, are able to pass on to the consumer the new prices listed below.



LEAK SANDWICH MKII  
SPEAKER SYSTEM \$119.00  
SIZE. 26" x 15" x 12"  
Available in Mahogany,  
Teak and Walnut.



LEAK "STEREO 30" PLUS AMPLIFIER \$198.00  
POWER OUTPUT 15 Watts. r.m.s. each channel



LEAK "STEREO 70" AMPLIFIER \$298.00  
POWER OUTPUT 35 Watts. r.m.s. each channel



LEAK MINI-SANDWICH  
SPEAKER SYSTEM \$ 85.00  
SIZE. 18½" x 11" x 7"  
Available in Mahogany,  
Teak and Walnut.

In Australia, as throughout the world, leading broadcasting and recording studios use Leak audio equipment for monitoring purposes.

**LEAK HI-FI**  
H.J. LEAK (AUST) PTY. LTD.  
P.O. BOX 14 FRENCH'S FOREST,  
N.S.W. 2086 PHONE 94 4902

for descriptive leaflet post coupon

Name \_\_\_\_\_  
Address \_\_\_\_\_  
Postcode \_\_\_\_\_

such. As for Walton's "Battle of the Air," this is perhaps not as outstanding as the same composer's "Spitfire Prelude and Fugue," but I suspect the two pieces will tend to become companion pieces in concert programs.

As with most film scores, the interest will lie mainly with those who want a souvenir of the film. (H.A.T.)

★ ★ ★

**PEER GYNT** Incidental Music. The Halle Orchestra conducted by Sir John Barbirolli, with Sheila Armstrong, soprano and the Ambrosian Singers. Studio 2 Stereo (E.M.I.) TWO269.

Interest: The complete music.  
Performance: Routine.  
Quality: Excellent.  
Stereo: Well spread.

This is not the usual "Peer Gynt" suites, but the (almost) complete score as written for Ibsen's play by Grieg, with only a few minor pieces left out. This requires a chorus (The Ambrosian Singers, in this case) and two sopranos. Here, Sheila Armstrong gives a pleasing performance of Solveig's music, and Patricia Clark sings Anitra's song during the Arabian Dance. Apart from Solveig's song, which to me always sounds so much better when sung, there does not appear to me to be much advantage in this version over the suites. There are some extra pieces (Overture, Norwegian Bridal Procession, and Solveig's Cradle Song) which are not found in the suites, but recent recordings of the suites have had some generous fills. There are no particular points of the performance which call for comment. The orchestra plays as competently as one would expect, the Ambrosian singers have only a minor role which allow them very little scope, and of the two singers, Sheila Armstrong sounds the more experienced and confident. (H.A.T.)

★ ★ ★

**DON TWEEDY.** Love Theme from "Romeo and Juliet" and other arrangements. United Artists (Festival) Stereo SUAL-933,518. Available in mono.

Interest: Film themes.  
Performance: Pleasing style.  
Quality: Excellent.  
Stereo: Good.

I gather that the only part played by the man with top billing on the sleeve is the arrangement of the tunes, but the uninformative waffle of the sleeve note doesn't give any enlightenment. What this disc actually offers is a selection of the theme tunes and songs from recent films. These are certainly competently arranged, and show some imaginative touches in some tracks. There is also an impressive line-up of names in the credits, where no less than nine musicians are credited as soloists. The main thing is that the music is very pleasant listening. The tunes are: Love Theme from "Romeo and Juliet" — Goodbye Columbus — 100 Rifles — We, from "Me, Natalie" — Oliver — Southern Star — Ole Turkey Buzzard, from "Mackenna's Gold" — Jean, from "The Prince of Miss Jean Brodie" — The Windmills of Your Mind, from "The Thomas Crown Affair" — The Night They Raided Minsky's — Hush-above Mountain — Love Theme from "Hannibal Brooks." (H.A.T.)

**ON WINGS OF OPERA.** Regina Resnik, with the orchestra of the Royal Opera House, Covent Garden, conducted by Edward Downes. A Decca recording, released exclusively in Australia by World Record Club. Stereo S/4660.

Interest: Opera arias.  
Performance: Magnificent.  
Quality: Excellent.  
Stereo: Normal.

Opera lovers who are members of World Record Club will be sure to give this disc a warm welcome. Discs featuring arias from operas have appeared only seldom in the W.R.C. programs in recent years. This disc has the outstanding artist Regina Resnik, now at the pinnacle of her career, with a pleasing selection of the most popular arias from Bizet's "Carmen" (Habanera — Seguidillas — Chanson Boheme — Carreau! Pique!), plus the following: Air des Adieux from "Jeanne D'Arc" (Tchaikowsky) — Softly Awakes My Heart, from "Samson et Dalila" (Saint Saens) — So Ist Es Den Aus from "Die Walkure" (Wagner) — Condotta Ell'era in Ceppi from "Il Trovatore" (Verdi) — O Don Fatale from "Don Carlos" (Verdi).

Madame Resnik is usually classified as a soprano, and I was surprised to find her apparently singing mezzo in this selection. Her rich-toned voice sounds particularly good in the "Carmen" arias, also in the "Dalila" aria, but there is not one track in which she does not sound entirely magnificent. The orchestra provides support of a high standard. (H.A.T.)

★ ★ ★

**SONGS YOU LOVE.** David Hughes, tenor, with orchestra or piano accompaniment. Music for Pleasure compatible stereo. MFP-A8072.

Interest: Welsh tenor.  
Performance: See review.  
Quality: Excellent.  
Stereo: Normal.

This program of very popular songs is sung by David Hughes with all the expression and sweetness of tone one expects from a Welsh tenor. However, he has a tendency to drift off pitch which the critical listener may find irritating. Apart from this (and let's face it, many listeners are unable to detect this type of fault), this is a very pleasing recital, comprising: Where'er You Walk (Handel) — Panis Angelicus (Franck) — Ave Maria — Angels Guard Thee — Silent Worship — The Lost Chord — I'll Walk Beside You — Absent — Faery Song — Drink To Me Only — Roses of Picardy. This is a modern recording, with excellent quality sound. (H.A.T.)

★ ★ ★

**HELLO, PARIS.** Petula Clark. Disque Vogue (Festival) Stereo.

Interest: P.C. sings French.  
Performance: Lively style.  
Quality: Some reservations.  
Stereo: Three channels.

Be a bit careful about this one if you are a Petula Clark fan, and you do not particularly care for foreign language songs. Although the song titles are clearly given in French, some people may not realise that Petula Clark is bi-lingual, and is equally at home in French as she is in English. On the other hand, if you enjoy French songs, as I do, you will find little to

BUY RIGHT... FROM ENCEL

## CONNOISSEUR

Stereo Cartridges  
and Turntables  
at Australia's  
lowest prices

### Turntable BD-1

This turntable gives "no compromise" performance at modest cost. The unique flexible belt drive eliminates vibration and transmission noise. The motor's low hum field makes the unit suitable for the most sensitive pickups. To attain maximum performance and sensitivity, complex mechanisms have been avoided. But mechanical specifications of the highest order have been maintained. Slim line construction.

Extract from review appearing "Hi-Fi Sound" December, 1968: "The BD-1 offers the advantages of light weight, simplicity, compactness and a credible performance standard which is entirely acceptable at this modest price."

Price (including sales tax) \$39.50



### Turntable BD-2

As BD - 1 plus:

SAU - 2 tone arm . . . the unusual and highly effective tone arm featuring a revolutionary type gimbal mounting with axis at 45 deg. Automatic bias adjustment. Lift lower device. Scales, to set the stylus pressure, provided. (Write for copies of "Hi-Fi" review).

Extract of review of BD-2 in "The Gramophone" July 1969: "Wow and flutter was absent, hum was inaudible." "attractive medium priced turntable unit with highly satisfactory standard of technical performance." ". . . well made and beautifully finished . . . robust enough for all domestic requirements."

Price (including sales tax) \$79.00

SCU-1 stereo cartridge. Ceramic Cartridge; Wide frequency response capable of loading effectively any amplifier or tape recorder; diamond stylus; (Write for copies of reviews). Price (inc. tax) \$12.50.

**ENCEL**  
ELECTRONICS  
(STEREO) PTY. LTD.

Head Office:

431 Bridge Rd., Richmond, Vic. 3121. Tel. 42 3762.

Sydney Store: Ground Floor, 2SM Building,  
257 Clarence Street, Sydney, N.S.W. 2000.

Tel. 29 4563, 29 4564.

Wholesalers ■ Trade-ins accepted ■ Terms

Australia's Greatest Hi-Fi Centre

# NEW ALL TRANSISTOR STEREO AMPLIFIERS ULTIMATE IN DESIGN—LONG DEPENDABILITY USING ALL SILICON TRANSISTORS 36 WATTS—RMS

## SPECIFICATIONS:

**POWER OUTPUT:** 18 watts per channel R.M.S.

Total output 36 watts R.M.S.

**FREQUENCY RESPONSE:** From 20 cycles to 20,000  $\pm$  1db.

**HARMONIC DISTORTION:** Less than 1 per cent at 14 watts output.

**HUM AND NOISE:** Aux. 70db, Mag. 50db.

**INPUT SENSITIVITY,** Mag. 3mv. Aux. and tuner 200 mv.

**SPEAKER IMPEDANCE:** 8 oms.

**EQUALISED:** Mag. RIAA.

**TONE CONTROLS:** Bass 50 c/s  $\pm$  12db. Treble 10 kc/s  $\pm$  12db.

**LOUDNESS CONTROL:** 50 c/s 10db.

**SCRATCH FILTER:** (High filter) at 10 kc/s 9db.

**RUMBLE FILTER:** (Low filter) at 50 c/s 5db.

**PROVISION FOR TAPE RECORDER.** Record or play-back with din plug connection.

**PROVISION FOR HEADPHONES** with headphone/speaker switch on front panel.



MODEL C300/20

**\$119.00** FREIGHT EXTRA.

**DIMENSIONS:** 16 $\frac{1}{2}$ in v 5 $\frac{1}{2}$ in x 11in deep.

Mounted in oiled walnut or teak veneered cabinet, with metal trim and matching knobs.

**THE CIRCUIT INCORPORATES** regular power supply with transistor switching protection for output transistors. 26 silicon transistors plus 5 diodes are used.

**ABOVE AMPLIFIER  
WITH INBUILT A.M.  
TUNER**

**\$144.00**

FREIGHT  
EXTRA



MODEL C300/20/T

12 WATT RMS PER CHANNEL VERSION OF ABOVE AMPLIFIERS AS PREVIOUSLY ADVERTISED  
ALSO AVAILABLE. \$134.00 WITH TUNER.

## NEW 24 WATT R.M.S. TRANSISTOR AMPLIFIER WITH INBUILT A.M. TUNER



MODEL C250

**\$118.00** FREIGHT  
EXTRA

**DIMENSIONS** 15 $\frac{1}{2}$ in x 4 $\frac{1}{2}$ in x 11in deep.  
Cover finished in teak or walnut wood grain.  
Incorporates 24 low noise silicon transistors plus 5 diodes.

## SPECIFICATIONS:

**POWER OUTPUT.** 12 watts per channel 24 watts R.M.S. total (48 watts music power).

**FREQUENCY RESPONSE.** 20 Cycles to 20,000  $\pm$  1db.

**HARMONIC DISTORTION.** Less than 1% at 10 watts.

**HUM AND NOISE.** Aux. 70db. Mag. 50db.

**INPUT SENSITIVITY.** Mag. 3mv. Aux. 200mv.

**SPEAKER IMPEDANCE.** 8 ohms.

**EQUALIZED.** Mag. RIAA.

**TONE CONTROLS.** Bass 50c/s  $\pm$  12db. treble 10kc.  $\pm$  12db.

**LOUDNESS CONTROL.** 50c/s 10db.

**SCRATCH FILTER.** (High filter) at 10kc. 9db.

**PROVISION FOR TAPE RECORDER.** Record or play back with standard din plug connection.

**TUNER.** This unit can be supplied with either valve or transistor tuner with a coverage of 530 to 1,600 K.C. Calibrated dial



**\$118.00**

FREIGHT  
EXTRA.

This amplifier is based on the Playmaster 118 circuit as featured in "Electronics Australia," to which has been added the following features:

- Inbuilt high gain A.M. tuner with a coverage of 530 to 1,600 K.C.
- Loudness control giving bass boost at low volume.
- Provision for tape, record and play-back, with din connector.
- Calibrated dial available for all States.
- EM84 tuning indicator giving accurate tuning with ease.

**POWER OUTPUT:** 9 watts per channel R.M.S. **FREQUENCY RESPONSE:** 20 to 20,000 cycles incorporating Ferguson O.P.412 gain oriented output transformers. **VALVES USED:** 4-6GW8, 12AX7 or 12AU7, 6AN7, 6N8, EM84 and 2 silicon diodes.

## MODEL C200V. BASED ON THE PLAYMASTER 118 WITH TUNER

Dimension 16 $\frac{1}{2}$ in x 5 $\frac{1}{2}$ in x 11in.

CABINET IN OILED WALNUT OR TEAK WITH METAL TRIM.

# CLASSIC RADIO

245 PARRAMATTA ROAD, HABERFIELD, N.S.W. PHONE 798-7145

## Play Bach Stereo Reissues

PLAY BACH Numbers 1, 2, 3, 4.

Jacques Loussier, piano and organ; Pierre Michelot, double bass; Christian Garrros, drums. London (E.M.I.) stereo. Numbers given below.

Interest: Bach, modern style.

Performance: Unique to this group.

Quality: Clean sound.

Stereo: Reprocessed.

The Jacques Loussier Trio are now so well known in consequence of their numerous recordings and personal appearances (they were in Australia only last year) that it is presumably not necessary to explain what they are trying to achieve with their "modern interpretations" of the music of J. S. Bach. Sufficient to say that they have so successfully blended the baroque and jazz idioms that their performances have found favour with both classical music and jazz enthusiasts.

Their first discs (Play Bach One to Play Bach Four) were only available in mono, for some inexplicable reason. These present re-issues have been reprocessed for stereo. The necessary filtering and rearrangement has been skilfully done, and has resulted in the piano being in the right channel with the bass and drums on the left—virtually two channel, with the middle left open. I do not imagine that those who already have these discs in the original mono are likely to be tempted to purchase these reissues for the dubious advantages of simulated stereo, but for the benefit of those who

complain about. Petula Clark's French accent is impeccable, and she sounds as confident, lively and entirely enchanting as she does when singing in English. She has been very well recorded, so that every word she sings comes over as clear as a bell, but on the other hand, the background chorus which accompanies her sounds muffled and distorted. Personally, I do not think this matters one bit, since their contribution is not particularly important. The orchestral accompaniment has a strong beat in most tracks which should please younger listeners. (H.A.T.)

★ ★ ★

**THE BEST OF NINA AND FRED-ERICK.** Columbia (E.M.I.) Stereo SCXO 6364.

Interest: Folk song duo.

Performance: Fine entertainment.

Quality: Good throughout.

Stereo: Varies.

Unlike many folk singers, Nina and Frederick have never set out to represent the social conscience by purveying the sentiments of "Protest songs." Instead, they have tried to be entertainers pure and simple, and in this they have succeeded superbly. True, they do sing Pete Seeger's "Where Have All the Flowers Gone?" and Bob Dylan's "Blowin' in the Wind" in this selection, but one feels they are doing so more in sorrow than in anger. The rest of the songs here are mainly lighthearted numbers, reflecting the happy philosophy of this charming pair: Listen to the Ocean — Inch Worm — Little Donkey — I Would Amor Her — Long Time

missed the first release, here is a brief rundown on the contents of each disc.

Number 1. SAHA 7751. Prelude 1 — Fugue 1 — Prelude 2 — Fugue 2 — Toccata — Prelude 8 — Prelude 5 — Fugue 5. The preludes and fugues are from the "Well-Tempered Clavier" set. The Toccata is from the well-known "Toccata and Fugue in D minor."

Number 2. SAHA 7752. Partita No. 1 — Choral — Prelude 6—Aria—Prelude 16 — Fugue 16 — Prelude 21. All six movements of the Partita are played, so that this work takes up the whole of Side 1. The Chorale is "Jesu, Joy of Man's Desiring," and the Aria is from Suite No. 3 in D, known popularly as "Air on the G String."

Number 3. SAHA 7753. Italian Concerto — Two Part Inventions Nos. 1, 2, 5, 18 and 15. Chromatic Fantasy in C minor. The Italian Concerto is possibly the most ambitious essay tackled by the group in these four discs, and has elaborate passages for all three.

Number 4. SAHA 7754. Overture from Cantata No. 28 — Choral No. 16 "Have Pity on Me, Oh Lord God" — Chorale No. 16 "Christ our Saviour is Come to Jordan" — Fantasy and Fugue in G minor — Choral No. 1, "Sleepers Awake." I found this the least interesting of the four discs. In the overture, Loussier plays organ as well as piano, and overdubbing is used to combine two instruments. This seemed to me to spoil the unique character of the group's work.

The sound in all four discs is clean, but lacks the immediacy of the best modern recordings. (H.A.T.)

Boy — Maladie D'Amour — Sippin' Cider — Little Boxes — Scarlet Ribbons — Mary's Boy Child — Puff the Magic Dragon — Hole in the Bucket — Sucu Sucu — Baby It's Cold Outside. The last-named is from the very successful Royal Albert Hall live performance reviewed on disc in these columns last year, and includes a hilarious send-up of the Oxford-accented Englishman as a lover. A thoroughly enjoyable disc all through. (H.A.T.)

★ ★ ★

**DEAR OLD DONEGAL.** Bing Crosby (with chorus in some tracks) and orchestra. Calendar (Festival) mono only R66-621.

Interest: Irish ballads.

Performance: Suave and sentimental.

Quality: Good mono sound.

I remember Bing Crosby recording Irish songs long before the beginning of the L.P. era, but I imagine that this present selection, in good quality mono sound, comprises songs of early L.P. vintage, to judge by the very acceptable sound quality. Bing's suave voice is ideally suited to the type of sentimental ballad included here, The Rose of Tralee—Dear Old Donegal—When Irish Eyes are Smiling—The Donovans—Danny Boy—The Isle of Innisfree—Galway Bay—How Can You Buy Killarney—I'll Take You Home Again Kathleen—Tobermory Bay—Where the River Shannon Flows—Did your Mother Come from Ireland? Here is enough sentiment and nostalgia to suit even the most home-

"INNERBOND"

(Regd.)

# BONDED ACETATE FIBRES

FOR PACKING IN

## SPEAKER ENCLOSURES

A new resilient Bonded Wadding made from ultra fine Cellulose Acetate Fibres that gives high efficiency for Sound Absorption.

"INNERBOND" is light, clean, dust-free and easy to handle. Because all the fibres are bonded "INNERBOND" will hang as a "curtain" and will not fracture or break down due to vibration.

"INNERBOND" is odourless, highly resistant to attack by bacteria or fungus and is vermin repellent; "INNERBOND" at 16oz sq. yd. has a normal thickness of 1" and at this density is recommended as a packing in Speaker Enclosures for Sound Absorption.

### STOCKISTS:

**SYDNEY:** Arrow Electronics Pty. Ltd. 342 Kent St.; Broadway Electronics. (Sales) Pty. Ltd. 91a York St.; Convoys International Pty. Ltd., 449 Kent St.; Encei Electronics Pty. Ltd., 257 Clarence St.; Kent Hi-Fi, 432 Kent St.; Mastersound Sales Pty. Ltd., 400 Kent St.; Radio Despatch Service, 869 George St.; Peter Shalley Electronics Pty. Ltd., 127 York St.; Stereo Music Systems, 193 Clarence St.; Circuit Components (A/sia) Pty. Ltd., 460 Bexley Rd., BEXLEY; Classic Radio, 245 Parramatta Rd., HABERFIELD; Dyna Stereo Pty. Ltd., 331 Prince's Hwy, ST. PETERS; Albert Wright Radio Service, 795 New Canterbury Road, HURLSTONE PARK; H. B. Radio Products, 103-105 Catherine St., LEICHHARDT.

**CANBERRA:** Kitchen and Hi-Fi Specialists. Cnr. Gilles and Kennedy Sts., Kingston.

**NEWCASTLE:** Martin de Launay Pty. Ltd., King and Darby Streets; Dynamic Sound, 587 Hunter Street.

**WOLLONGONG:** Electronic Parts Pty. Ltd., 82 Keira Street; Martin de Launay Pty. Ltd., 270 Keira Street.

**MELBOURNE:** J. H. Magrath and Co. Pty. Ltd., 208 Little Lonsdale Street.

**BRISBANE:** A. E. Harrold Pty. Ltd., 123 Charlotte Street; Brisbane Agencies, 78 Wickham Street, Fortitude Valley.

**IPSWICH:** Robert N. Smallwood, 205 Brisbane Road, Booval.

**NORTH QUEENSLAND:** Alvin Communications and Electronics, 38 Peggall St., Pimlico, Townsville.

**ADELAIDE:** Duncan Agencies, 57 Woodville Road, Woodville; General Accessories, 81 Filinders Street; Trustcott Electronics, 62-64 Hindmarsh Square.

**PERTH:** Atkins (W.A.) Ltd., 894 Hay Street; Carlyle and Co. Pty. Ltd., 1 Milligan Street; General Accessories, 46 Milligan Street.

**HOBART:** Homecrafts-Tasmania, 199 Collins Street.

If unobtainable

For 1 sq. yd. as above send \$2.00

For 2 sq. yds. as above send \$3.75

For 4 sq. yds. as above send \$6.50

Postage paid in Australia and Territories to the manufacturers.

## WONDER WOOL PTY. LTD.

87 JAMES STREET, LEICHHARDT.

N.S.W., 2040.

Box 548 — G.P.O., Sydney, 2001.

Phone: 56-2780.

# PERFECT MATES



**SHURE**

**V-15 TYPE II (IMPROVED) \$87.50\***

SUPER TRACKABILITY PHONO CARTRIDGE

## HIGHER TRACKABILITY IN THE "BACKBONE" REGION OF MUSIC

The grand structure of orchestral music relies heavily upon tympani, tuba, contrabass, bassoon, bass drum, and other low register instruments to form the solid foundation upon which the harmonies and melodic lines are built. Unfortunately it is exceedingly difficult to track these passages when they are cut at high velocities. Even the Shure V-15 Type II, the world's highest trackability cartridge, required raising the tracking force when playing recordings containing this type of program material. We took this as a challenge and have prevailed. The top line of the graph at right shows the increased bass and mid-range trackability of the **IMPROVED V-15 Type II**. Practically speaking, it means you can reduce 1 1/4 gram tracking force to 1 gram, or 1 gram force to 3/4 gram for records with high velocity bass register material. No increase in price (\$87.50 net), but you will significantly extend record and stylus tip life.

**NOTE:** You can attain this superior bass and mid-range trackability with your present V-15 Type II by using the **IMPROVED VN15E** stylus at \$27.50. Look for the word Shure in red letters on the stylus grip.

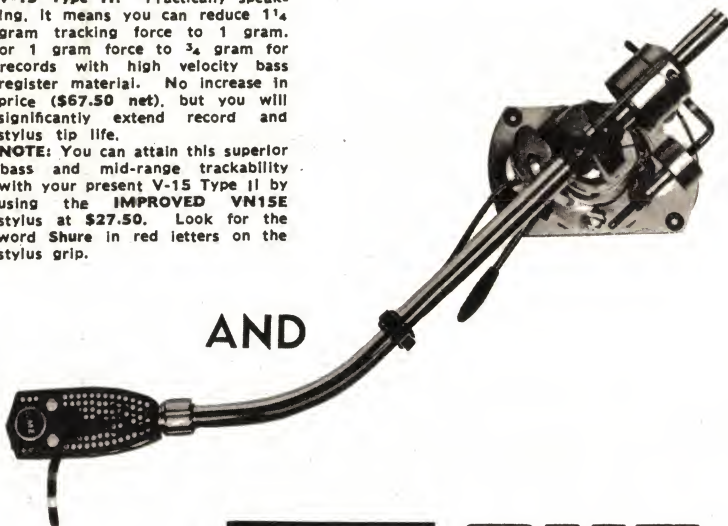
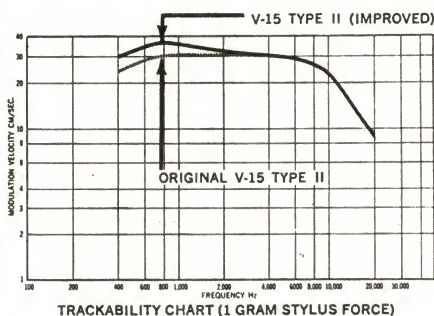

AND

**SHURE S.M.E**

## ... the best pick-up arm in the world

SHURE S.M.E. Precision Pick-up Arms offer all these features: ● Choice of arms length Model 3009 (9") or Model 3012 (12") for still lower tracking error—of special importance with elliptical styli ● Low inertia ● High precision ball races and knife-edge bearings for minimum pivot friction ● Linear offset chosen for lowest distortion ● Automatic slow-descent with hydraulic control ● Bias adjuster calibrated for tracking force ● Exact over-rand adjustment with alignment protractor ● Precise tracking force from 1/4-5 grams applied without a gauge ● Shielded output socket ● Low capacity 4' connecting cable with quality plugs ● Lightweight shell ● Camera finish in satin-chrome, gunblack and anodised alloy.

**MODEL 3009/S2 \$84.50\***

**MODEL 3012/S2 \$84.50\***

Contact your local Hi-Fi dealer or any of the following for more information:  
 N.S.W.: Audio Engineers, 342 Kent Street, Sydney.  
 O'LAND: Ron Jones Pty. Ltd., 7-9 Merton Road, Wollongabba, Brisbane.  
 VICTORIA: Audio Engineers (Vic.), 2A Hill Street, Thornbury, 44-3295.  
 W.A.: Athol M. Hill Pty. Ltd., 613-15 Wellington Street, Perth.  
 \* Recommended Resale Price.

sick Irishman, but this type of song seems to be, strangely enough, just as popular with those who would not know a shillelagh from a leprechaun, so I suppose there will be quite a few "strangers" buying this disc. They will find it very pleasant listening. (H.A.T.)

★ ★ ★

**CHORALES AND CHORALE PRELUDES FOR ADVENT AND CHRISTMAS.** King's College Choir, Cambridge; Andrew Davis, organ; David Willcocks, organ and conductor. A H.M.V. recording, released exclusively in Australia by World Record Club. Stereo S/4604.

Interest: See title.

Performance: Lightweight, but pleasing.

Quality: Good standard.

Stereo: Normal.

An interesting approach has been made to the selection of Bach chorales included here. First, a choir sings a verse of the chorale to "familiarise the listener with the melody" and then the organ plays the Bach work built upon it. To a modern listener, these are masterpieces, but it is perhaps not surprising to find in the sleeve note that Bach was censured by some churchmen, who said that he had "made many strange tones with them, so that the congregation was confused thereby." Pearls before swine? Perhaps, but we should also remember that it is only recently that the music of Mahler has received any degree of acceptance.

Twelve chorales are presented: Wachet Auf—Nun Komm' der Heiden Heiland—Allein Gott in der Hoh'—Christum Wir Sollen Loben Schon—Her Christ, der Ein'ge Gottes-Sohn—Vom Himmel Hoch—Lobt Gott, Ihr Christen—Jesu Mein Freud—Der Tag, der Ist so Freudenreich—Wir Christenleut'—Puer Natus in Bethlehem—In Dulci Jubilo. The famous King's College Choir, with its highly trained members, do not have much to do, but as always, they sing delightfully. The organ is a smallish sweet-toned affair, but no details are given of its stops and couplers. To judge by this rather lightweight performance, it has only limited resources. The interest in this case lies more with the music than with the organ, I feel. (H.A.T.)

★ ★ ★

**THE BEST OF LAURINDO ALMEIDO, Volume 2.** Laurindo Almeida, guitar. Capitol Stereo SP 8696.

Interest: Master guitarist.

Performance: Splendid.

Quality: Excellent.

Stereo: Not significant.

Having extracted great enjoyment from Album 1, issued a few months back, I was delighted to receive this second album of Laurindo Almeida. Although quite different in content, this disc is, in its own way, possibly even better than the first—although I should point out to intending purchasers that the interest is rather more specialised. In Album 1, Almeida was presented in a selection of popular light classics, mostly non-Spanish. Here the selection is either of Spanish origin, or of recent works composed especially for guitar (including one item by Almeida himself). Another difference is

## Apollo Mission

**MAN ON THE MOON.** Narrated by Walter Cronkite. Produced by CBS News. Mono, CBS, BP233712.

Interest: The project documented.  
Performance: Well planned.  
Quality: Communications.

When I prepared to play this record, I had more or less assumed that it would be a straightforward recording of the Apollo 11 mission. And with all its momentous import, one had seen the original TV coverage and replays so often that the urge to listen to the sound wasn't all that great.

In fact, this latest Moon album, expertly narrated by Walter Cronkite, embraces the whole of the U.S. space program which led up to Apollo 11. It recounts the early Soviet successes and the realisation that the U.S. was lagging in space rocket technology.

It records the personal plea of Dr

Werner Von Braun for a more ambitious approach to the space program, the recommendations of then Vice-President Johnson and the momentous announcement by President Kennedy of the target: Man on the moon in this decade.

The narration traces the evolution of unmanned and manned flights leading up to the Apollo program, itself punctuated by the tragic loss of three astronauts by fire.

And then the Apollo 11 mission itself, with narration and explanation linking the actual highlights. Despite earlier reservations, to listen was to recall the tension of those historic moments, heard and seen around the world in real time.

This is a record with which I have not the slightest intention of parting. I think you'll feel the same way when you've heard it. (W.N.W.).

that here all pieces are played straight, with no over-dubbing such as one found in the first album.

Side one begins with some of the better known Spanish works: Malaguena and Tango in D (Albeniz); and Spanish Dances Nos. 5 and 10 (Granados). If you do not recognise them by the titles, you will certainly know the tunes when you hear them. From here on, the pieces become more specialised and perhaps lesser known; Sacro Monte and Sevillana (Turin) — Tarantella (Castelnuovo-Tedesco) — Vals (Ponce) — Choro de Saudade (Barrios) — Invention in Two Parts (Almeido) — En Los Trigales (Rodrigo) — Prelude for Laurindo (Mancini) — La Coquette (George M. Smith).

Space does not permit individual notes on these pieces here, but each is described in the sleeve note, so that intending purchasers should make a point of reading the comments before purchasing, if in doubt about any of these numbers. In summary, I should say that this disc will be appreciated more by those who are able to appreciate the finer points of guitar playing, rather than those who appreciate the popular classics. (H.A.T.)

★ ★ ★

**JOHN OGDEN PLAYS POPULAR LISZT.** John Ogden, piano. His Master's Voice (E.M.I.) stereo OASD 2416.

Interest: See title.  
Performance: Brilliantly executed.  
Quality: Excellent sound.  
Stereo: Not significant.

There is surely no need to explain the aims of this disc — however, I question the inclusion of some of the pieces under the title "popular Liszt." Included here are: Etude d'execution transcendant apres Paganini — Hungarian Rhapsody No. 15 in A minor (Rakoczy March) — Polonaise in E major—Two Concert Studies (a) Wald-rauschen (b) Gnomenreigen — Liebes-traume, (a) No. 1 in A flat, (b) No. 3 in A flat—Concert Study No. 3 in D flat (Un Sospiro)—Valse Oubliee No. 1 —Harmonies poetique et religieuse, No. 7, Funerailles. Even the sleeve note admits that the Polonaises were never popular, and personally I have

my doubts about some of the others. However, these comments should not be allowed to detract from the qualities of this recital. John Ogden is rapidly acquiring a reputation as one of the most accomplished pianists of today. Not only does he have an assured technique, but also the ability to produce the kind of singing tone which makes his playing a joy to listen to.

He seems to be able to handle the most difficult passages in these very difficult pieces without strain. Yet despite this prodigious technique, he is not a flashy pianist — although here I would like to say that I did not enjoy his performance of the D flat study, which begins at white heat, and gradually subsides to the gentle reflective mood from which the piece has obtained its name of "The Sigh." Others may find this approach perfectly valid, but I prefer the slightly melancholy, nostalgic approach favoured by most pianists. In general, however, this is a splendid recital, featuring virtually faultless playing, and with recorded sound of the highest quality. (H.A.T.)

★ ★ ★

**THE SENTIMENTAL BLOKE**, by C. J. Dennis. Read by Peter O'Shaughnessy. Encore (E.M.I.). Mono only. OEX 9576.

Interest: Australian verse epic.  
Performance: Sounds authentic.  
Quality: Adequate.

I believe this reissue on E.M.I.'s \$2.50 Encore label to be the first low-price full recording of "The Sentimental Bloke." This being so, there should be many takers. I suppose most indigenous Australians will know the C. J. Dennis epic, telling of the Bloke's courtship of the fair Doreen, his wedding, subsequent fall from grace and bitter repentance, and the birth of "the Kid." The tale is simple enough, but his earthy philosophising and ripe language have delighted several generations of Australians. It is to migrants, especially those from Britain, that I recommend this disc. There is a fair chance that they will never have heard of the Bloke, and I can promise them an enjoyable experience.

Peter O'Shaughnessy's reading sounds

## COMPLETE HI-FI RADIOGRAM- TAPE RECORDER ALL IN ONE

MODEL TR9

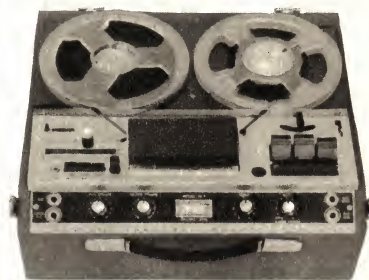

### AS AN AMPLIFIER . . .

- Frequency response, 20-20,000 cps.
- 7 Watts RMS. output per channel.
- Distortion less than .25%
- Separate treble and bass controls.

### AS A RADIO . . .

- Being fully transistorised, can be switched on all day at full output without heat problems. Program can be recorded on tape without any external connections.

### AS A TAPE RECORDER . .

- Freq. response 30-18,000 cps.
- Retractable Pinch wheel for easy threading
- Automatic Record switch
- 3 speeds. Meter level indicator.
- Push button operation.
- Superimposing.

### PRICES:

2 track mono, \$159.00  
4 track mono, \$169.00  
4 track stereo, \$230.00

RADIO TUNER CAN BE FITTED TO ANY MODEL OF THE ABOVE MODELS FOR \$28 EXTRA.

### TAPE DECKS

for the home constructor, complete with speed change switch wafers fitted . . .

2 tracks \$48. 4 tracks \$55

SPECIAL LOW IMPEDANCE HEADS for transistorised tape amplifier circuits (Mullard) available.

**Classic Tape Recorders**  
93B LIVERPOOL ROAD,  
SUMMER HILL, N.S.W.  
Telephone 79-2618

For the most **critical** listener—

# SONY® TC-630

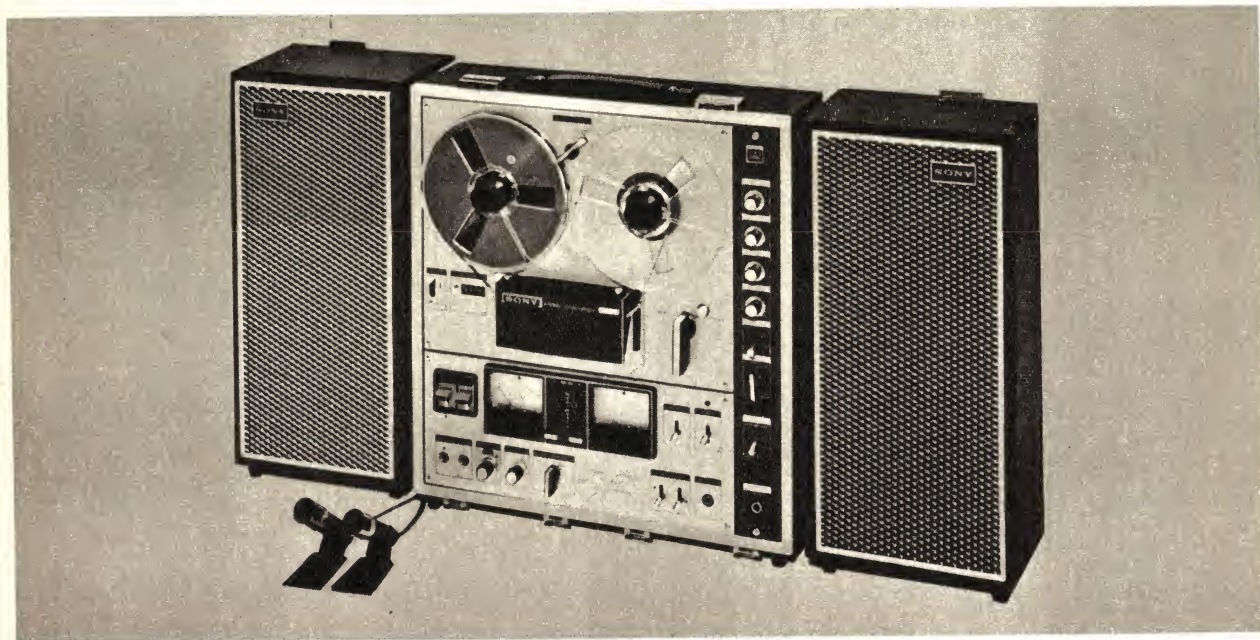

*3 heads, 3 speeds — Magnificent Sound Reproduction*

## FEATURES

- Versatility—functions independently as a tape recorder, amplifier and deck
- 3 heads—recording, playback and erasing
- Complete stereo music control centre with multiple inputs for phono, tuner, microphone and auxiliary
- 40 watt total power output, both channels (20 + 20)
- High precision solid state circuitry
- 160 kHz—high bias frequency
- Echo effect recording and sound-on-sound recording
- Two easy-to-read VU meters, noise suppressor
- 4 digits tape counter with reset button
- Sliding-type recording volume control, recording button for each channel
- Automatic shut-off switch, self-release instant stop
- Two lid speakers, and jacks for external speakers—speaker switch for P.A.
- Two headphone jacks: fixed and variable sound level monitoring
- Flexibility of vertical or horizontal operation
- Compact in size and professional in performance.

# SONY®

Distributed by:

## JACOBY & MITCHELL

SYDNEY • MELBOURNE • BRISBANE • ADELAIDE

## SPECIFICATIONS

**Recording systems:** 4 track stereo/mono recording playback

**Reel capacity:** 7" or smaller

**Frequency response:** 30-22,000 Hz at 7½ ips  
30-13,000 Hz at 3¾ ips  
30-10,000 Hz at 1⅞ ips

**Bias frequency:** 160 kHz

**Flutter and wow:** 0.009% at 7½ ips  
0.12% at 3¾ ips  
0.16% at 1⅞ ips

**Power output:** 15 watts RMS per channel

**Signal to noise ratio:** 50dB

**Dimensions:** 17¾" x 20" x 11⅝"

**Weight:** 46 lbs. 3 oz.

To: Jacoby, Mitchell & Co. Pty. Ltd., 469-475 Kent St., Sydney, 2000.  
Please send me information on Sony Tape Recorders and nearest Sony retailer.

NAME .....

ADDRESS .....

JMS/6-69 EA370



authentic enough for the most part, and only occasionally his pronunciation allows the accents of the educated Australian to show through. If you have not yet acquired a recording of "The Sentimental Bloke" for your collection, it is an opportunity not to be missed. (H.A.T.)

## Popular Jazz

**"KING OF THE SAVOY" — CHICK WEBB (Volume II), Festival Jazz Heritage Series (Calendar) stereo SR66-9653 (also available in mono).**

Interest: Great band of the thirties. Performance: Very valuable and enjoyable.

Quality: Well transferred.

Stereo: Electronically rechanneled.

This re-issue, on the \$2.95 Calendar label, represents the second volume by Chick Webb in Festival's Jazz Heritage Series. Like all the albums in this series the material is derived from the catalogues of American Decca. Volume One of the Chick Webb Band was reviewed in the December, 1969, issue.

Although Volume One was the better album musically, containing tracks from the period 1929 to 1936, this album is still most enjoyable. The earliest tracks date from the period when Ella Fitzgerald's singing was becoming rather more important (commercially) than the band itself. Nevertheless, the Chick Webb Band was still resident in the Savoy Ballroom in Harlem during this period and its tremendous swing and appeal for dancers can be heard on the 14 tracks. Four Ella Fitzgerald vocals are included, "The Dipsy Doodle" and "Hallelujah" (1937), the famous "A-Tisket A-Tasket" (1938) and "Undecided" (1939). We also get some flag-waving drum work by Webb on ar-

rangements like "Clap Hands," Liza" and "Harlem Congo." Although the arrangements are a shade less interesting than on the first volume, there are some wonderful moments from Sandy Williams, Bobby Stark, Taft Jordan and Ted McRae.

Stanley Dance's sleeve notes are of considerable interest and assistance, particularly to younger collectors who are unfamiliar with the music of the Chick Webb Band. Of the two Chick Webb L.P.s, I would recommend Volume One before this L.P. but, given the lack of Webb material which is available at the present time, most big band collectors will certainly wish to purchase both volumes. (T.F.C.).

★ ★ ★

**"KANSAS CITY PIANO" — Count Basie, Pete Johnson, Jay McShann, Mary Lou Williams, Festival Jazz Heritage Series (Calendar) stereo SR66-9654. Also available in mono.**

Interest: Four great pianists, 1936-41.

Performance: Magnificent throughout.

Quality: Well recorded and remastered.

Stereo: Electronically rechanneled.

As I said in my review of this album when it was originally released, "it has given me as much pleasure and musical satisfaction as any in the past year or so." In the 12 months since then, repeated playings of this album have merely served to enforce that first opinion.

The Basie tracks are, without doubt, minor jazz classics; and the tracks by Pete Johnson, Jay McShann and Mary Lou Williams are first-rate examples of the style of piano-playing which emerged from Kansas City in the late 1930s.

## The Living Shakespeare

**THE TAMING OF THE SHREW** by William Shakespeare. With Peter O'Toole as Petruccio, and Sian Phillips as Kate. The Living Shakespeare series, issued by World Record Club. Mono.

Interest: Shakespeare "digest."

Performance: Excellent.

Quality: Good sound, quiet surfaces.

One's judgment of what is "good Shakespeare" can be coloured so much by what one has heard and seen before that it is hardly safe to offer criticism of individual performances. Actors strive for their own individual interpretation of the roles they play, and if one has heard a particular performance of a play which gave special pleasure, the temptation exists to judge all other performances against this standard. For this reason, I will not attempt to comment on the individual performances here, beyond saying that the acting throughout is of a high order. Instead, I will deal with the aims of the Living Shakespeare series, and try to indicate the degree of success obtained.

The main aim is to present shortened versions of the major works of Shakespeare, using top-ranking actors. In editing, the intention has been to preserve

the story line, to maintain the interest, and to eliminate soliloquies and humorous sidelights which, while interesting in themselves, and even representing some of the glorious Shakespeare verse, can be omitted without detriment to the plot. This has a similarity to the technique used in Reader's Digest Books, and the results are something similar. The idea will appeal mainly to those who, for various reasons, do not want the complete versions of the plays (even assuming they were available. In the case of the present disc, the story line has certainly been maintained, but the editing leaves one with a slight feeling of breathlessness, as the plot rushes on from one situation to the other, without pause.

Where the series will be particularly valuable is in educational establishments, where students are being introduced to the great works of English literature. Adult readers interested in gaining an insight into the Shakespearean works, without wanting to get too deeply involved, will also find this series worth investigating. On the other hand, those who already know their Shakespeare, and want to listen to the plays occasionally, may not be entirely satisfied by these shortened performances. (H.A.T.)

The Basie tracks, four of the ten which he recorded for Decca in 1938-39 with Freddie Green, Walter Page and Jo Jones, show him at the peak of his form. Aside from being the complete band pianist, Basie has one of the most satisfying solo piano styles in jazz.

Two of the three tracks by Mary Lou Williams were recorded in 1936 while her fascinating version of Morton's "The Pearls" comes from a 1938 session. Her direct, down-to-earth approach on "Overhand" and "Clean

(Continued on page 130)

**If you want**  
**STEREO**  
**EQUIPMENT**  
**You'll deal better with**  
**H. B. RADIO SALES**

**MARCH SPECIALS**

**KENWOOD TK250 AMPLIFIER/** 2 Wharfedale unit 3 speaker systems. Dual 1019 player on platform, Shure magnetic . . . . . \$398.00  
**KENWOOD 150 AMP,** 2 Magnavox 10in speaker systems in Teak Garrard AT60 on platform, with Shure M44G . . . . . \$275.00  
**SANSUI 555 2** Wharfedale Super 10 speakers in R3 teak cabinets, Dual 1019 player, Shure M44G, platform and cover . . . . . \$465.00  
**MONARCH SA 500, 20W RMS—** Low and High Filter controls. 2 Peerless 10in speaker systems. Dual 1210-Shure M44G-platform-cover. \$312.00.

**SPEAKER UNITS**  
**PLAYMASTER, complete** . . \$31.00  
**Cabinet Kit and Parts** . . \$24.20  
**POINT 4, complete** . . . . \$35.00  
**Cabinet Kit and Parts** . . \$25.00  
**PLAYMASTER SUPER** . . . \$42.00  
**Cabinet Kit and Parts** . . \$32.50  
**WHARFEDALE Unit 3**  
(large) . . . . . \$54.00  
**Cabinet Kit and Parts** . . \$44.00  
**MAGNAVOX 8WR, 1.6 cf** cabinet . . . . . \$30.50  
**Cabinet Kit and Speaker** . . \$21.00  
**MAGNAVOX 10WR and 3TC,** complete . . . . . \$43.00  
**Cabinet Kit and Speakers** . \$31.00  
**MAGNAVOX 12WR, 3TC, complete** . . . . . \$44.50  
**Cabinet Kit and Speakers** . \$33.00  
**PEERLESS 10in 2cf cabinet** . \$57.50  
**Cabinet Kit and Speaker** . . \$47.00  
**W'DALE GOLD, 10 in R3** cabinet . . . . . \$65.00  
**Cabinet Kit and Speaker** . . \$52.00  
**Special quotes for other speakers.**  
*Available in Maple, Walnut or Rosewood colours. Teak veneer \$1 extra for Slimline and Bookshelf KITS. \$2.50 extra for other KITS.*

**Packing charge \$1 per order.**  
**Freight payable on delivery.**  
**Send for Stereo Catalogue**

**H. B. RADIO SALES**  
Established 37 years.  
105 Catherine Street,  
LEICHHARDT, SYDNEY.  
Telephone: 56-5580.

**AMPLIFIERS — PREAMPLIFIERS — TUNERS — CONTROL UNITS —  
GUITAR UNITS — INSTRUMENTS — INVERTERS — CONVERTERS —  
RECEIVERS — TRANSMITTERS — REGULATED POWER SUPPLY —  
TRANSISTOR AND VALVE TYPES.**



## THE "MUSICOLOUR" KIT

OPERATE A COLOUR LIGHT SYSTEM FROM YOUR AMPLIFIER

FULL KIT OR INDIVIDUAL PARTS

### POPULAR KITS - TOP QUALITY - LOWEST PRICES

**INSTRUMENTS C.R.O.**

- 1. Sin wide range.
- 2. 1963. 3in cal.
- 3. Audio.
- 4. 1966. 3in.
- 5. 1968—Audio.
- 6. Electronic SW.
- 7. W/band Preamp.
- MULTIMETERS and V.T.V.M.'s**
- 8. 20K ohm/Volt protected M/M.
- 9. Probe for above.
- 10. Protected D.C. M/M.
- 11. Meterless V/meter.
- 12. A.C. Millivoltmeter.
- 13. A.C. Solid State Millivoltmeter.
- 14. Solid State A.F. Millivoltmeter.
- 15. Noise Distortion Millivoltmeter.
- 16. Standard V.T.V.M.
- 17. 1966—V.T.V.M.
- 18. 1968—V.T.V.M.

**BRIDGES**

- 19. Standard R/C.
- 20. 1966. R/C.
- 21. 1968 R/C and Signal Injector.
- TV INST.'s**
- 22. Sweep and marker Generator.
- 23. Dual sweep Gen.
- 24. Silicon diode sweep Gen.
- 25. Silicon diode noise Gen.
- 26. Pattern Gen.
- 27. Trans. pattern Gen.
- 28. Wide range pulse gen.

**AUDIO INST.'S**

- 29. 1960 Audio Osc.
- 30. 1962 High perf. audio Gen.
- 31. Crystal locked std.
- 32. Electronic tuning standard.
- 33. 1965. Solid State audio osc.
- 34. Direct reading A.F. meter.
- 35. Sq. wave Gen.
- 36. 1967 transistor audio Gen.
- 37. Additive frequency meter.
- 38. A.F. tone burst gen.
- 38A. 1968. Solid state A.F. Generator.
- R.F. INST.'s**
- 39. 6-band service oscillator.
- 39A. Trans. wave meter.
- 40. "Q" meter.
- 40A. Crystal Calibrator—Solid state.

- 40B. 1969 Dip Osc.—Solid state.
- 41. G.D.O. wide range.
- 42. G.D.O. adaptor.
- 43. Trans. service osc.
- 44. Simple signal Injector.
- 45. Transistorised signal tracer.
- 46. Transistorised osc.
- 47. Basic test osc.
- 48. Transistor test oscillator.

**MISCELLANEOUS INST., ETC., KITS**

- 49. 1960 Trans. Tester.
- 50. 1968 Transistor test set.
- 51. Valve and Transistor tester.
- 52. Electronic Stethoscope.
- 53. Moisture alarm.
- 54. Electronic Pistol range.
- 55. Transistor Gelser Counter.
- 56. Light beam alarm.
- 57. Burglar alarm.
- 58. Flasher unit.
- 59. Transistor alarm.
- 60. Electronic switch.
- 61. Photo Timer.
- 62. Direct reading Impedance meter.
- 63. Electronic anemometer.
- 64. S.W.R. Indicator.
- 65. Simple proximity alarm unit.
- 66. Pipe and wiring locator.
- 67. Electronic metronome.
- 68. Monophonic organ.
- 68A. Keyless organ.
- 68B. Theremin.
- 68C. Laser unit.
- 68D. Color organ.
- 68E. Stereo Headphone Adaptor.

**BATTERY CHARGERS**

- 69. Universal unit.
- 70. 1 amp unit.

**REGULATED POWER SUPPLIES**

- 71. Transistor. 9v.
- 72. Transistor, fully protected supply.
- 73. 1966 H.T. unit.
- 74. 1968 lab. type, D-30v. supply.
- 74A Simple Pwr. supply.

**VOLTAGE/CURRENT CONTROL UNITS**

- 75. Vari-watt unit.
- 76. Vari-tach. motor speed control.
- 77. 2KW auto-light dimmer.
- 78. 4KW auto. light dimmer.
- 79. Model train control unit.
- 79A. Vari Light Dimmer.

- 80. Model train control unit with simulated inertia
- 81. Above-hi-power.
- 82. No. 81 with simulated inertia.

**TACHOMETER UNITS**

- 83. 6 or 12v Std.
- 84. 6 or 12v Mullard.
- 85. 6 or 12v with dwell angle.
- 86. Tachometer and dwell angle unit for service stations.

**TRANSISTOR IGNITION**

- 87. Ro-Fl. 6 or 12v.
- 88. Hi-Flre 6 or 12v. (transformer).

**POWER CONVERTERS**

- 89. D.C.—D.C. 60w.
- 90. D.C.—D.C. 40w.
- 91. D.C.—D.C. 40w. 12v—Input.
- 92. D.C.—D.C. 70w 12v—Input.
- 93. D.C.—D.C. 100w 12v—Input.
- 94. D.C.—D.C. 140w. 24v—Input.
- 95. D.C.—D.C. 225w. 24v—Input.

**HIGH FIDELITY AMPLIFIERS MONO UNITS**

- 96. Hi-Fi 3.
- 97. Mullard 3.3.
- 98. Mullard 5-10.
- 99. Mullard 5-10 transistor.
- 100. Transistor 20w.
- 101. Transistor 60w.

**STEREO UNITS**

- 102. Mullard 2-2.
- 103. Mullard (v) 3-3.
- 104. Mullard (t) 5-5.
- 105. Mullard (t) 5-5.
- 106. Mullard (v) 10-10.
- 107. Mullard (t) 10-10.
- 108. Philips Twin 10.
- 109. S.T.C. 10-10.
- 110. Wireless world transistor 20-20.
- 111. Hi-Fi 60 Plus 60. P/M. 128.
- 112. Playmaster 2-2.
- 113. Playmaster 3 plus 3.
- 114. Playmaster unit 3.
- 115. Playmaster unit 4.
- 116. Playmaster 10 plus 10
- 117. Playmaster 101.
- 118. Playmaster (t) 105.
- 119. Playmaster (t) 113.
- 120. Playmaster (t) 115.
- 121. Playmaster (v) 118.

**P.A. UNITS**

- 122. 10 watt std.
- 122A. Mullard 20w. Solid state.
- 122B. Mullard 40w. Solid state.

- 123. 25 watt std.
- 124. 35 watt std.
- 125. 30 watt (t).
- 126. 100 watt std.
- 127. stereo P.A.

**GUITAR UNITS**

- 128. 10 watt std.
- 129. 25 watt std.
- 130. 35 watt std.
- 131. 50 watt std.
- 132. 70 watt (t).
- 133. Playmaster 102.
- 134. Playmaster 103.
- 135. Playmaster 40w 118.
- 136. Playmaster 60w 117.
- 137. Guitar fuzz box.
- 138. Guitar Waa-Waa.
- 139. Reverb unit.
- 140. Guitar preamp.
- 140A. Guitar 50w. Solid State P/M 125.

**STEREOGRAMS**

- 141. Playmaster 105.
- 142. Playmaster 106.
- 143. Playmaster 107.
- 143a Playmaster 124.

**CONTROL UNITS**

- 144. Playmaster No. 9.
- 145. Playmaster No. 10.
- 146. Playmaster No. 104.
- 147. Playmaster No. 112.
- 148. Playmaster No. 120.
- 149. Mullard 2v.
- 150. Mullard 3v.
- 151. Philips Miniwatt.
- 152. P/M 127.

**PREAMP UNITS**

- 153. Transistor—Mono.
- 154. Transistor—Stereo.
- 155. Transistor—Silicon mono.
- 156. Transistor F.E.T. mono.
- 157. Transistor dyn. mic. mono.
- 158. Above-Stereo.
- 159. Playmaster 115 F.E.T. Stereo.
- 160. Playmaster 118 mag.
- 161. Sound projector.

**MIXER UNITS**

- 162. Trans. 4 ch. (1966).
- 163. Trans—4 ch. (1967).
- 164. Valve—4 ch.

**TUNER UNITS**

- 165. Playmaster u/style.
- 166. Playmaster No. 11.
- 167. Playmaster No. 114.
- 168. Playmaster No. 122.
- 169. Playmaster No. 123.
- 170. Philips Miniwatt.
- 180. Trans.—Long range.

**TAPE UNITS**

- 181. Trans. Preamp.
- 182. Playmaster 110 (M).
- 182. Playmaster 110 (S).
- 183. Power Unit 110.
- 184. Adaptor 110.
- 185. Playmaster 119 Adaptor.
- 186. Transistor V.O.X.
- 187. Tape Actuated relay.
- 188. Mullard Trans Tape Amp.

**RECEIVERS**

- 189. Fremodyne 4.
- 190. Fremodyne 4 R.F. Sock only.
- 191. Synchrodyne.
- 192. Communications RX.
- 193. Deltahet RX.
- 194. 3 Band Double Change 5/het RX.
- 195. Explorer VHF Transistor RX.
- 196. Interceptor 5 Semi-Comm. RX.

- 197. 1967 All-Wave 2
- 198. 1967 All-Wave 3
- 199. 1967 All-Wave 5
- 200. 1967 All-Wave 6
- 201. 1967 All-Wave 7
- 202. Transporta 7
- 203. Transistor 8 3 Band.
- 204. 3 Band 2V RX.
- 205. 3 Band 3V RX.
- 206. Interstate 5
- 207. Versatile Mantel Set.
- 208. All-Wave Transistor 3
- 209. A.B.C. 3
- 210. 1968 F.E.T.
- 210a. I/C TRF Rx.
- 210b. R.F. Preamp.
- 210c. "Q" Multiplier.
- 210D. 1970 Communications. Solid state.

**TRANSMITTERS**

- 211. 144 MHZ 50W. Linear Final.
- 212. 144 MHZ 20W.
- 213. 144 MHZ 75W.
- 214. 144 MHZ 18W.
- 215. 144 MHZ S.S.B.
- 216. 3 Band A.M.
- 217. Basic 3 Band.
- 218. 5 Band S.S.B.
- 219. 1967 S.S.B.

**CONVERTERS**

- 220. 50 MHZ.
- 221. 144. MHZ.
- 222. 50 and 144 MHZ Crystal Locked.
- 223. 1965 S/W.
- 224. 1965 S/W 2 Band.
- 225. 1966 3 Band.
- 226. Basic S/W.
- V.F.O. UNITS
- 227. Remote Unit.
- 228. 7, 8 and 9 H.F. and V.H.F.
- 229. All transistor.

Phone 63-3596

**E. D. & E. (SALES) PTY. LTD.**

Phone 63-3596

232 FLINDERS LANE, MELBOURNE, VICTORIA 3000

**K  
I  
T  
S**

Public Address Units — Geiger Counters — Metal Locators — Decade Boxes — Mixers — Battery Chargers — Oscillators — Bridges — Parts Supplied for Projects in Electronics (Aust.), Wireless World, Practical Wireless, Electronics World, Electronics Illustrated, Practical Electronics, etc.

**K  
I  
T  
S****STEREO 60W + 60W R.M.S.**

P/M  
128  
JAN, 1970.

1968 Solid State. V.T.V.M.  
ELECTRONICS (Aust.), Dec., 1968.

**BATTERY CHARGER 1A**  
ELECTRONICS (Aust.), Feb., 1966



**PLAYMASTER 116 and 117  
and 125 GUITAR AMP.**

Electronics Australia  
June 1967 — 40 watt  
July — 1967 60 watt  
July 1969 — 50 watt

**3-BAND SHORT-WAVE CONVERTER**  
ELECTRONICS (Aust.), May, 1966.

**LAB QUALITY**

Regulated Power Supply (0-30v)  
ELECTRONICS (Aust.), Sep-  
tember, 1968.

1966 R/C Bridge  
May, 1966.



**PUBLIC ADDRESS and  
GUITAR AMPLIFIERS**

10, 25, 50 and 100 watt  
units



**3-BAND DOUBLE-CHANGE RECEIVER**  
ELECTRONICS (Aust.), April, 1966.

1966 3In CRO  
ELECTRONICS (Aust.), May, 1966.

Playmaster 122  
Program Source.  
Electronics (Aust.),  
August, 1968.



**FOUR-CHANNEL AUDIO MIXER**  
ELECTRONICS (Aust.) Feb., 1966 & 1967

**3-BAND 3-RECEIVER**  
ELECTRONICS (Aust.), Nov., 1966.

**TRANSISTOR MILLIVOLT  
METER**

Electronics (Aust.),  
May, 1968.



**1970 - COMMUNICATIONS RECEIVER - 240  
SOLID STATE**



**FULL KIT  
OR PARTS ONLY**

**MAJOR STOCKISTS OF ALL GENERAL RADIO & ELECTRONIC COMPONENT  
PARTS -- YOU NAME IT -- WE WILL QUOTE**

VALVES — TRANSISTORS — ZENER & POWER DIODES — SEMI-CONDUCTORS  
— DIACS — TRIACS — S.C.R.'S. — I/C'S. SPEAKERS — MICROPHONES —  
COILS — IFT'S. TRANSFORMERS — INST CASES — METALWORK. PLAYERS  
& CHANGERS — METERS — RELAYS — CONDENSERS — RESISTORS — BEZELS  
— STYLII — CARTRIDGES — RECORDING TAPE — PROBES — INSTRUMENTS  
— POTENTIOMETERS — CRYSTALS — FERRITE BEADS — CORES — BALUNS  
— TERMINALS — CO-AXIAL PLUGS & SOCKETS — MULTI CONNECTORS —  
PRINTED CIRCUIT BOARDS — COPPER WINDING WIRE — ETC. — ETC. —

Phone 63-3596

**E. D. & E. (SALES)  
PTY. LTD.**

Phone 63-3596

232 FLINDERS LANE, MELBOURNE, VICTORIA 3000

BUY RIGHT... FROM ENCEL

# LUX... the amplifier

that is unequalled  
for  
Value  
Quality  
Performance



SQ-77TW

Frequency response: 10-50,000 Hz  $\pm$  3dB. Output: 30 watts (RMS) per channel. Input sensitivity: 1.8mV, aux. inputs 200mV and 800mV. Controls: stereo volume, stereo balance, mode switch, separate bass and treble, input selection. Also: headphones and tape recorder jacks. Tape monitor switch, rumble and scratch filter switches.

Extracts from reviews of SQ77-TW "Hi-fi Sound," Feb. 1969.

Both design and constitution reach very high standards." "After running the amplifier for several weeks in a typical domestic environment with all sorts of signals and sources and not encountering any troubles . . . I have no hesitation in voting this one of the most worthy amplifiers I have tested for a long time."

Price (including sales tax) \$169



SQ-1220

Over 10 watts RMS total output. 40 transistors and diodes. Frequency response 10-50,000 Hz  $\pm$  1dB. Separate bass and treble controls for each channel; high and low filters; frequency selectors, tape recorder facilities. Produces high quality distortion free sound. Write for review.

Price (including sales tax) \$350

Extracts from review of SQ-1220 in "Hi-fi News," January, 1969.

"Here is an amplifier of Japanese origin which conforms very closely (on some counts, better!) to the published specifications.

"The amplifier was run for several weeks under domestic conditions with a wide range of programme sources, pick up cartridges and speakers and at all times it performed perfectly and without flaw." "Nice to look at, nice to use and very well made and designed. I rate Lux SQ-1220 a top-of-the-class amplifier which I am sure will hold its own with the best of the other class B designs now available."



SQ-505

A silicon transistor unit with output of over 30 watts (RMS) per channel. Frequency response: 10-50,000 Hz  $\pm$  1dB.

Input sensitivity: 1.8mV (aux. inputs 200mV and 800mV). Controls: stereo volume, stereo balance, mode switch, separate bass and treble controls, input selection, phone and tape jacks, rumble and scratch filters etc.

Price (including sales tax) \$269

Write for full, unaltered reviews of these amplifiers.

AUSTRALIA'S LOWEST PRICES

# ENCCEL

ELECTRONICS (STEREO) PTY. LTD.

Head Office: 431 Bridge Rd., Richmond, Victoria. 3121. Tel. 42 3762

Sydney Store: Ground Floor, 25M Building, 257 Clarence Street, Sydney, N.S.W. 2000. Tel. 29 4563, 29 4564.

Australia's Greatest Hi-Fi Centre ■ Wholesalers ■ Trade-ins accepted ■ Terms

(Continued from page 127)

Pickin'" shows the influence of Earl Hines and the Kansas City boogie pianists.

Pete Johnson was, I think, the greatest boogie pianist of all. His four tracks come from one session in 1941 and they include the famous "Basement Boogie" and "Death Ray Boogie" in addition to "Just for You" and "Pete's Mixture."

Jay McShann was (and still is) a superb pianist, very much in the Basie mould. The three tracks (all written by himself) are "Vine St. Boogie," "Hold 'Em Hootie" and "So You Won't Jump" which were recorded in 1941. They are excellent examples of his solo piano and, in addition, they feature the splendid rhythm section of Gene Ramey and Gus Johnston.

I hope I have made it clear that this album is highly recommended—indeed indispensable. Nat Pierce's sleeve notes are suitably constructive and the album plays for 40 minutes. (T.F.C.)

★ ★ ★

"RARE ITEMS" — LOUIS ARMSTRONG. Festival Jazz Heritage Series. (Calendar) stereo SR66-965 (also available in mono).

Interest: Armstrong trumpet and vocals, late thirties.

Performance: Generally excellent.

Quality: Bright recordings, well transferred.

Stereo: Electronically re-channelled.

This album is another of the Festival Jazz Heritage Series reissued on Calendar at the much more realistic price, \$2.95.

As I suggested in my original review of this album, I would be more than happy to argue that the majority of Armstrong's finest trumpet solos were recorded in the mid-thirties. Apart from some superb trumpet playing on every track, 11 of the 14 tracks contain splendidly typical Armstrong vocals.

This particular set, which was recorded between 1935 and 1944, is not quite the pick of his work in this period, but it is a most rewarding and enjoyable album. It should, I suggest, be played in conjunction with the Armstrong thirties' material which has been made available in Australia on the excellent Swaggie albums.

The backings, by what was substantially Luis Russell's Orchestra, are excellent and both Charlie Holmes and J. C. Higginbotham make occasional appearances for brief but very telling solos.

The pick of the tracks for me are "Thanks a Million" (1935), "Ev'ntide" and "Thankful" (1936) and "Jubilee," "Struttin' With Some Barbecue" and "It's Wonderful" (1938).

I care rather less for the three tracks made in the early forties, "Everything's Been Done Before," "Hey Lawdy Mama" and "Groovin'" but the last named is a previously unissued 1944 recording.

Dan Morgenstern's sleeve-notes are sympathetic and helpful, but, unfortunately, full recording details are not given. The playing time is 41 minutes and, particularly at the bargain price of \$2.95, it should find a ready space in the shelves of any collector who is interested in Louis Armstrong. (T.F.C.)

# TRADE REVIEWS AND RELEASES

## ADVANCE 15MHz TIMER-COUNTER

The Advance Timer Counter TC11 is a recent addition to the range of digital instruments manufactured by Advance Electronics Ltd. It is intended for the measurement of frequencies up to at least 15MHz. Making extensive use of integrated circuits, the number of components has been reduced considerably from that of previous models while increasing the standard of performance.

Although the frequency range of the TC11 is quoted as 15MHz minimum, typical samples will function reliably well above this figure. The sample instrument we had for review operated reliably up to 20MHz. The exact figure would depend on the input amplitude. A three-position slide switch provides input sensitivities of 10mV, 100mV or 1V. The input impedance is 1 megohm shunted by 18pF, making it suitable for use with typical oscilloscope probes. The input is protected from damage against any likely overload. Two other inputs are provided for start and stop signals which are operative on time and count functions only.

The number of digits in a frequency measurement can be extended beyond the readability capability of four by taking two measurements, one to obtain the most significant digits and another to obtain further digits while overspilling the first significant digits. In this way, resolution down to 1Hz may be obtained but, for accuracy greater than one part in 100K, an external frequency standard must be used.

The major part of the circuitry, apart from the input amplifier, is accommodated on two printed boards measuring approximately 7 x 7½ inches. The input amplifier contains nine discrete transistors and is accommodated on a small, shielded printed board adjacent to the input sockets and attenuator.

The upper board, which hinges out for convenient servicing, accommodates the timebase circuitry. The internal standard is 100KHz crystal oscillator in the Pierce configuration. It is set to within one part of 100K and typical stability is 3 parts in 100K for the range from 10 to 40 degrees Centigrade. The drive from the oscillator is fed via squaring circuitry to integrated circuit decades which divide the frequency down in stages of 10 to 1Hz, giving gating times from 0.1 millisecond to 1 second.

There is a check position in which the instrument counts its own clock signal over 1 second, giving a reading of 9999, 0000 or 0001 if everything is as it should be.

A jack is provided on the rear panel to enable an alternative time standard to be used. This may be a sinusoidal source at any frequency between 10KHz and 2MHz with an amplitude between 0.5V and 10V RMS or a suitable pulse source from 10Hz to 2MHz at 1V to 20V peak to peak.

Frequency ranges are Hz, Hz x 10,



Hz x 100, KHz and KHz x 10. Multiple period measurements may be made from 10 to 100K selected in decade steps over a frequency range from 2Hz to at least 100KHz. Time period measurements may be made with ranges identical to that for multiple periods with single or two line operation between any of the three inputs. Similar provisions are made for event counting, the counting period being controlled by push-buttons on the front panel or external signals.

The display consists of four neon numerical indicator tubes behind a red tinted filter which results in bright clear display which is easily viewed under high

ambient light conditions. The decoding and indicator tube driving circuitry is comprised of integrated circuits which give increased reliability and reduce the number of components considerably.

The display time is continuously variable from less than 0.1 sec. to at least 4 seconds or may be held indefinitely by switching to the hold position. The display may be reset by push button or external reset.

Data output is available from pins on the Display printed board in 8421 BCD code. Outputs are high impedance, unbuffered.

The TC11 may be operated from 45-60Hz AC mains supplies, having voltages from 100-125V or 200-250V. Power con-

sumption is 25 watts. External dimensions of the instruments are 11½ x 5½ x 9-7/8 inches, weight is 10½lb and the case is finished in blue-grey vinyl-coated steel with a white front panel.

Examined and tested in our laboratory the sample TC11 gave every indication of being a well-designed and reliable instrument. Its performance comfortably met the manufacturer's specification and it appears to be very good value for money at the price of \$360 plus tax. Australian distributors of Advance equipment are Jacoby, Mitchell and Co. Pty. Ltd., 469-475 Kent Street, Sydney, to whom all inquiries should be directed. (L.D.S.)

## OPTRONICS AUDIO MIXER AT GTV-9

The Studio 2 audio mixer at GTV-9, Melbourne, supplied by Optronics Pty. Ltd. has 22 input channels, 12 being microphone inputs and 10 being high level inputs. Four of the high level inputs are fed via a 20-input 4-output electrically interlocked relax matrix. Two of the high level matrix channels enter the main mixing bus via equalisers which provide a 12dB/octave slope and a maximum boost or cut of 20dB. Four low frequency and three high frequency turn-over points can be selected by panel switches.

The relay matrix is constructed on a double-sided printed circuit board of epoxy glass supported on a hinged aluminium U-channel frame. Operation of the matrix is via four rows of 20 illuminated push buttons. A fifth row of push buttons provides pre-fade facility, while a sixth row of lamps serves as cue indicators.

Four line level outputs are provided as

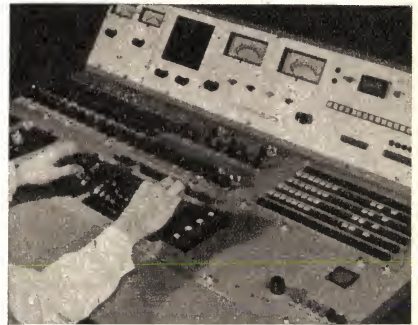

follows: Main, as primary program output; Auxiliary, as secondary isolated output; P.A., to feed public address facilities; Foldback, to feed foldback facilities to live performers. Dual main amplifiers are provided, with a manual front panel selector and illuminated indicator. Monitoring facilities are derived from 20 electrically interlocked push buttons. One input to this row is from a 24-position rotary selector. A 30W high-quality internal monitor amplifier feeds an external loudspeaker.

Dual, automatic changeover, power supplies are incorporated for no-break changeover if a power supply fault should occur. A front panel override key is provided. (Optronics Pty. Ltd., 62 Berkeley Street, Huntingdale, Vic. 3166.)

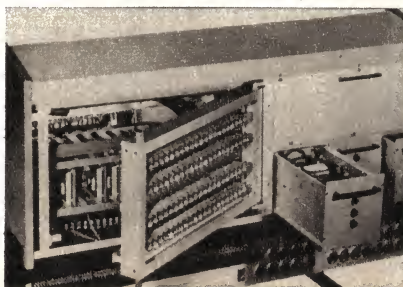

# UHER

Made in Western Germany

The World's Most Reliable Name for Precision Taperecorders

by

# ATRAM PTY. LTD.

## ACTION AND SOUND

with the



**UHER Royal Deluxe**

Royal Stereo Deluxe — a complete Home Studio Variocord 23/263 Stereo with exclusive tape comperator drive.

4000 Report L, the most successful reporters recorder.

4200/4400 Stereo, the world's smallest hi-fi stereo recorder.

the finest combination ever

**NEW BREED** styled

**UHER BANDRECORDER**

Stereo Home Studio of the ultimate hi-fi class. 20 watts rms. push/pull output by separate amplifier. Fully transistorised—4 or 2 track operation (stereo) 4 speeds—4 heads — A & B monitoring — 4 amplifiers — 11 exclusive recording functions operated by one control. All new tape comperator drive system—dial pilot—echo sound mixing—frequency response 20-20,000 cps at 7½ ips. Can be hung on wall.

BE SURE USE

# UHER

Your **NEXT** Choice

# john border

Distributed by

# ATRAM PTY. LTD.

Available from:

Dungate Lane — George Street  
Liverpool Street — Martin Place

5 McLaren Street,  
North Sydney  
92-4177

## The World's Most Versatile Circuit Building System!



1/8 in.  
3.2 mm

# Cir-kit

### INSTRUCTIONS

Remove paper backing and place adhesive side downwards in the selected position. Press down firmly. When used with plain board drill from the 'Cir-Kit' side. Pass through component lead, bend over and cut to length. Solder in usual way.

When used with 'punched' board lay strip between rows of holes, pass component leads through holes adjacent to strip, bend the leads over the strip, cut to length and solder in the usual way. Alternatively lay strip over the holes and using a drawing pin or scribe prick a hole in the 'Cir-Kit' in the required position.

'Cir-Kit' strip can be bent or curved to whatever form you require and used on either or both sides of the board. When joining two pieces of 'Cir-Kit' bend over the end of the overlapping strip so that a metal to metal contact is made and solder in the usual way.

Made in the U.K.

THE WORLD'S MOST VERSATILE CIRCUIT-BUILDING SYSTEM

**SIZES: 1/8" and 1/16" WIDTHS**

**LENGTH: 100ft. roll, 5ft. CARD**

IDEAL FOR PROTOTYPE AND PRODUCTION CONSTRUCTION

USEFUL FOR WIRING REPAIRS

☆ **NO DRILLING** ☆ **FAST** ☆ **NO MESS**

Available from all Leading Radio Houses

Marketed by—

**ZEPHYR PRODUCTS PTY. LTD.**

70 BATESFORD RD., CHADSTONE, VIC., 3148  
Telephone 56-7231



MANUFACTURERS OF RADIO AND ELECTRICAL EQUIPMENT AND COMPONENTS

# PRINTED BOARD ETCHING KIT

The Bishop Graphics printed board etching kit contains all the chemicals and most of the hardware needed to etch a printed wiring board. It is designed specifically for the small manufacturer specialising in "one off" products, or the laboratory which needs to make a "one off" board preparatory to quantity production.

There is a real need for such a system. A major problem confronting workshops and laboratories engaged mainly in developmental work—including our own at "Electronics Australia"—is that of providing a "one off" printed wiring board on which a prototype of a proposed project may be built. There is obviously no point in organising for quantity production until the prototype has been tested, modified if necessary, and finally proved.

While there are organisations who can provide a "one off" service—and who do it very well—there are obvious advantages

practical experience in producing printed boards, has a good background in photography. Armed with the kit, the book of instructions, and a small negative from one of our previous projects, he set about making a printed wiring board.

Initially we set up a temporary darkroom in a windowless storeroom attached to our own laboratory which seemed to meet the requirements given in the instructions. However, we soon realised the limitations of this arrangement and took advantage of a well equipped, air-conditioned darkroom attached to the quality



The complete board etching kit. Although only two packets of etchant are shown, six are supplied. The aluminium tray is used for the developer, which is a strong plastic solvent.

in being able to do this job on the spot, assuming the availability of a system which does not unduly tax existing facilities or call for more than ordinary care and skill. One of the main advantages is the saving of time, particularly that which is otherwise involved in transport of drawings to the board manufacturer, the need to wait one's turn for a place on his production line, and the transport to return the finished board.

Because of this background we were more than ordinarily interested in this kit. It is produced by Bishop Graphics Inc., U.S.A., and imported into Australia by Circuit Components (A/asia) Pty. Ltd. (formerly Craftsman Glass).

The kit consists of an aerosol can of photo resist, a can of developer, six packets of etchant powder, a bottle of stripper (to remove resist from the finished board), two trays, a contact printing frame, a quantity of copper clad epoxy laminated board, and an instruction booklet. The kit is designed with the intention that the user can spray a selected sheet of copper clad laminate, allow it to dry, expose it to a suitable light source through a negative of the required pattern, develop the image by washing away the resist which has not been exposed to light, then remove the copper so exposed by means of the etching bath. The result should be a finished board, ready for drilling, in only a few hours.

In order to test the system under what we felt would be reasonably typical conditions, we passed the kit over to one of our staff members who, while having no

control laboratory belonging to our parent company.

But even with these rather special facilities, we quickly discovered that the job called for a good deal more experience than was implied by the relatively simple and quite limited instructions given in the instruction manual.

In fact, our major criticism of the system is directed at the instruction manual. What is needed is a set of instructions which are sufficiently comprehensive and precise as to prevent the beginner from falling into the many traps which await him in this field. Such a manual should not only advise what not to do; it should advise what will happen if the wrong thing is done, thus allowing the user to recognise his mistake.

The inadequacy of these instructions is such as to make us seriously question the usefulness of the system as it stands. Anyone contemplating using the kit should be prepared for the inevitable failures involved in "learning the hard way."

For the benefit of such readers, here are some of the problems we encountered, together with what appears to be the solution as far as we can determine. In this regard we would point out that we used a whole can of photo-resist, a can of developer, and all the copper clad laminate (in approximately 2in square sections) in the original kit, without making what we would call a perfect board. The best we achieved were a couple of rough efforts which could have been electrically usable. It was only after several more attempts that we produced a

board which approached commercial quality.

**Cleaning the board:** The instructions say: "Scrub with Ajax Cleanser and a stiff brush." Unfortunately, there is no way of knowing what this means in terms of the Australian market. There appears to be at least three Ajax cleaning preparations available here and no way of knowing which, if any, approximate the American product referred to.

More importantly, it appears that the term cleaning is an oversimplification of what is required. While it is true that all foreign matter must be removed, our own photo engraving department advise that the type of surface presented to the resist is important. A bright, shiny surface is not only not required, but is actually wrong. What is required is a planned degree of roughness, typically a "matt" finish, which will provide a "tooth" for the resist to grip. Otherwise there is a risk that the resist will lift under the action of the etchant.

As nearly as we can determine Bon Ami powder or fine pumice powder would be near equivalents, and there may be some advantage in applying these with a Scotchbrite pad. However, working on a tip passed on to us by someone with many years' experience in the printed board industry, we tried a completely different approach. The board is first cleaned in the true sense, using a solvent such as methylated spirit, and allowed to dry. Without touching the copper surface, it is then dropped in the etchant bath for about 3 minutes, which produces a fine matt surface. If there is a tendency to discolouration in patches, the board may be removed, rinsed with water, and returned to the bath to complete the prescribed period.

**Drying the resist:** The instructions say, "... place the board flat for air drying or in an oven at 110° to 120°F. ... For further processing the board must be completely dry, no tackiness, no solvent smell."

There are two problems which can arise at this point. The first is insufficient drying. The "no tackiness, no smell" instruction is quite inadequate. A board can appear to satisfy these requirements, yet be still solvent under the dry skin which forms on the outside. When this happens, patches of resist whether acted upon by light or not, will lift under the action of the developer, leaving this portion of the board without any pattern.

This situation is further complicated by what appears to be a change in sensitivity between the partially dry resist and a completely dry one. Thus, any exposure experience gained on incorrectly dried resist will be false, and this requirement will have to be re-learned.

The second problem is the reverse of the first. If, in an effort to ensure complete drying, oven drying is too prolonged, or at too high a temperature, the resist appears to fog, exactly as if it had been exposed to light. The result is inability to develop any significant image. From our own experience we would recommend either air drying overnight or oven drying at 120°F for three hours. The latter assumes the availability of a light-tight, thermostatically controlled oven.

**Baking after development:** No mention is made of this in the instruction manual, yet it appears to be standard practice in both the printed board and photo-engraving industry. The problem at which it is aimed is that of failure of the resist in the etching bath. Our chief chemist, in charge of the laboratory, suggested that we could toughen the resist by baking the board after development but before etching. The exact time and temperature are not critical, provided that the temperature is not high enough to damage the base material. To date we have worked on the basis of several hours at 200°F. However, it may well be that this time could be shortened.

**Etching:** The instructions suggest that the etching bath should be of such a

# PETER SHALLEY

ELECTRONICS Pty. Ltd.

127 YORK STREET, SYDNEY

29-7021 29-3767



\$132 each

TOKAI TC502

- 1 watt.
- All steel case.
- Ruggedised/Defence spec.
- Leather case.
- Ext. Aerial con.
- Ext. power con.
- Fully P.M.G. app. as base or hand-held.
- Noise limiter/squelch.
- Ear plug and Mic. input Options.
- Nick. Cad. Batts.
- Base aerial
- A.C. adapter.

We've got lots cheaper.  
None better.

## NEW RELEASE Tokai TC512 now 300MW



300mw into final  
11 Transistors, 1 Diode,  
2 Thermistors,  
Variable Squelch

2 Channel Operation possible  
Call signal with Auto Cut Off  
All Metal Case. Plus Cow Hide  
Carrying Case

Boosted to 300mw  
only \$70.00 each

### Interstate Distributors:

QUEENSLAND: L. E. Boughen & Co.,  
30 Grimes St., Auchenflower.

VICTORIA: K. J. Kalres & C. P./L.,  
4 Hill Court, Macleod.

WESTERN AUSTRALIA: D. K. Northover,  
337 Wellington St., Perth.

We have lots of other units, new and used from as little as \$25 each. Repairs, tuning and alignment are our speciality.



\$49.95  
Post Inc.

Refer page 44 Nov. Electronics Australia

## CAPACITOR DISCHARGE IGNITION NOW INCLUDES INBUILT CHANGEOVER SWITCH TO STANDARD

- EASY STARTING
- IMPROVE M.P.G.
- PLUG LIFE TO 50,000 MILES
- POINT LIFE TO 100,000 MILES
- ALL SILICON DEVICES
- LONGER ENGINE LIFE
- FASTER ACCELERATION
- EASY FITTING (FULL KIT)
- FIRES FOULED PLUGS
- 12 VOLT POS. OR NEG. EARTH
- MANUFACTURED IN AUST.
- SUITS IMPULSE TACHO

## KIT BUILDERS NOTE

OUR INVERTOR TRANSFORMER NOW AVAILABLE

(\$8.75 includes Tax and Postage)

For further information and pamphlet Enclose stamped, self addressed envelope to:

## Electronic Discharge Ignition Systems of Aust.

348 BAY ROAD, CHELTENHAM, VICTORIA, 3192. PHONE 93-1201.



strength, temperature, etc., that the etching is complete in 45 minutes to one hour. And on this basis they claim that one packet of etchant should be sufficient for up to 25 square inches of board. This may well be true, but the point is that our own experience, and all the advice we could gather from the industry, suggests that the faster the etch the finer the detail that can be reproduced. This requirement appears to involve the problem of undercutting. Most commercial organisations appear to aim for an etching time of 10 to 15 minutes, with a few special systems as short as 5 minutes and capable of resolving extremely fine detail.

The best board we produced, and which approached commercial quality, was etched in 12 minutes, in a freshly prepared etchant solution. Even though the board amounted to no more than 4 square inches, an attempt to process a second board of the same size in the same solution was a failure. On this basis the cost of the etchant would appear to be unrealistically high. We are hoping to try one of the cheaper etchants, based on ferric chloride, but time has not permitted this so far.

At the risk of labouring the point, we would emphasise again the need for a fast etch. A prolonged etch can produce an effect very similar to that resulting from breakdown of the resist by the etchant; at best it results in a rough looking pattern, in which less relevant information, such as a type number, may have been lost. At worst, it results in a board in which vital parts of the pattern have been lost, rendering it virtually worthless.

Apart from low activity of the etchant, we have no doubt that the system we tried is chemically sound. But, if you feel inclined to experiment along these lines be aware that the production of successful boards involves a lot more skill and experience than the instruction booklet would have you believe. If you have sufficient need for such a system, and can justify the time needed to gain this skill and experience, then go ahead. If not, think carefully before you invest.

The materials are available either as a complete kit, or separately as individual items. Thus, a customer may replenish his kit as individual items run out or, where he already has most of the hardware available, purchase only the chemicals.

Further details, price structure, etc., may be obtained from Circuit Components (A/Asia) Pty. Ltd., 460 Bexley Road, Bexley, N.S.W. 2207. (P.G.W.)

## TRADE RELEASES -- in brief

**WARBURTON FRANKI LTD.**, 372 Eastern Valley Way, Chatswood, N.S.W. 2067. Agents for Go-Power Systems, U.S.A. Low-cost small engine dynamometer. Developed for engines from 1/4HP to 60HP, and weighing only 35lb. Engine rpm and torque are measured to an accuracy of 1.5 per cent, from which the horsepower can be determined. The dynamometer uses a water brake to absorb the engine power and change the rotating torque of the engine to a stationary torque that is measured by a precision hydraulic load cell. The engine rpm is measured by a mechanical tachometer. A knob on the control console regulates the engine load, while another knob adjusts the engine throttle between 0 and 100 per cent.

**EMERSON & CUMING INC.**, Canton, Mass. 02021, U.S.A. Eccosorb CV. A series of versatile broadband absorbers which can be used from 400MHz to over 100GHz. Six types in the series have thicknesses ranging from 3 to 18 inches. All members have reflectivities over 25-GHz of better than 50dB down on total reflection. Features include: effective at incidence angles to 70 degrees; rugged flexible foam construction; light weight — 0.7lb/sq. ft. for thinnest type, 4lb/sq. ft. for thickest; available in a weatherproof version.

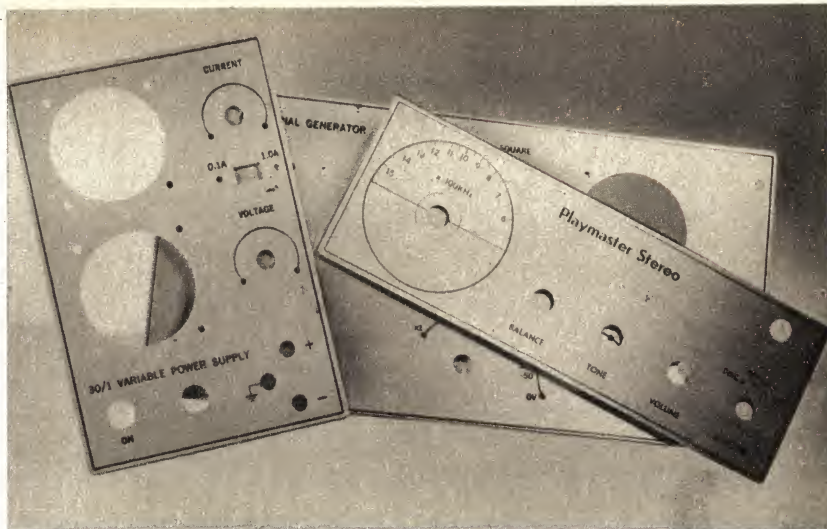

Illustrated is a selection from the wide range of "Oxford" front panels for Playmaster projects available from Heating Systems Pty. Ltd., 19 The Boulevard, Caringbah, N.S.W., 2229. The panels are brushed aluminium with etched lettering, lacquered finish. Heating Systems has been a supplier of metalwork for "Electronics Australia" projects for many years, and has produced metalwork for virtually all of these.

# DELCO THE BIG POWER IN TRANSISTORS



1400 V.  
Ic 3 amps  
Silicon



50 amps  
Ic 80 V.  
Germanium

Cut costs through the circuit simplification possible with Delco conservatively rated high power transistors. Ring Melbourne 792 0111; Sydney 212 1722; Adelaide 49 6166; Brisbane 47 3277; Perth 23 2768; for a catalogue listing performance characteristics of a wide range of Delco High Power Transistors. These include such items as 10 amp/500V. Silicon transistors. Many items are available from stock.

# DELCO RADIO

Industrial & Domestic Equipment Company

Distributors: Anodeon Sales, N.S.W, VIC, S.A,  
Dresser — S.I.E, QLD.

33/DEL70

# University

## T.V.T. VALVE TESTER



Due to the demand for the model T.V.T. Valve Tester, "University" have re-introduced the unit and it is now available from University Graham Instruments Pty. Ltd., or representatives in all States.

This fine instrument can be used as a portable or counter type Valve Tester. It is designed to operate from 240 volts A.C. and has provision for testing radio valves as well as T.V. valves.

An important feature of the model T.V.T. is that all the elements in a valve are brought out to individual lever switches. This allows for great flexibility and also provides for valves which may have unusual connections or unusual sockets. It makes it possible to apply filament voltage to any base pin.

The model T.V.T. incorporates the University model W4 all polystyrene meter with multi-coloured scale. The scale is marked "Good"—"Bad" so that quick and rapid indication of the condition of the valve under test is given.

The case is fitted with a carrying handle which lies flat when not in use, and a comprehensive instruction booklet listing valve test settings is provided.

The outside dimensions of the unit are 14" x 11" x 6".

**Valve Tester Price . . . \$88.00 each, plus 15 per cent Sales Tax**

Also available is a Picture Tube Adaptor model T.V.2. This allows for testing television picture tubes without the necessity of removing the tube from the television receiver.

**Picture Tube Adaptor Price \$4.00 each, plus 15 % Sales Tax.**

## University Graham Instruments Pty. Ltd.

106 Belmore Road, Riverwood, N.S.W., 2210.  
Telephones: 53-8758, 53-0644 (5 lines).  
Telegrams and Cables, Raquip, Sydney.

Victoria: Logitronic Sales Pty. Ltd.,  
3 Carroll Cres., Glen Iris, Melb., Vic., 3146.  
Phone: 20-6953.

### REPRESENTATIVES:

W.A.: Atkins (W.A.) Ltd.,  
894 Hay Street, 21-0101.

PERTH, W.A. 6000.

TAS.: W. P. Martin and Company,  
202 Argyle Street, 34-2811.

HOBART, Tas. 7000.

And 150 Wellington St.,  
LAUNCESTON, Tas. 7250, 22-844

S.A.: Compar Distributors Pty.  
Ltd.,

33 Market Street,

ADELAIDE, S.A. 5000, 51-6263.

QLD.: Keith Percy & Co. Pty. Ltd.,  
Waterloo Street,

NEWSTEAD, Bris. Qld. 4006.

51-5461.

NEWCASTLE DIS.:  
Hunter Engineering Sales Pty. Ltd.,

Cnr. Gordon Avenue and  
Parry Street, Hamilton

NEWCASTLE, N.S.W. 2303.

Phone 61-4321.

# MAGRATH'S



### PRECISION SOLDERING IRONS \$4.15

#### IDEAL FOR PRINTED CIRCUITS, TRANSISTORS AND OTHER VERY SMALL COMPONENTS

The iron is available for 6-volt or 12-volt operation. The element is situated within the lower part of the shaft, enveloped by the skirt of the bit. This provides efficient heat transfer and thus obviates the need for excessive element temperatures. Reliability is insured by completely sealing the element to prevent oxidation and by use of a special shock absorber which protects the element during everyday use in factory or workshop.

**REPLACEMENT BITS 55 cents each**  
No. 2 3/32" No. 3 5/32"  
No. 4 3/16"

Post free anywhere in Australia.

Prices exempt sales tax.

### "PIONEER" MODEL P-382 B

#### 15in BASS GUITAR ELECTRONIC ORGAN SPEAKER

This superb 15in unit is available with 8 ohm or 15 ohm Voice Coil. Power handling 30 watts R.M.S. 60 watts (peak). Frequency response to 500 cycles. Resonant frequency 60 plus or minus 12 cycles. Sensitivity 103 plus or minus 2 db/watt. Total flux 11,600 Maxwell. Flux density 9,360 gauss.



## \$30

Including  
Sales Tax  
POSTAGE FREE  
Anywhere in  
Australia

#### H.F. 1016 STENTORIAN MAJOR SPEAKER

Designed to achieve full range response when mounted in a "compact" cabinet. Cone diam. 10in. Pole diam. 1in. flux density 15,000 gauss. Total flux 64,000 Maxwells. Impedance coil at 15 ohms. Frequency response 50 c.p.s. to 16,000 c.p.s. In suggested cabinet, 30 c.p.s. to 16,000 c.p.s. In larger cabinet. Capacity 10 watts \$26.50 (including Sales Tax).

#### Model H.F. 1016 STENTORIAN SPEAKER

10in P.M. Unit and 16,000 gauss magnet. Universal impedance speech coil at 3, 7.5 and 15 ohms. Capacity 10 watts. Frequency response 30 c.p.s. to 15,000 c.p.s. Bass resonance 35 c.p.s. \$21 (including Sales Tax).

#### Model H.F. 1012 STENTORIAN SPEAKER

10in Unit 12,000 gauss magnet. Universal impedance speech coil at 3, 7.5 and 15 ohms. Capacity 10 watts. Frequency response 30 c.p.s. to 14,000 c.p.s. Bass resonance 35 c.p.s. \$14 (including Sales Tax).

#### Model T.10 STENTORIAN TWEETER

Speech Coil is aluminium wire wound on an aluminium former rigidly fixed to an aluminium diaphragm, giving high standard of reproduction when used with Stentorian H.F. 1016 speakers. Speech coil impedance 15 ohms. Response 200/15,000 c.p.s. flux density, 14,000 gauss. Capacity: 5 watts. \$16.00 (including Sales Tax).

#### CX 3000 CROSSOVER NETWORK

W./B. Crossover is of the filter type and is fitted to all the Duplex Loudspeakers. It is available for use separately, the 3,000 c./s. type is half section series connected having an attenuation of 12db per octave. CX 3000. \$6.50 (including Sales Tax).

#### T359 TWEETER

3,000—15,000 c.p.s. Size overall 3 1/2in diam. x 2in deep. Voice coil impedance 15 ohms. \$6.50 (including Sales Tax).

(All Post Free In Australia.)

**J. H. MAGRATH & CO. PTY. LTD.**  
208 LT. LONSDALE STREET, MELBOURNE, VICTORIA, PHONE 663 3731

**UNIVERSITY LABORATORIES**, 733 Allston Way, Berkeley, Calif. 94710, U.S.A. Continuous He-Ne gas lasers, models 351 and 361. Features include: CW outputs of 3mW and 4mW (respectively) of coherent visible red light (6328 Angstroms); theta-control beam adjustment allows beam angle to be changed by plus or minus two degrees in any direction without changing the beam centre; Laser-tion tube with permanently aligned hemispherical internal mirrors in a coaxial pyrex envelope; separate solid-state power supply.

**HEWLETT-PACKARD AUSTRALIA PTY. LTD.**, 22-26 Weir Street, Glen Iris, Vic. 3147. Hybrid hot-carrier diodes. Prices have been cut by up to 25 per cent on quantity orders. These diodes have the HF performance of point-contact diodes but with much higher reverse breakdown voltages. They have the high temperature characteristics of silicon but the turn-on voltage is low (410mV at 1mA) as for germanium. They have fast recovery as for Schottky-barrier diodes, but are also rugged like PN junction diodes.

**IRH COMPONENTS PTY. LTD.**, The Crescent, Kingsgrove, N.S.W. 2208 Rotary volume control switch, type 320. Features include: Rated at 250V 3A 0.75 power factor (inductive); moulded melamine cover with internal flash barrier between switch poles; life expectancy exceeds



25,000 actuations; low voltage DC rating of 12V 10A; contact resistance less than 5 milliohms after 50,000 actuations; available in four configurations — SPST normally open, SPST normally closed, SPDT and DPST; combined with IRH-patented converter unit, it becomes a compact in-line push-push switch in same configurations.

**DISTRIBUTORS CORPORATION PTY. LTD.**, 24 Johnston Street, Fitzroy, Vic. 3065. Agents for Master Instruments. Decade resistance boxes. Feature switches with sterling silver contacts and decades each with five resistors to reduce capacitance and residual resistance. Each decade is a self-contained integral unit, interconnected with copper strips to adjoining decades. The switch layout used eliminates wiring completely and reduces capacitance and residual resistance to a minimum. A



2oz copper clad epoxy board contains the circuit on one side and a series of 20 contacts on the other, with moving contacts of fine silver riveted and soldered to a copper ring. Contact resistance is of the order of 400 uohms with a repeatability of plus or minus 100 uohms. Overall accuracy is .05 per cent plus or minus .002 ohm. Resistors from 0.1 to 10 ohms are wound with Manganin wire, and 100 ohms and above are wound with Karma wire. They are of the flat card type to minimise inductance.

## Lamp-signalling Telephones

### AMALGAMATED WIRELESS (A'SIA) LTD.

47 York Street, Sydney, 2000, has received an order from the Postmaster-General's Department worth nearly \$1 million for lamp-signalling telephones of the type illustrated. This phone was designed in Germany, but A.W.A. is to manufacture them in Australia under licence. It is intended to operate mainly in small office systems, with incoming calls normally taken at one point and then routed to its destination. Direct connection to up to 10 internal phones is obtained by pushing one of the 10 buttons in the two front rows.



Each phone has access to four exchange lines, which can be selected by pushing one of the four dark (red) buttons in the rear row. The user can dial directly into the public network, and all sets are equipped for "hold" or "call-back" during

external calls. Lamps under the push-buttons light up to indicate an engaged exchange line. Signalling is by means of a soft-toned buzzer for internal calls, but by flashing light behind the appropriate push button for exchange line calls. A call is accepted by pushing the button illuminated by the flashing light.

**RCA LTD.**, 11 Khartoum Road, North Ryde, N.S.W. 2113. Electronic teaching devices. All solid-state training aids to provide a means of converting text-book theory to practical reality. Complete with a comprehensive instruction manual, the trainers present a progressive sequence of experiments and tests to take a student logically through his program. The first three units are: Digital computer logic systems trainer, model 1600-DCS. A laboratory trainer designed to enable students

to construct and operate logic configurations basic to digital computers. Digital computer logic systems demonstrator, model 1700-DCS. Electrically identical to the 1600-DCS but oversized and mounted vertically for demonstration purposes. Basic electronic components trainer, model 702-FD. A compact durable, completely self-contained device that provides all components and power inputs required to enable students to perform a wide range of basic experiments.

## PHOTOMULTIPLIER TUBES

### HAMAMATSU TV CO. LTD.

HIGH PERFORMANCE — LOW COST

#### PM TUBE

#### RESPONSE

HTV-R106	1,600 to 6,500°A	Critical Applications
HTV-R136	1,600 to 8,000°A	Wide range spectral response
HTV-R166	1,600 to 3,200°A	U.V. Range
HTV-R196	4,000 to 12,000°A	Vis. and infrared range
HTV-R213	1,850 to 8,000°A	U.V. to near IR Range

OTHER TUBES AVAILABLE R212, 913A, IP21, IP22, IP28  
9 Stage, side-on types, 11 pin base

FOR FULL DETAILS PLEASE CONTACT

Sole Australian Agents

## VARIAN TECHTRON PTY. LTD.

Springvale Road, North Springvale, Victoria

Phone: 560 7133

# R.C.S. SPECIALS



**NEW IMPROVED  
30 WATT  
NOMINAL  
54w MAX.**

## 12v All Transistor P. A. AMPLIFIER

**WIRED READY TO OPERATE**  
15 ohm output, No. 591D . . . \$62  
125, 250, 500 ohm, 592D . . . \$62  
Dimensions: 6 1/2 in. w. x 3 1/2 in. h. x  
8 1/2 in. d. For 240V. op. \$33 extra.  
**10 WATT P.A.**  
Inputs 5 MV and 100 MV, 10w R.M.S.  
at 1%. Frequency 40cy.—30Kc. For use  
with 1 4 ohm, 2 8 ohm or 4 16 ohm  
speakers in parallel. Same cabinet and  
dimensions as 30w above, complete with  
240v power supply.  
Wired and tested, No. 485 . . . \$40  
Freight extra In both cases.



## R.C.S. COMPLETE DO-IT-YOURSELF KITS

Peak reception,  
low price. No ex-  
pensive test equip-  
ment. Everything  
fits, 1964 RF  
Transports 7.  
Complete kit — No. 640 . . . \$43.50  
Portable car radio. Identical to 640  
above, plus extra switch and car coil,  
etc. No. 642 . . . \$46.00  
(Write for booklet on 640 and 642.)  
Postage \$1.

**NEW TRANSISTOR PREAMP KIT**  
SIZE 3 x 2 x 1 1/2 in. 2 req. for Stereo.  
LOW IMP. Input 2 trans, 672C \$6.50  
Wired ready for use, 672D . . . \$8.00  
HIGH IMP. 2 tran. 680C . . . \$6.50  
Wired ready for use, 680D . . . \$8.00  
HIGH IMP. silicon 3 tran, 682C \$8.00  
Wired ready for use, 682D . . . \$9.50  
Postage 10c each. Write for data.

## HI-FI BROADCAST TUNER UNIT 4 TRANSISTORS — HI SENSITIVITY.



R.F. mixer, I.F., pwr. dectr. stages, adjustable aerial  
coupling. Complete as illust. wired and tested with 461  
dial, knobs and switch pot No. 474D \$31. Postage \$1.  
**WHISTLE FILTER** for above set for 8Kc band width (can  
be altered to 9, 10 or 11Kc). No. 129, \$4. Postage 10c.

## PRINTED CIRCUITS

For all R. and H., E.A., Mullard, Philips and other designs.  
Clearly coded, White letters and numbers, easy assembly  
and service, polished and resined for easy soldering. With  
blueprint parts list.  
**SPECIALS:** To your drawing — write for particulars and  
drafting aids.

### New Printed Circuits

726 3 x 3 or 10 x 10 w  
stereo 68/AB . . . \$2.80  
736 B/C tuner EA  
69/TS . . . \$2.50  
727 E and A wide band,  
tuner 68/8T . . . \$3.20  
728 Audio osc., EA  
68-09 . . . \$3.20  
718 Mullard main  
amp. . . . . \$2.50

### Number Recent Designs

722 Mullard pre-amp, \$3.00  
725 Protected supply, \$3.50  
734 EA 69 01 gold p.  
organ . . . . . \$5.00  
709 Pre-amp, 67-P5 \$2.50  
684 Pre-amp, 65-P10 \$2.50  
737 AWA 10/25W amp  
\$2.50  
747 Music colour  
69C10 . . . . . \$3.00  
741 Guitar amp 69 P5 \$3.00

Immediate dispatch. Postage 10c.

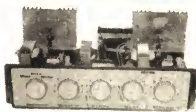

## 10W STEREO

**MULLARD 10 x 10  
watts R.M.S.**

With output transistor **PROTECTION**. Frequency response  
40cy. to 30Kc, Distortion 0.5%. Treble, bass, boost 20dB  
Complete kit of parts No. 480C . . . \$74.00  
Wired and tested No. 480D . . . \$79.00  
With hi-fi tuner and whistle filter, \$35 extra. Freight extra.  
Write for brochure. For special Sat. demo. ring 59-6550.

## MAGNETIC STEREO PRE-AMP

In 5Mv out 250Mv. Bass and  
treble 20dB. No. 724C \$29  
Wired ready for use . . . \$31  
Postage 30c each.  
For crystal ceramic  
No. 722D . . . . . \$27



## TRANSFORMER



Tap 6v and 9v D.C. at  
100 millamps.

Filter, condensers, rectifier, resistor.  
case, etc. \$6.50. Post 10c.

## PERSONAL PORTABLES 2 TRANSISTORS

Range 30 miles,  
200 with short  
aerial and earth.  
Earpiece only, no  
speaker.  
Do-it-yourself kit,  
No. 666C . . . \$9.00  
Postage 20c.

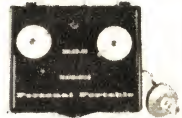

**1 TRANSISTOR — 1 DIODE  
593C Do-it-yourself kit, \$3. Post 10c.**

## NOISE FILTER

for radio and TV  
No. 27 line filter, 2  
amp. . . . . \$6.50  
No. 29 line filter, 10/  
20 amp. . . . . \$35  
No. 30 pulse filter, 2  
amp. . . . . \$11.50  
No. 11 aerial fil-  
ter. . . . . \$13  
Order direct. Pack. and  
post., 50c.



## NEW AUDIO AMPLIFIER



4 transistors,  
12 or 1 watt.  
Small size, cabi-  
net 3 1/2 x 2 1/2 x  
1 1/2 in plastic.  
Suitable crystal  
P./up. Inter-  
com. micro-  
phone, radio,  
etc. (9 volt.)

**DO-IT-YOURSELF KIT 665, \$10 (Post  
10c). Wired ready for use 665D \$11.50.**

## COILS & IF's 455 Kc

Aer. R.F., OSC. and IF's . . . \$1.80 ea.  
Ferrite Aer. . . . . \$2  
No. 265 Universal tape OSC. Coil \$6  
Postage 10c. Write for details and price.

# R.C.S.

Order by Mail Order, Postal Note or Money Order (add post.), direct to —  
**RADIO PTY. LTD., 651 FOREST ROAD, BEXLEY, N.S.W., 587-3491, 587-5385**

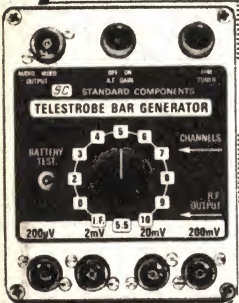

# FIND FAULTS IN TV RECEIVERS IN MINUTES WITH telestrobe BAR GENERATOR — SIGNAL TRACER

Made especially for the TV Serviceman; a completely portable Transistorised Bar Generator and Signal Tracer.  
operates on a 9-volt battery. Produces all TV frequencies VHF channels O-11, 36MHz Vision IF 5.5MHz FM  
Modulated (Sound IF) plus Audio and Video Signals.

All checks produce a horizontal bar pattern on the screen or an audio signal in the loudspeaker and this  
enables the serviceman to inject the appropriate signal into any stage of the TV receiver.  
Accurately calibrated outputs allow the serviceman to check the sensitivity, stage by stage, and quickly locate  
where the fault exists. Bar pattern can be used to adjust vertical height and linearity.

The Telestrobe can also be used as a signal tracer for radio receivers and audio amplifiers.  
The Mark II Telestrobe also features an adjustable negative bias which may be used in fault-finding the  
AGC system of a television or radio receiver.

The bias range is from 0 to -9 volts and is controllable from the A.F. gain control.  
A separate bias lead is included in the Telestrobe accessories and is connected to the "battery test" jack  
socket. These features all in one instrument measuring 4 1/2" x 3 1/2" x 2".

**WRITE FOR FREE BROCHURE**

**\$60.00**

plus 15  
per cent  
Sales Tax

Manufactured by **STANDARD COMPONENTS PTY. LTD., 10 Hill St, Leichhardt, N.S.W. 2040, 660-6066**

Interstate Agents: Qld. C. A. PEARCE & CO. PTY. LTD., Brisbane; Vic., RADIO PARTS PTY. LTD., MELBOURNE; S.A., DYNAMIC  
INDUSTRIES PTY. LTD., ADELAIDE; W.A., TEDCO PTY. LTD., PERTH; Tas., MEDHURSTS WHOLESALE LTD., HOBART



Mr Tan (left), sales engineer in Malaysia for Philips Telecommunications of Australia, discusses a new project with export manager, Mr K. J. Horan, during a recent visit to the company's South Australian factory. Mr Tan spent about a month in Australia to familiarise himself with the company's products and policies.

**ASSOCIATED CONTROLS PTY. LTD.**, 14 Enterprise Avenue, Padstow, N.S.W. 2211. Elmaset precision made card frames and cabinets. For printed circuit cards and modular units of many different sizes and kinds. All structural parts of the system are provided with slots or tapped holes to allow rapid and simple subdivision of units into almost any required size. The principle material is a light alloy with high corrosion resistance. The range includes all other necessary small components such as screws, nuts, washers, spacers, etc.

**NATIONAL SEMICONDUCTOR CORPORATION** (represented in Australia by Rutherford Electronics) has moved its world headquarters facility to 2900 Semiconductor Drive, Santa Clara, Calif. 95051, U.S.A.

**RUTHERFORD ELECTRONICS PTY. LTD.**, P.O. Box 30, North Balwyn, Vic., 3104. Agents for National Semiconductor Corporation, U.S.A. Monolithic, N-channel, dual FETs, series FM3954. Eliminates the difficulties in matching and testing individual die by integrating both transistors on one chip. The geometries of both FETs are intertwined to obtain a perfect match (as illustrated). Features in-

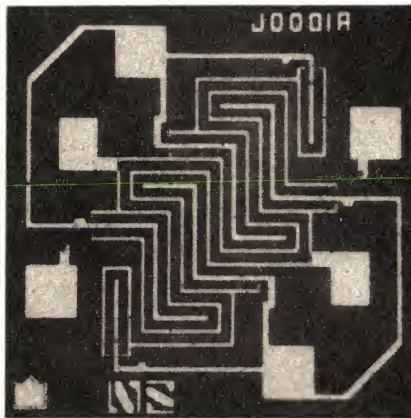

clude: very close tracking regardless of bias point from 50uA to 500uA; low leakage of 100pA; and high gain of 1000umhos. Applications include: balanced modulators and mixers; analog switching; multiplexers; AGC; RF applications to 30MHz; high slew rate operational amplifiers.

**THE AUSTRALIAN TELECOMMUNICATIONS DEVELOPMENT ASSOCIATION** has re-elected Sir Samuel Jones as chairman for a third term. Sir Samuel is chairman and managing director of Standard Telephones and Cables Pty. Ltd. The Association has added 11 companies to its membership and now comprises 49 firms engaged in telecommunications, electronics and related manufactures. The new member companies are: Electronic Industries Ltd., Elmaco Industries Ltd., Hewlett-Packard Australia Pty. Ltd., Hills Industries Ltd., Jacoby Mitchell Holdings Ltd., Nylex Corporation Ltd. (cables division), Radio Corporation Pty. Ltd., RCA Ltd., Servex Electrical Co. Pty. Ltd., Union Carbide Australia Ltd., and Weston Electronics Pty. Ltd.

**MOTOROLA INC.**, Phoenix, Arizona, U.S.A., has formed an Australian semiconductor company, Motorola Semiconductor Products Group. The new firm, located at Regent House, 37-43 Alexander Street, Crows Nest, N.S.W. 2065, is a branch of Motorola Australia Pty. Ltd., a subsidiary of the parent corporation. Named to head the new organisation as marketing manager is John Dunleavy, formerly Motorola's regional manager for semiconductor sales in Scandinavia. The local company will complement the efforts of Cannon Electric (Australia) Pty. Ltd., Motorola's franchised semiconductor distributor with offices in Melbourne, Sydney and Adelaide.



Mr Dunleavy

**PLESSEY TELECOMMUNICATIONS PTY. LTD.** has appointed Mr V. St. G. Magnusson — the former deputy assistant director-general, postal engineering, of the Postmaster-General's Department — as a consultant. Mr Magnusson, who has retired from the P.M.G.'s Department, took part in the initiation and launching of the Sydney Mail Exchange, and developed the present philosophy of mail flow and the modern concept of the machine system for the handling of large volumes of mail. He is a senior member of the Institution of Radio and Electronic Engineers (Australia).

**AD. AURIEMA INC.**, the U.S. principal of Auriema Asia Pty. Ltd., has moved to 120 Liberty Street, New York, N.Y. 10006, U.S.A.

# "OXFORD"

RADIO CHASSIS—  
INSTRUMENT CASE—  
ENGRAVE & PRINTED PANEL  
"MINI BOXES"  
(Aluminium)

Any kind of metalwork

All stock from our distributors:

S.A.

Gerard & Goodman,  
Rundle St., Adelaide,  
5000

Vic.

A. H. Nicholls,  
510 Bridge Rd.,  
Richmond, 3121

Tas.

Homecraft. (Tas.),  
199 Collins St.,  
Hobart, 7000

HEATING SYSTEMS  
PTY. LTD.

19-21 The Boulevard,  
Caringbah 2229  
Phone 525-5222  
5 lines

# INDUSTRY IS CLAMOURING FOR ELECTRONICS ENGINEERS

*Train now to go straight to the top*



**THE - DAY - BEFORE - YESTERDAY** the projector push-button age was the butt of the unimaginative.

**YESTERDAY** Woomera had a desperate task finding capable personnel and giving them the training to man the electronics functions of the space research complexes.

**TODAY** all Australian industry is committed to an immediate future of electronic concepts. These expose splendid new frontiers of production, of work output in commerce, of living standards. The lack of skilled personnel alone could retard this progression into a totally new world. Eventually the lack will and *must* be overcome. Meantime, Australia will search desperately about the world for the people with electronic skills. Already there is a dearth of them in Australia, *and overseas!* Trained Australians can choose their workplace from the whole world. If you train now with I.C.S., you will be rewarded well. You will reach the top of your profession while many thousands are just beginning to train.

*Make your decision for success now!*

These specialised subjects are available from I.C.S. for home study.

- |  |   |
|--|---|
| <input type="checkbox"/> Audio: Hi-Fi, Stereo          | <input type="checkbox"/> Monochrome and Colour TV           |
| <input type="checkbox"/> Automation Electronics        | <input type="checkbox"/> Electronic Drafting                |
| <input type="checkbox"/> Automatic Controls            | <input type="checkbox"/> Printed Circuits, Conventional     |
| <input type="checkbox"/> Industrial Applications       | <input type="checkbox"/> Printed Circuits, Micro Integrated |
| <input type="checkbox"/> Nuclear Instrumentation       | <input type="checkbox"/> Fringe Equipment                   |
| <input type="checkbox"/> Digital Techniques            | Also Computer Programming for Commerce, Research, Industry. |
| <input type="checkbox"/> Transistors & Semi-Conductors |   |
| <input type="checkbox"/> Communications                |   |

Read the **FREE I.C.S. Illustrated Prospectus**

Send Coupon today!

**International Correspondence Schools,**  
Dpt. 527, Division of Electronics,  
400 Pacific Highway, Crows Nest, N.S.W. 2065.  
Branches in all States and New Zealand.

**ICS**

Please send me **FREE** Prospectus about.....

Name..... Age.....  
(Please print)

Address.....

State.....

Postcode..... Phone..... Dpt. 527

# TECHNICAL BOOKS AND PUBLICATIONS

## Transistor data

**TRANSISTOREN** — Transistor interchangeability tables. Published by De Muiderkring N.V., Bussum, Netherlands, 1969. Plastic covers, 3½in x 5½in, 192 pages. Price in Australia \$2 plus 20c postage.

An earlier edition was reviewed in our December, 1967, issue. This edition is basically the same as the earlier one, and the comments made are still applicable. For the benefit of new readers and those who may have missed the earlier review, we present again our original comments substantially as they appeared then:

"A useful publication for those who are cutting their teeth on transistors, and particularly for those of the amateur radio fraternity. As one might expect, it is particularly good in its coverage of European transistor types. It also gives a reasonable number of American and Japanese types, although not nearly as many as one would like in a 1969 publication of this type. Even so, it would make a valuable addition to the amateur's reference shelf or to the service library, more so in view of its modest cost."

Our review copy was supplied by Technical Book and Magazine Co. Pty. Ltd., 289-299 Swanson Street, Melbourne, Vic. 3000, from whom copies are available ex-stock. (J.H.)

## Transistor practice

**SEMICONDUCTORS FROM A TO Z**, by Phillip Dahlen. Published by Tab Books, Blue Ridge Summit, Pennsylvania, 1969. Soft covers and hardbound, 5½in x 8½in, 272 pp., many photographs and diagrams. Price in Australia \$6.15 and \$9.95.

As the author explains in his preface, this book has been adapted from a series of articles written for and published in the U.S. magazine "Electronic Technician/Dealer." The name of the journal concerned gives a strong indication of the type of reader for whom the book was written: the service technician.

One might expect such a book to be rather practical in its approach, and this certainly is the case. In fact this reviewer considers that "pragmatic" would probably be a more appropriate description. The book plunges straight into the practical operation of bipolar transistor circuits, and then proceeds in almost cavalier fashion through FETs, tunnel diodes, integrated microcircuits (ICs), varicaps and miscellaneous devices and applications.

Author Dahlen makes no apology for this approach, supporting it by the statement that the average service technician need not concern himself with the actual theory of operation of semi-

conductor devices. However, while this is undoubtedly true to a certain extent, surely most service technicians need at least a basic insight into device operation in order to troubleshoot solid-state circuitry efficiently and effectively. One does not have to have a Ph.D. in solid state physics, to be sure, but without the basic concepts one's progress is rather painful and fumbling, as many service technicians have found and are still finding.

As it is, the present book merely seems to add yet another volume to the already appreciable number of "practical" books on semiconductors which either assume a pre-existing background of basic theory, or else decide as author Dahlen has, that such a background is not really necessary. It is up-to-date, to be sure, dealing with recent devices and their applications, and thus it may be of interest to those already possessing a basic background. But for those without such a background it will really not be of all that much value.

The review copy came from the Australian representatives for Tab Books, who are Grenville Publishing Company. By the time this review appears, copies should be available from all comprehensive book stores. (J.R.)

## DX information

**WORLD RADIO AND TELEVISION HANDBOOK**, 24th edition, 1970. Published in Denmark by J. Frost Paper covers, size 9in x 6in, 400 pages. Price on application to booksellers.

This annual comprehensive guide to the world's medium-wave, short-wave and television stations again reaches a new pinnacle of usefulness to DX listeners, as it is virtually impossible to criticise the contents and layout, and it is safe to assume that the high standard of accuracy of past issues has been maintained in this 24th edition.

Critics of past editions have complained of small type and too many articles of a general nature on radio reception. This year, larger type has been used, and most of the hobby-type articles have been omitted, as they have been accommodated in a new publication devoted to the DX hobby, entitled "How to Listen to the World." The leading articles for this edition are entitled: How to use the Handbook — Satellites in the 70s—Radio Australia's Darwin Relay — Broadcasting reception expected during 1970. Then follows the usual listings of world time in all countries, Time and Frequency Stations, DX Clubs of the World and DX programs.

However, the real heart of the book is the complete listing by continents and countries of station details, addresses, schedules, frequencies, lan-

guages broadcast, verification policy and other useful information. This is followed by another list, in order of frequency, of medium and short wave stations, for cross reference purposes. In my DX activities, I find the Handbook invaluable to identify stations not previously heard and not noted in any of the DX magazines. When the station is located in the Handbook, all the necessary details are there to enable the user to send a report to the station. Listings cover over 11,300 medium-wave stations, including over 4,000 operating in North America; and some 4,050 short-wave stations.

The editor takes a deep personal interest in ensuring the accuracy of the handbook. He has visited most of Europe's broadcasting stations to make personal contact with the engineering staff, with the result that he obtains up-to-date and detailed information on programs, frequencies and schedules.

"World Radio Handbook" should be in the hands of every radio listener who wishes to tune stations beyond his own shores. As a professional monitor myself, I found that the Handbook is used on numerous occasions every day. It is available from technical booksellers throughout Australia, and in New Zealand from Arthur Cushen, 212 Earn Street, Invercargill. (A. Cushen.)

## Network analysis

**NETWORK COMPUTER ANALYSIS**, Edited by George W. Zobrist. Published by Macdonald and Co. Ltd., London, and Boston Technical Publishers, Inc., Cambridge, Massachusetts, 1969. Hard covers, 10in x 7in, 303 pp., many diagrams. Price in U.K. £10.

As the title of this book is a little ambiguous, I should perhaps begin this notice by explaining that it deals not with the analysis of computer networks, but with the application of digital computers to the analysis, design and modelling of electronic circuits. In other words, it is concerned with those activities often grouped under the heading "computer-aided design" or "CAD."

The material presented is apparently based on seminar lectures presented at the University of Missouri in 1967 by some of the leading authorities in this field. Most of it deals with four of the major network analysis programs which have been evolved, known respectively by the acronyms ECAP, NASAP, NET-1 and SCEPTRE.

As those familiar with CAD tech-

**SENIOR TECHNICAL OFFICER  
UNIVERSITY OF MELBOURNE,  
DEPARTMENT OF OPHTHALMOLOGY.  
POSITION No. 576400.**

The Appointee will be responsible for research projects and the development of instrumentation in the Bio-Engineering field. Applicants should preferably be in the age group 25 to 40 years, should hold a degree in engineering (electronics) or equivalent and should have a minimum of 2 year's experience in this field. Salary will depend on qualifications and experience.

Terms of appointment are available on request from Professor G. W. Crook on 662-1644.

Applications in writing to the Staff Officer,  
University of Melbourne,  
Parkville, 3052,  
quoting the above position number.

# THE

# TANNOY

# Monitor

# GOLD



## Full range world famous dual concentric loudspeakers

The Monitor Gold is a further refinement in the almost legendary range of Tannoy Dual Concentric Loudspeakers. An entirely new crossover network not only provides facilities for adjusting treble energy to suit prevailing acoustic conditions, and treble roll-off to accommodate variations in programme material, but also gives a smoother frequency response in the middle treble register together with a more constant impedance characteristic; thus ensuring the highest performance from modern transistor amplifiers. The impedance is nominally 8 ohms but never falls below 5 ohms.



Distributed through the Consumer Products Division of

**AMALGAMATED WIRELESS (AUSTRALASIA) LIMITED**

554 PARRAMATTA ROAD, ASHFIELD. 71 0791

167 Queen Street, Melbourne. 67 9161 • 70 Merivale Street, Brisbane. 4 1631  
• Cnr. Darby and King Streets, Newcastle. 2 5166 • 231-233 Bulwer Street,  
Perth. 28 6400 • 48 King William Road, Goodwood, Adelaide. 72 2366 • 42  
Frederick Street, Launceston. 2 1804 • 123 Murray Street, Hobart. 3 3836-7

niques will no doubt be aware, ECAP is a network analysis program employing a "piecewise-linear" approach, and consists of three packages which deal with DC, AC and transient conditions. NASAP is a program based on signal-flow graphs, while NET-1 and SCEPTRE are non-linear programs used for stored-model analysis and transient radiation effects problem solving respectively.

As one might perhaps expect from the origin of the material, it consists basically of broad descriptions of the various analysis programs and their application. It is not intended to be a collection of software manuals, preparing for or assisting in the use of such programs. There are no program listings. The idea is mainly to give the reader a picture of the way in which these new techniques may be used to solve many complex and cumbersome design and analysis problems.

The four analysis programs considered in the book are introduced and discussed separately in the first four chapters. Following these are three chapters dealing with more general aspects of analysis programs and their use. Chapter 5 examines bipolar transistor and FET models for computer analysis, chapter 6 discusses computer design of active RC filters, with particular reference to NASAP, while chapter 7 discusses a reliability program utilising circuit analysis programs.

The various chapters have been written by different contributors, and there are inevitable minor variations in style. However, in general the text may be described as clear and concise, and well illustrated by diagrams and numerical examples.

In view of the material presented and the background assumed both in electronics and computing techniques, the book will really only be of interest to senior engineering students and professional circuit designers and analysts. For these people it should provide an interesting and worthwhile introduction to CAD techniques.

The review copy came direct from the U.K. publisher, and no information was supplied regarding Australian price and availability. (J.R.)

★ ★ ★

**AUDIO AMPLIFIERS.** Edited by J. R. Davies. Data Book Series No 18. Published by Data Publications Ltd., London. First printing January, 1969. Stiff paper covers, 5½ x 8½in, 124 pages, illustrated by photographs and diagrams. Australian price \$1.50 plus 20c postage.

This book was reviewed in our August, 1969, issue on page 157. We have been informed that copies are available from Technical Book and Magazine Co. Pty. Ltd., 289-299 Swanson Street, Melbourne, 3000.

## LITERATURE—in brief

**BISHOP TECHNICAL MANUAL AND CATALOG 104A,** 1970 edition. Published by Bishop Graphics Inc., U.S.A. Inquiries to Circuit Components (A'sia) Pty. Ltd., P.O. Box 70, Bexley, N.S.W. 2207. The 68-page manual describes more than 15,000 pressure-sensitive electronic component drafting aids, techniques and systems. Pressure-sensitive patterns, sym-



bols, tapes and multi-pad configurations are completely described with illustrated instructions for their use. New products include: Bishop "B" Neg Negative Drafting System for the preparation of negatives for prototype boards without photography; Bishop Red and Blue Tape Method for preparing artwork for two-sided boards in perfect registration.

**MI CONTACT**, Issue 14. Published by Marconi Instruments Ltd., U.K. Inquiries to Amalgamated Wireless (Asia) Ltd., P.O. Box 96, North Ryde, N.S.W. 2113. Contents include: M.I. announces a new 120MHz frequency meter; MI-Sanders microwave signal source; The Queen awards M.B.E. to Marconi Instruments executive; Q measurement with confidence; Still top value in RF voltage measurement; Accurate measurement of colour television system characteristics; "Autotest" deliveries to Europe in four weeks flat; Consolidation of servicing facilities; A new coaxial attenuator joins the MI-Sanders range; RF attenuator TF2163S handles fast pulses.

**TELECOMMUNICATION JOURNAL**, Vol. 37, No. 1, January, 1970. Published by the International Telecommunication Union (I.T.U.), Place des Nations, 1211 Geneva 20, Switzerland. Contents include: Economic study of satellite systems for telecommunications, air traffic control and navigation, by B. Manuali and C. Ganier; British Post Office transistors for deep-water submarine telephony, by M. F. Holmes and D. Baker; and a report on the activities of the International Radio Consultative Committee (C.C.I.R.) Study Groups during the period 1966-1969.

The section "Ideas and Achievements" includes reports on the Federal Republic of Germany's Azur satellite, Hungary's telecommunication industry, and a proposed new field strength standard. The section on "Union Activities" includes reports on the visit of the Secretary-General to Latin America, the meeting of the joint C.C.I.T.T./C.C.I.R. Regional Plan Committee for Latin America, the 4th session of the Inter-American Telecommunication Commission, and a meeting of the integrated global ocean station system.

**TECHNICAL INTERFACE**, Vol. 1, No. 3, 1969. Published by AIM Associates Cambridge Ltd., U.K. Inquiries to Rutherford Electronics Pty. Ltd., 62 Jackson Court, Doncaster, Vic. 3108. Contents: AIM Phase-Lock Techniques; Pulse Methods, a Theoretical Background, part 1; Pre-amplifiers and Equalisers, part 1; A New Low Drift Phase Sensitive Detector, PSD 122A; Principles of Phase Sensitive Detection; A Theoretical Look at Lock-in Amplifiers; Minilock — a New Miniature Lock-In Amplifier System; New Instruments from AIM; Company News.

**STANDARDS ASSOCIATION OF AUSTRALIA** is seeking comment on two draft Australian standard specifications. Doc. 1488 prescribes requirements for design, construction, physical properties and type testing of containers and cell covers for lead-acid batteries of the automobile type. Doc. 1492 applies to the performance, calibration and characteristics of pure tone audiometers for diagnostic and screening purposes. It will establish requirements intended to ensure that the testing of the threshold of hearing of individuals will give uniformity of results.

Copies of the documents may be obtained, without charge, from the various offices of the Standards Association of Australia in all capital cities and Newcastle. Comment on the provisions of the draft standards is invited from persons or organisations experienced in the relevant fields and should reach the head office of the Association, 80 Arthur Street North Sydney, N.S.W. 2060, or any branch office, not later than 31 March, 1970.

**HEWLETT-PACKARD JOURNAL**, Vol. 21, No. 4, December, 1969. Published by the Hewlett-Packard Co., U.S.A. Inquiries to Hewlett-Packard Australia Pty. Ltd., 22-26 Weir Street, Glen Iris, Vic. 3146. Contents: Network Analysis in the Range 100KHz to 110MHz, by William A. Ryland and David R. Gildea; High Impedance Probing to 500MHz, by Joel Zellmer. The former article describes a new Hewlett-Packard instrument which presents swept display of amplitude response up to 80dB with .05dB resolution. It discusses: Measuring method; Theory of operation; Frequency response; Amplitude measurement; Phase measurement; Transducers; Operation; N-Port power flow measurements; Network analyser applications. The latter article describes a new DC-500MHz voltage probe which can be used with analysers, counters, and oscilloscopes.

**NEW TECHNOLOGY**, No. 34, November, 1969. Published by the British Ministry of Technology and the Central Office of Information. Obtainable free on application to the Central Office of Information, Hercules Road, Westminster Bridge Road, London S.E.1, England. Contents: The Feeding of Successful Decision Makers; Management Decision through Information; RAE plus PERA plus Airmec-AEI equals NCADS; Work for Industry in Mintech Research Establishments; ERDE Advises on Adhesives and Sealants; News; Statistical Indicators.

**LONDON CALLING**, Vol. 4, No. 9, January, 1970. Published by the B.B.C., Bush House, Strand, London, W.C.2, England. Program bulletin of the B.B.C. world service. Contents: Broadcasts in English to the world; program highlights; daily schedules; frequency charts and tables.

**RACAL AUST. REVIEW**, Vol. 1, No. 2, October, 1969. Published by Racal Electronics Pty. Ltd., 47 Talavera Road, North Ryde, N.S.W. 2113. Contents: I.D.T./Link Simulator — Moulding Tomorrow's Drivers; New Products from Racal; Showcase — The New Zealand Trade Fair; Australian Post Office Approval for Racal-Milgo 4400/24PB Modems.

**AURI-NEWS**, Vol. VIII, No. 10, October, 1969. Published by Ad. Auriema Inc., U.S.A. Inquiries to Auriema (Asia) Pty. Ltd., 443 Kent Street, Sydney, 2000. Contents: Apelco solid-state depth sounder and marine radiotelephone; Blonder-Tongue field strength meter; International Data Sciences pseudo-noise transmission test set; Rotron solid-state inverters; General Instrument thermoelectric generators; International Instruments cathodic protection indicator; National solid-state communications receiver and solid-state amateur 5-band transceiver; Tarzian selenium rectifiers; Stackpole rocker and slide switches; Magitran hi-fi speaker system; Keppo power supplies.

**CUMULATIVE INDEX TO THE CLASSIFICATION OF PATENTS**, third microfilm edition. Published by the U.S. Patent Office. Obtainable from the Clearinghouse for Federal Scientific and Technical Information, U.S. Department of Commerce, Springfield, Va. 22151, U.S.A. Price \$70 (U.S.) Contains the official listing of all patent numbers issued up to December 31, 1968—more than 3,400,000 in all. The index consists of 16 reels of 16mm film; seven reels of original (primary) classification, and nine reels of cross-reference (secondary) classifications. Listings are arranged numerically by class and subclass for use in conjunction with the Manual of Classification. Reels may be purchased individually for \$6 each.

Available separately on one microfilm reel is "The Complete Record of the Classification of Design Patents." This reel, also priced at \$6, contains both original and cross-reference classifications of design patents.

## UNITED TRADE SALES

PTY. LTD.

**TRANSISTOR V.H.F. CONVERTER**  
Tunable 108-136 Mhz Aircraft Band 1F-600Kc to 1,000Kc. No connecting wires needed, 9V Battery, self-contained, just place alongside broadcast radio. Price only \$14.40 plus 45c postage.

**TRANSISTORS**  
2SD65, 2T76, OC66, 2T65 25c ea. or in 100 lots 20c ea.

**LSG11 SIGNAL GENERATOR**  
120KHZ to 260 MHZ New in sealed carton \$35, postage \$1.

**COMPLETE RANGE OF METRES.**

	P25's 2 1/2sq.	
100 uA ..	\$6.95	1mA ... \$4.50
500uA ..	\$5.25	50mA .. \$4.50
10mA ..	\$4.50	S'meter .. \$5.25

**MULTIMETERS**, 200H, 20K ohms per volt, \$11.25, inc. tax. CT 500 20K ohms per volt, \$15 inc. tax. CT 330 20,000 ohms per volt, \$17.25

**RESISTORS**. Mixed Values only in Bags; \$2 per 100, or 50 for \$1. 3,000 Type Relays. New stocks. 50c each. Plus postage.

**CAPACITORS**  
80 for \$2 in Poly Packed Bags. Mixed values only.

**TAPE HEADS**  
Cassette Recorder Type Replay Heads. 2-track Mono Current Manuf. New \$1.50 ea. PLU 10c pack. and post.

**MILLER TRANSISTORISED IF STRIPS**  
455 Kc Selectivity 5 Kc at 6db down. Power 6 Volts 2mA gain 50db. Price: \$9.70.

**MU-METAL SHIELDS**  
To suit 5BP1 and other 5in CRTs mfd. by Magnetic Shields Ltd. Brand-new, \$5 ea. plus 30c pack. and post.

**3,000 TYPE RELAYS**. Large range. Only 50c each.

**VALVE SPECIALS**

5V4 ..	\$1.00	6SA7 ..	\$1.00
6A8 ..	\$1.50	6SJ7 ..	.60
6AC7 ..	.20	6SK7 ..	.75
6AM6 ..	.65	6SL7 ..	\$1.00
6B6 ..	\$1.50	6U5 ..	\$1.00
6B8 ..	\$1.50	6U7 ..	.60
6BF6 ..	\$1.00	6X5 ..	.75
6CH6 ..	.50	12AT7 ..	.50
6G8 ..	\$1.50	85A2 ..	.75
6H6 Metal ..	.20	815 ..	.70
6J6 ..	.30	833A(used)	\$6.00
6J7 ..	.50	872A (used)	.75
6J8 ..	\$1.75	844 ..	\$1.50
6K7 ..	.50	ECC33 ..	\$1.50
6K8 ..	\$1.00	ECC35 ..	\$1.00
		KT61 ..	\$1.50

All prices subject to alteration without notice. All items PLUS POSTAGE.

**WANTED TO BUY**  
RECEIVERS, TRANSMITTERS  
TEST EQUIPMENT.

**280 LONSDALE STREET,**  
**Melbourne. Phone 663-3815.**  
(Opposite Myers)

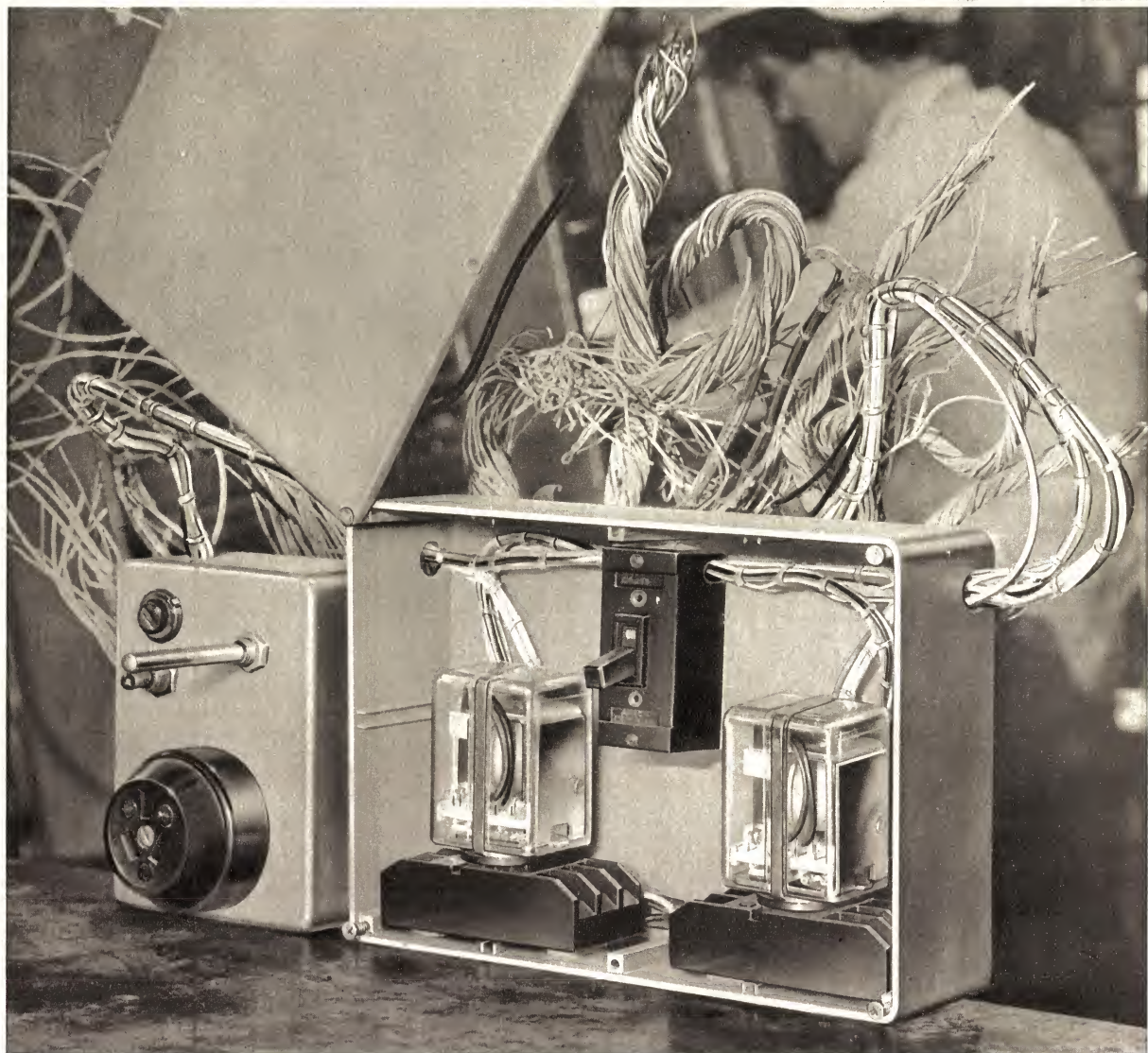

## Taming the junction jungle

### STC knows how

The DCB — Die Cast Box — is the answer. Neat, tidy STC aluminium boxes will house anything in electrical engineering. And house them better, safer than in sheet metal boxes. Buy an STC DCB and save yourself the agony of making up sheet metal boxes. Choose one that suits you. The five boxes in the STC range can be used for a variety of applications. Especially for sorting out "the junction jungle". The boxes have internal slots for screens, and dividing walls. Whatever electric gear you want to house, you'll

house it better in an STC DCB. Here's the technicals:

The 46R range consists of 5 sizes, from 4¾" x 3¾" x 1" to 10¾" x 6¾" x 2" all compatible with STC's modular construction system (ISEP).

For further details contact **Standard Telephones and Cables Pty. Limited**, Moorebank Avenue, Liverpool, N.S.W. 2170. Phone Sydney 602 0333. Wollongong 2.7974. Newcastle 61.5172. Melbourne 480.1255. Canberra 49.8667. Brisbane 47.4311. Adelaide 51.3731. Perth 21.6461.

AN **ITT**  
ASSOCIATE

worldwide telecommunications and electronics



U545



# AMATEUR BAND NEWS AND NOTES

## Australis Oscar V in orbit

The Australian built amateur radio satellite was successfully launched in January and has been tracked by enthusiastic amateur operators throughout the world.

by Pierce Healy, VK2APQ

On Friday evening, January 23 listeners to Wireless Institute stations in Victoria and New South Wales, heard an on-the-spot description of the launching of the NASA space vehicle which placed the Australis Oscar V in orbit around the earth. Description of the launch was given by members of the AMSAT group from the space tracking and control centre at Goddard in the United States.

The main communication link was between the Goddard centre and the Project Australis co-ordinator, Richard Tonkin, at the Australis Project Headquarters in Melbourne University. The conversations and technical details exchanged between the two centres was relayed interstate by landline and official transmissions were made on amateur band VHF and HF channels.

Shortly after 11.30 p.m. E.S.T., acquisition of the signals from the satellite was reported both in Melbourne and Sydney. The telemetry data was recorded on both 144.050MHz and 29.450MHz. These initial reports indicated that all systems were operating satisfactorily.

Since the launching many amateurs in all States, as well as other parts of the world, have been able to record the data transmitted. It is expected that the satellite will continue operation for about two months from the time of launching.

Details of the orbital predictions will be given from all W.I.A. stations during the Sunday morning news broadcast sessions on 7146KHz. Reports from stations tracking the satellite are necessary for the success of the project. These should be sent to Project Australis Co-ordinator, Richard Tonkin, 5/39 Tooronga Road, East Malvern, Victoria, 3145.

### THE ASIAN SCENE

An initial report on the First All India Amateur Radio Convention in Bombay was contained in last month's notes. Further details of the event will be given when a copy of the official report comes to hand.

After the convention my trip was continued on December 31 to Delhi, where I stayed until 3 January. During that time I visited Doyle Edmondson, VU2-BEO, who is stationed at the U.S. Embassy in Delhi. On the evening of December 31, which I spent with Doyle,

contact was made with Keith Johnston, VK7RX and Tom Moore, VK7FM.

This contact developed into what must be the first DX contact with a station using the AX prefix. Daylight saving time in Tasmania put stations in that State ahead of mainland stations in the right to use the Cook Bi-centenary prefix. The contact with Keith started before midnight Tasmanian time and at the witching hour Keith signed as VK7RX and called as AX7RX, under which call the contact was continued. VK7FM, realising what had transpired, again joined in the contact to give Doyle his second AX contact within minutes.

This was surely a unique contact — a visitor to VU land, VK2APQ, participating unexpectedly in the first ever QSO made between a DX station and an AX prefix station. Doyle's confirmation QSL card was given to me to bring back for VK7RX and VK7FM.

New Year's Day was spent on a trip to Agra and a visit to the Taj Mahal. The beauty of the Taj must be seen to be fully appreciated, and the experience could form the subject of a separate story.

On the evening of January 2, I was the guest of Amar Bannerjee, VU2CZ, Secretary of the Amateur Radio Society of India, M. G. Karnik, VU2CK and Anil Sen, VU2SA, at the Delhi Flying

Club. This meeting was most interesting, as it allowed me to meet executive members of the only amateur radio society in India which did not support the convention in Bombay.

The next stop was Bangkok, Thailand. After leaving Delhi during the morning of January 3, we were flying parallel to the mighty Himalayas — and what a sight to behold! What VHF locations! But what a lot of snow and ice; During this flight, the cities of Calcutta and Rangoon were seen.

On arrival at Bangkok I was met by an old friend, Howard Rider, VK3ZJY, now HS1ABA and Forrest McClure, HS1EI, and was escorted by them to my hotel. The evenings of January 3 and 4 were spent at the home of John Doherty, HS1AF, from where contact was made with John Lark, VK2ALK.

Both evenings were spent discussing aspects of amateur radio, both the local scene in Thailand and the international scene. Also present at these evenings were Chuck Farr, W6AJW on leave from Laos, and Fred Laun, HSSABD, vice-president of the Society of Thai Amateur Radio. Due to other commitments the president of the Society was unable to be present.

On January 5 it was announced that Thailand would in future be divided into nine districts but only five would be allotted; also, all call-signs would be revised. Three letter calls would be allotted to non-Thai nationals. It is interesting to note that the call-signs are issued by the Society of Thai Amateur Radio — STAR.

The next stage of the trip was to Hong Kong, where I arrived January 6. That evening was spent in the China Fleet Club at an unofficial gathering of members of the Hong Kong Amateur Radio Transmitting Society. Lyell Louttit, VS6BE/VK2BE, was present at this function.

More about Hong Kong and Singapore next month.

News and notes of Divisional and Club activities submitted for inclusion in these columns should be forwarded direct to Pierce Healy, 69 Taylor St., Bankstown, N.S.W. 2200.



## ELECTRONIC SERVICES

(CANBERRA) Pty Ltd.

ELECTRONIC ENGINEERS

No 6 Pirie Street,

FYSHWICK A.C.T.

2600

Phone 95 0679

### SPECIALISTS IN MAINTENANCE OF ★

- ★ DATA PREPARATION EQUIP.
- ★ DATA TRANSMISSION EQUIP.
- ★ TELEPRINTERS
- ★ MOBILE RADIO
- ★ INTERCOM EQUIP.
- ★ TRAFFIC SIGNALS

### MANUFACTURERS OF ★

- ★ PRINTED CIRCUITS
- ★ SPECIALISED ELECTRONIC EQUIP.
- ★ AUTOMOTIVE CABLES

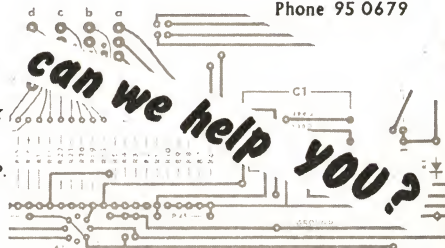

**AUSTRALIA'S BIGGEST RANGE OF MAIL ORDER BARGAINS**  
**MAIL ORDERS: DIRECT DISPOSALS 36 HELEN ST., VALLEY, BRISBANE 4006**  
**Est. 25 yrs.**  
**DIRECT MAIL from DIRECT DISPOSALS**

**240v. Electric Pumps**  
**BRAND NEW**  
**\$8.75**

Direct English purchase from a famous manufacturer. We purchased their entire stock of these **ABSOLUTELY BRAND NEW** in carton 240-volt electric motorised pump unit. Usually sell for \$25.00. Full 3 MONTH GUARANTEE. Special Neoprene impeller pump will handle corrosive fluids, fuel and water. Pumps 300 400 g.p.h. To be gravity fed and will lift to 8'. Ideal for fuel or water transfer, fountains, fish ponds, etc. Pump entirely non-corrosive. Rush your order now as stocks will not last at this price. Pack, post 75c.

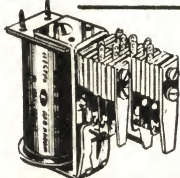

**SWISS RELAYS**  
**\$2.25**

P. & P. 25c

Beautifully made by "Elasta". Orig. for computers, cont. duty coil resistance 8000 ohm. 4 S.P.D.T. (or two D.P.D.T.) Contacts precious metal gold-plated, carry up to 10 amps. in low voltage A.C. or D.C. or up to 250V A.C., min pull in volts 45V D.C. 6 M.A. — Max. 100V D.C., brand new in plastic case, size 2 1/2" x 1" x 2".

**\$12.50**

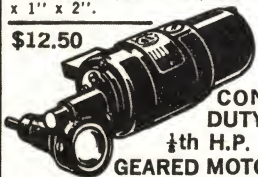

**CONT. DUTY**  
**1/4th H.P.**  
**GEARED MOTOR**

Made by Dumore, U.S.A., 28V D.C., works perfectly on 12V or 32V D.C., has threaded drive and shaft for standard flexible drive or pulley can be fitted to shaft. Approx. 150 final RPM BRAND NEW. P. & P. 75c.

**COMPUTER BOARDS**

Enormous purchase from famous computer manufacturer. Each board comprises a minimum 4 transistors and up to 6 transistors, plus host of resistors, diodes, capacitors, inductors, etc. Transistors are NPN & PNP germanium type T05 & T018 for R.F. audio, hi-speed switching, etc. 100's of uses. Size of board 2 1/2" x 4". 4 boards with minimum of 16 transistors \$1.50 post 20c. 8 Boards with minimum of 32 transistors \$2.75, post 25c. 16 Boards with minimum of 64 transistors \$4.95, post 60c. Special price for quantity

**ENGLISH NEON TESTERS**

4 for 80c P. 5c.  
 Voltage tester for 180 to 300v. A.C. Complete with inbuilt resistor and flexible leads with prods. Glows on contact. Also ideal for panels, etc. Special price for quantity.

**MODEL MOTOR & GEAR TRAIN**

**\$1.65**

\$1.65, P. and P. 25c. Powerful permanent magnet model motor in steel chassis, with all metal English reduction gear train, produces considerable torque, operating voltage 1 1/2 to 4 1/2 volts DC (torch batteries), final drive speed approx. 100 r.p.m. at 1 1/2 volts. Size 4" x 2 1/2" x 1 1/2" high, brand new, originally designed for Mecco products.

**MONEY CHEERFULLY REFUNDED IF NOT COMPLETELY SATISFIED**

**SPECIAL!**

**\$18.50**

p. and p. \$1.50

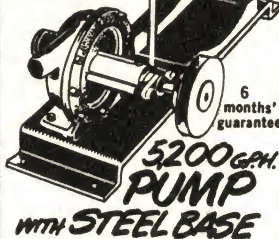

**5200 GPH. PUMP WITH STEEL BASE**

6 months' guarantee  
 1 1/2" inlet, 1" outlet (OD) centrifugal pump with 3" pulley all metal. Capacity and pressure of pump (up to 60 PSI) depends on electric motor used, special steel base designed to take any size electric motor 1/4 h.p. to 1 1/2 h.p., just tighten wing nuts. Ball type foot valve for 1 1/2" hose extra \$2.75. Pump and base fitted with 1/4 h.p. 240V A.C. electric motor, gives 2,000 g.p.h. \$29.50; Freight \$3.50; S.A., W.A. \$5.

**NEW D.L.R. DOUBLE EARPHONES**  
**\$1.65**

P. and P. 45c  
 Famous English make. Suberb for crystal sets, transmitters/receivers, silent radio and TV listening, etc., Complete with long lead. New double earphones with microphone has press to talk switch. \$2.40, P. and P. 60c.



**SHIPS WHEELS**

**\$12.50**



**BIG 18"**

Super special huge import of beautifully made fine grain polished wood ships wheels by the best craftsmen, big 18" diameter. Ideal decoration for bars, patios, study, above fireplace, etc., hang from ceiling as beautiful chandelier, fit candles or bulbs. Another first for Direct Disposals. Rush as these will not last at the special low price of \$12.50. Brand new; pack and freight \$1.50.

**SPECIAL OFFER!**  
 Brand new **STEPDOWN TRANSFORMERS \$1.75** (Post 30c). 240-volt input 2 1/2-volt output. 1.5 amps push-on terminal lugs with inbuilt heat relay. (Cuts off current if overloaded.)

**\$35 AXIAL FLOW BLOWER**

Fantastic bargain, made by "Dynamic Air" for U.S. govt. at \$200 ea. .4 h.p. 24/32v (also works well on 12v) double 6" fans, 6,200 r.p.m., draws only 10 amps, rated capacity 365 cub. ft. per min., has two 6" dia. fans cont. duty, static suppressor fitted, cost U.S. Govt. \$240 ea. 3 months g'tee. absolutely brand new. Ideal extractor fan for boats, etc., many other uses. Size 6" dia. x 8" long. Pack and post \$2.  
 4" Axial flow blower \$15, for 24-32V (works perfectly on 12V) made in U.S.A. new. P. and P. 75c.

**REFRIGERATOR THERMOSTATS \$1.50**  
 New — Teddington 115 to 250 volts, suitable for most makes of domestic refrigerator, deep freeze, ice cream conservator, etc. Size 2 1/2" x 1" x 1", supplied with capillary tube up to 1/2 h.p. motor. P. and P. 25c.

**ENGLISH MECHANICAL REV. COUNTERS**

**\$1.50 Post 25c.**

0-999 worm drive re-settable with knurled wheel. Counts also 999-0 with 2 screw mounting bracket. 2" x 3-16" shaft for drive. Brand new in packets.

**GEM TUMBLERS**  
**\$9.50**

P. and P. \$1.20  
 Tumbler and motor \$18; p. & p. \$2.

Terrific bargain, designed for the gemstone collector for tumble polishing large quantities of gems. A reliable trouble-free machine fitted with 1/2-gal. barrel which will process 4lb.-5lb. of stones, produces flawless gemstones of great beauty. Supplied in kit form, takes minutes to assemble, has pillow block bearings (4), shafts, pulleys, belts, 1/2-gal. barrel, mounting blocks. (Note: Flat wood base not supplied.) is complete with full instruction book for gem tumbling and assembly of unit. 240V A.C. AEI ball bearing electric motor to suit with 2 different size pulleys for slightly different speeds resilient mounting base, starting relay, an extra \$8.50. Post Tumbler and Motor \$2.20.

12" 40 watt \$17.50  
 15" 60 watt \$25.00

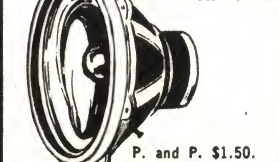

Huge purchase from liquidation of famous manufacturer. TRENT "PIONEER" Hi-Fi SPEAKERS Brand new in cartons, 1970 models. These beautifully made superb speakers are selling at 1/3rd of usual price. 8 OHM. IMP. For bass guitar or electric organ

**ENGLISH HEAVY DUTY TRANSFORMERS \$12.50**

240 Volt input, 6.3 volt 4 times (4 terminals) 6.3V. at 8 amps. each terminal). Originally made for radar units by Aero Transformers; cost \$60 to make; weighs 14lb. Freight \$1.50.

English 240v flasher fits into ordinary light socket. for 25 watt bulb, 85c; Great for displays. Post 25c.

**NEW "LUCAS" AIRCRAFT MAGNETIC RELAYS**

12 Volt, 60 amps., 2 make and break, \$1.50; 12 Volt, 20 amps, 1 make and break, \$1.20; 24 Volt, 60 amps., 2 make and break, \$1.50. P. and P. 50c.

New 4 AMP 3-18 volt SELENIUM RECTIFIERS Full wave Current English make. Brand new. Converts A.C. to D.C. 95c. post 25c. 2 1/2 AMP. 65c (Post 15c).

English dry reed switches, gold plated contacts 1" long x 0.15" up to 250V A.C. 250 M.A. 2 for 80c; post 5c.

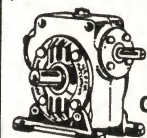

**\$15**

**GEARBOXES**

2 ratios available 10.5 to 1 and 14.5 to 1, made by David Brown "Radicon" England. Very robust construction, has two driving shafts at right angles and oil filter plug. Unit is drilled for 4-bolt fixing, size 4 1/2" x 4 1/2" x 3 1/2", 7/16" and 8" dia. x 1 1/2" long shafts (cost over \$100 to make). Bargain 100 only. (Pack and Post \$1.50.)

**HEAVY DUTY BATTERY CHARGERS**

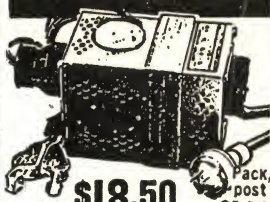

**\$18.50**

Charges 6V and 12V Batteries overnight • High 4-amp. charge rate • 12 months written GUARANTEE.

Top quality! Top performance! A fantastic direct deal from top manufacturer. They are usually sold at \$30.00. Finest quality components; steel case.

Silicon diode rectifiers. Charges 6v. and 12v. batteries from 240v. A.C. mains. Complete with fuse, ammeter, long lead with alligator clips for battery terminals and long flex with 3-pin plug. Units are brand new in carton and have passed strict electrical authorities test.

**HALF PRICE SPECIAL HI-FI RECORDING TAPE**

Fantastic purchase of "Mylar" professional recording, computer tape (the best money can buy). Famous 3-name brand (one we can't mention due to huge price reduction). Silicone lubrication. Suits all tape recorders, hi-fi and stereo. Selling well under half price. Post 10c each.

- 3" 225' ..... 65c
- 5" 600' ..... \$1.75
- 7" 1200' ..... \$2.95
- LONG PLAY
- 5" 900' ..... \$2.45
- 5 1/2" 1200' ..... \$2.75
- 7" 1800' ..... \$3.95

Empty spools 3" 25c 5" 35c Post 10c each.



Famous 200 H Model 20,000 OHMS MULTIMETERS \$9.75 P & P 50c

Extremely sensitive 20,000 ohms complete with full instructions and probes with overload protection RANGES:— D.C. VOLTAGE: 5-25-50-250-500-2.5K (20,000 ohms per volt). A.C. VOLTAGE: 10-50-100-500-1000 volts (10,000 ohms per volt). D.C. CURRENT: 0-50 uA, 0-2.5 MA, 0-250 MA. RESISTANCE: 0-6K, 0-6mg. (300 ohm and 30K at centre scale). CAPACITANCE: 10 uUF to .001 uF, .001 uF to 1uF. DECIBELS: -20 to +220B

**NIFE BATTERIES—95c**

P. and P. 10c ea.  
 Brand new! Nickel iron, spill-proof, leak-proof cells—Lasts forever, 4 A.H., 1.2 volts. Sizes 3 1/2" x 2 1/2" x 1". Couple together for any voltage—superb for spotlights, lamps, bells, flash equipment, etc. Set of 10 gives 12 volts 4 A.H. \$7.95 (Pack post \$1); Set of 5 for 6 volts, 3.95 (Pack post 50c).



**Compact Cassettes**  
**RECORDING TAPE**  
 P & P 20c.  
 Top quality Philips type cassettes by famous maker sells at half price. Individually packed in plastic library box. C60 (60 min. recording time), \$1.45; C90 (90 min. recording time), \$1.95. C120 (2 hours) \$2.75.

## QUARTER CENTURY WIRELESS ASSOCIATION

The Sydney Chapter of the Q.C.W.A. meets on the second Wednesday evening of each month at the Combined Services Club, Barrack Street, Sydney, for dinner and get-together.

Membership is open to amateur operators who have held a licence for at least 25 years. For details write to: The Secretary, who is George Wilson, VK2AGO, 31 Glenview Street, Greenwich, 2065; or Brian Anderson, VK2AND, 14 Stuart Street, Longueville, 2066.

### NEW PUBLICATION

A new publication, "OHM" (Oriental Ham Magazine) is being published by Pacifica Publications in Hong Kong. The publisher is Phil Wight, VS6DR and the editor is Roy Chalu. Editorial board: Herb Asmussen, VS6AD; Maurice Caplin, VS6AA and Ken Young, VS6AL. The first issue was in October 1969. Subscription rates are: Surface mail, world-wide, \$2 U.S. per year. Airmail, Australasia, \$10 U.S. per year.

"OHM" contains several technical articles of topical interest as well as a summary of up-to-date information on happenings in South-East Asia. The quality of the publication is very good. The size is 8in x 5½in and the copy seen had 24 pages, liberally illustrated with photos and sketches.

### NETHERLANDS PREFIX

Radio amateurs in the Netherlands may, in the future, be permitted to use the call sign prefix "PD" on special occasions instead of the current "PA" call. Also possible is the use of a digit other than the zero now employed by the Dutch nationals. At the present time foreigners under reciprocal agreements use a PA9 prefix.

### RTTY CHAMPIONSHIP

The committees of several RTTY groups and societies have decided to make an award to the "World Champion of RTTY."

The objects of this award are as follows:

1. To promote greater interest for the RTTY operator taking part in the various RTTY contests.
2. To increase the competitive spirit during the course of the contests during the year.
3. To make available an award to the radio amateur who has demonstrated his ability to operate RTTY during a period of one year.

At the present time the contests which will count towards this new award are as follows:

- 1969 BARTG Spring RTTY contest.
- 1969 DARC RTTY WAE Contest.
- 9th World-wide RTTY DX Sweepstakes.
- 1969 Alex Volta RTTY Contest.
- 1970 Giant RTTY Flash Contest.

Other societies who organise international contests are invited to join in this new idea, to increase interest in the RTTY mode for radio amateurs.

To arrive at the final score, and to decide the winner, the following points system will be used for each contest: 30 points to the winner; 25 points for 2nd place, 22 points for 3rd place; 20 points for 4th place; 18 points for 5th place; 17 points for 6th place; 16 points for 7th place, etc., to 1 point for 22nd place, and all other entrants.

For the final score for each year, only the best four scores (out of a possible of five) of each operator will be used.

In order to take part in this award contest, it is not necessary for entrants to send in a claim, as the entries of all competitors in the contests listed will be automatically included.

## DUNEDIN CONVENTION CONTEST

An 80-metre "All Modes" contest will be held in conjunction with the 44th Annual Convention to be held in Dunedin at the Queen's Birthday weekend, 1970.

It is to be held in April, 1970, and the rules are simple. You are invited to contact as many ZL4 stations as possible on 80 metres and to work them on as many different modes as possible, viz.: you may work each station on CW, SSB, AM, etc., and score points each time.

If you desire, you may work the same station several times running SO LONG AS YOU USE A DIFFERENT MODE EACH TIME. The ZL4 may continue to work you on the same mode as he started or he may change if he desires. It is YOU who have to change the transmission mode.

Example: You may work ZL4FD on AM. You will receive points. You may then call and work him on SSB. You receive more points. To count, the contacts MUST be made during April, 1970, and you may contact any ZL4 station at any time during this period.

### Rules:

Band: 80 metres only.

Time: During April, 1970, only.

Modes: As many as you like.

Points: Dunedin stations, 10 points each time worked, other ZL4 stations, 5 points each time worked.

Note: DUNEDIN STATIONS ARE BONUS STATIONS.

Logs: Send a list of stations contacted, the date, the time and the mode to:—David Lloyd, ZL4PG, P.O. Box 5220, Dunedin, New Zealand, to arrive not later than May 28, 1970.

The prize is a fully solid-state SSB exciter for 80 and 20 metres in complete operational condition, brand new and ready to plug into your linear amplifier. Value—over \$60.

To win this prize it is mandatory that you be at Dunedin convention in person to accept it. If the first placegetter is not at the convention to receive it in person, the second, third or fourth placegetter, as the case may be, will receive the prize in person.

A "Mystery" station will be on the air each Sunday evening during April. He will be a Dunedin station and will call "CQ, CQ, CQ. This is the convention mystery station, ZL4 . . . (as the case may be) calling CQ" for 20 seconds at 1930, 2030 and 2130 hours NZST. He could be on any mode and in any part of the 80 metre band. If you work him, you get 50 points every time.

### JAMBOREE-ON-THE-AIR

Two national reports on the 1969 Boy Scout Jamboree-on-the-Air, held on October 18 and 19, have been received. The first is from D. D. Devan, 9M2DD, of Malaysia, whom I had the pleasure of meeting when I visited Singapore early in January when taken on a visit to his home in Johore Bahru by Peter Pang, 9V1AZ. The report gives details of the activities

of 11 stations that participated in the event, and mention is made of several other amateur operators who also gave assistance. The Malaysian Boy Scouts Headquarters station 9M2BP, was operated from the Selangor Boy Scouts' Association's Castle Camp, just out of Kuala Lumpur city. Contacts with 10 Australian stations were made during the weekend.

In summing up his report, the Malay-

## SPECIAL 3 MONTHS OFFER ON STANDARD AMATEUR CRYSTALS

.01 per cent \$4.25, .005 per cent \$5.50 inc. S. Tax and Postage  
Style HC-6U Holder Frequency Range 9 to 15 MHz Commercial  
Crystals in HC-6U Holders .005 per cent Tolerance Frequency  
Range 9 to 15 MHz \$6.00 plus S. Tax.  
Prices of Closer Tolerance on application.

## BRIGHT STAR CRYSTALS

Preferred by leading Manufacturers throughout the country for—

### ACCURACY-STABILITY-ACTIVITY-OUTPUT

Consult us for Crystals for any Mobile Radio. All types available.

### DISCOUNT FOR QUANTITY ORDERS

Established 36 Years

AMATEUR AIRCRAFT and ULTRASONIC CRYSTALS also AVAILABLE

Our modern Factory equipment allows us to offer you  
PROMPT DELIVERY for all your CRYSTAL requirements.

DEVOTED EXCLUSIVELY TO THE MANUFACTURE OF

## PIEZO ELECTRIC CRYSTALS

Contractors to Federal and State Government Departments

REPRESENTATIVES AUSTRALIA AND NEW ZEALAND: Messrs CARREL & CARREL  
BOX 2102, AUCKLAND.

MESSRS ATKINS (W.A.) LTD.,  
894 Hay Street, PERTH.  
MESSRS. A. E. HAROLD PTY. LTD.,  
123-125 Charlotte Street, Brisbane.

MESSRS LAWRENCE & HANSEN  
ELECTRICAL (VIC.) PTY. LTD.,  
34 Brisbane Street, Hobart,  
and 29 St. John Street,  
LAUNCESTON, TASMANIA.

## BRIGHT STAR RADIO

546-5076 LOT 6 EILEEN ROAD, CLAYTON, VICTORIA 546-5076

# BUYING WALKIE TALKIES?

**IT'S NOT EASY!** Best way is an 'on site' demonstration, preferably with competition from brand 'x'—then you **KNOW** which does the job. We know you'll pick **TELECON** — not just because it's best in performance, but for service, spares and reliability too. Don't take our word—ask some of the 50 Government Departments (and others) that use them. Better still, ask for a demonstration—now. (User list and pamphlets available on request.

**FROM .1 to 5 WATTS, AND ALL PRICES FROM \$40 TO \$400. VHF AND UHF TYPES TOO.** Or perhaps you need a radio page system — or antennae — or test equipment. We should mention, we have the best equipped workshop for repairs, and spares to keep your equipment running for at least five years.



Australasian Agents:

**Strato Communications Pty. Ltd.,**  
 25 WENTWORTH ST., PARRAMATTA, N.S.W. 2150  
 Telephone 635-9856, 635-5569.

TEDCO PTY. LTD.,  
 579 Murray St.,  
 Perth, W.A. 6000

HEMOCRAFTS-TAS.,  
 199 Collins St.,  
 Hobart, TAS. 7000

AUSTRALIA SOUND &  
 TELEVISION CO., P/L.,  
 35-39 Yarra Bank Road,  
 South Melbourne, VIC. 3000

FRED HOE & SONS P/L.,  
 Block 23, Industries Road,  
 Salisbury North, Brisbane.  
 QLD. 4107

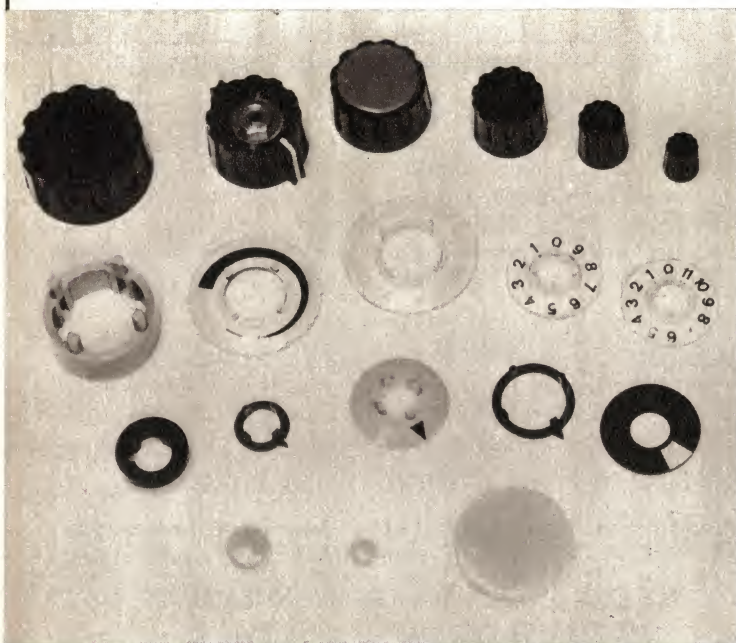

## ELMA KNOBS

- ★ Designed for professional equipment.
- ★ Reasonably Priced.
- ★ Large range of accessories
- ★ Selection of colours
- ★ Positive collet fixing.

FOR INFORMATION CONTACT

ASSOCIATED CONTROLS PTY. LIMITED  
 14 Enterprise Avenue, Padstow, N.S.W. 2211  
 Telephone: 771-3833 (4 lines)

**N.S.W.**

ASSOCIATED CONTROLS (VIC.) PTY. LTD.  
 2 Vicki Street, Blackburn South, Vic. 3130  
 Telephone: 878-6555

**VICTORIA**

sian National Organiser, Ahmad Bin H. A. Rashid, paid tribute to Television Malaysia for their coverage of the activity at the headquarters station; also to several willing assistants, including Avatar Singh, 9M2AV, whom I had met at the First All India Amateur Radio Convention in Bombay. According to the report, a rough estimate indicates that no less than 600 scouts took part in the 1969 Jamboree-on-the-Air.

The second report was from Noel Lynch, National Organiser for the Australian Boy Scouts' Association. Noel's report contained news from Branch Organisers in all States of Australia and Papua-New Guinea. From the participation figures given in the reports it seems that many

of the previous totals have been exceeded. In Victoria, 3,000 Scouts and Scouters participated together with 1,000 Guides and Guiders.

Nearly all reports mentioned the fact that they had a contact with the International Amateur Radio Club Station, 4U1ITU, which operated in conjunction with the Headquarters of the World Scout Bureau in Geneva, Switzerland.

One interesting point in the report is the fact that there are now 15 official Scout Group stations operating in Australia. The report, which has been sent to the World Bureau, acknowledged the press, radio and television coverage and paid tribute to all who assisted in making the event an outstanding success.

## WIRELESS INSTITUTE ACTIVITIES

The twenty-fourth Federal Convention of the Wireless Institute of Australia will be held in Adelaide over the Easter holiday weekend, March 27-30, 1970. The South Australian Division is the host to Federal Councillors from the other Divisions. This convention coincides with the 60th Anniversary of the formation of the W.I.A.

### NEW SOUTH WALES

The annual meeting of the New South Wales Division will be held on Friday, March 20, when the annual reports will be presented and the council for 1970 will be elected. On Saturday evening, March 21, the annual dinner will be held at the Argyll Tavern, Sydney. Bookings for the dinner should be made in writing to the Secretary, Wireless Institute Centre, 14 Atchison Street, Crows Nest. Tickets are \$5 each which must accompany the request for booking.

On Sunday, March 22, the annual field day will be held at the divisional transmitting station VK2W1, Quarry Road, Dural. Field events are being arranged as well as a display of equipment by trade houses.

At the January meeting of the Division, the Federal Councillor, Pierce Healy, VK2APQ, presented his report for the past year, in which the attention of members was drawn to matters that required consideration by those who had the well-being of the Division and amateur radio at heart. Following some discussion on the points raised, the meeting re-elected Pierce, unopposed, for a tenth term as Federal Councillor.

### URUNGA CONVENTION

The organising committee extend to you a warm invitation to attend this very popular convention, held on the North Coast of New South Wales, and trust that you and your family will be among the visitors to enjoy the hospitality of Urunga over the Easter holiday weekend.

There will be plenty of prizes, including a special jackpot for a Sunday morning event, and another very worthwhile award—a week's free accommodation for two at the Ocean View Hotel, Urunga. There will also be trophies and 1970 Urunga pennants for presentation to successful competitors.

In appreciation of the services given to amateur radio over a period of 21 years by the late Crieff Retallick, VK2XO, and the tremendous amount of work he had done in organising the Urunga Convention each year, the convention committee have decided that this year the convention will be known as The Wireless Institute of Australia Urunga Convention—Crieff Retallick Memorial Year.

The program, which is definitely for all the family, will start on Good Friday, March 27, with a general meeting and get-together at the Ocean View Hotel, commencing at 8 p.m.

**Saturday, March 28**

9 a.m.-12 noon. Registration at the booth (to be set up in the park opposite

Ocean View Hotel). Fees: Men, \$2.50; Ladies \$1.50; Children free. Registration Officer: Clive Jackson, VK2TD.

10 a.m.-11 a.m.: 144MHz novelty transmitter hunt, which will be within a radius of three miles from the registration point.

11.30 a.m.-12.30 p.m.: 7MHz hidden transmitter hunt.

2.30 p.m.-3.30 p.m.: 144MHz hidden transmitter hunt. There will be four transmitters, two each on 144.1MHz and 146MHz, located at two sites. The winner will be decided on the time taken to locate all four transmitters.

2.45: Events will be held for the ladies and those not participating in the field event.

8 p.m.: Social evening in the School of Arts, Urunga. All members and their families are invited to be the guests of the organising committee.

9 p.m.: Auction of members' surplus equipment. (No junk, please.)

**Sunday, March 29**

10.30 a.m.-12.30 p.m.: 144MHz hidden transmitter hunt. There will be four transmitters, two each on 144.1MHz and 146MHz, located at two sites. This is a jackpot competition, and in addition to the normal prize for the event there will be the jackpot prize which was not won last year.

2.30 p.m.-4 p.m.: All-band scramble, any power, any frequency, any mode.

8 p.m.: Prize giving and social evening at the Urunga Golf Club.

The competition requirements are: All events will be controlled by an official starter strictly on time from the park opposite to the Ocean View Hotel.

Please note: The 144.1MHz transmission will be carrier only and the 146MHz transmitter pulse modulated. The ruling of the committee on any matter will be final. Accommodation booking should be made direct with the hotel or motels at Urunga. Further information may be obtained from: Brian Slarke, VK2ZCQ, North Bank Road, Bellingen, N.S.W. 2454; or Ray Chaplin, VK2SB, either on the air or by phone—Nambucca Heads 154.

### QUEENSLAND

Classes conducted by the Queensland Division of the Amateur Operator's Certificate of Proficiency examination were scheduled to commence on February 11. These classes are designed to assist those wishing to obtain their amateur licence. This year it is intended to use visual aids as an adjunct to the lectures. However, assistance is required in the construction of such aids. The Class Organiser, Syd Carter, Masaman Terrace, Taringa, 4066, would like to hear from anyone willing to undertake the construction of such aids.

Instructors for the classes are Stan Armstrong, VK4SA, Reg Hildred, VK4RE, and Jack Morris, VK4JQ. The fee for the class is \$6. The class organiser would be pleased to hear from other amateurs who would assist as instructors.

The inaugural meeting of the Sunshine

## POTENTIOMETERS

(2 inch Shaft)  
STOCK RANGE: 1k, 5k, 10k, 25k, 50k, 100k, 250k, 500k and 1M, Log and Linear: 35c each. Switch Type: 75c each. Dual Gang (Log or lin): \$1.45 each. MINIATURE PRE-SET POTS: Same range as standard pots above. 20c each or 10 for \$1.50.



## MINIATURE VOLUME CONTROL

Universal 16mm type. 5k ohm with on-off switch. 30c each or 10 for \$2.50.

## PART PAKS

Pack 56: Contains 3 resistors of 57 valves between 10 ohms and 1M, totalling 171. All 5 P.C. types. 1/4W: \$4.75. 1/2W: \$4.84.

## POWER TRANSFORMERS

Gives: 6.3v, 7.5v, 8.5v, 9.5v, 12.6v, and 15 at 1 amp. Very useful for the hobbyist. \$4.50 plus 50c post.

## TRANSISTORS

We now stock the complete Philips range. Send S.A.E. for list.

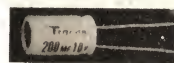

## ELECTROLYTIC CAPACITORS

Miniature Type		Top Grade	
Type	Price	Type	Price
25VWV 1-9	10-99	10VWV 1-9	10-99
5mf	16c	5mf	12c
10mf	18c	10mf	13c
25mf	19c	25mf	14c
50mf	21c	30mf	15c
100mf	25c	50mf	17c
200mf	29c	100mf	19c
500mf	40c	200mf	25c
1000mf	60c	500mf	33c
2000mf	98c	1000mf	49c

## POLYESTER CAPACITORS

100VW Types—Fully Guaranteed

MFD	Price	MFD	Price
0.001	1-9	0.033	10+
0.001	7c	0.047	10c
0.0022	7c	0.05	11c
0.0033	7c	0.068	11c
0.0047	7c	0.08	11c
0.005	7c	0.1	12c
0.0068	7c	0.12	14c
0.022	7c	0.33	21c
0.03	9c	0.47	23c

YELLOW-CAP. Ceramic Capacitors 100v. Range 2.2PF—820FF 6c each or \$5.00 per 100. Your selection in above range. Values may be mixed.

## RESISTORS

(Carbon Film + -5 P.C. Tol.)

1-99	4c	100-999	1000
1/4w	4c	3c	2.1c
1/2w	4c	5c	2.3c
1w	7c	3.5c	4.2c

RANGE: 1/4 and 1/2w 1 ohm—10meg.

1w 5 ohms—1 meg. NOTE: Values maybe mixed — We supply to your list.

DESPATCH: All orders are received at 9 a.m. at the P.O. and despatched to meet the 1 p.m. clearance the same day. This gives you a 4 hr. service.

POSTAGE: Add 10c pack/post fee to all orders irrespective of size.

QUALITY: All our parts are new and fully guaranteed. No surplus or rejects.

CATALOGUE: New catalogue now available. Send S.A.E. for same. Many new parts.

## KITSETS AUST.

MAIL ORDER DEPT., BOX 176 P.O., DEE WHY, N.S.W. 2099

SALES DEPT., SHOP 14, STONE'S ARCADE, 673-675 PITTWATER ROAD, DEE WHY, N.S.W., 2099.

Phone: 982-5571.

# Telite

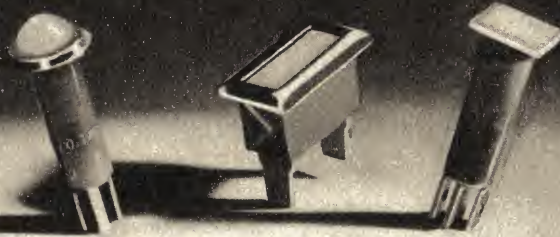

## The Light Fantastic

TELITE NEON INDICATORS ARE TRULY A "FANTASTIC" LIGHT

- NO FILAMENT TO BURN OUT!
- UNAFFECTED BY VIBRATION!
- NOR BY POWER SURGES!
- NOR BY FREQUENT SWITCHING!

TELITE NEON INDICATORS are available in voltages from 60V. A/C to 415V. A/C and in a variety of attractively styled mouldings in materials to suit your purpose — for example, Nylon, for high temperature operation — or indelibly impressed with letters or figures in permanent colours. Your new project is worthy of these advantages — ask for technical literature.

**IRH**  
**COMPONENTS**  
**PTY. LIMITED**

*A Subsidiary of IRH Industries Limited*

THE CRESCENT,  
KINGSGROVE,  
N.S.W. 2208.  
TEL. 50 0111

### INTERSTATE AGENTS & REPRESENTATIVES

MELBOURNE I R H Components Pty. Ltd. Phone 489-1088	LAUNCESTON W.P. Martin Pty. Ltd., Phone 22-844	PERTH Simon Holman & Co. Phone 8-2271
BRISBANE K.H. Dore & Sons Phone 2-1391	HOBART W.P. Martin Pty. Ltd., Phone 34-2811	ADELAIDE Collett & Cant Pty. Ltd. Phone 23-1971



Coast Amateur Radio Club was held on Tuesday, January 27, in Nambour on the Sunshine Coast. Election of Office Bearers resulted as follows: — President, John Purdon VK4PU; Vice President, Ken Chiverton VK4VC; Secretary, Wayne Shaw VK4WE; Treasurer, Bill Ryan VK4WR; Public Relations Officer, Norm McRae. A spokesman for the club said that the meeting was very successful with 20 persons attending, 12 of whom were licensed amateurs. The next meeting was to be held on the third Tuesday in February.

### WESTERN AUSTRALIA

Ted Gabriel, VK6TG, continues his work in the organisation of the WICEN network in Western Australia. Ted reports that every Sunday morning, after the call-backs following the VK6WI news broadcast on 40 metres, a WICEN call-back and discussion session is held on 7100KHz. During these sessions information is passed on, questions answered, band conditions reported and other emergency frequencies checked.

The call-backs are conducted by each net controller calling in his group members in turn, and arrangements are made for exercises to be conducted and WICEN activities discussed.

The new Albany District Radio Club includes many of the local bush fire brigade members. This is an example of how WICEN can be integrated with local emergency activities. An invitation is extended to all persons interested in participating in this very worthwhile organisation.

### VHF NOTES

The 144MHz beacon transmitter located at Mount Barker, near Albany, which has an output power of 40 watts, is proving to be an asset to VHF operators interested

## WORKED NORTH QUEENSLAND AWARD

To commemorate the Diamond Jubilee of the Wireless Institute of Australia and the bi-centenary of the voyage of Captain James Cook along the east coast of Australia, The Townsville Amateur Radio Club will issue an award to be known as "Worked North Queensland Award."

The award will be made under the following rules:

1. The award is available to any licensed amateur radio operator who is able to confirm contact with five amateur radio stations in North Queensland.
2. North Queensland is defined as that part of the State of Queensland north of the latitude of Sarina and includes such cities as Mackay, Ayr, Townsville, Charters Towers, Mount Isa and Cairns.
3. Confirmation is required in the form of QSL cards or a check list, the accuracy of which is confirmed by an executive officer of a radio club or society.
4. The Townsville Amateur Radio Club is the sponsor of the award. Any queries relating to the award will be resolved solely by the club committee.
5. A handsome multicolour certificate will be sent to those who apply and qualify for the award.
6. Applications should be addressed to:  
The Secretary,  
Townsville Amateur Radio Club,  
P.O. Box 964,  
Townsville 4810,  
Queensland.

in VHF propagation. The beacon has been heard in Perth on a number of occasions, and at the end of January was heard at good signal strength in Adelaide.

## W.I.A. Youth Radio Club Scheme

With the commencement of the 1970 school year, the Y.R.C.S. clubs are just getting under way again. This month there is little news to hand, as most schools had just re-opened when these notes were being compiled.

However, there is an item that may be of interest. While attending the First All India Amateur Radio Convention in Bombay last December, I (Pierce Healy, VK2APQ) had the privilege of addressing about 200 delegates to the convention on various aspects of amateur radio in Australia.

Among the subjects covered was the Youth Radio Club Scheme, and I was able to illustrate this aspect with some colour slides of the Westlakes Radio Club. I was very pleased with the interest shown in this aspect of amateur radio, and I was asked a number of questions about the operation of the scheme and the results and benefits gained. From the interest shown it is possible that similar clubs will be organised in India.

Y.R.C.S. members who are interested in SWL may like to correspond with the Madras Radio Listeners Club, C/o Rao's Radio Research Lab., 28k, Pandalai Road, Tondiarpet, Madras 21, India.

### NEW SOUTH WALES

After the holiday recess the Maitland Radio Club resumed activities on January 23 and the enrolment of new members took place on Saturday 24th.

The club was able to look back on the past year with great satisfaction. The membership now stands at 116 and the attendance figures from February to December totalled 2,842. The committee looks forward to further progress during the coming year, and is calling for more instructors for the increasing number of classes being held.

A special course of theory instruction for advanced members who wish to sit for the Amateur Operator's Certificate of

Proficiency has been arranged to prepare members for the P.M.G. examination to be held in August. Classes are held Friday nights. Six members attended the first class.

The club is preparing for its exhibition to be staged at the forthcoming Maitland Show, where last year a great deal of public interest was shown.

The executive officers of the club have arranged for a sale of surplus radio and electronic items to members. Last year, the club received donations from business firms, the electronics industry and individuals. The equipment includes radio transmitters, receivers, high-quality amplifiers and Morse code training equipment. It is essential that the equipment be cleared, as all available space is needed for classes and other activities.

Club members A. Counsell, VK2ZFH and A. Dever, VK2AWD, are working on the construction of six-metre FM equipment to operate on the net frequency 52.525MHz.

Congratulations have been extended to the club's patron, Sir Allen Fairhall, VK2KB, who was awarded a K.B.E. in the New Year's Honours List.

### SOUTH AUSTRALIA

Allan Dunn reports that the South Australian Youth Radio Clubs that got away to an early start in 1970 were: Port Augusta Youth Radio Club where activities were recommenced on January 17; and the Barossa Valley Youth Radio Club, which held an outing for senior members on the same date.

The Barossa Club outing included a visit to a well-known radio surplus store, and to amateur stations VK5ZDX, VK5GG/T and VK5EK, where each of the operators described his station and gave a short talk on a particular aspect of amateur radio.

A visit was also made to the A.B.C. broadcast transmitters at Pimpala. After

# ELECTRONIC DESPATCH

P.O. BOX 149, AUBURN 2144

9 - 1 DAILY AND SAT.

16 SHERIDEN ST., GRANVILLE,

MAIL ORDERS WELCOME

Please Add Postage

### NEW TRANSISTORS

BC107 NPN	70c
BC177 PNP	75c
BC108 NPN	60c
BC178 PNP	65c
BC109 NPN	75c
BF115	70c
BF179	\$1.50
OCF71	\$3.50
AC127	95c
AC128	85c
AC127/128	\$1.80
AD161	\$1.80
AD162	\$1.80
AD161/162	\$3.60
2N5459 (MPF105)	\$1.20

### DIODES

OA91	27c
BA100	35c
BA102	90c
AA119	30c
2-AA119	60c

### RECTIFIERS

BY126/100 100V PIV 1A	35c
MB1 Bridge 100V PIV 1A	\$1.80

### THERMISTOR

B8-320-01/50 (E201BC/P50E)	24c
----------------------------	-----

### ZENER DIODES

BZY94/C12	72c
BZY88/C9V1	72c
Set of Transistors, diodes, zeners and thermistor including heat sinks for 240 communications receiver Electronics Australia (Jan., 70), (Bridge rect. MB1), \$23.50.	

Transformer for above A & R  
No. 2150 240V Prim. Sec 6.3V  
2.5A or 12.6V CT at 1.25A \$4.25

### TRANSFORMERS

#### EX-COMPUTER

Prim. 240V sec. 115V at 0.6A 10V at 0.1A and 25V at 3A	\$4.00
2 prim 110-120-190V in series 220V or 240V sec. 34-37-40V at 5A, size 5 1/2 x 6 1/2 47.00	\$8.00

### DC REGULATORS

#### EX-COMPUTER

6V 16A \$10.00	12V 26A \$18.00
6V 24A \$14.00	20V 10A \$16.00
12V 20A \$14.00	30V 4A \$10.00
The above units require a smoothed DC input 30%-50% above the nominal voltage. The output voltage can be adjusted to CA±2V.	
240V 1/2 HP Motors	\$5.00

### COMPUTER BOARDS

10c per transistor.

2 1/2c per diode

Data sheet for most transistors and diodes supplied.

Reed relays

Hamlin DRG2 1A 250V DC .. 80c

### SPECIAL TRANSFORMERS

190-220-235V input.

Isolated output 110V 10A, 220 V 5A and 24-26V at 5A, \$25. Free on rail.

### TORRINGTON BLOWERS

Twin blower 200 cfm each side  
Motor 240V 0.4A. \$10.00.

Edge Connectors, single units	50c
16 pin 0.1", block of 8	50c
Plug in Cards with wires cut,	
Gold plated Contacts	25c
Fuse Holders ex computer	20c

## NEW RH (Radio House) RANGE OF MULTIMETERS

### Model RH-80 \$18.00 Postage 50c



20,000 Ohms per Volt DC  
10,000 Ohms per Volt AC

#### Specifications:

DC Volts. 0.5, 2.5, 10, 50, 250, 500, 1000 V  
AC Volts. 10, 50, 250, 500, 1000 V

DC Current: 50uA, 5mA, 50 mA, 500 mA

Resistance: 5 kΩ, 50kΩ, 500kΩ, 5 MegΩ

Decibels. -10 + 62 db

Accuracy. DC ±3%, AC ±4% (of full scale)

Batteries. Two 1.5V dry cells. Size AA, "Eveready" 915

● Overload-protected by dual silicon diodes. ● Mirror scale. ● Double-jewelled ±2% meter. ● ±1% temperature-stabilized film resistors.

### Model RH-100 \$39.75 Postage 75c

100,000 Ohms per Volt DC 10,000 Ohms per Volt AC

● Overload Protected by Dual Silicon diodes ● Double-jewelled ± 2 per cent Meter ● ±1 per cent Temperature-stabilised Film Resistors ● Polarity Changeover Switch ● Mirror scale, instruction for operation with circuit diagram.



#### SPECIFICATIONS:

DC Volts: 0.6, 3, 12, 60, 300, 600, 1200V (100,000Ω/V)

AC Volts: 6, 30, 120, 300, 1200V (10,000 Ω/V)

DC Current: 12μA, 300 μA, 6mA, 60mA, 600mA, 12 amps DC and AC Current 12 amps.

Resistance: 20KΩ, 200KΩ, 2MΩ, 20MΩ

Decibels: -20 to + 17, 31, 43, 51, 63.

Accuracy: DC ±3 per cent, AC ± 4 per cent (of full scale)

Batteries: Two 1.5V dry cells, size AA, "Eveready" 915

### NEW TYPE Y-3 MULTIMETER



MEASURING RANGE:  
D.C. Voltage: 6V, 30V, 150V, 600V (2000 ohms/V). A.C. Voltage: 6V, 30V, 150V, 600V (2000 ohms/V). D.C. Current: 150 mA. Resistance: 0-100,000 ohms. Complete with 1.5 volt battery and test leads. Size: 3 3/4" x 2 3/4" x 1 3/4"

Checked, Packed and Posted — \$9.50. Limited Stocks.

### "HANDYMAN" RH 150 \$11.50



Pocket-size 3 1/4" x 4 1/2" x 1 1/4". Instruction sheet and circuit.

#### SPECIFICATIONS

DC Volts 2 1/2, 10, 50, 250, 1000. AC Volts 10, 50, 250, 500, 1000. DC Current, .1, .25, 250 M/amps. Resistance, 20K and 2 megohms. Decibels, -20db = +62db .7K/c. Capacitance, .0001, .01, .0025, .25 mfd.

### Model RH-20 \$15.00 Postage 50c



20,000 Ohms per Volt DC  
10,000 Ohms per Volt AC

#### Specifications:

DC Volts: 0.25, 2.5, 10, 50, 250, 1000 (20,000/V)

AC Volts: 10, 50, 250, 500, 1000 (10,000/V)

DC Current. 50 uA, 25mA, 250mA

Resistance. 7kΩ, 700kΩ, 7MΩ

Decibels. -10 +22 (at AC/10V) +20 +36 (at AC/50V). Upper frequency limit 7kc.

Batteries: Two 1.5V dry cells. Size AA, "Eveready" 915

### Model RH-55 \$20.00 Postage 50c



30,000 Ohms per Volt DC  
14,000 Ohms per Volt AC

#### SPECIFICATIONS:

\*DC Volts: 0.6, 3V, 12V, 60V, 300V, 1200V (30,000 ohms/V).

\*AC Volts: 12V, 60V, 300V, 1200V (14,000 ohms/V).

\*DC Current: 60 A, 12mA, 300mA.

\*Resistance: 10K ohm, 1Meg ohm, 10Meg ohm.

\*Decibels: -10 db +23 db.

### Model RH-60 \$25.00 Postage 50c



50,000 Ohms per Volt DC  
10,000 Ohms per Volt AC

#### Specifications:

DC Volts: 0.25, 2.5, 10, 50, 250, 500, 1000 V

AC Volts. 10, 50, 250, 500, 1000 V

DC Current. 25 uA, 5 mA, 50 mA, 500 mA

Resistance: 10 kΩ, 100 kΩ, 1 MegΩ, 10 MegΩ

Decibels. -10 +62 db

Accuracy: DC ±3%, AC ± 4% (of full scale)

Batteries. Two 1.5 V dry cells.

Size AA, "Eveready" 915

Models RH-20, -55, -60 are—

● Overload-protected by dual silicon diodes ● Mirror scale ● Double-jewelled ±2% meter ● ±1% temperature-stabilised film resistors.

### TAPE RECORDER



\$20.50

#### BOOK TYPE

The latest model portable Tape-recorder. 4 transistor, 3in reels, 2 tracks. Instruction manual. Size 10 1/2in x 7in x 1 1/2in. Just open the book and record. Supplied complete with tape, microphone and batteries. Special discount price, \$20.50, posted anywhere.

### NOTICE

The Royal Arcade Branch shop has been closed during rebuilding.

NEW FOR 1970 — digital electric alarm clock, \$19.75, crystal radios, \$3.95, six transistor pocket radios, \$11.75, and seven transistor micro-radios, \$39.75.

# RADIO HOUSE PTY. LTD.

306-308 PITT STREET

760 GEORGE STREET, SYDNEY

# 1970 B.E.R.U. CONTEST

Radio amateurs throughout the British Commonwealth are invited to take part in the 33rd B.E.R.U. contest to be held on March 7-8, 1970.

The attention of entrants is drawn to Rule 1, and in particular to the requirement for separate log sheets for each band. This new rule has been introduced to simplify the adjudication of this very popular contest.

Reprints of these rules, the general rules for HF contests, and supplies of log sheets and cover sheets may be obtained from B.E.R.U. HF Contest Committee, Radio Society of Great Britain, 35 Doughty Street, London WC1, England.

The low-power section of the contest has been dropped because of minimal support in recent years.

## Rules

1. The General Rules for R.S.G.B. HF Contests, as published in the January, 1969, edition of Radio Communication will apply.

2. When: from 0001GMT on Saturday, March 7, 1970, to 2359GMT on Sunday, March 8, 1970.

3. Eligible entrants: Members of the R.S.G.B. resident in the British Isles, and radio amateurs licensed to operate within the British Commonwealth and British Mandated Territories.

4. Contacts: CW (A1) only, in the 3.5MHz, 7.00MHz, 14MHz, 21MHz and 28MHz bands. Contacts may be made with any station using a Commonwealth call sign, except those within the entrant's own call area. British Isles stations may not work each other for points.

5. Scoring: Each completed contact will score 5 points. In addition a bonus of 20 points may be claimed for the first, second and third contacts with each new Commonwealth call area (as defined in the accompanying table) on each band. All British Isles stations (G, GB, GC, GD, GI, GM and GW) count as only one call area.

6. Logs: These must be addressed to: B.E.R.U. R.S.G.B. HF Contests Committee, c/o J. C. Graham, G3TR, "The Willows," Church Road, Lowfield Heath, Crawley, Sussex, England. The check list showing call area worked on each band must be included.

7. Trophies: To the winner — The B.E.R.U. Senior Rose Bowl. To the runner-up — The B.E.R.U. Junior Rose Bowl. To the leading British Isles Station — The Col. Thomas Rose Bowl.

## Commonwealth Call Areas:

The following call areas are recognised for the purpose of the 1970 B.E.R.U. Contest.

A2/80/Z59*	VK9 (Norfolk Island)	VQ9 (Aldabra)	ZL (Auckland and
AC3	VK9 (New Guinea and	VQ9 D	Campbell Islands)
AP2	Bismarck Island)	VQ9 F	ZL (Chatham Island)
AR6	VK9 (Papua)	VR1 (British Phoenix	ZL (Kermadec Islands)
C2/VK9 (Nauru)	VP1	Islands)	ZL5 (N.Z. Antarctica)
G/GB/GC/GD/GI/	VP2A (Antigua and	VR1 (Gilbert and Ellice	ZM6/SW*
GM/GW	Barbuda)	and Ocean Islands)	ZM7
MP4B	VP2 (Dominica)	VR2	ZS3
MP4M	VP2 (Grenada)	VR3	ZS8/7P8* (Lesotho)
MP4Q	VP2K (St. Kitts, Nevis	VR4	ZS9* (See A2)
MP4T	and Anguilla)	VR5	SB4* (See ZC4)
VE1	VP2L (St. Lucia)	VR6	5H3
VE2	VP2M (Montserrat)	VS5	5N2
VE3	VP2V (British Virgin	VS6	5W* (See ZM6)
VE4	Islands)	VS9/8Q*	5X5
VE5	VP3/8R*	VS90	5Z4
VE6	VP4/9Y4*	VU	6Y5
VE7	VP5 (Turks and Caicos)	VU (Laccadive Islands)	7P8* (See ZS8)
VE8	VP5 ZF1* (Cayman	VU (Andaman and	7Q*
VK0 (Aust. Antarctica)	Island)	Nicobar Islands)	8Q* (See A2)
VK0 (Heard Island)	VP6/8P*	ZB2	8P* (See VP6)
VK0 (Macquarie Island)	VP7	ZC4/SB4*	8Q* (See VS9)
VK1	VP8 (Falklands)	ZD3	8R* (See VP3)
VK2	VP8 (Grahamland)	ZD5	9G1
VK3	VP8 (South Georgia)	ZD7	9H1
VK4	VP8 (South Orkneys)	ZD8	9J2
VK5	VP8 (South Sandwich)	ZD9	9K2
VK6	VQ1	ZE	9L1
VK7	VQ8 (Agalega and St.	ZF9* (See VP5)	9M2 (W. Malaysia)
VK8	Brandon)	ZI (Cook Island)	9M6/9M8 (E. Malay-
VK9 (Admiralty Island)	VQ8 (Chagos)	ZK1 (Manihiki Island)	sia)
VK9 (Christmas Island)	VQ8 (Cargados)	ZL	9V1
VK9 (Cocos Island)			9Y4 (See VP4)

\* British Isles count as one call area, as do others that are cross referenced.

a very interesting day which lasted from 8 a.m. until after midnight, the boys are now well informed on such aspects as VHF; ATV; HF-DX; and OSCAR satellites.

The prize for the most successful student at the Youth Radio Club Scheme examinations held in 1969 was Robert Johnson, of the Elizabeth Amateur Radio Club. For his achievement Robert received a book on transistors donated by Philips Electrical Pty. Ltd.

The most progressive club for 1969 was the Barossa Valley Youth Radio Club.

The final number of certificates issued to successful Youth Radio Club members during 1969 was: Elementary, 24; Junior, 8; Intermediate, 4.

## TASMANIA

During 1969, 10 clubs were registered in Tasmania. Of these, the following were most active:

Queechy High School  
Taroona High School

## Receiving Section

The Rules for the receiving section of the 1970 B.E.R.U. Contest are as follows:

1. Eligible Entrants: The contest is open to all fully paid-up members of the R.S.G.B. resident within the United Kingdom and to all short wave listeners resident within the British Commonwealth and British Mandated Territories. All entrants agree to be bound by these rules. Only the entrant may operate his receiving station for the duration of the contest. Holders of amateur transmitting licences are not eligible to take part.

2. Time and dates are as for the transmitting section.

3. Entries: (a) To count for points, a station outside the entrant's own call area must be heard in a contest contact and the following details logged in columns headed as follows: (i) Date/Time (GMT); (ii) Call sign of station heard; (iii) Report and serial number sent by station heard; (iv) Call sign of station being worked; (v) Band in MHz; (vi) Bonus points claimed; (vii) Points claimed. CQ or test calls will NOT count for points.

(b) Entries must be set out on one side ONLY of foolscap or international A4 log sheets. Entries must be marked not later than April 8, 1970, and must be addressed to — B.E.R.U. Contest Committee, Radio Society of Great Britain, 35 Doughty Street, London WC1. A check list showing call areas on each band is also to be included.

(c) All entries must contain the following declaration: I declare that this receiving station was operated strictly in accordance with the rules and spirit of the contest and I agree that the decision of the council of the R.S.G.B. shall be final in all cases of dispute. I do not hold an amateur transmitting licence.

Date . . . . . Signed . . . . .

4. Scoring: Each complete log entry will score 5 points. In addition a bonus of 20 points may be claimed for the first, second and third stations heard in each new Commonwealth call area on each band. The British Isles (G, GB, GC, GD, GI, GM and GW) count as one call area only as indicated in the appendix to the rules of the transmitting section. A station may be logged only once on each band for the purpose of scoring. Where both stations in a contact are heard, they may be logged separately; points may be claimed for both entries. 5. Awards: The B.E.R.U. Receiving Rose Bowl to the winner. Certificates of merit to the leading entrant from each I.A.R.U. continent.

## ON TELEX



Bob Cunningham

from  
**Cunninghams**

Call . . .  
Melbourne:  
31447  
Sydney:  
21707

FOR SERVICE.

## Automatic Aerial Rotator

UNRIVALLED AERIAL  
ROTATING SYSTEM!  
NEW STOCKS JUST ARRIVED

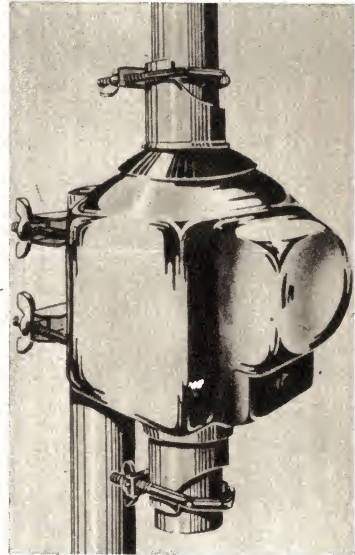

## STOLLE Automatic Aerial Rotor

Complete with direction control unit — fully synchronised balanced bridge circuit.

- Rugged—water tight.
- Hollow shaft, 1½" diam.
- Loading: 112 lbs. (max.)
- Rotation angle: 360 deg.
- Permanently lubricated.
- Speed: 1 r.p.m.
- Magnetic disc brake.
- 240v. AC (60w.) drive 42v.

**R.H. Cunningham**  
PTY. LTD.

VIC.: 608 Collins St., Melbourne.  
N.S.W.: 64 Alfred St., Milsons Pt.  
W.A.: 34 Wolya Way, Balga.  
QLD.: L. E. Boughen & Co., 30  
Grimes St., Auchenflower.

Friends School  
Deloraine High School  
Scotch College  
Hobart Teachers' College  
Devenport Boys' Brigade  
Glenora Area School

Six of the clubs have licensed amateurs as club leaders. Unfortunately, some of these groups may be inactive in 1970 due to transfer of their leaders.

Certificates awarded during 1969 were 25 Elementary and 6 Junior.

In addition, David Bradley, a member of Queechy High Y.R.C. gained his A.O.L.C.P. and was issued with the call sign VK7ZCY.

The W.I.A. is to conduct a radio class on alternate Saturday mornings at 10.30 a.m. during 1970. This is to follow the Y.R.C.S. certificate courses, and will be held at the W.I.A. Club Rooms, 147 Liverpool Street, Hobart (second floor).

Further information about Y.R.C.S. activities in Tasmania may be obtained from the Supervisor, R. Emmett, VK7KK, 6 Haig Street, Lenah Valley, 7008.

# electronic instruments serviced in 5 states...



AMPLIFIERS  
ANALYSERS  
CALIBRATORS  
COMPONENT TESTERS  
COUNTERS  
DATA ACQUISITION  
SYSTEMS  
DECADE BOXES  
DIGITAL INSTRUMENTS  
DISTORTION METERS  
ELECTRO MEDICAL  
EQUIPMENT  
ELECTRONIC VOLTMETERS  
FREQUENCY METERS  
IMPEDANCE BRIDGES  
LIGHTMETERS  
MICRO-WAVE EQUIPMENT  
MULTIMETERS  
OSCILLATORS  
OSCILLOGRAPHS  
OSCILLOSCOPES  
POWER SUPPLIES  
PULSE EQUIPMENT  
PULSE METERS  
R.F. POWER METERS  
RECORDERS  
SIGNAL SOURCES  
SOUND MEASURING  
INSTRUMENTS  
STROBOSCOPES  
SYNTHESIZERS  
TELEMETRY SYSTEMS  
ALL OTHER SPECIAL  
MEASURING AND  
TEST INSTRUMENTS

**Brisbane, Sydney, Melbourne, Adelaide, Perth**

WARBURTON FRANKI now have available in 5 States the most modern service facilities for testing, repairing and calibrating of all types of electronic test and measuring instruments. For prompt and efficient service contact:



**WARBURTON FRANKI**

ADELAIDE: Phone 56-7333. BRISBANE: Phone 51-5121.  
MELBOURNE: Phone 69-0151. PERTH: Phone 71-7744.  
SYDNEY: Phone 29-1111.

# I.A.R.C. PROPAGATION RESEARCH COMPETITION

Known as "A DX Contest with a Purpose," the 1970 International Amateur Radio Club Propagation Research Competition will take place between February 28 and April 19, 1970.

As a "Contribution to Propagation Research" (C.P.R.) the International Amateur Radio Club initiated a program in 1963 aimed at supplementing propagation predictions by gathering data on actual amateur radio contacts and feeding this data into a computer for purposes of verification and extending the usefulness of the predictions.

magazine. The official world map showing the 90 zones (75 I.T.U. Zones plus 15 zones created by the I.A.R.C.) was published in the February, 1967, issue of this magazine.

## RULES:

### Dates

CW/RTTY Section — 0001GMT  
February 28 to 2400GMT March 15.  
Phone Section—0001GMT March 28 to 2400GMT April 19.

### Categories:

Entries will be accepted from fixed

## Contact Points:

Fixed to fixed stations — 1 point; Fixed station to mobile station — 2 points; mobile station to fixed station — 2 points; mobile station to mobile station — 4 points. (Note: No contact points for QSOs within your own zone).

## Multippliers:

A multiplier of one (1) for each new zone and one (1) for each new country worked on each band and mode. For the purpose of this contest only, the following shall count for the countries multiplier: (i) All separate countries as shown on the official I.A.R.C. Country List. (ii) Each state in continental U.S.A. (iii) Each province of Canada and (iv) Each republic of the Soviet Union.

## Scoring:

(a) The same station may be worked as many times and as frequently as desired.

(b) Contacts lasting more than six minutes with the same station may be scored as separate contacts for each six minutes or fraction. To count as extra contacts, these extended contacts MUST be entered in the log as a new contact at the end of each six minutes. A single entry showing total points will be counted one contact.

(c) Multiplier credit may be claimed only once for each zone and each country worked on each band and mode.

(d) Contact points are not allowed for QSOs with your own zone, but zone and country credit may be claimed once only for each band and mode.

(e) Total score may be obtained by multiplying total points by total countries by total zones. If you are computing All Band or All Events scores, then country and zone totals are the sum of all bands, for All Events, the sum of all modes.

(f) Contacts with stations not in the contest or contacts made while engaged in other contests may be scored by supplying the correct zone number from the list.

Logging: Use official I.A.R.C. log sheets or a facsimile with 40 QSOs per page. Fill in every line. If you void an entry, draw a line across the entire page. Enter the claimed contact point credit in the proper column. Enter the zone and country in the designated column once only for each band and mode. Make all entries COMPLETE. You may enter your zone number only once on each sheet but be sure to enter the worked station's zone for each contact. Use separate log sheets for each mode and band. Use GMT only.

## I.A.R.C. PROPAGATION RESEARCH COMPETITION

### LOG SHEET

Contest log of amateur radio station ..... Page ..... of ..... Pages  
 CW ..... Aeronautical .....  
 Band .....MHz Phone ..... Fixed ..... Land ..... Mobile .....  
 RTTY ..... Maritime .....

Date/ Time GMT	Station	Serial Number		Fill in only when QSO is Multiplier		Points
		Sent	Received	Zone No.	Country	
Total Zones, Countries, Points this sheet						

### SUMMARY SHEET

Call ..... Page ..... of ..... Pages  
 Single band ..... Single operator ..... Phone ..... Teletype .....  
 All band ..... Multi-operator ..... CW ..... Mobile .....

Band	QSOs	Zone Multiplier	Country Multiplier	Points	Band Score	Band
1.8MHz				x	=	1.8MHz
3.5MHz				x	=	3.5MHz
7MHz				x	=	7MHz
14MHz				x	=	14MHz
21MHz				x	=	21MHz
28MHz				x	=	28MHz
Total				x	=	All bands

### Instructions

To determine All-Band score, total each column with double lines. Single-Band Stations are permitted to operate on more than one band. However, indicate and total only the band you wish to be judged.

Transmitter description and power .....  
 Receiver .....  
 Antennae .....  
 Other operators .....  
 Remarks (suggestions, criticisms, and comments) .....  
 Club participation .....

This is to certify that in this contest I have operated my transmitter within the limitations of my licence and observed fully the rules and regulations of the contest.

Signature .....

Name ..... Call .....

USE BLOCK LETTERS

Street and number .....

City ..... Country .....

Logs must be postmarked not later than 1 June, 1970.

Submit logs to: L.M. Rundlett, Chairman, Contest Committee, 2001 Eye Street,  
 N.W. Washington, D.C. 20006, U.S.A.

The final aim is the preparation and publication by the I.A.R.C. of a manual giving prevailing propagation conditions, and probable communication time, between each of the 75 I.T.U. zones, as a function of the amateur band used, month and the solar activity. In order to generate interest in this activity, the I.A.R.C. instituted the "C.P.R. Award." The contest is described as "a further effort to generate greater interest in this project," hence it is known as a "Contest with a Purpose."

In the January issue of these notes the C.P.R. List of Countries used in conjunction with this competition was published.

Please note that C.P.R. Zones are not the same as the WAZ Zones used by CQ

and mobile stations, single-band, all-band and all events. Single-band entries must be single operator only.

### SWL Participation:

SWL participation is encouraged. SWL rules are available from and all logs should be submitted to:

Mr Stewart Foster, G-10173,  
 Manager SWL Contest Activities,  
 68 Goldsmith Walk,  
 Lincoln, Lincs.,  
 England.

### Objective:

To work as many stations in as many different C.P.R. Zones and countries as possible. The I.A.R.C. Country and Zone list will be binding.

## CALLING ALL PROSPECTIVE AMATEURS

The Wireless Institute of Australia was established in 1910 to further the interest of Amateur Radio. With over half a century's experience, who could be more qualified in teaching this subject?

Correspondence Courses are available at any time. Personal Classes commence in February of each year.

For further information write to:

## THE COURSE SUPERVISOR, W.I.A.

14 ATCHISON STREET,  
 CROWS NEST, 2065  
 NEW SOUTH WALES

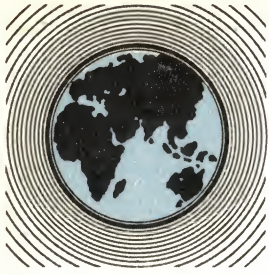

# LISTENING AROUND THE WORLD

## Nederlands plan Madagascar relay

Details of the progress of the Radio Nederlands relay station in Madagascar have been announced. Three 300KW transmitters are being installed at a site north of Tananarive.

by Arthur Cushen

Radio Nederlands' new relay base in Madagascar is now under construction and is expected to come into operation next year. It will consist of three 300KW transmitters with the necessary directional aerial systems to cover Africa, Asia and the Pacific.

Jim Vastenhou, who has rejoined the staff of Radio Nederlands after seven years with Dutch television, has been appointed as a technical project co-ordinator and has the planning of the new relay station as a major project. He reports that the sites are selected, the three 300KW transmitters and the aerials ordered, and a number of lots for the houses of employees bought.

The new Madagascar relay, together with the services from Holland and Bonaire relay, should enable Radio Nederlands to cover most of the world.

The transmitters will be located some 30 miles north of Tananarive, the capital of Malagasy. They will use 13 curtain-type areials suspended from 300-foot towers. The major service area of the transmitters will be Africa, Australia, New Zealand, Indonesia and South East Asia.

### TESTS FROM MANILA

The South East Asia Radio Voice, which we reported last issue as testing on 15420KHz, has advised us of further tests on two new channels, 11910 and 17860KHz.

A letter from the Technical Director, S.E.A.R.V., P.O. Box 4148, Manila, states: "Our main lobe is directed to 280° with a width of about 60°. Our target areas are India, West Malaysia, Burma, Thailand, East Pakistan and the China Mainland (South Portion). Your location is practically on the side lobe, but somehow a very ideal location for receiving DX signals."

The present schedule is:

GMT	KHz
0030-0130	15420
1130-1245	15420
1300-1400	11910 or 17860

### RECENT VERIFICATIONS

**BRUNEI:** John Eig, of Toowoomba, Qld., has verified Radio Brunei, which sent him a green and yellow card showing a map of the country. The reception was for the short-wave outlet. The card came airmail in 12 days from the date of logging the station.

**COLOMBIA:** Transmissora Caldas has verified Andrew Gardner, of Yeronga, Qld., with a friendly letter in Spanish

Notes from readers should be sent to Arthur Cushen, 212 Earn Street, Invercargill, N.Z. All times are GMT. Add 8 hours for Perth, 10 hours for Sydney 12 hours for Wellington.

and a small pennant. The station is heard on 5020KHz, and is best around 0700 with its all-night transmission. Return post is not necessary for this one. The reply came in three months, and was signed by Ignacio Escobar Uribe.

**CONGO:** Kinshasa, on 4880KHz, verified Siegfried Stoeger of Aldgate, S.A., with a friendly letter in French (according to "Australian DX News"). The reply was received in two months, and no return postage was enclosed. The letter was signed by V. Nikuna, Chief Engineer.

**PERU:** Radio Loreto has confirmed our reception with a letter and postcard, which verifies the reception on 5050KHz, of all-night broadcasts. According to the letter, the station operates OAX8D on 1150KHz medium-wave, OAX8E on 5050KHz and OAX8F on 9504KHz. The power on the short-wave frequencies has recently been increased from 1KW to 10KW. The verification letter is signed by Erico Ruiz Salas, the station manager. The address is Casilla 174, Jiron Arica No. 228, Iquitos, Peru.

### ENGLISH FROM MOSCOW

English broadcasts for Australia and New Zealand are carried over Radio Moscow's Siberian relay station on both medium and short-wave.

GMT	KHz
1100-1130	629, 9780, 9730, 11870
1130-1200	629, 1475, 7290, 9730, 9780
1230-1300	629, 1475, 5960, 7290, 9710, 9730, 9780
1330-1400	629, 1475, 6160, 7290, 9780, 9730, 11870

### LATIN AMERICAN NEWS

Some information which will enable listeners in the South Pacific to hear new Latin American stations in the coming winter, is taken from the latest issue of the Danish Short-Wave Club's "International

Bulletin." Listeners in the northern hemisphere are listening to many Latin American signals at the moment. These stations will be audible in our area shortly.

**PANAMA:** Radio Mirimar, Apartado 4402, Panama 7, on 6030KHz is a new station on short-wave. The call is HP5B and the schedule is 1030-0300GMT.

**CHILE:** Radio CE953, using 9530KHz with 1KW, is on the air 1100 to 0500GMT. The station has the mailing address of Casilla 49-D, Arica.

**COLOMBIA:** Radio Atlantico Barranquilla, is active on 4905KHz, and has been heard to 0500GMT. The station verifies with a letter and pennant. Radio Atlantico has been inactive on short-wave for some months.

**VENEZUELA:** Radio Merida is a new station operating on both medium and short-wave. The station operates 95YVTL on 1490KHz medium-wave, and as YVTR on short-wave 9720KHz. Both stations have the power of 1KW. The address of the station is Radio Merida, Avenida Principal, Merida, Venezuela.

**ARGENTINA:** Radio Argentina Exterior, Buenos Aires, has been observed in German from Monday to Friday at 2100GMT on 11710KHz. The station has also been heard in English at 0600 to 0700GMT on 9690KHz by Chris Davis of Featherston, N.Z.

**BOLIVIA:** Radio Cruz del Sur has moved from 4985 to 5025KHz. This is the second time this station has made this frequency change to avoid interference. The station is keen to receive reports, and verifies with a colourful card. The address is Cajon 1408, La Paz, Bolivia.

**ECUADOR:** Several signals from Ecuador are being observed in the 49M band. Radio Mundial is using 5965KHz with 1KW and is on the air 1200 to 0400GMT. The address is Casilla 12-44, Riobamba. Radio Colon, using 5970KHz, has the address Apartado 2912, Quito. Radio Metropolitana, on 6150KHz, has been heard at 0400 and again at 1100GMT. The station address is Manabi 556 y Fargas, Quito.

### HIGHER POWER FOR GUYANA

The Guyana Broadcasting Corporation, at Georgetown, is to add a further service on medium and short-wave with a new "action radio" type program. The station was officially opened on January 1, and is the most powerful voice in the eastern Caribbean.

## HONOUR FOR ART CUSHEN

Our short-wave correspondent Art Cushen has been honoured by the Queen in the New Year Honours List by the award of an M.B.E. This honour is in recognition of his community services in radio, broadcasting and journalism, and for work in the field of blind welfare. We warmly congratulate him on his award, and for the success he has achieved in his chosen field despite the handicap of total blindness from which he has suffered for many years. He is now recognised as one of the world's most prominent listeners, and besides his work for "Electronics Australia," to which he has been a regular contributor since 1952, he is a regular broadcaster for Radio New Zealand, the N.Z.B.C., and Radio Netherlands, in his own programs; the short-wave editor of the N.Z. Radio DX League's publication; and his contributions to SW listening are known throughout the world.



Two medium-wave transmitters are on 560KHz with 20KW and on 705KHz with 2KW. Two short-wave transmitters will operate on 3290 and 5950KHz, both with the power of 10KW. The station slogan "Action Radio" is to be used. The station is an off-shoot of the Guyana Broadcasting Corporation, which has been heard on 5980KHz at 0910GMT, using 2KW.

#### CYPRUS VERIFIES

A fine verification card has been received by Bob Padula, of Melbourne, Vic., confirming the reception of broadcasts from the Cyprus Broadcasting Corporation. The station is now using 11910KHz and has been heard after ETLF leaves the air at 1915GMT. A program of Mediterranean-style music was observed, with identification in Greek and English, when the station closed at 2100GMT. The station announced that they would return to the frequency at 1900GMT next day.

The verification card is most attractive, being printed in full colour. It has full verification details, and states the transmitter power is 30KW.

#### KGEI SOON 250KW

In a matter of weeks station KGEI at San Francisco, operated by the Far East Broadcasting Company, will be using 250-KW. A verification letter from the station Assistant Engineer Mr Tom Tweedell informs us of these plans.

Mr Tweedell said "It is very interesting to hear from people who have been acquainted with KGEI since its beginning in 1939 at the World's Fair. Our transmitter and studios are located near Belmont in a new subdivision of Redwood City, California, about 25 miles south and slightly east of San Francisco. We are still using the original basic transmitter which was at the fair. The power was raised to 50KW shortly after it was relocated here on the then mud flats, and it has been further modified since FEBC acquired the station in 1960.

"Our new 250KW transmitter is still to be constructed in Iowa. We had originally expected to have it some time ago, but as a prototype for the manufacturer it has taken longer than planned. We hope to have it later this year, but installation and testing may take some months thereafter."

The present schedule of KGEI is:

GMT	KHz
2220-0200	15240
0203-0503	9715

During October the station was heard for the period 0203-0503GMT on 11955KHz, but from November this was changed to 9715KHz, to provide a better signal in the coverage area stretching from Mexico to Argentina. The station's address is P.O. Box 15, San Francisco, California 94101. Verification, which is in the form of a card, pennant and letter, notes that English programs are from 0400GMT. The 9715KHz frequency is mixed with other stations, and at 0455GMT is blocked by Radio Nederland at Bonaire.

#### SLOW DOWN AT RADIO CANADA INSTALLATIONS

The plans of the International Service of the Canadian Broadcasting Corporation, Montreal, were discussed in the September issue, with the news of the installation of five 250KW transmitters at Sackville for early operation.

Due to Canada's present economic recession, the Government has rephased the new transmitter and antenna plan over a longer period of capital spending. The first two of the 250KW transmitters will be testing by the end of this year. The additional three 250KW transmitters required to complete the project will be tested late 1971. The new antenna systems and other work at Sackville is now expected to be completed by 1974, when the new transmitting facilities will be fully operational.

The slowing down of the project has delayed the final date for completion by two years, but the increase in power for the Montreal signals should be noted later this year. In Montreal, work proceeds on the huge new radio and television centre

# LAFAYETTE *Solid State*

## 5-Watt 27 MHz Two-Way Radio



**Model HE-20T** \$169.50 (Crystals Extra)  
P.M.G. Type Approved (Licence Required)

### Cool Instantaneous Operation

- Crystal Controlled Transmit and Receive.
- 13 Transistors, 10 Diodes.
- 117 VAC and 12 VDC Negative or Positive Battery Ground.
- 455 KHz Mechanical Filter.
- TVI Trap.
- Pi-Network Output.
- May also be used as P.A. Amplifier with External Speaker.

This solid state transceiver is ideal for 27MHz communications. Solid state circuitry features low battery drain and provides instant operation; 5-watt transmitter input with efficient push-pull audio modulator; a Pi-network for matching the output to 30-100 ohm antennas; an extra-sensitive superhetrodyne receiver. Fine selectivity and adjacent channel rejection is obtained through a 455 KHz mechanical filter. Sensitivity: .7 uV for 10 db signal to noise ratio. Receiver also incorporates automatic floating series-gate noise limiter and variable squelch control resulting in virtually no background noise between calls. A rear mounted low-loss antenna jack accepts SO-239 type connector used with ground plane and direct mounting antennas. Complete with fused DC line cord for negative ground battery and push-to-talk mike. Size: 8 1/4" D. x 4 1/4" H. x 1 1/4" W.

## .5-Watt 3 Channel Walkie Talkie



**MODEL HA-305** \$57.25  
P.M.G. Type Approved  
(Licence Required)

- Sturdy Metal Case.
- Battery Condition Indicator.
- Built-in Call Alert.
- Switchable 3 Channel Operation.
- Range Boost for Extended Talk Power.
- Adjustable Squelch. Noise limiter.
- Superhet Receiver with 1 uV Sensitivity.
- Large, Efficient Speaker/Mike.

Lightweight 2-way transceiver includes three switchable channels. Call alert system sends or receives a pleasant alerting tone for convenient calling. 14 transistors, 1 diode, 1 varistor superhet circuit with noise limiter and variable squelch, .5 watt transmitter with range boost. Supplied with telescopic antenna, batteries, carrying strap, and crystals for 27.240 MHz.

SEND REMITTANCE WITH ORDER FOR IMMEDIATE DELIVERY ANYWHERE. WRITE, PHONE OR CALL FOR DETAILED INFORMATION.

# LAFAYETTE

## ELECTRONICS

Division of Electron Tube Distributors Pty. Ltd.

VICTORIAN SALES  
CENTRE AND HEAD OFFICE,  
94 HIGH STREET,  
ST. KILDA, 3182, VIC.  
94-6036.

### SOUND PROJECTORS

Cinevox Prefect and Harbour and Heath 16mm in good working order. 240v operated, complete with speaker and amplifier. **from \$90.00**

### CIRCULAR SLIDE RULE

3 3/4in diameter. Will do the same work as the conventional slide rule. Instruction book included.

**\$1.25 each**  
Post 10 cents.

### REFLECTOR GUNSIGHT

Contains these lenses:

1 Lens 1in Focus, 1 1/2in diam.  
1 Lens 1 11/16in Focus, 1 1/4in diam.  
1 Air-spacer Lens, 1 1/4in diam.  
1 Filter Lens, 1 Graticule.  
1 Lampholder. **\$1.85**  
Post.: N.S.W. 30c; Interstate: 40c.

### P.M.G. TYPE TELEPHONES

Standard desk type with magneto bell calling device. Range 30 miles. Uses standard batteries at each phone. Any number can be connected together on single line. **\$23.00**

### (2 TELEPHONE SETS)

30c cartage to rail. Freight payable at nearest attended railway station.

Please note we are now able to include 1/2 mile of telephone cable FREE with each set of Phones.

### BATTERY CHARGERS

240 volt A.C. Input. Each battery charger will charge either 6 or 12 volt batteries. 2 amp. without meter, **\$13.75**  
2 amp. with meter, **\$15.75**  
Post N.S.W. 70c; Interstate 95c.

### MINIATURE ELECTRIC MOTORS

1 1/2 to 3 volts D.C. Ideal for model boats, cars, planes, etc. Strong torque. Only **65 cents each or 10 for \$4.00.** (Post 7c).

### TRANSCIEVER

(2-way radio) R.C.A. America RT 68. 24 volt. operated 10 watt output 38-54 megacycles F.M. crystal locked. Transmitter and receiver using frequency synthesiser in 100 K/c/s; step 10 channel per meg/cycle with power supply. Leads, mike and headphones **\$45.** 60c cartage to rail. Freight payable at nearest attended railway station.

### TRANSCIEVER

(2-way radio) 62 set ideal small ships, Hams, etc. 1.6 to 10 megs. Crystal locked or V.F.O. controlled 5 watt output. Complete with antenna, headphones and mike **\$60.** 60c cartage to rail. Freight payable at nearest attended Railway Station.

### HEAD PHONES

Low impedance moving coil fitted with rubber muffler to reduce external noise, fitted with press to talk, dynamic hand microphones. Ideal for use with all types of transceivers. **\$3.50 pair.** Same with black felt muffler, **\$4.50 pair.** Post N.S.W. 25c; Interstate 30c.

### COLLINS TRANSCEIVERS

Auto-tuned 100-150 megacycles, 10 channels **\$65.00**

### 16'6" WHIP AERIALS

6-Piece, brand new, **\$5.75.** 60c cartage to rail. Freight payable at nearest attended railway station.

### AVO MULTI METER

Type CT 38 **\$75.00**

### A.W.A. AUSTRALPHONE

Transceivers 12 V New Complete Station. 1.6 to 10 megs on transmit. 0.54 to 16 megs on receive. **\$150.00**

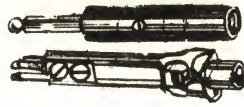

P.M.G. Phone Jack and plugs, 25c each, 45c the pair. Post 7c.

### NIFE CELLS

1.2 Volt fully charged, 4in x 3in x 1in 4 AH. **\$1.00 each**  
Post, N.S.W., 25c; interstate 35c.

### WALKIE TALKIE TWO-WAY RADIOS

P.M.G. Approved Citizen Band. 9 Transistor. **\$79.00** per set of 2. Post, N.S.W. 50c; interstate, 60c.



P.M.G. TYPE KEY SWITCHES. 45c each. Post, 15c.

### BC 221

Frequency Metres **\$55.00**

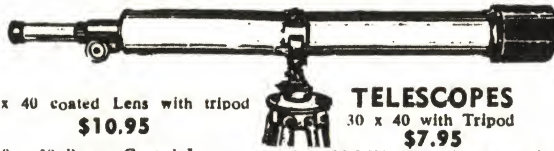

45 x 40 coated Lens with tripod **\$10.95**

30 x 30 Power Coated Lens Brand new. **\$3.75**

60 magnification with a 60mm coated objective lens. With tripod.

**\$23.00**

As illustrated.

Postage, 95c; Interstate \$1.20.

### HIGH STABILITY RESISTORS

I.R.C. brand new, usually 80c ea. 50 assorted values for only **\$3.75**  
Post 15c.

### RECEIVER 8C A.W.A.

With ABC and D Coils. Complete with all spares. **\$90.00**

### ZOOM FOCUSING MICROSCOPE

Battery and mirror illuminated 900 x magnification, complete with dissecting kits, slides. **\$14.50.**

Postage N.S.W. 65c. Interstate 85c

### TYPE S POWER SUPPLY

(240 Vac supply for AT 5-ARB) suit most types of Disposal transmitters and receivers outputs 250 volt, 10ma 550 volt 200ma, 300 volt 100ma, **\$30.00**

### TELEPHONE WIRE

21 gauge copper, plastic covered. Ideal telephone or bell wire. 1,320ft coil of twin (equal 1/2 mile) **\$7 per coil.**  
Post, N.S.W. 70c; interstate \$1.20.

### SCOOP PURCHASE

Gramo Motors. New. Made in U.S.A. 4-speed 240 volt A.C. 50 c/s. Only **\$2.75 each.**  
Post, N.S.W. 30c; interstate, 40c.

### CO-AXIAL SWITCH

70 ohms 4 positions, can be motor driven completely waterproof 70 ohms type connectors. Housed in metal case 9in x 8in x 8in **\$5.00 each.** Post N.S.W. 70c. Interstate \$1.20.

### ASTRONOMICAL TELESCOPE

3 1/2in reflector 126 X magnification. Complete with 4 X finder and equatorial mount. **\$59.00**  
Post \$1.50.

## VALVES BRAND NEW

### IN CARTONS

Special discount for quantity

807	75c	X61M	\$2.20
65N7GT	95c	CV850	\$1.50
8989	\$1.00	1H6G	30c
SU4G	95c	832	\$3.00
77	\$1.00	6AK5	\$1.50
EF50	35c	6X4	\$1.00
6U7	75c	12SK7	80c
5Y3	\$1.75	VR65	25c
6C4	80c	VT4C	75c
2 x 2	75c	AU5	\$1.00
6AG5	80c	80	\$1.25
12AU7	\$1.00	6AK5W	\$1.50

### CATHODE RAY TUBES

3FP7	\$2.95	5BP1	\$3.50
3JP1	\$2.95		
V1669 4/1	\$2.95	CY2184	\$2.95

**PLEASE ADD POSTAGE ON ALL ARTICLES**

### TELESCOPES

30 x 40 with Tripod **\$7.95**  
Post N.S.W., 70c; interstate \$1.20

### PETROL MOTOR GENERATOR SET

BRAND NEW EX-ARMY 300 watt, 15 volts, 20 amps. Made in Canada. Complete with tools, instruction book, spares, etc. Only **\$75.00**  
\$1 cartage to rail, freight payable at nearest attended railway station.

### C.M.A. CABLE

240 volt 3/036 black, new and perfect. 100yd rolls **\$3.00;** 6 or more. 30c cartage to rail.

Frequency Counter Cintel type 388. **\$250.00**

VIBRATORS, 6 volts, 7-pin 75c each.

UNISELECTORS, 4 BANK, **\$4.00** Post, N.S.W., 25c; Interstate, 30c.

INSTRUMENT TRIPODS, sturdy, wooden frame. Telescope. Extend to 4ft 6in **\$13.00**

SELSYN MOTORS MAGSLIP Mk. II **\$5.25 ea.**  
No. 19 TWO-WAY RADIOS Sold a sis without power supply, leads, accessories, etc. Only **\$15.** Or complete with above gear, **\$35.**

### BINOCULARS

PRISMATIC. Coated Lenses Brand new. Complete with case.  
8 x 30 **\$18.75**  
7 x 50 **\$22.15**  
10 x 50 **\$23.07**  
12 x 5 **\$23.95**  
20 x 50 **\$26.90**  
Post, N.S.W., 70c; Interstate, \$1.20

### 3000 TYPE RELAYS

P.M.G. 200 Ohm — 1500 Ohm Coils, **\$1.25 each.**

### A.W.A. AMPLIFIERS

240 VAC with pick up Terminal. Used in good order Ex Studio. **\$15.00**

5-watt model.

SPECIAL lucky dip valve offer, 15 new valves in cartons for only **\$2.00.** We haven't got time to sort them, so you reap the benefit. Post 60c.

### MINE DETECTORS

Ex A.M.F. with Instruction Book. Complete in wooden case. Ideal for plumbers, councils for locating buried pipes, etc. Freight payable at nearest attended railway station. **\$39.00**

### 4 DIGIT RELAY COUNTERS

50-volt D.C., suit slot car. Lap counters, etc. **\$1.25 each.** Post 13c.

### ALTEC STUDIO MICROPHONES

639B Western Electric, top grade. original cost **\$250.** Ideal Broadcast Studio, music recording, Church and play recording, etc. Fraction of original cost. Price on Application.

### 240 VOLT 522 POWER SUPPLY

Supplies all necessary voltages to operate 522 transceiver from 240 V A.C. Complete and ready to plug in **\$30.00.**

### SOLENOIDS

Plunger Type 12V 300M.A. Suit electric camera control, miniature trains, radio, etc. **\$1.25.** Post, 10c.

200 Mill. amp., 24 volt, 1/8in push movement. **\$1.25.** Post 10c.

### LENSES

TOP GRADE ACHROMATIC 2in DIAMETER, 20in FL Ideal as telephoto lens, telescope objectives. **\$13.** Postage 46c.

### CONDENSER LENS

2 1/2in DIAM. 2in FL. **\$1.80** each or **\$2.50** per pair. Post 21c.

### CONDENSER LENS

1 1/2in diam. 1 1/2FL. **50c each.** Postage, 17c.

### FOUR CHANNEL BRANCHING AMPLIFIER

With 4in Vu. meter GLORAD. Complete with Portable Power Converter. 600 ohm balanced input and output. Ideal for outside broadcasting, etc. **\$39.50**

### MONITOR SPEAKER UNIT

Ex-A.B.C., consisting of low resistance 8in speaker in Acoustic Labyrinth Baffle Box, complete with 10-watt amplifier, 600 ohms plus 8dbm input, 240 volt A.C. operated. **\$37.50**

### TEN CHANNELS VHF TRANSCIEVER

Types TR1934 100-125 meg/c/s. and TR1935 125-150 meg/cycles. 28 volt DC operated AM single crystal locks both TX and RX on same channel complete with generator. **\$33.00**

### RECORDING TAPE

Ex broadcast studio E.M.I. 3600 feet on 10 1/2in spool, **\$4.50.** Postage 85c, 600 feet on 5in spool **\$1.45.** postage 13c, 150 feet on 3in spool, 65c, postage 9c.

### CASSETTE TAPES

C60 **\$1.60.** C90 **\$2.20.** C120 **\$2.99.** Post 13c.

### TELEPRINTER PAPER TAPE

8 1/4in x 6 5/8in Full Page **\$1.50 per roll.**

### WHEATSTONE BRIDGE

Top grade In Multiples up to 1000 **\$65.00**

# Deitch Bros.

70 OXFORD STREET, SYDNEY, 2010

SORRY, NO C.O.D.



for the Canadian Broadcasting Corporation, which will also house the Radio Canada studios.

The transmissions from Montreal are well received in the service to the South Pacific, from 0830 to 0930GMT, using 9630 and 5970KHz. The special program for the short-wave listener, "Radio Canada Short-wave Club," is broadcast at 0845GMT on Saturday.

Radio Canada recently celebrated its 25th anniversary of short-wave broadcasting. The service commenced on December 25, 1944. It was originated from Sackville, New Brunswick, the site of the present transmitting facilities. Just before the transmissions began, 25 years ago, we heard the tests of CHTA using 15220KHz, then the initial service with a limited schedule of 1115 to 1700GMT. From then on, further transmitters were added until three 50KW units were in use. Callsigns, which numbered over 30, were verified. A 7500 watt transmitter was installed to provide a service to Northern Canada.

#### WORLD RADIO MARKET

Some idea of the types of radio receivers used by listeners throughout the world has been gleaned from a recent survey conducted by Radio Japan. It was found that some 30 per cent of the short-wave receivers used by listeners who took part in the survey were of Japanese manufacture. Then followed sets made in the Netherlands, United States, Germany and Great Britain. The survey, which was made of listeners throughout the world, found that more Philips sets were in use than any other brand of receiver, then followed the Japanese National and Sony brands.

Radio Japan services appear to be received well throughout most of the world. Their monthly program magazine is now mailed to over 100,000 listeners.

#### UN RADIO FOR CONGO

The United Nations has announced that they plan to operate a short-wave station from the Congo to serve European language speaking listeners in southern Africa. This move is seen as a measure to combat the broadcasts of Radio South Africa and attempt to tell southern Africa of the United Nations feelings on apartheid.

The stations will be in the Congo Kinshasa. This was the former Belgium Congo, which during the early 1940s was one of the best received countries in Africa. The Belgian Government moved there after the occupation of their country in 1940 and operated the "Goodwill Station," which was transferred back to Brussels at the end of the war. The Belgian station ORU formerly carried many English programs, but in recent years these have been reduced to two ten-minute sessions each day.

Some of our verifications from the old Belgium Congo include such stations as OTC at Leopoldville. The station had the power of 50KW.

During the struggles in the Congo some years ago, another powerful station was set up by Kitanga, at Elizabethville. This station is now known as the "Voice of African Brotherhood," and broadcasts from the renamed city, now known as Lumumbashi.

#### RADIO PORTUGAL EXPANSION

The broadcasts of Radio Nacional, Lisbon, Portugal, is familiar to short-wave listeners, and even more so in recent years, with their "Voice of the West" transmissions.

The station was planned in 1949 and was completed in April 1953. At the outset it was equipped with two 100KW and one 50KW transmitters. Four transmitters of 100KW were added and since then an additional 100KW and a 10KW transmitter have been installed.

The transmitting site also houses a 100KW medium-wave transmitter, used for the medium-wave service to Europe on 755KHz. Some 22 high-gain directional aerials are used, and at the present time

## NEW SCHEDULES OPERATING

### DARWIN BECOMES OPERATIONAL

On December 20, 1969, Radio Australia celebrated its 30th year of broadcasting. At the same time the relay station at Darwin was phased into the schedule. We covered the Darwin relay station in the January 1969 issue, with details of the receiving site and the transmitters. This month the complete Darwin installation is expected to be put into full operation after a period of testing over several months. Three 250KW transmitters will boost Radio Australia signals to Asia.

Radio Australia commenced on December 20, 1939, using two low-powered transmitters at Sydney, and a 2KW transmitter at Lyndhurst in Victoria, while another transmitter at Perth began broadcasting to South Africa. Today Radio Australia has broadcasts in eight languages, English, French, Indonesian, Mandarin, Thai, Japanese, Cantonese and Vietnamese. Radio Australia has some 58 hours of transmissions every day. It carries 44 news bulletins in its day's schedule.

The service teaches hundreds of thousands of Indonesian, Thai and Vietnamese to speak English, and its transcription service supplies programs to 59 stations in 29 countries. In conjunction with the Australian Post Office, Radio Australia now operates 12 high-powered transmitters at three sites, Shepparton, Lyndhurst and Darwin. The Darwin transmitters and facilities cost some \$8-million and took ten years to plan and establish.

Regular daily transmissions from Darwin are as follows:

GMT	KHz	Language
2300-0030	15130	English
2300-0030	15355	Indonesian
0030-1000	17715	English
0030-1230	15355	English
1000-1130	6055	Indonesian
1136-1330	6055	Mandarin
1230-1330	9650	Vietnamese
1330-1430	9650	Thai
1330-1430	6055	Cantonese

On Sundays only, transmissions begin at 2300GMT and run through to 1400GMT. In March, when the full facilities at Darwin and the aerial system will have been completed, it is planned to extend the schedule to cover both South Asia and East Asia.

### A WEEK'S FAVOURITE PROGRAMS

Readers often ask for information on some of the most interesting programs which are on short-wave each week. I find my listening always confined to some of the major DX sessions, as well as programs about short-wave listening and listeners. A typical week on my listening calendar is listed below, I should explain that this is only a small number of the 30 DX programs available, but these are the ones best received.

#### SUNDAY

GMT	KHz	Country	Program
0515	11750, 9410	Britain	Letter Box
0530	15240	Australia	Mail Bag
0545	7150, 9640	Britain	Listening Post
0630	11730	Holland	Happy Station
0730	11710	Britain	DXers Calling
0815	7150, 9640	Australia	B.B.C. World Radio Club
0835	9630, 5970	Canada	Listeners Corner
1005	11875, 15235	Japan	Listeners Corner and DX News.

#### MONDAY

0915	11775, 9590	Switzerland	DX Merry-go-round
0730	11890	Philippines	FEBC Mailbag

#### TUESDAY

0645	11730	Holland	His and Hers
1245	9625	Sweden	Sweden Calling DXers

#### WEDNESDAY

0645	9540, 11780	New Zealand	Arthur Cushen's DX World (First Wednesday)
0835	17815, 21545	South Africa	DX Corner
0930	9745, 11915	Ecuador	HCJB DX Party Line
1030	9520, 11830	New Zealand	DX World

#### THURSDAY

0645	11730	Holland	DX Jukebox
0815	9715	Holland	DX Jukebox

#### FRIDAY

0730	9540, 11780	New Zealand	Mailbag
------	-------------	-------------	---------

#### SATURDAY

0840	9630, 5970	Canada	Radio Canada Short-wave Club
------	------------	--------	------------------------------

### ENGLISH FROM PARIS

The latest schedule received from the ORTF in Paris for English broadcasts lists the transmissions as:

GMT	KHz
0515-0530	7155, 7255, 9700, 11920, 11930, 15120, 17730
1100-1115	15295, 17720, 21580
1930-1945	15185, 15295, 21580

The address for reports is now P.O. Box 9516, Paris 16, France. This address was announced in January, when the station was heard asking for reception reports.

## ANNOUNCEMENT

# **Deitron** KITSETS

**Are you interested in Kit Sets  
or parts for all future Electronics  
Australia projects. If you are,  
watch for future advertisements  
in this magazine.**

As from March 1st, 1970 all parts or complete kits of parts for all future E.A. projects will be available from DEITRON ELECTRONICS (SALES) PTY. LTD. or their distributors which will be listed in their advertisements. Interstate outlets will also be appointed (enquiries welcome)

*N.B. All Kit Sets will be of the highest quality components, e.g. Elna, Piher, Fairchild, A.&R: Deitron and many other well known brands. [All sheet metalwork & circuit board available]*

# **Deitron**

Cable Address: "DEITRONICS", SYDNEY.

Phone: 31-5430

# **ELECTRONICS**

31-6786

4-6 TAYLOR ST., TAYLOR SQUARE, DARLINGHURST. N.S.W., 2010

some special logarithmic aerials are being designed for the European service.

Of the original sets of aerials, six are directed to Asia and the Far East, seven to Africa, two to South America, six to North America, and two to areas off Newfoundland for the Portuguese fishing fleet. A special curtain antenna is used for European broadcasts.

## FLASHES FROM EVERYWHERE

### EUROPE

**U.S.S.R.:** Radio Kiev, Ukraine has English broadcasts to Europe and North America which are scheduled from March 1 as follows: 2230-2300GMT on 9640, 7120KHz; 0030-0100GMT on 11730, 11700, 9760, 9660, 9610KHz; 430-0500GMT on 11960, 11730, 11700, 9760, 9660, 9610KHz.

**YUGOSLAVIA:** Radio Belgrade has started using 7240KHz for its Home Service says the Swiss DX Session. Programs have been heard from 1400 to 2400GMT. The same service is carried on 6150KHz. Radio Belgrade's foreign service has transmissions in English from 1530 to 1600GMT on 9620, 11735 and 15240KHz; 1830-1900-GMT and from 2000 to 2030GMT on 6100, 7200, 9620.

**GREECE:** The National Hellenic Broadcasting Service, at Athens, now operates: 0700-0815 0900-1000, 1030-1300, 1930-2100, 2200-2230, 230-2330 GMT on 9605, 11720KHz; 1330-1515, 1630-1700, 1830-1900GMT on 7295, 9605KHz; and 1730-1800GMT on 11720, 15425KHz.

### AFRICA

**SENEGAL:** According to "DX News of Norway," Radio Senegal, Dakar, now has an International Service. The schedule from the station shows that it has a 100KW SW transmitter on the air with the International Service from 1800 to 1830GMT on 11895KHz.

**CONGO:** Radio Brazzaville has been heard on the new frequency of 15145-KHz according to "Australian Radio DX News." This channel carries the relay of news in English from Paris at 1930GMT. The time of this news bulletin was recently changed from 1915GMT. Following the news, the station has its own announcements at 1944GMT in French and English and then follows the interval signal. On another frequency, 15190KHz, Brazzaville is observed at 2000GMT with a

program in French; this transmission closes at 2030GMT.

**MAURITANIA:** According to Swiss DX Session, Radio Mauritania now broadcasts on the following schedule: Monday to Saturday 0700-0800, 1800-2230GMT on 4850KHz; 1200-1430GMT on 7245, 9610KHz; Sunday 0800-1400GMT on 7245, 9610KHz; 1700-2300GMT on 4850KHz.

The address of the station is P.O. Box 200, Nouakchott, Mauritania.

### ASIA

**IRAQ:** Baghdad Radio has programs for Europe which include English 1930-2020, German 2020-2100 and French 2100-2200GMT. These programs are carried on 6030 and 6905KHz. A service in Arabic is on the air 1800-2230-GMT on 7180KHz and 1100-2300GMT on 11782KHz; and sometimes from about 1800GMT on 6155KHz.

**CEYLON:** The Commercial Service of Radio Ceylon at Colombo, is now on the following schedule for the morning broadcasts.

GMT	KHz
0130-0430	7190, 11800, 15230 (service in Hindi).
0130-0330	9720, 15230 (service in English).

**CAMBODIA:** Radiodiffusion National Cambodia is reported by the Japanese Short-Wave Club to be operating on 690 and 740KHz. The present weekday schedule is 2315-0100, 0400-0700, 0900-1700GMT; and Sunday 0015-1600GMT.

#### DZ4 ON 2425KHz

We were surprised to hear a new signal from the Philippines in the 120-metre band, when we tuned DZ4 relaying medium-wave station DZHP in late January. This station was received on 2425KHz. Later, we heard DZHP confirm, after the news bulletin at 1130GMT, that DZ4 was carrying the program also.

The Philippines has two signals in the 90-metre band, but this the first use of the lower band. Programs were in English throughout, with frequent commercials, mainly of American style, after each musical item, and the station had the standard announcement that "You are tuned to DZHP broadcasting from Manila on United Nations Avenue, 1130KHz on your radio dial." At 1200GMT or 8 p.m. Manila time, the complete network of the stations operated by the Radio Mindanao Network were called in for a network program.



*Jim Vastenhoud, who has been appointed technical project coordinator for Radio Nederlands (see page 156). He is well known for his work with DX Jukebox, being technical advisor to the program.*

News in French is at 2330 (Sunday 0030), 0530 and 1230GMT; English 2345 (Sunday 0045), 0545 and 1245GMT. Each bulletin of 15 minutes duration.

**CEYLON:** The Ceylon Broadcasting Corporation now issues a new verification card, which shows a selection of wild life of Ceylon. This card has been received by some of our Australian readers, in confirmation of recent reception reports.

## BROADCAST BAND NEWS

**TURKEY:** A new 300KW transmitter on medium-wave, opened last November, is located at Diyarbakir. The transmitter broadcasts the radio programs of Turkish Radio and Television, and operates on 1061KHz, from 0355 to 2200GMT.

**COLOMBIA:** A new station reported in "Sweden Calling DXers" is "La Voz Portena" Aereo Baranquilla. The station is using 1500KHz, and the station is already confirming reception reports by a verification card.

**LIBYA:** Benghazi Radio now has programs in English with news at 1600-1615. Five minute programs of news in English, Italian and French are broadcast from 1800 and 2000GMT on 1546KHz. ■

# ELECTROLUBE 2A-X

Registered Trade Mark

IMPROVES ELECTRICAL CONTACTS  
INCREASES RELIABILITY AND  
LOWERS MAINTENANCE COSTS

SAFE ON

POLYSTYRENE, P.V.C. MAKROLON,  
PAINTS, NATURAL AND SYNTHETIC  
RUBBER NON-HAZARDOUS VAPOUR

Write for free Products Summary on the range of electrical and mechanical oils and greases

**RFA**

**RICHARD FOOT (Australia) PTY. LTD.**  
63 Hume St., Crows Nest, N.S.W. Tel. 43-0326.

Available from leading  
electrical wholesalers.

**A.** AMPLIFICATION

**C.** COMMUNICATION



**E.** ELECTRONICS

**RADIO**

PHONE 51-3845  
51-7008

37 VICTORIA AVENUE, MIDDLE COVE  
WEEKENDS & AFTER HOURS 40-5391

**136 VICTORIA ROAD MARRICKVILLE - 51-3845**

**PORTABLE ELECTRIC ORGAN BASS**  
2 Octaves. C1 to C3 Modes.  
Mellow, bright, sustain, percussion.  
Slow and fast decay.  
Fine Tuning adjust for orchestra.  
**\$74.50**

**K 20 K 20**  
  
CT330 CT500

**C.T.330 20K. OPV**  
D.C. Volts 6, 6, 30, 120, 600, 1,200, 3,000, 6,000 A.C. Volts 6, 30, 120, 600, 1,200, D.C. Current .06-6, 60, 600mA. Resistance, 6K, 600K, 6meg., 60meg., D.B. minus 200 to plus 62, 5 Ranges. Specially suitable for transistor use.  
**\$16.45**

**C.T.500 20K. OPV**  
D.C. Volts, 2.5, 10, 50, 250, 500, 1,000 A.C. Volts, 10, 50, 250, 500, 1,000, D.C. Current, .05, 5.50, 500mA. Resistance, 12K, 120K, 1.2meg., 12meg. D.B. minus 20 to plus 62.  
**\$13.25**

**KAMODEN—100B**  
100,000 O.P.V.  
D.C. Volts, .5, 2.5, 10.50, 250, 500, 1,000.  
A.C. Volts, .25, 10.50, 250, 500, 1,000.  
Mils., 0.1, .25, 2.5, 25, 250, ID.A Res., 20K, 200K, 2M, 20M:OHM. DB minus 20 to plus 62, 5 Ranges  
**\$29.75 POST \$1.00**

**200H 20K. OPV**  
D.C. Volts, 5, 25, 50, 250, 500, 2,500 A.C. Volts, 10, 50, 100, 500, 1,000, D.C. Current, 50uA, 2.5, 250mA. Resistance, 6K, 600K, Capacitance, 2 D.B. Ranges.  
**\$10.95 Post 50c**

**PANEL METERS**  
EDGE METERS. 1mA.  
Scaled V. U.S.  
Tuning Stereo, Bal. **\$2.50**  
A FULL RANGE OF UNITS.  
85 Types, 1/4in to 3/4in.  
FROM \$3.25.  
Send for full list.

**TV CAMERA**  
Fully Transistorised  
Monitor on Standard TV Set. High quality wide angle lens.  
**\$335.00**

**TAPE CASSETTE**  
8 TRACK CAR STEREO PLAYER  
4 watts per channel  
12V operation. Neg. earth.  
**\$69.00**  
4 track 240V unit 8 watts per channel.  
**\$79.00**

**AMPLIFIERS**  
Public Address Range  
240V-AC

**MINIATURE P.A. AMPLIFIER**  
15 WATT OUTPUT  
Multi Match Ferguson O.P. transformer input for crystal mike and pick-up with electronic mixing  
P.P. EL-84 output . . . . . **\$42.50**  
30 Watt. As above, EL-34 P.P. . . . . **\$57.50**  
40 Watt. As above, EL-34 P.P. . . . . **\$85.50**  
60 Watt. As above, 6DO6 P.P. . . . . **\$105.50**

**LINE OR VOICE COIL. SOLID STATE 240V A.C.**  
20 Watt . . . . . **\$49.50**  
50 Watt . . . . . **\$69.50**  
50 Watt 240 A.C. plus 12V. D.C. Plus Self Battery Charging. **\$95.00.**  
All have inputs for 2 microphones or 2 Magnetic or Crystal P.U. With Mixing.

**P.A. SPEAKERS**  
8 WATT.  
8in Units in Waterproof Projection Horns.  
15 Ohm Voice Coils.  
**\$15.25**  
Line Output Transformers to suit. \$1.75 extra.

**MICROPHONE GOOSE NECKS. SATIN**  
9in . . . . . **\$2.75** MIC. STAND.  
12in . . . . . **\$3.50** Floor Model.  
18in . . . . . **\$4.35** **\$11.75.**  
24in . . . . . **\$5.00** Table mod. **\$3.65**

**LOW LOSS MIC. CABLE**  
15c per yard or \$10 per 100yds.

**50 WATT SOLID STATE GUITAR AMPLIFIER**  
E.A. July & August Issue. Kitset, including Cabinet.  
**\$98.00**  
Wired and Tested, **\$114.00**  
Speaker Enclosures to suit **\$104.00**  
4 M.S.P. Speakers.  
2 Pioneer 15in Speakers, **\$94.00**  
2 Rola 50 watt speakers **\$128.00**

Model UDM-105 Cardioid.  
50K-600 ohms. . . . . **\$16.95**  
Model DM-304 50K-600 ohm . . . . . **\$14.95**  
Model DM-108 . . . . . **\$11.95**  
DX-129 . . . . . **\$12.75**  
Hi Imp Dynamic DM 401 **\$8.75**  
Hi Imp Dynamic DM 203 **\$8.75**  
Hi Imp Dynamic DMS-3 . . . . . **\$5.50**  
Crystal Pencil BM-3 . . . . . **\$7.50**  
Crystal Lapel . . . . . **\$1.75**

**HI-FIDELITY TWIN CONE SPEAKERS**  
Aust. made, 8 to 16 ohms.  
6in . . . \$9.00 12in **\$11.75**  
8in . . . \$7.50 Postage:  
8in . . . \$9.50 Interstate 80c  
10in . . \$10.75 N.S.W., 50c

**NEW SPEAKER SPECIALS**  
8 to 15 ohms  
2in . . . **\$2.75** 6in . . . **\$4.00**  
2 1/4in . . **\$2.75** 4 x 2in **\$3.30**  
2 3/4in . . **\$2.85** 5in x 3in **\$3.30**  
80mm . . **\$2.85** 6in x 4in **\$4.25**  
3 1/2in . . **\$3.95** 9in x 6in **\$5.95**  
5 1/4in . . **\$3.20** N.S.W. 25c  
Magnavox 10in Twin Cone 8 ohm **\$6.75**

**STEREO RECORD CHANGERS**  
Latest Model, 4-speed.  
**\$28.75**  
De Luxe Model.  
Fully machined and balanced. Heavyweight turntable. Ceramic Cartridge.  
**\$34.00**  
Post: N.S.W. \$1.25. Interstate \$1.75.  
De Luxe Model with mechanical cueing device. Calibrated stylus. Pressure control. Adjustable counter balance. Two spindles.  
**\$46.50**

Fully Auto. Player  
All Refinements  
Magnetic Cartridge. **\$65.**

**8 TRANSISTOR CAR RADIOS**  
R.F. Stage for long range reception. 6 or 12 volt operation. On ordering please state polarity requirements complete with lock down aerial and lead.  
Speaker Selection. 5", 6", 8", 7" x 5" or 6" x 9".  
De Luxe Push Button Model, **\$55.75**  
Standard Manual Model. Complete with 5" x 3" Speaker. **\$43.00**. Post **\$1.25**; Interstate **\$2.00**  
Car Aerials complete with lead. Top cowl mounting, 3", 6", **\$2.75**  
Lock Down, 3" 6" . . . **\$4.75**

**V.T.V.M. MODEL TE-40 MILLIVOLTER**  
Spec. AC.V. Imp.—300 Vrms, 10 ranges. Accuracy 5 cps-1 2 mc, plus-minus 2db, 10 cps-1 mc, plus-minus 1db 20 cps-250 KC, plus-minus 0.2db.  
dB. Scale: 40-30-20-10-0, 10,20, 30-4 50 dBm, 240 V.A.C.  
**\$48.75**

**MODEL TE-65 V.T.V.M.**  
DC, V 0-1, 5-5-15-50-150-500-1,500 V. Rms. A.C.V. 0-1.5, 5.5-15-50-150-500-1,500, V. Rms. 0-1-4-14-40-1400-1400-4000 V. P.P. Resistance: RX10 100.1K .10K, .100K, 1M 10M, Decibel — 100db minus-plus 65db.  
240 V.A.C.  
**\$43.75**  
TECH. P.V.58, \$40.50.

**ORGAN KEYBOARDS**  
49-Note. Complete with Switching System.  
**\$72.00**  
13-Note. Pedal Claviers. Complete with Switches.  
**\$39.95**

**HI-FI STEREO HEADPHONES**  
8-OHM.  
Range 25c to 17Kc.  
**\$9.75**  
Post 35c.

**TAPE CASSETTES TENSILISED MYLAR**  
C 60 . . . . . **\$1.25**  
C 90 . . . . . **2.00**  
C120 . . . . . **\$2.75**  
Head Cleaners . . . . . **\$1.75**

**NEW RECORDING TAPE**  
Most Popular Brand  
3in Correspondence . . . . . **90c**  
3in Mylar L.P. 300ft . . . . . **\$1.05**  
3 1/4in Mylar D.P. 600ft . . . . . **\$1.25**  
5in Mylar L.P. 900ft . . . . . **\$2.50**  
5in Mylar D.P. 1200ft . . . . . **\$3.15**  
5 1/4in Mylar L.P. 1200ft . . . . . **\$3.15**  
5 1/4in Mylar D.P. 1800ft . . . . . **\$3.50**  
7in Mylar L.P. 1800ft . . . . . **\$3.75**  
7in Mylar D.P. 2400ft . . . . . **\$5.00**  
7in Mylar T.P. 3600ft . . . . . **\$6.00**  
7in P.V.C. 1200ft . . . . . **\$2.50**  
Postage: N.S.W. 15c. Interstate 25c.



## GUITAR AMPLIFIERS

10-Watt, Two-Channel, with Twin Cone Speaker . . . \$53.55  
 14-Watt, 4 Inputs, Bass and Treble Boost, 2 Twin-cone Speakers, \$63  
 17-Watt, 4-Channel, Bass and Treble Boost, Two Twin-cone Speakers . . . \$76.25

### 35 WATT

4-Channel, Bass and Treble Boost, 4 Twin-cone Speakers . . . \$109.05  
 Vibrato with foot control and 2 preset controls for frequency and intensity, \$10.50 extra on above models.

## REVERBERATION UNITS

Latest design to suit organs, stereo, guitar, any hi-fi equipment.

**\$5.75**  
 Post 35c.

## FUZZ BOX

FUZZ BOX, E. AND A. AUG. WIRED AND TESTED. \$15.  
 Post 75c.

## REVERB UNIT

COMPLETE with AMPLIFIER. E.A. October issue. Kitset \$39.95. Wired and tested, \$41.95.



## MULLARD MAGNAVOX BOOKSHELF ENCLOSURE

Maple, Teak or Walnut Complete \$24.75  
**SUPER BOOKSHELF \$36.75.**

Post: N.S.W. 50c, Interstate \$1.00. CABINETS ONLY.  
 R.H. BOOKSHELVES, \$11.50. MULLARD, \$10.95.  
**BOOKSHELF UNITS**  
 6in 8in 10in 12in  
 \$27.75 \$33.50 \$39.75 \$42.75

## PLAYMASTER 127 STEREO CONTROL UNIT

For tape replay, Magnetic, disc, and crystal cartridge input. Radio fully described Nov. 69 issue E.A.



**KIT SET \$49.50**  
 Wired and Tested \$59.50.  
 Pack and Post 75c.

## 128 STEREO AMPLIFIER

64 watts per channel  
 Kit Set . . . . . \$95.00  
 Wired and Tested . . . . . \$109.00

## PIGGY BACK GUITAR AMPLIFIER

Excluding Speakers  
 30 Watt . . . . . \$79.75  
 45 Watt . . . . . \$99.75  
 60 Watt . . . . . \$119.75  
 4 Inputs, Bass and Treble Boost  
 Vibrato if required, \$10.90 extra.

## PIGGY BACK GUITAR AMPLIFIER

Complete with Speakers & Cabinet  
 30 Watt Lead . . . . . \$138.75  
 30 Watt Bass . . . . . \$146.75  
 45 Watt Lead . . . . . \$156.75  
 45 Watt Bass . . . . . \$166.75  
 50 Watt Lead . . . . . \$218.00  
 60 Watt Bass . . . . . \$234.00  
 Vibrato if required extra \$10.50

## 119 STEREO TAPE ADAPTER

Suits all Playmaster Stereo amplifiers and others that accept crystal P.U.

Kitset . . . . . \$79.00  
 Wired and tested . . . . . \$96.00

## 10 + 10 STEREO AMPLIFIER

With Overload Protection Circuit  
 Kit Set . . . . . \$62.75.  
 Wired and Tested . . . . . \$72.75



## AUTOMATIC RHYTHM BOX

12 RHYTHMS.  
 9 PERCUSSIVE INSTRUMENTS.  
 240v A.C. OPERATION.  
**\$145.00**

## NEW COMMUNICATIONS RECEIVER

Kit-Set . . . . . \$190.00  
 Wired and Tested . . . . . \$230.00

## ALL SILICON TRANSISTOR SOLID STATE STEREO AMPLIFIER

240V AC powered, 8 watts RMS per channel inputs for magnetic, ceramic, and crystal cartridge, also recorder and radio tuner. Hi-Fi frequency response speaker matching 4-16 ohms. Size 10 1/2 in x 6 1/2 in x 3 1/2 in. Attractive oiled teak cabinet.

**\$54.00** Pack and Post \$1.50.

## 240V. A.C. INPUT VARIABLE POWER UNITS

TRANSISTORISED, REGULATED, METERED.  
 0-to-20V. 1 amp. **\$21.50**  
 0-to-35V 1 amp **\$27.50**



## 240V A.C. POWERED SOLID STATE STEREO T.S.135

18 Transistor, 15-watt per channel. Inputs for Tape, Mag. P.U., Ger. P.U., Radio Aux. Freq. Range 30c to 20KC. Max. Sensitivity 3 MV. Speaker matching 4 to 15 ohms.  
**\$78.00**

## SIGNAL INJECTOR

Transistorised, Fountain pen-sized Unit for Signal Tracer in Radio, TV and Amplifier Service.  
**\$5.75.** Post, 25c.

## WIDE BAND OSCILLOSCOPES

### SPECIFICATIONS

#### VERTICAL AXIS

Deflection Sensitivity (at 1 kc) 0.1 V p-p/cm.  
 Frequency Characteristics, 1.5 cps—1.5 MC.  
 Input Impedance, 2 M ohms 25pF.  
 Calibration Voltage IV p-p/cm.

#### HORIZONTAL AXIS

Deflection Sensitivity 0.9V p-p/cm.  
 Frequency Characteristics 1.5 cps—800 KC.  
 Input Impedance 2 M ohms 20 pF.  
 Sweet Oscillator (5 Range) 10 cps  
 —300 KC.  
 Synchronisation Devices Internal (Positive and Negative, External).  
 Power 240v AC 50/60 cps.  
 Cathode Ray Tube 3KF1F.



5 Mes Bandwidth Push-Pull vertical and Horizontal Amplifiers. 8 positions, high sensitivity, vertical Amplifier Frequency Compensated on all positions. Calibrated .02 to 600 volts. Hard time base, 20 cycles to 75K. Latest American R.C.A. circuitry. Complete with probe.

**3-Inch \$102.75;**

**5-Inch \$118.75**



## PLAYMASTER 115

The new Solid State Stereo-Amplifier. April issue.  
 Wired and tested . . . . . \$104.00  
 Kit Set . . . . . \$90.00  
 Pre-amp to suit magnetic Cartridge . . . . . \$12.00



## MUSICOLOUR

Sound control of coloured lights. As described E.A. Oct., 69.  
 Kit set . . . . . \$46.05  
 Wired and Tested, \$54.00.

## 3" VERNIER DIAL

8:1 Ratio  
**\$2.95, Post 25c.**



## AUDIO GENERATOR

De Luxe Model TE—22D.  
 Freq. range, Sine 20 cps—200 KC. 50, 20 cps—25KC. Output voltage, Sine 7V. 50. TV P.-P. Output Impedance 1000 ohms. Acc. 5 per cent. Distortion less than 2 per cent. 4-range attenuation. 1/1, 1/10, 1/100, 1/1K. Printed circuit, 240V A.C.  
**\$42.95**

## TACHOMETERS

Mullard ACE, scaled for  
 5.7 or 9K . . . . . \$20.75  
 With Dwell Angle . . . . . \$23.75  
 OHNAR  
 240-degree Circular Movement.  
 Scaled 6K or 8K . . . . . \$24.75  
 Standard Scale 6 or 8K . . . . . \$19.75  
 Postage N.S.W. 50c, Interstate 75c.

## G.D.O. UNITS

Post: N.S.W. 50c, Interstate 75c.  
 T.E. 15 Transistorised, 7 Band, 360 Kc to 270 Megs.  
**\$39.75**

## TV BOOSTER

240VAL. Especially designed for fringe area reception. Also up to 3 TV sets can be operated off common aerial for improved signal strength.  
**\$15.95** Post Free.

## NEW GRAMMO MOTORS

240V. A.C.  
 3 Speeds, \$2.75.  
 Post: 40c.

## SIGNAL GENERATOR

De Luxe Model TE20D.  
 Freq. Range 120 KC—500 Mes. Bands. Accuracy 2 per cent. Output 8V. Provision for Xtal Suitable for self-calibration Marker generator. Printed circuit. 240 T.E.20. \$25.50. **\$31.75**  
 V.A.C.

## HIGH POWER LOW FREQUENCY SPEAKERS

Suit Bass and Organ  
 15in imported. 30 watts RMS . . . . . \$30.00  
 15in Local 25 watts RMS \$47.50  
 12in Rola 50 Watts RMS \$46.50  
 12in Rola Twin Cone 50 watts RMS . . . . . \$52.50



## NEW LOOK SPEAKER ENCLOSURES

Hi-Fi Freq. response. Power rating 5 watts R.M.S. Attractive, modern, oiled teak finish. Size 14 1/2 in x 4 3/4 in x 9.  
**\$15.00 EACH**  
 Post 75c. Interstate \$1.25.

## T.E. 46 RESISTANCE-CAPACITANCE

Bridge and Analyser.  
 Capacity 20pf to 2000mf.  
 Resistance 2 ohms to 200 meg.  
 Also tests power factor, leakage, impedance, transformer ratio, insulation resistance to 200 meg. at 600V.  
 Indications by eye and meter.  
**\$53.75**

## VOLT. A.C.

VARIABLE TRANSFORMER.  
 0-260V, 10 amp. . . . . \$49.50  
 0-260V, 5 amp. . . . . \$37.50  
 0-260V, 2 1/2 amp. . . . . \$25.50

# A.C.E. AMPLIFICATION

# COMMUNICATION



# ELECTRONICS



PHONE 51-3845  
51-7008

# RADIO

37 VICTORIA AVENUE, MIDDLE COVE  
WEEKENDS & AFTER HOURS 40-5391

## 136 VICTORIA ROAD MARRICKVILLE - 51-3845

### NEW VALVES

All valves 75c unless otherwise stated.

1G4	75c	12SK7	50c
1H5	75c	723A	\$6.00
1S5	75c	809	\$1.75
1T4	75c	813	\$7.00
6AK6	75c	289B and Socket	\$5.75
6AR6	75c	866A	\$1.50
6B6	75c	954	50c
6B8	75c	956	50c
6BF6	75c	9006	50c
6C8	75c	AV11	25c
6F6	75c	EF36	75c
6G6	75c	EF39	75c
6J6	75c	EM35	75c
6JG	75c	6U7	75c
6K6	75c	VR105/30	\$1.50
6K7	50c	VR150/30	\$1.50
6N7	75c	TZ40	\$1.50
6SA7 Metal	75c	6C6	\$1.25
6SC7	75c	6SC7	75c
6SH7	40c	6L6	\$1.50
6SI7	95c	6AK5	75c
6SN7	75c	807	75c
6SS7	75c	6G8G	\$1.50
6X5	75c	6J8G	\$1.50
7C5	50c	12AU7	\$1.00
12AT7		6N3	75c
12BE6		6AW8A	\$1.00
12CB		6EM5	\$1.00
12SJ7		6BQ7	\$1.00
2A3		6CW7	\$1.00
2C26		12BH7	\$1.00
2X2-879	50c	6DX8	\$1.00
3A4		6AU4	\$1.00
5X4	50c	6BW7	75c
5Y4	50c	1R5	75c
5Z4		6X9	\$1.00
6AC7	75c	6Y9	\$1.00
6AG5	95c	6BY7	\$1.00
6AG7		6HS8	\$1.00
6AJ5	50c	649	\$1.00
6AL5	75c	6F6	75c
6AM5	75c		
6AN5	\$1.25		

### NEW POWER TRANSFORMERS

240VAC. 50cps. Primary standard fl. windings.

385VCT 80MA	\$3.75
325VCT 80MA	\$3.75
385VCT 60MA	\$3.00
385VCT 50MA	\$3.00
325VCT 40MA	\$3.00
240/240 60MA	\$5.50
125MA filter choke	\$2.00
100MA filter choke	\$2.00
50MA filter choke	\$1.25

Add Pack & Post.

### NEW POWER TRANSFORMERS

124V Doubler 300MA	\$6.75
130V Doubler 400MA	\$7.75
145V Doubler 450MA	\$9.75
150 x 150, 30MA	\$3.75
225 x 225, 50MA	\$4.25
193.5in C.R.O. Transformer	\$12.95
150V Doubler 6003MA	\$12.75

### WHIP AERIALS

12ft, 3-section	\$3.00
Base to suit	\$1.00
Roof Mounting, Flexible Base, suit Autos.	\$2.75
3ft 1in diam. Screw together sections	85c
Set of 4 Guy Ropes with Insulators	\$2.50

### CHASSIS PUNCHES

SIZES, 3/16in, 1/4in, 3/8in, 1in, 1 1/2in with tapered Reamer and Carry Box.

\$5.75

Post 50c. Interstate \$1.00.

### LAB STANDARD (METERS)

7in in Cedar Cabinets. Leather Cases.  
0 to 10 amps. 0-20 amps.  
0 to 50 amps. 0-250 amps.

\$10.50

### CAVITY TUNING

Resonator. Complete with digital counters—also lighthouse tubes. Type 2C4Z, 2C46.

\$5.75

### PYE

EX-TAXI TRANSCEIVER. Complete All Valves, speaker, mic. Clean condition.

\$32.00

### TYPE 62 TRANSCEIVER

2 to 10 megs. NEW.

\$49.50

### RELAYS

Weston Microamp Meter	Relays
75UA-218UA	\$5.00
12 volts, DPDT, 5 amp	\$2.00
12 volts, DPDT	\$1.25
100pf TX var. condensers	\$1.00
Hi-speed Polarised relay	\$5.00
2000 ohms	\$1.25
1000 ohms	\$1.25

### NEW C.R.O. TUBES

3AP1-906 3in	\$2.75
CV112 5in	\$2.00
VCR97 6in	\$3.75
ACR10/VCR139A 3in	\$3.00
CV152 1 1/4in	\$2.25
SE5A7	\$9.75
89D	\$9.75
09D	\$9.75
09J	\$9.75
T35-P2	\$9.75
T31-P2	\$9.75
4EP1	\$9.00
4/1	\$9.00
5FP7	\$4.75
5CP7	\$4.75
3FP7	\$4.75

3FP7 complete with shield and magnetic deflection coils

\$10.00

### TWIN SHIELDED MICROPHONE CABLE

P.V.C. covered, 15c per yard, \$13.50 per 100yds. Add pack & post.

### LIGHTING PLANT

Johnson 1 h.p. Engine, 12V, 30 amp. Generator. New. Tested.

\$72.00

### 2 H.P. ENGLISH

J.A.P. PETROL ENGINES. Tested. Perfect order.

\$39.00

### DUMONT 5" WIDE BAND OSCILLOSCOPE

LABORATORY MODEL. Tested. New condition.

\$99.00

### COSSOR 1 1049 DOUBLE BEAM

\$170.00

### NEW MOBILE R.F. LINEAR AMPLIFIERS

2 to 10 Megs. 200 Watt P.E.P., 12v Power supply. Easily converts to other brands. Suitable for S.S.B. Silver. Variable Inductance. Sufficient reserve power for exciter.

\$15.00

### No. 19 TRANSCEIVERS

2 to 8 megs. 15 valves. New condition.

\$19.75

ALSO BRAND NEW.

\$27.00

### TRANSISTORS

2N174	\$5.00
2N422	\$4.50
2N441	\$4.00

High-powered units for 75-watt audio, 200-watt power units or transistor ignition.

### PLESSEY B47 TRANSCEIVER

Inbuilt 24VDC power supply. Variable tuning. Freq. 38-56 MHZ. F.M.-V.F.O. Controlled. Output 2 watts.

\$95.00

### BLOWER MOTORS

24-28VDC. 10,000 RPM 400MA. Cap. 24GFM. Free air.

\$5.75

Pack & Post 50c.

### COAX CABLE

P.V.C. covered. 72 ohms. 20c per yard. \$18.00 per 100yds.

### NEW DIEHL FANS

12" industrial exhaust fans. 115VAC. 1.75A.

\$30.00

### 100 YDS HOOK-UP WIRE

10 Assorted Colours. \$1.00 Post 25c.

### TYPE 1935 V.H.F. TRANSCEIVER

100 to 155 megs. New condition.

\$29.75

### BENDIX FREQUENCY METERS

New. factory fresh. Modulated units. With A.C. supply.

\$75.00

### WANTED

Communications Receivers. Test equipment. P.A. Gear. Large or small surplus stock. Best prices. Call, write or phone any time.

### NEW DYNAMIC OR SOUND POWERED MICROPHONES

Pushbutton Operation. Low Impedance.

\$1.25

Post 50c.

### EX PMG HAND SETS TELEPHONE HANDSETS

\$3.00 Pack & Post 50c.

### PORTABLE BLOWER MOTORS

230VAC. 220 watts. Complete with flexible hose.

\$15.00

Pack & post. \$1.50.

### VACUUM PUMPS

Huppert type B3X. MK111. 1/2" shaft.

\$25.00

### EX FORESTRY COMMISSION

Portable Transceivers. Battery operated. Freq. 3-7 MHZ. Suitable conversion marine band. Complete—valves, meter, speaker, mic.

\$15.75

### NEW

34ft Vertical Collapsible Antennas. Complete with Guys and Base Insulator.

\$7.75

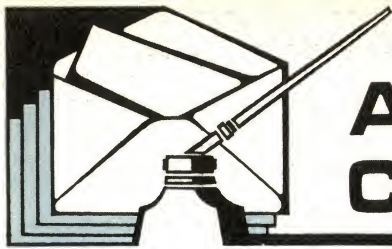

# ANSWERS TO CORRESPONDENTS

**MAKESHIFT EQUIPMENT:** I have enclosed a not-so-recent article from the "Sydney Morning Herald." It tells how a few high school students picked up signals from weather satellites using a tape recorder, which was played into a television set and viewed — in their lunch hours at that! Could your magazine write an article on how improvised equipment like this could be set up for a tracking station or how TV programs could be recorded with a conventional tape recorder? I like your magazine and am looking forward to interesting articles in the 70s. (D.K., Peakhurst, N.S.W.)

● There is a lot more complication behind the student ventures than you have interpreted the article to mean. In fact, university students in Australia have built and operated similar equipment and we carried a picture and brief story about their efforts some time back. Even without synchronous motor drive, the antenna poses a fair order of challenge to design, construct and mount. While some success may be had with discarded radar receivers, there is the problem of securing a suitable unit and adapting it for the purpose. The incoming signals might well be recorded on an ordinary tape recorder, because the relatively slow rate at which the picture is built up involves only a modest bandwidth. There is nothing in the story to suggest that the students did — or could — record regular television pictures on an ordinary recorder. Most likely, the picture would have been reconstructed, line by line, on the picture-tube face, with the camera lens open for the duration of the scan. It would be more akin to facsimile than to television. The activities of the second group, involving observation of orbits, etc. would have been a joint effort involving a lot of time by dedicated students, and probably dedicated lecturers as well, in a science laboratory situation. It's a fine way to learn but it involves a lot more than you appear to imagine. Behind it would be a lot of text book material, practical experience, and constructional know-how that would not easily be covered even in a series of articles. We have little hope of tackling anything like this in the foreseeable future.

**FREQUENCY-WAVELENGTH CONVERSION:** Have just purchased a dual-wave portable receiver and am becoming very interested in short-wave listening. However, I am not sure of the relationship between Kilohertz and Metres, and this causes problems in seeking stations which have been mentioned in your "Listening Around the World" columns. Could you please tell me of the way to convert frequency into wavelength and vice-versa? (D.R., Broadwater, N.S.W.)

● There are numerous ways of remembering the relationship between frequency and wavelength, D.R., but to our mind the easiest way is to remember that wavelength of radio waves is inversely proportional to frequency, and that the wavelength is 1 metre at a frequency of 300MHz (Megahertz). If these two facts are remembered, it becomes a fairly easy matter to find the wavelength of a

particular frequency and vice-versa. Whatever the number by which one must divide 300MHz to give the frequency, this same number should be used to multiply by 1 metre to give the wavelength. Hence a 30MHz signal will have a wavelength of  $(300/30) \times 1$ , or 10 metres, while a 10MHz or 10,000KHz signal will have a wavelength of  $(300/10) \times 1$ , or 30 metres. Another form in which this relationship may be expressed is  $F \times L$  equals 300,000. Here F represents the frequency in Kilohertz, L the wavelength in metres.

**MINIATURE TV RECEIVER:** Would it be possible for you to design a miniature transistorised television receiver using one of the common 3in or 5in cathode ray tubes and a wide-band oscilloscope? (N.S., Whyalla Norrie, S.A.)

● You appear to have combined two separate ideas in the one request, N.S., but we assume that you are thinking of a transistorised wide-band oscilloscope. (We have described a number of valve type wide-band oscilloscopes.) We have no immediate plans for an oscilloscope along these lines, but we will take a look at the situation to see whether it might be a proposition for the home constructor. The possibility of a TV set along the lines you suggest is much more remote. First, we doubt whether anyone would want to spend a lot of time and money to produce a set using an oscilloscope type CRT. Secondly, it is very unlikely that the home builder could build a set for the same or lesser price than he could buy one, which makes the idea even less attractive.

**SOLID STATE SERIES:** I find your magazine interesting, instructive and helpful. May I, in particular, offer congratulations to Jamieson Rowe for his exceptionally good series on the subject of solid state. Having in mind the number of readers who appear to lose track of what has been described in the past, and who want to know about prices, etc., would it not be possible to bring out an annual catalogue containing projects that have been featured during the year, along with relevant prices, advertisements, etc.? (G.H., Red Hill, A.C.T.)

● Thanks for the encouraging remarks, which have been brought to the attention of Mr Rowe. Without going into likely costs and revenue, we could not be sure about the commercial viability of an annual, such as you suggest. Many years ago, we did bring out one or two special books of the "annual" variety. Our main problem at the moment is that we just could not cope with the extra work that would be entailed.

**P.A. AMPLIFIER:** I am interested in a 30-60W transistorised high-quality P.A. amplifier with output of 70-100V. Is it possible that the latest transistor guitar amplifier could be modified for P.A. use, and if so, do you intend to publish details shortly? If it is not suitable, have you such a project in mind for later publication? (D.D., Swan Hill, Victoria.)

● We can only say "No" to both questions. We do not regard the guitar amplifier as suitable for modification for your requirements, and we have no plans for presenting as a construction project an

## "ELECTRONICS Australia" Information Service

As a service to readers "ELECTRONICS Australia" is able to offer: (1) Photographs, dye-line prints and other filed material to do with constructional projects and (2) A strictly limited degree of personalised assistance by mail or by reply through the columns of the magazine. Details are set out below:

**PROJECT REPRINTS:** For a 20c fee, we will supply data, as available from our files. The amount of data available varies but in no case does it include material additional to that already published in the magazine. For complicated projects involving material extracted from more than one issue, an extra fee may be requested. As a rule, requests for project data will be answered more speedily if the projects are positively identified and the request is not complicated by questions requiring the attention of technical personnel. Where articles are not on file, we can usually provide a photostat copy at 20c PER PAGE.

**PHOTOGRAPHS, DYE-LINE PRINTS:** Original photographs are available for most of our projects, from 50c plus 8c postage for a 6in x 8in glossy print. In addition, metalwork dye-line prints are available for most projects for 50c each; these show dimensions and the positions of holes and cut-outs but give no details of wiring.

**BACK NUMBERS:** A fairly good selection is available. On issues up to six months old the cost is the face value, plus 5c surcharge. From seven to 12 months, 10c surcharge; over 12 months, 20c surcharge. Package and postage is 10c extra per issue. Please indicate whether a PROJECT REPRINT may be substituted if the complete issue is not available.

**REPLIES BY POST:** This provision is made primarily to assist readers in matters relating directly to articles and projects published in "ELECTRONICS Australia" within the last 12 months. Note, however, that we cannot provide lengthy answers, undertake special research or modifications to basic designs. A 20c query fee must be enclosed with letters to which a postal reply is required; the inclusion of an extra fee does not entitle correspondents to special consideration.

**OTHER QUERIES:** Technical queries which fall outside the scope of "Replies by Post" may be submitted without fee and may be answered through the columns of the magazine at the discretion of the Editor. Technical queries will not be answered by interview or telephone.

**COMMERCIAL EQUIPMENT:** "ELECTRONICS Australia" does not maintain a directory of commercial equipment, or circuit files of commercial or ex-disposals receivers, amplifiers, etc. We are therefore not in a position to comment on proposed adaptation of such equipment, or on its general design. "ELECTRONICS Australia" does not deal in electronic components. Prices, specifications or other assistance must be sought from the appropriate advertiser or agent.

**REMITTANCES:** These must be in a form negotiable in Australia. Where the charge may be in doubt, an open cheque, endorsed with a limitation, is recommended.

**ADDRESS:** All requests for data and information, as set out above, should be directed to The Assistant Editor, "ELECTRONICS Australia," Box 2728 G.P.O., Sydney, N.S.W. 2001: 5/69

# PRE-PAK electronics

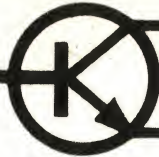

P.O. BOX 131,  
KINGSGROVE, N.S.W. 2208.  
SALES CENTRE,  
103 Regent Street,  
REDFERN, N.S.W. 2016.  
69-5922

## DON'T BUY COMPONENTS!

until you have seen the prices in our **ALL NEW ILLUSTRATED 1970 CATALOGUE**  
**TO OBTAIN THE LATEST PRE-PAK CATALOGUE**

Send the coupon below which entitles you to membership of the Pre-Pak Electronics Club. Only members of the Pre-Pak Electronics Club will be privileged to buy components at the special prices advertised in our catalogue and supplements, and to receive the benefits of our club services. Include \$1.00 with the coupon to cover membership printing, cost and postage.

### MEMBERSHIP OF THE PRE-PACK ELECTRONICS CLUB OFFERS YOU

10 vouchers each worth 10c discount for each dollar spent, 10" x 8" gloss covered illustrated catalogue with 6 free regular supplements each year to keep you up to date with new products and prices. Standard mail order forms to speed your order to us. Despatch of all orders within 24 hours.

#### COMPUTER BOARDS

Containing a variety of NPN and PNP germanium transistors and a host of other components, these 4in x 2½in boards are supplied with free technical information on all parts. Each board has a minimum of 4 transistors.

#### PRICE POST

100 Boards . . . . . 20c ea. 50c  
25-99 Boards . . . . . 25c ea. 25c  
10-24 Boards . . . . . 30c ea. 25c  
1-9 Boards . . . . . 35c ea. 10c

Stocks are running low. To avoid disappointment order now.

#### BARGAINS

2N3054 . . . . . \$1.90  
2N3055 . . . . . \$1.90  
BC108 . . . . . 50c  
BC109 . . . . . 60c  
BF115 . . . . . 65c  
AC125 . . . . . 80c  
AC126 . . . . . 80c  
AC127/128 . . . . . \$1.75  
AC187/188 . . . . . \$1.85  
AD161/162 . . . . . \$3.20  
EM404 . . . . . 30c  
BA100 . . . . . 35c  
OA91 . . . . . 20c

#### Magnetic Pre-Amp Kitset

As in E.A., Oct., 1965.

All parts supplied.

Use for pick-up or tape heads.  
Mono \$4.90. Stereo \$9.00.

#### TWEETERS

3½in 5KHz-16KHz  
12w R.M.S., \$3.30.  
3½in 5KHz-18KHz  
15w R.M.S., \$4.10.  
Post 50c.

#### SUN-LITE DELUXE

2 STATION INTERCOM

Supplied with 100ft wire and 9 volt battery.

\$11.25

Pack. and Post. 50c.

**PACK AND POST**  
10c ANY ORDER  
UNLESS INDICATED.

#### INTEGRATED CIRCUITS



Plessey SL403A/Sinclair 1C10  
10W peak, 5W R.M.S.  
\$10.50. Post 25c.



#### G.T.S. CAPACITOR

Discharge Ignition  
by Summit.

A MODEL TO SUIT  
EVERY MOTOR.

6 months' guarantee.

Deluxe . . . . . \$39.95  
Competition  
(higher output) . . . . . \$48.00  
Marine . . . . . \$64.00



#### MODEL MF-15

Pocket Multi-  
meter, 2,000 Ω/V  
designed for  
radio service.

#### MULLARD

Semi-Conductor

Interchangeability list, latest  
edition, \$1.00.

Miniwatt valve and transistor  
data book, latest (7th) edition.  
\$3.05.

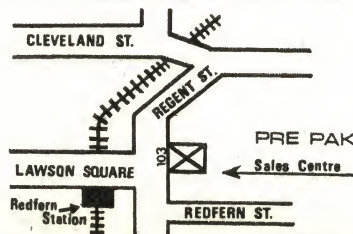

#### SELENIUM BRIDGE RECTIFIERS

20v 1A KA1 . . . . . \$1.00  
20v 2A LT91 . . . . . \$1.50

#### G.E. INTEGRATED CIRCUITS

PA 237 2W . . . . . \$6.95  
PA 246 5W . . . . . \$9.00

#### HIGH-POWER SPEAKERS

Suit guitar amps., etc.  
12in Aust. 15w Twin Cone,  
\$20.00.

12in Imported 40w . . . . . \$30.00  
12in Aust. 50w . . . . . \$50.00  
15in Aust. 30w . . . . . \$50.00  
Freight \$1.00 ea.

#### STEREO HEADPHONES

SDH-7 25Hz-15KHz . . . . . \$7.50  
SDH-8 20Hz-17KHz . . . . . \$9.50

#### MAGNETIC CARTRIDGES

At 66.

20Hz-20KHz ± 2db.  
Tracking weight .5-2.5 grams.  
\$8.50.

At 215, \$11.50.

At 33, \$13.95.

Post 25c.

#### NEON MAINS TESTING

SCREWDRIVERS . . . . . \$1.00

#### HI-FI TWIN-CONE

SPEAKERS

8 ohm or 15 ohm.

6½" 30Hz-15KHz 6W.  
R.M.S. . . . . . \$12.00

8" 30Hz-15KHz 8W.  
R.M.S. . . . . . \$12.00

10" 30Hz-15KHz 10W.  
R.M.S. . . . . . \$12.40

12" 30Hz-15KHz 10W.  
R.M.S. . . . . . \$12.84

#### TO PREPAK ELECTRONICS:-

I enclose cheque/m.o. for \$1.00 for  
your new catalogue with 10 x 10 coupon  
and membership of the Pre-Pak  
Electronics Club.

Name . . . . .

Address . . . . .

. . . . .

Postcode . . . . .



# ANSWERS - continued

amplifier such as you describe. In general, we can only publish circuits which will interest a sizable portion of our readers, and the more specialised equipments such as the type you require do not fall within this category. Sorry.

**ENJOYS READING E.A.:** I was agreeably surprised to see details of my "Simple Variable Power Supply" in the December issue, "Reader Built It." I am very happy with your magazine which, in my opinion, goes from strength to strength. The December article on the noise silencer was interesting and I intend to incorporate something like it in my Sony CRF 230. Radio reception is very good on Norfolk Island but static is an ever-present nuisance on the broadcast band during summer. (P.B., Duncombe Bay.)

● Thanks for your letter. Payment has been authorised for the item, now that we are sure of your present address. Static may be a problem but our guess is that quite a few of our readers would be prepared to put up with it in exchange for a few months on Norfolk!

**WATT POWER:** Manufacturers seem to label their guitar amplifiers with fictitious power ratings. I would like to know if there is any test instrument with which I can measure the power output of amplifiers while they are still in the shop. (A.H., Clarence Park, S.A.)

● Unfortunately there is no single test device or simple method to measure the power capability of a guitar amplifier in a shop. About the best you can do is seek a reputable dealer.

**PHOTO-METER:** Currently on the photographic accessories market is an instrument known as a "Photo-meter." I feel that this would make a good constructional project for your magazine. Essentially, the instrument indicates correct diaphragm opening for flash photography. A photocell is placed in the area of exposure measurement and the flash synchro-cable is connected to the photo-meter. Operating a "press-hold" button will cause the flash set-up to fire and the light value at the cell is indicated on the meter, calibrated directly in "F" values. Such an instrument is useful in measuring the light at the edge of the angle of flash and also where multiple flashes are to be used. (N.H., Darwin, N.T.)

● Many thanks for the suggestion N.H., and we will certainly keep this idea in mind. We assume that the device would be intended for use mainly with electronic flash sources, rather than expendable bulbs since use with the latter could be quite expensive. This would be particularly so where multiple flash was involved and it was necessary to make several test firings in order to achieve the required lighting balance and coverage.

**PEN-FRIEND SOUGHT:** Would you please publish my name and address? I am aged 14, and would like to hear from anyone living near me who is also interested in amateur radio. Also would you explain briefly what is the meaning of the word "VOX." (Allan Downie, 2 Inge Street, Mt Gravatt, Brisbane, Qld. 4122.)

● As you can see above, A.D., we have published your name and address to comply with your request. We hope that you receive the desired replies. The word "VOX" is actually a contraction of "voice-operated transmitter," so that a device called a "Vox unit" is strictly one which is capable of operating a radio transmitter automatically whenever the operator is speaking. Such units typically consist of a microphone preamp, a signal detector

with fast-attack/slow/decay time constant characteristics and a power amplifier to operate a relay for transmission switching; also a circuit to prevent operation from sounds emanating from the receiver speaker (this is sometimes called "anti-Vox"). In recent years the term "Vox" has often been extended in meaning to cover any device used to permit automatic voice control of equipment. Hence another variety of "Vox" unit is used to operate tape recorders and automatic message devices.

**STEREO CASSETTE EQUIPMENT:** I am looking for a stereo cassette or cartridge recorder system which must be self-contained, able to operate from 12V in a car or 240V in the home. I want to be able to re-record my own material from my present hi-fi system. I am not worried about the number of tracks, etc., but naturally want reasonably good results and a reasonable price. (C.R., Tarragindi, Qld.)

● There have been references in our own and other publications to units of this general type but we have no up-to-date file of information on hand from which we could draw conclusions about availability, price, quality, service back-up etc. for the various systems which might meet your need. We can only suggest that you do what we would have to do ourselves — follow up advertisements, hi-fi dealers, etc., and draw conclusions therefrom.

**TRANSISTOR DELTAHET:** Several years ago, you published a series of articles on the Deltahet receiver. Later, you supplied me with a set of those articles. On the basis of those articles, I built two Deltahet receivers and both are still going strong. Thanks for your magnificent description. Still, the temptation to build something new again is here, and so I would like to ask you whether you propose to publish a transistor version of the Deltahet receiver. Any information would be appreciated. (B. H., Munich, West Germany.)

● Thank you for your letter and we are indeed pleased to learn that you have built not one, but two, Deltahet receivers and that they are so successful. We have been asked many times about the possibility of a transistor version of this popular receiver. In point of fact, the designer of the original Deltahet has been working on a transistor version for quite a while, in his spare time. Development is well under way and some construction work has already been done. While this is all good progress and we have little doubt regarding a successful outcome, it will be some time before it is ready for publication.

**TRANSISTOR SUBSTITUTE:** I refer to your article "A 'Different' Metal Locator" in the January, 1970 issue. An excellent replacement for the 2N2712 is a BC107 or BC108. The specified type is listed by G.E. as "economy planar NPN small signal amplifier audio to 30MHz," possessing the following characteristics (with BC107/8 characteristics given for comparison):

	hFE	V <sub>ceo</sub>	P <sub>t</sub>	F <sub>t</sub>
2N2712	75-225	18V	200mW	120MHz
BC107	125-500	45V	300mW	175MHz
BC108	125-500	20V	300mW	175MHz

The suggested replacement, BFX13, will be more expensive than either the BC107, BC108. (R.H., Mt. Lawley, W.A.)

● Many thanks for this information, which we gladly pass on to our readers. Thanks also to others who have written in on similar lines. Some readers have also indicated that the BSX77 is a suitable replacement.

BUY RIGHT... FROM ENCEL

## MICRO CARTRIDGES

provide excellent performance at modest cost

In each price range Micro cartridges offer outstanding performance... at Encels extremely modest prices. The two most popular magnetic cartridges continue to be the 2100-5 and the VF 3100. The ceramic type SC-303 will always be a best seller.

**SC-303:** The economical ceramic stereo cartridge for the budget-conscious buyer. Frequency response 20-15,000 Hz. 15 deg. tracking angle. Comes with diamond stylus. Price (including sales tax) \$6.90.

**2100-5:** Economical moving magnet model. Input sensitivity: 5mV. Frequency response: 20-20,000 Hz plus or minus 3dB. Tracking angle 15 deg. Channel separation: 3dB at 1kHz. Recommended tracking pressure: 1-3 gms. Stylus: Conical diamond. Comment: Performance equal to a cartridge three times as expensive. Price (including sales tax) \$14.50.

**VF-3100** stereo cartridge continues to attract great attention. Frequency response: 20-28,000 Hz. Channel separation: 2dB. Two models — VF—3100E with elliptical diamond stylus; VF-3100/5 with conical diamond stylus. (Both track efficiency at 1/2 gms). Styli are replaceable. Comment: VF-3100 has established a new performance standard for lower-priced magnetic cartridges.

Price VF—3100/5 \$19.50  
VF-3100E \$24.50.

"Extract" Comment from "Electronics Australia" (Page 119, February, 1969) "frequency response checked out at plus or minus 2dB. from 30Hz. to 20 kHz... a very good performance indeed."

**MDP—3 Dust Bug.** Picks up dust automatically as the record plays.

Price (including sales tax) \$3.50.

**MA77-Mk II** Static Balance Tone Arm High sensitivity arm with split and revolving counterweight for easy balancing adjustment. Anti-skating device eliminates inside-force distortion. Accepts all 1/2" mounting cartridges. Direct reading scale for stylus adjustment. Oil damped arm lift incorporated.

Price (including sales tax) \$44.50

# ENCCEL

ELECTRONICS  
(STEREO) PTY. LTD.

Head Office:

431 Bridge Rd., Richmond, Vic. 3121. Tel. 42 3762.

Sydney Store: Ground Floor, 2SM Building,  
257 Clarence Street, Sydney, N.S.W. 2000.

Tel. 29 4563, 29 4564.

Wholesalers Trade-ins accepted Terms

Australia's Greatest Hi-Fi Centre

## NEW RANGE OF RESISTORS CONDENSERS AND POTENTIOMETERS

The resistors are mainly I.R.C. and Morganite and are in a wide range of values from 100 ohms to 3 meg. in  $\frac{1}{2}$ , 1 and 2 watt and include wire wound. LIST PRICE \$9.00 per 100. OUR PRICE \$2.00 per 100. Post and packing 35c extra.

The condensers are in most popular brands and include Polyester, Paper, Mica, Ceramic and Electrolytic in values up to 8mfd. LIST PRICE \$11.00 per 100. OUR PRICE \$2.00 per 100. Post and packing 65c.

The pots, are all current types and include switch pots, and dual concentric, tandem, tab pots. etc. LIST PRICE \$12.00 per dozen. OUR PRICE \$2.50 per dozen. Post and package 60c extra.

**FREE** With each lot of resistors, condensers or pots, we will supply one new valve. Type 6U7G, 1T4, 6K7G, or 6X5GT.

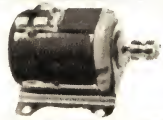

## NEW MINIATURE MOTORS

Ideal for models, toys, etc.  $1\frac{1}{2}$  to 3 volts. 6,000 r.p.m. 39c each or \$3.50 per doz. Post 10c.

## NEW TRANSISTOR 8 KIT SET SPECIAL PURCHASE ENABLES US TO OFFER THIS KIT SET AT \$24.00



**DIMENSIONS**  
9" x 5" x 3" deep

- Complete kit of parts with circuit and full instructions.
- Eight transistors.
- Magnavox 5X3 speaker gives excellent fidelity.
- High sensitivity, suitable for city or country use.
- Heavy duty battery for economical operation.
- Modern design, plastic cabinet with gold trim.
- Dial calibrated for all States.
- Available in colours of off-white, red, black.

Post N.S.W., \$1.25; Interstate, \$1.75.

## New Electrolytic Condensers

These condensers are miniature pigtail type insulated new stock in packets of 12, each packet containing 3 16 mfd 300 V.W., 2 32 mfd. 300 V.W., 1 25 mfd. 450 V.W. and 6 low voltage electrolytics. \$2.50.

Post and packing 20c extra.

## NEW IMPORTED 4" P.M. SPEAKERS

Available with a 4 or 16 ohm voice coil. \$2.00.  
Post and packing 30c extra.

## NEW ENGLISH & AMERICAN TRANSISTORS AT $\frac{1}{4}$ LIST PRICE PACKET OF 12 FOR \$3.00

Ideal for the experimenter and service man. Each packet of 12 contains 3 each of the following types.

Mazda XA 101. Equivalent . . . . . OC45  
Texas 2N1108. Equivalent . . . . . OC44  
Texas 2N1111. Equivalent . . . . . OC75  
Texas 2N1110. Equivalent . . . . . OC45

Post and packing 25c extra.

## NEW 240V ELECTRIC MOTORS



3300 R.P.M. Size  $3\frac{1}{2}$ " x  $2\frac{1}{2}$ " x  $3\frac{1}{2}$ ". including spindle.

**\$2.75**

plus 60c postage



## SOLID STATE GUITAR AMP.

Here is a fully solid state guitar amplifier rated at a nominal 50 watts continuous power. Featuring two totally independent tone control channels and tremolo facility, the amplifier offers unique flexibility in a light and compact unit. (Featured in July-August issue Electronics Aust.)

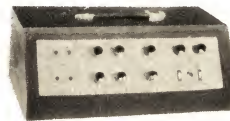

Complete kit of parts to Electronics Aust. specifications supplied with foot control switch (and lead for remote tremolo. Cabinet finished in black vinyl and control panel in black and silver with matching knobs.

**COMPLETE UNIT  
WIRED and TESTED**

**\$114.00**

**COMPLETE KIT OF PARTS**

**\$98.00**

## NEW P.A. AMPLIFIERS

These amplifiers are suitable for installation in clubs, schools, restaurants, factories, etc. Wherever the amplification of speech or music is required. All amplifiers have two microphone and radio or pick-up inputs with mixing facilities and can be supplied with tapped line or voice coil output.



Standard Amplifier

**25 WATT**

Valve amp. using 2-6CA7, 2-12 AX7, EF86 valves.  
Dimensions 11in x 6in x 8in. Weight 23lb.

**\$61.00** Freight extra.



Amplifier with Bass and Treble Controls

**45 WATT**

Solid state amplifier using 9 transistors, with separate bass and treble controls. Dimensions 12in x 6in x 9in. Weight 22lb.

**\$79.00** Freight extra.

## A TRANSISTOR PREAMP FOR MAGNETIC PICK-UP OR TAPE HEAD

Using 3 transistors per channel as featured in Electronics Aust. Complete kit of parts including transistors. P.C. board and resistors and condensers.

Circuit and full details supplied.

Stereo Kit \$12.00.

Mono Kit \$6.50

240V Power Supply \$7.00.



## NEW MIDGET POWER TRANS. \$3.75

40mA prim., 240v. Sec 225 x 225 with 6.3v Fil.

Winding. 30mA 240v. Prim. Fil. Winding.

Postage: N.S.W., 25c; Interstate, 45c.

150 x 150v. Sec. with 6.3v.

Postage: N.S.W., 35c; Interstate, 60c. **\$3.75**

## NEW AMERICAN TWIN TELESCOPE TV AERIAL.

Extends to 36in, each section can be used singly for car or portable \$1.50. Post 20c. **SINGLE TELESCOPIC Aerial, 12in extends to 33in. 60 cents. Post 10c.**

# NATIONAL RADIO SUPPLIES

332 PARRAMATTA ROAD, STANMORE, N.S.W. PHONE 56-7398



# HAM RADIO SUPPLIERS

## Mail Order Specialists

323 ELIZABETH STREET,  
(2 Doors from Little Lonsdale Street)  
MELBOURNE, VIC. 3000  
TELEPHONES: 677329, 674286

### 7 WATT SOLID STATE STEREO AMPLIFIER

10 Transistor, 3.5 Watts per channel, Crystal/Ceramic input (250mV), Frequency Response 50-20,000 c/s, 8 and 16 ohms output, polished wood case, metal front panel. Dimensions: 8 1/4 in x 3 in x 5 3/8 in.

**Special Price \$34.50. Post 75c**



**REALISTIC DX-150 SOLID STATE COMMUNICATION RECEIVER**

**Features:**  
240V A.C. or 12V D.C. operation,  
30 Transistors and Diodes,  
535 Kc. to 30 Mc. in 4 Bands.  
Bandspread tuning, "S" Meter, AM/CW/SSB.  
Product Detector for SSB. Compact size  
14 1/8 in x 9 1/4 in x 6 1/2 in. Polished metal panel,  
small internal speaker.

**F.O.R. PRICE: \$229.50**

Matching external speaker \$13.30 extra.

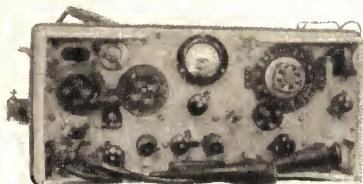

**No. 62 TRANSCEIVERS.** Wireless set No. 62 Mk.2 (PYE) Frequency Range 1.6 to 10 McS, in 2 bands, inbuilt 12-volt Generator Power Supply. Clean condition. Fully air tested on Transmit and Receive.

**F.O.R. PRICE: \$49.50**



**WESTON LM-330 MOBILE TAXI RADIO.** Low Band A.M., 60 Kc. Bandwidth, 70-80 Mc. Crystal Channel Locked, Single Channel, Inbuilt Transistor Power Supply, 12-volt operation, suit country taxi service or conversion to Ham Bands, inc. microphone and cradle.

**AS NEW AND AIR TESTED.**

**F.O.R. PRICE: \$45. Packing 50c**

### LAFAYETTE \*5 WATT C.B. TWO-WAY RADIO

**MODEL HE-20, FULLY TRANSISTORISED, SOLID STATE,** 13 Transistors, 10 Diodes, 27,240 Mc. Provision for 23 channels, CRYSTAL channel locked, Push-pull Audio Modulator, 455 Kc. mechanical filter, spotting switch for accurate reception, TV1 Trap, 230V A.C. and 12 Volt (positive or negative ground). Inbuilt P.A. Amplifier. **IDEAL FOR FIXED BASE STATION OR EMERGENCY MOBILE,** including microphone and mobile cradle.

\* Subject to P.M.G. approved licence.  
**F.O.R. Price: \$169.50. Tax Paid**  
Fibreglass Helical Aerial 4ft high, cowl mount, for mobile use \$16.50 extra.



**BENDIX BC-221 FREQUENCY METER.** 125Kc. to 20 Mc. including A.C. power supply, CRYSTALS, Calibration Book etc. V. clean condition.

**F.O.R. Price: \$49.50. P'ckg. 75c**



**MODEL C-1000 POCKET MULTIMETER,** 1000 ohms/per Volt, AC Volts: 0-10/50/250/1000 (1000 opv). DC Volts: 0-10/50/250/1000 (1000 opv), DC Current: 0-100mA Resistance: 0-150K ohms (3K centre). 2 colour scale, Range Selector Switch. Dimens.: 3 1/2 x 2 1/4 x 1 in.

**PRICE: \$6.50 post free**



**MODEL 200H MULTIMETER,** 20,000 opv, DC Volts: 0-5/25/50/250/500/2500V (20,000 opv) AC Volts: 0-15/50/100/500/1000V (10,000 opv) DC/Amps: 50uA/2.5mA/250mA. Resistance: 0-60K/6M ohm (scale centre 300 ohm—30K ohm. Capacitance: 10uuf to .001uF/.001uF — .1uF, D3 scale 20 db to plus 22 db. Size 4 1/2 x 3 3/4 x 1 1-8.

**PRICE: \$11.25 post 30c.**



**MODEL CT330 MULTIMETER,** 20,000/OPV, DC Volts: 0-6/6/30/120/600/1.2K Volts, AC Volts: 0/6/30/120/600/1.2K Volts (10K/OPV). DC/Amps: (0-0.06mA/60mA/600mA). RESISTANCE: 0-6K/60K/6M/60M/600Megohm. (30/3K/30K/300K ohms) centre scale: Capacitance: 50 uf to .01 uf .001 to 0.2 uf. Decibels: —20 to plus 63db size approx. 5 1/2 x 3 5/8 x 1 3/4.

**PRICE: \$16.75 post 30c.**



**MODEL OL-64D MULTIMETER,** 20,000/OPV, DC Volts: 0-0.25/1/10/50/250/500/1000V at 20K/OPV, 5000 volts at 10K/OPV, AC Volts: 0-10/50/250/1000V at 8K/OPV, DC/A: 50uA/1mA/50mA/500mA/10 amps. RESISTANCE: 0-4K/400K/4M/40Megohm. DB Scale: —20 to plus 36db. Capacitance: 250pF to .02uF. Induct. 0-5000H. size 5 3/4 x 4 1/8 x 1 3/4 in.

**PRICE: \$19.50 post 30c.**



**NEW MODEL US-100.** Overload protection. Shockproof Movement, polarity switch. DC volts: 0.25/1/25/10/50/250/1000V (20K/OPV) AC Volts: 0-2.5, 10/50/250/1000V (5K/OPV). DC/Amps: 1mA/25mA/500mA and 10A. AC/Amps 10A. RESISTANCE: 0-50M/ohms (centre scale 50) R X 1/10/100/1K/10K, db scale —20 to plus 10 plus 22/plus 35/plus 50 db.

**PRICE: \$28.75 post 40c.**

**Mirror Scale**



**MODEL AS100/DP HIGH SENSITIVITY** 100,000/ohms/volt DC, Mirror Scale, PROTECTED MOVEMENT, SPECIFICATIONS: 6/20/120/300/600/1200 Volts A.C. (10K/OPV), Volts D.C.: 3/12/60/120/300/600/1200 (100K/OPV) D.C. Amps: 12uA/6mA/60mA/300mA/12 Amps. RESISTANCE: 2K/200K/20Mg/200Meg. Decibels: —20 to plus 63db. AUDIO OUTPUT: 6 Volts/30/120/300/600/1200V A.C. Size: 7 1/2 in x 5 1/2 in x 2 3/4 in.

**PRICE: \$34.50. Post 75c**



**MODEL A10/P, GIANT (6 1/2-inch), METER, CIRCUIT TESTER** 30,000/OPV D.C. with inbuilt signal injector, overload protected. Specifications: A.C. Volts: 2.5/10/50/250/500/1,000 (10,000/OPV). D.C. Volts: 0.5 Volts/2.5/10/50/250/500/1000 at 30,000/OPV, 5000V at 10,000/OPV, D.C. Current: 50uA/1mA/50mA/500mA/1 Amp/10 Amp/A.C. Current: 1 Amp/10 Amp. Resistance: 10K/100K/1 Megohm/100 Megohm. SIGNAL INJECTOR: Blocking Oscillator circuit with a 2SA102 Trans. DECIBELS: —20 to plus 63db. SIZE: 6 1/2 in x 7 1/4 in x 3 3/4 in.

**PRICE: \$55 Tax Paid. Post 75c**



**TE-16A TRANSISTORISED TEST OSCILLATOR.** Freq. Range: 400Kc. to 30MC. in 5 bands, Modulated: 800 c/s sine wave. Modulation: 30 p.c. approx. Output Imp.: Low impedance. Dimensions: 5 7/8 in x 5 7/8 in x 3 5/8 in. Weight, 1.5lb.

**PRICE: \$23.75. Tax Paid. Post 75c.**

### TRIO COMMUNICATION RECEIVER MODEL 9R-59DE

4 band receiver covering 550 Kc/s to 30 Mc/s, continuous and electrical bandspread on 10, 15, 20, 40 and 80 metres. 8 valve plus 7 diode circuit. 4/8 ohm output and phone jack. SSB-CW, ANL, Variable BFC, S meter, Sep. bandspread dial, IF 455 Kc/s, Audio output 1.5 W, Variable RF and AF gain controls. 115/250V. A.C. Mains. Beautifully designed. Size: 7 x 15 x 10 in. With instruction manual and service data.

**PRICE \$175 inc. Sales Tax.**

Speaker to suit type SP5D inc. tax.

02S Large Rubber Earpiece. 20-12,000 c/s (as per photo). **\$6.75**

03S As above. Larger earphone. 20-18,000 c/s. **\$9.25**

04S Deluxe model Individual Tweeter and Woofer control. **\$12.95**



### "NIKKA" 1 WATT TRANSCEIVERS

P.M.G. APPROVED, SOLID STATE 14 Transistor Circuit inc. R.F. Stage. 27,240 Mc (Provision for 2 Channels). Range Boost Circuit. Up to 10 miles in open country or water. Buzzer Type Call System. Squelch Control. Complete with leather carrying case.

**\$165.00 PAIR**

# MARKET PLACE

Send your ads for this page on the form overleaf

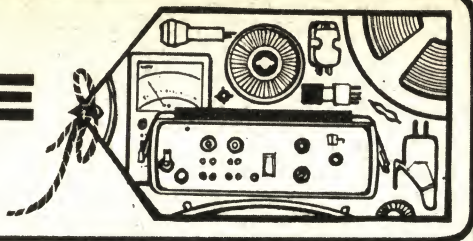

## FOR SALE

**LATEST** Video tape recording system complete with 12" monitor set (also suitable to receive all normal TV stations); recorder; tripod; video camera and microphone. Demonstration model. \$1,250. EDS P/L. 12-16 Queen St, Chippendale, N.S.W. 69-6548.

**MODEL** railways. Call or write for free literature on this fascinating hobby. Ready to run or build it yourself kits. HO and N. Rivarossi; Peco; Triang-Hornby; Atlas, etc. P.J.P. Productions, 15 Hamilton Street, Gisborne, Victoria, 3437.

**RECONDITIONED** Channel Master "Teistar" transistorised aerial booster amplifiers \$25 each. V. J. Yalden, 21 Oxford St, Glen Innes, N.S.W. 2370.

**ANTEX** DESOLDERING IRON. Suction created by compressed air which also deposits solder in external catcher \$12. Technical and Scientific Equipment Co. Pty. Ltd., Box 1726P, G.P.O., Melbourne, 3001.

**NEON** lamps suit 240V AC operation 25c each. 6AN7 valves \$1.20 ea. Transistors 60c each; 6 for \$2. Price lists available. Mail orders only please. Comack Trading Company, 15 Grove Street, Eastwood, N.S.W. 2122.

**CABINETS**, kits, stereo equipment, Innerbond grille fabric, accessories, available from Robert N. Smallwood, Sound Specialist, 205 Brisbane Road, Booval, Qld. 4304. Mail orders, write for price lists or phone 82-1550 anytime.

**MAIL** orders: IC, transistors, FET, diodes, zener diodes, electronic parts, kits, tapes, meters etc. Cheapest prices. Free catalogue on request. IEC, P.O. Box K1829, Hong Kong.

**TAPE** books (UK) reviewed Electronics: Sound Effects (Jan. 70) 75c; Yearbook (Oct. 69) \$1.75; Introduction to Tape Recorder (Sept. 69) 75c. Each post free from B. T. Lovett, 5 Glover Street, Willoughby, N.S.W. 2066.

**CONTENT** recording studio, including Rola .66 Ferrograph series 3A Presto disc lathe with Gramplan feed-back cutter head, 17-channel mixer, two smaller mixers, four professional turntables, limiting amp., microphones, stand etc. \$1100 lot. Write Box 213, North Quay, Brisbane. Phone 75884.

**STEREO** BW amplifier pre-amp enclosed Garrard 301 table top speakers \$65. 1B, The Parade, Marlon, S.A. 76-4634.

**RADIO** control. New O.S. reed relays. Suit mod. of E.A. circuit to 10 channels. Only \$7. 2/19 Ithaca Road, Elizabeth Bay, N.S.W.

**PRECISION** freq. meter 100KHz-20MHz, .001pc, oven, crystal, 24 valves. Harmonic identification zero beat by phones, lamp, meter, CRO. Heavy transit case, two cal. books \$250. 1 Ridley Street, Charlestown, Newcastle, N.S.W.

**ELECTROS** 11,000uF 19V \$1.50. Transformer pri. 110V, sec.1 15V 16A 15V, sec.2 7.5V CT 7.5V \$3. Ex-computer. Sydney 622-2439.

**NEW** OC44, 45, 71, 72, 6 for \$2 or 40c ea. OC84, AC128, BC108, 109, 2N3638, 5 for \$2 or 50c ea. 2N3642, 3643, 3638A, OC171, 2N370, 371, AF116N, 117N, BF115, 2N3694, AC127, 4 for \$2 or 60c ea. Power types 2N176, \$1 ea. 2N301, \$1.20 ea. OC28, 29, 35, 36 \$1.50 ea. 2N3055, BDY20, 40250, \$1.60 ea. OA210, EM404, 1N4004, 40c ea. OA211, BW100, EM410, 70c ea. UJT 2N2160 FET 2N4360, \$1 ea. MPF105, 2N5459, 90c ea. RA100, 25c ea. OA81, 85, 91, 95, 12 for \$2 or 20c ea. No S.A. sales. Post and pack 15c Custom Electronics, Box 1452, G.P.O., Adelaide, S.A. 5001.

**TRANSISTORS** bargains. New stocks. 2N3055, \$1.60 mat pr \$3.40. 2N3035 \$1.70. AD161/162 \$2.60. AC187/188 \$1.70. AC127/128 \$1.00. BF115, BC107, OC171 50c. BC108-109 40c. OC71, 72, 44, 45 35c. OA91 15c. 2N5459 (MPF105) \$1.00. Silicon diodes 5A 400V 55c. 1N4006 1A 800V 60c. 1N4004 1A 400V 40c. 1W zeners small plastic type 9 or 12V only \$1.25. Stereo pots small size, long shaft 470K plus 470K log or lin, 47K plus 47K log \$1.60 ea. Single same type 470K lin 47K lin 40c each. Post 10c any order. Goods guaranteed and branded as advertised. No substitutes. T. & M. Electronics, P.O. Box 57, Haberfield, 2045.

**MODEL** ships. "Endeavour Bark" blue prints. Set \$4.60 posted. Full detail. Bolton, 72 King Street, Sydney, Catalogue \$1.50.

**TAAS900** IC Class B AF amp. 9V rail, 8mV at 15K in, 1W RMS to 8-15 ohm load. \$2.85 incl. cct, data, post. Padifer Associates, 24 Gulfview Road Blackwood, 5051.

## FOR SALE

**OLD** Philips television yokes and NT3102 EHT transformers. 250 Parramatta Road, Ashfield. Phone 798-9999, ext. 13.

**PHILIPS** tuners brand new with PCF801 and FC900 valves. Turret with printed biscuits. Standard Philips diagram NT 3011 used. \$5 each. Also Philips TV power transformers. Voltage doubler \$4.50 each. Also, Philips HT filter choke for TV \$1 each. Also Philips audio output transformers, \$1 each. EDS P.L., 12 Queen St, Chippendale, N.S.W. 69-6548.

**BURGLAR** ALARMS. 12V, 15uA. Transistor control units \$12, plus 12 p.c. s.t. Unit on 4 x 2 plate and case, \$16, plus s.t. 4 1/2V rotary siren, \$10.50. All above plus 60c p. and post. Foil tape terminals, mats, key switches, beils, reed switches, infra-red ray unit. Complete quote and installations service to Insurance requirements. EDORE ENTERPRISES, 802 Doncaster Rd., Doncaster, Vic. 848-1386.

**PYE** base station 2-way radio 60KHz AM low band, best offer. Sydney, 50-6526.

\*\*\*\*\*  
**Classified Advertisers**  
 For the April issue your advertisement must reach our office by March 12, 1970. Please address your advertisement to the Advertising Manager, "Electronics Australia," Box 2728, G.P.O., Sydney, N.S.W. 2001.  
 \*\*\*\*\*

## READER SERVICE

**TOP** quality discs from your tapes. Any quantity, all sizes and speeds. We guarantee our work to comply with R.I.A.A. and A.B.C.B. standards. Inquiries welcome. Write for details. A.A.V.R., 87a Mullens St. Balmaln, 2041. Phone 82-5158, Sydney.

**REPAIRS** to receivers, transmitters, construction, testing; TV alignments; X-ray converted electronic equip. Eccleston Electrics, 146a Cotham Rd, Kew, Vic. 80-3777.

**BACK** ISSUES "Electronics Australia" stocked, 40 cents each. Prompt service. Post free T. Weir, 53 O'Connor St., Haberfield, N.S.W., 2045. Phone 798-7569.

**TV** picture tubes: Sure Brite Pty. Ltd., now at 542 King St., Newtown, N.S.W. Now the largest factory of its kind in N.S.W. Daily delivery Sydney, suburbs, and to railway station. Lowest prices in Sydney to the trade. Duds bought. Send all duds to Sydenham Station freight paid, Customer sales rear of building. Phone 519-3403, 51-5928. Brisbane area: 1120 Oxley Rd, Oxley, 79-6828.

**TAPE** to disc service. Take advantage of W. and G. Records' professional experience when next needing a tape to disc service. W. and G. Record Processing Co., 185 A'Beckett Street, Melbourne, Tel.: 329-7255.

**ELECTRONIC** Organs: Do not build yourself an organ without first finding out about the superb Schober (U.S.A.) Assemble-it-Yourself Kits. Inquiries to Schober Organs (Australia), 124 Livingstone Ave., Pymble, N.S.W. 2073. (Mail only, please.)

**TRANSFORMERS** wound. Output or mains and specials to order. Reply with S.A.E., Paris Radio Electronics, 7a Burton St., Darlinghurst, N.S.W. 31-3273.

**METERS**, moving coil, moving iron, meggers, etc. all types, makes, single or multi-range, expertly repaired. Guaranteed work, quick service. R. Hawkins, 19 Caledonian Street, Bexley, 2207. Sydney, 599-2418.

**EEB IS NOT FOR EVERYONE**  
 (BECAUSE NOT EVERYONE LOVES TO EXPERIMENT)  
 Send for Sample Copy  
 THE AUSTRALIAN EEB  
 P.O. BOX 177 SANDY BAY  
 TASMANIA, 7005, AUSTRALIA.

## READER SERVICE

**PRE-RECORDED** TAPE hired to members of Australian Tape Recording Society. Bi-monthly release. "The Microphone," newspapers round robins, sales, service, tape-sponding. Send 5c. 9 in x 4 in S.A.E. to ATRS, Box 9, P.O. Crow's Nest, N.S.W. 2065, or phone (2) 43-6681, after hours.

**CAPACITOR** discharge ignition systems. \$32.00. 12V systems only. State whether positive or negative side of battery connected to car body. Two Way Radio Service, 31 Rotherham Street, Kangaroo Point, Brisbane, Queensland.

## WANTED

**GOOD** quality modern DX receiver. Collins, Drake, etc. Coverage preferred 15MHz-30MHz continuous. Details. Jack Zeffert, 119 Bradford Street, Mount Lawley, W.A. 6050. Phone 24-2485.

**GOODMANS** Midax, preferably long horn model also XO 750/5000 or XO 950/5000. D. Ragless, Branch Road, Stirling, S.A. 5152.

**SPEAKERS** Old 12" 15", 20, 30, 40, 50, 60W, etc., any impedance. R. J. Kelly, Narre Warren Nth, Victoria. Ph. 796-8223.

**CONVERTER** circuit VHF 2740KHz 2 or 3 transistor, on 1.5V cell. Ph. 796-8223, R. J. Kelly, Narre Warren Nth., Victoria.

**WIDE** band oscilloscope and sweep generator. Particulars price to R. Adriaans, 5 Waldemar Street, Ballarat, Vic. 3355. Ph. 92761.

## POSITION VACANT

**CONSULTANT** electronics assist administrator radar club for blind. 15A Dunstan St., Preston, 3072.

## ALWAYS RELY ON R.D.S.

# SPECIALS

# R D S

Matched prs., AC127/  
128 trans., \$1.00 pair.

200V pl diodes at 500MA,  
25c nett each.

STD Stereo plug 3290,  
45c nett.

DPDT Rocker switch - No.  
16, 45c nett.

DPDT Slider switch 3570,  
19c nett.

P53p Stereo plug. Line  
jack. 80c nett.

Pkts. mixed pots & conds.  
Great value. \$1.00 nett.

AC127 TRANS. .... 50c each.  
OAB1 DIODES ..... 15c each.

*The Independent Wholesaler*

## RADIO DESPATCH SERVICE

Radio and Electrical Distributors

**869 GEORGE STREET,  
SYDNEY.**

Corner George and Harris Streets

Telephone 211-0816, 211-0191

**Open Saturday mornings**

# ADVERTISING INDEX

A & R Transformers Pty. Ltd.	91
A.C.E. Radio	162, 163, 164
Adcola Products Pty. Ltd.	30
Akal Australia Pty. Ltd.	108
Allied Capacitors Pty. Ltd.	96
Amalgamated Wireless (A'sia) Ltd.	142
Amalg'd Wireless Vaive Co. Pty. Ltd.	22
Amplion (A'sia) Pty. Ltd.	69
Arrow Electronics Pty. Ltd.	117
Associated Controls Pty. Ltd.	148
Astronics Australasia Pty. Ltd.	44, 76, 110
Atram Pty. Ltd.	96, 134
Audio Engineers Pty. Ltd.	144
Aurlema (A'sia) Pty. Ltd.	119
Australian AMP Pty. Ltd.	54
Australian EEB	175
Australian Musical Ind. Pty. Ltd.	98
Aust. Radio and TV College Pty. Ltd.	87, Outside Back Cover
Bright Star Radio	147
British Institute of Careers	174
Broughton, Peter G.	171
B.W.D. Electronics Pty. Ltd.	16
Classic Radio Service	122
Classic Tape Recorders	125
Convoy International Pty. Ltd.	119
Cunningham, R. H. Pty. Ltd.	153
Decca	118
Deitch Bros.	158
Deltron Electronics (Sales) Pty. Ltd.	160
Direct Disposals Trading Co.	146
Duratone HI-FI	71
E. D. and E. (Sales) Pty. Ltd.	128, 129
Electronic Despatch	151
Elec. Disch. Ignition Systems of Aust.	131
Electronic Services	145
Encel Electronics (Stereo) Pty. Ltd.	19, 43, 99, 114, 121, 130, 167
Falk, Fred A. (Sales) Pty. Ltd.	102
Ferguson Transformers Pty. Ltd.	48
Ferris Bros. Pty. Ltd.	151
Foot, Richard (Aust.) Pty. Ltd.	161
General Accessories Ltd.	42, 60, 72
Goldring Eng (A'sia) Pty. Ltd.	6, 7, 106, 107
Gray, Simon Pty. Ltd.	36, Inside Back Cover
Green Corporation Ltd.	32
Haco Distributing Agencies Pty. Ltd.	Inside Front Cover
Ham Radio Supplies	170
H.B. Radio Sales	85, 147
Heating Systems Pty. Ltd.	139
Homecrafts Pty. Ltd.	80
Indeva Pty. Ltd.	95
Industrial and Domestic Equipment Co.	135
Instral HI-FI Centre	4, 5, 7
International Correspondence Schools	140
IRH Components Pty. Ltd.	12, 58, 86, 150
Jacoby, Mitchell and Co. Pty. Ltd.	14, 66, 146
J.H. Reproducers Co.	90
Kitsets Australia	149
Lafayette Electronics	105, 157
Leak, H. J. (Aust.) Pty. Ltd.	120
Lempriere, O.T. and Co. Ltd.	67
Macron Pty. Ltd.	104
Magna-Technics (Aust.) Pty. Ltd.	100
Magnecord Sales & Service	74
Magrath, J. H. and Co. Pty. Ltd.	136
Manufacturers Spec. Prod. Pty. Ltd.	82, 89
Marconi School of Wireless	175
Market Place	175
Mastersound Sales Pty. Ltd.	113
Miniwatt Electronics Division	2
Mullard-Australia Pty. Ltd.	24
National Radio Supplies	168
Philips Electrical Pty. Ltd.	56
Photimport Pty. Ltd.	26
Plessey Rola Pty. Ltd.	28
Pre-Pak Electronics	166
Radio Despatch Service	175
Radio House Pty. Ltd.	152
R.C.S. Radio Pty. Ltd.	136
Recorded Music Salon	96
Rubin E. S. Pty. Ltd.	64
Sato Parts Co. Ltd.	60
Shalley, Peter Electronics Pty. Ltd.	134
Soanar Electronics Pty. Ltd.	75
Standard Components Pty. Ltd.	138
Standard Telephones and Cables Pty. Ltd.	50, 51, 144
Stott's Tech. Correspondence College	112
Strato Communications Pty. Ltd.	148
Tasmanex Pty. Ltd.	81
Trade Supplies Pty. Ltd.	92
Technical Training Int. Pty. Ltd.	92
Trio Electronics Inc.	8, 9
Truscott Electronics	48
Turnbull, Bill	48
United Radio Distributors Pty. Ltd.	30
United Trade Sales Pty. Ltd.	142
University Graham Inst. Pty. Ltd.	138
University of Melbourne	141
Varian Techtron Pty. Ltd.	137
Victor, A and Co.	69
Wagner, R. H. and Sons Pty. Ltd.	78
Warburton Frankl Ltd.	34, 154
Wedderspoon, W. C. Pty. Ltd.	68
Weston Electronics Pty. Ltd.	84
Wills, S. E. Trading Co.	172
Wireless Institute of Australia (N.S.W.)	159
Wonder Wool Pty. Ltd.	123
Zephyr Products Pty. Ltd.	38, 132

## CLASSIFIED ADVERTISERS

USE THIS FORM FOR YOUR NEXT ADVERTISEMENT IN THE

## ELECTRONICS Australia MARKET PLACE



- FOR SALE
- WANTED
- READER SERVICE
- POSITION VACANT

To the Advertising Manager,  
ELECTRONICS Australia,  
Box 2728 G.P.O.,  
Sydney, 2001

Endorsement .....  
Residential Address .....  
State .....

● I enclose P. Note/Cheque for \$.....  
being full payment for ..... lines at \$0.72 per line. (Min. 2 lines)

Please write in block letters with ink or ball-point pen. Number of insertions .....

## ELECTRONICS Australia

SPECIAL ORDER FORM

Guarantee yourself a complete set of issues for your library with no copies missing.

### SUBSCRIPTION RATES

Australia, New Guinea, Fiji, New Zealand  
Elsewhere

PER YEAR  
\$5.00  
\$7.00

### POST THIS COUPON TO:

The Circulation Manager, ELECTRONICS Australia,  
Box 2728, G.P.O., Sydney, 2001, Australia.

Name .....

Address .....

Enclosed is \$ ..... for ..... years. Start with .....

(Please use cheque, money order, etc. Do not enclose cash).

*Simon Gray*  
proudly presents  
the "SILCRON" . . .  
an all-new  
precision built Australian turntable



**ONLY  
\$44.50!**

With a wow and flutter specification of less than 0.04% the new SILCRON two-speed turntable combines precision engineering with the proven design principle . . . BELT DRIVE.

The most sophisticated stereo cartridges and tone arms may be used with this high-performance turntable. Speed accuracy is absolute as a substantial 12-pole sealed synchronous motor provides the motive power. A unique speed change mechanism of robust design permits changes from 33 $\frac{1}{3}$  to 45 r.p.m. in less than one second. Cast from aluminium, the 12" diameter turntable itself is machined to fine tolerances and dynamically balanced. An anti-static rubber mat is fitted as standard equipment. The actual drive belt is pure latex and drives the turntable around its perimeter where a deep groove is machined into the turntable edge. Depth required below the motor board is only  $\frac{3}{4}$ " and height above can be as little as 2". No other turntable on the Australian market offers as much value and as much performance as the new SILCRON . . . which is backed by the national sales/service network of Simon Gray Pty. Ltd. Ask your favourite hi-fi dealer for a SILCRON demonstration!

Australian National Distributors:

*Simon Gray Pty. Ltd.*

Head Office: 28 Elizabeth St., Melbourne, Vic. Tel. 63 8101\*  
Sydney Office: 22 Ridge St., North Sydney, N.S.W. 929 6816  
Canberra Office: 31-33 London Circuit, Canberra City, A.C.T. Tel. 49 6050

INTERSTATE REPRESENTATIVES:

N.T.: Pfitzner's Music House, Smith Street, Darwin. Tel. 3801  
Q'land: Sydney G. Hughes, 154-158 Arthur St., New Farm, Brisbane. 58 1422  
S.A.: Eilco Sales Pty. Ltd., 7-9 Osmond Terrace, Norwood, S.A. Tel. 63 4844  
Tas.: K. W. McCulloch Pty. Ltd., 57 George Street, Launceston. Tel. 2 5322  
W.A.: Athol M. Hill, 613-615 Wellington Street, Perth. Tel. 21 7861



# YOU CAN EARN BIG MONEY IN RADIO- TELEVISION ELECTRONICS

## ASK YOURSELF THESE 3 QUESTIONS!

1. Am I in a dead-end job? 2. Could I earn more by learning more? 3. Could I use my spare time to get ahead?

If the answer is yes, there is room for you in radio/television/electronics.

## NOW IS THE TIME TO TRAIN!

Does your job offer good prospects — real security? Does it hold your interest? If not, now is the time to do something about it. Electronics is expanding daily. It's the most exciting subject you can study. The sky's the limit for the trained electronic technician . . . but only the trained man. Radio and television technicians are in huge demand. Train for success now, in Australia's fastest-growing industry! Join the ranks of skilled men . . . the Australian Radio and Television College can train you for a bright future with unlimited prospects. Send for the free booklet, "Careers In Radio, TV & Electronics" and find out how A.R.T.C. can bring you success—in your own business or as well-paid technical staff!

## A.R.T.C. CAN TRAIN YOU AS IT HAS THOUSANDS OF OTHERS

For nearly 40 years A.R.T.C. has successfully trained thousands of progressive Australians who realised how much the training could mean to

them. Now they're making big money in radio and television. Training can bring you success, too.

## FOR A FEW CENTS PER DAY YOU CAN STUDY THE A.R.T.C. WAY

. . . in your spare time, you can equip yourself for a rewarding career in electronics. The future belongs to the trained.

A.R.T.C. teaches you from the ground up . . . step by step . . . at your own pace. Remember, opportunity is always knocking for the trained man!

## PRACTICAL UP-TO-DATE LESSONS

At the work benches and lecture halls of A.R.T.C. — or in your own home by correspondence — you can learn every necessary aspect of radio, television and electronics. The Course gives you both basic and advanced instruction.

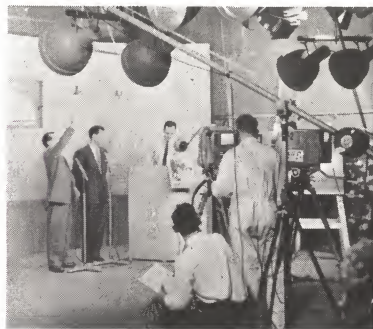

No previous experience or high educational standard required . . . only enthusiasm and normal intelligence. A.R.T.C. will give you

all the instruction you need. Each lesson is made easy to understand by numerous illustrations and diagrams. The Course adapts itself to your requirements, your speed. It's up to you! Instruction is individual and intensely practical.

## THOUSANDS OF SUCCESSFUL STUDENTS HAVE PROVED THIS

Make your spare time earn money for you while training at home.

Many students make extra money after only a few weeks' tuition. Train at the modern A.R.T.C. workshops, if more convenient.

GET INTO ONE OF THESE  
PROFITABLE CAREERS  
IN RADIO/TELEVISION  
ELECTRONICS

There is a career for you in one of the many branches of electronics including manufacture, servicing, research, sales, executive positions, armed forces, audio, etc., etc.

A.R.T.C. can help you gain one of these sought-after careers. Remember it's the trained man who wins, every time!

## MAIL COUPON NOW!

Safeguard your future! You are invited to see in the coupon below. A.R.T.C. will mail you by return their big free and post-free booklet "Careers in Radio, TV and Electronics." The exciting book shows you definite steps you can take towards a big future—how you can succeed in life and find satisfaction in doing a worthwhile job well.

# AUSTRALIAN RADIO AND TELEVISION COLLEGE PTY. LTD.

E. S. & A. BANK BUILDING,  
Cnr. Broadway and City Road, Sydney.  
(Opp. Grace Bros.) Phone 211-4244 (3 lines.)

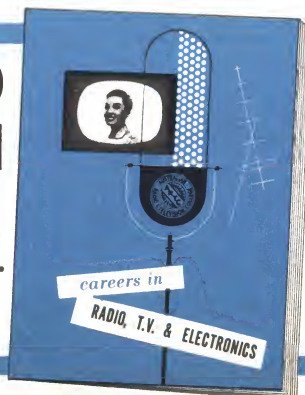

AUSTRALIAN RADIO & TELEVISION  
COLLEGE PTY. LTD.  
206 Broadway, Sydney, N.S.W.

Dear Sir,  
Please send me, without obligation, your free booklet "Careers in Radio TV and Electronics."

NAME .....

ADDRESS .....

.....