

ELECTRONICS

Australia

December, 1969

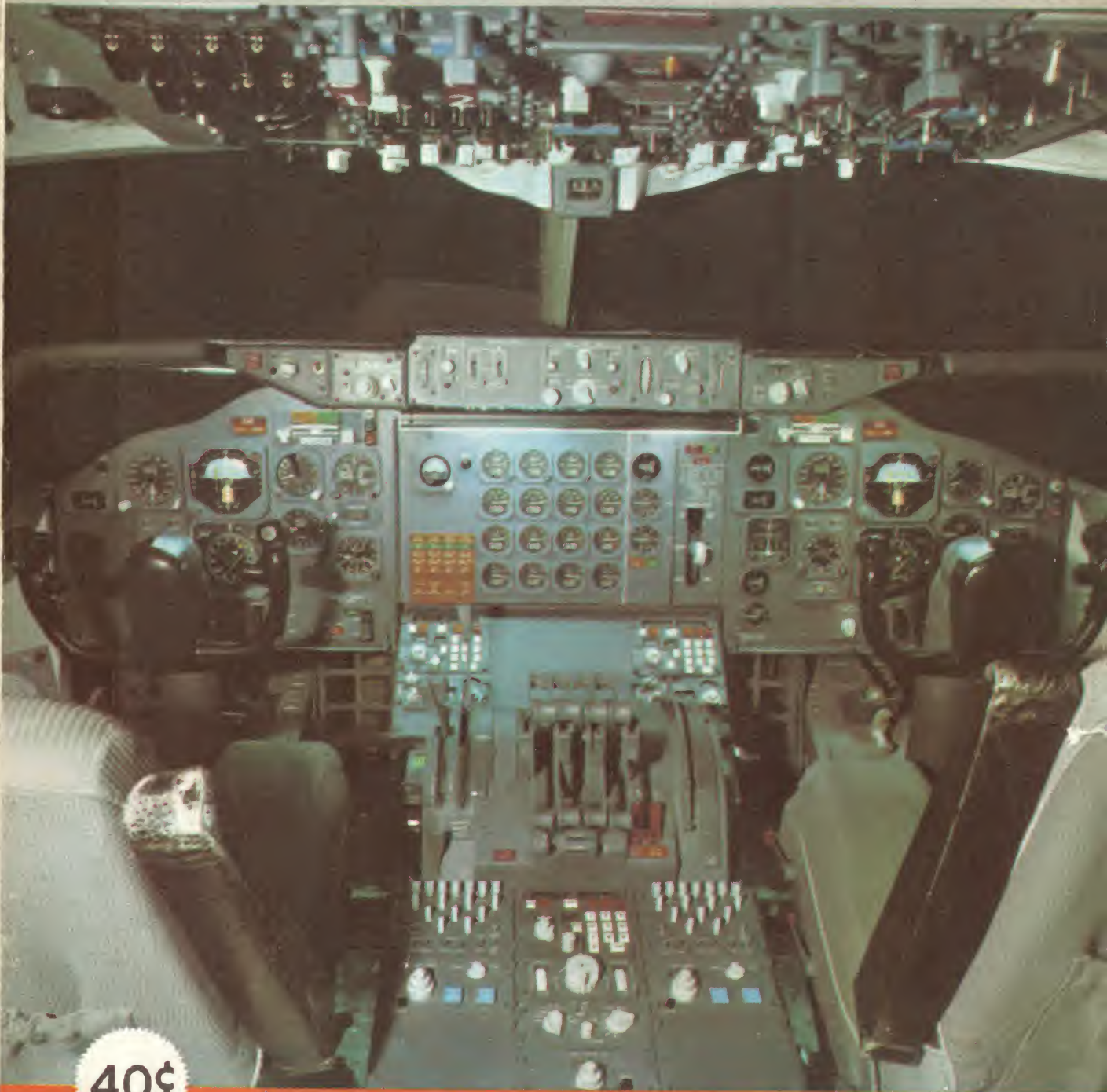

40¢

Cockpit of the Boeing 747 Superjet (See page 13)

STEREO HEADPHONE ADAPTOR ● SPACE AGE TELEMETRY
OUR MUSICAL SCALES AND CHORDS ● TV HERE IN 1929



NATIONAL HI-FI STEREO EQUIPMENT



Stereo Revolution!

Stereo hi-fi has come of age. National announces the introduction of the largest, most perfectly matched, most advanced stereo hi-fi equipment range in Australia. You can sit back and hear it at any of the **new National authorised hi-fi centres** . . . any unit, any combination. For addresses and free colour brochure, just fill in and send the coupon.



TO HACO DISTRIBUTING AGENCIES
PTY. LIMITED

57 Anzac Parade, Kensington, N.S.W. 2033

Please tell me all about the great new National Stereo Hi-Fi
Equipment and where I can hear it.

Name.....

Address.....

Postcode.....

U696



ELECTRONICS Australia

incorporating RADIO, TELEVISION and HOBBIES

ABC certified circulation in excess of 47,000

volume 31, number 9

FIRST AUSTRALIAN TV: *It may come as a surprise to many readers to discover that television signals were first broadcast in Australia as long ago as 1929 from radio station 3UZ, Melbourne. See page 24.*

FIELD EFFECT TRANSISTORS: *Chapter 8 of our "Solid State" series on page 66 is a thorough but easy-to-read treatment of FET's. It will round out your knowledge of these most important devices.*

RADIO TELEMETRY: *How can mission controllers on the ground know so much about the physical condition of astronauts and of their space vehicle? This special article on page 90 gives an overall picture of the techniques involved.*

MUSICAL SCALES: *Music is an art form but it is also a science that yields to a considerable degree of mathematical analysis. In our "Audio Topics" section on page 108, a contributor explains the mathematical basis of scales and chords.*

CONTENTS — DECEMBER, 1969

features

- 3 Editorial—study now, play later!
- 10 Search for safer brakes
- 13 Electronic systems for 747s
- 16 Radio link telephone system
- 18 Self-navigating boat
- 21 Laser TV at EXPO 70
- 23 Theatre bookings by computer
- 24 Australia's TV pioneers

technical digest

- 27 U.S. Navy plans ELF communications
- 29 Speech translator for divers
- 31 Touch-and-read logic probe

technical articles

- 40 Vari-light light dimmer
- 45 Shortage of Triacs
- 48 Stereo headphone adaptor
- 66 Fundamentals of solid state, chapter 8
- 78 Noise silencers
- 87 Economy line source loudspeaker
- 90 Radio telemetry

regular features

- 33 Scientific and industrial news
- 56 Forum
- 59 Radio—unofficial history
- 61 Serviceman
- 101 Reader built it
- 108 Audio topics—development of musical scale
- 117 Record reviews—classical
- 124 Record reviews—devotional, popular, jazz
- 140 Trade reviews and releases
- 153 Technical books and publications
- 161 Amateur band news and notes
- 173 Listening around the world
- 181 Answers to correspondents
- 191 Market place—classified advertisements
- 192 Index to advertisers
- 190 Notes and errata

Editorial Office:

12th Floor, 235-243 Jones Street,
Broadway, Sydney, Australia.
Phone 2-0944.

Postal Address:

Box 2728, G.P.O., Sydney, 2001, Australia.

Advertising:

Manager, Selwyn Sayers,
Sales Exec., Howard Jenkins
Sydney Representative, Bill Summons.
Office: 8th Floor, 235-243 Jones Street,
Broadway, Sydney, Phone 2-0944.
Melbourne Representative, Clarrie Levy.
Office: 392 Little Collins Street,
Melbourne, 3000. Phone 67-8131.

Circulation:

Alan Parker, Manager.
Office: 9th Floor, 235-243 Jones Street,
Broadway, Sydney, Phone 2-0944.

Subscription Rates: See back page.

Representation:

Melbourne—John Fairfax and Sons Ltd., 392 Little
Collins Street, 3000. Phone 67-8131.
Brisbane—Sungrave Pty. Ltd., 78 Elizabeth Street,
4000. Phone 2-6688.
Adelaide—John Fairfax and Sons Ltd., 104 Currie Street,
5000. Phone 51-3502.
Perth—Sungrave Pty. Ltd., 454 Murray Street, 6000.
Phone 21-8217.
Newcastle, N.S.W.—Associated Newspapers Ltd., 22
Bolton Street, 2300. Phone 2-3696.
London—John Fairfax and Sons (Aust.) Ltd., Reuter
Building, 85 Fleet Street.
New York—The Sydney Morning Herald Ltd., 1501
Broadway, New York, N.Y., 10036.

Distribution:

Distributed in N.S.W. by Sungrave Pty. Ltd., Jones
Street, Broadway, Sydney, N.S.W.; in Victoria by Sun-
grave Pty. Ltd., 392 Little Collins Street, Melbourne;
in South Australia by Sungrave Pty. Ltd., 104 Currie
Street, Adelaide; in Western Australia by Western Press;
in Queensland by Gordon and Gotch (Asia) Ltd.; in
New Zealand by Truth (N.Z.) Ltd.; in Tasmania by
Davies Bros. Ltd., "Mercury," Hobart.

Copyright. All rights reserved.
Devices or arrangements shown or described herein may
embody patents. Information is furnished without re-
sponsibility for its use and without prejudice to patent
rights.



**Miniwatt
have a
heatsink
design
for all
power
semi-
conductor
applications**

Write, phone or call for FREE booklet on "Miniwatt" Heatsink Designs

SYDNEY
20 Herbert St, Artarmon,
Sydney N.S.W. 2064
phone 43.2171
ADELAIDE
11-13 West Terrace, Adelaide,
S.A. 5000,
phone 516051
BRISBANE
56-58 Cordelia Street, South
Brisbane, Qld. 4101,
phone 422471

CANBERRA
86 Wentworth Avenue
Kingston, Canberra, A.C.T.
2604,
phone 90321-2-3
HOBART
2A Pierce Street, Moonah
Hobart, Tas. 7009,
phone 84691

MELBOURNE
252 Sturt Street, South
Melbourne, Vic. 3205,
phone 690141
NEWCASTLE
194 Parry Street, Newcastle
West, N.S.W. 2302,
phone 615001
PERTH
672 Murray Street, Perth,
W.A. 6000,
phone 213131

"Miniwatt" ELECTRONICS DIVISION OF PHILIPS ELECTRICAL PTY. LIMITED.
Sydney, Melbourne, Brisbane, Adelaide, Canberra, Hobart, Perth.



EDITORIAL VIEWPOINT

by Neville Williams

Study now, play later!

Well, December is with us again and happily, at "Electronics Australia," we are able to look back on a record year, with the best figures ever for circulation, number of pages printed, and advertising support. Perhaps we should also add that the costs of production and distribution have also set their own individual records!

For most people in the community, December and the Christmas period comes as a welcome break in the day-to-day routine, with holidays, festivities, carols and an all-too-rare touch of neighbourliness.

For a particular group, however, December is the time for decisions which may well have lifelong ramifications. I refer to the younger people among our readers who have to decide what to do next year . . . whether to quit school now or to carry on to certificate or matriculation level; whether to settle for either one of these as an objective or to press on with trade level, diploma or degree courses.

To a teenager, who has had to make do with a parental allowance, the money offered with positions immediately available seems like a fortune, increasing in magnitude with each succeeding birthday. It is a tempting alternative compared with further years of hard study and frugal living.

The pay-off comes later, when ambitions of a home and family replace the ultimates of youth — "transistors," "boards" and a "set of wheels." Then comes the realisation that the birthday increments have stopped and the once-tempting salary has assumed its true character as a modest and static reward for a modest and static skill. The person concerned has the options of accepting the situation, of hoping for some lucky break, or seeking to gain belated qualifications.

In some cases, economic factors do force an early termination of studies but, these days, the more frequent lament from young people is that they did not seize the opportunities offered them; that, having at last set goals, they now have to reach them by a longer and more devious route.

Undoubtedly, the most critical decision is whether to settle for trade level qualifications or aim higher. The extra years at secondary school can be time well spent; but they can also be time wasted if the individual concerned is not able or not prepared to cope with the greater demands they impose.

There is no universal answer to what are individual problems, nor is it easy to put old heads on to young shoulders. Perhaps the best we can do is to recommend the motto which forms the title of this editorial.

And, finally, the staff of E.A. would like to express to our readers, writers and advertisers the compliments of this Christmas and New Year season.

On the cover

The cockpit of a 747 airliner presents the usual — and to the layman, bewildering — array of switches, knobs and dials. Airline companies are anxious to achieve as much standardisation as possible in cockpit conventions and layout to simplify retraining, cross-chartering, crew exchange, etc. A typical but vexed question is the "on-off" positions for toggle switches, which may be mounted on panels facing upwards, downwards or horizontally.

(See also page 13.)

EDITOR

Neville Williams
M.I.R.E.E. (Aust.)
(VK2XV)

ASSISTANT EDITOR

Philip Watson
A.M.I.R.E.E. (Aust.)
(VK2ZPW)

TECHNICAL EDITOR

Jamieson Rowe
B.A. (Sydney), B.Sc.
(Technology, N.S.W.)
M.I.R.E.E. (Aust.)
(VK2ZLO)

TECHNICAL STAFF

Ian Pogson (VK2AZN)
Harry Tyrer (VK2ZHH)
Anthony Leo (VK2ZHK)
John Horsfield
Robert Flynn
Leo Simpson

ON SALE
THE
FIRST MONDAY
OF EACH MONTH

Broadway Electronics introduces the new INSTROL HI-FI the largest HI-FI showroom in Australia.



THE NEW E.S.P. AUTO-REVERSE STEREO TAPE RECORDER SPECIFICATIONS

- Recording system : 4-track stereo/mono recording playback
- Power requirements : 240 V, 50/60 Hz 50 watts DC 12V
- Tape speed : 7½ ips, 3¾ ips, 1 7/8 ips
- Frequency response : 20-21,000 Hz at 19 cm/s
- : 50-17,000 Hz ±3dB at 19 cm/s
- Power output : 5 watts X2 (20 watts total music power)

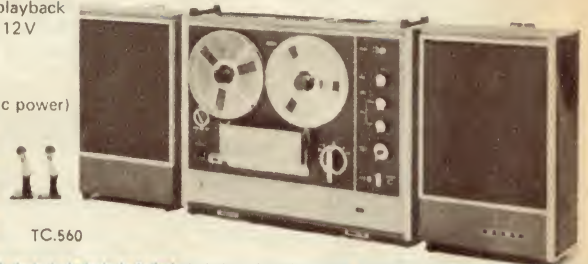

TC.560

Sony
TC.360

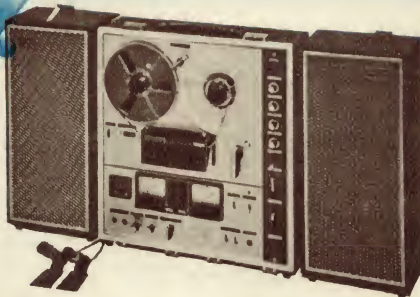

3 HEADS, 3 SPEEDS · MAGNIFICENT SOUND REPRODUCTION FOR THE MOST CRITICAL LISTENER SPECIFICATIONS

- Recording system : 4-track stereo/mono recording playback
- Tape speed : 7½ ips, 3¾ ips, 1 7/8 ips
- Frequency response : 30-22,000 Hz at 19 cm/s
- : 30-13,000 Hz at 9.5 cm/s
- : 30-10,000 Hz at 4.8 cm/s
- Power output : 15 watts per channel

SONY TC 124CS COMPLETE STEREO CASSETTE-CORDER



SPECIFICATIONS

- Recording system : 4-track stereo, 2-track mono recording and playback
- Power requirements : AC 100 V, 110-120 V or 220-240 V, 50 HZ, DC 6V
- Tape speed : 1 7/8 ips
- Frequency response : 50-10,000 Hz at 1 7/8 ips
- Power output : 2 watts both channels 2.8 watts (dynamic power)
- Weight : 4 lb 13 ozs (with batteries)



8RC.25 SONY'S NEW DIGIMATIC A.M. RADIO/ALARM CLOCK

A visit to the new Instrol Centre is an experience that will satisfy the most critical hi-fi enthusiast. Hi-Fi, Accessories, Tape Recorders, Furniture in fact the ultimate range available in one large modern Showroom. For those readers who are at present unable to see this exciting display for themselves, we suggest you ask for our free descriptive and illustrated Cabinet Catalogue, or our Hi-Fi Catalogue.

The Instrol Hi-Fi Centre includes the largest possible range of Hi-Fi furniture –



over 50 different cabinets and enclosures are on display. Should you be unable to visit our new exciting Showroom, ask for our free descriptive Cabinet Catalogue. (Pictured above is the new "Flamenco" Setting).

for descriptive leaflet post coupon

Please include postage stamp.

Name _____

Address _____

Postcode _____

- Instrol Cabinets Hi-Fi Equipment

INSTROL HI-FI CENTRE
91a York St. (between King & Market St.)
PHONE 29-4258 SYDNEY N.S.W. 2000

CENTRE

91a York St. (between King & Market St.)

☆☆☆☆

*Christmas
Time is*

Research Makes the Difference

SONY
Time

NOWHERE IS THERE A
GREATER RANGE OF
SONY'S LATEST
RELEASES, THAN
AT INSTROL



Wharfedale Unit-3,
Goodmans Sherwood,
Leak Sandwich.
Just some of the
magnitude of speaker
systems on display.
All major brands,
including Wharfedale,
Goodmans, Instrol,
Leak, Magnavox,
Kenwood, Sansui, etc.



The new DUAL 1200 series Turntables
are being demonstrated at our exciting new
centre. Full range of other players also
on display.

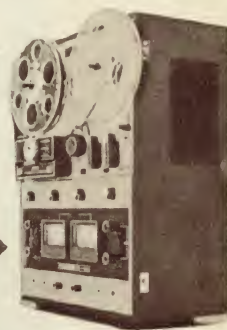

At last . . . A Tape Recorder Centre, with
trained personnel, to serve you. Choose from
our wide range of Sony, Akai, Tandberg, etc. .
All available for demonstration
including the Akai MIO (as pictured)



The Kenwood TK 250U — one of many
Stereo Amplifiers being demonstrated.
Perhaps you prefer something more elaborate,
such as the Kenwood KA6000, Sansui AU777
or Leak Stereo 70. Whatever you desire in
Amplifiers or Tuners, our new Showroom
will satisfy.



The Instrol range includes a wide
variety of Player Stands and
combination Amplifier-Player
Cabinets. High quality perspex
covers (clear and tinted) are also
available, some hinged, others
separate. In addition to our
standard range, we can supply
cabinets and perspex covers
to your individual specifications.
Grill cloth, innerbond, styli,
recording tape . . . in fact all
accessories are available
ex stock.

If you possess, or prefer
fully shelf mounting hi-fi
equipment, the Instrol
Modular system of wall
units, illustrated at
right, is your answer.
A full range of these wall
units is on display
at our new showroom.
Similarly, our Instrol
Cabinet Catalogue has
full details of these
Modular units. Built and
finished or pre-cut
to assemble yourself, these
modular wall units
are priced from \$60.00.



FREE FREIGHT
THE GREATEST SPECIAL
OFFER OF THE YEAR
We at the new Instrol
Centre will pay all freight
charges on any amplifier,
player or speaker sent to
any State in Australia by
Registered Post or Rail.
NOW country and interstate
customers will pay no more
than Sydney residents, be-
cause the freight cost will
be paid by Instrol Hi-Fi
Centre. We regret that this
wonderful offer
unfortunately CANNOT in-
clude player-stands, speaker
enclosures or equipment
cabinets.

Fantastic is the word for the

The new GRUNDIG TR6000 is no set for just everyone. Its technical brilliance, extraordinary ease of operation and its sturdy, fascinating looks will satisfy the most meticulous radio enthusiast.

See and hear it at:

Goldring Sales & Service (N.S.W.) Pty. Ltd.
443 Kent St., Sydney, 29-5802.

or at leading retailers in all States

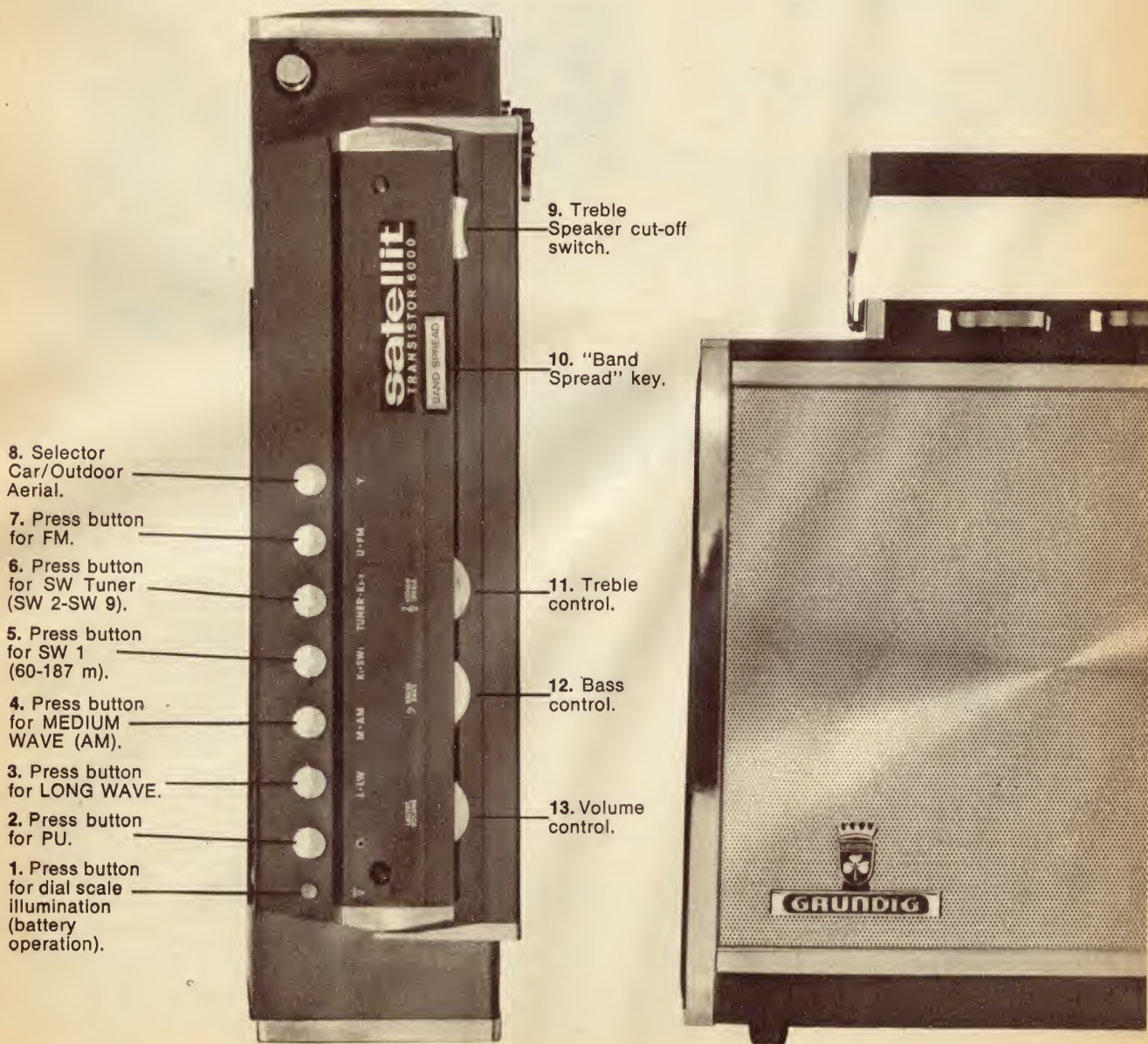

GRUNDIG

Transistor 6000

Technical Specifications:

20 tuning ranges: FM, 17 x SW (SW 1: 60-187 m, SW 2: 42-60 m and 49 m band, SW 3: 36-50 m and 41 m band, SW 4: 26,5-37 m and 31 m band, SW 5: 21,5-30 m and 25 m band, SW 6: 16,5-24 m and 19 m band, SW 7: 14-20 m and 16 m band, SW 8: 12-16,7 m and 13 m band, SW 9: 10-14 m and 11 m band), Medium Wave (AM) and Long Wave • circuits: FM 14 (3 can be tuned), AM (without SW Tuner) 9 (3 can be tuned); SW Tuner 14 (3 can be tuned) • 19 + 1 transistors (17 of these are silicon trans) • best possible cross modulation by field effect transistors • 14 + 2 diodes • tuned-in first stage on all ranges • double superimposition of SW Tuner with 4-circuit band filter • gain control: AM 3-stage, SW Tuner 3-stage with additional control, FM 1-stage • ferrite aerial for MW (AM) and LW; MULTI-MATCH telescopic aerial for FM and SW (switchable) • DUPLEX Single Selector tuning • separate SW rotating drum selector drive by means of a pull-and-push

tuning knob • colour marks for station tracing • SW fine tuning for SW 1 • "Band Spread" key • switchable AFC on FM • AM band width selector switch • tuning indicator (S-meter) • battery voltage indicator • 2 Superphone speakers (treble speaker can be switched off) • bass and treble control • 2 Watts push-pull output stage • battery operation by 6 x 1,5 V mono cells • built-in mains power pack TN 12 • dial scale illuminated • sockets for external power supply, earphone, external speaker, outdoor aerial, car aerial, outdoor dipole antenna, ground, record player/tape recorder • receptacles for SSB device with switch-over to manual control, sound filter, product demodulator • cabinet: wood, w/leatherette covering, in black and walnut.

Size approx. 44 x 26 x 12 cm
(= 18½" x 10¼" x 5")

Weight (incl. power pack), approx. 6.1 kg
(w/out batt.)

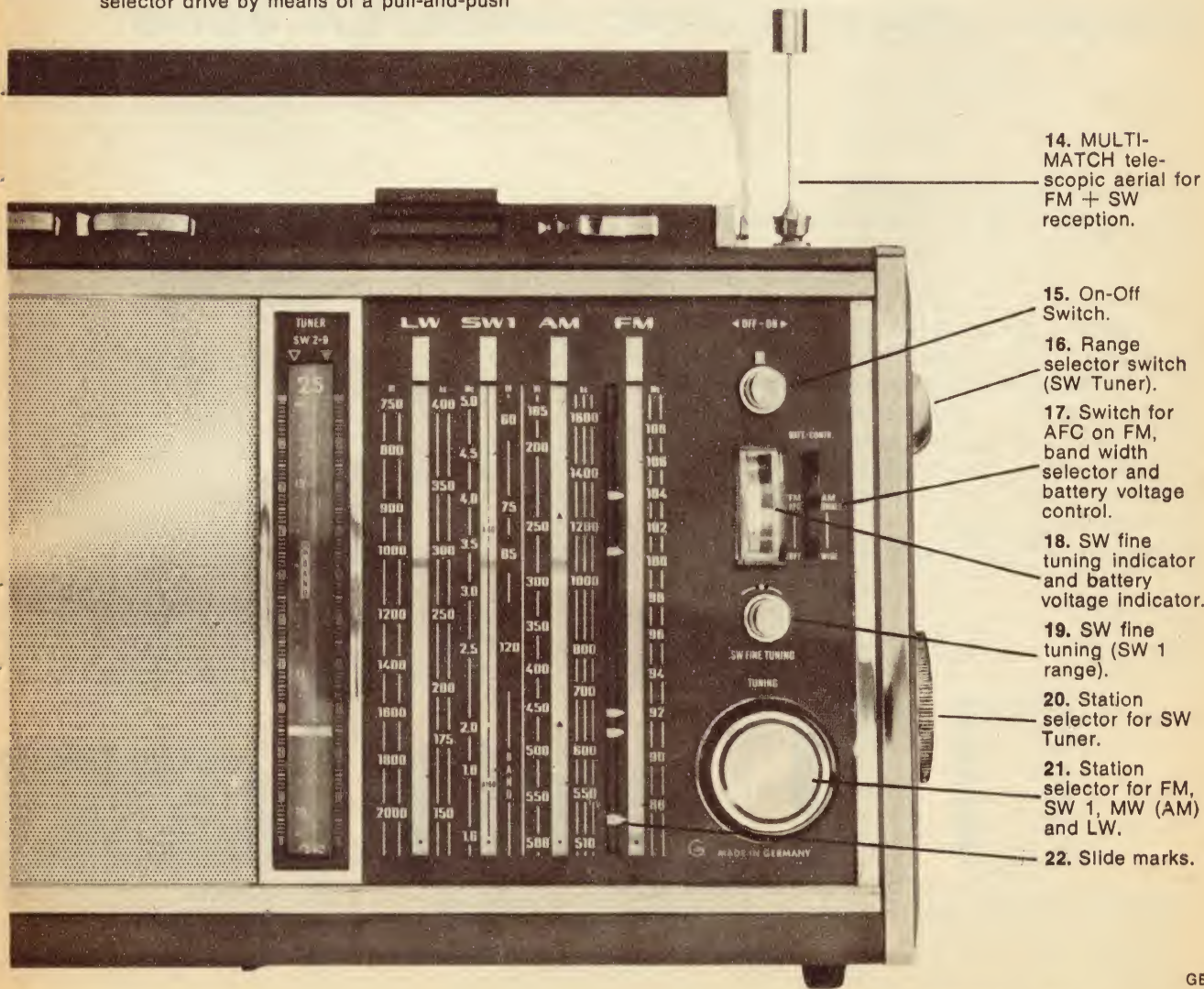

GE:P439

A New Member of KENWOOD's Powerful



120-WATT SOLID STATE STEREO AMPLIFIER **KA-4000**

Introducing KENWOOD's KA-4000, the solid state stereo amplifier that's the right answer for your Hi-Fi problems. Here's 120 watts of IHF standard total music power—a power-packed instrument that's up to the most severe stereo task. Wide power bandwidth is another outstanding feature with 13 Hz to 30,000 Hz range. IM distortion is almost totally eliminated. The KA-4000 offers momentary silence with a lever type -20 dB quick response muting switch. This amazing stereo advance is further equipped with 2 dB step type tone controls and lever type high and low filter switches. The KA-4000 also has a blue light indicator for input selector switch. If you desire even more total stereo power, another member of the KENWOOD family, the KA-6000 has a booming 180 watts. If you need less power, KENWOOD's diversified range of instruments offers an amplifier with the output you need.



BOOKSHELF TYPE 4-WAY 5 SPEAKER SYSTEM **KL-60**

- * Mounted speakers: 12 inch, free-edge woofer · 1 (Bass)
- 6½ inch cone squawker · 1 (lower midrange)
- 4 inch cone squawker · 1 (higher midrange)
- Horn type tweeter · 2 (Treble)
- * Dimensions: 15"(W), 25½"(H), 11½"(D).



40-WATT SOLID STATE STEREO AMPLIFIER **TK-150U**

- * 5 pairs of input terminals for MAG, AUX 1, AUX 2, TAPE REC and TAPE PLAY
- * Damping factor: 40 (at 16 ohms), 20 (at 8 ohms)
- * Dimensions: 10½"(W), 4½"(H), 9½"(D).



60-WATT SOLID STATE STEREO AMPLIFIER **TK-250U**

- * 2 sets of stereo speaker terminal and front panel speaker selector switch.
- * Dimensions: 13"(W), 4½"(H), 9½"(D).

Stereo Family

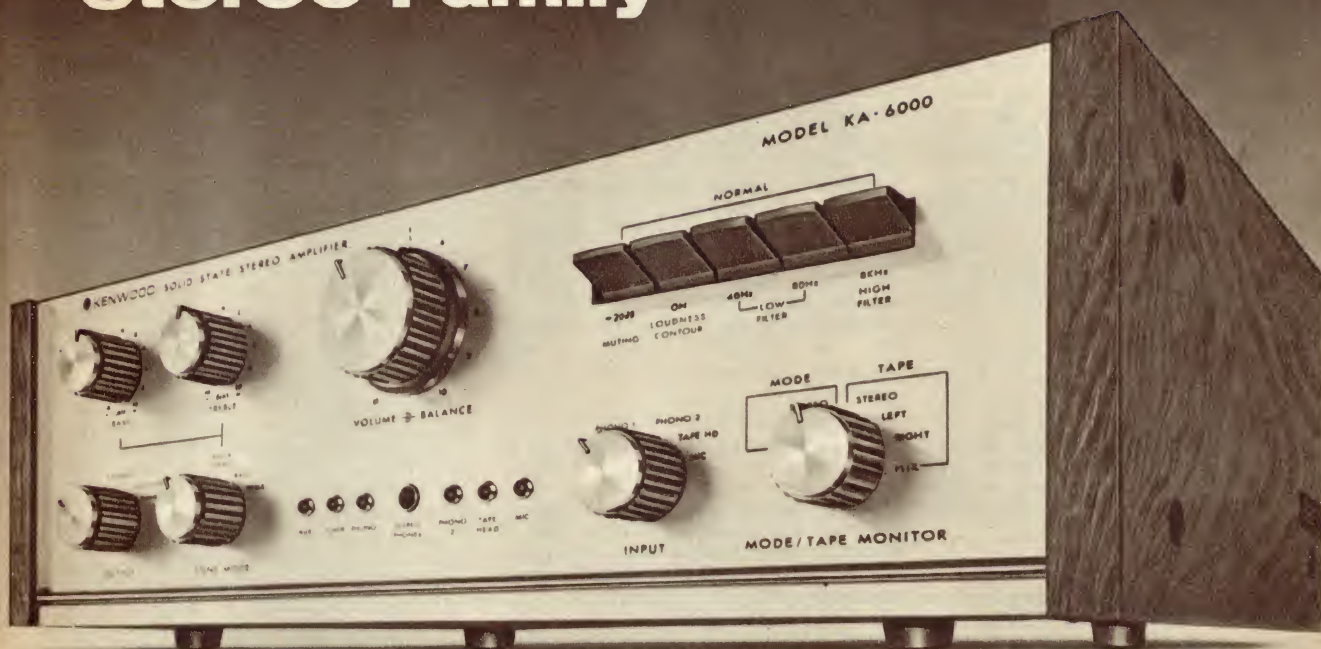

180-WATT SOLID STATE STEREO AMPLIFIER KA-6000

Special Features of KA-6000

- * Wide power bandwidth of 10Hz to 50,000Hz with very low IM distortion.
- * Exclusive Low Level Phono Inputs for the Low Level Output Cartridges, the output of which is 2mV, 0.5mV, or 0.05mV.
- * 2 pairs of MAG Input Terminals for 2 sets of record players.

the sound approach to quality



KENWOOD
TRIO ELECTRONICS, INC.

6-5-1-CHOME, SHIBUYA, SHIBUYA-KU, TOKYO, JAPAN

Sole Agent in Australia: Jacoby, Mitchell & Co., Pty., Ltd.: Head office: 469-475 Kent Street, Sydney Tel: 26-2651 Melbourne: 15 Abbotsford Street Tel: 30-2491 Brisbane: 56 Edward Street Tel: 2-6467 Adelaide: 652 South Road, Glandore Tel: 53-6117 Perth: United Australia Co., Pty. Ltd. 435 Hay Street, Subiaco Tel: 8-4665 Tasmania: K. W. McCulloch Pty. Ltd. 57 George Street, Lounceston Tel: 25-322 Newcastle, Edmunds Moir & Co. Pty. Ltd. 18 Wood Street Tel: 61-4991
Distributor in New Zealand: JOHN GILBERT & CO Tasman Buildings Anzac Ave Auckland C I

Ask for a catalogue or demonstration by your nearest dealer.



30-WATT FET SOLID STATE AM/FM STEREO RECEIVER TK-20U

- * F.E.T. (Field Effect Transistor) 3 Gang Tuning Condenser frontend for superior sensitivity, image rejection and cross modulation ratio.
- * Dimensions: 14 1/2" (W), 4 3/4" (H), 11 1/4" (D).

To: Jacoby Mitchell & Co., Pty., Ltd. EA
469-475 Kent St., Sydney.

Send me information on KENWOOD RECEIVER, AMPLIFIERS, SPEAKERS & name of nearest KENWOOD retailer,

NAME: _____ AGE: _____

ADDRESS: _____

THE SEARCH FOR SAFER BRAKES

A detailed study is being carried out by the U.S.A.'s National Bureau of Standards into vehicle braking systems.

Automobiles, for decades an essential part of our way of life, are frequently used with little thought for maintenance until failure occurs. This is particularly true of brakes, the wearing components of which are hidden from the user's sight. Braking systems are now being more closely examined because of the increase of high-speed travel on improved highways, sometimes by cars bearing or towing heavy loads.

Repeated sudden stops under these conditions are a severe test of brake systems. Partly in consequence, brake systems are now undergoing their first changes in basic design since acceptance of the hydraulically actuated system in the 1930s. Performance standards are needed for evaluating these new braking systems.

The National Bureau of Standards in the U.S.A. has studied many aspects of automobile operation in the past, including standardisation of octane ratings in the 1940s and studies of tyre durability and its measurement up to the time of the creation of the Department of Transportation. The Department sponsors automotive research by the N.B.S. Office of Vehicle Systems Research (O.V.S.R.) on braking systems, tyres and occupant restraint systems.

The O.V.S.R. braking systems program includes work in three general areas: on-the-road performance, laboratory performance of brakes and lining material, and standards for brake fluid and other braking system components. These programs are expected to lead to standards for, and production of, brake linings and pads that are more stable and resistant to fading, for better brake-control systems, and for brake fluids that perform better at high and low temperatures.

O.V.S.R. has installed a brake dynamometer, a machine which "runs" auto "wheels" — without a car attached — and applies their brakes, to measure brake performance under reproducible laboratory conditions. The amount of energy imparted to brakes by stopping the dynamometer shaft is known from the inertia of its components. This can be programmed to simulate the driving conditions desired for evaluating the durability, reliability, and operating characteristics of brake systems.

The dynamometer consists of a 36-foot long mechanical assembly with a centrally mounted motor and a brake test position at each end, a motor-generator power supply for the motor, a control and recording console, and a ducted brake cooling system. The rotating system is accelerated to the desired speed (simulating road speeds to 125-m.p.h.) by the 125HP motor and slowed or stopped by the brakes under test. The inertia of the rotating system can be adjusted to simulate vehicle weights from 900 to 14,000lb by adding the desired number of steel discs to the shaft.

Brake assemblies to be tested are mounted on massive tailstocks at each end of the dynamometer, so that the wheel studs mate with sockets on the ends of the dynamometer shaft. Each tailstock contains transducers to measure the individual brake torque exerted during deceleration, and the brakes are fitted with thermocouples for measuring temperatures during tests. A slip clutch is mounted on the shaft between the inertial mass and one test station to allow one "wheel" to turn more slowly than the other one, simulating tyre slip or wheel lockup. This unusual feature will permit testing

anti-locking brake systems currently being developed.

The dynamometer can be set to operate automatically in test cycles having preset shaft speeds, inertial load, brake actuating pressures or torques, cooling air velocities, and cycle times. A drum programmer automatically carries out the test sequence to completion or until a brake malfunction occurs, in which case the test is automatically terminated. Data is collected on a 12-channel strip chart recorder in the control console.

Provision has been made for later addition of another two-station brake dynamometer coupled with the existing unit. The dynamometer will then be able to test all four brakes of a vehicle simultaneously.

The O.V.S.R. braking systems laboratory includes some of the same apparatus used by manufacturers of cars and brake components to measure the friction and wear characteristics of brake lining and pad materials. A friction materials test machine and a FASF (Friction Assessment Screening Test) machine measure the performance of these materials on brake drums and discs at various loads, speeds, and temperatures. One O.V.S.R. mission is to verify that these tests are meaningful indicators of performance in use.

A popular model passenger vehicle has been instrumented to measure braking system performance and to develop test techniques. The test vehicle's instruments include a "fifth wheel" attached to the rear bumper to measure stopping distance and vehicle speed, gauges indicating brake fluid line pressure and power-assist vacuum, and thermocouples and pyrometers measuring temperature of brake linings and brake fluid at selected points. Vehicle deceleration while braking is measured with both a U-tube device and an electronic servo accelerometer system. A strip chart recorder is utilized to record selected data.

Wet brake performance and recovery characteristics can be measured by flooding the brakes with a built-in pressurised watering system before test stops.

Shutoff valves are installed in the brake fluid lines to each wheel so that various modes of partial brake failure can be simulated. Road tests with one or more brakes disabled can be made to determine how the vehicle will react with a partially effective braking system.

Since much of the road testing is done at high speeds, the vehicle is equipped with a roll bar and test personnel wear crash helmets in addition to seat belts and shoulder harnesses.

Hydraulic braking systems for cars were developed early in the century and were widely and successfully used in racing cars in the early 1920s, although they did not replace mechanical brakes on passenger cars until a decade later. The first successful hydraulic



Part of the elaborate instrumentation used in the N.B.S. research.

brake fluids consisted of castor oil thinned with various solvents, such as diacetone alcohol. Now the fluids are formulated of various polyglycol compounds, with inhibitors and anti-oxidants added to improve stability and to prevent corrosion.

The severe demands on today's braking systems are countered by compounding brake fluids to resist extremes of service and high temperatures and to have low corrosivity. The fluid properties must be balanced between extremes — high boiling point and fluidity at low temperatures. The ideal brake fluid will not only be satisfactory when placed in service, but will maintain the desired properties despite aging, heat, and the introduction of water.

Water is the enemy of brake systems in several ways. It seems to be impossible to keep it from penetrating the braking system, where it can lead to corrosion of metal parts and possibly disable the system in freezing weather. To prevent this, modern fluids are formulated to be compatible with water and to absorb rather than reject it.

N.B.S. research confirms that with aging and increasing water content a fluid's boiling point falls drastically and it becomes more viscous in cold weather. Because of this it is important that standards take this degradation into consideration; also needed are criteria and field test procedures for determining when a fluid has become so degraded that it should be replaced. These become more necessary as the passage of time brings cars that are heavier, faster, and more powerful; highways that are more crowded and more demanding; and body designs that hide brakes from cooling airflow. Even engineering advances can add to demands on brake fluid; the disc brake brought with it higher localised temperatures and consequent greater stress on the brake fluid and other components.

The first industry specification for brake fluids was developed during World War II, and in 1947 the Society of Automotive Engineers published its first brake fluid standard.

Government regulations entered the picture in 1953 with the enactment in Minnesota of the first compulsory standard for brake fluid. Federal legislation in 1962 empowered the Secretary of Commerce to set and publish specifications for motor vehicle brake fluids in interstate commerce. In 1966 this authority was transferred to the Secretary of Transportation, whose Department now supports the N.B.S. auto safety research programs.

The immediate goals of the O.V.S.R. brake fluid research are: to determine if existing tests are meaningful in relation to actual service; to evaluate and improve measurement reproducibility; and to develop better tests where possible. The laboratory analyses and tests brake fluids, using gas-liquid chromatography, infrared spectroscopy, and chemical and physical procedures. The Bureau's efforts are directed toward establishing performance requirements.

At the present time the Bureau is developing other evaluation capabilities for the cups, seals, and hoses that also are components of the automotive braking system. ■



TOP: Measuring the thickness of brake linings during dynamometer tests on a braking system.



RIGHT: Titration tests to measure water in a sample of brake fluid. Even a small amount of water can seriously affect brake performance.

BOTTOM: Part of the massive dynamometer used for testing brakes. Vehicles of different weights can be simulated by selection of appropriate discs.





NEW D54

DUAL-TRACE SOLID STATE OSCILLOSCOPE



- 10 MHz Bandwidth at 10mV/cm
- All Solid State Design
- Dual-trace, FET Inputs
- Small Size, Lightweight
- 22 Calibrated Sweep Speeds
- Chopped or Alternate Switching
- 6 x 10 cm Viewing Area
- Built-in Voltage Calibrator

The D54 is an all solid state, dual-trace 10 MHz portable oscilloscope. Wide time-base range, broad bandwidth characteristics and calibrated deflection factor make the D54 well suited for general-purpose laboratory work and production line testing applications.

Solid state design, using FET input circuitry, provides minimum drift and fast stabilisation time. Weighing only 20 lb, its ruggedness of design renders it ideal for field applications.

Price \$400.00 (plus tax and duty if applicable).

TEKTRONIX



Distributed by Tektronix Australia Pty. Limited
 N.S.W.: 80 Waterloo Road, North Ryde 2113. 88 7066
 VIC.: Suite 20, 67 Queens Road, Melbourne 3004. Phone 51 1592
 S.A.: 128 Gilles Street, Adelaide 5000. 23 2811

ELECTRONIC SYSTEMS



FOR THE 747s

A great deal has been written about the Boeing 747 Superjet—its huge dimensions compared with present-day international airliners; its passenger and freight capacity and the demands it will make on airport facilities. Less well publicised is the enormous array of electronic communications equipment it will carry—almost one million dollars' worth on each individual aircraft.

Equipment for the 747 was described recently by Mr John Wilmott, assistant communications manager of Qantas Airways. He was addressing a Sydney Division meeting of the Institution of Radio and Electronics Engineers, Australia.

Mr Wilmott said that some of the equipment was comparable with that currently in use in the airline's smaller 707 aircraft. Some of it reflected a changing emphasis in facilities and procedures; some of it represented a complete departure from present methods.

Like all other modern planes, the 747 makes extensive use of electronic devices to meter, monitor and control its physical and mechanical functions. The communications and navigational equipment which formed the subject of the lecture was quite distinct from this, adding up to 28 major systems for the Qantas version, as currently planned. Other equipment may be substituted or added during the life of the aircraft, if and when the need arises.

Many of the systems involve duplication or triplication as a precaution against failure. In design, the equipment relies heavily on solid-state technology, a factor which has not only made possible improved operational efficiency, but also a reduction in size, weight and power supply demand. As a result, while the equipment adds up to a complex and costly whole, it does not present anything like the weight penalty than would otherwise have been the case.

Summarised, the communications equipment in the Qantas 747s is as follows:

- Two HF single-sideband transceivers for the range 2-30MHz. These operate in conjunction with probe antennas, through couplers which adjust automatically to each new select-

- ed frequency, with a VSWR of better than 1.3. Since most ground stations still operate on AM, the equipments will be used for much of the time in a compatible signal mode, radiating full carrier with upper sideband.

- Three VHF communications transceivers, operating in the range 118-136MHz. Two include provision to communicate via a satellite circuit. The antenna system is circularly polarised to minimise fading due to Faraday rotation. Qantas experiments during trans-Pacific flights some time ago demonstrated the potential value of a VHF satellite communications system, normally referred to as "SATCOM."

- Three VHF Omni-range navigation systems (VOR) operating in the range 112-118MHz. Integrated with them are three instrument landing systems (ILS) on 108-112MHz, and glide slope receivers on 328-335MHz.

- Two ADF radio compass systems operating on 190-1750KHz.

- Two DME (distance measuring

- equipment) systems, 960-1215MHz. The display system includes a new feature, "ident blanking." If two beacons on the same frequency are within range, the call sign of the "locked-on" beacon will be the only call sign displayed to the pilot. The effective range has been increased from 200 miles to 300 miles.

- One VHF marker receiver on 75MHz.

- Two weather radar systems, operating on 9345MHz. These are for X-band operation, which represents a change for Qantas, whose aircraft are currently equipped with C-band weather radar. While the case for and against different classes of weather radar are not conclusive, X-band radar penetrates to more remote weather fronts and also offers the physical advantage of a much smaller antenna. Both features are an advantage for supersonic aircraft, such as the Concorde, which are faster and slimmer, and it makes good sense to standardise equipment for the 747 and the Concorde. The complete duplication of the weather radar elements, apart from the final waveguide and dish, is also an innovation in Qantas aircraft.

- Two air traffic control transponders, 1030-1090MHz. These automatically display the position and identity of the aircraft to the ground radar controller, together with its altitude.

- Two low-range radio altimeters

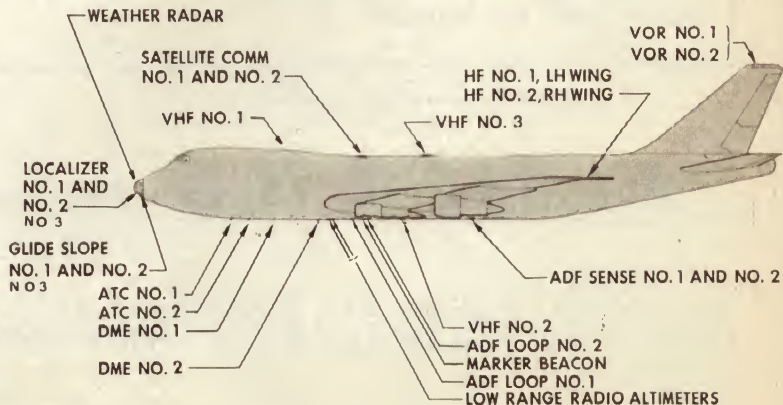
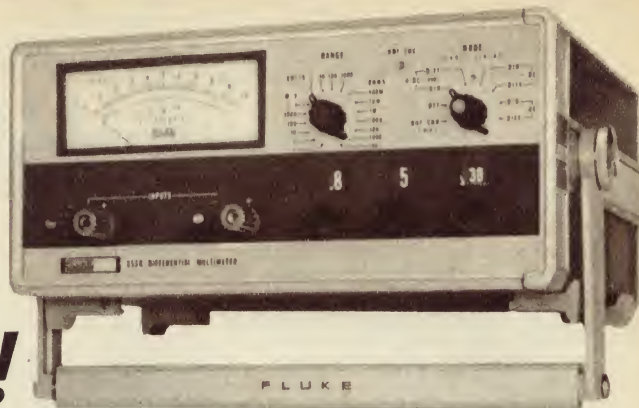

Diagram showing the locations of the 747s aerial systems.

THIS IS NO ORDINARY MULTIMETER!



The Fluke 853A has proved itself a most versatile general purpose instrument or laboratory sub-standard.

In the direct mode this instrument is used like any other multimeter. It has the added convenience of one linear scale for all measurements including ohms. Accuracy is 2 per cent DC and ohms 2 per cent AC.

In the differential mode accuracy is increased 10 times, resolution 100 times. The instrument then has an incredibly wide range of measuring capabilities as follows:

VOLTS: 1 mv to 1110 volts AC and DC
AMPS: .1 microamp to 11.10 amps AC and DC
OHMS: .1 ohm to 111.0 megohms

ACCURACY: .2 per cent DC and ohms .5 per cent AC (for a minimum of 12 months)

The instrument operates from inbuilt batteries or 240 volts 50Hz and is well protected from overload.

PRICE \$465.00 EX-STOCK

NEW ZEALAND

Customers please note, as from 1st January, 1970 most FLUKE Instruments will be available ex stock or bond Sydney.

We also offer products from the following Companies:

Optimization Inc.,—California, U.S.A.

Precision A.C. Calibration sources, precision oscillators, etc.

Physio Control Corp.—Seattle, U.S.A.

Medical intensive care systems. The new portable battery operated D.C. Defibrillator combination cardioscope.

We have full service and recalibration facilities for all instruments we handle.

For more information contact:

***ELMEASCO* Instruments Pty. Ltd.**

**Head Office: P.O. Box 334, BROOKVALE, N.S.W. 2100. Tel. 93-7944
P.O. Box 213, MT. WAVERLEY, VIC. 3149. Tel. 82-6159**

(LRRA) operating on 4300MHz. The frequency is deviated at a periodic rate and the equipment senses height by comparing the outgoing frequency at any instant with that returning after reflection from the ground. At 2500ft, the upper limit for this equipment, altitude reading is instantaneous, with an accuracy of plus and minus 2ft. At lower altitudes the error diminishes to less than 6 inches. The LRRA equipment provides essential data for the autopilot system and triggers the flare function in autoland equipment at a height of 65ft.

- Four survival beacons.
- Two selcal decoders, operating in conjunction with the HF and some VHF radiotelephone circuits; these decoders respond to a particular sequence of audio tones and bring up the channel whenever a message is being directed to the individual aircraft.
- Three inertial navigation systems. Built around extremely sensitive gyroscopic platforms, the equipment displays positional information, track, ground speed, distance and time to destination (or the next selected point on the track), the cross-track distance and track angle error, heading and drift angle, wind direction and speed and the desired track angle. Because of the availability of these data and the reliability of the triplicated equipment, no navigation station will be carried in the 747. In fact, the plane has no facilities for astro-sightings.
- One cockpit voice recorder.
- One flight data recorder.
- Two central air data systems (CADS). Using static and pitot pressure and temperature sensors, the system provides data on altitude, air-speed, etc., for injection into other automatic systems.
- Two magnetic heading references.
- One central instrument warning system.
- Two flight control systems, which involve auto pilot, flight director, auto throttle, mach trim and yaw damper.

In addition to the above communications and flight control systems, a variety of audio systems are provided in the 747. These include:

- Crew interphone system.
- Cabin telephone system.
- Passenger address system.
- Passenger audio entertainment system.
- Passenger services system.

The equipment to provide passenger services, public address and entertainment breaks new ground. It is envisaged that each passenger will have access to something like ten different taped audio channels, two channels of audio for movies, a hostess call button and a reading light switch. In addition, an over-ride facility will allow announcements to be cut into whatever audio is being used.

In an aircraft carrying as many passengers as the 747, the weight problem would be significant if physical wiring were used to link each source or function to each individual seat. The mass of wiring, along with connectors, could also present a maintenance problem after a period of service.

Telephone Call Analyser

Business managements worried by imprudent or improper use of their telephone service are expected to welcome a new development by post office engineering research teams.

The new unit, called the "PETRA" Call Analyser, is intended to help management maintain a higher degree of supervision over the number and length of STD and local calls, or STD calls only, made from PABX and PMBX switchboard extensions. It is undergoing field trials and the first units should be available for service early in 1970.

Installed in the client's premises on a rental basis, PETRA will register pertinent details of a random sampling of STD calls passing over from one to five exchange lines and up to 100 extensions.

The complex electronic and electro-mechanical equipment of PETRA is coupled with a commercially-produced time tape printer and can be programmed to supply on paper tape a variety of information about telephone traffic, as required by the management.

It can be set to print out the number dialled, a code for the extension making the call, and the time at which the call begins and ends. Alternatively, it can give a wider sampling by printing only the time a call begins then disengage itself from that particular call and prepare to accept the next number dialled. It can also be programmed to



The PETRA Call Analyser undergoing field trials by the Post Office in Melbourne. The tape printer is standing in its normal operating position, on top of the cover, which has been removed to show the interior of the equipment.

detect numbers dialled by extensions not being supervised, with an indication that the call is from an unsupervised extension. In large PBX's the extensions under analysis will be selected by the subscriber and connected by a Post Office technician. The Post Office will change to another selection of extensions periodically, as required.

PETRA will be leased on a non-profit basis and a nominal charge will apply for a technician's visit to change the mode of operation.

In the 747, a single coaxial distributor is used to carry all the program or service information in multiplexed form. The descriptive data indicates that audio sampling is based on a 12-bit sample with a sampling rate of, typically, 17KHz. The system is capable of providing a frequency response 50-10,000Hz within plus and minus 3dB and with a signal/noise ratio of about 75dB. These figures are better than are achieved with the passenger entertainment systems currently in use.

Audio, which is common to the whole aircraft — notably the taped programs — is fed into the line through a central multiplexer. In local zones of the aircraft, typically five in number, secondary multiplexers add sound appropriate to the movies or television being displayed in that zone, plus "local" announcements, etc.

The system also interrogates the call-button or light switch at each seat and reacts to any new "command" within a small fraction of a second.

The multiplexing system has been made possible largely by ready availability of integrated microcircuits containing a high density of active

elements and able to perform complicated tasks reliably and cheaply.

For example, the seat unit which "de-multiplexes" the signals from the cable is built around a silicon chip which measures 0.1 x 0.125in and which contains 424 transistor and 115 logic gates. One such unit serves each group of two or four seats, making available the full range of programs for local selection. Other ICs in each seat unit process the passenger call and service functions.

The encoding units and decoding units are standardised for ready replacement and ease of subsequent maintenance. It is anticipated that the system will be more reliable and easier to maintain than the traditional wired ducts and forms and a necessarily large number of complex plugs and sockets. The saving in weight in the 747 is about 500 pounds.

Success with the system will point up its possibilities for a variety of other applications in large aircraft, which currently rely on conventional wired circuits. This would include radio and intercom. facilities and a variety of monitoring and sensing functions. ■

Radio telephones to serve

The Post Office is currently testing under field conditions a compact radio link telephone system which can be installed in isolated properties where connection by land line would not be feasible. The system can provide users with all the normal facilities of the Post Office telephone network, including direct dialling and full duplex operation.

The system has been developed by Almagamated Wireless (Australasia) Ltd., in response to requests from the Postmaster-General's Department for simple and relatively inexpensive radio links.

For many years, isolated dwellings have been denied telephone facilities due to the cost of erecting poles and wire or of running cables. Radio telephones have been considered but their application has been restricted because of the power supply requirements associated with valve equipments. The development of reliable 12 volt VHF power transistors has changed this, and has made possible the design of inexpensive radio links, which can extend the national telephone network to remote areas.

The equipment to be described provides a simple and reliable VHF radio link between a subscriber and a telephone exchange. It comprises two basic units, one for installation at the subscriber's home and one for the exchange terminal. The two units are similar, and have been designed to operate with either magneto, central battery or automatic exchanges without modification. Each terminal unit is connected via cable to its respective aerial and into the exchange or subscriber's telephone by means of telephone lines. The units are designed for wall mounting in a specially designed cradle. The dimensions of the installed equipment are 11 inches wide, 12 inches high and 5 inches deep.

Figure 1 shows a simplified block diagram of the subscriber's terminal and figure 2 that of the exchange terminal. Both terminals contain the following sub-units:

- (a) combining and signalling unit
- (b) receiver
- (c) transmitter
- (d) diplexing unit

Every attempt has been made to make the operation of the subscriber's telephone as near as possible to that of a normal telephone. To this end the system operates on a full duplex basis employing two frequencies suitably separated in one of the following frequency bands: 70-85-MHz, 148-156MHz and 156-174MHz.

The equipment may be supplied from any 12.6 volt DC source which will normally be a rechargeable battery

charged from the mains, home lighting system or fuel cells run from bottled gas.

Operation into a central battery exchange is achieved as follows: To make a call the subscriber lifts the handset and completes the telephone circuit. This operates relay RLM and thus the slow-fall-out slave RLMS. Operation of RLMS causes power to be applied to the transmitter via contacts MS1. At the exchange terminal reception of the subscriber's signal causes the carrier relay RLC to operate. This applies power to the exchange transmitter via contacts C2 and completes the exchange line loop (contacts C1) operating a call detector at the exchange. When the exchange answers, the circuit is complete and the call can proceed.

In the case of the exchange initiating the call, the normal 16Hz ring tone is applied to the line by the operator. The ring tone is rectified and operates relay RLR. Operation of RLR causes power to be applied to the transmitter and the 3825Hz Tone Oscillator (contacts R1 and R2). Relay RLR, the transmitter and oscillator TO2 will therefore be keyed in sympathy with the bursts of ring tone. At the subscriber's terminal, reception of the keyed exchange signal — modulated at 3825Hz — causes relay RLA to operate. Contacts A1 connect the ring tone generator to the subscriber's telephone each time the exchange signal is received.

When the call is answered, relay RLM and RLMS operate and disconnect the ring tone generator (contacts MS2), reconnect the telephone line to the hybrid transformer and apply power to the transmitters. Reception of the subscriber's signal at the exchange operates relay RLC which disconnects the rectifier circuit (contacts C1) and completes the telephone loop. The call can now proceed.

When used with an automatic exchange the subscriber's equipment is the same as for a central battery exchange except that an automatic phone is provided. To make a call, the telephone circuit to the exchange is completed in the same way as described for a central battery exchange. On the reception of the normal dial tone from the exchange, the subscriber can dial the wanted number in the same way as on a normal telephone. The action of dialling is to short- and open-circuit the subscriber's line and this

Figure 1. Block schematic of the subscribers' terminal

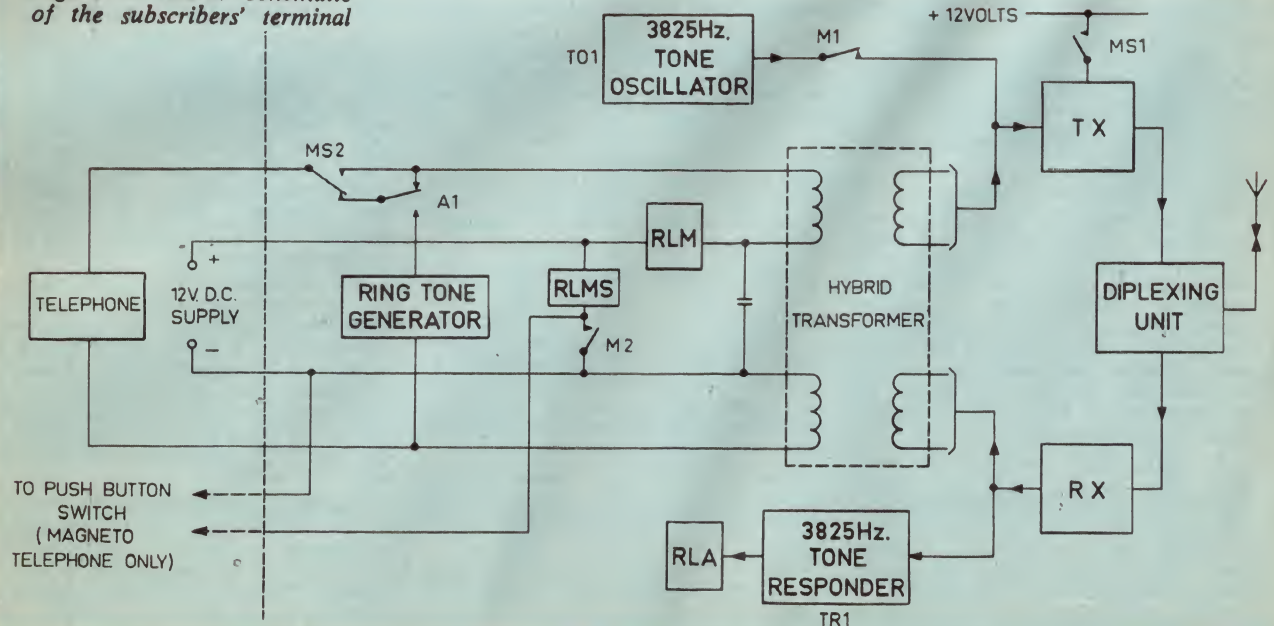

isolated areas

By J. G. Spence

causes relay RLM to fall out for the duration of each dial pulse. (Relay RLMS is a slow fall out type and does not follow RLM.) Contacts M1 connect the 3825Hz tone oscillator TO1 to the transmitter during each dial pulse.

Reception of the 3825Hz pulse train at the exchange terminal activates tone responder TR2 and relay RLB. Contacts B1 follow the 3825Hz pulse train and open and short the exchange line in the same manner as the dial in a normal telephone. Although not shown in figures 1 and 2, provision is made to disconnect the hybrid transformers while dialling takes place. This is necessary to prevent loop oscillations which would otherwise occur, since the hybrids would be unbalanced during the dialling period.

To operate with a magneto exchange, terminals x and y are strapped together in the exchange terminal. The subscriber is supplied with a telephone similar to that used for a central battery exchange except that it has a push-button switch. To call the exchange the subscriber operates the push button for a short period. This operates relay RLMS and hence applies power to the transmitter which is modulated by the 3825Hz tone oscillator TO1.

As in the case of the automatic exchange, the reception of the modulated signal at the exchange terminal operates relay RLB. Contacts B1 connect the 16-25Hz ring tone generator to the exchange line and thus simulate the action of a normal magneto telephone. The ring tone generator operates so long as the push button is depressed.

The receiver used in the subscriber's equipment is an adapted version of the current A.W.A. FM Base Station.

The transmitters used in the subscriber's system are the result of a general program of VHF solid state transmitter development carried out by A.W.A. FM Mobile Development Group. The basic transmitter output power is 1 watt and this can be increased to 10 watts by the addition of a power amplifier module. Provision is made to house this module inside the main equipment case.

The receiver and transmitter are connected to the aerial via a diplexing network, which employs two band-pass filters connected such that the transmitter and receiver are effectively isolated from each other. In the case of the receiver, the degree of isolation is important, since the



A subscriber's terminal installation

receiver would be desensitised if a high level of transmitter signal were allowed to reach its terminals. The network used allows the transmitter and receiver frequencies to be spaced 6MHz apart. At this frequency the attenuation, at the transmitter frequency, between transmitter output and receiver input, is 80dB, which is adequate to prevent receiver desensitisation.

In addition to the simple subscriber-exchange link described, a number of party line systems have been investigated. It is expected, however, that until this type of radio-telephone equipment becomes more widely used the simple subscriber exchange link will remain the most popular.

An experimental link has been operating successfully, under Post Office surveillance, during the past 12 months and it is confidently expected that its reliable performance will help encourage the more rapid adoption of this type of equipment within Australia.

(This article is based on a paper by J. G. Spence and R. Westmore, published in "Proceedings of the Institution of Radio and Electronics Engineers Australia," May, 1969 and subsequently updated by J. G. Spence.)

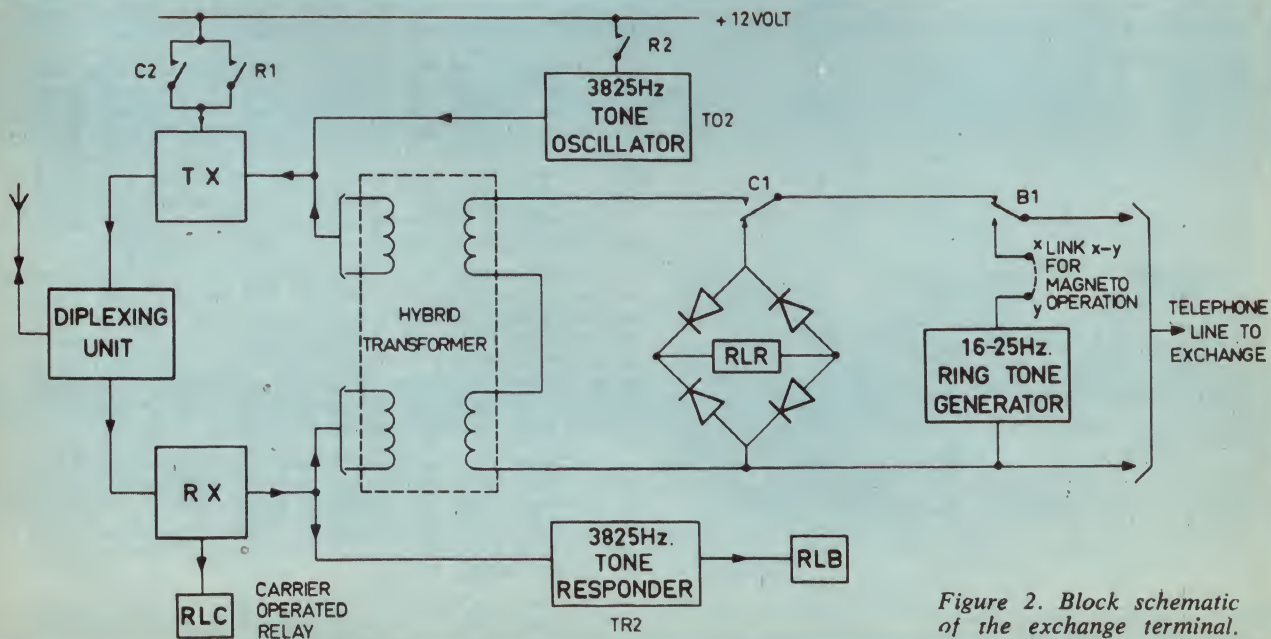

Figure 2. Block schematic of the exchange terminal.

UNMANNED BOAT IS SELF-NAVIGATING

A unique robot sailing boat that can navigate itself to any point on the world's seas to perform oceanographic, meteorological and other missions, and maintain its position to an accuracy of one-fifth of a mile, is being developed by RCA in the U.S.A.

The unmanned sailing craft, which is capable of remaining on station automatically for up to a year without a mooring, has the potential of performing its mission more effectively and at less cost than present oceanographic systems, RCA says.

The buoy-like vessel, called SKAMP (for Station Keeping And Mobile Platform), employs computer-based electronic navigation and a combination of movable air foils and rudders. It can sail unattended to a designated location and remain there unattended until commanded by radio to return or to move to another station.

The vessel is designed to sail in hurricane-force winds. Since it is wind-driven, it sails silently with no internal power required for propulsion.

SKAMP, which is essentially an unmanned sailboat, comprises a rigid "sail," a disc-shaped buoyant elastic hull, a centre body, and reinforced plastic underwater fins and rudders. The sails are made of reinforced, foam-filled plastic and can withstand wide variations in wind direction without excessive loss in propulsion. The hull yields easily to wave pounding and locally applied loads. The buoyancy of the sail and hull enables the platform to resist capsizing

and maintain its upright position. The fins and rudders provide good performance over a wide range of water speeds and can accommodate centrally supported sensor cables. Therefore, the configuration results in an unusually compliant but durable seaworthy structure. In addition, SKAMP can be easily modified or adapted to conform to individual mission requirements.

Although relatively small, SKAMP offers a large payload-carrying capacity to meet the needs of special missions. The limited angular motion of the platform coupled with its automatic self-righting capability qualifies this platform as an excellent instrumentation base, especially for meteorological and oceanographic sensors. There are a number of other special features which are potentially applicable to the vessel.

It can be designed for a very low acoustic noise level. If required, its superstructure can be constructed without any metal parts, thus making it virtually transparent at all radar frequencies. In addition, when appropriately painted, it can be visually undetectable more than a mile away. On the other hand, the system's detectability can be accentuated if desired.

SKAMP can be made self-deployable from a harbour or base to its selected station. Similarly, the platform can be remotely recalled for modifications or periodic maintenance. Collision-hazard is minimised by the elastomer hull and flexible sail construction which absorbs the force of impact and prevents damage to the other craft.

Thus this platform will economically provide in one unit both accurate station-keeping and self-navigating abilities. These qualities indicate that SKAMP can significantly contribute to the needs of many programs.

Receiving information from a navigation system, such as the U.S. Navy Navigation Satellites, the electronics and servo system manipulates the vessel's air foils and rudders to guide it on course to its station. Once there, it will sail a tight "back-and-forth" course to remain within two-tenths of a nautical mile of its assigned true position.

Versatility of the platform enables it to accept virtually any type of sensor, suiting it to tasks such as charting ocean currents or monitoring surface weather at remote points, according to C. S. Constantino, Division Vice-President of RCA's Astro-Electronics Division, Princeton, N.J., where the craft is being developed. In all its applications, a SKAMP could function alone or as part of a far-flung, precisely positioned network. Also it could accompany oceanographic vessels.

While a number of uses in the meteorological and oceanographic areas are obvious for SKAMP, Mr Constantino added, it would lend itself to many other missions. For example, the craft's ability to stay within two-tenths of a nautical mile of true position could allow it to serve as a navigation station for ships, submarine or aircraft. Missions employing sonar, imaging and radio sensors is another possible application for the system.

Because it requires infrequent maintenance, SKAMP can be operated at significantly less cost than other systems. It also would pose no hazard to ships since it is kept on station by an "electronic tether" rather than a cable. It also can be expected to stay in one place more reliably than cable-attached buoys.

Global capability of SKAMP, deployable from either a shore installation or a ship, would result from its operation with the U.S. Navy Navigation Satellites. ■



BUY RIGHT... FROM ENCEL

LUX SOLID STATE STEREO AMPLIFIERS STAND ALONE

FOR PERFORMANCE, QUALITY, VALUE



Price (including Sales Tax)

\$269

LUX SQ-505

Rated at 30 watts R.M.S. per channel, the all-new model 505 is a silicon. Power transistors are designed to withstand temporary short circuits and overloading. Overall frequency response is 10,50,000Hz. plus or minus 1 dB. in the power amplifier; 20,500,000Hz. plus or minus 2 dB. in the pre-amplifier. Controls and features include volume, balance, mode selector, treble/bass controls, filters, tape monitor, headphone jack, exclusive A/B speaker systems selector, etc. A fine amplifier.



Price (including Sales Tax)

\$219

LUX SQ-606

This new model is an all silicon unit with 27 silicon transistors and is rated at over 30 watts R.M.S. per channel. Power transistors are designed to withstand temporary short circuits and overloading. Acoustic performance is most outstanding, with overall frequency response of 10,50,000Hz. plus or minus 1 dB. Volume and balance controls, mode selector, treble/bass controls, filters, tape monitor, headphone jacks, etc. This very desirable unit is attractively priced.

LUX SQ-1220



Price (including Sales Tax)

\$350



Price (including Sales Tax)

\$169

EXTRACTS FROM REVIEW OF LUX SQ-1220 INTEGRATED AMPLIFIER APPEARING IN "HI-FI NEWS" JANUARY, 1969.

"Here, then, is an amplifier of Japanese origin, which conforms very closely (on some counts better) to the published specifications". "The amplifier was run for several weeks under domestic conditions with a wide range of program sources, pickup cartridges and speakers and at all times it performed perfectly and without flaw". "Nice to look at, nice to use and very well made and designed. I vote the Lux SQ-1220 a top-of-the-class amplifier, which, I am sure, will hold its own with the best of the other Class B designs now available."

EXTRACTS FROM REVIEW OF LUX SQ-77 AMPLIFIER APPEARING IN "HI-FI SOUND" FEBRUARY, 1969.

"Both design and construction reach very high standards of electronic engineering. Some idea of the excellence of the design of the amplifier can be gleaned from the illustrations. It is also noteworthy that the components employed are of good quality and reasonably rated, especially the mains transformer, so normal servicing should not cost much from one year to the next". "After running the amplifier for several weeks in a typical domestic environment with all sorts of signals and sources, and not encountering any troubles or even mere shortcomings on my ordinary dynamic speaker systems of various kinds, I have no hesitation at all in voting this one of the most worthy of amplifiers I have had the pleasure of testing for a long time. For the power that it delivers and the way it is made it is well worth the price."

ENCCEL

ELECTRONICS (STEREO) PTY. LTD.

Head Office: 431 Bridge Rd., Richmond, Victoria. 3121. Tel. 42 3762.

Sydney Store: Ground Floor, 2SM Building. 257 Clarence Street, Sydney, N.S.W. 2000. Tel. 29 4563, 29 4564.

Australia's Greatest Hi-Fi Centre ■ Wholesalers ■ Trade-ins accepted ■ Terms

The new Wharfedale "DOVEDALE III" provides the smoothest frequency response ever achieved in a Wharfedale enclosure.

Wharfedale sound has always been highly respected by the music lover and audio enthusiast alike; with the release of the new "Dovedale III" compact speaker system, Wharfedale have surpassed even the obvious superiority of earlier Wharfedale enclosures.

Frequency response ranges from 40 Hz. to 20,000 Hz. without colouration, or audible peaks and troughs. Speaker complement comprises a 12" woofer, a 5" mid-range speaker and a 1" tweeter with electrical crossovers at 500 Hz. and 2500 Hz. respectively. Smooth response is successfully achieved by use of matched speaker chassis with carefully blended roll-off characteristics. Impedance is 4-8 ohms and power handling capacity is 35 watts R.M.S. (70 watts "music power").

Cabinets are of sophisticated design in oiled teak or polished walnut . . . extraordinary attention has been given to structural strength to avoid any spurious cabinet resonances. Dimensions are 24" x 14" x 12".

List price of the "Dovedale III" is extremely competitive at only \$184.



See your favorite hi-fi store — compare the audibly superior Wharfedale "Dovedale III" with any other enclosure anywhere near its price. There's a power of difference!

SGD3



Australian National Distributors:

Simon Gray Pty. Ltd.

Head Office: 28 Elizabeth St., Melbourne, Vic. Tel. 63 8101*
 Sydney Office: 22 Ridge St., North Sydney, N.S.W. 929 6816
 Canberra Office: 31-33 London Circuit, Canberra City, A.C.T. Tel. 49 6050

INTERSTATE REPRESENTATIVES:

N.T.: Pfitzner's Music House, Smith Street, Darwin. Tel. 3801
 Q'land: Sydney G. Hughes, 154-158 Arthur St., New Farm, Brisbane. 58 1422
 S.A.: Eilco Sales Pty. Ltd., 7-9 Osmond Terrace, Norwood, S.A. Tel. 63 4844
 Tas.: K. W. McCulloch Pty. Ltd., 57 George Street, Launceston. Tel. 2 5322
 W.A.: Athol M. Hill, 613-615 Wellington Street, Perth. Tel. 21 7861

LASER TV AT EXPO '70

The world's first public demonstration of large screen laser television will be given in the Hitachi pavilion at the EXPO '70 exhibition to be held in Osaka, Japan, next year

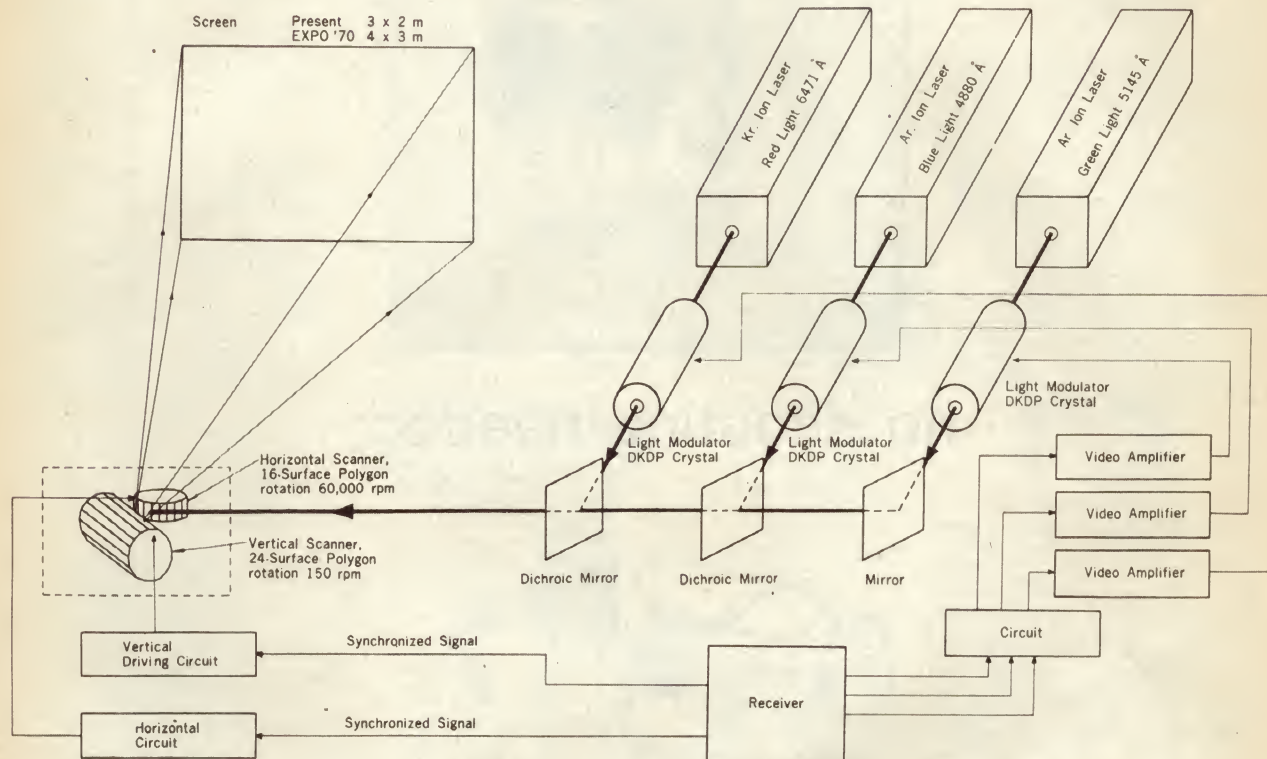

Advance publicity from Hitachi says that the display will be on a screen measuring about 13ft 4in x 10ft, and that the pictures will be of "unprecedented" brightness and colour quality. This is to be achieved by using a projection system in which three powerful lasers are used in conjunction with a mirror drum scanning system.

Hitachi claims that the peculiar qualities of laser light are responsible for the improved brightness and colour. The light is very intense, coherent (directional) and of high spectral purity. These qualities have already found wide potential application in such fields as medicine, machining and surveying. Many research scientists believe that the laser also has great potential in the fields of communications and entertainment. The demonstration at EXPO '70 of Hitachi's laser television project is intended as a practical demonstration of the progress the company is making in this area of application.

The development of the laser colour TV started two years ago at Hitachi's Central Research Laboratory. The management of the project was given to Dr Yahiko Yamada. A graduate of Osaka University, Dr Yamada had done advanced work in spectroscopy at the Massachusetts Institute of Technology before joining Hitachi in 1960 to become manager of the scientific instruments division. Soon after the project was started, a proposal was made to the Hitachi top management

to exhibit a working model at the 1970 World Fair. The project had therefore to be completed under high pressure, so as to have a workable scheme ready in time for the opening date.

At present, the system is still a laboratory model. It has one krypton laser, which emits red light, and two argon lasers, one each for blue and green light. All three lasers were developed at the Hitachi Central laboratory, and have a maximum output of 8W. The krypton laser is regarded as something of a breakthrough. Dr Yamada commented: "Many manufacturers, especially in the United States, now produce relatively strong argon lasers, but there are no other strong krypton lasers. We believe ours to be the most powerful in the world."

Basically, the laser television system operates in the following manner: The composite video signal, either off-air or closed-circuit, is processed, and the colour information separated into red, green and blue components. The colour signals are then fed to specially developed video amplifiers, which boost signal level to 1000V. Crystal light modulators are used to impress the colour signals on to the three laser beams. The beams are then passed to a mirror system which combines them into a single multi-coloured beam and relays the composite beam to the mirror drum scanner system. This has one drum with 16 mirror faces, reputedly rotating at 60,000rpm to form the

horizontal scan; and a second drum with 24 mirror faces, rotating at 150-rpm for the vertical scan.

In the opinion of Dr Yamada, practical use of laser television is still five to 10 years away. Some problems still have to be solved—for example, the limited life of the currently available lasers. Because of the high power, life expectancy is only a few hundred hours. With lower-powered lasers, this could be increased to something like 500 to 1,000 hours, so improvements in the optical display system are needed to increase transmission efficiency. Dr Yamada hopes eventually to be able to use gallium molybdenate crystals in the light modulators, instead of the dipotassium phosphate crystals used at present, but crystal size obtainable at the moment is still too small.

The future of laser television is seen to be in situations where large screen colour TV displays are needed, such as classrooms, air traffic control centres, simulators and in public entertainment.

COMMENT: Laser television as a demonstration feature at EXPO '70 may make an impressive display, but whether it has any future remains to be seen. The high intensity and spectral purity of laser light may be points in its favour but whether, in practice, this is significant enough to justify a return to the mechanical scanning systems abandoned in television practice 30 years ago is debatable.



no shouting needed:

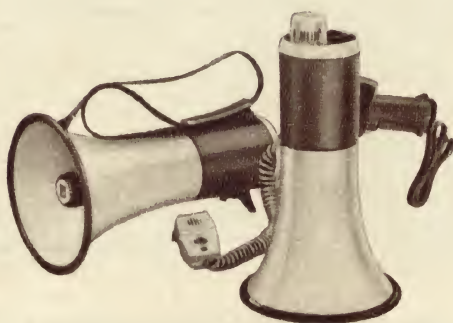

TOA MEGAPHONES

If you've got something to say, if you direct traffic, train a team, fight a fire, direct construction, start a race, make a movie, or simply sound off.

TOA amplifiers are lightweight, easy to operate, rugged and fully transistorised.

TOA equipment delivers high efficiency, long life and the kind of full colour sound that stretches carrying power even under the most difficult conditions.

ER308 hand-operated pistol type. Fully transistorised, battery operated. Maximum output is 16 watts. Special mic construction makes it

feed-back proof. This enables maximum volume. Projects voice up to 1,000 yds. Weight, 3.5 lb.

ER64 shoulder type. Details as ER308.

ER45 shoulder type as ER64. Plus equipped with emergency alarm. Red all over and covered in reflective red tape which glistens in the dark.

ER65 shoulder type as ER64. Maximum output 20 watts (most powerful in the world). Can be installed as stationary type. Projects voice to 1,500 yds. Weight, 6.5 lb.

All models are leakproof and backed by the unrivalled AWA sales and service organisation.



AMALGAMATED WIRELESS (AUSTRALASIA) LIMITED

Australia's National Wireless Organisation



TOA ELECTRIC CO. LTD.
Public Address Equipment

AMALGAMATED WIRELESS (AUSTRALASIA) LIMITED: Sydney, Newcastle, Canberra, Brisbane, Melbourne, Hobart, Launceston, Adelaide, Perth; and also Chandlers Pty. Ltd., Queensland, and Newton McLaren Ltd., South Australia.

THEATRE BOOKINGS BY COMPUTER

Buying tickets for theatres, concerts and boxing matches soon will be computerised in London. The "Computicket" tells you instantly whether the position you want, on the day you want, at the price you want to pay, is available . . .

By Trevor Blore

Demonstrations are being organised in London of a system to computerise the booking operations of the capital's huge entertainment industry, from theatres to sporting events. It is regarded by its promoters, International Data Highways limited (I.D.H.), as the first stage of a plan which should ultimately take in much of Europe as well.

I.D.H. has bought, from a Californian company, the rights of this "Computicket" system for Britain, western Europe and some eastern European countries. It is due to go into action in early 1970.

This is how it works:

A central computer complex is programmed with the seating and prices of all places of entertainment which are to have their box-offices computerised.

At outlying points throughout the hundreds of square miles of Greater London, and beyond, will be the booking terminals connected to the central computer by Post Office telephone lines.

At the computer centre, electronic message-handling facilities switch the ticket-booking inquiry to the correct sector of the computer.

The terminal is a desk unit, providing a local operator with a keyboard which transmits inquiries for tickets and subsequent booking commands to the computer; a display, something like a television screen, first shows the details of the inquiry, so that the customer can check them, and then shows the computer's reply as to the best seats available in a particular section of the theatre at the specified price.

There is also a small printing unit controlled by the computer which issues the actual tickets as soon as the booking is confirmed. The customer goes away with his ticket and in the knowledge that the computer cannot make a double-booking which could lead to an embarrassing situation when he arrives at the theatre.

The ticket specifies, not only the name of the theatre and the show, but also the day, date and time of performance, the number of the seat, the row and the correct aisle approach within the theatre or stadium. It also carries a colour code which tells the ticket-collector at the door how to direct the customer to his seat.

Mr Charles Burt, Chairman of International Data Highways, explained: "Our system works in real time and is a multiple access one, so that an al-



The terminal unit of the "Computicket" machine. Once the operator punches in the request, the response of the machine is almost instantaneous. The machine also prints the tickets.

most unlimited number of terminals can have access to the computer at the same time and each terminal operator will feel that he has instantaneous, individual use of the computer.

"Our Computicket system will be available to any place of entertainment which appreciates the great advantages of having its box office operation computerised.

"The terminals can be at all kinds of retail outlets — in ticket agencies, hotels, supermarkets, department stores, women's hairdressers, airports, and, of course, attached to the box office of the places of entertainment themselves.

"Already, eight or nine large organisations, with multiple retail roles in the London region, have expressed great interest in our system.

"Eventually we hope to penetrate deeply into Europe. There is no reason why a German visitor leaving for London should not be able to make an advance booking for a London show before he departs—or an English visitor to the Continent make an advance booking for a German festival, either for one performance or a season ticket."

Technical experts of I.D.H., which has wide experience in the computer field, are well ahead with preparing the software for the London system.

The memory banks of the "Computicket" are given detailed descriptions of event management and are told the event site, scheduled events, dates, times, prices and house scales, sections, aisles, rows and boxes, seat numbers, seat status and quality codes, colour codes, car parking information, tax discount ticket information for such cases as party bookings, information about seats reserved by the management for distinguished guests, and the allocations of blocks of seats for sale by brokers.

The computer can recognise and answer the demands of a customer right down to the specification of seats adjoining an aisle of the theatre, arena or stadium. If the section or

price specified by the customer is already booked up, the computer will search its memory bank for the next best seats still available, and offer these to the customer. When the seats are actually booked and tickets issued, the computer cancels these out of its memory so that they cannot be offered again.

The terminal operator is not prevented from completing a sale because the customer has given incomplete or incorrect information about his requirements. The central computer, in such cases, flashes back the complete and correct information for display on the terminal's screen.

A special box-office terminal at the event site, operated by the management's own ticket personnel, provides additional special services, such as a display of current running totals, box office statements and advance sales reports by individual event. By use of a private control key and confidential identification code at his terminal, an event manager can obtain sole access to certain confidential sales information at any time. Electronic circuits make it impossible for one management to receive another management's reports.

An additional service covers the highly successful shows which are known to be booked out for a considerable time ahead. The prospective purchaser is then informed of the earliest date on which the seats he has requested will be available. The purchaser may then request tickets for the first day they are available, or for a specific first day available, such as a Monday or a Tuesday. Then the booking operation is carried out as usual.

In the case of discount sales, where an event management offers cheaper seat prices to teachers, students' children, groups or other categories, the terminal operator passes code letters to the computer by the terminal keyboard, and the computer can make the booking accordingly. Such system code letters are TE for teacher, ST for student or CH for child.

AUSTRALIA'S TV PIONEERS

When did the first television transmission take place in Australia? Would you believe 1949? or even earlier, perhaps 1939? In fact, the exact date for this historic occasion was January 10th, 1929, when test transmissions began from the Melbourne radio station 3UZ.

By Harry Tyrer

The results would certainly not compare with modern television. In fact, the transmissions were made using a low definition system of 24-lines per picture, and without sound.

The organisation behind these demonstrations was Television and Radio Laboratories Pty. Ltd., formed by a Melbourne radio engineer, Mr Donal McDonald, who became its first managing director. The technical side of the transmissions was handled by Mr Gilbert Miles. Mr Miles was previously chief engineer with a Hobart Radio station, and was one of Australia's early radio amateurs, with callsign VK3IL. (He now lives in the Sydney area, and has callsign VK2KI.)

These two men apparently had boundless enthusiasm for the new art, and no doubt, in later years, permitted themselves an indulgent smile when assessing in retrospect their high hopes against the comparatively crude system they used, and the correspondingly crude results obtained.

In September, 1928, the company published the first issue of a magazine entitled "Radiovision," described as "An Australian journal devoted to television and allied subjects." The explanation of the journal's title in this first issue shows the attitude of mind of these concerned with the early experiments:

RADIOVISION OR TELEVISION!

Is this new art as applied to Broadcasting to be called by the old name — Television — or by the newer one — Radiovision?

Attempts at television date back to the early eighties, and were on very similar lines to those now generally employed (except that there was then no such thing as a valve amplifier), and the name Television was naturally adopted, for at that time radio was not in existence, but as it would now seem that as greater development is likely to take place through the medium of broadcasting than through physical line channels, a differentiation would appear to be, not only justified, but necessary.

The proposal is to employ the term Television where physical communication channels are used, and Radiovision where the transmission is by radio. We will, in the future, adopt this nomenclature ourselves and confidently recommend its general adoption. In Australia, we are on the eve of big things in Radiovision, and much confusion will be avoided if matters of this nature be made clear at the outset.

That the enthusiasm of the editors of "Radiovision" tended to outstrip the state of the art is to be found in the encouraging announcements which appeared in many issues of "Radiovision." One such pronouncement says: "... we have no hesitation in expressing the confident opinion that within a year every broadcasting station will be a Radiovision station too." (October, 1928).

Optimistic statements of this kind produced a reaction in official circles, where a more tempered view of "Radiovision" was held. In a following issue of "Radiovision" there is a brief

mention of a statement by the Postmaster-General, warning the public "against investing in concerns which may hope to profit by the introduction of a television service."

Before embarking on its public "Radiovision" broadcasts, the company had been working on a facsimile system for sending pictures by wire, hence the use of the word "television" in its name. They had constructed prototype equipment capable of reproducing pictures of good standard, and were pushing ahead with a scheme to transmit news pictures to country newspapers, by radio.

They had proved the feasibility of the system by transmitting pictures from the laboratory in South Melbourne to the home of Mr Miles, in Glen Iris. Shortly after this, Mr Miles was married, and the members of the company's staff sent a congratulatory message to his home via the system which the newly-weds read at their wedding breakfast. Mr Miles believes this is the first time such a message was transmitted in facsimile form anywhere in the world.

The laboratories where the experiments were conducted were closely guarded to prevent competitors from gaining knowledge of the work being carried out. A report which appeared in the Melbourne "Age" some years afterwards says the laboratory "was fitted with burglar alarms on every door and window, and the windows were guarded by heavy iron shutters. Here, in an atmosphere of profound secrecy, experiments were carried out, and apparatus built by McDonald and Miles. Such a veil of secrecy surrounded the place, in fact, that it was common gossip in the district that the experimenters were building a new type of submarine."

In the process of their work, the experimenters apparently became interested in the idea of sending pictures to private homes, by using apparatus attached to ordinary radio receivers. From there, the idea of sending moving program material for reception on a Baird-type scanning disc receiver was advanced. The experimenters therefore set about preparing slides, and cartoon type strips incorporating motion, for transmission. They commenced sending pictures, using this material, from Station 3UZ on January 10th, 1929. Shortly after, Station 3DB was also used.

The transmissions were quite simple. To use the words of the experimenters, as published in "Radiovision," February, 1929:

"... the object is to demonstrate the soundness of principles rather than to show perfection in detail. A compromise has been found desirable, mainly with a view to keeping the cost of the construction of the transmitter within reasonable limits, and to provide the maximum light at the receiver.

"The subjects that have been selected, and which clearly demonstrate the operation of the system, are:

(a) Silhouettes and geometric figures with definite outlines.

(b) Motion pictures on similar lines to (a).

(c) Definitely graduated half-tone test slips.

"We do not, at present, propose to transmit subjects containing greater detail for several reasons, the first being the increased cost of construction and maintenance of our transmitting appliances, and the second to enable such matter

LEFT: A section of a cartoon film strip used for the 1929 experimental transmissions.

as we broadcast to be transmitted without interference to other broadcasting stations, and to permit them to be received without abnormal distortion by anyone with the aid of an average set of good quality."

The reference to "interference to other broadcasting stations" draws attention to the limited bandwidth available to the experimenters. They were operating within the normal broadcast band, using a normal broadcast transmitter, and had to restrict their modulating frequency to the 10KHz allowed for operation of broadcast stations. Compare this with the 5.5MHz of today's TV stations, and it is not difficult to see why a 24-line system was used.

The transmitting system employed a Nipkow disc and photoelectric cell. This system suffered from all the limitations of the mechanical scanning process which led to its eventual abandonment in favour of the electronic scanning system. Television as we know it today, based on the cathode ray tube, was not then a practical reality, although the British engineer A. A. Campbell-Swinton had suggested such a scheme in 1908, and described a complete system in a paper in 1911. (See "Electronics Australia," August, 1967, page 25). His scheme was for pictures transmitted by landline, however, since radio broadcasting was not then possible, the valve having not been invented. At the time of the early Australian experiments, all schemes for broadcast television were based on mechanical scanning methods, as exemplified by the Baird system.

It may be as well at this stage to consider the receiver system being advocated by "Radio-vision." The vision receiver was regarded as an adjunct to the normal domestic broadcast receiver. This picked up and amplified the transmitted signals, and the output was fed to a neon lamp instead of to a loudspeaker. The modulations caused the lamp to change in brightness according to the instantaneous amplitude of the transmission, which varied according to the light and shade of the image being scanned at the studio. A rotating disc of the Nipkow type in front of the neon lamp produced the scan lines which recreated the picture in crude form, with the limited number of lines used for the system.

The scanning disc had to run in synchronism with the disc used for the transmissions, and was controlled manually by means of a speed regulating device for the motor driving the disc.

A simple system such as this was well within the capabilities of the radio experimenters of the day, and it is this very simplicity which apparently engendered such wild hopes on the part of the early experimenters.

It is not surprising that this simple apparatus was capable only of crude results. Nevertheless, to the television enthusiast, the mere fact that it worked at all suggested endless possibilities for television. In its January, 1929 issue, "Radio-vision" made the following comment: "It is safe to say that before the end of the coming winter, radiovision will occupy a very important place in broadcasting circles."

Despite the high hopes, and the brave talk, the "radiovision" experiments were abandoned in 1929. The depression was on the way, and no doubt by now the experimenters were beginning to realise the limitations of the mechanical scanning system. The company therefore decided to concentrate on the manufacture of broadcast receivers, for which there was a steady demand. They continued an active interest in picture facsimile transmission, and tendered for the supply of picturegram equipment for the Sydney-Melbourne system which went into service a few years later. Their tender was not accepted.

There were other Australian experimenters interested in television transmission at the same time as the experiments described here, but the broadcasts from 3UZ and 3DB were the first public broadcasts in Australia. Nearly 30 years were to pass before the dream of a public television service became a reality. ■



ABOVE: Mr Gilbert Miles operating a facsimile device for transmitting pictures by radio, developed by Television and Radio Laboratories Pty. Ltd.



RIGHT: An electrochemical picture transmitted by radio with the Television and Radio Laboratories equipment.

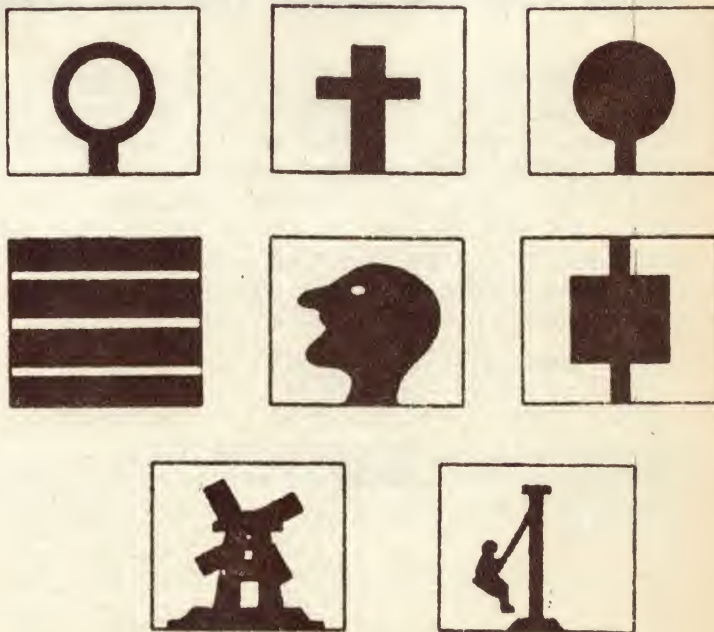

Examples of the simple outlines transmitted from Stations 3UZ and 3DB in 1929. The two lower diagrams are single frames from a moving picture sequence.

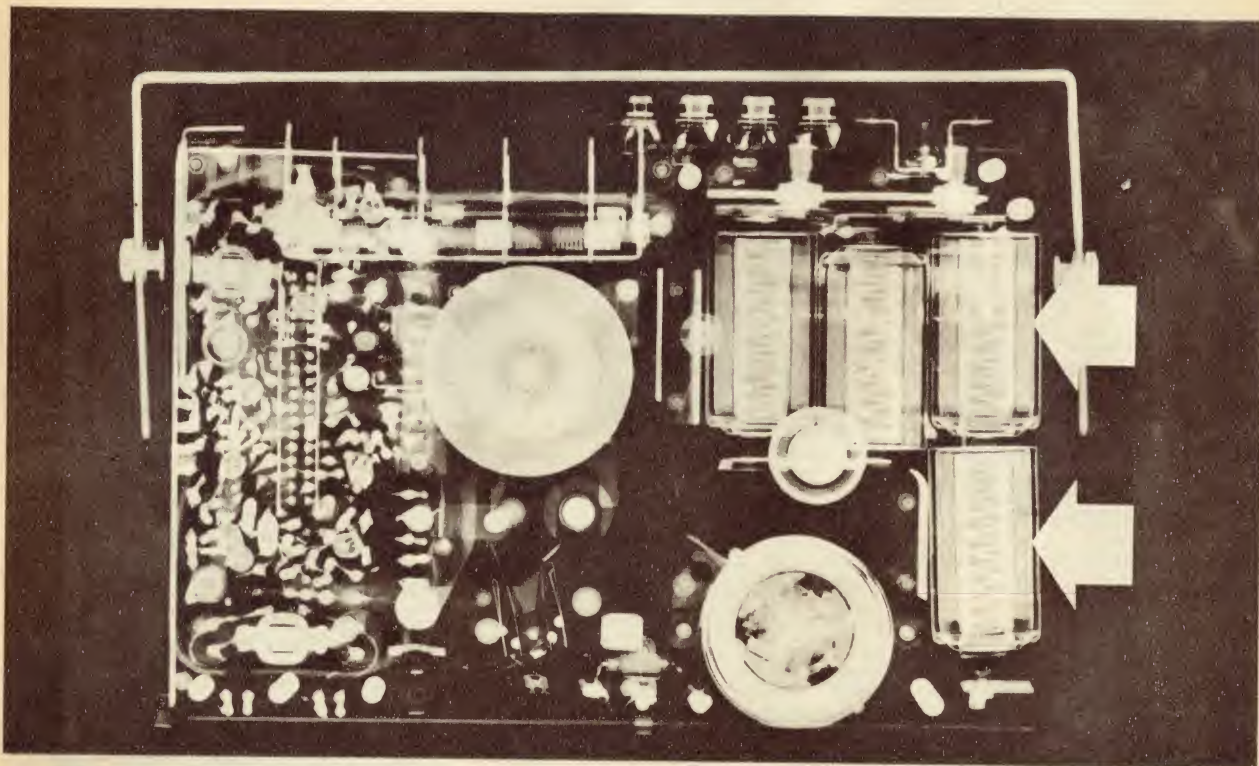

The more they put into tape recorders

the more you need Duracell®

They put in interlocks to give you sound-on-sound. Automatic shut-offs to save you tape. VU meters, reset counters, automatic level controls—all built-in. Today's portable tape recorders have everything. But it takes heavy-duty batteries to run them. Many manufacturers now recommend Duracell. Duracell, the long distance power cells, pack a maximum of power in a minimum of space.

Inside its steel-jacketed body are almost a dozen patented advances — power cores, special seals and electrolytes. And they all work to stand up to the heavy drains of tape-drive motors. Keep voltage levels high for precise amplifier operation. Hold their power for years. Ask for Duracell—the long distance power cells — wherever batteries are sold.



**DURACELL. THE LONG DISTANCE POWER CELL
STILL GOING STRONG LONG AFTER ORDINARY BATTERIES ARE DEAD.**

Trade enquiries to Mallory Batteries (Australasia) Pty. Ltd., marketers of Duracell 439 2544

MALLORY

® Registered trademark of
P. R. Mallory & Co. Inc

MB2P00/68



TECHNICAL DIGEST

U.S. Navy plan for massive ELF communications system

A massive underground grid extended across some 21,000 sq. miles of northern Wisconsin, as part of a world-wide unjammable communications system, using Extra Low Frequency techniques, is planned by the U.S. Navy. The scheme has the code name "Sanguine."

The story of Sanguine begins during World War I, when German agents tried to intercept telephone conversations between French Army commanders by sticking electrodes in the ground. The noise they encountered was so great that radio engineers were called in to identify and eliminate the source of the mysterious interference.

The noises were identified easily enough as being generated by electrical storms, some very distant. But almost accidentally the investigators discovered a strange phenomenon. The low-frequency noise had a peculiarly strong resonance—an energy peak—at 7Hz. But the German experts thought this an interesting curiosity without practical value.

No one could blame them. Radio engineers were then experimenting with higher and higher frequencies. The higher the frequency, the shorter the wavelength (and vice versa). And the size of the transmitting antenna varies directly with the wavelength. So higher frequencies brought the payoff of smaller antennas. To produce ELF waves, the longest of all radio waves—would require the largest antenna ever conceived.

There was also the question of attenuation—loss of signal power with distance travelled. Experiments had revealed that the frequency least attenuated was around 10,000Hz. Below that frequency, the attenuation curve started back up sharply. No one bothered checking it below 3,000Hz because it seemed logical that attenuation would keep on increasing as the frequency dropped.

Then along came W. O. Schumann. An eminent German scientist, Schumann conducted studies in the physics of the atmosphere, and came to a remarkable conclusion:

The earth and the ionosphere formed the boundaries of a spherical resonant cavity, with a fundamental resonant frequency of about 7Hz. The earth is nearly 25,000 miles around. Radio waves, which travel at some 186,000 miles a second, would therefore travel around the earth in this cavity seven times per second. If the waves had a

matching frequency—seven Hz—and they were broadcast from a single source, they would circle the earth and meet exactly in phase. The result: a reinforcement, or resonance.

Schumann published the results of his findings in a series of scientific papers beginning in 1952. Other scientists picked up the cue and expanded Schumann's original findings. Among other things, they established that the Schumann cavity had a series of resonances beginning at 7Hz and continuing in increments of six or seven.

They also finished plotting the attenuation curve and found that it did not go up indefinitely below 3KHz, but, in fact, turned down again and headed back toward zero with lower frequencies. Below 100Hz, they learned, the attenuation would be almost negligible, even better than above 10KHz. In other words, frequencies below 100Hz could be used to signal around the world, using the Schumann cavity, with almost no attenuation.

Even so, many scientists were still sceptical about ELF. One of them concluded pessimistically, "Unfortunately for communication applications, the problem of building a large enough transmission antenna appears insurmountable." To be efficient, an antenna must at least approach in size the wavelength it is to transmit. ELF waves are thousands of miles long.

The U.S. Navy was not so pessimistic. For ELF could yield not only a one-source global communications system, but also the ability to signal nuclear submarines underwater. The reason is that the lower the frequency, the deeper into water a radio signal will go. At 10KHz, the signal delves only about 40ft beneath the surface. But at 100Hz, the depth is 400ft, and at 7Hz, 1,500ft. The ability of a sub to receive information without having to surface is obviously of vital strategic importance.

So, about 10 years ago, the Navy and some of its civilian contractors, notably RCA and Westinghouse, went to work on the problem of building an antenna big enough for ELF. And someone, somewhere, came up with an

ingenious idea, which led to Project Sanguine being sited in Wisconsin. The idea was: Take advantage of the fact that much of northern Wisconsin sits on a huge chunk of some of the oldest rock in the world.

This rock, the tip of a much larger formation called the Laurentian Shield, is more than two thousand million years old. It is therefore extremely dry. This gives it the lowest conductivity of any rock on earth.

What has all this to do with Sanguine?

Suppose you form an antenna from a wire by passing current through it and grounding it at both ends. The electricity seeks to complete a circuit by returning from one end of the wire to the other through the ground. How far this current actually penetrates the earth is called the skin depth. The lower the conductivity, the deeper the current penetrates. In moist earth, the current travels practically at the surface. But in the bone-dry bedrock of the Laurentian Shield, the skin depth can be 10 to 20 miles! And if your wire is a cable 100 miles long, the result is a whopper of a loop antenna.

A 100-by-20-mile loop antenna is impressive, but it would be a lot more effective if it had many turns. Because the ground is common, the turns can't be connected in series. But they can be parallel-connected, by crisscrossing the cables.

And here, again, the vast extent of the ancient rock plays its role. If the Navy utilises all of it, they will form a grid 150 miles wide and 140 miles long, covering almost the upper third of Wisconsin. Cables would intersect at six-mile intervals, with a transmitter at each intersection—perhaps 240 in all. The cables would be buried about 6ft underground, to get the wires out of harm's way.

This is the Navy's schedule. It has already built one transmitting antenna, two crisscrossed cables of about 14 miles each, near Clam Lake, Wis., in the Chequamegon National Forest—Federally owned land. The cables are strung on poles above ground with a transmitting station at the intersection. This complex will be used for a test program "to develop and perfect techniques and devices for reducing induced electrical interference to non-interference levels."

If this initial test is successful, the Navy will move on to the next phase.

Plessey Professional Carbon Controls

Plessey potentiometers use a hot moulded carbon track construction giving extremely low electrical noise throughout a long, trouble-free life. Unit life expectancy is in the order of 9,000,000 cycles of rotation with a resistance change of no greater than 1%.

The track consists of a phenolic moulding loaded with carefully controlled proportions of conducting carbon filler providing superior power dissipation and temperature coefficient characteristics compared to carbon film types.

Ganged potentiometers with track matching to within 1.6 db are available for stereophonic equipment, test instruments and other applications. Plessey have a wide range of DEF Qualification Approved and commercial type controls including miniatures and standards, printed circuit and edge-driven, also miniature pre-sets and fully sealed units designed to meet the most stringent specifications.

For further information please contact Professional Components Department, Ducon Condenser Pty. Ltd., Box 2 P.O., Villawood, N.S.W., 2163.

miniature and preset



Type MP (customer)



Type MP (dealer)



Type G Mark 5a



Type N Mark 2



Type Q

miniature sealed qualification approved



Type L Mark 2



Type M

standard and dual

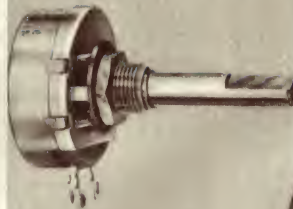

Type E

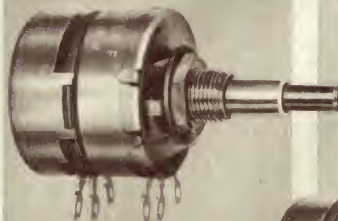

Type ED

double and triple ganged

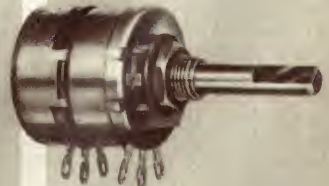

Type EC2.



Type EC3

PLESSEY
Components



Ducon Division
Plessey Components
Box 2 PO Villawood NSW 2163
Telephone 720133

Melbourne 42 3921
Brisbane 2 3287
Adelaide 76 3434
Perth 21 4821/21 7867

AD2

SPEECH TRANSLATOR FOR DIVERS

burying more and longer cables in the ground near Park Falls, Wis., southeast of Clam Lake, and conducting still more tests. If the Navy is convinced it has solved all the problems, it will go ahead and build the whole system. Although the Navy won't say how much current will flow through the final system, the cables in the interference tests will handle several hundred amperes. In previous pilot tests in another state, the large currents electrified fences, rang telephone bells, disrupted communications, and generally gave people the willies.

Here are some of the problems the Navy will consider, from the top down;

Air Navigation. Will Sanguine interfere with existing air navigation facilities? Very unlikely; most of them operate in much higher frequency ranges.

Power lines. Here, Sanguine is definitely a problem. The ELF signals of Sanguine — below 100Hz — could induce currents that would affect 60-Hz household electricity. Results might be flickering lights, TV picture hash, tripping circuit breakers. The solution is to convert to balanced power lines, which are much less susceptible to induced currents than unbalanced ones.

Telephone lines. The currents that ring the telephone usually operate below 100Hz; those that carry voice transmissions operate roughly from 200Hz to 3,000Hz. Induced currents could ring the telephones when no one was calling, and cause buzzing and other noise to interfere with conversation.

The solution is one the Bell Telephone system has been using for years to rid its lines of unwanted current—installing neutralising transformers.

Railway signals. Induced currents could turn signals on when no trains were coming or going, or turn the wrong ones on when they were. Fortunately, railways in the Sanguine area use mostly balanced circuits already.

Metal fences. If a metal fence, with metal poles stuck in the ground, runs for any length—say a mile or more—parallel to a power line, it can carry an induced current, and may create a dangerous situation. The Navy will ask permission of the owner of any such fence to chop it into shorter segments, then hook it together again with insulating materials cutting the closed loop.

Animal and plant life. Could underground currents endanger plants and animals? The Navy will explore Sanguine's possible biological hazards, using plants and animals native to the area.

Cable television. CATV, or cable television, uses a master antenna for a whole community, and feeds TV signals to homes of subscribers via cables susceptible to induced currents.

The solution appears simple. CATV systems employ booster amplifiers at various intervals. Interrupting the outer shield of the coaxial cable with capacitor couplings at the amplifier stations, would break up the closed loops.

The Navy is confident it can overcome these hurdles, and has planned to spend the next four years running tests to prove it. Then, and only then, will the world's largest antenna be buried, and come to life. (Condensed from "Popular Science," September, 1969.)

A speech synthesiser developed by British electronics engineers kills the "Donald Duck" effect which makes deep sea divers speaking in a helium atmosphere sound as though they have been neutered.

The device, known as HUSTLE (Helium Underwater Speech Translating Equipment), is important because it will permit clear and unambiguous communications with the surface; so vital now that divers are being called on to carry out increasingly complex tasks at ever greater depths.

A helium-oxygen mixture is used for deep sea diving operations instead of the normal atmosphere, to prevent "divers' paralysis". This occurs when bubbles of nitrogen form in the body after a person who has been working in a compressed atmosphere returns too quickly to normal pressure.

The speech distortion results from the fact that sound travels at twice the speed in helium as it does in air and consequently the resonant frequency of an air cavity is doubled when helium filled. But speech intelligence is imparted to the basic vocal chord vibration by a series of resonant cavities in the vocal tract and which are modified by the speaker. He thereby modulates the basic chord vibration, imparting to it what are termed formant frequencies.

So in a helium atmosphere these

each channel the selected harmonics are modulated according to the control signal amplitude. However, the filters used are in each case centred on a frequency only about half that of the filter in the corresponding channel. After the channel outputs have been summed, this results in the restoration of the formants or consonants to their proper place in the spectrum and the divers' speech sounds more normal.

Work on this experimental prototype arose out of the B.B.C. program "Tomorrow's World," where a team of researchers described their work on coders. As a result of the program, they had a request from a diving company to develop a unit which would unscramble divers' speech.

Development work since then has translated a large general purpose rack into a small experimental prototype unit, which it is claimed, offers a performance far in advance of anything yet available.

Meanwhile, in the U.S.A., frequency transposition has been suggested as a means of aiding the very deaf. Dr James M. Pickett, Director, Sensory Communication Research Laboratory and Professor of Speech Communica-

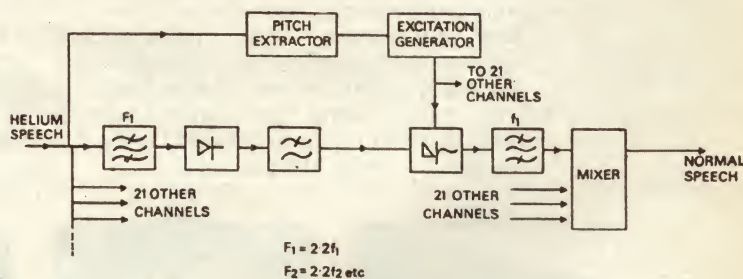

formant frequencies are raised in pitch, their frequency distribution is spread and the result makes speech unintelligible. However the fundamental frequency is unaltered as it is a mechanical vibration of the vocal chords. It is also characteristic of the speaker and any speech processing must preserve its characteristic quality.

So in the HUSTLE equipment this fundamental frequency is extracted and is used as a building block from which the resynthesised speech is built up.

A continuous real time analysis is also performed to extract the information imparted by the vocal tracts. The analysis is carried out by dividing the speech spectrum into 22 slices each 300Hz wide by using filters. After this input bandpass filter, the signal is rectified to obtain the envelope. This resulting DC signal is lowpass filtered at 35Hz to smooth it, before being used to reshape the vocal chord vibration.

The resulting signal is then applied to a set of synthesiser filters and in

tion Research, Gallaudet College, thinks that by transposing speech information in the middle and higher frequency ranges down to lower ranges, people with impaired hearing and severely deaf people can be considerably helped.

In one experiment a transposer operated by sampling, storing and slow play back so as to restore the original time patterns of speech but dividing the original frequencies by two. With training on identification of transposed words, deaf pupils improved with practice but the training also improved their identification of normal non-transposed words to an even higher level of performance than for transposed words.

Another transposer leaves the mid-frequencies unchanged and transposes only the higher frequencies. Tests with this transposer showed dramatic improvements in discrimination of fricative and stop consonants by profoundly deaf children.

(“Electronics Weekly,” 18/6/69.)

How to put a battery in its place

Silver is the Eveready low-priced battery for torches and transistors used occasionally.

Red is the Eveready medium-priced battery for transistors, torches and appliances used frequently.

Gold is Eveready's new alkaline battery. Gives up to—10 times more service in toys; 7 times in industrial torch use; 6 times in cameras; 5 in tape recorders and record players; 4 times in flash guns and 3-4 times in transistors.



EVEREADY

BATTERIES Products of

**UNION
CARBIDE**

Eveready' & Union Carbide' are registered Trade Marks

E121R

"TOUCH-AND-READ" PROBE SIMPLIFIES LOGIC CHECKS

A Hewlett-Packard "touch and read" logic probe clearly signals the presence of nanosecond pulses and indicates logic levels in TTL and DTL integrated-circuit logic networks.

In checking out integrated logic circuits, voltmeters and oscilloscopes are indispensable for measuring logic levels and observing pulse shapes. However, now that IC logic threshold voltages and switching characteristics are becoming standardised, the checkout problem often reduces to questions like "Is the voltage on this logic line in the high state or is it in the low state?" or "Are pulses present on the line?" In these cases the voltmeter and the oscilloscope give more information than is wanted. What's more, an oscilloscope requires several adjustments to display pulses, and it may also require a viewing hood, if the pulses are narrow and widely spaced. A better instrument for checking IC logic would be a small one which would clearly indicate levels and pulses, even single narrow pulses, and wouldn't require the user to shift his eyes from his circuit. Triggering should be automatic, without slope or level adjustments.

From these considerations came the idea for the Model 10525A Logic Probe. The probe is an inexpensive logic-signal-tracing instrument compatible with TTL and DTL integrated circuits which account for the majority of new logic design. Mounted near the tip of the probe is an indicator lamp which flashes on for 0.1 second when a positive pulse occurs on the line being probed, extinguishes for 0.1 second when a negative pulse occurs,

glows brightly for a high logic state or an open circuit, turns off for a low logic state, and glows at partial brightness for pulse trains. Single pulses as narrow as 25 nanoseconds will trigger the probe.

To see whether the probe would be useful to logic designers, several prototypes were built and made available in the H-P laboratory. The response was enthusiastic; all of the probes were soon in constant use. There seems to be no doubt that the probe fills a need in the development and trouble-shooting of logic networks.

For operation, the probe requires a source of five volts and a ground return. Usually the probe can simply be clipped into the supply and ground fuses of the circuit being tested. A small laboratory power supply and a ground jumper may also be used.

One way to use the probe is to operate a logic circuit at its normal clock

rate and probe from point to point, checking for the presence of timely pulses such as clock, reset, start, count, shift, transfer, and so on. This gives a quick indication of any sections of the circuit which are not operating. A second technique, which is especially useful in serial arithmetic units and other sequential machines, is to replace a unit's internal clock generator with a slow external pulse generator which produces approximately one pulse per second. Then single pulses and state changes can be observed in real time with one or more logic probes. (Multiple probes are especially helpful for observing timing relationships.) These real-time observations, and the ease with which the probe's indications can be interpreted, usually give an experienced designer a strong intuitive feeling for what a logic network is actually doing.

Inside the probe is a logic board containing 22 discrete components and an integrated circuit. The probe has an input protection circuit which will withstand overloads as high as +200V. The input circuit is followed by a high-impedance input amplifier which sets

BELOW: The probe's lamp lights when the probe touches a high logic level or open circuit, turns off for a low level, and glows dimly for a pulse train. Pulses between 25nS and 0.1S are stretched to turn the lamp on (positive pulse) or off (negative pulse) for a full 0.1S

RIGHT: Inside the probe are 22 discrete elements and an integrated circuit.

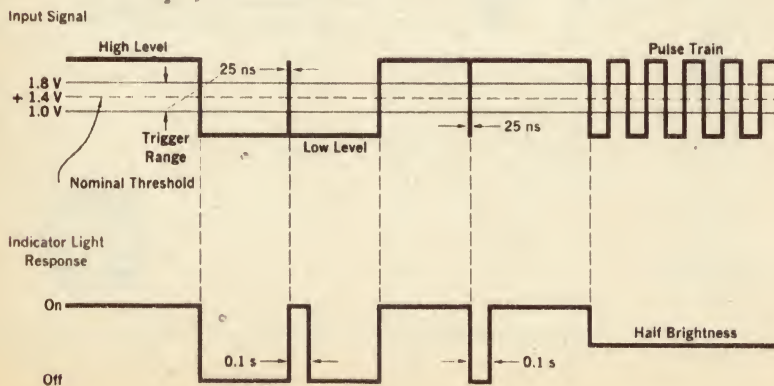
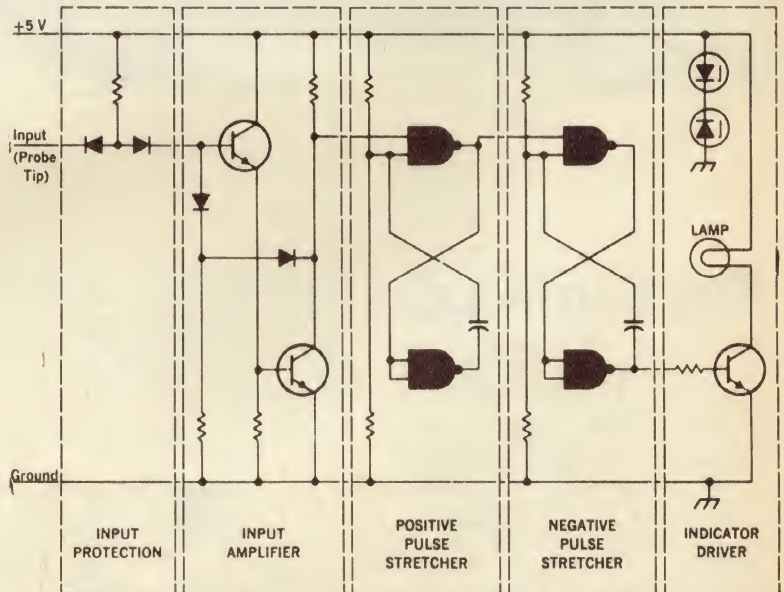

the input threshold at +1.4V with respect to the probe's ground lead. This is compatible with TTL, DTL and some other types of logic (but not ECL). Non-linear negative feedback prevents saturation and enhances the switching speed of the input amplifier. Two pulse stretchers follow the input amplifier; one triggers on incoming positive pulses and the other on incoming negative pulses. Each stretcher is a monostable multi-vibrator formed by cross-connecting two NAND gates. When one multivibrator is stretching, the other acts as an inverting amplifier. The second stretcher controls the lamp driver. ("Hewlett-Packard Journal," June, 1969.)



“The day anyone can deliver me SCR's and diodes straight away I'll give 'em an order.”

Start writing!

STC and NEC have combined in an exclusive marketing agreement to provide them all by the plane-load! Ready now for delivery.

Silicon controlled rectifiers, avalanche rectifiers, TRIAC's, DIAC's and unijunction transistors are included. The complete and widely accepted range of NEC SCR's and power diodes are immediately available to you under this exclusive agreement.

Additional information on new products geared to the dynamic and competitive Japanese Power market, is also immediately available to you. Information on the 3000V 600 amp diodes and matching SCR's to a cheap reliable range of TRIAC's.

Order now from STC, sole Australian market outlet.

Call or telex (collect), your order direct to STC Components Division.
 Phone Sydney 602-1314, 602-1329, 602-1369; Melbourne 480-1255;
 Brisbane 47-4311; Adelaide 51-3731;
 Perth 21-6461. Or telex Sydney 20328.



For more details and free brochures fill in the coupon:

Please send me information on

.....

.....

NAME

COMPANY

ADDRESS

..... POSTCODE

Standard Telephones & Cables Pty. Limited
 Moorebank Avenue, Liverpool N.S.W. 2170

AN **ITT** world-wide telecommunications and electronics
 ASSOCIATE



U546A



SCIENTIFIC AND INDUSTRIAL NEWS

Magnetic card typewriter

IBM Australia has introduced an electric typewriter which allows a secretary to record each page of her typing on a magnetic card. Called the IBM Magnetic Card Selectric Typewriter, it is expected to be particularly effective for work which requires frequent retyping of standard content material or constantly revised documents. The machine uses Mylar-based magnetic cards, identical in size to the punched cards widely in use, each with a capacity of 5,000 typed characters.

In use, a magnetic card is inserted into a small console placed alongside the typewriter and a letter is typed on its standard keyboard. If a mistake is made while typing, the typist backspaces and then types over the error with the correct letter or word. The recording on the card is automatically corrected. Once the typing is completed, and all corrections have been recorded, the typist inserts a fresh piece of paper in the machine, presses a button, and a perfect copy is typed out at speeds of up to 180 words per minute. After copy has been typed, new words, lines or whole paragraphs can be inserted. Only the changes must be typed in, the remainder of the stored copy will type out automatically.

Since each line or track on the card is easily correlated to the corresponding line on the typed page, the exact place where a change is to be made can be located in seconds by pressing a button and scanning the appropriate track. The magnetic card is prenumbered for filing convenience and may be stored for future reference or immediately used again to record and play back new material.

Data system for Hovercraft

An advanced data handling system will be used by Tracked Hovercraft Ltd. in the testing of a new Hovercraft initially capable of carrying 100 passengers at speeds of up to 250 mph. Experimental vehicles will be tested on a 20-mile site near Cambridge, England, and test runs will be of short duration due to the high speeds.

The data equipment, supplied by the British Aircraft Corporation's Space and Instrumentation Group, will collect 432 measurements sequentially from all parts of the craft at sampling rates up to 512 samples per second. The information so gathered will be converted into a continuous stream of digital data at a rate approaching a million bits per second. The information is transmitted in serial form and includes addresses, labels, and frame identification. The data will then be relayed over a UHF radio link to a base station where it will be recorded on magnetic tape and fed directly into a computer. The computer will process the information so that design engineers can receive the results of the trial in the shortest possible time.

Seawolf missile

The Marconi Company, Chelmsford, Essex, England, has been awarded a contract by the British Ministry of Defence to continue development work for the complete electronic system for Seawolf, a new generation of missile for the Royal Navy. Seawolf will be an advanced shipborne, point defence system with an anti-missile capability. Completely automatic in operation, it will have an extremely short reaction time and the

high degree of accuracy necessary to destroy a small and rapidly moving target. Once a target has been identified as hostile, all phases of the launch and guidance sequence will be carried out automatically and without further manual control.

Marconi is responsible for the complete electronic equipment of the missile system, including surveillance radars, target tracking radar, missile gathering and guidance television, data handling and display of equipment, and command guidance communications. The company is also responsible for all aspects of management and co-ordination of development of the complete system. A major part of the data handling equipment is sub-contracted to Ferranti, and will be based on the Ferranti computer type FM1600B. The airframe and rocket motors for Seawolf are currently being developed by the British Aircraft Corporation, and the launching system by Vickers.

Post Office at CETIA

The Australian Post Office is to be very actively engaged at the 1970 National Control, Electronics, Telecommunications, Instruments and Automation (CETIA) Program to be held in Melbourne from February 23 to 27, 1970. (See "Electronics Australia," November, 1969, page 41.) Papers will be presented by the Post Office on the following subjects: Satellite communications; Electronic switching exchanges; The flexibility of the Post Office telecommunications network; Remote control of radio systems; Modern automatic mail handling equipment.

Two major working displays by the Post Office will be presented at the exhibition. Working demonstrations on several facets of important work at present being carried out in the Post Office research laboratories will form one display. The other will show the flexibility of the Post Office network in providing facilities for Australia's business and industry. Linked through the network to remote stations, the display will feature on-line demonstrations of terminal equipment. Operational equipment will include: A time-sharing terminal giving access to a central computer; A magnetic tape encoder to record data on a computer magnetic tape; Data modems for connecting data processing equipment to the telephone network; Facsimile equipment for document transmission; A bank teller terminal linked into a central computer; An electrowriter for the transmission of handwritten material.

SSB time signal ceases

The experimental single-sideband time signal transmission from VNG Lyndhurst, Vic., on 20.5 and 25.5MHz has been terminated. The normal double sideband transmissions are continuing with the following schedule: 0945-2130GMT, 4.5MHz; 2245-2230GMT, 7.5MHz; 2145-0930GMT, 12MHz. Times of resumption of emission following the break for frequency change are approximate.

Students' satellite tracker

Six British pre-university students, including one girl, designed and built this tracker aerial for weather satellites in 10 weeks for a cost of about \$200. Designed to receive data from the weather satellites that continually pass in polar orbit over Britain, it is code-named POINTER (Pre-university Orbital Information Tracker Equipment and Recorder.) The aerial, which can be controlled either manually or remotely, will traverse through 360 degrees of azimuth and vertically through 190 degrees for horizon-to-horizon tracking. The control panel enables the operator to track the target with the aid of headphones, or to pre-set the controls so that the aerial follows the predicted orbit of the satellite.

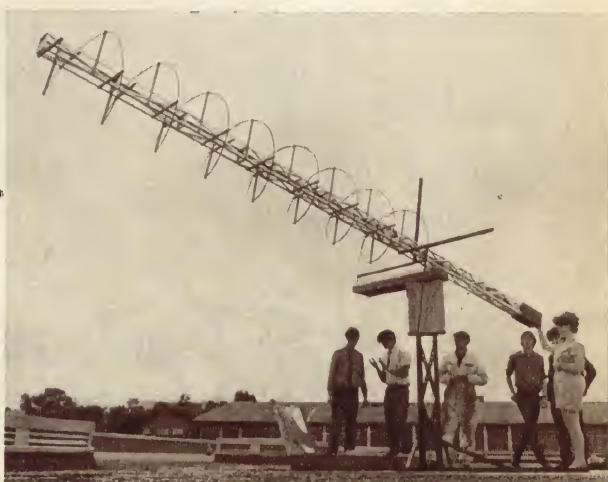

DESPITE the initial reservations felt by many people, particularly with reference to servicing, the printed circuit is now firmly established in most types of electronic equipment, ranging from the incredibly cheap pocket radios that have flooded the country in recent years, to some of the most sophisticated professional equipment available. Its origins lie in weaponry — a heritage unfortunately common to many good "electronic" ideas, but printed circuitry is, and indeed has been for some time, an attractive system for the amateur who constructs his own equipment, for it solves the mechanical problems of component mounting and eliminates the chores of wiring — as well as facilitating a neat and workmanlike job. For the amateur who has so far shied away from etching his own boards, a new system is now available, which is both economical and easy to use, yet with care, is capable of excellent results. Known as **Cir-kit**, the system utilises bakelite boards, similar to those used commercially, in conjunction with self-adhesive copper strip. This is 1/16in or 1/8in wide — easily cut with scissors or a model knife — and attaches to the boards rather like a piece of Sellotape. The adhesive is very efficient, although the bond is not quite as good as that on pre-laminated boards — which means that care is needed when soldering not to overheat the copper. However, anyone who is competent to solder a transistor or capacitor without causing damage should have no trouble, and the adhesive improves with aging, so that long-term stability is satisfactory. Layouts can normally be planned using the theoretical circuit diagram as a guide, and boards may be pre-punched or drilled according to requirements. With the pre-punched board, the strip can either be laid over the holes, and then punched through with a small drill or a watchmaker's screwdriver, or it can be laid alongside the holes and component leads are inserted through the board, folded over and soldered (see photo). The former method permits a more compact layout.

A few tips on planning layouts. Always be sure that the component spaces you allocate are adequate — it is preferable to purchase the bits before embarking on this task, although capacitors are available in literally dozens of shapes for board mounting and resistors are more or less of standard size, dependent on ratings. Avoid siting adjacently on to your layout components which are in different stages — as this can lead to instability. If instability does occur, of course, **Cir-kit** does permit alterations to be made, although it is as well to investigate the problem before redesigning sections of the board for it may not prove necessary.

The excellence of the system, however, lies in its versatility, for it enables the home constructor to produce a wiring board on a one-off basis for most of the circuits described in this and other journals, and while it will no doubt encourage many to "try their hand," it will also enable many who already build their own equipment to achieve neater, more reliable results with a minimum of fuss.

**AVAILABLE ALL LEADING
RADIO HOUSES.**

(SOLE AGENT)



ZEPHYR PRODUCTS PTY. LTD.

70 BATESFORD ROAD, CHADSTONE, VICTORIA—PHONE 56-7231

MANUFACTURERS OF RADIO & ELECTRICAL EQUIPMENT & COMPONENTS

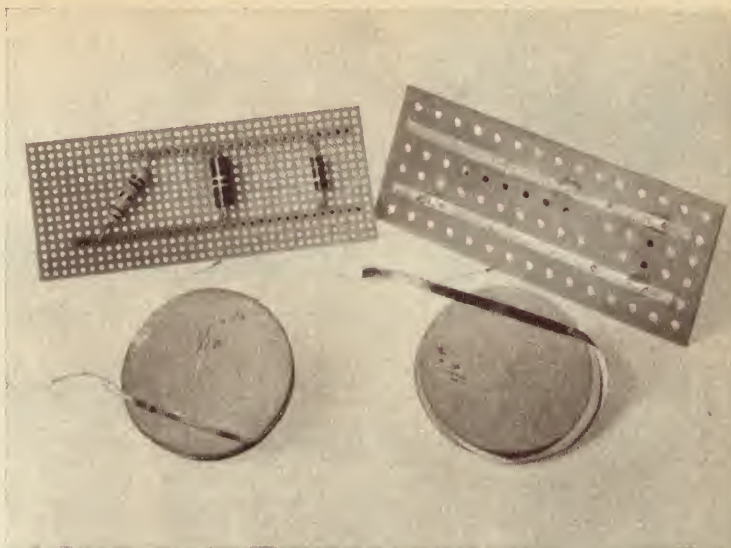

INSTANT CIRCUITS

A new method of making component boards using self-adhesive copper strip.

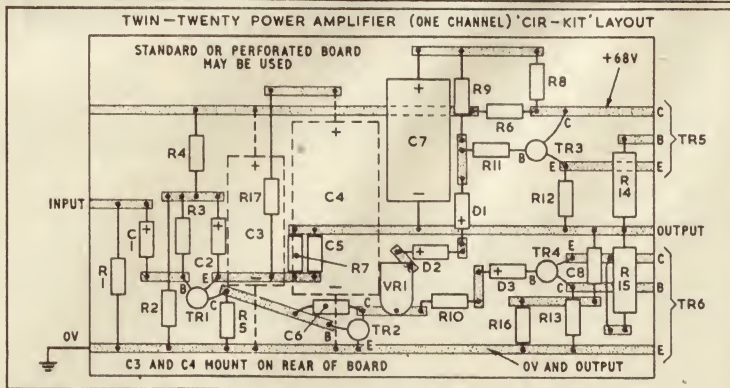
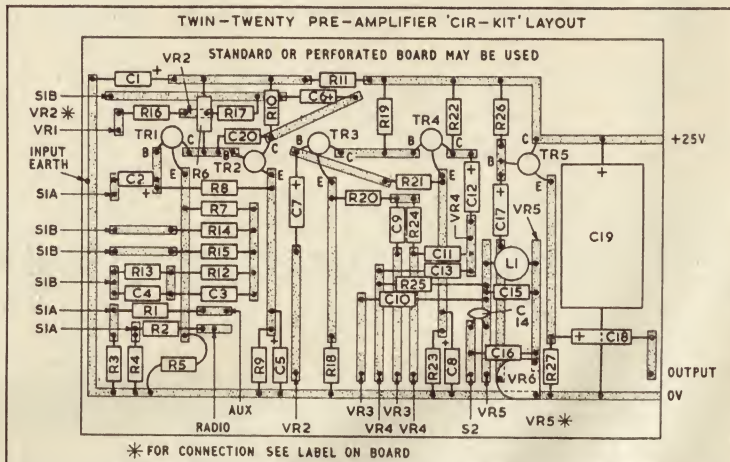

Commercial broadcasting

The Postmaster-General's Department has received only one application for a licence to operate a commercial broadcasting station at Alice Springs. The application, from Alice Springs Commercial Broadcasters Pty. Ltd., has been referred to the Australian Broadcasting Control Board which will hold a public inquiry into the application on a date to be announced.

Opera on cassette

A full-length opera on stereo cassette is being marketed in the U.S.A. by Ampex Stereo Tapes. The opera is the London recording of Verdi's "La Traviata" featuring Pilar Lorengar, Giacomo Aragall and Dietrich Fischer-Dieskau. The performance is approximately two hours long, and is contained on two stereo cassettes packed in a simulated leather grained case. Other operas to be released in two or three cassette packages will include Puccini's "Tosca" and "La Boheme" and Donizetti's "Daughter of the Regiment."

Data service centre in Perth

A data service centre, aimed specifically at providing a technical and scientific data processing service, was opened recently in Perth, W.A., by IBM Australia. The centre is equipped with an IBM 1130 system and ready-made "package" programs. These are sets of computer instructions, pre-written by expert programmers, and ready for feeding to the computer with any of the standard engineering calculations which they are designed to handle. This requires a minimum of local programmer intervention and little effort on the part of engineers who submit the calculations. An experienced systems engineer and programmer is on hand to assist users with application problems and with the running of the computer. (IBM Australia Ltd., 159 Adelaide Terrace, Perth, W.A. 6000.)

Black Arrow electronics

This thermal vacuum space chamber, which simulates orbital conditions, is being used to test electronic equipment for Britain's Black Arrow X-3 satellite at the GEC-AEI development establishment at



Portsmouth, England. The Black Arrow X-3 technological satellite is one of a series to be launched from Woomera, South Australia, in 1971, using the all-British Black Arrow launcher. The main purpose of the spacecraft is to test various subsystems for use in later satellites, including a PCM telemetry system, power supply equipment, thermal control surfaces and solar cell assemblies. It will also be used to determine the micrometeoroid flux in the earth's outer atmosphere using a counter developed by the University of Birmingham.

Automatic message and data distributor

A low-cost automatic message and data distributor, originally conceived by the Department of Civil Aviation, is being manufactured by Philips Telecommunications of Australia Ltd. D.C.A.'s prototype unit was installed at Sydney Airport in 1968, and is currently handling the distribution of all local teleprinter traffic. The Philips unit, which uses 290 integrated circuits, is expected to have wider application for data distribution because of its cost and compactness. The equipment has been submitted for type approval for use over P.M.G. networks. The photograph shows development en-



gineer, Mr K. Hauser (right), and engineering assistant, Mr E. van Wegen, discussing the operation of the unit.

gineer, Mr K. Hauser (right), and engineering assistant, Mr E. van Wegen, discussing the operation of the unit.

10KV thyristor

Hitachi has developed a 10KV 400A silicon thyristor, type CH99, which is believed to be the largest in capacity in the world. It is expected to find wide application with heavy electrical machinery and can be used for solid-state circuit interrupters and for high tension static converters. The company has applied for patents in the U.S.A. and other major industrial countries for the thyristor and for similar products — a 10KV 600A rectifier diode, type GO1, and a 2.5KV 1.6KA thyristor, type CAO1. (Hitachi Ltd., Nippon Building, Ohte-machi, Chiyoda-ku, Tokyo, Japan.)

Dual-role studio

An RCA colour television studio, scheduled for installation this year at Southern Illinois University, Edwardsville, will perform a dual role as a laboratory for teaching broadcasting techniques and as a production centre for TV programs. The studio system will be capable of producing "live," filmed or tape-recorded programs, all in full colour. Students preparing for careers in television and related fields will operate cameras, recorders and other equipment as part of their practical training. In addition to instructional programs for use on the campus, the new facility will produce and record cultural and educational programs for distribution through syndicates and individual stations.

Reactor monitor

If the fissionable particles in a nuclear reactor bunch up rather than follow the flux paths predicted for them, a dangerous rise in radiation level could occur within the reactor core. To guard against such a development, an in-core miniature detector, control and readout system has been designed and developed by nuclear engineers of the Lockheed-Georgia Co., Marietta, Ga., U.S.A. It is a major component of the flux monitoring system being installed by Teleflex Corporation in nuclear electric power plants built by Westinghouse Corporation. The flux mapping system consists of several nuclear detectors which sense the radiation inside the core of the reactor. Solid state logic circuits and digital readouts are incorporated in the design.

Apollo sites

The National Aeronautics and Space Administration (NASA) has selected nine tentative moon landing sites for Apollo missions after Apollo 12. The sites are selected primarily on the basis of scientific interest. NASA plans call for a total of 10 manned lunar landing missions beginning with Apollo 11 which was successfully accomplished in July. The selected sites are: Fra Mauro; Rima Bode II; Littrow; Censorinus (north-west); Tycho (north rim); Copernicus; Descartes; Marius Hills; Hadley Apennines.

Neutron therapy equipment for cancer treatment

The first of a new type of equipment harnessing neutrons for cancer treatment is due to be installed at the Christie Hospital, Manchester, England, in August, 1970. Encouraging results from pilot trials have indicated that, in certain types of cancer, neutron beams offer some advantages over other forms of treatment. In 1967, the Services Electronics Research Laboratory (S.E.R.L.) of the Ministry of Defence showed the feasibility of a neutron tube having a neutron output at least ten times that of their existing tubes and sufficient for a hospital therapy machine. Following this, Elliott-Automation Radar Systems Ltd. submitted a proposal for the development of a neutron therapy equipment using the S.E.R.L. neutron source tube and suitable for routine clinical use in hospitals.

Development of the neutron tube at S.E.R.L. is at an advanced stage, several prototypes having already been made and

satisfactorily operated at outputs approaching a million million neutrons per second. Design of the equipment has been substantially completed and manufacture of the prototype has been started. In this equipment, known as the Hiletron, the neutron source is housed in a neutron shield through which the beam is extracted. A series of interchangeable applicators determine the size of the beam, the appropriate one being inserted into the shield.

The head unit — comprising the neutron source, shield and applicator — is mounted on a rotating structure so that, in conjunction with the treatment table, fully isocentric movements are available for easy and accurate alignment of the tumour in the neutron beam. In addition to the Hiletron to be installed in the Christie Hospital, a second unit has been ordered for installation in another major hospital. (Neutron Division, Elliott-Automation Radar Systems Ltd., Elstree Way, Borehamwood, Herts., England.)



drop a subtle hint this Christmas

Don't go into details — we do that for you when you fill in the coupon — idly mention how much safer a Scope iron is — you know the sort of thing — low voltage operation — approved transformer — — — — — and don't forget the Economy angle — Scope won't let you waste money — you get heat only when and where you want it — no expensive heating element to replace — the small copper bit lasts longer and costs so little.

IRH
COMPONENTS
 PTY. LIMITED

The Components Division of IRH Industries Limited
 THE CRESCENT, KINGSGROVE, N.S.W. 2208. PHONE 50 0111 
 INTERSTATE TELEPHONES
 MELB. VIC. 489.1088 BRIS. QLD. 2.1391
 HOB. TAS. 34.2811 PERTH W.A. 8.2271
 LAUN. TAS. 22.844 ADEL. S.A. 23.1971

AVAILABLE FROM ALL MAJOR ELECTRICAL WHOLESALERS AND HARDWARE STORES — THE FULL GUARANTEE APPLIES ONLY WHEN THE IRON IS USED WITH THE APPROVED 'SCOPE' TRANSFORMER. MANUFACTURED BY NATRONICS PTY. LTD.

VOTED FIRST BY A HOST OF SATISFIED USERS.

Please Post free illustrated SCOPE literature ^{XM1}

NAME _____

ADDRESS _____

CITY _____ POSTCODE _____

Smaller IBM computer

A moderate-cost computer system, designed by the U.S. parent company especially for small businesses, was announced recently by IBM Australia Ltd. Called IBM System/3, the system requires only 150 square feet of floor space, is easy to program and operate, and is the lowest priced card data processing system in the IBM product line. The system uses a



new punched card that is less than half the size of present 80-column cards but holds 20 per cent more information. Disc storage for the System/3, up to 9.8 million bytes of information, is housed in a built-in sliding drawer. The unit can hold up to four 14in disc cartridges like the one shown. Access time to any specific data on the discs averages 250ms. A printer keyboard may be used instead of the data entry keyboard (pictured) for placing information into the system and for providing additional printing capacity.

Half-mile long accelerator

A half-mile long 800MeV proton linear accelerator is being built in New Mexico by the University of California, U.S.A. Known as the Los Alamos Meson Physics Facility (LAMPF), it will produce more than ten times the beam energy of any installation of this type now in operation. With an average current of 1mA, the highly intense proton beam will produce enormous quantities of pi and mu mesons.

Over 100 Varian VacIon pumps, each rated at a speed of 600 litres per second, will be mounted along the accelerator's drift tube to provide long term ultrahigh vacuum. The pumping system will provide a working vacuum of less than 10^{-8} of atmospheric pressure.

O.T.C. annual report

The Overseas Telecommunications Commission (Australia) handled a record amount of traffic during the year ended March 31, 1969. Compared with the previous year, international telephone traffic to and from Australia increased by 32.2 per cent, telex by 34.5 per cent, leased services by 15.2 per cent, and telegraph by 4 per cent. O.T.C. is pursuing a \$56 million five-year capital works program to provide the additional facilities needed to cope with the growth in traffic which, on present indications, will necessitate the doubling of capacity every three or four years.

The year marked the introduction by O.T.C. to Australia of a commercial international satellite television service, a total of 29 programs being received during the year. Among other innovations were the introduction of a fully automatic telex service to Britain with a one-minute minimum charge and reductions in telex rates to many other countries. A station-to-station telephone service was introduced with reduced rates to Canada and the U.S.A. A new message relay system which uses computers and CRT display keyboard units for handling international telegrams was brought into service in February this year.

Translator station

The Postmaster General has approved the issue of a licence to TVT-6, the Hobart commercial television station, permitting it to establish a translator station on one of the hills surrounding the town of Strathgordon. It is anticipated that very good reception will be available in the township, which is expected to have a population of some 2,000 by June, 1970. The matter of a national translator from the same site is under discussion between the Post Office and the Australian Broadcasting Commission.

Testing spacecraft

Aerospace firms are testing new spacecraft in chambers that simultaneously subject hardware to the forces of heat, cold, radiation, vacuum, vibration and other conditions. A senior research engineer at Lockheed Missiles and Space Co., Sunnyvale, Calif., U.S.A., William L. Tierney,

has described how an effect called "synergism" can set in when a space vehicle is subjected to many adverse conditions at the same time. Synergism is what happens when the sum of two conditions taken together is greater than the two conditions taken separately.

"For example, some electrical parts passed a vibration test and a vacuum test," Tierney said, "but when tested simultaneously under vibration and vacuum, the parts failed." Sometimes the reverse can occur, he said. Some plastic material being tested for uses in space fared rather badly in individual tests but got better results when tested under several space conditions at once. The Lockheed engineer said this sort of discovery is an exciting stimulant to experimentation, but it also poses puzzles that must be solved if engineering excellence is to be attained in future space efforts.

Lightweight alloys

New lightweight fabricable alloys are being investigated by metallurgists at Lockheed Missiles and Space Co., Palo Alto, California, U.S.A. Suited for both tension-critical and compression-critical structural applications, three series of beryllium-aluminium-magnesium alloy extrusions have been produced for evaluation. Tests are under way to determine the effect of pressing and extrusion variables on the strength and ductility of these alloys and to provide material for tensile and notched-tensile fatigue tests. According to the company, these alloys have a higher tensile strength/density ratio than any commercially available metals or alloys, and should give significant structural weight savings for missiles, spacecraft and conventional aircraft.

Photochromic displays

Corning Glass Works, in the U.S.A., is experimenting with the use of photochromic glasses for computer storage and display components. Photochromic glasses are normally transparent, but darken when exposed to ultraviolet light. When removed from the ultraviolet light source, they become clear again. This unique property stems from tiny crystallites of silver halides in their composition.

Corning scientists have shown that these glasses fulfil the basic requirements for computer storage and display components. They say that the functions of writing, reading and erasing on the glasses are all feasible. Information is written on the glass by a beam of ultraviolet light. Information so written will remain legible for some time. Erasing is effected by using light of a different wavelength.

Shipping line communications

A method of transmitting information across the world via the normal international telephone network at the very fast rate of 6,000 characters a minute has been developed by the British Post Office. The system was developed as a result of a requirement of the P & O Lines shipping company to keep its offices in London, Sydney and San Francisco informed on the day-to-day world booking position in the company's 250 ships. Formerly, the information was obtained on an individual inquiry basis, using the relatively expensive telex system. Now information relating to the overall booking position is encoded and sent in one short session once a day.

The answer to the company's problem was supplied by National Cash Register Company (NCR) who were able to supply an encoder unit that converts words and numbers into characters on a magnetic tape, and feed the information over a public telephone line to a receiver unit in the overseas offices. A series of experiments followed, to iron out problems associated with transmitting coded information over long distances. These tests were concluded in early September, and P & O put its system into operation shortly after.

This NCR tape recorder, installed at P & O Lines of Australia Pty. Ltd., Sydney, was used in the recent communication tests.



World's most efficient pot core assembly . . . Mullard

Vinkor

gives you 50% saving in assembly and test times

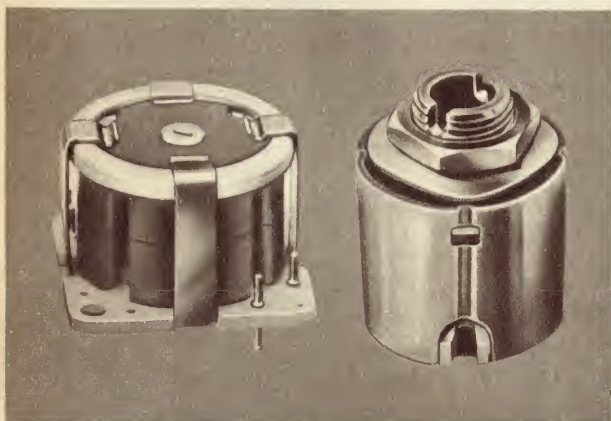

- Precise inductance without core grinding
- Inductance adjustment range of $\pm 7\%$
- Setting accuracy of 0.02%
- Long term stability of 0.1%
- Easy assembly
- Single hole or printed circuit mounting

Four standard ranges of Mullard Vinkor Pot cores for high quality inductor applications are available from which you will be able to select the most suitable Vinkor for your application.

- For inductors in use up to 800kHz
- For inductors in use up to 300kHz where very high Q values are required
- For inductors in use between 300kHz and 2 MHz
- For inductors in use between 1.5MHz and 15MHz

Contact your local Mullard office for full information on Vinkor electrical and mechanical parameters, accessories and housings.

SIZES AND FREQUENCY RANGES...

... 10 to 45mm, 1kHz to 15MHz

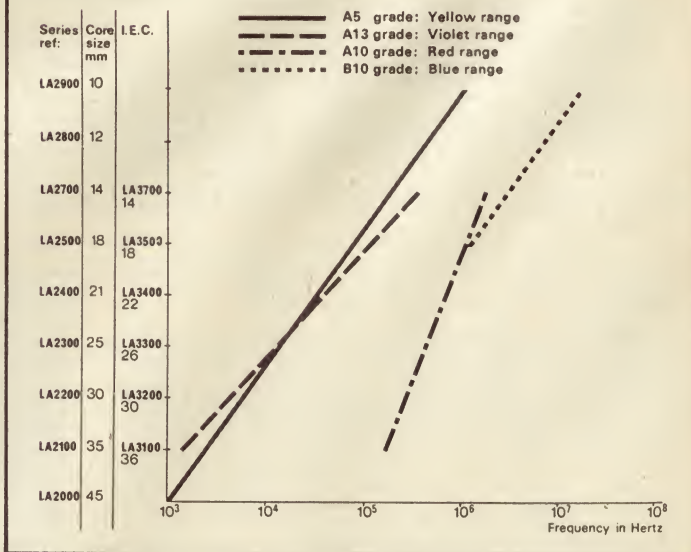

Mullard

Mullard-Australia Pty. Ltd.

35-43 Clarence Street, Sydney, N.S.W., 2000. Phone: 29 2006 • 123-129 Victoria Pde., Collingwood, VIC., 3066. Phone: 41 6644 • St. Paul's T'ce. and Light St., Bowen Hills, QLD., 4006. Phone: 51 5151 • 579 Murray St., Perth, W.A., 6000. Phone 21 2561 • Medhurst Wholesale Ltd., Hobart, Launceston, Burnie, TASMANIA.

Associated with MULLARD LTD., LONDON

M 233



Seven centres of the U.S. National Aeronautics and Space Administration (NASA) now use a Lockheed quick-retrieval information system. Called RECON, the system gives scientists and officials access to a file of space data and other scientific information stored in a central computer. RECON permits an untrained user to sit down at a terminal and unearth the information he needs from the data file,

often in a matter of seconds or minutes. A video screen on the terminal displays the titles, authors, dates and other particulars about previous research papers in the fields of interest. Here, Lockheed scientist Dr Roger K. Summit demonstrates a terminal with the Lockheed technical library in the background. (Fish Eye lens photograph).

you may
HEAR
about
QUAD
now
HEAR
QUAD
for yourself?

E.C.G.s by telephone

A system to transmit electro-cardiograms by telephone is being investigated for the Broussais Hospital in Paris, France, by Thomson-Medical-Telco, a subsidiary of Thomson-Brandt. The need is to provide a fast link between patient and doctor where hospital consultation is impractical. The system uses a telephone link between the patient and a monitoring device in the cardio-vascular centre. The electro-cardiographic (E.C.G.) signal is presented on appliances such as oscilloscopes, cardio-tachometers, or graph recording instruments operated by a group of specialists.

To match the characteristics of the telephone line, the E.C.G. signal is

frequency-modulated on a carrier frequency close to that of the spectrum of the human voice. The operation is straightforward, since it consists of connecting a "black box" at the patient's end, provided with an instrument to call the cardio-vascular centre. At the hospital, the instrument is permanently connected to a suitable switchboard.

Emergency light

A lamp that switches on automatically in a power failure is being manufactured by Alkaline Batteries Ltd. of the U.K. Fixed to a wall by a bracket and connected to the mains supply, the lamp is held by a solenoid lock while mains current is flowing. If the mains fail, the lamp comes on automatically and the solenoid lock is released so that the lamp can be removed and carried where necessary. Powered by a nickel-cadmium alkaline battery, it will provide light for two hours. When replaced in the bracket, the battery is re-charged in about five days, but 75 per cent of full charge is achieved in three days. Inquiries to the Australian associate company, Alkaline Batteries (Aust.) Pty. Ltd., 6 Marigold Street, Revesby, N.S.W. 2212.

Penrith TV factory

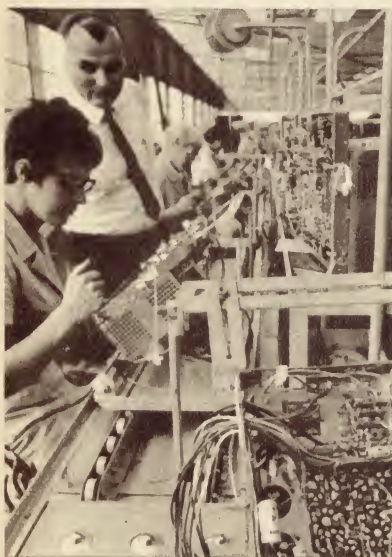

Workers on the production line at the new Matsushita plant at Penrith, near Sydney, install components in chassis for National television receivers. (See "Electronics Australia," October, 1969, page 151.)

Local radio in the U.K.

The B.B.C. has been authorised to proceed with a general service of local radio following the success of a trial local radio scheme put into operation in 1968. (See "Electronics Australia," June, 1968, page 21.) In addition to the eight stations already in operation, the B.B.C. intends to bring a further 12 stations into service by about September, 1970. Over the subsequent four years 20 more, including stations in Scotland and Wales, will follow. The local station managers will be guided by Local Radio Councils to be appointed by the Postmaster-General in consultation with the B.B.C.

The British Government has recognised that the B.B.C. will need more money to provide local radio and to continue to play a leading role in musical patronage. To provide the necessary finance for the B.B.C., the Government has decided to increase the combined TV and radio licence fee from £6 to £6/10/ on April 1, 1971. The sound-only fee will be abolished at the same time.



If you have heard QUAD, you know what we are talking about. If you have only heard about QUAD let us at U.R.D. show you, tell you, demonstrate to you what Hi-Fi stereo is really all about.

Drop into our showroom and experience the sound of the best equipment in the world. Or send us the coupon below so we can post you a comprehensive brochure on QUAD giving you all the facts.

URD

UNITED RADIO
DISTRIBUTORS PTY. LTD.

SHOP 32, ASH STREET,
ANGEL ARCADE,
SYDNEY.

Telephone 28-3718, 28-3926.

Please forward me all available literature on QUAD.

Name

Address

..... State



The VARI-LIGHT . . . lighting to suit your mood

By LEO SIMPSON

Has your wife ever said to you, "I would like to dim the room lights sometimes." If so, then here is the Vari-light, an unobtrusive wall mounting control to make a room bright or dim — or any level in between.

There are many occasions in the home when the full brilliance of the lights is not required: when watching television, listening to music or just plain relaxing and of course, at parties when the lights can be dimmed "way down low." A light dimmer such as the Vari-light can be used to advantage in bedrooms so that lights may be left on at low level; a particularly useful facility when children are sick or for those who are nervous in a completely darkened room. If for these, or any other reasons, you wish to control domestic light levels, the Vari-light is the answer.

Externally, the Vari-light appears as a mains power point surround with a blank face and a knob in the centre. Inside, it contains a standard Triac light dimmer circuit which will control incandescent lamp loads up to 300 watts. The circuit is very similar to that featured in the article on the Vari-watt power controller which was published in the January, 1966, issue of "Electronics Australia." (File No. 2/PC/4.)

For readers who may be unfamiliar with the operating principles of light dimmers using Triacs, the following explanation should be helpful. The heart of the Vari-light is a Triac, a silicon AC control device, originally developed by General Electric of U.S.A. It is closely related to the thyristor and is triggered into conduction by a gate signal in the same way as the thyristor. For the purpose of this explanation, a Triac can be considered as a pair of thyristors connected in inverse parallel with a common case and common-gate electrode.

In essence, the Triac is a bidirectional switch which after being triggered into conduction, stays "on" until the supply voltage decreases to zero or reverses in polarity, when it turns off and can be switched on again. Used with AC, a Triac can be triggered into conduction at any point on either half cycle by a low voltage signal of either polarity applied between the gate electrode and terminal 1 (anode 1). Note that, since the Triac is a bidirectional device it has no anode or cathode as such. The two end terminals are normally referred to as "anode 1" and "anode 2" or "terminal 1" and "terminal 2."

(Reference: "Keeping Up With Semiconductors" Electronics Australia, November, 1966. Reprints available. File No. 8/KS/4.)

As the Triac is a switching device which is either fully conducting or "off," the only means by which it can be used to obtain variable control of power is to use it as a very rapid switch which closes for variable periods of time during each half-cycle of the AC voltage waveform—by adjusting the instant during the half-cycle when it triggers into conduction.

While there are many methods of varying the triggering point of a Triac, the most satisfactory one is known as "phase control." This involves applying to the gate electrode a sharp pulse of current whose phase, relative to the AC waveform, can be varied. This is done by means of a capacitor which is charged while the Triac is in the non-conducting state. The time the

capacitor takes to charge will depend on its size, the resistance in series with it and the voltage supplied to it.

Figure 1 shows a basic Triac light control circuit employing phase control. In this circuit the capacitor and the charging voltage (240VAC) are constant and the triggering point of the Triac is varied by adjusting the resistance of the rheostat. The capacitor's charge is delivered to the gate of the Triac via a voltage sensitive device which conducts only when the voltage across it reaches a certain value. The voltage sensitive device used here is called a Diac, a three-layer symmetrical breakdown diode which is an open-circuit until the applied voltage rises to breakdown rating, whereupon it breaks down to a negative resistance. The breakdown voltage for Diacs is generally of the order of 30V in either direction, i.e., they are bi-directional devices.

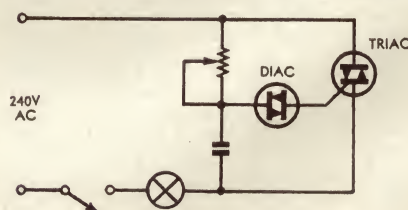

Figure 1

A basic Triac control circuit which serves to illustrate the principles involved.

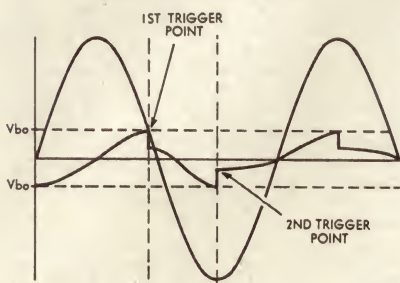

Figure 3

Waveform showing the cause of hysteresis: the drop in voltage across the capacitor when the Triac fires.

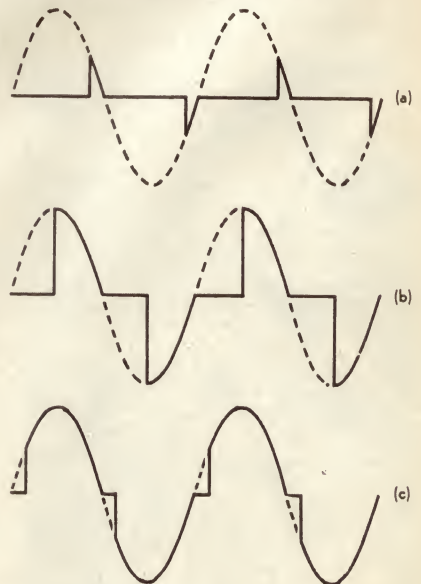

Figure 2

Waveforms applied to the lamp at various power levels. The dotted line shows the mains voltage, the solid line that applied to the load.

Figure 2 shows the waveform that is applied to the lamp at different power levels. The dotted sine wave represents the mains voltage. Figure 2(a) shows the Triac firing late in each half-cycle which corresponds to a low level of power. Similarly, figure 2(b) shows the waveform at half-power operation and figure 2(c) shows the waveform at a high power level where the Triac is firing early in each half-cycle.

Although a simple light dimmer can be constructed using the components shown in figure 1, additional components are added to this to reduce hysteresis effects, extend the effective control range of the rheostat, and suppress radio-frequency interference.

When applied to light dimmers, the term hysteresis refers to a difference in the rheostat setting at which the light initially turns on and the setting at which it is extinguished. With the simple circuit in Figure 1 the rheostat may have to be turned through 30 to 40 per cent of its rotation before the lamp begins to glow and at this initial setting the lamp will be quite bright. The rheostat has to be turned back to a much lower setting to extinguish the lamp.

Besides giving a poor control action, hysteresis is undesirable because, at low levels of illumination, the light may be extinguished by a momentary drop in the mains voltage; for example, when a radiator, washing machine or other high-power domestic appliance is switched on.

Hysteresis is caused by the sudden drop in capacitor voltage when triggering first occurs. Figure 3 shows the charging cycle of the capacitor. The large sine wave shows the mains voltage (240VAC) while the discontinuous waveform shows the voltage across the capacitor. The two waveforms are not drawn to the same scale. The initial triggering of the Diac occurs late in the first half-circle of the mains voltage, causing an abrupt drop in the capacitor voltage just after the capacitor voltage rises to V_{bo} , the Diac breakdown voltage. As a result, the capacitor recharges in the opposite direction to the Diac breakdown voltage sooner than if the abrupt voltage drop had not occurred. This means that the Diac fires earlier in the following half-cycles and so the Triac delivers more power to the lamps than is desired for an initial setting.

The hysteresis effect can be reduced if the decrease in voltage across the capacitor, caused by the Diac firing, can be minimised. This can be done by feeding the capacitor from another RC network, forming a "double-time constant" network. The added capacitor reduces hysteresis by charging to a higher voltage and maintaining voltage on the capacitor which is being discharged by the Diac.

The ideal situation, giving maximum range of light control, is obtained when the lamp begins to light as soon as the control is turned slightly away from the zero setting. The addition of the "double-time constant" network to the circuit improves the situation, but initial triggering may still occur at about 40 per cent of the control range, meaning that the actual brightness control is only effective for 60 per cent of the control rotation. Performance

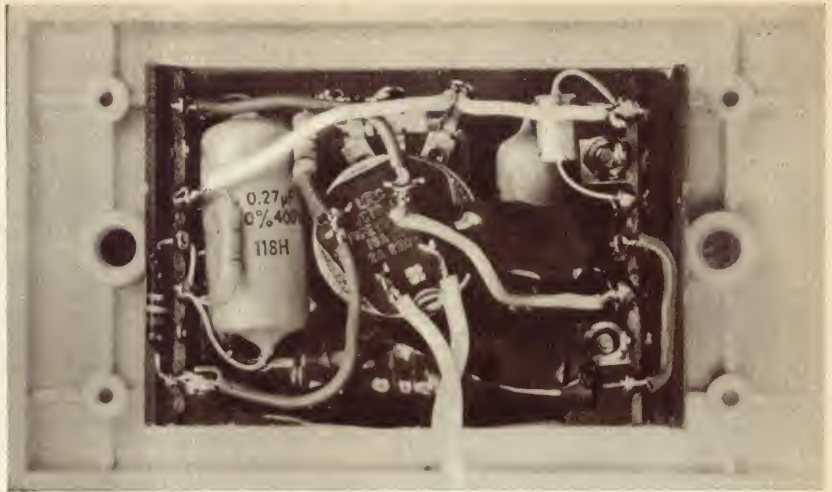

Rear view of the finished unit. The choke is lying horizontally below the pot., the Triac (in plastic tape) is to the right, and the Diac in the top right corner. (See also page 43.)

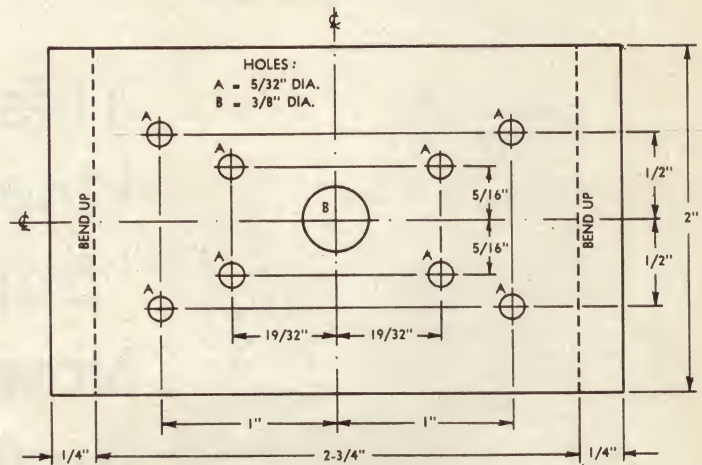

Dimensions and hole positions for the metal plate on which the components are assembled. Aluminium in 22g or 24g would be a suitable material. It is mounted on the blank face-plate.

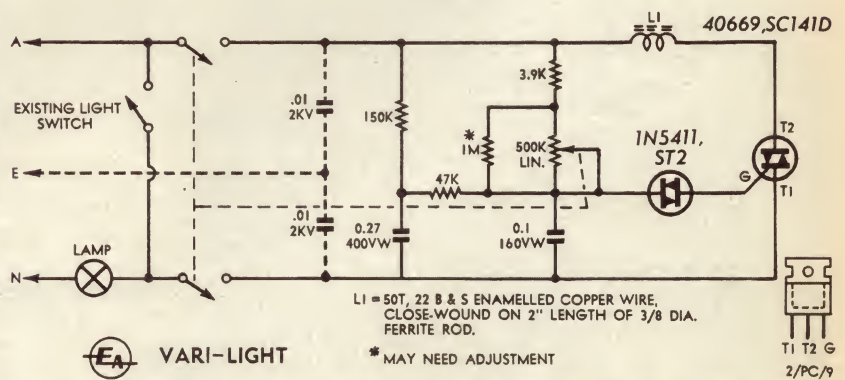

The main circuit, showing its connection to the existing lighting circuit. The 1M resistor should be adjusted to give the greatest range of control. Additional interference suppression wiring and components are shown dotted.

can be improved still further by the addition of a resistor in parallel with the rheostat, the value being selected experimentally to give the maximum control range. A 1M resistor was needed in the prototype, but may vary with individual units.

With a "double time-constant" cir-

cuit and a resistor across the rheostat to adjust for maximum control range, the result is a dimmer with very smooth control over just about the whole range of the rheostat. The purpose of the 3.9K resistor in series with the rheostat is to protect the resistance element by limiting the capacitor

**Dual Differential Amplifiers for DC to 120 MHz
RCA-CA3054 or CA3026**

Here's new flexibility for your amplifier designs—RCA's latest addition to its line of linear "building block" IC's. It's RCA-CA3054 in a DIP package for easy handling and added accessibility. The fourteen-lead package provides access to bases and collectors of differential pairs, bases and emitters of constant-current-source transistors, and separate substrate connection.

You can design the CA3054 into a wide range of applications...including differential and/or cascode amplifiers; IF amplifiers; video amplifiers; doubly-balanced modulators and demodulators and more. If your design requires a full military tem-

perature range, then use RCA-CA3026 in a TO-5 package.

Other RCA Linear Diff Amp Array IC's for Design Flexibility Include:

- CA3050 Two Darlington-connected diff and amps with diode bias string;
- CA3051 CA3050 in DIC CA3051 in DIP,
- CA3045 Three isolated transistors and a differential pair CA3045 in DIC,
- CA3046 CA-3046 in DIP,
- CA3049 First 200 MHz ampl array—pair of diff/cascode amps on a single chip. In 12-lead TO-5,

Matched differential amplifiers with:
Independent inputs and outputs
Input offset voltage = 5 mV max.
Max. V_{CE0} = 15 V
Max. collector current = 50 mA

Dynamic forward current transfer ratio (h_{fe}) (typ.) = 110 @ 1 kHz,
 $V_{CE} = 3 V$, $I_0 = 1 mA$
Operating temperature ranges:
0°C to + 85°C (CA3054)
-55°C to +125°C (CA3026)
Voltage gain @ 1 kHz, 32 dB (typ.)
single-stage, double-ended output
CMR = 100 dB (typ.)

For technical details, write to Amalgamated Wireless Valve Co. Pty. Ltd., Private Mail Bag, P.O. Ermington 2115 or Interstate Offices and Distributors.

CA3054 in 14-lead Dual-In-Line Plastic (DIP) Package

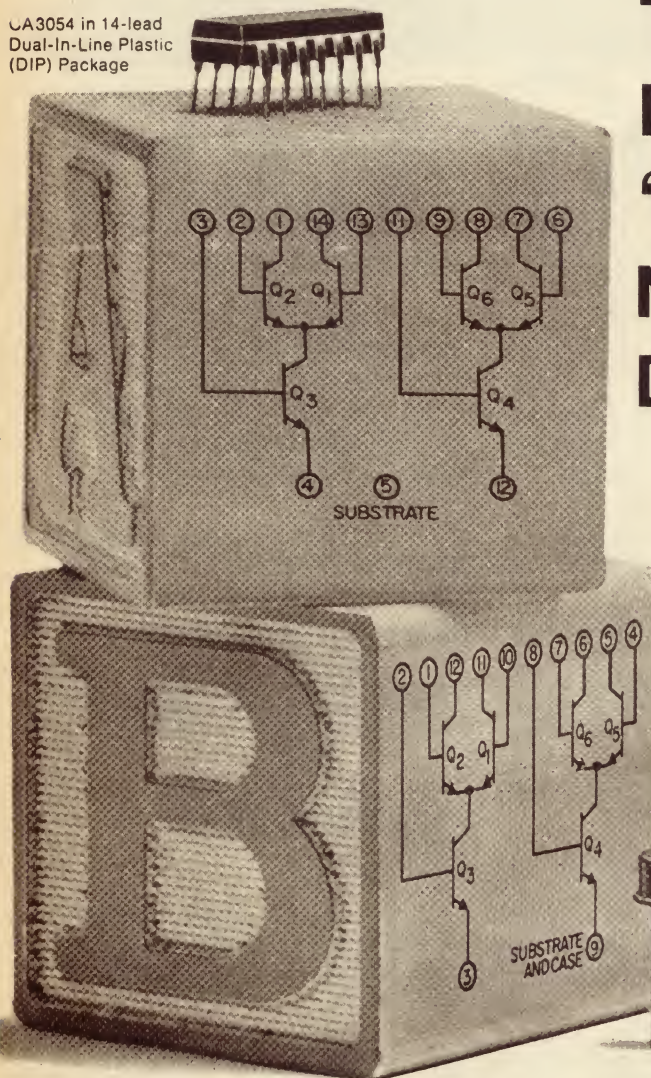

This Flexible Linear IC "Building Block" Now Comes in Dual-In-Line Plastic



AMALGAMATED WIRELESS VALVE CO. PTY. LIMITED

CA3026 in TO-5 Package for full military temperature range operation

charging current when the rheostat is at low resistance settings.

In operation, the Triac switches on in about 1 or 2 microseconds, the current rising to whatever the load permits within this period. The rapid rise in current produces radio interference extending up into the region of several megahertz. This will affect the broadcast band and the lower short-wave bands. The interference will be evident as a buzzing noise.

RF interference caused by the Vari-light is reduced by the inductor, L1, which is wound on a ferrite rod. In most light dimmer circuits, several .01uF suppression capacitors are connected between active points in the circuit and earth. However, since the Vari-light will be used in the lighting circuit of homes no earth wire will be available for these suppression capacitors. Because of the 300 watt limit we have placed on the dimmer the current level is not great and consequently the interference is only moderate — less than that radiated by most commutator motors in domestic appliances such as food mixers.

If radio reception in your area is weak the RF interference generated by the Vari-light may be unsatisfactory. The RF suppression which is satisfactory in strong signal areas will have to be improved upon. One method of improving RF suppression is to connect 0.01uF/2KV ceramic disc capacitors from both sides of the Triac to an earth wire, as shown by the dotted portion of the circuit. The whole of the dimmer circuitry can be installed in an earthed metal box to shield the inductor. Finally, all the lighting cables could be run in earthed metal conduit as the ultimate solution.

The Triac used is the economy, plastic-encapsulated unit, 40669, made by RCA. It has ratings such that it can control a load of up to 300 watts without the need for any external heatsink. The Diac used is also made by RCA, type 1N5411. The Triac/Diac pair are available for about \$3.00, including tax, from parts suppliers, which makes this a very economical project.

The Vari-light is encased in a standard mains power point surround with a blank face-plate. These are readily available from electrical supply and hardware stores. The components themselves are mounted on a metal plate which, in turn, is secured to the faceplate by means of four 1/8in Whitworth screws in ready-tapped holes.

No electrical connections are made to the metal plate, for safety reasons. All terminations are made to two tagstrips one at each end of the plate and the 500K potentiometer which is wired to function as a rheostat.

The metal plate is 2in wide with an overall length of 2-7/8 inches, including a 1/4in flange at each end. The accompanying diagram shows the dimensions and positions of the holes which should be checked against the tapped holes in faceplate. The thickness of metal is non-critical — 22 or 24 gauge would be a good choice.

The interference suppression inductor L1 is not available commercially but is quite easily made. Start by winding a layer or two of thin insulation

tape on a 2in length of 1/4in diameter ferrite rod. If a full length ferrite rod has been purchased it can be cut by filing a nick right around the circumference of the rod and then snapping it as if it were of glass — do not try to saw the rod. Close wind 50 turns of 22 B and S enamelled wire over the insulation tape. Then wind insulation tape tightly over the rod in a couple of layers. This last step is important — if it is not wound tightly the inductor will make a buzzing noise due to currents being switched by the Triac.

The capacitors used in the prototype are dipped polyester types, as made by Ducon or Philips. The recommended

PARTS LIST

- 1 Mains power point surround and blank faceplate.
- 1 metal plate to suit faceplate.
- 1 ferrite rod inductor (see text).
- 1 500K (lin) potentiometer with rotary DPST switch.
- 1 plastic knob.
- 1 Triac. 40669, SC141D.
- 1 Diac. 1N5411, ST2.
- 2 7-lug tagstrips (with two mounting feet).

RESISTORS.

- (1/2 watt rating)
- 1 x 1M (see text), 1 x 150K.
- 1 x 47K, 1 x 3.9K.

CAPACITORS.

- 1 x 0.27uF/400VW polyester.
- 1 x 0.1uF/160VW polyester.
- 2 x 0.01uF/2KV ceramic disc or Ducon CDX 102.

voltage ratings must be adhered to. If they are low the capacitors will break down; if they are high they will be too large for the available space.

The order of assembly should be as follows: first, cut the potentiometer shaft to a length of 1/4in. Attach the potentiometer and two tagstrips to the metal plate. Drill a 3/8in hole in the centre of the faceplate. Care is needed

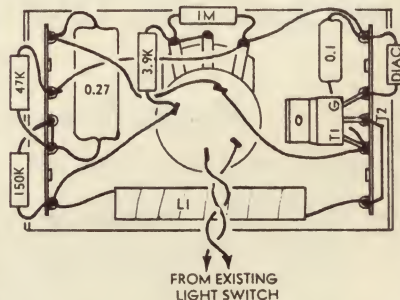

Wiring diagram showing the approximate disposition of the components. Compare it with the photo on page 41.

here, otherwise the plate will fracture. Use three drills to bring the hole to size, e.g., 1/8in, 1/4in and 3/8in. Then attach the metal plate to the faceplate by means of 1/4in long, 1/8in Whitworth roundhead screws.

The components can now be soldered into place. The two capacitors and Triac should be installed first. The

BATTERY SAVER —A.C. ADAPTOR

Permits A.C. mains operation of Transistor and other 6-9v. Battery Powered Equipment at Negligible Power Cost!

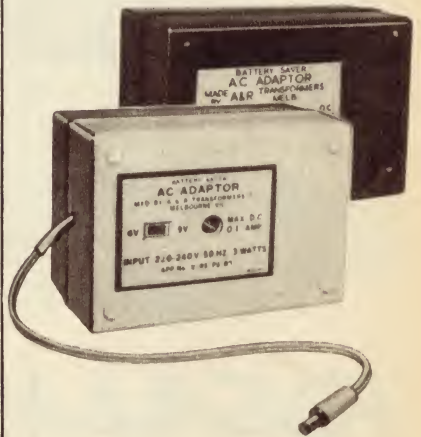

- 6 or 9 volt (nominal voltage) selected by external switch.
- Double insulated for absolute safety.
- Handsome cabinet complete with 3-pin power point plug, and radio lead with plug.
- Measures a compact 3 1/2" x 2 1/2" x 2".
- Suitable for any 6 or 9 volt battery operated transistor equipment.

Approved by Electricity Supply Authorities

PS64 specially for Tape Recorders
PS82 specially for Transistor Radios

Manufactured by

**A & R ELECTRONIC EQUIPMENT
COMPANY PTY. LTD.**

A & R—Soanar Group Company

42-46 LEXTON ROAD, BOX HILL,
VIC., 3128

Phones: 89-0238, 89-0239

AGENTS IN ALL STATES

- N.S.W.: SOANAR ELECTRONICS PTY. LTD.
82 Carlton Cres., Summer Hill. Ph. 798-6999.
- OLD.: R. A. VENN PTY. LTD.
71-73 Doggett St., Valley, Bris. Ph. 51-5421.
- S.A.: SCOTT THOMPSON PTY. LTD.
93 Gilles St., Adelaide. Phone 23-2261.
- W.A.: EVERETT AGENCY PTY. LTD.
17 Northwood St., W. Leederville. Ph. 8-4137.

REALISTIC PERFORMANCE REALISTIC PRICE



REALISTIC ^{DX} 150

ALL SOLID STATE—4 BAND

COMMUNICATIONS RECEIVER

A big professional looking set that makes exciting news for amateurs . . . the DX150 gives realistic reception on SW/CW/SSB/AM-Broadcast bands; obsoletes tube receivers with their warm-up delay; banishes dependence on AC main power . . . the DX150 will run on dry cells if current fails or is not available; will operate from a car's cigarette lighter or any 12V DC service. 240V AC power supply is built-in, of course.

Over 30 semi-conductors—Product detector for SSB/CW, plus fast and slow AVC—variable pitch BFO—illuminated electrical bandspread fully calibrated for amateur bands—Cascade R.F. Stage—ANL for RF and AF—Zener stabilised—OTL audio—illuminated "S" meter—Built-in monitor speaker plus front panel jack for external (optional) matching speaker.

Attractive silver extruded front panel, solid metal knobs, grey metal cabinet, size 14 1/2" x 9 1/4" x 6 1/2". . . a truly Realistic performer at a realistic price.

\$229.50

**Brings in the
whole wide world of
SW/CW/SSB/AM-
Broadcast**

**240V AC or 12V DC
operation.**

Triac leads should be trimmed to 1/4 in and bent slightly apart. Take care not to fracture the leads as they are bent. After soldering the capacitors and Triac into place, the Diac and resistors can be installed. The 3.9K resistor should have a spaghetti sleeve fitted to the lead which is soldered to the potentiometer switch, to avoid shorting the switch to the potentiometer case. Take care to ensure that no connections are made to the mounting feet of the tagstrips.

Lastly, the Triac should be wrapped with one or two turns of insulation tape to ensure that the flag does not short to the potentiometer case. Ensure that all the components are within the boundary of the metal plate so that they do not foul the power point surround when the faceplate is being installed.

A plastic knob should be used on the Vari-light so that the metal plate and potentiometer case are completely isolated. The knob should be installed so that its skirt is almost flush with the surface of the faceplate.

Having checked the wiring against the wiring and circuit diagrams, final testing and adjustment may be carried out. This is best done by wiring the Vari-light to a three pin-mains plug and connecting a light socket in series with the active lead, as shown in the circuit diagram. The test lamp may be the same as that to be used, although this is not critical. The brightness should increase smoothly with rotation of the knob. Adjust the 1M resistor for the desired initial level of brightness.

Since this is a mains operated device it may be wise to seek the advice of an electrician before attempting to install the unit, or even have him make the actual connections. In any case, the appropriate light fuse must be removed and/or the main switch turned off before any work is done on the lighting circuit. As a further precaution, make sure that the light switch is left in the "on" position and that the lamp is functioning, when the power is turned off at the switchboard. This will provide an indication that the correct circuit has been opened and also discharge any capacitors, such as fluorescent power factor correction capacitors across the line. Such capacitors can deliver a frightening, though relatively harmless, shock in some circumstances.

There are several ways in which the unit may be installed. Perhaps the most satisfactory arrangement is to connect it in parallel with the existing light switch — this means that the light switch will override the Vari-light so that a person entering a darkened room can light his way without fumbling with knobs. In this case, installation would be a matter of securing the power point surround to the wall with suitable screws, taking two wires from the potentiometer switch and soldering them to the existing light switch.

The Vari-light should be fitted with a pair of flying leads of suitable length to run behind the architrave, through the holes from which the existing switch wires emerge, and into the switch terminals, where they will be screwed down alongside the regular wires. To facilitate feeding the flying

CONSULT YOUR LOCAL RADIO DEALER, OR

MAIL THIS COUPON *today*

Please forward free illustrated literature and specifications on Realistic.

Name.....

Address.....



(A unit of Jacoby Mitchell Holdings Ltd.)
376 EASTERN VALLEY WAY, ROSEVILLE, N.S.W.
Cables and Telegraphic Address: 'WESTELEC.'
Sydney, Phone: 40 1212

leads through the holes already occupied by the switch wires it may be necessary to enlarge these holes and feed "fish wires" through them from the front. These are then joined to the flying leads and used to pull the latter through the holes from behind.

In this way it should be possible to complete the operation without the need to use a soldering iron while the power is turned off. Alternatively, it may be possible to use the type of insulated screw connectors which elec-

tricians use in junction boxes, again avoiding the need for a soldering iron. If soldering cannot be avoided it is usually possible to leave the power circuit energised while the light circuit is switched off, since these are separate in most houses. However, be very careful that these two circuits are not confused.

Remember that the maximum load to be controlled by the Vari-light must not exceed 300 watts—at this power level the Triac will be dissipating

approximately 1.25 watts. With more elaborate heatsink arrangements the same circuit is suitable for loads up to 1,000 watts. Fluorescent lamps cannot be controlled with the Vari-light.

Well, the party season will soon be upon us. Does your living-room need a Vari-light? If the lights are dimmed the guests will never know that your ceiling needs painting—and the Vari-light will cost less than a gallon of premium quality paint and it's easier to use. ■

SHORTAGE OF TRIACS

At the time of writing the type 40669 Triacs is in short supply. Before committing ourselves to the "Vari-light" and the "Musicolour" in the October issue, we were assured by the local agent that he had good stocks on hand and had placed adequate forward orders to cover all likely demand. Unfortunately, an increase in local demand and failure of the overseas company to deliver fresh stocks on time has created a temporary shortage.

In regard to the "Musicolour" there are some alternative types which can be used with little or no difficulty. The SC141D is directly interchange-

able in the accompanying photograph. Connection to the stud was made by means of an automotive type terminal, which was then soldered to the appropriate terminal on the tag strip.

However, we are not altogether happy about the arrangement. There is little room to spare and it is difficult to provide insulation for the case of the Triac. If this unit is used, extreme care must be taken to see that there is adequate clearance between the case of the Triac—which is at mains potential—and other components. In particular make sure that the pot is securely fastened, with the aid of a lockwasher, so that it cannot be rotated by any heavy handed individual.

A better improvisation seems to be possible with the AC06DR. The main problem is connection to the case, which cannot be made by means of the clamp supplied, due to lack of space. One solution is to solder directly to the case. The makers do not officially approve this, but indicate that the risk should be small.

The best spot for soldering appears to be on the upper rim of the main body, adjacent to the terminals. Scrape off the plating, use a good paste flux, and a hot iron such as a Scope. With

leads soldered to both the case and terminals the unit can be wrapped in several layers of plastic tape and mounted in same general position as was allocated for the 40669. ■

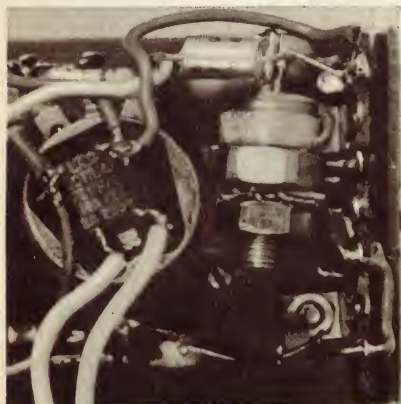

Rear view of a Vari-light showing how a stud-mounting Triac is accommodated.

able and it is hoped that there will be good stocks available by the time this appears in print. Another possibility is the SC40D, a larger stud mounting type. This can be accommodated quite easily by drilling suitable size holes in the heat sinks. However, it is a dearer unit and would add several dollars to the cost of the project.

Also suitable is the type AC06DR which, at the time of writing, is in good supply. This uses a clamp type mounting, different from either of the previously mentioned types, but the clamps are supplied with the units and there should be no mounting problem on the "Musicolour" heat-sink.

In regard to the "Vari-light" the SC141D is a direct replacement, as in the "Musicolour." Alternatively the SC40D can also be considered. Apart from its higher cost, the main objection is its larger size. We tried re-arranging the component layout and managed to accommodate it in the limited space available, as can be seen

COMPUTER BOARDS

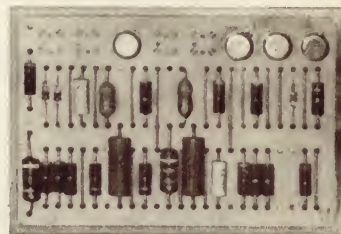

TRANSISTORS 15c Each.
Resistors, Diodes, Capacitors Free.
8 BOARDS WITH A MINIMUM OF 30 TRANSISTORS \$4.00
Pack and post 25c
25 BOARDS WITH A MINIMUM OF 100 TRANS. \$12.00
Pack and post 70c
 Technical information supplied with goods.
 Minimum order \$1.50.
 Please add Postage.
COLSTOK ELECTRONICS
 Box 178, KELLERBERRIN. 6410

CAPACITIVE DISCHARGE

IGNITION SYSTEM

the MARK TEN a U.S.A. topseller. Special kitset price \$45.00 by direct mail order only.

Ideal for ALL gasoline engines on CARS, TRUCKS and BOATS.

A MUST for Every Sports or Modified Engine
SOME OF THE BENEFITS YOU CAN EXPECT . . .

- Dramatic increase in Acceleration & General Performance.
- Instant Start in All Weather.
- Improved Gasoline Mileage.
- Longer Plugs & Points Life.
- Virtually eliminates Ignition Tuneups

For further details write to:

TASTRADE SUPPLIES, P.O. Box 78, CAMPSIE, 2194

When ordering state 6/12 volt +ve or -ve earth system

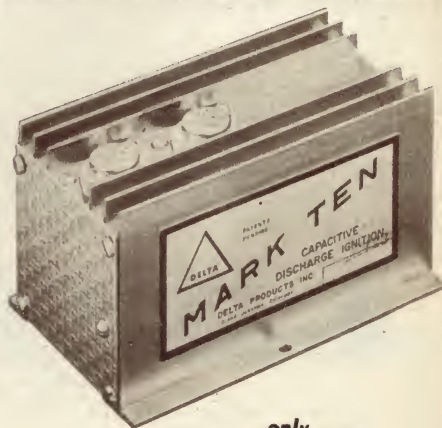

only \$68.45 p. paid

UHER

Make your next choice a Uher

Made in Western Germany

"The World's Most Reliable Name for Precision Taperecorders"

Technical Perfection

ACTION AND

Music as never
'the finest com

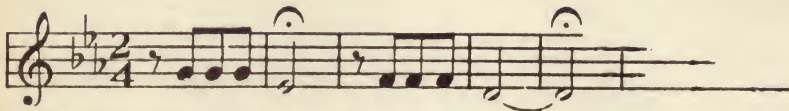

The All NEW BREED VARIOCORD 263 Stereo BANDRECORDER.

The New UHER Royal Deluxe

Stereo Home Studio of the ultimate hi-fi class 20 watts rms push/pull output by separate amplifier—fully transistorised—4 or 2 track operation (stereo)—4 speeds—4 heads—A & B monitoring—4 amplifiers—VOR—11 exclusive recording functions, operated by one control—all new tape comparator—dia pilot-echo sound mixing—frequency response 20-20,000 cps at 7½ ips. Teakwood cabinet, can be hung on wall.



Also available as VarioCORD 23 Hi-Fi 4 track

based on the famous UHER Royal Deluxe UHER VARIOCORD 263 STEREO

Made exactly 'to measure'. Vary your machine in four different ways. Your choice of 2 track and 4 track operation. Automatic or manual level control. Mixing of sound sources. 2 x 6 watts rms. output or 2 x 9 watts music power. 3 speeds, 30-20,000 cps. 2 built-in loudspeakers. Can be hung on wall like a picture. Optimum wow and flutter performance. Uher's exclusive tape tension comparator controls tape speed in any position.

Showroom — Sales Enquiries Welcome

ATRAM PTY. LTD.

Sole N.S.W./N.T. Distributor:
5 McLaren Street, North Sydney.
Telephone 92-4177 (3 lines)

Available in All States from Franchised UHER Agents

N.S.W.: John Border Photographics Pty. Ltd.
175 Liverpool St., Sydney.
Tel.: 26-1106.
N.S.W.: Milverson Sound Centre,
791 Pacific Highway, Chatswood.
Tel.: 41-4365.
N.S.W.: Glen Dor Camera Centre,
43 The Corso, Manly.
Tel.: 92-2709.
N.S.W.: Alderson Camera Store Pty. Ltd.,
King St. and Prince's Highway,
Rockdale. Tel.: 59-2589.

A.C.T.: Canberra Sound and Recording Service.
109 Majura Ave., Dickson.
Tel.: 4-5980.
QLD.: A. E. Harrold Pty. Ltd.,
123-125 Charlotte St., Brisbane.
Tel.: 31-3081.
VIC.: Atram Pty. Ltd.,
1 Corr St., Moorabbin. Tel.: 95-5633.
VIC.: Klapp Electronics Pty. Ltd.,
224 Chapel St., Prahran.
Tel.: 51-4653.

VIC.: Photosound Pty. Ltd.,
7 Cookson St., Camberwell.
Tel.: 82-7042.
S.A.: Kallin Distributors (Wholesale)
Pty. Ltd., 140 Gawler Place, Adelaide.
Tel.: 8-7171 (11 lines).
W.A.: Alberts TV and Hi-Fi Centre Pty. Ltd.,
282 Hay St., Perth. Tel.: 21-5004.
N.T.: N.T. Musical and Electrical (W/S)
Pty. Ltd., 54 Cavanagh St., Darwin.
Tel.: 3072.

The Staff of Atram Pty. Ltd. and a very Happy and

PE

The Great Brand from the black forest

Made in Western Germany

The Most Advanced Hi-Fi Automatic Turntables for Finest Systems

in another page of

SOUND

*before
bination ever'*

The Ultimate Auto-Professional Turntable PE 2020 with 'command centre' one lever control — anti-skating device coupled with stylus pressure adjustment — automatic record scanning device — cuing lift device, viscosity damped — pitch control — rotating spindle — balanced diecast non ferrous turntable, weight 7.5 lbs. — non resonant rigid baseplate, specially laminated — $\frac{1}{2}$ inch international mounting slide in pick-up head — 4 pole-4 phase induction motor, plus many other features.



Exclusive unique 15 deg. vertical tracking angle adjustment.

The All NEW PE 2016/2018 Auto-Professional Turntable.



Ultra modern functional design — perfect finish — choice of VTA adjustment control — slide in $\frac{1}{2}$ inch mounting pick-up head — coupled anti-skating/stylus pressure adjustment — pitch control — low friction tubular tonearm moving on precision ball bearings — lift cuing device for manual or automatic operation — command centre one lever control — automatic record scanning, plus many more features. Finish in brushed aluminium or charcoal grey.

PE 2016/2018

Also available PE 2001 and PE 2010 featuring the exclusive 'command centre' with one lever control for all operating functions.

You will not be satisfied until you have seen PE.

Ask for a demonstration at any leading dealer or write for literature.

ATRAM PTY. LTD.

Sole Australian Importer and General Agent.
5 McLaren Street, North Sydney.
Telephone 92-4177 (3 lines)

**Wish You a Merry Xmas
Prosperous New Year**

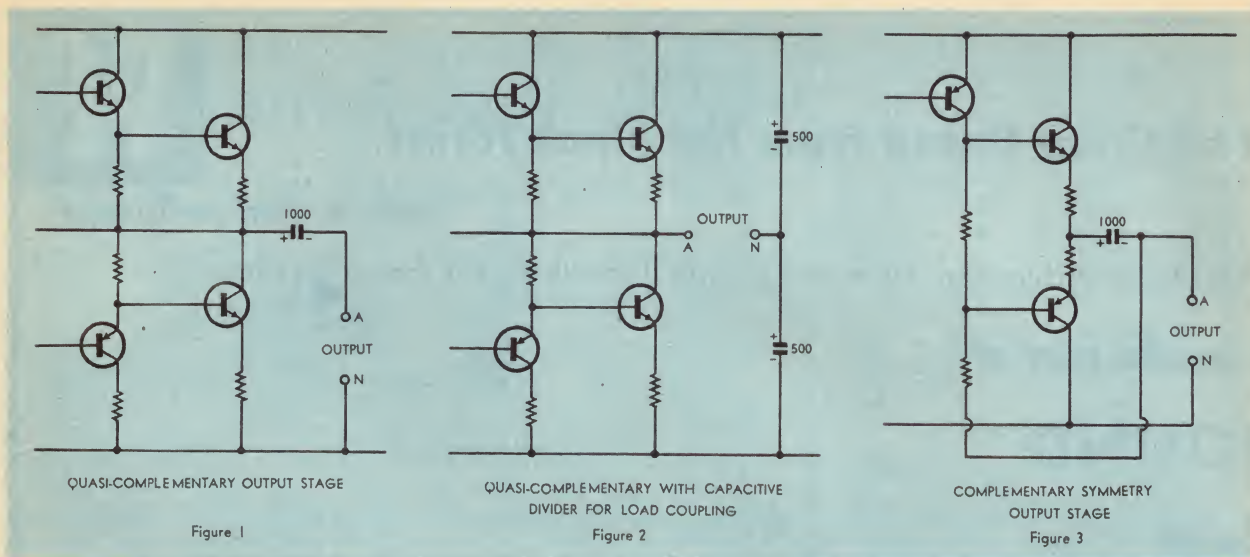

Typical output stage configurations for transistor power amplifiers. A headphone adaptor would need a blocking capacitor in the case of figure 2. None would be necessary for figures 1 and 3, or for valve type amplifiers, which almost invariably use an output transformer.

A STEREO HEADPHONE ADAPTOR

In answer to the requests of many readers, this article discusses a universal headphone adaptor which is suitable for all types of amplifier, valve or transistor and all types of stereo headphones, regardless of impedance. Two pairs of headphones can be connected and a switch is provided to silence the loudspeakers.

By LEO SIMPSON

The only experience that many people have had of headphones is with a pair of "cans" bought from a dispossal store and connected to a short-wave radio or a crystal set. Because the frequency response of such phones is usually peaked in the middle of the range, the sound may sound "clear" enough but it lacks the balance that is essential to high fidelity reproduction. The distortion content is also rather high, as a rule.

In addition, the sound lacks any sense of dimension. In fact, if the individual phones are balanced and connected so that the diaphragms move inwards together and outwards together, the sound appears to originate from a point source right in the middle of the listener's head. It is, in fact, a most peculiar place to have a full orchestra, or a grand organ!

Modern, high fidelity headphones exhibit lower distortion and a response that is much wider and smoother than any of the older, general purpose types. Reproduction, overall, compares very favourably with that from high fidelity loudspeakers.

Furthermore, by feeding the phones separately from the respective channels of a stereo system, the apparent

signal source no longer remains captive inside the listener's head.

On fully dispersed stereo program material, the listener has the sensation of sitting right in the middle of the orchestra, with instruments dispersed on either side, and his head, maybe, inside the lid of the grand piano!

With the more gimmicky "two-channel" type of stereo recording, the listener has the impression of sitting between two distinct groups of musicians. With a "three-channel" type of recording, there is an additional group inside his head!

These impressions are not present when listening to a normal stereo loudspeaker set-up. The sound sources are usually in front of the listener, not adjacent to his ears. Each ear hears each sound source, both by direct and reflection paths, and the listening situation more closely approaches that which it would obtain if the performers were actually located at the far end of the listening room.

Because of the rather unnatural—though startling—illusions created, it is possible to argue that headphones are not a legitimate method of listening to ordinary stereo program material. Be that as it may, however, the repro-

duction can be very satisfying and an alternative, far to be preferred to no listening at all.

Headphones do not suffer from apparent attenuation of the high frequencies due to "beaming" effects as do loudspeakers, since the headphone aims right into the ear, as it were. At low frequencies, provided the phones are adequately sealed to the head by flexible surrounds, headphones can produce plenty of undistorted bass; they do not have to set up a large wavefront in a room and cannot excite boomy room resonances. Finally, because the diaphragms need to make only small excursions to move a limited amount of air, they may well contribute less distortion than loudspeakers.

However, the real reason for the continuing popularity of headphones is, as we intimated, that they enable one to listen to music as loud as desired without disturbing the neighbours, babies or parents-in-law.

As far as the listener is concerned, headphones cushioned to the ears are far more sensitive than any kind of loudspeakers standing several feet away. This leads to certain immediate and serious complications.

The first arises from the fact that all practical amplifiers have some inherent noise and hum output, even with the volume control turned right down. Through a loudspeaker system this is normally not troublesome but, heard through earphones, it is generally quite objectionable and sufficient to compromise or ruin enjoyment of the program.

Another aspect is that since so little audio power is necessary to produce adequate output from the headphones, the volume control may have to be set at a critical position, not far advanced from fully off. If, by chance, it hap-

pens to be turned up too far, the headphones could easily be damaged.

A possible secondary effect is that, at such low volume control settings, the balance in the two sections may be anything but good, requiring manipulation of the balance control to equalise the two channels.

What is clearly required is some kind of an attenuation circuit, such that only portion of the voltage at the output of the amplifier ever reaches the headphones. It will reduce the hum and noise fed to the phones and allow the amplifier to be operated with the volume control somewhere near the setting normally employed for loud-speaker listening.

Many commercial amplifiers have jack sockets for one or two sets of headphones and these are fed from amplifier outputs via resistors which may have a value from 150 to 500 ohms. While these resistors may give a suitable order of attenuation for low impedance headphones, e.g., 8 ohms, they will be less effective for the many headphones on the market which have impedances ranging up to 600 ohms, and as high as 10K in one particular case.

What is needed is a voltage divider network which can provide a suitable order of attenuation regardless of the type of headphone used. To this end, we have used a pair of 100-ohm slider resistors fed by 47-ohm resistors for each set of headphones. (See circuit diagram.) By adjusting the moving contact on the slider resistor, the amount of attenuation can be varied over a wide range.

The above network provides only light loading of the amplifier output circuits. While most transistor amplifiers are tolerant of light loading, a few valve types are prone to damage if they are inadvertently overdriven without a load; others may tend to instability. Complementary-symmetry amplifiers (see figure 3) will not operate unless they are loaded, as the load forms part of the bias network for the output transistors.

For the above reasons we have specified a 22-ohm, 5-watt resistor as the dummy load for each channel. This value is low enough to ensure correct operation of all amplifiers likely to be encountered and is high enough for the 5-watt rating to be quite adequate for likely levels of operation.

In normal stereo systems, the loudspeakers are independent units, each fed by an entirely separate twin lead. The output circuits of the two amplifiers can be entirely independent of each other in respect to both the active and neutral wiring. It is wise to preserve this isolation, at least in respect to the loudspeakers, to minimise any risk of introducing unforeseen complications.

However, isolation cannot be preserved with many types of headphones because they use a common return (or neutral) lead. For this reason we have suggested a 5-wire circuit between the amplifier and headphone adaptor. Four wires provide the separate active and neutral leads for loudspeaker operation; the fifth wire allows the headphones to be connected from the respective activities to chassis.

The use of a common earth return

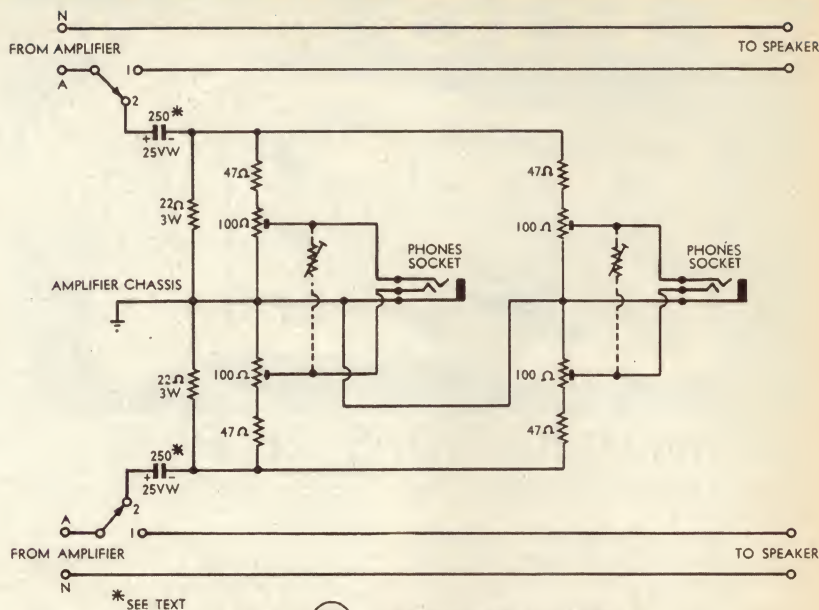

HEADPHONE ADAPTOR

The circuit of the headphone adaptor and, at right, the unit itself. Note that the plugs and sockets for the phones must be of the "stereo" type.

PARTS LIST

- 1 Eddystone utility box, 4-5/8 x 3-5/8 x 2-1/8 inches.
- 1 two-pole, two-position switch.
- 2 Stereo jack sockets.
- 2 13-lug tagstrips.
- 1 4-way insulated terminal block.
- 2 250µF/25VW electrolytic capacitors (see text).
- 2 22-ohm, 5-watt resistors.
- 4 47-ohm, 1/2-watt resistors.
- 4 100-ohm slider resistors.
- 1 knob, 4-conductor cable with shield, cord clamp, solder lug, hook-up wire, screws, nuts, etc.



circuit with headphones will cause a complication with those amplifiers which operate with the loudspeaker above chassis potential, i.e., neither side of the loudspeaker is connected to earth, via the chassis.

A case in point is the Playmaster 115 Stereo amplifier published in the April, 1967, issue of "Electronics Australia." This uses the familiar quasi-complementary output stage but, instead of using the normal large electrolytic capacitor for loudspeaker coupling, it uses a capacitive voltage divider across the positive and negative supply rails to eliminate the charging pulse delivered to the speakers at the point of switch-on. This places the load at about 25 volts D.C. above chassis potential, which means that the common earth return system used in the adaptor cannot be used without the addition of D.C. blocking capacitors. For this reason, we have incorporated the 250µF/25VW electrolytic capacitors in the circuit so that one side of load can be connected to the amplifier chassis (common earth).

With amplifiers other than those just mentioned the capacitor may be omitted. With complementary-symmetry amplifiers the capacitor must be omitted, since the load forms part of the D.C. bias network for the output transistors, as mentioned earlier.

If there is any doubt as to whether the amplifier on hand should be used with the blocking capacitors, this can be determined without reference to a circuit diagram by measuring the D.C. potential of the loudspeaker voice-coil circuit with respect to the amplifier chassis with no signal applied. If it is zero, then no capacitor is necessary.

Note that if the D.C. potential of the voice coil proves to be negative with respect to the chassis, as was the case with one or two circuits we have seen in overseas magazines, the polarity of the electrolytic capacitors in the adaptor unit would have to be reversed to that shown in the circuit and wiring diagrams.

Problems to do with the internal circuitry of amplifiers are mainly con-

TRIO 9R-59DE



COMMUNICATIONS RECEIVER

- 4 BANDS COVERING 540 Kcs. TO 30 Mcs.
- TWO MECHANICAL FILTERS ENSURE MAXIMUM SELECTIVITY.
- PRODUCT DETECTOR FOR S.S.B. RECEPTION.
- AUTOMATIC NOISE LIMITER.
- LARGE TUNING AND BAND-SPREAD DIALS FOR ACCURATE TUNING.
- CALIBRATED ELECTRICAL BANDSPREAD.
- "S" METER AND B.F.O.
- 2 MICROVOLTS SENSITIVITY FOR 10 dB S/N RATIO.

PRICE: FOR/FOA SYDNEY: \$175.00

CONSULT YOUR LOCAL RADIO DEALER, OR

MAIL THIS COUPON *today*

Please forward free illustrated literature and specifications on Trio equipment.

Name

Address



(A unit of Jacoby Mitchell Holdings Ltd.)

376 EASTERN VALLEY WAY, ROSEVILLE, N.S.W.
Cables and Telegraphic Address: 'WESTELEC',
Sydney. Phone: 40 1212

fined to transistor types. Valve type amplifiers almost invariably used output transformers with no D.C. potentials associated with the secondary winding; in most cases, one side of the secondary winding was earthed to chassis. No blocking capacitor is necessary in a headphone adaptor but, by the same token, the presence of a blocking capacitor would not adversely affect its operation.

The prototype headphone adaptor was constructed in an Eddystone die-cast metal box, which is available from most electronic part suppliers. All the components are installed between two 13-lug tagstrips. The switch to select loudspeakers or phones is a two-pole, two-position type. The wiring layout is not critical but should be neat and tidy and follow good wiring practice.

The cable to the earphone adaptor needs five effective conductors and could logically be five insulated leads inside an outer covering. Because it was most readily available, we used a cable with four insulated conductors, two of which have a common outer braided shield; this was used as the fifth conductor and logically as the earth lead from the amplifier chassis.

SENNHEISER HEADPHONES



The attractive model with the enthralled expression on her face is listening to a pair of Sennheiser HD414 stereo headphones which are made in West Germany. They are lightweight units, making them less tiring when listening for extended periods. They are unusual in that the sound is coupled to the ears through foam rubber pads. The pads are easily removable so that they can be washed periodically.

The frequency response is quoted as ranging from 20Hz to 20KHz and the sensitivity is quite high; only 1 milliwatt per channel is required for adequate sound level. Impedance of the units is a nominal 2000 ohms.

Price of the headphones is quoted as \$14.34 plus tax. Details of performance and availability on this and other products in the Sennheiser range should be directed to the Australian distributors, R. H. Cunningham Pty. Ltd., 608 Collins Street, Melbourne, Victoria, or their interstate branches.

ADCOLA

Cat. No. M207



DE-SOLDERING/SOLDERING TOOL

This unique tool allows fast removal of 90 per cent of the solder on soldering tags and printed circuit board component terminations.

Removal of components is greatly simplified and P.C.B. and component damage can be avoided.

A range of six tips for both de-soldering and soldering, allows this tool to be used for all applications from micro-miniature to standard radio and TV circuit work. All tips are specially plated and de-soldering tips are stainless steel lined.

Cat. No. M207 is **Approved** in all Australian States for mains voltage operation. Models are available for all voltage ranges.

See the range of Adcola "M" Series Solder Tools illustrated in "Electronics Australia," September, 1969, edition, or write for illustrated brochure to —
ADCOLA PRODUCTS PTY. LIMITED, 22 FIRTH STREET, DONCASTER, VIC.,
3108. Phone 848-3777.
17 BURWOOD ROAD, BURWOOD, N.S.W. 2134. Phone 747-1606.
S.A. Distributor: F. R. Mayfield Pty. Ltd., 11 Halifax Street, Adelaide. 8-4131.
Qld. Agent: T. H. Martin Pty. Ltd., 56-74 Edward Street, Brisbane. 2-0555.
W.A. Agent: Everett Agency Pty. Ltd., 17 Northwood Street, West Leederville, 6007. 8-4137.

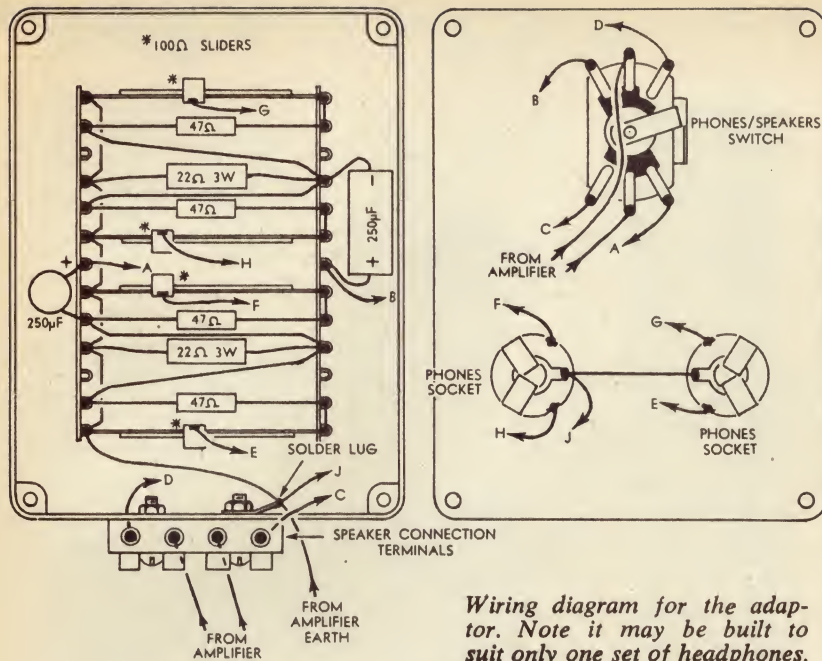

Wiring diagram for the adaptor. Note it may be built to suit only one set of headphones.

The four insulated leads are used for the active and neutral loudspeaker leads; the neutral lead is that lead which is at zero A.C. potential with respect to the amplifier chassis, i.e., the earthy side. On these amplifiers with screw terminals for the loudspeaker connections, the active side may be coloured red or coded with a "plus" sign. If this is not the case, the active side of the speaker output may be determined by trial and error when the adaptor is completed; if the headphones are effectively connected between neutral side of the amplifier output and the amplifier chassis, no sound will be heard.

The cable enters the case through a grommetted hole and is clamped to avoid risk of straining the connections. The shield is terminated to a solder

lug which is secured by the same screw which secures the cord clamp. The neutral lead from the amplifier are then brought out through the grommetted hole and terminated on the four-way insulated terminal block. The two leads from the "speakers" lugs on the the speakers/phones switch (terminal 1) are also brought out through the grommetted hole and terminated on the four-way terminal block. The four leads from the loudspeakers can then be taken from the other side of the terminal block.

Alternatively, the terminal block may be dispensed with and the four insulated leads in the cable used to take the active leads from the amplifier to the speakers/phones switch and back

(Continued on page 55)

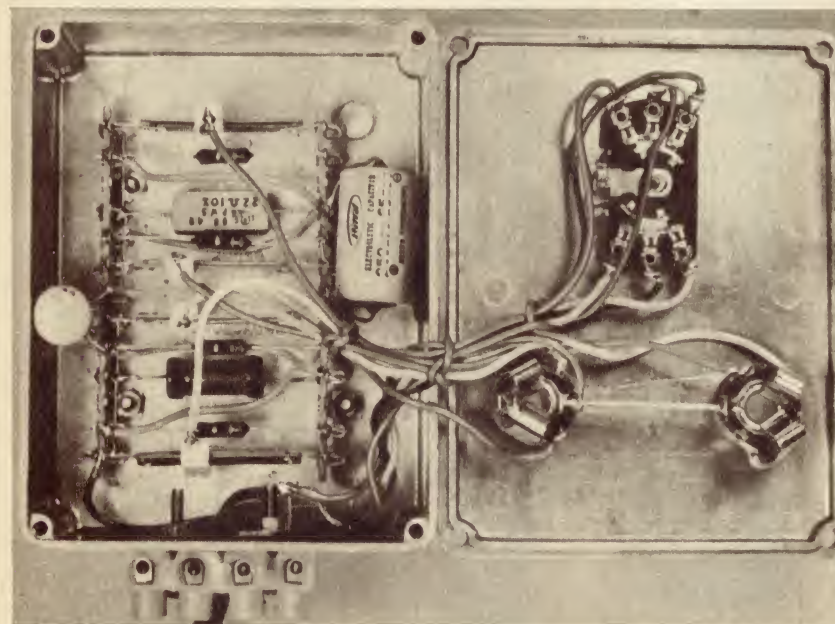

A view inside the utility box showing disposition of components. We used electrolytic capacitors which were on hand, hence the different (but typical) mounting arrangements for the two.

up to ten times longer life



MAXELL Alkaline Dry Cell — this unique new design concept features high capacity and durability that surpasses the performance of the world's top dry cell batteries. The construction of the Maxell Alkaline Dry Cell differs greatly from conventional types of carbon ZINC cells. However, the Maxell Alkaline cells can be used where you normally use a carbon ZINC cell. MAXELL ALKALINE CELLS are especially suitable where there is a demand for increased current, combined with durability and little voltage drop. Even near the end of the cell life the discharge capacity is large and stabilized.

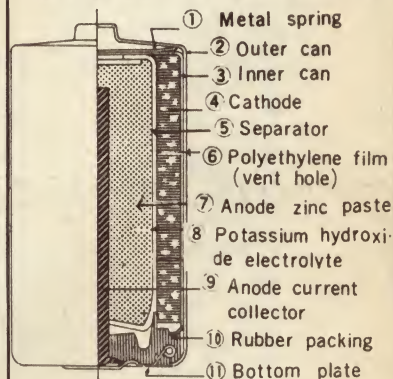

Exclusive new construction minimises leakage. Double cans are used and rubber sealing with the unique spring safety device. (see diagram)

Interior drying is prevented by hermetic sealing, therefore long storage periods are possible (over two years). Even then Maxell Alkaline cells are in the same condition as when they left the production line. These cells will withstand severe temperature changes. Rigid tests have shown extremely stabilized capacities from the low temperature of -4F to the high temperature of 150F at which temperatures dry cells would fail to operate satisfactorily.

Prices:

AM1	75c
AM2	50c
AM3	40c

Trade enquiries to
TASMANEX PTY. LTD.
376 Pittwater Road, Harbord 2096

ANNOUNCING

THE SIGN OF
PRESTIGE
SOUND



A TOTALLY NEW CONCEPT

CLAYBRIDGE SOLID-STATE POWER MODULES

HIGH POWERED STAGE EQUIPMENT THAT COMBINES TO SUIT ANY STAGE REQUIREMENTS



CONTROL MODULES

Designed for power amplification in either instrument or P. A. Power Stack. Three channels each with volume, bass and treble controls, Master tone network, stand by switch, tapping device, fully flexible.

RMS watts	50	100	150	200
Full Price	\$244	\$263.50	\$306.50	\$338.50



BOOSTER MODULES

Suitable for use with your present amplifier, or can be used in conjunction with any Claybridge control module in any quantities to obtain unlimited total power. Control, booster and instrument speaker modules are of uniform size and have fittings for instant power stacks.

100 watts RMS	200 watts RMS
\$223.50	\$309.50



ECONOMY CONTROL MODULES

High gain multi-purpose units for use as P. A., instrument or music amplification in Hi-Fi Sound. Inputs for two microphones and two instruments. Bass and treble controls, multi-impedance output. Use with either instrument speaker modules or P. A. speaker modules in vinyl or teak veneer finish.

30 watts RMS	\$122.50
--------------	----------



ECONOMY P. A. MODULES

One of our ever popular modules for those who only desire the basic essentials in a P. A. amplifier. Inputs for 4 pairs of microphones each with separate volume control, master volume on-off switch etc., rear jack connections for tape-echo, or external mixer etc. 100% reliable.

50 watts RMS	100 watts RMS
\$193.50	\$222.50



ADD-ON EFFECTS MODULE

Adds fully variable echo and tremelo to any Claybridge power module at the push of a plug. Simply connect to the special socket for all those sought after effects. Works only on channel 'A', enabling multi-channel effects.

Full Price	\$93.50
------------	---------

INSTRUMENT SPEAKER MODULES

Pure, clean sound with crisp driving clarity. Fitted with strong corners and scuff-proof dark brown vinyl, bold grill cloth, multi-stacking castors and three hidden handles fitted. Many speaker combinations from which to choose.

RMS watts	30	50	100	150
From	\$89.50	\$112	\$142	\$193.50

A NEW MODEL OF OUR FAMOUS FUZZ MACHINE

Fuzzmaster
WILDCAT

Can be used either as a treble-booster, pre-amp or, fuzzbox, or any combination! Must be heard to be believed.

\$27

CLAYBRIDGE INSTRUMENT SOUND STACKS

Unlimited Variation
- Design Your Own.

CLAYBRIDGE COMPREHENSIVE HIRING SERVICE

A FULL RANGE OF STAGE MICS ALWAYS IN STOCK



Just a small selection from our vast range.

COMPREHENSIVE RANGE OF STANDS AND ACCESSORIES



OBTAIN YOUR



CATALOGUE TODAY

PUBLIC ADDRESS SPEAKER MODULES

Smooth, pure driving sound for all over sound description with no feedback or distribution multi-stacking, castors, comfortable carrying handles, various speaker combinations, portable, compact.

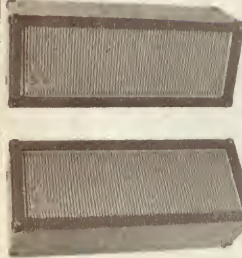

RMS watts	30	50	100	150	300
Price/Pair	\$133	\$171	\$218.50	\$355	\$379.50

CLAYBRIDGE P. A. SOUND STACKS

Limited Only

By Your

Imagination.



THE LATEST IN PSYCHEDELIC LIGHTING



Every Imaginable Type Full Details In Catalogue.

To: Claybridge Sound, 163 Clayton Rd., Clayton, 3168.
(Ralph & Barbara Bridges-Proprietors)

Dear Sir, I am flabbergasted by all your gas new gear, please rush me your new monster Catalogue and Price Card. I have enclosed 50¢ to defray your costs. I will be pleased to use the \$1 gift voucher with the Catalogue.

PLEASE PRINT

NAME: _____
ADDRESS: _____
Code: _____ Phone: _____

NEW **SONY** TC-540

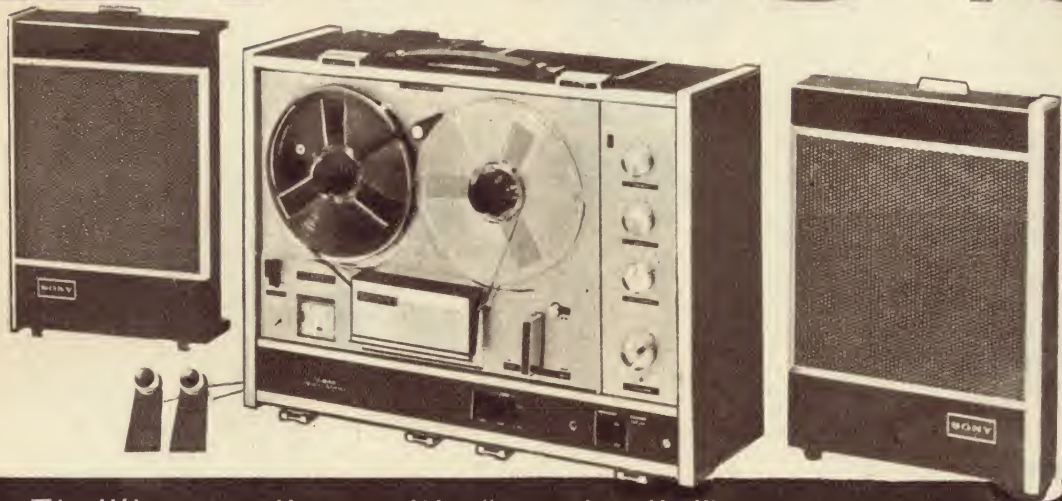

Thrilling realism with "quadradiol" sound system

MODEL TC-540: The ultimate in stereo performance is yours from SONY's quality solid-state tape recorder TC-540 with 4 track stereo/mono recording and playback operation. "Quadradiol" sound system, uniquely designed separate speakers—two high compliance low frequency speakers are installed in baffle enclosures on each side of the recorder case and the two satellite high frequency speakers in the split lids, which can be separately placed up to 16 feet apart, for maximum effect in stereo.

Individual bass and treble tone controls for your personal listening preferences, speaker monitoring volume control, three tape speeds, retractable pinch roller for ease of tape threading, easy sound-on-sound recording, line/microphone mixing recording with optional microphone mixer, automatic sentinel shut-off switch, either vertical or horizontal operation and noise suppressor for reduction of hiss are only a few of the many outstanding features.

You will be fascinated by the full range stereo performance from dynamic fortissimo to thrilling pianissimo.

Specifications

Recording system: 4-track stereo/mono recording and playback. **Power requirements:** 100, 110, 117, 125, 220 or 240V AC 65 watts, 50/60 Hz. **Tape speeds:** 7½ ips, 3¾ ips, 1⅞ ips. **Reels:** 7" or smaller. **Frequency response:** 30-20,000 Hz at 7½ ips • 30-13,000 Hz at 3¾ ips • 30-10,000 at 1⅞ ips. **Flutter and wow:** 0.09% at 7½ ips • 0.12% at 3¾ ips • 0.16% at 1⅞ ips. **Harmonic distortion:** 2%. **Signal-to-noise ratio:** 50dB. **Power output:** 5W per channel (20W total dynamic power). **Speakers:** Two built-in speakers 4" x 8" and two lid-integrated speakers 4" diam. **Recording time (1,800' tape):** 4-track stereo 6 hrs. at 1⅞ ips • 4-track mono 12 hrs. at 1⅞ ips. **Fast forward and rewind time:** Within 2 min. 20 sec. (1,200' tape). **Inputs:** MICROPHONE • Sensitivity -72dB (0.19mV) • Impedance 600 ohms LINE • Sensitivity -20dB (0.078V) • Impedance Approx. 100k ohms. **Outputs:** LINE • Sensitivity 0dB (0.775V) • Impedance 100k ohms EXTERNAL SPEAKER • Sensitivity 11.2dB (2.83V) • Impedance 8 ohms MONITOR • Sensitivity 11.2dB (2.83V) • Impedance 8 ohms (or 10k ohms). **Rec/PB connector:** INPUT—Sensitivity -40dB (7.8mV), Impedance 10k ohms OUTPUT—Sensitivity 0dB (0.775V), Impedance 10k ohms **Dimensions:** 19-11/16" x 9-15/16" x 15-7/16". **Weight:** 41 lbs. **Accessories:** Two microphones F-96, empty reel R-7A, connection cord RK-74, two reel caps, motor pulley, power cord, head cleaning ribbon, splicing tape PS-2, demonstration tape, SONY oil OL-1K. **Optional accessories:** Telephone pick-up TP-4S, microphone mixer MX-600M, MX-6S, stereo headset DR-3A, DR-3C.

SONY®

Distributed by:

jacoby, mitchell & co. pty. ltd.

SYDNEY • MELBOURNE • BRISBANE • ADELAIDE

To: Jacoby, Mitchell & Co. Pty. Ltd., 469-475 Kent St., Sydney, 2000. Please send me information on Sony Tape Recorders & nearest Sony retailer.

NAME

ADDRESS

MS/1-68/EA1269

SONY STEREO HEADPHONES



Pictured is a pair of Sony DR3C stereo headphones which is supplied in the high impedance of 10Kohms. They are well finished and have a good range of adjustment for comfortable wearing. The padded surrounds are close-fitting to obtain an extended bass response and are easily removable to allow cleaning. The overall characteristic of the response of these headphones is a tendency to emphasise the "middles" but they are pleasant and easy to listen to. Price is \$18.75 and they are available from most retailers of high fidelity equipment.

(Editor's note: For information on yet another brand of headphones see the review of AKG K20 and K60 stereo headphones which appeared on page 143 of the September, 1969, issue of "Electronics Australia".)

to a terminal block on the rear panel of the amplifier.

Once the adaptor has been completed the slider resistors should be set to the position which would give minimum volume in the headphones. After having connected the various leads to the amplifier and connected the loudspeakers to the appropriate points in the adaptor circuit, program material should be played through the loudspeakers with volume, balance and tone controls at their normal settings. Leaving these set, switch to the headphones and adjust the appropriate slider resistors for a suitable level in each channel. With the levels set in this way, switching from speakers to headphones can be done without the need for re-setting the volume control. The effective signal/noise ratio should be about the same.

The diagrams provide for operating two pairs of headphones but, if provision has to be made for only one pair, one of the sockets may be omitted, along with the associated 47-ohm and 100-ohm slider resistors.

Readers may care to experiment with the idea of cross-coupling the two headphone circuits to diminish deliberately the isolation between the two channels.

This has been the subject of a fair amount of discussion in overseas audio journals. The circuits usually involve various configurations of L, C and R, intended to make the cross-coupling frequency and phase conscious, in an effort to simulate the conditions which obtain in ordinary loudspeaker listening.

Before being qualified to offer an opinion about the various circuits which have been suggested, it would

NEW RECEIVER, NEW AMPLIFIER



Beginning in the January issue, we plan to describe a new communications receiver, which we have developed. The objective was to produce a receiver of high performance, consistent with the best possible economy. The result is a high-stability receiver, with excellent signal-to-noise ratio and suitable for AM, CW and SSB reception. The photograph indicates that the finished article has a professional appearance. The following are some of the features: Solid state. Full coverage, 0.5-30MHz. Tunable IF. Crystal-locked front end. FET RF amplifier.

Two selectivity band-widths, 5KHz and 2.5KHz, using ceramic resonators and performance rivalling mechanical filters. Noise silencer on Lamb principle. Product detector and ceramic high-stability BFO.

We also plan to feature next month a high power basic stereo amplifier delivering up to 60 watts per channel and catering for load impedances between 16 and 4 ohms, with distortion figures from 0.05 per cent. The amplifier is intended to complement the Playmaster 127 control unit described in the November issue, and, with it, will constitute a high-performance, state-of-the-art Playmaster system.

Watch out, too, for a balanced-bridge metal locator!

be necessary to conduct quite lengthy listening tests with a variety of stereo program material and this we have just not had time to do. It is obvious, however, that provision of even the simpler kind of network would add materially to the cost, bulk and complexity of a headphone adaptor.

For those who wish to experiment on a simpler basis, however, low value resistors or a potentiometer may be tried in the position shown dotted on the circuit diagram.

Go out and purchase yourselves a pair of headphones then, build this adaptor unit and you can listen to stereo any time you like. You may even listen to bagpipes at 3 a.m. on Sunday morning — as long as it's on headphones!

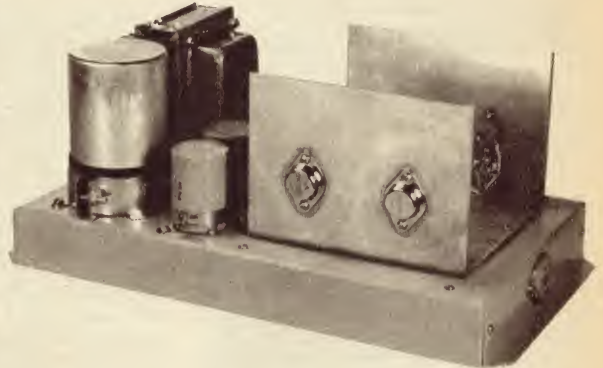

RESISTORS.

(Carbon Film ±5 P.C. Tol.)

	1-99	100-999	1000-
¼w	4c	3c	2c
½w	4c	3c	2.2c
1w	7c	5.5c	4c

RANGE: ¼ and ½w 1 ohm-10 meg.
1w 5 ohms-1 meg.

NOTE: Values maybe mixed — We supply to your list.

YELLOW-CAP Ceramic capacitors. 100v. Range 2.2PF-820PF 6c each or \$5.00 per 100. Your selection in above range. Values may be mixed.

±10%

POLYESTER CAPACITORS

100VW Types—Fully Guaranteed

MFD	Price 1-9	10+	MFD	Price 1-9	10+
0.001	7c	6c	0.033	9c	8c
0.0022	7c	6c	0.047	10c	8c
0.0033	7c	6c	0.05	11c	9c
0.0047	7c	6c	0.068	11c	9c
0.005	7c	6c	0.08	11c	9c
0.0068	7c	6c	0.1	12c	10c
0.01	7c	6c	0.22	16c	13c
0.022	8c	7c	0.33	21c	17c
0.03	9c	8c	0.47	23c	19c

All components are new and guaranteed. Pack/Post 10c any order. Prompt service.

KITSETS AUST.
BOX 176, P.O., DEE WHY, 2099, N.S.W.



FORUM

Solid state, control tones — and Hertz

This month, our Technical Editor, Jamieson Rowe, is the target for a broadside — but he is well qualified to speak for himself. Other letters are from readers irate about control tones on the mains and about changes in terminology.

Conducted by the Editor

The broadside with which Jim Rowe has to deal was aimed at one of his articles in the current series on solid state technology. Somewhat condensed to conserve space, the letter reads as follows:

Dear Sir,

I wish to congratulate you on the fine series of articles by Mr Jamieson Rowe, entitled "Fundamentals of Solid State." However, there would appear to be a very important question raised in chapter three of this series, and one which Mr Rowe has left unanswered. With reference to figure 3.5, the related text states that when an atom of an acceptor impurity such as aluminium is added to a silicon crystal lattice, it "effectively brings with it into the crystal lattice nothing other than a positively charged valence band hole." Now the silicon crystal lattice prior to the addition of the acceptor atom should be electrically neutral overall, as far as I can see; similarly the acceptor atom by itself should be electrically neutral. How is it, then, that two electrically neutral entities can combine to produce something which suddenly has a net positive charge?

I hope Mr Rowe can answer this question, because it seems to be one of considerable importance. The position with regard to donor impurity doping seems simple and straightforward, but unless the mystery of the appearance of a positive charge in acceptor impurity doping is cleared up, I, for one, will still be seeking a really satisfying exposition of the subject. (F.R., Upper Hutt, N.Z.)

In reply, our Technical Editor has this to say:

I must confess that when the Editor first showed me this letter, my reaction was a trifle emotional.

How could anyone have so misinterpreted such concise prose, each paragraph of which I have been delivered only after much sweat and striving for unambiguous communication? Or something along these lines, anyway...

It looks as if I'll never fully convince myself of the fact that the writing of a perfectly unambiguous, fully communicative technical article is one of those glorious ideals which we humans set up for ourselves as goals never-to-be-reached but always-to-be-striven-after.

But enough of the workdesk profundity. Upon re-reading both our correspondent's letter and the relevant section of the article concerned, and after the cooling-off period necessary for some slight return to objectivity, I realised that the cause of the trouble lay fairly and squarely in the paragraph quoted. It is undeniably ambiguous, and could quite possibly have led other readers besides F.R. into thinking that a crystal of P-type semiconductor has an overall positive charge.

For the ambiguity I apologise. I can only hope that the following explanation satisfies both F.R. and any other readers who interpreted the paragraph in a similar fashion.

It would indeed be a "mystery" if

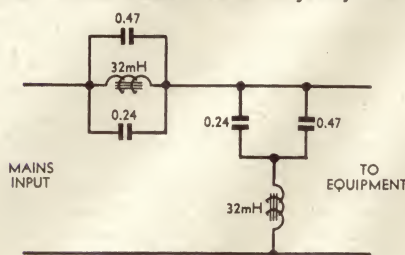

Referred to in the text, this filter is claimed to afford better than 11dB attenuation of 1050Hz control tones. Inductors must be able to carry the load current of, typically, 1½ to 2 amps. The shunt capacitors in particular must be rated to operate continuously with 240VAC applied.

two electrically neutral entities could combine to produce a product having a net charge. Luckily, while electronics involves a great many "mysteries," to the best of my knowledge this is not one of them. The fact is that when an acceptor impurity atom is added to a neutral silicon crystal the resultant P-type material is still electrically neutral.

The situation is really just as simple as that for N-type material. The acceptor atom added to the silicon lattice differs from the host silicon atoms in two ways: it has a different nucleus, and it has one less valence electron. The charges on the impurity nucleus and on its "own" electrons are equal and opposite, hence the addition of the atom to the silicon crystal merely adds equal numbers of positive and negative charges to those already present, and neutrality is maintained.

But whereas the nucleus of the impurity atom becomes fixed in the lattice, the three electrons at the valence level enter into the valence binding system of the lattice and become the shared "common property" of all lattice atoms.

Because the impurity atom only contributes three valence electrons to the binding system in this manner, whereas four are normally associated with each lattice position, it therefore effectively contributes to the valence binding system a "vacancy," "defect," "weakness," or hole. And this hole is really just as much a part of the valence binding system as the electrons.

Like the electrons, it is effectively "common property," belonging not only to its parent impurity atom but rather to all of the atoms in the semiconductor lattice. When excitation energy is added to the lattice, a neighbouring valence electron can "jump" over to fill the hole, leaving another hole in its place to be filled in turn by another valence electron, and so on. As a result the hole effectively moves around throughout the lattice binding system, and can accordingly behave as a positively charged current carrier.

In short, then, just as a donor impurity atom effectively brings with it into the semiconductor crystal an excess electron which can move through the lattice in the conduction band as a negative current carrier, so an acceptor impurity atom effectively brings with it into the semiconductor crystal a hole which can move through the lattice in the valence band as a positive current carrier. In each case the atoms also bring nuclei of different positive charge to the

WHY MESS ABOUT WITH WORDS?

To set your mind at whatever is the reverse of ease, let me assure you that the controversy between Hertz and cycles-per-second has by no means died out and, barring an unexpected capitulation by the Hertz faction, isn't likely to. If this makes me an unabashed supporter of Auckland's L.S. (Forum, September) — and it does — I make no apology. I read the contribution by Mr Spackman in the December '68 issue and am unimpressed by his sophistries: the fact remains that cycles-per-second means something to the thoughtful person whether he knows anything of the esoteric language of electronics or not, while Hertz is — unless one is contemplating renting a car — essentially meaningless.

And why, anyhow, this recent passion for changing the names of things? of changing perfectly good names with long and honorable histories? There is just a suspicion of arrogance in the whole thing, as if the name changing were a demonstration of the power of an individual or a committee to do so. In 1956 an international conference on measurements decided that the word centigrade (in reference to the temperature scale) could be replaced by Celsius, thereby honouring a pioneer in thermometry. The conference saw no reason why the new name couldn't be rammed down the throats of the scientific community. And so it was. Publications hovered. Some converted at once to Celsius, while others (no doubt waiting to see what was finally going to happen) held out for centigrade. After twelve years we have seen some of the original converts regress to the former word because they weren't convinced their readers knew what the new one meant. We have, at the moment, both words in use and no guarantee that either of them will be understood.

Other illustrations abound of the practice of swapping terminology for something that is not better but just different.

We have seen, since the end of World War II, the international phonetic alphabet changed twice, first to a remarkable system of gibberish that was, I am told, invented by philologists and linguists (and never has the academic community shown itself so out of touch with practical reality), and then to a compromise alphabet which consisted of a mixture of the old and the new with a few original letters added for form's sake. No one I have ever talked to believes that the present alphabet is any better than the one used during the war, yet each change has required the amending of tens of thousands of publications and the relearning of the alphabet by probably millions of individuals.

I think that L.S. is right and that most of us now in the electronics game (either professionally or as interested amateurs) will continue to think "cycles-per-second" no matter what the "official" term is for as long as we continue to live (and some of us have a fair bit of life left in us).

The only creatures who suppose they are making progress when they are going sideways are crabs.

(D.C., Darwin, N.T.)

host semiconductor nuclei, maintaining overall electrical neutrality; however as these nuclei remain fixed they do not play a significant part in conduction.

So much for solid state, holes and electrons.

CONTROL TONES: During the past year, we have had quite a deal to say about control tones which the supply authorities impose on their power mains to effect various switching functions. The tones have caused a large amount of annoyance in some areas because they penetrate audio systems and interrupt public meetings, church services, recording sessions — and the plain enjoyment of music at domestic level.

It has been suggested that the gradually increasing level of annoyance probably indicated not only more widespread use of tone-operated equipment but a tendency to increase the level of the control voltages on the lines to offset ohmic and reactive losses, sluggish relays, etc.

In the controversy, supply authorities have remained conspicuously silent but, strangely enough, a number of complainants have recently commented that the level of annoyance seems to have fallen.

Could it be that the publicity given to the subject in this journal has at

last awakened authorities to the idea that they can't just go on winding up the amplitude of the control tones?

I hope so.

In the meantime, here is a letter from a reader in Queensland who was not willing to submit meekly to this electronic pestilence:

Dear Sir, — Professor Huey's letter in the September, 1969, issue seems to offer a glimmer of hope to hundreds of thousands of Australians seeking freedom from the menace of control tones; hope that they may enjoy their leisure or advance themselves through the medium of listening to lectures on taperecorders; hope for those who in their spare time make tape books for the blind.

But, personally, I don't hold much hope for, you see, representatives of the Brisbane City Council and the P.M.G. Radio Branch have been out to my house to listen to, and try to suppress or remove the 1050Hz switching tone from the mains.

"Firstly they said that the equipment was suffering from a fault such as a bad earth. However, the Council man checked my earth, tightened up clamps, etc., but the 1050Hz signal remained unchanged. Someone suggested that I drive three 6ft fencing spikes down into the ground, couple them together and take this 'silent' earth to

Research Makes the Difference

A. VICTOR & CO.

proudly present the superb
SONY TC560

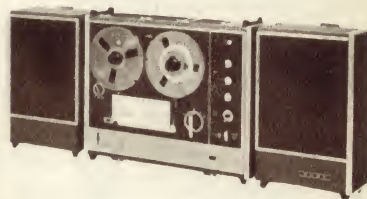

THE ULTIMATE STEREO CENTRE

- Automatic Tape Reverse System
- 240V A/C and 12V D/C Operation
- 10 Watts RMS Output
- Input Selector ● 3 Speeds Frequency: 20-21,000 Hz at 7½ IPS: 20-15,000 Hz at 3½ IPS: 20-8,000 Hz at 1½ IPS; Flutter and Wow; Less than 0.15% at 7½ IPS; Flutter and Wow; Less than 0.2% at 3½ IPS. Signal to Noise: Better than 50dB.
- Separate Bass and Treble Controls. Size: 20½ x 11½ x 17½.

Write or call for details on this special **SONY FOR SCHOOLS** offer featuring models TC 210-TC 505.

VICTOR'S HI-FI CENTRE

Corner Wentworth Avenue, and Elizabeth Street, Sydney.
61-2967 61-6031

LAY-BY NOW. Terms.
Take advantage of our
PROGRESSIVE DISCOUNT SYSTEM

AKAI MODEL STEREO 1800L

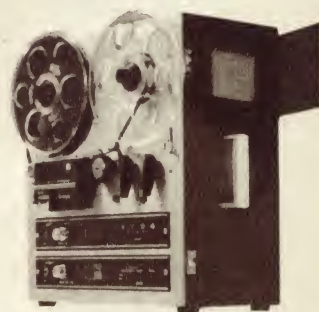

- * Unique multi-purpose
- * Exclusive Reel-8 track cartridge recording and transfer.
- * Plus many other outstanding Akai features.

ALSO ASK FOR THE
NEW AKAI M10

Ask in person for our expert advice and unbeatable offer.



varian EIMAC

new 3-500Z offers high power gain, less circuitry.

EIMAC's new 3-500Z is a compact, heavy-duty power triode with 500 W plate dissipation, designed for operation in zero-bias Class B r-f or audio amplifiers. The tube can be used as a cathode driven (grounded grid) linear amplifier where low distortion, high plate dissipation, and great thermal anode reserve are desired. The 3-500Z may be operated at plate potentials up to 3000 Vdc, and eliminates expensive, bulky screen and bias supplies. The 3-500Z will replace EIMAC's 3-400Z where additional plate dissipation or greater reserve is desired. Forced-air requirement is approximately equal to that of the 3-400Z, and a blower capacity of only 13 cfm at a back pressure of 0.2 inch is satisfactory for a single tube. The 3-500Z's zero-single plate current is somewhat higher than that of the 3-400Z. When used as a replacement for the latter tube, the 3-500Z's zero-signal plate current can be reduced by addition of a simple zener diode in the cathode return. This technique is particularly suggested if plate potentials over 3000 Vdc are contemplated, or if the tube is used in equipment that is power supply limited.

3-500Z TYPICAL OPERATION*

(Minimum Distortion Products at 1 kW PEP Input)

DC Plate Voltage 2500 V
Zero-Sig DC Plate Current** 130 mA
Single-Tone DC Plate Current 400 mA
Single-Tone DC Grid Current 120 mA
Two-Tone DC Plate Current 280 mA
Two-Tone DC Grid Current 70 mA
Peak Envelope Useful Output Power 500 W
Resonant Load Impedance 3450 ohms
Intermodulation Distortion Products -33 dB

*Measured data from a single tube

**Approximate



varian PTY LTD

electron tube and device group

38 oxley street/crows nest/nsw 2065/43 0673

679 springvale rd/nth springvale/vic 3170/560 6211

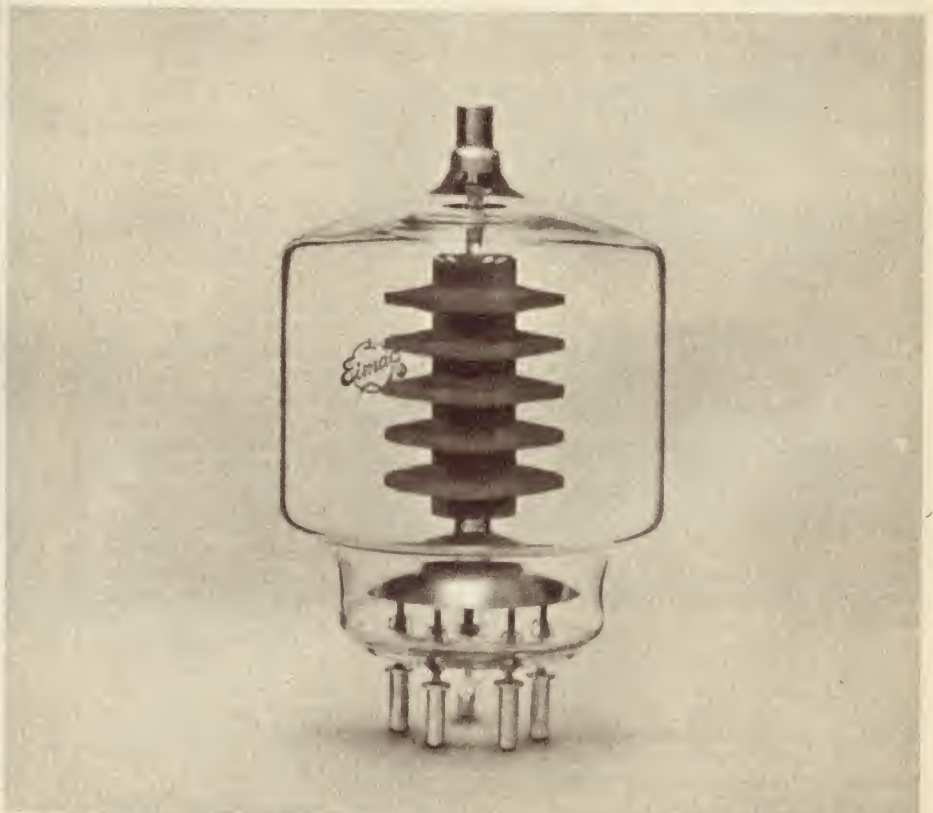

ETG 1069

the plug that I take the mains supply from.

"Then followed this gem of conversation: 'But you only get the 1050Hz when your Hi-Fi is turned on.' 'Elementary, my dear Watson,' I replied 'but that's when it annoys me most. When I hear it in the fridge and the fluorescent lights and on the phone, it doesn't worry me as much — I put up with it then. It's only when I'm doing professional tape recording and listening to lectures that it drives me up the wall.'

"Said the P.M.G. man: 'Oh, I see. I'll try this filter.' Well, it did nothing and he promptly excused the filter by saying: 'It used to work. Maybe the capacitors are drying out.'

"So they measured the signal coming through with a special voltmeter the B.C.C. man had with him and measured the signal voltage at my place at 5.5 volts. They said it should not be more than 3 volts.

"The B.C.C. and P.M.G. men both agreed that the level was objectionable. The B.C.C. man said it was not his baby. The P.M.G. man suggested I buy the parts and make up a filter and to try it. (The circuit is enclosed with this letter.) Failing this, I could shield every cable in the circuit including the speaker leads.

"Well I've heard some ideas in my time but that last one was a kookie. However, he finally consoled me by telling me I've no hope of really getting rid of it and to add insult to injury, the B.C.C. man asked me if I would not like a Zelweiger Switching System relay fitted on my board. I replied I'm not encouraging the system; I'm against it. What he really was trying to tell me was, why don't you join us for, brother, you sure won't beat us.

"I and many of my colleagues agree on one point but unfortunately cannot prove it. That the B.C.C. boost up the gain to make sure all the faulty and sticky relays operate, especially on the perimeter areas, for they can tell when the load increases or decreases. Perhaps servicing their relays might be a step towards helping the problem."

(W.F., Zillmere, Qld.)

Well, there you are . . . a man very angry about control tones, and typical enough of the way other readers feel, who have expressed themselves on the subject.

As for the mains filter, someone may have the time and inclination to work out the inductor specifications and make it up. A quick check on a reactance chart indicated that it was intended to resonate at 1050Hz and any merit the unit might have would be dependant on resonance actually being achieved in both the series and the shunt arms.

And, speaking of angry readers, a letter on an earlier page, on the subject of terminology, starts with Hertz and finished with the International Phonetic Alphabet.

As far as Hertz is concerned, the article by L. S. Spackman in our December, 1968, issue explained the extreme precision which has become necessary in expressing time and frequency now that science has become

RADIO: Unofficial history

Bankstown was one of the districts hardest hit by the depression. In those days, it was a tough town in which to make a living or learn a trade. As a young teenager, I rode a push-bike all over this area, with a haversack filled with radio parts and primitive test equipment strapped to my back.

I know this column is for humour, but before I tell my true funny story I should like to say that my experiences in that harrowing period have given me, like Kylie Tennant, a deep affinity with the "battlers."

I served my apprenticeship with my father, who, in 1923, established what was probably the first radio shop in the suburbs. He taught me the hard way.

At the age of 11 years, I was given a "Wireless Weekly" and a heap of parts and told to build a crystal set. I left school at 14, and, soon after, built my first radio for sale — a three-valve battery set in a cabinet nearly as big as a self-contained flat.

My funniest experience concerns an old German customer out Revesby way. When I was given a service call, I was always instructed not to come back without five shillings for my time plus the cost of the parts. But, as my kindly father knew well, this was a tall order in a poverty-stricken town.

I arrived at the German gentleman's home and he informed me that the radio only worked if he put his finger on the cap of one of the valves. I turned the radio on and was surprised

to find that it worked, although not very well.

"It's working now," I said.

"Ah, yes, But look, will you," he replied, lifting up the lid of the receiver. There, stretched from the cap of the RF amplifier across to the top of the aerial coil was a foot-long German sausage.

"Finger iss meat; so iss sausage," he explained, noting my surprise.

In the era of my youth, teenaged kids were expected to show respect for their elders, and I managed somehow to suppress my laughter, albeit with difficulty; but I could not resist asking one cheeky question.

"Doesn't the sausage get smelly after a while?"

"Nein, my poy," he answered. "I am sausage maker. I change him every week."

I was not able to get five shillings for repairing the fault, which, by the way, was an open-circuit aerial coil. He beat me down to three shillings and sixpence, but threw in two German sausages weighing about a pound each. We parted on the best of terms, particularly as he was kind enough to say: "You goot fixit, poy. Here for you threepence to spend and saveloy to eat on vay home."

I have often wondered in after years whether the two German sausages given in part payment for services rendered, as well as the saveloy I received as a bonus, had already served a term of duty inside the old German's radio. (R.M., Wentworthville, N.S.W.)

(Readers are invited to submit contributions to "RADIO: Unofficial History" and a publication fee will be paid for those used. Stories must be humorous and they must be true. Letters must be signed and the locale of the story indicated as a mark of good faith. The Editor reserves the right to re-phrase contributions as necessary to preserve uniformity of style.)

involved, among other things, in inter-planetary navigation. It explained the ambiguities which have emerged about the exact meaning of cycles per second and the consequent reason for adopting the term Hertz.

Our correspondent chooses to reject this and expresses himself as unimpressed by such "sophistries." C.D. can — and obviously will — please himself in the matter but, as far as this journal is concerned, we have no regrets about standardising on the word Hertz, nor have we the slightest inclination to back-pedal.

It is true that many other terms are being introduced into scientific terminology and, grouped together, they look quite forbidding to those who are not involved in their everyday use.

But so also do the terms they are superseding!

For this December issue, we looked at an article from the U.S. National Bureau of Standards, listing and inter-relating a large number of terms, old and new. We decided against publishing it on this occasion, partly because of the type-setting difficulties involved and partly because, for most readers, it would be material they already had or didn't need.

Presumably, the only explanation C.D. can see for such changes is "a suspicion of arrogance" and a "demonstration of power." I fancy that there is something more to it than this. Dig deep enough and you might even find that the changes stem from new and more precise methods of quantising standards, the emerging inter-relationship of physical units and a desire for international standardisation!

I take it that the phonetic alphabet to which D.C. refers is not the one aimed at evolving letters to signify basic speech sounds but the Able-Baker-Charlie sort of thing, used to reinforce identification of conventional letters, A, B, C, etc.

Even the changes in this so-called alphabet may be found to be based on something other than an abstract exercise for philologists and linguists. The changes might just be found to have stemmed from shortcomings in the original convention; from a desire to find words which would result in fewer ambiguities when pronounced by the variety of other-racial individuals who are flying aeroplanes these days, and engaging in pursuits which involve international speech traffic. ■



BIG SOUND BIG SPEAKER

Pioneer lead the 'Pop' scene with the finest lead & bass guitar speakers



15" Guitar Speaker P-382

Voice Coil Impedance:	8 Ohms (P382B) or 15 Ohms (P382A).
Nominal Power:	60 watt.
Frequency Response:	60 — 5000 c/s.
Sensitivity:	103 db/watt.



12" Guitar Speaker 30-35Q

Voice Coil Impedance:	8 Ohms.
Nominal Power:	40 watt.
Frequency Response:	70/5000 c/s.
Sensitivity:	102 2 db/watt.

Contact your State Office of **ASTRONICS AUSTRALASIA PTY. LTD.** (Sole Australian Agents, and a member of the Electronic Industries Limited Group of Companies) for your nearest dealer's address.

VIC: 161-173 Sturt St, South Melb. Phone 69 0300.
 N.S.W.: 121 Crown St, E. Sydney. Phone 31 6721.
 S.A.: 81-97 Flinders St, Adelaide. Phone 23 4022.
 W.A.: 28 Belmont Ave, Belmont. Phone 65 4199.
 TAS: 199 Collins St, Hobart. Phone 2 2711.
 QLD: 50-54 Lt. Edward St, Brisbane. Phone 2 0271.



PIONEER

— THE BIGGEST SOUND AROUND

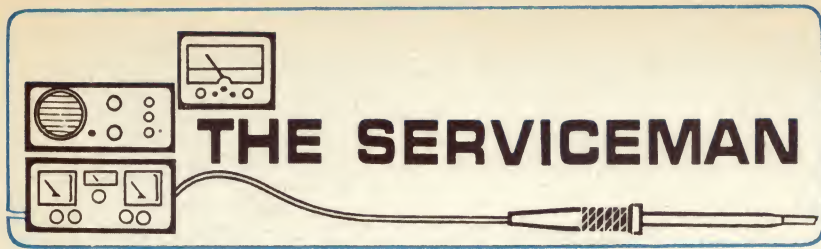

On dry joints and hasty conclusions

What is the difference between a keen snap diagnosis, which brands you as a genius, and a hasty jump to a wrong conclusion which brands you as a clot? Very little really; it's almost entirely a matter of whether the guess was a good one or a bad one.

Two things I mentioned in last month's stories prompted comments from friends who read these notes. The first arose out of my story about the deflection yoke with the shorted turn and, specifically, my comment that "the quite normal sound that was issuing from the loudspeaker seemed to suggest that there was nothing wrong with the normal HT supply . . ." which, as it turned out, proved to be correct.

"Don't you kid yourself, mate," said one of my colleagues, commenting upon the story. "I was caught out properly, on a recent job, because I jumped to a conclusion like that."

Then he went on to tell what happened, even though it was something of a story against himself. On the other hand, for those who may be inclined to scoff, let me emphasise that most servicemen work long hours in a job that requires all one's concentration at the best of times. It would be surprising if some of us DIDN'T make a mistake now and again.

This job was the last on the run for the day. It had been a long day and my friend was tired. On top of that the customer lived in a home unit, on the third floor, and in a district where parking was at a premium. So, by the time he had found a parking spot, walked a couple of hundred yards back to the home unit and up three flights of stairs, lugging his kit, he was tired and—let's be frank—a bit cranky. He just hoped that this would turn out to be a routine fault so that he could get home for his evening meal, already overdue.

The set turned out to have sound but no picture or, at any rate, no picture that was readily discernible under normal room lighting conditions. But not only was the sound section functioning: it was functioning so well, with ". . . oodles of good clean sound," as my friend put it, that there could be no question of a simple loss of HT.

And at that point my friend virtually convinced himself that the job was going to be a hard one. Foolish? Perhaps so; but he had reached the stage where the thought of delving into an upturned chassis on the lounge room floor, perhaps for the next hour, was more than

he could take. Better not to start if the end of the job was not in sight. Better to assume that it was a hard one and treat it as such. Which meant removing the chassis and taking it back to the shop, where someone else could worry about it. To be sure, this meant lugging the chassis down the stairs and several hundred yards along the road, but at least this called for no special mental effort and only a one-way walk.

So this was what he did. Naturally, the customer was less happy than he would have been had the set been fixed on the spot, but not so unhappy as if the serviceman had not called at all. So, superficially at least, he had discharged his responsibility.

The punch line to the whole story came late the following day when he returned to the factory. The bench serviceman who had handled the fault bailed him up.



"You're too late—I fixed it and it's working perfectly!" (TV Times).

"That set you brought back," he said, identifying the make and model, "did you have any particular reason for bringing it in? There didn't seem to be much wrong with it."

"What was wrong with it?" asked my friend.

"Two crook 6N3s" (rectifiers) was the reply.

So much for my friend's snap diagnosis and his (or anyone else's) reliance on the behaviour of the sound section as an indication of adequate HT voltage. I am sure both he and I will be more careful in future.

The other point I raised last month was in the form of a question, "How long can a joint remain dry?"

It is the kind of question to which there is no conclusive answer, but there is plenty of evidence to indicate that dry joints can turn up in the most unexpected places and that they can remain undetected for a long time.

Hardly had I completed last month's notes than I had occasion to drop in on my amateur friend. I found him in his shack, poring over his latest disposals buy; a relatively modern car radio telephone unit which he had been fortunate enough to acquire "for a few quid" and which he planned to convert to the six-metre amateur band.

One of the conversion steps involved removing the aerial coil and rewinding it with a larger number of turns. The coil was wound on a small bobbin similar to that used for RF chokes, and simply supported by its pigtailed. Getting it out presented a minor problem, since it was tucked down in a corner of the chassis. We studied the layout together and decided that the earthy end would be the easiest connection to tackle first. Once that was free, the other end would become more accessible.

So, soldering iron in one hand and pliers in the other, my friend prepared to operate. First he coaxed the jaws of the pliers down through the maze of components and managed to grip the pigtail with it, while preparing to bring the soldering iron in from another angle. But it wasn't necessary. As he gave a gentle tug on the pigtail, just to make sure he had a good grip on it, it came clean away from the chassis connection. It was as "dry" a joint as either of us had ever seen.

While of little consequence at this point in time, both my friend and myself were inspired to speculate on just how much strife this fault may have caused over the years. How many times, for example, did the driver of the vehicle complain that he had failed to receive a message because the receiver was not working correctly? And how many times did the maintenance mechanic find nothing wrong and accuse the driver (privately at any rate) of being "in the pub" when the call came through? Equally, how many times did the driver privately accuse the mechanic of being a brainless clot, incapable of changing a set of torch batteries without an instruction manual? And so on.

I wonder.

One of the questions which customers, particularly migrant customers, ask fairly regularly concerns the compatibility of foreign TV sets with the Australian system. This is usually prompted by the situation where a relative or friend "at home" is planning to migrate to Australia and wants to know whether he should bring his TV set with him, or sell it and buy a new one when he arrives.

I don't mind answering these questions — in fact I tend to encourage them — but one would need to be a walking encyclopedia these days to keep track of all the information about all the systems in use. In the European



AKAI's Wide Range of Products Carries the Best Christmas Message

AKAI's high prestige stereo products carry a distinctive Christmas message—one with the meaning of lasting quality. AKAI—world renowned for its leadership in tape recorders—has broadened the scope of its production activities to now include many different, uniquely designed speakers and amplifiers. The same over-all distinctive top quality design and superior craftsmanship are brought to these distinguished products. Make it a memorable Christmas! With AKAI you'll have only the best memories.

AKAI AUSTRALIA PTY. LTD.: 276 Castlereagh St., Sydney, N.S.W./146 Burwood Rd., Hawthorn, VICTORIA/399 Montague Rd., West End, Brisbane, QUEENSLAND/8 Arthur St., Unley, S.A./579 Murray St., Perth, W.A. HOMECRAFTS: Petrie St., Canberra, A.C.T. J.B. YOUNG: Giles St., Kingston, A.C.T.

Prove it by the sound!
.....prove it with

AKAI[®]
CROSS-FIELD HEAD

area alone there are some 14 different systems, involving such variations as number of lines, type of sound modulation, sense of vision modulation, vision/sound separation, band width etc. And to these must be added a variety of channel numbering systems and channel combinations within these systems.

Fortunately, I recently acquired a discarded short-wave listeners' guide (World Radio-TV Handbook) which, I was surprised to discover, listed a good many things other than short-wave stations, including broadcast and TV stations. While it might have been out of date as far as short-wave schedules were concerned—which was how I acquired it—I imagine it is still accurate and fairly up to date in regard to TV stations and standards.

However, I'm afraid I was hardly prepared for the first use I would make of this handy reference. The customer explained that he had migrated from Czechoslovakia some years ago, leaving his parents behind. "Here it comes," I thought, "he wants to bring the old folks out and is wondering whether they should bring their TV set with them." "What I want to know," he said, "is whether an Australian set will work in my country. I would like to take one back as a present."

Well? So much for my jumping to conclusions. But I had to admit that it was a switch on the usual theme.

So I fished out my reference and looked up the system used by Czechoslovakia. It looked promising at first; 625 lines, negative modulation, FM sound, exactly the same as ours. Then came the vision bandwidth and channel bandwidth, which were slightly wider than ours, though not enough to present a problem in itself. But it all added up to a sound and vision carrier separation of 6.5MHz as against our standard of 5.5MHz. Whether such a difference could be accommodated within the adjustment range of the sound IF transformers would depend on the design of the transformers and a certain amount of luck.

Next the channels. Here the situation varied from virtually "spot on" in one or two cases to "nearly" in most cases, but "completely missing" in one case.

What did all this add up to? Would it be a proposition? It was hard to be definite, but I was strongly inclined to advise against it. Granted, the sound IFs could be doctored and the tuner coils could probably be adjusted by means of the slugs to give reasonable performance from most of the channels. But all this depends on finding someone with the ability to do these jobs. And even then it left one channel not covered, several with the aerial and RF stages off tune in varying degrees, and the whole set with a lesser bandwidth than it should have had. Enough, in my opinion, to mix a lot of disappointment with the excitement of receiving a present in these circumstances.

I happened to mention this incident

to a colleague; one I have mentioned before in these notes and who works for a firm specialising in closed circuit TV systems, video recorders, and such. They also encounter a lot of customers who have foreign sets which they want modified, mostly American or Japanese. And, mainly because my colleague has a fair amount of experience in this field, they usually tackle them.

My comment served to remind him of a recent incident which he felt I might like to re-tell. It concerned a Japanese set, but one made for one of the European systems, and which the owner now wanted changed to the Australian system. Which seems to be doing things the hard way, but that's how it goes. Fortunately, the particular European system was fairly compatible with our own, the main difference being a sound vision separation of 6MHz, rather than 5.5MHz.

And that's where the trouble started. Before the set reached my friend's organisation someone else had been having a fiddle with it. And, while they obviously knew what they were trying to do, they had been rather heavy handed in their attempts to do it.

More specifically, they had butchered the discriminator transformer. To understand how this had happened it is necessary to have some idea of the construction of the discriminator transformer. The coils were wound on a circular ferrite bobbin, approximately "T" shape in cross section. Over the top of this fitted an inverted ferrite cup, something like an inverted "U" in cross section. This was threaded on the outside and engaged matching threads moulded in two uprights extending from the base. It was slotted at the top to take a screwdriver and provided the means of tuning the transformer, by being screwed up or down.

This was where the fiddler had come to grief. Since he needed more inductance to tune to the lower frequency he had screwed the cup down as far as it would go, presumably without achieving the required inductance. Unfortunately, the wires from the coils ran along the base of the unit underneath the edges of the ferrite cup. When this was screwed hard down it severed the wires close up against the coil.

What to do? A replacement coil was out of the question, so there was nothing for it but to try to rewind the old one. My friend very carefully removed the windings, taking careful note of the number of turns, gauge of wire, and general configuration. The primary consisted of one turn, while the secondary consisted of two windings, of seven turns each, bifilar wound. So, having tracked down some wire of approximately the same gauge, he rewound it accordingly.

Then he did what the fiddler should have done in the first place; added a few pF of capacitance across the winding to allow it to tune to 5.5MHz

with a reasonable setting of the ferrite cup. The operation was a complete success and the set was easily adjusted for the local sound channels.

Probably the most interesting point arising out of the exercise is that it is easier to modify the European sound IFs, which operate on either 6MHz or 6.5MHz than the American or Japanese ones on 4.5MHz. It is relatively easy to lower the frequency, by adding a small amount of "C," but not nearly so easy to raise it.

Still on the subject of foreign set conversion, my friend's next story must surely take first prize as an exercise in futility. It took some time to piece together the history of the set and set it down in correct chronological order. As nearly as I can make out, it went something like this:

The customer was a migrant, resident in Australia for several years, who decided he wanted a TV set. And, apparently convinced that nothing on the local market was good enough, he made arrangements to import one from Europe. This took a lot of organising. Money had to be transferred to the European company, arrangements made for transport by sea and then, when everything was finalised, there was a wait of several

FLASHLIGHT

BALL POINT PEN S-88



Lights up automatically when pen cover is in position for writing.

\$2.00
posted

Bright illumination. Modern shape with silver finish. You can write when it is dark. Spare parts available. Two batteries 30c. Pen refill 15c. Globes 15c.

RADIO HOUSE PTY. LTD.
306-308 Pitt Street, Sydney

also at

6 Royal Arcade and 760
George Street, Sydney.

TURN BACK IF YOU MISSED
THE GREATEST RANGE OF STAGE
EQUIPMENT EVER OFFERED!

A MERRY CHRISTMAS FROM

TRUSCOTT'S

AUSTRALIA'S GREATEST MAIL ORDER TAPE RECORDER & HI-FI CENTRE

STOCKISTS OFF ALL LEADING BRANDS OF TAPE RECORDERS HI-FI EQUIPMENT, COMPONENT PARTS AND ACCESSORIES

NEAT MAN—THAT'S THE WAY TO ENJOY HI-FI MUSIC

TRUSCOTT ELECTRONICS are the sole Australian agents for NEAT HI-FI equipment. Send now for details on these outstanding products, including test reports and reviews by the Gramophone, Hi-Fi Sound and "Electronics Australia" and ask for a T.M.Q.

Fast Mail Order Service

When ordering, please give your full address printed in BLOCK LETTERS. All Truscott equipment is brand new and fully guaranteed. Sales tax is included in all quoted prices. All orders are despatched promptly. All prices quoted are Nett, Postage and freight extra. NOTE: T.M.Q.—Truscott Mail Order Quote.

TAPE RECORDER AND HI-FI SERVICE CENTRE

For service on all leading brand tape recorders and HI-FI equipment — come to the experts. Truscott's modern service centre uses only the finest servicing aids, backed up by fully trained professional technicians.

SPEAKER ENCLOSURE PADDING

Truscott's are the leading South Australian stockists of Innerbond Lining and Bonded Courtelle filling. Ensure dust-free padding for your speaker enclosure. Send for a T.M.Q.

AKAI TAPE RECORDERS

All latest models in stock — XV 1710, M9, 1800, X360, 4000D, X150D, X200D. Prices slashed to an all-time low. Send now for a T.M.Q.

COMPONENT PARTS AND ACCESSORIES

Truscott's are stockists of all General Electronic components, including resistors, capacitors, plugs and sockets, solder, Scope irons and spares, hook-up cables, valves, terminals, tap strips, matrix board, Cam-acoustic fuses, chassis, grommets, boric spaghetti, fuses, chassis, grommets, solder lugs, alligator clips, valve sockets, D.I.N. connectors, TV connectors, battery savers, and also a large range of semi conductors for all Japanese makes.

SAVE YOUR RECORDS . . . USE THE UNIVERSAL LUSTRE TONE ARM LIFT



LUSTRE SA-202

—risk of record damage may now be eliminated—Truscott's price only \$8.00.

This beautifully finished and functional universal tone arm lift will fit all tone arms. The lowering action is pneumatically damped and extremely smooth.

TAPE RECORDERS & DECKS



TESLA B46

Tesla — Akai — Sony — National — Thorn Atlas BSR — Julicorder — BSR — Toshiba — Sanyo — AIWA — Philips — Grundig — Tandberg — Uher.

ACOUSTIC SPEAKER GRILLE CLOTHS

Select your speaker grille cloth from the largest range in Australia. Over 60 top-grade cloths now available to choose from. Send now for samples and a very attractive T.M.Q.

STEREO HEADPHONES



ELEGA DR-65C

Truscott's carry all the leading brand top quality stereo headphones, including Elega, Akai, Sony, Sennheiser, Sansul, Ashida-vox, Foster, etc. Send for details and a T.M.Q.

SENNHEISER DYNAMIC MICROPHONES



SENNHEISER MD421

This attractively styled Dynamic Microphone Model MD421 has been designed to meet the requirements of professional installations, which require low-priced directional studio microphones. A full range of famous Sennheiser studio microphones for amateur or professional use is available at Truscott's. Send now for specifications and a T.M.Q.

NEAT G30 PROFESSIONAL TONE ARMS

A precision-built arm, outstanding in appearance and simple to mount and use in any installation. The results obtained are far beyond those usually expected at such an extremely moderate price. Like all Neat tone arms, the G30 will accept all standard 1/2" mounting cartridges, including Ortofon and S.M.E. headshells without any modification. The G30 complete with tone-arm lift-lowering device is priced at only \$23.75, inc. sales-tax.

TRUSCOTT'S HI-FI COMBINATIONS

Select your HI-FI equipment from our vast range and send for a Truscott combination price — the lowest in Australia.

ACCESSORIES

Microphones and Stands — Tapes and Spools — Splicing Kits — Record Care Accessories — Speaker Enclosure Acoustic Cloth and Inner Baffling — Headphones — Pre-packed Leads — Plugs and Connectors — Head Cleaning Kits — Pillow Phones — Bases and Covers, and Many Others.

AMPLIFIERS



KENWOOD TK 20U

Akai — Sound — Monarch — Lux — Compaq — Kenwood — Trio — Sony — Trio — Sony — Tempo — Sansul — Leak — Grundig — Cosmos — Linmark.

TURNTABLES

DUAL 1009F



Dual — JH — Neat — BSR — PE — Compaq — Labcraft — Goldring — Sony.

TONE ARMS AND CARTRIDGES

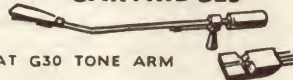

NEAT G30 TONE ARM

NEAT V70 CARTRIDGE

Neat — ADC — Ortofon — All Balance — Goldring — Decca — Audio Technica — Dual — Shure — Micro — S.M.E.

SPEAKERS



SOUNDMASTER SPEAKER SYSTEMS

Soundmaster — Wharfedale — Tesla — Philips — Roia — Kenwood — Sansul — Akai — Leak — Magnavox — Goodmans.

NEW MODEL DUAL TURNTABLES

Stocks are now available of the new Dual Hi-Fi turntables, models 1210, 1212, 1209 and 1219. Send now for details of these outstanding turntable and ask for a T.M.Q. All other model Dual turntables stocked.

HI-FI TRANSCRIPTION TURNTABLE COMBINATION

Consists of the one and only JH Synchronous Turntable, the new Neat G30 Tone Arm with lifting/lowering device, Neat V70 magnetic cartridge, and hand-finished oiled TEAK wooden base. Retail \$96.00. Truscott's price only \$77.50. If assembly required — add \$6.00.

TAPE RECORDER BELTS

Belts available to suit most models of Telefunken, Uher, Philip, Cossor, Steig, Grundig, BSR, Ferguson, Walter and Korting Recorders. When ordering, it is most essential to state the correct make and model of recorder.

NEAT V70 MAGNETIC CARTRIDGES

A top-performance, high-quality magnetic cartridge that outperforms many more expensive cartridges. When used with the Neat G30 tone-arm, an excellent low-priced combination is obtained. The V70 is priced at only \$11.25 inc. sales-tax.

PE34 TRANSCRIPTION TURNTABLES

Limited stocks are still available of this very popular German Hi-Fi transcription turntable. Buy now at only \$69.50 inc. sales-tax, and avoid disappointment — as stocks are going fast. All other models P.E. turntables stocked.



TRUSCOTT ELECTRONICS

AUSTRALIA'S GREATEST TAPE RECORDER & HI-FI CENTRE

62-64 HINDMARSH SQ. ADELAIDE, 5000 Phone: 233024 233278

weeks before the ship reached Australia. Then there were Customs formalities to organise, import duty and sales tax to be paid, and so on, resulting in more delays.

But, eventually, he took delivery of the precious set. The only trouble was it wouldn't work. At exactly what stage the owner realised that it would need to be modified for Australian conditions is not quite clear. Perhaps he knew before he started and imagined that it was a simple routine procedure; perhaps he didn't know until he tried to use the set. At any rate, the set eventually reached my friend's service bench with the brief request that it be modified to receive Australian stations.

My friend made a cursory inspection of the set, established that it was a valve type receiver, intended for 240V operation, and that did not use a power transformer. Then he plugged it in, switched it on, and began adjusting the various controls in the hope that he could at least bring in a picture.

Eventually he succeeded, but it was not a very satisfactory picture. For one thing the set appeared to be badly overloaded, the picture presenting a distorted negative image similar to that sometimes experienced when a set suffers AGC failure or severe maladjustment. Also, although the picture could be locked in a sort of a way, it was far from satisfactory.

At this point my friend decided to remove the chassis from the cabinet and take a closer look at it. One of the first things that struck him was that both IF strips used printed wiring type inductors, these being small vertically mounted boards which plugged into the main circuit board. And the second thing he noted was that the sound and vision IF systems appeared to be completely separate, both commencing at the tuner and progressing to their respective destinations. In short, it did not employ the normal intercarrier sound IF system.

The next thing he found was a circuit diagram. Tucked away in an envelope inside the cabinet, it had been hidden by a section of the cabinet back which did not need to be removed in order to extract the chassis. From this he made a number of additional discoveries. The first and most obvious one was that the sound IF system fed into a conventional AM detector, rather than the more usual FM discriminator. Fairly obviously, the set was designed for a system using AM sound.

This explained why the set did not employ the intercarrier system; intercarrier operation is possible only with an FM sound system, which is needed to reject the AM video component which would otherwise intrude on the sound channel.

More interesting information was found in the video amplifier section.

By working out the phase of the video signal as it was derived from the detector, and checking the phase reversal contributed by each video stage, he eventually concluded that the set was made for a positive modulation system; hence the negative picture which he had blamed on an overload condition.

At this point my friend was beginning to wonder what was really involved. He had been led to believe that the set was designed for one of the European standards, rather than the English standard, yet here was evidence of positive modulation and AM sound; two major characteristics of the old English system.

In the face of this apparent anomaly, my friend then checked over the remainder of the circuit in search of some other clue. He found it in the form of frequency figures quoted alongside the various IF transformers, and obviously intended as a guide to alignment. In themselves they were not particularly interesting, but they did indicate the spacing between sound and vision channels — approximately 11MHz.

This rather startling discovery sent my friend scurrying for his own list of European TV systems. It took only a few minutes to find the appropriate reference: 11.15MHz sound/vision separation, positive vision modulation, AM sound, and — in case you haven't already guessed it — 819 lines. Yes, the set was designed for the French 819-line system!

Just how all this came about is any-

body's guess. The owner had had no direct contact with my friend's organisation, the set having come via another dealer. Which is a pity, because it would have been very interesting to determine the reasoning and sequence of events which led up to such a ridiculous situation.

My own guess is that they went something like this: Some well-meaning but non-technical friend had advised the owner that the best TV sets were made by a certain German company (which might well be true) and that the sets which gave the best results were those using 819 lines (which, again, could be true). And, on this evidence either the migrant or his friend, or both of them together, decided that the best combination was a set made by this company and designed to work on 819 lines.

And what could be done to salvage the situation? As far as my friend was concerned, nothing. It would have been a colossal task, amounting to a virtual rebuilding of the set, to bring it into line with the Australian system. It simply was not economically practical. So the set was simply returned to the owner with the comment, "Sorry, no can do."

To suggest that he must have found this verdict profoundly disturbing is probably an understatement. After the trouble and expense involved he must have felt like cutting his throat. But I'm afraid that is what happens when uninformed people embark on ventures of this kind without seeking advice from a responsible source. ■



One squirt . . . frees you from switching troubles **SUPER SERVISOL**

Instant removal of corrosion and oxidation from all electrical contacts without dismantling. Provides a lasting and protective film, removes loosened deposits almost instantaneously, resulting in, and maintaining, low and noiseless contact resistance. Non-toxic, non-inflammable . . . DOES NOT ATTACK PLASTIC, PAINT OR RUBBER.

Use SUPER-SERVISOL for:

- Variable capacitors • Valve holders and pins • Relay contacts • Switches • Turret tuners • Noisy volume controls and all contacts in the electrical and electronic field • Potentiometers.

Price: \$1.25 per 8 oz. Aerosol Container with 6" Applicator from your Electrical Wholesaler.

Distributed by—



Jacoby, Mitchell & Co Pty Ltd

Sydney • Melbourne • Adelaide • Brisbane

**TURN BACK IF YOU MISSED
THE GREATEST RANGE OF STAGE
EQUIPMENT EVER OFFERED !**

Fundamentals of SOLID STATE



Chapter 8

by Jamieson Rowe

Field-effect transistors — the junction FET — operation — cut-off and pinch-off — channel current "plateau" — static drain-source characteristics — triode and pentode operation, depletion and enhancement modes—the transfer characteristic — transconductance — other parameters and characteristics — constant current diodes — insulated gate FETs — the three basic types of MOSFET — the dual-gate MOSFET — insulation breakdown.

In the discussion of unijunction device operation given in the last chapter it was noted that one aspect of device behaviour involved a so-called "field effect" mechanism, in which the effective conductivity of one region of the device was modulated by the width of a depletion layer extending from an adjacent P-N junction. Mention was made of the fact that this type of mechanism is quite important, and that it actually forms the basis of a number of useful semiconductor devices. The best-known of these devices is the field-effect transistor, and it is appropriate that we now turn our attention to this device.

Like the unijunction, the field-effect transistor is a device whose complexity is only slightly greater than that of the basic semiconductor diode. However, even more so than in the case of the unijunction, the field-effect transistor is a device capable of performing many unique and highly useful functions. Because of this it has, in recent years, found use in many different applications, and it seems likely that it will be used to an even greater extent in the future.

In concept, the field-effect transistor was actually the first semiconductor amplifying device to be proposed. Far-sighted American engineer Julius E. Lilienfeld first proposed such a device as early as 1928, and patented the idea in 1930. Then in 1948 the pioneering semiconductor physicist William Shockley proposed a more practical form of the device—although his work at that time actually led to the development, with W. Brattain and J. Bardeen, of the bipolar transistor.

Despite the early theoretical predictions, it was not until 1958 that the first commercial field-effect transistor appeared. Called the "Tectnetron," it was developed by Polish scientist Stanislaus Teszner in the laboratories of the French firm, Compagnie Francaise Thompson-Houston.

The Tectnetron was a germanium device and had rather limited performance; as a result, interest in field-effect devices did not really awaken until 1960, when the first commercial silicon device was produced by the American firm Crystalonics, Inc. Since then the devices have been developed to a stage where they are now highly com-

petitive with the more established bipolar devices.

A number of different varieties of field-effect transistor have been developed, and although it is true that these all operated in a broadly similar fashion, the differences are significant enough to justify at least partially individual treatment. Accordingly, this chapter will adopt the procedure of dealing initially and primarily with the device which represents the most direct development from the basic semiconductor diode, namely the junction field-effect transistor or "JFET." It will use this device to develop most of the basic concepts

plementary" versions of the JFET—i.e., one can produce either a device having an N-type channel region and adjacent P-type gate regions, or alternatively a device with the opposite arrangement. Both types of JFET are in fact produced, and both are found in typical circuit applications.

Figure 8.1 shows the basic structure of a modern silicon JFET device of the "N-channel" variety. It may be seen that the lightly doped N-type channel of the device is roughly U-shaped, and that it is bounded on either side by heavily doped gate regions. The electrodes connecting to the gate regions are labelled here "gate 1" and "gate 2," but in most devices these connections are tied together internally and brought out as a single gate electrode.

The electrodes connecting to the ends of the channel region are conventionally known as the source and drain electrodes. However, in most JFETs the internal structure is symmetrical, so that these labels are actually interchangeable.

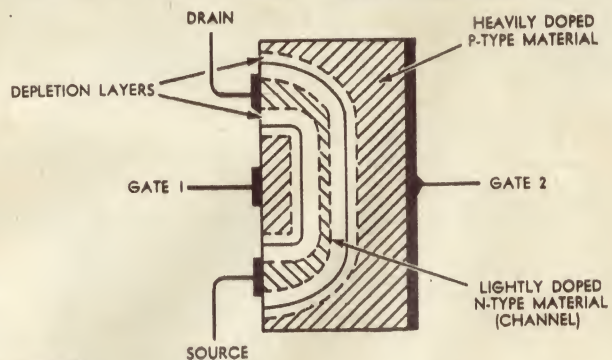

Figure 8.1

and will then deal briefly with the other main types of device.

Other names which have been used for the JFET are "fieldistor" and "unipolar transistor," the latter term intended mainly to distinguish the device from the bipolar transistor.

In structure, the JFET is only slightly more complex than the unijunction, which we examined in the last chapter. It consists basically of a narrow strip or channel of lightly doped semiconductor material, whose effective conductivity is modulated by the width of the depletion layer or layers associated with one or more P-N junctions formed between the channel and adjacent heavily doped gate regions.

Like the unijunction, the JFET may in theory be made from either germanium or silicon; in practice, it is made almost exclusively from silicon because of the lower saturation currents and higher performance which this material offers. And, as may be expected, it is possible to make "com-

Naturally enough, even when such a device is in equilibrium with no external bias voltages applied to the electrodes, the familiar depletion layers will be set up in the vicinity of the P-N junctions along the sides of the channel. And because the channel material is intentionally doped rather lightly, compared with the gate regions, these depletion layers will extend further on the channel side of the junctions than on the gate side, as shown.

As we have seen in earlier chapters, a depletion layer is a region in a semiconductor which has been effectively "converted" into very high resistivity by the removal of all current carriers. Because of this very high resistivity, a depletion layer is actually closer to an insulator than to a conductor.

The depletion layers which extend into the channel region of a JFET thus represent areas in that region which are capable of only slight conduction relative to the remaining central strip. As a result the effective

electrical width of the channel is somewhat less than its physical width, and its resistance is accordingly higher than would be the case if the depletion layers were not present.

From the discussions of P-N junction operation and depletion layer behaviour given in earlier chapters, it should be fairly easy for the reader to see that if an external bias voltage is applied to the JFET between the gate and channel regions, it will change the effective width of the channel region and hence change its resistance from the equilibrium value. An external voltage which reverses biases the gate-channel junctions will cause the depletion layers to widen, encroaching further into the channel to reduce its effective width still further and increase its resistance. Conversely, if the external voltage forward biases the junctions, the depletion layers will narrow, widening the effective width of the channel and lowering its resistance.

If another external voltage is applied to the device between the drain and source electrodes, the current drawn by the channel region will naturally depend upon both the applied drain-source voltage and upon the channel resistance. But the channel resistance is itself determined by the actual bias voltage present across the gate-channel junctions which will depend in turn upon both the external gate-channel bias and the drain-source voltage.

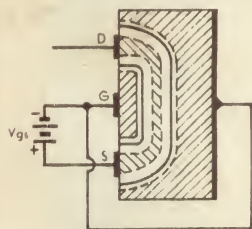

(a) (NO CHANNEL CURRENT) GATE-CHANNEL CHARACTERISTIC AS FOR A NORMAL P-N DIODE. FOR REVERSE BIAS AS SHOWN, ONLY A SMALL AND VIRTUALLY CONSTANT SATURATION LEAKAGE CURRENT I_{gss} FLOWS.

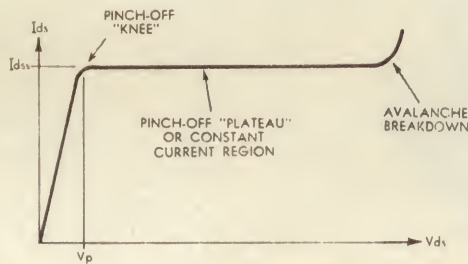
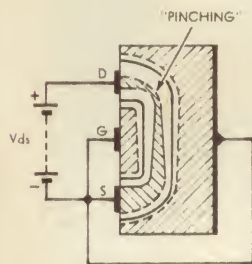

Figure 8.2

Hence the channel current which flows will be determined by both the gate-channel and drain-source voltages.

Although the relationship between channel current and the applied voltages may seem rather complex from the foregoing, it can be broken down into two quite simply understood mechanisms. One of these is associated with an "external" gate-channel junction bias component provided by the external gate bias voltage, while the other is associated with an "internal" bias component derived within the device from the applied drain-source voltage. The two mechanisms may be understood by reference to the diagrams of figure 8.2.

The diagram of figure 8.2 (a) shows the effect of an external gate-source bias V_{gs} applied to the JFET, with the drain electrode left unconnected. Here there is no longitudinal channel

current, and hence no source of "internal" junction bias. The external bias simply causes the depletion layers of the junctions to adjust evenly to the altered conditions. In fact the gate-channel junctions of the device will behave in these circumstances exactly as a normal P-N diode.

If the polarity of V_{gs} corresponds to reverse bias of the junctions, as shown, the depletion layers will be found to extend considerably into the channel; at the same time only a small

therefore, the narrow portion of the channel will effectively consist of very high resistivity material— i.e., the channel will be effectively cut off.

The value of V_{gs} at which cutoff occurs is known as the cutoff bias, usually symbolised by $V_{gs(off)}$. With typical JFETs it varies between about $-1V$ and $-10V$, depending upon the doping levels and the device dimensions or "geometry."

When external gate-source bias alone is applied to the JFET, then, the deple-

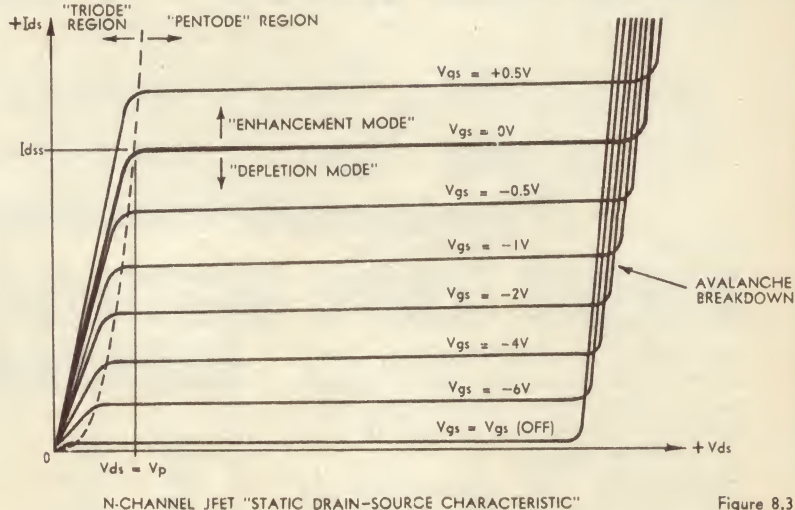

N-CHANNEL JFET "STATIC DRAIN-SOURCE CHARACTERISTIC"

Figure 8.3

tion layers are uniform in width along the length of the channel, and the latter has a uniform width which is directly related to the gate-source bias. As soon as the applied voltage reaches the reverse-bias value $V_{gs(off)}$ where the depletion layers meet, the channel is cut off. This illustrates the first of the two mechanisms responsible for JFET operation.

The second mechanism is that which is best seen when only drain-source bias is applied to the device, as illustrated in figure 8.2(b). Here the two gate regions are tied to the source electrode, so that in this case there can be no external component of gate-channel bias. However, because the drain-source bias voltage V_{ds} is applied between the ends of the channel, there is a current and a voltage gradient in the latter, and this produces an internal gate-channel bias component.

Because of the voltage gradient in the channel, the gate-channel junctions will in fact be reverse-biased to an increasing extent along the channel length. The reverse bias will reach a maximum value at the drain end, where virtually the full value of the drain-source voltage V_{ds} will be present as reverse bias.

As a result of the progressive increase in reverse bias, the junction depletion layers will increase progressively in width along the length of the channel as shown. At the source end they will have the modest width corresponding to equilibrium conditions, while at the drain end they will have widened to correspond to a reverse bias of V_{ds} .

Because of this progressive widening of the depletion layers, a pronounced "pinching" occurs at the drain end of the narrow portion of the channel. Naturally the result of this pinching effect is that the effective channel resistance does not remain constant at its initially low value, but rises with increasing drain-source voltage. The

and almost constant gate-source saturation current I_{gss} will flow. Conversely if V_{gs} were connected to bias the junctions in the forward direction, the depletion layers would be found to extend only a small distance into the channel. Of course if the forward bias were increased beyond the turn-on knee (0.6V in the case of a silicon device), significant gate-source current would flow; however, as will be seen later this significantly disturbs device operation, and is therefore not permitted to occur in the majority of JFET applications.

In the reverse-bias situation, there will naturally be a value of applied gate-source bias V_{gs} at which the depletion layers will have extended sufficiently to meet one another along virtually the full length of the narrow portion of the channel. For this and higher reverse-bias values of V_{gs} ,

brand five

magnetic recording tape

DISCOUNT PRICES!

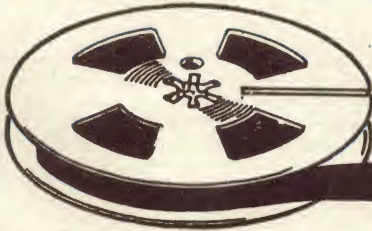

AUSTRALIA'S BEST VALUE!

from

DIRECT TAPE DISTRIBUTORS

OUR PRICE

"BRAND 5"—unconditionally guaranteed and manufactured to highest USA professional standards. It's sensationally priced at half that of comparable tapes.

"BRAND 5" has high remanence iron oxide emulsion coated to highest grade Acetate or Mylar base material.

"BRAND 5" ensures unmatched results in high fidelity mono and stereo recordings, with certain protection against head wear, squeal and gumming of heads.

SAVE over 50%

LENGTH	TYPE No.	DESCRIPTION & MIL. THICKNESS	NORMAL PRICE	OUR PRICE
7" REELS				
1200'	15D7	1.5 ACETATE	6.60	3.00
1800'	10D7	1.0 ACETATE	7.25	3.25
1800'	10D7M	1.0 MYLAR	9.15	3.99
2400'	5D7M	.5 MYLAR	10.40	4.75
2400'	5D7MT	.5 TENSIL MYLAR	11.90	5.25
3600'	5D7MS	.33 MYLAR	13.20	6.75
5 1/2" REELS				
1200'	10D57	1.0 ACETATE	5.50	2.55
1200'	10D57M	1.0 MYLAR	6.00	2.95
1800'	5D57M	.5 MYLAR	8.90	3.75
5" REELS				
600'	15D5	1.5 ACETATE	3.40	1.80
900'	10D5	1.0 ACETATE	4.15	1.98
900'	10D5M	1.0 MYLAR	5.32	2.25
1200'	5D5M	.5 MYLAR	6.95	2.50
1200'	5D5MT	.5 TENSIL MYLAR	8.70	2.75
1800'	5D5MS	.33 MYLAR	9.60	3.75
CORRESPONDENCE TAPES				
3 1/4" REELS				
900'	3D32MS	.33 MYLAR	3.90	1.95
3" REELS				
150'	15D3	1.5 ACETATE	.95	.50
225'	10D3	1.0 ACETATE	1.20	.65
225'	10D3M	1.0 MYLAR	1.65	.70
300'	5D3M	.5 MYLAR	1.95	.85
600'	3D3MS	.33 MYLAR	3.30	1.60
CASSETTES				
		C30	3.10	1.55
		C60	3.50	1.65
		C90	4.75	2.65

SEND THIS COUPON WITH YOUR ORDER TODAY!



DIRECT TAPE DISTRIBUTORS

BOX 3040, G.P.O. SYDNEY, N.S.W. 2001

Please send me BRAND 5 Tape/s as per attached list.

I enclose \$..... covering purchase price
PLUS Postage and Packing @ 10 cents per reel.
Any surplus postage will be refunded.

D/E2

NAME.....

ADDRESS.....

STATE..... CODE.....

change in resistance is slow at first, but becomes more rapid as V_{ds} rises.

If V_{ds} is increased sufficiently, a point is eventually reached where the "pinching" of the channel at the drain end becomes virtually complete. The depletion layers effectively touch one another in the pinched region, converting this portion of the channel into high resistivity "intrinsic" material. Further increase in V_{ds} then simply causes this "pinched off" portion of the channel to extend further down the channel towards source end.

Re-stating the situation, the result of this mechanism is that the drain-source current I_{ds} drawn by the channel rises sharply with small values of V_{ds} , then rises more slowly and finally flattens off as pinch-off is reached at the drain end of the channel. This is shown in the graph plotted on the right of figure 8.2(b), and it may be seen that the channel current has a distinct "knee" at the onset of pinch-off.

Not surprisingly, perhaps, the value of gate-channel reverse bias at the drain end of the channel which corresponds to the onset of pinch-off is known as the **pinch-off voltage**, symbolised V_p . Hence for the situation of figure 8.2(b) pinch-off occurs when $V_{ds} = V_p$, because virtually the whole of V_{ds} appears as reverse bias at the drain end of the channel.

With most devices the value of the pinch-off voltage V_p is almost exactly the same as that of the cutoff bias $V_{gs(off)}$. A moment's thought should reveal why this is so: $V_{gs(off)}$ effectively represents the junction bias necessary for the channel depletion layers to meet fully **throughout the length of the channel**, while V_p effectively represents the bias necessary at the drain end of the channel to cause the depletion layers to meet **in that region**. Providing the channel is reasonably uniform in width, therefore, one would expect the values of V_p and $V_{gs(off)}$ to be identical.

Note, however, that this equivalence in value between V_p and $V_{gs(off)}$ does not imply that the two have the same significance, or that "pinch-off" and "cut-off" are simply alternative names for the same situation. V_p and $V_{gs(off)}$ merely have the same value because the two phenomena concerned each begin when the gate-channel depletion layers meet.

The important difference between pinch-off and cut-off is that in the cut-off situation the depletion layers have met throughout the length of the channel, converting the whole of the channel to high resistivity material, and preventing the flow of significant channel current even when drain-source voltage is applied; whereas in the pinch-off situation the meeting of the depletion layers involves only a relatively small portion of the total channel length, with the result that current flow is merely regulated.

The cutoff situation may actually be regarded as a special and "limit" case of pinch-off, as may become clear shortly. This is because the term "pinch-off" really applies to any situation in which the drain-source voltage V_{ds} is equal to or greater than V_p .

It may be seen from figure 8.2(b) that for values of V_{ds} above the pinch-off voltage V_p , the drain-source current I_{ds} remains virtually constant, forming a "plateau" region. This is a result

of the fact that drain-source voltages larger than V_p simply cause the pinched off portion of the channel to extend back toward the source end. The very high resistivity of the extending pinched off region thus effectively "absorbs" the additional voltage, maintaining the current constant at substantially its value at the pinch-off knee.

The drain-source current level corresponding to the constant-current "plateau" in the zero-external-gate-bias situation of figure 8.2(b) is known as the **zero-bias saturation current**, symbolised I_{dss} . Like $V_{gs(off)}$ and V_p , I_{dss} is actually quite an important JFET behaviour parameter. It, too, varies with doping levels and device geometry, as one might expect, and with typical devices it ranges between about 1mA and 30mA.

Note that while the JFET pinch-off plateau current is termed a "saturation" current, it is a saturation current of a different type from that which flows through a reverse-biased P-N junction. As we saw in earlier chapters the

region, or even in some cases on the upper portion of the pinch-off plateau, for very short periods.

Although the two mechanisms involved in JFET operation have been treated separately in the foregoing discussion, and are shown separately in figure 8.2, they are generally both involved in device operation. Most JFETs are operated with both gate-source bias V_{gs} and drain-source bias V_{ds} applied, so that the gate-channel junctions are presented with both "external" and "internal" bias components, and both mechanisms contribute to device operation.

The combined effect of the two mechanisms is basically a straightforward additive one. The external gate-source bias V_{gs} provides a fixed component of gate-channel bias, and hence contributes to widening (or narrowing) of the channel depletion layers in a uniform fashion, while the drain-source bias V_{ds} provides a progressive internal reverse bias component, and hence a tapering or pinching contribu-

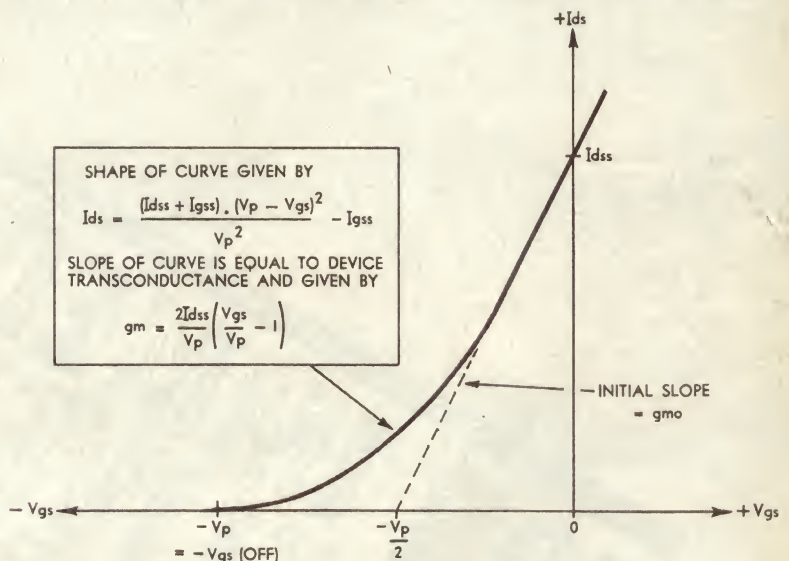

Figure 8.4 N-CHANNEL JFET "STATIC TRANSFER CHARACTERISTIC"

latter type of current is "saturated" in the sense that it is limited by the number of available current carriers generated by the "intrinsic" mechanism; the JFET plateau current is limited, not by the number of carriers available, but by the pinching action of the channel depletion layers.

The channel current of the JFET remains substantially constant in the pinched-off region, then, over a wide range in drain-source voltage V_{ds} . Significant increase in the channel current only occurs if V_{ds} is increased to the point where the electric field strength in the depletion layers is sufficient to initiate avalanche breakdown. The current then rises sharply, as may be seen, and also the device dissipation.

As with the devices which were discussed in earlier chapters, the JFET can enter avalanche breakdown without necessarily sustaining damage. However, avalanche is a high dissipation region of operation, and like any other device a JFET has the usual continuous and short-term power dissipation ratings based on the allowable internal temperature rise. Accordingly, many low-power JFET devices may only be operated in the avalanche

region to the depletion layer width. The resultant width of the depletion layers is simply the sum of the two.

Pinch-off still occurs when the effective gate-channel reverse bias at the drain end of the channel is equal to V_p , the pinch-off voltage. However, this point will no longer in general correspond to the point where $V_{ds} = V_p$, as in the zero-external-gate-bias case, but because V_{gs} also contributes to the depletion layer width it will now correspond to the situation

$$V_{ds} - V_{gs} = V_p \quad \dots (8.1)$$

where the negative sign simply draws attention to the fact that the external gate bias is nominally of the opposite polarity to the drain bias.

In other words, the effect of a fixed negative bias component produced by V_{gs} is simply to lower the value of drain-source voltage V_{ds} at which pinch-off is reached. The higher V_{gs} is made, the wider the uniform widening of the channel depletion layers and the lower the value of V_{ds} at which the layers meet at the drain end.

Ultimately, of course, if V_{gs} is made equal to or greater than V_p , and hence

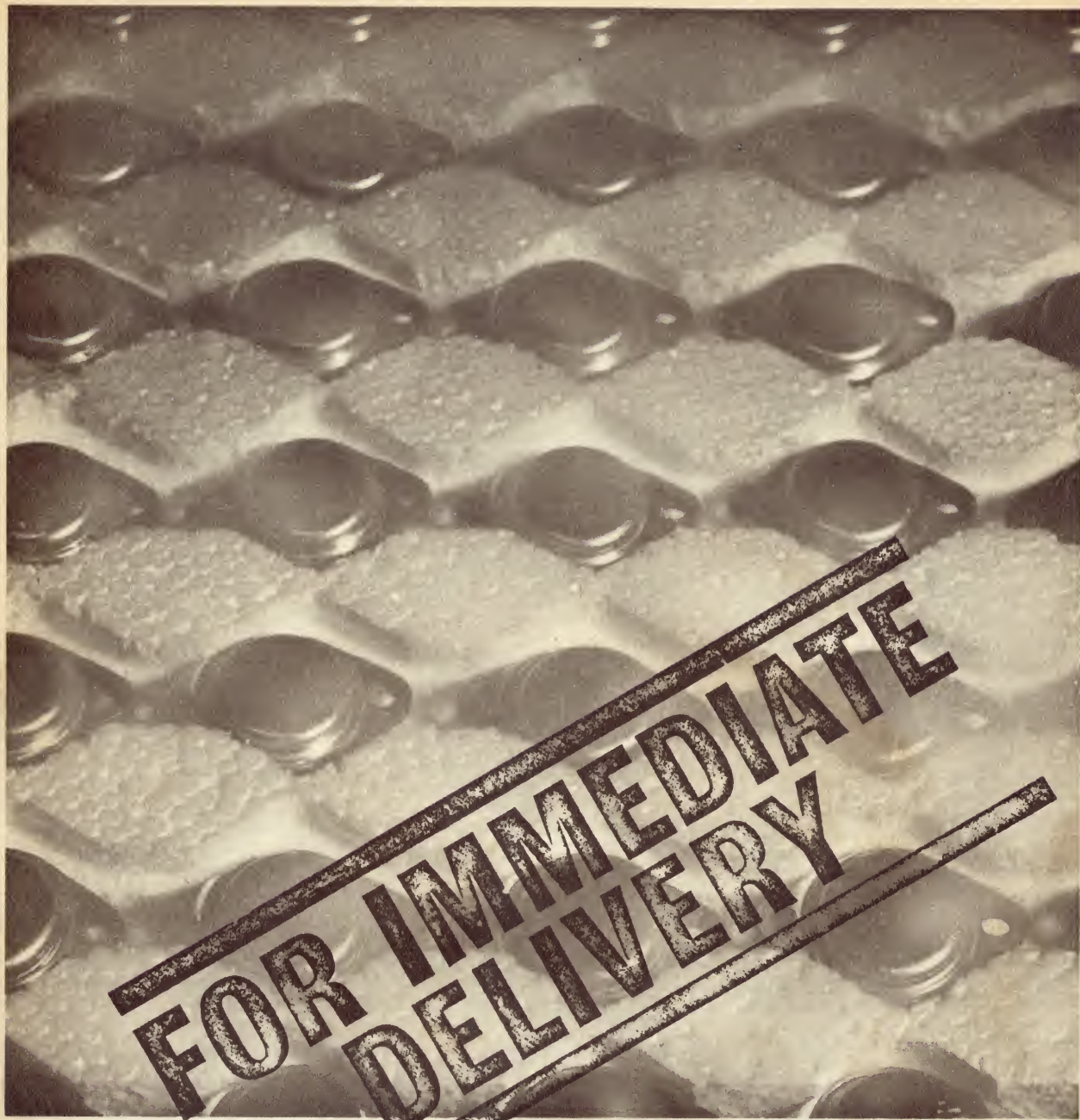

2N3055, NPN POWER TRANSISTOR.

The first BI-MESAR™ product to be released in Australia

The new BI-MESAR technology is the result of two years intensive research. BI-MESAR is a high volume low cost process producing exceptionally reliable power amplifiers and switches.

BI-MESAR features: High forward and reverse-bias safe area. Leakage levels approaching Planar structures due to an exclusive Vapox protection of the mesa collector-base junction. High voltage. Typical frequency response of 2-7 MHz. Excellent switching performance, both in speed and saturation characteristics.

FAIRCHILD

AUSTRALIA PTY. LTD.

420 Mt. Dandenong Road, CROYDON, VIC., 3136. P.O. Box 151, Croydon. Cables: Fairchild Melbourne. Telephone: 723 4131. Sydney Office: 43 7508. Adelaide: 51 7083. Auckland, N.Z.: 57 9307. NEW ZEALAND DISTRIBUTING AGENTS: John Gilbert & Co. Ltd., Tasman Buildings, Anzac Avenue, Auckland, N.Z. FAIRCHILD DEVICES NOW AVAILABLE IN DISTRIBUTOR QUANTITIES FROM: George Brown & Co., 267 Clarence Street, Sydney, N.S.W., 2000. General Accessories, 81 Flinders Street, Adelaide, S.A., 5000. J. H. Magrath & Co. Pty. Ltd., 208 Lit. Lonsdale Street, Melbourne, Vic., 3000. Radio Parts Pty. Ltd., 562 Spencer Street, West Melbourne, Vic., 3003. Purvisonic Sound and Distributing Co., 44 McCoy Street, Myaree, Perth, W.A., 6154. Douglas Electronics, 7 Gralunga Street, Mansfield, Qld., 4122.

equal to or greater than $V_{gs(off)}$, the device is in the pinch-off region of operation even when $V_{ds}=0$ —i.e., it is cut off. Hence the reason for regarding the "cutoff" condition as a special and limiting case of pinch-off.

Naturally the converse effect occurs if the applied gate-source bias is in the forward-bias direction. Here the effect will be to increase the value to which V_{ds} may be raised before pinch-off is reached.

It should be noted in passing that in saying that the drain-source voltage V_{ds} and the gate-source voltage V_{gs} both contribute to the width of the channel depletion layers, and hence to pinch-off, all we are really saying is that it is the effective drain-gate voltage present across the device which determines whether or not it has entered pinch-off.

In short, an alternative general requirement for pinch-off is that the drain-gate voltage V_{dg} must be equal to or greater than the pinch-off voltage V_p .

With either polarity of applied gate-source bias, the altered depletion layer situation also results in a value of pinch-off plateau current different from the value I_{dss} corresponding to the zero-bias case. When V_{gs} is of the reverse-bias polarity the plateau current level is naturally lower than I_{dss} , while with V_{gs} values of the forward-bias polarity (but below about 0.6V)

locus may be seen to resemble fairly closely the familiar plate characteristics of a triode thermionic valve. For this reason this area of the JFET drain-source characteristics is often called the "triode region" of operation. Similarly because the remaining portions of the various curves resemble the plate characteristics of a pentode thermionic valve, this area of the characteristics is often called the "pentode region" of operation.

In most circuit applications JFETs are operated in the pentode region of operation—that is, at operating points to the right of the dashed curve in figure 8.3.

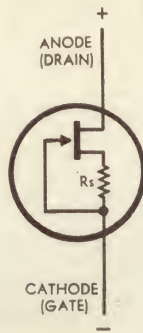
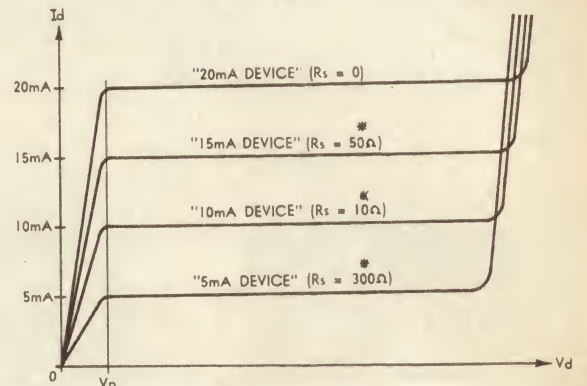
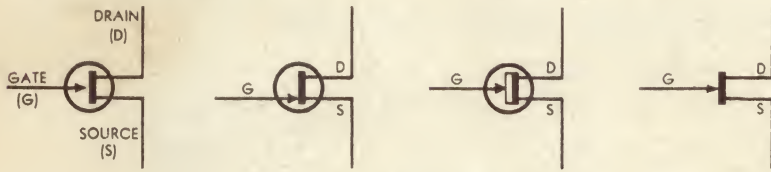

Figure 8.6



* VALUES GIVEN FOR ILLUSTRATION ONLY



(a) N-CHANNEL JFET SYMBOLS

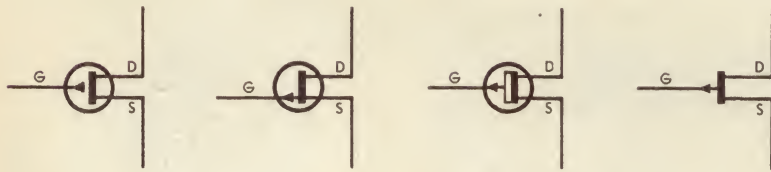

(b) P-CHANNEL JFET SYMBOLS

the plateau current level exceeds I_{dss} .

Because each value of V_{gs} thus results in both a unique value of V_{ds} corresponding to the pinch-off knee, and also a unique value of pinch-off plateau current, it is convenient to represent JFET operation by a family of characteristic V_{ds}/I_{ds} curves of the type shown in figure 8.3. The polarities shown are for an N-channel device as shown in figure 8.1; for a P-channel device they would be reversed.

It may be seen that for each of the sample values of V_{gs} for which the curves are drawn, there is a different value of V_{ds} appropriate to the pinch-off knee. In fact the knee points of the curves all lie on a parabolic locus (dashed curve), which is exactly what one would expect from the relationship given in expression (8.1). Similarly each curve has its current plateau at a different value of I_{ds} .

The portions of the various curves to the left of the dashed knee-point

Because the narrower channel depletion layers produced by forward gate-source bias result in higher I_{ds} (or "enhanced channel conduction") of a device in the pentode region of operation, relative to the zero-bias situation, this mode of operation is known as **enhancement mode**. This mode of JFET operation is represented in figure 8.3 by the curve marked " $V_{gs} = +0.5V$ ".

Fairly obviously the range of enhancement mode operation possible with JFETs is rather limited, because V_{gs} cannot be increased beyond the point where forward conduction current begins to flow through the gate-channel junctions. However, it will be shown later that other types of field-effect device are capable of more extended enhancement mode operation.

In contrast with forward gate-source bias, reverse bias produces wider channel depletion layers and results in lower I_{ds} or "depleted channel conduction" in the pentode region

of operation, again relative to the zero-bias situation. This mode of operation is accordingly known as the **depletion mode**, as shown.

JFET devices are almost always biased to a quiescent operating point in the depletion mode region, if only for the reason that this allows a device to be swung over a greater dynamic range before non-linearity occurs.

A further point which may be noted from figure 8.3 is that the drain-source voltage V_{ds} at which a device enters avalanche breakdown reduces with increasing reverse gate-source bias V_{gs} . This is really only to be expected, because V_{gs} and V_{ds} are additive in

terms of the effective maximum reverse bias present across the gate-channel junctions at any time.

In effect, then, it is really the drain-gate voltage present across the device which determines whether or not it enters avalanche breakdown, just as this same voltage determines whether or not the device is operating in the pinch-off or pentode region. Hence a common way of rating a JFET in terms of its avalanche breakdown point is to quote its **drain-gate breakdown voltage**, usually symbolised BV_{dgo} .

JFET "static drain-source characteristics" of the type illustrated in figure 8.3 show quite well the operation of the device, as may be seen. However, for design work they are often of less interest and lower utility than the so-called "static transfer characteristic," which is illustrated in figure 8.4. This curve shows the controlling action of gate-source bias V_{gs} upon the device drain-source current I_{ds} , for the pentode region of device operation (only).

Note that whereas there is a whole family of curves comprising the static drain-source characteristics, the static transfer characteristic consists of but a single curve. This arises from the fact that the transfer characteristic by definition only applies to the pentode region of operation, where the constant-current nature of the drain-source characteristics makes the "transfer" or controlling effect of V_{gs} over I_{ds} virtually independent of drain-source voltage V_{ds} .

It may be seen that the transfer characteristic is a parabolic curve whose shape and slope are described by the expressions shown. The essential points to note are that the curve cuts the I_{ds} axis at a value equal to I_{dss} , the zero bias drain-source current, and that it becomes asymptotic to the V_{gs} axis at a value equal to both $V_{gs(off)}$ and V_p .



SPECIAL XMAS OFFER

Deluxe stereo headphones, stereo-mono switch, individual controls 8 ohms, 25-18,000cps, amazing value

\$12.50 including postage anywhere in Australia — Rush these.

\$99.00
full price



TOP BRAND HI-FI SOLID STATE AMPLIFIER

POWER OUTPUT:— 42 watts total music power (IHF)
17.5 watts r.m.s. per channel into 8 ohms.

FREQUENCY RESPONSE:—20-20,000 HZ ± 1db.

DISTORTION:—0.9 p.c. total at 15 watts r.m.s.

SIGNAL TO NOISE RATIO:—Phone 60db. Aux. Tuner 75db.

INPUT SENSITIVITY:—Phono magnetic 3mv, Phono Ceramic 50mv, Aux. 150mv, Tape Record 250mv.

LOW FILTER:— 80HZ Roll-off.

HIGH FILTER:—5,000 HZ Roll-off.

BASS CONTROL:—± 10db (at 50 HZ).

TREBLE CONTROL:—± 12db (at 9,000 HZ).

SPEAKER IMPEDANCE:—4, 8 and 16 ohms.

BUILT-IN CIRCUITS:—Loudness Control, High Filter, Low Filter, Headphone Jack.

DIMENSIONS:—14½" (W) x 4¾" (D).

WEIGHT:—13lbs.

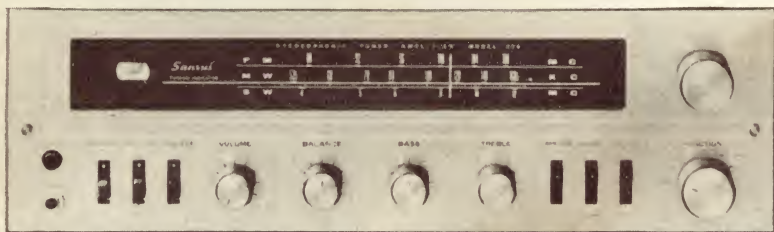

Rush this further bulk release of Sansui Model 220 tuner amplifier at the amazingly low price of \$154 tax paid.

Limited quantity reserved for mail orders

Check us last for the lowest discount prices on all tape-recorders and Hi-Fi sound.

DOUGLAS TRADING P/L

Inc. City Hi Fi — Tape Recorders (Vic.) — BJD Electronics
191 BOURKE STREET, MELBOURNE 3000—PHONE 63-9321

The transfer characteristic describes the relationship between I_{ds} and V_{gs} , so that its slope at any point represents the rate of change in I_{ds} for a change in V_{gs} —i.e., the **transconductance** or “mutual conductance,” usually symbolised **gm**.

Because of the parabolic shape of the curve, its maximum slope occurs in the region where it crosses the zero bias or I_{ds} axis, at I_{dss} . In other words, the transconductance of a JFET is greatest when the device is operating at zero or slight forward gate bias.

This being the case, device manufacturers usually specify the transconductance of a JFET for the zero-bias condition, where it is nominally at a maximum. This “maximum transconductance” is usually symbolised **gmo**. Because of the shape of the transfer curve **gmo** is closely approximated by the simple expression

$$gmo = \frac{-2 \cdot I_{dss}}{V_p} \quad \dots (8.2)$$

which in graphical terms simply corresponds to the dashed line in figure 8.4 joining the I_{ds} axis at I_{dss} and the V_{gs} axis at $-V_p/2$.

An alternative to **gm** sometimes quoted on JFET data sheets is the **forward transadmittance**, symbolised **Yfs**. This is strictly a more general device parameter, including any susceptance (inverse reactance) components of the transfer behaviour in addition to conductance. However, in most cases it is specified at a low frequency (around 1KHz) where the zero-bias value of **Yfs** is generally almost identical with **gmo**.

For typical JFET devices in current production, **gmo** ranges from about 1000-8000 micromhos, or 1—8mA/V.

From figure 8.4 and from expression 8.2 it may be seen that the transconductance characteristics of a JFET are closely determined by the zero bias current I_{dss} and the pinch-off voltage V_p . In fact, knowing these two parameters it is quite easy both to calculate **gmo** and to construct the transfer characteristic. This provides further evidence of the importance of the two parameters.

It may be worthwhile to summarise our present discussion of the JFET by drawing attention to those unique aspects of the device behaviour which are together responsible for its wide range of circuit applications, and which are accordingly of particular significance for circuit design.

Possibly the first thing which the reader may have realised from the foregoing description of JFET operation is that the device is one which, like the thermionic valve, is capable of **power amplification**. A small change in gate-source voltage V_{gs} is capable of producing a relatively large change in drain-source current I_{ds} . Hence if a small AC signal is superimposed upon a suitable quiescent gate-source bias, an amplified AC signal can be obtained at the JFET drain electrode by placing a suitable load resistor in series with the V_{ds} supply.

Because in normal operation its gate-source junctions are biased either only slightly in the forward direction, or more usually in the reverse direction, the JFET also has another important property in common with the thermionic valve: **high input resistance**. The only current which normally flows in the gate circuit is the junction satura-

tion/leakage current I_{gss} , mentioned earlier, which is typically in the order of but a few nanoamps. This gives typical devices an input resistance of around 1000 megohms.

As we observed from the static drain-source curves shown in figure 8.3, the V_{ds}/I_{ds} characteristics of the JFET in the pinch-off region are virtually “constant current” lines, having a very low current change/voltage change slope. In other words, then, the device resembles a pentode valve, possessing a **high output resistance**. Typical figures for JFET output resistance r_{ds} range from about 20K to 100K.

As with transconductance, some device manufacturers do not quote the output resistance r_{ds} on their JFET data sheets, but instead give values for **output admittance**, symbolised **Yos**. Usually this is quoted at a low frequency, say 1KHz, where its value is very close to the inverse of r_{ds} . Hence

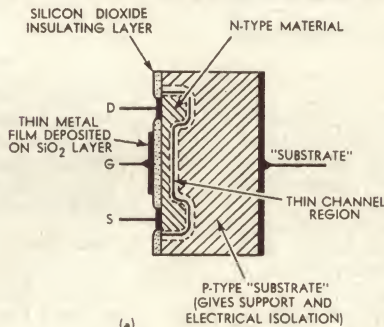

Figure 8.7

operation. Let us now turn to consider briefly some of the other types of field-effect device in present use.

A device which is very closely related to the JFET is the so-called **constant current diode**. Although basically a very simple development from the JFET, this device is finding increasing use in many circuit applications in which current levels must be maintained despite voltage and impedance variations.

Basically the device consists of a JFET which is fitted with an “internal” self-bias resistor in series with the source, with the gate being tied to the remote end of the resistor. Figure 8.6 shows the basic arrangement, where it may be seen that only the drain and gate connections are brought out as device electrodes. These are labelled “anode” and “cathode” respectively.

As one might expect the operation of the device is again dependant upon the two basic JFET mechanisms dis-

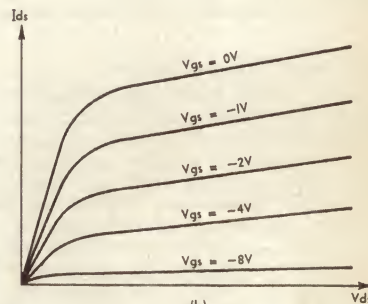

(b)

DEPLETION OR "TYPE A" MOSFET (N-CHANNEL)

typical devices have **Yos** values in the range 10-50 micromhos.

Not surprisingly the depletion layers which separate the gate and channel regions of a JFET in normal operation behave as a dielectric, in this respect being no different from the depletion layer of a normal P-N junction diode. As a result there is a small but often significant capacitance between the gate and channel regions. The distribution of capacitance is naturally non-linear due to the tapering depletion layers, and also varies with the applied bias.

For convenience in circuit design the gate-channel capacitance is normally considered to consist of two main components: the **effective input capacitance** of the device as seen by the gate electrode, symbolised by C_{gs} , and the **reverse transfer or drain-gate “feedback” capacitance**, symbolised C_{dg} .

Typical modern JFET devices designed for low- and medium-frequency applications have C_{gs} figures ranging from 4—7pF, and C_{dg} figures ranging from 1—3pF. Devices intended for high frequency applications have figures somewhat lower than these.

The reverse transfer capacitance C_{dg} is often of particular significance for circuit design, because being coupled between the input and output of the device it can be effectively magnified in value by the familiar “Miller effect.” Further discussion of this will be found in the next chapter.

The circuit symbols commonly used for JFETs of both configurations are shown in figure 8.5.

It is hoped that the foregoing discussion of the junction field-effect transistor has given the reader a basic understanding of the device and its

cussed earlier. However, in this case the single bias voltage V_d applied to the device is connected directly between drain and gate, so that pinch-off simply corresponds to the situation where $V_d = V_p$. The pinch-off voltage is not dependent upon the value of R_s .

The function of the resistor is to provide a “fixed” component of gate-source bias derived from the device channel current. This quite naturally has the effect of determining the value of device current at which the pinch-off plateau occurs. Thus a device fitted with no resistor might have a plateau current (in this case equal to I_{dss}) of say 20mA, while a device fitted with a resistor of 100 ohms might have a plateau current of 10mA, as shown.

It should be fairly clear from this that the plateau current of such a device may be set to any desired value below the basic I_{dss} for the internal structure, merely by fitting the appropriate value of resistor R_s . Hence it is possible to produce such devices with plateau currents covering quite a useful range, suitable for use in circuit applications as current regulating devices. In operation, the devices are merely arranged to operate on their pinch-off plateau, so that they tend to pass a substantially constant current despite variations in applied voltage.

No doubt the astute reader will have realised while reading the foregoing that virtually any normal JFET device could be used as a current regulating element, simply by connecting it into circuit with the source tied to the gate via a suitably chosen resistor. And in fact this forms the basis of many JFET circuit applications. However, semiconductor device manufacturers

Facts

ON COAXIAL LINE EQUIPMENT

Facts and only facts count for Philips' family of coaxial line equipment. There are many striking facts worth mentioning.

Fact No. 1: Sound Design

Firstly, for the automatic compensation of the cable attenuation changes, the principle of pre/post-regulation is used. Half of the compensation is effected at the transmitting side (pre-regulation), the other half at the receiving side (post-regulation).

Secondly, only one out of 36 repeaters is a surface station with one master regulator per direction. The remaining 35 are buried, three of them being remotely regulated and the remaining 32 non-regulated.

All level regulation is by remote control from surface stations thus simplifying the underground repeaters.

Fact No. 2: Proven Reliability — Experience

The fact that many of these repeaters are submerged under the sea in Denmark and are used in Belgium, Sweden, Switzerland and the Netherlands indicates the confidence these administrations have in this series of equipments. Remember too that Philips was one of the first companies in the world to introduce underground repeaters.

Fact No. 3: Quality

Quality is expressed in figures. Here are some for the 12 MHz system on normal coaxial cable (which is only one of the family):

Noise figure of the non-regulated dependent repeater: 3dB at 12 MHz.

Intermodulation noise: negligible (less than 10% contribution of total noise).

Total noise: 1 pW/km, under all operational conditions and for all channels. Accuracy of automatic compensation of seasonal cable-loss variations: within 1%.

Distance between power feeding points: 166km, all stations in between being underground. Line current: 50 mA DC. Maximum feeding voltage: 500 V between two inner conductors, with possibility of making a section voltage-free. Nominal repeater spacing: 4.7 km (max. acceptable repeater spacing: 5.2 km).

Fact No. 4: Installation

All dependent repeaters (regulated and non-regulated) are suitable for direct burial. The installation of these repeaters is not critical because they are highly insensitive to ambient temperature. Special sea-cable cases are available.

Fact No. 5: Maintenance

Maintenance is very simple and does not require any special skills. Philips actually taught a tea lady to operate the main line-up equaliser in a few minutes. This is possible because semi-automatic devices are employed to aid alignment and fault finding and such operations can be carried out during normal traffic.

Fact No. 6: Flexibility in Application

Philips' coaxial line equipment is a family consisting of 4, 6 and 12 MHz versions for small-diameter (1.2/4.4 mm) and normal diameter (2.6/9.5 mm) cable. Bays, repeater cases, etc. are identical. Replacing a 4 MHz system by a 12 MHz system, for instance, merely means interposing new repeaters, while in the existing repeaters only plug-in conclave units need be replaced. All have the same safe line current of 50 mA.

The repeater is so small that it can be mounted in a variety of underground housings including that designed by the Australian Post Office.



*Philips Telecommunications
of Australia*

Limited

113 Tapleys Hill Road, Hendon, S.A. and all States

PTA.001

have found it possible to provide a range of "custom-made" current regulating devices with specified current ratings, and accordingly circuit designers have been able to take advantage of the devices.

An important type of field-effect device which differs both in construction and in certain aspects of its operation from the JFET is the **insulated-gate field effect transistor, or IGFET**. Other general names for this type of device are MISFET, standing for "metal-insulator-semiconductor FET," and TFT, or "thin film transistor." The last of these names is usually reserved for devices which are in the form of elements within micro-circuits or "ICs."

In broad terms the operation of IGFET devices is very similar to that of the JFET device which we have already examined. As before, the effective conductivity of a semiconductor channel region is modulated by a control bias applied between the channel and an adjacent electrode termed the gate.

However, an important difference between the two types of device is that whereas in the JFET the gate electrode is isolated from the channel by a non-conducting P-N junction, in the IGFET this isolation is performed by a very thin layer of insulating material such as silicon oxide or silicon nitride. Also the gate electrode is a metallic film deposited on the surface of the insulating layer, rather than a semiconductor region.

Probably the most common type of IGFET device is the **MOSFET** or

give optimum performance under different conditions. Thus there are (a) the depletion-mode or normally on MOSFET, designed to operate in a very similar fashion to the JFET; (b) the depletion/enhancement MOSFET, designed for operation at around zero bias, and capable of linear signal excursions into both the depletion and enhancement modes; and (c) the enhancement-mode or normally off MOSFET, designed for optimum operation in the "forward-biased" condition.

The three types of MOSFET are sometimes known respectively as type "A," type "B" and type "C" devices.

The basic construction of a depletion-mode or type "A" MOSFET is shown in figure 8.7(a). It may be seen that the device channel here consists of a very thin semiconductor layer linking the drain and source regions at the surface of a supporting or "substrate" region. The device shown is of the "N-channel" variety, with an N-type channel and a P-type substrate; however the complementary configuration is also made. Like JFETs, MOSFETs can be made in both "polarities," this applying to all three types of device.

As the channel and substrate regions of the device are of opposite type, the junction between the two is surrounded by the usual depletion layer even in equilibrium. However, in this case the depletion layer plays no part in the operation of the device, serving merely as an internal isolation medium for the channel. In typical circuit applications the substrate electrode of a JFET is simply tied to the source, to earth

as soon as external reverse bias is applied to that electrode. The electric field between the gate and the semiconductor material causes carriers to be repelled from the surface, leaving a carrier-depleted region virtually identical to that associated with a P-N junction. (The repelled carriers are normally swept away by the longitudinal channel field, just as in the case of the JFET; they correspond to charging current of the gate-channel capacitance.)

As before, the encroaching depletion layer reduces the effective electrical thickness of the channel.

Not surprisingly, when gate-source bias V_{gs} and drain-source bias V_{ds} are both applied, there is again a pinching action at the drain end of the channel, and channel current tends to reach a saturation or pinch-off level. Hence the depletion-type MOSFET has very similar V_{ds}/I_{ds} characteristics to those of a JFET, as may be seen from figure 8.7 (b). The "plateau" segments of the curves are not quite as horizon-

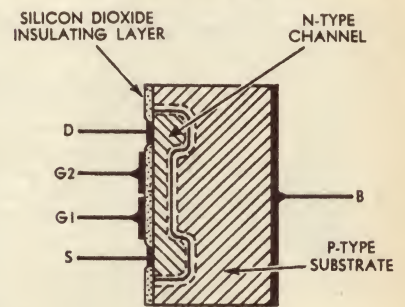

DUAL-GATE DEPLETION-TYPE MOSFET (N-CHANNEL)

Figure 8.9

tal as those of the JFET, because of the less intimate control exercised by the gate, but the behaviour of the device is very similar.

In contrast with the depletion-mode MOSFET of figure 8.7 is the enhancement-mode type, whose basic construction and operation are shown in figure 8.8. The type shown is the "P-type channel" version, or more strictly the "induced P-type channel" configuration.

The construction of this type of device is similar to that of the depletion type, as may be seen, except that there is no physical channel between the two "islands" forming the drain and source regions. The substrate is continued right up to the oxide-covered surface between the two. Hence when no external gate bias is applied to the device, there can be no drain-source current except a small saturation/leakage current through the drain substrate and substrate-source junctions.

This explains why the enhancement-type MOSFET is often called a "normally off" device, in contrast with the "normally on" characteristics of the JFET and depletion-type MOSFET.

At this point the reader may well be wondering how the enhancement-type device can be persuaded to pass current. Actually the answer to this is fairly obvious — by the creation of an "effective channel" linking drain and source. And not unexpectedly, this effective channel is created at the surface of the substrate by the external bias applied to the gate electrode.

The idea is that "forward" bias applied to the gate produces an electric

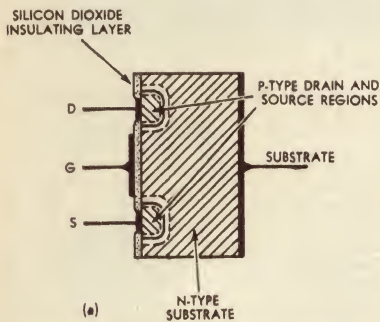

Figure 8.8 ENHANCEMENT OR "TYPE C" MOSFET (P-CHANNEL)

metal-oxide-semiconductor FET, in which as the name suggests the gate-channel insulation is performed by a thin layer of silicon dioxide. Other names for this device are "MOST," "MOS transistor" and "SCOUT" — the latter standing for "surface controlled oxide unipolar transistor."

Because the MOSFET relies upon an oxide layer for gate-channel isolation rather than the depletion layers associated with non-conducting P-N junctions, it is not inherently subject to the restriction on enhancement-mode operation which applies to the JFET. There are definite restrictions to the voltage which may be applied between gate and source, as will be explained shortly, and these restrictions are of paramount importance if a MOSFET is to be protected from damage; however in general they apply equally for both polarities of applied gate-channel voltage.

Taking advantage of this, device manufacturers have been able to provide three different types of MOSFET, each of which is designed to

or to some other "cold" reference point.

The surface of the MOSFET above the channel is covered, as may be seen, with a silicon dioxide insulating layer. The layer is very thin, typically in the order of 1,000 angstroms (.0001mM). Deposited in turn on the top of this layer, above the channel, is the gate electrode. This is simply a thin film of metal, usually aluminium.

Fairly obviously, because there is no "junction" as such between the gate and channel of the device, there can be no depletion layer at the top of the channel for zero bias, to correspond to the "equilibrium" depletion layers present in the JFET. However, the depletion mode MOSFET nevertheless operates in a very similar manner to that of the former device, as a result of the close electrical coupling between the gate and channel provided by the very thin oxide layer.

In fact although there is no depletion layer at the top of the channel for zero gate bias, such a layer begins to "grow" inwards from the top of the surface of the channel beneath the gate



Xmas Suggestions



AMPLIFIERS

DYNACO

A variety of Dynaco amplifiers in kit form or assembled is available. The quality of this well renowned equipment will please the most fastidious audio enthusiast:

"STEREO 120" a fully solid state 2 x 60 watts (rms) mains amplifier with almost incredible specifications and performance.

"STEREO 70" 2 x 35 watts rms, "STEREO 35" 2 x 17½ watts rms. The quality of these amplifiers is outstanding.

"PAS 3 X" and "PAT 4" pre-amplifiers, matching quality and performance for the Dynaco main amplifiers.

"SCA 35" an integrated pre-main amplifier with magnetic cartridge sensitivity and all control facilities; 17½ watts (rms) output each channel.

FOR THE YOUNG MUSIC LOVER

As a good stereo set up from Danish Hi-Fi at very low cost we recommend the Labcraft 643 turntable, the "Mayston" amplifier and a pair of 1001 pressure chamber speakers. This system will occupy little space but produce big sound! See and hear at our showroom.

FOR THE DISCERNING

A top quality stereo sound system for the serious music lover. The B & O Beogram 1500 and Beovox 1000 speakers imported from Denmark will satisfy practically all your demands regarding music reproduction and appearance. The Beogram 1500 consists of the famous B & O 1000 turntable with belt drive and ± 10% fine speed adjustment, the ST/L 15° pick up arm with hydraulic lift and built in anti skate device, SP 7 or SP 9 B&O cartridge and a fully solid state 2 x 8 watts rms amplifier. The Beovox 1000 contains one woofer and one tweeter plus crossover network in a special pressure chamber designed for maximum efficiency and sound quality. Various other Beovox speaker systems of the same high standard of workmanship and performance are available as an alternative.



LOUDSPEAKERS

Peerless



A complete range of circular and oval high quality speakers of all sizes and for every application. Dual cone speakers; coaxials; woofers including the latest models 8" L 825 WG and 10" L 100 WG with rubber roll surround for wide cone excursion and absolute clean bass reproduction, cone resonance: 25 Hz and 20 Hz respectively. Midrange speakers; tweeters - including the latest type MT 225 HFC with an almost flat response from 1500 Hz - 20 kHz! Crossover networks. Complete speaker systems of various sizes designed by Peerless are available in kit form or assembled.



Labcraft

TURNTABLES



Labcraft turntables are a must for those who demand highest quality. Made by SRT of Denmark they represent good value for money. Various models are available: 605 with a grey 9" rubber mat, 605L with a 11" grey rubber mat and 655 with 11" black mat and centre insert (illustrated). Common to all is the vibration free, spring mounted, fully shielded (potted) motor with 15V AC winding to power a solid state pre-amplifier for magnetic cartridges. 33⅓, 45 and 78 speed drive spindle ground and polished to extremely fine tolerances (0.000,04"). Manual fine variation ± 10% on all speeds. Wow and flutter less than ± 0.15% peak. Rumble: 35 dB below ref. level at 1.4 cm/100 Hz. The platter is running in self lubricating bronze and nylon bearings. Base plates are ready drilled to accept the B&O arms or the All Balance arm, though other arms can be fitted. A smoke grey plastic cover and bases in ash, teak or palisander are available.

Danish Hi-Fi Pty. Ltd.

941 BURKE ROAD, CAMBERWELL 3124, PHONE 82 4839

field at the surface of the substrate, and this in turn has two effects. One is that majority carriers in the substrate material are repelled away from the surface; the other effect is that minority carriers are attracted towards the surface. And the net result of both these effects is that the material at the surface of the substrate is effectively **inverted in type** to become what is termed an **induced channel** linking drain and source.

Hence the example shown, forward bias (gate negative) tends to repel electrons from the surface of the N-type substrate, and at the same time attract thermally generated holes. The surface is thus inverted in type to form an induced P-type channel linking the drain and source regions, and drain-source current is able to flow if a drain-source bias V_{ds} is applied.

Naturally the greater the forward bias applied to the gate, the deeper the induced channel and the lower the drain-source resistance. However, as before the drain-source bias V_{ds} tends to reverse-bias the drain end of the induced channel, so that a phenomenon very similar to pinch-off occurs. Hence apart from the different gate bias

one, but two control gate electrodes. The two gates are arranged to act upon the channel conductivity in cascade, as may be seen from the diagram of figure 8.9. For practical reasons associated with both the fabrication and application of such devices they are normally made in either the type A (depletion) or type B (depletion/enhancement) variety—i.e., in "normally-on" form.

The two gate electrodes of this type of device make it very well suited for use as a controlled-gain amplifier, a "cascode" RF amplifier, and an RF mixer. Thus although the device is a relatively late development on the semiconductor device scene, it is already finding many applications.

The circuit symbols commonly used for the various types of MOSFET are shown in figure 8.10.

Because of the excellent insulating properties of the silicon dioxide layer insulating the gate of a MOSFET from its channel, the input resistance of these devices is typically some 1,000 to 10,000 times greater than that of a JFET—i.e., from 1 to 10 Teraohms (1 to 10 million Megohms). This is even higher than many thermionic valves, and is, in any case, independent of the

to reduce the thickness of the silicon dioxide layer separating the gate electrode from the channel sufficiently to achieve as high a transconductance with MOSFETs as can be achieved fairly easily with the JFET. Very thin oxide layers are not only difficult to achieve reliably during manufacture, but they also present stability problems; their insulation becomes more subject to imperfections due to trapped impurities, and a phenomenon known as "ion drift" can occur over a period of time due to migration of impurity ions from the oxide into the semiconductor channel.

Not only this, but the silicon dioxide layer of a MOSFET does not possess the same breakdown characteristic as that of the P-N junction insulating the gate of a JFET. Whereas the latter can enter avalanche breakdown without necessarily sustaining damage, the oxide layer of a MOSFET is only capable of the "punch-through" breakdown typical of dielectrics such as paper and plastic film. Hence if a critical field strength is exceeded the gate-channel insulation is punched through at a particular point, and the device may well be ruined.

Because of the very high resistance and low capacitance between the gate and channel, even slight "static electricity" charges reaching the gate of a MOSFET can produce permanent device damage in this fashion. Hence such devices are normally supplied by the manufacturer with all electrodes temporarily shorted together to preclude static charge effects, and the electrode shorting clips are normally left connected until the devices are wired into circuit ready for operation.

Recently MOSFET devices have been released featuring "internal" protection against gate insulation failure, by means of zener diode structures incorporated into the basic device. The diodes are arranged to enter non-destructive avalanche breakdown before the oxide punch-through voltage is reached. Naturally these devices provide a form of MOSFET which is somewhat more rugged electrically than the standard type; however because the protection diode P-N junctions are effectively in parallel with the gate-channel insulation, the input resistance of these devices is lowered to the level of approximately 1000M typical of JFET devices. Luckily this figure is still very high, and quite adequate for many applications.

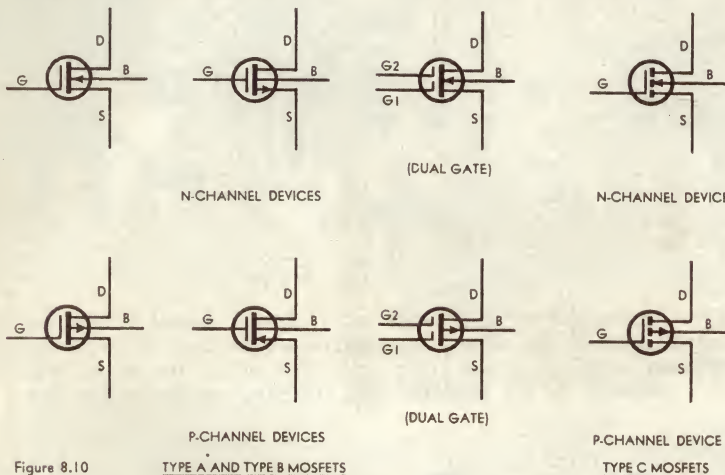

Figure 8.10 TYPE A AND TYPE B MOSFETS

sense, the v_{ds}/i_{ds} curves of an enhancement-type MOSFET prove rather similar to those of a depletion-type device. This may be seen by comparing the typical curves given in figure 8.8(b) with those of figure 8.7(b).

Note that in the case of the depletion-type MOSFET the gate need not extend for the full length of the channel in order to achieve proper device operation, whereas with the enhancement-type device it is essential for the gate to extend the full distance between the drain and source in order to provide a link between the two. This tends to make the enhancement-mode device harder to fabricate, and also gives it a higher gate-channel capacitance.

The depletion-enhancement or "type B" MOSFET is very similar in construction to the depletion-type device shown in figure 8.7. The only difference is that the channel section is made particularly thin, allowing the gate bias to be used either to diminish its conductivity in the manner of a depletion-type device, or to enhance its conductivity in the manner of an enhancement-type device.

A further type of MOSFET device which should be briefly mentioned here is the **dual-gate MOSFET**, which as the name suggests is a device having not

polarity of the applied gate bias—in contrast with both the JFET and the thermionic valve. At the same time the gate-channel capacitance of the MOSFET is generally somewhat lower than for the JFET, due to the isolation associated with the oxide layer, and this gives lower values for both C_{gs} and C_{gd} .

Together with these advantages come problems, however. It proves difficult

SUGGESTED FURTHER READING

- CHERRY, E. M., and HOOPER, D. E., **Amplifying Devices and Low-Pass Amplifier Design**, 1968. John Wiley and Sons, New York.
- COHEN, J. M., "An Old-Timer Comes Of Age," in *Electronics*, V. 41, No. 4, February 19, 1968.
- HEIMAN, F. P., and HOFSTEIN, S. R., "Metal-Oxide-Semiconductor FETs," in *Electronics*, V. 37, No. 30, November 30, 1964.
- NOLL, E. M., **FET Principles, Experiments and Projects**, 1968. Howard W. Sams, Inc., Indianapolis.
- SEVIN, L. J., **Field Effect Transistors**, 1965. McGraw-Hill Book Company, Inc., New York.
- WALSTON, J. A., and MILLER, J. R. (Eds.) **Transistor Circuit Design**, 1963. McGraw-Hill Book Company, Inc., New York.

NOISE SILENCERS —

A developmental model

Last August we presented a noise silencer based on the well known Lamb principle. This used modern valves and was designed to be fitted as an outboard unit to existing short-wave and communications receivers. However, the need still exists for a silencer suitable for use in solid state receivers. Here is one version of such a unit which we developed during our investigations.

By Ian Pogson

The silencer we are about to describe was evolved during our work on the new short-wave receiver currently under development. While it works extremely well, and we have presented enough information to allow any reasonably experienced reader to duplicate it, we should emphasise that it is only a developmental model. Even as we prepare this article, another unit is under development. While it is unlikely to function any better, we hope that it will offer the advantage of greater simplicity, fewer components, and smaller physical size.

In our earlier article we went into some detail regarding noise, together with possible ways of dealing with it. We do not propose to go over this ground in the same detail again. Rather will we summarise what has already been said. Readers who may wish to refer to the previous article can find it in the issue for August, 1969.

The noise we are considering is that received by the aerial system, rather than any generated within the receiver or which may find its way into the receiver via the power mains.

Man-made noise comes from neon signs, arc welders, switches, domestic appliances, high tension power line leakage, car ignition, etc. Atmospheric noise results from lightning discharges often referred to as "static." Galactic or cosmic noise emanates from outer space.

Noise can be divided generally into two groups, hash or hiss in one instance and impulse in the other. Hiss is more or less random pulses which are continuously overlapping. Impulse noise is quite different, being normally of very short duration and high amplitude. This latter type of noise is much easier to deal with than the former.

For the benefit of readers, we are repeating the block diagram which was used for the previous article. Between the mixer and first IF amplifier, and ahead of any highly selective circuits, there is a "gate." From the mixer are taken the signal and noise, which are passed through an amplifier. This is followed by a detector or rectifier. The amplifier is biased by a gain control. This is so adjusted that the two circuits combine to separate the signal from the noise pulses, by reason of the greater amplitude of the latter. As a result, pulses only, caused by the noise, emerge from the detector.



This photograph of the "signal path" board should be studied and correlated with the wiring diagram shown on page 81. The emitter-follower stage is at the right, with the gating transistor next and followed by the amplifier and switching diodes at the left.



The reverse side of the assembly, this board contains the noise amplifier at the left, followed by the phase-splitter, detector and pulse amplifier at the right. This should be studied with the wiring diagram on page 81.

The pulses are then passed through an amplifier and, from this, are fed into the gate. The pulses are of such polarity as to close the gate for the duration of the pulse.

As the ratio of the duration of a noise pulse, to the time between pulses, is generally quite high, the signal through the gate is cut off for only a very small percentage of the total time.

Apart from their effect on read-

ability, noise pulses have the additional effect of actuating the A.G.C. system and desensitising the receiver accordingly. In extreme cases, this can reduce the receiver sensitivity to a point where the signal is inaudible for this reason alone.

Although the Lamb system is most effective in the fight against impulse type noise, it can often be used to at least reduce the nuisance of other types of noise. Also, as the silencing occurs

early in the IF system, noise which would otherwise desensitise the receiver is eliminated or reduced.

Having met with such success with the valve version we thought it worthwhile to try to develop a solid state version. This presented a number of problems, a prime requirement being that the silencing circuits should not take up more than their fair share of space. In the valve version the components taking up the lion's share are the valves and the IF transformers. While the valves will be eliminated, the transformers are still a problem.

Considering, in turn, each transformer as used in the valve system, we debated whether we could dispense with it. The transformer normally fitted to the input of the silencer was the first to be considered. A major function which this transformer normally performs is that of filtering out any local oscillator signal which may appear at the output of the mixer stage. Without this filtering action, local oscillator signal can reach the gate circuit and seriously upset its operation.

However, the receiver with which this silencer was intended to be used was a special case. It features a double balanced or "ring" mixer, a major characteristic of which is that very little local oscillator signal appears at its output. For this reason we felt that the transformer might possibly be

omitted. Assuming that it could, the arrangement would have the additional advantage that there would be no tuned circuits to degrade the noise pulse — by lengthening it — before silencing.

As it turned out, the idea worked, but we must emphasise that it is suitable for use only with mixer systems which have a very low local oscillator output. Where more conven-

functions as a phase-splitter. We reasoned that a transistor phase-splitter could be used here.

In theory at least, we were doing quite well thus far. However, the gate circuit, with its input and output transformers, presented a more difficult problem. Fortunately, our attention was drawn to an unusual type of gate, used by William K. Squires in his noise

This block diagram will serve to refresh the reader's memory regarding the basic operation of typical noise silencers. Compare it with the circuit below.

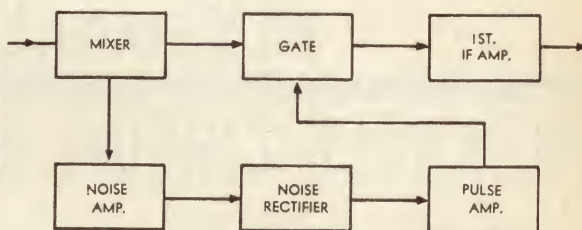

tional mixer systems are used it will almost certainly be necessary to fit a transformer, undesirable though this may be in regard to its effect on pulse duration. The best compromise is to damp the tuned windings as much as can be tolerated in order to minimise the effect.

The next transformer to receive attention, was the one between the noise amplifier and the detector/rectifier circuits. In addition to being an impedance changing device, it also

silencer (QST October, 1963). This gate, which uses a symmetrical transistor, is an unbalanced arrangement and needs no input or output transformers. This seemed to be the answer. Although the symmetrical transistor used by Squires (RCA 2N-1169) is not available in Australia, we were able to obtain some near equivalent types offered by Mullard.

A symmetrical transistor is one in which both emitter and collector junctions are the same physical size. While, electrically, these are the same as a normal bi-polar transistor, the identical emitter and collector junctions produce a relatively low-gain device which, however, has useful characteristics in

Circuit diagram of the developmental noise silencer. Note that no transformers have been used but that an input transformer would be necessary when used with the more conventional mixer circuits. Components shown dotted will provide additional gain.

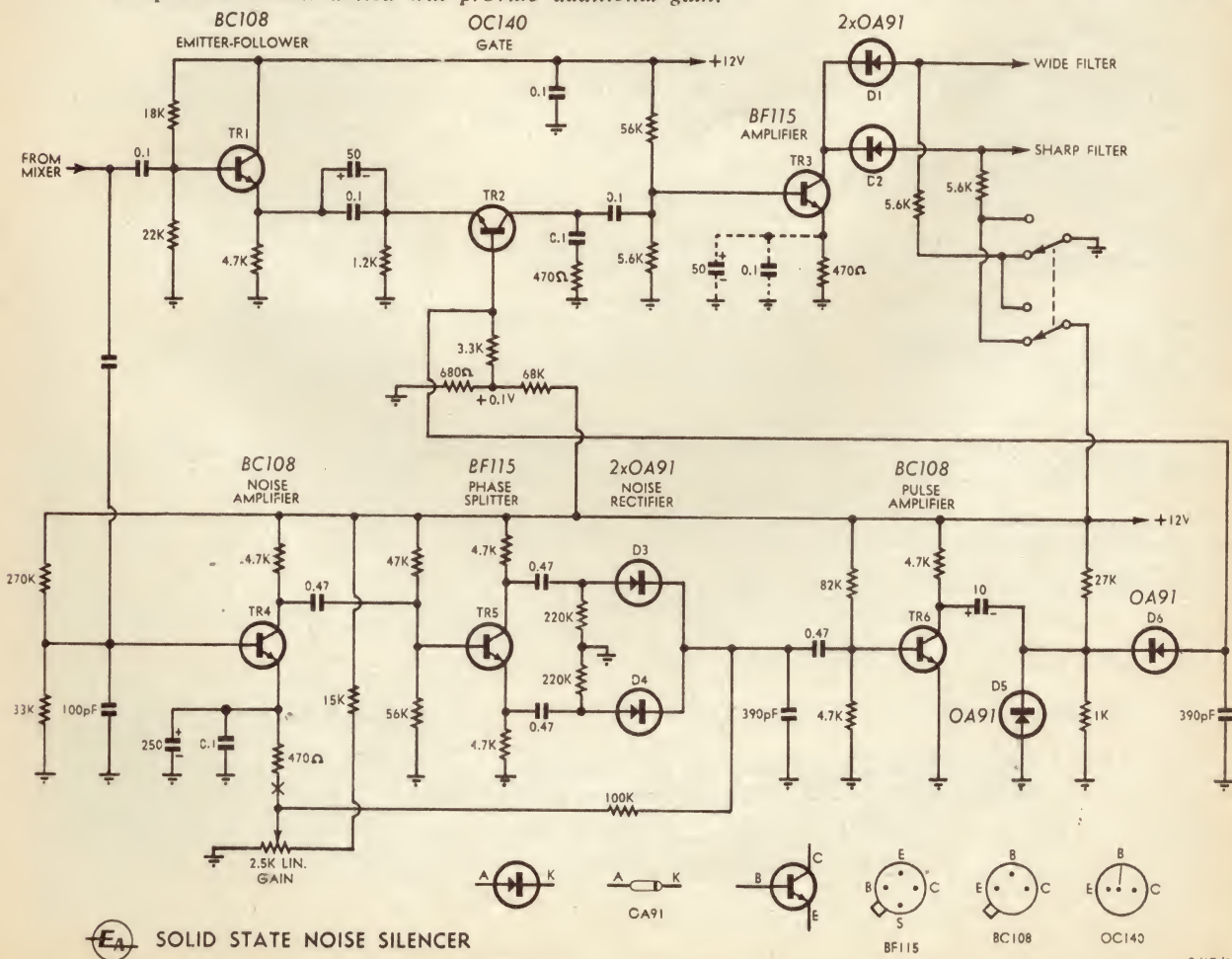

E4 SOLID STATE NOISE SILENCER

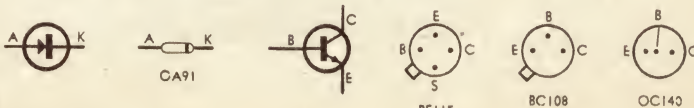

reliable
pre-tested
tight performance
NEWMARKET

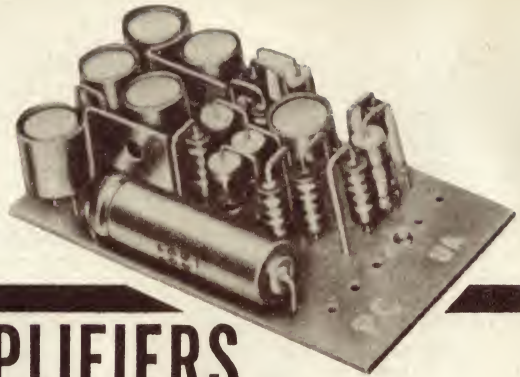

PACKAGED CIRCUIT AMPLIFIERS

The Newmarket PC range provides *Development Engineers* with reliable pre-tested units of tight performance specifications to incorporate in any equipment at minimum cost. Use of such units not only obviates the need to develop purpose-made amplifiers for every job, but cuts down the number of small

components that company *Buyers* have to buy and maintain in stock. Each unit is guaranteed for 12 months and replacement units are supplied if any fault develops. Our guarantee also enables the manufacturer to guarantee his product to the ultimate user.

some applications

MODEL No. PC 1

Stethoscope Amplifier.
General Purpose Audio Amplifiers and Drivers.
Intercomm Amplifier.
Telephone Amplifiers.
Laboratory Instrument Amplifiers.
Back Projector Audio Amplifiers.
Loudspeaker Amplifier.
Hospital Board Control Units Intercomm Amplifiers.

MODEL No. PC 2

Modulator Driver Stage.
Intercomm.
Church Hearing Aid Amplifier.
Office Dictating Machines.
Door-Caller Monitor Amplifier.
Inter-Office Communication Amplifier.
Tape Replay Amplifier.
General Purpose Audio Amplifiers and Drivers.
Telemetry Audio Amplifier.
Radio Receiver Audio Amplifier.
Telephone Amplifiers.
Educational Equipment Audio Amplifiers.
Laboratory Instrument Amplifiers.
Language Laboratory Amplifiers.
Tape Recording Amplifiers.
TV Aerial Riggers Intercomm Amplifier.
Loudspeaker Amplifier.
Radio Concentrator.
Mine Communication Amplifier.

MODEL No. PC 3

Disc Talking Book.
DC Relay Driver.
Telecommunications Conference Monitor Amplifier.
Sound-level Meter Amplifier.
Close Background Music Amplifier.

Sound Reinforcement Amplifier.
General Purpose Audio Amplifiers and Drivers.
Low Power Battery Stereo.
VHF Communications Receiver Audio Amplifier.
Radio Receiver Audio Amplifier.
Telephone Amplifiers.
Heating and Ventilating Control Amplifier.
Laboratory Instrument Amplifiers.
Museum Portable Commentary Equipment System.
Radio Relay System Amplifier.
Loudspeaker Amplifier.

MODEL No. PC 4

Battery Record Player.
General Purpose Amplifiers and Drivers.
Office Dictating Machines.
Telephone Amplifiers.
Pay TV Control Circuits Amplifier.
Stereo Listening Booth Amplifiers.
Laboratory Instruments Amplifiers.
Loudspeaker Amplifier.
Radio Relay System Amplifier.

MODEL No. PC 5 Plus

Salesman's Portable Cine Projector Audio Amp.
Meter Type Galvanometer Amplifier.
Helmet Intercomms: (a) Diving Suits, (b) Crash Helmets, (c) Pilots' Helmets.
Car Radio Audio Amplifier.
Communications Receiver Audio Amplifier.
Lecturer Non-interruption Monitor.
Erogenic Amplifier.
Small Public Address Portable Amplifier.
Servo Amplifier (Hydraulic Valve Control).
General Purpose Amplifier.
Fault Finding Tone Detector Amplifier.
Tape Replay Amplifier (Aircraft Ground Equipment).
Automation Drive Amplifiers.
Colour Television Receiver Audio Amplifier.
Tape Recorder Replay Amplifier.
Hi-Fi Amplifier.

Vibration Test Amplifiers.
Telephone Intercomm System.
Office Dictating Machines.
Telephone Amplifiers.
Fire Detection Equipment Amplifier.
Mines Telephones Amplifiers.
Cigarette Manufacturer Production Test Equipment Amp.
Instrument Audio Amplifier.
Sound Reinforcement Intercomm Amplifier.
Null Detector Instrument Amplifier.
Public Address Amplifier.
Mobile and Fixed Transmitter Modulators.
Telephone System Audio Amplifier.
High Power P.A. Driver Amplifier.
TV Camera Channel Talk Back Amplifier.
Sound Intercomm Amplifier.
Industrial Test Instrument Amplifier.
Burglar Alarm Audio Amplifiers.
Transceiver Audio Amplifiers.
Laboratory Instrument Amplifiers.
Airport Loudspeaking System Amplifier.
Pocket Paging System Amplifier.
Carrier System Mains Intercomm (Portaphone).
Loudspeaker Amplifiers.
Electronic Organ Power Amplifier.

MODEL No. PC 7 Plus

Tape Language Laboratory.
Telephone Dictating Machine Amplifier.
Automation Drive Amplifiers.
Control Amplifier for Textile Machinery.
Radio Receiver Audio Amplifier.
TV Receiver Audio Amp.
General Purpose Amplifier.
Telephone Amplifier.
Laboratory Instrument Amplifiers.
Tape Language Laboratory Amplifier.
Loudspeaker Amplifier.

specification details	PERFORMANCE DATA								
	PC1	PC2	PC3	PC4	PC5	PC7	PC7 + /12	PC9	
Power Output mW	150	400	400	400	3W	800	800	Pre-amp	
Input Sensitivity mV	50	1	5	150	5	5	5	1V	
Input Impedance ohms	1.5K	1K	2.5K	220K	1.5K	1.5K	1.5K	1M	
Output Impedance ohms	40	15	15	15	3	8	15	600	
Supply Voltage—volts	9	9	9	9	12	9	12	9	
Typical Distortion %	2	3	3	3	3	3	3	1	
Frequency Response	300-15K	200-12K	200-12K	200-12K	50-12K	50-12K	50-12K	20-20K	
Overall Dimensions All ¾ in. high	2x1	2½x1½	2½x1½	2½x1½	5½x1¾	3x1¾	3x1¾	2x1	

Circuits are of transformerless, complementary symmetry type, operating off Standard Voltages. Can be wire-in or plug-in as required.

tecnicco ELECTRONICS

53 Carrington Road, Marrickville, N.S.W.
18 Normanby Rd., South Melbourne, Vic.

SYDNEY: General Accessories Limited, 443 Concord Road, Rhodes 2138; G. Brown & Co. Pty. Ltd., 267 Clarence Street, Sydney 2000. **NEWCASTLE:** Martin de Launay Pty. Limited, King and Derby Streets, Newcastle 2300. **WOLLONGONG:** Electronic Parts Pty. Limited, Keira Street, Wollongong 2500. **MELBOURNE:** Radio Parts Pty. Limited, 562 Spencer Street; Warburton, Franki Limited, 220 Park Street 3000. **BRISBANE:** General Accessories Pty. Limited, 50 Little Edward Street 4000. **ADELAIDE:** General Accessories Pty. Limited, 81 Flinders Street 5000. **PERTH:** General Accessories Pty. Limited, 46 Milligan Street 6000.

TE5066

other respects. Its main use is in high-speed switching circuits in computers. Also, although the Mullard types are coded to indicate "emitter" and "collector" in the usual way, the leads may in fact be reversed and the device will function equally well.

Having dispensed with the transformers in a theoretical design, we had to make up a practical unit. The circuit diagram shows the end result and we will go over it and explain the various functions.

At the silencer input, the signal is

The noise pulses are passed to the phase splitter which, in turn feeds a full-wave rectifier. In addition to the separation of noise pulses from the signal, within the noise amplifier, this process is augmented by the fact that the rectifier diodes are also reverse biased by the same control.

Positive-going pulses which emerge from the noise rectifier are, in turn, fed into a pulse amplifier, so biased that it is just in conduction without any signal. Due to the phase reversing characteristic of the common -

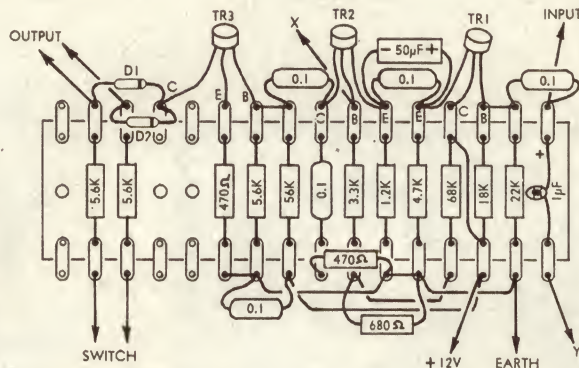

The upper diagram on the right shows the layout and wiring of the "signal path" board. Compare it with the upper photograph on page 78.

The board in the lower diagram carries the noise amplifier, phase-splitter, detector, and pulse amplifier. See lower photograph, page 78.

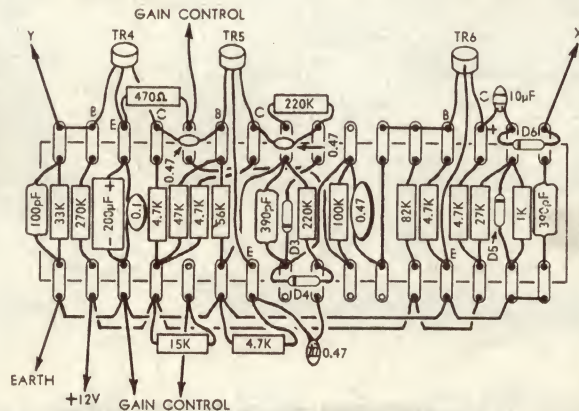

split. Part is directed via an emitter-follower to the emitter of the symmetrical transistor, or gate. The gate is connected such that the signal passes from the emitter to the collector. The emitter junction is forward biased with about 0.1 volt and emitter current flows under these conditions. It will be noted, however, that there is no provision for collector current. The output of the gate is terminated with a 0.1μF capacitor and a 470 ohm resistor in series, and the input resistance of the following transistor amplifier. This amplifier is needed to make up for the insertion loss of the gating-circuit.

At the output of the amplifier there is provision for diode switching the signal into one of two channels. These provide filters having two selectivity band widths. This may be omitted, using a single 5.6K resistor for the amplifier collector load.

Returning to the input, the other split feeds the noise amplifier. The function of this amplifier is not only to amplify the noise pulses but also to separate, from the signal, those noise pulses which are of greater amplitude than the signal. This is done by so biasing the amplifier that it will not pass the wanted signal, but only the noise pulses above a predetermined level.

emitter configuration, negative-going and amplified pulses are produced at the collector of the pulse amplifier. These pulses, after being subject to clipping by two diodes, are fed into the base of the symmetrical transistor gate. This closes the gate for the duration of the pulse, preventing any signal from passing for this period.

This circuit, while it performs very well, could be still considered as developmental. It will be noted that there is a 50μF electrolytic capacitor across the 0.1μF blocking capacitor, between the emitter follower and the

If you want STEREO EQUIPMENT

You'll deal better with
H. B. RADIO SALES

DECEMBER SPECIALS

- KENWOOD TK250 AMPLIFIER/** 2 Wharfedale unit 3 speaker systems. Dual 1019 player on platform, Shure magnetic **\$398.00**
KENWOOD 150 AMP, 2 Magnavox 10in speaker systems in Teak. Garrard AT60 on platform, with Shure M44G **\$275.00**
SANSUI 555 2 Wharfedale Super 10 speakers in R3 teak cabinets, Dual 1019 player, Shure M44G, platform and cover **\$465.00**
MONARCH SA 500. 20W RMS—Low and High Filter controls. 2 Peerless 10in speaker systems, Dual 1210-Shure M44G-platform-cover. **\$312.00.**

- SPEAKER UNITS**
PLAYMASTER, complete . . . **\$31.00**
Cabinet Kit and Parts . . . **\$24.20**
POINT 4, complete **\$35.00**
Cabinet Kit and Parts **\$25.00**
PLAYMASTER SUPER **\$42.00**
Cabinet Kit and Parts **\$32.50**
WHARFEDALE Unit 3 (large)
Cabinet Kit and Parts **\$54.00**
Cabinet Kit and Parts **\$44.00**
MAGNAVOX 8WR, 1.6 cf cabinet **\$30.50**
Cabinet Kit and Speaker **\$21.00**
MAGNAVOX 10WR and 3TC, complete **\$43.00**
Cabinet Kit and Speakers **\$31.00**
MAGNAVOX 12WR, 3TC, complete **\$44.50**
Cabinet Kit and Speakers **\$33.00**
PEERLESS 10in 2cf cabinet **\$57.50**
Cabinet Kit and Speaker **\$47.00**
W'DALE GOLD, 10 in R3 cabinet **\$65.00**
Cabinet Kit and Speaker **\$52.00**

Special quotes for other speakers. Available in Maple, Walnut or Rosewood colours. Teak veneer \$1 extra for Slimline and Bookshelf KITS. \$2.50 extra for other KITS.

Packing charge \$1 per order. Freight payable on delivery.

Send for Stereo Catalogue

H. B. RADIO SALES

Established 37 years.
105 Catherine Street,
LEICHHARDT, SYDNEY.
Telephone: 56-5580.

TRANSFORMERS FOR PROJECTS

Specialists in the small-batch production of high-quality Transformers for industrial and entertainment equipment. Transformers can be produced for any project published, or to your own special requirements.

Facilities available for vacuum impregnation in a wide variety of materials or complete encapsulation in Epoxy or Polyester resins.

Trade and retail enquiries handled throughout Australia, New Zealand and the Pacific Islands.

TRANSFORMER WINDERS LIMITED

37 CRUMMER ROAD, AUCKLAND, NEW ZEALAND.

TEAC



Read what 'High Fidelity' (USA) says about TEAC A-1200

"High Fidelity", the authoritative USA stereo equipment journal, in March, 1969, tested the A-1200 and commented, "The dual-channel VU meter proved to be one of the most accurate yet tested and certainly better than the meters usually found on home recorders. Speed accuracy, as tested at CBS Labs, was the best yet seen in any tape recorder: no measurable error at any line voltage setting for either of the deck's two speeds. The A-1200 also had negligible wow and flutter—the values measured in the lab actually were lower than those claimed by the manufacturer. Harmonic distortion was somewhat better than average, signal-to-noise definitely better than average, for this price class. The crosstalk measurement shows ample channel separation for excellent stereo".

TEAC is justly proud of the quality of its equipment, and the A-1200 is typical of the range. It is a three-head, three-motor, two-speed record and playback machine. The three-head arrangement permits direct monitoring while you record.

If you want excellent stereo from a tape deck, the TEAC A-1200 is the equipment to provide it. List price \$399.

AUSTRALIAN MUSICAL INDUSTRIES PTY. LTD.

155 Gladstone St., Sth. Melb., 3205. Phone 69 7281 Telegrams AMUS Melb.

SPECIFICATIONS

- All solenoid controlled electrical operation system.
- Triple-motored, durable drive mechanism.
- Instant off the tape monitoring.
- Mike/line mixing.
- Stereo echo, and sound on sound by push-button operation.
- Optional remote control.
- 2-track head configuration available.
- Wow and flutter—0.12%.
- Frequency response—30-20,000 Hz.
- Dimensions—
15½" H x 17¼" W x 9¾" D.

RETAIL ENQUIRIES:

VIC.: Brashs Pty. Ltd. 63 6701 (Melb. and Suburbs)
Suttons Pty. Ltd.
60 1201 (Melb. and Country)

VIC.: Stereo Sound Systems Pty. Ltd.
870 4961 (Ringwood)
Southern Sound
97 7245 (Moorabbin)
N.S.W.: Convoy International Pty. Ltd.
29 6475 (Sydney)

S.A.: Ernsmith & Co. Ltd. 51 6351 (Adelaide)
W.A.: Albert TV & Hi-Fi Centre Pty. Ltd. 21 5004 (Perth)
TAS.: B.B.C. Radio Centre Pty. Ltd. 31 4415 (Burnie)

gate. More than likely this 50uV capacitor could be dispensed with, as its presence is perhaps more academic than necessary. A similar condition exists with the 250uF capacitor which bypasses the 470 ohm resistor in the emitter of the noise amplifier.

Also, when used with some receivers and depending on signal levels and other conditions, some minor changes may be necessary. The amplifier following the gate is normally operated without an emitter by-pass, the limited gain resulting from this degenerative circuit being normally quite sufficient to make up for the insertion loss of the gating system. However, if more IF gain is desired the 470 ohm emitter resistor may be by-passed with a 0.1uF capacitor (shown dotted). The 50uF electrolytic is an academic addition and probably will not be needed.

Again, depending on the actual receiver with which it is used and/or due to high signal levels, there may not be enough control afforded by the 2.5K gain control in the noise amplifier stage. Rather than increase the emitter junction control voltage, some degeneration can be automatically introduced by returning the emitter resistor by-pass capacitor(s) to the other end of the 470 ohm resistor, rather than to earth.

In some cases even this may not provide sufficient control in the presence of large signals. With signals of this magnitude it is unlikely that the silencer will be needed, but it is necessary to be able to control or disable the noise amplifier. A switch on the 2.5K pot can be used to break the circuit at point "X."

The reason that it is necessary to reduce the gain of this amplifier so drastically is that the system becomes "suicidal" if the amplifier is allowed into pass more than a small predetermined level of wanted signal. If passed, it will be rectified, amplified in the pulse amplifier and then as negative pulses from the wanted original signal, will close the gate and produce a "lock-out" condition.

The transistors shown on the circuit diagram are those we used in the prototype. They consist of random positioning of BF115 and BC108 types. Although the BC108 is intended for audio use, it performs quite well at least up to 455KHz. Such others as SE3001, 2N3565 and similar types may be used without difficulty.

The symmetrical transistor is a Mullard OC140. This does the job adequately. However, there are three different types in a series offered by Mullard. These are the OC139, OC140 and OC141. They differ from each other mainly in the gain characteristic. The OC139 has the lowest gain, followed by the OC140, with the OC141 being the highest. The price of the OC139 is the lowest, the OC141 the highest. As far as we can ascertain, the OC139 should do the job adequately and there is no point in paying more for the others.

The capacitors are not critical as to type. The lower values could be mica or polystyrene and the mid values either low voltage ceramics, such as the Redcaps, or low voltage polyester. In the prototype, for values from 10uF to 0.47uF, we used tantalum types, but this is not necessary. We used them simply because we had them on hand. An exception to the use of tantalum or

other polarised capacitors, as mentioned above, is the 0.47uF coupling capacitor from the output of the noise rectifier. The voltage across this unit can reverse and so a ceramic or polyester must be used.

We built this unit in modular form, along the same lines as the IF strip described in the issue for November. The general idea was to make it so that it could be used in the complete solid state receiver on which we are currently working.

Two lengths of miniature tag board are used, each with 16 pairs of tags, mounted either side of an aluminium panel. On one side, we have the emitter-follower, the "gate," the amplifier, and provision for diode switching. In short, this panel contains the IF signal circuits.

The other panel consists of the noise amplifier, phase splitter, noise rectifier and pulse amplifier. The components on each board are so located that they follow a logical order with respect to each other—in much the same way as the circuit is drawn.

Assembly and wiring are simple and straightforward and are made even easier with the wiring diagrams. The usual care should be taken with soldering, making sure that there are no dry joints. At the same time, overheating of all components, particularly the transistors, should be avoided.

When mounting and wiring those components which fall at four lugs in from each end on each board, provision must be made so that fixing screws and nuts can be passed through. Also, under the screw adjacent to the emitter-follower on one side and the noise amplifier on the other side, we have provided a solder lug, which is soldered to the nearest earth connection in each case. When the unit is completely assembled, these lugs ensure that the appropriate circuits are bonded to the chassis or frame of the receiver.

The aluminium panel is 4in long, 2in high and fitted with a 5/16in mounting foot. Holes corresponding to the fixing screw positions are provided, together with three more holes for leads to pass from one board to the other. These leads are an interconnecting earth, positive 12 volts supply, and the lead from the output of the pulse amplifier to the base of the gating transistor. These holes may be drilled at any convenient positions, at the discretion of the builder.

When completed the solid state silencer is ready to be fitted into a receiver. No alignment is needed, as there are no tuned circuits. The only possible adjustments are those associated with high signal levels, as mentioned earlier in the article.

Tests and measurements have shown that this silencer is capable of operating at very high speed and excellent results can be expected when used with noise of an impulse nature. As mentioned previously, this unit has only just been developed. It is presented at this early stage with the idea of giving readers new food for thought on the noise combating front. No doubt, many readers will already have an application for such a device, either in its present form, or perhaps with some changes which may suggest themselves for a particular application. ■

CORRECTION

October 1969 issue

The address shown in the Magnecord International Pty. Ltd. advertisement was incorrectly printed.

It should have read

**MAGNECORD
INTERNATIONAL
PTY. LTD.**

**276 CASTLEREAGH STREET,
SYDNEY N.S.W. 2000**

TRANSISTOR SERVICE

All Japanese and
local sets repaired
including . . .

Aristone	Aurora	Belair
Berlin	Crown	Fujiya
General	Hitachi	Kenco
Mariner	Mitsubishi	Nanaola
National	Nivico	Sanyo
Sony	Spica	Standard
Sharp	Toshiba	Yashica

We do not sell spare parts

PETER G. BROUGHTON
211 George Street, Sydney.
Tel. 27-5831 (3 lines)

PRINTED CIRCUITS

MAKE YOUR OWN AND SAVE MONEY.
New easy method. No chemicals. No mess.
Kit \$3 including full instructions.
Post and packing 40c.
Mail Order Catalogue 25c refunded with
first order.

B. M. ROBBINS
Box 129 CARLINGFORD, N.S.W. 2118

SERVICE

TRADE-RETAIL

To all brands of transistor radio, tape recorder, record player, TV and specialising in Hi-Fi Stereo equipment. (Trade pick-up and delivery available).

**DEITRON ELECTRONICS
SERVICE DIVISION**

4-6 TAYLOR ST., DARLINGHURST
31-5430 31-6786

Broadway
Electronics
introduces
the
self-service

INSTROL



The 10-Plus-10 is a high quality solid-state stereo amplifier (10 watts RMS per channel). This, and other amplifiers featured in Electronics Australia, are available in either kit form or built and tested.

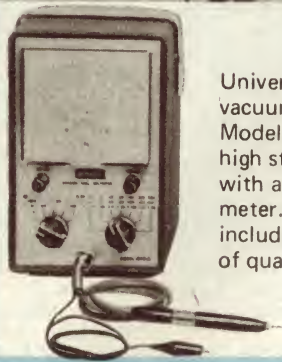

University, general purpose, vacuum tube/Voltmeter – Model MVA6 – A high impedance, high stability instrument, with a large easy-to-read meter. Our new showroom includes a large display of quality test equipment.



The Electronic Tool Kit, an inexpensive, yet most comprehensive outfit. The complete kit fits snugly into a strong attractive zip-fastening carrying satchet. Price – only \$12.50 (postage \$1.00 extra).



Popular Instrol-Playmaster 40 watt and 60-watt RMS Guitar Amplifier, in kit form or ready built. Complete with all optional extras.



Stackmaster
12C

CAPSTAN "JIFFY" CABINETS

Suitable for many household applications, a must for the garage or workshop. Available in a wide range, with clear see through drawers, for instant visual identification. Plus exclusive raised back edge prevents draw falling out. All cabinets finished in rustproof ZINCANNEAL with grey enamel coating.

Send for your free illustrated brochure and price list.



Stackmaster 16A

ELECTRONICS CENTRE

Everything for hobbyist and technician

OPEN NOW...

Revolutionary

new concept

FEATURING!

- (1) Large audio demonstration section to enable you to hear your favourite Instrol-Playmaster and other Electronics Australia projects.
- (2) Ready-packaged Kits for Instrol-Playmaster projects, other Electronics Australia projects and Test Equipment Kits.
- (3) Large range of test equipment, service parts and allied components.
- (4) Hire Purchase Terms available for most Kits and ready-built Units.
- (5) Self-service display area so that you can see for yourself and choose the many component parts available.
- (6) Modern book section, including many of the famous Howard Sams technical books.
- (7) A large service department to accurately diagnose and repair your Playmaster equipment.
- (8) Sydney's largest Hi Fi and audio centre.

STOP PRESS
NOW AVAILABLE

The new Playmaster Solid State Control Unit, featuring IC Operational Amplifier as featured in November Electronics Australia

NEW EXCITING MUSICOLOUR



Kit of Parts
\$46.05 Plus Postage \$1.30
MUSICOLOUR

Metalwork \$4.40 Plus Postage 70¢
Printed Circuit Board \$2.50 " " 15¢
Label \$2.00 " " 20¢



Instrol-Playmaster 124 Stereogram.
This is a combination of 3-Plus-3 stereo amplifier and a solid state broadcast tuner. All major stations for six States are engraved on the attractive silver label.



We are now stocking a large range of robust and attractive meters, including edge-wise types. Meters with special scales to suit "E.A." projects also available.



The Instrol Educational Electronic Kit, a must in this electronic age. Learn the basic principles of computers, communications, etc. Priced at - \$16.90 (Post 85c).

INSTROL ELECTRONICS CENTRE

91a York St. (between
King & Market St.)

PHONE 29-4258 SYDNEY N.S.W. 2000

for descriptive leaflet post coupon

Playmaster
 Toolkit
 Microphone
 Metalwork
 Test Equip. Kits
 Cannon Connectors

Please include postage stamp.

Name _____
Address _____
Postcode _____



PIONEER AUDIO EQUIPMENT

General Accessories has the widest range of Pioneer equipment in Australia. Visit your local showroom for inspection and audition.

Ask to see the new PIONEER AX 330 TUNER AMPLIFIER - all solid state, black dial and amazing value too. General Accessories PRICE \$185 - DON'T MISS IT!

See PIONEER TURNTABLES from \$110 complete and, SOLID STATE AMPLIFIERS FROM \$145 TUNER AMPLIFIERS from \$250

15" PIONEER BASS SPEAKER suit Guitar or Organ. Model P382B - 8 ohms. Model P382A - 15 ohms, 60 watts peak. Unbelievable value at \$27.60 tax paid plus 60c postage.

SUNWOOD SPEAKERS

Model AS57

Speaker Unit: 7"x5" wide range oval.
Power Handling Capacity: 8 watts Peak.
Voice Coil Impedance: 8 ohms.
Freq. Response: 90-13,000 c/s.
Enclosure: 6 1/4 x 7 1/4 x 15 1/2".
Walnut hand-rubbed oil finish.

Model AK122

Speaker units:

Crossover:

Power Handling Capacity: up to 20 watts (Music input)
Voice Coil Impedance: 8 ohms
Freq. Response: 40-20,000Hz
Enclosure: 17 3/4 x 23 3/4 x 7 3/4".
Walnut hand-rubbed oil finish.



PALACE HI FI AMPLIFIERS

- SA 80S 8 watt stereo valve 60Hz to 15kHz. Christmas Special ... \$30. post free.
- AM 269 20 watt solid state with bass and treble controls. \$60 post free.
- AM320V 40 watt vertical style timber case. Similar to AM320 but in timber case and vertical mode. \$115 Post free.
- AM320 40 watt solid state. Accepts magnetic cartridge input, bass and treble controls, headphone output. \$100 post free.
- AN323 80 watt Hi Fidelity Solid State of outstanding quality. Full 20 watts RMS per channel, complete relay overload protection, record outlets etc., all the facilities you would expect of a quality hi fi amplifier. \$143 freight free.

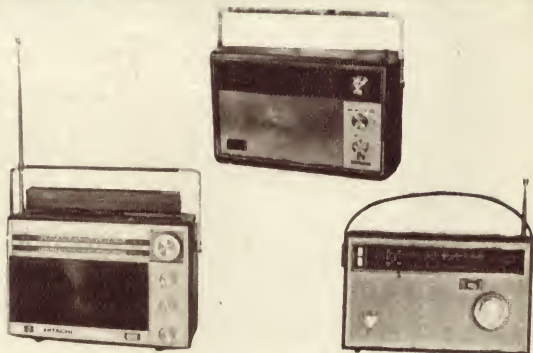

HITACHI - THE POWERFUL NEW NAME IN THE AUSTRALIAN ELECTRONICS SCENE.

WH 828 H. 2 band portable in leatherette case, 8 transistor. an attractive all round set. High performance with reliability. Price: \$52

WH 1050. High sensitivity 10 transistor with 4 bands including marine. Powerful 1.5 watt output. HiFi tone, leatherette case. Price: \$65

WH 1160. 11 transistor marine radio direction finder with B.F.O. 4 band with rotating Pelorus Antenna. Price: \$76

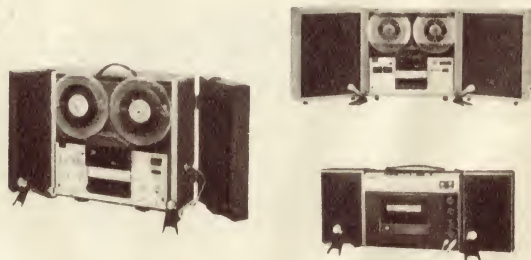

HITACHI TAPE RECORDERS

TRQ 242. A high performance Stereo Cassette Tape Deck with recording and replay amplifiers. Large twin VU meters. RCA plug or DIN output and input, AC operation only. Price: \$140

TRQ 222. A portable 26 transistor AC/DC Stereo Cassette Recorder with separable speakers. A very popular unit. Price: \$140

TRQ 717. A portable 7" three speed solid state Stereo Recorder with in-built speakers. Use as deck also through DIN connection. Excellent value. Price: \$160

INFORMATION AND LITERATURE AVAILABLE FROM LOCAL RETAILERS OR GENERAL ACCESSORIES.

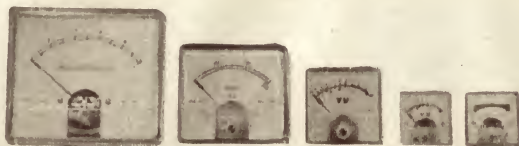

TEST EQUIPMENT

- Volt - Ohm - A FET Meter \$114 tax included
- Model 200 CRT Rejuvenator Tester \$108 tax included
- Transistor Tester and Tracer \$30
- Transistorized Shorted Turns Tester \$30
- "Zen Tra Stab" Low voltage Power Supply and Charger \$108

WRITE FOR FULL DETAILS.

GENERAL ACCESSORIES - BRANCH ADDRESSES.

- GENERAL ACCESSORIES: QLD: 50-54 Little Edward Street, Brisbane. 4000. N.S.W.: 443 Concord Road, Rhodes. 2138.
W.A.: 46 Milligan Street. Perth. 6000. S.A.: 81-97 Flinders Street, Adelaide. 5000.
QLD: Ingham Road, Townsville. 4810. N.S.W.: 116 Clarence Street, Sydney. 2000.
VIC: 153 Sturt Street, South Melbourne. 3205.
- HEMOCRAFTS: TAS: 199 Collins Street, Hobart. 7000.

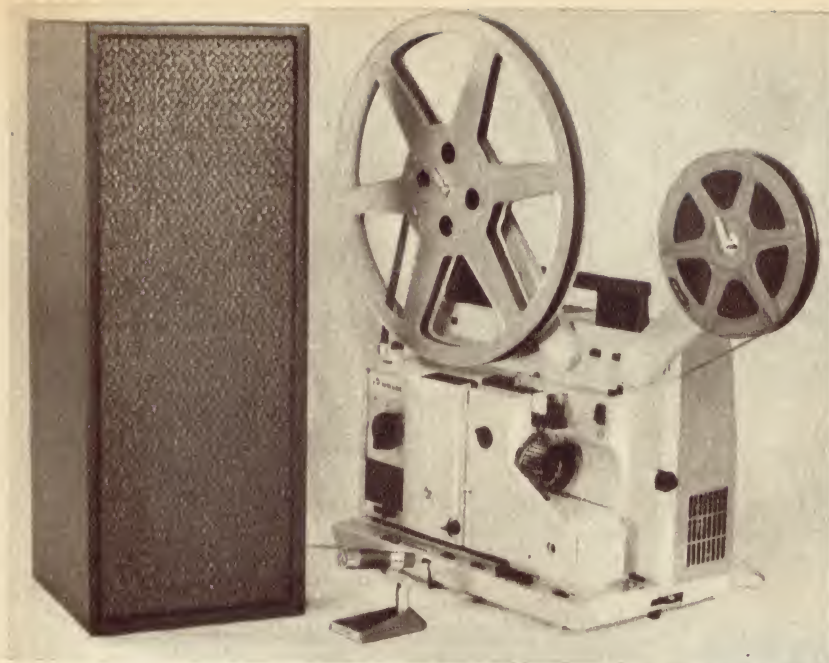

For projectors, tape recorders, small P.A.

ECONOMY LINE SOURCE LOUDSPEAKER

Recently, we had occasion to make up this loudspeaker system to satisfy a need in our Parent Company. It worked so well for such a reasonable outlay we felt it would be worthwhile passing the details on to readers. It contains two 9" x 6" twin-cone loudspeakers and will handle the output of amplifiers up to 15 watts.

The project began with a request for a suitable loud-speaker and microphone to be used in conjunction with the 16mm film projector shown in the accompanying illustration. This would allow the projector to double as a public address system at meetings and gatherings which inevitably occur in any large business organisation. The projector was fitted with an internal loudspeaker but this was inappropriate for a large audience and useless if the projector was in an enclosed projection booth.

More often than not, auxiliary loudspeaker systems which somebody "knocks together" for use with film projectors and modest public address systems are 12-inch units in a minimum sized, open-back enclosure. While it is true that 12-inch loudspeakers, as a class, are efficient, the radiation pattern from the single loudspeaker is far from optimum for the purpose.

A single, round loudspeaker radiates sound energy in something approaching a spherical pattern, the energy being distributed in all directions. While this pattern may be acceptable in a small room, it may not be so with a large group of people in a hall. The ideal pattern is a wide flat beam rather like that from the latest rectangular, "asymmetric" auto headlights. This would be aimed obliquely down over the heads of the listeners to give maximum coverage.

The type of loudspeaker which best approximates the above radiation pattern is commonly referred to as a "line-source" or "column" system. This consists of a number of moderately-sized loudspeakers arranged in a tall, narrow cabinet. This can be mounted at a suitable height above the listeners' heads and aimed towards the rear of the hall so that most of sound passes over those at the front, becoming progressively more effective towards the rear. In this way, those at the rear may be given adequate level without "blasting" those in the front. In short, the result is a substantially even level of sound along



An inside view of the enclosure, minus the acoustic filling. Two 33-ohm units were used to produce an approximate 16-ohm system.

the entire hall. And, by selecting efficient loudspeakers, the overall system can be very efficient.

While we have published details of column P.A. speakers in the past, these generally used a minimum of four loudspeakers and were intended as a more permanent installation. The present loudspeaker was required to be light and portable. For this purpose we felt that four loudspeakers were not justified but we still wanted the advantages of the "line source."

We decided to use two 9 x 6in elliptical units, mounted vertically to obtain the beam effect. Our further requirements were good sensitivity, to ensure acoustic efficiency, a reasonably low free-air cone resonance and a tweeter cont to make use of any high frequencies that might be available.

The loudspeakers which came to our notice at the time were type 96S1X, produced by Magnavox. While these were used in the prototype, other loudspeakers which would meet the specifications could be substituted. If the upper treble response is not considered vital for particular applications, loudspeakers without tweeter cones could be used.

The loudspeaker were mounted in an enclosure 24 x 9 x 9 inches which was made of 1/2-inch thick particle board covered in black vinyl. The grille cloth was black with a gold fleck dispersed through it, making an attractive but unobtrusive enclosure. For a start, we decided to try the system with a closed back and to sort out any problems from there.

The main problem we expected was the inevitable rise in cone resonance which results when a loudspeaker is installed in a small, completely sealed enclosure. The Magnavox 96S1X and other equivalent speakers have a free air cone resonance of around 75Hz. Placing two of these speakers in an enclosure with a volume of approx. 0.8 cubic feet would probably cause the resonance of the cones to rise to well over 120Hz, being prominent not only in frequency but in amplitude. This would give an unnatural "chestiness" on speech and a pronounced "one note bass" effect on music. In this direction, our fears were certainly confirmed. The system resonance was up around 150Hz and the system was anything but good on music signal. Plainly, the resonance would have to be damped down to a large degree before the system could be pronounced satisfactory.

A common approach to the above problem is to provide some sort of venting to dissipate the "back pressure" which is the reason for the greatly increased cone resonance figure. This can take the form of a distributed port, a vent with a tuned tunnel or simply a hole in the form of a handhold in the rear of the cabinet. While all these ideas can be satisfactory, if one particular loudspeaker is used, the results can be rather indeterminate if a variety of loudspeakers are envisaged.

Of the methods mentioned, perhaps the one most assured of giving good results with a variety of loudspeakers is the distributed port, which involves drilling an array of holes of deliberate number and size, preferably around the edge of the baffle.

However, in trying to keep the

GE PROGRAMMABLE unijunction transistors (PUT) add flexibility to your UJT applications.

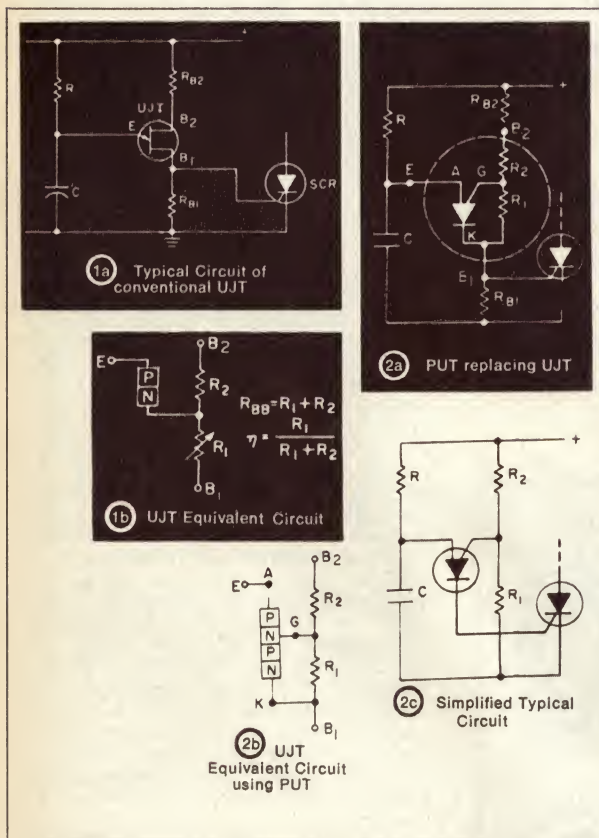

General Electric now offers a complete choice of state-of-the-art negative resistance threshold devices with the flexible programmable D13T UJT.

D13T permits you to program n, R_{BB} , I_p, and I_v . . . and very simply.

By replacing the standard UJT with the D13T plus resistors R_1 and R_2 both circuits (fig. 1b & 2b) have a diode connected to a voltage divider. When this diode becomes forward biased in the UJT, R_1 becomes strongly modulated to a lower-resistance value. This generates a negative resistance characteristic between the emitter E and base one, B_1 . For the D13T, resistors R_1 and R_2 control the voltage at which the diode (anode to gate) becomes forward biased. After the diode conducts, the regeneration inherent in a PNP device causes the D13T to switch on. This generates a negative resistance characteristic from anode to cathode simulating the modulation of R_1 for a conventional UJT (fig. 2b).

Resistors R_{B2} and R_{B1} (fig. 1a and 2c) are generally unnecessary when the D13T replaces a conventional UJT. Resistor R_{B1} is often used to bypass the interbase current of the UJT which would otherwise trigger the SCR. Since R_1 in the case of the D13T can be returned directly to ground there is no current to bypass at the SCR gate. Resistor R_{B2} is used for temperature compensation and for limiting the dissipation in the UJT during capacitor discharge. Since R_2 is not modulated, R_{B2} can be absorbed into it.

Applications of the programmable D13T include SCR triggers, pulse and timing circuits, oscillators, sensing circuits, and sweep circuits.

D5K has characteristics like those of standard silicon planar passivated UJT except that the currents and voltages applied to it are of opposite polarity. The choice of this polarity enables the

use of standard NPN planar passivated transistor processing techniques. This results in a unijunction having superior stability and better uniformity than any model previously available. The device also features a much tighter distribution of intrinsic standoff ratio.

Completing GE's full-line availability are the UJT 2N489-494 (proved reliability, MIL spec version), 2N1671, and UJT 2N2646-47 (hermetic sealed device). These devices provide top performance for trigger, timer, oscillator, phase control, and variable threshold.

Australian General Electric Pty. Ltd.
 Dept 40-20 99
 103 York Street
 Sydney, N.S.W. 2000
 Telephone 29 8711;
 or 552 Lonsdale Street
 Melbourne, Victoria 3000
 Telephone 67 8221
 or 453 Ann Street
 Brisbane, Queensland 4000
 Telephone 21 5207

GENERAL  ELECTRIC

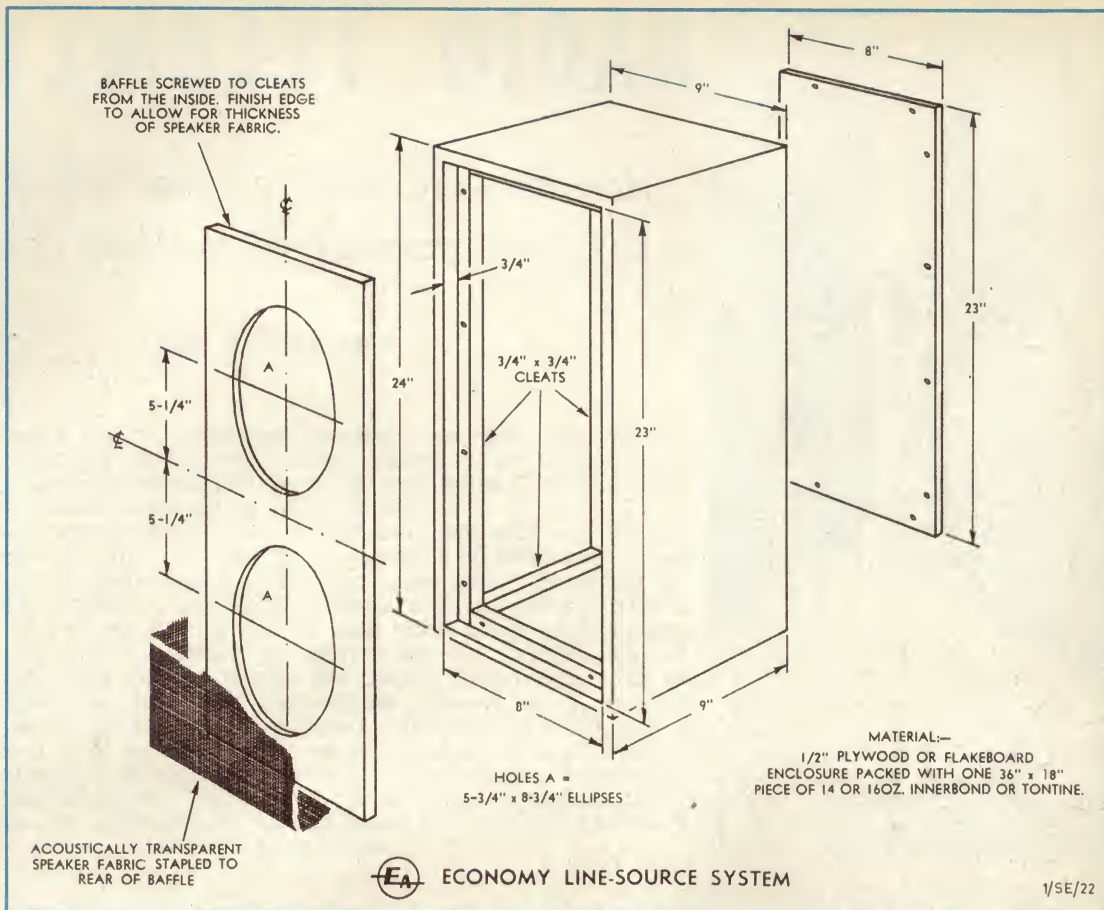

dimensions of the enclosure to a minimum we found there was not much room in the front baffle to drill holes. Added to this, it poses problems for factory production.

So we reverted to what we had found to be successful with systems in the past: a completely airtight enclosure substantially filled with acoustic absorbent material such as Innerbond, Bonded Courtelle or Tontine, to lower and damp the system resonance. Subsequent tests showed that the resonance was substantially reduced by filling the enclosure with one piece of 16oz material 36 x 18 inches rolled loosely to fill the space around the speakers. The overall result would probably not satisfy the critical "hifi" enthusiast but it is eminently suitable for the intended application.

With the projector shown, the loudspeaker was a great improvement over the internal unit. Efficiency showed a marked increase and, as could be expected, frequency response at both ends of spectrum was considerably extended. In modest P.A. applications when teamed with a 10-watt amplifier, the system would work very well. The amplifier could be a compact, solid-state unit sitting on top of the enclosure.

Having explained at length how the new unit came into being, we must discuss some of the details of construction. The prototype enclosure was a very well finished unit supplied by courtesy of Beech Electronics, P.O. Box 160, Kogarah, N.S.W. This firm can supply ready-built loudspeaker units to those who do not wish to build their own.

The exploded diagram shown gives

the essential dimensions and shows details of cleats to hold it firmly together. The dimensions can be varied somewhat to suit individual needs provided the internal volume is not decreased. It may be increased to advantage, if overall size is no problem.

With the relatively small panel sizes used in the enclosure, 1/4-inch thick material is adequate. It may be made thicker but not thinner, to avoid panel resonances. If the enclosure is made of particle board, the cleats should, for best results, be made of timber, as particle board is not very satisfactory if screws have to be wound in and out several times. The cleats for the front baffle will have to be "relieved" slightly to clear the speaker chassis.

Make sure that the enclosure is, in fact, airtight. Joints at the four corners should be snugly glued and all cleats accurately fitted and glued in position. The baffle of the prototype was recessed about 1/4 inch to lessen the possibility of the grille cloth being damaged when in transit. If the front and rear panel are dressed to a close push-fit there should be no problem obtaining an airtight cabinet, especially if it has been trimmed in vinyl.

Do not spoil all the good work by merely passing the leads out through oversize holes. Fit connectors or screw terminals or plug the holes with a non-hardening compound.

The system may be built with a nominal 16 or 8-ohm impedance by connecting two 33-ohm or 16-ohm units in parallel. Ensure that the loudspeakers are correctly phased. While manufacturers generally code one of the terminals with a red dot or other

(Continued on page 190)

ALWAYS RELY ON R.D.S.

SPECIALS

- R** Matched prs., AC127/
128 trans., \$1.20 nett.
- D** 200V pl diodes at 500MA,
25c nett each.
- S** STD Stereo plug 3290,
45c nett.
- DPDT Rocker switch No.
16, 45c nett.
- DPDT Slider switch 3570,
19c nett.
- P53p Stereo plug. Line
jack. 80c nett.
- Pkts. mixed pots & conds.
Great value. \$1.00 nett.

Compax Turntable. \$39.50 nett

Catalogue now available, 25c

The Independent Wholesaler

RADIO DESPATCH SERVICE

Radio and Electrical Distributors

**869 GEORGE STREET,
SYDNEY.**

Corner George and Harris Streets
Telephone 211-0816, 211-0191

Open Saturday mornings

RADIO TELEMETRY

How the data about a space vehicle and its crew is radioed back to Mission Control

* By John D. Lenk



Over the years, we've become accustomed to the tense countdowns that precede each rocket launch from Cape Kennedy. The voice from Mission Control sets the measured, tension-building pace "5... 4... 3... 2... 1... lift off!" But, as the rocket curves away towards the horizon, attention shifts toward the situation in the capsule: "Pressure, temperature, O.K. pulse... normal..." And so it goes on. How do the ground controllers know these things? How can they read off a whole array of data about a crew and a space vehicle that is speeding into space at the head of a fiery trail? The key to the problem is radio telemetry — the science of gathering and transmitting back to some central point distinct bits of vital information; information about such things as pressure, temperature, heart rate, breathing rate, along with a stream of information about the vehicle itself. Called parameters, the various kinds of information are first picked up from their source by transducers, which translate physical phenomena into equivalent and decipherable electrical signals. How these are processed and transmitted over long distances for recording and observation is the subject of the article which follows.

Any telemetry system is made up of several building blocks. It makes no difference whether the information is gathered aboard a guided missile and transmitted to ground control or a tracking station, or if the information is obtained at various locations in a vast industrial complex and transmitted (often by cable) to a central control location.

There are different telemetry systems and each system requires special building blocks. However, when you boil it down, there are only four that are basic: FM/FM (frequency modulated FM), PAM (pulse-amplitude modulation), PDM (pulse-duration modulation), and PCM (pulse-code modulation). We'll look at each of these systems to see how measurements are taken in one place and then transmitted to a remote location where they are displayed and recorded. If you understand these four techniques, you'll have no difficulty in understanding other telemetry systems such as FM/FM/FM (triple FM), PACM (combined PAM and PCM), SS/FM (Single-sideband FM), and PPM (pulse-position modulation).

FM/FM (frequency-modulated FM) is one of the original techniques used in telemetry and is still in use today. It consists of frequency modulating a transmitter with the output of one or more subcarrier oscillators. These subcarrier oscillators are in turn frequency modulated by information obtained from transducers.

Shown in figure 1 is the block diagram of a typical FM/FM transmission system that might be used aboard a guided missile. Three transducers sense information and convert it into electrical signals. In this case, the information includes pressure, vibration, and radiation. The transducer outputs are applied through signal conditioners to their respective subcarrier oscillators. The frequency-modulated outputs of the three subcarrier oscillators are mixed, or multiplexed, and then amplified. (Multiplex operation is the simultaneous transmission of several messages on a single RF carrier. Information is modulated so that time-sharing of single channels is possible.) This output is used to frequency-modulate the transmitter and the double-modulation process results in an FM/FM output which is transmitted to the receiving station.

A block diagram of a typical FM/FM receiving system that might be used at a missile ground station is seen in figure 2. Here, the function is to receive, separate, and display signals which are proportional to the trans-

ducer outputs. The RF carrier is demodulated by the receiver to produce a multiplexed signal. This signal is the same as that appearing at the output of the mixer-amplifier system.

The multiplexed signal is then routed to several subcarrier discriminators where the subcarrier signals are separated and the information signals are recovered. In their simplest form, the subcarrier discriminators consist of a bandpass input filter, a discriminator (or detector), and a low-pass output filter. The bandpass filter of each channel separates the three subcarrier signals. The output from each bandpass filter is the same as that appearing at the output of each corresponding subcarrier oscillator.

After the three signals are detected by their corresponding discriminators, they are fed through low-pass filters. This signal is the same as that appearing at the input to the subcarrier oscillators (i.e., the transducer output).

The output from the subcarrier discriminators is often routed to a patch panel or switching network. This permits the outputs of individual channels, or groups of channels, to be monitored or recorded. When the information is monitored directly at the same time as it is being sensed by the transducers, the term "real-time monitoring" is used.

In addition to recording individual signals from the discriminators, most telemetry systems have a provision for recording the composite signal from the receiver on magnetic tape. These tapes can then be played back through the subcarrier discriminator circuits at any future time.

A transducer is any device that changes energy from one form into another. In our case, we want to change parameters like pressure, vibration, and radiation into electrical signals that can frequency-modulate the subcarrier oscillators of the FM/FM transmitting system.

A variable-resistance transducer is often used to measure pressure. A typical transducer using the voltage-divider principle is shown in figure 3A. Here, a full 5V is placed across the resistance element. (Five volts is chosen since it's common practice in aerospace telemetry to standardize transducers of all types so they'll operate in the range from 0 to 5V.)

The contact arm of the resistance element is moved by



* Reproduced by arrangement with "Radio-TV Experimenter"

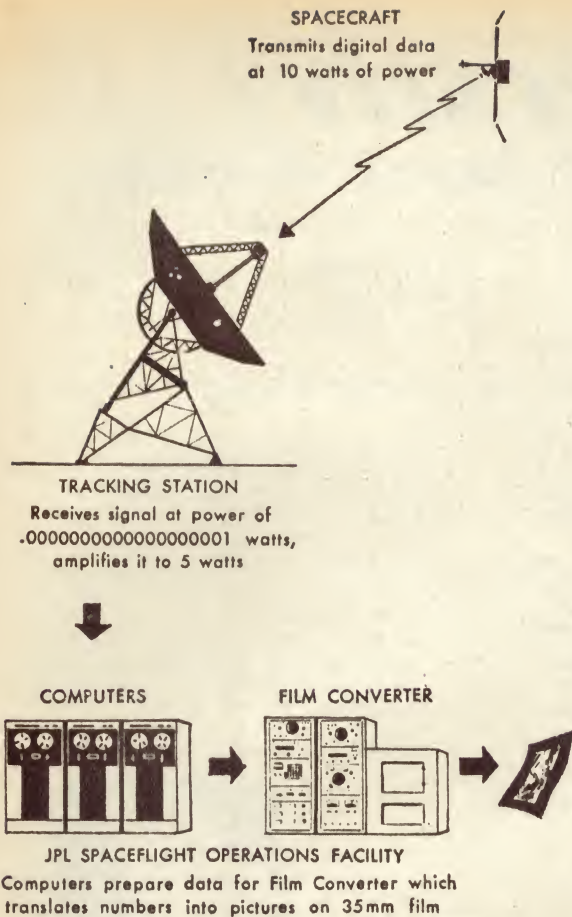

mechanical force, such as the force produced by a bellows which has been sealed at a given air pressure. If the air pressure surrounding the bellows changes, the bellows will expand or contract and move the contact arm across the resistance element. The output voltage, therefore, is proportional to the change in pressure.

A magnetic-induction transducer is the logical choice for measurement of vibration. Its operating principle is similar to that of sound-powered telephones or a magnetic-phonograph pickup. A permanent magnet is suspended within a coil (see figure 3B) and joined directly to a probe that takes up the vibrations. As the magnet vibrates, it moves back and forth within the coil.

Each time the magnetic lines of force around the magnet move in one direction, the coil develops an output current in one direction. Since the magnetic lines of force change direction, the output current also changes direction. Therefore, the output is an alternating current. Its strength is proportional to the amplitude of vibration, while its frequency is proportional to the vibration frequency.

Though several types of transducers are used to measure radiation, a scintillation counter is the most common. In its simplest form (figure 3C), it consists of a solar cell placed in a sealed chamber with a mineral that emits light in the presence of nuclear radiation. If there is enough radiation to cause the mineral to emit a measurable amount of light, the solar cell develops an output voltage. The

amplitude of this voltage is proportional to the amount of light.

Signal conditioners are necessary to convert transducer outputs into a form suitable to modulate a subcarrier oscillator (or the transmitter itself). If you take another look at the three transducers you'll see why.

Assume that the ideal signal going into the subcarrier oscillators is 0 to 5V DC, proportional to the quantity being measured. In the case of the pressure transducer, no signal conditioning would be needed since the transducer output is a varying DC voltage that doesn't exceed 5V.

The solar cell's output is also DC, but probably only a few millivolts at most. Thus, a DC amplifier is needed to raise its output to the 5V level. In the vibration transducer, however, we have a different conditioning problem. This transducer's output is AC, while we need DC for the subcarrier oscillator.

If we want to measure vibration amplitude only, it's a simple matter to rectify the AC output into a DC signal and then amplify the DC to the required level. If we wish to measure the vibration frequency, however, we have to convert frequency into a proportional DC signal.

This requires a frequency-to-analog conversion signal conditioner. There are several circuits used for this type of operation. Most of the circuits use a Schmitt trigger output and a rectifier as the basic elements. Figure 4 shows such a circuit in simplified block form: the Schmitt trigger produces a pulse output for each cycle of the AC input while the width of these output pulses remains constant. So as frequency increases, the on time of the trigger output increases. This increases the DC output from the rectifier.

The subcarrier oscillator is frequency-modulated by the information signal coming from the transducer, and in turn generates a subcarrier frequency. In FM/FM telemetry, one subcarrier oscillator is used for each information channel. Though there are many types of subcarrier oscillators, the voltage-controlled oscillator (VCO) is the most common.

Figure 5 reveals the circuit of a typical solid-state VCO. Transistor Q1 functions as a DC amplifier and raises the modulating voltage from the signal conditioning circuit to a level suitable to deviate the multivibrator's frequency. Transistors Q2 and Q3 make up a typical free-running multivibrator whose frequency is determined by the modulating voltage.

In most VCO circuits, the multivibrator runs free at a given centre frequency when no information signal is applied. When a signal is applied, the multivibrator's output is deviated above and below the centre frequency as the amplitude of the information varies above and below its zero-signal reference. Should the transducer's voltage increase, the multivibrator's frequency also increases. Finally, the output is applied through a low-pass filter which reduces the amplitude of harmonics (multivibrators produce numerous harmonics) so they will not interfere with or distort other channels.

The outputs from all of a system's subcarrier oscillators are mixed prior to the final frequency modulation of the transmitter. This mixing is usually accomplished across a resistive network as shown in figure 6. The network consists of potentiometers located at the output of each subcarrier oscillator.

In some telemetry equipment, a mixer-amplifier must be available to amplify the FM multiplex signal so that it can drive the transmitter. These amplifier circuits are straightforward, and often a wide-band audio amplifier is used. Amplification must be linear within the multiplex signal's frequency range.

The telemetry transmitter must provide an FM/FM signal which accurately reflects the information contained

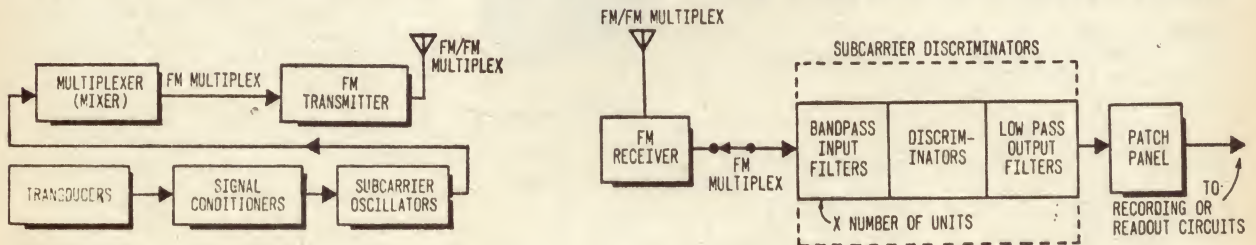

Figure 1 (left) A block diagram of a typical FM/FM telemetry transmission system used in missiles. Figure 2 (right) FM/FM receiving system showing just one of what may be many subcarrier discriminators.

University

Diode Protected, General Purpose Multimeters

COMPLETE WITH TEST LEADS, BATTERIES & INSTRUCTIONS

- AS USED IN
- GENERAL INDUSTRY
 - RADIO & TV SERVICING
 - LABORATORIES
 - MOTOR GARAGES & BOATSHEDS
- WORKSHOPS
 - HOBBYIST
 - COLLEGES & UNIVERSITIES

All backed by "UNIVERSITY" sales, spare parts and 24-hour repair service

MODEL MVA-4 (20,000 ohms/volt)



Price \$14.50
+15% Sales Tax

SPECIFICATIONS:

- D.C.V. : 2.5-10-50-250-1000 (20 K Ω /V)
- A.C.V. : 2.5-10-50-250-1000 (8 K Ω /V)
- D.C.A. : 50 μ A-2.5 mA-25 mA-250 mA
- Ohms : 10K-100K-1M-10M
- db : -20/0/+22,+22/+36
- Accuracy : \pm 3% for D.C. \pm 4% for A.C.
- Battery : 3 x 1.5 V
- Size : 6" x 4-3/16" x 2 1/4"
- Weight : 1.34 lbs.
- Optional Extra : Leather case
- Features : Diode overload protection, Multicolour scale, Engraved front panel, 90 day Guarantee.

MODEL MVA-5 (20,000 ohms/volts)



Price \$10.00
+15% Sales Tax

SPECIFICATIONS:

- D.C.V. : 5-25-50-250-500-2.5K (20K Ω /V)
- A.C.V. : 10-50-100-500-1000 (10K Ω /V)
- D.C.A. : 50 μ A-2.5 mA-250 mA
- Ohms : 0.6K — 6M
- db : -20/0/+22
- Accuracy : \pm 3% for D.C. \pm 4% for A.C.
- Battery : 1 x 1.5V
- Size : 4 1/2" x 3 1/2" x 1 1/4"
- Weight : 10 oz.
- Optional Extra : Leather case
- Features : Diode overload protection, Multicolour scale, Engraved front panel, 90 day Guarantee.

MODEL MVA-100 (100,000 ohms/volt)



Price \$35.00
+15% Sales Tax

SPECIFICATIONS:

- D.C.V. : 0.5-2.5-10-50-250-500-1000 (100K Ω /V)
- A.C.V. : 2.5-10-50-250-1000
- D.C.A. : 10 μ A-250 μ A-2.5 mA-25 mA-250 mA-10A
- A.C.A. : 0-10A
- Ohms : 20K-200K-2M-200M
- db : -20/0/+62
- Accuracy : \pm 3% for D.C. \pm 4% for A.C.
- Battery : 2 x 1.5V + 1 x 22.5V
- Size : 7" x 5 1/2" x 3"
- Weight : 3 lbs.
- Optional Extra : Leather Case
- Features : Mirror scale, Diode overload protection, multicolour scale, spring loaded shock resistant movement, engraved front panel, 90 day guarantee.



Heavy Duty Shunt

For further information on "University" Multimeters and test equipment, fill in the form supplied and mail it to University Graham Instruments Pty. Ltd.
All test equipment can be inspected at

University Graham Instruments Pty. Ltd.

105 Belmore Road, Riverwood, N.S.W., 2210.
Telephones: 53-8758 53-0534 (5 lines)
Telegrams and Cables: Raquip, Sydney.
or at
Victoria: Logitronic Sales Pty. Ltd.,
3 Carroll Cres., Glen Iris, Melb., Vic. 3164.
Phone: 20-6953.

REPRESENTATIVES:

W.A.: Atkins (W.A.) Ltd.,
894 Hay Street,
PERTH, W.A. 5000.
TAS.: W. P. Martin and Company,
202 Argyle Street,
HOBART, Tas. 7000.
And 150 Wellington St.
LAUNCESTON, Tas. 7250.
S.A.: Compar Distributors Pty.
Ltd.,
33 Market Street,
ADELAIDE, S.A. 5000.

QLD.: Keith Percy & Co. Pty. Ltd.,
Waterloo Street,
NEWSTEAD, Bris. Qld. 4006.
N.Z.: Alluon Electrical Co. Ltd.,
21 Liverpool Street,
AUCKLAND, N.Z.
NEWCASTLE DIS.:
Hunter Engineering Sales Pty. Ltd.,
Cnr. Gordon Avenue and
Parry Street, Hamilton,
NEWCASTLE, N.S.W. 2303.
Phone 61-4321.



Current Transformer

The A.C. and D.C. Current Ranges of the above multimeters can be extended, with the use of "University" shunts and multi-range current transformers.

Please forward to:—

Mr
of

.....
information on "University" Multimeters and Test Equipment.

in the FM multiplex signal. The function of the FM receiver is to amplify the desired FM/FM signal, convert the RF carrier to a lower intermediate frequency, and remove the FM multiplex from the FM/FM signal with a minimum of distortion.

The transmitters and receivers used in FM telemetry are

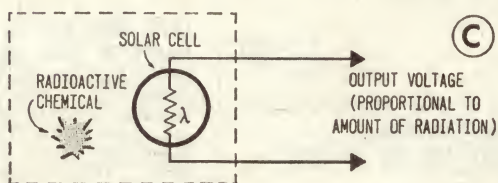
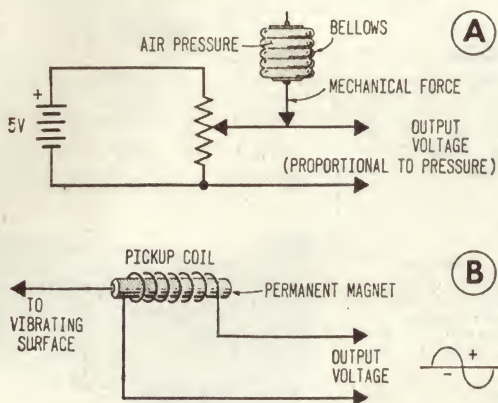

Figure 3. Air-pressure transducer (A) has variable resistor that is actuated by a sealed bellows. Magnetic induction pickup (B) responds to mechanical vibrations. Transducer (C) with light cell detects small amounts of light flashes which are caused by nuclear particles hitting photo-chemical.

almost identical to corresponding FM communications equipment. In fact, FM telemetry systems can be used as communications systems. With this in mind, we won't discuss the radio link here. Instead, let's concentrate on the subcarrier discriminator in the receiver—this is the counterpart of the subcarrier oscillator (VCO) in the transmitter.

The subcarrier discriminator selects a specific FM channel frequency from the incoming FM multiplex, separates the intelligence signal from the FM carrier with a minimum of distortion, and then supplies the intelligence with sufficient amplitude to drive a monitoring device. Sometimes the discriminator is also used to compensate for varying tape speeds, but we'll talk about that later. As shown in figure 7, the subcarrier discriminator contains a bandpass input filter, a detector, and an output filter.

The bandpass filters used in FM/FM telemetry consist of a low-pass filter and high-pass filter, shown in Fig. 8. The bandpass filters are designed to separate the desired FM signal from random noise and other FM multiplex signals.

After being filtered by the bandpass input the FM signal data is applied to the input of a limiter-amplifier. As

the FM signal. Since the subcarrier discriminator detects only positive zero crossings, the diode output is applied to a monostable multivibrator to get a square-wave output which defines the positive zero crossings with the sharp leading edge of each pulse.

The pulse-averaging FM detector (figure 10) operates on

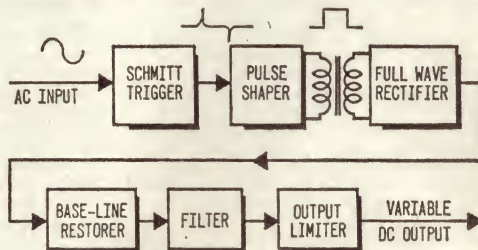

Figure 4. This frequency-to-analog system converts AC signals to DC signals—as the frequency increases, the DC output increases.

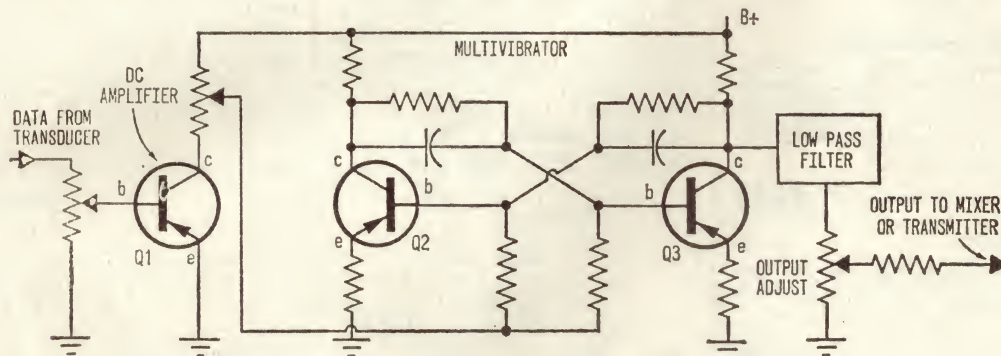

Figure 5. This voltage-controlled oscillator (VCO) includes a free-running multivibrator and DC amplifier. Output from the amplifier determines the frequency of the multivibrator.

with any FM receiver, the limiter-amplifier eliminates amplitude modulation (AM) imposed on the FM signal by noise and interference. The circuitry, however, can be quite different!

Figure 9 is a diagram of a limiter used in a subcarrier discriminator that has a pulse-averaging detector. As will be explained, this kind of detector reveals the positive zero crossing of the FM signal. Zero crossings must be well defined at the detector's input.

To bring this about, the limiter contains a high-gain amplifier, limiting diodes, and a monostable multivibrator. The FM signal coming out of the bandpass filter is first amplified by the high-gain amplifier to provide a large-

the principle that the frequency of an input signal can be determined by measuring the time between zero crossings. The basic operation of pulse averaging can be seen in figure 10. The waveforms that appear at the input to the trigger generator and at the output of the monostable multi-vibrator are shown in figure 11.

The positive-going edge of each monostable output pulse is initiated by a pulse from the trigger circuit, which in turn is initiated by the positive-going (zero-crossing) edge of the FM signal. The duration of the positive portion of the multivibrator's waveform is determined by the RC time constant regardless of the input frequency.

The duration of the negative portion of the waveform

BUY RIGHT... FROM ENCEL

COMPAX SOLID STATE TUNERS

A high quality wide band AM tuner, the Compax represents outstanding value. Output suits all amplifiers and tape recorders. The external teak finish case is optional. Price (with case).

\$49.50

NOW . . . A NEW 8-INCH CO-AXIAL SPEAKER WITH UNIQUE PERFORMANCE AND SIX POWERFUL MAGNETS . . .



ONLY \$36.50!

Can any 8in speaker be worth \$36.50? Easily . . . when you see and hear the remarkable CX-20D. Here at last is a total-performance 8in co-axial speaker with six magnets, a horn-type tweeter, an electrical crossover, high compliance and unusually robust ribbed construction. Total weight is almost 8lb and frequency response is 35-20,000 Hz. The response curve is substantially flat; from an engineering viewpoint the CX-20D is superb in design and construction. The matching enclosure is easy to make and any handyman can make it from readily available materials. We want you to head the CX-20D and make your own appraisal.

Price (including sales tax).

\$36.50

CHRISTMAS GIFT LIST

TAPE HEAD DEMAGNETISERS

Simply plug the tape head demagnetiser into any AC power point and pass over the heads. Takes only five seconds and can make a world of difference. Two models — single and double probe.

Price (including sales tax).

\$4.50

TAPE SPLICES

Special purchase! An easy-to use splicer which saves you time, fuss and fidgeting. While they last.

Price.

\$2.50

SONIC STEREO HEADPHONES

Model HS-304 at \$12.50.

For comfortable personal listening.

MICRO DUST PICKUPS

An effective automatic record cleaner which removes dust as the record plays. Including sales tax.

\$3.50

SAVE MORE ON ALL LEADING MAKES OF TAPE RECORDERS

Encel Stereo Centres stock all the best makes . . . Akai, Sony, National, Toshiba, Philips, Revox, Tandberg and many more. You'll be wise to secure an Encel price before you commit yourself elsewhere. Save at Encel's!

KENWOOD AMPLIFIERS NOW AVAILABLE

Save more at Encel's . . . write or call for your Kenwood price. Ask for a trade-in valuation on your old equipment; often the allowances made for working units will reduce your outlay considerably. All Kenwood models available.

TRADE-IN AND TRADE-UP

When purchasing equipment from Encel Electronics, be sure to ask for a trade-in valuation on your old equipment. If your old equipment is in good working order, the cost of your current purchase can be reduced considerably. Bring in your amplifier, tape recorder, tone arm, etc. . . . and save more than ever at Encel Stereo Centre!

PE TURNTABLES MODELS/PE2020, PE2010 and PE2001

Perpetuum-Ebner turntables are probably the most popular in their price categories . . . and the low Encel price adds further value to these fine German products. Write for Encel products (EMQs) or call for your PE proposition. Stocks are limited although more are on the water. Contact Encel's now!

SEE A COMPLETE AUDIO RANGE AT ENCEL STEREO CENTRES

Apart from the many exclusive Encel lines, you'll find a vast range of high-quality equipment at Encel stores in both Sydney and Melbourne. Here are a few of the manufacturers represented: Trio-Kenwood, KEF, Sony, ADC, Wharfedale, Ortofon, National, Toshiba, Shure, Akai, Sansui, Philips, BSR, Garrard, and many, many more. Ge sure to get an Encel EMQ ("Encel Mail Quote") . . . you'll save much more at Encel Electronics!

SAVE YOUR RECORDS . . . USE THE UNIVERSAL LUSTRE TONE ARM LIFT



\$8.50

This beautifully finished and functional universal tone arm-lift will fit all tone arms . . . the lowering action is pneumatically damped and extremely smooth. Risk of record damage may now be eliminated (including sales tax).

SAVE ON SANSUI AMPS/AND SPEAKERS

All popular Sansui models are available . . . amplifiers and speaker systems. Write for your EMQ or call at your nearest Encel Stereo Centre.

CANBERRA ENQUIRIES FOR ENCEL EQUIPMENT

If you live in Canberra and you want further information on Encel equipment, please phone Canberra 81-1667.

"DITTON 10s" AND "DITTON 15s" ARE ONCE MORE IN LIMITED SUPPLY



The Celestion Ditton 15 measures only 21in x 9½in x 9½in and incorporates the HF 1300 Mark 11 tweeter, a new type of bass drive unit and the revolutionary auxiliary bass radiator. Many favourable reviews have been published — ask for your copies! "Hi-Fi Sound" — "It was difficult sometimes to realise that so small a loudspeaker was really producing such well-defined low frequency sounds. It goes without saying that the treble performance was fully up to standard of the HF 1300."

"The Gramophone" — "The listening tests made an excellent impression. Treble was bright and forward; the bass was clean and powerful enough to produce a good balance." "Hi-Fi News" — "the quality of bass sound was above average; plenty of bass, but always clean and clear . . . a very wide range of programme material was enjoyed and nothing caught it out or gave cause for reservation."

The Celestion Ditton 10 measures 12in x 6½in x 8½in and features a specially designed bass unit and the well-known Celestion tweeter. Both 3 and 15 ohm impedances are available. One review of the Ditton 10 in "Records and Recording" says, "On a wide range of music it proved to be a clean-sounding speaker with the sort of characteristics which would make it one of the most popular in its class."

Prices: "Ditton 15in" (incl. sales tax).

\$94.50

"Ditton 10in" (incl. sales tax).

\$64.50

CASSETTE RECORDERS

If you're looking for a cassette tape recorder, call at your nearest Encel Centre or write for an EMQ. (We are unable to advertise discount prices for these cassette recorders.)

ENCCEL

ELECTRONICS (STEREO) PTY. LTD.

Head Office: 431 Bridge Rd., Richmond, Victoria. 3121. Tel. 42 3762.

Sydney Store: Ground Floor, 2SM Building, 257 Clarence Street, Sydney, N.S.W. 2000. Tel. 29 4563, 29 4564.

Australia's Greatest Hi-Fi Centre ■ Wholesalers ■ Trade-ins accepted ■ Terms

is determined by the frequency of the input signal. Once the multivibrator's output falls to a negative level, another positive zero-crossing trigger pulse must occur before the multivibrator output can be driven positive. This output is applied to a current generator which averages the pulses. The output from this current switch is filtered by the low-pass filter to provide a DC level which represents the frequency originally applied to the trigger's input.

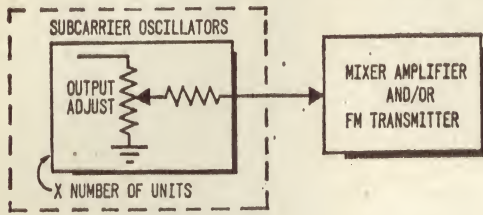

Figure 6. A typical resistor-mixer circuit usually used in FM/FM telemetry systems.

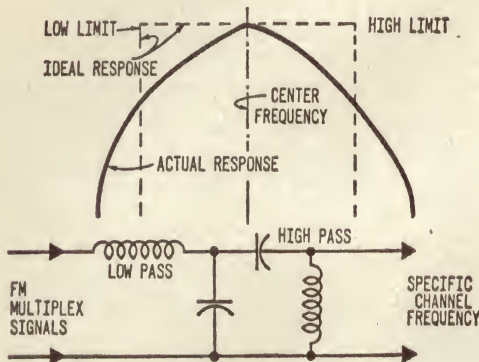

Figure 8. The bandpass filter is nothing more than two filters—a low-pass and high-pass—coupled together and passing only a narrow band.

Since most of the data are recorded on tape, telemetry systems usually include some type of tape speed compensation. Variations of tape speed (better known as wow and flutter) during recording or playback cause spurious frequency modulation of all channels. Unless the effects of tape speed variations are corrected in a system used to record FM telemetry signals serious errors will result since the discriminator will not be able to tell the difference between these random variations and the data.

A basic frequency-lock servo circuit is detailed in figure 12. It is used to correct variations in tape speed due to such factors as varying line voltage, improper regulation of the drive motor, mechanical slippage, tape stretching, etc. The information to be recorded is applied to the record head through an amplifier and mixer. A bias signal is also applied to the head as in an ordinary tape recorder, but this bias signal is applied through a modulator circuit.

The modulator also receives a 60Hz signal from a frequency standard. The result is that the bias signal is modulated by this 60Hz reference.

During playback the data are amplified to a level suitable for the readout devices. At the same time, the modulated bias signal is separated into another channel by a bandpass filter, and the 60Hz reference is recovered by a detector. The detector output is then compared with the 60Hz standard used during record. If there is any difference, an error voltage is produced. This error voltage is used to control an

oscillator similar to the VCO previously discussed. The VCO signal is amplified so it will control the tape-drive motor, and the motor tracks any variations that may have occurred during recording.

Pulse-amplitude modulation is a technique that makes for better use of the data-handling capacity of a telemetry system. One of the drawbacks to FM/FM is the bandwidth limitation of the FM transmitter (i.e., the allowable carrier-frequency deviation).

For example, assume that the input to the subcarrier oscillators can be no more than 2000Hz. Also assume that two of our data channels require a 1500Hz response, while a third channel requires only a 1Hz response. If FM/FM telemetry were used, two transmitters would be required; one transmitter for the 1Hz and 1500Hz channels and a second transmitter for the other 1500Hz channel. With PAM telemetry, only one transmitter and one sub-carrier oscillator are required for the three channels.

The heart of any PAM system is a commutator in the transmitter and a decommutator in the receiver. These com-



Figure 7. Block diagram of a typical subcarrier discriminator. First block, bandpass input filter, selects a very narrow range of frequencies that is related to a specific telemetry channel.

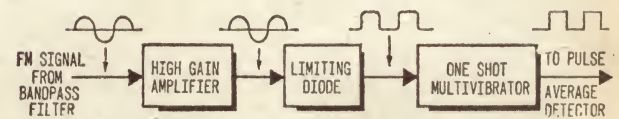

Figure 9. Block diagram of a typical limiter with a pulse-averaging detector effect.

mutators and decommutators can be either mechanically or electronically operated. As shown in figure 13, mechanical commutators and decommutators are essentially a series of contacts that can be selected by a motor-driven arm. Both units must be driven at a constant speed, and they must be synchronised.

The outputs from the transducers (and signal conditioning circuits) are fed to contacts on the commutator —30

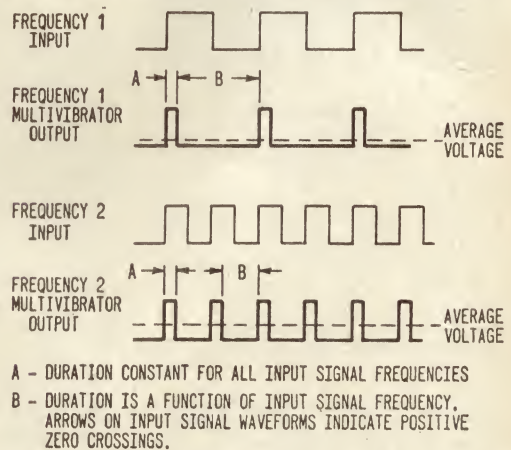

Figure 11. These waveforms are the inputs and MV outputs shown in figure 10.

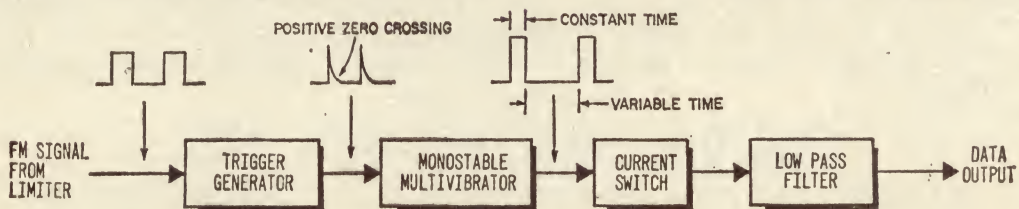
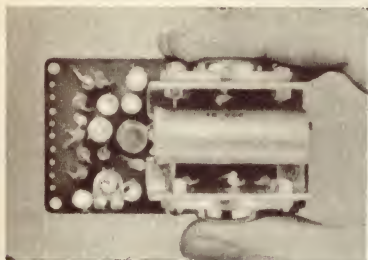

Figure 10. The pulse-averaging detector uses a monostable multivibrator. Output pulse width remains constant.

Sinclair products for the electronic constructor—



Z12 INTEGRATED 12-WATT HIGH FIDELITY AMPLIFIER

Technical specification

Output: Class B, ultra-linear, with generous negative feed-back.
 Output Power: 12 watts R.M.S. continuous sine wave (24 watts peak); 15 watts R.M.S. music power (30 watts peak).
 Frequency Response: 15 to 50,000 c/s, ± 1 dB.
 Input Sensitivity: 2 mV K Ω .
 Signal to Noise Ratio: Better than 60dB.
 Output Impedance: Suitable for 3, 7.5 and 15 ohm loudspeakers. Two 3 ohm speakers may be used in parallel.
 Power Requirements: 6 to 20 volts D.C. or Sinclair PZ.4 Mains Power Supply Unit.
 Quiescent Current Consumption: 15mA
 Size: 3in x 1½in x 1¼in (7.6 x 4.45 x 3.2cm).
 Weight: 3oz (85gm).
 Ready Built and Tested with Manual, \$13.60, plus sales tax.
 Z12 Power Supply, Ready Built, \$13.60, plus sales tax.



IC.10 INTEGRATED CIRCUIT 10-WATT AMPLIFIER

Specifications

Output: Class AB. 10 watts peak, 5 watts RMS.
 Frequency response: 5Hz to 100kHz ± 1 dB. Total harmonic distortion less than 1% at full output.
 Power gain: 110dB (100,000,000,000 times) total.
 Supply voltage: 8-18 volts.
 Sensitivity: 5mV. Input impedance adjustable externally up to 2.5m Ω for above sensitivity. Size: 1in x 0.4in x 0.2in.
 Circuitry: 3 transistors in pre-amp; 10 (including two power output) in power amplifier. Both sections are d.c. coupled, and a high level of negative feedback is applied over all. With a transistor cut-off greater than 500mHz, the pre-amp can be used as an RF or IF transformer and the whole IC.10 used as a radio receiver without the need to add further transistors.
 Price, including application manual, \$10, plus sales tax.

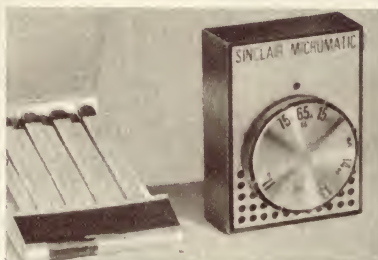

MICROMATIC WORLD'S SMALLEST RADIO

Technical specification

Size: 1 13-16in x 1 7-16in x ¼in (46 x 33 x 13mm).
 Weight including batteries: 1oz (28.35 gms) approx.
 Transistors: High gain silicon types.
 Circuit: Five stage reflex.
 Aerial: Self-contained ferrite rod.
 Earpiece: High-fidelity magnetic type for best possible quality.
 Battery requirements: Two Mallory Mercury Cells, type RM 675, giving extra long working life.
 Complete Kit with Instructions. \$7 plus sales tax.



STEREO 25 PRE-AMPLIFIER

Technical specification

Performance figures obtained from using the Sinclair Stereo 25, two Z.12's and a Z12 Power Supply Unit.
 Sensitivity for 10 watts into 1.5 ohms load per channel. Mic.: 2mV into 50 K ohms. Pick up: 3 mV into 50 K ohms. Radio: 20 mV into 10 K ohms.
 Frequency Response (Mic. and Radio): 25 c/s to 30 kc/s ± 1 dB extending to 100 kc/s ± 3 dB.
 Equalisation for P.U.: Correct to within ± 1 dB on RIAA curve from 50 c/s to 20 kc/s.
 Tone Controls: Treble + 12dB to -10dB at 10 kc/s. Bass +15dB to -12dB at 100 c/s.
 Size: 6½in x 2½in x 2½in (14.5 x 6.3 x 6.3cm) overall, plus knobs.
 Finish: Front panel in brushed and polished solid aluminium with solid aluminium knobs. Black figuring on front panel.
 Ready Built and Tested with Manual, \$29.80, plus sales tax.
 DELIVERY: All items ex stock at present. Micromatic supplies limited. I.C.10 new order deliveries 8-10 weeks. Back orders are being processed.

Sole Australian Agents:

CENTRAL IMPORTS PTY. LTD.

196 ADELAIDE TERRACE, PERTH, W.A.
 Manufacturer and distributor

PHONE 23-5103
 Enquiries welcomed



Q.14 HIGH FIDELITY LOUDSPEAKER

New Design Principles
 New Materials

Construction: The seamless sound, or pressure chamber and mounting baffle are of special high-density ultra-low resonance materials made possible by modern bonding and processing techniques to ensure freedom from spurious coloration.

Loading: The Sinclair Q.14 has an input impedance of 8 ohms and will comfortably accept loading in excess of 14 watts, far greater than that required for average listening requirements.

Frequency response: As the independently made test curve shows, remarkably smooth response is maintained between 60 and 15,000 Hz.

Driver unit: This is a specially designed unit having exceptionally high compliance due to the method of cone suspension employed. It has a massive ceramic magnet of 11,000 gauss and aluminium speech coil, with the cone treated to ensure a brilliant transient response.

Contoured pressure chamber: The shape of the sealed chamber has been determined mathematically to ensure forward sounding presence and freedom from directional effect. Connections at rear are marked for correct phasing.

Size and styling: The Sinclair Q.14 measures 9½in square on its front face by 4½in deep from front to back. A separate base for free standing position is provided as well as a template for wall or flush mounting. A neat solid aluminium bar inset is used to embellish the front.

Price \$29.80, plus sales tax.

R.T.C. Recording Tapes

High quality British product. Send for price list. All reel sizes available. In single, long, double and triple play.

OTHER SINCLAIR PRODUCTS

Z20 P.W.M. 20 watt amplifier and pre-amp Built and Tested, \$20.00, plus sales tax.

Z20 Power Supply, \$12.60, plus sales tax.

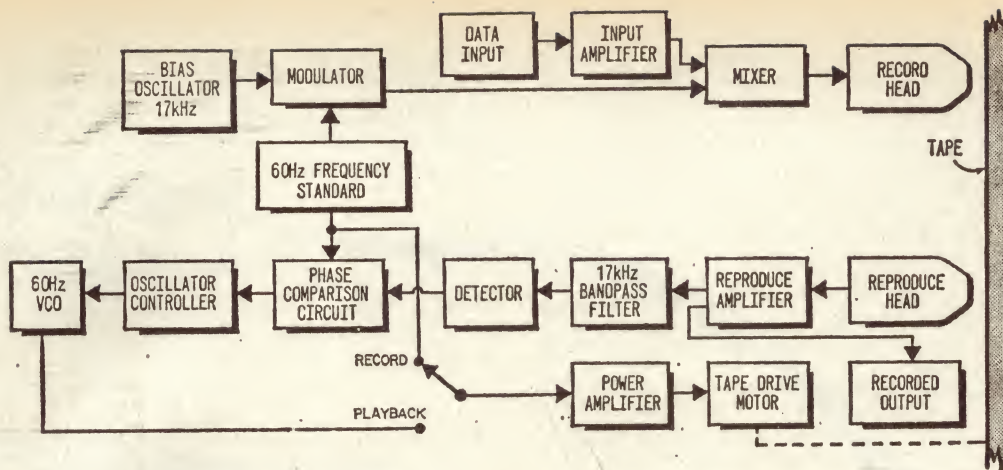

Figure 12. Varying line voltage can play havoc with tape recorders. Diagram shows basic frequency-lock servo used for speed compensation.

or more channels operating from one commutator is not uncommon. The commutator arm is connected to the input of a single subcarrier oscillator. This may feed directly into the transmitter, or it may be mixed with other oscillator outputs.

As the commutator arm turns, each particular transducer output is applied to the subcarrier oscillator at a particular instant. Simultaneously, the decommutator arm at the receiver makes contact with the corresponding subcarrier discriminator output.

Actually, the input to the subcarrier oscillator is a series of pulses, whose amplitudes correspond to the transducer input. These pulses cause the subcarrier oscillator to deviate from the subcarrier centre frequency by a corresponding amount. Each train of pulses generated in one full revolution of the commutator also includes a synchronising signal which is transmitted along with the remaining pulses. This serves to synchronise the decommutator and commutator.

Figure 14 shows a typical multi-channel, electronic PAM commutator. With this system, the inputs from transducers and signal conditioners are applied to individual "gates." The gates are opened and closed in sequence, under the control of a logic matrix and binary divider chain, faster than the eye can blink.

This chain is driven by a master clock oscillator at a given frequency. The gate outputs are combined and then further processed under synchronous control of the clock oscillator. This results in a time-division multiplex operation (each transducer input being given equal time).

A typical gate circuit is shown in figure 15. Gating is a process whereby a valve (or transistor) will only conduct at certain instants. The valve is held in a cutoff state (extreme negative bias) so that conduction only occurs upon application of a positive gating pulse.

When a pulse train contains both wanted and unwanted information at regular intervals, synchronised gating pulses may be applied so that only the desired signal is passed (and amplified) by the valve. Obviously, this is a form of synchronised switching.

Since decommutation is the complement of commutation, the same basic circuits can be used for both operations, except in inverted form. In a commutator, inputs from various channels are applied to individual gates, mixed, and then fed to the transmitter. The same gates and control circuits can be used at the receiving end, except that the gate inputs are now connected in parallel to the input from the receiver, while the gate outputs remain separate.

Synchronisation between commutator and decommutator is a major problem in any telemetry system. There are many synchronisation systems used in PAM telemetry.

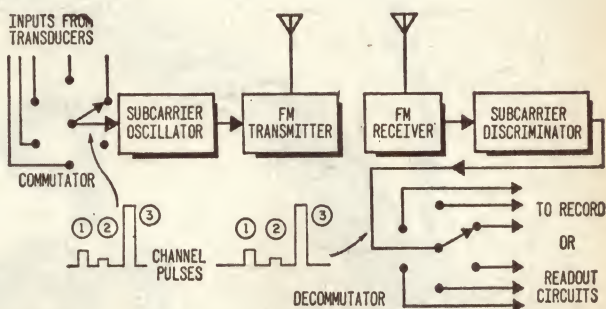

Figure 13. A commutator in the transmitter and a decommutator in the receiver are always in step to pick the desired signal on time.

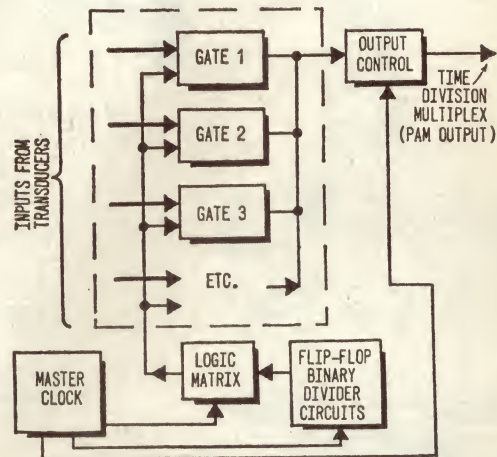

Figure 14. The important thing in telemetry is to keep in step. The basic commutator and gate circuit helps in this particular task.

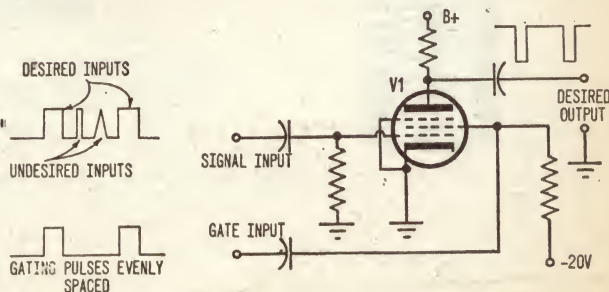

Figure 15. A commutator can be an electronic device as this circuit shows. Only those signals that occur at the same instant will be amplified by the valve. All other signals do not pass through the circuit. The gate pulses unlock the valve whenever input is a positive-going pulse.



power rectifier problems?

WARBURTON FRANKI have available a varied selection of International Rectifier diodes, components and assemblies including: epitaxial-type, silicon-controlled rectifiers to 740 amperes RMS with matching firing circuits.

- 1.5 micro-sec recovery diodes at 250 amperes average.
 - The only 60, 100 and 200 ampere Logic-Triacs.
 - Silicon rectifier diodes up to 500 A at 2 kV.
 - A complete line of compatible surge protectors and heat exchangers.
- Selenium rectifiers in plates, diodes and cartridges.
- Power stacks to 2,300 amperes and zeners to 50 watts.

FOR FULL DETAILS CONTACT THE INSTRUMENTATION SPECIALISTS



WARBURTON FRANKI

ADELAIDE: 204 Flinders St. 5000. Ph. 23-3233. BRISBANE: 13 Chester St., Fortitude Valley 4006. Ph. 51-5121. MELBOURNE: 220 Park St., Sth. Melbourne 3205. Ph. 69-0151. MOUNT GAMBIER: 92 Penola Road 5290. Ph. 2-3841. NEWCASTLE: 40 Annie St., Wickham 2293. Ph. 049 61-4183. SYDNEY: 307 Kent St. 2000. Ph. 29-1111. WOLLONGONG: 136 Auburn St. 2500. Ph. 2-5444. HOBART: Associated Agencies Pty. Ltd., 25-29 Barrack St. 7000. Ph. 2-1841. LAUNCESTON: Associated Agencies Pty. Ltd., 212 York St. 7250. Ph. 31-3300. PERTH: Henderson Instrument Co. Pty. Ltd., 309 Hay St., Subiaco 6008. Ph. 8-4131.

W.F.2987

Figure 16 shows a typical closed-loop circuit where incoming signals from the receiver are applied to a limiter and bandpass filter.

The limiter removes AM variations and the filter generates a sine wave at the fundamental repetition frequency of the data. If there is any variation in the PAM signals (for instance, as a result of variation in the transmitter's

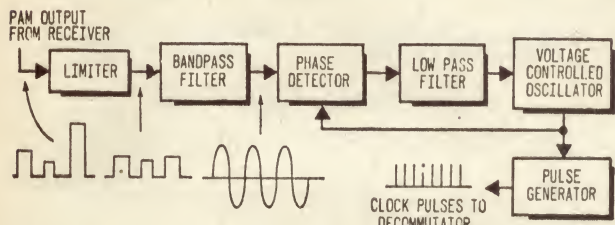

Figure 16. It is important to keep step in telemetry. One way the job is done is with this closed-loop PAM telemetry channel synchronization circuit.

commutator circuit) this appears as a frequency variation at the output of the filter.

The output from the filter is applied to a phase detector which is also excited by a local oscillator whose frequency can be varied with a control voltage. The detector's output is a voltage which is proportional to the difference in phase between the two sine waves applied to it.

After low-pass filtering, this error voltage is used to control the frequency of the local VCO. When the circuit is in balance, the VCO frequency is identical to that of the incoming pulse repetition frequency and is locked in a definite phase relationship (usually 90 deg.) to the incoming signals. This phase shift ensures that the clock pulses will arrive in sufficient time to trigger the decommutator just ahead of the incoming PAM signals.

Pulse-duration modulation is a technique that eliminates some of the basic problems of any PAM system using mechanical commutation. Another problem associated with PAM systems is that noise can be introduced due to inter-modulation between subcarrier oscillators.

Like a PAM system, PDM telemetry involves the use of a commutator which receives signal inputs from a group of transducers. However, PDM commutators have an extra set of contacts. These contacts are used to trigger a keyer circuit that is placed between the signal contacts and the subcarrier oscillator or transmitter (see figure 17).

The keyer or encoder converts constant-width, variable-amplitude pulses into constant-amplitude, variable-width pulses. This conversion results in a train of pulses whose amplitude can tolerate substantial noise without affecting data accuracy. This is because information is now represented by pulse width. The PAM (amplitude) measurements have become PDM (time) measurements. Thus, a large-amplitude PAM pulse will now produce a wide PDM pulse.

A typical PDM keying circuit is a saw-tooth (or linear-ramp) generator that is triggered by pulses from the extra contacts of the commutator. A separate voltage is developed for each triggering pulse. This occurs simultaneously upon application of the variable-amplitude data pulse which has also been applied to the keyer circuit. The two signals are compared in the keyer circuit, and when the two values are equal, the pulse-width output is stopped.

Pulse-code modulation is one of the latest techniques developed for telemetry. A form of PCM telemetry has been used to transmit photographs of the moon (see "Electronics Australia," January 1967).

As with other pulse systems, the PCM technique also uses a commutator and de-commutator arrangement. However, these are always electronic devices (usually solid-state), and the commutated data is usually sampled at rates of 50,000 samples per second, or more. Because of this high speed it's possible to feed the output of a slow PAM system into a PCM channel and get a PACM (pulse-amplitude/code modulation) system.

Figure 18 shows how the high-speed commutator's pulse train is fed to a high-speed analog-to-digital converter. (In PCM, the high-speed commutator is usually referred to as a multiplexer.) In the analog-to-digital converter,

each channel pulse is converted into a series of binary digits representing the amplitude of the signal data.

The encoding or conversion process in the converter is accomplished by comparing the magnitude of the input pulse with a number of precise reference voltages within the converter, and transmitting a coded group of pulses representing the magnitude of each input pulse. Each group

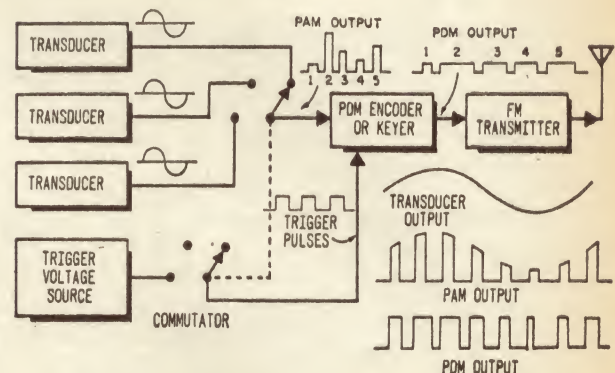

Figure 17. Pulse-duration modulation can be best understood by looking at the output signals—note size of each pulse width.

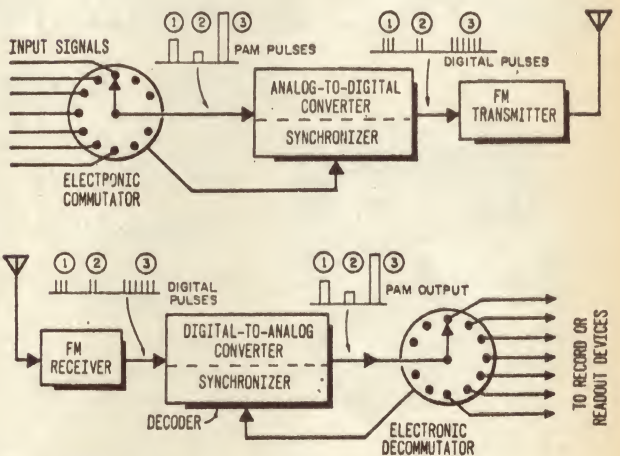

Figure 18. This simple pulse-code modulation telemetry system is very much like that used to relay moon and Mars TV pictures to our earth from outer space.

of pulses has a code representing the binary numbering system, where the presence or absence of a pulse can indicate a "one" or "zero."

In some PCM systems a number of slower-speed commutators are built in to increase data-handling capacity. Actually, these are sub-commutators that feed their output into the main high-speed commutators. Because of this system of subassemblies it is possible for PCM systems to handle thousands of channels—which is necessary to convert the output from a television camera (i.e., scanning the moon) to 35-mm film exposures.

In most cases, the encoder's output goes directly to the transmitter, resulting in a single modulation system (PCM/PM). In addition to the large number of channels that can be handled, PCM also has the advantage of being able to operate in the presence of considerable noise and interference. This is because the information is transmitted in binary form. The receiver doesn't have to recognise pulse amplitudes (PAM) or pulse widths (PDM), but only the presence or absence of pulses that define the data.

Because of high-speed commutation, PCM information is recorded on magnetic tape at the receiving station and then played back at lower speeds on digital counters or computer tape. Engineers, technicians, and scientists can analyse these data at will and learn more about the conditions prevailing in a capsule, the trajectory of a rocket, or the nature of the lunar surface.

MAGRATH'S

CHRISTMAS GIFT SUGGESTIONS

SCOPE The fastest heating IRON money can buy!

SCOPE DELUXE. Complete with pouch pack, stainless barrel only 6 secs. initial heat-up time **\$5.95**
SCOPE STANDARD. 6 secs. INITIAL warm-up. Performs work of irons requiring up to 150 watts **\$5.50**
MINISCOPE Light. Only 1oz, 5 secs. to INITIAL heat-up time. Ideal for hard-to-reach spots **\$5.28**
VIBRASCOPE. Protects your property. Etch any metal ferrous or non-ferrous or annealed dull or polished. Produces deep penetration **\$3.50**
 Matching 3.3V transformer for these Scope products **\$8.30**
POST FREE Anywhere in Australia and its Territories.

PANBRAKE Bench Mounting **\$19.50** METAL FOLDER

Invaluable for design prototypes, model shops and hobbyists in very field where light sheet metal work is used.
FOLDS—angles from 175 deg. to 85 deg. 18in long. **FORMS**—pans (chassis) from 1/2in x 1/2in to 16 1/2in. Maximum depth of pan—1 1/2in. Makes Channels from 1/2in upward by 18in long. Z-section decorative trims, etc.
CAPACITY. Aluminium to 13-gauge. Mild steel to 21 gauge. 1/2in bedplate adjustable by cam—multiple slots permit a range of 14 pan sizes from 3/4in to approx. 16 1/2in. **SIZE:** 20in x 4in x 4in. **WEIGHT:** 17lb. Comes with 4 5/16 bolts.

PLUS 15% SALES TAX. ADD POSTAGE
 Within Victoria **\$1.25.**
 Within N.S.W., TAS. and S.A. **\$1.80.**
 Elsewhere in Aust. **\$2.60.**

"PIONEER"

MODEL P-382 B

15in BASS GUITAR ELECTRONIC ORGAN SPEAKER

This superb 15-in unit is available in 8 ohm or 15 ohm Voice Coil. Power handling 30 watts R.M.S. 60 watts (peak). Frequency response to 500 cycles. Resonant frequency 60 plus or minus 12 cycles. Sensitivity 103 plus or minus 2 db/watt. Total flux 11,600 Maxwell. Flux density 9,360 gauss.



\$30

Including Sales Tax
POSTAGE FREE
 Anywhere in Australia

BATTERY SAVERS - for all Transistor Radios Tape Recorders, etc.

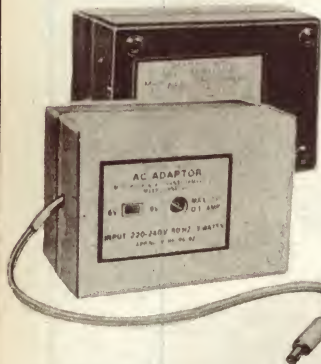

A & R Battery Saver-A/C Adaptor

Permits A/C mains operation of 6-9V battery powered equipment.

APPROVED BY ELECTRICAL SUPPLY AUTHORITIES

PS 64 Specially for tape recorders **\$14.00**

PS 82 Specially for transistor radios **\$9.00**

- 6 or 9 Volt (Nominal Voltage) selected by external switch.
- Double insulated for absolute safety.
- Handsome cabinet complete with 3-pin power point plug and radio lead with plug.
- Measures a compact 3 1/2in x 2 1/2in x 2in.
- Suitable for any 6 or 9 Volt Battery Operated Transistor Equipment.

PS 104 SPECIALLY FOR TAPE RECORDERS **\$21.45**

- Output Voltage 4.5V, 6V, 7.5V, 9V and 12V DC by selector plug, max. current 0.5A.
- Size—4in wide x 2 3/4in high x 5 1/2in deep.

ALL SALES TAX AND POSTAGE PAID

RADAR REGULATED BATTERY ADAPTER

Input 11.15 Volts D.C. Model 912. Output 9 Volts plus-minus 5 per cent D.C. Model 712. Output 7.5 Volts plus-minus 5 per cent D.C. Ideal for Cassette Tape Recorders. Model 612. Output 6 Volts plus-minus 5 p.c. D.C. Save your batteries while motoring. Size 2 1/2in x 1 1/2in x 7/8in. **\$8.75.**

Radar Solid State INVERTER

Ideally suitable for use in your car, boat or caravan. With it you can use your Electric Shaver, Tape Recorder, Record Player, Radio, Small P.A. System, Personal Fan or any other A.C.-powered unit up to 10 watts consumption. Simply connect the Unit to any 12V car battery. The Inverter will draw 4 amps. a full load equivalent to the consumption of one headlamp. With a fully charged battery the unit can operate for many hours without danger of battery drainage. **\$26.**

RADAR 05X POWER SUPPLY UNIT

Designed to operate the majority of ELECTRONICS APPLIANCES—Transistorised Tape Recorders, radios, record-players, small amplifiers, radiograms, Battery shavers and all Battery operated units of 6 volts, 9 volts and 12 volts at a maximum current of 0.5 amps. The only unit available incorporating these three-power outputs. This unit features full wave bridge rectification with capacitor and choke filtering. Select your voltage by adjusting the Selector Switch then plug into any power point. 220 to 250 Volt A.C. Costs 1c per 100 hours—Save dollars on Battery purchases. Can be used also for car batteries as a trickle charger. **\$15.**

REGULATED BATTERY ELIMINATOR

240 Volt A.C. Regulated output of 4.5 Volts, 6.5 Volts, 7.5 Volts and 9 Volts D.C., also an unregulated 12 Volt supply. Model 05XR 1/2 amp. Input. **\$20.70.** Model 1XR 1 amp. Input.

ALL SALES TAX AND POSTAGE PAID

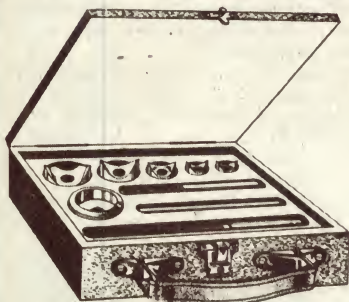

CHASSIS TOOL SET

Punch Kits

Comprises—Wooden Carrying Case, Reamer, Tommy Bar, 1 1/2" Die, plus 5 Combination Die-Cutters to suit 3/16in, 1/4in, 7/16in, 1in 1 1/2in standard valve sockets.

\$7.00

Hand operated Nibbling Tool

"Adel" cuts round, square or irregular holes and shapes to any size over 7/16in and notches and trims undersized holes to fit points. Capacity—Steel to 18-gauge. Aluminium or Copper to 16-gauge. Punching Bakelite, Plastics, etc.

\$5.95 Replacement Cutting Punch **\$3.75**

POST FREE. Anywhere in Australia and territories

J. H. MAGRATH & CO. PTY. LTD.
 208 LT. LONSDALE STREET, MELBOURNE, VICTORIA, PHONE 663 3731



A READER BUILT IT

A Four-channel Audio Mixer

Although several projects for the construction of audio mixers have appeared in "Electronics Australia" in past issues, this circuit submitted by a reader has several features which may prove of interest.

Our contributor has the following comments to make on the circuit:

The basic circuit is fairly straightforward and follows standard practice, but a number of modifications have been made to the standard configuration with a view to improving performance and versatility, so that it can be adapted to particular needs in recording and public address work.

The following features may be noted in an examination of the circuit:

The last 12AX7 has a separate grid return resistor instead of using the master gain control for this purpose. This was done to isolate the mixing potentiometers from the DC in the grid return circuit and so almost avoid the scratching noise that appears when the carbon tracks become dirty, worn, etc., and make the DC return intermittent.

The next point to note is the output section where I have used the twin triode as a "branching" amplifier. This gives two essentially identical outputs — each virtually independent of the loading on the other. This is useful when two amplifiers of different input impedances are to be used from the same signal source and also enables the normally spare channel to be used to drive the monitor amplifier. This branching is achieved by tying the grids and cathodes in parallel but having separate plate loads. Each triode operates as if it were a separate amplifier. The only change in normal circuit values is the halving of the cathode bias resistor, as it now carries twice the current.

The monitor amplifier is connected to the "Aux" channel as previously mentioned. The loading of this amplifier does not affect the gain of this channel by more than a dB or two unless the output is connected to less than about 700K. This inbuilt monitor is invaluable when amplifying or recording musical groups or discussions as it enables the exact sound balance to be heard.

Although I have used two 12AX7s and a 12AU7 in my design, any valves in the 12A—7 series of twin triodes could be used to tailor the gain of the mixer to suit your own needs. The only changes necessary are the cathode bias resistors.

At the inputs I used 2M grid resistors to enable crystal or ceramic microphones to be used, but on the two

higher-gain channels I have made provision to shunt this down to 47K to suit dynamic microphones. The "Aux" inputs are suitable for connection to ceramic pickups or fairly high level outputs, such as tape recorder "Aux" outputs. The shorting type jacks used at the "Mic" inputs prevent hum pickup when the "Aux" inputs are in use because they effectively earth the grids with respect to the signal. Non-shortening jacks must be used for all other connections. (See Editor's note page 103.)

Overall frequency response can be

improved at the sacrifice of some gain by omitting the cathode bypass capacitors. This introduces some local negative feedback at each stage left unby-passed.

On the rare occasions where more gain than is normally available is needed, an "Aux" input can be used as an output and fed into another "Mic" input. Admittedly this will cause a loss of bass response due to the three 0.1uF capacitors in series, but this loss would be of little importance where such drastic measures have to be taken.

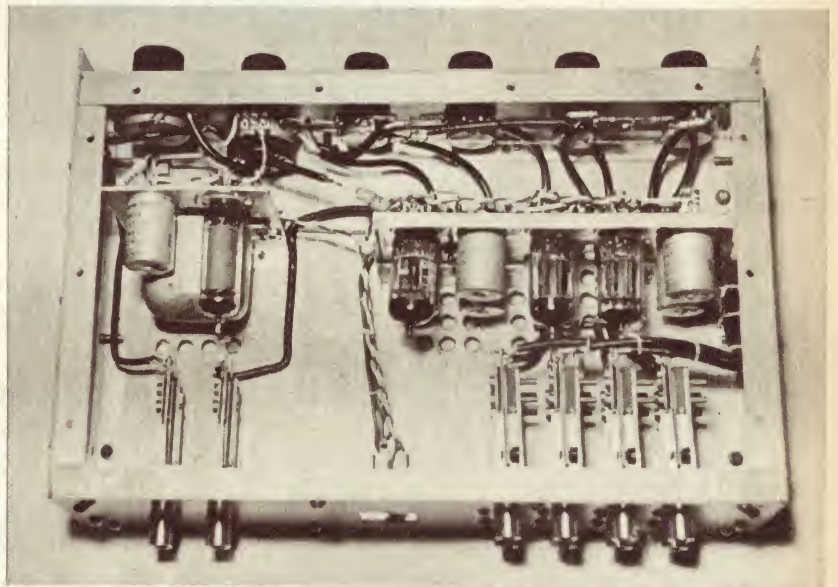

Underside view, showing component arrangement.

Specification

Sensitivities

Mic 1 and 2 1mV for 500mV output (55dB) 2M or 47K.
Mic 3 and 4 4mV for 500mV output (44dB) 2M
PU 1-4 40mV for 500mV output (23dB) 1M.

Outputs

Two, branched—nominal 500mV (Aux. also drives monitor amp.).

Frequency Response

40Hz to 16KHz, — 3dB (0dB=1KHz).

Signal/Noise Ratio

Better than 45dB below 500mV (to be improved, see text).

Distortion

Less than 1% (not accurately measured).

Monitor Output

2 Watts into 8 ohms (internal speaker or phones).

WELLER

TEMPERATURE CONTROLLED SOLDERING IRONS

1. No matter how long a Weller iron has been idling, it is always ready for use at the chosen temperature.
2. 4 temperature ranges available by merely changing tips at the workbench. No operator time is wasted.
3. Safe 24 volt operation from a fully isolated transformer.
4. Consider the economy of replacing a multitude of 10-120 watt irons by ONE TCP-1 plus WELLERTIPS of suitable size and temperature.

PRICE: IRON ONLY \$13.95 with standard tip.
 Transformer \$12.00
 Tips \$1.30 32 sizes and wattages available.

MULTIDRAWERS

Clear Plastic Modular Equipment drawers for small components, screws, resistors, capacitors etc. Fully adjustable to suit components. All items fully visible, a must for the home workshop.

PRICES: Plain Drawer - only \$1.95
 Drawer with 9 compartments \$2.95
 Drawer with 18 compartments \$3.85
 Tax included - Post Free.

Top Cowl Car Radio Aerial 3 piece 6' extension. Complete with lead-in and connector (No. YAT-30)
PRICE: \$2.50 each Post 30c

Astor Car Radio 5 Push Button Tuner.
PRICE: \$4.00 Post 20c

Oral Model 1000 Mono Tape Recorder. 5" Spool 2 Speed AC/DC.
PRICE: \$48.50 Postage 50c

ROLA LOUDSPEAKERS

General Accessories is the largest distributor for PLESSEY ROLA components throughout the Commonwealth. The full range of Rola Speakers is available at your State Branch Showroom. SEE THESE LATEST RELEASES -

65M Hi Compliance Woofers - 8 ohms. A new exciting high compliance neoprene suspension woofer. Ideal for bookshelf speaker systems. A modest price for such a good performance. \$11 post free.

65MX Hi Compliance Wide Range 8 ohm Speaker. Similar to 65M but fitted with high frequency throat for extended treble range performance. \$11.95 post free.

12V50 'EG' Now a massive 50 watt RMS bass speaker, the most powerful guitar speaker made in Australia. A must for the musician who wants reliability with that extra reserve of power. Available 8 or 15 ohms. \$56.95 post free

TRADE & WHOLESALE ENQUIRIES INVITED.



TAKT

TP 52: AC/DC Mono Record Player. Portable in attractive case. \$28 Post Free.

P 514: AC/DC Stereo Portable Record Player. With separate Lid Speakers. \$40 Post Free.

POEMUSICA 1: AC Modular Stereo Player. With separate timber grain speaker boxes and clear perspex lid. \$59 Freight

RECORDING KITS

Allows you to record your favourite TV or Radio program through a direct electrical connection. Kit consists of a twin socket for attachment to the TV set and a lead to the recorder.

PRICE: \$2.00 each plus 20c postage.

DISPOSAL STOCK SPECIALS

Tone Crest Recording Tape 7" 1200' in cardboard boxes.

PRICE: \$1.80 per Reel Post Free.

7" Boxed Empty Spools.

PRICE: 40c each Post Free.

Stylouve Stylus Inspectors.

PRICE: \$1.60 each Post Free.

Single 23/0076 Cable 100yd Reel. Colour blue.

PRICE: \$2.90 per Reel Post 50c
 Original Price \$7.50 per Reel.

GENERAL ACCESSORIES - BRANCH ADDRESSES.

GENERAL ACCESSORIES: 50-54 Little Edward Street, Brisbane. QLD. 4000. 443 Concord Road, Rhodes. N.S.W. 2138.
 46 Milligan Street, Perth. W.A. 6000. 81-97 Flinders Street, Adelaide. S.A. 5000.
 Ingham Road, Townsville. QLD. 4810. 116 Clarence Street, Sydney. N.S.W. 2000.
 153 Sturt Street, South Melbourne, VIC. 3205.
 199 Collin Street, Hobart. TAS. 7000.

HEMOCRAFTS:

It will also be noticed that I have used only a 200V HT supply. This was done as I had a 150-0-150V transformer on hand. With the necessary adjustments the unit would probably work better on the more usual 300V HT line, but I am satisfied with the present setup and propose to leave it as it is.

The only real problem is the signal to noise ratio. The figure of -45dB is not as low as could be desired. The main source of noise is hum injected from the heater wiring. I propose to run the heaters on DC soon, using a selenium bridge rectifier and a two-stage R-C filter. Further reduction in noise and hum could be achieved by the use of low noise and controlled hum valves such as 12AY7 and 7025, etc., but the cost must be considered.

I constructed the case from 1/16in aluminium sheet and 1/16in x 1/2in x 1/2in aluminium angle and it measures 12in by 7 1/2in x 3in. The inputs and outputs are on the back panel with the power socket in the centre. The pre-amps and branching amp are on the larger vertical panel and the monitor amplifier is on the smaller one. All the 1M mixing resistors are strung between the potentiometers directly to reduce hum pickup. The 4in monitor speaker is mounted facing up under the top panel with a generous pattern of 3/16in holes above it for the sound. For serious monitoring, headphones or a good quality external speaker would be used.

Ventilation holes are provided above and below the valves to allow an adequate flow of air through the unit. The slider switches for the input shunts and speaker/phone selection are mounted with countersunk bolts which are covered by the white perspex false front. This is held in place by the retaining nuts of the potentiometers and is labelled with dry transfers. I covered the lettering with the clear protective lacquer available for this purpose.

The case was sprayed with "hammer finish" grey enamel and rubber feet were added to complete the unit.

The power supply was constructed as a separate unit and was housed in a 6in x 4in x 3in aluminium box with a vertical panel inside on which I mounted the rectifier tube, choke and can-type electrolytic capacitor. The power supply is connected to the mixer by 3ft of six-core cable and a six-pin female plug. The mixer has a six-pin male socket in the rear panel to match. This enables the power supply to be placed on the floor, thus keeping the magnetic fields of the transformer and choke away from the high gain pre-amps.

(Submitted by Mr G. P. Bell, 9 Freeman Road, Chatswood, N.S.W. 2067.)

EDITOR'S NOTE. While the use of single-circuit jacks for the auxiliary inputs does allow cascading of the stages when insufficient gain is obtained from a single stage, it has the effect of loading the inputs with the 100K load resistors in the anode circuits of the 12AX7s. An alternative arrangement would be to use single-circuit jacks for two auxiliary inputs, to provide for the cascading function when required, and to use double-circuit jacks in the other cases, so that crystal pickups can be fed into two of the auxiliary inputs. The jacks shown with asterisks have been drawn this way.

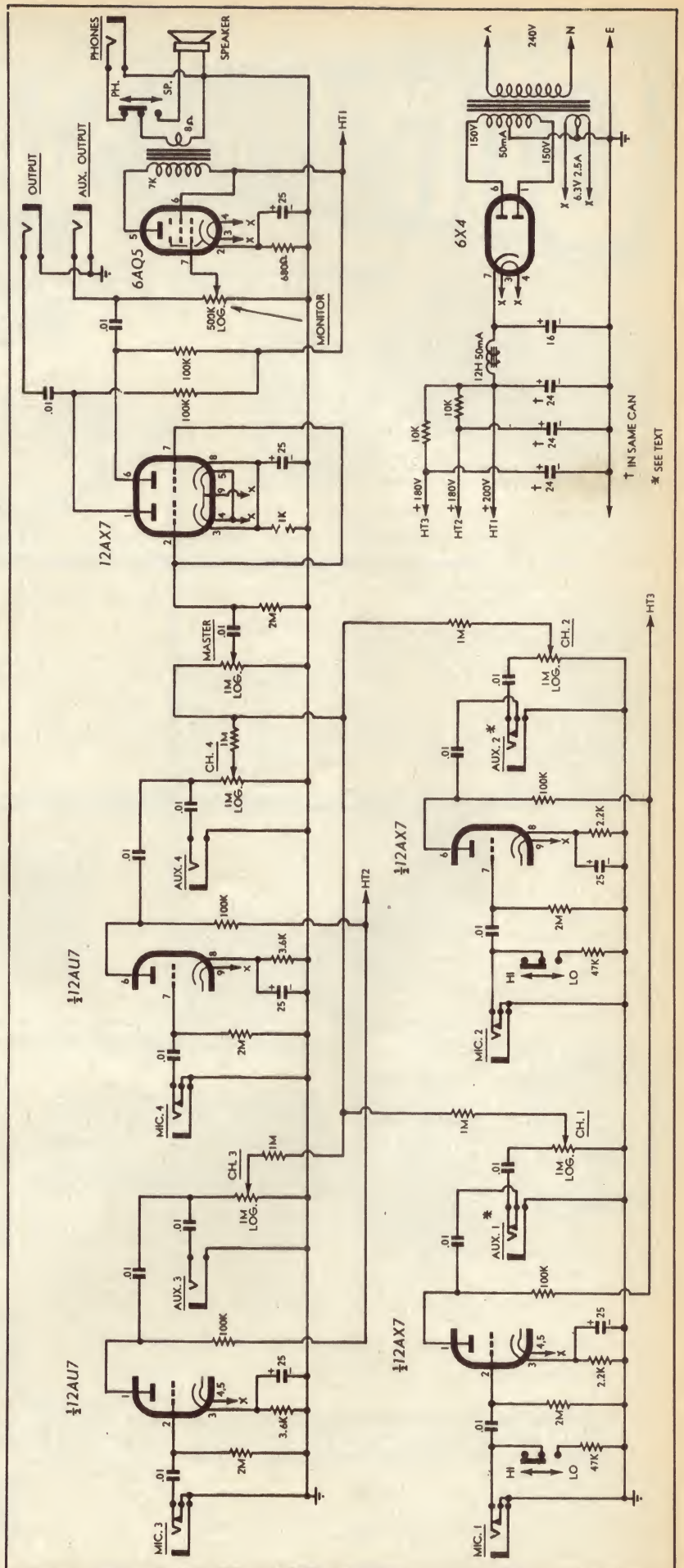

Christmas Specials!

AVAILABLE FROM



JULI-CORDER 999A
AC/DC STEREO RECORDERS
\$269.95



Built in Batt Recharger Complete with all Accessories Auto Stop
3 Heads AC/DC Operation Completely Portable Tapes 7" Spool

ELECTRONICS THREE STORES

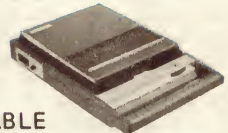

AC/DC PORTABLE
RECORD PLAYER TRP-1500

3 Speed
Teak Outer Cabinet
Cut/off Switch on Arm
Big Watt Output
Includes Power Lead
and Batteries \$31.95



Circuit complete with
batteries, ear piece
Gift Boxed - Colours
Red, black, brown,
blue batts, ear piece
Only \$19.95

ZODIAC 8
TRANSISTOR RADIO



6 Transistors
Radios complete with
Carry Case ear piece
Battery. Gift Boxed
\$12.50

FUSI CASSETTE RECORDERS

TPC - 105

Very compact, ideal for student
or business application
Complete with remote control
microphone, C-60 Cassette tape,
battery and carry case.

\$49.95



SANYO STEREO DS-40T
Solid State Compact
Stereo Phonograph

33, 45 rpm
Attractive woodgrain cabinets
Transparent dust cover
Constant speed motor
Precision tonearm with stereo
cartridge Power output 2.5 watts
total music power

Price \$59.95



ONKYO MODULAR

STEREOGRAM SM10

\$244.50

Big 10 x 10 watt amplifier Auto return and cutoff arm 8" Speakers Din +
Headphones Jacks Latest type slide control system AM, FM, FM Multiplex



STEREO HEADPHONES
With volume control
mounted on each earpiece
\$10.75



W1 SPEAKER ENCLOSURES

Hand rubbed Walnut finish Freq. response = 40 - 20,000 HZ
Size 23 3/4 x 11 x 11 1/2 Output : 15 Watts RMS (8 OHM)
12" Woofer + 4" Tweeter

\$55.00



STEREO AMP CE-6000
30 WATT PER CHANNEL
TEAK FINISH CABINET
\$119.50



AIWA PORTABLE TPR-101
CASSETTE RECORDER WITH
MULTI-BAND RADIO \$129.00

EASY TERMS AVAILABLE ON ALL EQUIPMENT

Christmas Specials Available Now! At these Three Stores -

ELECTRONICS THREE STORES

EXPO PHOTOGRAPHICS

Shop 24 Westfield Plaza Hornsby 476.1363

DEITRON PHOTOSOUND PTY. LTD.

696 George St., Sydney 212.1149 Cable Code Deitronics Sydney

DEITRON ELECTRONIC (SALES) PTY. LTD.

4-6 Taylor St., Darlinghurst 31.5430, 31-6786 Cable Code Deitronics Sydney

A Reader Built It... continued

SIMPLE VARIABLE POWER SUPPLY*

Here is a circuit for a variable power supply made from junk box parts, which I have been using for a number of years. It is quite simple, and may interest some of your readers.

I used 6M5 valves, simple because that is what I had in the junk box, but almost any kind of power output valve would do, with some adjustment to the values of resistors in the voltage divider. I used a shunted 500K pot., simply because this is what I had on hand.

In use, the control is particularly smooth, the output voltage being reduced as the negative grid bias is increased. As arranged, a minimum voltage of 45 is achieved quite nicely, (P.B.)

EDITOR'S NOTE: Any valves selected for this circuit should be used with due thought to their voltage and current ratings. Ordinary output valves such as 6M5, 6V6 for example, would probably cope with transformer RMS voltages of up to 285V per side at load currents up to about 80mA. For higher output voltages or higher load current, it would be wise to select valves, either pentode or triode, with higher ratings. Note that the heaters should be supplied from a separate winding on the power transformer connected to the cathode.

(Editor's Footnote: "Reader Built It" projects are published for the general interest of experimenters and as a source of ideas. Based on readers' contributions, they have not been tested in our laboratory and we cannot accept responsibility for them.)

Two-speed alignment tool



The device pictured here is a two speed alignment tool, made from a planetary-drive vernier control knob. The shaft can be made from metal or hard plastic rod, or from a small screwdriver with the handle removed. The shaft is then fitted into the socket of the knob and held in position by the grub screw. To hold the normally fixed portion of the knob stationary while in use, a small handle is fitted, made from plastic or other suitable material. The device was made in the workshop of the School of Chemistry, University of N.S.W. (A. Ingster.)

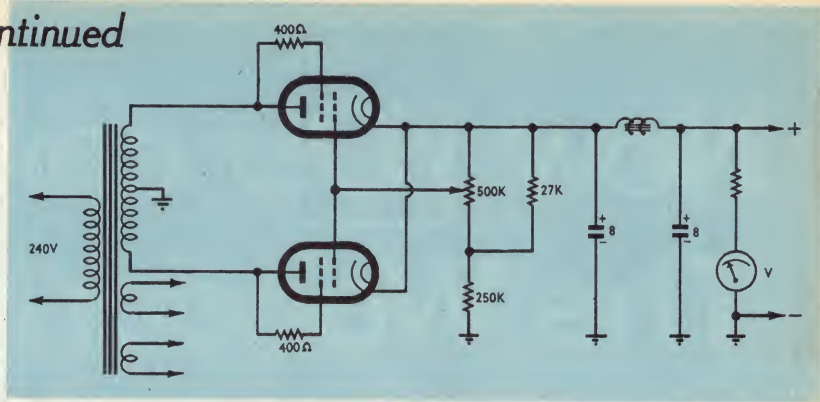

Adding reverberation to 78rpm records*

Readers who still find pleasure in their collection of 78rpm discs may find the idea outlined below of interest.

The sound on 78rpm discs is notoriously non-reverberant. Some readers with large collections of these records could well be interested in an enhancement of the reproduction by a simulated reverberation which can be achieved by playing the discs through two heads slightly separated in the track.

The photograph shows how this can be achieved. Two replay heads are used, and in the set-up shown in the photograph, one is a normal commercial arm and cartridge, the second is a specially made arm with an off-set head. This arrangement allows one head to be used normally, while the special arm is sited so that a second cartridge can be placed with its stylus in the same groove as the first, but slightly behind it, so that it plays the same material. The short time interval between the first and second playings give the simulated reverberation and might even be regarded as a pseudo-stereo effect.

In the arrangement shown in the photograph, the signals from the two heads are fed to different channels which are driving the two earpieces of a headset individually. There is no reason why the two signals cannot be fed to a single amplifier channel and



loudspeaker to achieve the reverberation effect. (A.M.)

EDITOR'S NOTE: Our contributor advised that he had sent details of this scheme to "The Gramophone" and that he had applied for a patent. We would like to point out that readers who have a tape recorder could obtain a similar effect by recording their discs on tape and fitting a second replay head a short space away from the existing head.

* This circuit was submitted by a reader some time ago, and since it may no longer be appropriate to publish the name and address as supplied, we have used initials only. If the reader concerned cares to contact us, we shall be pleased to arrange payment for the item. ■

SCOOP!! Components and Products

AUSTRALASIA'S LOWEST-PRICED RADIO COMPONENTS AND ELECTRONIC PRODUCTS ARE BEING OFFERED BY AUSTRALASIA'S FASTEST GROWING AND MOST PROGRESSIVE MAIL ORDER HOUSE.

An example of our prices:—

BAG OF 20 POTS, Brand new standard carbon type. Assorted—some with switch—some with nuts.

OUR GIVE-AWAY PRICE—\$2.50 per bag of 20.

BAG OF 50 ASSORTED RESISTORS. All values — mainly cracked carbon—not cheap composition types. **\$1.00 for 50.**

WRITE FOR FREE MAIL ORDER CATALOGUE TO:—

COYLE ELECTRONIC INDUSTRIES LTD.

P.O. BOX 778, WANGANUI, NEW ZEALAND.

Now YOU can enter
The Wonderful
World of Electronics
with

TECHNIPAC

The Complete Training System

TECHNIPAC didn't 'just happen.' It is the result of many years of experience, research and design in the field of Electronics training. TECHNIPAC is a unique combination of the theory and practical application of Electronics presented and arranged in a simple, logical and effective manner. Whether you are a beginner or have some knowledge or experience in Electronics, the TECHNIPAC system is designed to meet your individual requirements. Find out *NOW* how you can enter *the Wonderful World of Electronics*—through the **TECHNIPAC SYSTEM**

Technical Training International Pty. Ltd.

Archer House, 75 Archer St., Chatswood, N.S.W. 2067. Tel 41 4444.

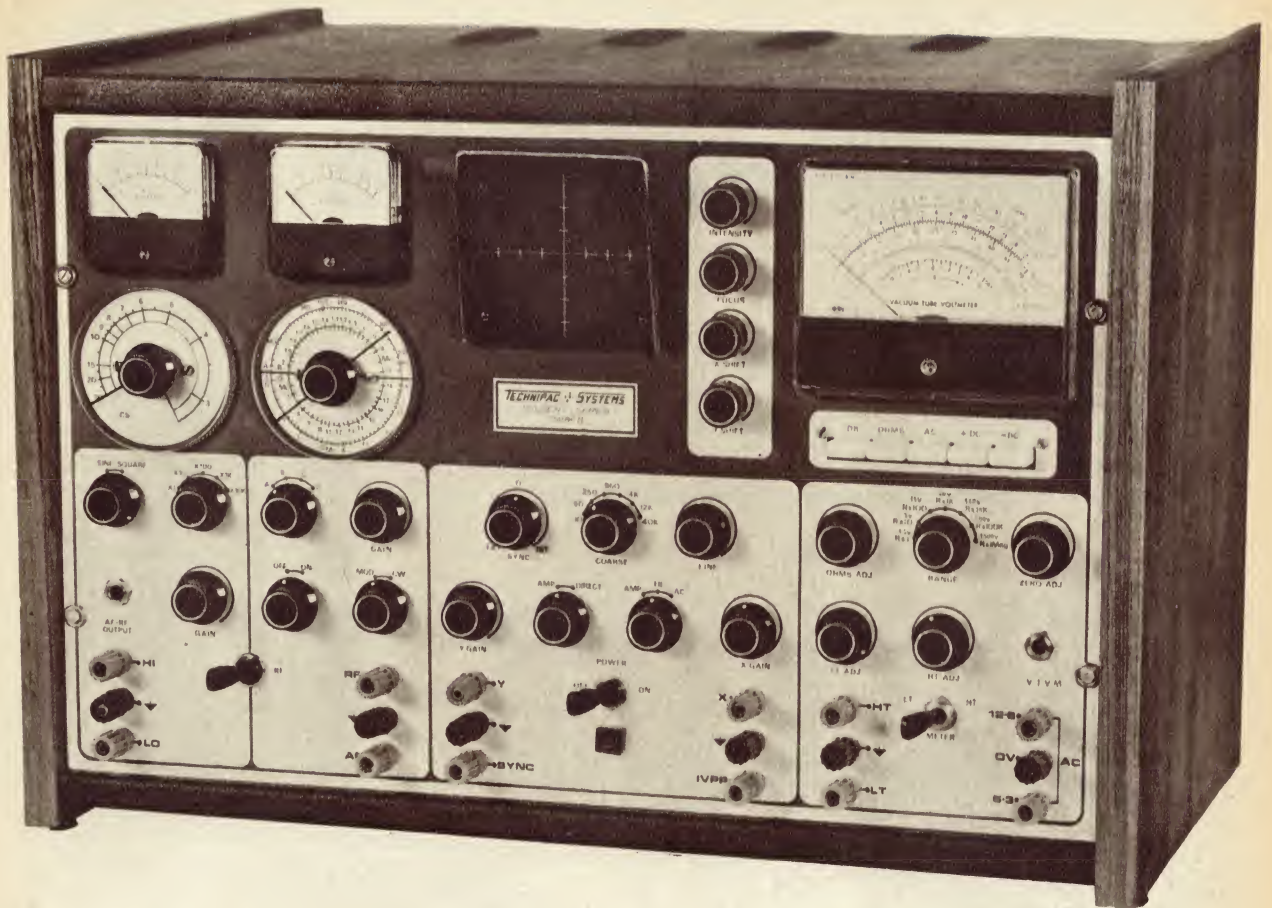

Illustrated above is the **TECMARK II TEST EQUIPMENT CONSOLE**. It incorporates a DC/AC power supply with a stabilized LT. section, vacuum-tube voltmeter, oscilloscope, audio frequency generator and an R.F. generator.



To: **TECHNIPAC SYSTEMS DIVISION**,
 Technical Training International,
 P.O. Box 328, Chatswood, N.S.W. 2067.
 Please forward full details immediately,
 including illustrated *brochure* on Technipac.

NAME: _____ AGE: _____

Address: _____ Postcode: _____

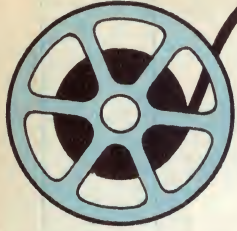

AUDIO TOPICS



The development of the music scale

The musical scale in universal use today did not just happen, nor was it invented suddenly. As this article will show, it was developed over a period of centuries, from a few tones to the present complex structure of keys and modes.

By L. C. Debnam*

Since the advent of radio and electronic sound reproduction, music has become a part of nearly every person's experience. Although a great many people enjoy music, and many of these play musical instruments, its physical basis is not generally understood. Musicians are primarily interested in music as an art or a living and other people are interested in it as a form of relaxation or enjoyment.

Physicists in general are not interested in music as a science because a detailed study yields insufficient rewards. One of the main reasons for this is that music is not generally subject to fixed laws and equations, much of the enjoyment being due to physiological and psychological factors. "Correct" music may be played by anyone on a pianola, and computers may be programmed to play almost any instrument—but these "playings" pale to insignificance when compared with the same tune played by a Winifred Atwell or an Arthur Rubinstein.

Science associated with music ap-

* The author is Instructor in Mathematics and Physics at the Darling Downs Institute of Technology.

pears to have started with Pythagoras of Samos, who discovered, about 525 B.C., that two or more strings when plucked at the same time made a pleasant note if the length of the strings were in the ratios of small whole numbers. The lengths of the strings are related to the frequencies of the notes emitted and it is more usual to discuss musical notes in terms of frequencies.

The simplest ratio of frequencies involving whole numbers is the ratio 2:1, and if two notes are sounded with this ratio, i.e., one being twice the frequency of the other, the resultant sound is not unpleasant to the ear. Pythagoras admitted only three ratios which sounded pleasant. These were notes with the frequency ratios 1:2, 2:3 and 3:4 and from these ratios the tetrachords (four-stringed instruments) were derived. With this system as a basis, Greek music developed as melody in which any of the four fundamental notes may be followed by any other without the music seeming harsh. Although more than one note could be sounded together without discord, apparently only the frequency ratio 1:2 was used in this manner.

The sound of ancient Greek music

was not consistent, as they used at least seven different scales which, although they bore the Pythagorean relationships, had different frequencies for their bases. These scales, or modes, were later adopted by the early Christian Church with some alterations and are known as the "Ecclesiastical Modes."

Harmony (the simultaneous sounding of more than one note) was not generally recognised as legitimate in music until the fourteenth century A.D. Before then, nearly all music was melodic (consecutive) but during the period A.D. 1300-1600 harmony of the Pythagorean and other ratios was gradually accepted, along with melody of the same ratios. Since about A.D. 1600 music has developed more as harmony than melody.

Before the development of harmony the four-note scale of the Greeks had been improved by the admission of more ratios into the system of modes so that the scale took the form of the ratios

4, 5, 6, 8.

This scale may be seen to contain the Pythagorean ratios 1:2 (as 4:8), 2:3 (as 4:6) and 3:4 (as 6:8) with the addition of a "triad" of 4:5:6. This triad was found to be pleasant and to contain the Pythagorean ratios but the gaps between notes were large so a second triad of notes was fitted between.

The second triad has the ratios 5-1/3 : 6-2/3 : 8 (the same as 4:5:6) and the two triads interlock to form the scale:

4, 5, 5-1/3, 6, 6-2/3, 8.

About the year A.D. 1000 a third triad of 6 : 7-1/2 : 9 (again in the ratio 4:5:6) was introduced into the scale to fill the large gaps between 4:5 and 6-2/3 : 8. "9" is outside the range of 1:2 (4:8) so it was halved and inserted between 4 and 5 and the scale took on the ratio form

4, 4-1/2, 5, 5-1/3, 6, 6-2/3, 7-1/2, 8.

As there are eight notes in this scale it is known as an octave, from the Latin word for eight. The last note is exactly twice the frequency of the first and a new octave may be constructed using the same ratios but with "8" as a basis. Similarly a lower scale may be constructed which gives a total range of ratios for three octaves of the form

2 $2\frac{1}{4}$ $2\frac{1}{2}$ $2\frac{2}{3}$ 3 $3\frac{1}{3}$ $3\frac{3}{4}$ 4
 4 $4\frac{1}{2}$ 5 $5\frac{1}{3}$ 6 $6\frac{2}{3}$ $7\frac{1}{2}$ 8
 8 9 10 $10\frac{2}{3}$ 12 $13\frac{1}{3}$ 15 16

and similar octaves may be constructed above and below these.

In the early part of the eleventh century, a Benedictine monk named

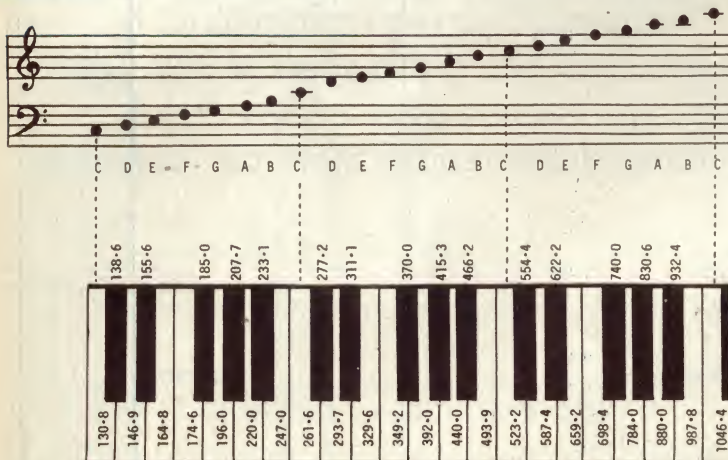

Figure 1. The tempered scale frequencies are shown in relation to a section of a piano keyboard, the names of the notes and their position on the musical staff.

Guido d'Arezzo invented the four-line staff (which in modern music has been translated to the five-line staff) and placed letters on certain lines to indicate their pitch. These letters have gradually turned into the Clef signs known today, the G or treble clef; the F or bass clef; and the C clef. It is also traditional that he composed a hymn to John the Baptist which is as follows:

UT queant laxis REsonare fibris,
MIRA gestorum FAMuli tuorum,
SOLve polluti LABii reatum
Sanite Ioannes.

The capitalised syllables of this hymn correspond to ratios in the octave as follows:

4 4-1/2 5 5-1/3 6 6-2/3 7-1/2 8
Ut re mi fa so la — —
which was the forerunner of the "do-re-mi" scale learnt today.

The fundamental frequency of the scale of modern music often causes some confusion. The ratios were in the eleventh century given letters to distinguish them but the fundamental note was quite variable. There are two scales in use in the world, the Physical Scale, based on the note "C" of 256Hz and the Musical Scale based on the note "A" of 440Hz. These may be compared with the ratios as follows:

Ratio	Name	Physical frequency	Musical frequency
4	C	256	261.6
4-1/2	D	288	293.7
5	E	320	329.6
5-1/3	F	341-1/3	349.2
6	G	384	392.0
6-2/3	A	426-2/3	440.0
7-1/2	B	480	493.9
8	C	512	523

The musical scale does not follow exactly the ratios expressed in the first line but the differences are generally less than 1 per cent when compared with C and are barely discernible to the ear.

The reason for the changes of frequency in the musical scale is the introduction of "altered notes," the sharps and flats represented by the black keys of a piano.

The altered notes (accidentals in musical terminology) were introduced in a confused process during the thirteenth to seventeenth centuries. The strict modal melodies were somewhat monotonous and harmony was not generally in fashion so that musicians occasionally modulated from one key (fundamental frequency) to another which imposed changes in the scale separations. If the "true" musical scale (corresponding to the true ratios with A=440Hz as fundamental) is used the ratios between consecutive notes are as follows:

Notes	True Ratio
D/C	1.125
E/D	1.111
F/E	1.067
G/F	1.125
A/G	1.111
B/A	1.125
C/B	1.067

When musicians changed from one note to another as "fundamental," the scale did not sound the same, because the ratios were different. This may be tried on a piano. If the scale is played in the sequence CDEFGABC' the ratios sound different from that played in the sequence DEFGABC'D'. To overcome this difficulty and at the same time to keep the notes at the same

KEW-SNAP

SNAP-AROUND VOLT-AMMETER



The KYORITSU range of four Tong Testers allows quick and accurate measurements from 6 to 900 amperes, voltage to 750 volts and resistance to 25 ohms or 300 ohms midscale; according to the model.

Jaw openings are to 1 7/8" and are snap positive in their movement.

Prices range from \$19.00 to \$50.00 plus sales tax, if applicable, Pocket-sized, the instruments have features which enable electricians, service maintenance men and engineers to trace faults and investigate operating conditions without shutting down equipment.

KEW-SNAPS—

- Are safe to use.
- One hand operation.
- Thumb selection of ranges.
- Rotating scales show only the range in use.
- Rotating instrument bodies through 180° for easy readings.
- Lock-in of meter indications reduces reading errors.
- Dust proof and rugged in construction, they lend themselves to use in both industrial and field work.

jacoby, mitchell
& co. pty. ltd. phone 26-2651
469-475 kent street, sydney

MELBOURNE 30-2491
 ADELAIDE 53-6117
 BRISBANE 2-6467
 PERTH 28-1102
 LAUNCESTON 2-5322





Introducing a dramatic
breakthrough
in recording tape...

BASF low noise-high output.

BASF LH Magnetic Recording Tape is the world's only tape which combines ultra-low noise with a significant increase in output level across the entire audio spectrum. Other "low-noise" tapes simply do not have this increased output level.

By decreasing the basic tape noise, and increasing sensitivity BASF engineers have achieved a dramatic improvement in signal-to-noise ratio (Dynamic range) of as much as 8db over other quality tapes on the market. This means that recorders can reproduce sounds, from the faintest whisper to a booming crescendo, with more clarity, realism and less distortion than ever before.

BASF Low noise-High output magnetic recording tape — "the beginning of a new recording revolution."

MAURICE CHAPMAN & CO. PTY. LTD.,



276 Castlereagh Street,
Sydney, N.S.W., 2000.
Phone: 61 9881

frequency, five new notes were introduced between the eight notes of the octave. These notes were fitted between C and D, D and E, F and G, G and A, and A and B. These "half-notes" enabled the scale to be filled so that approximately the same intervals could occur in an octave regardless of which fundamental note was used. It is interesting to note that the use of "altered" notes was an infringement of canonical law for ecclesiastical singing and our present knowledge of fourteenth and fifteenth century musical practice is incomplete because accidentals were rarely marked on musical scores of this period.

The accidentals were given names which correspond to the nearest "whole" notes, and termed "sharp" (indicated by the symbol \sharp) and "flat" (indicated by the symbol \flat) to indicate whether the frequency was above or below the whole note to which it referred. For example the black note on a piano between C and D is known both as "C sharp" and "D flat." When written on a musical score the sharp and flat symbols are placed before the dot signifying the note.

With the insertion of the accidentals, the scale over one complete octave now contains 13 notes (including the first note of the next octave) which is shown as follows:

C, {C \sharp }, D, {D \sharp }, E, F, {F \sharp }, G, {G \sharp }, A, {A \sharp }, B, C.

By using the accidentals it is possible to play an eight-note scale over the octave with almost the same frequency ratios regardless of which note is used as a starting note. For example, comparison may be made between the two scales in the "key of C" and the "key of D," as follows:

Key of C True ratios	Key of D True ratios
C to D 1.125	D to E 1.111
D to E 1.111	E to F \sharp 1.130
E to F 1.067	F \sharp to G 1.061
F to G 1.125	G to A 1.111
G to A 1.111	A to B 1.125
A to B 1.125	B to C \sharp 1.12
B to C 1.071	C \sharp to D 1.071

As may be seen from the above illustration the ratios of the scales in the key of C and the key of D are very nearly the same if accidentals are introduced. This almost solves the problem of the scales but a few minor anomalies still occur with this system. One of these may be seen by considering the ratio required to obtain the note G sharp which occurs in the key of A. In determining the value of G sharp it is found to require a frequency of 1.5625 times the frequency of C, but the frequency of G sharp in the key of E requires a frequency of 1.600 times the frequency of C. Similarly the introduction of G sharp into the key of

B and the introduction of A flat into scales such as the key of E flat requires other variations in its frequency. As G sharp and A flat are the same note this presents difficulties on a keyboard instrument such as a piano or when string instruments such as the violin (the notes of which are not fixed but continuously variable) are to be played in unison. The same trouble occurs in all of the accidentals and to overcome this a TEMPERED SCALE was introduced.

In the tempered scale (the ratios of which are shown in Table 1) the octave is divided into 12 equal ratios (or semitones) of value 1.059463. Thus the note one higher than C, i.e., C sharp, has a frequency of 1.059463 times the frequency of C and the next note, D (which is one higher than C sharp) has a frequency of 1.059463 times that of C sharp or $(1.059463) \times 1.059463 =$

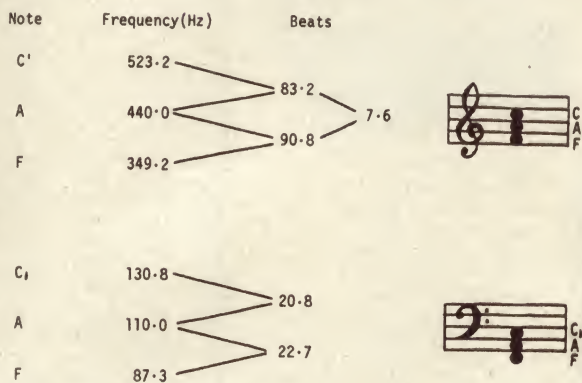

Figure 2. Beats in the major triad.

1.12246 times the frequency of C. The tempered scale has the added advantage that when a scale is played in any key the ratios are exactly the same—unlike the earlier example using the "true scale" when they are only approximately the same.

Few musicians are able to detect the difference between the true scale and the tempered scale, which differ by a maximum of 13 parts per thousand (on the note B).

The frequencies of the tempered scale and the musical notation for the "white" keys for three octaves are shown compared with part of a piano keyboard in figure 1.

The development of the musical scale, although the most fundamental part of music, is far from being the only part. The scale was developed on the principles of consonance and dissonance and the physical meanings of these words have changed with time. "Consonance" occurs when notes sound pleasant whether played harmonically or melodically and "dissonance" occurs when notes sound unpleasant. These words have real meaning only to the observer, and consonances such as the major triad F-A-C which sound pleasant today would have been treated as dissonances by the ancient Greeks.

Harmonic consonance (the sounding of notes at the same time to produce

BETTER RADIO RECEPTION FOR ONLY 20 Cents

Published by Eddystone, a complete guide how to get the best results from your receiver, contains 24 pages, with illustrations; covers propagation, aeriels, interference, and other useful data.

Write now with 20 cent postal note to:

R.H. Cunningham
PTY. LTD.

608 Collins Street, Melbourne,
Victoria, 3000

BUY RIGHT... FROM ENCEL

SOLID STATE STEREO AMPLIFIERS

With specifications that demand attention and most effective quality control in manufacture, it's not surprising that Sound stereo amplifiers command a high proportion of the markets in their respective price ranges. In Australia Encel prices make Sound amplifiers better value than ever. Ask for a trade-in valuation when you write or call!



SOUND SAQ-203

Frequency response is 30,200 Hz. and input sensitivity suits magnetic cartridges at 3mV. Output is 12 watts R.M.S. or 30 watts E.I.A. peak power. 18 low noise transistors. Headphone jack, all necessary controls, attractive front control panel. Speaker matching for 4, 8 and 16 ohm speakers or speaker systems. An ideal compact amplifier for use with tape recorders or for building into cabinets and bookshelves.

Price (Including sales Tax) **\$74.50**

ENCCEL
ELECTRONICS
(STEREO) PTY. LTD.

Head Office:

431 Bridge Rd., Richmond, Vic. 3121. Tel. 42 3762.

Sydney Store: Ground Floor, 2SM Building,
257 Clarence Street, Sydney, N.S.W. 2000.

Tel. 29 4563, 29 4564.

Wholesalers Trade-ins accepted Terms
Australia's Greatest Hi-Fi Centre

LEADER TEST INSTRUMENTS

NEW 5" OSCILLOSCOPE

Wide Range, High Sensitivity At A Budget Price.

FEATURES

Wide Bandwidth with high sensitivity, DC-10MHz at 10mVp-p/cm.
DC amplifiers for vertical and horizontal inputs.
Highly linear wide sweep range with automatic synchronization.
Vector pattern display for color TV circuits.



MODEL LBO-52B

SPECIFICATIONS

Vertical Axis	Deflection sensitivity Bandwidth, at -3dB	10mVp-p/em or better. DC: DC to 10MHz. AC: 2Hz to 10MHz.
Horizontal Axis	Deflection sensitivity Bandwidth, at -3dB	300mVp-p/em or better. DC: DC to 500kHz. AC: 2Hz to 500kHz.
Sweep Circuit	Frequency Synchronization	1Hz to 200kHz in six steps: H-TV at 15.75kHz/2. INT+ & -, EXT and LINE.
Size and Weight		10½" x 8" x 16½"; 24 lbs.

3" PRIMA - SCOPE

The PRIMA-SCOPE is a compact oscilloscope designed for all-around service. Its small and handy size will appeal to experimenters, servicemen and plant technicians who desire maximum performance with minimum space requirements.



MODEL LBO-31M

Maximum Performance With
Minimum Space Requirements.

Vertical Channel	Sensitivity: 80mVp-p/em, at 1kHz. Response: -3dB, 3Hz to 1MHz.
Horizontal Channel	Sensitivity: 2.5Vp-p/em. Response: -3dB, 3Hz to 400kHz. (at max GAIN)
Size and Weight	Sweep Frequency: 10Hz to 100kHz in 4 steps. 7" x 4" x 12"; 11 lbs.

FROM ALL GOOD TRADE HOUSES
WHOLESALE ENQUIRIES ONLY TO
SOLE AUSTRALIAN REPRESENTATIVES:
ASTRONICS AUSTRALASIA PTY. LTD.,
ALL STATES.

a pleasant sound) is allied with the production of overtones, or harmonics, by the instrument being used. Generally dissonance occurs between two notes sounded together if a beat frequency between 10 and 50 per second is formed by the notes, either by their fundamentals or any of their overtones. For example, the major triad F-A-C, when sounded near the centre of a piano keyboard, sounds pleasant and is considered the most perfect consonance, but when sounded two octaves lower the result is not pleasant. It can be seen from figure 2 that beats of 90.8, 83.2 and 7.6 per second occur with the fundamentals near the centre of the piano keyboard and these are not in the range of 10-50 per second, but two octaves lower, beats of 22.7 and 20.8 per second occur. The reverse effect can also occur, as in the case of B and C, near the middle of the piano keyboard (B = 493.9Hz and C = 523.2Hz) the notes are dissonant with a beat of 29.3 per second. These same notes two octaves lower (B = 123.5Hz and C = 130.8Hz with a beat of 7.3 per second) would not sound harsh were it not for the fact that a piano, especially in the low notes, is rich in overtones. On the stopped pipes of an organ, which have nearly pure notes with very little overtones, these two lower notes (B = 123.5Hz and C = 130.8Hz), do not; whereas B = 493.9Hz and C = 523.2Hz do sound dissonant.

It is possible to arrange two notes played together so that the beat produced acts as a third note which will fully harmonise with the two initial notes, thus forming a triad. Although this beat is of lower intensity than the two initial notes it is readily apparent on the diapason stop of an organ and can form a more "mellow" triad than the playing of the three notes together. An example of this is the sounding of C (261.6Hz) and F (174.6Hz) together which produces a difference tone (beat) of 87.0Hz, one octave lower than the F initially played. Similarly playing the major triad C-E-G (261.6Hz, 329.6Hz and 392Hz) produces beats very close to C₂ (65.6Hz) two octaves lower and C₁ (130.8Hz) one octave lower than the original. If the true scale, rather than the tempered scale, is used the beats in these examples are at the exact frequencies of the lower notes.

The "dissonance" figures of 10-50



NOTE	TRUE SCALE	TEMPERED SCALE	PERCENTAGE DIFFERENCE
C	1.00000	1.00000	0
C#,D \flat	1.05946	-
D	1.12500	1.12246	-0.3
D#,E \flat	1.20000	1.18921	-0.9
E	1.25000	1.25992	+0.8
F	1.33333	1.33484	+0.1
F#,G \flat	1.41421	-
G	1.50000	1.49831	-0.1
G#,A \flat	1.60000	1.58740	-0.8
A	1.66667	1.68179	+0.9
A#,B \flat	1.78180	-
B	1.87500	1.88775	+1.3
C'	2.00000	2.00000	0

Tables of true and tempered intervals (above) and overtones produced by musical instruments (right).

INHARMONIC			
Instrument	Overtones as multiples of fundamental frequency		
Drum	1.594	2.136	2.296
Xylophone	2.76	5.43	
Thin Bells	2.928	5.423	8.771

HARMONIC	
Instrument	Harmonics in order of intensity
Flute	1, 2, (4,3)
Violin	{ E String 1, 3, (2,4) A String 1, 5, 2, 4, 3, (6,7,8) D String 1, 2, 3, 5, 4, 6, (7,8,9,11,12) G String 4, 5, 3, 2, 1, 6, (7,8,9,11,12,13,14)
Clarinet } Saxophone }	8, 9, 10, 3, 1, 7, 11, 12, (5,4)
Oboe	5, 4, 6, (10,37,11,8,2,1)
Piano	Low notes: Weak fundamental. All harmonics up to 42 nd Mid notes: 1-10. All about equal. High notes: 2, 1.
Organ Pipes	1, (2,3)

per second are only approximate and often depend on the individual. For example the chord of the "augmented eleventh" (as used by George Gershwin in "Rhapsody in Blue") comprising C, E, G, B, D' and F', contains second order beats of 11.2, 31.4 and 46.0 per second but this is still recognised as consonant, and is common in jazz.

Because of the different harmonic content of different types of instruments, music which sounds good on one type of instrument may sound dissonant when played on another, and special "arrangements" of the musical score have to be made to translate from one type of instrument to another.

Harmonic content is also an important consideration when two or more types of instruments are to be played together. The harmonics of one type of instrument can beat with the harmonics of another to produce dissonance even though the tune may be consonant if played individually by each instrument. For this reason the string quartet was favoured by classical composers and the addition of the piano to the string quartet to form a quintet is not nearly as good as the clarinet quintet in which the piano is replaced by the clarinet. The harmonics of the clarinet are sufficiently like those of the strings that the tone combination is homogenous when required (which is not true of the piano quintet), yet is sufficiently different to be readily discernible when required, as may be seen in Brahms' Clarinet Quintet, opus 115.

Some instruments produce "partial tones" which are not harmonics of the fundamental and care must be exercised in the use of these with other instruments. Such instruments are referred to as "inharmonic" and the partial tones produced by some of these (in terms of the fundamental frequency) are listed in Table II. Also listed in Table II are the harmonics produced by some other common instruments.

In addition to the harmonic content, many different instruments play

over different frequency ranges. As an example, the piano notes cover the range 27.5Hz to 4.1856KHz; the pipe organ may extend down to 16.35Hz (C—a 30ft pipe) and up to 16.5KHz; the piccolo extends from 523.3Hz to 4.699Hz. Most other instruments are limited to cover only part of the range of a piano. The use of high fidelity amplifying equipment with responses

up to 40KHz is not necessary to reproduce the fundamental frequencies but to reproduce the harmonics of the instruments, and, although many of these harmonics are outside of the range of detection by the human ear, beats produced by them are detectable and the absence of these beats can often be detected even though the beats, when present, are faint. ■

PHOTOMULTIPLIER TUBES

HAMAMATSU TV CO. LTD.

HIGH PERFORMANCE — LOW COST

PM TUBE		RESPONSE
HTV-R106	1,600 to 6,500°A	Critical Applications
HTV-R136	1,600 to 8,000°A	Wide range spectral response
HTV-R166	1,600 to 3,200°A	U.V. Range
HTV-R196	4,000 to 12,000°A	Vis. and infrared range
HTV-R213	1,850 to 8,000°A	U.V. to near IR Range

OTHER TUBES AVAILABLE R212, 913A, IP21, IP22, IP28
9 Stage, side-on types, 11 pin base

FOR FULL DETAILS PLEASE CONTACT

Sole Australian Agents

VARIAN TECHTRON PTY. LTD.

Springvale Road, North Springvale, Victoria

Phone: 560 7133

AMPLIFIERS — PREAMPLIFIERS — TUNERS — CONTROL UNITS —
GUITAR UNITS — INSTRUMENTS — INVERTERS — CONVERTERS —
RECEIVERS — TRANSMITTERS — REGULATED POWER SUPPLY —
TRANSISTOR AND VALVE TYPES.

1967
ALL WAVE
3-4-5-6-7



ANY PART FROM A
SINGLE RESISTOR
TO THE FULL KIT

POPULAR KITS - TOP QUALITY - LOWEST PRICES

INSTRUMENTS
C.R.O.

1. 5in wide range.
2. 1963. 3in cal.
3. Audio.
4. 1966. 3in.
5. 1968—Audio.
6. Electronic SW.
7. W/band Preamp.

MULTIMETERS
and V.T.V.M.'s

8. 20K ohm/Volt protected M/M.
9. Probe for above.
10. Protected D.C. M/M.
11. Meterless V/meter.
12. A.C. Millivoltmeter.
13. A.C. Solid State Millivoltmeter.
14. Solid State A.F. Millivoltmeter.
15. Noise Distortion Millivoltmeter.
16. Standard V.T.V.M.
17. 1966—V.T.V.M.
18. 1968—V.T.V.M.

BRIDGES

19. Standard R/C.
20. 1966. R/C.
21. 1968 R/C and Signal Injector.

TV INST.'s.

22. Sweep and marker Generator.
23. Dual sweep Gen.
24. Silicon diode sweep Gen.
25. Silicon diode noise Gen.
26. Pattern Gen.
27. Trans. pattern Gen.
28. Wide range pulse gen

AUDIO INST.'S

29. 1960 Audio Osc.
30. 1962 High perf. audio Gen.
31. Crystal locked std.
32. Electronic tuning standard.
33. 1965. Solid State audio osc.
34. Direct reading A.F. meter.
35. Sq. wave Gen.
36. 1967 transistor audio Gen.
37. Additive frequency meter.

38. A.F. tone burst gen.
- 38A. 1968. Solid state A.F. Generator.

R.F. INST.'s.

39. 6-band service oscillator.
40. "Q" meter.

40A 1969 Dip Osc. Solid state.

41. G.D.O. wide range.
42. G.D.O. adaptor.
43. Trans. service osc.
44. Simple signal injector.
45. Transistorised signal tracer.
46. Transistorised osc.
47. Basic test osc.
48. Transistor test oscillator.

MISCELLANEOUS
INST., ETC., KITS

49. 1960 Trans. Tester.
50. 1968 Transistor test set.
51. Valve and Transistor tester.
52. Electronic Stethoscope.
53. Moisture alarm.
54. Electronic Pistol range.
55. Transistor Geiger Counter.
56. Light beam alarm.
57. Burglar alarm.
58. Flasher unit.
59. Transistor alarm.
60. Electronic switch.
61. Photo Timer.
62. Direct reading impedance meter.

63. Electronic anemometer.
64. S.W.R. indicator.
65. Simple proximity alarm unit.
66. Pipe and wiring locator.
67. Electronic metronome.
68. Monophonic organ.
- 68A. Keyless organ.
- 68B. Theremin.
- 68C. Laser unit.
- 68D. Color organ.

BATTERY CHARGERS

69. Universal unit.
70. 1 amp unit.

REGULATED POWER SUPPLIES

71. Transistor. 9v.
72. Transistor, fully protected supply.
73. 1966 H.T. unit.
74. 1968 lab. type. D-30v. supply
- 74A Simple Pwr. supply.

VOLTAGE/CURRENT CONTROL UNITS

75. Vari-watt unit.
76. Vari-tach. motor speed control.
77. 2KW auto-light dimmer.
78. 4KW auto. light dimmer.
79. Model train control unit.

80. Model train control unit with simulated inertia.

81. Above-hi-power.
82. No. 81 with simulated inertia.

TACHOMETER UNITS

83. 6 or 12v Std.
84. 6 or 12v Mullard.
85. 6 or 12v with dwell angle.
86. Tachometer and dwell angle unit for service stations.

TRANSISTOR IGNITION

87. Ro-Fo. 6 or 12v.
88. Hi-Fire 6 or 12v. (transformer).

POWER CONVERTERS

89. D.C.-D.C. 60w.
90. D.C.-D.C. 40w.
91. D.C.-D.C. 40w. 12v—input.
92. D.C.-D.C. 70w 12v—input.
93. D.C.-D.C. 100w 12v—input.
94. D.C.-D.C. 140w. 24v—input.
95. D.C.-D.C. 225w. 24v—input.

HIGH FIDELITY AMPLIFIERS MONO UNITS

96. Hi-Fi 3.
97. Mullard 3.3.
98. Mullard 5-10.
99. Mullard 5-10 transistor.
100. Transistor 20w.
101. Transistor 60w.

STEREO UNITS

102. Mullard 2-2.
103. Mullard (v) 3-3.
104. Mullard (t) 5-5.
105. Mullard (t) 5-5.
106. Mullard (v) 10-10.
107. Mullard (t) 10-10.
108. Philips Twin 10.
109. S.T.C. 10-10.
110. Wireless world transistor 20-20.

111. Hi-Fi 60-60.
112. Playmaster 2-2.
113. Playmaster 3 plus 3.
114. Playmaster unit 3.
115. Playmaster unit 4.
116. Playmaster 10 plus 10.
117. Playmaster 101.
118. Playmaster (t) 105.
119. Playmaster (t) 113.
120. Playmaster (t) 115.
121. Playmaster (v) 118.

P.A. UNITS

122. 10 watt std.

123. 25 watt std.
124. 35 watt std.
125. 30 watt (t).
126. 100 watt std.
127. stereo P.A.

GUITAR UNITS

128. 10 watt std.
129. 25 watt std.
130. 35 watt std.
131. 50 watt std.
132. 70 watt (t).
133. Playmaster 102.
134. Playmaster 103.
135. Playmaster 40w. 116.
136. Playmaster 60w 117.
137. Guitar fuzz box.
138. Guitar Waa-Waa.
139. Reverb unit.
140. Guitar preamp.
- 140A. Guitar 50w. Solid State P/M 125.

STEREOGRAMS

141. Playmaster 105.
142. Playmaster 106.
143. Playmaster 107.
- 143A Playmaster 124.

CONTROL UNITS

144. Playmaster No. 9.
145. Playmaster No. 10.
146. Playmaster No. 104.
147. Playmaster No. 112.
148. Playmaster No. 120.
149. Mullard 2v.
150. Mullard 3v.
151. Philips Miniwatt.
152. Wireless world stereo system unit.

PREAMP UNITS

153. Transistor—Mono.
154. Transistor—Stereo.
155. Transistor—Silicon. mono.
156. Transistor F.E.T. mono.

157. Transistor dyn. mic. mono.
158. Above-Stereo.
159. Playmaster 115 F.E.T. Stereo.
160. Playmaster 118 map.
161. Sound projector.

MIXER UNITS

162. Trans. 4 ch. (1966).
163. Trans—4 ch. (1967).
164. Valve—4 ch.

TUNER UNITS

165. Playmaster u/style.
166. Playmaster No. 11.
167. Playmaster No. 114.
168. Playmaster No. 122.
169. Playmaster No. 123.
170. Philips Miniwatt.
180. Trans.—Long range.

TAPE UNITS

181. Trans. Preamp.
182. Playmaster 110 (M).
183. Power Unit 110.
184. Adaptor 110.
185. Playmaster 119 Adaptor.
186. Transistor V.O.X.
187. Tape Actuated relay.
188. Mullard Trans Tape Amp.

RECEIVERS

189. Fremodyne 4.
190. Fremodyne 4 R.F. Sock only.
191. Synchrodyne.
192. Communications RX.
193. Deltatet RX.
194. 3 Band Double Change S/het RX.
195. Explorer VHF Transistor RX.
196. Interceptor 5 Semi-Comm. RX.
197. 1967 All-Wave 2
198. 1967 All-Wave 3
199. 1967 All-Wave 5
200. 1967 All-Wave 6
201. 1967 All-Wave 7
202. Transports 7
203. Transistor 3 Band. 8
204. 3 Band 2V RX.
205. 3 Band 3V RX.
206. Interstate 5
207. Versatile Mantel Set.
208. All-Wave Transistor 3
209. A.B.C. 3
210. 1968 F.E.T.
- 210a. I/C TRF Rx.
- 210b. R.F. Preamp.
- 210c. "Q" Multiplier.

TRANSMITTERS

211. 144 MHz 50W. Linear Final.
212. 144 MHz 20W.
213. 144 MHz 75W.
214. 144 MHz 18W.
215. 144 MHz S.S.B.
216. 3 Band A.M.
217. Basic 3 Band.
218. 5 Band. S.S.B.
219. 1967 S.S.B.

CONVERTERS

220. 50 MHz.
221. 144. MHz.
222. 50 and 144 MHz Crystal Locked.
223. 1965 S/W.
224. 1965 S/W 2 Band.
225. 1966 3 Band.
226. Basic S/W.

V.F.O. UNITS

227. Remote Unit.
228. 7, 8 and 9 H.F. and V.H.F.
229. All transistor.

Phone 63-3596

E. D. & E. (SALES) PTY. LTD.

Phone 63-3596

232 FLINDERS LANE, MELBOURNE, VICTORIA 3000

**K
I
T
S**

Public Address Units — Geiger Counters — Metal Locators — Decade Boxes — Mixers — Battery Chargers — Oscillators — Bridges — Parts Supplied for Projects in Electronics (Aust.), Wireless World, Practical Wireless, Electronics World, Electronics Illustrated, Practical Electronics, etc.

**K
I
T
S****P/M
124**

1968 Solid State. V.T.V.M.
ELECTRONICS (Aust.), Dec., 1968.

BATTERY CHARGER 1A
ELECTRONICS (Aust.), Feb., 1966

**PLAYMASTER 116 and 117
and 125 GUITAR AMP.**

Electronics Australia
June 1967 — 40 watt
July — 1967 60 watt
July 1969 — 50 watt



3-BAND SHORT-WAVE CONVERTER
ELECTRONICS (Aust.), May, 1966.

LAB QUALITY

Regulated Power Supply (0-30v)
ELECTRONICS (Aust.), Sep-
tember, 1968.

1966 R/C Bridge
May, 1966.



**PUBLIC ADDRESS and
GUITAR AMPLIFIERS**

10, 25, 50 and 100 watt
units



3-BAND DOUBLE-CHANGE RECEIVER
ELECTRONICS (Aust.), April, 1966.

1966 3ln CRO
ELECTRONICS (Aust.), May, 1966.

Playmaster 122
Program Source.
Electronics (Aust.),
August, 1968.

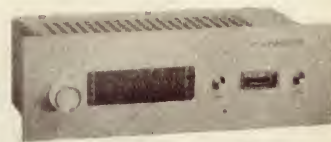

FOUR-CHANNEL AUDIO MIXER
ELECTRONICS (Aust.) Feb., 1966 & 1967

3-BAND 3-RECEIVER
ELECTRONICS (Aust.), Nov., 1966

**TRANSISTOR MILLIVOLT
METER**

Electronics (Aust.),
May, 1968.

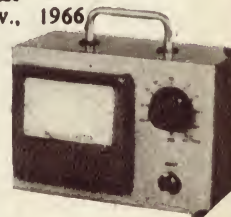

THE "MUSICOLOUR" KIT

OPERATE A COLOUR LIGHT SYSTEM FROM
YOUR AMPLIFIER

FULL KIT OR INDIVIDUAL PARTS

MAJOR STOCKISTS OF ALL GENERAL RADIO & ELECTRONIC COMPONENT PARTS -- YOU NAME IT -- WE WILL QUOTE

VALVES — TRANSISTORS — ZENER & POWER DIODES — SEMI-CONDUCTORS
— DIACS — TRIACS — S.C.R.'S. — I/C'S. SPEAKERS — MICROPHONES —
COILS — IFT'S. TRANSFORMERS — INST CASES — METALWORK. PLAYERS
& CHANGERS — METERS — RELAYS — CONDENSERS — RESISTORS — BEZELS
— STYL II — CARTRIDGES — RECORDING TAPE — PROBES — INSTRUMENTS
— POTENTIOMETERS — CRYSTALS — FERRITE BEADS — CORES — BALUNS
— TERMINALS — CO-AXIAL PLUGS & SOCKETS — MULTI CONNECTORS —
PRINTED CIRCUIT BOARDS — COPPER WINDING WIRE — ETC. — ETC. —

Phone 63-3596

E. D. & E. (SALES) PTY. LTD.

Phone 63-3596

232 FLINDERS LANE, MELBOURNE, VICTORIA 3000

LEAK

... the finest high fidelity equipment at realistic prices!

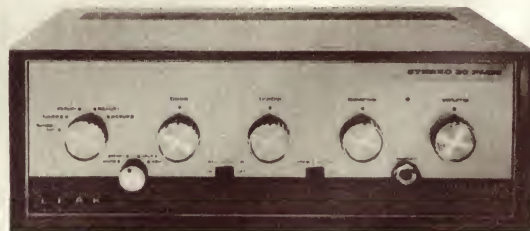

*The most
Wonderful
Gift of them
all!*

1 LEAK 70' STEREO
AMPLIFIER \$298.00

The 'Stereo 70' is full of latent power - up to 35 watts r.m.s. per channel. Distortion is a mere 0.1% at 1,000 Hz for all power outputs up to 25 watts r.m.s. per channel.

2 LEAK MINI-SANDWICH
SPEAKER \$85.00

This superlative small speaker system provides almost identical performance as its larger companion — with the exception of the lowest octave.

3 LEAK SANDWICH MK.11
SPEAKER SYSTEM \$119.00

Available in mahogany, teak and walnut, this beautifully finished enclosure is the still only compact speaker system offering substantially linear frequency response. Size 26" x 15" x 12".

4 LEAK STEREO 30+
AMPLIFIER \$198.00

The New Stereo 30 Plus combines the long proven circuitry of the Stereo 30 with a new range of Silicon transistors and facilities up-dated to meet today's needs:-

*See and hear LEAK Equipment today at leading Hi-Fi Stores and sound centres. For leaflets and information write to:

LEAK HI-FI

H.J. LEAK (AUST) PTY. LTD.
P.O. BOX 14 FRENCH'S FOREST,
N.S.W. 2086 PHONE 94 4902

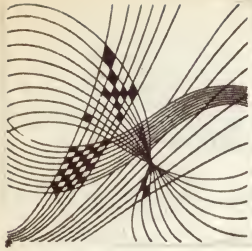

CLASSICAL RECORDINGS

Reviewed by Paul Frolich

BARTOK: The Six String Quartets.
The Bartok Quartet of Budapest.
Record Society stereo 6306-8 (3 discs).

At the time of Bartok's death in 1945, there would not have been more than a handful of professional musicians in Australia who had heard these six string quartets and, had such a set been available then, it is unlikely that 50 copies of it could have been sold to Australian collectors. Since then, there has been nothing less than a revolution in listening habits; the quartet have been performed in public on several occasions, by local as well as imported ensembles, and to capacity audiences. Imported recorded sets of the quartets have been sold for years; in 1962, the World Record Club issued the whole set on three records, played by the Vegh Quartet. It is nothing short of amazing (and very gratifying!) that there should be a market for another such set for their subscribers a mere seven years later.

My own position is probably not far outside the normal listening range of keen listeners. In 1945 I had heard two of the quartets and had been unable to make anything of them. It was not until September, 1961, when the Fine Arts Quartet from Chicago played the whole cycle in Sydney, that I began to see the light and I have become increasingly familiar with and attached to these works ever since. I am aware that the leading performers regard Bartok's quartets as probably the most important works in the repertoire after the late Beethoven quartets; I now agree that they have quite a lot in common with the Beethoven works and although there are still many fine points that puzzle and elude me, the quartets are firm favourites of mine.

Most of us, brought up on traditional European music, have difficulty in listening to works in completely new idioms and it is useless trying to assess such compositions in terms of the traditional. The best of Bartok's music, which includes at least five of the quartets, remains inaccessible to all who are not prepared to listen with utter concentration and to cast aside all their old notions. Given such an attitude, and repeated listening, one may expect the beauty and content of the music to reveal themselves.

With increasing familiarity comes discrimination. I am no longer quite sold on the 1st quartet and find that one should not hear it too often. The others, particularly the 4th and 6th are immensely rewarding and well deserving of anyone's very close attention. If you are fortunate enough to be a good score reader, you will benefit even more if you manage to get

hold of the scores, to follow while listening. In any event, you will become aware of much that is easily related to other music of recent decades, to say nothing of the foundation in Hungarian folk material which is ever present in Bartok's music and of the interest invariably created by skilfully written music.

The ensemble heard on this disc is a Hungarian one, working under the supervision of Professor Mihaly, one of the leading Bartok specialists. Their playing is highly polished, technically flawless and, to my ear, the equal of any other set of the works I have yet heard. The string tone is clean and clear and the recorded sound all one could wish for.

There are fine recordings of these works already in existence, played by the Vegh, the Fine Arts, the Hungarian, Juilliard and Tatrai Quartet. I imagine that, should you already own one of these sets, you might hesitate about getting it duplicated. I have heard most of them, but do not recall their performances in sufficient detail to make a valid comparison. I can only say that this set is 'absolutely first-rate, in every respect and that nobody is likely to regret adding it to their collection of great musical treasures.

★ ★ ★

DVORAK: Symphony No. 7 in D minor, op. 70. Israel Philharmonic Orchestra, conducted by Zubin Mehta. Decca stereo SXL 6381.

TCHAIKOVSKY: Symphony No. 5 in E minor, op. 64. Israel Philharmonic Orchestra, conducted by Zubin Mehta. Decca stereo SXL 6380.

These two recordings were made in London's Kingsway Hall during the final days of the orchestra's brief tour of Britain in May, 1968. The recorded sound is among Decca's best and the discs may well be welcomed as a hi-fi item and as a souvenir of the orchestra's tour.

Musically, and in performance quality, I cannot be equally enthusiastic. Mr Mehta is undoubtedly one of the most exciting and dynamic of living conductors and he manages to enthuse his players as few conductors can. Unfortunately, the orchestra is not equal to the stimulus. The string sections are decidedly poor — the violins are shrill, the celli and violas lacking in richness.

Having heard this orchestra on other occasions, I think these discs fail to do it justice. It is probable that, by the end of their tour, the players were over-tired and simply no longer able to give of their best — as happened to the English Chamber Orchestra during their recent tour of Australia. Allowing

for these shortcomings, the reading of the Dvorak work at any rate is quite worth the trouble. Mehta's interpretation is direct, accurate and unaffected. The first movement is taken rather slowly and, much as I can enjoy this performance in some respects, it is a long way from displacing the performances by Monteux and Kertesz.

The Tchaikovsky comes off less well. There seems to be an utter absence of spontaneity and, however meticulous Mehta is in attending to details, there is little trace of anything personal in all this. The only exception is the final movement, which does get off the ground and becomes both lively and alive. In view of the many first-rate recordings of this work already in existence, I doubt that the disc will attract many collectors except for the marvellous Decca sound.

★ ★ ★

HAYDN: Overture in D major (1777); Concerto for Harpsichord and Orchestra in D major.

J. C. BACH: Harpsichord Concerto in A major. George Malcolm harpsichord; The Academy of St. Martin-in-the Fields, directed by Neville Marriner. Decca Stereo SXL 6385.

Haydn's Overture, originally titled "Sinfonia," is a slight but utterly delightful work which I had not heard in this form previously. Haydn fans will easily recognise it, however, as one of the alternate final movements to the symphony No. 53. It is scored for strings, oboes, bassoons, horns, drums and solo flute — the last two possibly having been added by a hand not Haydn's. The work seems to stand well enough on its own and is here played with great gaiety and verve — a sheer joy.

The D major concerto is that usually described as opus 21 and more commonly heard on the piano; on that instrument, Alfred Brendel gave a wonderful account of it in a 1967 recording. More recently, Veron-Lacroix and Igor Kipnis have returned to the harpsichord version, probably the original one. I recently reviewed the C.B.S. recording by Kipnis with considerable enthusiasm.

Comparison of two different issues only a few months apart becomes all the more interesting when one sees that the accompaniment is given by the same "director" — I have no doubt at all that the "London Strings" heard on the C.B.S. disc are Mr Marriner's usual colleagues too! Apart from considerable differences in tempo, there are other ways in which Kipnis tends to romanticise; while Malcolm, ever the purist, does all he can to keep emotion out of his performance. The differences between the instruments as such are not so very great; Kipnis plays one built by Rutkowski and Robinette and I presume that Mr Malcolm, as usual, plays one made by Thomas Goff.

Interpretation apart — and here my own taste leans a little towards Malcolm's purism — the recordings differ considerably. Kipnis' performance is greatly enhanced by the continuo, provided by a second harpsichord, a Gobel one. By comparison, the sound produced by George Malcolm is at times a little too discreetly covered by the strings.

It is not easy to come down finally for one version or another. Unless you



For quality and value, for world's best Hi-Fi materials
RECORDED MUSIC SALON IS UNBEATABLE



UNIT 1: World's most brilliantly designed turntable and pick-up arm, ERA, made in France—basic resonance 2 cycles, will track perfectly as low as 1/10th gram (you cannot afford not to have a perfect turntable and arm), Armstrong 521 integrated fully transistorised stereo amplifier frequency response from 20-20,000 cycles plus or minus 1 db less than 1/2% distortion on 25-watt RMS output measured 1 kilocycle, world-famous Empire 888TE diamond magnetic cartridge, frequency response from 6-32,000 cycles, compliance 25 x 10⁻⁶ cm/dyne, Empire model 2000 loudspeakers frequency response from 30-18,000 cycles, power handling, 60-watt.

Total Price: \$786.

UNIT 2: Armstrong Model 127 tuner/amplifier AM-FM, 2 Goodmans 10in Twincone loudspeakers, frequency response from 40-18,000 cycles.

Plus PE34 turntable and Decca Deram cartridge (diamond needle).

Total Price: \$290.

UNIT 3: Schaub-Lorenz Model 4000 integrated stereo tuner/amplifier, fully transistorised, most beautifully designed stereo unit, power handling 18-watt per channel, superb sound reproduction on the full frequency range from 20-40,000 cycles, ERA Mk. 4 beautifully designed turntable and arm complete with base, Empire 808 cartridge, 2 Slim-Line speaker systems made by Schaub-Lorenz complete in cabinets.

Total Price: \$400

UNIT 4: Schaub-Lorenz Model 3000 stereo tuner/amplifier short-wave broadcast FM, Sound reproduction: Superb sound reproduction ensured by push-pull output stages with a continuous sine-wave power of 2 x 10 watts. Music power: 2 x 15 watts. Balance Control. Separate treble and base controls. * Suitable for magnetic and ceramic cartridges. Plus 2 Jordan Watts loudspeakers, frequency range from 25-20,000 cycles, Era Mark IV turntable with Empire 808 cartridge.

Total Price: \$400

UNIT 5: Armstrong 227 integrated stereo tuner amplifier AM-FM 10 watts RMS per channel. Frequency response from 30-20,000 cycles plus or minus -1dB less than 1/2% distortion measured at 8-watt RMS. Plus 2 Goodman's Twinxiette loudspeakers.

Total Price: \$220

Plus a Dual 1210 turntable complete with Decca Deram cartridge total price.

UNIT 6: Schaub-Lorenz STV101 stereotronic transistorised amplifier power output 10-watt per channel, frequency response from 20-40,000 cycles plus or minus 1 dB, 2 Schaub-Lorenz Slim Line Hi-Fi speakers complete in cabinets.

Total Price: \$335

Plus ERA Mk. 3 world's finest turntable, complete with arm, hydraulic-controlled lowering device with Empire 888E cartridge, add \$180.

UNIT 7: Armstrong 226 AM-FM tuner amplifier 10-watt RMS per channel, complete with 2 Wharfedale 10in RSDD loudspeakers.

Plus PE 34 turntable complete with 808 cartridge, frequency response from 10-30,000 cycles 30 dB separation.

Total Price: \$400.

UNIT 8: Leak Stereo 30 integrated transistorised amplifier, 2 Leak Mini Sandwich loudspeakers, PE34 Hi-Fi turntable, Empire 808 cartridge.

Total Price: \$410

UNIT 9: Schaub-Lorenz Cassette Player, Armstrong 521 integrated stereo amplifier, 25 RMS per channel, plus two Harman Kardon HK50 loudspeakers omnidirectional, frequency range from 30-20,000 Hz.

Total Price: \$500

Cost of the amplifier is \$240. Cost of the cassette player is \$70.

UNIT 10: Nord Mende 8001 professional tape recorder. The "no compromise" three-motor tape recorder makes an ideal component for the Nord Mende audio system. Simplicity of operation ensured by colour coded light indicators to show the track which is switched to record or playback at any given time; separate equalising pre-amplifier for recording and playback; built-in monitoring amplifiers and speakers (2 x 3 Watt output). Plus ERA Mk. IV turntable complete with suitable cartridge. Retail price, \$700.

Our Special Pre-Christmas Price: \$600

UNIT 11: Kenwood TK 250 solid state stereo amplifier complete with Dual 1210 turntable.

Total Price: \$210

Plus 2 Jordan Watts loudspeakers, add \$100.

UNIT 12: ERA Mark III turntable complete with Empire 888VE diamond magnetic cartridge frequency response from 6-35,000 cycles, high-quality turntable.

Total Price: \$208.

RECORDED MUSIC SALON

G. PINCZEWSKI

TRUE FIDELITY

**23 COLLINS STREET,
 MELBOURNE 3000.**

Telephone 63-6257

are definitely in favour of hearing this work played on the piano, both these interpretations, in their various ways, are bound to give pleasure.

It will be the contents of the second side which must help one's decision. Kipnis gave us a marvellous version of Mozart's concerto K. 271; as nobody else has recorded this work on the harpsichord, those who prefer this to the usual piano sound will clearly buy the Kipnis disc.

On the Decca disc, the concerto of J. C. Bach is an even rarer bonus; since his enormous output included no less than 37 concerti for "clavier," it is not surprising that the one played here makes its first appearance on disc, as far as I can ascertain. There are considerable doubts about the work's authenticity and while there are sections in it which might well have been written by the gallant Johann Christian in his younger days, there are about as many which point to the less polite methods of his elder brother, Carl Philipp Emanuel.

What matters, in any event, is that this is a delightful work, played with great skill and beauty of tone by Mr Malcolm. Throughout the two sides of the disc, the orchestra is as good as, apparently, only this ensemble can reliably be; and the quality of the Decca sound is truly excellent, with bright stereo and very clear instrumental texture.

★ ★ ★

DEBUSSY: La Mer; Nocturnes (Nuages; Fetes; Sirenes). L'Orchestre de Paris, conducted by Sir John Barbirolli. H.M.V. stereo OASD 2442.

Graced by a jacket with a superb Monet sea-scape reproduction, this is quite an interesting disc. The fact of Sir John's return to conduct in France after an absence of many years stirred many Francophiles to enthusiasm. Of equal interest is the fact that this orchestra, especially formed in 1967, is being groomed as a true prestige ensemble. Since first-rate orchestras have always been extremely rare in France, one will follow their progress with a sympathetic ear.

This is certainly not one of the most exciting recordings of these works, but it is a thoroughly sound one, without any excesses. If *La Mer* is duller than necessary (certainly by comparison with such a wonderful reading as was Szell's), there is a distinctive French flavour to be heard in it, at any rate.

Whilst this orchestra is not, at present, one of the world's great ones, its members certainly have the key to the correct sound for Debussy. The performances, which are thoroughly constructed, are gloriously measured ones, made the more impressive by the French studio's grandly resonant characteristic, which is utterly at variance with the surgically clean English sound we are so used to. It is a sound which, in the event, suits the music very well. As far as the orchestra is concerned, every section of it plays exceedingly well.

The first two movements of *La Mer* are taken at a considerably slower pace than is now customary, but the final one is exactly as "anime et tumultueux" as the composer prescribed. The only blemish (and not everyone will agree that it is a blemish)

Elisabeth Schwarzkopf sings Lieder

THE ELISABETH SCHWARZKOPF SONG BOOK, Volume 2. Songs by Schubert, Mozart, Schumann, Mahler, Wolf, Strauss, Moussorgsky and Tchaikovsky; with Geoffrey Parsons, piano. H.M.V. stereo OASD 2402.

On December 9, Elisabeth Schwarzkopf will be 54 years old and it seems fitting that her spectacular career as one of the greatest sopranos of our day should come under detailed scrutiny. In the long course of her public life, two characteristics seem to stand out: durability and versatility. The former was demonstrated during her 1967 tour for the A.B.C. Although her voice had begun to darken a little it was still pure gold, she continued to move with the grace of a young queen, and her musicianship and artistry had merely deepened since her previous tour in 1949.

Miss Schwarzkopf's versatility is best studied in a record catalogue. In a vast range of dramatic, lyric and epic music, she was always assured, sensitive and musically immaculate. Ordinary versatility apart, it is as an interpreter of great songs that she probably made her greatest contribution to our experience as listeners and it is in songs, particularly in German lieder, that a singer's greatest versatility is needed.

is Sir John's audible singing with the orchestra.

The *Nocturnes*, a less exacting piece, is also rather on the slow side but, despite the unfavourable acoustics, every sound emerges crystal clear. Whatever one's reservations about the lack of excitement, the performances do full justice to Debussy and are quite a triumph for Barbirolli.

★ ★ ★

TCHAIKOVSKY: Piano Concerto No. 1 in B flat minor, op. 23 Marina Mdivani, piano; Colonne Concerts Society Orchestra; conductor Pierre Dervaux.

RIMSKY KORSAKOV: Capriccio Espagnol.

BORODIN: In the Steppes of Central Asia. Philharmonia Orchestra; conductor Andre Cluytens. H.M.V. Concert Classics stereo SOELP 9481.

Much as bargain-priced records are appreciated by collectors who find them selves overwhelmed by the range of available music, some of them are not genuine blessings. Of late, a number of first issues have appeared on bargain-labels and it is beginning to be clear that one should be very cautious about any items which are not reputable and genuine re-issues.

I know nothing of Miss Mdivani, a Georgian (U.S.S.R.) pianist in her early thirties other than there have been one or two earlier recordings by her, which I have not heard, and that she has won some international competitions. On the evidence of this recording, she is a pianist who may repay watching, but she is not, at this stage, in the top rank. There isn't anything wrong with Miss Mdivani's playing; she plays this popular concerto probably just as capably as any other aspiring virtuoso, but it is just as certain that she has nothing

In the items on this disc, Miss Schwarzkopf moves effortlessly through the whole gambit of human emotions, proving once again a superb singer and actress.

In a collection such as this one, favourites are bound to be a wholly personal matter. On first hearing, it was the three Mahler songs that gripped me most powerfully and seemed to demonstrate the singer's histrionic ability most convincingly. The next time, it was in the Wolf songs where she moved me most by her expressive range.

I am convinced that there is not any one song on this disc that will not, at some time, take one's fancy, and it is safe to predict that, however much different interpretations of these songs may appeal to an audience, Miss Schwarzkopf's will be among the chosen few "definitive" versions of almost any piece she has ever undertaken.

Geoffrey Parson's accompaniments, a true partnership as distinct from a discreet one, are of a standard worthy of the great artist he was chosen to accompany; the mere fact of his being so chosen seems, to me, adequate proof of his own musicianship. The recorded sound, also, is all anyone could wish for and I have no hesitation in recommending this disc most warmly to all lovers of fine singing.

personal or in any way new to say about the work. She seems to have some difficulty with the prestissimo in the slow movement which, instead of flowing without obstruction, sounds a little laboured. The other drawback is the sound; though certainly not bad, it is not the best by current standards. For interpretation, and recording, this is not a preferred version of this concerto.

The works on the other side are genuine re-issues of Cluytens' 1960 recording and, despite the age of the recording, the sound is considerably brighter in these works. The Philharmonia was head-and-shoulders above most European orchestras at the time and I am glad to be reminded of this fact. Mr Cluytens directs the Russian music with a lively touch and although there must be several better versions of both pieces by now, I would happily settle for this recording.

★ ★ ★

WEBER: Concerto No. 1 in F minor, op. 73; Concertino in E flat, op. 26.

ROSSINI: Introduction and Variations. Gervase de Peyer, clarinet; New Philharmonia Orchestra; conductor Rafael Frubbeck de Burgos. H.M.V. stereo OASD 2455.

Weber wrote a great deal of music for solo winds — instruments which produce distinctive and very versatile sounds; of them all, the clarinet was clearly his favourite. Two concerti, a concertino, a quintet and a duo concertante are among works of his featuring the clarinet. The second clarinet concerto, possibly the finest of these pieces, was last recorded by de Peyer in 1961 and is not, as far as I know, currently available on disc!

The 1st clarinet concerto, which exists in two different versions, has

TANNOY

THE FIRST NAME
IN SOUND FOR
OVER 40 YEARS

40 years of accumulated wealth of research and manufacturing experience make the **TANNOY Gold Monitor** unequalled for incorporation in domestic systems or for studio monitoring in order to ensure original programme material which is above reproach

The **Monitor Gold** accommodates two entirely separate driver units on one frame. The Bass driver is the ultimate in cone design and termination, giving firm, distortion free bass at high or low levels. Treble is handled by a horn loaded unit providing consistency of high frequency response and delicacy of reproduction unequalled by other systems.

The **Tannoy Monitor Gold** comes in either 12" or 15" versions. Power handling capacity is 30 watts or 50 watts respectively. You are cordially invited to hear the outstanding sound of **Tannoy** at your showrooms.

NEW **Dual** 1219 TURNTABLE

With the **Dual 1219**, **Dual** has surpassed even hitherto unmatched performance of **1019** and established yet another level of professional quality. Check these features

- ★ Extended length tone arm with gimbal suspension.
- ★ Separate anti-skating control for conical or elliptical stylii.
- ★ Mode selector for maintaining correct vertical tracking angle in either single play or changer mode.
- ★ Non-magnetic 12" platter
- ★ Pitch control, 6% range, equivalent to a semitone.

Arrow are very proud to be one of the first to receive the new **Dual 1219** turntable and look forward to demonstrating this magnificent example of high class equipment to you in the very near future.

Write or call for full details and your "Arrow quote."

AE **ARROW ELECTRONICS** 342 Kent St.
NOW AT SYDNEY 29-6731

Opposite 2UW between KING & MARKET Sts.

AE891

fared rather better. The version used here by de Peyer, edited and with a cadenza by Baermann for whom Weber wrote the piece, is also on a DGG disc; the original version may be had on Turnabout, played by Glazer. Clarinet experts may find some aspects of de Peyer's playing irritating in the excessive attention to detail and somewhat self-conscious indulgence of subtleties; to my ear, these all seem perfectly justified and I cannot find fault with the soloist's high degree of sensitivity. In any event, his beautiful playing is wholly in accord with the interpretation chosen by the conductor.

If there is any shortcoming in de Peyer's playing it is in the Concertino, not in the concerto. Here, his tone tends to be hard and his tempi are just a little too fast. The Rossini work, a delightful bit of frivolity, is quite brilliantly played, in a performance that is far better than the music itself. I put this disc well ahead of both the DGG and the Turnabout, if for no other reason than because of the beautifully balanced HMV recording, which really does Weber's fine scoring justice. In addition, the playing by the Philharmonia is exceptionally tasteful and the conductor's contribution far from negligible.

★ ★ ★
BASSOON AND TRUMPET CONCERTOS. — Vivaldi: Bassoon Concerto in A minor, P. 70; Weber: Bassoon Concerto in F major, op. 75; Hummel: Trumpet Concerto in E flat; Leopold Mozart: Trumpet Concerto in D major. Henri Helaerts, bassoon; Michel Cuvit, trumpet; L'Orchestre de la Suisse Romande; conductor Ernest Ansermet, Decca stereo SXL 6375.

Issued in the U.K. just before Ansermet's death early this year, this is a rather curious record, an almost total failure in some respects, yet a great success in at least one unexpected way. The two bassoon concertos are no winners; musically, both the Vivaldi and the Weber work have quite a lot to offer and it would be nice to have a really good performance of Weber's concerto since this composer had an appreciation of the bassoon's potential beyond mere buffoonery.

Although the recorded sound is pretty good, Ansermet's direction was most unstylish in the Vivaldi in which the orchestral forces used sound grossly excessive; in the Weber, the orchestral phrasing lacks precision. In both works, regrettably, the soloist's playing is unimaginative and humourless; much as one might admire his technical proficiency, Mr Helaerts does little for the music. Unfortunately, there is no first-rate recording of the Weber concerto on the market and one can but hope that a really fine bassoonist (such as Sydney's John Cran) will one day be engaged to record this work, which is potentially delightful.

The trumpet side, despite rather variable stereo balance, is far better. Leopold Mozart's two-movement work is so completely negligible that neither the excellence of the performance nor any other aspect matters much. The Hummel concerto, on the other hand, really is a major event and likely to win this neglected composer many new friends and adherents.

Hummel has, generally, been overshadowed by his great contemporaries—his teachers Mozart, Haydn and Albrechtsberger, his fellow-student Beethoven, his own pupils Czerny and Thalberg—and it takes works such as this concerto to prove that his talents were not limited to the piano and that his instrumental knowledge was indeed wide.

The Hummel concerto is beyond doubt one of the most attractive pieces for the trumpet; it is in three movements, including a lovely Andante of dreaming beauty, not at all the mind of effect one expects from this brash instrument. Mr Cuvit's playing is not perhaps absolutely ideal, but it certainly does the music and the composer far greater justice than I had expected.

★ ★ ★

SHOSTAKOVICH: Symphony No. 5, op. 47. L'Orchestre de la Suisse Romande, conducted by Istvan Kertesz. Decca Ace of Diamonds stereo SDD 179.

This is a re-issue of a very successful 1963 release. Shostakovich's 5th has remained one of the composer's most popular works even if but few of us can appreciate its alleged political, ideological and sociological implications. It succeeds, first and foremost, as music.

The symphony is quite a difficult work technically and such as to test the competence of any orchestra. Following a conventional four-movement design, it is scored for quite enormous forces, including a piano. Its "content" apart, the music is strongly characteristic of Shostakovich and certainly among his best works for orchestra.

Mr Kertesz' interpretation of the score is sound, attentive to detail and faithful in every respect. I felt that he rather rushed the scherzo and that his approach, in general, lacked lyricism; it is quite possible, however, that these apparent shortcomings are the orchestra's rather than the conductor's. In recent years, we have had ample evidence of Kertesz' lyricism in Dvorak and other works of a similar nature.

In any event, this performance is a sound and workmanlike one and it is not in any way inferior to other versions known to me. As a performance, it seemed wholly adequate in 1963 and it still does so today. The recording quality seemed quite uncommonly sumptuous in 1963; nowadays we are used to such rich sound. The record, despite its age, remains a very good one — on this label, it is indeed quite a splendid bargain.

★ ★ ★

CHERUBINI: Medea. Gwyneth Jones, Pilar Lorengar, Bruno Prevedi, Fiorenza Cossotto, Giovanni Foiani, Justino Diaz, Giuliana Tivolaccini, Dora Carral; chorus and orchestra of the Accademia di Sta Cecilia, Rome; conductor Lamberto Gardelli. Decca stereo SET 376-8 (3 discs, boxed with booklet and bilingual libretto).

Although Cherubini did write an opera called "Medee," this is not it. The opera referred to was presented in Paris in 1797; it was a three-act French opera-comique with a French libretto and consisted of a series of static sung numbers, interspersed with

much spoken dialogue. As far as I have been able to ascertain, this Cherubini work was not again performed until a very recent, experimental, revival. The opera we get to hear on this Decca set owed merely the title and a few of the major sung numbers to Cherubini; everything else comes from the highly competent pen of one Franz Lachner and was especially written for a performance in 1855.

Lachner was a thorough craftsman, who really understood his metier; he tightened up the libretto (the Italian text used on this set is a translation of his German libretto) and improved matters by introducing any amount of dramatic action and music to replace the original spoken play. Lachner was uncommonly skilful, genuinely inventive and by no means a poor composer. It is as well to keep in mind, all the same, that what we get to hear is basically mid-nineteenth century German opera, not a French or Italian work of the eighteenth century. It makes one shudder to think what Lachner, using the same methods, might have done to Mozart's "Magic Flute" which also contains much spoken dialogue!

Once we become reconciled to certain stylish improbabilities, inherent in the work's history and provenance, it becomes thoroughly enjoyable and excellent fun. Miss Jones is not, I think, doing her talents proper justice in the role of Medea, which is more spectacular than musically rewarding. She sings very well indeed, but might well have left this particular chore—the bringing to light of unknown operas—to Miss Sutherland, the specialist.

The singing by everyone else is simply excellent, Miss Lorengar, as usual, sounds just a trifle harsh, owing to a Spanish quality in her voice which is unsuited to polite opera; Prevedi, as Jason, gives the most convincing account of the sung parts; and the orchestra's playing is quite excellent. Mr Gardelli is a circumspect and hard-driving conductor and manages to get first-rate results from everyone involved in the work. Special praise must be given to the recording team who have, once again, produced a Decca set of outstanding merit.

BUY RIGHT... FROM ENCEL

MICRO CARTRIDGES

SC-3030 LOW COST CERAMIC CARTRIDGE

This popular ceramic cartridge has a frequency response of 20,15,000 Hz, an output of 38 mV at 1 kHz, 1.54 cm/sec, tracking angle is 15 degrees and is a standard 1/2 in mounting to suit latest model P.U. arms. Includes a diamond stylus. Price (Inc. Sales Tax) .. **\$6.90**

2100/S LOW COST MOVING MAGNET STEREO CARTRIDGE

With an input sensitivity of 5 mV, the new Model 2100/S stereo cartridge has a frequency response of 10-28,000 Hz plus minus 1 db and a tracking angle of 15 deg. Tracking pressure recommended is 1-3 grams; channel separation is 30 dB at 1 kHz. Sounds three times as expensive! A conical diamond stylus is standard equipment. Price incl. sales-tax .. **\$14.50**

VF-3100. MOST POPULAR STEREO CARTRIDGE

With a frequency response of 20-28,000 Hz, and channel separation of 28 dB, the Micro VF-3100 series cartridges have already established new performance standards for lower priced magnetic cartridges. Two models are available, the VF-3100/E with elliptical diamond stylus and the VF-3100/S with a conical diamond stylus. Replaceable styli; both track effectively at 1 1/2 grams.

EXTRACTS FROM REVIEW

In "Electronics Australia," Page 199, February, 1969. Speaking of the Micro VF-3100/E cartridge: "frequency response checked out at plus or minus 2dB from 30 Hz. to 20 kHz ... very good performance indeed."

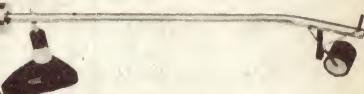

MICRO DUST PICKUPS—\$3.50

An effective automatic record cleaner which removes dust as the record plays. An ideal gift. \$3.50 inc. sales tax. **\$3.50**

ENCCEL

ELECTRONICS (STEREO) PTY. LTD.

Head Office:

431 Bridge Rd., Richmond, Vic. 3121. Tel. 42 3762.

Sydney Store: Ground Floor, 2SM Building, 257 Clarence Street, Sydney, N.S.W. 2000.

Tel. 29 4563, 29 4564.

Wholesalers Trade-ins accepted Terms

Australia's Greatest Hi-Fi Centre

ACOS

REPLACEMENT LONG LIFE CARTRIDGES

Acos 90 Series — a family of pick-up cartridges, covering all the main types needed today, each fitted with Diamond Stylus at no extra cost.

- GP91-1 MONO CRYSTAL Stereo Compatible .. \$5.95
- GP91-2 HIGH OUTPUT MONO CRYSTAL Stereo Compatible .. \$5.95
- GP92 MONO CERAMIC Stereo Compatible .. \$6.55
- GP93 STEREO CRYSTAL .. \$7.55
- GP94-1 STEREO CERAMIC .. \$7.95
- GP94-5 STEREO CERAMIC FOR TRANSISTOR AMPLIFIERS .. \$8.95

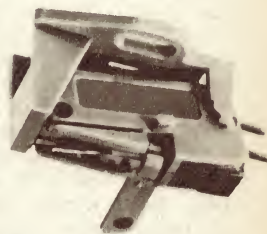

fitted with **DIAMOND** Stylus at no extra cost.

TECHNICAL DATA SHEETS SENT FREE ON REQUEST

Sole Australian Agents:

AMPLION (A'SIA) PTY. LTD.

29 Majors Bay Rd., Concord, Sydney, N.S.W. Phone 73 1227

With a BSR X3M
 'compatible' cartridge,
 almost any mono
 record playing
 equipment can take
 stereo records
 (without damaging
 them)

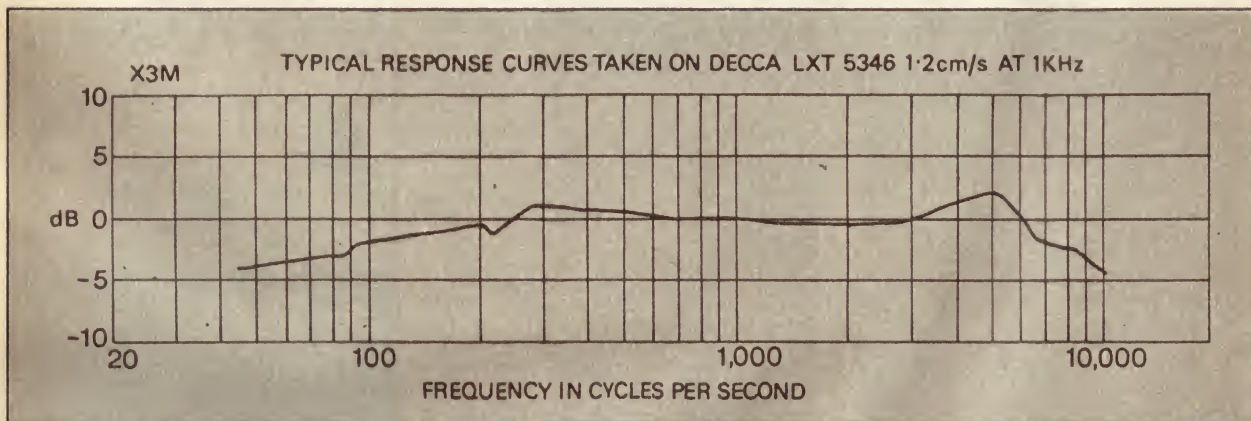

Why compatible cartridges?

An increasing number of record companies are now making stereo LP records only.

Until now these records could not be played on a mono player without distortion and damage to the records.

When playing stereo records the stylus tip moves vertically and horizontally following groove contours. Mono records have grooves which only move the stylus horizontally so old mono cartridges will not allow vertical movement of the stylus. Playing stereo records with old mono cartridges will damage the vertical component of the groove irrevocably.

The X3M 'compatible' cartridge, designed and perfected by BSR, is the answer to this problem. For a small outlay it allows you to play both stereo and mono records without harming either. Retail price, \$6.00.

TECHNICAL DATA X3M

Output: 350 mV \pm 2 dB

1 KHz test record Decca
 LXT 5346 at 1.2 cm/s

Frequency Response: See typical curves above

Dynamic Compliance:

Horizontal 3.0×10^{-6} cm/dyne ($\pm 20\%$)

Vertical 1.0×10^{-6} cm/dyne ($\pm 20\%$)

Equivalent Capacity: 800 pF

Nominal

Recommended Loading: 2 M. ohm 100 pF

Stylus Pressure: 4-6 grammes
 depending on pick-up arm

Measuring Temperature: 20° C 68° F

Colour: Beige



BSR (A/ASIA) PTY. LTD.
 SOUTHERN SECTION INDUSTRIAL ESTATE
 ST. MARY'S, N.S.W.
 PHONE: 623-0375, 623-0376



DISTRIBUTORS:
 GOLDRING ENGINEERING (A/ASIA) PTY. LTD.
 443 KENT STREET, SYDNEY, N.S.W.
 OFFICES IN ALL CAPITAL CITIES.

BSR:P100



Model 500 with ceramic cartridge . . . \$103
 Model 500 with 800H Magnetic cartridge . . . \$114
 Model 600 with CI/ST4 cartridge . . . \$114
 Model 600 with 800H Magnetic cartridge . . . \$125

The only triple tested total turntables. BSR McDonald.

Every BSR McDonald automatic turntable is precision made and tested in Great Britain to the most exacting specification. Upon arrival in Australia, every model is unpacked, tested and assembled in the total turntable concept, then re-tested again under actual playing conditions. That's why BSR service calls are the lowest in the

Industry – and perhaps that also explains why BSR sells more turntables than anyone else in the world.

The BSR McDonald 500 and 600 are complete modular units ready for use. Each unit has an ebony polystyrene base, smoke tinted dust cover, mains and audio leads – the only complete, packaged, factory tested units.

Features such as

- Dynamic anti-skate control applies continuously corrected compensation at all groove diameters.
- Cueing and pause control lever allows for exact positioning of stylus on record and permits you to interrupt listening and reposition to same groove.
- Micrometer stylus pressure adjustment permits 1/3 gram settings from 0 to 6 grams.
- Automatic lock on tone arm after last record is played.
- Dynamically balanced 4-pole



- Induction motor has high torque, constant speed design – assuring minimum rumble and row.
- Tubular aluminium tone arm is perfectly counter-balanced both horizontally and vertically.
- Resiliently mounted, coarse and fine vernier adjustable counterweight.
- Tone arm is jam-proof even if it is held during the cycling operation.
- Clip-in cartridge holder, provides universal mounting and quick change. (Optional).



BSR A'Asia Pty Ltd
 Southern Section Industrial Estate
 St Marys New South Wales
 Telephones 6230375 and 6230376

Wholesale Distributors Goldring Engineering (A'Asia) Pty Ltd New South Wales 443 Kent Street Sydney 2000 Telephone 29-5802/3/4 Victoria 162 Pelham Street Carlton 3053 Telephone 34-5105 Queensland 415 Adelaide Street Brisbane 4000 Telephone 2-3247 Western Australia 32 Northwood Street Leederville 6007 Telephone 84-988 South Australia 77 Wright Street Adelaide 5000 Telephone 51-5117 BSR:P 104



VARIETY FARE

By HARRY TYRER, FORBES CAMERON, NEVILLE WILLIAMS

Devotional and Christmas

NAT COLE SINGS SPIRITUALS.

With the Choir of The First Church of Deliverance. Stereo, World Record Club W.R.C. S/4550.

Interest: Hymns, "driving" spirituals.

Performance: Polished.

Quality: Virtually flawless.

Stereo: Excellent.

I remember listening to this album some years ago on the Capitol label under the title "Nat King Cole Sings Hymns & Spirituals." While having to concede its excellent quality, musically, I had some reservation about its classification as a devotional record.

Having listened to a lot of devotional records since then—formal, revival, adolescent, Negro—I have fewer such reservations. If you have an ear for the driving rhythm usual with some of the numbers featured, I think you'll enjoy it: Every Time I Feel The Spirit—I Want To Be Ready—Sweet Hour Of Prayer—Ain't Gonna Study War No More—I Found The Answer—Standin' In The Need Of Prayer—Oh, Mary, Don't You Weep—Go Down, Moses—Nobody Knows The Trouble I've Seen—In The Sweet By And By—I Couldn't Hear Nobody Pray—Steal Away.

Nat King Cole's diction and voice control are outstanding, the choir is excellent and the organ/rhythm accompaniment is first rate. So also is the technical quality. As I said, if you like the style of music, I think you'll enjoy it. (W.N.W.)

★ ★ ★

THE COUNTRY-GOSPEL STYLE of

Joel and LaBreeska Hemphill.

Stereo. Word CAS-9634-LP.

(Sacred Productions Aust., 181

Clarence St, Sydney, and other

capitals).

Interest: As per title.

Performance: Good in its class.

Quality: Good.

Stereo: Normal.

Country style music is something that individuals seem positively to like or dislike, and this is as true of country-style Gospel as it is of secular songs. And I must confess that, if I had to stand and be counted, it would be with the "Don't Like" group.

However, that is not to say that the Hemphills are anything but talented. They maintain true country-style harmony, backed with percussion, piano, organ and guitars. It comes as no surprise to find a small note on the sleeve indicating that, label not withstanding, the album was recorded at

the Nashville studios of RCA.

The titles: He Filled A Longing — Point Of No Return — Crying In The Garden — I Wouldn't Take Nothing For My Journey — Life Evermore — Not In A Million Years — A Mansion Just For Me — The Eyes Of Jesus — The Way Is Made — Led Out Of Bondage — It Might As Well Be Me — There's Been A Lot Of Changes.

Fine for C. & W. enthusiasts. (W.N.W.)

★ ★ ★

THE LITTLE DRUMMER BOY. The

Jack Halloran Singers. Stereo.

Universal Record Club U-794.

Interest: Gentle Christmas harmony.

Performance: Pleasant, capable.

Quality: Excellent.

Stereo: Normal.

Perhaps it was because this was the first of the current Christmas releases that I listened to this year, but it seemed very well to catch the Christmas spirit—a season of jollity and yet one with strong devotional connotations.

The Jack Halloran Singers are not a particularly large group and they sing largely without accompaniment but their harmony is excellent. Altogether

there are 15 tracks on the album: Little Drummer Boy—Christmas Is A'Comin'—I Wonder As I Wander—While Shepherds Watched—Lullaby For The Infant Jesus—Holly And Ivy—Deck The Halls—Carol Medley—Pat-A-Pan—Mary's Boy Child—Tell It On The Mountain—Prince Of Peace—Angels We Have Heard On High—Carol Medley—We Wish You A Merry Christmas.

Pleasant sound, good value. (W.N.W.)

★ ★ ★

LOVE CAME DOWN AT CHRIST-

MAS. Frank Boggs with Paul

Mickelson directing the Concert

Orchestra of London and the Paul

Mickelson Choir. Stereo, Word,

W-3140-LP. (From Sacred Pro-

ductions Aust., 181 Clarence St,

Sydney.)

Interest: Christmas music with a

difference.

Performance: Notable.

Quality: Clean, well balanced.

Stereo: Normal.

Paul Mickelson's capabilities as an arranger and conductor of sacred music are forcibly demonstrated in this new album of Christmas music. While the titles have a familiar ring most of them are, in fact, outside the usual run of simpler and over-worked carols. Beautifully and tunefully arranged, they are extremely well presented by the Concert Orchestra of London and by Frank Boggs, a dedicated artist with a fine bass-baritone voice.

A King Is Born (medley) — O Come, O Come, Emmanuel — Once In Royal David's City — I Heart The Bells On Christmas Day — Jesus, Jesus, Rest Your Head — The Birthday Of A King — Love Came Down At Christmas — O Holy Night — What Child Is This? — While Shepherds Watched Their Flocks By Night — Sweet Little Jesus Boy—Medley Of Carols.

I doubt that you'll buy a better Christmas album than this, or one that commends itself better for all-the-year-round listening. (W.N.W.)

Instrumental, Vocal and Humour . . .

BERNSTEIN'S GREATEST HITS.

Vol. 2. The New York Philhar-

monic Orchestra, conducted by

Leonard Bernstein. C.B.S. stereo

SBR 235326.

Interest: Familiar classics.

Performance: World class.

Quality: Excellent.

Stereo: Normal.

Here is another attractive program of popular classics, and while it hardly merits the accolade "Greatest Hits" it is certainly one which will appeal to a great many people: Russian Sailor's Dance (Gliere) — Procession of the Sardars (Ippolitov-Ivanov) — Excerpt from "Polovtsian Dances" (Borodin) — The Moldau (Smetana) — Trepak from "The Nutcracker" (Tchaikowsky) — Can-Can from "Orpheus in the Underworld" (Offenbach) — Miller's Dance from "The Three Cornered Hat" (Falla) — Ride of the Valkyries (Wagner) — Danse Macabre (Saint Saens) — Somewhere from "West Side Story" (Bernstein) — Finale from "William Tell" Overture (Rossini).

This varied program provides plenty of opportunities for the polished New

Yorkers to show their paces — the strings shine particularly in the "Water Nymphs" section of "The Moldau" where a light shimmering string tone is essential—and I have no hesitation in awarding this disc high marks on all counts. However, I would like to point out that the list of titles could mislead an intending purchaser. This list says "Polovtsian Dances" and one would be entitled to expect the work to be played in full, whereas only two sections are included. (H.A.T.)

★ ★ ★

TCHAIKOWSKY'S GREATEST

HITS. The New York Philhar-

monic/Bernstein and The Phila-

delphia Orchestra / Ormandy.

C.B.S. Stereo SBR 235325.

Interest: Popular classics.

Performance: Good standard.

Quality: Satisfactory.

Stereo: Normal.

I wonder what Tchaikowsky would have thought of the collection of bits and pieces presented here being called his "greatest hits." Somehow, I do not think he would have approved. Let's face it, this is simply a collection of

pleasing tunes presented by a couple of very fine orchestras. The Philadelphia Orchestra under Ormandy plays the following: Andante Cantabile from Symphony No. 5—Waltz from Serenade for Strings. The New York Philharmonic and Bernstein tackle Trepak and Waltz of the Flowers from "The Nutcracker" — 1812 Overture. Not by any means a generous program for what is virtually a sampler, with all pieces lifted from existing recordings. However, if you are a Tchaikowsky fan, and you think this selection is worth \$5.75, I can say that the performances are up to standard (although I have heard better performances of the "1812") and the technical side of the disc is entirely satisfactory. (H.A.T.)

★ ★ ★
THE COUNT OF LUXEMBOURG.
 Franz Lehar. Lyrics by Adrian Ross and Basil Hood. June Bronhill, Neville Jason, The John McCarthy Singers. Direction Vilem Tausky. Stereo, Columbia TWO-246

Interest: Highlights from operetta.
 Performance: Vital.
 Quality: Modern sound.
 Stereo: Used to advantage.

The background to the operetta and the story theme are given in the detailed jacket notes. Working under duress, Lehar was most apprehensive that any operetta, which invited any comparison with the very successful "The Merry Widow," could only be a dismal anti-climax. On the contrary, "Luxembourg" was an immediate success and has remained popular ever since.

The highlights presented here include: Overture—Bohemia — Pierrette and Pierot—The Count Of Luxembourg—Love Goodbye — Cousins Of The Czar—Finale, Act One—Hail Angele, Our Nightingale—Love Breaks Every Bond—Are You Going To Dance.

Lead soloist June Bronhill gives a fine performance, ably supported by Neville Jason, and orchestra and chorus under Vilem Tausky. The quality is good, with excellent stereo definition. (W.N.W.)

★ ★ ★
POMP AND CIRCUMSTANCE. The Hollywood Bowl Symphony Orchestra conducted by Alfred Newman; The Capitol Symphony Orchestra conducted by Felix Slatkin, Earl Bernard Murray, Carmen Dragon. World Record Club, stereo S/4576.

Interest: Stirring marches.
 Performance: Satisfactory.
 Quality: Good.
 Stereo: Normal.

Those who like their marches to be of the type intended for the opera stage or the concert hall will find this disc to their taste. The first item, "Stars and Stripes Forever," is a genuine military march by Sousa. Next is "La Marsellaise," the French National Anthem, and a stirring piece of music. From here on, the selection belongs exclusively to the repertoire of the concert hall or the stage: Procession of the Sardars, and Entry of the Boyards (Ippolitov-Ivanov)—Pomp and Circumstance No. 1 (Elgar)—Rakozcy March (Berlioz)—March of the Dwarfs (Grieg)—Wedding March from "Midsummer Night's Dream (Mendelssohn). This stirring music is well presented by the two orchestras, with the Capitol men sounding to me rather more polished and with better tone. (H.A.T.)



AUDIO ENGINEERS

PUBLIC ADDRESS AMPLIFIERS

**35 WATT P. A. AMPLIFIER
 MODEL PA 539**

**20 WATTS RMS OPERATES ON
 12 VOLT DC—240 VOLT AC
 MODEL TPA 30**



\$75 inc. tax and freight.

with mounting bracket fitted
 Price \$59 inc. tax and freight.

35 watts	Specifications	30 Watts Music power
30-15,000 CPS ±2db	Output Power	20 Watts RMS at 8ohm
8, 16, 250 ohms and 70V line	Frequency Response	50 — 18,000 cps
Mic Input 5mV AUX 300mV	Output Impedance:	4, 8, 16 ohm
Mic —1 50 K ohm Mic —2 500 K ohm AUX 500K ohm	Input Sensitivity:	25 and 70 Volt Line outputs
54db	Input Impedance:	Mic-1 2mV at 600 ohm Mic-2 2mV at 50,000 ohm AUX. 200mV Music, 200MV
Mic —1 Volume Control Mic —2 " " AUX " "	S/N RATIO	Better than 50 db
MASTER	CONTROLS	Mic-1 Volume Control Mic-2 Volume Control AUX & Music Volume Control Tone Control
BASS ±12db 100 CPS TREBLE ±12db 10 KC 240 Volt, 50 Cycles	AC Source:	240 Volt AC and 12 Volt DC switched

H, 5 1/2" x W, 12 1/2" x D. 10"

Size:

DYNAMIC MICROPHONE WITH ON-OFF SWITCH 50K OR 600 OHM

- Response—40 15,000 CPS + 3DB
- Semi-Cardioid-Type
- Low Feed-back

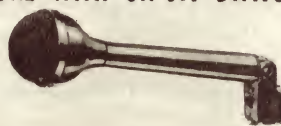

- Satin Chrome Metal Case
- Swivel Stand Mounting
- Fitted with 20 Foot Cord

DUAL IMPEDANCE Price \$26 inc. tax & freight

'RAPAR' BLOCK MODULES

	BM1 \$5.00	BM3 \$5.00	BM2 \$5.00	BM4 \$6.00
Specifications	Phono Pre Amp	Tape Pre Amp	Mic Pre Amp	Power Amp
Input Impedance	100 K	100 K	100 K	1000
Gain	28 db	25 db	28 db	20 db
Maximum Output	3V	3V	3V	300 mV
Maximum Input	50 mV	50 mV	50 mV	—
Distortion	0.15% at 1V	0.15% at 1V	0.15% at 1V	3% at 200MV
Frequency Response	RIAA	NARTB	10HZ-50K HZ	50HZ-10KHZ
Power Supply	9V-12V DC	9V-12V DC	9V-12V DC	No Sig. 20 mA Max. Out 80 mA

ORDER FORM
 To: CHARLES MUTTON ELECTRONICS,
 2a Hill Street, Thornbury, Vic., 3071.
 (PLEASE PRINT)

Name

Street

City

State Postcode

Please supply items indicated thus
 I enclose cheque/postal note—money order. Goods forwarded freight free.

NEW from SHURE

We couldn't leave well enough alone

We have improved the trackability of the V-15 Type 11 in the bass register—without affecting its excellent treble. Result: Where, in the past, you may have been required to increase tracking forces to track heavily modulated bass drum, tympani, organ pedal, bassoon, tuba, or piano passages . . . you can now play these passages **without** increasing tracking force . . . without bass flutter or IM distortion . . . and double (or even triple) record and stylus tip life.

You can modify your present V-15 Type 11

You may attain this higher bass trackability by installing the IMPROVED VN15E Stylus. These improved cartridges and styli can be identified by the Shure label on the stylus grip which is in red letters against a silver background.

V-15 Type 11 Cartridges & replacement Styli

Model No.	Description	Price
	V-15 Type 11 Improved Dynetic Cartridge . . . Biradial Elliptical Stylus	\$87.50
	VN15E Elliptical Stylus for V15 Type 11	\$38.00
	V-15 11-7* Dynetic Cartridge . . . ".0007" Spherical Stylus	\$87.50
	VN7 Spherical Stylus for V15 11-7	\$38.00

*This model already incorporated the improvements in the V-15 Type 11 when introduced.

New reduced prices on the popular elliptical M55E and M44E cartridges and Styli

	M55E elliptical cartridge	\$27.50
	N55E stylus	\$18.90
	M44E elliptical cartridge	\$24.00
	N44E stylus	\$16.70

Remember the N55E and N44E styli can be used in any M44 series cartridge. You can upgrade any M44 series cartridge by replacing with the elliptical styli.

Contact your local Hi-Fi dealer or any of the following for more information:

N.S.W.: Audio Engineers, 342 Kent Street, Sydney.

W.A.: Athol M. Hill Pty. Ltd., 613-15 Wellington Street, Perth.

QLD.: Ron Jones Pty. Ltd., 7-9 Merton Road, Wolloongabba, Brisbane.

VIC.: Audio Engineers (Vic.), 2A Hill Street, Thornbury, 44-3295.

THE FOUR SEASONS (Vivaldi). The Vienna State Opera Orchestra, conducted by Hermann Scherchen. Music for Pleasure MFP-A9026.

Interest: Program music.

Performance: Precise.

Quality: Dated, but clean sound.

Stereo: Normal.

This must be the cheapest recording of "The Four Seasons" on the market, yet it is by no means to be despised. Those who know Scherchen's approach will not be surprised at the safe tempos used, the careful phrasing (one might almost say fussy) and the general air of a work carefully rehearsed beforehand. However, in general, this is performance with no particular vices, and quite a few virtues. The recording appears to date from about 1959, and accordingly the sound quality and recording technique is somewhat below that of current recordings, but still of very acceptable standard. Those who want a low-priced version of this work will, I feel, find this disc quite satisfactory. (H.A.T.)

★ ★ ★

MUSIC OF THE DANCE. Orchestra and conductor not named. Calendar Classics (Festival) stereo SR66-9663.

Interest: Light classics.

Performance: Good standard.

Quality: Clean sound.

Stereo: Normal.

No information is given on the sleeve about the orchestra, but I assume it is the Vienna Promenade Orchestra under Max Schonherr, since this combination has previously appeared on the Elite label, from which this disc originates, with this type of material. Whatever the names, they are a very competent group and play with precision and dash in this selection of popular light classics. However, the disc title is a misnomer. Only three of the items are ballet music, the rest being orchestral dances by Brahms and Dvorak. The selection comprises: Hungarian Dances Nos. 5 and 6 (Brahms)—Slavonic Dances Nos. 5, 6, 7 and 8 (Dvorak)—Czardas and Waltz from Coppelia (Delibes)—Excerpt from Polovtsian Dances (Borodin). An attractive program, nicely played and well recorded. Good value at \$2.95. (H.A.T.)

★ ★ ★

THE WATNEY SILVER BAND, Conductor Albert Meek. Music for Pleasure, Stereo, MFP-A 8077.

Interest: U.K. band.

Performance: High standard.

Quality: Excellent.

Stereo: Well spread.

The brass band field in the U.K. is dominated by such groups as the Foden, G.U.S., B.M.C. and other groups from the Midlands and the North, where the band tradition is very strong. However, the art is by no means neglected in the south, as is proved by this excellent performance by the Watney Silver Band. There is some fine solo and ensemble work here, and if only the material had been more carefully selected this would have been the equal of many higher-priced discs. As it is, the material is made up largely of hackneyed material and, at the other extreme, some numbers which I am sure most people will not know at all. The titles are: Watneys Fanfare—Best Foot Forward—Round the Clock—

Kathleen Ferrier re-issues

When Kathleen Ferrier died in 1953, aged 41, she left us only a small legacy of records, since her rise to fame was so rapid, and the record industry was by no means so large as it is today. Her total recorded performances comprised only 12 L.P.s, only a few E.P.s and a quantity of 78 r.p.m. discs. A few of her discs have been reissued at intervals, the last to come my way being in 1966, when I expressed a wish that more would be forthcoming. Well, here they are, and on the low-price Ace of Clubs label. Those already familiar with the work of this great artist will need no urging to buy these re-issues. Here is a brief summary of each disc:

Record 1, ACLA 305. The Song of the Earth (Mahler). With Julius Patzak, tenor and the Vienna Philharmonic Orchestra conducted by Bruno Walter. A famous performance, still regarded as one of the greatest ever recorded. The engineering does not compare with that of today, and both soloists sound rather too remote. Originally recorded as an L.P., the sound is nevertheless acceptable enough, and there is little background noise.

Record 2, ACLA 306. Works of Brahms, comprising: Alto Rhapsody—Four Serious Songs—Sapphische Ode—Botschaft—Gestillte Sehnsucht—Geistliches Wiegenlied. The major interest is of course the Rhapsody, which is superbly sung. While it is hard to pick any item as better than others, I particularly enjoyed the "Sapphische Ode" because of its beautiful melody.

Record 3, ACL 307. A Lieder Recital. Although it is generally accepted that Kathleen Ferrier was not the best of Lieder singers, one cannot fail to appreciate the qualities of her noble voice, even though aware of her inadequacies as an interpreter of the songs. Included here are: Frauenliebe und Leben—Volksliedchen—Widmung—(Schumann); Gretchen am Spinnrad—Die Junge Nonne—An Die Musik—Der Musensohn (Schubert); Verborgenheit—Der Gartner—Auf Ein Altes Bild—Auf Einer Wanderung (Wolf). Some of these tracks were originally recorded before the LP era, and exhibit considerable background noise.

Record 4, ACLA 308. Arias by Bach, Handel, Gluck and Mendelssohn. Some items were originally recorded as 78 r.p.m. discs and the sound quality is poor by today's standards, also background noise is very noticeable on high quality equipment. However, the standard of the performances is very high. The contents include four arias from Bach's "St. Matthew Passion," with the Bach Choir and the Jacques Orchestra; "Art Thou Troubled" and "Ombrai Mai Fu" (Handel); "What is Life" from Gluck's "Orpheus;" and two items from Mendelssohn's "Elijah." Some of the performances on this disc have never been equalled.

Record 5, ACLA 309. A Recital of English Songs. Kathleen Ferrier was very interested in the traditional music of England before the folk singing movement was in vogue. This disc is a most delightful performance which includes such favourites as The Keel Row—Blow the Wind Southerly—O Waly, Waly—Drink to Me Only—Down by the Sally Gardens. Originally recorded as two 10in LPs, the sound is of reasonable standard. If you do not intend to buy the whole set, I suggest that this one is not to be missed.

Record 6, ACLA 310. More folk songs on this disc, the second side being devoted to the famous broadcast recital of June, 1952 (except that "Oh, Waly, Waly" has been omitted as it is included in Record 5). The other items are: From Silent Shades . . . Mad Bess of Bedlam (Purcell)—The Fairy Queen . . . Hark the Echoing Air (Purcell)—Atlanta . . . Like as the Love Lorn (Handel)—Admeto . . . How Changed the Vision (Handel). These were all originally issued on 10in LPs, and sound is of acceptable standard. (H.A.T.)

Trombones to the Fore—Il Bacio—Poet and Peasant—The Arcadians Overture—The Red Barrel—Caramba—The Rovers Return—Chi-Chi—Merry Mancunians.

However, if this program attracts, the disc will be found excellent value, as technically and performance-wise it cannot be faulted. (H.A.T.)

★ ★ ★

WHEN IT WAS DONE—Walter Wanderley Set. A & M Records (Festival) Stereo SAML 933,236 (also in mono).

Interest: Bossa Nova.
Performance: Pleasant.
Quality: Well recorded.
Stereo: Normal separation.

The numerous albums by the Brazilian pianist and organist, Walter Wanderley, have become very popular in the past year or two, both in this part of the world and overseas.

His music has strong rhythmic and melodic qualities and it makes for very easy and relaxed listening. The atmosphere of the music is similar to the Sergio Mendes sound but the instrumentation is rather different. Although Wanderley's organ dominates the music, there are pleasant features for flugelhorn, flute and two girl singers and, on most tracks, background strings are added.

Several Brazilian writers are represented including 3 compositions by Deodato, Jobim's attractive "Surfboard" and Lobo's "Ponteio"; besides Burt Bacharach's "Reach Out for Me" and Jim Webb's haunting "When It Was Done." The arrangements generally are neat and beautifully played.

This is a pleasant record which will appeal to most readers who enjoy the lilting, gentle rhythms of the bossa nova. (T.F.C.)

★ ★ ★

GREAT CATHEDRAL ORGAN SERIES, No. 16: CANTERBURY CATHEDRAL. Allan Wicks, organist. His Master's Voice Stereo CSD 3657.

Interest: Great Willis organ.
Performance: Outstanding.
Quality: Excellent.
Stereo: Skilfully done.

At last E.M.I. have got around to recording the Willis organ in Canterbury Cathedral in this series. Presumably the reason for this comparative lateness is to be found in the sleeve note, which says that in 1968 "a complete reconstruction and redistribution of the main parts was undertaken by Henry Willis and Sons." The results were certainly worth waiting for, at least in terms of the performance (the music may not be to every-

AKG
D 200

More details from
your dealer or



Engineering
Products
Division

SYDNEY 88 6666	MELBOURNE 87 9161
BRISBANE 41 1631	ADELAIDE 72 2366
PERTH 28 6400	LAUNCESTON 2 1804



you've never heard it so good

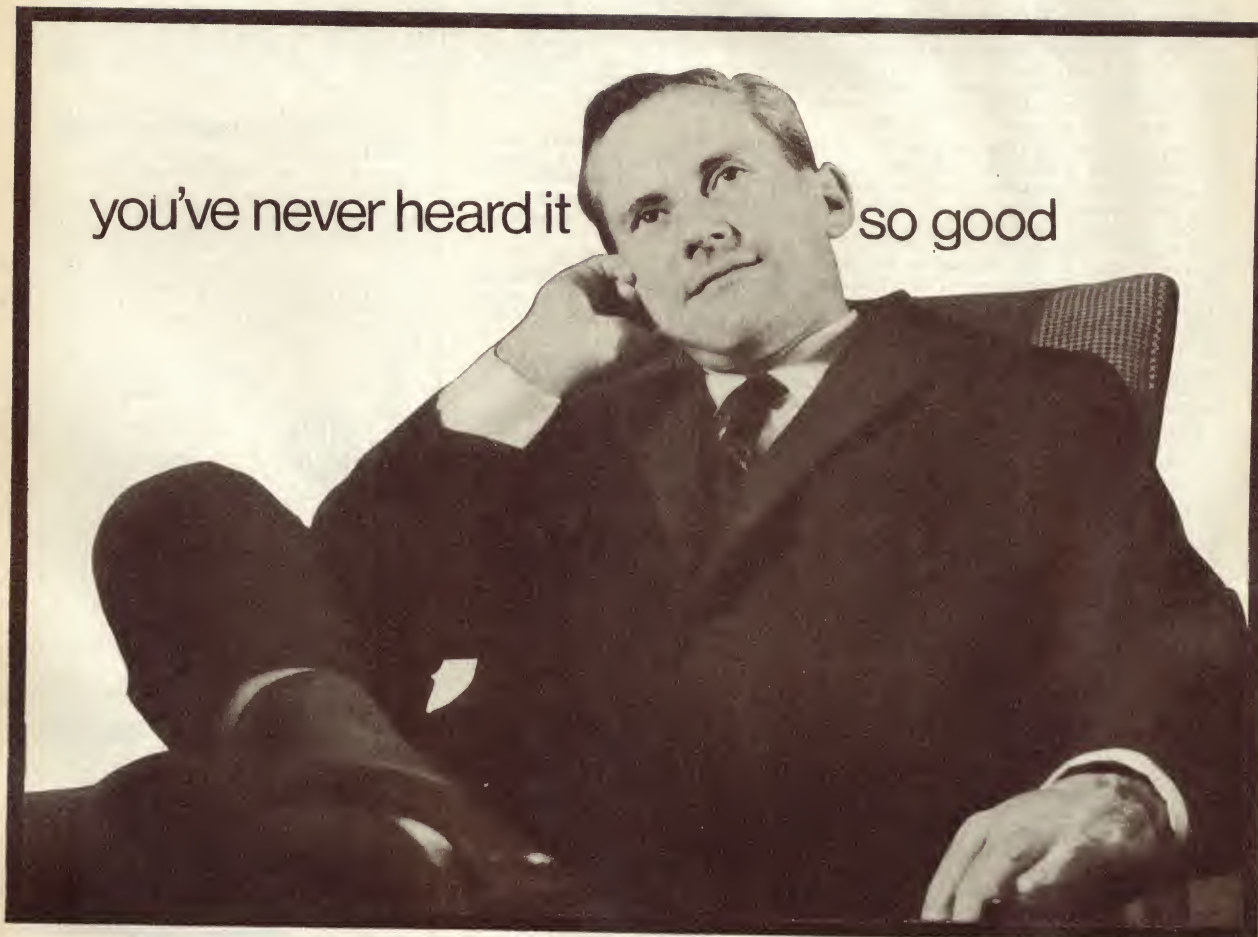

new Rola 65MX wide range and 65M woofer hi-fi speakers give exceptional performance - way down low, below 35 Hz*

* Measured in accordance with RETMA standards

Hi-Fi enthusiasts never had it so good. In their new series 65M speakers Rola has packed in more performance, more quality in less space for less cost. Now you can range from 30Hz to 14,000Hz in one compact, 6½" diameter speaker with the high fidelity you could normally expect only from a much larger unit. Truly, these speakers sound great:

High compliance suspension, with large diameter spider and synthetic rubber pneumatic rim for large linear excursions. Specially treated cone to give sharp cut-off at crossover frequency; aluminium voice coil former for long-term stability and increased power handling.

Power handling: 65MX — 7 watts RMS
65M — 10 watts RMS
Frequency: 65MX — 30Hz to 14,000Hz
65M — 30Hz to 5,000Hz

ROLA 65MX — a twin-cone, medium-throw loudspeaker designed to provide a compact, single unit, wide-range sound system.

ROLA 65M — a medium-throw loudspeaker designed for use as a woofer in two-speaker enclosures. The new Rola 3DX speaker is an ideal tweeter to use with the 65M for extended upper frequency response.

Enclosure plans specially prepared by Rola are available on request for both speakers.



PLESSEY
Rola



Plessey Rola Pty Limited
The Boulevard Richmond Victoria 3121
Telephone 42 3921 Telex 30383
NSW PO Box 2 Villawood 2163
Telephone 72 0133

body's taste). The resident organist, Allan Wicks, is regarded as one of England's best, as one would expect. After all, Canterbury is the seat of the Primate of England.

For his recital, he has chosen two familiar works for side one, Bach's "Tocatta and Fugue in D minor" and Mendelssohn's "Sonata No. 1 in F minor"; while for side two he comes right up to date with compositions from two contemporaries — "Epitaphs for Edith Sitwell" by Malcolm Williamson, and "The Seven Last Words" by Alan Ridout. Those who know something of Alan Wicks will not be surprised by the modern works, since he has been active for many years in encouraging modern composers to write original works for the organ. His playing throughout is a delight, and the recording engineer has done a wonderful job in capturing the tone of this superb instrument with no fuzziness or other undesirable traces. The results may be summed up as three arts brought to a peak of perfection: the organ builder's, the organist's and the recording engineer's.

As to the instrument itself, the sleeve note tells us that it was built in 1886 by Henry Willis and Sons, and incorporated several unique mechanical innovations. There are four manuals, CC to C 61 notes and a Willis pedal board CCC to G 32 notes; and there are 98 registers, comprising 68 speak-

ing stops and 30 couplers. As usual in this series, there is a complete specification on the sleeve. (H.A.T.)

* * *

TENDER STRINGS. Orchestra conducted by Felix Slatkin. Liberty (Festival) stereo SLYL-933,310. Available in mono.

Interest: Romantic mood music.
Performance: Suitably lush.
Quality: Excellent.
Stereo: Good spread.

This has all the makings of a very fine disc—an excellent selection of tunes expertly played by accomplished musicians, with full marks going to Slatkin for his individual and imaginative arrangements. There is no doubt that the quality is there, but unfortunately the quantity is sadly lacking. Side one has about 14 minutes of playing time, and side 2 is even worse, a mere 12 minutes. If you think this is satisfactory value for your \$5.75, by all means go ahead and buy; if, like me, you think this is way below par for the money, you will be wise to invest in something you regard as better value. There is plenty of competition nowadays. If you are still interested, the selection comprises: Blue Tango—Autumn in New York—Exodus—On the Street Where You Live—Winter's Sadness—I Get a Kick out of You—April in Paris—Pensive Prelude—Wistful Haven—Run Strings Run. (H.A.T.)

Reader's Digest album

POPULAR MUSIC HIT PARADE. Ten-Record boxed set, plus bonus record "Music For Dreaming." Stereo, Reader's Digest/RCA Dynagroove. Various orchestras, artists.

Interest: Easy-on-the-ear popular music.
Performance: Smooth, happy, well played.
Quality: Clean, modern sound.
Stereo: Good spread, definition.

In putting together this ten-record set, Reader's Digest/RCA have sought out the middle-of-the-road popular music that has contributed to the fun and the pleasure of several generations—or should we say generation—decades? In so doing, they had to recreate the distinctive styles of the big-name bands of the thirties; select popular favourites from the big Broadway shows. They have had to look back into the realms of country and western, and add elements from more recent sounds—Tijuana style brass, Beatle tunes and the more definitive of the television themes.

They have had to retain the general style of this varied music while discreetly avoiding the more raucous and noisy elements that might alienate an audience that would almost certainly be interested in pleasant sound, easy on the ear.

With 122 tracks on twenty sides, not counting the bonus record, it is quite impossible to list the track titles. We can, however, indicate the content of the sides. In order from record 1, they are titled as follows:

Best Hits Of Today (two sides) — Academy Award Winners — Downright Fun — A Gershwin Serenade — The Insinuating Bossa Nova — Dance Time — Swing Time — Pop Hits From The Countryside — Country Music Whing Ding — Sweet and Lovely — A Touch Of Tijuana — Happy Pianos Of Wayne And Gerald — Dixieland Jam Session — Remember? — Popular TV Themes — Show Stoppers — The Sounds Of Nashville — March, March, March — Pops Pourri.

Glancing down the credits, one notices: Bob Crosby Orchestra and "Bobcats," The Nelson Riddle Orchestra, Marty Paich and His Orchestra, Vic Damone, Jo Stafford, Paul Weston and Orchestra, Hank Levine Singers and Orchestra, Pete King Chorus and Orchestra, Hugo Montenegro, Johnny Gibbs, Les Brown and His Band, Ray Davis and His Button Down Brass — and many others.

To assist the owner to find what takes his fancy, the set includes an 8-page brochure, in which artists and bands, and track titles are indexed in alphabetical order. Individual records are in distinctively coloured sleeves, numbered in the corner for easy identification.

To be sure, I didn't listen through all 122 tracks, but I did sample a representative number; enough to satisfy me that the sound was consistently of excellent quality, and well up to the usual Reader's Digest/RCA standards. Only fault I noticed was a slight flaw on Record 10, side 2, track 3. Most likely it would be confined to my particular pressing.

If the music appeals, you can buy the ten-record — sorry, eleven record set with confidence. (W.N.W.)

BUY RIGHT... FROM ENCEL

SONICS

HIGH PERFORMANCE
SPEAKER SYSTEMS
AT LOW COST

Separate speaker systems are essential if you wish to exploit the full potential of your amplifier, tape recorder or radio. Sonics speaker systems are beautifully finished in selected walnut/teak veneers, are styled to blend with period or modern decor and are extremely effective from an audio point of view. Many models including:

MODEL AS-303

A magnificent hand finished teak & walnut speaker system with three speakers and a 3-way crossover network. 12in woofer with a long throw voice coil provides excellent bass response, a 6½in mid-range speaker covers the middle ranges and a horn type tweeter comes in at 4kHz. Power handling capacity is over 15 watts R.M.S. Extremely wide frequency response free of coloration. Size 25in x 14¾in x 11in. Price (including sales tax) **\$69.50**

Other Sonics High Performance Speaker systems are available at prices from **\$22.50 to \$98.50** (Including sales tax).

HS-304 STEREO HEADPHONES

The popular model HS-304 offers fatigue free listening on a personal basis... the headset is very comfortable even over lengthy periods. Price? Only **\$12.50**

ENCEL
ELECTRONICS
(STEREO) PTY. LTD.

Head Office:

431 Bridge Rd., Richmond, Vic. 3121. Tel. 42 3762.

Sydney Store: Ground Floor, 25M Building,
257 Clarence Street, Sydney, N.S.W. 2000.

Tel. 29 4563, 29 4564.

Wholesalers Trade-ins accepted Terms

Australia's Greatest Hi-Fi Centre

\$200 to \$2,000

Let us help you decide on quality
Systems to suit your pocket—hear them!



(Finance Available)

Look what "Stereo Review" says about the NEW TEAC A-1200 TAPE DECK

"There's no doubt that it can meet the standards of the most critical listener . . . One of the best features of the TEAC A-1200U is its price. We have never tested a recorder at this price level that could match the A-1200U. It's only real competition would seem to come from the \$500-and-up class of recorders."

TEAC A-1200 \$369.
Three direct drive motors, 3 head operation, solenoid switching, complete mixing, sound on sound and stereo echo.

Hear it with the equally astounding TEAC AS-200 integrated amplifier (120 watts) only at Convoy Technocentre.

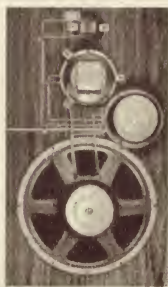

Peerless *High Fidelity*

12" THREE-WAY SPEAKER SYSTEM from \$122

Aluminium formers in the voice coil give exceptional realism. Mid-range backsealing eliminates cross modulation. The factory made crossover unit gives a truly rich bass range even at low levels. Peerless systems are different because they perform equal at high or low volume.

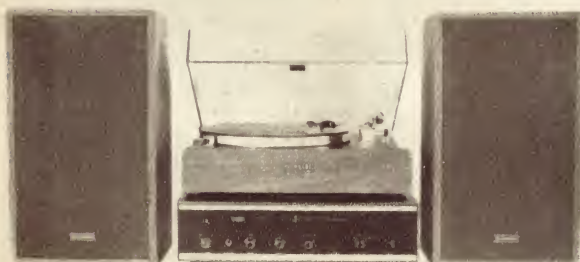

Complete home stereo system, 12in turntable hydraulic microlift and matching magnetic cartridge, SAX 330 amplifier, 8in 2-way speakers, oiled walnut all only \$375.

PIONEER

At last you can buy a Hi-Fidelity integrated Amplifier with an AM Tuner only—The Pioneer SAX330 is attractively styled in a wooden case—

AT ONLY \$185.00

It will fit into your stereo budget, yet is designed to meet all performance standards.

CHRISTMAS SPECIAL! MAGNETIC CARTRIDGE \$8

THE SOUND EXPERTS

Convoy

FOR SOUND SATISFACTION

TECHNOCENTRE

449 KENT STREET, SYDNEY. (near Town Hall) 29-6475.

Dr Faustus

THE TRAGICAL HISTORY OF DR FAUSTUS (Christopher Marlowe).

Text edited and supervised by Neville Coghill, Richard Burton and Members of the Oxford University Dramatic Society. World Record Club, stereo S/4595.

Interest: Elizabethan masterpiece.

Performance: Finely acted, but over cut.

Quality: Very good.

Stereo: Used to good effect.

To condense Marlowe's "Faustus" to the 45 minutes' playing time accommodated in this L.P. requires drastic cutting, to the extent that anybody approaching this play for the first time could be left with the impression that this is a simple morality play—Faustus bequeaths his soul to the devil for 24 years of high living, and gets his just deserts by going to hell. This is not what Marlowe intended at all. To be sure, the plot has strong moral implications, but the character of Faustus is complex, and I recommend that anybody buying this record should first read through a modern text (preferably Neville Coghill's, as used here by the players).

With this taken care of, one should be able to appreciate the many fine qualities of this performance. Burton dominates throughout, as one would expect, but he receives sterling support from the members of the Oxford University Dramatic Society. Andreas Teuber's characterisation of Mephistopheles, sophisticated, resigned to his fallen state, yet remembering with longing his earlier state of bliss in Heaven, is somehow touching, despite the underlying currents of evil. Robert Scott deserves mention in his reading of the Chorus, and is particularly good in the epilogue, when his measured voice takes up after the horrific final scene when Lucifer claims Faust's soul.

The disc has been very well recorded, and the stereo is suitably spacious. (H.A.T.).

ORGAN HIGHLIGHTS. Peter Piccini at the Conn Organ. Stereo, Calendar SR 66-9607. Also in mono R66-607.

Interest: Recital on the Conn.

Performance: Theatre solo style.

Quality: Good.

Stereo: Normal.

The jacket gives no information whatever on the performer or the instrument, apart from identifying the maker. However, Peter Piccini's music is in strict theatre tradition and is very well presented. The numbers vary in style and will make pleasant listening for anyone with a liking for this class of music. Those with a more technical knowledge of electronic organs will find plenty to interest them in picking out the varied voicings which Piccini uses. His program:

Days Of Wine And Roses—Spanish Flea—Night And Day—Nola—Flamingo—I Wish You Love—Poeme—Fascination—It Could Happen To You—As Time Goes By—The High And The Mighty. Playing time is about 25 minutes.

One you should hear, if you are interested in electronic organs. (W.N.W.)

★ ★ ★

PIECES FOR CLASSICAL GUITAR. Luis Suelves. Universal Record Club Stereo and mono U1007.

Interest: As per title.

Performance: Beautiful.

Quality: Excellent sound.

Stereo: Not significant.

This disc has had more playings in the few days I have had it than any other in a comparable period. Senor Suelves has a delightful style of playing that is fluid and mellow, devoid of any of the aggressive tendencies that so many guitar players exhibit. His program is a most pleasing one, comprising: Minuet and Rondo (Sor) — Le Rondo (Sor)—Gavotte (A. Scarlatti)—Prelude from "Small Preludes and Fugues" (Bach)—Allemande (Bach) — Romance (Anon) — Crepuscule

Espagnol (J. Sallinas)—Asturias (Leyendas) from "Suite Espanol" (Albeniz)—Capricio Arabe (F. Tarrega)—Sueno (F. Tarrega)—Danse Espanole No. 5 (Granados)—Recuerdes de la Alhambra (F. Tarrega). The only point of criticism I should like to make is that in the last item the melody, given out tremolo, is dominated by the plucked accompaniment. Apart from this, I found this a most pleasing recital. The recording, originally by Disques Vogue, of France, is of excellent quality, but the surface of the review copy was not one hundred per cent. (H.A.T.)

★ ★ ★

MOOG. The Electric Eclectics of Dick Hyman. Stereo, EMI Stateside SOSL-10055.

Interest: Improvising with a Moog. Performance: Dick Hyman had fun.

Quality: No complaint.

Stereo: Part of the fun.

The Moog electronic music synthesiser is probably the most elaborate and most ingenious device of its type to date but, having got one, there remains the problem of what to do with it!

Undoubtedly, it provides the musician and the student with an unsurpassed means of experimenting with tonal structure, interval, progression, etc., and, as such, may be a rich source for ideas and developments therefrom. But ideas and experiments are no more structured music than experimental panels are a finished building.

For all Dick Hyman's reputation for improvisation and his expressed intention of "humanising" the Moog synthesiser, I feel that he has accomplished little more than indicate what a musician can do with the instrument.

In themselves, the track titles won't mean too much but here they are: Topless Dancers of Corfu—The Legend of Johnny Pot—The Moog and Me—Tap Dance in the Memory Banks—Four Duets in Odd Metre—The Minatour—

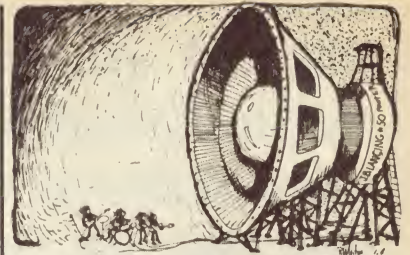

IT ONLY SOUNDS LIKE A FIFTY FOOTER

MUSICAL INSTRUMENT SPEAKERS



OF LOS ANGELES, CALIFORNIA

These are the first professional-quality loudspeakers designed for use with electrical musical instruments. Their unique engineering features and careful craftsmanship provide the amazing "JBL Sound": Lowest bass, sharp mid-range, bright smooth treble, instantaneous response and effortless total sound which is not available with any other speaker, regardless of price or size. Did you read about them in the November issue?



The D110F, 10", D120F, 12", and D130F, 15", create new dimensions in total sound—crisp, spacious, each note has all the bite and body needed for the most demanding assignments. The new D140F, illustrated, is specifically designed for bass guitar or organ, delivering rich, full, solid bass at any loudness level.

Trade enquiries invited.

For free illustrated brochures and the name of your nearest JBL Dealer contact

AURIEMA

(Australasia) Pty Limited
443 Kent Street Sydney 2000
Telephone 29 6144

In association with Goldring Engineering.

GE:PS18

PETER CLARK SAYS. "I'M BACK AGAIN IN EUROPE and HERE THE RAGE IS THE ADD-A-KIT WAY TO BUILD YOUR OWN THING IN HI-FI STEREO SYSTEMS."



ADD-A-KIT HI-FI STEREO SYSTEM



TURNTABLE from \$55

TAPES from \$5.35

AMPLIFIER from \$69

TAPE DECK from \$150

PHONES from \$7.50

SPEAKERS from \$40 PR.

STEP 1. If you own a stereogram, all you buy is the Tape-deck. This lets you feed-in the glorious stereo music you record from friends' records, OR the music from the thousands of pre-recorded tapes on loan at 50c each from Peter Clark's free membership Tape Library.

STEP 2. Starting from scratch. Buy the amplifier above and then ADD-A-PAIR of free-standing speakers to be placed to the best acoustic advantage in your home. Then,

ADD-A-TURNTABLE to pour in all the music you can afford to buy on stereo records. Then,

ADD-A-TAPE-DECK to extend your available music to tapes you record yourself, AND thousands of pre-recorded tapes as above. Then,

ADD-A-PAIR of stereo headphones, so the family can have some peace while you drift privately off to Beethoven or Beatles.

ADD-A-CABINET to contain the lot, from Sydney's most distinguished range of craftsman-built pieces.

ADD-A-WORD. This Add-a-Kit system only works properly when you get proper advice . . . from the specialists at Magnetic Sound, where all the Leading Brands are.

SEE OUR FULL RANGE OF:

- SONY
- NATIONAL
- AKAI

- TOSHIBA
- SHARP
- ELAC
- DUAL

- SANSUI
- KENWOOD
- LEAK
- CROWN

COMPARE OUR PRICES LAST

Magnetic Sound INDUSTRIES

387 GEORGE ST., SYDNEY | door from Kodak **29-3371**
Parramatta Branch, 20 Macquarie St., 635-0830 opp. Astra Theatre.

Total Bells and Tony; Improvisation in Fourths—Evening Thoughts.

Included in these are examples of Moog plus live musicians; Moog played solo; Moog with over-recording, reverberation, tape echo, etc.; Whistling with the Moog; simulated tap dance; Moog with Lowrey organ, etc. Guided by the jacket notes, people interested in the subject will doubtless find it all very intriguing but I doubt that many others will accept it as music to be listened to.

It has nothing in common with the very successful "Switched-On Bach" reviewed in these columns some months ago, which seemed to tickle the ears of a very wide range of listeners.

The unkindest cut is that in the last track, where the Moog is teamed with a Lowrey organ, the thing that impresses is the remarkably pipe-like qualities of the latter, itself an entirely electronic synthesiser! (W.N.W.)

★ ★ ★

MORE GREAT SHOW TUNES. Victor Sylvester and his silver strings. Stereo, World Record Club W.R.C.-S/4549.

Interest: Dance tempo show tunes. Performance: Good for dancing, background.

Quality: Clean.

Stereo: Normal.

For those who may want to dance, Victor Sylvester lays down a strict beat for all fourteen numbers, six quicksteps and eight slow foxtrots. For those who prefer just to listen, he interchanges instrumental solos with the massed strings to produce a program which, in its own way, is very pleasant sound—except perhaps for the very abrupt start and finish to each track.

And the tunes are certainly popular: Hello Dolly—What Kind Of Fool Am I—If Ever I Would Leave You—Just In Time—No Strings—I've Grown Accustomed To Her Face—Mr Wonderful—Put On A Happy Face—People—The Sound Of Music—A Lot Of Livin' To Do—Who Can I Turn To—Younger Than Springtime—I Could Have Danced All Night.

Danceable, listenable and good for background when turned down low. (W.N.W.)

★ ★ ★

THE LOOK OF LOVE. John Duffy at the organ, with orchestra. Stereo, Liberty (Festival) SLYL-933,329. Also in mono LYL-33,329.

Interest: Nice organ, orchestra blend.

Performance: Top ranking.

Quality: Smooth, round.

Stereo: Good separation.

Organ-plus-orchestra albums can all too easily end up as a competition which nobody wins, or a let's-keep-together sound which becomes tedious after a few tracks. John Duffy avoids both pitfalls by swapping the lead with other instruments, including a piano played from his own keyboard. And, when the organ does come in, it has the sound of a large instrument at a suitably remote distance.

And it is indeed a large instrument, an Allen theatre model, with a generous array of tone sources and facilities that do, in fact, make it a notable feature of the presentation.

A thoroughly romantic program includes: The Look Of Love—A Man

And A Woman—Thoroughly Modern Millie—The Eyes Of Love—Love In Every Room—There's A Kind Of A Hush—It Must Be Him—Valley Of The Dolls (Theme)—This Is My Song—Love Is Blue.

Pleasant as featured sound or as background. A good one. (W.N.W.)

★ ★ ★

I FEEL A SONG GOING OFF.

Marty Feldman. Decca stereo SKLA 4983.

Interest: Nonsense songs.
Performance: Inadequate.
Quality: Very good.
Stereo: Normal.

Readers who know Marty Feldman from his recent successful television series will find little of the inspired lunacy which fired the action there. The Feldman touch is noticeable in the cover, which is in strip cartoon style. The songs themselves are not a product of the fertile Feldman mind, but were written by a group who rejoice in the names of King, Solly, Junkin and Essex. The style is a mixture of Flanders and Swan and Tom Lehrer, yet without the elegant humour of the former, or the satirical bite of the latter, I am afraid, and not likely to please the discerning listener. (H.A.T.)

★ ★ ★

GOLD AND SILVER. G.U.S. (Footwear) Band conducted by Stanley H. Boddington, LRAM, ARCM. Stereo, Columbia TWO-256.

Interest: Champion band.
Performance: Worthy.
Quality: Excellent.
Stereo: Normal.

Of long-standing repute, the G.U.S. (Footwear) Band are currently holders of the world band championship, due to defend their title in 1970 at Kerkrade in the Netherlands. The performance here is what one would expect of such a band, and of such a conductor as Stanley Boddington.

In evaluating the album, however, it is necessary to bear in mind that quite a few top quality band recordings have been issued from Britain in recent years and one can afford to be influenced by the selections as much as by the band or the occasion. One might almost add: or by the charming scene on the jacket of this particular album.

The track titles here are twelve in number: Punchinello — Coronation Street — Amparito Roca — March of the Cobblers — Les Preludes — Fight The Good Fight — No Hiding Place — The Arcadians — March from a Little Suite — Theme from the Last Rhapsody — Gold and Silver Waltz — Praise My Soul, The King of Heaven. Well played, well recorded. (W.N.W.)

★ ★ ★

ONLY FOREVER. Dean Martin. Music for Pleasure, mono, MFP-A 8085.

Interest: Dino sings standards.
Performance: Good stuff.
Quality: Good mono sound.

Dean Martin fans will certainly find this low-cost disc a welcome issue. Recorded in good-quality mono sound, it has "Dino" singing some of the standards of the 1930s and 1940s, numbers which are still very popular today: I Can't Give You Anything but Love—Only Forever—Sleepy Time Gal—Maybe—I Don't Know Why—Pretty

Baby—You've Got Me Crying Again—One in a While—The Object of My Affection—For You—It's Easy to Remember—Nevertheless. Some are sung in swinging up-tempo style, others are presented as slow ballads, but in all the engaging Martin personality comes through. Backing is provided by orchestra and female choir. Excellent value. (H.A.T.)

★ ★ ★

SONGS OF STEPHEN FOSTER. The Roger Wagner Chorale. World Record Club Stereo S/4578.

Interest: See title.
Performance: Fine.
Quality: Very good.
Stereo: Effective.

I suppose there can be no true music-lovers, whatever their levels of taste, who do not appreciate the beautiful melodies penned by that unhappy composer Stephen Foster, particularly when sung by such a splendidly disciplined body as the Roger Wagner

Chorale. The selection here certainly comprises some of his most successful inspirations: My Old Kentucky Home—Oh, Susannah—Open Thy Lattice, Love—Some Folks—Nelly Bligh—Old Folks at Home—Camptown Races—Beautiful Dreamer—Oh, Lemuel—De Glendy Burke—I Dream of Jeannie with the Light Brown Hair—Ring, Ring de Banjo—Old Black Joe—Katy Bell. Fourteen tracks in all, making a generous program of pure melody, performed by a group of fine musicians, and excellent value at the club price. (H.A.T.)

★ ★ ★

DREAM — The Mills Brothers. Dot Records (Festival) SZL 933,351 (also in mono).

Interest: Famous vocal group.
Performance: Disappointing.
Quality: Good, bright recording.
Stereo: Well balanced.

This most recent album by the wonderful Mills Brothers is, unfortunately,

BUY RIGHT... FROM ENCEL

FOUR TOP VALUE SYSTEMS



- 1.** Sound, Model SAQ-203 solid state stereo amplifier (12 watts R.M.S. output), MA70 turntable, Micro 2100 magnetic stereo cartridge with diamond stylus, two Sonics AS-61 multiple speaker systems. Each five speakers. (Cabinets as illustrated above.) Total Encel price inc. sales tax **\$275**
- 2.** Sound SAQ-203 amplifier, Connoisseur BD-1 Turntable, Lustre model 1/ST-510 pickup arm, with Micro 2100/5 or Shure M44-7 magnetic cartridge (complete with diamond stylus). Two Sonics AS-60 speakers. Base for turntable with acrylic lid. Price (including sales tax) **\$225**
- 3.** Kenwood TK-250 amplifier. PE2020 turntable, Micro 3100/E, Shure M55E or ADC550E cartridge (all with diamond stylus). Two Sonics AS-220 speaker systems. Base with hinged acrylic lid for turntable. Price (including sales tax) **\$425**
- 4.** The Lux SQ-1220 solid state stereo amplifier (100 watts RMS output), a Goldring Model G99 transcription turntable, Grace G545 tone arm, Grace F-8L stereo magnetic cartridge with an elliptical diamond stylus, two Celestion "Ditton" 15in speaker systems, a base for the turntable with a perspex dustproof lid. Fully assembled, ready to switch on, Inc. sales tax **\$679**

ENCCEL

ELECTRONICS (STEREO) PTY. LTD.

Head Office: 431 Bridge Rd., Richmond, Victoria, 3121. Tel. 42 3762.
Sydney Store: Ground Floor, 25M Building, 257 Clarence Street, Sydney, N.S.W. 2000. Tel. 29 4563, 29 4564.

Australia's Greatest Hi-Fi Centre ■ Wholesalers ■ Trade-ins accepted ■ Terms

Kent firm 'speaks' to the world

The "KEF" success story

— and the man
behind it —



RAYMOND E. COOKE,
B.Sc. (Eng.), F.B.K.S.T.S., F.R.S.A.,
Managing Director of
KEF ELECTRONICS LIMITED.

11.37% OF WORLD MARKET CAPTURED

In manufacturing a loudspeaker, not only science but art is involved and it follows that a wise buyer ought to give some consideration to the man behind the scenes. Is he a researcher, an originator, a designer capable of bringing the products of art and science together in such a manner as to advance the technique of sound production?

Raymond E. Cooke is all of these things and is pre-eminent in the field of designing sound reproduction equipment. In a recent screening of the B.B.C.'s "Made in Britain" program, it was revealed that in the relatively short time of eight years since late 1961, Kef Electronics Limited has captured the astronomical figure of 11.37% of the total world market for their product.

Apart from his academic qualifications obtained at the Battersea Polytechnic and the Reading University, he has had a lifelong interest in music, being an accomplished violinist at an early age. His success with hi-fi is a fusion of musical and electronic interests. Recognition of his technical genius has been implicit in the progress of his career which has included such posts as Production Engineer in Chief of Mullard and Philips, Design Engineer, of the British Broadcasting Corporation, Technical Director of Wharfedale and author of numerous recognised works on sound reproduction, including the well-known articles, "You And Your Loudspeaker," regularly seen in "Hi-Fi News."

His excursion into the field of speaker manufacture commenced when he joined a small sound reproduction concern at Wharfedale, Yorkshire. This business was eventually taken over by the Rank Organisation. From there, armed with a number of advanced concepts and with the partnership of John Balls (also of Wharfedale) and Bob Pearch (of the foundry firm, Kent Engineering and Foundry) these three friends started the subsidiary company of KEF Electronics in literally nothing more than a diminutive green hut close to the main foundry.

Success came suddenly. Exhibiting loudspeakers at a Paris exhibition only four months later in March, 1962, the French filled Kef's order books. This was followed by success in the Swiss market and other European countries eventually became spellbound by the quality of Kef products. From a start with three working directors, the work force is now approaching 150 people. Such able executives as Colin Goodman (Works Manager), formerly of Elliott Automation Ltd. and Laurie Fincham (Chief Engineer), formerly Chief Engineer of Rola-Celestion and Goodmans, are now actively engaged in the non-stop career of this fine manufacturing organisation.

THERE MUST BE A REASON FOR SUCH A SUCCESS STORY. You can hear the reason when you listen to Kef speaker systems, which are taking a firm hold on the Australian market. You understand the reason when you realise that Raymond E. Cooke designs the monitoring systems of the British Broadcasting Corporation, which require the application of the most advanced techniques in order to achieve the closest approximation of natural reproduction.



LIFELIKE SPEAKER SYSTEMS

J. H. REPRODUCERS CO.

293 HUNTINGDALE ROAD, CHADSTONE, VICTORIA. 3148

TELEPHONE: 277-3066

Exclusive Australian Agents for — ADC Cartridges and Amplifiers, Kef speakers, J. H./G. H. Unipoise Pickup Arms, Pritchard Arms, TRANSCRIPTOR TURNTABLES and the popular J.H. Synchronous Turntable.

very disappointing. The two L.P.s which they made with the Count Basie Orchestra, for example, were thoroughly enjoyable and a large part of the success can be attributed to the high quality of the songs.

On this L.P., however, the only numbers which really suit the Mills Brothers are Johnny Mercer's beautiful ballad, "Dream" and "Happy Go Lucky Me." The other eight songs, including Bobby Goldsboro's hit, "The Straight Life," and their American hit, "Jimtown Road," make the group seem rather ordinary, which they most emphatically are not. The arrangements by George Tipton are competent and well played, without ever showing much imagination or sparkle.

Even if one is a confirmed Mills Brothers' collector, the complete absence of a sleeve-note and the limited playing time of 26 minutes must be very irritating. (T.F.C.)

★ ★ ★

CLOUDS. Joni Mitchell. Reprise (Australian Record Company) Stereo RS 6341.

Interest: Modern folk music.
Performance: Appealing.
Quality: Very good.
Stereo: Normal.

This is apparently Joni Mitchell's second L.P., and I mentally kicked myself for missing the first one, after I had heard this one. Jonie has a voice of great appeal, clear and sweet, with a unique quality which gives her a style entirely her own. She is particularly good when singing duets with herself, using dubbed tracks, when her ability to sing in two registers is used to great effect. She writes all her own material, much of which is couched in the high-flown language favoured by the intellectual kind of folksinger today. Although I am not always sure what she is getting at, the imagery is always fascinating. Her guitar accompaniments are a bit weak, but she is supported by a competent group of instrumentalists.

The titles here are: Tin Angel — Chelsea Morning — I Don't Know Where I Stand — That Song About Midway — Roses Blue — The Gallery — I Think I Understand — Songs to Aging Children — The Fiddle and the Drum—Both Sides Now. "The Fiddle and the Drum" is a protest song which Joni sings unaccompanied, and presumably is designed to show her views on the Vietnam situation. This disc should appeal to anybody with an interest in modern folksinging. (H.A.T.)

★ ★ ★

GREAT COUNTRY HITS. Ken Lemon. Music for Pleasure, stereo, MFP-A 8086.

Interest: C & W hits.
Performance: A fine voice.
Quality: Some tape hiss.
Stereo: Restricted spread.

Ken Lemon has the right kind of rich, deep, resonant voice to present C & W songs, but personally I find the type of small orchestra and female choir backing included here a bit out of character. However, this quibble aside, C & W enthusiasts will find this a very pleasant disc, entirely due to Mr Lemon's natural singing ability. The titles include some of the best known C & W standards: Livin' in a House Full of Love—I Love You Be-

cause—Houston—I Can't Help It—Send Me a Pillow—He'll Have to Go—King of the Road—Don't Tell Me Your Troubles—Pearly Shells—Sea of Heart Break—Blueberry Hill—Oh! Lonesome Me. Technically, the disc is not one hundred per cent. The sound is clean enough, but there is distinct tape hiss in some tracks which may worry those with wide range equipment; and the stereo spread is limited. (H.A.T.)

★ ★ ★

YOU MEAN THE WORLD TO ME. Richard Tauber, tenor. Various orchestras. Mono, EMI Parlophone PME-9477.

Interest: Famous tenor.
Performance: Memorabile.
Quality: Well remastered.

Critics notwithstanding, Tauber insisted on his right to sing anything which he felt it worthwhile to sing, whether from the world of opera or of popular music. But, whatever the music, he identified himself with it completely and with a finely developed sense of control and pitch—something that could not be said of many operatic tenors who followed in his footsteps.

Remastered from some of his best-remembered performances, this album contains a generous program: You Mean The World To Me (Tauber)—Friends, Life Is Worth Living (Lehar)—You Are My Heart's Delight (Lehar)—Kiss Your Hand Madame (Erwin)—Humoreske (Dvorak)—It Is No Sunday Every Day (Clewing)—Yes, Green Is The Meadow (Flower)—Serenade D 957 (Schubert)—Heimliche Aufforderung (R. Strauss)—Folger Der Heissgeliebten (Mozart)—Flower Song (Bizet)—Weep No More Liu (Puccini)—Your Tiny Handy Is Frozen (Puccini).

From the period 1928 onwards (not all are dated), the recordings have all been very well remastered. While the frequency response is limited, there is very little surface noise and none of the hollow resonance that betrays overzealous filtering.

For those with an interest in the famous tenor—definitely recommended. (W.N.W.)

Popular Jazz

THE TURNING POINT. Woody Herman and his Orchestra. Calendar (Festival) Jazz Heritage Series. Stereo SR66-9638 (also in mono).

Interest: Commercial Herman 1943-44.

Performance: Interesting but not indispensable.

Quality: Well recorded and remastered.

Stereo: Electronically rechanneled.

This is yet another in Festival's Jazz Heritage series (from the American Decca label) which has now been reissued in Australia on the cheap Calendar label.

Overall, it is perhaps the least important of the dozen or so L.P.s in the series. It does, however, contain fourteen tracks by the Woody Herman band, which were made between November, 1943, and December, 1944—just before the formation of his First Herd.

The personnel of the orchestra is

COMPLETE HI-FI RADIOGRAM-TAPE RECORDER ALL IN ONE

MODEL TR9



AS AN AMPLIFIER . . .

- Frequency response, 20-20000 cps.
- 7 Watts RMS. output per channel.
- Distortion less than 25%
- Separate treble and bass controls.

AS A RADIO . . .

- Being fully transistorised, can be switched on all day at full output without heat problems. Program can be recorded on tape without any external connections.

AS A TAPE RECORDER . . .

- Freq. response 30-18000 cps.
- 3 speeds. Meter level indicator.
- Push button operation.
- Superimposing.

PRICES:

- 2 track mono, \$159.00
- 4 track mono, \$169.00
- 4 track stereo, \$230.00

RADIO TUNER CAN BE FITTED TO ANY OF THE ABOVE MODELS FOR \$28 EXTRA.

TAPE DECKS

for the home constructor. COLLARO (Magnavox) tape decks complete with record/play and speed change switch wafers fitted . . .

2 tracks, \$48. 4 tracks, \$55. SPECIAL LOW IMPEDANCE HEADS for transistorised tape amplifier circuits (Mullard) available.

CLASSIC TAPE RECORDERS

93B LIVERPOOL ROAD,
SUMMER HILL, N.S.W.
Telephone 79-2618

SANSUI

AMPLIFIERS ARE POPULAR BECAUSE THEY OFFER GREATER PERFORMANCE AT A MODERATE COST.

For over a quarter of a century Sansui has been Japan's leading manufacturer of high quality stereo amplifiers . . . today this progressive company is recognised as a leading *international* manufacturer. Over 75% of Sansui's total production sells rapidly on world markets — irrevocable proof of the acceptance of Sansui quality and reliability. *Simon Gray proudly presents three of Sansui's best selling high fidelity solid state stereo amplifiers.*

SANSUI MODEL **AU 222** — 46 WATTS

Using low noise silicon transistors throughout, the Model AU-222 features a frequency response of 20-30,000 Hz. \pm 1dB. and a power output of 46 watts (music power). Input sensitivity suits magnetic cartridges at 2 mV. Performance of this compact stereo amplifier is quite outstanding and every desirable control is incorporated. List price is \$180 inc. sales tax.



SANSUI MODEL **AU 555** — 60 WATTS

Total music power is 60 watts and frequency response is 20-80,000 Hz \pm 1 dB. Input sensitivity suits magnetic cartridges at 2 mV. Advanced circuitry is employed — low noise silicon transistors are used throughout. Controls are extremely flexible — audio quality is superb. List price is \$217 inc. sales tax.

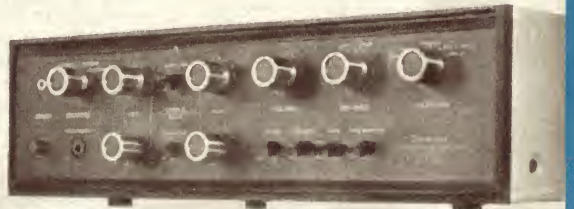

THE NEW SANSUI MODEL **AU 777A** — 70 WATTS

An extremely fine, all silicon transistor, stereo amplifier with a frequency response of 20-100,000 Hz \pm 1 dB. at normal listening levels. Power output is 70 watts (music power) and input sensitivity suits magnetic cartridges at 2 mV. All desirable controls are incorporated. Price is \$321 inc. sales tax.



Every Sansui amplifier has many unique advanced features and offers flexibility and control unsurpassed in its price range. We invite you to see your nearest Sansui amplifier supplier and listen to these fine amplifiers. Ask for complete unabridged specifications. Examine the construction of Sansui equipment closely—engineering and electronics reflect Sansui's quality control in manufacture. Above all, listen. Hear the extraordinary difference Sansui quality makes!

SGS 10/69



Australian National Distributors:

Simon Gray Pty. Ltd.

Head Office: 28 Elizabeth St., Melbourne, Vic. Tel. 63 8101*
Sydney Office: 22 Ridge St., North Sydney, N.S.W. 929 6816
Canberra Office: 31-33 London Circuit, Canberra City, A.C.T. Tel. 49 6050

INTERSTATE REPRESENTATIVES:

N.T.: Pfitzner's Music House, Smith Street, Darwin. Tel. 3801
Q'land: Sydney G. Hughes, 154-158 Arthur St., New Farm, Brisbane. 58 1422
S.A.: Elco Sales Pty. Ltd., 7-9 Osmond Terrace, Norwood, S.A. Tel. 63 4844
Tas.: K. W. McCulloch Pty. Ltd., 57 George Street, Launceston. Tel. 2 5322
W.A.: Athol M. Hill, 613-615 Wellington Street, Perth. Tel. 21 7861

unusual and interesting. With the demands on manpower during World War II, famous musicians like Johnny Hodges, Ben Webster, Ray Nance, Budd Johnson and Juan Tizol were temporarily recruited by Herman for these sessions.

The music is commercially slanted with, for example, six dire vocals by Herman. On the other hand, several of the tracks, including "Ingie Speaks," "Crying Sounds" and "Perdido," are well worth hearing for the solos and the arrangements.

This album may not be essential listening but Woody Herman collectors will certainly want to obtain it, particularly at the attractive new price of \$2.95. The playing time is 45 minutes. (T.F.C.)

★ ★ ★

MEMPHIS UNDERGROUND —
Herbie Mann. Atlantic (Festival).
Stereo SAL 933,384 (also in mono).

Interest: R and B material.

Performance: Exciting.

Quality: Rather fuzzy recording.

Stereo: Normal separation.

On this album, flautist Herbie Mann works with three members of his regular group — Roy Ayers (vibes) and guitarists, Larry Coryell and Sonny Sharrock — together with a five-piece Memphis studio rhythm section.

The material is basically R and B with "soul" hits like "Hold On I'm Comin'" and "Chain of Fools"; together with a long original by Mann called "Memphis Underground" and the traditional tune "Battle Hymn of the Republic."

I have never been a great admirer of Mann's flashy and rather shallow flute playing but, in this album, he plays with much more fire and excitement than usual. A large part of this undoubtedly rubs off from guitarist Larry Coryell, one of the most outstanding young musicians to appear for some years. He takes quite remarkable solos, for example, on "Memphis" and "Hold On."

The added rhythm section, too, is very solid and relaxed with bass player Tommy Cogbill and drummer Gene Christman outstanding.

While the tension and atmosphere,

Chick Webb — "highly recommended"

A LEGEND — Chick Webb, Volume One 1929-36. Festival Jazz Heritage Series. Calendar Stereo SR66-9650 (also mono).

Interest: Great band of the 1930s.

Performance: Most enjoyable.

Quality: Good transfers.

Stereo: Electronically rechan-nelled.

The unexpected re-release, on the \$2.95 Calendar label, of the albums in Festival's Jazz Heritage series probably means that the albums did not sell satisfactorily at the full \$5.75 price. However, I always felt that this was excessive for re-issue material (from the American Decca catalogues). In addition, Festival undoubtedly glutted the limited Australian market for specialise jazz released, instead of spacing them over a period of months.

But the albums were important musically and well presented with in-

which is almost unbearable on "Chain of Fools," may be little more than a surface excitement, the L.P. is still well worth hearing, particularly for Coryell. It goes without saying that Herbie Mann admirers will undoubtedly want to add this to their collections. The playing-time is 36 minutes. (T.F.C.)

★ ★ ★

RAY CHARLES AT NEWPORT. At-
lantic (Festival). Stereo SAL 933-
403 (also in mono).

Interest: Vocals and instrumentals.

Performance: Exciting.

Quality: Good for "live" record-
ing.

Stereo: Adds little.

The eight tracks on this L.P. were recorded "live" at the 1958 Newport Jazz Festival. This was, incidentally, one of the first occasions on which Ray Charles had been presented to a predominantly jazz audience, his appearances and recordings up to that time having been directed more towards the R and B market.

Ray Charles is very much a matter of personal taste. I myself prefer his piano playing to his gospel and blues singing, but both are well represented on this LP.

Four of the eight tracks are instrumentals featuring his seven-piece backing group, under the direction of tenorist, David Newman. "Blues Waltz" and "Hot Rod" (Charles originals) feature most of the band while "Sherry" is mainly a piano feature for Charles himself. The remaining instrumental "In a Little Spanish Town" is very dull and could have been omitted.

The four vocals on the album include "Talkin' About You" and "A Fool for You," and they are typical Charles performances. He sings with great feeling and "soul" and he is a past master at creating unbelievable tension in his performances.

This Newport L.P. has always been regarded as one of Ray Charles' most exciting and successful sessions. I suspect that it has not really stood the test of 11 years, but many admirers of Ray Charles will be pleased to welcome its return to the catalogues. The playing time is 40 minutes. (T.F.C.)

formative sleeve-notes. At the Calendar price of \$2.95, they represent exceptionally good value.

The first of the Chick Webb volumes covers the period from 1929 to 1936, when Ella Fitzgerald's singing was becoming rather more important than the band itself. As I pointed out in my original review of this L.P., the secret of the Webb Band was not so much its individual personality, or even its considerable solo strength; but rather the fact that it swung very hard and had tremendous appeal to dancers.

Among the highlights on this album are Edgar Sampson's great arrangements (especially "Don't be That Way"); the trombone solos by Jimmy Harrison and Sandy Williams; and the trumpet work of Bobby Stark and Taft Jordan. This, and most of the Jazz Heritage Calendar albums, can be highly recommended. (T.F.C.)

"INNERBOND"

(Regd.)

BONDED ACETATE FIBRES

FOR PACKING IN

SPEAKER ENCLOSURES

A new resilient Bonded Wadding made from ultra fine Cellulose Acetate Fibres that gives high efficiency for Sound Absorption.

"INNERBOND" is light, clean, dust-free and easy to handle. Because all the fibres are bonded "INNERBOND" will hang as a "curtain" and will not fracture or break down due to vibration.

"INNERBOND" is odourless, highly resistant to attack by bacteria or fungus and is vermin repellent; "INNERBOND" at 16oz sq. yd. has a normal thickness of 1" and at this density is recommended as a packing in Speaker Enclosures for Sound Absorption.

STOCKISTS:

SYDNEY: Arrow Electronics Pty. Ltd. 342 Kent St.; Broadway Electronics (Sales) Pty. Ltd., 32 Glebe Point Rd.; GLEBE: Convoy International Pty. Ltd., 449 Kent St.; Encl Electronics Pty. Ltd., 257 Clarence St.; Kent Hi-Fi 432 Kent St.; Mastersound Sales Pty. Ltd., 400 Kent St.; Radio Despatch Service, 869 George St.; Peter Shalley Electronics Pty. Ltd., 127 York St.; Stereo Music Systems, 193 Clarence St.; Circuit Components (A/sia) Pty. Ltd., 460 Bexley Rd.; BEXLEY: Classic Radio, 245 Parramatta Rd.; HABERFIELD: Dyna Stereo Pty. Ltd., 331 Prince's Hwy St.; PETERS: Albert Wright Radio Service, 795 New Canterbury Road, HURLSTONE PARK; H. B. Radio Products, 103-105 Catherine St.; LEICHHARDT.

NEWCASTLE: Martin de Launay Pty. Ltd., King and Darby Streets; Dynamic Sound, 587 Hunter Street.

WOLLONGONG: Electron Parts Pty. Ltd., 82 Keira Street; Martin de Launay Pty. Ltd., 270 Keira Street.

MELBOURNE: J. H. Magrath and Co. Pty. Ltd., 208 Little Lonsdale Street.

BRISBANE: A. E. Harrold Pty. Ltd., 123 Charlotte Street; Brisbane Agencies, 78 Wickham Street; Fortitude Valley.

IPSWICH: Robert N. Smallwood, 205 Brisbane Road, Booval.

NORTH QUEENSLAND: Alvin Communications and Electronics, 38 Peggall St., Pinlco, Townsville.

ADELAIDE: Duncan Agencies, 57 Woodville Road, Woodville; General Accessories, 81 Flinders Street; Trustcott Electronics, 62-64 Hindmarsh Square.

PERTH: Atkins (W.A.) Ltd., 894 Hay Street; Carlyle and Co. Pty. Ltd., 1 Milligan Street; General Accessories, 46 Milligan Street.

HOBART: Homecrafts-Tasmania, 199 Collins Street.

If unobtainable

For 1 sq. yd. as above send \$2.00
For 2 sq. yds. as above send \$3.75
For 4 sq. yds. as above send \$6.50

Postage paid in Australia and Territories to the manufacturers.

WONDER WOOL PTY. LTD.

87 JAMES STREET, LEICHHARDT.

N.S.W., 2040.

Box 548 — G.P.O., Sydney, 2001.

Phone: 56-2780.

NEW ALL TRANSISTOR STEREO AMPLIFIERS ULTIMATE IN DESIGN-LONG DEPENDABILITY USING ALL SILICON TRANSISTORS 36 WATTS—RMS

SPECIFICATIONS:

POWER OUTPUT: 18 watts per channel R.M.S.
Total output 36 watts R.M.S.

FREQUENCY RESPONSE: From 20 cycles to 20,000
± 1db.

HARMONIC DISTORTION: Less than 1 per cent at
14 watts output.

HUM AND NOISE: Aux. 70db, Mag. 50db.

INPUT SENSITIVITY: Mag. 3mv, Aux. and tuner
200 mv.

SPEAKER IMPEDANCE: 8 oms.

EQUALISED: Mag. RIAA.

TONE CONTROLS: Bass 50 c/s ± 12db. Treble
10 kc/s ± 12db.

LOUDNESS CONTROL: 50 c/s 10db.

SCRATCH FILTER: (High filter) at 10 kc/s 9db.

RUMBLE FILTER: (Low filter) at 50 c/s 5db.

PROVISION FOR TAPE RECORDER. Record or
play-back with din plug connection.

PROVISION FOR HEADPHONES with headphone/
speaker switch on front panel.



MODEL C300/20

\$119.00 FREIGHT EXTRA.

DIMENSIONS: 16½in v 5½in x 11in deep.

Mounted in oiled walnut or teak veneered cabinet,
with metal trim and matching knobs.

THE CIRCUIT INCORPORATES regulated power
supply with transistor switching protection for
output transistors. 26 silicon transistors plus 5
diodes are used.

**ABOVE AMPLIFIER
WITH INBUILT A.M.
TUNER**

\$144.00 FREIGHT
EXTRA

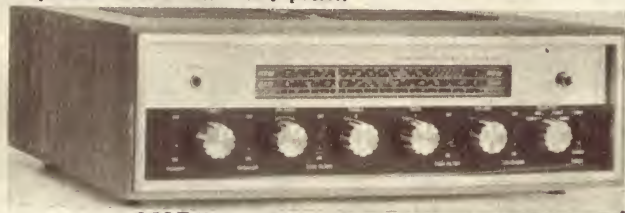

MODEL C300/20/T

12 WATT RMS PER CHANNEL VERSION OF ABOVE AMPLIFIERS AS PREVIOUSLY ADVERTISED
ALSO AVAILABLE. \$134.00 WITH TUNER.

NEW ALL-TRANSISTOR A.M. TUNER WITH PRE-AMPLIFIER



DIMENSIONS: 10½in. x 3in x 5½in.

Suitable for use with all transistor or valve Hi-Fi amplifiers, tape recorders or
P.A. amplifiers.

\$40.00

SPECIFICATIONS:

Frequency coverage 530 to 1,600 K.C. Inbuilt aerial, provision for external aerial.
240 volt A.C. operation. Output variable from 50mv to 1.5 volts. Timber cabinet
finished in teak or walnut. Band width 9KC.



**MODEL C200V. BASED ON THE
PLAYMASTER 118 WITH TUNER**

Dimension 16½in x 5½in x 11in.

CABINET IN OILED WALNUT OR TEAK WITH
METAL TRIM.

\$118.00

FREIGHT
EXTRA.

This amplifier is based on the Playmaster 118 circuit as featured in "Electronics Australia," to which has been
added the following features:

- Inbuilt high gain A.M. tuner with a coverage of 530 to 1,600 K.C.
- Loudness control giving bass boost at low volume.
- Provision for tape, record and play-back, with din connector.
- Calibrated dial available for all States.
- EM84 tuning indicator giving accurate tuning with ease.

POWER OUTPUT: 9 watts per channel R.M.S. **FREQUENCY RESPONSE:** 20 to 20,000 cycles incorporating
Ferguson O.P.412 gain oriented output transformers. **VALVES USED:** 4-6GW8, 12AX7 or 12AU7, 6AN7,
6N8, EM84 and 2 silicon diodes.

CLASSIC RADIO

245 PARRAMATTA ROAD, HABERFIELD, N.S.W. PHONE 798-7145

NEW Releases!

IN HI-FI STEREO EQUIPMENT BY CLASSIC

NEW 24 WATT R.M.S. TRANSISTOR AMPLIFIER WITH INBUILT A.M. TUNER



MODEL C250

\$118.00 FREIGHT EXTRA

DIMENSIONS 15½in x 4½in x 11in deep.
Cover finished in teak or walnut wood grain.
Incorporates 24 low noise silicon transistors plus 5 diodes.

SPECIFICATIONS:

POWER OUTPUT: 12 watts per channel 24 watts R.M.S. total (48 watts music power).
FREQUENCY RESPONSE: 20 Cycles to 20,000 ± 1db.
HARMONIC DISTORTION: Less than 1% at 10 watts.
HUM AND NOISE: Aux. 70db. Mag. 50db.
INPUT SENSITIVITY: Mag. 3mv. Aux. 200mv.
SPEAKER IMPEDANCE: 8 ohms.
EQUALIZED: Mag. RIAA.
TONE CONTROLS: Bass 50c/s ± 12db. treble 10kc. ± 12db.
LOUDNESS CONTROL: 50c/s 10db.
SCRATCH FILTER: (High filter) at 10kc. 9db.
PROVISION FOR TAPE RECORDER: Record or play back with standard din plug connection.
TUNER: This unit can be supplied with either valve or transistor tuner with a coverage of 530 to 1,600 K.C. Calibrated dial available for all States.

COMPACT STEREO SYSTEM



Cabinet Dimensions
18in x 12in x 7in

Above amplifier and tuner in attractive timber cabinet with hinged tinted perspex cover fitted with the new Garrard 60 Mk. II changer or SP25 Mk. II player with Pickering AC2 magnetic cartridge plus two Playmaster bookshelf speakers.

Available in teak, walnut or maple. Oiled finish.

\$260.00 FREIGHT EXTRA



CABINET DIMENSIONS
18 x 14½ x 8½



Dimensions: 14in x 8½in x 8½in.

MULLARD MAGNAVOX MINI SPEAKERS
These units designed by Mullard and Magnavox engineers compare favourably with imported B/S Speakers costing more than twice the amount and are ideal where space is limited. Incorporates the Magnavox 6WR 6-inch Speaker and the new 3TC Mk. II tweeter frequency response, 50 to 18,000 cycles. Power rating max. 8 watts. Available in 7½ or 15-ohm impedance.

\$27.00
Post and Packing: N.S.W. \$1.50, Interstate, \$2.00.

NEW BOOKSHELF SPEAKER SYSTEMS

PLAYMASTER BOOKSHELF SYSTEM

Available in 15 ohms or 8 ohms.

\$30.00

Post and Packing: N.S.W. \$2.00, Interstate \$2.50.

PLAYMASTER SUPER BOOKSHELF

Using two of the new Magnavox 6WR Speakers and one 3TC tweeter. Dimensions: 19½in x 10in x 8in.

Available in 8 or 15 ohms.

\$40.00

Post and Packing: N.S.W. \$2.00, Interstate \$3.00.

ALL SPEAKER UNITS FINISHED IN OILED WALNUT, MAPLE OR TEAK.

CLASSIC RADIO

245 PARRAMATTA ROAD, HABERFIELD, N.S.W. PHONE 798-7145

TRADE REVIEWS AND RELEASES

DOVEDALE III LOUDSPEAKER SYSTEM

The Wharfedale Dovedale III is one of the loudspeaker systems with a volume of 2 cu. ft. — a size currently popular in overseas markets. It uses three loudspeakers; a 12in woofer, a 5in midrange unit, and a 1in dome tweeter. A pair of these systems was submitted to us for review by Simon Gray Pty. Ltd.

The Dovedale enclosure measures 24 x 14 x 12 inches and is made of 5/8in thick particle board, apart from the front baffle, which is made of 5/8in thick plywood. It is finished on four sides in polished walnut or, in the case of our samples, in oiled teak veneer. The front grille is removable and is covered in black, gold-flecked, acoustically transparent cloth which gives an attractive but unobtrusive appearance. The cabinet may be used horizontally or vertically.

The enclosure is sealed and partially filled and lined with bonded fibre. The



woofer is mounted from the rear of the baffle, while the other two units are mounted from the front. The woofer has a conventional, corrugated paper cone fitted with a synthetic rubber roll and generous spider assembly to allow large cone excursions. Magnetic flux density of 11,500 oersted in the voice coil gap is provided by a large, square ceramic magnet. As might be expected, the massive cone basket is of cast construction.

The 5in midrange unit is interesting in that the cone is doped with a shiny, rubbery material. The loudspeaker itself is mounted in a rigid cardboard tube to prevent "pumping" by the woofer; the cardboard tube being packed with B.A.F.

wadding to soak up sound from the rear of the cone.

The tweeter is a 1in plastic dome unit with a large square ceramic magnet. The magnet and dome assembly are attached to a plastic phasing plate which in turn is secured to the front baffle; more about this later.

Frequency response is quoted by the manufacturer as ranging smoothly from 40Hz to 20KHz. The nominal impedance of the system is 8-ohms and it is suitable for amplifiers designed for 4 to 8-ohm loads. Power handling capability of the system is rated at a generous 35 watts

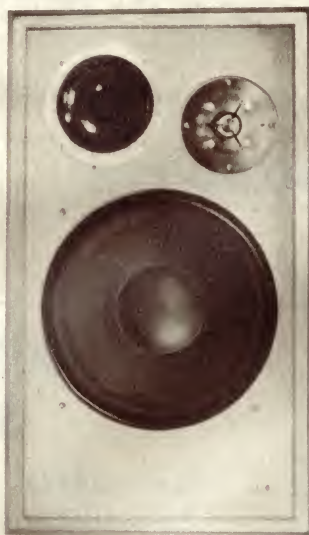

The Dovedale III with front fret removed. Note the powerful 12-inch woofer.

RMS. The woofer covers the range from 40Hz to 450Hz, the midrange unit carries on up to 3Kz and the tweeter ranges up from there.

Glide tone testing with an AF sinewave generator indicated that the frequency response over the whole of the audible range was very smooth indeed, apart from some lumpiness in the region from 50 to 40Hz, below which the response was attenuated sharply. In this respect, the Dovedale is probably one of the smoothest loudspeaker systems we have tested to date and a smooth frequency response is a highly desirable characteristic for any loudspeaker system in order to reproduce music accurately.

We were surprised to note that the

acoustic efficiency was only on a par with that expected from compact systems with miniature woofers. Plainly, the Dovedale is intended for use with very powerful amplifiers which are appearing in ever-increasing quantities on the market. Hence, the high power handling capability which is necessary in order to achieve a high loudness level.

While the glide tone tests revealed that the loudspeakers were well teamed, the cabinet left something to be desired. At high power levels the rear panel exhibited some resonance and front grille cloth buzzed audibly. Also noticeable was a spurious noise coming from the tweeter when the woofer was heavily loaded with low-frequency signals in the region of 100 to 200Hz.

At first we thought the spurious noise was caused by "crossing over" the tweeter at too low a frequency and thereby exciting its natural resonance, which can typically be of the order of 500Hz. Close inspection proved that this was not the case. What was actually occurring was that the plastic mounting plate to which the tweeter's magnet/dome assembly was attached was being flexed by the low frequency energy from the woofer.

While these effects may not be provoked as readily by program material as by high level test tones, the possibility of them colouring particular passages is there.

Actual listening tests again pointed up the smooth frequency response of the Dovedale system. There was little need for bass boost and treble dispersion was good, due to the "point source" effect of the small tweeter. Strangely enough, the Dovedale sounded less bright in the treble than many less expensive systems we have heard — probably because these other systems have not had the very smooth response, particularly in the critical 2 to 5KHz region, that the Dovedale has. And it certainly does not need much, if anything, in the way of bass boost.

In short, the Dovedale is a very promising loudspeaker system, capable of excellent reproduction with modern higher-powered amplifier systems. It has been well reviewed and well received overseas. We do feel, however, that the manufacturers should give attention to certain cabinet details and remove any apprehension which these may cause.

Retail price of the unit, including sales tax, is \$184.

Further information regarding this and other products in the Wharfedale can be obtained from the Australian distributors, Simon Gray Pty. Ltd., 28 Elizabeth Street, Melbourne, Victoria, or normal retail outlets. (L.D.S.)

3-Lead IC Regulator

An integrated circuit packaged in a three-lead transistor can have been introduced by the National Semiconductor Corporation of the U.S.A. It is the LM109, a 5V regulator for digital logic systems. The LM109 needs no external components; its only leads are for input, output and ground. The circuit is available in two packages — a solid Kovar TO-5 can from which, with adequate heat sinking, it can deliver 200mA; and a TO-3 power package with output current of over 1A. The LM109 is protected against overload by thermal limiting as well as current limiting, and is said to be virtually blowout proof.

The circuit operates at an input voltage of only 6.5V by using for its reference voltage the emitter-base voltage of silicon transistors (1.218V) instead of a zener breakdown voltage. The output voltage requires no adjustment, being determined at the production stage. The long-term stability is better than 10uV.

For further information contact the distributors, Rutherford Electronics Pty. Ltd., P.O. Box 30, North Balwyn, Vic. 3104.

MULTIMETER ALSO MEASURES TEMPERATURE

Jacoby, Mitchell & Company Pty. Ltd. recently submitted for review a Normatest Multimeter, which has measuring capabilities well in excess of normal instruments of this size. In spite of its small size, it has many features, such as a large, easily read scale, a sensitivity of 20,000 ohms/volt on DC, taut-band suspension, a 6-amp AC range and the ability to make temperature measurements with an optional thermocouple probe.



The unit is housed in a grey plastic case measuring $6\frac{1}{2} \times 3\frac{1}{4} \times 1\frac{1}{4}$ inches thick. The dial carries five ranges and maximum use has been made of the available glass areas for easy legibility. The movement is of the taut-band suspension type, which has good overload capability.

The DC voltage ranges, with a sensitivity of 20,000 ohms/volt are 1.2, 6, 30, 60, 120 and 600 volts. The accuracy claimed is plus or minus 2.5 per cent, and checks on all ranges showed that it was well within this figure. AC voltage ranges have a sensitivity of 4000 ohms/volt and are as follows: 6, 30, 150, 300 and 600 volts. An error additional to that for the DC ranges is quoted for the AC ranges as follows: from 15 500Hz — plus or minus 1 per cent; from 500Hz to 5KHz — plus or minus 2.5 per cent and from 5KHz to 30KHz — plus or minus 5 per cent. In actual fact we found the accuracy to be within plus or minus 3 per cent even at frequencies beyond 30KHz.

The reference which we used for checking is a digital voltmeter with an accuracy of the order of 0.1 per cent.

DC current ranges are as follows: 30uA, 120uA, 600uA, 3mA, 12mA, 60mA, 300mA, 1.2 amps and 6 amps. AC current ranges are 150uA, 600uA, 3mA, 15mA, 60mA, 300mA, 1.5 amps and 6 amps. The Normatest thus has more current ranges than voltage ranges, which is unusual.

There are two ohms ranges; x1 and x100, which enable most resistor values except those below 20 ohm to be easily checked. A single penlite cell provides current for the ohms ranges and is accommodated behind a spring-loaded sliding partition in the back of the case.

The ranges are selected by a large rotary switch in conjunction with a four-position slide switch which selects the temperature scale, ohms ranges and AC or DC ranges. We found that having to use a rotary switch and a slide switch was sometimes confusing and one could easily forget to move the slide switch to the correct position for the desired range.

The circuitry for the unit is accommodated on printed board and a feature of this was the large, ruggedly con-

structed, tapped shunt which is apparently calibrated in situ.

Because of the taut suspension the manufacturer claims that the meter is able to withstand momentary overloads with a factor up to 1000. The pointer is made of glass so that it cannot be bent by these severe overloads. If the overload is maintained for more than a few seconds permanent damage would naturally result to the internal circuitry. Because of the confusion regarding the selector switches noted above, the meter was inadvertently overloaded several times but no apparent damage resulted and accuracy was not impaired.

The major feature of this multimeter is the ability to make temperature measurements with the aid of an optional iron-constantan thermocouple probe. This allows temperature measurement up to a maximum of 240 degrees Centigrade above ambient or a maximum of 300 degrees Centigrade. This is very convenient when developing new circuitry and indeed, it was used in the development of a high power amplifier in our own laboratory.

To sum up, the Normatest is a well-designed, compact instrument which is very versatile. The little handbook supplied with it describes the many uses to which the meter can be put. Price is \$30 plus tax and the thermocouple probe is \$14 plus tax which is a very worthwhile addition to the meter. It is available through most trade houses or direct from the distributors, Jacoby, Mitchell and Company Pty. Ltd., 469-475 Kent Street, Sydney or their interstate branches. (L.D.S.)

=====

KODAK (A'ASIA) PTY. LTD., 173 199 Elizabeth Street, Coburg, Vic., 3058. **High Speed Duplicating Plates.** For making quantity copies of printed circuit negatives with precise tolerances, and for reproducing line negatives and other scribed images. The new plates deliver maximum density from either negatives or positives, exposing the original film through the base, or emulsion-to-emulsion (for duplicating either films or plates). The plates are available in ten sizes, ranging from 4 x 6in on a .06in base to 20 x 24in on a 0.25in base. For further information contact any branch of Kodak in Australia.

WANTED TECHNICIANS

For casual employment on our night servicing shift 6 p.m. to 11 p.m., also weekend work available.

Work entails servicing all brands of radios, tape recorders, stereo equipment, etc.

(Experienced people need only apply.)

Ring or direct application to:

31-5430 Mr L. DEITCH 31-6786
(Deitron Electronic Service Division)
4-6 TAYLOR ST., TAYLOR SQ.
DARLINGHURST, N.S.W. 2010

NEW EQUIPMENT CABINETS



MODEL 154. With lift-up lid over player. Sliding door in front of amplifier compartment. Large storage space with four separators. Size 36in wide, 17½in deep, 31in high.

Price

Made and Polished, maple, walnut or teak	\$65.00
Packing	\$2.20
Kit of Parts, maple	\$36.50
Teak extra, kits only	\$6.50
Packing	\$1.40

New Player Platform model 175 is 16in x 14in x 3½in. Price \$7.50 for maple or walnut. Kit of parts \$4.00. Teak, 50c extra. Perspex cover, 3½in or 5½in high, \$8.20 and \$1.50 extra if required hinged. Please specify cut out required.



MODEL 186

New Player Cabinet model 186 is 10in high, 16in wide, 16½in deep and 5½in above shelf. Finished with tinted perspex top. Price \$22.00 for maple or walnut or teak. Kit of parts, \$13.50. Teak, \$1.00 extra (kits only). Height of this model can be increased to take various amplifiers. Tailored cut out. Ask for quotation. F.O.R. Packing \$1.

Write for Catalogue and Player Guide

H. B. RADIO SALES

105 Catherine Street,
Leichhardt, Sydney.
Telephone: 56-5580.

WORLD FAMOUS HI-FI STEREO EQUIPMENT COMES TO

ADELAIDE

An exciting new range of Hi-Fi Stereo equipment is now available to the South Australian enthusiast. Our comprehensive market research assures that we offer the best value for money and our realistic low prices are backed by guaranteed after-sales service.

New Speaker Kit Handles 15 Watt R.M.S.

Careful technical research has developed a new 2-way speaker kit capable of handling 15 watt r.m.s. (8" bass and 2" tweeter). Overall frequency response is 30-20,000 cycles and the kit sells for a modest \$23.50 (including crossover network). The kit can be used in vented enclosures up to 3 cu. ft. and also gives outstanding performance in less than 1 cu. ft. (infinite baffle).

Challenge Recording Co.

- ★ LUX AMPLIFIERS
- ★ GRACE tone arms — magnetic cartridges
- ★ CELESTION co-axial loudspeakers
- ★ REVOX tape recorders
- ★ CONNOISSEUR belt drive turntables

LUSTRE Tone Arms, RICHARD ALLAN Loudspeakers, SOUND Amplifiers, PEERLESS Loudspeakers. SONICS Speaker Systems, P.E. Turntables, MICRO Magnetic Cartridges, KALTRO Loudspeakers, COMPAX Radio Tuners.

**6 GAYS ARCADE,
ADELAIDE**

(off Adelaide Arcade)

Phone 23-2203

UNITED TRADE SALES

PTY. LTD.

POWER SUPPLIES

600V. 400 mA. Complete with 2 x 866A Rectifiers, 2 x 500mA Filter Chokes on 19in Rack Panel. Good condition. Weight approx 50lb.
\$15.00.

Freight extra.

VALVE SPECIALS

833A. \$6.00 (use	6SJ7. 60 cents.
872A 75 cents.	5V4. \$1.00.
6SL7. \$1.00.	6AL5. 30 cents.
6SN7. 60 cents.	6AU6. \$1.00.
6A8G. \$1.50	6J6. 30 cents.
6J8. \$1.75	6K7. 50 cents.
6K8. \$1.00.	6J7. 50 cents.
6B8. \$1.50.	813. \$6.00.
6U7. 60 cents.	807. 70 cents.
6SK7. 75 cents.	5U4. \$1.00.
6AC7. 20 cents.	SR4. \$1.00.
6X4. 60 cents.	12AT7. 50 cents.
6X5. 75 cents.	815. 70 cents.
6AM6. 65 cents.	

Postage extra.

RECEIVERS

AWA Type 1C8388 — 2.5MHz to 22MHz.
14 Tubes B.F.O. 455KC. xtal filter.
A.V.C. Fast and Slow S meter.
Octal tubes. Separate power supply.
With speaker. Plug in coils.
Nice clean condition, weight approx 60lb.

A bargain at \$50.
Freight extra.

NU-METAL SHIELDS

To suit 5BP and other 5in CRTs mfd. by Magnetic Shields Ltd. Brand-new, \$5 ea. plus 30c pack. and post.

TAPE HEADS

Cassette Recorder Type Replay Heads. 2-track Mono Current Manuf.
New \$1.50 ea.

PLUS 10c pack. and post.

CAPACITORS

80 for \$2 in Poly Packed Bags. Mixed values only.

TRIO TR2E

2-METRE TRANSCEIVER

- Triple conversion receiver with crystal locked second and third oscillators for maximum selectivity and sensitivity.
- Separate VFO tuning for both receiver and transmitter.
- Nuistor RF amplifier.
- Provision for crystal locking of the transmitter.
- 12 volts DC (internal transistor power supply) and 230-240 volts AC operation.
- Noise limiter and squelch.
- 17 tubes, 4 transistors and 7 diodes.
- 1 microvolt sensitivity for 10 db. S/N ratio at 14 6 Mc.
- "S" meter, RF output meter and netting control.

Price: \$282.

3,000 TYPE RELAYS.

Large range. Only 50c each.

COMPLETE RANGE OF METERS.

100uA . . .	P25s 24sq.	1mA . . .	\$4.50
500uA . . .		50mA . . .	\$4.50
10mA . . .		S'meter . . .	\$5.25

MULTIMETERS, 200H, 20K ohms per volt, \$11.25, incl. tax. CT 500 20K ohms per volt, \$15 incl. tax. CT 330 20,000 ohms per volt, \$17.25.

COSSOR 1049 Double Beam Oscilloscopes in good condition. Fully checked.

\$85.

Freight extra.

TRANSISTOR V.H.F. CONVERTER

Tunable 108-136 Mhz Aircraft Band 1F-600Kc to 1,000Kc. No connecting wires needed, 9V Battery, self-contained, just place alongside broadcast radio. Price only \$14.40 plus 45c postage.

TRANSISTORS

2SC73, 2SD65, 2T76, OC66, 2T65 25c ea. or in 100 lots 20c ea.

LSG11 SIGNAL GENERATOR

120KHZ to 260 MHZ New in sealed carton \$35, postage \$1.

MILLER TRANSISTORISED IF STRIPS

455 Kc Selectivity 5 Kc at 6db down. Power 6 Volts 2mA gain 50db.
Price: \$9.70.

RESISTORS. Mixed Values only in Bags; \$2 per 100, or 50 for \$1. 3,000 Type Relays. New stocks. 50c each. Plus postage.

WANTED BUY:

RECEIVERS, TRANSMITTERS
TEST EQUIPMENT.

All prices subject to alteration without notice. All items PLUS POSTAGE.

**280 LONSDALE STREET,
Melbourne. Phone 663-3815.**

(Opposite Myers)

DT-360 DIGITAL MULTIMETER

Pictured is the Model DT-360 Digital Multimeter, a compact, low-cost instrument manufactured by Data Technology Corporation of Palo Alto, California, and available in Australia from Racal Electronics Pty. Ltd.

The DT-360 is suitable for use in production testing, servicing, research and development, and educational applications. It offers virtually all of the functional versatility of a conventional analog multi-meter and electronic voltmeter, together with the resolution, accuracy and freedom - from - reading-error characteristic of digital instruments.

Fully solid-state apart from the gas discharge readout tubes, the instrument offers a display with "3 full decades plus single digital over-range" resolution (.05 per cent). It employs the highly stable dual-slope integration technique for analog-digital conversion, and gives automatic DC polarity indication. Rated measurement accuracy on the DC voltage ranges is within (0.1 per cent ± 1 LSD); on the AC voltage ranges, within (0.5 per cent ± 2 LSD) from 50Hz to 10KHz (useful current range much wider); on the DC and AC current ranges, within (0.2 per cent ± 2 LSD), and on the resistance ranges, within (0.2 per cent ± 2 LSD).

Range selection on the DT-360 is performed by a row of pushbuttons adjacent to the readout display. Four white buttons select the functions, i.e., DC-AC-MA-K Ω , while five black buttons select from the range multipliers 0.2, 2, 20, 200, and 2000. The last of these applies only to the current and resistance functions, as the maximum FSD on the voltage ranges is 1000V. The instrument provides a total of 25 measuring ranges. Decimal point indication is provided on the display, operated by the range selector buttons. The input may be floated at up to 500V above ground during measurements.

Input impedance of the instrument on the DC voltage ranges is greater than 100M on the two lowest ranges, and 10M on the higher ranges. On the AC ranges it is 10M/90pF. The output current on the resistance ranges is 1mA maximum. Instrument overflow is indicated flashing of the over-range digit. The instrument is quite extensively protected from gross overload damage, and a table giving the overload capability-for the various ranges is attached to the rear of the case for easy reference.

The instrument is housed in a very compact case measuring 9in x 7in x 3in with handle extended, the case itself being a buff coloured impact-resistant plastic moulding. Preset controls are available for adjustment beneath a clip-on fascia strip on the case front. Total weight of the instrument is only 42 ounces.

Although normally supplied for AC mains operation (it draws a mere 7 watts), it may be operated from an internal DC source for fully mains-free use, by means of an optional battery pack.

The sample DT-360 unit pictured was examined and tested in our laboratory, and gave a very impressive account of itself. Apart from its noteworthy compactness and light weight, which were immediately apparent, we were most impressed with the readout display, which is particularly



crisp and bright for an instrument in this price range.

On the operational side, the instrument was found to be equally impressive. The many ranges provided are easily selected, and the range in use is quite unambiguously indicated by the selector buttons. The performance itself is of a high standard, the stability being of a very high order and the accuracy proving well within the manufacturer's ratings.

In fact although the rated warm-up time of the instrument is quoted in the accompanying instruction manual as 5 minutes, the sample unit stabilised to well within its specifications in less than half this time. This compares very favourably with other instruments in the price range concerned.

In all respects, then, we found the DT-360 a most attractive instrument, and one which should find many applications in both laboratory and field situations.

Quoted price of the instrument is \$395 duty free, or \$420 duty paid, excluding tax. Enquiries may be directed to Racal Electronics Pty. Ltd., of 47-53 Bennie Street, North Ryde, N.S.W. 2113. (J.R.)

CONTINUITY TESTER

A novel instrument for checking the continuity of circuits has been submitted for review by Ronald J. T. Payne Pty. Ltd.

Known as the "Bleeptest," the unit is a simple continuity tester for use by technicians, wiremen, inspectors, electricians, etc., where the continuity of a circuit has to be confirmed and can stand a nominal load of 6mA.

The unit uses a transistor oscillator and a rocking armature motor to produce an audible note when connected to a low-resistance circuit.

The tester is fitted with a stainless steel dress clip so that it may be used with both hands free. A small eyelet is provided for a lanyard. The unit is enclosed in a high impact moulded case with a tough durable finish. Output sockets for 4mm. plugs are fitted in the bottom of the case; the tester is supplied complete with plugs.

Access to the battery compartment is by removal of the lid, attached to the base by three screws. The battery used is a PP3 or equivalent 9V type.



The unit we examined passed a current of 4.3mA though a short circuit load. This current fell to 1.2mA when the load was increased to 4.7K Ω — the highest resistance at which the unit would oscillate.

All inquiries should be addressed to the Australian distributors Ronald J. T. Payne Pty. Ltd., 385-387 Bridge Road, Richmond, Vic. 3121. (J.H.)

HY-Q ELECTRONICS PTY. LTD.,
10-12 Rosella Street, Frankston, Vic. 3199, has been awarded the major portion of a Department of Supply contract to supply substantial quantities of quartz crystals to the R.A.A.F. over a two year period.

RECORDING TAPE

RECORDING TAPE
Cheapest in Australia

7" 2,400ft	-----	\$3.50
7" 1,800ft	-----	\$2.75
5" 1,120ft	-----	\$2.25

COMPACT CASSETTES
Made in U.S.A.

C.60	-----	\$1.25
C.90	-----	\$2.00
C.120	-----	\$2.75

GENUINE B.A.S.F.

C 60	-----	\$2.25
C.90	-----	\$3.00
C.120	-----	\$3.75

**BRAND NEW, BOXED
GUARANTEED**



RADIO MART
338 PITT STREET,
SYDNEY

All Mail
Box 4913 G.P.O. 2001



A SYMPHONY ORCHESTRA IN YOUR LOUNGE...

(AND ROOM FOR YOU TOO.)

YOU MAY NOT HAVE A ROOM THE SIZE OF CARNEGIE HALL BUT YOU CAN REPRODUCE CONCERT HALL SOUND AND CLARITY WITH PIONEER



The PIONEER AX330 amplifier

The PIONEER AX330 is an imported, solid state tuner amplifier for the quality conscious, thrifty Audiophile! The AX330 is a high quality unit for those who don't have a living room the size of Carnegie Hall — but want Concert Hall clarity and purest sound reproduction.

NOW AVAILABLE FROM YOUR DEALER.

Contact your State Office of **ASTRONICS AUSTRALASIA PTY. LTD.** (Sole Australian Agents, and a member of the Electronic Industries Limited Group of Companies) for your nearest dealer's address.

VIC: 161-173 Sturt St. Sth. Melb. Phone 69 0300.
 N.S.W.: 121 Crown St. E. Sydney. Phone 31 6721.
 S.A.: 81-97 Flinders St, Adelaide, Phone 23 4022.
 W.A.: 28 Belmont Ave, Belmont. Phone 65 4199.
 TAS: 199 Collins St, Hobart. Phone 2 2711.
 QLD: 50-54 Lt. Edward St, Brisbane. Phone 2 0271.



PIONEER

— FOR PURE SOUND

SWITCH AND INDICATOR FROM IRH

The Switch and Indicator Division of IRH Components Pty. Ltd. has introduced an appliance switch from N.K.K. and a series of indicators by Telite.

The N.K.K. appliance switch, type SDB-122, has been examined and tested by the Sydney County Council, and approved for connection in appliances connected to the Council's mains. Brief specifications of the switch are: rating, 6A at 250V AC, 10A at 125V AC, and 15A at 30V AC; contact resistance .01 ohm maximum; insulation resistance at 500V DC 1000M minimum; dielectric strength 1500V AC for 1 minute minimum; mechanical life 50,000 cycles; electrical life 25,000 cycles.

Designed for switch panel operation, the Telite series LT indicators are available with a choice of neon, fluorescent and filament lamps. Standard voltages are: neon or fluorescent 110/120V AC, 230/250V AC, or 400/450V AC; filament 6V 50mA, 12V 90mA, or 24V 50mA. Three different modes of termination may



be specified: white twin flex 9in long, end stripped 1/2in and tinned; heavily plated 6BA cheeshead screws with rigid terminal separation barrier; standard 1/2in quick connect terminals with separation barrier. Lenses are available rounded or flat in a choice of clear or five colours.

All inquiries should be addressed to the Switch and Indicator Division, IRH Components Pty. Ltd., The Crescent, Kingsgrove, N.S.W. 2208.



TRADE RELEASES—in brief

WARBURTON FRANKI LTD., 372 Eastern Valley Way, Chatswood, N.S.W., 2067. Agents for General Radio, U.S.A. **Universal Counter, model GR 1192.** Measures frequency from DC to 32-MHz, single and multiple period, time interval, frequency ratio, or counts input pulses. Features include: 10mV sensitivity up to 20-MHz; trigger threshold and attenuation can be controlled; internal crystal oscillator to provide better than average stability; bench or rack mounting; models can have 5, 6 or 7 digits; optional BCD output. When used with a General Radio 1157-B scaler, the upper frequency limit is extended to 500-MHz. Prices range from \$878 for a 5-digit bench model without BCD output, to \$1,290 for a 7-digit rack model with data output.



Universal Counter GR 1192.

McMURDO (AUST.) PTY. LTD., 15 Edinburgh Street, Huntingdale, Vic. 3167. Agents for Isostat, France. **Push-Button and Piano Key Switches.** Four types of switch module, each forming a self-contained unit, are identical in design and dimensions except for length, which varies with the number of DT contacts (2, 4, 6 or 8). The modules can be used singly as self-contained switches (momentary or push-pull) or as multi-module units mounted on a common metal bracket which also carries the latching elements. Each module comprises a compression moulded block, fitted with fixed contacts mounted symmetrically (three fixed contacts for each DT switch), and a slide unit, carrying the moving contacts and fitted with limit stop and interlocking ramps. A dust-proof slide tunnel ensures balanced contact pressure.

Multiple modules provide the following alternatives: latch free switching (momentary); independent switching push-pull; interlocked switching, actuation of one button releasing the others. In addition, use can be made of a contactless module (zero module) to release the others. All switches are rated for low current service, 10 to 20W continuous duty with resistive loads.

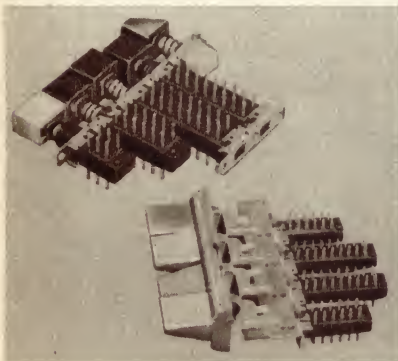

Isostat switches.

Tudor Radio

L. E. Chapman. Est. 1940.
103 ENMORE ROAD, ENMORE,
N.S.W.
Phone 51-1011.



STEREO AMPLIFIER KIT SETS

- TU 10, 3.5 watt per channel .. \$19
 - TU 11, 3.5 watt per channel, has facilities for tape and microphone channels .. \$23
 - TU 12, 5 watt per channel .. \$22.00
 - TU 13, 5 watt per channel, with TU 11 facilities .. \$27.00
- Each kit set includes valves and all components. Front face plate, if required, \$1 extra.
- Single stage amplifier kit set:
5 watt per channel .. \$22.00
Transistor ear plugs .. 3 for \$1.00
Tag strips, mixed types .. Dozen, 60c
Switches, oak 4 position .. 50c each
2 position .. 40c each

SPEAKERS

- MSP 8-inch dual cone .. \$6.50
 - MSP 12-inch dual cone .. \$8.50
 - MSP 7 x 5 15 ohm .. \$4.00
 - MSP 3 1/2-inch 3 ohm .. \$2.00
 - Rola 6 x 4 15 ohms .. \$3.50
 - Rola 5 x 3 15 or 27 ohm .. \$2.50
 - Rola 5B 3 ohm .. \$2.00
 - MSP 6 x 9 15 ohm .. \$5.00
 - 3-inch single cone 15 ohm .. \$4.20
 - 6 x 4 33 ohm .. \$3.00
 - MSP 20 Watt .. \$19.75
 - MSP 12-inch 8 ohm .. \$8.50
 - MSP 2-inch 15 ohm .. \$2.00
 - MSP 8-inch dual cone, 8 ohm .. \$6.50
 - MSP 12-inch 3.5 ohm .. \$6.00
 - MSP 4-inch large magnet 8 ohm .. \$2.50
 - MSP 3-inch 150 ohm .. \$2.50
 - MSP 3-inch 15 ohm .. \$3.00
 - National 8-inch built-in tweeter and crossover network .. \$14.75
 - MSP Electro Dynamic, 8in, \$4, or 6 x 9 .. \$3.00
 - MSP 6 x 2 15 ohm .. \$3.00
 - MSP 6 x 4 15 ohm .. \$3.50
 - Peak 607 16 cm Hi-Fi Dual Tone 6in .. \$7.50
 - MSP 20-watt radial beam 12pqb .. \$21.50
 - Magnavox 8 ohm 4in tweeter .. \$2.50
 - 2 gang tuning condenser .. \$1.00
 - Peak H50 horn type tweeter .. \$12.00
 - MSP 8-inch Speakers .. \$4.00
 - Pioneer 15-inch 8 ohm 60 watt .. \$40.00
- SPEAKER CABINETS** complete with radial beam MSP 20 watt speaker and horn type tweeter with crossover network .. \$70 each
Solid oiled teak 23 1/2 x 17 x 12.

SPEAKER CABINETS

- 7 x 10 1/2 x 4 1/2, suit 5 x 7 speaker .. \$3.50
- 10 x 6 1/2 x 4 1/2 .. \$3.50
- 12 1/2 x 8 1/2 x 6 .. \$5.00

SPEAKER ENCLOSURE

- Complete with 8in M.S.P. dual cone speaker, 8 or 15 ohm .. \$15.80
- Cabinet without speaker .. \$10.00
- Cabinet size 16 x 10 x 8.

RECORD CHANGERS

- B.S.R. UA25 .. \$25.00
- B.S.R. UA70 .. \$40.00
- B.S.R. MA75 .. \$50.00



PORTABLE PHILIPS RECORD PLAYER, \$7.75
6 volts.

You name your price

we will assemble a perfectly matched sound system for you

\$279

KENWOOD AMPLIFIER
C.E.C. TURNTABLE WITH MAGNETIC CARTRIDGE
APOLLO SPEAKER SYSTEM
BASE & COVER

LAFAYETTE AMPLIFIER —
GARRARD SP25 TURNTABLE
SHURE M32E CARTRIDGE
MAGNAVOX SPEAKER IN ENCLOSURE
BASE & COVER

\$255

\$405

KENWOOD TURNER AMPLIFIER
MAGNAVOX 10" SPEAKER IN ENCLOSURE
THE NEW DUAL 1212 TURNTABLE
SHURE MAGNETIC CARTRIDGE
BASE & COVER

FAMOUS LEAK STEREO AMPLIFIER —
WHARFEDALE MELTON SPEAKERS
THE NEW DUAL TURNTABLE MODEL 1209
SHURE M31E CARTRIDGE
BASE & COVER

\$580

CHRISTMAS GIFT IDEAS!



New Hi-Fi Parastat (Reg'd Pat. App. 58216/67)
Gramophone Record Maintenance and Stylus Cleaning Kit



"Parastatik" Reg'd Disc Preener (Patent No. 982599)



The original "Dust Bug" reg'd (Patent No. 817598)

MASTERSOUND SALES PTY. LIMITED

400 KENT STREET,
SYDNEY. 29-1527

Please send Post Free

..... Disc Preeners at \$2.10..... Hi-Fi Parastats at \$9.75

..... Dust Bugs at \$5.60

I enclose cheque/P.N., value \$.....
(Do not send postage stamps)

Name

Address

IGNITION SYSTEM IN KIT FORM

Following the article "Background to Capacitor Discharge Ignition" published in our November, 1969 issue, TasTrade Supplies is offering the Delta Mk. 10 system not only in a fully assembled form through retailers but also in kit form which should appeal to readers of "Electronics Australia." As a kit set, the system is available only by direct mail order from the distributors for \$45.

The kit, which can be assembled in two hours, is supplied complete with original



U.S. components and a comprehensive assembly manual. The manual gives step-by-step instructions and diagrams for the assembly and wiring of the unit, for both negative and positive ground systems. Also provided are installation instructions and operational checks, including the unit's use with electronic tachometers. The manual has a simple description of the unit's operation with complete circuit diagrams for both negative and positive ground systems.

All inquiries should be addressed to the distributors, TasTrade Supplies, P.O. Box 78, Campsie, N.S.W. 2194.

AURIEMA (AUSTRALASIA) PTY. LTD., 443 Kent Street, Sydney, 2000. Agents for JBL Professional Products Division. **Control Room Monitor model 4310.** A loudspeaker system consisting of three direct-radiator transducers and a frequency dividing network installed in a tube-ported enclosure. Recessed front panel controls allow separate adjustment of the 1.5KHz to 7KHz "presence" range and the 7KHz to 15KHz "brilliance" range. Brief specifications are: power capacity 50W program; crossover 1.5KHz and 7KHz; nominal impedance 8 ohms; dispersion 90 degrees horizontal and vertical; frequency response 30Hz to 15KHz plus or minus 5dB.

Studio Monitor model 4320. A loudspeaker system consisting of a 15in low frequency loudspeaker, a horn-loaded high frequency driver, and a frequency dividing network in a tube-ported enclosure. Brief specifications are: power capacity 60W RMS, 120W program; crossover 800Hz; nominal impedance 8 to 16 ohms (minimum 12.5 ohms at 175Hz); dispersion 45 degrees vertical, 120 degrees horizontal; frequency response 40Hz to 15KHz plus or minus 3dB.

GRANGER ASSOCIATES PTY. LTD., 1 Dale Street, Brookvale, N.S.W. 2100. Agents for Hatfield Instruments Ltd., England. **Miniature Encapsulated LF Modulators, types MD 51 and MD 53.** Suitable for use in the manufacture of SSB communications equipment, the modulators are low-cost versions of the earlier MD 4 modulator. Frequency range: type MD 51 — ports A and C, 0.5MHz to 150MHz, port B, DC

to 150MHz; type MD 53—ports A and C, 10KHz to 50MHz, port B. DC to 50MHz. Impedance 50 ohms. Dimensions 1.6 x 0.86 x 0.05in (less pins). Connections — solder pin terminations spaced to 0.05in grid for direct mounting to printed wiring boards. Also available fitted with BNC sockets with slightly larger dimensions.

IRH COMPONENTS PTY. LTD., The Crescent, Kingsgrove, N.S.W. 2208. Agents for Emerson & Cuming Inc., U.S.A. Eccosorb MG. A series of six magnetically loaded epoxide rod and sheet materials designed for use as absorbers, attenuators and terminations in waveguides, coaxial lines and striplines. The attenuation at 8.6GHz ranges from 1.5 to 63dB/cm. Other electrical properties are: volume resistivity greater than 100,000M/cm; dielectric strength greater than 25V/mil. Possible applications include the use as a high-Q inductor core material in such devices as slug tuners, and as simple RF filters by passing leads through small blocks of the material.

CIRCUIT COMPONENTS (A'ASIA) PTY. LTD., 460 Bexley Road, Bexley, N.S.W. 2207. Distributors for Adams & Westlake Co., U.S.A. Mercury Wetted Relays, series MWK/AWK. The relays incorporate centre-off form K switching. They are made with plug-in octal bases or printed circuit mounting (0.2in centres) and single or double wound coils for operation on 6, 12, 24 or 48 volts DC. Sub-miniature Relays, series AWCM/AWDM. Designed for printed circuit mounting. Supplied with single or double wound coils, single side stable or bi-stable, form C or form D contacts.

MUTUAL COMPUTER SYSTEMS, Suite 508, 9107 Wilshire Boulevard, Beverly Hills, Calif. 90210, U.S.A. Reconditioned Computer Systems. The company markets completely reconditioned and tested computer systems, peripheral input-output equipment, and software, at a fraction of the initial cost. It is a direct exporter of 1st, 2nd and 3rd generation computers and data processing equipment. Inquiries are invited from direct users and from sales organisations interested in representing the company. The company also acts as brokers and buying agents for any type of system, hardware, input-output equipment, peripherals, etc. and welcomes inquiries in this field.

Repeater uses ICs

The Overseas Telecommunications Commission (Australia) has ordered 170 of these regenerative repeaters, manufactured in Australia by Amalgamated Wireless (Australasia) Ltd. This latest version uses integrated circuits and is only one-eighth the size of an earlier version. The repeaters are installed near the receiving end of a long-distance line or radio link.

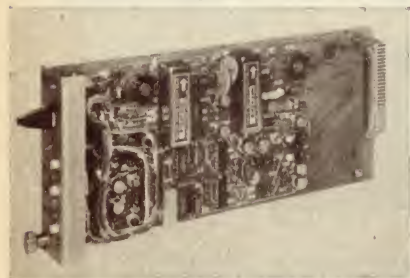

When, due to the characteristics of the line or link, signals may be distorted, they are fed into the repeater and transmitted to the receiving teleprinter as entirely new and completely accurate reproductions of the original messages.



Non-corrosive Soldering Fluid

A non-corrosive rosin-based soldering fluid has been introduced by Schiedam (Australasia) Pty. Ltd., P.O. Box 185, Healesville, Vic., 3777. The advantage of this type of flux fluid over the more aggressive chlorides is that the residue it leaves after soldering is inoffensive, being non-corrosive, non-tacky and non-conductive. The makers point out that the removal of solder flux residues is often impossible or expensive, either because of the intricate shape of the parts, or because the use of solvents or water is impracticable. The new flux, which is marketed under the name of Corex-Akta 300, enables even iron to be safely soldered.

CLIMB TO THE TOP IN ENGINEERING

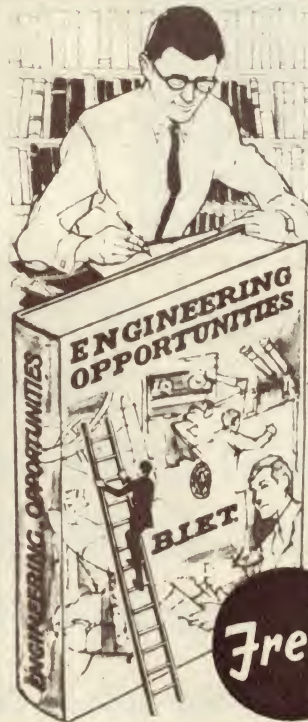

Do you want promotion, security, better pay, and a really worthwhile job? Then write for YOUR copy of "ENGINEERING OPPORTUNITIES", the most successful career book ever published. This authoritative guide tells you how, whatever your age, experience, education, or circumstances, we can open your eyes to advantages you have been missing and help you in a practical — **proved** — way to get what you want out of life.

WHAT INTERESTS YOU?

Administration	Civil	Marine
Aeronautical	Computers	Mechanical
Arch. Drwg. & Design	Diesel	Production
Automation	Draughtsmanship	Radio
Automobile	Electrical	Structural
Building	Electronics	Surveying
Chemical	Maintenance	Television

And many other Engineering Subjects. Details of Engineering Exams., Certs. of Competency, Matriculation, etc.

POST COUPON NOW!



To B.I.E.T. Dept. L169, College House, 113 Pacific Highway, Nth. Sydney. 2060.

I am interested in _____
Please send me "Engineering Opportunities", without any obligation whatsoever.

NAME (PLEASE PRINT) _____

ADDRESS _____

Post Code _____

Occupation _____

Age _____

BRITISH INSTITUTE OF ENGINEERING TECHNOLOGY
THE WORLD UNIVERSITY OF POSTAL EDUCATION



MODEL bwd 509A 5 inch OSCILLOSCOPE

Take a 17 transistor & FET circuit which provides —
 DC to 5MHz — 3db bandwidth,
 50mV to 100V/cm Sensitivity,
 200 nSec to 1Sec/cm time base,
 Superb, completely automatic
 triggering from 1Hz to 10MHz,
 X 5 horizontal expansion,
 DC coupled blanking,
 DC to 250kHz horizontal amplifier,
 A calibration waveform
 and 5% calibration irrespective
 of 10% mains input changes.

Style and package it attractively

PRICE IT AT **\$185.00** + TAX.
 and you have the NEW Standard in
 low cost Oscilloscopes, from

BWD ELECTRONICS PTY. LTD.
 333 BURKE RD. GARDINER VIC. PHONE 25-4425
 127 BLUES POINT RD. N. SYDNEY. PHONE 929-7452
 ALSO PHONE 23-1922 IN S.A. AND 23-3847 IN W.A.



BWD/6



**IF YOU ARE IN THE
 MARKET FOR SOUND
 EQUIPMENT COME AND
 SEE JACK & MIKE AT
 Allied Music Systems**



WE SPECIALISE IN TOP QUALITY, TOP BRAND NAME EQUIPMENT ONLY

**ALL THE FAMOUS NAMES.... Akai, Sansui, Revox, Sony, Kenwood,
 Philips, Toshiba, National, Fisher, Craig-Pioneer, Dokorder.**

cartridge cassette tape phono radio

**TRADE-INS ACCEPTED & WE SELL ON TERMS
 FOR THE CASH PRICES**

**FEEL FREE TO WANDER IN AND TALK TO US AT OUR
 SHOWROOM AT 210 CLARENCE ST., SYDNEY..... NOW!
 FOR AN OBLIGATION FREE QUOTE ON THE EQUIPMENT YOU
 ARE THINKING ABOUT**

PLESSEY DUCON PTY. LTD., P.O. Box 2, Villawood, N.S.W. 2163. **Micro-miniature CJ Relays.** Production changes in the manufacture of these relays has given reduced cost and improved quality. The changes introduced include automatic forming and setting of contacts, and high-speed welding of the can to the base. There has been no change in the specification, and the performance is said to continue to match current requirements. Features include: 1A switching at 28V DC (resistive) for 100,000 operations; TO5 plan area; temperature range minus 65 to plus 125 degrees C; 250mW sensitivity.

RUTHERFORD ELECTRONICS PTY. LTD., 62 Jackson Court, Doncaster, Vic. 3108. Agents for National Semiconductor Corporation, U.S.A. **Operational Amplifier type LM108.** A monolithic general purpose device said to out-perform FET amplifiers by a factor of 10 over the military temperature range, from minus 55 to plus 125 degrees C. The new IC is pin compatible with the LM101 and LM101A and will operate with the same compensation circuit (a 30pF capacitor from input to output of the second stage).

Features of the LM108 include: maximum input bias current 3nA over the temperature range; offset current less than 400pA; power consumption 1mW at low voltage; offset voltage 3mV maximum; offset voltage drift typically 3uV per degree C; operates from supply voltages from 5V to 20V; supply rejection typically 100db permitting use of unregulated supplies. Selected units, type LM108A, are available with offset voltages less than 1mV and drifts less than 5uV/°C, also over the entire military temperature range.

HONEYWELL PTY. LTD., 863-871 Bourke Street, Waterloo, N.S.W., 2017, has appointed distributors in all States to stock and supply Honeywell Micro Switch products. The distributors are as follows: N.S.W.—Micro Logic Pty. Ltd. (Ashfield), Industrial Engineering Services (Wollongong), Alan Strachan and Co. (Newcastle) and Knight Industries Pty. Ltd. (Albury); Victoria—Clarke Strickland Pty. Ltd. (St. Kilda) and S.I.R.S. (North Geelong); Queensland—Austral Lighting Pty. Ltd. (Breakfast Creek); South Australia—Gerard and Goodman Pty. Ltd. (Adelaide); Western Australia—Western Machinery Co. Pty. Ltd. (Belmont); Tasmania — George Harvey Electric Pty. Ltd. (Hobart and Launceston).

PERKIN-ELMER PTY. LTD., 269 Princes Highway, Dandenong, Vic. 3175. has appointed Mr Peter R. Sadesky as general sales manager based in Melbourne. He succeeds Mr W. J. R. Hargrave who has returned to the U.S.A. to take up a senior position with the parent company,

HEWLETT-PACKARD AUSTRALIA PTY. LTD., 22-26 Weir Street, Glen Iris Vic. 3146. **Electronically Tuned Solid State Oscillator model 35009A.** A YIG tuned transistor oscillator and buffer amplifier built as a thin-film hybrid micro-circuit on a sapphire substrate and hermetically sealed with a well-shielded magnet into a single self-contained unit. Features: electronically tunable from 2 to



4GHz; uses only low voltages for power, bias and control; frequency is a linear function of control voltage; output more than 10mW over complete range; output level into 50 ohms varies no more than 1.5dB with any frequency change; oscillations continue under any load variation from short to open circuit with frequency almost unaffected; output is comparable in spectral purity to that of a good backward-wave oscillator.

Perkin-Elmer Corporation. Mr Philip J. Wilford has been appointed northern sales manager with headquarters in Sydney.

METAL INDUSTRIES (AUST.) PTY. LTD., 196 Silverwater Road, Lidcombe, N.S.W. 2141, has been appointed official agent and distributor for the products of Keyswitch Relays Ltd. of U.K.

PLESSEY PACIFIC PTY. LTD., has announced the following senior appointments: Mr R. W. R. Wiltshire has been appointed as executive director of a newly formed management committee. The other members are Mr Robert Hall (managing director of Plessey Pacific) and Dr W. A. S. Butement (research director). Mr Wiltshire continues as general manager and director of Plessey Ducon Pty. Ltd.

Mr R. T. Elvish, divisional manager of Plessey Dynamics Pty. Ltd., has been appointed to the new position of defence sales executive to co-ordinate the sales activities of the group in this field. Mr Elvish, who remains a director of Plessey Dynamics, has had a long association with the defence supply industry.

Mr W. Fielder-Gill, formerly group pro-

WESTON ELECTRONICS PTY. LTD., 376 Eastern Valley Way, Roseville, N.S.W. 2069. **"Realistic" DX 150 Communications Receiver.**

An all-solid-state four band receiver which operates from AC mains or from dry cells; it will also operate from a 12V car cigarette lighter or any other 12V DC source. DX150 is a single conversion, four-band superheterodyne covering the range 535KHz to 30MHz. It has a tuned RF stage; two IF stages; full-wave product detector for SSB/CW; fast and slow AGC; variable pitch BFO; illuminated electrical band spread; fully calibrated for amateur bands; illuminated S-meter; built-in monitor speaker; front panel aerial



trimmer; RF gain control. Dimensions are 6 1/2 in high x 14 in wide x 9 in deep. The metal cabinet is finished in grey, and has a polished metal front panel furnished with solid metal knobs. The unit is priced at \$229.50.

"OXFORD"



THE METALWORK SPECIALIST



HEATING SYSTEMS PTY. LTD.

24 O'RIORDAN STREET,
ALEXANDRIA



WE ARE

MOVING TO

19 The Boulevard,

Caringbah 2229

Phone 524-0782

EMPIRE: The 999VE—Premier stereo cartridge in the high-performance field. Price in U.S.A. \$74.95.

Price in Australia \$75.00.

SUPERB STEREO SOUND WITHOUT RECORD WEAR.

For perfect lightweight tracking, smooth, level frequency response, outstanding stereo separation and peak-free "ring"-free performance, the 999VE leads the cartridge field. Two independent laboratory tests, two virtually identical sets of findings charged and described, two spectacular demonstrations of the 999VE's superlative stereo performance. And how does the 999VE stack up against the other "light-track" cartridges on today's market? "Hi-Fi Review" compared them all for low-force tracking ability, and rated the 999VE Number 1.

Frequency response: 6 to 35,000 Hz.
Output voltage: 5 millivolts per channel.
Stereo separation: More than 30 dB.
Load Impedance: 47,000 ohms.
Weight: 7 grams.
Compliance: 30 x 10-6 cm/dyne.

Tracking force: .5 to 1.5 grams.
Stylus: .2 x .7 mil elliptical diamond.
Tracking angle: 15 deg.
Terminals: 4.
Mounting: Standard 7/16 or 1/2in centres.



THE COMPACT WORLD OF HARMON KARDON (made in U.S.A.)

High-performance compact music system SC1510, illustrated and described below, is a true high-fidelity instrument which provides a maximum of sound from a minimum of visible equipment. Every Harman Kardon compact has extra-wide band sound, solid state, electronics throughout, including a newly developed integrated micro circuit and a unique speaker selector switch that allows you to connect the stereo speaker system in two rooms. They truly look as good as they sound. A reviewer once wrote that Harman Kardon products are made for the sake of music and our demanding love for it. The music centre, complete with two compact HK10 Harman Kardon speaker system: Total Price \$400. The same unit can be used with any top-quality loudspeakers.

Power Output: 25 watts, 1HF (50 watts, E.I.A. Peak).

Frequency Response: Plus or minus 1.5 dB 18-30,000 Hz at 1 watt.



Harman Kardon

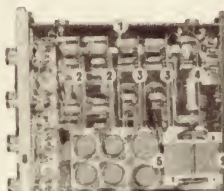

Armstrong Model 521

ARMSTRONG MODEL 521 STEREO AMPLIFIER:

Made in England, is one of the best amplifiers available on the market. This is a summary of a review in the "Hi-Fi" Sound from April, 1969: Armstrong's new 521 stereo amplifier has been designed as the basis of a complete stereo/mono system for records, radio and tape. Offering a number of interesting features, it matches electrically and in appearance the Armstrong Series 500 radio tuners. This transistorised unit is designed primarily for use with 8 ohm speakers but performs well with those having an impedance of 15 ohms. I feel I can summarise on frequency response—or at least the control over it—by saying that the Armstrong 521 is indeed very flexible. Last but not least, is the noise level, which due to careful selection of transistors for the preamplifier was found to be better than the maker's quote. The radio input yielded minus 63db, the tape input minus 74dB and pickup (both inputs) minus 57dB. Crosstalk between channels at 1,000Hz and full output was measured as minus 46dB. This is altogether a very good performance and surpasses anything ever achieved with comparable valve amplifiers.

Power output: 25 watts (8 ohms).
Frequency response: 20 to 20,000 Hz plus or minus 1dB.
Harmonic distortion: Less than 0.5 per cent at 25 watts output.
Crosstalk: Better than minus 40dB.
Channel matching: Plus or minus dB.
Bass control: Plus or minus 10dB at 70Hz.
Treble control: Plus or minus 10dB at 70Hz.
Rumble filter: Minus 5dB at 30Hz.
Treble filters: 10KHz, minus 25dB and 9KHz, minus 40dB.
Loudness: 70Hz plus 10dB, 10KHz plus 5dB reference, minus 20dB at 1KHz.
Tape record output: 400mV.
Inputs: Tape 400mV, radio 100mV, ceramic pu 60mV, mag pu 3.5mV.
Signal to noise: Tape minus 70dB, radio minus 60dB, ceramic pu minus 55dB, mag pu minus 55dB. Price \$240.

RECORDED MUSIC SALON

C. PINCZEWSKI

TRUE FIDELITY

23 COLLINS STREET, MELBOURNE 3000.

Telephone 63-6257



ALLIED CAPACITORS

specialised facilities and years of experience enable Allied to design and manufacture for your specific needs



- Ceramics
- Plastic Film
- Electrolytics
- Silvered Mica
- Potentiometers
- Paper Capacitors
- Connectors
- Switches
- Trimmers
- Centralab Packaged Electronics



ALLIED CAPACITORS PTY. LIMITED



Distributed by Ferris Bros. Pty. Limited, 752 Pittwater Rd. Brookvale, N.S.W. 2100. Ph. 93-0221 (10 lines)



A Hawker Siddeley Company

Write for catalogue and service information to Allied Capacitors Pty. Limited, 752 Pittwater Rd., Brookvale, N.S.W. 2100.

NAME.....PHONE.....

ADDRESS.....

EA.....POSTCODE.....

FB4211/69

MINIATURE SOLDERING IRON

Illustrated is the Mini-Mico miniature soldering iron for delicate soldering work. The unit, without bit, measures only $5\frac{1}{2}$ in long, and it is supplied with three different bits, as illustrated. It is a low voltage iron, intended to operate from a suitable transformer.

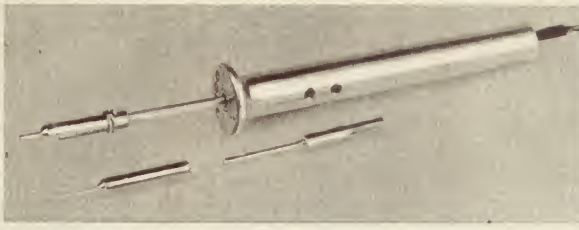

The makers recommend using a transformer with a selection of secondary tapings, for example, 5, 6 or 7 volts to provide a variation of heat for different types of work. The iron is guaranteed against

failure of the electrical element for three months. Irons which fail are repairable. Further information can be obtained from Watkin Wynne Pty. Ltd., 32 Falcon Street, Crows Nest, N.S.W. 2065.

duction executive of Plessey Pacific, has been appointed general manager and director of Plessey Telecommunications Pty. Ltd. (formerly T.E.I.) following the resignation of Mr W. K. Jennings. Mr Fielder-Gill has had wide experience with T.E.I. where he was responsible for the development and installation of the Sydney Mail Exchange sorting equipment. Before that, he was a senior engineer with the Australian Post office.

Mr D. G. Mulder, divisional manager of Plessey Rola Pty. Ltd., becomes general manager responsible for the operations of the three manufacturing subsidiaries in Victoria and South Australia — Plessey Rola Pty. Ltd., Plessey Electronics Pty. Ltd and Plessey Dynamics Pty. Ltd. — and joins the boards of these companies. He

has been with the company for 17 years and was manager of the magnetic materials division before his appointment as head of Plessey Rola last year.

Mr F. R. Tew continues as general manager and director of Plessey Communication Systems Pty. Ltd., also with headquarters in Melbourne.

ELMEASCO INSTRUMENTS PTY. LTD., P.O. Box 334, Brookvale, N.S.W. 2100, has been appointed sole Australian agents for Fairchild Controls of New York and California, U.S.A. Included in the range of products are single and multi-turn potentiometers, trim pots and dials, as well as a wide variety of transducers and pressure switches. These products are in addition to the Fairchild modular amplifier line which Elmeasco has been handling for some time. The company points out that these devices are not handled by Fairchild Australia.

HEATING SYSTEMS PTY. LTD. has moved to 19 The Boulevard, Caringbah, N.S.W. 2229. The new telephone number is 524-0782. The company manufactures a wide range of metalwork for Playmaster and other "Electronics Australia" projects.

FERRIS INDUSTRIES LTD., recently acquired by Hawker Siddeley, has changed its name to Hawker Siddeley Electronics Ltd. The head office remains at 752 Pittwater Road, Brookvale, N.S.W. 2100. The company will consolidate the Electronics Division of Hawker de Havilland Australia Pty. Ltd., Ferris Bros. Pty. Ltd., and SpaceTrack Pty. Ltd. (previously a Hawker de Havilland subsidiary.) Ferris Bros. Pty. Ltd. remains the operating company for Ferris products and present distributing arrangements will continue.

Mr G. I. Ferris, the chairman and managing director of Ferris and one of the founders of the business 37 years ago, has retired as chief executive. Mr T. W. Air, previously technical director of Hawker de Havilland, has been appointed managing director of Hawker Siddeley Electronics Ltd. and of Ferris Bros. Pty. Ltd. Mr Ferris will continue as a director of Hawker Siddeley Electronics Ltd., and has been appointed a director of Hawker Siddeley Australia Ltd., the senior holding company of the group in Australia. Mr Ferris has been retained as a consultant to both these companies and to Hawker Siddeley Brush Pty. Ltd.

Hawker Siddeley Electronics Ltd. has announced the formation of two new divisions. The Systems Division (Thetis Court, Bougainville Street, Manuka, A.C.T. 2603) has absorbed SpaceTrack Pty. Ltd. and is concerned with space tracking station operations, systems engineering and systems management activities. The Engineering Division (Salisbury, S.A.) will be involved in defence electronics, guided missile development and specialised electronic products.

ELECTRONIC DESPATCH

P.O. BOX 149, AUBURN 2144

9-1 DAILY AND SAT.

16 SHERIDEN ST., GRANVILLE,

MAIL ORDERS WELCOME

Please Add Postage

OPEN OVER XMAS HOLIDAYS
EXCEPT PUBLIC HOLIDAYS

RESISTORS from 1 ohm to 10 ohms
now in stock, $\frac{1}{4}W$ at 8c, $\frac{1}{2}W$ at 6c.

TRANSISTORS

The following are always in stock:

BC 107 .. . 70c	OCP 71 .. \$3.50
BC 108 .. . 60c	AC 127 .. . 95c
BC 109 .. . 75c	AC 128 .. . 85c
BC 148 .. . 55c	AC 127/128 \$1.80
BC 178 SI PNP	BF 179 .. \$1.50
.. . . . 65c	200 V Video amp
Comp. to 108	BF 115 .. . 70c
AD 161/162 \$3.60	FET 2N 549 \$1.20
AD 161 .. \$1.80	(MPF 105)
AD 162 .. \$1.80	UJT D13T1 \$1.20
SCR BTY 79/400R	2N 3055 .. \$2.50
AO 91 .. . 27c	10A 400 V \$3.75
	BA 100 .. . 35c

BRIDGE SI RECTIFIER

MB 1 .. . \$1.60 100V PIV .. \$1.80

SPECIAL

2N 526 (2G 526) GE PNP
225 MW F 6.5 MHz BV cbo 45V
BV cco 30V BV ebo 15V 1c 500 MA
40c each

FOR XMAS

Flashing miniature light bulbs.
2.5V 5c each.

SPECIAL ELECTROS

80 MFD 4V 15c
4 MFD 100V 10c

CO-AXIAL FANS

Ex computers PABST outer
Rotor motors 240V \$5.00
Large range of silver mica capacitors
in stock 20 per cent to 1 10c 10 per
cent and better 15c. Please ask for full
list.

For personal shoppers large range of
computer parts in stock. Power Supplies,
transformers, edge connectors, contactors,
tape decks, memory cores and
various other parts.

COMPUTER BOARDS

10c per transistor.
24c per diode
Data sheet for most transistors and
diodes supplied.
Reed relays
Hamlin DRG2 1A 250V DC .. 80c

VALVE SPECIAL

6AM4 .. . 75c	6 AV6 .. . 50c
6AM5 .. . 65c	6 BA6 .. . 40c
6AM6 .. . 75c	6 V4 .. . 40c
6 AK5 .. . 75c	12 AT7 .. . 75c
6 AL5 .. . 40c	2 x 2 .. . 50c
6 AN7 .. . 75c	CV 309 (QVO4/ 7) .. . 75c

TECNICO ELECTRONICS, P.O. Box 12, Marrickville, N.S.W. 2204. Agents for Princeton Applied Research Corporation, U.S.A. **Universal Low Pass/High Pass Filters**, models 216 and 217. May be used independently as 24dB/octave high or low pass filters, or in various combinations to provide "tailored" curves, band-pass or 48dB/octave attenuation. Band-reject (notch) filtering can be achieved when the filters are used with an ampli-



fier, such as the Princeton model 212 Differential Preamplifier.

Features include: rolloff frequency continuously adjustable in five overlapping ranges from 10Hz to 1.1MHz (model 216) or from 0.1Hz to 11.0KHz (model 217); four-pole filtering with switch selectable maximally flat (Butterworth) or simple RC characteristics; may be AC or DC coupled as selected by front-panel switch; high-pass or low-pass is front-panel selectable; each filter gives unity gain; and overload indication.

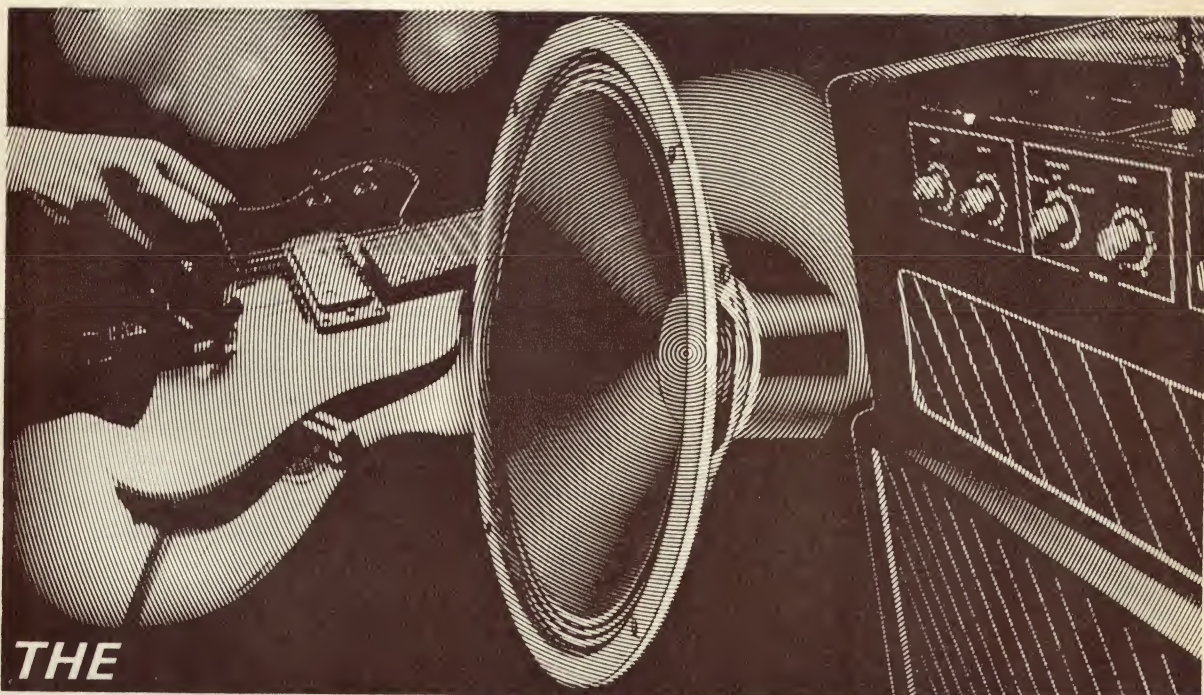

THE

BIG SOUND

MSP Hi-Flux electric guitar speakers

Sounds plucked from a guitar string have characteristics that have challenged speaker manufacturers for many years—but, now MSP can supply the speaker design that all good guitarists have been waiting for. And you can have speakers and detailed instructions of specially designed vented-enclosures for your electric guitar whether it be Lead, Rhythm, or Bass.

There are two series of speakers produced for electric guitars. Type 12UA for lead

or rhythm and type 12PQ for bass. These new speakers reproduce the full range of sound produced by a guitar and handle with ease the large power input supplied by the amplifier.

When four 12 inch Hi-Flux speakers are mounted in the specially designed enclosure the combination is rated at 60 watts and outperforms all other units tested including some very elaborate and expensive models.

More information on the extensive range of Hi-Flux speakers and recommended enclosure designs can be obtained from your nearest distributor.



47 YORK STREET SYDNEY 2 0233

MANUFACTURERS SPECIAL PRODUCTS PTY LTD

ADELAIDE 51 0111 BRISBANE 31 0341 HOBART 3 3836 LAUNCESTON 2 1804 MELBOURNE 67 9161 PERTH 28 3425 SYDNEY 533 1277 & 29 7031

TECHNICAL BOOKS AND PUBLICATIONS

Antennas for amateurs . . . "buy a copy"

73 DIPOLE AND LONG-WIRE ANTENNAS. By Edward M. Nill, W3FQJ. Published by Editors and Engineers Ltd., New Augusta, Indiana, U.S.A. Paper covers, 160 pages, 8½in x 5½in. Many illustrations, tables and some photographs. Australian price \$5, postage approximately 25c.

The publishers, Editors and Engineers, already have such a good reputation that any new publication they have to offer, gives it an initial interest for further investigation. The author is not well known to me but this is soon resolved and he establishes himself as one who knows his subject.

The title indicates that there are no less than 73 (nothing to do with "best wishes") individual dipole and long-wire aeriels and indeed, this turns out to be so. Admittedly the variations between individual aerial systems may be very small in some cases. The difference may be an alternative feed system, or simply a slightly different length for operation in another part of the same band. For all that, there are so many different aeriels to choose from, that the general need is more than likely to be met.

Although this publication is aimed at transmitting amateurs, it would also have a vital interest for short-wave listeners and indeed, for all who need aeriels for the high frequency range of the spectrum.

The book is divided up into eight sections with seven appendices following. Apart from a list of contents, which is comprehensive enough, there is no index. To give the reader an idea of the material covered, here is a list of the section titles and the appendix material.

Section 1. — Regular and Modified Dipole Antennas; Section 2.—Inverted-Vee Antennas; Section 3. — Long-Wire Antennas; Section 4. — Vee-Beam Antennas; Section 5. — Long Vee-Beam Antennas; Section 6. — Rhombic Antennas; Section 7. — Very long Long-Wire Antennas; Section 8. — Special Vees and Rhombics.

Appendix I — Antenna Noise Bridge; Appendix II — How to Measure the Velocity Factor of Transmission Line with a Noise Bridge; Appendix III — Cutting Half-Wave Sections of Transmission Line Using the Antenna Noise Bridge; Appendix IV — Measuring the Resonant Frequency and Resistance of an Antenna With the Antenna Noise Bridge; Appendix V — Cutting an Antenna to Resonance Using an SWR Meter; Appendix VI — The Construction and Tuning of a Line Tuner; Appendix VII — Antenna Tuner for Long-Wire Vees and Rhombics.

The foregoing list largely speaks for itself. However, to do this book the justice due to it, some further comments are indicated. At first, one would gain the impression that this is not a theoretical treatise on aeriels. However, mixed in with some of the most practical information I have seen on the subject of wire aeriels there is a subtle intermixing of basic theory and technical information which many readers will find interesting and easily digestible.

From a practical point of view, each aerial system discussed, is very well illustrated with diagrams and tables where necessary. The information is so complete

that no trouble should be experienced in installing the aerial system of your choice. Incidentally, the author points out that he has erected and used every one of the aeriels described.

I have been using the term, aerial system, because in quite a large number of cases, an item comprises a multi-band array. This may be variations of the dipole, it may be a long-wire, an inverted vee, a horizontal vee or even a rhombic—for those fortunate individuals who have enough real estate for what is virtually the ultimate!

At the risk of repeating myself, this is a must for all amateurs, short-wave listeners and other interested in wire aeriels for the high frequency band. In short, buy a copy.

This copy for review came from the Technical Book and Magazine Company Pty. Ltd., 289-299 Swanston Street, Melbourne, Vic. 3000. Copies should be available from the above, or from other large technical booksellers. (I.L.P.).

Semiconductors

WORKING WITH SEMICONDUCTORS by Albert C. W. Saunders. Published July 1969 by TAB Books, Blue Ridge Summit, PA. 17214 U.S.A. Stiff paper covers, 224 pages, 8½in x 5in, illustrated by circuits and line diagrams. Price in Australia \$6.15, or \$9.95 for hard cover edition.

The first two or three paragraphs of this book give the rather unpromising impression that the author plans to avoid unfamiliar terms, even if the text thereby loses most of its value. Presumably, however, he has deliberately adopted the "soft" approach and it doesn't take him long to qualify the earlier statements and get involved in the usual terminology of semiconductor physics — valence, impurities, carriers, holes, junctions, etc.

His expressed intention, however, is to keep the text readable and this reviewer's impression, from inspection and sampling, is that he has succeeded in this objective.

Following the initial chapter "Getting Acquainted With Semiconductors," a second chapter introduces the reader to transistor parameters. These are presented in a way that would allow the reader with an experimental turn of mind to observe some of the characteristics in practical set-ups. If there is a point of criticism, it would be the rather uncautious approach to transistors with a multimeter.

Chapter 4 compares transistor with valve concepts, while chapter 5 discusses typical biasing arrangements.

Chapters 5 to 9 inclusive set out to introduce the reader to transistor circuit configurations. Covered are: Amplifier: General; Audio Amplifiers; RF And IF Amplifiers; Transistor Oscillators; Inverter Type Power Supplies. A later chapter deals with High Frequency Oscillators And Amplifiers. The information is necessarily brief, but it is practical and up-to-date, as evidenced by reference to flip-flops, counting and logic.

Separate chapters are devoted to the Varactor, Field-effect Transistors, Unijunction Transistors and to Zener And Special-Purpose Diodes. In the space available, the author has not the space to say much

about the basic physics of these devices, the text merely indicating in broad terms what they are, how they behave and the applications to which they are applied.

A final chapter lists a few typical circuit arrangements, again for the reader who is inclined to experiment.

Because of the author's intentional and strong emphasis on "practical" theory, the book would hardly qualify as a text for a formal study course but the qualities which prompt this observation equally commend the book for reading by hobbyists, technicians, licensed amateurs or those aspiring to the amateur ranks. Such people should find it both readable and informative. Our review copy came from Grenville Publishing Co. Pty. Ltd., 401 Pitt Street, Sydney 2000. Copies should be available through all major technical bookshops. (W.N.W)

AM broadcasting

MODERN RADIO BROADCASTING.

Management and Operation In Small-to-Medium Markets. By Robert H. Coddington. First edition, published August 1969 by TAB Books Blue Ridge Summit, PA 17214. Hard covers, 286 pages 8½ x 5½ inches, mainly text but some photographs and diagrams. Price in Australia \$16.20.

Over and above the price barrier, one can expect only a limited market for this book in Australia.

In the first place, opportunities for

RADIO ENTHUSIASTS

Learn amateur radio in your spare time.

Whatever your interests are in amateur radio, there's a Stott Radio course for you. Easy to follow. Practical. Modern. Guidance all the way by top-flight radio engineers.

Radio for amateurs

Learn the exciting skills of building modern radio receivers. Learn about the latest advances in electronics, design, construction and operation.

Let Stott's show you how.

Amateur Operator's Certificate Course:

Broadcasting is fascinating. Stott's offer an entirely new course that enables you to sit for the Amateur Operator's Certificate of Proficiency Examinations with complete confidence.

Get full details now on Stott's Radio Courses.

POST THIS COUPON TODAY

Stotts 

TECHNICAL CORRESPONDENCE COLLEGE
159 Flinders La, Melbourne. 383 George St, Sydney
290 Adelaide St, Brisbane. 45 Gilles St, Adelaide.
1130 Hay St, Perth.

Please send me, free and without obligation, full particulars of your courses in Radio for Amateurs.

Mr Mrs Miss

Address

Age

No sales representative will call

EA 1269

STOP RUST OUTDOORS 2 YEARS -- OR MORE!

Lubricates Penetrates Stops Rust

DRY YOUR ELECTRICAL SYSTEMS
with LPS — the NON-GREASY ONE

**STOPS
Squeaks!**



LPS is NOT a paint, lacquer or a varnish, and will NOT damage paint, rubber, fabrics, plastics, or finishes.

Displaces Moisture Fast!

TECHNICAL INFORMATION

Physical Properties:

LPS 1

Less than .0001 inch non-greasy molecular film with capillary action that spreads evenly and easily to seal out moisture at very low cost.
Rust Inhibitor: Protects all metals from rust and corrosion.

Water Displacing Compound: Dries out mechanical and electrical systems fast.

Lubricant: Lubricates even the most delicate mechanisms; non-gummy, non-sticky; does not pick up dust or dirt.

Penetrant: Penetrates to loosen frozen parts in seconds.

Volume Resistivity per ASTM D-257: Room temperature, ohm/cm; 1.04×10^{12}

Dielectric Constant per ASTM-877:

Dielectric Constant 2.14 Dissipation Factor: 0.02

Dielectric Strength per ASTM D-150:

Breakdown Voltage 0.1 inch gap, 32,000 volts

Dielectric Strength volts/inch 320,000 volts

Flash Point (Dried Film)

Fire Point (Dried Film) 900 degrees F

TESTS AND RESULTS: 950 degrees F

Lawrence Hydrogen Embrittlement Test for

Safety on High Tensile Strength Steels: Passed.

Certified safe within limits of Douglas Service Bulletin 13-1 and Boeing D6 17487.

Mil Spec. C-16173D-Grade 3

Passed

Mil Spec. C-23411

Passed

Swiss Federal Government Testing Authority for

Industry: Passed 7 Day Rust Test for acid and

salt water, Passed Weiland Machine Test for

lubricity as being superior to mineral oil plus additives.

LPS PRODUCTS CONFORM TO
FEDERAL MIL SPECS
C-23411 and/or C-16173D



LPS RESEARCH LABORATORIES, INC.
2050 COTNER AVE • LOS ANGELES CALIF 90025

HOW LPS SAVES YOU TIME AND MONEY

1. LPS PROTECTS all metals from Rust & Corrosion.
2. LPS PENETRATES existing rust — stops it from spreading.
3. LPS DISPLACES moisture on metal—forms fine protective film
4. LPS LUBRICATES even the most delicate mechanisms at extreme temperatures.
5. LPS PENETRATES to free rust frozen parts, nuts, bolts, etc.
6. LPS PREVENTS equipment failures due to moisture (drives it out).
7. LPS LENGTHENS LIFE of electrical & electronic equipment—improves performance.
8. LPS RESTORES equipment damaged by water contamination & corrosion.
9. LPS PENETRATES AND PROTECTS plated and painted metal surfaces.
10. LPS PROTECTS metals from salt atmosphere, acid & caustic vapours.
11. LPS LOOSENS dirt, scale, minor rust spots & cleans metal surfaces.
12. LPS ELIMINATES squeaks where most everything else fails.

(SOLE AGENT)



ZEPHYR PRODUCTS PTY. LTD.

70 BATESFORD ROAD CHADSTONE, VICTORIA—PHONE 56-7231

MANUFACTURERS OF RADIO & ELECTRICAL EQUIPMENT & COMPONENTS

starting small broadcasting stations here are very limited. Relative to the Australian population and its distribution, the medium-wave AM band is full to bursting point, and the FM band is being allocated to other non-broadcast services.

In the second place, this book has to do with the situation in the U.S.A. and the discussion about F.C.C. regulations and obligations would only have vague parallels in other countries.

But, having said this, it is also necessary to concede that there is no great abundance of reference books on this subject and this new book could be of value to individuals in Australia and New Zealand who may have ideas about investing in existing stations, aspirations towards management, plans to re-think current approaches, etc.

Chapters 1 to 3 have to do mainly with the audience, the market, rates and profits.

Chapters 4 and 5 have to do with procedures (in the U.S.A.) to obtain a licence and obligations to the F.C.C.

Chapters 6 to 8 make suggestions about property, buildings and technical requirements of a small market broadcasting station. Other chapters, later in the book discuss fidelity, the choice of microphones, microphone concepts, planning and maintenance.

The author discusses the choice of staff, including the vital post of Chief Engineer. He also has something to say about programming for a small market and about sales and promotion.

A useful book but with a limited potential audience. Our review copy came from the Grenville Publishing Co. Pty. Ltd., 401 Pitt St, Sydney, 2000. (W.N.W.)

Training course

TRANSISTOR TV TRAINING COURSE, by Robert G. Middleton. Published by W. Foulsham and Co. Ltd., Slough, England, 1969. Hard covers, 8 1/2 in x 11 1/2 in, 126pp., many circuits and diagrams. Price in Australia \$5.95.

Although a high proportion of domestic television receivers are still basically "valve" equipment, transistors and integrated circuits are steadily encroaching into the field as prices are lowered and performance limits raised. Already many designs have been "hybridised," with both valves and solid state devices used in combination, and this trend seems likely to accelerate in the near future. It also seems likely that when colour television makes its appearance here, the receivers concerned will be almost wholly solid-state in composition.

One of the implications of this trend is that television service technicians are going to find themselves dealing more and more with circuitry based on transistors and other solid-state devices. And if they are to deal effectively and efficiently with this circuitry, many technicians are going to need some form of retraining.

"Transistor TV Training Course" is a book intended to assist technicians in self-retraining along these lines. Progressing in logical fashion through the various sections of a solid-state TV receiver, it explains the basic operation of the circuitry and discusses the general ways in which it differs from circuitry designed around thermionic valves. The treatment is essentially practical in orientation, in keeping with the purpose of the book, and many illustrative circuit examples are given.

Almost of necessity the author of the book has had to assume that the reader has a fairly solid background both in monochrome TV operation, and in basic transistor fundamentals. Because of this the book may not be sufficient in itself for a self-retraining program; the technician may find it necessary to revise either basic TV theory and or transistor

operation with the help of other works. Similarly the student serviceman would be well advised to read and digest both TV theory and semiconductor device theory before progressing to Mr Middleton's book.

Within the context of the assumed background and the practical orientation, however, the book appears to be very well produced. It deals systematically and carefully with the various sections of TV receivers — both monochrome and colour (NTSC) — and illustrates each point made with sample circuits from practical designs. The devices and circuitry discussed are up to date, too; included are sections dealing with junction FETs, MOSFETs, varactor diodes and ICs, also sections discussing transistor UHF tuners and colour decoders.

Naturally enough, being American in origin the book assumes the American TV standards and the NTSC colour system. However the differences between the U.S. standards and colour system and our own monochrome and projected PAL colour system are not great, so that the local technician should find the book of considerable value despite this. In any case much of the text is written in a fairly general fashion, and is equally applicable to either country.

To summarise, a book which is both topical and well produced, and one which should be of value not only to practising TV technicians keen to keep abreast of current developments in their "patients" but also to students in both servicing and engineering courses seeking background information on trends in TV receiver design.

The review copy came from Grenville Publishing Company, who are Australian agents for Foulsham-Sams. We are advised that copies are already in stock at all major bookstores. (J.R.)

Oscilloscopes

THE OSCILLOSCOPE, New 3rd Edition. By George Zwick. First printing May, 1969. Stiff paper cover, 260 pages 8 1/2 x 5 1/2 inches, freely illustrated by diagrams and circuits. Published by TAB Books, Blue Ridge Summit, PA 17214. Price in Australia \$6.15. For the hard cover edition \$9.95.

The first edition of this book, which one of our staff members happened still to have on hand, was published in August, 1954, when the author was an instructor at the Beleahy Institute, New York.

This new edition carries much the same chapter headings, as under:

Waveforms — The Cathode-Ray Tube — Sweep Systems — Typical Oscilloscopes — Alignment — Oscilloscope Techniques — Tests and Measurements — Experiments.

Chapters 1 to 3, dealing with basic principles, look to be much the same as in the original text, but with a few changes here and there. They assume that the reader will have some familiarity with electronic terminology and circuitry, but the average student, hobbyist or technician will have no difficulties in this respect. In chapter 4, this general discussion is brought together in an examination of circuitry actually used in typical oscilloscopes. It is noteworthy that only valves are featured in these examples.

The section on alignment is concerned mainly with sweep techniques applied to FM and television receivers. Again, valves dominate the scene, there is no mention of varicap sweep systems, and split sound TV receivers gain prominent mention. This would seem to indicate too much adaption from the 1954 text rather than a complete rewrite, as mentioned in the publicity sheet.

The remaining chapters, as already listed, cover the use of oscilloscopes in fairly routine situations. Here, again, the text has been heavily adapted from the earlier editions and carries the aura of



Tanner-James QUALITY COMPONENTS

Terminals



CAT. No. D7

15 amp. 250 volts
4mm top socket.
Captive & Free rotating head. Nickel plated brass. Nylon insulant. 6 standard colours.

32c List



CAT. No. D8

30 amp. 250 volts
4mm top socket.
Captive & Free rotating head. Nickel plated brass. Nylon insulant. 6 standard colours.

48c List

4mm Plugs



CAT. No. D35

4mm single stacking plug. Silver plated contacts. Screw wire connection. Fully insulated. 6 standard colours.

28c List



CAT. No. D41

Twin 4mm stacking plug. 1/2 in. centres. Silver plated contacts. Screw wire connections. 6 standard colours.

70c List

**MADE IN
AUSTRALIA**

by

Tanner-James

Pty. Ltd.

34 STAFFORD STREET
HUNTINGDALE VIC. 3166

TEL: 544 8830

A vast range of SATO Parts

- For manufacturers
- For TV
- For radio
- For instruments
- For amplifiers
- For kitset builders
- For sound equipment
- For industry
- For stereo equipment
- For educational purposes
- For electronics
- For tape recorders

Distributed by



GENERAL ACCESSORIES

(A DIVISION OF ELECTRONICS INDUSTRIES)

116-118 CLARENCE STREET, SYDNEY 443 CONCORD ROAD, RHODES — 73-0211
BOTH STORES OPEN SATURDAY MORNING

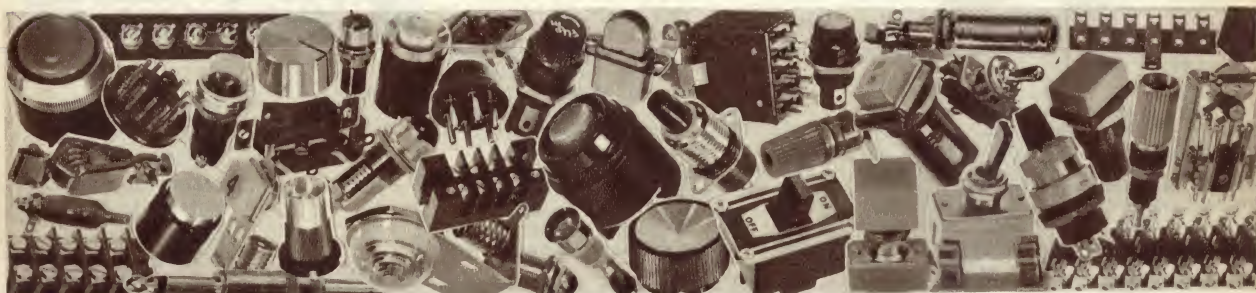

Like being proud of their Kangaroo, Sato's large variety of electrical parts is the favorite choice by Australians. Your inquiries are welcome.

SATO PARTS

SATO PARTS CO., LTD.

HEAD OFFICE: EBISU, SHIBUYA-KU, TOKYO, JAPAN TEL: (442) 8506-8
BANK ACCOUNT: MITSUBISHI BANK

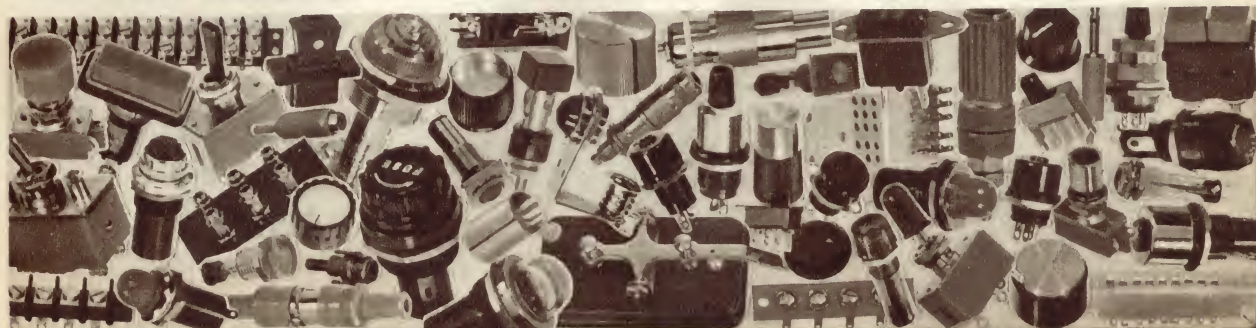

student exercises of that era. It raised no special enthusiasm on the part of this reviewer. Quite the contrary, in fact!

But more to the point was the memory of some of the material in the early chapters which seemed to indicate a carelessness about which we have complained in these columns on other occasions. On page 13, the reader's attention is drawn to figure 1-7 illustrating the overshoot and slope characteristics of a typically distorted square wave; the diagram shows nothing of the kind.

A paragraph on page 58 reads: "There are a large variety of synchronising voltages, the most commonly known being the sine wave, widely used in oscilloscopes . . ." I know what the author was trying to say, but I don't admire his method of saying it.

On page 60, while still ostensibly talking about synchronised time bases, he shows three-quarters of a sine wave stationary on the screen, formed by a sweep marginally too high in frequency. Such a pattern would not be stationary at all.

On page 68, dealing with video response curves, figure 3-26 is highly suspect, to say the least. On the same page, the author describes the marker on a sweep pattern as "an RF pulse of adjustable amplitude and frequency."

Again on page 69: "Obviously, any marker system that identifies the frequency of one cycle, or even a small group of adjoining cycles is quite accurate."

It certainly would be! The width of marker pulses is normally determined by the pass-band of the CRO display.

And, on page 81: "The triggering circuits" (of a lab. type scope) "are similar to the external sync. on popular scopes."

No, this is not a book that we can recommend. (W.N.W.)

LITERATURE—in brief

WATVIC SCIENCE RECORD, Vol. 3. Published by Watson Victor Ltd., P.O. Box 100, North Ryde, N.S.W. 2113. Contents: LKB precision calorimetry system; Diffpet X-ray diffractometer; Mettler balances; Radiometer pH meter; Orion divalent cation activity electrode; LKB fraction collector; Sorvall general purpose centrifuge; Radiometer acid-base analyser; Nikon stereo-zoom microscope; Sorvall tissue sectioner; Unitest calorimeter system; Corning Pyrex laboratory glassware; Qualtex constant temperature water baths; Controlled Environments plant growth chambers; Mufax facsimile communication system; Goerz multirange recorder; Multitone pocket paging system; Mico miniature soldering irons; Acoos sound level meter; Rollei single lens reflex photographic system.

NEWS BULLETIN, Vol. 3, No. 71. Published by A. F. Bulgin and Co. Ltd., U.K. Australian agents, R. H. Cunningham Pty. Ltd., 608 Collins Street, Melbourne 3000. Contents include: 3, 4 and 6 pole miniature mains connectors; double-pole moulded insulation switches; printed-circuit mounting signal lamp; illuminated switch; power resistors in three ratings; legended signal lamp fittings. Also available with this issue is a wall chart showing the current range of Bulgin moulded switches.

ECCOCLEAR. Published by Emerson and Cuming Inc., U.S.A. Australian distributors, IRH Components Pty. Ltd., The Crescent, Kingsgrove, N.S.W. 2208. A folder, illustrated with application photographs, contains a handy selection chart which lists characteristics of eleven Eccoclear clear casting resins. Properties and application data included are viscosity, pot life, cure temperature, colour, index of refraction, flexibility, hardness, specific gravity, flexural strength, water absorption, operating temperature, dielectric strength, volume resistivity, dielectric constant, and dissipation factor.



TECHNICAL BULLETIN 1001, The Red and Blue Tape Method of Preparing Artwork Masters for Printed Wiring Boards. Published by Bishop Graphics Inc., 7300 Radford Avenue, North Hollywood, Calif. 91605, U.S.A. The 8-page bulletin describes the use of photographically separated red and blue patterns on a single master artwork for both sides of two-sided printed wiring boards. The introduction outlines the total process from

circuit schematic to finished negatives. This is followed by a step-by-step description of the drafting techniques, materials, and short cuts developed by Bishop's customers as well as by the company's research team. The next section deals with the photographic processes, with specific lighting, film, and filter data for successful precision photography under controlled conditions.

KU-BAND STEP RECOVERY MULTIPLIERS, Hewlett-Packard Application Note 928. Inquiries to Hewlett-Packard Australia Pty. Ltd., 22-26 Weir Street, Glen Iris, Vic. 3146. The 6-page note gives a detailed design for a practical times-8 single-stage step-recovery-diode frequency multiplier with a typical maximum output power of 75mW at 16GHz. It includes references and a discussion of how to modify the design to meet other performance requirements.

NATIONAL SEMICONDUCTOR CORPORATION, U.S.A. has published a TTL 54/74 Series performance guide. This lists general rules of thumb to be used by a design engineer regarding particular uses of ICs in the series. The guide includes hints on preset and clear pulses, clock pulses, expanders, line termination, decoupling and other topics. National Semiconductor is represented in Australia by Rutherford Electronics Pty. Ltd., P.O. Box 30, North Balwyn, Vic. 3104.

Be Paid What You are REALLY WORTH!



Develop your aptitudes at your own pace, for recognition that brings HIGHER PAY. Begin YOUR Progress Today! Select the course you want and which will benefit you most. ICS will send YOU promptly—a FREE illustrated BOOK, giving FULL DETAILS.

GENERAL

Journalism—Short Stories
Writing for Radio & TV
Interior Decorating
Etiquette & Entertaining
Textiles
Photography
Mathematics
General Education
Dressmaking

DRAUGHTSMANSHIP

Architectural
Builders' Plan Drawing
Mechanical Structural
Surveying & Mapping

ILLUSTRATING

Still Life—Landscape
Caricature & Cartoons
Oil & Water Colour.
Fashion Drawing
Showcards & Tickets
Signwriting

COMMERCIAL

Accountancy
Cost Accountancy
General Bookkeeping
Salesmanship
Shorthand Typing

Retail Management

Commercial Management
Small Business Owners
Hotel-Motel Management
Club Administration
Window Dressing
Business Letters

BUILDING

Architecture
Building Contracting
Carpentry, Joinery
Structural Engineering
Concrete Engineering
Estimate & Quantities
Roofing, Steel Square
Timber Home Building

INDUSTRIAL

All Mechanical Eng.
Fitting & Turning
Soft Drink Manufacture
Air Conditioning
Gas or Elect. Welding
Chemistry, Plastics
Electronics
Electrical Mechanics
Radio Eng. or Service
Television
Refrigeration
Diesel Engines

Auto Mechanics

Civil Engineer
Production Management
Industrial Management
Executive Training
Modern Supervision

SPECIAL EXAMINATION COACHING COURSES

Account'cy: All Exams
Institute of Secretaries
Inst. Cost Accountants
Inst. Sales & Marketing,
Matric. or Leav. Cert.
Intermediate Certificate
Senior or Junior Public
C'wealth Clerical Exams
Police Entrance Exam
Nurses' Entrance Exam
Steam Certificate
Refrigeration Certificate
Radio Examinations
Inst. Auto. Mech. Engrs.
Inst. Diesel Engineers
Shire Overseers' Exam
Engineers' Institutions.

ADVERTISING

Copywriting
Commercial Art
Advert'g Inst. Aust.

TO INTERNATIONAL CORRESPONDENCE

Dept. 526 **SCHOOLS.**

SYDNEY: 400 Pacific H'way, Crow's Nest. Tele.: 43-2121.

MELBOURNE: 234 Collins Street. Tele.: 63-7327.

BRISBANE: Heindorff House, 171 Queen St., Brisbane. Tele.: 2-6125.

ADELAIDE: T. & G. Building, King William St. Tele.: W-4148.

PERTH: C'wealth Bank Building, 55 William St. Tele.:21-7268.

NEW ZEALAND: Wellington, 182 Wakefield St. Tele.: 53-109.

Please send Free Book on

NAME (Mr, Mrs, Miss) AGE

ADDRESS

..... STATE Dept. 526

OCCUPATION PHONE

EA 12 69

Here are the famous names in **INSTRUMENTATION**

together with the standard of service to match

A SELECTION FROM THE OUTSTANDING RANGE OF INSTRUMENTS AVAILABLE FROM JACOBY MITCHELL:

JAYEM

(Right) Model 555 Oscilloscope 5" CRT has 10 x 8 cm viewing. DC—7 MHz (—3dB). 20 mV sensitivity.



ADVANCE

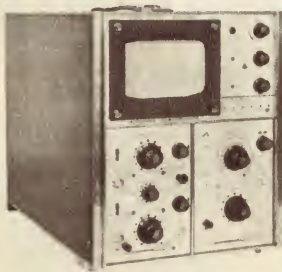

(Above) Advance OS2000 Oscilloscope. 20 MHz Bandwidth at max. sensitivity of 10 mV/Cm. 10 Cm x 6 Cm display area. Also—OS25 5 MHz Dual Trace Oscilloscope. • B4 RF Signal Generator. Alt. freq. ranges either 100 kc/s to 80 Mc/s or 30 kc/s to 30 Mc/s. • J2E AF Signal Generator. Freq. ranges 15 Hz-50 KHz. • H1E AF Signal Generator. Provides sinusoidal signal from 200 uV to 20V RMS over freq. range 15 Hz to 50 KHz. • SG67 Wide Range Oscillator. 5 freq. ranges covering 10 Hz to 1 MHz. • SG68 Low Distortion Oscillator. Freq. range 1.5 Hz to 150 KHz. • TC11, TC12 15 MHz Timer Counters. TC11 has 4 digit and TC12 5 digit display. • TC9 32 MHz Timer Counter with 6 digit display.

KEW

(Right) Model K-1420 VTVM. Meter sensitivity 200 uA. Also Model K-1400 VTVM. Meter sensitivity 50 uA.

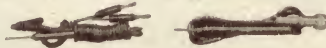

COMARK

(Right) 1200 Series Electronic Multimeter. A range to measure mV, mA, uV, uA, ohms, DC, AC. For portability, lab. or panel mounting.



KIKUSUI



(Above) Model 433 RC Oscillator. Freq. 10 Hz—10 MHz (6 ranges). (Below) Model ORC-27A RC Oscillator. Freq. 18 Hz—200 KHz (4 ranges).



TAYLOR

(Right) Model 88B Multimeter. Sensitivity 20,000 o.p.v. DC, 2,000 o.p.v. AC. Also—
• Model 100 A Multimeter. Sensitivity 100,000 o.p.v. DC, 5,000 o.p.v. AC.
• Model 101 Multimeter (slightly modified version of 100 A). • Model 127A Multimeter. Sensitivity 20,000 o.p.v. DC, 1,000 o.p.v. AC.



LEVELL

(Right) TG150 RC Oscillators. 1.5 c/s to 150 kc/s. Constant amplitude, low distortion, stable frequency.



KYORITSU



The newest snap-on volt-ohm-ammeters in a full complement of portable rotary scale and swivel case styles that go to 900 amps and 750 volts AC in 8 feature packed models.



Send for details on any of these and many other instruments.

Distributed by—

jacoby, mitchell & co.pty. ltd.

469-475 Kent Street, Sydney. 26-2651

MELBOURNE
30-2491/2

ADELAIDE
53-6117

BRISBANE
2-6467

PERTH
28-1102

LAUNCESTON
2-5322

JM/34-69

MATHS HANDBOOK REACHES 100,000

HANDBOOK OF MATHEMATICAL FUNCTIONS, Edited by M. Abramowitz and I. Stegun. National Bureau of Standards Applied Mathematical Series 55, 1964. Available from the Superintendent of Documents, U.S. Government Printing Office, Washington, D.C., 20402. U.S.A. Price \$U.S.6.50 plus 25 per cent postage and packing.

In a recent ceremony in Washington, D.C., the 100,000th copy of the "Handbook of Mathematical Functions" was presented to U.S. Presidential Scientific Advisor Lee A. DuBridge. It is rare for a technical book to reach the 100,000 mark, but for a 1060-page compendium of advanced mathematics it is almost inconceivable.

At the ceremony, A. V. Astin, Director of the National Bureau of Standards (publisher of the book), paid tribute to the book itself, to the scientists who planned it and brought it to realisation, and to the National Science Foundation which gave the necessary financial backing. Frequently mentioned was Dr Milton Abramowitz, the N.B.S. mathematician who drew up the first outline for the Handbook, contributed substantially to its contents, and served as Editor until his death in 1958. In recognition of his efforts, Dr Abramowitz is listed as Editor of the volume jointly with Miss Irene A. Stegun who is also one of the authors.

The Handbook is essentially a series of mathematical tables — tables of the numerical values of various mathematical functions together with instructions for their use. Some of the functions appearing in the Handbook are the Gamma, Theta, Zeta, Exponential Integral, Error, and Fresnel functions, and the various families of Bessel, Hypergeometric, Coulomb Wave, Orthogonal Polynomial, and Elliptic functions. Most of those originated as solutions to differential equations of mathematical physics, but now find application

also in engineering and in areas beyond the physical sciences.

Mathematical tables have not been outdated by computers. A procedure for solving a problem by computer must be worked out and broken down into elementary computational steps. The corresponding instructions must then be stored in the machine possibly with extensive initial data and values of special functions. Mathematical tables can help in various stages of this preliminary process, even in checking out the solution procedure as a whole. Also, many problems that researchers have to solve do not justify the use of a computer, and there are always those without access to a computer. For them the aid of mathematical tables is indispensable.

The complete Handbook contains 29 chapters written or co-authored by 27 individuals. Seven chapters were prepared outside of the N.B.S.; members of the N.B.S. were responsible for the other 22. Altogether there are 180 tables — one third are new, one third are based on previously existing N.B.S. tables, and the remaining third came from various other sources. Besides the numerical tables, the chapters contain graphs, polynomial or rational approximations for automatic computers, and statements of the principal mathematical properties of the tabulated functions particularly those of computational importance. Many numerical examples are given to illustrate the use of the tables and also the computation of function values which lie outside their range.

NEW DEVELOPMENTS, Issue B045, October, 1969. Published by Jacoby, Mitchell and Co. Pty. Ltd., 469-475 Kent Street, Sydney, 2000. Dana AC/DC digital voltmeter; Advance differential high gain plug-in, rack mounted main frame, and sine/square signal generator; Teac DR/FM portable data recorder; TRW microwave tuning varactors; Wandel and Goltermann level meter and level generator; Taylor miniature captive terminals; Siliconix matched FET pairs; Telonic voltage tunable bandpass filters, and tunable filter for telemetry frequencies; Sefram Graphirac recording millivoltmeters and microammeters; Shinkoh universal dynamic strain amplifier.

PROCEEDINGS I.R.E.E. AUSTRALIA, Vol. 30, No. 9, September, 1969. Published by the Institution of Radio and Electronics Engineers Australia, Science House, 157 Gloucester Street, Sydney, 2000. Contents: Theory and Design of Loudspeaker Enclosures, by J. E. Benson; Interference in Multi-Channel Telephony FM Radio Systems with Pre-emphasis, by S. W. Conning; The Tellurimeter as a Path-Testing Instrument, by G. Rosman; Landing, Take-off and En Route Guidance of Aircraft, by E. O. Willoughby; The Steady-State Analysis of Networks with Periodically Varying Piecewise Constant Parameters, by L. W. Cahill.

SWITZERLAND CALLING, No. 2/1969. Published by European and Overseas Services, Swiss Broadcasting Corporation, CH 3000 Bern 16, Switzerland. The program schedule of the S.B.C. covers the period from November 2, 1969 to May 2, 1970, indicating frequencies, reception areas and times together with additional information on the programs. Published in four versions: English/German, Spanish/French, Portuguese/Italian, and Arabic.

APPLICATIONS OF PIN DIODES, Hewlett-Packard Application Note 922. Available from Hewlett-Packard Australia Pty. Ltd., 22-26 Weir Street, Glen Iris, Vic. 3146. The 15-page note discusses the characteristics of PIN diodes that make them behave as electrically controllable resistances at RF and higher frequencies. It then describes how these characteristics are applied to a variety of circuits, including microwave switches, attenuators and phase-shifters. Other sections discuss techniques to obtain maximum power handling capability and the effects of package parasitics on performance.

ASPECTS OF HIGH-QUALITY MONITORING LOUDSPEAKERS, BBC Engineering Monograph No. 78, September, 1969. Part 1, A New Two-Unit High-Quality Loudspeaker, by H. D. Harwood and S. A. Hughes. Part 11, Monitoring Loudspeaker Quality in Television Sound-Control Rooms, by H. D. Harwood and C. L. S. Gilford. Available from BBC Publications, 35 Marylebone High Street, London W.1, England. Contents: Part 1—Introduction to Part 1; Design considerations, units and cabinet; Design, prototype and final model; Performance, listening tests, response frequency characteristics, overload performance, impedance, reproducibility of LF units, general comments; Conclusions: Part 11—Introduction to Part 11; Preliminary investigation; Study of reflections from surfaces close to a loudspeaker; Discussion; Application; Conclusions; References.

NATIONAL SEMICONDUCTOR SERIES 74N TTL CROSS REFERENCE GUIDE. Published by National Semiconductor Corporation, U.S.A. Inquiries to Rutherford Electronics Pty. Ltd., P.O. Box 30, North Balwyn, Vic. 3104. The guide lists the ICs of 13 manufacturers in cross reference with National's TTL line, indicating which are pin-for-pin replacements and which are near equivalents.

PLAN YOUR FUTURE

CHOOSE a career in the field of **ELECTRONICS*** — the Nation's most progressive and fastest expanding industry.



Advancement in this modern science demands technical ability, a sound knowledge of basic principles and applications.

YOU can master the subject by training at the **MARCONI SCHOOL** and be ready to grasp the opportunities that occur in the three fundamental branches of Radio-technology.

KNOW WHERE YOU'RE GOING

A = APPLIED SERVICING

Comprehensive training in the maintenance and repair of radio and television receivers offers substantial rewards to competent technicians. Marconi School training covers all aspects of radio and television receiver circuit applications, practical exercises in fault finding and alignment procedures.

B = BROADCASTING

A thorough and practical grounding is available to students in broadcasting transmitter performance standards and maintenance techniques, with individual instruction in station operation and studio control and testing.

C = COMMUNICATIONS

Combines all the foregoing, together with radio aids to navigation, mobile telephony, marine service application and international wireless telegraph regulations, qualifying the successful student for the Commonwealth Government Certificate of Proficiency and the Marconi School Diploma in Radiotechnology. Classes are conducted at

21 Pier Street, Sydney (at the foot of Goulburn Street).

Daily: 9.30 a.m. to 4.30 p.m.

Evenings: 6 p.m. to 8.30 p.m.

or by Home-Study Courses (except practical instruction on equipment).

STUDY NOW

Send for training syllabus. There is no obligation.

NAME.....
ADDRESS.....

the **MARCONI SCHOOL** of
wireless

G.P.O. Box 2516, Sydney
A Service of Amalgamated Wireless (Australasia) Ltd

PRE-PAK

electronics



P.O. BOX 131,
KINGSGROVE, N.S.W. 2208.

SALES CENTRE,
103 Regent Street,
REDFERN, N.S.W. 2016.
69-5922

24 HOUR DESPATCH SERVICE

SPECIALIZING IN MAIL ORDERS

Send 20c in stamps or a postal order for our latest information packed catalogue which will be sent to you by return mail.

**E.A. 10 PLUS 10
STERO AMPLIFIER**
Nov. 1968

Complete kit \$58.00
Built and Tested \$68.00
Freight \$1.00

MODULAMPS ea. \$4.00
Small 1W transistor audio amplifiers by Pre-Pak.
Supply volts . . . 6-12v DC.
Input sensitivity 1v P-P.
Freq. response 50Hz-20KHz.

**SPEAKER ENCLOSURES
TEAK CABINETS**
8WR & 3TC \$30.00ea
2 x 8WR & 3TC . . \$45.00ea
FREIGHT \$1.00

COMPUTER BOARDS

Containing a variety of NPN and PNP germanium transistors and a host of other components, these 4" x 2 1/2" boards are supplied with free technical information on all parts. Each board has a minimum of 4 transistors.

	PRICE	POST
100 Boards . . .	20c ea	50c
25-99 Boards . .	25c ea	25c
10-24 Boards . .	30c ea	25c
1-9 Boards . . .	35c ea	10c

PACK AND POST
10c ANY ORDER
UNLESS INDICATED
Sales Centre open
Mon. to Sat. 8.30 a.m.-5.30 p.m.

Magnetic Pre-Amp Kitset

As in E.A., Oct., 1965.
All parts supplied.
Use for pick-up or tape heads.
Mono \$4.90 Stereo \$9.00

BARGAINS

2N3054	\$1.90
2N3055	\$1.90
BC108	50c
BC109	60c
BF115	65c
AC125	80c
AC126	80c
AC127/128	\$1.75
AC187/188	\$1.85
AD161/162	\$3.20
EM404	30c
BA100	35c
OA91	20c



PIONEER PURE SOUND

HEAR IT NOW AT

HOMECRAFTS

289 ELIZABETH ST. MELBOURNE.

PHONE 60 1442

WE INVITE YOU TO CALL AND INSPECT OUR VAST RANGE OF HI-FI STEREO EQUIPMENT·AMPLIFIERS·TURN TABLES·LOUD SPEAKERS ETC. DISPLAYED IN OUR "PIONEER CORNER" SOUND ROOM. ERIC VERRAN OUR HI-FI SPECIALIST WILL GLADLY DEMONSTRATE THE EQUIPMENT OF YOUR CHOICE.

Homecrafts FOR RADIO PARTS

289 Elizabeth St. Melbourne. Phone 60 1442



AMATEUR BAND NEWS AND NOTES

First All India Amateur Radio Convention

Final arrangements are being made to hold a convention in Bombay, to discuss many aspects of amateur radio.

by Pierce Healy, VK2APQ

The 1st All India Amateur Radio Convention will be held in Bombay over the period December 27-30, 1969. The purpose of the convention is:

To discuss the problems and difficulties confronting amateur radio and to endeavour to formulate ways and means of solving them.

To discuss the development of amateur radio in the service of the nation.

To examine the possibility of establishing sources of supply of components needed by amateurs but not readily available in the country.

The program also includes technical discussions and a display of amateur band equipment. There will also be sessions for short-wave listeners and tours of inspection to manufacturing establishments connected with the electronics industry.

The venue for the convention and exhibition is the Birla Kreed Kendra, Chowpatty, Bombay. This is said to be an ideal location, being comparatively free from QRM and QRN.

Amateur radio was first introduced into India in the early 1930s but has not developed as well as in some other countries. At the present time there are only 500 licensed operators, and only about 25 per cent are active.

In brochures publicising the convention, concern has been expressed regarding the lack of development in amateur radio. It is hoped that the convention will create an awareness of the advantages that a large amateur population would be to the electronics industry.

A pioneering effort in the use of radio amateurs for the advancement of the industry in India has been made by M/s Bharat Electronics Ltd., reputed to be the largest manufacturer of electronic equipment in India. The company has formed a very active amateur radio club among its employees.

It is proposed to produce a "Souvenir Publication" to commemorate the Convention. Also, the club station VU2HAM will be in operation continuously from December 15, first at a permanent location and then at the convention location from December 27 onwards. Special QSL cards will be printed and sent to all stations contacted.

The writer of these notes has been honoured by being invited to attend the convention to "... give the delegates attending the convention the benefit of your knowledge and experience to the development of amateur radio in India."

As these notes were being collated the

possibility of being able to accept the invitation was being seriously considered.

A number of committees have been constituted to manage various aspects of the convention. The personnel are as follows:

Chairman, Executive Committee: Shri B. S. Dutt, VU2AJ, Chief Engineer, Overseas Communication Service, Bombay.

Chairman, Steering Committee: Shri Y. A. Fazalbhoy.

Chairman, Exhibition and Souvenir Subcommittee: Shri D. W. Dalrymple, VU2OLK, Senior Engineer, Beckman Instruments International S.A.

Hon. Secretary Shri T. P. Sheth VU2TP

Hon. Liaison Secretary Shri G. V. Sulu VU2GV

Shri J. A. Faithful VU2JA
Shri Subranamian J.V. —

Executive Committee

Lt. Col. K. Gopinathan VU2BG
Vice-chairman.
Shri V. G. Kiri VU2VG
Shri V. P. Asar VU2VA
Shri Chandrakumar Piprani VU2PI
Shri V. J. Bhatt VU2RX
Shri Saad Ali VU2ST
Shri C. A. F. Periera VU2FP
Shri N. G. Hathiram VU2NH
Shri A. Sengupta VU2PY
Shri Darab S. Dhalla VU2GJ
Maj. J. K. Deshpande VU2ED
Shri Gopal Kamat VU2IEZ
Shri Idress Ali VU2IAZ
Shri N. J. Mehta —
Shri C. D. Jeffries —
Shri Sunil Sangvi —

Exhibition and Souvenir Sub-Committee

Shri V. P. Patil VU2XX
Shri C.A.F. Pereira VU2FP
Shri Saad Hussain Ali VU2ST
Shri S. R. Kavishwar VU2CC
Shri V. P. Asar VU2VA
Shri S. R. Sivaswamy VU2RU
Shri S. R. Chowdappan VU2FC
Lt. Col. K. Gopinathan VU2BG
Dr P. K. Kapre —
Shri A. G. Vaidya VU2NQ
Shri Subramaniam J. V. —
Shri M. Nilcantan VU2LN
Shri V. J. Bhatt VU2RX
Shri M. V. Chauhan VU2MV

Sponsoring Radio Clubs and Societies

Bangalore Amateur Radio Club
Baroda Amateur Radio Club
Coimbatore Amateur Radio Club
Electronics Club, Patna
Goa Amateur Radio Society
Gujarat Amateur Radio Society
Gwalior Amateur Radio Club
Hublis Amateur Radio Club
I.I.T. Amateur Club, Powai
Indian Technology Amateur Club, Khargpur
Madras Amateur Radio Society
Pondicherry Amateur Radio Society
Radio and Electronics Society of India
Secundarabad Amateur Radio Club
School of Signals Amateur Club, Mhow
Visakapatnam Amateur Radio Society.

It is understood that the Amateur Radio Society of India, whose headquarters are in Delhi, has also been invited to attend and play an important part in the Convention by actively participating in the proceedings.

NEWS FROM OVERSEAS

Several items of general interest appeared in the August issue of the Region 1 News.

Sweden: QUAX is the title of a monthly newsletter devoted only to events occurring on the 28MHz band. The newsletter is not an official SSA publication but is produced by Ullmar Qvick, SM4DXL, Djurgardsv 35C, S-68100 Kristinehamn, Sweden. The annual subscription is 10 IRCs. The newsletter contains details of propagation events and provides a most useful record of activity on 28MHz.

South Africa: The Max-Planck Institute of Lindau has set up a new beacon station in South West Africa, using the call-sign ZS3AW. The frequency is 14MHz precisely, and the power 1KW. A four-element beam is directed north and the

Season's Greetings to all readers of these notes

A very sincere thank you to those who have sent in notes on local and overseas events. Also, to those who have expressed interest in various aspects of amateur radio.

Looking forward to hearing from you again in 1970.

73'
VK2APQ

Steering Committee

Commandt. Gen. M. J. B. Maneckji VU2CJ Vice-chairman.
Maj. Gen. R. Z. Kabraji VU2BK Vice-chairman.
Condt. Gen. Udyan Chinubhai VU2UD Vice-chairman.
Brig. B. M. Chakravarty VU2BU Vice-chairman.
Maj. Gen. Bhagwati Singh VU2IB Vice-chairman.
Shri D. R. Paranjpi VU2AU
Shri D. T. Kapadia VU2KT
Smt. M. D. Kapadia VU2WW
Shri S. R. Sivaswamy VU2RU
Shri M. V. Chauhan VU2MV
Shri S. R. Chowdappan VU2FC
Shri Chittaranjan Das VU2JW
Shri Karta Ram VU2KM
Shri S. Venkatraman VU2SV
Dr G. H. Shah VU2HG
Shri R. M. Pandya VU2MO
Shri S. Srinivasan VU2AA
Shri A. Balasubramanian VU2AB
Shri B. D. Bhat VU2CT
Shri K. Venkatraman VU2KV
Shri J. N. Adeicha VU2JF
Shri K. G. Girimaji VU2GX

News and notes of Divisional and Club activities submitted for inclusion in these columns should be forwarded direct to Pierce Healy, 69 Taylor St., Bankstown, N.S.W. 2200.



BARGAIN PACKS!

SEMI CONDUCTOR PACKS GUARANTEED BRAND NEW AND TESTED.

SILICON & GERMANIUM

- 10—Audio Type, Similar BC108 .. \$2.95
- 10—Audio Type, Similar BC109 4010 .. \$3.00
- 10—RF Type, Similar BF115 .. \$2.95
- 10—RF High Gain .. \$2.95
- 10—RF Low Noise VHF Sim. 2N3564 .. \$3.50
- 10—Audio Output, Matched pairs .. \$3.28
- 5—Pair Complementary Output .. \$3.25
- 1—NPN Output .. \$2.00
- 1—2N3055/BDY20
- 1—PNP RF IF Type, Sim. AF116, AF117, each .. .35
- Or 10 for .. \$3.00
- 1—PNP Power Output, Sim. 2N301, 2N2148 .. \$1.30
- 1—PNP Audio, Sim. OC70 .. .40

- ### FETS
- MPF 102 .. \$1.10
 - MPF 105—2N5459 .. \$1.10
 - MPF 106—2N5458 .. \$1.30
 - 2N5819 .. \$1.10
 - T15 88—2N5345 .. \$1.10
 - UNIJUNCTION 2N2160 .. \$2.00
 - SCR C106 .. \$1.20

SILICON RECTIFIERS

- 50v, 25c ea. or 10 for \$2.25
- 100v, 25c ea. or 10 for \$2.25
- 200v, 30c; 400v, 35c;
- 600v, 55c; 800v, 60c;
- 1000v, 95c.
- 3 Amp 100V Surge Protected ea. .. 75c

DIODES

- OA90 Type, 25c ea. or 10 for .. \$2.30
- OA91 Type, 25c ea. or 10 for .. \$2.30
- OA95 Type, 27c ea. or 10 for .. \$2.50
- BA100, each .. .30

INTEGRATED CIRCUITS

- SINCLAIR 1C-1D .. \$11.25
- GE 1W RMS .. \$3.19
- GE 2W RMS .. \$5.57
- GE 10W Audio 5W RMS .. \$8.57
- BHA Special 15' RMS \$21.88
- PHILIPS Pre-amp and Tape. MOTOROLA.
- FAIRCHILD—Flipflop, etc.
- PRICES ON APPLICATION.
- STATE REQUIREMENTS.



TRANSISTORIZED TUNERS

- Unit 10c with Ceramic Filter and Power Supply, \$37.00.
- Teak Cabinet \$6

- ### NEW WIDE BAND TUNER
- Based on Playmaster Design.
 - Ceramic Filters, Tuning Meter
 - Whistle Filter, etc. \$62 plus tax.
 - Teak Cabinet \$8 extra.



CONVERTERS FOR AIRCRAFT, MARINE, FIRE, AMATEUR BANDS

- RF FET CONVERTER
- Crystal Controlled — 1mHz Band-WIDTH, INTERNAL OR EXTERNAL BATTERY. CONVERT YOUR CAR RADIO OR HOME RADIO INTO SENSITIVE VHF RECEIVER.
- \$24.75 Incl. Tax.
- Crystal \$5 extra.
- CRYSTALS—State Exact Listening Frequency.

SOLDER SPECIALII RESIN-CORED "SUPER FAST" 2 1/2lb Reels. ONLY .. \$2.75



- 7W Stereo Amplifier, 50-20,000 Hz. In oiled timber Cabinet.
- \$34.50 Complete.

STEREO HEADPHONE SPECIAL



- BRAND NAME — 8 Ohm.
- Wide Range. \$6.00.

TAPE DECKS—Van Der Molen Cassette Decks from .. \$27

RECORDING TAPE, POPULAR MAKE, AT WHOLESALE PRICES

- 3in 150ft .. .50
- 3in 225ft .. .70
- 3in 300ft .. .85
- 5in 600ft .. \$1.80
- 5in 900ft .. \$1.98
- 5in 1200ft .. \$2.50
- 5 1/2in 1200ft .. \$2.55
- 7in 1200ft .. \$3.00
- 7in 1800ft .. \$3.25
- 7in 2400ft .. \$4.75
- 7in 3600ft .. \$6.75

PHILIPS TYPE CASSETTES

- C60 60 Min .. \$1.65
- C90 90 Min .. \$2.65
- C120 120 min .. \$3.30



- DIGITAL CLOCK
- 240V, 2W
- 12 Hour, plus Seconds.
- SPECIAL — \$11.75.

MURATA CERAMIC FILTERS

- BF 455A, ea .. .32
- SF 455D, SF D455B ea. .75

ALL COMPONENTS, TRANSISTORS AND DIODES AT SPECIAL PRICES.

SEND S.A.E. FOR DETAILS.

SPECIALII SUPER PAKS

Comprising New Assorted Resistors, Condensers, Knobs, Dials. \$1.50 lot. Plus 10c P/Pack.

SUPER-LUS PAKS, Comprising 300 NEW Assorted Transistors, Diodes, Pots, Resistors, Sockets, Dials, Condensers. \$3.00 the lot, plus 10c Post.

RESISTORS

- 1/2W 4c ea. or \$3.00 per 100.
- POLYESTER CAPACITORS
- .001 Mf.-01 7c ea.
- All Values Available.

- ELECTROLYTIC CAPACITORS
- All Values—5mf, 12c.
- Send for list.

NEW SPECIALII GREY PLASTIC CABINETS

- Suit Instruments or kits.
- 5 1/2" x 4" x 3" only
- 25c ea. or 10 for \$2.



SMALLEST RADIO KIT IN AUSTRALIA

1 5/8in x 1 5/8in x 15/16in. Uses 2 Silicon Transistors and High Impedance Magnetic Earphone.

5-Stage Reflex Circuit and Ferrite Aerial.

Complete Kit with Instructions. \$6.75.

Batteries required: 2 Mercury Cells type RM675.

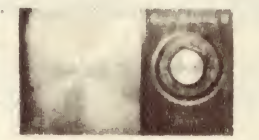

SPECIALIIII 15T RELEASE.

8 TRANSISTOR RADIO KIT! USES SILICON TRANSISTORS AND DIODES. COMPLETE with Instructions. Carrying Case and earphone \$16.50. Wired, Tested, \$16.50. Post & pack. 75c.



ELECTRONIC PROJECT BROADCAST TRANSISTOR RADIO KIT with Speaker,

- \$9.25 & 50c p.p.

NEW 1969 TRANSISTOR RADIO KIT



6 Silicon Transistors and Complete with Instruction book, carrying case and earphone. Special Price .. \$11.25

Wired .. \$13.50

Post and pack. 75c.



BOYS' CRYSTAL SET KIT

Complete with Plastic Cabinet, earphone and instructions .. \$2.50



TRANSISTOR MODULES

10 Watt RMS. 25W RMS. 65W Hi Fi Amplifiers. Pre-amp Tone Control Stage, etc. REDUCED PRICES. SEND FOR NEW PRICE LIST.

DENSHI BOARD KIT

- Make 16 PROJECTS. \$12.50
- Make 30 PROJECTS. \$14.00

IDEAL CHRISTMAS GIFT FOR BEGINNERS. Post 75c.

call sign is transmitted every other minute by A1 followed by two minutes of unkeyed carrier.

Amateurs are asked to give reports through D.A.R.C. or directly to the Institute at Lindau/Harz, West Germany.

United Kingdom: G3JVL and G8LY broke down the United Kingdom to Iceland path on 4 metres (70MHz) on the morning of June 27. TF3EA was the Iceland station in the contact. The distance between Hampshire and Reykjavik is about 1,200 miles. This contact creates a new record, exceeding the previous longest distance — U.K. to Gibraltar — by nearly 200 miles.

Yugoslavia: Up to this year, Yugoslav state authorities have been issuing temporary station licences to foreign amateurs without requesting that the condition of written licence reciprocity agreement should be satisfied. But, at the same time, Yugoslav radio amateurs could not get a visitor's station licence in several foreign countries, i.e. their applications have been denied.

The Yugoslav authorities have now reconsidered this matter and changed their attitude. In future, the licence for foreign visitors will be issued only on the reciprocity principle, certified by written agreement concluded between relevant state authorities. This matter will have to be processed by law in Yugoslavia, and is not expected to come into effect until some time next year. Up to that time no foreign radio amateurs will get station licences nor will they be allowed to bring radio station equipment into Yugoslavia.

YU CERTIFICATE

The certificate "YU" is issued by the Savez Radio Amatera Jugoslavije (S.R.J.) to acknowledge outstanding achievements of foreign and home amateurs in their radio contacts with amateurs in Yugoslavia.

The certificate will be issued to those amateurs who contact a certain number of "YU" amateur radio stations during one calendar year.

The following number of contacts with different YU stations (different call signs) regardless of band or type of emission, is necessary before claiming the certificate:

- a. Amateurs from Yugoslavia 50 contacts
- b. Amateurs from Europe 15 contacts
- c. Amateurs from Asia, Africa, North America 5 contacts
- d. Amateurs from South America and Oceania 3 contacts.

The contacts which YU amateurs make with radio stations from their own town are not valid for the certificate.

Each application for the certificate should be followed by a list of call signs from the station log, without any other data, but this list should be confirmed by two operators or by the club committee. Foreign amateurs should enclose five IRCs with their application.

All applications should be addressed as follows:

- Savez Radio Amatera Jugoslavije,
- Awards Manager,
- P.O. Box 48, Beograd,
- Yugoslav.

The operator of an amateur station who gains the award in three successive years can claim a special badge if desired. An additional 10 IRCs are required.

M.A.R.C. CERTIFICATE

The executive of the Montreal Amateur Radio Club Inc. have announced the formation of an Awards Committee and the issuance of an attractive bilingual certificate available to all licensed radio amateurs and shortwave listeners meeting the following general rules and conditions:

- 1. Effective date — January 1, 1967.
- 2. (a) For Canadian and U.S.A. amateurs.
- Produce evidence of having made two-way communications with 15 or more M.A.R.C. members in good standing on each of two bands—30 contacts.

S. E. WILLIS TRADING CO.

38 Riversdale Road, Camberwell Junction, Vic. 3124, Phone 82-5787. Please Include Freight. Sorry, No. C.O.D. Postal Address: P.O. Box 263, Box Hill, 3128

- (b) DX and all others.
Produce evidence of having made two-way communications with 15 or more M.A.R.C. members in good standing on any band or combination of bands—15 contacts.

(c) — as above but **having heard**.

3. Modes — Phone, or CW, or mixed, with minimum reports R4 S3 T9 for CW or R4 S3 for phone.

4. Send a list only of stations worked (NO QSL CARDS), certified by two other amateur radio operators or an officer of a radio club or have it notarised. The list must show the stations claimed, mode of operation, date and band(s) used.

5. All stations must be land stations, fixed or mobile.

6. Cost: \$1.00 Canadian Funds or 7 International Reply Coupons. This fee includes return postage. It is payable by postal or bank money order and should be addressed to:

Awards Chairman,
Montreal Amateur Radio Club, Inc.,
535 Landsdowne Avenue,
Montreal 6, Canada.

7. The Awards Committee reserves the right to reject any application when requested confirmations are not sent within one month of receipt of request (except for remote countries where postal service is slow) or if the committee for any reason has any doubt about the authenticity of the submitted verifications.

8. Endorsements: Will be issued for each additional group of 10 stations worked or heard to all applicants providing the necessary proof and a stamped self-addressed envelope or one International Reply Coupon.

9. All certificates will be recorded and numbered consecutively.

10. Eligible stations will be published from time to time in the club magazine "MARGOGRAM."

11. In the case of any dispute concerning a claim the decision of the committee shall be final.

NEW ZEALAND

VHF Century Club

To qualify for this award an applicant must obtain the 100 points required from QSOs with New Zealand stations on the following basis:

- 56MHz band contacts count, 1 point.
- 144MHz band contacts count, 3 points.
- 420MHz band contacts count, 6 points.

Further may be added in the future. The same station may be claimed ONCE on any one band but may be claimed repeatedly on different bands.

FM Broadcasting

From the September issue of "Break-In," the official journal of the New Zealand Association of Radio Transmitters, is an interesting note on plans for a frequency modulated broadcasting station. Amateurs are playing a leading part in the project.

The plan is for Radio Newlands to build and operate New Zealand's first FM broadcasting station on the 90-94MHz band.

Newlands is a suburb in Wellington, where Ben Furby, ZL2TFR and Vic Stagpoole, ZL2ACF live. As former broadcasting technicians, they conceived the idea of a local suburban station, operating three or four evenings a week, for about three hours.

The station is intended to give a local service to the suburb and to encourage local artists and performers, public speakers, amateur actors, news writers and others interested in learning broadcasting techniques, both for professional purposes and as a hobby.

Additionally, the FM transmissions will be in stereo, exploiting the high quality of stereo music from records, as ordinary

Details of N.Z.A.R.T. Awards

The New Zealand Association of Radio Transmitters issues a number of awards to amateur radio operators and short-wave listeners. The usually accepted rules apply to all N.Z.A.R.T. Awards, especially those relating to fair play and good operating ethics. All Certificate Hunters' Club codes apply.

Endorsements are available for Phone and for CW (note that SSB is recognised as phone and not as a separate classification) as well as for different bands where applicable.

All confirmations must date from November, 1945. When applying for an award, whether through the N.Z.A.R.T. or through an overseas society, courtesy demands that the following points are observed:

Write a letter of application for the award. Supply a checking sheet with the call-signs, date of QSO, etc., of the cards submitted.

Write your call-sign, name and address legibly preferably in block capitals.

Enclose stamps or reply coupons for return postage on your cards.

Attention to these points makes the task of the fellow at the receiving end much easier.

Applications for the awards may be posted to the N.Z.A.R.T., Box 489, Wellington; or direct to Contest Manager, Jock White, ZL2GX, 152 Lytton Road, Gisborne.

AWARDS

WAP—Worked All Pacific

Confirmations required from 30 different

Oceania "countries" from the WAP list.

CR8/CR10 Timor VK9 Papua

DU Philippines VK9 Nauru Island

FB8 Adelle Land VK9 Christmas Island

FK8 New Caledonia VK9 Cocos Island

F08 French Oceania VK9 Gilbert Island

FW8 Wallis Island VR1 Ellice Island

FUB/YJ New Hebrides VR1 Phoenix Islands

KB6 Baker, Howland, VR3 Fanning and

KC6 East Carolines Washington Is-

KC6 West Carolines lands

KG6 Marianas Islands VR4 Solomon Island

KG6 Bonin and Vol- VR5 Tonga

KG6 Marcus Island VR6 Pitcairn Island

KG5 Guam VS4 Sarawak (9M)

KH6 Hawaiian Islands VS5 Brunel (9M)

KJ6 Johnston Island ZC5 North Borneo

KM6 Midway Island (9M)

KP6 Palmyra Island ZK1 Northern Cook

KS6 American Samoa Island

KW6 Wake Island ZK1 Southern Cook

KX6 Marshall Island Island

VK Australia ZK2 Niue

VK2 Lord Howe Island ZL New Zealand

VK4 Willis Island ZL/C Chatham Island

VK0 Macquarie Island ZL/A Auckland and

VK9 New Guinea Campbell Islands

VK9 Norfolk Island SW1 Samoa (ZM1)

ZM7 Tokelau Island

W.A.Z.L.—Worked All New Zealand.
Confirmations required from 45 different
Branches of N.Z.A.R.T. — except for OVER-
SEAS APPLICANTS for whom only 35 differ-
ent Branches are required. Special endorse-
ment is required when W.A.Z.L. is com-
pleted within a 12-month period.

N.Z.A.R.T. Branches for W.A.Z.L.

01 Ashburton	34 South Canterbury
02 Auckland	35 South Otago
03 Western Suburbs	36 South Westland
04 Cambridge	37 Southland
05 Christchurch	38 Taumarunui
06 Dannevirke	39 Tauranga
07	40 Te Awamutu
08 East Southland	41 Thames Valley
09 Egmont	42 Tairāhiti Bay
10 Franklin	43 Waihi
11 Gisborne	44 Matamata Radio
12 Hamilton	45 Taupo
13 Hastings	46 Waimarino
14 Hawera	47 Wairarapa
15 Hawke's Bay	48 Waitara
16 Horowhenua	49 Wanganui
17 Huntly	50 Westland
18 Hutt Valley	51 Wellington
19 Inglewood	52 Whakatane
20 Manawatu	53 Wairoa
21 Manukau	54 Te Puke
22 Marlborough	55 Patea
23 Martin	56 Waitomo
24 Motueka	57 Hornby
25 Napier	58 Tokoroa
26 Nelson	59 Helensville
27 New Plymouth	60 Mangakino
28 Northland	61 Taupo
29 North Shore	62 Central Otago
30 Otago	63 Reefton-Buller
31 Pahiatua	64 Upper Hutt
32 Rāhōtu Coastal	65 North Otago
33 Rotorua	66 Papakura
	67 Auckland
	68 Kawerau

N.Z.A.—New Zealand Award.

Available to all radio amateurs other than

New Zealand.

Requirements:—

35 confirmations from ZL1 plus 35 confirma-

tions from ZL2 plus 20 confirmations from

ZL3 plus 10 confirmations from ZL4 plus 1

confirmation from a ZL "territory" — either

from N.Z. Antarctica; Chatham Island; Kermadec Island; or Campbell Island. This one con-

firmation may be substituted by 20 ordinary

ZL confirmations if desired.

This makes a minimum of 101 confirma-

tions which should be dated from December

8, 1945.

W.A.D.—Worked All Districts.

A VHF Award. For this award, confirmations

are required on any VHF band or mixture of

VHF bands, from ZL1; ZL2; ZL3; ZL4.



EDDYSTONE EC10

Transistorised Communications Receiver

Completely Portable --- Battery Operated



**RUGGED
COMPACT
LIGHT!**
Designed for
Commercial
and Amateur
use.
Ideal for
marine
purposes and
remote
operational
areas
Covers
citizens band

Write for fully illustrated technical brochure

Sole
Agents:

R.H. Cunningham
PTY. LTD.

608 Collins St., Melbourne, Vic. 3000.

Phone 61-2464

64 Alfred St., Milson's Pt. N.S.W. 2061.

Phone 929-8055

34 Wolya Way, Balga, Perth, W.A. 6061.

Phone 49-4915

L. E. Boughen & Co., 30 Grimes Street,

Auchenflower, 4066. Phone 74097.

PETER SHALLEY Electronics Pty. Ltd.

127 YORK STREET, SYDNEY

Phone 29-3767 — 29-7021



Walkie-Talkie Christmas Special

Limited Stocks only

- Pony CB 16 .1 watt
- All metal case
- Battery meter
- Miniature size 5¼ x 2½
- P.M.G. approved
- 10 transistors

\$69.95

100s OF OTHERS AVAILABLE NEW AND SECOND—HAND

pair plus 5c postage

R.C.S. SPECIALS



NEW IMPROVED 30 WATT
NOMINAL 54w MAX.

12v All Transistor P. A. AMPLIFIER

WIRED READY TO OPERATE

15 ohm output, No. 591D . . . \$62
125, 250, 500 ohm, 592D . . . \$62
Dimensions: 6½in. w. x 3½in. h x 8½in. d. For 240V, op. \$33 extra.

10 WATT P.A.

Inputs 5 MV and 100 MV 10w R.M.S. at 1%. Frequency 40cy.—30Kc. For use with 1 4 ohm, 2 8 ohm or 4 16 ohm speakers in parallel. Same cabinet and dimensions as 30w above, complete with 240v power supply.

Wired and tested, No. 485 . . . \$40
Freight extra in both cases.



R.C.S. COMPLETE DO-IT-YOURSELF KITS

Peak reception, low price. No expensive test equipment. Everything fits. 1964 RF Transports 7.

Complete kit — No. 640 . . . \$43.50
Portable car radio, identical to 640 above, plus extra switch and car coil, etc. No. 642 . . . \$46.90
(Write for booklet on 640 and 642.)
Postage \$1.

NEW TRANSISTOR PREAMP KIT

SIZE 3 x 2 x 1in. 2 req. for Stereo. LOW IMP. Input 2 trans. 672C \$6.50
Wired ready for use, 672D . . . \$8.00
HIGH IMP. 2 trans. 680C . . . \$6.50
Wired ready for use, 680D . . . \$8.00
HIGH IMP. silicon 3 trans. 682C \$8.00
Wired ready for use, 682D . . . \$9.50
Postage 10c each. Write for data.

HI-FI BROADCAST TUNER UNIT 4 TRANSISTORS — HI SENSITIVITY.



R.F. mixer, I.F., pwr. dectr. stages, adjustable aerial coupling. Complete as illust. wired and tested with 461 dial, knobs and switch pot No. 474D, \$31. Postage \$1.
SPECIALS: To your drawing — write for particulars and drafting aids.
WHISTLE FILTER for above set for 8Kc band width (can be altered to 9, 10 or 11Kc). No. 12B, \$4. Post 10c.

PRINTED CIRCUITS

For all R. and H., E.A., Mullard, Philips and other designs. Clearly coded, White letters and numbers, easy assembly and service, polished and resined for easy soldering. With blueprint parts list.

Number	Recent Designs
722 Mullard pre-amp.	\$3.00
725 Protected supply	\$2.50
734 EA 69 01 gold p. organ	\$5.00
709 Pre-amp. 67-P5	\$2.50
684 Pre-amp. 65-P10	\$2.50
737 AWA 10/25W amp	\$2.50
747 Music colour	\$3.00
69C10	\$3.00
741 Guitar amp 69 P5	\$3.00

Immediate dispatch. Postage 10c.



10W STEREO

MULLARD 10 x 10 watts R.M.S.

With output transistor PROTECTION. Frequency response 40cy. to 30Kc. Distortion 0.5%. Treble, bass, boost 20dB. Complete kit of parts No. 480C . . . \$74.00
Wired and tested No. 480D . . . \$79.00
With hi-fi tuner and whistle filter, \$35 extra. Freight extra. Write for brochure. For special Sat. demo. ring 59-6550.

MAGNETIC STEREO PRE-AMP

In 5Mv out 250Mv. Bass and treble 20dB. No. 724C \$29
Wired ready for use . . . \$31
For crystal ceramic No. 722D . . . \$27



TRANSFORMER

Tap 6v and 9v D.C. at 100 millamps.

Filter, condensers, rectifier, resistor, case, etc. \$6.50, Post 10c.

PERSONAL PORTABLES 2 TRANSISTORS

Range 30 miles. 200 with short aerial and earth. Earpiece only, no speaker. Do-it-yourself kit No. 666C . . . \$9.00
Postage 20c.



1 TRANSISTOR — 1 DIODE

593C Do-it-yourself kit, \$5. Post 10c.

DIAL KITS SCALE GOLD WITH WHITE LETTERS.

Size 6½ x 2½in.
● No. 459 to match 300 pf gang. Price . . . \$4.50
● No. 461 to match 200 pf gang. Price . . . \$4.50
Post 20c.

NEW AUDIO AMPLIFIER



4 transistors. 1/2 or 1 watt. Small size, cabinet 3in x 2in x 1in plastic. Suitable crystal P/up. Inter-com. microphone, radio, etc. (9 volt.)
DO-IT-YOURSELF KIT 665, \$10 (Post 10c). Wired ready for use 665D \$11.50.

COILS & IF's 455 Kc

Aer. R.F. OSC. and IF's . . . \$1.80 ea.
Ferrite Aer. \$2
No. 255 Universal tape OSC. Coil \$6
Postage 10c. Write for details and price.

R.C.S. RADIO PTY. LTD., 651 FOREST ROAD, BEXLEY, N.S.W., 587-3491, 587-5385

Order by Mail Order, Postal Note or Money Order (add post.), direct to —

medium-frequency AM broadcasting cannot do.

The Newlands Broadcasting Society is planning to become incorporated. A Steering Committee of five has been formed, headed by Ben Furby, with Peter Rennie another member. Another committee, to look after the technical details for the proposed station, appointed at a public meeting of residents, consists of Vic Staggpoole, ZL2ACF, Murray Willis, ZL2THW L. Steeneken, ZL2AZR, S. England, ZL2AVU and one non-amateur. Another amateur, T. R. Clarkson, ZL2AZ, has helped a lot with encouragement.

Other items of interest appearing in the September issue of "Break-In" include:

Slow-Scan TV News. Malcolm Pryor, ZL1DW, of Tokanui, Te Awamutu, tells of his activities with slow-scan television (SSTV). Malcolm has been an active amateur operator for over 20 years and in that time has experimented in many different spheres of amateur radio. He believes he is the first in New Zealand to have had two-way contact with the U.S.A., using SSTV.

Malcolm started transmitting SSTV on 20 metres to amateurs in the U.S.A. in May 1969. Despite QRM on the frequency used, pictures were received in the U.S.A. by Jim Bland, K4YXP, in Memphis, Tennessee, on May 24.

Other contacts have been made with over 20 stations in the U.S.A., two in Alaska (KL7), one in Sweden (SM) and one in Finland (OH).

In the near future, Malcolm hopes to have an article on SSTV for publication in "Break-In." At the present time he is working on a project for an adapter and mount to enable photographs to be taken of pictures received. A number of good recordings have been made of pictures received from the United States, recorded on an ordinary tape recorder at 3ips.

He is running a sked on 3760KHz SSB at 2000 hours N.Z. time on Monday and Thursdays. Anyone interested in SSTV would be most welcome to join in.

W.I.A. ACTIVITIES

Federal executive of the Wireless Institute of Australia has requested all divisional councils and members to give serious thought to matters that may be raised at the forthcoming International Telecommunication Union Conference, to be held in Geneva during June 1971.

As this conference will be dealing with space frequency allocations, it is most important that amateurs interested in VHF and UHF techniques give serious thought to the future requirements of the amateur service.

Such factors as satellite communication, lunar repeaters, the fact that the amateur service is only a secondary service on bands above 148MHz, are a few of the aspects to be considered. It has been suggested that amateurs who are technically informed on current and future trends that may be applicable to the amateur service, keep their divisional councils informed on such matters. It is most important that such reports be in written form so that adequate records may be compiled and an Institute policy determined.

NEW SOUTH WALES

As recorded elsewhere in these notes the New South Wales Division suffered a serious loss of equipment through theft from the division's transmitting station VK2WI, at Dural.

However, the service to members will be continued from the Wireless Institute Centre, Crow's Nest. Transmissions will be made on 7146KHz and VHF channels each Sunday at 11 a.m. and VHF channels only at 7.30 p.m.

Hunter Branch: On Sunday, October 12, at Marmong Point, on the shore of Lake Macquarie the Hunter Branch conducted a most successful Field Day. Over 120 persons were present.

THIEVES TAKE VK2WI EQUIPMENT

The transmitting station of the New South Wales Division of the Wireless Institute of Australia, VK2WI, at Quarry Road, Dural, was broken into and a substantial quantity of equipment stolen.

The theft took place between midday, Thursday October 23 and 10.30 a.m., Sunday, October 26. The matter is in the hands of the Parramatta Police and anyone seeing or hearing of any of the following equipment being used or offered for sale should notify the police immediately.

- 1 Pye 20 watt AM VHF transmitter Type F.T.C. 330N. Reference No. 28444G Serial No. 113. With type D crystal for 53.866MHz.
- 1 Pye AM VHF receiver Type F.T.C. 3002N Reference No. 28445I Serial No. 136. With type D crystal for 53.866MHz.
- 1 Kingsley Type AR7 Communication Receiver Serial No. 1177, Chassis No. 02022, with 7050KHz crystal locked coil box.
- 1 Kingsley Type AR7 Communication Receiver Serial No. 1738, Chassis No. 02625, with "D" band coil box and 144MHz converter.
- 1 Kingsley Type AR7 Communication Receiver Serial No. 245B/S1746, Chassis No. 01407 with "D" band coil box and 3.5 MHz converter.
- 5 Coil boxes for Kingsley Receivers.
- 3 Power supplies for Kingsley Receivers, 250V DC 12V AC.
- 1 829B Transmitting valve.
- 2 Quartz Crystals Type D, Frequencies 2247.916KHz; 11190.0KHz.
- 2 Quartz Crystals Type 5587 Holders, Frequency 3525KHz.
- 2 Quartz Crystals Type 5587 Holders, Frequency 3573KHz.
- 1 Bendix Frequency meter Type BC221.
- 1 S.W.R. meter, "2WI" stencilled on case.
- 1 Philips Cathode Ray Oscillograph, "2WI" stencilled on case.
- 1 AWA Portable Beat Frequency Oscillator, "2WI" stencilled on case.
- 1 Desk Microphone and Control Box with pilot light and push button.
- 1 Palec Valve Testing Set.
- 1 Multimeter.
- 2 Pair Headphones with plugs and cords.
- 5 Coaxial cable connectors type PL259.

An unsuccessful attempt was also made to break into the Wireless Institute Centre, Crow's Nest, on the night of Thursday, October 23.

On the night of November 12, another attempt was made to break into the Centre at Crow's Nest, this time successfully. The following items were stolen:

- 1 Halicrafters Communications Receiver Model SX111. Serial No. 1110109/23168.
 - 1 RCA Communications Receiver. Type AR88.
 - 1 Paros Transceiver.
 - 1 522 Transmitter mounted on 19in x 9in blue metal panel.
 - 1 522 Transmitter and Receiver in black case.
- Assorted transistors, resistors, coil formers, new text books, log books, call books, and PMG Regulations books. Cash and stamps to the value of approximately \$20.

On registration, each person was given a bag of components which contained two power diodes, transistors, resistors and capacitors, all of which had been made available by the many manufacturers who generously supported the field day.

Contests were conducted throughout the day. One of the best supported was a 146MHz event based on the exchange of portions of a complete message, giving details of the route to be followed. However, due to confused messages and QRM, many contestants became lost and none finished the course within the time limit. The contest did highlight the necessity for accuracy in passing messages and other normal operating techniques, and as such was an outstanding success.

During the lunch interval while all were partaking of the hot meal provided, films were screened of mining development in north-western Australia. There was also a display of photographs of the various units that make up the Australis Oscar satellite.

Hunter Branch meetings are held on the first Friday of each month at the Newcastle Technical College, Tighes Hill. Visitors are always welcome. Latest news from the Hunter Branch can be heard on the news broadcast from VK2AWX each Monday night at 7.30 p.m.

South West Zone Convention: Another very successful South Western Zone Convention was held at Albury over the weekend October 4 and 5. Members of the Victorian Division North East Zone attended.

The official Convention Dinner was held on Saturday evening, with 102 members, their families and visitors present. Among those present were the Mayor of Albury, Alderman Clevedon Bunton; Federal President W.I.A., Michael Owen VK3KI; Federal Secretary W.I.A., Peter Williams, VK3IZ.

The Convention was officially opened by the Federal President. Other speakers were the Mayor of Albury who welcomed the visitors to the city of Albury; Federal Councillor N.S.W. Division, Pierce Healy, VK2APQ, representing the Divisional President and Council; and Jim Meyland, VK3AJM, representing the Victorian Division President and North Eastern Zone members.

On the Sunday, there was a full program of hidden transmitter hunts, VHF and HF scrambles, quiz competitions and

CALLING ALL PROSPECTIVE AMATEURS

The N.S.W. Division of the Wireless Institute of Australia announces that the 1970 personal classes will commence on February 12. Applications will be accepted in their order of receipt.

CORRESPONDENCE COURSES ARE AVAILABLE THROUGHOUT THE YEAR.

For further information write to:
THE COURSE SUPERVISOR, W.I.A.
14 ATCHISON STREET,
CROW'S NEST, N.S.W. 2065

LAFAYETTE High Quality Multitesters



99-5065 \$53.95

100,000 OHMS PER VOLT "LAB-TESTER"

- Giant Easy-To-Read 6½" Scale.
- 2 p.c. Accuracy on DC; 3 p.c. on AC.
- ½ p.c. Multiplier Resistors.
- Built-in Meter Protection All Ranges.

SPECIFICATIONS
 SENSITIVITY: 100K ohms/volt DC, 5K AC. RANGES: DC 0-5-25-10-50-250-1000V. AC 0-3-10-50-250-500-1000V. DB: minus 10 to plus 49.4 in 4 ranges. DC CURRENT: 0-10-100 uA, 0-10-100 500 mA, 0-2.5-10 amps. RESISTANCE: 0-1K-10K-100K-10M-100M. METER MOVEMENT: 9 uA full scale deflection. OUTPUT: to 250 V with built-in series capacitor.



99-5076 \$42.50

50,000 OHMS PER VOLT MULTITESTER

- Large 5½" Meter.
- 50K ohms Per Volt DC; 5K on AC.
- Low Voltage Ranges for Transistor Circuitry.
- Built-in Overload Protection.

SPECIFICATIONS
 RANGES: DC VOLTS 50K ohm/V 0-125-1.25-5-25-500. 25K ohm/V 0-.25-2.5-10-50-500-1000. AC VOLTS 5K ohm/V 0-1.5-5-25-125-500. 2.5K ohm/V 0-3-10-50-250-1000. DC mA 0-2.5-25-250. 0-5-50-500. DC AMPS 0-5. 0-10. RESISTANCE: 0-2K-10K-100K-1M-10M. DB minus 20 to plus 85 in 10 AC volt ranges.



99-5071 \$29.50

30,000 OHMS PER VOLT MULTITESTER

- 30K ohms Per Volt DC; 15K on AC.
- 4" Meter, 2 Colour Scale.
- 1 p.c. Precision Resistors.
- Built-in Overload Protection.

SPECIFICATIONS
 RANGES: DC VOLTS 0-.25-1-2.5-10-25-100-250-1000. AC VOLTS 0-2.5-10-25-100-250-500-1000. DC CURRENT 0-.05-5-50-500 mA. 0-12 amps. RESISTANCE: 0-60K-6M-60M. DB minus 20 to plus 56 db. SHORTS TEST Internal Buzzer. Audio Output Jack.



99-5073 \$19.50

20,000 OHMS PER VOLT MULTITESTER

- 20K ohms Per Volt DC; 10K on AC.
- 3½" Meter, 40 Microamp Movement.
- 1 p.c. Precision Resistors.
- Built-in Overload Protection.

SPECIFICATIONS
 RANGES: DC VOLTS 0-.6-6-30-120-600-1200. AC VOLTS 0-6-30-120-600-1200. RESISTANCE 0-10K-100K-1M-10M. DC CURRENT 0-60uA, 0-6-60-600 mA. DB minus 20 to plus 63 db. CAPACITY: 200 mmf to .2 mfd.

novelty events. An excellent barbecue lunch, prepared by the wives of the local amateurs, proved to be the most popular event.

The presentation of prizes brought to a close a very successful and pleasant get-together. All present extended their thanks and congratulations to the organisers.

The 1970 South Western Zone Convention will be held at Wagga.

QUEENSLAND

The committee formed to investigate the feasibility, and technical requirements, also likely service areas, for the installation of VHF repeater installations has been investigating various aspects as applied to the amateur service. Tests have been carried out at four sites, Tamborine Mountain, Dayboro Mountain, Denmark Mountain and Mount Cootha, for mobile coverage and an actual repeater station was set up at Tamborine Mountain.

It is hoped that three licences will eventually be granted for South East Queensland — one on a site at Mount Cootha to serve the Brisbane area; the second on Tamborine Mountain for areas around the Gold Coast; and, when the demand warrants, a third to service the Ipswich and Toowoomba area.

The Brisbane and Gold Coast groups are at the stage when construction and testing could commence.

Any Queensland amateur radio operator who has any ideas or suggestions to make on the subject should contact the committee by writing to: Secretary, VK4 Repeater Committee, Box 638, G.P.O., Brisbane, 4001.

Members of the committee are:—

Malcolm Aldred	VY4ZEL
Allan Watts	VK4ZAW
Mike Adams	VK4ZDA
Roy O'Malley	VK4ZRM
John Edwards	VK4IE

Cairns Amateur Radio Club. At the Annual General Meeting of the Cairns Amateur Radio Club, the following officers were elected for the ensuing year.

President: Ian Brown, VK4DB; Vice-presidents: Harry Kinzbrunner, VK4HK; Paul Kochan —: Secretary-Treasurer; Eric Wise —.

Although the club is small, with 11 financial members, social evenings are being organised to build up the financial position so that an SSB transceiver may be purchased.

Four members, including a lad of 14 years, recently sat for the A.O.L.C.P. All were students at the weekly classes conducted by Ian Brown, VK4DB.

Townsville Amateur Radio Club. Two members of the Townsville Amateur Radio Club, Ross Ramm, VK4RO and Peter Lindsay, VK4ZPL have been successful in again making 52MHz contacts with stations in Japan. Ross has been mentioned, with his photograph in the J.A.R.L. magazine "CQ."

Visitors to Townsville are invited to attend the Club meeting held on the first Thursday of each month. The venue for the meeting is the Broadcast Station 4TO Auditorium.

WESTERN AUSTRALIA

The October Bulletin of the Western Australian Division has news of the first 160-metre contact with the United States. Cliff Waterman, VK6NK, worked W9BKA/8 on September 30. The two-way contact was on CW, and the reports exchanged were R4-S4-T9 both ways.

WICEN: Aub Keightley, VK6XY has been appointed Net Controller for the Albany area, with Tom Reed, VK6TR, as Deputy Net Controller. These were two appointments recently announced by Ted Gabriel VK6TG, the Division's WICEN Co-ordinator.

LAFAYETTE ELECTRONICS

Division of Electron Tube Distributors Pty. Ltd.

All Mail Enquiries and Orders to:—

VICTORIAN SALES CENTRE & HEAD OFFICE
 94 HIGH ST., ST. KILDA, VIC., 3182. PH: 94-6036

W.A. Representative: Athol M. Hill Pty. Ltd., 613-615 Wellington St., Perth.

S.A. Representative: Tyquin Distributors Pty. Ltd., 13 Deacon Ave., Richmond.

1970 A.R.R.L. INTERNATIONAL DX COMPETITION

Amateurs throughout the world are invited to participate in the 36th A.R.R.L. International DX Competition. Special certificates of performance will be issued to the top phone and top CW scorer in each country. In addition, a handsome plaque will be awarded to the continental high-scorers (non-W/VE), single operator, phone and CW. If three or more multi-operator stations submit logs, the top scoring multi-operator entry will receive a certificate award.

Dates. Phone: February 7-8, March 7-8, 1970. CW: February 21-22, March 21-22, 1970.
Times. Starts at 0001GMT Saturday, ends at 2400GMT Sunday.

Object. DX stations QSO as many of the 48 contiguous United States and Canadian call areas as possible. (See check list.) Repeat contacts on additional bands are permitted.

Points. Each complete contact counts 3 points. Incomplete contacts count 2 points.

Exchange. Send RS(T) and DC input power. The W/VE will transmit RS(T) and his state or province.

Multipliers. On each band, your multipliers are the 48 contiguous United States, plus VO and VE1 to VE8; a total of 57. Use the check list. Your final multiplier is the sum of multipliers worked on each band. QSO points times the final multiplier equals the claimed score.

Logs. Logs must contain dates, times in

Call..... Country..... PHONE

Check one: Single Operator Multioperator C. W.

If multioperator, show calls of all operators and loggers.....

Name.....

Number and Street.....

City and Country.....

Transmitter..... D.C. input power.....watts

Receiver..... Antenna..... Hours of operation.....

	1.8 MHz.	3.5 MHz.	7 MHz.	14 MHz.	21 MHz.	28 MHz.	TOTALS
Multiplier							*
Contacts							

Contacts X 3 =points Xmultiplier* =claimed score

I certify, on my honor, that I have observed all competition rules as well as all regulations for amateur radio in my country, and that my report is correct and true to the best of my belief. I agree to be bound by the decisions of the ARRL Awards Committee.

Date..... Signature..... Call.....

Sheet	of	Call	EXCHANGE		Country					PTS	
			SENT	RCVD	1.8	3.5	7	14	21		28
FRBQ.		DATE/TIME GMT									
		STATION									

A summary sheet, similar to the one above, must be enclosed with all entries. At left is a sample log sheet with a check list of the U.S. and Canadian call areas.

1	Connecticut	CONN								
	Maine	ME								
	Massachusetts	MASS								
	New Hampshire	NH								
	Rhode Island	RI								
	Vermont	VT								
2	New Jersey	NJ								
	New York	NY								
3	Delaware	DEL								
	Maryland-D.C.	MD								
	Pennsylvania	PA								
4	Alabama	ALA								
	Florida	FLA								
	Georgia	GA								
	Kentucky	KY								
	No. Carolina	NC								
	So. Carolina	SC								
	Tennessee	TENN								
	Virginia	VA								
5	Arkansas	ARK								
	Louisiana	LA								
	Mississippi	MISS								
	New Mexico	NMEX								
	Oklahoma	OKLA								
	Texas	TEX								
6	California	CAL								
7	Arizona	ARIZ								
	Idaho	IDA								
	Montana	MONT								
	Nevada	NEV								
	Oregon	ORE								
	Utah	UTAH								
	Washington	WASH								
	Wyoming	WYO								

8	Michigan	MICH								
	Ohio	OHIO								
	W. Virginia	WVA								
9	Illinois	ILL								
	Indiana	IND								
	Wisconsin	WIS								
10	Colorado	COLO								
	Iowa	IOWA								
	Kansas	KANS								
	Minnesota	MINN								
	Missouri	MO								
	Nebraska	NEBR								
	N. Dakota	NDAK								
	S. Dakota	SDAK								
VO	Newfoundland-Labrador	NFLD-LAB								
VE1	New Brunswick	NB								
	Nova Scotia	NS								
	Pr. Ed. Is.	PEI								
VE2	Quebec	QUE								
VE3	Ontario	ONT								
VE4	Manitoba	MAN								
VE5	Saskatchewan	SASK								
VE6	Alberta	ALTA								
VE7	Br. Columbia	BC								
VE8	Yukon-N.W.T.	YUK-NWT								

GMT, bands, exchanges, and points. Please use the log form style shown. (Signed legible copies of your log are acceptable.)

Entrants are requested to enclose operating and antenna photos with their entries, plus any comments or suggestions, etc.

Logs, with a summary sheet and a multiplier check list, must be sent to A.R.R.L. International DX Competition, 225 Main Street, Newington, Connecticut 06111, U.S.A., to arrive no later than April 27, 1970.



**PRINTED CIRCUITS
DESIGN &
PRODUCTION**

WE MANUFACTURE P.C. TO MEET THE HIGHEST STANDARDS OF QUALITY. SPECIALIZE IN LAYOUT, ASSEMBLY, ALL TYPES OF PRINTED CIRCUITS, COPING AND SPECIAL FINISHES.

PHOTRONIC Tel. 937864

515 PITTSWATER ROAD, P.O. BOX 195, BROOKVALE, N.S.W. 2100

The World's Most Versatile Circuit Building System!



SIZES: 1/8" and 1/16" WIDTHS
LENGTH: 100ft. roll, 5ft. CARD

IDEAL FOR PROTOTYPE AND
PRODUCTION CONSTRUCTION

USEFUL FOR WIRING REPAIRS

☆ **NO DRILLING** ☆ **FAST** ☆ **NO MESS**

Available from all Leading Radio
Houses

Marketed by—

ZEPHYR PRODUCTS PTY. LTD.

70 BATESFORD RD., CHADSTONE, VIC., 3148
Telephone 56-7231



MANUFACTURERS OF RADIO
AND ELECTRICAL EQUIPMENT
AND COMPONENTS

BUY RIGHT... FROM ENCEL

NEW HIGH PRECISION TONE ARM THE GRACE G545



PRICE (including sales tax)
\$38.50

Although they have been available only a few months, Grace tone arms are already prized by the audio enthusiast. This new model, the G545, is a winner . . . it will track down to 1/4 gram with suitable cartridges and features a gimbal type gyroscopic bearing system. An ultra light weight head shell is supplied . . . and the new arm shape reduces tracking error to the point where this factor may be disregarded.

The main counter balance weight is divided into two for easier, more precise balancing. Sub-weight adjustment sets stylus pressures from 9 to 3 grams. The arm accepts all Ortofon/SME type headshells without modification and all "New Generation" cartridges. Tracking ability of this fine tone arm is best demonstrated with stylus pressures below one gram. Ask for an EMQ or call at Encel Stereo Centres in Melbourne or Sydney for a demonstration.

THE GRACE F-8M STEREO CARTRIDGE



PRICE (including Sales Tax)
\$39.50

With an output of 7mV. and a frequency response of 5,35,000 Hz., the Grace F-8M stereo cartridge tracks down to 1/2 grams. An elliptical diamond stylus 0.2 x 0.8 mil. is standard equipment. tip mass is 0.75 m/grams. and total cartridge weight is only 6 1/2 grams. Cross talk is less than -30 dB. at 1 kHz. Musical performance rivals many stereo cartridges selling at twice the Encel price. Write for complete specifications and for prices better still, call and compare when you listen to several top quality cartridges.

Ask about these too: The F-8L (5mV.), \$39.50 (including tax), and the latest addition to the Grace range, the F-8C, \$49.50 (including tax).

ENCCEL

ELECTRONICS (STEREO) PTY. LTD.

Head Office: 431 Bridge Rd., Richmond, Victoria. 3121. Tel. 42 3762.

Sydney Store: Ground Floor, 2SM Building, 257 Clarence Street, Sydney, N.S.W. 2000. Tel. 29 4563, 29 4564.

Australia's Greatest Hi-Fi Centre ■ Wholesalers ■ Trade-ins accepted ■ Terms

W.I.A. YOUTH RADIO SCHEME

NEW SOUTH WALES

Westlakes Radio Club. Eight members of the Westlakes Radio Club were successful in examinations held in September. The most outstanding success was that of Robert Day, a fourth form student at the Booragul High School. Robert passed the Theory and Regulations sections of the A.O.L.C.P. examination and also qualified for the Broadcast Ten certificate for proficiency in broadcasting listening. It is understood that he will not be applying for the Limited Licence but will be attempting the Morse code examination at an early date so that he may experiment on the 160 metre band.

The other successful members were: Paul McCosker — Radio Telephony Operator's Certificate Grade 3. Stephen Wiche — Elementary Certificate, Honours with special mention. Jeffery Smith — Elementary Certificate, Honours pass. Anthony De Lyal — Elementary Certificate, Credit pass. Peter Shylan — Elementary Certificate, Credit pass. Geoffrey Ainsworth — Elementary Certificate, Credit pass. Henry Myles — Elementary Certificate Pass grade.

Work is progressing with the outfitting of the new club rooms at Anzac Parade, Teralba, and it is anticipated that all the club's activities will be resumed early in the New Year.

For details of the club contact the Secretary, Bruce Morley, VK2ZNB, P.O. Box 1, Teralba.

Maitland Radio Club. During the 12th annual Scout Jamboree on the Air in October, the Maitland Radio Club was host to a number of local scouts, girl guides, sea rangers, cubs and brownies. Equipment used during the weekend included mobile FM units, SSB transceiver on HF and AM equipment on both VHF and HF.

Over 100 people attended the club during that weekend, making it one of the most successful Jamborees held in the Maitland district. Contacts were made with many local and overseas stations, including some in New Zealand, Papua, Philippines, Hawaiian Islands, Peru, Bolivia, Japan and Macao.

District Commissioner Mr. F. Gerard and Assistant Area Commissioner for Boy Scouts Mr. R. Miller were visitors to the club. The Assistant Area Commissioner for Rover Scouts, on behalf of the Boy Scouts Association, presented to the club a certificate of appreciation for the part it played in arranging participation in the event for the scouts in the district.

At the September meeting of the club, Mr. C. H. J. Hargreaves, Inspector of Schools, Maitland, presented Elementary Certificates to five successful candidates at a recent examination.

They were:— Mrs. E. Berman Honours
K. Murray Honours
John Murray Honours
R. Phee Credit
Laurie McTackett Credit
John Murray, 9 years old, who attends the Tenambit Primary School, is the youngest member to have gained the Elementary Certificate.

From late November to early January the Maitland Radio Club will be in recess. However, information about the club's activities can be obtained by writing to the Secretary, Box 54, P.O. East Maitland, N.S.W. 2323; or telephone Maitland 33-7286 (STD area code 049).

St. Ives High School. A Youth Radio Club has been formed at the St. Ives High School, and is known as the St. Ives Radio and Electronics Club. At present there are 12 members. The club leader is Craig McGregor, who will be attempting the A.O.C.P. examination during 1970.

The publicity officer is Robert

Davis, who advises that club meetings are held during lunchtime on Mondays, and that all members will be attempting the Y.R.S. Elementary Certificate examination at the end of the school term.

Details and further information on the club's activities may be obtained from: Robert Davis, 5 Catherine Street, St. Ives, N.S.W. 2075.

VICTORIA

Camberwell Grammar School. This year has been a most successful one for the Camberwell Grammar School Club. The membership increased to 30, double the number of the previous year.

The establishment of the Club Station VK3BCG, has been responsible for an increased interest within the school. A total of 14 Y.R.S. certificates in various grades were won by members. This is said to be a record for a club in Victoria.

Timothy Robertson, the Publicity Officer, who supplies the news for these notes, says that the success during the year has been due to the work of Mr. J. Trean who has instructed members sitting for the various grades and who has developed a system of tests that make the students "find" the information required. This system has been responsible for the high standard of passes gained.

Credit is also due to David Buchanen for the assistance he has given to younger members; to Chris Holliday, VK3JU, for his instruction on operating techniques; and to Tim Robertson, who has kept many members busy developing sound effects and commentaries for the school film productions.

SOUTH AUSTRALIA

From Allen Dunn comes a round-up of Y.R.S. activities in South Australia.

On a holiday weekend in October, Steve Johnston, VK5ZNJ, Youth Radio Officer of the Elizabeth Amateur Radio Club, made a visit to the Port Augusta Youth Radio Club. The aim of the visit was to familiarise Port Augusta members with amateur radio operating procedures.

The main activities included a lecture and practical demonstration on transmitters, followed by the erection of an antenna and the reading of the field strength around the antenna.

Two club stations operated on a recent VHF Field Day Contest. The Port Pirie Amateur Radio Club station VK5PP, was portable at Laura and worked many stations in the Adelaide area. Grant, VK5ZGI, was active from near Seppeltsfield with plenty of assistance from members of the Barossa Valley Youth Radio Club.

The Prince Alfred College Radio Club continues to progress with both elementary and junior courses doing studies. It is expected that four candidates will sit for the elementary and at least six for the junior examinations to be held before the end of the year.

A Youth Radio Club will be commencing in Adelaide in February, 1970, and a deal of preparatory work has already been carried out. Mr. Geoff Renner of the Y.M.C.A. is organising the club, with the Wireless Institute providing the instructors to run the classes. Full details will be given later.

TASMANIA

The Friends School Youth Radio Club. A Y.R.S. Club was started at the Friends School, North Hobart, early in the year. The club meets during lunchtime each Wednesday. Already three of the members have gained their Y.R.S. Elementary Certificates.

They are: Rodney McGee, Honours; Barrie Hosking, Credit; Neil Wellington Pass.

BRIGHT STAR CRYSTALS

PREFERRED BY LEADING MANUFACTURERS
THROUGHOUT THE COUNTRY FOR —

ACCURACY - STABILITY - ACTIVITY - OUTPUT



All types of Crystals Available
Such as DC11, FT 243 HC6U CRA
B7G, HC18U, ETC.
TOLERANCES: .0015%, .002%,
.003%, .005% ETC.



Consult us for Crystals for any Mobile Radio.
Prices depend on tolerance and frequency
required.

DISCOUNT FOR QUANTITY ORDERS

Established 36 Years

AMATEUR AIRCRAFT and ULTRASONIC CRYSTALS also AVAILABLE

*Our new Factory employing the most modern equipment
allows us to offer you PROMPT DELIVERY for all your
CRYSTAL requirements.*

DEVOTED EXCLUSIVELY TO THE MANUFACTURE OF

PIEZO ELECTRIC CRYSTALS

Contractors to Federal and State Government Departments

REPRESENTATIVES AUSTRALIA AND NEW ZEALAND: Messrs. CARREL & CARREL
BOX 2102, AUCKLAND.

MESSRS ATKINS (W.A.) LTD., 894 Hay Street, PERTH.
MESSRS. A. E. HAROLD PTY. LTD., 123-125 Charlotte Street, BRISBANE.
MESSRS LAWRENCE & HANSEN ELECTRICAL (VIC.) PTY. LTD., 34 Brisbane Street, HOBART, and 29 St. John Street, LAUNCESTON, TASMANIA.

BRIGHT STAR RADIO

546-5076

LOT 6 EILEEN ROAD, CLAYTON, VICTORIA

546-5076

A. AMPLIFICATION

C. COMMUNICATION



E. ELECTRONICS

RADIO

PHONE 51-3845
51-7008

WEEKENDS & AFTER HOURS 98-5956.

136 VICTORIA ROAD MARRICKVILLE — 51-3845

VOLT-OHM-MILLIAMMETER

MODEL SK-100



HIGH SENSITIVITY
100,000 Ohms per Volt DC
10,000 Ohms per Volt AC

SPECIFICATIONS

- DC Volts: 0.6 3, 12, 60, 300, 600, 1200V.
- AC Volts: 6, 30, 120, 300, 1200V.
- DC Current: 12uA, 300uA, 6mA, 60mA, 600mA, 12A.
- AC Current: 12A.
- Resistance: 20K ohms, 200K ohms, 2M ohms, 20M ohms.
- Decibels: Minus 20 to plus 17, 31, 43, 51, 63.
- Accuracy: DC plus minus 3%, AC plus minus 4% (of full scale).

- Overload Protected by Dual Silicon diodes
- Double-jewelled plus minus 2% Meter
- Plus minus 1% Temperature-stabilised Film Resistors.
- Polarity Changeover Switch
- Scale with Mirror

Price \$34.75. Post 75c. Interstate \$1.00.

Refer our advt. Nov. '69 issue for particulars full range
Kaise or write.

50 WATT SOLID STATE GUITAR AMPLIFIER

E.A. July & August Issue.
Kitset, Including Cabinet.
\$98.00

Wired and Tested,
\$114.00
Speaker Enclosures to suit
4 M.S.P. Speakers,
\$104.00
2 Pioneer 15in Speakers,
\$94.00

TAPE CASSETTES TENSILISED MYLAR

C 60	...	\$1.65
C 90	...	\$2.45
C120	...	\$3.25
Head Cleaners	...	\$1.75
Post. 10c per unit.		

6" & 8" METAL SPEAKER BOXES

Suit wall or desk.
\$4.00. Post 50c.

V.T.V.M. MODEL TE-40 MILLIVOLTER

Spec. A.C.V. Inv.—300 Vrms, 10 ranges. Accuracy 5 cps-1 2 mc, plus-minus 2db, 10 cps-1 mc, plus-minus 1db, 20 cps-250 KC, plus-minus 0.2db.
dB. Scale: 40-30-20-10-0, 10,20, 30-40, 50 dBm, 240 V.A.C.

\$48.75

MODEL TE-65 V.T.V.M.

DC, V. 0-1, 5-5.15-50-150-500-1,500 V. Rms. A.C.V. 0-1.5 5.5-15-50-150-500-1,500 V. Rms. 0-1.4-4-14-40-140-400-1,400-4,000 V. P.P. Resistance: RX10 100 1K .10K, .100K, 1M, 10M, Decibel—100db, minus-plus 65dB.

240 V.A.C.
\$43.75

TECH. P.V. 58, \$40.50.

ORGAN KEYBOARDS

49-Note. Complete with Switching System.

\$72.00

13-Note. Pedal Claviers. Complete with Switches.

\$39.95

SPECIAL: Semi-finished Stromberg Organ Cabinets to suit above.

\$19.50

Organ Stools ... \$14.50

HI-FIDELITY TWIN CONE SPEAKERS

Aust. made, 8	to 16 ohms.	
6in	.. \$9.00	12in .. \$11.75
8in	.. \$7.50	Postage: ..
8in	.. \$9.00	N.S.W., 50c.
10in	.. \$10.75	Interstate 80c.

NEW SPEAKER SPECIALS

2in	.. \$2.75	8 to 15 ohms.
2 1/2in	.. \$2.75	4 x 2in \$3.30
2 3/4in	.. \$2.85	5in x 3in \$3.30
80mm	.. \$2.85	6in x 4in \$3.50
3 3/4in	.. \$2.95	7in x 4in \$4.25
3 3/4in	.. \$3.20	9in x 6in \$5.95
6in	.. \$4.00	N.S.W. 25c.
		Interstate 40c.

NEW RECORDING TAPE

3in	Most Popular Brand	
3in	Correspondence	50c
3in	Mylar L.P. 300ft	\$1.05
3 1/4in	Mylar D.P. 600ft	\$1.25
5in	Mylar L.P. 900ft	\$2.50
5in	Mylar D.P. 1200ft	\$3.15
5 3/4in	Mylar L.P. 1200ft	\$3.15
5 3/4in	Mylar D.P. 1800ft	\$4.70
7in	Mylar D.P. 1800ft	\$4.70
7in	Mylar D.P. 2400ft	6.25
7in	Mylar T.P. 3600ft	\$7.00
7in	P.V.C. 1200ft	\$2.50
Postage: N.S.W. 15c.		
Interstate 25c.		

AMPLIFIERS Public Address Range 240V-AC



MINIATURE P.A. AMPLIFIER 15 WATTS OUTPUT

Multi Match Ferguson O.P. transformer input for crystal mike and pick-up with electronic mixing
P.P. EL-84 output ... \$42.50
30 Watt. As above, EL-34 P.P. ... \$57.50
40 Watt. As above, EL-34 P.P. ... \$85.50
60 Watt. As above, 6D06 P.P. ... \$105.50

LINE OR VOICE COIL. SOLID STATE 240V A.C.

20 Watt ... \$49.50
50 Watt ... \$69.50
50 Watt 240 A.C. plus 12V. D.C. Plus Self Battery Charging, \$95.00.

All have inputs for 2 microphones or 2 Magnetic or Crystal P.U. With Mixing.



P.A. SPEAKERS 8 WATT.

8in Units in Waterproof Projection Horns.
15 Ohm Voice Coils.

\$15.25

Line Output Transformers to suit. \$1.75 extra.

MICROPHONE GOOSE NECKS. SATIN

9in	.. \$2.75	MIC. STAND.
12in	.. \$3.50	Floor Model.
18in	.. \$4.35	\$11.75.
24in	.. \$5.00	Table model. \$3.65

LOW LOSS MIC. CABLE

15c per yard or \$10 per 100yds.

K 20 CT330



K 20 CT500

C.T.330 20K. OPV

D.C. Volts 6, 6, 30, 120, 600, 1,200, 3,000, 6,000 A.C. Volts 6, 30, 120, 600, 1,200 D.C. Current .06-6, 60, 600mA. Resistance, 6K, 600K, 6meg, 60meg. D.B. minus 20 to plus 62, 5 Ranges. Specially suitable for transistor use.

\$16.45

C.T.500 20K. OPV

D.C. Volts, 2.5, 10, 50, 250, 500, 1,000 A.C. Volts, 10, 50, 250, 500, 1,000. D.C. Current, .05, 5.50, 500mA. Resistance, 12K, 120K, 1.2meg., 12meg. D.B. minus 20 to plus 62.

\$13.25

KAMODEN—100B

100,000 O.P.V.
D.C. Volts, .5, 2.5, 10.50, 250, 500, 1,000.
A.C. Volts, .25, 10.50, 250, 500, 1,000.

Mils., 0.1, .25, 2.5, 25, 250, ID.A Res., 20K, 200K, 2M, 20M-OHM. DB minus 20 to plus 62, 5 Ranges

\$29.75 POST \$1.00

200H 20K. OPV

D.C. Volts, 5, 25, 50, 250, 500, 2,500 A.C. Volts, 10, 50, 100, 500, 1,000. D.C. Current, 50uA, 2.5, 250mA. Resistance, 6K, 600K, Capitanee, 2 D.B. Ranges.

\$10.95 Post 50c

PANEL METERS

EDGE METERS. 1mA.
Scaled V. U.S.
Tuning Stereo. Bal. \$2.50.
A FULL RANGE OF UNITS.
85 Types. 1 1/4in to 3 1/2in.
FROM \$3.25.
Send for full list.



GUITAR AMPLIFIERS

10-Watt, Two-Channel, with Twin Cone Speaker . . . \$53.53
14-Watt, 4 Inputs, Bass and Treble Boost, 2 Twin-cone Speakers, \$63
17-Watt, 4-Channel, Bass and Treble Boost, Two Twin-cone Speakers . . . \$76.25

35 WATT

4-Channel, Bass and Treble Boost, 4 Twin-cone Speakers . \$109.05
Vibrato with foot control and 2 preset controls for frequency and intensity. \$10.50 extra on above models.

ELECTRIC GUITAR

Pickup Units . . . \$8.75
Accordion Pickup Units . . . \$8.75
Harmonica Pickup Units . . . \$1.95
Post: N.S.W. 40c, Interstate 75c.

FUZZ BOX

FUZZ BOX, E. AND A. AUG.
WIRED AND TESTED.
\$15.
Post 75c.

REVERB UNIT

COMPLETE WITH AMPLIFIER.
E.A. October issue. Kitset \$39.95.
Wired and tested, \$41.95.



MULLARD MAGNAVOX

BOOKSHELF ENCLOSURE

Maple, Teak or Walnut
Complete \$24.75
SUPER BOOKSHELF
\$36.75.

Post: N.S.W. 50c, Interstate \$1.00.
CABINETS ONLY.
R.H. BOOKSHELVES, \$11.50.
MULLARD, \$10.95.

BOOKSHELF UNITS

6in 8in 10in 12in
\$27.75 \$33.50 \$35.50 \$36.50

PLAYMASTER 106 AND 107



Feb. and March Elect Aust.
106

WIRED AND TESTED \$94.75

107

WIRED AND TESTED \$83.75

P.V.C. TWIN FLEX

7/010 . . . \$4.95
Per 100 Yards.
300 Ohm TV Ribbon, per yd 10c

PIGGY BACK GUITAR AMPLIFIER

Excluding Speakers
30 Watt . . . \$79.75
45 Watt . . . \$99.75
60 Watt . . . \$119.75
4 Inputs, Bass and Treble Boost
Vibrato if required, \$10.50 extra.

PIGGY BACK GUITAR AMPLIFIER

Complete with Speakers & Cabinet
30 Watt Lead . . . \$138.75
30 Watt Bass . . . \$146.75
45 Watt Lead . . . \$158.75
45 Watt Bass . . . \$166.75
50 Watt Lead . . . \$218.00
60 Watt Bass . . . \$234.00
Vibrato if required extra \$10.50

119 STEREO TAPE ADAPTER

Suits all Playmaster Stereo amplifiers and others that accept crystal P.U.

Kitset . . . \$79.00
Wired and tested . . . \$96.00

10 PLUS 10 STEREO AMPLIFIER

E.A. November.
Kit Set . . . \$59.75
Wired and tested . . . \$69.75



LOW FREQUENCY HI POWER SPEAKERS

Especially designed for electronic organ and guitar use.
Imported 15in . . . \$30.00
Aust. made 15in . . . \$60.00
Aust. made 12in . . . \$37.50

PAROS-310 STEREO TAPE RECORDER

SPECIFICATIONS
RECORDING SYSTEM: In line 4-track stereo and monaural recording by A.C. bias system.
TRANSISTORS: 14 transistors.
POWER SOURCE: 240V 50cps.
REEL SIZE: Up to 7in.
HEADS: 1/4 track lamination type stereo record/play head, double gapped high efficiency erase head.
BIAS FREQUENCY: 90 kc.
FREQUENCY RESPONSE: 60cps-12,000cps at 7 1/2ips.
SIGNAL TO NOISE RATIO: Better than 40 db.
CROSS TALK: Better than 38 db.
OUTPUT POWER: 6 watts (3W x 2)
INPUTS: Mic., Input level -60 db, impedance 50k ohm.
Aux., Input level -10 db, impedance 150k ohm.
TAPE SPEED: 7 1/2ips and 3 3/4ips.
REWIND AND FAST FORWARD SPEED: Within 180 sec.
WOW AND FLUTTER: Less than 0.2% at 7 1/2ips WRMS.
STANDARD ACCESSORIES: 7in empty reel x 1, Dynamic microphone x 2.
\$157.50



240v A.C. POWERED SOLID STATE STEREO T.S.133

18 Transistor, 15-watt per channel.
Inputs for Tape, Mas. P.U.
Ger. P.U., Radio Aux.
Freq. Range 30c to 20KC.
Max. Sensitivity 3 MV.
Speaker matching 4 to 15 ohms.
\$78.00

11 1/2" FULLY BALANCED PICK-UP ARM

COMPLETE WITH MAGNETIC Stereo Cartridge . . . \$19.50
Arm less Cartridge . . . \$11.50
Mag. Cartridge only . . . \$9.50

WIDE BAND OSCILLOSCOPES

SPECIFICATIONS

VERTICAL AXIS

Deflection Sensitivity (at 1 kc) 0.1 V p-p/cm.
Frequency Characteristics, 1.5 cps-1.5 MC.
Input Impedance, 2 M ohms 25pF.
Calibration Voltage IV p-p/cm.

HORIZONTAL AXIS

Deflection Sensitivity 0.9V p-p/cm.
Frequency Characteristics 1.5 cps-800 KC.
Input Impedance 2 M ohms 20 pF.
Sweet Oscillator (5 Range) 10 cps-300 KC.
Synchronisation Devices Internal (Positive and Negative, External).
Power 240v AC 50/60 cps.
Cathode Ray Tube 3KF1F.

3-inch \$102.75; 5-inch \$118.75



5 Meg Bandwidth Push-Pull vertical and Horizontal Amplifiers, 8 positions, high sensitivity, vertical Amplifier Frequency Compensated on all positions. Calibrated .02 to 600 volts. Hard time base, 20 cycles to 75K. Latest American R.C.A. circuitry. Complete with probe.

PLAYMASTER 115

The new Solid State Stereo-Amplifier. April issue.
Wired and tested . . . \$104.00
Kit Set . . . \$90.00
Pre-amp to suit magnetic Cartridge . . . \$12.00



AUTOMATIC RHYTHM BOX

12 RHYTHMS.
9 PERCUSSIVE INSTRUMENTS.
240v A.C. OPERATION.
\$145.00



MUSICOLOUR

Sound control of coloured lights. As described E.A. Oct., 69.
Kit set . . . \$90.00
Wired and Tested, \$54.00.

3" VERNIER DIAL

8:1 Ratio
\$2.95, Post 25c.



AUDIO GENERATOR

De Luxe Model TE-22D.
Freq. range, Sine 20 cps-200 KC.
SQ, 20 cps-25KC. Output voltage, Sine 7V. SQ, TV P-P. Output Impedance 1000 ohms. Acc. 5 per cent. Distortion less than 2 per cent. 4-range attenuation, 1/1, 1/10, 1/100, 1/1K. Printed circuit, 240V A.C.
\$42.95

TACHOMETERS

Mullard ACE, sealed for 5.7 or 9K . . . \$20.75
With Dwell Angle . . . \$23.75
OHNAR
240-degree Circular Movement. Scaled 6K or 8K . . . \$24.75
Standard Scale 6 or 8K . . . \$19.75
Postage N.S.W. 50c, Interstate 75c.

G.D.O. UNITS

Post: N.S.W. 50c, Interstate 75c.
T.E. 15 Transistorised, 7 Bands, 360 Kc to 270 Mergs.
\$35.75

TV BOOSTER

240VAL. Especially designed for fringe area reception. Also up to 3 TV sets can be operated off common aerial for improved signal strength.
\$15.95 Post Free.

NEW GRAMMO MOTORS

240V. A.C.
3 Speeds, \$2.75.
Post: 40c.

SIGNAL GENERATOR

De Luxe Model TE20D.
Freq. Range 120 KC-500 Mcs.
7 Bands. Accuracy 2 per cent.
Output 8V. Provision for Xial Suitable for self-calibration Marker generator. Printed circuit. 240 V.A.C.
T.E.20. \$25.50. **\$28.50**

CHASSIS PUNCHES

SIZES, 5/8in, 3/4in, 7/8in, 1in, 1 1/8in with tapered Reamer and Carry Box.
\$5.75
Post 50c. Interstate \$1.00.

L.S.G. 11 SIGNAL GENERATOR

FREQ. RANGE IN 6 BANDS
120KC-130MCS.
Calibrated Harmonics.
120MCS-390MCS.
R.F. Output over 100,000UV.
120KC-38MCS.
Mod. Freq. 400 and 1000CPS.
Crystal Osc. 1.15MCS.
A.F. Output, 3 to 4 Volts.
A.F. Input, 4V approx.
240 V. A.C. Operation.
\$31.75. Post 75c.

T.E. 46 RESISTANCE-CAPACITANCE

Bridge and Analyzer.
Capacity 20pF to 2000mfd.
Resistance 2 ohms to 200 megohms.
Also tests power factor, leakage, impedance, transformer ratio, insulation resistance to 200 megohms at 600V.
Indications by eye and meter.
\$49.75

VOLT. A.C.

VARIABLE TRANSFORMER.
0-260V, 10 amp. . . . \$49.50
0-260V, 5 amp. . . . \$37.50
0-260V, 2 1/2 amp. . . . \$25.50

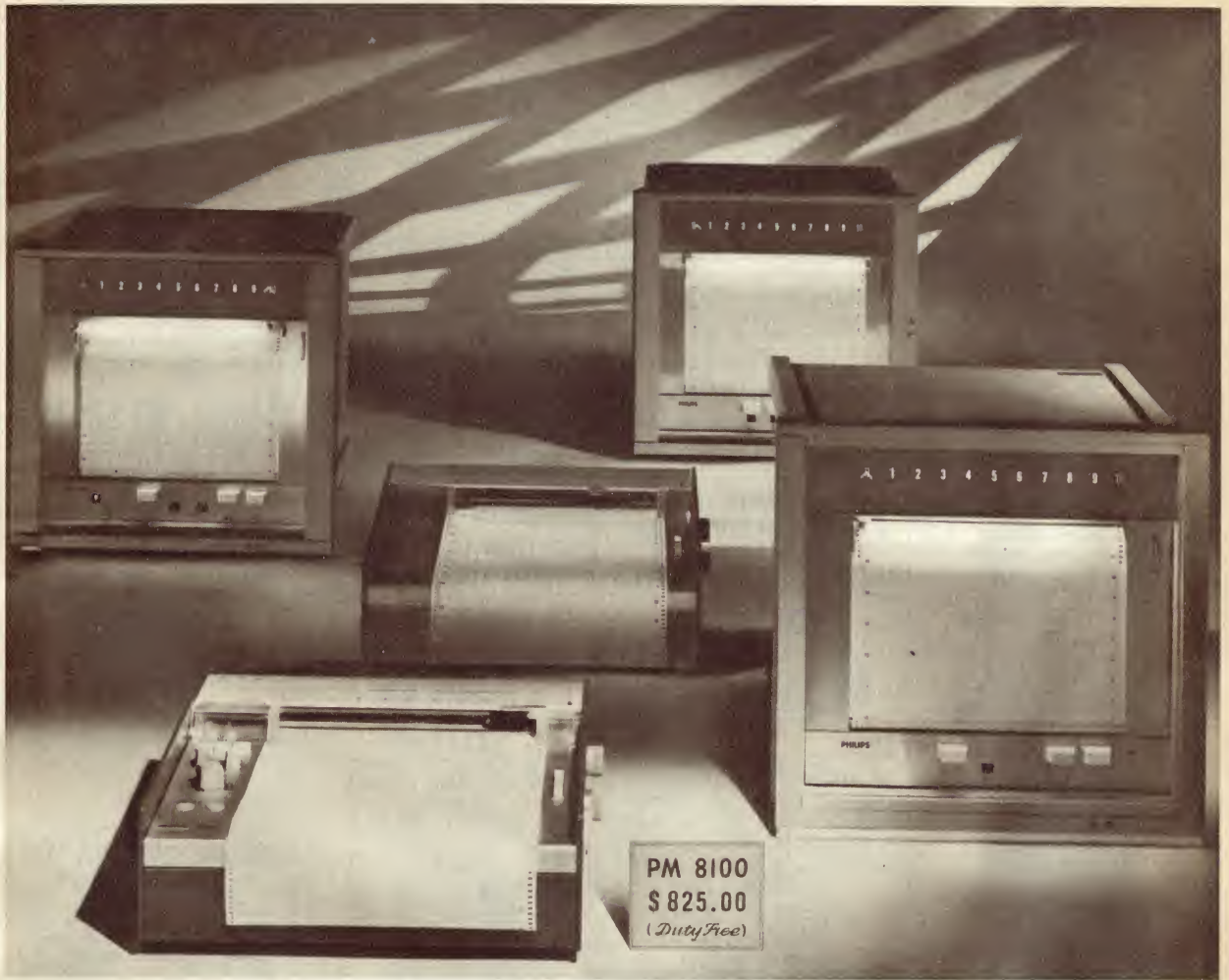

PM 8100

The Universal flatbed recorder

This is the multi-function, portable rugged flatbed instrument in Philips' complete line of recorders for scientific applications.

The high measuring accuracy and sensitivity makes it compatible with all your analytical equipment, whilst the wide dynamic range is an unknown luxury for everyday's mea-

suring problems in the laboratory. The full scale zero drift, with three calibrated positions greatly facilitate direct measurements of all DC signals. Operation convenience by registration with a disposable ink cartridge with clog free pen on a 250 mm wide chart. This is just one of the models available in the Philips

continuous line of scientific recorders. Write today for our descriptive leaflet, which gives you full details.

PHILIPS ELECTRICAL PTY. LTD.
69 CLARENCE ST., SYDNEY
or your nearest Philips office.



test and measuring instruments

PHILIPS



LISTENING AROUND THE WORLD

Broadcasting is now fifty years old

In the last two months, several special broadcasts have taken place to commemorate fifty years of broadcasting, dating from KDKA's music program on October 17, 1919.

by Arthur Cushen

Just 20 days after the memorable broadcast of KDKA in Pittsburg, the Dutch inventor Idzerda had equipped a studio, and on November 6, 1919, broadcast his first concert. This date was celebrated last month by Radio Nederland, with a special program dedicated to the history of radio in Holland and the introduction of broadcasting to the European continent.

This broadcast was the first of many, which became known as the "Hague Concerts." The London "Daily Mail" paid for them to be relayed to London, where they were known as the "Dutch Concerts." Then followed the experimental broadcasts from the Philips station PCJJ, in Eindhoven. In 1927, a program from London was relayed by PCJJ for rebroadcast by 2ME in Sydney, and was received in New Zealand.

Though Australian and New Zealand amateur operators had set up some world records for communication, including the first contact between Australia and Europe in 1919, it was not until the winter of 1923 that DX reception of MW broadcasts came into the picture. In the winter of that year, New Zealand listeners reported hearing signals from North America for the first time, and KFI in Los Angeles, using 500W, was the dominant signal. During the following years, United States stations were to be received regularly and strongly, to provide Australian and New Zealand listeners with an alternative source of radio programming.

About this time, New Zealand's private radio stations were being put into service on short schedules and with makeshift equipment, and in 1922 ten such stations were operating. Radio licences then cost 5/- with 3/- stamp duty. The forms had to be witnessed by a Justice of the Peace, and each application approved by the Postmaster-General. In 1922, New Zealand had 800 licensed radio receivers.

AMATEUR PIONEERS

Radio amateurs and hobbyists pioneered broadcasting in Australia as they did in New Zealand. In this field, 4XD in Dunedin is one of the oldest established stations. The Dunedin station, which is still operated on 1430KHz by the Otago Radio Association, and is the only private broadcaster in the country, came into being in October, 1922. By 1932, New Zealand had 36 private radio stations, as well as the stations operated by the N.Z. Broadcasting Company. The company sold their stations to the Government in 1932, and the Broadcast-

Notes from readers should be sent to Arthur Cushen, 212 Earn Street, Invercargill, N.Z. All times are GMT. Add 8 hours for Perth, 10 hours for Sydney 12 hours for Wellington.

ing Board was formed. In 1937 the National Broadcasting Service was operating in conjunction with the National Commercial Broadcasting Service, to provide two distinct networks. This was virtually the end of private broadcasting stations, all except two having now been acquired by the Government. In 1943 the two Government services, the N.B.S. and the N.C.B.S., were linked to form the New Zealand Broadcasting Service. In 1962, this was reconstituted to form the present New Zealand Broadcasting Corporation. History has turned a full circle with the establishment last year of the Broadcasting Authority to licence private commercial radio stations.

VATICAN USING 17800KHz

The new frequency of 17800KHz for the Vatican Radio is in use to South America, but reception at our listening post has been spoilt because the frequency is also being used by the Deutsche Welle relay at Kigali, in Ruanda, Central Africa. The Vatican transmission opens at 2300GMT on 17800KHz with a program in Portuguese. At the same time, the Kigali relay station opens its service in German, also with a service to South America. The two signals are mixed, but the Vatican transmission is generally the stronger.

Deutsche Welle programs in German are on the air from 2300 to 0100GMT, and are also to be heard on 11935KHz. Both the transmitters now use 250KW. The present transmissions to Australia and New Zealand, are:

GMT	KHz
1125-1140	17845, 21690
2210-2220	9645, 11745

The present frequencies in use by Vatican Radio are as follows:

Band	KHz
49M	6190.
41M	7155, 72501
31M	9625, 9630, 9645, 9670.
25M	11705, 11720, 11725, 11740, 11745, 11760, 11785, 11850.
19M	15120, 15210, 15255, 15285.
16M	17800, 17840, 17845, 17850, 17885.
13M	21485, 21560, 21690.

A late report from Samson Voron, Coogee, N.S.W., mentions the use by Vatican Radio of the 11M band for the first time. Reception has been on 25850KHz at 1245GMT, when the program was in English, and at 1300GMT programs were in French. The transmission was strongly received. It is understood the target area is the Philippines and South Asia at this time.

DENMARK REDUCES SERVICES

The Danish Radio at Copenhagen have announced plans to reduce their shortwave services, due to a budget cut. It is planned to discontinue all English

and Spanish broadcasts as from April, 1970.

The reduction is expected to make a saving equivalent to about \$70,000. In the past six months the station has received over 3,000 reception reports. During my visit to Radio Denmark in June, I discussed the matter of better transmissions with the Director. Their 50KW transmitter has been in use for over 21 years, and the station is using only two frequencies, 9520 and 15165KHz. The need to concentrate broadcasts on such a limited frequency range has not done justice to the excellent programs which Radio Denmark broadcasts to the world.

It is expected that listeners will write to the Director-General of Radio Denmark, appealing for the continuation of their English programs.

RECENT VERIFICATIONS

COLUMBIA: Radio Pacifico, Cali, has verified to Bob Padula, of Melbourne, Victoria, with a personal letter. The verification was signed by Alberto Acosta. The reception on 6055KHz was reported in Spanish.

PERU: Radio Victoria, in Lima, has confirmed the reception of its programs in a letter to Samson Voron, Coogee, N.S.W. The letter stated it was using 10KW and hopes to increase shortly to 50KW. It operates two stations, OAX4X on 780KHz and OAX4Q on 6020KHz. As well as a verifying letter it also sent 10 mint Peruvian stamps, a postcard, a card with a drawing of the station, and a calling card on a thin piece of wood. Radio Union has also verified Samson Voron after several reports. Included with the verification letter was two I.R.C.s, a pennant and a verification letter. It operates on 6115KHz and is heard around 1100GMT.

MORE CHANNELS FOR N.Z.

In a recent announcement, the Australian Postmaster-General indicated that, in order to provide more channels for New Zealand with the pending introduction of private broadcasting stations in that country, some frequency alterations would have to be made in Australia. As well, those country radio stations which up to now have enjoyed a clear channel shared by no other Australian or New Zealand station would have to surrender this privilege. By using directional aeriels, each country would try to protect the sharing stations from mutual interference.

It appears that any New Zealand private broadcasting station approved would have the use of one of the following frequencies: 990, 1050, 1090, 1150, 1190, 1240, 1260, 1290, 1360, 1410, 1490 and 1600KHz.

ENGLISH FROM JEDDAH

The Saudi Arabian Broadcasting System now has two programs in English daily on 11855KHz. The first period, 0430-0530 GMT, has a news bulletin at 0445GMT. The second program is also on 11855KHz between 1700 and 2000GMT. During this transmission there are news bulletins in English at 1730 and 1945GMT.

CYPUS RADIO

The Cyprus Broadcasting Service, P.O. Box 1824, Nicosia, Cyprus is now broadcasting a regular service for reception in

CHEST OF DRAWERS

Three types of Galvanised Chests measuring 17½in x 6¾in x 11½in, containing 16 drawers, each measuring 6¾ x 3¾in x 2½in.

- TYPE C.D.1. With 16 undivided drawers.
- TYPE C.D.2. With 16 triple compartment drawers.
- TYPE C.D.3. With 8 triple compartment drawers, and 8 undivided drawers.
- TYPE C.D.4. A 17½in x 11½in Galvanised Chest containing 4 full-length drawers each measuring 15¾in x 6¾in x 2½in.

The Chests are finished in blue hammerstone stoving enamel, are complete with identification cards and packed in strong corrugated cartons. Provision is made for all units to be bolted together in tiers.

WRITE FOR FREE CATALOGUE AND PRICE LIST OF TOOL BOXES AND CHESTS OF DRAWERS.



COLOUR TELEVISION

With particular reference to the PAL system by G. N. PATCHETT
This book now available
\$5.95



"PIPGRAS" HOLE PUNCHES

"PIPGRAS" Hole Punches are made from Alloy Tool Steel, and cut clean and accurate holes in sheet metal. They make a smooth, perfect hole without reaming or filing.

SCREW TYPE, ROUND

Supplied with "UNBRAKO" High Tensile Socket Screws and Wrenches. Cut holes in sheet metal up to 18 gauge.

Type No.	Nominal Size	Actual Size	Water Size (I.D.)	Pilot Size	Price Each
32.S	¼in	0.507in	—	¼in	\$2.17
40.S	¾in	0.618in	¼in	5/16in	\$2.17
48.S	¾in	0.742in	¾in	5/16in	\$2.80
56.S	¾in	0.884in	½in	¾in	\$3.86
64.S	1in	1.008in	—	¾in	\$4.10
72.S	1¼in	1.133in	¾in	¾in	\$4.53
76.S	1 3/16in	1.172in	—	¾in	\$4.53
80.S	1¼in	1.258in	—	¾in	\$4.97
88.S	1¾in	1.382in	1in	7/16in	\$8.97

With Heat Treated, High Tensile Steel Hex. Head Bolt and Nut.

Cut holes in sheet metal up to 16 gauge.	Size	Price
96.S	1¼in 1.512in	— 9/16in \$6.68
112.S	1¾in 1.762in	1¼in 9/16in \$7.69
128.S	2in 2.014in	1¼in 9/16in \$8.33

BELLPHONE



Pick up the receiver and dial push number desired.

Large \$13.50 per pair
Small \$10.12 per pair

KALTRO SVC TV-RADIO REMOTE CONTROL LISTENER



This TV-Radio Remote Control Listener is a combination of an extension speaker and a remote control station to regulate the sound of both the TV, Radio, Phono, or Hi-Fi set and the speaker incorporated in the Listener itself. In addition, up to two earphones can be attached for listening to the sound of the TV, Radio, Phono, or Hi-Fi set without disturbing others around you. Unwanted commercials can be easily cut off by merely turning down the control of the TV-Radio Remote Control Listener. A modern designed plastic cabinet with easily adjustable fingertip controls ideal for use in home, office and business. Complete with earphone, 20ft of lead wire and installation instructions.

Price \$8.75

Trade enquiries
prices available
on application

★
Free parking
at Rhodes

★
Phone:
73-0211 Rhodes
29-4451 City
73-5586 Sat. Morning.

THIS MONTH'S SPECIALS

Radar 1XR Power Supply \$30.60
Radax 05XR Power Supply \$20.40
Lapel Microphone X67 .. \$00.90
Table Microphone BM3 .. \$ 7.50

8 WATT STEREO AMPLIFIER MODEL SA-80S



SPECIFICATIONS

Output Power: 8 Watt, 4 Watts per channel.
Frequency Response: 60 to 15,000 cps. plus or minus 1 db.
Harmonic Distortion: Less than 3%.
Hum and Noise: 52 db below rated output.
Sensitivity: Phone (Crystal) 100mV 250K ohm.
Tuner 100mV.
Tube Complements: 12AX7x1, 30A5x2, 1S315x1 (Silicon Rectifier).
Dimensions: 5.1lb, 9¾in x 6¼in x 3in.

BOOK SHELF TYPE SPEAKER SYSTEM MODEL SP-4S



Speaker: 4in, 8 ohms.
Frequency Response: 70-13,000 cps.
Sensitivity: 93dB.
Power Input: 8W (Music Power).
Cabinet Size: 9¾in (H) x 6¼in (W) x 5¾ (D).
Finish: Walnut lacquer.

MODEL M6 FOUR CHANNEL TRANSISTORISED MICROPHONE MIXER



All four inputs accept standard two circuit Phone Plugs, while the output jack accepts a standard circuit Phone Pin Plug.

SPECIFICATIONS:

● Input Impedance: "HI" Impedance for Crystal Microphone, etc. ● Gain: Approximately 6 db. ● Maximum Input Signal: 1.5 volts. ● Maximum Output Signal: 2.5 volts. ● Output for Minimum Distortion: 2 volts. ● Hum: 0. ● Battery: 9 volts.

Mono \$6.75 Stereo \$9.75

GENERAL ACCESSORIES

(A DIVISION OF ELECTRONICS INDUSTRIES)

116-118 CLARENCE ST., SYDNEY 29-4451 443 CONCORD RD., RHODES 73-0211
BOTH STORES OPEN SATURDAY MORNING FREE PARKING SPACE AT RHODES FOR CUSTOMERS

Great Britain. The programs are in Greek, but some announcements are in English. News in Greek is at 2000GMT and 2100GMT. The station operates as follows:

GMT	KHz
1900-2105 weekdays	15260
0900-1600 Sunday	17875

NEW SIGNALS FROM PERU

A new signal to be received at our listening post is "Radio Oficial del Congreso del Peru" broadcasting from Lima on 6095KHz. The station has the call sign OAX4H, and the power is 10KW. Reception has been from 1100GMT, when the station carries the same news as "Radio Nacional del Peru," using 6082-KHz. Then follows light music of Latin American variety from 1115GMT. The station address is Jr Union 733, Lima, Peru.

Another relatively new Peruvian station, "Radio Pacifico," is reported by Mike Highley of Wellington N.Z. This station uses 9675KHz and has been received with an English news bulletin and commentary at 0200GMT.

Another new Peruvian signal we have observed is OCX4M, Radio Pasco, using 6135KHz. This station appears to operate a 24-hour-a-day schedule. It has been noted with popular dance music at 0615 GMT and is still in operation at 0800 GMT. Signals are free from direct interference on 6135KHz. The station has the mailing address, of Apartado 128, Cerro de Pasco, Peru.

RANGOON SCHEDULE.

According to the Ceylon Shortwave Listeners' Club the Burma Broadcasting Service, at Rangoon, is now operating on a new schedule.

GMT	KHz
0030-0230	7120
0230-0430	6035
0340-0700	9730
1100-1600	5040

Second Program

1100-1445	4725
-----------	------

On Sundays, the first program remains on 9730KHz to 0730GMT.

THREE SHARE AWARD

For the first time in the 15-year history of the inter-branch competitions of the New Zealand Radio DX League, three branches shared in the award for the 1968-69 competition. This was announced at the twenty-first annual meeting of the New Zealand Radio DX League in Timaru recently.

The competition between the six branches of the League in New Zealand is a team effort. Each branch enters its best 24 verifications on medium-wave and short-wave, and no member may enter more than six for his particular branch. The award for the best aggregate, the elaborate 2ft-high Columbus Trophy, was won this year by the Canterbury Branch; the medium-wave trophy, the Albert Stanton Cup, was won by the Southland Branch; and the short-wave trophy, the Hope McGregor Cup, by the Wellington Branch.

The League continues to be the major DX organisation in the South Pacific. Its membership showed an increase of 50 new members in the past year, while the standard of the DXing continues to be very high.

NOVELTY VERIFICATION

Radio Nederlands, Hilversum, has under way the issue of a novelty verification card which shows the contributors to its popular DX Jukebox program, as well as two of the Radio Nederlands team.

The new card which contains photos of Glenn Mauser (North American DX report), Jan Tuner and Bjorn Fjaestad (Scandinavian DX report), Maarten van

NEW SCHEDULES OPERATING

ENGLISH BROADCASTS FROM BERNE

The Swiss Broadcasting Corporation in Berne is operating its English transmissions according to the following schedule up to May 2, 1970.

GMT	KHz	Area
0700-0800	9595, 11775	Australia, New Zealand
0700-0800	6165, 9535	Europe (week days)
0845-0945	9665, 11760	Japan, China
1000-1100	15305, 17795, 21520	Africa
1130-1230	8665, 11865	United Kingdom
1315-1415	15305, 17845, 21520	Far East
1500-1600	15305, 17830	Near and Middle East
1815-1915	15305, 17795	Africa
1930-2030	6055, 8665	United Kingdom
0130-0230	6120, 9535, 11715	North America
0445-0545	6120, 9720	North America

RADIO NORWAY SCHEDULE

The present schedule of Radio Norway, Oslo, includes the use of some new frequencies. The last 30 minutes of the Sunday broadcast is in English and is called "Norway This Week."

GMT	KHz	Area
0700-0830	11735, 21655, 21730, 25730, 25900	Australia, New Zealand
1100-1230	7210, 11735, 21655, 25730, 25900	Australia, New Zealand
1300-1430	9645, 21655, 21730, 25730, 25900	India, Pakistan
1500-1630;	17825, 21655, 21730, 25730, 25900	Middle East
1700-1830	15175, 21655, 21730, 25730, 25900	Africa
1900-2030	9645, 11735, 11850, 21655, 25730	Europe, West Africa
2100-2230	11735, 11850, 11860	South America
2300-0230	99550, 9510, 9645, 1578	U.S.A., Canada
0100-0230	9550, 9610, 9645, 1578	North America
0300-0430	9610, 9645, 11735, 1578	North America, Pacific

BROADCASTS FROM LISBON

Radio Portugal, Lisbon, is operating to its overseas audience on the following schedule.

GMT	KHz	Language
0100-0145	15125, 11840, 9585	Spanish
0200-0245	15125, 11935, 6025	English
0345-0430	15125, 11935, 6025	English
0215-0300	11830	French
0300-0345	11840	English
0700-0745	15125, 6025	French
1830-1915	6025	French
1915-2000	6025	Italian
2000-2045	6025	German
2045-2130	6025	English
0730-0900	21495, 17880	English
1345-1430	21495, 17895	English
1730-1815	17895, 21495	French
1815-1915	17895, 21495	English

Self (Benelux DX Club) and Arthur Cushen, who presents the Pacific DX Report. Harry van Gelder of the English section, and producer and compere of the program, and Jim Vastenhaus who supplies the technical information, are included in the photos. This novel verification card of the DX Jukebox team will be issued by Radio Nederland shortly.

DX Jukebox is on the air on each Thursday of the month, with the Pacific report on the first Thursday; Scandinavian report on the second; North American report on the third; and Benelux report on the fourth Thursday; When a fifth Thursday occurs, this is taken up by a report on European DX Council affairs.

The program can be heard via the Bonaire relay as follows: 0645GMT, 11730KHz; 0815GMT, 9715KHz.

Radio Nederland has an antenna course coming up in 1970, which will enable listeners to follow, in text and through broadcasts, information of many types of receiving aerials used by listeners. Details on this course are available from DX Jukebox, Radio Nederland, P.O. Box 222, Hilversum, Holland.

SERVICE

BILL TURNBULL offers you service on Hi Fidelity equipment tape Recorders, Communication Receivers and Electronic Test Equipment.

25 years experience
All work guaranteed

BILL TURNBULL

11 ELLALONG ROAD,
CREMORNE, N.S.W. 90 4825

THE AUSTRALIAN RADIO DX CLUB

The Australian Radio DX Club welcomes enquiries regarding membership from persons interested in long-distance radio reception. The Club bulletin, "The Australian DX News," published monthly, contains up-to-the-minute information on all aspects of DX listening, and the weekly Club broadcast, "World at Your Fingertips," is heard every Sunday night over radio 3NE Wangaratta 1600 kHz, at 10.35 p.m. THE AUSTRALIAN RADIO DX CLUB is a hobby organisation, serving the needs of DX listeners throughout Australia. Full details concerning the Club and its activities will gladly be supplied on request, and all enquiries should be sent to: THE HON. GENERAL SECRETARY, AUSTRALIAN RADIO DX CLUB, 22 HOWARD STREET, GLEN IRIS, VICTORIA, 3146.

REVOX



The ultimate in high fidelity systems



Engineering Products Division
422 LANE COVE ROAD NORTH RYDE NSW AUSTRALIA 88 6666

AMALGAMATED WIRELESS (AUSTRALASIA) LIMITED

MELBOURNE 67 9161 BRISBANE 41 1631 ADELAIDE 72 2366 PERTH 28 6400 LAUNCESTON 2 1804

KGEI EXPANDS SERVICE.

The KGEI transmissions from San Francisco, which have been on the air since 1939 (in recent years as the Latin American service of the Far East Broadcasting Company) have been expanded. The station was established in 1939, when we heard its broadcasts with the call sign W6XBE at the Golden Gate Exposition. It was then located on Treasure Island.

In recent years KGEI has been used for gospel programs in Spanish, Portuguese and English to Central and South America from transmitters at Belmont. One transmitter of 250KW has been used, but in the last month the service has been extended, and is now heard on three frequencies to sign off at 0500GMT. The normal service on 15240KHz is usually blocked by Radio Australia. A new frequency of 11955KHz is operational to 0500GMT when programs are in English, while 9715KHz is also used at this time. The station is asking for reports on reception of the new frequencies to P.O. Box 15, San Francisco.

FLASHES FROM EVERYWHERE

AFRICA

CAPE VERDE ISLANDS: Radio Barlavento, is using 3910KHz according to the World Bulletin. The station is on the air weekdays 1300-1400GMT and 2000-2200GMT. On Sunday the transmission is 0900-1100GMT, 1300-1500 GMT and 200-2200GMT. The station uses 1KW and is planning to install a 100KW transmitter later.

MOROCCO: Radio Morocco at Rabat has been observed on the new frequency of 15250KHz at 0700GMT. The announcement indicates that the station is also using 701, 1025, 1151 and 827KHz on medium wave and 7225KHz on short-wave.

SOMALI REPUBLIC: Radio Somali, Mogadiscio, is using a new frequency, according to a report in Sweden Calling DXers. The new channel is 9655KHz which replaces 9588KHz, with 6095KHz in parallel. English has been observed 1730-1800GMT.

COMORO ISLANDS: The latest schedule of the Comoro Islands is reported in the World Bulletin as being 0330-0500GMT on 7260KHz, 0900-1030GMT on 7260KHz and 1530-1900GMT on 3331KHz.

NIGERIA: Radio Television Kaduna has been received on 9570KHz at 0520GMT and still audible at 0550GMT. The

August Balbi, aged 78, is one of the veterans of short-wave listening. Arthur Cushen and his wife spent some time with Mr Balbi while they were in Los Angeles during their recent world tour.



station has an English program with African music, and opens its transmission on this frequency at 0500GMT.

ASIA

SYRIA: Radio Damascus, Syria, has been received on 15270KHz by Mike Highley of Wellington, N.Z. Damascus is on the air at 1730 to 1800GMT in German, and then in English at 1930 to 2000-GMT. The station is asking for reports to the English Section, Radio Damascus, Damascus, Syria.

MONGOLIA: Radio Ulan Bator, is on the air in English in two transmissions each day. The first is 1220-1250GMT on 7340 and 9540KHz, and the second 2200-2230GMT on 9540, 11810 and 11860KHz. A mailbag session is broadcast in its transmissions on Saturday and Sunday.

MALAYSIA: According to a schedule received from Bob Padula of Melbourne, Vic., the Voice of Malaysia is now using 7220KHz. This new frequency is used for the morning broadcasts in Indonesian at 2315-0100GMT with news at 2330 and 0030GMT. Parallel outlets are 6100 and 6175KHz. In Invercargill we have been receiving good reception of Radio Malaysia on 5965KHz. News in Malay is heard at 1230GMT, and this is interspersed with commercial announcements.

KUWAIT: Radio Kuwait continues to be observed on new frequencies, and we have heard the English transmission at 0400GMT on 15185KHz. This frequency is beamed to Europe, while the channel of 17750KHz carries the same program for India and Pakistan.

Another frequency 17840KHz has been observed at 0900GMT with an Arabic program.

BRUNEI: Radio Brunei is now using 7215KHz for its evening transmission according to a listener in Ceylon. The station has been heard 1300 to 1430-GMT and has news at 1315GMT.

NEPAL: Radio Nepal, Kathmandu, has been heard by Keith Barton, an Australian listener. According to verification the station operates:

GMT	KHz
0220-0350	7105, 11970
0720-0920	7165
1320-1650	7165, 11970

THE AMERICAS

MEXICO: Radio Mexico, with the call XERMX, has been heard on the frequency of 11720KHz. The station has been conducting test transmissions up to 0300GMT and later. Announcements have been in French, Spanish, German and English. The station is located in Mexico City.

ARGENTINA: Radio Nacional, Buenos Aires, now opens at 0900GMT on 6060KHz. Following the national anthem the station presents news in Spanish. Radio el Mundo has been noted on 6120KHz at the same time. It is understood that the reason for the earlier opening of these stations is that Argentina is now on summer time.

PERU: Radio La Cronica, Lima, has been heard on 6120KHz with sign off at 0700GMT. The station is generally received on its other channel of 9520KHz. Radio Tropical using 9710KHz

(Continued on page 180)

ELECTROLUBE FREEZER SPRAY

FOR ISOLATING FAULTS IN TRANSISTORS, DIODES AND OTHER SEMI CONDUCTORS, FINDING DRY JOINTS AND BAD CONTACTS. PROTECTING HEAT SENSITIVE COMPONENTS WHILST SOLDERING, CHECKING THERMOSTATS AND THERMAL CUT-OUTS.

ELECTROLUBE IS NON-TOXIC AND WILL NOT EFFECT ANY PAINTS, PLASTICS, OR RUBBERS.

RFA

RICHARD FOOT (Australia) PTY. LTD.
63 Hume St., Crows Nest, N.S.W. Tel. 43-0326.

AVAILABLE FROM
LEADING ELECTRICAL
WHOLESALEERS

The MUSICOLOUR—

SOUND CONTROL OF COLOURED LIGHTS

Complete kit of parts for above unit as featured in October issue of Electronics Australia.

\$44.00

Complete unit wired and tested.

\$54.00



NEW RANGE OF P.A. AMPLIFIERS 23-30 AND 45 WATT

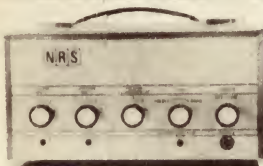

Standard Amplifier

25 WATT

Valve amp. using 62A7, 2-12 AX7, EF86 valves. Dimensions 11in x 6in x 8in. Weight 23lb.

\$61.00 Freight extra.

These amplifiers are suitable for installation in clubs, schools, restaurants, factories, etc. Wherever the amplification of speech or music is required. All amplifiers have two microphone and radio or pick-up inputs with mixing facilities and can be supplied with tapped line or voice coil output.

30 WATT FOR 240V OR 12V OPERATION

This solid state amplifier is for 240V. A.C. or 12V. D.C. operation with regulated power supply using 10 transistors. Dimensions 11in. x 5in. x 8in. Weight 14lb.

\$74.00 Freight extra.



Amplifier with Bass and Treble Controls

45 WATT

Solid state amplifier using 9 transistors, with separate bass and treble controls. Dimensions 12in x 6in x 9in. Weight 22lb.

\$79.00 Freight extra.

NEW TRANSISTOR CAR RADIO

New transistor six car radios with R.F. stage, of Australian manufacture using A.W.A. components and transistors. Available in manual with dial calibrated for all Australian States. Supplied with speaker (5in, 6in, 5in x 7in model OR 6in x 9in) and lock-down aerial.

MANUAL MODEL \$43.00

Post and Packing N.S.W. \$1.50, Interstate \$2.50.



Suitable for 6 or 12 volts for positive or negative earth.

NEW TRANSISTOR STEREO RECORD PLAYER \$38.00

This Stereo Record Player is fitted in a durable and attractive vinyl covered case with silver trim and incorporates an 8-transistor Stereo Amplifier with two Magnavox 5in x 3in speakers and B.S.R. record player (4-speed) with crystal pick-up. For 240 volt A.C. operation only. DIMENSIONS:—21in x 10in x 3½in. WEIGHT, 12lb.

Post and Packing extra. N.S.W. . . . \$1.50. Interstate . . . \$2.50.



7193	25c
807	\$1.75
1C7G	30c
1D8GT	95c
1K8G	40c
1K7G	40c
1M5G	40c
1P8G	28c
1Q8G	25c
1T4	45c

NEW VALVES AT BARGAIN PRICES

3Q4	75c	6K7G	45c	6SJ7	95c
3S4	\$1.00	6K8G	68c	7C7	35c
5V4G	\$1.00	6SA7GT	95c	6U7G	45c
6C8G	50c	6SS7 equiv.		6X5GT	75c
6H6G	35c	6SK7	35c	12AT7	\$1.00

Please add postage on all valves.

6A7GT	75c
IL5G	95c
12SK7	50c
12A6	50c
12K8	50c
12SH7	50c
866	\$1.50
954	25c
955	25c
EK32	68c

NATIONAL RADIO SUPPLIES

332 PARRAMATTA ROAD, STANMORE, N.S.W. PHONE 56-7398

NEW RANGE OF RESISTORS CONDENSERS AND POTENTIOMETERS

The resistors are mainly I.R.C. and Morganite and are in a wide range of values from 100 ohms to 3 meg. in $\frac{1}{4}$, 1 and 2 watt and include wire wound. LIST PRICE \$9.00 per 100. OUR PRICE \$2.00 per 100. Post and packing 35c extra.

The condensers are in most popular brands and include Polyester, Paper, Mica, Ceramic and Electrolytic in values up to 8mfd. LIST PRICE \$11.00 per 100. OUR PRICE \$2.00 per 100. Post and packing 65c.

The pots, are all current types and include switch pots, and dual concentric, tandem, tab pots. etc. LIST PRICE \$12.00 per dozen. OUR PRICE \$2.50 per dozen. Post and package 60c extra.

FREE With each lot of resistors, condensers or pots, we will supply one new valve. Type 6U7G, 1T4, 6K7G, or 6X5GT.

LEADER SIGNAL GENERATOR LS611

240V A.C. operated, 6-band 120KC to 390 Megs. Provision for crystal.
Post N.S.W., 75c; Interstate, \$1.25. **\$32**



NEW TRANSISTOR 8 KIT SET SPECIAL PURCHASE ENABLES US TO OFFER THIS KIT SET AT \$24.00

- Complete kit of parts with circuit and full instructions.
- Eight transistors.
- Magnavox 5X3 speaker gives excellent fidelity.
- High sensitivity, suitable for city or country use.
- Heavy duty battery for economical operation.
- Modern design, plastic cabinet with gold trim.
- Dial calibrated for all States.
- Available in colours of off-white, red, black.

DIMENSIONS
9" x 5" x 3" deep

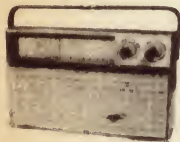

Post N.S.W., \$1.25; Interstate, \$1.75.

New Electrolytic Condensers

These condensers are miniature pigtail type insulated new stock in packets of 12, each packet containing 3 16 mfd 300 V.W., 2 32 mfd. 300 V.W., 1 25 mfd. 450 V.W. and 6 low voltage electrolytics. **\$2.50.**

Post and packing 20c extra.

NEW IMPORTED 4" P.M. SPEAKERS

Available with a 4 or 16 ohm voice coil. **\$2.00.**
Post and packing 30c extra.

NEW ENGLISH & AMERICAN TRANSISTORS AT $\frac{1}{4}$ LIST PRICE PACKET OF 12 FOR \$3.00

Ideal for the experimenter and service man. Each packet of 12 contains 3 each of the following types.

Mazda XA 101. Equivalent OC45
Texas 2N1108. Equivalent OC44
Texas 2N1111. Equivalent OC75
Texas 2N1110. Equivalent OC45

Post and packing 25c extra.

NEW 240V ELECTRIC MOTORS

3300 R.P.M. Size $3\frac{1}{2}$ " x $2\frac{1}{2}$ " x $3\frac{1}{2}$ ". including spindle.

\$2.75

plus 60c postage

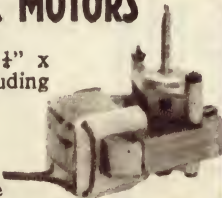
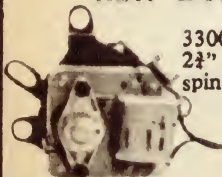

SOLID STATE GUITAR AMP.

Here is a fully solid state guitar amplifier rated at a nominal 50 watts continuous power. Featuring two totally independent tone control channels and tremolo facility, the amplifier offers unique flexibility in a light and compact unit. (Featured in July-August issue Electronics Aust.)



COMPLETE UNIT
WIRED and TESTED

\$114.00

Complete kit of parts to Electronics Aust. specifications supplied with foot control switch (and lead for remote tremolo). Cabinet finished in black vinyl and control panel in black and silver with matching knobs.

COMPLETE KIT OF PARTS

\$98.00

USED HIGH-SPEED 240V. AC/DC MOTORS

These 240V A.C. or D.C. motors are 1/8 H.P. with a speed of 7,000 r.p.m. and are ideal for small drills, grinders, etc. Dimensions: $5\frac{1}{2}$ in x $3\frac{1}{2}$ in, with 5/16in spindle **\$3.75**

Postage N.S.W., 50c; Interstate, 85c.

NEW SPEAKERS

6 inch Twin Cone 15 ohm **\$5.50.** Post and pack 55c
4 inch 15, 8 and 3.5 ohm **\$3.50** Post and pack 25c
 $3\frac{1}{2}$ inch 3.5 ohm **\$2.50** Post and pack 25c

NEW MINIATURE MOTORS

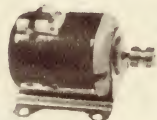

Ideal for models, toys, etc. $1\frac{1}{2}$ to 3 volts. 6,000 r.p.m. 39c each or **\$3.50** per doz. Post 10c.

ROTARY SWITCHES

Single Bank 11 x 1, 4 x 2, 3 x 3, 2 x 5, **69c.** Single Bank 2 x 1, **35c.** Two Bank 3 x 3, **\$1.20.**

Rocker Switches D.P.D.T. **55c**

Rocker Switches S.P.D.T. **45c**



A TRANSISTOR PREAMP FOR MAGNETIC PICK-UP OR TAPE HEAD

Using 3 transistors per channel as featured in Electronics Aust. Complete kit of parts including transistors. P.C. board and resistors and condensers.

Circuit and full details supplied.

Stereo Kit **\$12.00.**

Mono Kit **\$6.50**

240V Power Supply **\$7.00.**



NEW MIDGET POWER TRANS. **\$3.75**

40mA prim., 240v. Sec 225 x 225 with 6.3v Fil. Winding. 30mA 240v. Prim. Fil. Winding.

Postage: N.S.W., 25c; Interstate, 45c.

150 x 150v. Sec. with 6.3v.

Postage: N.S.W., 35c; Interstate, 60c. **\$3.75**

NEW AMERICAN TWIN TELESCOPE TV AERIAL.

Extends to 36in, each section can be used singly for car or portable **\$1.50.** Post 20c. **SINGLE TELESCOPIC** Aerial, 12in extends to 33in. **60 cents.** Post 10c.

NATIONAL RADIO SUPPLIES

332 PARRAMATTA ROAD, STANMORE, N.S.W. PHONE 56-7398

Two big-in-features

5" CRT oscilloscopes



JAYEM

Model 555

- DC—7 MHz (—3dB) • 20 mV sensitivity • 50 nanoseconds rise time
- 5" flat-faced screen • Solid-state, lightweight, portable • Low capacity probe included • 12 months' warranty.

Synchronisation
Internal, external, mains freq.
Trigger Range
Internal 20 Hz-7 MHz
External 20 Hz-7 MHz
Calibrator
Output Waveform 1 KHz square wave
Voltage 5, 0.5, 0.05 V p-p
Vertical
Sensitivity 0.02 V/cm-10V/cm

Freq. response DC—7 MHz within —3dB
Rise Time approx. 0.05 uS
Input impedance 1 megohm parallel capacity 33 pF
Horizontal
1-50 uS/cm and 1 sec/cm. In 19 ranges
1-2.5 step

KIKISUI

Model 553

A dual-trace unit incorporating a trigger sweep system and featuring lightweight, compact, easy operation as well as high reliability by employing a highly sensitive 5" CRT.



Vertical Axis
Sensitivity: 10 mV/cm-20V/cm
Bandwidth: DC—7 MHz
AC—2 Hz-7 MHz
Input Impedance: 1 MΩ, parallel capacitance 38 pF
Rise Time approx. 0.05 uS

Sweep Magnifier: X5, accuracy ± 5%
Horizontal Amplifier
Sensitivity: Approx. 1V p-p/cm (0.2 V p-p/cm in case sweep magnifier is actuated)
Bandwidth: 2 Hz-200 KHz within —3dB

Time Base
Sweep Time: 1 uS/cm-1 sec/cm

CRT
130 ARB1 or 130ARB31

For further information contact:

jacoby, mitchell
& co. pty. ltd. 26-2651
469-475 kent street, sydney

MELBOURNE 30-2491
ADELAIDE 53-6117
BRISBANE 2-6467
PERTH 28-1102
LAUNCESTON 2-5322



JM/35-69

has been observed by Samson Voron, Coogee, N.S.W., at 1133GMT. The program consisted of music and talks, with trumpet interval signal.

BROADCAST BAND NEWS

AUSTRALIA: New stations and frequency and power changes, announced by the Broadcasting Control Board, are:

A new commercial station has been approved for Alice Springs, Northern Territory, and applications closed on August 29. No frequency or power has yet been decided.

4GD, Gladstone District Broadcasting Pty. Ltd., Gladstone, Qld., on 930KHz, with 2KW, is expected to open shortly, using a directional aerial to limit radiation in the direction of 3UZ Melbourne.

5EP, Eyre Peninsula Broadcasters Ltd., Port Lincoln, S.A., will operate on 1220KHz with 2KW using a directional aerial to limit radiation in the direction of 4AK Oakey.

The board approved in principle an increase in the power of 5SE Mount Gambier from 500W to 2KW at a new site, and using a directional aerial. To implement the power increase, a change in frequency will probably be necessary, but this has not yet been determined. The station will adopt substantially independent programming, instead of relaying 5AD.

The new national station 6BS Busselton, W.A., will operate on 680KHz instead of 760KHz as previously announced. It will now open in February, 1970, with the power of 2KW.

6CA Carnarvon changed from 720KHz to 850KHz on June 19, 1969.

6WF Perth is to be changed from 690KHz to 720KHz in February, 1970.

A new national station has been approved for the north-west area of N.S.W. A suitable frequency has been made possible by agreement with the N.Z. administration. A directional aerial will be used.

5PA Penola, S.A., is to increase power from 2KW to 10KW with a new site and directional antenna. The project is nearing completion and the power increase should take place before the end of December.

PHILIPPINES: The Far East Broadcasting Company has now opened its third station in remote parts of the Philippines to broadcast its gospel programs. The latest station is on Guinaras Island and services the Iloilo area. The first station to be established was at Marabel DXKI on 1060KHz and the second station, DXKO (now DXAS) is broadcasting from Julo Sulu.

THAILAND: According to a verification received by Stephen Reed of Christchurch, N.Z., Radio 555 appreciates reports. The verification is signed by Col. Lek Suntorosorn. The station is operated by the Armoured Car School and broadcasts on 785, 890, 1300 and 1550KHz.

"VOICE OF PALESTINE"

A new station with the slogan "The Voice of Palestine" has been heard at our listening post around dawn, using the medium-wave frequency of 773KHz. The station has a program in Arabic up to 1730GMT, and at this time the Cairo clock chimes are broadcast with the half-hour chime. Then follows its announcement in English, "This is the Voice of Palestine. Time is 1930 hours in Palestine, and 2030 hours summer time in other Arabic countries. The Voice of Palestine is broadcasting for the Palestine Liberation Organisation." Arabic music follows, then announcements about the freedom fighters. This is followed by a news bulletin.

Signals from the Cairo 500KW transmitter are good, but sideband interference is experienced in New Zealand from 4YA Dunedin on 780KHz. It is expected the new service will also be available on short-wave, for reception in the Middle East.

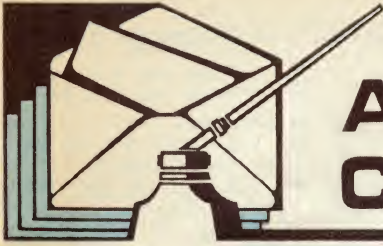

ANSWERS TO CORRESPONDENTS

TRANSMITTERS, LICENCES: Does an RF oscillator have to be licensed as a transmitter? What if it is modulated with signals from a microphone? How should one measure RF voltage and current, because when a friend of mine was trying to measure the output from his transmitter with a multimeter, the readings didn't make sense at all. Did you publish any amateur transmitters of 10-50 watt output between 1956 and 1966? What is a "Z call" licence, and how does one qualify for it? Finally, what about some more projects using spare parts, as these are surely of interest to almost every reader. (L.J.B., Blackburn South, Vic.)

● It would not be possible to answer all of your many questions fully, and in any case they are for the most part outside the stated range of this Information Service. However, the following brief answers may be of some assistance. An RF oscillator, modulated or unmodulated, would not have to be licensed unless it is actually being used as a transmitter. For measurement of RF voltage and current we would refer you to one of the standard amateur texts, such as "Radio Communication Handbook" published by the R.S.G.B. There were quite a number of transmitters published in the period you quote, and details of these may be obtained from this service; we would suggest that you narrow the field down a little further by stating the frequency bands and operating modes in which you are particularly interested. Note however, that we normally prefer readers who request transmitter circuits to give their amateur licence call-sign, as a sign that they are able to comply with the regulations. For information regarding the "Z-licence" or Amateur Operator's Limited Certificate of Proficiency, and the qualifications required for it, we must refer you to the radio branch of the Postmaster-General's Department. There are radio branch offices in each capital city. Finally projects using spare parts will probably be featured from time to time in the magazine, but as you may perhaps realise such projects are not without their problems. The contents of one spare parts box will be quite different from those of another, and the practical value of any spare-parts project is severely limited as a result.

ALKALINE BATTERIES, LAMB NOISE SILENCER: I have enclosed an advertisement for alkaline and carbon-zinc cells. I am interested in a statement it makes that "due to an odd scientific quirk" these cells actually give higher fidelity in transistorised equipment. Also, would it be possible to use the Lamb noise silencer with an IF other than 455KHz, more particularly 915KHz. (P.R., Townsville, Qld.)

● The advertiser is making a legitimate claim for alkaline cells, even though his choice of the phrase "odd scientific quirk" may be unfortunate. Alkaline cells can give significantly longer service than carbon-zinc cells in heavy duty applications, and they tend to maintain their voltage over the whole of their useful life. By comparison, the voltage of carbon-zinc cells tends to fall from the beginning of their use. Alkaline cells also maintain a lower internal impedance, and it is this factor which can result in better fidelity in the class-B audio output stages used

in most transistorised equipment. The Lamb noise silencer should work satisfactorily with an IF of 915KHz provided that the tuned circuit is arranged accordingly. We regret that we are not able to supply further details.

PLANAR SPEAKERS: Would you please consider describing a Playmaster enclosure design based on the "poly-planar" wafer speakers recently released. These would seem to offer particular advantages for portable use, and should be of considerable interest to drama groups, travelling shows, etc. (C.T., Bayswater, Vic.)

● We have not as yet had the opportunity to examine or try the speakers concerned, C.T. but from the published information it would appear that despite their unorthodox shape they would still require the use of a fairly standard enclosure to ensure adequate damping and correct acoustic performance. Because of this they may in practice offer less of an advantage in terms of compactness than might seem likely at first sight. It may be possible for us to describe a system based on this type of speaker in the future, but at present this is not planned.

SUPERCONDUCTORS: I read with interest "Cool Thoughts On Superconductive Power" (Vol. 31, 6), with special note of the French system. How is power inserted or removed from the ring? Need it be toroidal shaped? Assuming perfect insulation how would it compare on a watt/size/weight ratio to modern storage batteries, and what would its promise be for powering an electric car? Another subject I would like to comment on is the operational principles of a microwave oven ("Basic Radio Course," 1967,

Ch. 20, p. 108). An interesting but messy experiment is to try to fry or poach an egg in a microwave oven. The egg has about 7 layers of yolk separated by very thin films of white. The egg-white quickly coagulates, to give a series of very inelastic films. As the water in the yolk starts to boil, the pressure builds up to more than the white can take. The rest is easy to picture. Incidentally, I am a happy 115 builder. (R.V., Oakleigh, Vic.)

● The article on superconductors was reprinted by arrangement from an English magazine who, in turn, accepted it from a contributor. Without doing some special homework, we couldn't undertake to answer your questions. As regards application for electric vehicles, our impression is that the possibilities are very remote in terms of present technology. Thank you for the warning about frying eggs, although we imagine that this is the very thing that some reader will try to do, given access to one of these ovens. The idea would seem to have the same fascination as a "Wet Paint" sign. We are glad to note also that your Playmaster 115 amplifier is performing well.

GEIGER COUNTER: I hope that the recent publication of the experimental laser is an indication of an emphasis on nucleonics in future editions of your magazine. I would like to see plans for a Geiger counter as there is an ever-increasing need for such a device in laboratories in this day and age. (A.L.B., Belrose, N.S.W.)

● We described a transistorised Geiger counter in our July, 1962 issue. Copies of this article are available through the Information Service for the usual 20c fee. —(File No. 3/GC/2.)

"ELECTRONICS Australia" Information Service

As a service to readers "ELECTRONICS Australia" is able to offer: (1) Photographs, dye-line prints and other filed material to do with constructional projects and (2) A strictly limited degree of personal assistance by mail or by reply through the columns of the magazine. Details are set out below: **PROJECT REPRINTS:** For a 20c fee, we will supply data, as available from our files. The amount of data available varies but in no case does it include material additional to that already published in the magazine. For complicated projects involving material extracted from more than one issue, an extra fee may be requested. As a rule, requests for project data will be answered more speedily if the projects are positively identified and the request is not complicated by questions requiring the attention of technical personnel. Where articles are not on file, we can usually provide a photostat copy at 20c PER PAGE.

PHOTOGRAPHS, DYE-LINE PRINTS: Original photographs are available for most of our projects, from 50c plus 8c postage for a 6in x 8in glossy print. In addition, metalwork dye-line prints are available for most projects for 50c each; these show dimensions and the positions of holes and cut-outs but give no details of wiring.

BACK NUMBERS: A fairly good selection is available. On issues up to six months old the cost is the face value, plus 5c surcharge. From seven to 12 months, 10c surcharge; over 12 months, 20c surcharge. Package and postage is 10c extra per issue. Please indicate whether a PROJECT REPRINT may be substituted if the complete issue is not available.

REPLIES BY POST: This provision is made primarily to assist readers in matters relating directly to articles and projects published in "ELECTRONICS Australia" within the last 12 months. Note, however, that we cannot provide lengthy answers, undertake special research or modifications to basic designs. A 20c query fee must be enclosed with letters to which a postal reply is required; the inclusion of an extra fee does not entitle correspondents to special consideration.

OTHER QUERIES: Technical queries which fall outside the scope of "Replies by Post" may be submitted without fee and may be answered through the columns of the magazine at the discretion of the Editor. Technical queries will not be answered by interview or telephone.

COMMERCIAL EQUIPMENT: "ELECTRONICS Australia" does not maintain a directory of commercial equipment, or circuit files of commercial or ex-disposals receivers, amplifiers, etc. We are therefore not in a position to comment on proposed adaptation of such equipment, or on its general design. "ELECTRONICS Australia" does not deal in electronic components. Prices, specifications or other assistance must be sought from the appropriate advertiser or agent.

REMITTANCES: These must be in a form negotiable in Australia. Where the charge may be in doubt, an open cheque, endorsed with a limitation, is recommended.

ADDRESS: All requests for data and information, as set out above, should be directed to The Assistant Editor, "ELECTRONICS Australia," Box 2728 G.P.O., Sydney, N.S.W. 2001: 5/69

NEW RH (Radio House) RANGE OF MULTIMETERS

Model RH-80 \$18.00 Postage 50c



20,000 Ohms per Volt DC
10,000 Ohms per Volt AC

Specifications:
DC Volts. 0.5, 2.5, 10, 50, 250, 500, 1000 V
AC Volts. 10, 50, 250, 500, 1000 V
DC Current: 50 μ A, 5mA, 50 mA, 500 mA
Resistance: 5 k Ω , 50k Ω , 500k Ω , 5 Meg Ω
Decibels. -10 + 62 lb
Accuracy. DC $\pm 3\%$, AC $\pm 4\%$ (of full scale)
Batteries. Two 1.5V dry cells. Size AA, "Eveready" 915
● Overload-protected by dual silicon diodes. ● Mirror scale. ● Double-jewelled $\pm 2\%$ meter. ● $\pm 1\%$ temperature-stabilized film resistors.

Model RH-100 \$39.75 Postage 75c

100,000 Ohms per Volt DC 10,000 Ohms per Volt AC
● Overload Protected by Dual Silicon Diodes ● Double-jewelled ± 2 per cent Meter ● ± 1 per cent Temperature-stabilised Film Resistors ● Polarity Changeover Switch ● Mirror scale, instruction for operation with circuit diagram.



SPECIFICATIONS:
DC Volts: 0.6, 3, 12, 60, 300, 600, 1200V (100,000 /V)
AC Volts: 6, 30, 120, 300, 1200V (10,000 Ω /V)
DC Current: 12 μ A, 300 μ A, 6mA, 60mA, 600mA, 12 amps DC and AC Current 12 amps.
Resistance: 20K Ω , 200K Ω , 2M Ω , 20M Ω
Decibels: -20 to + 17, 31, 43, 51, 63.
Accuracy: DC ± 3 per cent, AC ± 4 per cent (of full scale)
Batteries: Two 1.5V dry cells, size AA, "Eveready" 915



Actual Size

MINI-TORCH

With fob keyring, attractive gold finish case. Simply squeeze. Illuminates car and house locks. \$4 posted anywhere.



TAPE RECORDER

\$20.50

BOOK TYPE

The latest model portable Tape-recorder. 4 transistor, 3in reels, 2 tracks. Instruction manual. Size 10 $\frac{1}{2}$ in x 7in x 1 $\frac{1}{2}$ in. Just open the book and record. Supplied complete with tape, microphone and batteries. Special discount price, \$20.50, posted anywhere.

Model RH-20 \$15.00 Postage 50c



20,000 Ohms per Volt DC
10,000 Ohms per Volt AC

Specifications:
DC Volts: 0.25, 2.5, 10, 50, 250, 1000 (20,000/V)
AC Volts: 10, 50, 250, 500, 1000 (10,000/V)
DC Current. 50 μ A, 25mA, 250mA
Resistance. 7k Ω , 700k Ω , 7M Ω
Decibels. -10 +22 (at AC/10V) +20 +36 (at AC/50V). Upper frequency limit 7kc.
Accuracy. DC $\pm 3\%$, AC $\pm 4\%$ (of full scale)
Batteries: Two 1.5V dry cells. Size AA, "Eveready" 915
● Overload-protected by dual silicon diodes. ● Double - jewelled $\pm 2\%$ meter. ● $\pm 1\%$ temperature-stabilized film resistors.

Model RH-55 \$20.00 Postage 50c

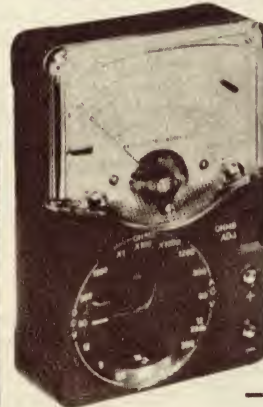

30,000 Ohms per Volt DC
14,000 Ohms per Volt AC

SPECIFICATIONS:
*DC Volts: 0.6, 3V, 12V, 60V, 300V, 1200V (30,000 ohms/V).
*AC Volts: 12V, 60V, 300V, 1200V (14,000 ohms/V).
*DC Current: 60 A, 12mA, 300mA.
*Resistance: 10K ohm, 1Meg ohm, 10Meg ohm.
*Decibels: -10 db +23 db.
*Meter Sensitivity: 23 A.
● Overload-protected by dual silicon diodes. ● Mirror scale. ● Double-jewelled $\pm 2\%$ meter. ● $\pm 1\%$ temperature-stabilized film resistors.

Model RH-60 \$25.00 Postage 50c



50,000 Ohms per Volt DC
10,000 Ohms per Volt AC

Specifications:
DC Volts: 0.25, 2.5, 10, 50, 250, 500, 1000 V
AC Volts. 10, 50, 250, 500, 1000 V
DC Current. 25 μ A, 5 mA, 50 mA, 500 mA
Resistance: 10 k Ω , 100 k Ω , 1 Meg Ω , 10 Meg Ω
Decibels. -10 +62 db
Accuracy: DC $\pm 3\%$, AC $\pm 4\%$ (of full scale)
Batteries. Two 1.5 V dry cells. Size AA, "Eveready" 915
● Overload-protected by dual silicon diodes. ● Mirror scale. ● Double-jewelled $\pm 2\%$ meter. ● $\pm 1\%$ temperature-stabilized film resistors.

Just arrived. New stocks of the latest model Crystal Radios. Price \$3.95 plus postage 35c. Complete with earphone, aerial clip and attractive plastic case.

RADIO HOUSE PTY. LTD.

306-308 PITT STREET; 6 ROYAL ARCADE & 760 GEORGE STREET, SYDNEY

ANSWERS - continued

TUBE DATA: Can you supply me with any technical data for a Du mont 5JP1 cathode ray tube? (A.L., Warwick, Qld.)

● The following data are all that we have:

Pins: 1, heater; 4 and 5, anode 1; 7, anode 2; 10, grid; 11, heater and cathode; Top or side caps: 1, X1; 2, Y1; 3, X2; 4, Y2; 5, anode 3.

Volts: anode 1, 520; anode 2, 2000; grid, 75; filament, 6.3.

Filament current, 0.6A.

This information is obtained from the "International Radio Tube Encyclopedia" published by Benards (Publishers) Ltd., The Grampians, Western Gate, London W.6.

POWER OSCILLATOR: Have you published a circuit for an oscillator with an output of 15,000KHz at 12V and 4 to 4.5A. I wish to use it for lighting in a model locomotive and rolling stock by placing a capacitor in the rolling stock to separate this frequency from the DC used to power the motors. I want to use this method as in many cases I don't have enough room for anything larger than a capacitor. (W.S., St. Albans, Vic.)

● We have not described a project of the type you require, but we wonder if the frequency you quote is correct; more likely it is 15KHz or 150KHz. Further, a device such as you describe would radiate its 50W in the HF band and cause interference to receivers operating in the area. We suggest that you read the articles we published on lighting for model railways in October to December, 1967, inclusive. Copies of the articles are available through the Information Service for 20c each. (File Nos. 2/MX/12, 13 and 15.)

THOSE BOOKS! For about two years, I have been an avid reader of your excellent magazine and have never wished for a higher standard of workmanship and design than is evident in your various projects. I particularly enjoy reading your section entitled "Technical Books and Publications." I like the way you clearly state the facts about some of the poorly designed circuits in the books that are presented for review. I wonder just how good are some of the circuits that I come across in various books that I buy. I find myself turning more and more to your magazine and tend to ignore other books unless you recommend them. May I also compliment Leo Simpson on his design of the Theremin. (G. McK., Roma, Qld.)

● We do try to maintain a high standard of presentation in our projects and articles and it is gratifying to read your reaction. You can rest assured that we do not

enjoy "knocking" books. It is much easier to write words of commendation than of censure. Leo Simpson has duly taken his bow! We shall keep our eyes open for new ideas to do with electronic musical instruments.

MORE POWER OUTPUT: I agree with your correspondent I.A.G., Brisbane (October issue), regarding the desirability for more power output. Some years ago, I built your Playmaster 101 with accompanying control unit, with which I have been most happy. Its power output has been more than adequate with one exception — at large, noisy parties, its total of 20 watts for the two channels seems to be submerged. I am therefore looking around for a larger system to use with my present equipment. (P.S., Hurstville, N.S.W.)

● Give our regards to your neighbours, P.S.! It looks as though you'll be lining up for the parts for our new solid-state amplifier. Thanks for the very nice remarks about the mag. with which you ended your letter.

CROSS-FIELD BIAS: I am very interested in the subject of cross-field bias and slow-speed recording, discussed in "Audio Topics" in the October issue. I should like to know a lot more about cross-field bias, such as: Can it be incorporated into my present recorder? Does it use an ordinary record-play head? Can the bias leads be disconnected from the recording head, then reconnected to the separate bias head? If leads to the erase head were cut and fitted with a switch so as to switch off for recording sound-on-sound, would this have any other effects on the system or machine? I enjoy reading the magazine, and try to pick up points, especially on tape recorders. (A.B., Mitchell Park, S.A.)

● We can understand your interest in the subject but your questions are of a type which we state specifically to be outside the scope of our query service. Note what we say in the panel in the "Answers To Correspondents" page under the heading "Commercial Equipment." Our impression is that any idea of adding cross-field bias to an existing recorder would involve a complete appraisal of mechanical and electrical design and is not the kind of exercise which could be undertaken at anything less than laboratory level. Simply to disconnect the erase head might completely upset the level of bias in the record head, at least in many recorders. We imagine that you would have to substitute a resistive load of such value, determined experimentally, that the amplitude and frequency of the record bias would remain the same with either the erase head or the resistor in circuit.

What's a few million miles?

DISTANCE TO MARS: Re "Mars Landing in 1973," by William Clothier (July, 1969) and W.G.P., Jannali (Correspondent, October, 1969). You do Mr Clothier an injustice and yourself a discredit by unreservedly agreeing with W.G.P. It appears that W.G.P. has misquoted both the author and his informant at the observatory. Fifty million miles is not the mean distance between Earth and Mars but is the average distance between their orbital paths (93 million and 142 million miles radius respectively). Earth and Mars approach as close as 36 million miles and move as far away from each other as 247 million miles. The article implied (second paragraph) that at the time of the landing the distance between the planets would be 150 million miles. This works out to be about right if the probe is to be in space for the shortest possible time (about eight months). (L.B., Toowoomba, Qld. and R.V., Oakleigh, Vic.)

● The above is a composite condensation of the two readers' letters, which contained almost identical data. All of which seems to suggest that we should apologise for apologising — or something! Seriously, however, it does appear that W.G.P.'s inquiry went off the rails somewhere; either he asked the wrong question of the observatory, or they misunderstood his question, or he misunderstood their answer. Anyway, the explanation offered by our two readers appears to be a most competent one, and should clarify the position once and for all. And we tender our apologies to anyone to whom an apology is owing.

BUY RIGHT... FROM ENCEL

CONNOISSEUR.. FOR CONNOISSEURS The highly successful SAU-2 Tone Arm

This unusual and highly effective tone arm features a revolutionary type gimbal mounting with axis at 45 deg. Bias adjustment is automatic—an action-dampening, resilient backed rear counterweight controls the playing weight. The lifting/lowering device is standard equipment. The head shell accepts all standard 1/2in mounting cartridges. A small set of scales (accurate to 0.1 gms.) to set the stylus pressure, is provided. The arm height is adjustable: 7/8in to 1 1/2in. SAU-2 tracks down to 1 gm. (Write for copies of "Hi-Fi's" review.)

Price
(including sales
tax)

\$29.50

SCU-1 STEREO CARTRIDGE

SCU-1 is designed to load effectively any amplifier or tape recorder. This ceramic stereo cartridge, which comes with a diamond stylus, has an extremely wide frequency response. (Write for copies of reviews.)

Price
(including sales
tax)

\$12.50

TURNTABLE BD-1

This turntable gives "no compromise" performance at modest cost. The unique flexible belt drive eliminates vibration and transmission noise. The motor's low hum field makes the unit suitable for the most sensitive pickups. To attain maximum performance and sensitivity, complex mechanisms have been avoided. But mechanical specifications of the highest order have been maintained. Slim line construction.

Price
(including sales
tax)

\$39.50

TURNTABLE BD-2

This turntable gives "no compromise" performance at modest cost. The unique flexible belt drive eliminates vibration and transmission noise. The motor's low hum field makes the unit suitable for the most sensitive pickups. To attain maximum performance and sensitivity, complex mechanisms have been avoided. But mechanical specifications of the highest order have been maintained. Slim line construction. Fitted with SAU-2 pickup arm and mounted on oiled teak base.

Price
(including sales
tax)

\$79

**ENCCEL
ELECTRONICS
(STEREO) PTY. LTD.**

Head Office:

431 Bridge Rd., Richmond, Vic. 3121. Tel. 42 3762.

Sydney Store: Ground Floor, 2SM Building,
257 Clarence Street, Sydney, N.S.W. 2000.

Tel. 29 4563, 29 4564.

■ Wholesalers ■ Trade-ins accepted ■ Terms

Australia's Greatest Hi-Fi Centre

HAM RADIO SUPPLIERS

Mail Order Specialists

323 ELIZABETH STREET,
(2 Doors from Little Lonsdale Street)
MELBOURNE, VIC. 3000
TELEPHONES: 677329, 674286

7 WATT SOLID STATE STEREO AMPLIFIER
10 Transistor, 3.5 Watts per channel, Crystal/Ceramic input (250mV), Frequency Response 50-20,000 c/s, 8 and 16 ohms output, polished wood case, metal front panel. Dimensions: 8½in x 3in x 5 3/8in.

Special Price \$34.50. Post 75c



REALISTIC DX-150 SOLID STATE COMMUNICATION RECEIVER

Features:
240V A.C. or 12V D.C. operation.
30 Transistors and Diodes.
535 Kc. to 30 Mc. in 4 Bands.
Bandspread tuning, "S" Meter, AM/CW/SSB.
Product Detector for SSB. Compact size
14 1/8in x 9¼in x 6½in. Polished metal panel,
small internal speaker.

F.O.R. PRICE: \$229.50

Matching external speaker \$13.30 extra.

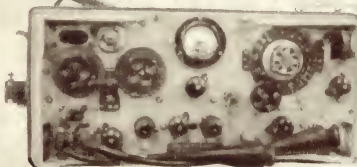

No. 62 TRANSCIVERS. Wireless set No. 62 Mk.2 (PYE) Frequency Range 1.6 to 10 McS. in 2 bands, inbuilt 12-volt Genemotor Power Supply. Clean condition. Fully air tested on Transmit and Receive.

F.O.R. PRICE: \$49.50



WESTON LM-330 MOBILE TAXI RADIO. Low Band A.M., 60 Kc. Bandwidth, 70-80 Mc. Crystal Channel Locked, Single Channel, inbuilt Transistor Power Supply, 12-volt operation, suit country taxi service or conversion to Ham Bands, inc. microphone and cradle.
AS NEW AND AIR TESTED.

F.O.R. PRICE: \$45. Packing 50c

LAFAYETTE *5 WATT C.B.

TWO-WAY RADIO
MODEL HE-20, FULLY TRANSISTORISED, SOLID STATE, 13 Transistors, 10 Diodes, 27,240 Mc. Provision for 23 channels, CRYSTAL channel locked, Push-pull Audio Modulator, 455 Kc. mechanical filter, spotting switch for accurate reception, TVI Trap, 230V A.C. and 12 Volt (positive or negative ground), inbuilt P.A. Amplifier, IDEAL FOR FIXED BASE STATION OR EMERGENCY MOBILE, including microphone and mobile cradle.
* Subject to P.M.G. approved licence.

F.O.R. Price: \$169.50. Tax Paid
Fibreglass Helical Aerial 4ft high, cowl mount, for mobile use \$16.50 extra.



BENDIX BC-221 FREQUENCY METER. 125Kc. to 20 Mc. including A.C. power supply. CRYSTALS, Calibration Book etc. V. clean condition.

F.O.R. Price: \$49.50. P'ckg. 75c



MODEL C-1000 POCKET MULTIMETER, 1000 ohms/per Volt. AC Volts: 0-10/50/250/1000 (1000 opv). DC Volts: 0-10/50/250/1000 (1000 opv). DC Current: 0-100mA Resistance: 0-150K ohms (3K centre). 2 colour scale. Range Selector Switch. Dimens.: 3½ x 2¼ x 1in.

PRICE: \$6.50 post free



MODEL 200H MULTIMETER, 20,000 opv, DC Volts: 0-5/25/50/250/500/2500V (20,000 opv) AC Volts: 0-15/50/100/500/1000V (10,000 opv) DC/Amps: 50uA/2.5mA/250mA. Resistance: 0-60K/6M ohm (scale centre 300 ohm—30K ohm. Capacitance: 10uF to .001uF/.001uF — .1uF, D3 scale 20 db to plus 22 db. Size 4½ x 3¼ x 1-8.

PRICE: \$11.25 post 30c.



MODEL CT330 MULTIMETER, 20,000/OPV, DC Volts: 0-6/6/30/120/600/1.2K/3K/6K Volts. AC Volts: 0/6/30/120/600/1.2K Volts (10K/OPV). DC/Amps: (0-0.06mA/60mA/600mA). RESISTANCE: 0-6K/600K/6M/60M/600Megohm. (30/3K/30K/300K ohms) centre scale; Capacitance: 50 uF to .01 uF .001 to 0.2 uF. Decibels: —20 to plus 63db size approx. 5½ x 3 5/8 x 1¾.

PRICE: \$16.75 post 30c.



MODEL OL-64D MULTIMETER. 20,000/OPV, DC Volts: 0-0.25/1/10/50/250/500/1000V at 20K/OPV. 5000 volts at 10K/OPV. AC Volts: 0-10/50/250/1000V at 8K/OPV. DC/A: 50uA/1mA/50mA/500mA/10 amps. RESISTANCE: 0-4K/400K/4M/40Megohm. DB Scale: —20 to plus 36db. Capacitance: 250pF to .02uF. Induct. 0-5000H. size 5¾ x 4 1/8 x 1¾in.

PRICE: \$19.50 post 30c.



NEW MODEL US-100. Overload protection. Shockproof Movement, polarity switch. DO volt: 0.25/1/25/10/50/250/1000V (20K/OPV) AC Volts: 0-2.5, 10/50/250/1000V (5K/OPV). DC/Amps: 1mA/25mA/500mA and 10A. AC/Amps 10A. RESISTANCE: 0-50M/ohms (centre scale 50) R X 1/10/100/1K/10K, db scale —20 to plus 10 plus 22/plus 35/plus 50 db.

PRICE: \$28.75 post 40c.

Mirror Scale



MODEL AS100/DP HIGH SENSITIVITY 100,000/ohms/volt DC, Mirror Scale, PROTECTED MOVEMENT, SPECIFICATIONS: 6/20/120/300/600/1200 Volts A.C. (10K/OPV), Volts D.C.: 3/12/60/120/300/600/1200 (100K/OPV) D.C. Amps: 12uA/6mA/60mA/300mA/12 Amps. RESISTANCE: 2K/200K/20Mg/200Meg, Decibels: —20 to plus 63db. AUDIO OUTPUT: 6 Volts/30/120/300/600/1200V A.C., Size: 7½in x 5½in x 2¾in.

PRICE: \$34.50. Post 75c



MODEL A10/P. GIANT (6½-inch). METER, CIRCUIT TESTER 30,000/OPV D.C. with inbuilt signal injector, overload protected, Specifications: A.C. Volts: 2.5/10/50/250/500/1,000 (10,000/OPV). D.C. Volts: 0.5 Volts/2.5/10/50/250/500/1000 at 30,000/OPV, 5000V at 10,000/OPV, D.C. Current: 50uA/1mA/50mA./500mA./1 Amp/10 Amp/A.C. Current: 1 Amp/10 Amp. Resistance: 10K/100K/1 Megohm/100 Megohm. SIGNAL INJECTOR: Blocking Oscillator circuit with a 2SA102 Trans. DECIBELS: —20 to plus 63db. SIZE: 6½in x 7¼in x 3¾in.

PRICE: \$55 Tax Paid. Post 75c



TE-16A TRANSISTORISED TEST OSCILLATOR. Freq. Range: 400Kc. to 30Mc. in 5 bands. Modulated: 800 c/s sine wave. Modulation: 30 p.c. approx. Output Imp.: Low impedance. Dimensions: 5 7/8in x 5 7/8in x 3 5/8in. Weight, 1.5lb.

PRICE: \$23.75. Tax Paid. Post 75c.

TRIO COMMUNICATION RECEIVER MODEL 9R-59DE

4 band receiver covering 550 Kc/s to 30 Mc/s, continuous and electrical bandspread on 10, 15, 20, 40 and 80 metres. 8 valve plus 7 diode circuit, 4/8 ohm output and phone jack. SSB-CW. ANL
• Variable BFC • S meter • Sep. bandspread dial • IF 455 Kc/s • Audio output 1.5 W • Variable RF and AF gain controls. 115/250V. A.C. Mains. Beautifully designed. Size: 7 x 15 x 10in. With instruction manual and service data.

PRICE \$175 inc. Sales Tax.

Speaker to suit type SP5D inc. tax.

02S Large Rubber Earpiece. 20-12,000 c/s (as per photo). **\$6.75**

03S As above. Larger earphone. 20-18,000 c/s. **\$9.25**

04S Deluxe model Individual Tweeter and Woofer control. **\$12.95**



"NIKKA" 1 WATT TRANSCIVERS

P.M.G. APPROVED. SOLID STATE 14 Transistor Circuit inc. R.F. Stage. 27,240 Mc (Provision for 2 Channels). Range Boost Circuit. Up to 10 miles in open country or water. Buzzer Type Call System. Squelch Control. Complete with leather carrying case.

\$165.00 PAIR

ANSWERS - continued

While the emphasis, these days, seems to be on frequency standards using crystals, integrated circuits and logic techniques, it is possible to produce a useful audio standard for laboratory or music situations using valves and a tuning fork. The only unusual components in this circuit are the drive and pickup coil units shown alongside the fork. In fact, these were simply ex-disposals type ear-phones made by S.T.C. or Stromberg-Carlson and branded "C.L.R."; at the time, they were referred to as low impedance types. Used without diaphragms, they were locked rigidly

on either side of the fork, the spacing being critically adjusted so that the oscillator would start reliably and maintain oscillation without overdriving the fork. The fork, too, has to be mounted rigidly and, in the prototype unit, the fork and coils were held by clamps to a stout wooden block. This was glued to a piece of foam plastic which was glued, in turn, to the metal

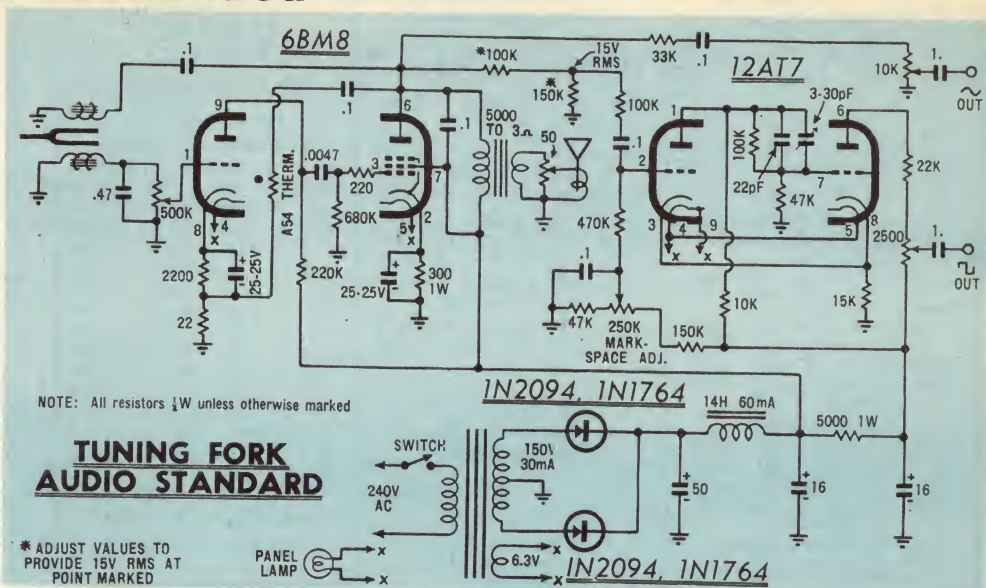

chassis of the instrument. The Tuning Fork Frequency Standard was described in full in our October, 1961, issue (then called "Radio, Television and Hobbies"). Copies of the article are available for 20c. Address your letter to the Assistant Editor, "Electronics Australia," Box 2728, G.P.O., Sydney, 2001. Quote our file number 7/AO/8.

● Thank you for your appreciative comments, which we are too modest to print in full! Also for the various suggestions, which we will certainly keep in mind. Regarding amateur telemetry, experiments of the kind you have in mind might possibly receive the approval of the P.M.G.'s Department for operation in one of the amateur bands or on 27MHz. We suggest you contact the Radio Branch for further information. We believe the Radio Branch has a district office in your town. However, we cannot really see the point in using a radio link over the short distance you have in mind. A cable link would be much simpler, as well as more economical and efficient.

DIGITAL READOUT: To my knowledge, you have never published a circuit for an electronic counter or digital readout system. The crystal clock was designed to drive a conventional readout, and I

BASIC ELECTRONICS: Would it be possible for you to publish a series of articles explaining the basic principles of electronics. This would assist boys attending secondary school, such as myself, to have a reasonable understanding of the subject. (M.K., Queenstown, S.A.)

● We published a series of articles similar to what you have in mind a few years ago. We have reprinted those articles in booklet form under the title "Basic Electronics." Copies of this are available through the Information Service for \$2.20 including postage.

RADIO CONTROL UNIT: Congratulations on your magnificent magazine which represents the best buy of any radio/electronics magazines on the market, with no exceptions. I would like to see you publish another radio control unit (transmitter and receiver). Like G.P. (October issue, page 187), I would appreciate an article on a more up-to-date control transmitter. In your reply you said you were investigating a new radio control system, and I should like to make a few suggestions:

(1) The receiver and transmitter should both be completely transistorised to save the expense and bulk of HT batteries.

(2) The receiver should be extremely light to facilitate its use in such models as aeroplanes, rockets and gas-filled balloons.

(3) The units need have a range of only about 100-150 yards, as outside of this most models are out of sight and therefore uncontrollable.

I should also like to see an article on the production of a complete issue of the magazine, from the initial work on projects and articles to the finished magazine. I feel that if this was published, readers would have a better understanding of how their magazine is produced.

I find that electronics often comes in handy in connection with my other hobbies of motor racing and weather watching. For example, I have just completed

a transistorised ignition system and tachometer for my go-kart. The basic ideas for these units were obtained from your magazine. Can you tell me if there is any provision in the radio spectrum for the use of amateur telemetry units? This would be useful in recording of weather information from a distant point (the back yard, for example). (B.R., Maryborough, Qld.)

"COMMUNICATOR" Mk VB 1970 MODEL

with more built-in features than ever before.

- Greater range and reliability, by coupling the 1 watt output to an unbreakable centre loading whip antenna.
- Extended battery life, by using space age calling light device.
- Extra sensitive squelch control, which reduces outside noise to a minimum.
- Sturdy unbreakable case, and for extra protection a leather carrying case.

**CURRENTLY \$95 including sales tax.
Phone 82-0730.**

GENTELEX SECRETARIES

Automatic telephone answering and message recording unit. Solid state design. P.M.G. approved. **New from \$245.**

Also second-hand, fully warranted units in stock. Price on application.

Phone 82-0739.

In stock a range of traded-in walkie talkie units, also to suit the amateur mobile 2-way radios, base stations, parts and test. Equipment from \$10.

TWO-WAY COMMUNICATIONS PTY. LTD.

202 VICTORIA ROAD, ROZELLE 2039

Telephone 82-0730

SOUND PROJECTORS

Cinevox Prefect and Harpox and Heath 16mm in good working order. 240v operated, complete with speaker and amplifier. **from \$90.00**

CIRCULAR SLIDE RULE
3 3/4in diameter. Will do the same work as the conventional slide rule. Instruction book included.

\$1.25 each
Post 10 cents.

REFLECTOR GUNSIGHT

Contains these lenses:
1 Lens 1 1/2in Focus, 1 1/2in diam.
1 Lens 1 1/16in Focus, 1 1/4in diameter.
1 Air-spaced Lens, 1 1/4in diam.
1 Filter Lens, 1 Graticule.
1 Lampholder. **\$1.85**
Post.: N.S.W. 30c; Interstate: 40c.

P.M.G. TYPE TELEPHONES

Standard desk type with magneto bell calling device. Range 30 miles. Uses standard batteries at each phone. Any number can be connected together on single line. **\$23.00**

(2 TELEPHONE SETS)

30c cartage to rail. Freight payable at nearest attended railway station.

Please note we are now able to include 1/2 mile of telephone cable FREE with each set of phones.

BATTERY CHARGERS

240 volt A.C. Input. Each battery Charger will charge either 6 or 12 volt batteries.
2 amp. without meter, **\$13.75**
2 amp. with meter, **\$18.75**
Post N.S.W. 70c; Interstate 95c.

MINIATURE ELECTRIC MOTORS

1 1/2 to 3 volts D.C. Ideal for model boats, cars, planes, etc. Strong torque. Only **65 cents each or 10 for \$4.00.** (Post 7c).

TRANSCEIVER

(2-way radio) R.C.A. America RT 68, 24 volt, operated 10 watt output 38-54 megacycles F.M. crystal locked. Transmitter and receiver using frequency synthesiser in 100 K/c/s; step 10 channel per meg/cycle with power supply. Leads, mike and headphones \$45, 60c cartage to rail. Freight payable at nearest attended railway station.

TRANSCEIVER

(2-way radio) 62 set ideal small ships, Hams, etc. 1.6 to 10 megs. Crystal locked or V.F.O. controlled 5 watt output. Complete with antenna, headphones and mike \$60, 60c cartage to rail. Freight payable at nearest attended Railway Station.

HEAD PHONES

Low impedance moving coil fitted with rubber muffler to reduce external noise, fitted with press to talk, dynamic hand microphones. Ideal for use with all types of transceivers. \$3.50 pair. Same with black felt muffler, \$4.50 pair. Post N.S.W. 25c; Interstate 30c.

12 VOLT D.C.

DESYNTH INDICATOR AND TRANSMITTER UNIT. Suitable for aerial rotation indicator, etc. 0-360 deg., weatherproof mountings.

\$5.00 per set.
Postage: N.S.W., 95c;
Interstate \$1.67.

16'6" WHIP AERIALS

6-Piece, brand new, \$5.75, 60c cartage to rail. Freight payable at nearest attended railway station.

AVO MULTI METER

Type CT 38
\$75.00

A.W.A. AUSTRALPHONE

Transceivers 12 V New Complete Station, 1.6 to 10 megs on transmit. 0.54 to 16 megs on receive. **\$150.00**



P.M.G. Phone Jack and plugs, 25c each, 45c the pair. Post 7c.

NIFE CELLS

1.2 Volt fully charged. 4in x 3in x 1in 4 AH. **\$1.00 each**
Post. N.S.W., 25c; interstate 35c.

WALKIE TALKIE TWO-WAY RADIOS

P.M.G. Approved Citizen Band. 9 Transistor, \$79.00 per set of 2. Post. N.S.W. 50c; interstate 60c.

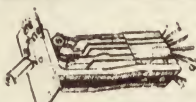

P.M.G. TYPE KEY SWITCHES. 45c each. Post. 15c.

BC 221

Frequency Metres
\$55.00

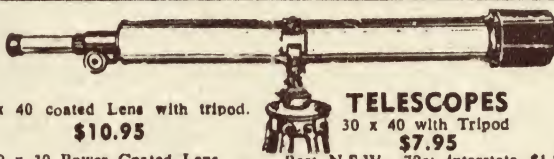

TELESCOPES

45 x 40 coated Lens with tripod. **\$10.95**
30 x 30 Power Coated Lens Brand new. **\$3.75**
60 magnification with a 60mm coated objective lens. With tripod. **\$23.00**
As illustrated.
Postage, 95c; Interstate \$1.20.

HIGH STABILITY RESISTORS

I.R.C. brand new, usually 80c ea. 50 assorted values for only **\$3.75**
Post 15c.

RECEIVER 8C A.W.A.

With ABC and D Coils. Complete with all spares. **\$90.00**

ZOOM FOCUSING MICROSCOPE

Battery and mirror illuminated 900 X magnification, complete with dissecting kits, slides. **\$14.50.**
Postage N.S.W. 65c. Interstate 85c

TYPE S POWER SUPPLY

(240 Vac supply for AT 5-ARB) suit most types of Disposal transmitters and receivers outputs 250 volt, 10ma 550 volt 200ma, 300 volt 100ma. **\$30.00**

TELEPHONE WIRE

21 gauge copper, plastic covered. Ideal telephone or bell wire. 1,320ft coil of twin (equal 1/2 mile) \$7 per coil.
Post. N.S.W. 70c; interstate \$1.20.

SCOOP PURCHASE

Gramo Motors. New. Made in U.S.A. 4-speed 240 volt A.C. 50 cye. Only **\$2.75 each.**
Post. N.S.W. 30c; interstate, 40c.

CO-AXIAL SWITCH

70 ohms 4 positions, can be motor driven completely waterproof 70 ohms type connectors. Housed in metal case 9in x 8in x 8in \$5.00 each. Post N.S.W. 70c. Interstate \$1.20.

ASTRONOMICAL TELESCOPE

3 1/2in reflector 126 X magnification. Complete with 4 X finder and equatorial mount. **\$59.00**
Post \$1.50.

VALVES BRAND NEW IN CARTONS

Special discount for quantity

807	75c	X61M	\$2.20
65N7GT	95c	CV850	\$1.50
8989	\$1.00	1H6G	30c
5U4G	95c	832	\$5.00
77	\$1.00	6AK5	\$1.50
EF50	35c	6X4	\$1.00
6U7	75c	12SK7	80c
5Y3	\$1.75	VR65	25c
6C4	80c	VT4C	75c
2 x 2	75c	AUS	\$1.00
6AG5	80c	80	\$1.25
12AU7	\$1.00	6AK5W	\$1.50

CATHODE RAY TUBES

3FP7	\$2.95	5BP1	\$3.50
3JP1	\$2.95		
V1669 4/1	\$2.95	CY2184	\$2.95

PLEASE ADD POSTAGE ON ALL ARTICLES

MINE DETECTORS

Ex A.M.F with Instruction Book. Complete in wooden case. Ideal for plumbers, councils for locating buried pipes, etc. Freight payable at nearest attended railway station. **\$39.00**

4 DIGIT RELAY COUNTERS

50-volt D.C., suit slot car. Lap counters, etc. **\$1.25 each.** Post 13c.

ALTEC STUDIO MICROPHONES

639B Western Electric, top grade, original cost \$250, ideal Broadcast Studio, music recording, Church and play recording, etc. Fraction of original cost. Price on Application.

240 VOLT 522 POWER SUPPLY

Supplies all necessary voltages to operate 522 transceiver from 240 V.A.C. Complete and ready to plug in **\$30.00.**

SOLENOIDS

Plunger Type 12V 300M.A. Suit electric camera control, miniature trains, radio, etc. **\$1.25.** Post. 10c.

200 Mill. amp., 24 volt, 1/8in push movement. **\$1.25.** Post 10c.

LENSES

TOP GRADE ACHROMATIC 2in DIAMETER, 20in FL. Ideal as telephoto lens, telescope objectives. \$13.
Postage 46c.

CONDENSER LENS

2 1/2in DIAM. 2in FL. \$1.50 each or \$2.50 per pair. Post 21c.

CONDENSER LENS

1 1/2in diam. 1 1/2FL. 50c each. Postage, 17c.

FOUR CHANNEL BRANCHING AMPLIFIER

With 4in Vu, meter GLORAD. Complete with Portable Power Converter. 600 ohm balanced input and output. Ideal for outside broadcasting, etc. **\$39.50**

MONITOR SPEAKER UNIT

Ex-A.B.C., consisting of low resistance 8in speaker in Acoustic Labyrinth Baffle Box, complete with 10-watt amplifier, 600 ohms plus 8dbm input, 240 volt A.C. operated. **\$37.50**

TEN CHANNELS VHF TRANSCEIVER

Types TR1934 100-125 meg/cys. and TR1935 125-150 meg/cycles. 28 volt DC operated AM single crystal locks both TX and RX on same channel complete with generator. **\$33.00**

RECORDING TAPE

Ex broadcast studio E.M.T. 3600 feet on 10 1/2in spool, \$4.50. Postage 85c, 600 feet on 5in spool \$1.45, postage 13c. 150 feet on 3in spool, 65c, postage 9c.

CASSETTE TAPES

C60 \$1.60, C90 \$2.20, C120 \$2.99. Post 13c.

TELEPRINTER PAPER TAPE

8 1/4in x 6 5/8in Full Page
\$1.50 per roll.

WHEATSTONE BRIDGE

Top grade
In Multiples up to 1000
\$65.00

Deitch Bros.

70 OXFORD STREET, SYDNEY, 2010

SORRY, NO C.O.D.

ANSWERS - continued

have seen advertisements in your magazine for mechanical digital readouts costing about \$30. Would an electronic unit be much dearer, bearing in mind increased reliability, accuracy and perhaps decreased power consumption? The prime use of ICs is in digital circuitry, and this may make the idea practical. I am surprised you did not use IC dividers in the crystal clock, as this might avoid the problems inherent in free-running multivibrators. As you may have gathered, I do not know much about digital circuitry. M.L., East Kew, (Victoria.)

● We are currently working on a series of digital readout instruments, based on ICs which will be presented as soon as practical. An electronic digital readout for the crystal clock would make the project very expensive as prices now stand.

5BP1 CR TUBES: A friend and myself have each obtained a 5BP1 cathode ray tube. Do you have any articles describing equipment using these tubes? Anything you could supply would be greatly appreciated. (P.S., Dallas, Vic.)

● "Audio" oscilloscopes using the 5BP1 tube were described in the April 1955 and June 1960 issues, while a wide-band oscilloscope using the tube was described in the February, March and April 1957 issues. An adaptation of the 1958 TV Receiver for this tube was described in the September 1958 issue. The June 1960 and 1957 group of oscilloscope articles, and the September 1958 TV article, are still available from our Information Service at the usual rates. It should be noted that the 5BP1 tube has been obsolete for a long time now, and that even tubes described as "brand new in original carton" are very likely more than 20 years old. Even if they are still in new condition, their performance is likely to be disappointing in comparison with modern tubes; also after so many years of storage there is a strong chance that they will have gone "soft", or have otherwise deteriorated. In short, it would be very wise to have the tubes checked thoroughly before purchasing any other components for an oscilloscope or TV receiver.

INFRA-RED DIODE: I recently began building an improved infra-red communications device but had to abandon the project because I found that the infra-red diode would cost about \$50. Could the device be modified to use something cheaper? I would also like to know of any source from which I could obtain circuits for short-range radio communication equipment (200 to 300 yards) and also for SONAR equipment. (D.G., Brookfield, Qld.)

● Since the infra-red device was not one of our projects, we cannot justifiably take time off to investigate the position for you. However, light emitting diodes are still rather special devices and we are not optimistic about your chances of obtaining a cheap substitute. We can only suggest that you get in touch with the firm which first issued the circuit; they should be in a good position to advise. It may also be worth your while to write to the Components Division of Plessey Ducon Pty. Ltd., P.O. Box 2, Villawood, 2163. If you have an amateur licence, you can use home-made transmitting equipment within the terms of your amateur licence. For radio control activities you can also use home-made equipment on certain frequencies, details being available from the Radio Branch in Brisbane. For activities other than these, you must have a licence and must use type approved equipment, which largely rules out the home-made variety. We do not know where you might obtain circuits for SONAR type equipment. The fact that this relies on specialised transducers and often electro-mechanical display equipment makes it

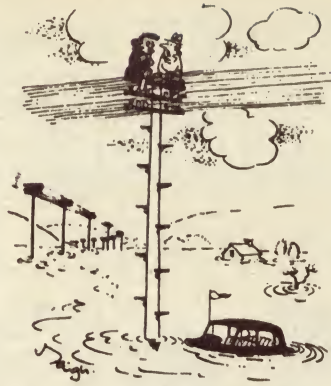

Stop grumbling, Martha—you stay on the phone for hours at home! ("Rolls Royce News.")

rather unattractive for home building, except around a fully packaged kit. We suggest that you check with Messrs Warburton Franki, to see whether there is a depth sounder in the Heathkit range which will suit your needs.

TRANSISTORS: Have you published any articles explaining how transistors operate? I have been reading the magazine for a while now, but haven't seen any dealing with this subject. I have also missed the July, August and September 1969 issues, and wonder how I can obtain back copies. (C.M., Westport, Vic.)

● Articles dealing with the operation of bipolar transistors were published in the May and June 1958 issues, C.M., while

articles dealing with other types of transistor have been published more recently in the "Keeping Up With Semiconductors" series. Examples are the article of August 1966 dealing with the uni-junction, and that of February 1967 dealing with the field-effect transistor. However probably of more immediate use to you would be the current series of "Fundamentals of Solid State" articles, which commenced in May 1969. These start right off from basic electrical theory, and are dealing in turn first with diodes and then with the various types of transistor and more complex devices. The three issues of the magazine which you have missed are all available from the Information Service, at a cost of 45c, plus 10c postage, each.

SPEECH TRAINING: In the footnote to the "Musicolour" unit in the October issue, you mentioned that a reader was using a similar device to teach deaf children and that he was seeking a method whereby he could present a visual interpretation in terms of loudness and frequency. Has he considered using an oscilloscope, which should efficiently fulfill both these requirements? (S.W., Kogarah, N.S.W.)

● An ordinary oscilloscope produces patterns which are certainly related to both amplitude and frequency but they have to be interpreted in a somewhat technical way. Transient peaks happen so rapidly that they may not be easily seen and the pattern is not segmented in terms of bands of low, middle and high frequencies. Oscillographic techniques are used to analyse speech patterns but the equipment involved differs markedly from ordinary oscilloscopes. The idea behind the training aids in question is to build the display around coloured lights or other gadgetry which will interest children and not look like test equipment from the adult, scientific world.



ADCOLA

SOLDERING TOOLS

THE VITAL POINT IN PRECISION SOLDERING

No more guesswork . . . the correct size, the correct temperature for every job.

See the range of Adcola "M" Series Solder Tools illustrated in Electronics Aust. September 1969 edition or write for illustrated brochure to:
ADCOLA PRODUCTS PTY. LTD. LIMITED, 22 Firth Street, Doncaster, Vic., 3108. Phone 848-3777.
ADCOLA PRODUCTS PTY. LTD., 17 Burwood Road, Burwood, N.S.W. 747-1606
Queensland: T. H. Martin Pty. Ltd., 56-74 Edward Street, Brisbane. 2-0555
F. R. Mayfield Pty. Ltd., 11 Halifax St., Adelaide, S.A. 8-4131
W. Australia: Everett Agency Pty. Ltd., 17 Northwood St., West Leederville, 6007
Phone 84137



Special! Tremendous value! Standing idle. Direct purchase in huge quantity from manufacturer enables us to sell top quality charger at nearly 1/2 price. Comes complete with long leads and plug in mains power when car is fully portable or mount under bonnet. (This is ideal for milkmen, bakers, etc., anyone whose car is continuously stop-starting, just plug in mains power when car is not in use.)

A beautifully made trickle charger for 12 VOLT car, truck, tractor, boat, etc. Charges batteries overnight from 240 VOLT MAINS. Cannot overcharge battery. Can be used in car or home.

Special! Money cheerfully refunded if not completely satisfied.



SPECIAL BRAND NEW
Famous English Automatic GARRARD RECORD CHANGER — \$32.50 p. & p. \$1.50

Quality checked by Garrard. Type 1025, automatic record changer and player wired for stereo. Latest 240V 1970 model just released. Takes all size records 45's, 10" and 12" — up to 9 records at a time. Features many refinements: 4 speed laboratory series motor, adjustment for pick-up height, adjustment for stylus pressure, etc. Brand new in cartons.

Famous English "ACOS" complete PICK-UP cartridges with STYLUS. Current issue to fit "Garrard" player. GP 91-2. Mono Crystal Sapphire STEREO COMPATIBLE, usually \$6—now \$2.50. GP 93-1 stereo Crystal Sapphire, usually \$7.55—now only \$3.50. GP 93-1 stereo Crystal Diamond, usually \$8—now only \$4.50. GP 94-1 stereo Diamond Ceramic, usually \$9—now only \$5.50. Cartridges sold separately, fit nearly all make players.



LIQUID PRISMATIC COMPASSES
\$24.50 p. & p. 50c

British Army issue—accurate to under one degree. Stout hinged brass case, external diameter 2 inches. Prism Holder with focussing arrangement. Compass interior contains Mother-of-Pearl Azimuth, divided to single degrees, mounted with sapphire centre floating on liquid on an iridium point. Transparent Rotary Scale on case divided to every 5 degrees and figured every 1 degree. Its steadiness makes it a perfect compass for geologists or surveyors or for taking bearings from boats, cars, aircraft, etc. Units are near new and fully checked by instrument maker. Sells at a fraction of Govt. cost. Absolutely brand new \$32.50. We have sold these to nearly every Govt. dept., shire Councils, mining coys., surveying coys., etc. in Australia.

DIRECT DISPOSALS TRADING COMPANY
36 HELEN ST., VALLEY, BRISBANE, QLD. 4006
(3 SHOPS BRISBANE. PH. 5 4833)

A.C. FAN
\$2.75



Post 60c. Small but very powerful 240v. mains motor by "VARLEY" England. With 4" 4 blade fan, ideal for cooling equipment or as extractor fan. Self-aligning bearings, silent but very efficient. Mounts from back or front. Brand new. Motor separate \$2.45. Post 60c.
0-10 amp. D.C. moving iron amp-meters. English \$1.95. P. & P. 20c. Rugged construction.

240v. Electric Pumps
BRAND NEW \$8.75



direct English purchase from a famous manufacturer. We purchased their entire stock of these ABSOLUTELY BRAND NEW in carton 240-volt electric motorized pump unit. Usually sell for \$25.00. Full 3 MONTH GUARANTEE. Special Neoprene impellor pump will handle corrosive fluids, fuel and water. Pumps 300 400 g.p.h. To be gravity fed and will lift to 8'. Ideal for fuel or water transfer, fountains, fish ponds, etc. Pump entirely non-corrosive. Rush your order now as stocks will not last at this price. Pack, post 75c.

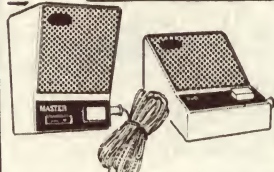

Famous make solid state INTERCOMS — \$9.50

Post 60c. Huge purchase of these brand new transistorised two station intercommunication system, comprising master and sub-station. A faultless unit with volume control and 50ft. of connecting wire. Has press-button buzzer call on each station. Battery-operated. desk or wall mounting. Indispensable in the home, office, etc.—DOOR PHONE—baby listening. Kitchen to nursery, etc. Operates up to 1/2 mile. Neatly packed in carton with wire, etc. Bargain, us. \$15.



CONT. DUTY 1/4th H.P. GEARED MOTOR \$12.50 P. & P. 75c.

Made by Du more, U.S.A., 28V D.C., works perfectly on 12V or 32V D.C., has threaded drive and shaft for standard flexible drive or pulley can be fitted to shaft. Approx. 150 final RPM. BRAND NEW.

NEW Type DLR No. 5 DOUBLE EARPHONES \$1.65



P. and P. 45c. Famous English make. Suberb for crystal sets, transmitters/receivers, silent radio and TV listening, etc.. Complete with long lead. New double earphones with microphone has press to talk switch. \$2.40, P. and P. 60c.



Magnificent "Cutler Hammer" TOGGLE SWITCHES Post pack 10c. 4-Pole, 3-way (3 position) panel switches (centre off). Handles 10 amps. at 12 or 24/32 volts D.C. Ideal for panels, control boards, 75c.

Micro switches 10 amp. 125v AC 5 amp. 240v AC, \$1.25, P & P 10c. New.

Fantastic New Item! **PEN TELESCOPE \$1.95** 10-Power pocket telescopes. 4 1/2" closed; 8" long extended. Very clear image. Has clip for pocket. Closed, can also be used as a 50-Power microscope. Post 10c. Use also for inspecting record stylus needles.

Compact Cassettes RECORDING TAPE
P & P 20c.

Top quality Philips type cassettes by famous maker sells at half price. Individually packed in plastic library box. C60 (60 min. recording time), \$1.75; C90 (90 min. recording time), \$2.65. C120 (2 hours) \$3.20

COMPUTER BOARDS
Enormous purchase from famous computer manufacturer.

Each board comprises a minimum 4 transistors and up to 6 transistors, plus host of resistors, diodes, capacitors, inductors, etc. Transistors are NPN & PNP germanium type T05 & T018 for R.F., audio, hi-speed switching, etc. 100's of uses. Size of board 2 1/2" x 4". 4 boards with minimum of 16 transistors \$2 post 20c. 8 Boards with minimum of 32 transistors \$3.50, post 25c. 16 Boards with minimum of 64 transistors \$6.40, post 60c. Special price for quantity.

11 position oak switch has 14-2500 ohm silver tolerance resistors housed in metal case with knob, size of switch 2 1/2" dia. x 4 1/2" long. New, ideal multimeter use \$2.50, p. & p. 30c.

Repeater Motors 28V D.C. steps per rev. 12. Size 2 1/2" x 2 1/2". New \$5.95. p. & p. 30c.

"SMITHS" SYNCHRO RESOLVER (2 phase/2 phase) 26-65V at 400 c/s. Size 2 1/2" x 1". New in cartons \$6.50. p. & p. 25c.



MORSE KEYS \$1.45
Adjustable, beautifully made for British Army, new. BUZZERS 1.5V. TO 3V.. 65c.

ENGLISH HEAVY DUTY TRANSFORMERS \$12.50

240 Volt input, 6.3 volt 4 times (4 terminals) 6.3V. at 8 amps. each terminal). Originally made for radar units by Aero Transformers; cost \$60 to make; weighs 14lb. Freight \$1.50.

ENGLISH NEON TESTERS — 25c.

Post 5c. Voltage tester for 180 to 300v. A.C. Complete with inbuilt resistor and flexible leads with prods. Glows on contact. Also ideal for panels, etc. Usually 65c.



\$1.65 MODEL MOTOR & GEAR TRAIN
\$1.65, P & P 25c. Powerful permanent magnet model motor in steel chassis, with all metal English reduction gear train, produces considerable torque, operating voltage 1 1/2 to 4 1/2 volts DC (torch batteries), final drive speed approx. 100 r.p.m. at 1 1/2 volts. Size 4" x 2 1/2" x 1 1/2" high, brand new, originally designed for Meccano products.

ANTENNAE RODS — 69c post 10c. 5 Section telescopic, chromed brass, fits most transistor radios, extends from 5 1/2" to 27", female threaded base.

24 volt English Selsyn (synchro) Repeater Motors (Slave) for indicators and other mechanisms. 4" x 4" x 3". Shaft 1/8" x 1/4". Also works on 12v or 32v. Type B2. Ref. No. 5U/4317. Freight 50c. \$5.95

HALF-PRICE SPECIAL HI-FI RECORDING TAPE

Fantastic purchase of "MYLAR" professional recording, computer tape (the best money can buy). Famous 3-name brand (one we can't mention due to huge price reduction). Silicone lubrication. Suits all tape recorders, hi-fi and stereo. Selling well under half price. ABSOLUTELY BRAND NEW post — 3" and 5", 10 cents post — 7", 20 cents

3" 225' 65c
5" 600' \$1.75
7" 1200' \$2.95
LONG PLAY
5" 900' \$2.45
5 1/2" 1200' \$2.75
7" 1800' \$3.95
Empty spools 3" 25c 5" 35c Post 10c each.

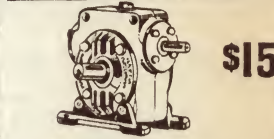

GEARBOXES No. 198
2 ratios available 10.5 to 1 and 14.5 to 1, made by David Brown "Radicon" England. Very robust construction, has two driving shafts at right angles and oil filler plug. Unit is drilled for 4-bolt fixing, size 4 1/2" x 4 1/2" x 3 1/2" and 5" dia. x 1 1/2" long shafts (cost over \$100 to make). Bargain 100 only. (Pack and Post \$1.)

NEW 4 AMP 3-18 volt SELENIUM RECTIFIERS Full wave Current English make. Brand new. Converts A.C. to D.C. 95c post 25c. 2 1/2 AMP. 65c (Post 15c).

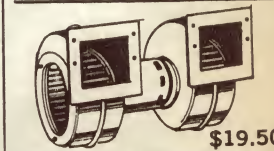

DOUBLE CENTRIFUGAL HIGH VOLUME BLOWERS
German "PAPST" balanced 240 volt A.C. ball-bearing motor, capacitor start with twin 4" x 4" centrifugal blower fans gives 350 c.f.m. Originally designed for computers. Three months full guarantee. freight \$1.50.

Computer Motors \$4.95 P. and P. 60c

Beautifully made for computers, 240V. A.C., 50 CPS, ball bearing, double shafts ea. 7" x 3/16", size of motor 4" x 2 1/2".

English reed switches, 1 amp. up to 50V. D.C. 3 amps. at 240V. A.C., 39c, P. and P. 5c. us. 95c.

INDUCTION MICROPHONES
Will pick up sound waves from a distance. Has suction cap, long cord and plug for tape recorder, etc. Sticks to wall or case of telephone for recording speech. \$1.25.

12 VOLT D.C. FAN — \$2.85

P. and P. 30c. Made in England has 5" 3 blade plastic fan. Bargain. Motor is reversible for blowing or extracting air.



CRYSTAL MICROPHONES \$1.40
CM21 for desk or hand, high sensitivity load resistance 500K-1M ohms. with 5' lead and plug, \$1.40 P & P 20c. Crystal mike smaller size lapel clip. CM62 response 100-9000 Kc/s. 3' lead and plug, 69c, P & P 10c.

WRITE FOR NEW 8 PAGE CATALOGUE JUST PUBLISHED.

ANSWERS - continued

METER EXPERIMENT. I have constructed the moving coil meter described in the lesson on meters in the December 1962 issue. I tested it using a three volt battery but without the 22-ohm resistor. The meter worked for a while, then failed. I increased the voltage to six and fitted the 22-ohm resistor, but it still does not work. Although the current was in the coil there was no magnetic field. What has gone wrong? The battery was made from No. 6 cells. (J.Y., Shepparton, Vic.)

● We could suggest a number of reasons why the meter has failed after its initial success. The most likely one is that failure to use the limiting resistor has resulted in the coil being burnt out. A second is that the batteries have been discharged, and a third that the bearings have jammed. In regard to the first two suggestions we realise that they conflict with your statement "... there was current in the coil but ... no magnetic field," but we wonder how valid is the statement that there was current in the coil. Was this actually measured, or was its presence simply assumed because the coil was connected to a battery? In any case, the statement is really a contradiction in terms, since there could not be current in the coil without producing a magnetic

field. (R.P., Auckland, N.Z.)

● A circuit for a metal detector was published in the November issue, in the "Reader Built It" section of the magazine. Also, we are planning to feature another design in an article in the near future. However, we draw your attention to the October, 1969 issue, on the subject of treasure seeking and the limitations of these devices. We cannot assist you with the names of books and other publications, as our staff has no time to search out such references for individual readers.

IHFM AND RMS POWER. After reading American audio magazines and the advertisements therein, I have decided to find out the exact relationship between IHF power and RMS output. The RMS value is the only true value to go by, so could you please tell me the correspondence between the two. (N.B., Hampstead Gdns., S.A.)

● The matter was explained in the article "Measuring Audio Power Output" in the April, 1969 issue. If you do not have a back issue, a copy of the article can be obtained through the Information Service for 20c. The matter cannot be satisfactorily explained in a few words here.

Dream still "Impossible"

I read the item in your October issue entitled "The Impossible Dream". Perhaps you could publish articles along the lines of the one enclosed from an overseas magazine. On another subject, could you develop a circuit for a drill speed controller? (R.J., Maryborough, Qld.)

● The article you enclose does not in any sense negate what we said; on the contrary, it tends to prove it. It devotes half a dozen pages to describing typical receivers, the sequence of stages and the broad lines along which they operate. This is useful information but it is far removed from the detail and the knowledge of circuit functions that would be necessary to enable a reader to find and rectify anything like a subtle fault. The article gives a few "typical" circuits but the correlation—or lack of it—between any one circuit and receivers which actually turn up for repair is a matter of pure chance. Such articles can lay a foundation for further study or help tie together previously un-related observations but that is all they can possibly do. As regards the drill speed controller, we have already described one in the March, 1966 issue. No backnumbers are available but we can supply a copy of the article for 20c; please quote file number 2/PC/5.

field. We suggest you try to contact someone with a little more experience who, being on the spot, would be in a better position to help than we are at a distance.

SHORTWAVE LISTENERS. We should like to put forward an idea which has been in use in the U.S.A. for several years. Under this system, short-wave listeners are allocated "call" signs. They use the ordinary call signs used for amateurs but with slight modifications to signify that it is that of a SWL. The allocation of "call" signs in the U.S.A. is organised by "Popular Electronics." We think that this system would be of particular interest to prospective amateurs. Would you ask for readers' opinions in your "Answers to Correspondents" section. We would like you to organise a similar method for use in Australia. (J.E.C. and D.T., Guildford, N.S.W.)

● Although we think your suggestion is interesting, we at "Electronics Australia" have too many commitments already. There would also be the problem of recovering the costs of running such a scheme. However, the Wireless Institute of Australia has been conducting a similar system for a number of years. We suggest that you contact the N.S.W. Division at 15 Atchison Street, Crows Nest, 2065.

METAL DETECTORS AGAIN. I would appreciate it if you would advise me in which issues you have published circuits for metal and treasure detectors. Alternatively, the names of any book or other

PLAYMASTER METALWORK. Can you tell me where I can obtain the chassis front panel and printed wiring board for the Playmaster 125 Guitar Amplifier featured in the July and August, 1969, issue of "Electronics Australia"? (K.W., Rostrevor, S.A.)

● Metalwork and all other components for "Electronics Australia" projects are available from a number of suppliers who advertise their availability in most issues of the magazine. Since it is our policy not to recommend any one supplier we recommend readers to study the advertisements and decide for themselves which one they will deal with.

WHY NOT A QUESTIONNAIRE? I have been a regular reader of your fine magazine for five years. Over this period, I have formed a number of minor criticisms, none of which I shall go into at this stage, but may I suggest conducting a questionnaire to ascertain readers' requirements. Although creating many problems of its own, a questionnaire must surely inform you of the requirements of the vast majority of readers, whereas at present you rely heavily on the letters you receive to evaluate readers' requirements. I assert that the majority of mature readers do not want crystal sets and low power transmitters "to talk to my mate down the street" as requested by many correspondents. A questionnaire would make you aware of the projects and technically oriented subjects of interest to many other readers. (A.G., Amberley, Qld.)

● Thank you for your suggestion. We must say, however, that the feedback from readers is far more extensive than the letters published at the back of each issue. It includes comment made, more or less in passing, in letters answered through the postal query service, in business letters and in conversation with members of the staff, in the ordinary run of trade and social contacts. Allowing for the identity and mood of the person making comment, a fairly valid picture can be built up of how readers are reacting. At first glance, a questionnaire might seem to be better again but it can actually give quite misleading results, because it is more likely to evoke a response from people with a complaint than from people who are satisfied. The result is likely to be a high degree of distortion in the statistical sense.



ELECTRONIC WEATHER EQUIPMENT

- Electric wind speed generator.
- Instant wind direction indicator.
- Barometer
- Hygrometer
- Thermometer

EXPLORATION UNLIMITED

- Telescopes
- Microscopes
- Binoculars
- Astronomical books, charts, atlases
- Build-it-yourself kits
- Celestial globes
- Scientific weather equipment

**SEEK OUR EXPERT ADVICE
ENJOY OUR FRIENDLY SERVICE AND
BIG PRICE SAVINGS**



Become a weather expert



Prompt mail order service
All goods fully guaranteed.

WRITE OR CALL FOR OUR FREE CATALOGUE NOW

AMATEUR ASTRONOMERS SUPPLY CO.
Dept. E 11A-B Clarke St., Crows Nest,
Sydney 2065 Phone 43-4360

Stereo Music Systems Centre of the World's Finest HI-FI and STEREO equipment

monarch

Amplifier Model SA500

Australia's largest-selling budget-priced amplifier. Check these features: * 17.5 Watts/channel r.m.s. * Inputs for magnetic crystal cartridge tuner tape * Low filter * High filter * Loudness.

Check our price in the system of your choice.



Acoustic Research Speakers

From the inventors of the acoustic suspension bass driver. The natural sound — The tightest bass — The smoothest and best dispersed highs. These famous American speakers are for the connoisseur, the lover of true high-fidelity.

Don't buy a quality speaker without hearing A.R.

AR



BOSE 901

What is revolutionary about a speaker system with 18-4" full range speakers — five sides and a direct/reflecting principle? Why not come and hear them! Especially if you have a mighty good speaker system now. You'll have a lot of questions to ask. We can answer them for you. Then —

Go back to your own system — if you can.



We are now also demonstrating the new Stanton range of cartridges and invite you to hear, particularly the 681EE. Hi-Fi Stereo Review said, "The tracking was distinctly better than any other cartridge we have tested. The frequency response was the flattest of the cartridges tested".

For all Hi-Fi requirements plus our unique demonstration facilities and extended guarantee.



Sales and Service
193 Clarence Street. 29 6681
(Between King and Market)

SHORTWAVE CONVERTER. Have you published a circuit for a 3-band shortwave converter covering 1600KHz to 30MHz with an output on a fixed 1F within the broadcast band. (K.R., Tottenham Vic.)

● We published a 3-band converter in May, 1966 (File No. 2/CV/20) but this covers from 1700KHz to 21.5MHz only. To obtain the wider coverage you could use our "Universal Converter" of September, 1961 (File No. 2/CV/16) which covered the frequency range 1600KHz to 65MHz. However, this is a fixed tuned converter with interchangeable coils and a crystal-controlled oscillator; the tuning being done by tuning an associated broadcast receiver. These articles are available through the Information Service for 20c each.

DEAD LETTER. We are holding a letter addressed to Mr B. Williams, 55 Milton St., Mackay, Queensland, 4740. This has been returned by the P.M.G.'s Department marked "Address unknown." Would the writer please advise his current address. ■

POSITION ON OUR STAFF

We have a position on our staff for a young person, male or female, as assistant to our draughtsman. The person we are looking for:

- Must not be more than 18 years of age.
- Must have had a hobby background in electronics, experience in building simple pieces of equipment and able to read a circuit diagrams.
- Must be prepared to undertake a technical college course in electronics or an allied subject.
- Should preferably have taken technical drawing as a school subject.
- Be resident in the Sydney area and able to commence duties immediately upon appointment.

For a young person with suitable aptitudes, this position could lead to a career in technical journalism.

If you are interested in this unique opportunity, apply at once in writing, setting out your background and enclosing at least one personal character reference. Applications should be addressed to The Editor, "Electronics Australia," Box 2728, G.P.O., Sydney, 2001.

Notes and Errata

CASSETTE DATA RECORDER (Scientific and Industrial News, August, 1969, page 35). The complete address of Mobark Instruments Corporation is 1273 Terra Bella Avenue, Mountain View, Calif. 94040, U.S.A.

LOUDSPEAKER—cont.

sign, phasing can be checked simply by connecting a torch cell across the voice coils and noting that both speaker cones move in the same direction. If not, reverse the leads to one voice coil. Note that we bolted the loudspeakers in, for strength, rather than relying on screws.

So there it is, a compact, easily portable loudspeaker system which can fill a need in many small P.A. situations in halls at slide or movie shows or at a party to keep the guests under control. ■

MARKET PLACE

Send your ads for this page on the form from page 192

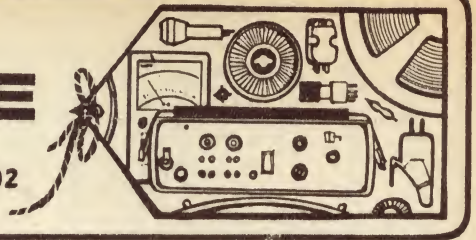

FOR SALE

NEW OC44, 45 71, 72, 84, 2N3638, 6 for \$3.50 or 50c ea. BC108, 109, 2N3638A, AC128, 5 for \$2 or 50c ea. 2N3642, 3643, OC171, 2N370, 371, AF116N, 117N, BF115, 2N3694, AC127, 6 for \$3 or 60c ea. Power types 2N176, \$1 ea. 2N301, \$1.20 ea. OC28, 29, 35, 36, 2N3055, 8D720, 40228, \$1.50 ea. OA210, EM404, 50c ea. OA211, BY100, EM410, 60c ea. UJT 2N2160, FET 2N4360, \$1 ea. MPF105, 2N5459, 2N3819, 90c ea. BA100, 30c ea. OA81, 85, 91, 95, 12 for \$2 or 20c ea. No S.A. sales. Post and pack 15c. Custom Electronics, Box 1452, G.P.O., Adelaide, 5001.

TV SETS, all sizes working and not working-order from \$10. Radiograms, tape recorders, valves, picture/tubes. An accumulation or trade-ins must be cleared. Sydney 969-1333.

SIX Transceivers ECK088 (4 chan) 12V amp. and power supply \$6 ea. Box 272 Pt. Augusta, S.A. 5700.

PRE-SET Pots, Miniature type, close tolerance. Range: 1K, 5K, 10K, 25K, 50K, 100K, 250K, 500K and 1M. 20c ea or 10 for \$1.50, 10c pack/post any order. Kit-Sets Aust., Box 176, Dee Why, N.S.W., 2099.

RESISTORS: Top grade 5pc 1/4W and 1/2W types. Both 4c each or \$3 per 100, 1 ohm to 10M. 1W types 7c each or \$5.50 per 100, 5 ohm to 1M. We supply to your list. 10c pack/post any order. Kit-Sets Aust., Box 176, P.O. Dee Why N.S.W., 2099.

TRANSISTOR Bargains. New, guaranteed. BC108, BC109, OC44, OC45, OC71, OC72, AC128, all 50c each or 5 for \$2.00. OC28, OC29, AD140, AD149 all \$1.20 each. AD161/162 \$2.75 the pair, 10c pack/post any order. Kit Sets Aust. Box 176, P.O., Dee Why, N.S.W., 2099.

KIT-SETS AUST. wishes to thank our many clients for their support over the past year and assure you of our continued prompt and efficient service in the future. We pass on Seasons Greetings to you all. From the management and staff at Kit-Sets Aust.

PROFESSIONAL recording equipment: Ampex 4-track 1/2-inch MR70 recorder; complete disc-cutting unit including Gramplan cutterhead and RA5 amplifier; equalisers, etc. Write for complete list. Bill Armstrong Pty. Ltd., 100 Albert Road, South Melbourne, Victoria, 3205. Phone (Melb.) 699-1844.

DISCOUNT hi-fi. It pays to get a Duratone quote on Sony, Kenwood, Sansul, Wharfedale, Goodmans, Dual, Silcron, J.H., Labcraft, Thorens, Tandberg, Quad, etc., up to 30 p.c. off new famous brand low noise tape. Mail-order, Box 125, Curtin, A.C.T. Phone Canberra 81-2549.

TRANSISTORS, OC83 (new) 10 for \$5.00 or 60c ea., also AC127. Whitworth Electronics, 61 Hillview Cres., Cairns, 4870.

AUDIO mixer E.A. Feb. 1966 2 mic. and 2 PU channels built and tested, \$26. P. Dooley, 6 Wallis St., Horsham, 3400.

A.W.A. 25 watt P.A. amplifier 4 mic inputs 1 phono, \$95. Akal 707 mono tape-rec. 2 tracks 2 speeds, \$160. Sydney 622-8886.

TAPE heads, non-scratch, for 8 and 16mm film. \$18 a set. Magnetic sound films and projectors. Haplin, 12 Swinburne Ave., Hawthorn, 3122. 81-4724.

NEW CRO tubes. 3BP1, \$4.85. Waltham Dan, 96 Oxford St. Darlinghurst, N.S.W. 31-3360.

SAVE money! Buy direct from importer famous name cartridges, speakers, etc. Quotations. Sudana Products, P.O. Box 44, Turramurra, N.S.W. 2074.

SELL all back issues "Electronics Australia" in stock at all times, 1939-63 50c, 64 to date, 60c. Post free. T. Weir, 55 O'Connell St., Haberfield, Sydney, N.S.W., 2045. Phone: 798-7569. Wanted to buy copies also.

MODEL RAILWAYS: Rivarossi, Tri-ang, Peco. Prompt mail order service. Write for free price lists, free packing and postage on all orders. P.J.P. Productions, 15 Hamilton St., Gisborne, Victoria, 3437.

AMPLIFIERS, 35W. Two microphone inputs, two guitar inputs, bass and treble controls, line or voice coil output. Xmas special \$80 including freight. Kee Sound Systems, Box 38, P.O., Merewether, N.S.W. 2291.

FOR SALE

BURGLAR ALARMS. 12V, 15uA. Transistor control units, \$12, plus 12 p.c. s.t. Unit on 4 x 2 plate and case, \$16, plus s.t. 41V rotary sirens, \$10.50. All above plus 60c p. and post. Foil tape terminals, mats, key switches, bells, reed switches, infra-red ray unit. Complete quote and installation service to insurance requirements. EDORE ENTERPRISES, 802 Doncaster Rd., Doncaster, Vic. 848-1386.

CRYSTALS, New 500KHz, \$3.85. Waltham Dan, 96 Oxford St. Darlinghurst, N.S.W. 31-3360.

RECORDING tape. New 3/4 x 900, \$1.55; 5 x 1200, \$2; 5/8 x 2400, \$3.55; 7 x 2400, \$3.65; 7 x 4800, \$9.80. All Mylar. Full lists free, all brands and sizes. Recorders, players, radio, etc., at wholesale prices, quotes free. BSR turntables UA 25 \$30, MA 70 \$50. Freight free anywhere. A. Mail Orders, Box 15, Footscray, Vic. 3011. Phone 68-4436.

MODEL engineer's bench drill. Castings, blue print \$21.25, Postage extra, 141b, Bolton, 72 King Street, Sydney. Catalogue \$1.50.

CHANNEL Master "Telstar" transistorised aerial booster amplifiers. Normally \$40, our price \$25 each. Ideal for poor signal areas and in fringe areas. J. Yalden, 21 Oxford St., Glen Innes, N.S.W. 2370.

PROJECTION TV components. Schmidt optics, deflection coils, EHT transformers, sult 3' tube, \$40 the lot. Verstrepen, 11 Alandale Ave., Baiwyn, Vic. Phone 857-7818.

PICTURE screen, Roll up, 20ft x 8ft 6in. Plastic Fireproof, without masking. Best offer. Theatre, Barellan, N.S.W.

TRANSISTOR Bargains: BF115, 55c. OA91, BC107, 65c. AD161/162, \$2.70. AC187/188, 20c. MPF 105 90c. 263055, \$1.80, matched pair \$3.90. 2N3053, \$1.20. BC108, 109 50c. \$1.80. AC127/128, \$1.20. OC71, 72, 44, 45, 171 all 30c ea. sil diodes stud 6A 400V, 60c. Min. types 1A, 800V 60c. 1A 400V, 40c. ganged stereo pots 470K plus 470K log or lin 47K plus 47K log, \$2.00 ea. 470K lin, single 60c. Post 10c any order. Sorry, no C.O.D. T. & M. Electronics, Box 57, P.O. Haberfield, N.S.W. 2045.

Classified Advertisers
 For the January issue your advertisement must reach our office by December 11th, 1969.
 Please address your advertisement to the Advertising Manager, "Electronics Australia," Box 2728, G.P.O., Sydney, N.S.W. 2001.

WANTED

RECORD cutting equipment 45 and 33-1/3 microgroove capability. Please send full details. Box 388, Alice Springs, N.T.

OLD television yokes. Pay fifty cents each. Nalco Industries, 250 Parramatta Road, Ashfield, 2131. 798-9999.

WANTED: Wanted all types of surplus or redundant stocks of electronic components and instruments. Manufacturers please forward lists or advise by phoning Sydney, 337-3230. Will view and pay on spot. Electro Disposals.

READER SERVICE

TRANSFORMERS wound. Output or mains and specials to orders. Reply with S.A.E., Paris Radio Electronics, 7a Burton St., Darlinghurst, N.S.W. 31-3273.

TOP quality discs from your tapes. Any quantity, all sizes and speeds. We guarantee our work to comply with R.I.A.A. and A.B.C.B. standards. Enquiries welcome. Write for details A.A.V.R., 87a Mullens St., Balmain 2041. Phone: 82-5158, Sydney.

READER SERVICE

REPAIRS to receivers, transmitters, construction, testing: TV alignments: Xtal conv., specialised electronic equip. Eccleston Electrics, 146a Cotham Rd., Kew, Vic., 80-3777.

PRE-RECORDED TAPE hired to members of Australian Tape Recording Society. Bi-monthly release. "The Microphone," newspapers round robins, sales, service, tape-sponding. Send 5c, 9in x 4in S.A.E. to ATRS, Box 9, P.O. Crow's Nest, N.S.W., 2065, or phone (2) 43-6681, after hours

TV picture tubes: Sure Brite Pty. Ltd., now at 542 King St., Newtown, N.S.W. Now the largest factory of its kind in N.S.W. Daily delivery Sydney, suburbs, and to railway station. Lowest prices in Sydney to the trade. Duds bought. Send all duds to Sydenham Station freight paid. Customer sales rear of building. Phones 519-3403, 51-5928. Brisbane area: 1120 Oxley Rd., Oxley, 79-6828.

TAPE to disc service. Take advantage of W. and G. Records' professional experience when next needing a tape to disc service. W. and G. Record Processing Co., 185 A Beckett Street, Melbourne. Tel.: 329-7255.

ELECTRONIC organs: Do not build yourself an organ without first finding out about the superb Schober (U.S.A.) Assemble-It-Yourself Kits. Inquiries to Schober Organs (Australia), 124 Livingstone Ave., Pymble, N.S.W., 2073. (Mail only, please.)

POSITION VACANT



SEVERAL POSITIONS ARE AVAILABLE FOR MEN WITH THE FOLLOWING QUALIFICATIONS.

Age 20 to 35 years. A technical background and the ability to read a circuit diagram.

Desire to participate in a challenging and rewarding outdoor life with the opportunity to travel throughout Australia and possibly overseas.

A good salary, full board and accommodation provided in the field. Opportunities for promotion.

The work in general is concerned with the operating and maintenance of various types of geophysical equipment.

Write for further information to:

McPHAR GEOPHYSICS PTY. LTD.,

Post Office, Box 42,

Unley, South Australia, 5061.

or to Kalgoorlie Branch:

Post Office, Box 463,

Kalgoorlie, Western Australia, 6430.

MULTIMETER SERVICE

Repairs to all types of Multimeters, Panel Meters, Switchboard Meters, VTVM's, Meggers and Sub-standards. We stock only quality brands of Multimeters and Test Equipment.

METROPOLITAN METER SERVICE

103 REGENT STREET, REDFERN, SYDNEY.

Telephone 69-5922.

ADVERTISING INDEX

A & R Electronic Equip. Co. Pty. Ltd.	43
A.C.E. Radio	170, 171
Adcoia Products Pty. Ltd.	50, 187
Aikal Australia Pty Ltd.	62
Allied Music Systems	148
Amalgamated Wireless (A'sia) Ltd.	22, 127, 176
Amalg'd Wireless Valve Co. Pty. Ltd.	42
Amateur Astronomers Supply Co.	189
Amplicon (A'sia) Pty. Ltd.	121
Arrow Electronics Pty. Ltd.	120
Astronics Australasia Pty. Ltd.	60, 112, 144
Atram Pty. Ltd.	46, 47
Audio Engineers Pty. Ltd.	126
Aurilens (A'sia) Pty. Ltd.	131
Australian General Electric Pty. Ltd.	88
Aust. Musical Ind. Pty. Ltd.	82
Aust. Radio and TV College Pty. Ltd.	175
Australian Radio DX Club	Outside Back Cover
Bright Star Radio	169
British Institute of Careers	147
Broadway Electronics Pty. Ltd.	84, 85
Broadway Electronics (Sales) Pty. Ltd.	4, 5
Broughton Peter G.	83
B.W.D. Electronics Pty. Ltd.	148
Central Imports Pty. Ltd.	96
Challenge Recording Co.	142
Chapman, Maurice and Co. Pty. Ltd.	83, 110
Classic Radio Service	138, 139
Classic Tape Recorders	135
Claybridge Sound	52, 53, 63, 65
Coistok Electronics	45
Coyle Electronic Ind.	105
Convoy International Pty. Ltd.	130
Cunningham, R. H. Pty. Ltd.	111, 163
Danish Hi-Fi Pty. Ltd.	76
Deitch Bros.	186
Deitron Electronics (Sales) Pty. Ltd.	83, 104, 141
Direct Disposals Trading Co.	188
Douglas Trading Pty. Ltd.	72
E. D. and E. (Sales) Pty. Ltd.	114, 115
Electronic Despatch	151
Elmeasco Instruments Pty. Ltd.	14
Encel Electronics (Stereo) Pty. Ltd.	19, 94, 111, 121, 129, 133, 168, 183
Fairchild Australia Pty. Ltd.	70
Ferris Bros. Pty. Ltd.	150
Foot, Richard (Aust.) Pty. Ltd.	177
General Accessories Ltd.	86, 102, 156, 174
Goldring Eng (A'sia) Pty. Ltd.	6, 7, 122, 123
Gray, Simon Pty. Ltd.	20
Green Corporation Ltd.	136, Inside Back Cover
Haco Distributing Agencies Pty. Ltd.	Inside Front Cover
Ham Radio Supplies	184
H.B. Radio Sales	81, 141
Heating Systems Pty. Ltd.	149
Homecrafts Pty. Ltd.	160
International Correspondence Schools	157
IRH Components Pty. Ltd.	36
Jacoby, Mitchell and Co. Pty. Ltd.	54, 65, 109, 158, 180
J.H. Reproducers Co.	134
Kitsets Australia	55
Lafayette Electronics	166
Leak, H. J. (Aust.) Pty. Ltd.	116
Magnetic Sound Industries	132
Magrath, J. H. and Co. Pty. Ltd.	100
Mallory Batteries (A'sia) Pty. Ltd.	26
Manufacturers Spec. Prod. Pty. Ltd.	152
Marconi School of Wireless	159
Market Place	191
Mastersound Sales Pty. Ltd.	146
Metrop Meter Service	191
Miniwatt Electronics Division	2
Mullard-Australia Pty. Ltd.	38
National Radio Supplies	178, 179
Philips Electrical Pty. Ltd.	172
Philips Telecomms. of Aust. Ltd.	74
Phononic	187
Plessey Ducon Pty. Ltd.	28
Plessey Rolia Pty. Ltd.	128
Pre-Pak Electronics	160
Radio Despatch Service	89
Radio House Pty. Ltd.	63, 182
Radio Mart	143
Radio Paris Pty. Ltd.	123
R.C.S. Radio Pty. Ltd.	18
Recorded Music Salon	118, 150
Robbins, B. M.	83
Sato Parts Co. Ltd.	156
Shalley, Peter Electronics Pty. Ltd.	164
Standard Telephones & Cables Pty. Ltd.	32
Stott's Tech. Correspondence College	153
Tanner-James Pty. Ltd.	155
Tasmanex Pty. Ltd.	51
TasTrade Supplies	43
Technical Training Int. Pty. Ltd.	106, 107
Technico Electronics Division	80
Tektronix Australia Pty. Ltd.	12
Transformers Winders Ltd.	81
Trio Electronics Inc.	8, 9
Truscott Electronics	145
Tudor Radio	64
Turnbull, Bill	175
Two-Way Communications Pty. Ltd.	185
Union Carbide Australia Ltd.	30
United Radio Distributors Pty. Ltd.	39
United Trade Sales Pty. Ltd.	142
University Graham Inst. Pty. Ltd.	92
Varian Pty. Ltd.	58
Varian Techtron Pty. Ltd.	113
Victor, A. and Co.	87
Warburton Frankl Ltd.	98
Wedderspoon, W. C. Pty. Ltd.	190
Weston Electronics Pty. Ltd.	44, 50
Willis, S. E. Trading Co.	162
Wireless Institute of Australia (N.S.W.)	163
Wonder Wool Pty. Ltd.	137
Zephyr Products Pty. Ltd.	34, 154, 168

CLASSIFIED ADVERTISERS

ELECTRONICS Australia MARKET PLACE

USE THIS FORM FOR YOUR NEXT ADVERTISEMENT IN THE

- FOR SALE
- WANTED
- READER SERVICE
- POSITION VACANT

To the Advertising Manager,
ELECTRONICS Australia,
Box 2728 G.P.O.,
Sydney, 2001

Please insert the following advertisement in the

..... issue



Endorsement
Residential Address

State

I enclose P. Note/Cheque for \$.....

being full payment for lines at \$0.72 per line. (Min. 2 lines)

Please write in block letters with ink or ball-point pen.

Number of insertions

ELECTRONICS Australia

SPECIAL ORDER FORM

Guarantee yourself a complete set of issues for your library with no copies missing.

SUBSCRIPTION RATES

Australia, New Guinea, Fiji, New Zealand	PER YEAR \$5.00
Elsewhere	\$7.00

POST THIS COUPON TO:

The Circulation Manager, ELECTRONICS Australia,
Box 2728, G.P.O., Sydney, 2001, Australia.

Name

Address

Enclosed is \$ for years. Start with

(Please use cheque, money order, etc. Do not enclose cash)

TANDBERG TWINS?

Not quite. One costs far less.

Here we have two high fidelity TANDBERG tape recorders with every desirable facility . . . both feature the proven and effective Tandberg Cross Field Bias Heads . . . in fact, feature for feature, *they're almost identical*. What is the advantage of Tandberg Cross Field Bias? Dramatically improved frequency response and signal-to-noise figures!



On the left is the popular, completely self-contained, Tandberg Model 1241X . . . the solid state stereo recorder that's taken the music loving world by storm. Performance is quite amazing . . . even at the middle speed of $3\frac{3}{4}$ i.p.s. frequency response is 20-18,000 Hz.! At $7\frac{1}{2}$ i.p.s. response is 20-25,000 Hz. and signal-to-noise better than -58 dB. Input sensitivity suits magnetic or ceramic stereo cartridges. Power output is 10 watts R.M.S. per channel — double volume controls are provided for both inputs and outputs. Twin wide range speakers are built in. *The 1241X can be the heart of any high fidelity stereo system . . . no external amplifier is required.*

On the right is the new TANDBERG Model 1641X. In terms of performance and features it's almost identical to the 1241X . . . but *it costs far less*. The money saving difference is that the Model 1641X is designed for use with your own high fidelity stereo amplifier and your personally selected wide range speaker systems.

Compare the performance of either of these fine TANDBERG units with any recorder in a similar price category. *Look at the extra value, the extra facilities, the extra quality.* When you step up to TANDBERG you invest in "Sound reproduction indistinguishable from the original". See and hear TANDBERG Models 1241X and 1641X at selected Simon Gray dealers in all states.

ABRIDGED SPECIFICATIONS

TANDBERG MODEL 1241X

Three speeds — $7\frac{1}{2}$, $3\frac{3}{4}$ and $1\frac{1}{2}$ i.p.s.
 Frequency response at $7\frac{1}{2}$ i.p.s. — 20-25,000 Hz.
 Signal-to-noise at $7\frac{1}{2}$ i.p.s. — Better than -58 dB.
 Twin VU meters.
 Inputs for radio, dynamic microphones, pick-ups.
 Wow/flutter at $7\frac{1}{2}$ i.p.s. — Less than 0.10% R.M.S.
 Power output — 10 watts R.M.S. per channel.
 Built-in wide range stereo speakers.
 List price: \$517 inc. sales tax.

TANDBERG MODEL 1641X

Three speeds — $7\frac{1}{2}$, $3\frac{3}{4}$ and $1\frac{1}{2}$ i.p.s.
 Frequency response at $7\frac{1}{2}$ i.p.s. — 20-25,000 Hz.
 Signal-to-noise at $7\frac{1}{2}$ i.p.s. — Better than -58 dB.
 Twin VU meters.
 Inputs for radio, dynamic microphones, pick-ups.
 Wow/flutter at $7\frac{1}{2}$ i.p.s. — Less than 0.10% R.M.S.
 All desirable control facilities.
 List price: \$367 inc. sales tax.

Ask for complete and unabridged specifications. TT/1



Australian National Distributors:

Simon Gray Pty. Ltd.

Head Office: 28 Elizabeth St., Melbourne, Vic. Tel. 63 8101*
 Sydney Office: 22 Ridge St., North Sydney, N.S.W. 929 6816
 Canberra Office: 31-33 London Circuit, Canberra City, A.C.T. Tel. 49 6050

INTERSTATE REPRESENTATIVES:

N.T.: Pfitzner's Music House, Smith Street, Darwin. Tel. 3801
 Q'land: Sydney G. Hughes, 154-158 Arthur St., New Farm, Brisbane. 58 1422
 S.A.: Eilco Sales Pty. Ltd., 7-9 Osmond Terrace, Norwood, S.A. Tel. 63 4844
 Tas.: K. W. McCulloch Pty. Ltd., 57 George Street, Launceston. Tel. 2 5322
 W.A.: Athol M. Hill, 613-615 Wellington Street, Perth. Tel. 21 7861

This A.R.T.C. Success Story Can Be Yours!

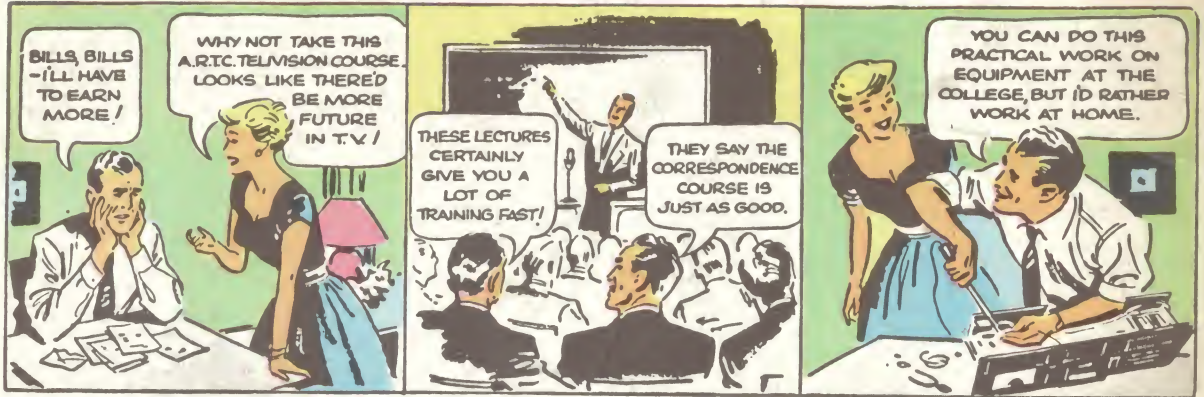

GET INTO ONE OF THESE PROFITABLE CAREERS IN RADIO AND TELEVISION

There is a profitable career for you in the many phases of radio television including manufacturing, radio servicing, television servicing, research, sales broadcasting and television executive, armed forces. A.R.T.C. can help you gain one of these much sought-after positions. But remember, it is only the trained man who succeeds and A.R.T.C. can give you the complete training which is necessary.

TRAIN AT HOME OR AT THE COLLEGE

With A.R.T.C. you can obtain the training you need. At the benches and in the lecture halls of Australian Radio and TV college or in your own home by correspondence . . . you can be taught every important aspect of radio, television, details of every application of the fundamental principles. The course is intensely practical and individual.

MAKE SPARE-TIME MONEY

If you wish you can make your spare time earn money for you. Many students make extra money at spare time work after only the first few weeks. Think of all those things extra money can bring you, home of your own, car, time for relaxation, etc. Safeguard your future . . . mail the coupon today.

MAIL COUPON NOW

You are invited to mail the coupon below which can be your first step towards securing a job or business of your own with good prospects, security and big money. A.R.T.C. will mail to you by return, at no obligation to you the big free booklet: "Careers in Radio and Television." This booklet will show you definite steps you can take for a better job, how you can succeed in life. Post the coupon, phone or call NOW.

AUSTRALIAN RADIO AND TELEVISION COLLEGE PTY. LTD.

E. S. & A. BANK BUILDING,
Cnr. Broadway and City Road, Sydney.
(Opp. Grace Bros.) Phone 211-4244 (3 lines.)

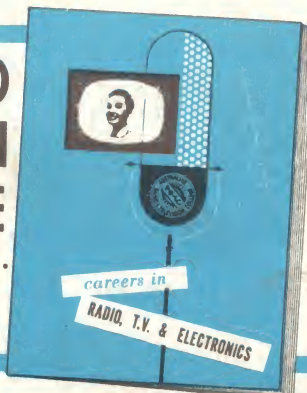

AUSTRALIAN RADIO & TELEVISION COLLEGE PTY. LTD.,

206 Broadway, Sydney, N.S.W.

Dear Sir,

Please send me, without obligation, your free booklet, "Careers in Radio, TV and Electronics."

NAME

ADDRESS