

ELECTRONICS

Australia

November, 1969

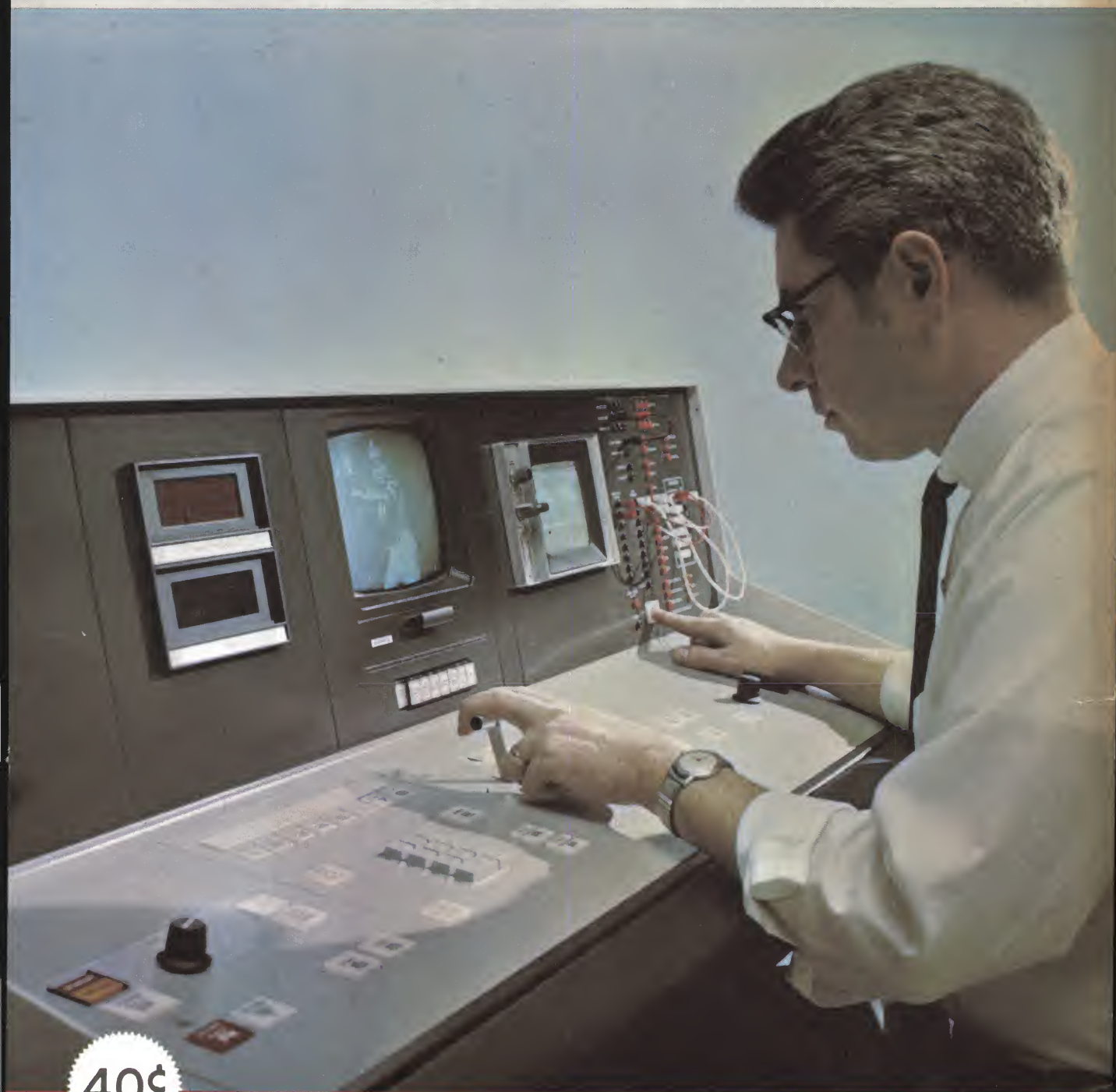

40¢

Ampex video disc slow-motion recorder. (See page 20)

CAPACITOR DISCHARGE IGNITION

HISTORY OF ARMY RADIO

● I-C CONTROL UNIT

● 100-WATT LOUDSPEAKERS



NATIONAL HI-FI STEREO EQUIPMENT



Stereo Revolution!

Stereo hi-fi has come of age. National announces the introduction of the largest, most perfectly matched, most advanced stereo hi-fi equipment range in Australia. You can sit back and hear it at any of the **new National authorised hi-fi centres** . . . any unit, any combination. For addresses and free colour brochure, just fill in and send the coupon.



TO HACO DISTRIBUTING AGENCIES
PTY. LIMITED

57 Anzac Parade, Kensington, N.S.W. 2033

Please tell me all about the great new National Stereo Hi-Fi
Equipment and where I can hear it.

Name.....

Address.....

..... Postcode.....

U696



ELECTRONICS Australia

incorporating RADIO, TELEVISION and HOBBIES

ABC certified circulation in excess of 47,000

volume 31, number 8

A RECORD ISSUE . . .

This issue of "Electronics Australia" is the largest we have ever produced: 208 pages, plus covers.

It has a full editorial content, plus the largest ever quota of advertising — over 3,600 inches.

More than ever, it is Australia's electronic marketplace.

And we expect it to sell well over 50,000 copies. Estimated sale of the August issue was 51,900 copies.

Editorial Office:
12th Floor, 235-243 Jones Street,
Broadway, Sydney, Australia.
Phone 2-0944.

Postal Address:
Box 2728, G.P.O., Sydney, Australia.

Advertising:
Manager, Selwyn Sayers,
Sales Exec., Howard Jenkins
Sydney Representative, Bill Summons,
Office: 8th Floor, 235-243 Jones Street,
Broadway, Sydney. Phone 2-0944.
Melbourne Representative, Clarrie Levy,
Office: 392 Little Collins Street,
Melbourne, 3000. Phone 67-8131.

Circulation:
Alan Parker, Manager,
Office: 9th Floor, 235-243 Jones Street,
Broadway, Sydney. Phone 2-0944.

Subscription Rates: See back page.

Representation:
Melbourne—John Fairfax and Sons Ltd., 392 Little
Collins Street, 3000. Phone 67-8131.
Brisbane—Sungrave Pty. Ltd., 78 Elizabeth Street,
4000. Phone 2-6688.

Adelaide—John Fairfax and Sons Ltd., 104 Currie Street,
5000. Phone 51-3502.

Perth—Sungrave Pty. Ltd., 454 Murray Street, 6000.
Phone 21-8217.

Newcastle, N.S.W.—Associated Newspapers Ltd., 22
Bolton Street, 2300. Phone 2-3696.

London—John Fairfax and Sons (Aust.) Ltd., Reuter
Building, 85 Fleet Street.

New York—The Sydney Morning Herald Ltd., 1501
Broadway, New York, N.Y., 10036.

Distribution:
Distributed in N.S.W. by Sungrave Pty. Ltd., Jones
Street, Broadway, Sydney, N.S.W.; in Victoria by Sun-
grave Pty. Ltd., 392 Little Collins Street, Melbourne;
in South Australia by Sungrave Pty. Ltd., 104 Currie
Street, Adelaide; in Western Australia by Western Press;
in Queensland by Gordon and Gotch (A'sia) Ltd.; in
New Zealand by Truth (N.Z.) Ltd.; in Tasmania by
Davies Bros. Ltd., "Mercury," Hobart.

Copyright. All rights reserved.
Devices or arrangements shown or described herein may
embody patents. Information is furnished without re-
sponsibility for its use and without prejudice to patent
rights.

CONTENTS — NOVEMBER, 1969

features

- 3 Editorial
- 10 Army radio communications
- 20 The video disc
- 27 Telephone service developments
- 67 Aesthetics of antenna design

technical digest

- 31 Fungus growth on electronic equipment
- 33 Reed switches as non-mechanical locks
- 35 Toshiba in production with IC receivers

technical articles

- 44 Background to capacitor discharge ignition
- 55 Fundamentals of solid state, chapter 7
- 73 Resistor colour code
- 77 Ceramic resonators, part 3
- 90 Playmaster 127 control unit
- 109 100W-plus guitar loudspeaker systems
- 117 Apparent-wind-direction indicator
- 123 How to make a sensitive microphone (historical)

regular features

- 37 Scientific and industrial news
- 71 Serviceman
- 73 Radio—unofficial history
- 112 Forum
- 119 Reader built it
- 126 Audio topics—loudspeaker systems
- 132 Record reviews—classical
- 139 Record reviews—documentary
- 141 Record reviews—devotional, popular, jazz
- 156 Trade reviews and releases
- 168 Technical books and publications
- 177 Amateur band news and notes
- 189 Listening around the world
- 197 Answers to correspondents
- 206 Market place—classified advertisements
- 208 Index to advertisers
- 205 Notes and errata

Now low cost, power rectification to 25 amps!*

with "Miniwatt" BYX21L

Series Silicon Power Diodes made in Australia

BYX21L/200 + 100 Piv
BYX21L/200R +

BYX21L/400 + 200 Piv
BYX21L/400R +

25 AMP

(+ Reverse Polarity Version)

Mechanical
Data (mm)

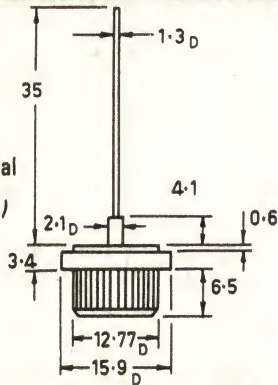

Clip

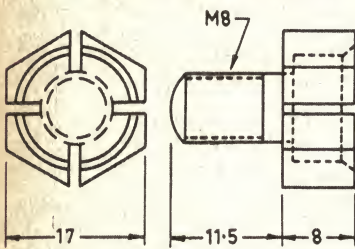
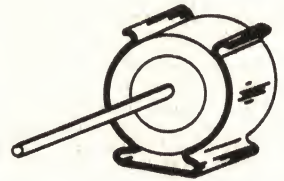

MTG Adaptor



Press

Solder

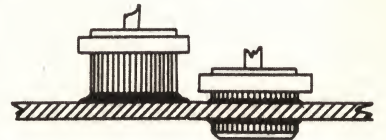

* WITH SUITABLE HEATSINK

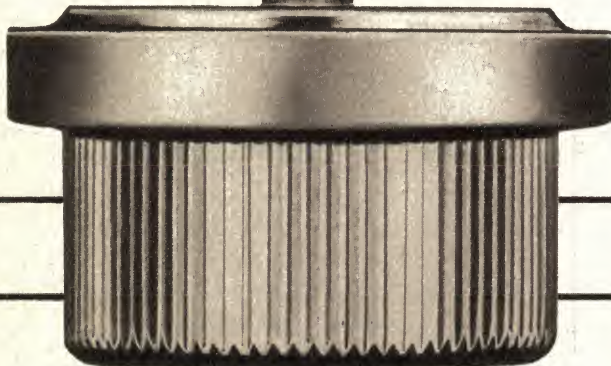

"Miniwatt"

ELECTRONICS DIVISION OF PHILIPS
ELECTRICAL PTY. LIMITED

Sydney, Melbourne, Brisbane, Adelaide,
Perth, Hobart, Newcastle, Canberra.



EDITORIAL VIEWPOINT

by Neville Williams

Licensed larrikins . . .

Attention has been drawn, in this and other journals, to the abuse of privilege which has occurred on 27MHz, referred to in other countries as the Citizens Band. Understandably, local authorities have sought to avoid a free-for-all situation in Australia by restricting use of the equipment to those who have a genuine need for it.

Licensed amateur operators have been among the severest critics of CB'ers. They accuse them of having no technical ability or ambition, no regard for the terms of their licence and no sense of responsibility—to the point of being anti-social.

By contrast, amateurs are often represented as being technically enlightened; public spirited and committed to observing the regulations. Such being the case, they deserve the full support and protection of licensing authorities against competition for their frequency bands.

Nice sentiments, but I wonder how realistic they are?

To be sure, many amateurs are true to the traditions of their hobby, but there is a disturbing minority which is not. Lately, there has been a spate of complaints about larrikinism in the amateur bands, particularly on VHF. Inebriated talk, "blue" jokes, coarse language and obscenity have characterised far too many QSOs. And, lest there be any mistake, the complaints have not been made by professional wowsers but by ordinary amateurs who object to this kind of stuff being overheard by their families.

Confronted with loose talk in the amateur bands, there is a natural tendency to turn a deaf ear; to avoid saying anything that might rock the boat. There's a sense of loyalty to a fellow licensee and an unwillingness to take any action which would brand one as a P.M.G. pimp.

I doubt that we can afford such sentiments any longer. The time has come for responsible amateurs to realise that the larrikins in their ranks are more than a mere personal embarrassment. They could all too easily turn out to be the feet of clay of the whole amateur image.

People are asking why other amateurs don't do something about the offenders; why the W.I.A. doesn't do something; why the authorities don't do something. All good questions, but here's another one:

How sincerely and for how much longer are the authorities going to safeguard the amateur bands, when they hear amateurs behaving in a way that they have already taken a stand against on 27MHz?

The W.I.A. proposes to send an observer to Geneva to assist in presenting the case for amateur radio to the I.T.U. — an assignment that was filled by our late Editor, John Moyle, before his untimely death. Undoubtedly, Australian amateurs should be represented at Geneva. But let's have a care that the cause is not lost by the activities of a fifth column, right here at home!

EDITOR

Neville Williams
M.I.R.E.E. (Aust.)
(VK2XV)

ASSISTANT EDITOR

Philip Watson
A.M.I.R.E.E. (Aust.)
(VK2ZPW)

TECHNICAL EDITOR

Jamieson Rowe
B.A. (Syd.),
B.Sc. (Tech., N.S.W.)
M.I.R.E.E. (Aust.)

TECHNICAL STAFF

Ian Pogson (VK2AZN)
Harry Tyrer (VK2ZHH)
Anthony Leo (VK2ZHK)
John Horsfield
Robert Flynn
Leo Simpson

On the cover

Television viewers, particularly in Sydney and Melbourne, have been intrigued by a recently installed facility, which allows highlights of sporting events to be instantly replayed at any desired speed, or analysed frame by frame. The equipment, which makes this possible, is the Ampex video disc recorder type HS-100. Pictured is the control console from which the unit is normally operated. How the unit operates is explained in an article beginning on Page 20.

ON SALE
THE
FIRST MONDAY
OF EACH MONTH

Broadway Electronics introduces the new

INSTROL HI-FI

the largest HI-FI showroom in Australia.



A visit to the new Instrol Centre is an experience that will satisfy the most critical hi-fi enthusiast. Hi-Fi, Accessories, Tape Recorders, Furniture in fact the ultimate range available in one large modern Showroom. For those readers who are at present unable to see this exciting display for themselves, we suggest you ask for our free descriptive and illustrated Cabinet Catalogue, or our Hi-Fi Catalogue.

The Instrol Hi-Fi Centre includes the largest possible range of Hi-Fi furniture —

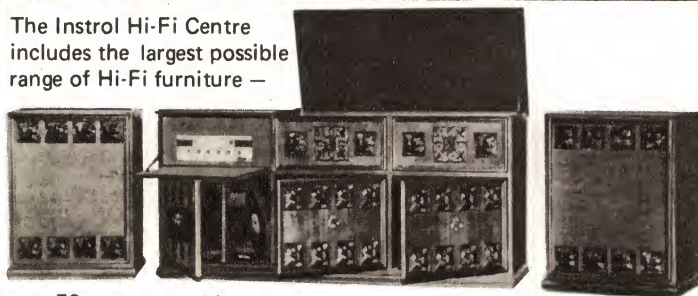

over 50 different cabinets and enclosures are on display. Should you be unable to visit our new exciting Showroom, ask for our free descriptive Cabinet Catalogue. (Pictured above is the new "Flamenco" Setting).

for descriptive leaflet post coupon

Please include postage stamp.

Name _____

Address _____

Postcode _____

Instrol Cabinets Hi-Fi Equipment

INSTROL Phone: 29-4258
HI-FI CENTRE SYDNEY, N.S.W.
 2000
 91^a York St. (between King & Market St.)

CENTRE

91a York St. (between King & Market St.)

**FREE FREIGHT
THE GREATEST
SPECIAL OFFER
OF THE YEAR**

We at the new Instrol Centre will pay all freight charges on any amplifier, player or speaker sent to any State in Australia by Registered Post or Rail. NOW country and interstate customers will pay no more than Sydney residents, because the freight cost will be paid by Instrol Hi-Fi Centre. We regret that this wonderful offer unfortunately CANNOT include player-stands, speaker enclosures or equipment cabinets.



Wharfedale Unit-3, Goodmans Sherwood, Leak Sandwich. Just some of the magnitude of speaker systems on display. All major brands, including Wharfedale, Goodmans, Instrol, Playmaster, Magnavox, Leak, Pioneer, etc.



The new DUAL 1200 series Turntables are being demonstrated at our exciting new centre. Full range of other players also on display.

At last A Tape Recorder Centre, with trained personnel to serve you. Choose from our wide range of Sony, Akai, Tandberg, etc. . . All available for demonstration at the new Instrol Hi-Fi and Tape Recorder Centre.



The Kenwood TK 250U — one of many Stereo Amplifiers being demonstrated. Perhaps you prefer something more elaborate, such as the Kenwood KA6000, Sansui AU777 or Leak Stereo 70. Whatever you desire in Amplifiers or Tuners, our new Showroom will satisfy.



The Instrol range includes a wide variety of Player Stands and combination Amplifier-Player Cabinets. High quality perspex covers (clear and tinted) are also available, some hinged, others separate. In addition to our standard range, we can supply cabinets and perspex covers to your individual specifications. Grill cloth, innerbond, stylii, recording tape . . . in fact all accessories are available ex stock.

You would never believe that so much Hi-Fidelity equipment was in existence until you visit our New Instrol Centre. All leading brands of Tape Recorders, Turntables, Amplifiers and Speakers, as well as the full range of famous Instrol Hi-Fi furniture — all on display and demonstration under one roof. Pictured here is the Instrol "Queen Anne" Hi-Fi Setting.

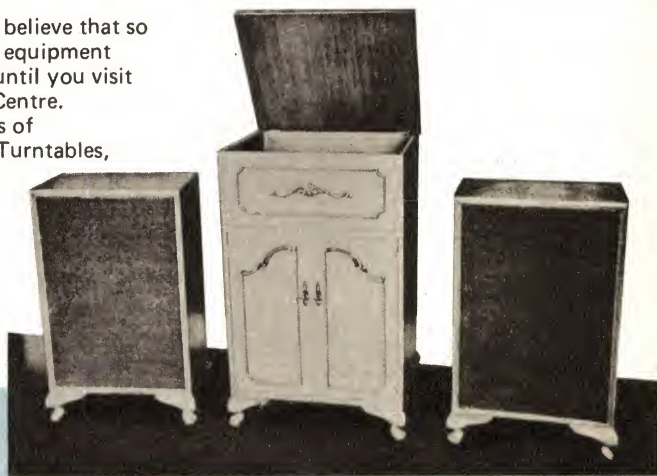



Goldring Trendsetters in sound equipment

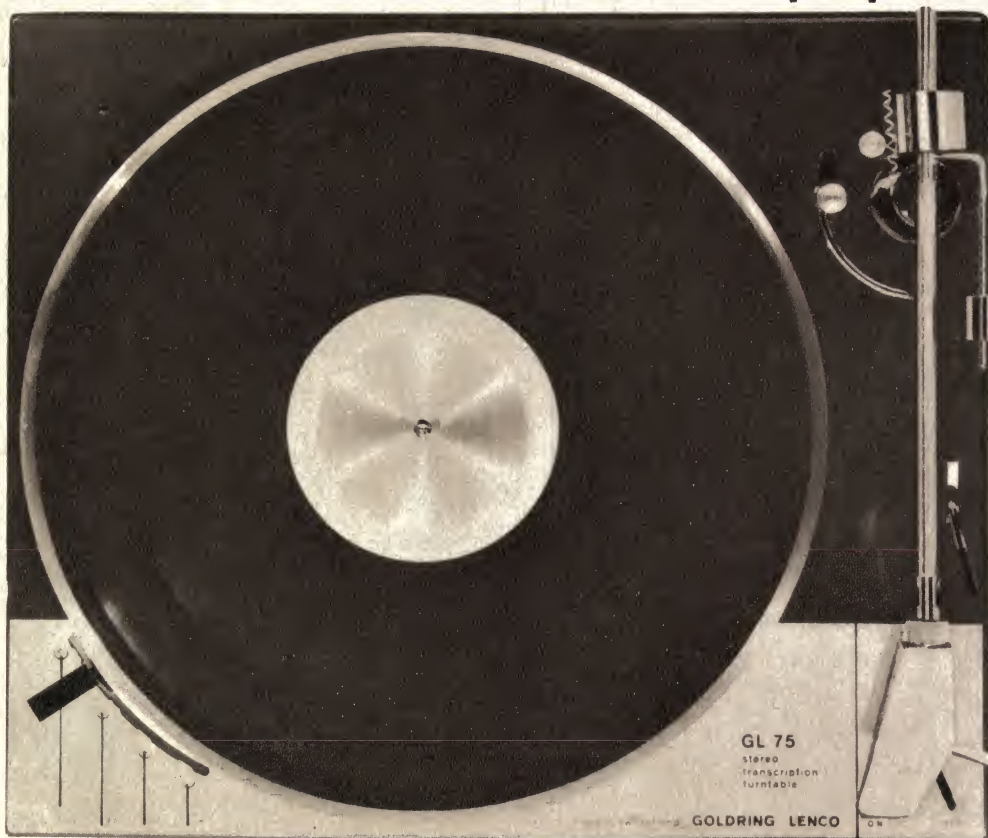

Latest release, Swiss made precision transcription unit GL75

Integrated transcription motor unit and arm, built to instrument standards of quality and appearance. The drive system is the unique Goldring-Lenco constant velocity 4-pole motor with conical shaft coupled to the underside of the turntable by a knife-edged idler (automatically disengaged by the on/off switch, which is fully click-suppressed and also operates a turntable brake). The turntable is die-cast from non-ferrous material, weighs 9 lb and is dynamically balanced. Speed is continuously variable from

86-30 rpm and from 18-15 rpm with adjustable positive stops for the four standard playing speeds. There is only 0.2% change of speed for 10% mains voltage change.

The transcription arm is the Goldring-Lenco L75 with knife-edge bearings, full balancing facilities, calibrated stylus pressure adjustment, and 'anti-skating' bias compensation. It is lowered hydraulically by a lever fitted to the deck plate. Shock-damping mountings are supplied with the unit.



Goldring '800' series free field stereo cartridge

800: In this cartridge a very lightweight tube of magnetic material lies in a "free field" generated by a fixed source coupled to a low mass diamond point. It features a low mechanical impedance (tracks at 1 to 3 grams), screening from external hum fields, gold-plated contacts. Stylus is replaceable. Rivals finest in the world. Frequency response 20-20 kHz, compliance 20×10^{-6} .
800E: Using the same cartridge body as the standard model, an elliptical diamond stylus is fitted. Compliance is substantially increased resulting in brilliant linear, resonant free, performance. Frequency response 20-20 kHz, compliance 30×10^{-6} .

GOLDRING ENGINEERING (AUSTRALASIA) PTY. LTD.

N.S.W.: 443 Kent Street, Sydney. 29-5802. Vic.: 162 Pelham Street, Carlton. 34-5105. Qld.: 415 Adelaide Street, Brisbane. 2-3247. W.A.: 32 Northwood Street, Leederville. 8-4988. S.A. Farhy & Fahy Co. Ltd., 75-77 Wright St., Adelaide. 51-5117.

From the ever-widening range of hi-fi equipment available from Goldring.

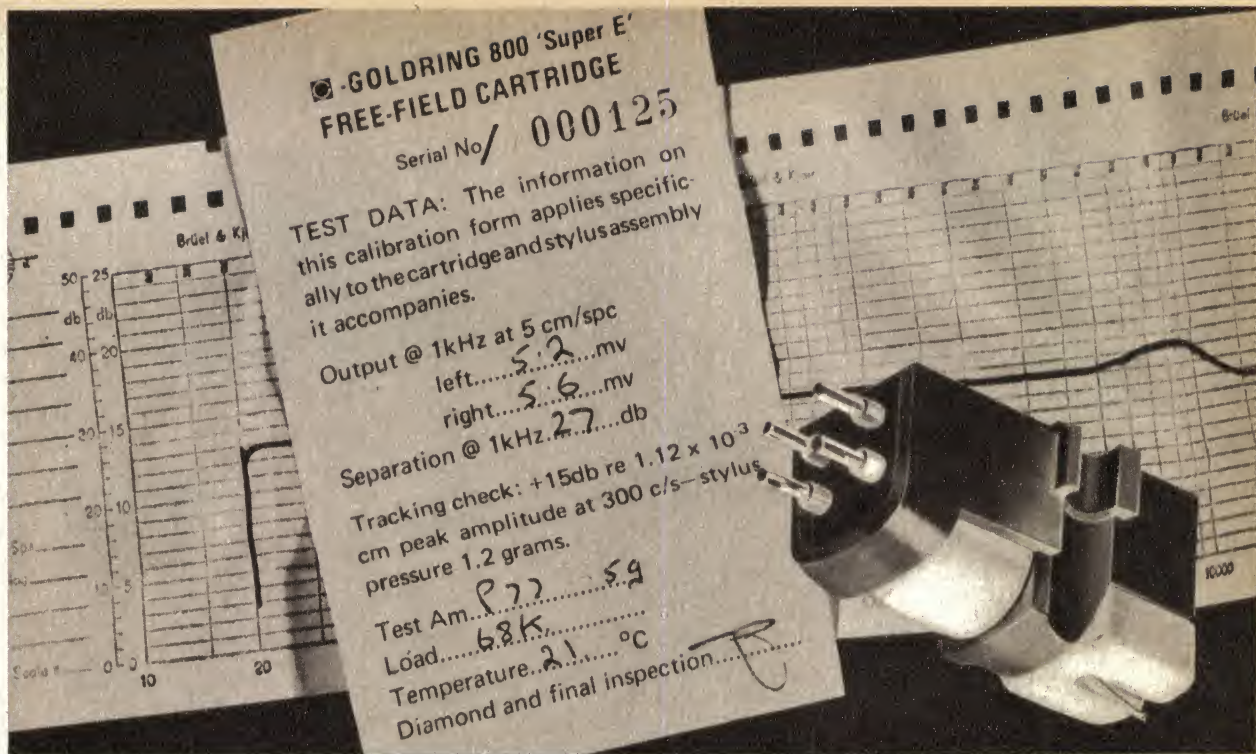

NEW RELEASE!

GOLDRING 800 'SUPER E'

free field stereo cartridge

...hand-crafted and tested for the most critical hi-fi buffs.

The 800 series, as used by the BBC, has won wide acclaim for its outstanding performance.

Now Goldring goes one step further with the 800 'SUPER E,' a cartridge capable of reproducing the complete dynamic range captured on your records. And, used with ancillary equipment having sufficient overload margins, it permits new peak loudness levels.

What's more each 800 'SUPER E's' performance is **certified**. Each one is accompanied by its own individual Bruel & Kjoer Performance Chart and Serial Numbered Calibration Form.

The 800 series is based on a very advanced principle: a very lightweight tube of magnetic material lies in a 'free field' generated by a fixed source coupled to a low mass diamond point. They feature low mechanical impedance (tracking at 3/4-2 grams), screening from external hum fields, gold-plated contacts, replaceable elliptical diamond stylus.

SPECIFICATIONS:

Frequency Response:	10 cps-25 kc's
Sensitivity:	5 mV per cm/55 sec
Separation:	25 dB at 1 kc and nowhere less than 15 dB
Load:	47 k-100 k ohms
Compliance:	30 x 10 ⁻⁶ cm/dyne
Effective Point Mass:	Less than 1 mg
Stylus Tip:	Elliptical Diamond 0.0008" x 0.0003"
Tracking Weight:	3/4-2 grms
Head Weight:	8 grms
Connections:	4 pins
Mounting:	1/2" standard
Vertical Tracking Angle:	15°

GOLDRING ENGINEERING (A'ASIA) PTY. LTD.

N.S.W.: 413 Kent Street, Sydney. 29-5802. Vic.: 162 Pelham Street, Carlton. 34-5105. Qld.: 415 Adelaide Street, Brisbane. 2-3247. W.A.: 32 Northwood Street, Leederville. 8-4988. S.A. Farhy & Fahy Co. Ltd., 75-77 Wright St., Adelaide. 51-5117.

FROM THE EVER-WIDENING RANGE OF HI-FI EQUIPMENT AVAILABLE FROM GOLDRING.

A New Member of KENWOOD's Powerful



120-WATT SOLID STATE STEREO AMPLIFIER KA-4000

Introducing KENWOOD's KA-4000, the solid state stereo amplifier that's the right answer for your Hi-Fi problems. Here's 120 watts of IHF standard total music power—a power-packed instrument that's up to the most severe stereo task. Wide power bandwidth is another outstanding feature with 13 Hz to 30,000 Hz range. IM distortion is almost totally eliminated. The KA-4000 offers momentary silence with a lever type -20 dB quick response muting switch. This amazing stereo advance is further equipped with 2 dB step type tone controls and lever type high and low filter switches. The KA-4000 also has a blue light indicator for input selector switch. If you desire even more total stereo power, another member of the KENWOOD family, the KA-6000 has a booming 180 watts. If you need less power, KENWOOD's diversified range of instruments offers an amplifier with the output you need.



BOOKSHELF TYPE 4-WAY 5 SPEAKER SYSTEM KL-60

- * Mounted speakers: 12-inch, free-edge woofer · 1 (Bass)
- 6½ inch cone squawker · 1 (lower midrange)
- 4 inch cone squawker · 1 (higher midrange)
- Horn-type tweeter · 2 (Treble)
- * Dimensions: 15"(W), 25½"(H), 11¼"(D).



40-WATT SOLID STATE STEREO AMPLIFIER TK-150U

- * 5 pairs of input terminals for MAG, AUX 1, AUX 2, TAPE REC and TAPE PLAY.
- * Damping factor: 40 (at 16 ohms), 20 (at 8 ohms)
- * Dimensions: 10½"(W), 4½"(H), 9¾"(D).



60-WATT SOLID STATE STEREO AMPLIFIER TK-250U

- * 2 sets of stereo speaker terminal and front panel speaker selector switch.
- * Dimensions: 13"(W), 4½"(H), 9¾"(D).

Stereo Family



180-WATT SOLID STATE STEREO AMPLIFIER KA-6000

Special Features of KA-6000

- * Wide power bandwidth of 10Hz to 50,000Hz with very low IM distortion.
- * Exclusive Low Level Phono Inputs for the Low Level Output Cartridges, the output of which is 2mV, 0.5mV, or 0.05mV.
- * 2 pairs of MAG Input Terminals for 2 sets of record players.

the sound approach to quality



KENWOOD

TRIO ELECTRONICS, INC.

6-5-1-CHOME, SHIBUYA, SHIBUYA-KU, TOKYO, JAPAN

Sole Agent in Australia: Jacoby, Mitchell & Co., Pty., Ltd. Head office: 469-475 Kent Street, Sydney Tel: 26-2651 Melbourne: 15 Abbotsford Street Tel: 30-2491 Brisbane: 56 Edward Street Tel: 2-6467 Adelaide: 652 South Road, Glandore Tel: 53-6117 Perth: United Australia Co., Pty., Ltd. 435 Hay Street, Subiaco Tel: 8-4665 Tasmania: K. W. McCulloch Pty., Ltd. 57 George Street, Louceston Tel: 25-322 Newcastle: Edmunds Moir & Co. Pty., Ltd. 18 Wood Street Tel: 61-4991
Distributor in New Zealand: JOHN GILBERT & CO Tasman Buildings, Anzac Ave. Auckland C 1

Ask for a catalogue or demonstration by your nearest dealer.



30-WATT FET SOLID STATE AM/FM STEREO RECEIVER TK-20U

- * F.E.T. (Field Effect Transistor) 3 Gang Tuning Condenser frontend for superior sensitivity, image rejection and cross modulation ratio.
- * Dimensions: 14 1/4" (W), 4 3/4" (H), 11 1/4" (D).

To: Jacoby Mitchell & Co., Pty., Ltd. EA
469-475 Kent St., Sydney.

Send me information on KENWOOD RECEIVER, AMPLIFIERS, SPEAKERS & name of nearest KENWOOD retailer.

NAME: _____ AGE: _____

ADDRESS: _____

ARMY RADIO COMMUNICATIONS

Over the 55 years since the start of World War I to the present day, Army communications have changed from the semaphore and heliograph capable of being used only over line of sight to massive electronic systems giving world-wide coverage. The author of this article was intimately connected with the development of communications systems for the British Army over a long period.

This is a history of wireless communication for the U.K. and Australian Armies, tracing it from its commencement in World War I to the evolution of the sophisticated equipment of today; in the space available it is in no sense a complete history.

It is possible to cover the middle part of this epoch from personal experience in that the author was responsible for the circuit and design of a number of Service equipments developed in England during the decade preceding World War II and during it. Specifically these equipments were:

The wireless sets:—

No. 5 (Army chain).

No. 7 and No. 9 (Tank Radio).

No. 10 (U.S. AN/TRC/6; 6cm, 8-channel, pulse width modulated speech, used for rear link communication).

No. 11 (General purpose light vehicle equipment).

No. 13 (Man pack equipment).



Back-pack radio telephones ("walkie-talkie") as used by British forces during World War II.

It is interesting to consider some of the communication systems used prior to the introduction of radio in World War I. Extensive use was made of pigeons; a cage fitted with a gas mask can be seen in the Australian War Museum in Canberra. Among the other equipment used during this time was the daylight signalling lamp, the heliograph, the shutter device for sending morse, a sample of which can also be seen in the War Museum, and the ordinary signalling flag.

General Cole, in his presidential address to the Radio Society of Great Britain a few years ago, gave some account of the use of wireless in World War I and has indicated that it was not very extensive, until the appearance of the 30 watt CW set. This, of course, was not surprising, in that on the Western Front, to which he no doubt referred in particular, the static position of warfare in general which prevailed practically throughout that War, left little scope for radio communication. Signals were in general transmitted by telephone or by "Fuller"-phone, using lines of various sorts.

Radio, of course, is particularly advantageous as a communications medium for military purposes in conditions of mobile warfare; this will be elaborated later in regard to the communication between armoured units, particularly between command vehicles and tanks. In World War I, mobile warfare was seen at its best where cavalry was employed, and probably the most extensive use of this was in the Mesopotamian Campaign.

Here we see the advance of the cavalry units and indeed of the army as a whole, strongly supported by radio communication and interestingly enough, the bulk of this communication was provided by the "Anzac Wireless." It is felt, therefore, that in saying something about the exploits of this unit one is touching upon the highlight of radio communication in World War I. The units were assembled in Australia and came largely from the areas of Sydney and Melbourne and from New Zealand. An extensive part was played by the "Anzac Wireless" in the advance up the Tigris and Euphrates rivers, in the capture of Baghdad and in subsequent campaigns. A few extracts from a book written in 1927, entitled "With Horse and Morse in Mesopotamia," edited by Keast Burke, are of interest:

● "Serious work began on April 1 (admirably chosen date), when the remount depot handed over 74 Australian horses, all specially picked and splendid animals, but mostly were unbroken. The depot had realised that the fortunate arrival of a 'gang of Australian bushmen' had given them a chance of getting rid of some very rough stuff. The horses were so wild that nosebags could only be placed on them with difficulty. However, the men stuck to it and after a whole chapter of humorous, strenuous and plucky endeavours, got their teams into workmanlike shape. Incidentally, it was the turning point in their careers. Once they had believed themselves a distinguished technical unit; but now, disillusioned, they found themselves horse-trainers, stable hands, jockeys and grooms. We pass lightly over the daily task of taking the brutes to water through the best mud Mesopotamia could produce. But there was one alleviation—the vocabulary of many was poor at the beginning, but at the end all were equipped with a rich store of appropriate adjectives, ready on the tip of the tongue for any eventuality."

"At about 5 a.m. the following morning, the memorable March 11, 1915, we were told to get on the march at double-quick speed, and advance as fast as possible. We

SINCE 1914

By W.A.S. Butement*
C.B.E., D.Sc.

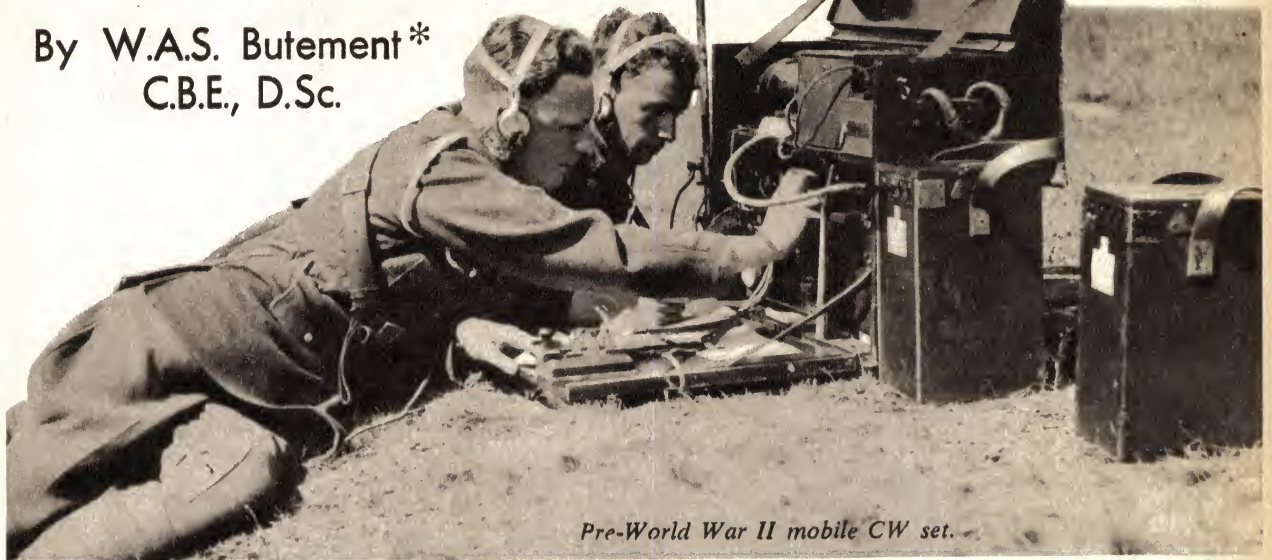

Pre-World War II mobile CW set.

were given precedence over all other troops for the road, and had to go at a fast trot for three hours to overtake Corps H.Q. At times we can hardly tell where we are, as the rising dust is so dense, but since we have authority to pass all others on the road, are soon in front and so escape much of it. A final gallop brings us to Corps H.Q., where the station is at once erected to send messages, and we then pack up again and go off with the General. We are told that we shall be in Baghdad in a few hours (and so we are). Erecting near the railway, we pass back the good news. The finish is great — heavy guns, light guns, infantry, cavalry, hospital and engineering stores, all advancing at the double. Ambulances are at work clearing our casualties, every kind of vehicle being pressed into service. Near the station destruction is supreme. A giant wireless station (that has sent

only one message), roundhouse, waggons, and rolling stock — all destroyed. Coal stocks burning — rubbish and litter on every side."

During the advance on Baghdad, General H.Q. was set up on a river boat, a paddle steamer, and this moved up the Tigris as the advance proceeded. Mounted on the boat was one of the radio sets with 3 or 4 operators from "Anzac Wireless." Thus contact was maintained with other units of "Anzac Wireless" in the field during the whole of this phase of the campaign. In this we see the beginning of the evolution of the mobile command vehicle fitted with radio and able to operate on the move, as exemplified by the "Armoured Command Vehicle" of later years.

The wavelength used during most or all of this campaign was 700 metres, although contact was sometimes made with a fixed 30-kilowatt station at Basra which operated on 2000 metres.

Basra was sometimes contacted at ranges of several hundred miles.

It is interesting to look at the breakdown of the equipment comprising the so-called half-kilowatt spark set, with its guaranteed daylight range of 35 miles. This was divided into 5 separate mule or horse loads. It is perhaps of even greater interest to picture the 1.5KW waggon set, consisting of two limbered waggons each drawn by teams of six horses driven postillion fashion.

These two equipments, with their synchronous rotary spark gaps, and their carborundum crystal detectors, probably represented the pinnacle of mobile spark wireless communication equipment; from now on a new epoch was to commence with the evolution of the three electrode valve and with the discovery, by Armstrong, of the principles of feed-back, and thus of an easy means of generating continuous waves.

* The author is Director of Research, Plessey Pacific Pty. Ltd. The article is based on a paper given before the Commonwealth Defence Science Organisation Symposium, in Canberra, in May, 1969.



During World War I the heliograph was widely used for sending messages over short distances. In this picture, the device is being used for transmitting messages back from a forward spotting position to an artillery post.

In the decade immediately following World War I, little seems to have been done during the several years of re-establishment of peace-time conditions, but at the end of the decade the wireless set No. 1 was designed by H. W. Foreshaw who was later Chief Superintendent of the Signals Experimental Establishment (S.E.E.) which eventually became Signals Research and Development Establishment (S.R.D.E.). This set employed a very early version of tetrode in which the screen was designed to be surrounded by a cylinder just inside the glass envelope. This early version of a multi-valve set was a great improvement on the 30-watt set.

Some curious rules had grown up during this period, and in the No. 1 set, in conformity with these, all valves were accessible through doors in the front panelling and all resistors were wire wound.

Towards the beginning of the next decade the War Office began to think more widely in terms of the equipment it sought and the author was given the interesting task of developing a tele-

THE

TANNOY

Monitor

GOLD

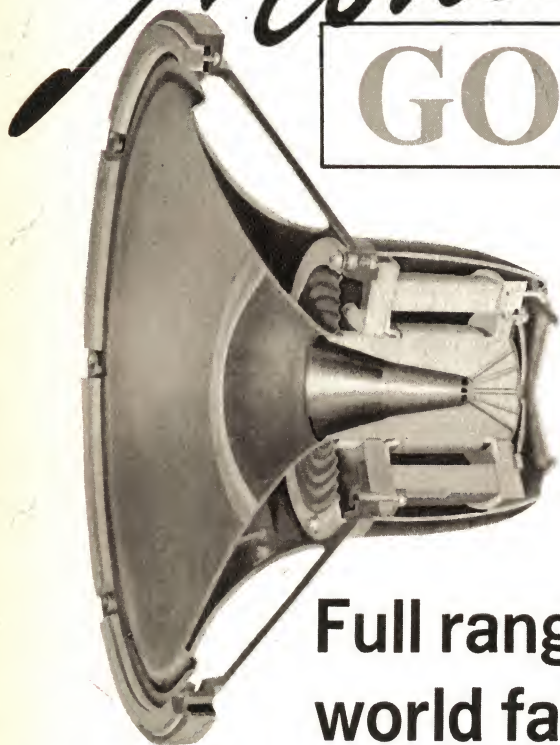

Full range world famous dual concentric loudspeakers

The Monitor Gold is a further refinement in the almost legendary range of Tannoy Dual Concentric Loudspeakers. An entirely new crossover network not only provides facilities for adjusting treble energy to suit prevailing acoustic conditions, and treble roll-off to accommodate variations in programme material, but also gives a smoother frequency response in the middle treble register together with a more constant impedance characteristic; thus ensuring the highest performance from modern transistor amplifiers. The impedance is nominally 8 ohms but never falls below 5 ohms.



Distributed through the Consumer Products Division of

AMALGAMATED WIRELESS (AUSTRALASIA) LIMITED

554 PARRAMATTA ROAD, ASHFIELD. 71 0791

167 Queen Street, Melbourne. 67 9161 • 70 Merivale Street, Brisbane. 4 1631
• Cnr. Darby and King Streets, Newcastle. 2 5166 • 231-233 Bulwer Street,
Perth. 28 6400 • 48 King William Road, Goodwood, Adelaide. 72 2366 • 42
Frederick Street, Launceston. 2 1804 • 123 Murray Street, Hobart. 3 3836-7

12 **ELECTRONICS Australia, November, 1969**

vision system with the object of eliminating the Morse operator, so that written messages could be sent directly.

In parenthesis it is interesting to note the difference in philosophy revealed in this approach by the War Office from that of the U.S. Army. In the latter case it was realised that the encouragement of radio transmitting amateurs would lead to a substantial number of trained Morse operators being available in the event of war. Thus, in contrast with the British War Office, the U.S. Army encouraged these amateurs, and when World War II commenced, many thousands of trained Morse operators were available.

The television equipment which was developed was very simple. It used Nipkow discs with a spiral of holes for transmitting and receiving. The transmitting disc was used to scan the message written on a strip of paper, and passed in front of it. The scanned image of the message was applied to a photo cell, which modulated a radio transmitter. A second disc was run in synchronism at the receiving end, and a neon lamp modulated by the output of a receiver tuned to the signal frequency, was viewed through the holes in the disc.

An interesting technique was proposed by the head of the Establishment, the late Dr S. Brydon, to synchronise the discs at transmitter and receiver. A DC motor had its commutator tapped at two opposite segments, and these were connected to a pair of slip rings. The AC output thus generated was then short-circuited by an electrically operated tuning fork, so that, at operating speed, the AC output was short circuited once per cycle. Thus if the motor was fed with DC, so that (if not fork-controlled) it would run a little faster than operating speed, it would immediately drop into synchronism when the fork was connected. The resulting system never "hunted" or varied in speed and perfect synchronism between transmitter and receiver was readily maintained. It is interesting to observe that a modern facsimile system uses this principle although it does not appear that Brydon ever wrote a paper about it.

This television equipment was developed in 1929, and was demonstrated to the Chief of the Imperial General Staff. It showed the practicability of transmitting messages in this way, but equally that the equipment was hardly suitable for field use.

It is interesting to note that Mr John L. Baird, at about this time, developed a system of television based on similar principles, but it is not known whether he actually witnessed a demonstration of the War Office equipment.

At about this time, Baird gave a demonstration of his system to representatives of the Establishment. He showed apparatus employing in the transmitter a sort of Nipkow disc, comprising a bicycle wheel, on the rim of which was mounted a series of small lenses. The wheel was made to rotate in front of his "object," a rather ugly ventriloquist's dummy. The receiver used a conventional Nipkow disc rotating in synchronism with the bicycle wheel, and mounted in front of a neon lamp, modulated by the received signals. Considering the crudeness of the equipment, reasonable

signals were demonstrated, but the "flicker" was somewhat excessive.

Someone then proposed that Baird speed up the wheel, and disc, which was done with some improvement in the image. However, in his anxiety to show that the problem of flicker could be readily overcome, Baird increased the speed still further with the result that all the lenses flew off the rim of the bicycle wheel.

The early experiments in facsimile transmission and reception conducted in S.E.E. (S.R.D.E.) at about this time are of interest. A contract was let to a firm in Paris, Belin and Co., to provide experimental equipment and two models were delivered to the Establishment early in the 1930s. These consisted of tables about 4ft sq. made of steel, and precision ground to be flat, and on these tables were mounted the various pieces of transmitting and receiving equipment. A drum was used to mount the picture and this was rotated at about 1 rev. a second. A pin-point of light was focused on the drum, and a photo electric cell picked up the variable light signal resulting. A similar drum, rotating in synchronism, was used for the receiver. A chemical inking method using an iodide salt mixed with starch was employed to give a blue image.

Arrangements were made to encrypt



At the beginning of World War II the field telephone still played a dominant role in short distance communication (above); but mobile radio telephone sets were coming into use, and were extensively used by the Armed Forces for field communications after 1939 (below).



the signal from the transmitting equipment, so that classified information could be transmitted, but it took many hours of hard work to adjust the equipment so that a readable message could be received after encrypting and decrypting, whereas the director of the establishment, one weekend, worked out a very simple technique for breaking the code. Thus early attempts to develop secure equipment were abandoned, although the work led to the development of further experimental apparatus for facsimile transmission and reception known as the "Eidograph." The Eidograph was not made in any quantity.

Early in the 1930 decade, the author was given the task of developing communication equipment for tanks, and the first of these equipments was the wireless set No. 7 which was designed to fit into the turret of a medium size tank, all sides of which sloped so that the armour could be set at a suitable angle. The consequence was

that the No. 7 set looked like a sliced-off section of a pyramid, and a small number was made, in order to obtain a general feeling for the problems which were involved in this somewhat novel task of communicating between very noisy, moving vehicles.

Soon after this it was decided to design a new tank with a turret suitable to take a fairly large radio transmitter and receiver. With the components and valves available at the time, such a volume was necessary, so the wireless set No. 9 was specified to occupy a volume of 42in x 12in x 16in and the turret was designed accordingly. The tank was the Medium Mark II, and most of these were sold to the Finns just before the start of World War II.

Up to this date the specifications of radio sets were written by the War Office, and issued to the Establishment for execution, and little or no departure from it was contemplated. How-

ever, it was realised that so many novel features arose in regard to communication between moving tanks that such a rigid specification was impossible, and arrangements were made for the author to spend quite long periods on the Salisbury Plains attached to the 1st Tank Brigade, under the command of Brig. Percy "Hobo" Hobart (later Major-General Sir Percy Hobart).

The author got to know "Hobo" well, and during these visits to his unit helped to hammer out the whole philosophy of tank communication. He accompanied "Hobo" on many manoeuvres standing beside him in the tank and the outcome of discussions of these was the evolution of an equipment comprising an "A" and a "B" set, the former for communication between units and headquarters and the latter for communication within the tank troop.

During this time the concept of automatic netting evolved, whereby a large number of tank radio sets could be automatically tuned to the same frequency, so avoiding the need, as would otherwise have been the case at that date, of large numbers of piezo-electric crystals in each set, as was done in the case of U.S. equipments. The No. 9 set was therefore provided with a facility so that the master-oscillator of the transmitter could be switched on momentarily during reception in a particular tank, and tuned so as to give a zero beat with the incoming signal from the "command" tank, thus ensuring that when the particular tank equipment was switched to "transmit," the two stations would be operating on the same frequency.

The principle of automatic netting of a large number of radio equipments on to a given frequency (which was effected in a somewhat different manner in the No. 11 set; see below) was, as far as is known, a unique development of the British War Office. On the whole it worked well, and saved the production of thousands of quartz crystal discs, which would have required many skilled operatives during World War II.

During the trials of radio equipment on Salisbury Plain in this epoch, advice was received from units operating in the Middle East that a curious noise

Rotex presents
two great labelling systems

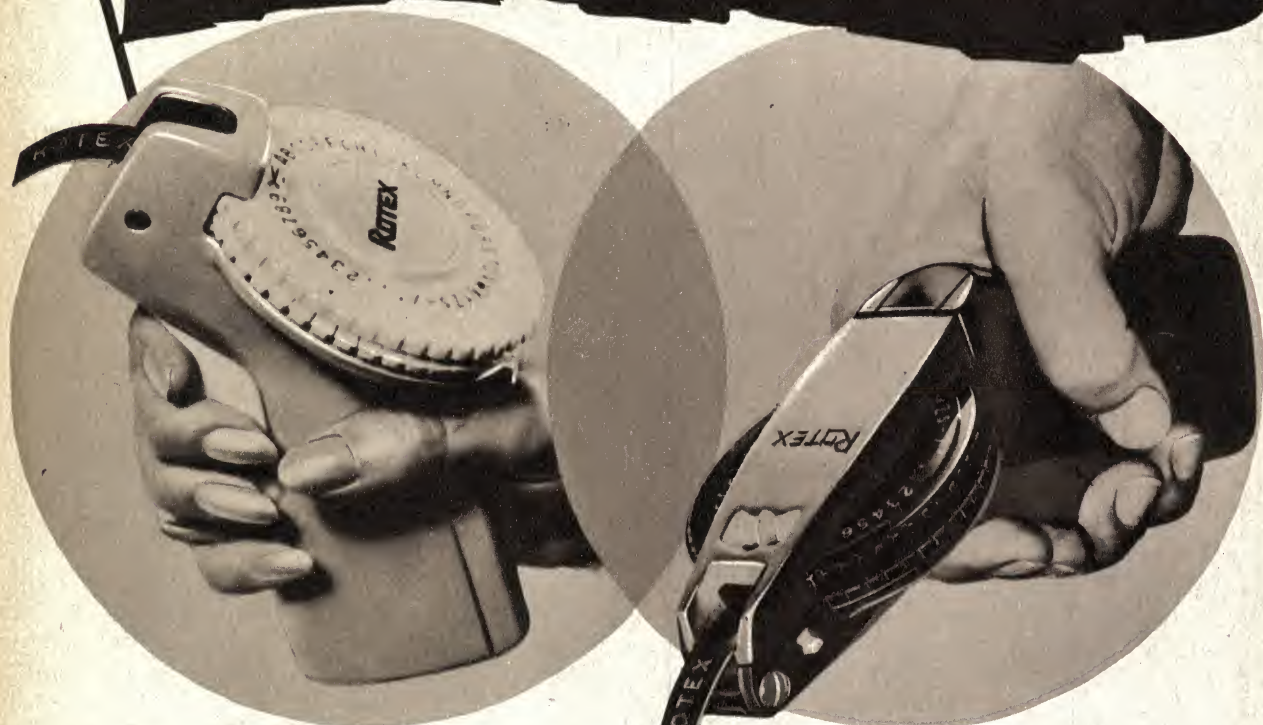

**interchangeable
dials** SNAP-IN DIALS, CHANGE LETTER SIZES,
TAPE SIZES.

**heavy duty
model**

plus Superflex Tape

4 TIMES THE ADHESION –
SHARP CONCISE LABELS ON ANY SURFACE.

- TEFLON – TELCATHINE – CEMENT – MANY OTHERS.
- MOISTURE PROOF
- ADHERES TO CURVES – AROUND CORNERS – ON RODS
LEADS OR WIRES AS SMALL AS 3/8" DIAMETER.



ROTTEX Identify for keeps with a
ROTTEX label maker.

**IRH
COMPONENTS
PTY. LIMITED**

THE COMPONENTS DIVISION OF IRH INDUSTRIES LIMITED

THE CRESCENT,
KINGSGROVE,
N.S.W. 2208.



was observed on the radio sets when tanks were travelling, but did not seem to be present when the tanks were stationary. These problems were discussed, and the tentative conclusion was reached that it could be due to friction causing the tyres of the wheels supporting the track to become charged and to discharge to the tracks in a series of small sparks. It was planned therefore on a hot dry day when the phenomenon was quite marked, to drive a tank through a shallow pond and it was immediately observed that all signs of interference ceased. This, in its turn, led to the development of conducting rubber of which the tyres of the wheels of later tanks were constructed.

It is worth recalling here that during these exercises on Salisbury Plain in the mid-1930s, the whole concept of the "Blitzkrieg" was refined by "Hobo" and it is paradoxical indeed that it was the Germans who put it into full effect early in World War II.

During this time the 1st Tank Brigade had attached to it three experimental tanks weighing some 50 tons, thickly armoured, and mounting an adapted 3.7 inch anti-aircraft gun. These tanks were very fast and indeed might also be regarded as the prototype of the German Tiger tank of World War II. It must be a matter of deep regret that the War Office did not see fit to go into production of these tanks, but concentrated on the lighter infantry tank with its cast turret, and armour about 3in thick, and its smaller weapons.

The wireless set No. 11 was the next to be tackled and here it became apparent that the rules, which had been laid down in earlier days for the design of radio transmitting and receiving equipment would have to be substantially modified if a compact and effective set was to be developed.

The wireless set No. 11 was a much smaller equipment than the No. 9, and it was intended for use in ordinary vehicles, and as a general purpose set in the light-weight class. These rules, to which reference has already been made, just had to be broken if an efficient set was to result, so that the concept of pulling the entire set out like a drawer in order to provide access to the valves was developed. The rule that only wire wound resistors be used was set aside.

Thus it was possible to design a set with a three-gang condenser for tuning the receiver, with automatic netting, and with provision in the transmitter for any aerial impedance. The set used 10 tuned circuits in the intermediate frequency amplifier, and thus gave comparatively high selectivity, the sides of the selectivity curve having a slope of about 10dB per KHz.

The transmitter signal was generated by mixing the output of an oscillator, operated at intermediate frequency, with that of the receiver local oscillator, and filtering the resulting signal, ampli-

fying it, and feeding it to the power output stage. This output stage of the transmitter was, in the early models, a tetrode capable of a dissipation of 10 or 15 watts, but was replaced a little later by a single valve, type 807.

The set was available in its so called low-power form, in which the rotary generator used for the receiving high tension supply was also used for the transmitter. There was a so-called high-power version, in which a separate generator was added for the transmitter output stage, giving a substantially higher voltage.

The wireless set No. 11 was developed in close concert with E. K. Cole Company, and not in sequence, as had hitherto been the practise with radio equipments. During the time when 2 or 3 equipments were being made in the S.E.E. workshops, E. K. Cole were making a dozen or so to production drawings and although this led to the scrapping of one or two comparatively minor parts, the overall saving of time was more than justified. It was quite clear that this principle of mutual development by the Establishment and a commercial organisation had much to commend it.

The No. 11 was made in fairly large numbers and was copied in Aus-

frequency on an ordinary telephone dialling unit, but after a study of the detail of what this would entail, it was decided to settle for a simpler method of frequency selection.

The wireless set No. 13 was developed as an equipment to be mounted on a man's back and operated in the VHF spectrum, but only a limited number was made and the set does not seem to have had extensive use.

At the commencement of World War II a new equipment was required, for use primarily in tanks, which had to be a good deal smaller than the No. 9 set of the previous decade. The S.E.E. produced several experimental equipments designed to meet a fairly rigid War Office specification, and in parallel with this an industrial organisation produced an equipment which, while a good deal easier to manufacture and a great deal cheaper to produce, did not meet all the requirements of the specification.

The firm in question made a dozen or so sets and these, together with the two or three made by S.E.E. were demonstrated to a large and representative gathering of interested people. It is

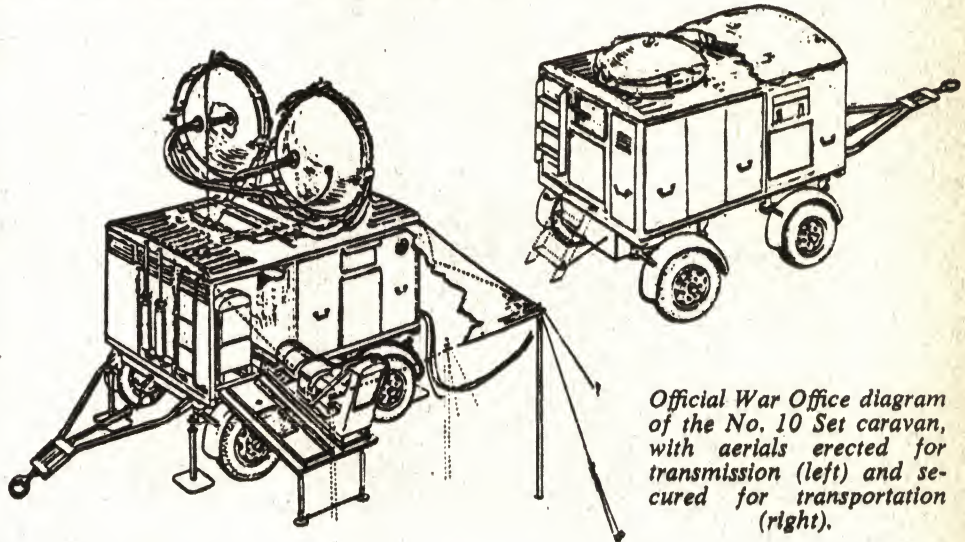

Official War Office diagram of the No. 10 Set caravan, with aials erected for transmission (left) and secured for transportation (right).

tralia and re-named the No. 111. It set a pattern for the later equipment developed in the early days of World War II, namely the Nos. 19 and 22 sets, about which a word will be said a little later.

The No. 11 set had fairly extensive use during World War II, and it is interesting to recall that General Le Clerk, who undertook the remarkable exploit of leading a substantial unit all the way from Dakar through the Sahara Desert to attack Rommel from the south, as he withdrew north to Tunisia, used a No. 11 set as his main communication link.

The wireless set No. 5 was developed for Army Chain communication, and provided an output of about 2KW of CW for the purpose. It had a world-wide range, when using a suitable aerial, and was designed so that the frequency in use could be changed quickly, to accommodate changes in ionospheric conditions. It was intended to arrange for the frequency changing to be done by dialling the desired

understood that faults in two of the S.E.E. sets made it impossible for these to be adequately demonstrated, while the larger number available of the commercial equipment enabled a rather impressive trial to be given.

The consequence was that, for the first time in War Office history, an equipment was adopted which failed to meet the specification laid down in a number of features. This set was the No. 19 set, which saw extensive use in World War II. Among the features of the equipment which did not meet War Office requirements was the specification of the components, in that these had not been tested over the wide range of temperatures prescribed in the normal specification. The consequence of this was that during some very hot weather in North Africa, during the campaign against Rommel, almost all the No. 19 sets (Mark I) were out of action as a result of a breakdown of a capacitor in the power pack, which reached a very high temperature. Extreme measures had to be taken and 10,000 capacitors of a special type



NEW D53S DUAL BEAM STORAGE OSCILLOSCOPE



The D53S offers the operator the same characteristics as the popular D53A Plug-in Oscilloscope PLUS:—

- **Normal display**—P31 phosphor characteristics
- **Variable persistence**—continuously variable persistence control from 0.2 second to more than 1 minute
- **Storage**—as a storage oscilloscope it is capable of storing traces for periods of up to 10 minutes in normal use
- **Integrate**—the storage mode can be selected to integrate successive pulses and build up a bright display
- **Time Base**—wide range time base with single shot facility and sweep delay
- **Versatility**—full range of proven performance plug-ins
- **Price**—\$1,181.00 (plus tax and duty if applicable). Plug-ins not included

TEKTRONIX



Distributed by Tektronix Australia Pty. Limited
N.S.W.: 80 Waterloo Road, North Ryde 2113. 88 7066
VIC.: Suite 20, 67 Queens Road, Melbourne 3004. Phone 51 1592
S.A.: 128 Gilles Street, Adelaide 5000. 23 2811

were produced in the U.S.A. as a matter of great urgency, and flown to North Africa to replace those which had failed, in order to enable the sets to be used.

Despite this unfortunate event, it must be conceded that the wireless set No. 19 (at least in its later Marks, particularly the Mark III) saw extensive and successful use throughout the war. One thing was clearly demonstrated, namely that the rigid view of an unalterable War Office specification on the one hand, and the more laissez-faire approach of the industrial organisation on the other hand, were both wrong, and that the right way to develop a satisfactory military equipment was by close co-operation between the Government establishment and the commercial organisation as had indeed been the case with the wireless set No. 11.

The No. 22 set, which followed the No. 11 and adopted many features of the latter, was intended to replace the No. 11 for general purpose, and ordinary vehicle use. Again this set had extensive use in World War II.

Just before the War, at Baudsey Research Station, when trials were being conducted of the first beamed radar equipment CD/CHL, it had been observed that occasionally very long ranges could be achieved well beyond the horizon, and it had been concluded that this phenomenon was due to ducting resulting from a layer of water vapour near the sea.

Later experiments at Christchurch on the South Coast, of 50cm radar equipment, tended to confirm this prediction, and good echoes from the cliff at Cherbourg at a range of some 70 miles were obtained from near sea level. The Communication Committee of the Scientific Advisory Council of the Ministry of Supply, under the Chairmanship of Sir Edward Appleton, considered the possible application of the phenomenon to enable communication to take place at long distances between the islands of the Pacific as in due course the Japanese would be driven out of these. It was decided therefore to conduct some experiments across the Red Sea, between Aden and Berbera, where the humidity was expected to be very high as well as the temperature. Two specimens of equipment operating on 8cm wavelength were therefore developed, using a single channel of pulse width modulation. These sets were put in charge of a Lt. Walker, who was sent out with instructions to establish communication between these two towns across the Red Sea, with the equipment more or less at sea level — the distance being some 120 miles. In due course Walker reported for attachment to "T.R.E. Middle East" which was an out-station of the Telecommunications Research Establishment (now R.R.E.) with headquarters in Cairo.

T.R.E. Middle East promptly signalled back to London to say that there must have been some serious mistake in the instructions to the lieutenant in that what he was asked to do was contrary to the laws of nature, and was therefore impossible. The signal caused a great deal of amusement to Sir Edward Appleton, who replied in suitable terms to the Middle East out-station.

Lt. Walker therefore proceeded to

Aden and tried to establish communication, but for some days without success, so that it began to look as though T.R.E. Middle East would be vindicated. So he set up one equipment in a dhow and the other on the shore, tuned in the signals at a very short distance, and slowly sailed the dhow across the Red Sea, maintaining intermittent contact all the way. He then carefully set up the equipment on the opposite shore.

His report in due course showed that reliable communications could be achieved in such circumstances for some 90 per cent of the occasions, but after considerable discussion in the Communications Committee, it was decided that this was regrettably not good enough to form the basis for the design of Service equipment. The Committee, however, decided that further experiments should be conducted regarding "anomalous" propagation, and these were undertaken on the Welsh Coast on wave lengths of 3, 6, and 9cm, under the oversight of the National Physical Laboratory.

The Japanese attack upon Malaysia and the capture of the rubber growing areas led to a crisis in the War Office in that it was envisaged there might be a serious shortage of rubber for cables for Army rear communications using channel-modem equipment. The Director of Signals, General Phillips, therefore called an emergency meeting with the Ministry of Supply to consider what might be done, and the author was asked to make proposals for a radio solution. The General stated he required a minimum of 8 channels of speech.

The experiments between Aden and Berbera had shown that practical equipment could be designed at least for line-of-sight communications using 8cm waves, and that a single channel of pulse width modulated speech could be effective. The equipment proposed was to operate on about 6½cm wavelength and to use 8 channels of interlaced pulse-width modulation. A paper setting out the proposal in some detail was presented to Appleton's Communication Committee, and the system was recommended to the War Office. The War Office accepted the recommendation and asked for a demonstration of a working equipment in one month. In order to achieve this very difficult task, Mr A. J. Oxford was transferred from another establishment to develop this demonstration equipment.

In exactly one calendar month (as it happened of 31 days), Oxford demonstrated the equipment operating with a simulated radio link. Senior officers from the War Office, in two groups of 8, spoke to each other over



A British Army No. 52 set for telephony, CW and MCW, in use at the time of the Suez crisis and the Korean war.

the 8 channels, and were able to observe that there was no cross-talk between the channels, and that clear and intelligible speech was obtainable.

It is interesting to reflect upon the subsequent history of the wireless set No. 10. In the event, the acute shortage of rubber that had been envisaged did not prevent cable communication from being planned for use after "D" Day, and so the priority of the wireless set No. 10 was reduced. Despite this, it was arranged to check out two early models between Ventnor on the Isle of Wight and Beachy Head, because the distance between these two points and the relative heights were similar to those between Ventnor and an area near Cherbourg in North France, should it be decided to use the equipment after "D" Day. Successful results were obtained between Ventnor and Beachy Head.

A little after "D" Day, as a result of a severe storm, the cable link was disrupted between England and Montgomery's forces in France. It was then decided to put a No. 10 set link across the Channel and communication was immediately re-established. In due course an extra link was installed up to Caen in Normandy; thus some experience of the use of the No. 10 set was established.

Some time later, when Montgomery broke out from Caen and moved very quickly through Europe and up into Belgium, he found that although line communication equipment was available it was impossible to install it and set it to work fast enough to keep pace with his rate of advance. It therefore became a matter of urgency to arrange for the No. 10 sets to take over the role, but as this equipment had in the meantime been accorded low priority no operators had been trained to use

it. As a consequence Mr J. G. Mac-Millan, a technical officer of the S.E.E., was sent to France with the rank of major and the task of re-training the line operators in the use of the No. 10 equipment. He did this with great effect so that General Montgomery in choosing his headquarters would draw a circle of about 5 miles diameter and say, "Find your hill for your No. 10 set thing in that circle." Thus it is probable, as a consequence of this, that the Armistice was signed on Luneberg Heath because it was adjacent to suitable high land. Twenty No. 10 sets, providing 10 links of relayed communication, enabled Montgomery to be connected with Brussels, and thus by cable to London, so that he was able to talk to Churchill regarding the Armistice conditions.

Of this equipment, Montgomery said: "I have no hesitation in saying that I consider the No. 10 set to be the very marked and rapid advance in wireless technique. No other Army, allied or hostile, possessed equipment equally effective in its role.

"I had considerable personal experience of this set during the campaign in north-west Europe, most noticeably perhaps at the crossing of the Rhine and during the final pursuit through Germany. By using a chain of No. 10 Set stations, I was enabled to maintain my Tactical H.Q. as far forward as I did and still have direct contact with London. The value of being able to retain personal control over my Armies in these circumstances cannot be over-estimated."

Some further details of the No. 10 set are given in "Science at War," by Crowther, J. G. and Whiddington, R., H.M. Stationery Office, 1947, p.81 et. seq.

In the years just after World War II, work was generally devoted to further improvements of communication equipment, including the provision of frequency as well as amplitude modulation in some of these. Also attention was given to the problem of making some of the forward sets immersion proof.

One of the new principles in radio equipment which appeared in the latter days of the war was the use of a synthesiser to generate frequencies in the HF spectrum on a decade basis, so that a row of knobs could be set, the first to read megacycles, the second hundreds of kilocycles, the third tens, and so on. This synthesiser principle was first developed in the latter days of World War II in the wave-meter "D" by Mr D. Cook of S.E.E.

In the latest version of radio equipment developed for the British Army this principle has been used, the first knob on the set reading megacycles, and so on to the last reading hundreds of cycles. The equipment uses integrated circuits wherever possible, and provides a system of single-sideband communication. It is interesting to note that one or other setting of the last knob, varying frequency in hundred cycle steps, will always allow tuning close enough to give clear speech from the SSB transmission. The set is intended for manpack use and with its battery, weighs about 11lb.

Some experiments were conducted in Melbourne recently with this equipment, feeding a 3-element Yagi an-

A more recent one-man mobile radio telephone, which is unaffected by immersion in water. This set, type A510, was designed and built in Australia, and used by British, Canadian and American forces.



tenna, on a frequency of about 14MHz, and easy communication with amateurs in Canada and Hong Kong was maintained. This result bears interesting comparison with the "guaranteed range of 35 miles in daylight" of the 500W five mule load equipment of World War I.

Some mention must be made of satellite communication. Among the earliest satellite communication experiments were those relating to passive satellites in close orbit around the earth. The "Echo" satellites consisted of metallised balloons of diameters up to 135ft, and signals were reflected from these. The experiments have not been continued. Another series of experiments which has also been discontinued related to the dispersal of large numbers of small metallic "rods" in space from a satellite. Signals were reflected from these in a manner similar to the reflection of radar signals from "Window" or "Chaff" used to provide spurious echoes during World War II.

Satellites have been used in various ways in close, and therefore non-synchronous orbit, but as such satellites are in radio range of a given point on the ground for comparatively short periods of time, the use of them is limited.

A number of "Applications Technology Satellites" has been launched and many techniques for improving communication have been evolved. As a result it is hoped to demonstrate the practicability of re-transmitting TV signals to the ground for reception by comparatively simple TV receivers. Such experiments will even more effectively demonstrate the practicability of satellite communications using very simple ground equipment, since much narrower band widths can be employed than for TV.

Synchronous geostatic satellites have been used very successfully in a wide variety of applications. Such satellites orbiting the earth once every 24 hours appear as stationary objects above some point on the equator. In an ideal situation they can be retained accurately in position so that beamed antenna systems on the earth do not require to be continuously tracked. The main penalty is that their distance from the earth is some 23,000 miles; thus more power is required for communication than in the case of the close orbit

types. There is no doubt, however, that satellite communication, particularly by geostatic types will be of steadily increasing importance in the military sphere.

Some thought might be given to the problem of jamming of HF military communications. An exercise was mounted by NATO not very long ago which showed how vulnerable HF communication is to deliberate and systematic jamming by an enemy. So greatly does the modern mobile division rely on HF communication that it is obviously in great jeopardy should a heavy jamming campaign be mounted against it. When the No. 10 set was planned it was assumed that not only would such a narrow-beam equipment be almost unjammable, but if the sets were detected at all, the enemy would assume they were radar systems. In the event the Germans never knew of their existence, as was stated by their Chief Signals Officer after the end of the War.

It is for consideration, therefore, whether it would not be a prudent thing for some units to be equipped with narrow beam centimetre wave sets so that at least point to point communication between areas of high land could be assured as a partial solution to the problem. The recent evolution of Gunn Effect Devices now makes it possible to design such centimetre wave equipment to be simple, efficient and light in weight.

The A.B.C.A. Nations have recently given serious thought to a completely new system of radio communication for the Services under the code name "Mallard." This will be a system in which intelligence will be conveyed in a digital form and the system will have several other novel features. Extensive research and development of the Mallard system, is at present being conducted in the four countries, and it is expected that the Services will be equipped during the latter half of the coming decade.

● The author is indebted to Mr Arnold Holst, M.L.D., VK3OH, for first-hand information concerning the activities of "Anzac Wireless" in the Mesopotamia campaign. Unfortunately, an appendix supplied by Mr Holst, and which formed part of the original paper, had to be omitted here for space reasons. ■



THE NEW LUSTRE MODEL ST-510 TONE ARM . . . TRACKS AT LESS THAN 3/4 GRAM . . . AND COSTS ONLY \$19.

Orders for the new Lustré Model ST-510 tone arm can now be filled immediately. Miniature ball races are used throughout, the head shell accepts all standard 1/2 inch mounting cartridges, finish is satin chrome and anodised aluminium. An outrigger bias adjustment is fitted and stylus pressure is adjusted with the counter balance weight. The MODEL ST-510D is fitted with a lifting/lowering device and costs \$24.50. The Model ST-510 (without lift) Inc. sales tax is priced at \$19.



SAVE YOUR RECORDS . . . USE THE UNIVERSAL LUSTRE TONE ARM LIFT!

This beautifully finished and functional universal tone arm lift will fit all tone arms . . . the lowering action is pneumatically dampened and extremely smooth. Risk of record damage may now be eliminated. Including Sales Tax **\$8.50**

COMPAX SOLID STATE TUNERS

A high quality wide band AM tuner, the Compax represents outstanding value. Output suits all amplifiers and tape recorders. The external teak finish case is optional. Price with case is \$49.50 Inc. Sales Tax **\$49.50**

DEMAGNETISE YOUR TAPE HEADS AND IMPROVE TAPE PERFORMANCE!

Simply plug the tape head demagnetiser into any AC power point and pass over the heads. Takes only five seconds and can make a world of difference. Two models — single and double probe. Both Inc. Sales Tax **\$4.50**

NOW . . . A NEW 8-INCH CO-AXIAL SPEAKER WITH UNIQUE PERFORMANCE AND SIX POWERFUL MAGNETS . . . ONLY \$34.50!

Can any 8in speaker be worth \$34.50? Easily . . . when you see and hear the remarkable CX-20D. Here at last is a total-performance 8in. co-axial speaker with six magnets, a horn type tweeter, an electrical crossover, high compliance and unusually robust ribbed construction. Total weight is almost 8lbs and frequency response is 35-20,000 Hz. The response curve is substantially flat; from an engineering viewpoint the CX-20D is superb in design and construction. The matching enclosure is easy to make and any handyman can make it from readily available materials. We want you to hear the CX-20D and make your own appraisal. It's tremendous value for money! Inc. Sales Tax **\$34.50**

CONNOISSEUR STEREO CARTRIDGE — ONLY \$12.50

Designed to effectively load any amplifier or tape recorder the Connoisseur Model SCU-1 ceramic stereo cartridge has an extremely wide frequency response and is fitted with a diamond stylus **\$12.50** Ask for copies of reviews

SAVE ON SANSUI AMPS AND SPEAKERS

All popular Sansui models are in stock . . . amplifiers and speaker systems. Write for your EMQ or call at your nearest Encel Stereo Centre.

CANBERRA ENQUIRIES FOR ENCEL EQUIPMENT

If you live in Canberra and you want further information on Encel equipment, please phone Canberra 81-1667.

TAPE SPLICERS . . . ONLY \$2.50!

We've just made another special purchase of tape splicers . . . while the stock lasts this easy-to-use unit is priced at only \$2.50. Save time and fidgeting — and frayed nerves; order now!

HIGH QUALITY MICROPHONES DESIGNED FOR USE WITH MOST TAPE RECORDERS

LONDON LM-100
An omni-directional dynamic dual impedance microphone with a response of 50-15,000 Hz. An ideal general-purpose unit, robust and designed to withstand studio or field use. Ask for complete specifications. **\$9.75**
Encel price Inc. Sales Tax



LONDON MODEL LM-200
A dynamic cardioid dual impedance microphone with balanced output and a frequency response of 50-15,000 Hz. Discrimination at 180 deg. eliminates unwanted background noise. Natural recordings are possible even under unfavourable acoustic conditions. Weight is only 4 1/2oz including the cable. Ask for complete specifications. **\$16.85**
Encel price incl. Sales Tax



SONICS STEREO 'PHONES — \$12.50
Model HS-304 Sonics stereo headphones are very comfortable and offer fatigue free listening on a personal basis. wide frequency response and remarkable stereo presence . . . **\$12.50**

JUNCTION BOXES FOR ONLY \$4.50
Add a headset to your amplifier even if it's not fitted with a headphone jack. Model J83 Junction boxes may be fitted in the speaker leads **\$4.50**
Inc. Sales Tax

TRADE-IN AND TRADE-UP!
When purchasing equipment from Encel Electronics, be sure to ask for a trade-in valuation on your old equipment. If your old equipment is in good working order, the cost of your current purchase can be reduced considerably. Bring in your amplifier, tape recorder, tone arm, etc . . . and save more than ever at Encel Stereo Centres!

SAVE MORE ON ALL LEADING MAKES OF TAPE RECORDER
Encel Stereo Centres stock all the best makes . . . Akai, Sony, National, Toshiba, Philips, Revox, Tandberg, and many more. You'll be wise to secure an Encel price before you commit yourself elsewhere. Save at Encel's!

KENWOOD AMPLIFIERS NOW AVAILABLE
Save more at Encel's . . . write or call for your Kenwood price. Ask for a trade-in valuation on your old equipment; often the allowances made for working units will reduce your outlay considerably. All Kenwood models available.

SEE THE NEW GRUNDIG STENOIRETTE AT ENCEL'S!

If you need a dictating system, be sure to see the Grundig Stenoiretette Model L at Encel Stereo Centres in Melbourne or Sydney. This fine tape cassette machine features a remote control microphone so you can control recording, playback, forward and backspace facilities without moving from your chair. Ask for the complete details and for your special Encel price. Your new Stenoiretette will cost you far less than you thought possible!

GRUNDIG PORTABLE/OFFICE DICTATING SYSTEMS

Away from your office you use the Grundig ENS electronic notebook and record your reports, notes, memos and instructions on

an instant loading 44 minute cassette. It is a completely transistorised battery operated dictating machine which fits in your pocket. In the office the AC operated Grundig EW3 transcriber offers every desirable facility for speedy typing of recorded matter. Foot or keyboard control, fast erase for security, internal speaker . . . they're all there. Ask for a special price on both units at Encel Electronics stores in Melbourne or Sydney. You'll save more and be left with spending money!

ENCEL SERVICE DIVISIONS
Modern and efficient service centres operate in Sydney and Melbourne. Up to the minute servicing equipment is provided and skilled technicians who have been specially trained actually save you money when service is necessary. As time expended is kept to a minimum, Encel service does not cost — it pays

CASSETTE RECORDERS
If you're looking for a cassette tape recorder, write or call at your nearest Encel Stereo Centre for an EMQ. We are not permitted to reveal the current cash prices for popular cassette recorders through advertising.

FOUR TOP VALUE COMPLETE ENCEL STEREO SYSTEMS

1 Sound Model SAQ-203 solid state stereo amplifier (12 watts R.M.S. output), B.S.R. Model MA70 turntable, Micro Model 2100 magnetic stereo cartridge with diamond stylus, two Sonics Model AS-61 multiple speaker systems. Each enclosure houses five speakers. Total Encel price Inc. Sales Tax **\$275**

2 The well known Sound Model SAQ-203 solid state stereo amplifier (12 watts R.M.S. output), a belt driven Connoisseur turntable, the Lustré ST-510 tone arm, your choice of the Micro 2100 or Shure 44-7 stereo magnetic cartridge, a matched pair of Sonics Model AS-60 speaker systems. Base for the turntable. This unit is wired and ready to switch on. Sales Tax **\$209**
With a perspex dustproof cover for the turntable **\$223**

3 The powerful Sound Model SAQ-505X solid state stereo amplifier (30 watts R.M.S. output), Connoisseur belt driven turntable, Lustré ST-510D tone arm with lift, Micro 3100/E magnetic stereo cartridge with elliptical diamond stylus, two matched Sonics Model AS-303 multiple speaker systems, base for the turntable with a dustproof perspex lid. Completely assembled. Inc. Sales Tax **\$360**

4 The Lux SQ-1220 solid state stereo amplifier (100 watts RMS output), a Goldring Model G99 transcription turntable, the Grace Model G545 tone arm, the Grace Model F-8L stereo magnetic cartridge with an elliptical diamond stylus, two Celestion "Ditton" 15in speaker systems, a base for the turntable with a perspex dustproof lid. Fully assembled, ready to switch on. Inc. Sales Tax **\$679**

SEE A COMPLETE AUDIO RANGE AT ENCEL STEREO CENTRES!

Apart from the many exclusive Encel lines you'll find a vast range of high quality equipment at Encel stores in both Sydney and Melbourne. Here are a few of the manufacturers represented: Jico-Kenwood, KEF, Sony, ADC, Wharfedale, Ortofon, National, Toshiba, Shure, Akai, Sansul, Philips, BSR, Garrard, and many, many more. Be sure to get an Encel EMQ (Encel Mail Quote) — you'll save much more at Encel Electronics!

KEF SPEAKER SYSTEMS
Two popular KEF speaker systems, the Cresta and Concord, are now available at Encel Stereo Centres. Write for your personal EMQ (Encel Mail Quote) or call . . . you'll be pleasantly surprised at the low Encel price!

PE TURNTABLES
Perpetuum-Ebner turntables are probably the most popular in their respective price categories . . . and the low Encel prices add yet further value to these fine German products. Models PE-2020, PE-2010 and PE-2001 are now in stock. Write for an EMQ or call at the Melbourne or Sydney Encel Stereo Centres.

WHARFEDALE SPEAKERS
See the complete range of famous Wharfedale speakers and speaker systems ask for an EMQ or a trade in valuation, as we are not permitted to advertise prices.

ENCEL
ELECTRONICS (STEREO)
PTY. LTD.

Head Office:
431 Bridge Rd., Richmond, Victoria 3121. Tel. 42 3762.
Sydney Store: Ground Floor, 25M Building
257 Clarence Street, Sydney, N.S.W. 2000. Tel. 29 4563, 29 4564.
Australia's Greatest Hi-Fi Centre *Wholesalers *Trade-ins accepted

THE VIDEO DISC—immediate replay

One of the most significant television advances in recent years has been the development of the video disc recorder. Designed to provide immediate replay of sporting highlights, it features variable speed ranging from frame by frame up to twice normal, and can also operate in reverse. Although used only for monochrome TV in Australia, it is designed to accommodate any of the current colour TV systems.

An analysis of the operational requirements for a slow and stop motion recorder made it quite evident that the majority of events requiring time base manipulation, especially those connected with athletic activities, do not have a duration in excess of a few seconds. A 30-second storage period would adequately accommodate most situations.

The Ampex HS-100 Slow Motion Video Recorder and Reproducer is a fully transportable, instant replay television recorder/reproducer manufactured for use in studio, mobile vans, or indoor remote broadcast sites. It is capable of recording standard PAL colour or monochrome video signals and then immediately replaying the recorded material, either forward or in reverse, at normal speed, twice normal speed, one-half normal speed, one-fifth normal speed, or in manually controlled, continuously variable speeds ranging from stop-action (freeze) to normal.

The recorder also permits operator-controlled, single-frame video advance, either forward or in reverse, whenever playback is in the freeze mode. The video output fully complies with PAL standards regardless of speed or direction changes. Storage capacity is 1800 television fields, corresponding to 36 seconds of video material in the normal record mode, or 72 seconds of material

in the alternate field record mode (i.e., recording only every other television field).

The recorder uses the broad principle of magnetic recording, but with a disc in place of the more conventional tape. The recording takes the form of a series of concentric tracks recorded on the disc, each track, i.e., each complete rotation of the disc, representing one complete image field. Thus, during playback, a head may remain stationary over each track for as long as necessary, during which time it simply repeats this field. However, in detail, the process is a good deal more complex than this, as will be evident.

The disc servo unit contains the electromechanical components and their associated electronics. Electromechanical components include a disc drive assembly with its associated circuitry and four head stepper assemblies. The disc drive assembly controls the rotation of two magnetic recording discs, each of which provides two recording surfaces (i.e., top and bottom side of each disc).

The discs are 16in in diameter and $\frac{1}{16}$ in thick. They consist of an aluminium base, a coating of nickel cobalt as the recording medium, and a flash coating of rhodium as a protective layer. The highly polished, hard surface provides extremely long life and

the specialised ability of continuous repetition of a given track for indefinite periods of time.

Video signals are recorded on the four surfaces of the two discs, which rotate about a common vertical shaft. Recording is continuous until the operator overrides the record mode by selecting a reproduce or fast search mode. As long as recording is continuous, the last 36 seconds (72 seconds for alternate field recording) of recorded video is maintained in storage, ready for instant playback. Material recorded prior to the 36-second storage limit is progressively erased to permit recording of new material.

Rotation speed of the two recording discs is 50 revolutions per second (3000rpm). This speed is precisely controlled by a disc drive servo system which instantly detects and corrects disc drive motor speed variations. The primary purpose of the disc drive servo is to lock the rotation of the discs in phase with the external reference vertical sync. This phase lock ensures that each complete revolution of the discs corresponds exactly to one television field, beginning and ending during the vertical blanking period.

Each of the four head assemblies is moved by an independent stepper assembly that steps the head radially across the surface of the disc. For purposes of identification the heads and their associated signal paths are referred to as head (or channel) A, head (or channel) B, head (or channel) C, and head (or channel) D. In addition to recording, each head also functions as a playback and erase head. During operation, head A steps radially across the top of the top disc, head B steps across the bottom of the top disc, head C steps across the top of the bottom disc, and head D steps across the bottom of the bottom disc.

Each head assembly consists of a head transducer and two pads mounted so that the head and the two pads extend perpendicularly from the corners of a triangular platform. The head and the two pads provide a stable three point contact with the disc surface, and are held against the disc by a cantilever spring which bears against the rear of the platform. The head carriage assembly, which moves the head assembly, is mounted on guide rails extending radially across the disc surface. As the head carriage is moved a given distance along the rails, the head transducer is carried across the



A typical control position setup for a sporting event, showing the video disc control unit with cueing clock. This unit provides all the control and cueing facilities necessary to operate the recorder.

with variable speed

This article has been prepared by the editorial staff of Electronics Australia from material supplied by Ampex Australia Pty. Ltd., a subsidiary of Ampex International.

disc in the same direction and the same distance.

Driving power for the carriage assembly is provided by a stepping motor controlled by logic circuits and end stop sensors (which provide reversing commands). The carriage assembly is coupled to the shaft of the stepping motor through a pinned stainless steel belt.

(Prior to describing the recording sequence, it may be advisable to clarify the terms "field" and "picture" as used in this context. A "field" is one interlaced half of a picture," consisting of 312.5 lines of the total 625 lines which make a complete picture. There are 50 fields per second and 25 pictures per second in the Australian TV system. Editor, Electronics Australia.)

Each field is recorded on the disc as a circular track; the head is held stationary, while the disc makes one complete revolution. When head A completes recording a single field, head B starts recording the next field. While head B is recording, head A is being stepped to a new position. When head B has recorded its field, head C records the next field. While head C is recording, heads A and B are both being stepped to new positions. (The reason for the "double step" action of head A — and subsequent heads — will be explained shortly.) When head C has completed recording one field, head D starts recording, head A erases the track in which it is now positioned, and heads B and C are stepped to new positions. When head D completes recording one field, head A starts recording in the track it just erased, head B erases, and heads C and D step to new track locations. In this manner each head records every fourth field, and successive fields are recorded by heads A, B, C and D in rotational sequence. Heads A and C record odd numbered fields; heads B and D record even numbered fields.

Recording, moving, and erasing follows a definite sequence for each head. For example, during field 1, head A records. During field 2, the stepper assembly moves head A 0.010 inch radially across the disc (tracks are 0.007 inch wide, 0.010 inch centre-to-centre).

During field 3, head A is moved an additional 0.010 inch radially, placing it a distance of two tracks away from where it recorded (during field 1). During field 4, head A erases, with a DC current, any signal previously recorded on the track in which it is

now positioned. At the start of field 5, the erase current to head A is switched off and head A is fed signal output from the record amplifier.

During any given field, one head is always recording, one head is erasing, and the remaining two heads are being stepped to new track positions. The heads move in this manner toward the centre of the discs until head A eventually reaches its innermost track. This position of head A is sensed by a lamp and photocell arrangement positioned so that the photocell detects head A as it makes its first step from its last record track position.

The photocell output, acting through the carriage control logic circuits, prevents head A from making the second stepping movement. During the two subsequent fields, heads B and C also reach their innermost point of travel and are similarly prevented from making their second stepping motion. On the next field, head A records on the track where it was stopped, and head D steps one track. On the following field, the direction of rotation of all four stepping motors is reversed. The heads then begin stepping toward the outer edge of the disc, and recording between the tracks used when the head movement was toward the centre of the discs.

(The reason for the "double step" action, referred to previously, will now be obvious.)

At the outer edge of the discs, head travel is again inhibited and reversed by a second lamp and photocell arrangement. Thus, the heads travel continuously until stopped by an operator command. If a stepping error occurs, the head carriage logic circuits detect it and correct it at the end stops before allowing the carriages to reverse direction.

In the normal speed, forward direction, playback mode, the sequence of carriage movement is identical to that used in the record mode. The head connections are transferred, by means of relays, from the record and erase amplifiers to the reproduce amplifiers. The outputs of the reproduce preamplifiers are sequentially gated through the rest of the reproduce electronics in the same manner that the record current was gated to the heads in the record mode. Each field is reproduced in the exact sequence in which it was recorded, so that the demodulated video output is in standard monochrome or PAL colour formation.



The 16in disc used in the recorder. The high quality of the polished surface is indicated by the perfection of the reflected image.

In the still picture or freeze mode, the playback sequence is stopped on a particular field, and the video output is derived from the continuously repeated playback of a single track. In this mode, line interlace, chroma phase and burst phase are restored by special techniques to produce a standard television signal.

The normal television video signal is a succession of odd and even fields characterised by a half-line shift of horizontal sync (with respect to vertical) in each field. This half-line shift produces line interlace of the two fields, constituting a complete picture, when displayed on a picture monitor. When, as in the freeze mode, each successive field is derived from the same recorded track, and is therefore identical to the one preceding it, interlace must be restored artificially.

The technique of reconstructing a complete picture from a single field, rather than two successive fields, may appear at first glance to be undesirable since, in theory at least, the picture has been deprived of half the information which it should contain. In fact, this is not so in practice, while the technique offers several worthwhile advantages in this application.

The artificial creation of the missing field is not objectionable visually because, for the greater part of the picture, the information in the missing field would be the same as, or very similar to, that in the field being used.

On the other hand, the advantages of the technique are considerable. One concerns the amount of blur which will be created by rapidly moving objects, when individual pictures are presented in very slow sequence. The amount of blur present in a single field, which is scanned in 1/50 second, will be only half of that present in a complete picture, scanned in 1/25 second.

It must also be appreciated that, if both fields were used, and fast movement was being photographed, there would be a noticeable displacement of image between the first and second

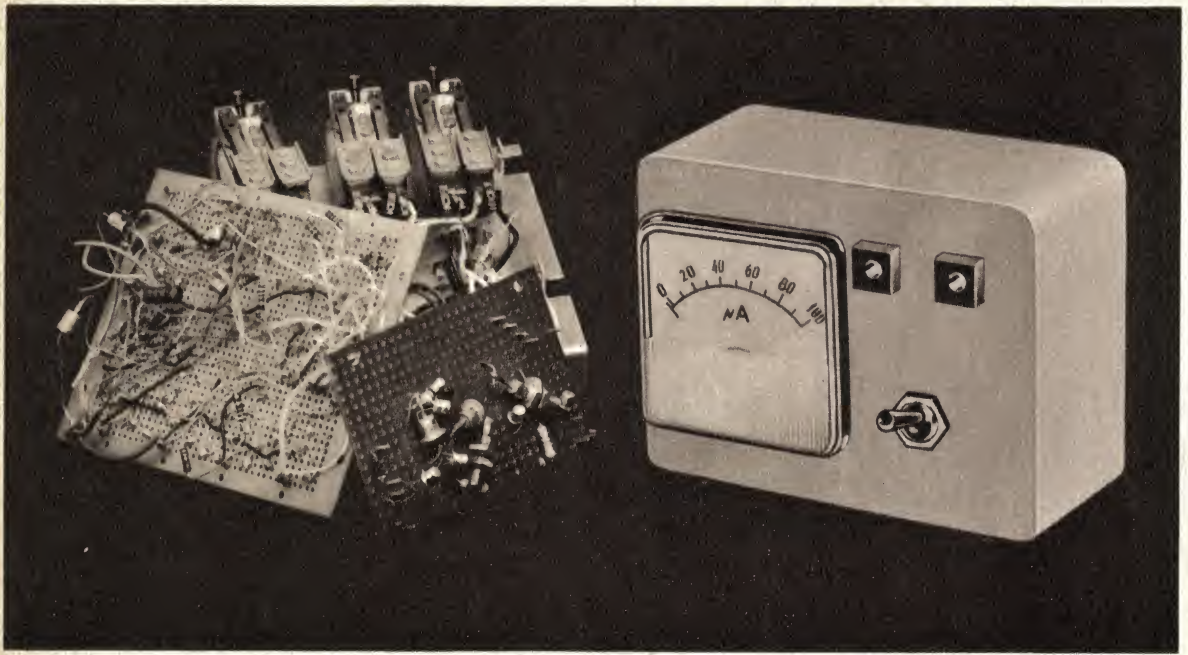

Mess.... or Masterpiece

The difference is a \$3 Die-Cast Box

Sure it works, and it works well . . . mostly. But it looks messy. For just three dollars you can turn that mess into a masterpiece. These natty little aluminium STC Die-cast Boxes will house the most conventional or zany electronic gadgetry.

The five boxes in the STC 46R range can be used as rigid chassis for mounting in instrument cases, conveniently shaped junction boxes, compact test sets and other complete equipments. They feature

internal slots for sliding in screens and printed circuit boards. Make your mess into a masterpiece with STC Die-Cast Boxes.

Available in five sizes selected to cater for most circuit sizes and compatible with ISEP Racking system (from $4\frac{3}{4} \times 3\frac{3}{4} \times 1$ to $10\frac{3}{4} \times 6\frac{3}{4} \times 2''$).

For further information contact: Components Division, **Standard Telephones & Cables Pty. Limited**, Moorebank Ave., Liverpool, N.S.W. 2170. Phone Sydney 602 0333 or Phone Melbourne 480 1255, Brisbane 47 4311, Adelaide 51 3731, Perth 21 6461, Newcastle 61 5172, Wollongong 2 7974.

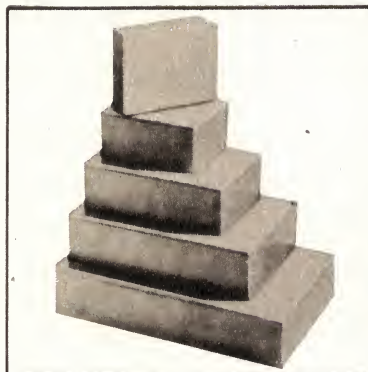

AN **ITT** ASSOCIATE worldwide telecommunications and electronics



P556

fields. If a picture was now presented in, say, the freeze mode using both fields, the first field would show the image in one position, the second in another, while the third scan (a replay of the first field) would show it moved backwards, followed by another forward movement for the fourth scan, or replay of the second field. Thus the movement would jitter or flicker back and forth.

To produce line interlace artificially, odd fields are changed to even fields, or even fields are changed to odd fields, by insertion of a half-line delay in the video signal following the last equalising pulse of the vertical block.

The half-line delay insertion is controlled by the system logic. By knowing what type of field is required (by examining reference sync) and knowing what type of field is being reproduced by each head, the logic controls the insertion or removal of the half-line delay, as required.

A further consideration arises from the need to create a complete picture from a single field when replaying colour signals. The PAL colour system employs a precise frequency relationship between the chroma subcarrier and the horizontal and vertical scanning rates. As a result the complete PAL picture comprises eight consecutive fields which occur in a specific chroma phase sequence.

In the freeze mode these relationships would be disturbed, resulting in a non-standard signal for broadcast purposes, without the use of special compensating circuits.

Compensation is provided by the One Line Delay and Chroma Inverter module. The one line delay section of this module is used as a means of shifting the U component phase by an amount equivalent to one TV line period. The function of the chroma inversion section is to shift the phase of the chroma only by 180°. Additionally, the half line delay module referred to earlier in relation to selection of the monochrome freeze mode is also inserted during every other field in order to maintain normal interlace.

As in the monochrome freeze mode situation the logic system controls the insertion or removal of the half line delay, the one line delay and the chroma inverter circuits, during the colour freeze mode, by identifying the particular colour field being rescanned. These compensating circuits are then suitably applied to reconstruct the complete PAL colour picture from a single field, in its correct eight field chroma sequence with reference to the station colour sync generator.

Slow motion is essentially a combination of normal motion and freeze.

The head assembly. The head itself is at the extreme right at the apex of the triangular head platform. Behind it are two pressure pads. The connecting leads to the two pin plug are thin flexible metal strips.



To produce the effect of slow motion, each recorded track is scanned not once but several times, depending on the slow motion rate selected, after which the playback signal is taken from the next track. Selection of a particular speed determines the average number of scans per track, even though some tracks may be scanned more often than others. For example, if a speed reduction of 2:1 is selected, each track is scanned twice; at 3:1 reduction, each track is scanned three times. At a 2.5:1 speed reduction, half the tracks are scanned twice and half are scanned three times. Thus speed control is continuously variable from normal to freeze.

During the time a particular track is being rescanned, the system operates

of the half-line delay remains unchanged during the transition. That is, if the half-line delay was in the signal path before the switch, it remains in after; if it was bypassed before the switch, it remains bypassed after.

In reverse motion playback the sequence of carriage motion and head switching is reversed and the carriages are made to move in the opposite direction. Thus the fields are played back in opposite sequence to that in which they were recorded.

Head switching sequence D, C, B, A preserves the normal progression of fields from odd to even, but loses the track-to-track phase continuity of the chroma signal. In switching, for example, from head D to head C, switching is from the end of one

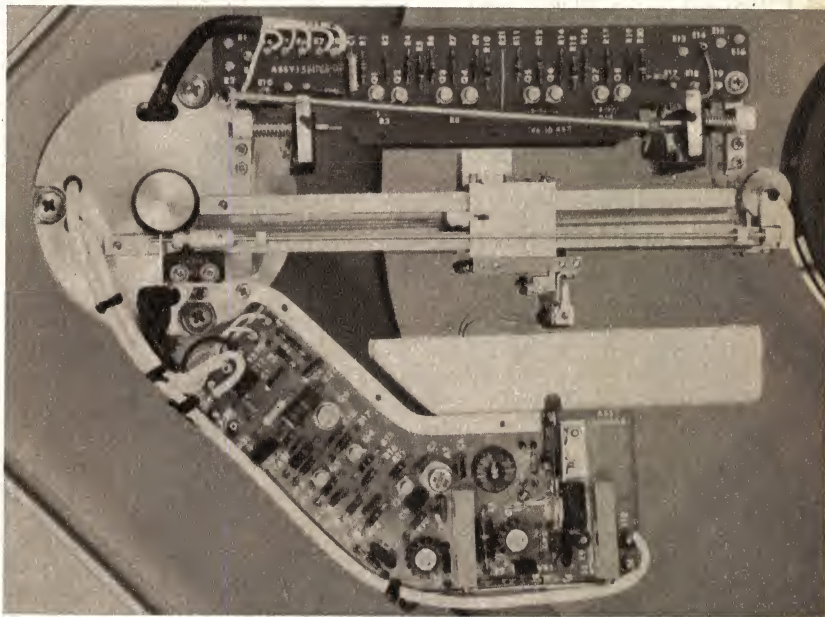

The stepper assembly in position over the disc. The stepper motor pulley is at the left, with an idler pulley at the opposite end of the carriage rails. The head assembly is mounted on the right of and beneath the head carriage.

exactly as described for the freeze mode. Carriage motion stops, the signal is derived from one particular head, the half-line delay is switched in or out at the beginning of each rescan, and the chroma phase is controlled by the system logic which switches in the one line delay and/or chroma inverter as required.

When the playback signal is advanced from one track to the next, carriage movement and head switching progress from one field to the next as in normal motion. Since switching from one track to the next produces a normal transition from one field to the next, the state

field to the beginning of the one which preceded it in the original recording. This constitutes a 180° chroma phase reversal, which must be corrected by reversing chroma phase in the chroma inverter. Thus, when switching from track to track in the reverse motion direction, the half-line delay is not altered but the chroma phase is reversed by the chroma inverter.

When rescanning a track in slow motion reverse, the action of the half-line delay, one line delay and chroma inverter is identical to rescanning in the forward direction.

Recordings made in the alternate field record mode differ from those made in the normal mode in that only odd fields are recorded (the first field of each picture).

STOP RUST OUTDOORS 2 YEARS -- OR MORE!

Lubricates Penetrates Stops Rust

DRY YOUR ELECTRICAL SYSTEMS
with LPS — the NON-GREASY ONE

**STOPS
Squeaks!**



LPS is NOT a paint, lacquer or a varnish, and will NOT damage paint, rubber, fabrics, plastics, or finishes.

Displaces Moisture Fast!

TECHNICAL INFORMATION

Physical Properties:

LPS 1

Less than .0001 inch non-greasy molecular film with capillary action that spreads evenly and easily to seal out moisture at very low cost.
Rust Inhibitor: Protects all metals from rust and corrosion.

Water Displacing Compound: Dries out mechanical and electrical systems fast.

Lubricant: Lubricates even the most delicate mechanisms; non-gummy, non-sticky; does not pick up dust or dirt.

Penetrant: Penetrates to loosen frozen parts in seconds.

Volume Resistivity per ASTM D-257; Room temperature, ohm/cm: 1.04×10^{12}

Dielectric Constant per ASTM-877:

Dielectric Constant 2.11 Dissipation Factor: 0.02

Dielectric Strength per ASTM D-150:

Breakdown Voltage 0.1 inch gap. 32,000 volts

Dielectric Strength volts/inch 320,000 volts

Flash Point (Dried Film)

Fire Point (Dried Film) 900 degrees F

TESTS AND RESULTS: 950 degrees F

Lawrence Hydrogen Embrittlement Test for Safety on High Tensile Strength Steels: Passed. Certified safe within limits of Douglas Service Bulletin 13-1 and Boeing D6 17487.

Mil Spec. C-16173D-Grade 3

Passed

Mil Spec. C-23411

Passed

Swiss Federal Government Testing Authority for Industry: Passed 7 Day Rust Test for acid and salt water. Passed Weiland Machine Test for Lubricity as being superior to mineral oil plus additives.

LPS PRODUCTS CONFORM TO
FEDERAL MIL SPECS
C-23411 and/or C-16173D



LPS RESEARCH LABORATORIES, INC.
2050 COTNER AVE. • LOS ANGELES, CALIF. 90025

HOW LPS SAVES YOU TIME AND MONEY

1. LPS PROTECTS all metals from Rust & Corrosion.
2. LPS PENETRATES existing rust — stops it from spreading.
3. LPS DISPLACES moisture on metal—forms fine protective film
4. LPS LUBRICATES even the most delicate mechanisms at extreme temperatures.
5. LPS PENETRATES to free rust frozen parts, nuts, bolts, etc.
6. LPS PREVENTS equipment failures due to moisture (drives it out).
7. LPS LENGTHENS LIFE of electrical & electronic equipment—improves performance.
8. LPS RESTORES equipment damaged by water contamination & corrosion.
9. LPS PENETRATES AND PROTECTS plated and painted metal surfaces.
10. LPS PROTECTS metals from salt atmosphere, acid & caustic vapours.
11. LPS LOOSENS dirt, scale, minor rust spots & cleans metal surfaces.
12. LPS ELIMINATES squeaks where most everything else fails,

(SOLE AGENT)



ZEPHYR PRODUCTS PTY. LTD.

70 BATESFORD ROAD, CHADSTONE, VICTORIA—PHONE 56-7231

MANUFACTURERS OF RADIO & ELECTRICAL EQUIPMENT & COMPONENTS

Recording only half the fields also affects the system in the following ways:

- a. The storage capacity of the system is doubled, from 36 to 72 seconds.
- b. fast motion is available as well as slow motion. Speed is continuously variable from twice normal speed to freeze.
- c. Increments of motion from field to field are doubled in the reproduced picture. This becomes noticeable as jerkiness in fast action sequences when played back at very slow speed.

The HS-100 is packaged in four units: the Disc Servo Unit (DSU), the Electronics Signal Unit (ESU), the Output Processing Unit (OPU) and the Control Unit. Each unit is enclosed in a weather-resistant metal cabinet.

The electronics for the DSU are on plug-in printed circuit modules (cards) which plug into a card rack extending across the front of the unit chassis below the top plate assembly. These components are protected by a door on the front of the unit.

Protection for the DSU top plate assembly is provided by a clear acrylic dust cover. During handling and shipping additional protection is provided by a removable steel cover that fits over the acrylic dust cover and latches to the DSU cabinet.

The ESU contains most of the signal electronics, the control logic, and the major parts of the power supply system. Printed circuit modules on plug-in type card assemblies are housed in a card rack extending across the front of the unit. A panel above the card rack contains secondary operating controls. A power supply, containing front-mounted fuses, and test points, is mounted on a second panel directly below the card rack. The front of the ESU is protected by a hinged metal door. A connector panel at the rear of the unit contains connectors for the main power cable, video inputs and outputs, sync inputs, and cables that interconnect with the disc servo unit, the output processing unit, and the control unit.

The OPU contains a standard Ampex AMTEC, a device for eliminating distortions in picture geometry in monochrome transmissions, by line-by-line compensation of timing errors generated anywhere in the system; a standard Ampex COLORTEC, which carries out similar functions in colour television systems, and also ensures correct phasing of the colour signals by comparison with internally generated reference bursts; and an Ampex Processing Amplifier. These assemblies are mounted on side rails in the OPU cabinet for easy maintenance access.

The Control Unit (see photo) contains all the primary controls used to operate the HS-100. It connects to the electronic signal unit by means of a 30-foot cable (200-foot extender cables are available). All controls are illuminated pushbuttons except for a lever used for variable slow-motion speed control. All internal circuitry is mounted on one printed wiring board assembly.

Mounted above the control panel is an illuminated clock type dial, calibrated from 0 to 36. A white pointer on this dial indicates the head location relative to the 36 seconds storage

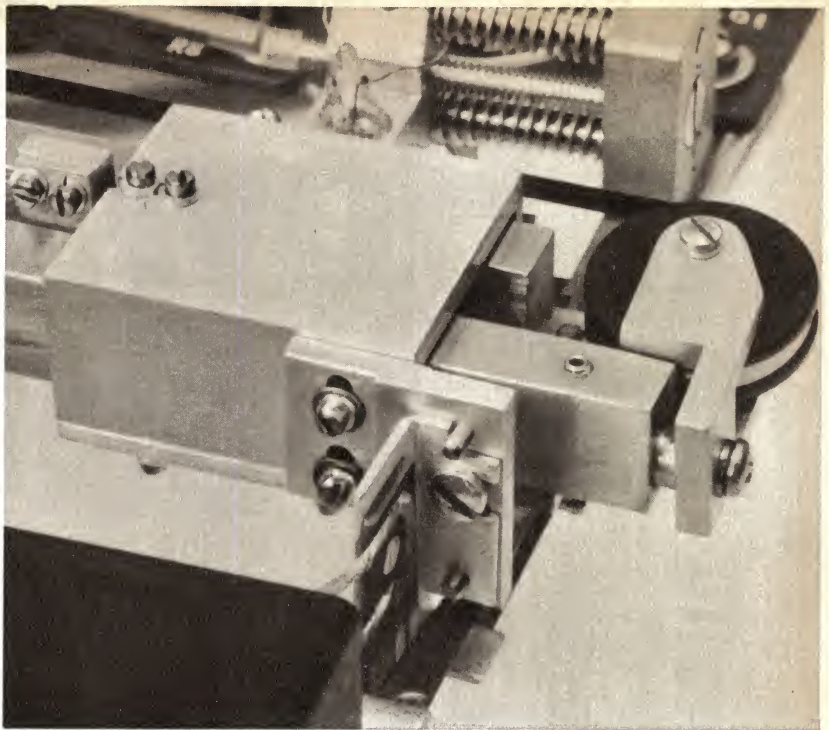

A closeup of the head carriage. The rear of the head assembly proper and the two flexible connectors can be seen in the foreground. The rest of the assembly is beneath the carriage.



The control unit showing control buttons and cueing clock. It includes a fast search facility which can locate any part of the recording in four seconds.

capacity of the system. When something occurs in the image that may require immediate replay the Technical Director can depress a cue button and a red pointer, which normally rotates in synchronism with the time indicating pointer (and is hidden by it), will stop its movement and remain as a timing cue mark. This makes the operator aware that he must take the machine out of the record mode before this segment of the recording is erased.

As soon as a sufficient period of the significant action has been recorded, subsequent to the cue indicator's static position, the recording may be stopped and two fast-search buttons used to drive the white time pointer (and the

heads on the video disc), indexing them to the proper position prior to replay. The fast-search mode can locate any part of a recorded segment in four seconds or less, the shortest path being the direction in which the white time pointer has less than 180 degrees separating it from the red cue pointer.

Because of the inertia of the carriage drive system moving at search speed, it is not convenient to reverse the direction of travel of the carriages at the inner and outer limits of travel. Therefore a lamp and photocell arrangement, located on carriage drive A detects the approach of the heads to the inner and outer limits and briefly slows the carriage speed to normal while carriage direction is being reversed.

The fast search system moves the heads rapidly (at about four times normal speed) from one point on the discs to another. In fast search, as in normal operation, the heads must remain precisely in step, otherwise loss of field-to-field continuity would result in subsequent playback. Therefore the sequence of motion is kept the same as in normal-speed operation.

Video recording in the HS-100 is accomplished by using "high band" standards to ensure highest picture quality. The incoming composite video signal is converted to a frequency modulated signal before it is recorded. During playback the signal is demodulated to produce a standard video output signal.

The reproduce signal path contains the four head transducers, the four head preamplifiers, the four head switcher module, an RF equaliser module, a demodulator module, a low pass filter, a delay line, a delay switcher and a video output (amplifier) module, an AMTEC assembly, a chroma inverter module, a COLORTEC assembly, and a processing amplifier assembly. ■

How to put a battery in its place

Silver is the Eveready low-priced battery for torches and transistors used occasionally.

Red is the Eveready medium-priced battery for transistors, torches and appliances used frequently.

Gold is Eveready's new alkaline battery. Gives up to—10 times more service in toys; 7 times in industrial torch use; 6 times in cameras; 5 in tape recorders and record players; 4 times in flash guns and 3-4 times in transistors.



SILVER

RED

GOLD

EVEREADY BATTERIES Products of **UNION CARBIDE** Eveready & Union Carbide are registered Trade Marks

E121R

What the Post Office is doing to provide

IMPROVED TELEPHONE SERVICE

The Postmaster-General's Department is continually testing new devices which are likely to improve its telephone service to the public, or contribute to its operating efficiency. Recent issues of Post Office publications contained information on a number of devices which fall within one of the above categories, some intended to be of assistance to handicapped persons

The four devices to be described below are representative of the considerable amount of research and development work conducted by the Post Office to improve its service for telephone subscribers.

Our first story concerns a system designed to assist telephone users who have hearing deficiencies. The system was developed over a period of several years by the Post Office, working in close co-operation with the Audiometric Clinic of the Alfred Hospital, Melbourne, and Glendonald School for the Deaf. As a result of this research, 30 experimental deaf-aid telephones were built and installed in homes throughout Australia. Every home where the special phone was installed had one or more occupants suffering from some degree of deafness.

The system was developed specially to help sufferers from presbycusis (deafness of the aged) which causes high frequency hearing acuity to decline in most people over the age of 45. This loss is usually progressive, so that there can be severe loss in the upper audio range by the age of 70, sufficient in some cases to affect the upper speech band. Since normal telephone transmission techniques cause fairly substantial roll-off of the lower frequencies, the presbycusis sufferer is left with very little to hear at all. A corollary problem concerns the calling system, which in the normal telephone is a bell. The bell tones are often too high in frequency to be heard by deaf persons.

The special telephone developed by the Post Office to overcome, or at least minimise, these problems has an amplifier designed to emphasise the frequencies in the lower speech range that the user can still hear, and is accustomed to hearing. It is equipped with an amplifier which compensates for the roll-off in low frequencies found in transmission lines. The amplifier is adjusted so that when the control knob is turned right down, the telephone behaves as a normal instrument, but when it is turned right up the low frequencies are emphasised to the order of 20dB at 400Hz.

The ordinary telephone bell is replaced by a special calling device which operates over a range of frequencies (400-900Hz) in a rising and falling tone. Experience has shown that a tone caller which glides up and down through a frequency range such as that chosen provides a sound that even those with severe hearing loss can pick up over part of its range. The tone is said to be readily identifiable by partially deaf people several rooms away.

Another modification to the new phone is the provision of a special coil in the earpiece. This coil will set up an external magnetic field which will enable the phone to be used with most modern hearing aids.

The field trials have been so successful that the Post Office is going ahead with full scale production of the deaf-aid phone. News of the development has been received with great interest overseas. In Britain, the Post Office is keen to introduce a similar instrument, and telephone organisations in Canada and the U.S.A. have also shown interest.

Further indication of the concern



P.M.G. research technical officer Jack Laughlin fits the external hearing aid coil for the telephone developed specially for the use of deaf persons.



In external appearance, the telephone set developed for the use of deaf persons differs little from the normal set. Note, however, the potentiometer control to the lower right of the dial.

PLESSEY Dry Reed Inserts

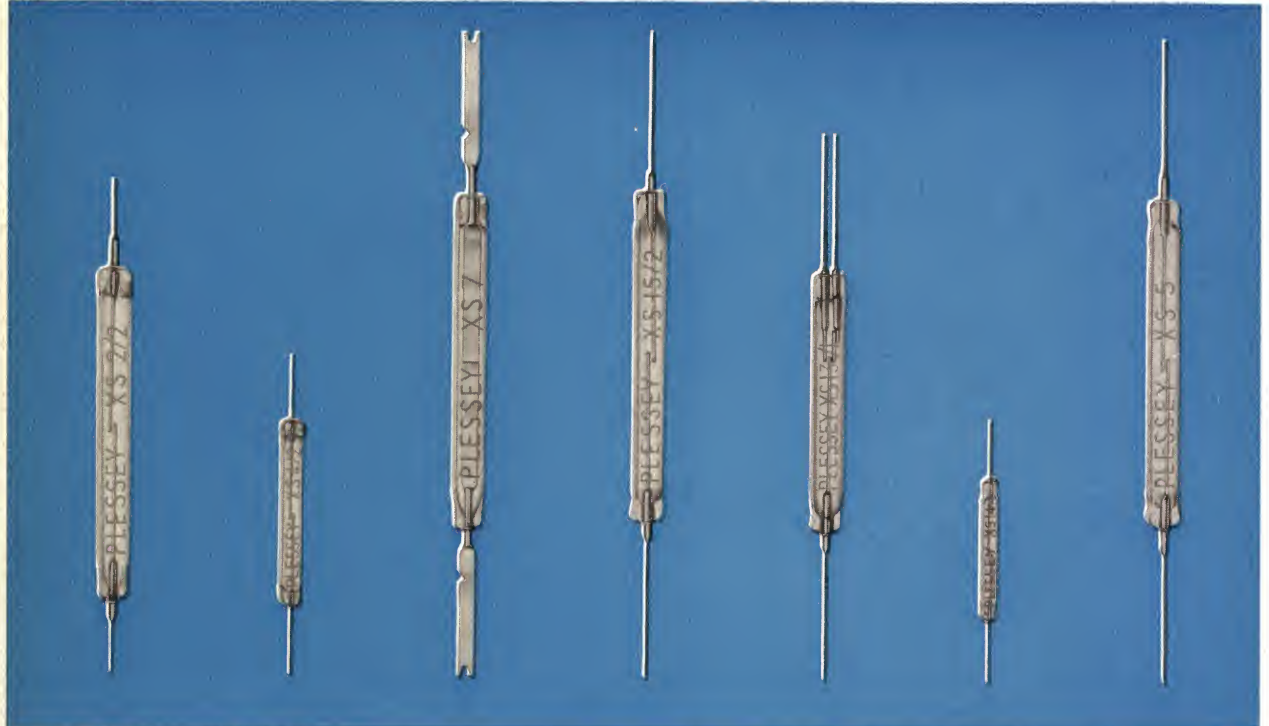

Preferred Types	Glass Length (inches)	Max. Glass Diameter (inches)	Overall Length (inches)	Max. D.C. Switched Current	Max. D.C. Switched Voltage	Max. Switched Load Watts	Min. D.C. Breakdown Voltage
XS2	2.0	0.217	2.75	0.5	250	15	750
XS4	1.1	0.156	1.815	0.15	250	5	500
XS5	2.0	0.217	3.6	0.5	250	15	750
XS7	2.0	0.217	3.6	0.5	250	15	750
XS13	1.375	0.25	3.1	0.25	250	10	300
XS14	0.83	0.125	1.5	0.1	250	3	400
XS15	2.0	0.217	3.6	1.5	250	100	750

Plessey Dry Reed Inserts offer extreme life and reliability since their contacts are totally sealed within an inert gas-filled glass envelope. A range of standard, miniature and subminiature types is available which includes both single pole "normally open" and single pole changeover configurations. Associated bobbins, coils and suitable biasing magnets are also available.

The bobbins employ a unique patented method for retaining the insert in position, providing secure anchorage and facilitating replacement when necessary.

Operation

Operation of dry reed inserts is by a magnetic field which can be generated by a coil or permanent magnet. The combination of a coil and reed insert offers a relay of the highest professional standard. In this form dry reed inserts are used by the million in telephone systems and similar applications.

Application

Plessey Dry Reed Inserts are used with alarms, control systems and fail-safe devices of every kind. The high speed

of operation permits their use in monitoring movement of fast reciprocating and rotating parts. Furthermore their low contact resistance enables them to handle signal level currents, while types are available handling several amps. This versatility is far greater than that provided by any other single type of switch or relay.

Full technical information and application data available on request from Professional Components Department, Villawood, N.S.W. or Ducon Interstate Offices.

PLESSEY
Components



Ducon Division
Plessey Components
Box 2 PO Villawood NSW 2163
Telephone 72 0133

Melbourne 42 3921
Brisbane 2 3287
Adelaide 76 3434
Perth 21 4821/21 7867

the Post Office feels for handicapped people is to be found in another special development. This is a telephone unit for physically disabled persons who are unable to use a normal telephone service. The unit, illustrated here, is said to be specially suitable for paraplegics. It is designed to enable the user to operate it by using a stick held in the mouth.

Basically, the unit comprises a normal wall mounted telephone mounted on a vertical, chrome-plated tube fixed to a polished wooden base, as shown in the photograph alongside. The normal switch hook has been replaced by a push-button key. The key is dished to prevent the stick used for operation from slipping, and is provided with a warning lamp which lights up to indicate that the receiver is "off the hook."

To ensure that the user can hear incoming signals, the instrument is fitted with a standard hearing aid telephone amplifier attachment, the control potentiometer for this being mounted on the top right hand side of the casing. The handset unit is mounted by means of a chrome-plated flexible tube, to facilitate adjustment to the needs of individual users.

P.O. engineers are vitally concerned with any techniques which allow more effective use to be made of the existing facilities. They are therefore very interested in the recent development of economical carrier equipment which exploits the unused frequency spectrum above the voice range in subscribers' cables.

With the telephone subscribers' network doubling in capacity every 12 years, the Post Office has had to spend huge amounts each year in the provision of extra lines required to cater for the increased demand for additional telephone facilities. Up till now, it has been necessary to provide each new subscriber with a discrete pair of wires for his particular service. Furthermore, any subscriber who needs more than one line has been provided with extra pairs of wires for each additional line. Any previous attempts to derive extra circuits from existing lines by using carrier techniques have proved too costly when compared with the provision of facilities by conventional means.

Recently, however, developments in equipment design brought about by the growing use of transistors and other solid-state devices have resulted in low-cost subscribers' carrier systems. These devices use frequencies above the voice frequency range and generally below 100KHz. When connected to a conventional telephone line, they provide all the facilities expected from a normal service.

A typical single-channel system of this type has, superimposed on the normal voice frequency line, a carrier frequency of 64KHz in the exchange-to-subscriber direction and 28KHz for the return path. Signalling (i.e., dialling) is effected by interruption of the channel carrier. The subscriber's terminal is powered by a nickel cadmium battery, trickle-charged from the bearer subscribers' exchange circuit during its idle periods.

Subscribers' carrier systems are available in two types (a) shorthaul single-channel cable systems operating up to six miles, and (b) multi-channel

TOP: The telephone set developed by the Post Office for physically handicapped persons. It can be operated by a stick held in the mouth.

BELOW: The P.M.G.'s experimental transmission test set. Note how it is inserted between the subscriber's set and the line termination.



systems employing repeaters, which operate on distances up to 16 miles. Current prices enable subscribers' carrier to compete with cable pairs as a method of providing bearers for telephone services. The carrier systems are particularly appropriate when urgent cable relief is not available, or when an additional service is required in the same premises.

Original development work carried out at the Post Office Research Laboratories in Melbourne has resulted in a system for testing telephones in cases where subscribers complain of poor transmission. The system consists of a portable checker and an oscillator situated in the exchange which sweeps a range of frequencies between 300 and 3000Hz, 25 times a second. This oscillator places the swept frequency tone on the subscriber's line and the portable instrument is used to check the level of signal received. Connection to the tone generator in the exchange is made by dialling the appropriate number for the telephone under test.

Four basic tests are provided. An orifice fitted to one end of the tester is connected to the sweep oscillator and functions as an artificial voice to

test the transmitter. The same orifice functions as an artificial ear to test the receiver when the latter is connected to the sweep oscillator. Direct measurement of the sweep oscillator provides an indication of line loss. The meter displays a single reading which is an average of the received power over the swept range. A low reading could therefore indicate an overall line loss or a selective loss over part of the speech spectrum. A fourth test position measures line current. A chart attached to each test set shows acceptable performance values for various types of telephone.

Provision is also made for calibration of the tester and for normal use of the telephone. The tester will remain connected to the oscillator during change of transmitter or receiver inserts.

At present, the Post Office regards the tester as experimental only, but a number of them are undergoing field trials, and it is expected that their use will have beneficial effects. The system will provide the attending technician with a standard system upon which to judge the performance of the telephone under test.

20W ZENERS in DO-4

available from Mullard
—part of a total range
which offers
170 different
voltage/power
ratings

The compact DO-4 encapsulation used for the Mullard type BZY93 zener diode is the smallest available anywhere for a 20W device. It has also resulted in an extremely low cost-per-watt figure on a device with $\pm 5\%$ tolerance.

Other features of the BZY93 include drift-free operation and a very high standard of reliability—even at extreme rating limits. This latter characteristic results from the Mullard conservative rating policy which specifies life performance at maximum rated power.

The Mullard zener range offers 170 different voltage/power ratings—400mW to 75W, and 3.3 to 75V. Advantages include sharp knee characteristics, low dynamic resistance, and low leakage current.

Pocket Chart—This new Selector gives you quick reference information on Mullard Zeners. Send stamped, addressed envelope for your copy to the Mullard office in your State.

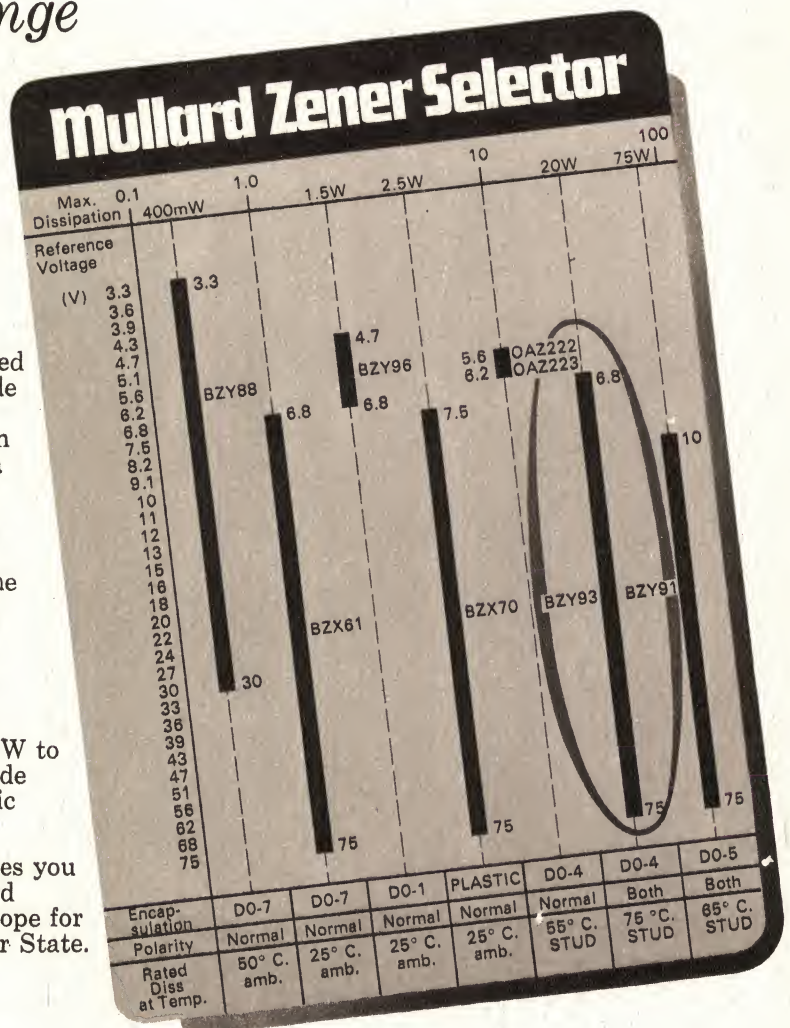

Mullard

Mullard-Australia Pty. Ltd.

35-43 Clarence Street, Sydney, N.S.W. 2000. Phone: 29 2006
123 Victoria Parade, Collingwood, Vic. 3066. Phone: 41 6644
St. Paul's Tce. and Light St., Bowen Hills, Qld. 4066. Phone: 51 5151
Associated with MULLARD LIMITED, LONDON

M231

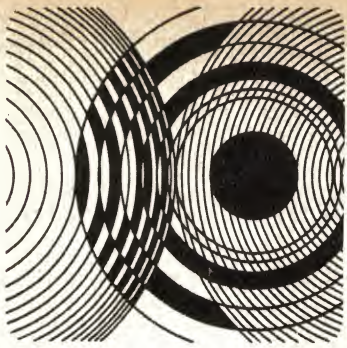

TECHNICAL DIGEST

Fungus growth on electronic equipment

Some plastics materials used as insulants in electronics components are not resistant to fungus attack, according to a recent study carried out in the United Kingdom.

One of the end products of high humidity is the growth of fungi, and the destructive nature of these is manifested in many ways, some more critical than others; for example:

1. They may attack and deface labelling or other essential instructional information on a product.

2. They may attack and lessen the tensile strength and durability of a product, causing it to fail short of the time indicated in endurance testing.

3. They may, in their metabolic activity, emit organic acids that etch or in some way disfigure a smooth or polished surface.

4. The development of a spore culture under warm, moist conditions within a motor or instrument enclosure may result in eventual malfunction due to interference with moving parts.

5. Fungus grows most readily on organic materials such as insulation, but also grows on paint surfaces and on slightly dirty bare-metal surfaces.

6. There is no satisfactory method of reconditioning once fungus growth has taken place.

7. Residual solder flux does not in itself act as a good source of fungus nutrients, but the flux residue does act as a particularly good base for fungus growth if the nutrients were supplied from outside. Test results show that, while all soldered joints were weaker than at the start, they were not significantly different from joints aged under ordinary room-temperature conditions.

Fungi are opportunists, natural inhabitants of the land. They are a group of micro-organisms, many of which attack, digest, and eventually return to their elements, all types of organic materials. Fungi lack a control system to maintain body temperature above or below the environment for the temperature favourable to their metabolic chemical processes. A temperature requirement of $30 \pm 4^\circ\text{C}$ is found in the general fungus-resistance test procedure; this is the temperature of an average summer day (In the U.K. — Editor.), one that fungi might find in actual field conditions.

At this temperature both the extracellular and intracellular enzymes of a

fungus may function at, or very near, the optimum level, and so a more or less rapid growth is encouraged. Chemical reactions continue at ever increasing rates as the temperature rises because of the excitement of the atoms at higher and higher temperatures.

What then, is the limit of fungus growth? For most fungi generally 40° to 43°C is the maximum. At temperatures over 40°C , the viscosity of the cytoplasm of most forms of life begins to change.

Looking at a growth of mould of fungus, one perceives a network of thread-like filaments resembling cotton; these are topped with a mass of colour, usually black, green, yellow, pale blue and brownish grey. When brushed off the coloured material has the appearance of powdery dust which under the microscope is seen as a mass of individual particles. Such particles, known as spores are so small that they float on air currents and, as seeds of the parents, are carried along on fertile material. The small organisms are complete chemical factories with a growth potential governed only by the environment in which they find themselves. The environment permitting, they will grow for ever, and the presence of fungal growths requires a sustained high moisture content. Thus plastics with low moisture-absorbing tendencies are preferred for many electrical applications because their surfaces are less hospitable to the growth of organisms.

Materials that are nutrient to fungi should be avoided; such materials are cellulose nitrate, melamine formaldehyde, and vinyl-acetate. If a plastic happens to be a modified material, its susceptibility to fungus is often unpredictable.

To prevent the growth of fungus on plastics an attempt has been made to introduce fungicides into the materials; unfortunately fungi are susceptible to only a few fungicides and are exceedingly hard to treat. The best method is to select and use materials that are non-nutrient to fungi; among these can be listed ceramics, mica, glass, nylon, and PTFE.

The following materials have given

rise to heavy fungus growth during tests:

Castor oil (basis of lubricating oil)

PVC (has vinyl-acetate content)

Glyceryl laurates

Sorbitol laurates

Ethylene glycol

Tetraethylene glycol disterate

Lacquers and varnishes which are usually compounded with resins and natural oils.

Materials such as glass-fibre sleeving can provide a suitable path or bridge for fungus. This can be overcome by impregnation with PTFE.

Degradation of physical properties by bacterial action is usually associated with naturally occurring fibres and it is disturbing to learn that synthetic materials are by no means immune to attack.

Polymers are often used which are anything but pure; but, apart from these technical impurities, plastics are often mixed with all kinds of other substances, e.g. plasticisers, stabilisers, fillers and the like, and it is just these admixtures which succumb first to biological deterioration.

The start of an investigation should be at the point of mixture of substances, which in practice are grouped under the name of plastics and which under conditions of practical use, may give rise to the occurrence of biological deterioration. Polyethylene and PVC, which are considered to be particularly inert materials, can be attacked, and insulation of cables and terminal boxes has failed as a result of the action of micro-organisms which cannot be detected by the eye. It is not safe to assume that a material which appears to be resistant to attack when it is first produced will remain immune.

Many plastics are themselves insensitive to attack by micro-organisms (they are inert), but they do allow the growth to develop on their surfaces. This is highly undesirable, especially in the case of insulating materials. One might state that deterioration of the material concerned does not apply; but things are not as simple as that, because, in the process of overgrowth, the structure of the surface and the presence of microscopically thin water layers play a part. These are undoubtedly properties of the material itself.

Surface fungal growth on plastics is certainly an "undesirable change," at

4

SOPHISTICATED SPEAKER SYSTEMS FROM THE WHARFEDALE RANGE

Music lovers and audio enthusiasts all over the world agree that Wharfedale sound is distinctive and appealing . . . Wharfedale popularity is reflected in ever increasing sales wherever high fidelity speaker systems are available.

Research engineers at Rank-Wharfedale Ltd. have solved the problems associated with small speaker systems which until now have been loss of musical quality and limited frequency response. As a result, Wharfedale's compact speaker enclosures, the "Denton" and the "Super Linton", sound like much larger speaker systems . . . bass registers are reproduced without restraint or collapse and trebles are smooth, clean and satisfying.

WHARFEDALE "SUPER LINTON" \$89 inc. sales tax

A most musically satisfying compact system with dimensions of only 19" x 10" x 10" . . . and a conservatively quoted frequency response of 40-17,000 Hz. Low frequencies are reproduced by a specially designed 8" roll surround bass unit with a long throw voice coil . . . trebles by the renowned Wharfedale Acoustiprene tweeter. The "Super Linton" will handle 15 watts R.M.S. Available in selected oiled teak or polished walnut veneers.



Simon Gray proudly introduces to Australian music lovers two medium size Wharfedale speaker systems; both enclosures are already popular overseas. These are the 2-way "Melton" and the 3-way "Rosedale" . . . high performance systems which have been acclaimed in international music circles.



WHARFEDALE "DENTON" \$69.50 inc. sales tax

Measuring only 15" x 9 3/4" x 9", the "Denton" has a conservatively quoted frequency response of 65-17,000 Hz. It features a specially designed 8" roll surround bass speaker with a long throw voice coil and the proven Wharfedale H.F. pressure unit tweeter. Power handling capacity is 15 watts R.M.S. Cabinets are available in selected oiled teak or polished walnut veneer.



WHARFEDALE "MELTON" \$130.50 inc. sales tax

With its 12" wide spectrum bass reproducer and Wharfedale Acoustiprene tweeter the new Wharfedale "Melton" offers large speaker performance from a cabinet with dimensions of only 21" x 13" x 10 1/4". Power handling capacity is 25 watts R.M.S. Frequency response is conservatively quoted at 45-17,000 Hz. Make your selection from selected oiled teak or polished walnut veneers.



WHARFEDALE "ROSEDALE" \$284 inc. sales tax

With a genuine frequency response of 35-20,000 Hz. free of colouration, the period styled "Rosedale" is recognised as one of the world's finest speaker systems. Speaker complement includes a massive 15" woofer, a specially designed 5" mid-range speaker and an effective Wharfedale 1" tweeter. Power handling capacity is 40 watts R.M.S. Available with oiled teak or polished walnut veneers.

SGW4

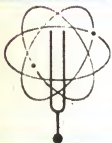

Australian National Distributors:

Simon Gray Pty. Ltd.

Head Office: 28 Elizabeth St., Melbourne, Vic. Tel. 63 8101*
 Sydney Office: 22 Ridge St., North Sydney, N.S.W. 929 6816
 Canberra Office: 31-33 London Circuit, Canberra City, A.C.T. Tel. 49 6050

INTERSTATE REPRESENTATIVES:

N.T.: Pfitzner's Music House, Smith Street, Darwin. Tel. 3801
 Q'land: Sydney G. Hughes, 154-158 Arthur St., New Farm, Brisbane. 58 1422
 S.A.: Eiko Sales Pty. Ltd., 7-9 Osmond Terrace, Norwood, S.A. Tel. 63 4844
 Tas.: K. W. McCulloch Pty. Ltd., 57 George Street, Launceston. Tel. 2 5322
 W.A.: Athol M. Hill, 613-615 Wellington Street, Perth. Tel. 21 7861

least of the condition of the material in the sense of the definition of biological deterioration.

The properties of different types of resins vary considerably; the nature of the ingredients cannot always serve to determine whether decay occurs or not. For the least exigent organisms causing deterioration, conditions are:

Sufficient water

A source of carbon

A small quantity of minerals, i.e. containing phosphorous and nitrogen
A suitably high temperature

Consequently it is not sufficient to investigate whether some substance or another may serve as a carbon source; other conditions must be satisfied too, and this may lead to considerable complications owing to the environments in which these factors of growth occur.

Cellulose appears to be very liable to attack; whereas cellulose acetate is not, cellulose nitrate is. In the case of polyvinyl chains we see, however, that the acetate is vulnerable and that the chloride is not; it is not a matter of simply adding up properties of chemicals, but in this respect every compound itself should be considered on its own merits.

This is particularly evident in the case of polythene, which, after all, is a chain of CH₂ groups, whilst it is known that paraffins, which have shorter chains, are vulnerable. In practice it is not often that we deal with pure synthetic resins and plasticisers which, because of the microstructure, are liable to deterioration and are susceptible to fungal growth.

The mainly physical bond between synthetic resin and plasticiser causes no problem to micro-organisms attacking the plasticiser in the mixture.

Tests made on materials used in cable manufacture showed that heavy fungus growth was found on PVC sleeving and, to a lesser extent, on Neoprene latex sleeving. The tests showed conclusively that PVC materials are nutrient to fungus growth. Assemblies appeared to have a deeper penetration of growth when castor base oil was used as a lubricant. The tensile strength and durability were affected. Insulation resistance showed a pronounced drop, in many cases below the acceptable limit. Organic acids which formed, etched and disfigured the sleeves, blistering and separating the overlay.

Fungi was shown to be a major cause of deterioration of polyurethane coatings in wet situations. Deterioration caused by fungi is lessened if hydrolysis inhibitors are added to the polyurethane and can be prevented by the addition of a fungicide.

One of the slight disadvantages of polyurethane is that, under certain conditions, particularly in tropical climates, the polyurethane develops soft areas and deforms. Inspection of a number of such prematurely discarded coatings shows that the softened areas are sponge-like in structure and the spaces contain fungus hyphae. The fungus might be a major cause of the deterioration or, as softening due to hydrolysis will eventually occur in any case, the fungus may be present only after this deterioration has occurred.

Experiments showed that fungi grow readily on polyurethane in the presence of water, and that the fungi

REED SWITCHES AS NON-MECHANICAL LOCKS

A novel type of lock which can be opened with a card with a magnetic pattern impressed on it was described in "Electronics" by R. Michel Zilberstein, of Microsonics Inc., U.S.A.

A non-mechanical electrical lock can be made with dry reed switches. Several normally open and normally closed switches are connected in series and mounted on a board. Using a coded card to activate the normally open switch with permanent magnets will close the circuit, permitting operation of the electric door latch, automobile ignition, or whatever.

The lock won't operate with the wrong magnetic pattern, or with a single large magnetic field, because the normally closed switches will open, interrupting the circuit. The security factor of the lock depends on the number of reed switches and the pattern in which they're arranged. Each lock will respond only to the magnetic pattern that will close the normally open switches and leave the normally closed switches closed.

The card is an array of small per-

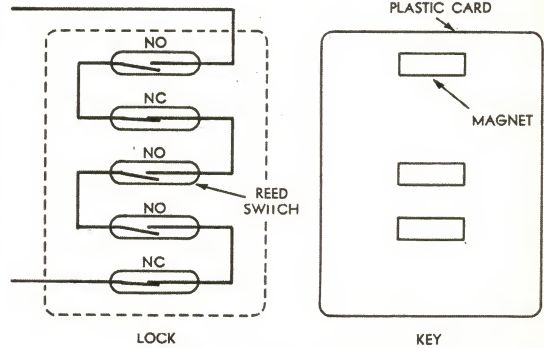

The security lock can only be activated by the correct pattern of permanent magnets on the card "key".

manent magnets arranged so that they're over the normally open switches when the card is inserted. The lock can be sealed in a non-magnetic box, recessed into any flat surface, and then disguised with trim. The key can be a laminated plastic card.

are a major cause of deterioration and softening. After hydrolysis due to other causes (accelerated aging) fungal growth is more rapid. Fungicides can be added to the polyurethane to prevent mould growth. Additives which prevent hydrolysis of the polyurethane also improve its resistance to fungus.

Since many compounding ingredients such as plasticisers are attacked by fungi, only those known to be resistant should be used in applications where fungus growth might occur. Castor oil cures of polyurethanes are somewhat susceptible to fungus attack and should be protected with appropriate fungicides. Cases have occurred where solder flux has crept along stranded wires under insulating sleeves; as the flux never reached the decomposition temperature, mould growth was brought about in the presence of moisture.

Another mould-growth problem is that of fingerprints imposed when handling printed wiring boards and components. This has been directly responsible for many failures. It is of interest to note that growth is more prevalent where female labour is employed on assemblies; this is associated with the use of hand cream.

Tobacco smoke also has an effect on assembled materials, such as plastics where mould has grown extensively on areas which have been in direct contact with smoke from cigarettes, and testing shows that it is not coincidence, but a fact, that substantially less growth is found from the non-smoking operation. It has also been experienced that, where the meniscus of a plastic-encapsulated capacitor had been

fractured at its wire termination seal, flux and moisture had penetrated through the seals carrying fungus spores; these spores had created small chemical factories inside the capacitor and their products were ultimately the direct cause of breakdown.

The ends of cables or wires sleeved or open should be sealed against the entrance of moisture with a suitable compound at the maker's premises and kept sealed during storage and transit, until used in the manufacture of cable assemblies.

Prior to attachment of terminations to prepared lengths of cable, the ends should be protected against moisture and fungus by treatment with a fungicidal varnish; after the terminals are attached, the connections should be adequately touched up with the same varnish.

The use of fungi-nutrient materials should be avoided in printed-circuit component parts and materials. If this cannot be accomplished, materials should be pre-treated with an acceptable fungicide or sealed from exposure; but this is not applicable where non-fungi-nutrient materials are used or where printed-circuit boards and components are to be encapsulated.

It is very important that the encapsulating medium is tested to ensure that fungi-inert and non-fungi-supportive materials are used.

The use of clean rooms and the wearing of suitable gloves would materially assist in the prevention of mould growth activity. (Condensed from an article by Charles E. Jowett in the September, 1969 issue of "Design Electronics.")

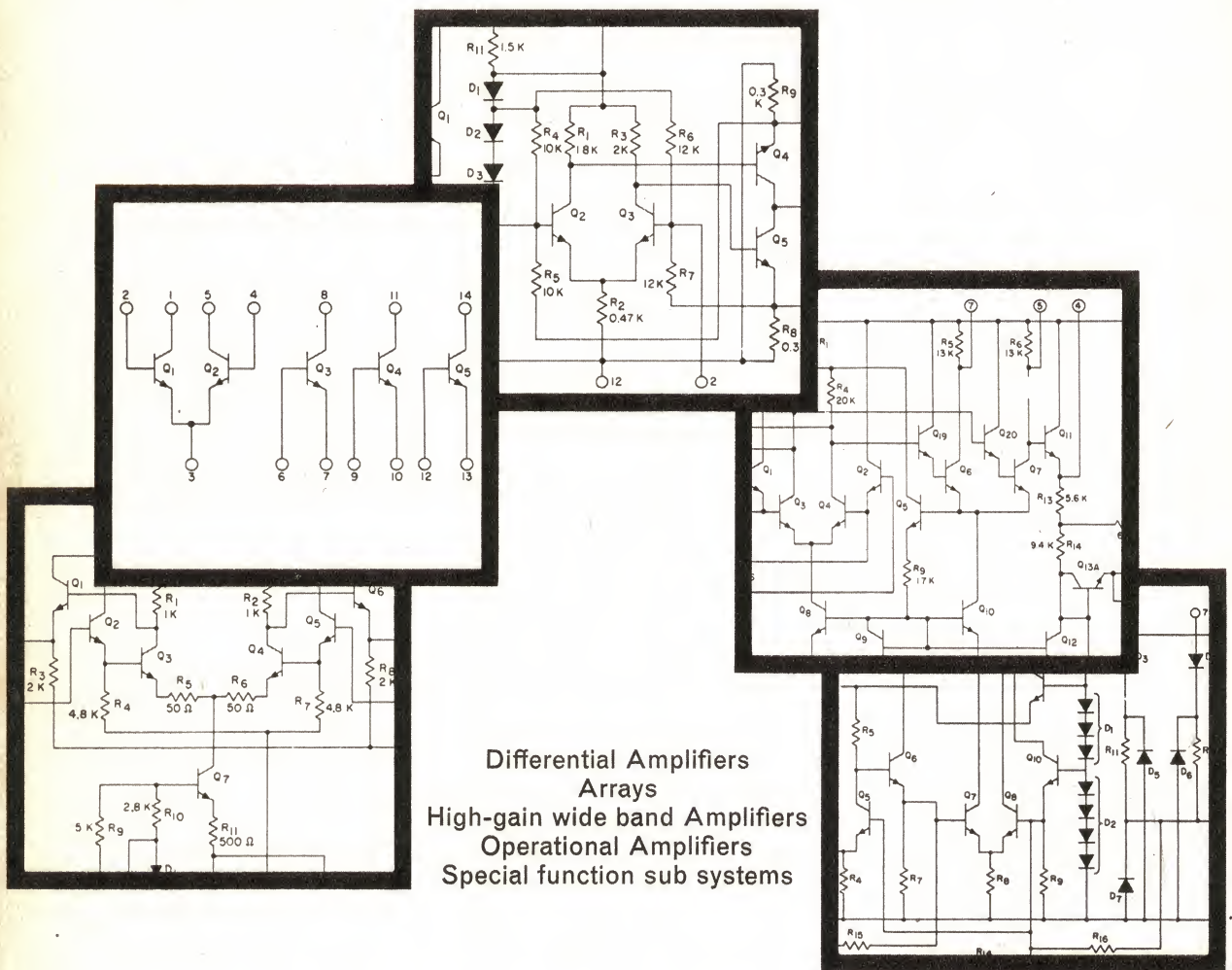

Differential Amplifiers
 Arrays
 High-gain wide band Amplifiers
 Operational Amplifiers
 Special function sub systems

Want Linear Integrated Circuits?

AWV stocks the broadest range.

AWV's range of Linear Integrated Circuits is constantly expanding. At this moment we have over 55 different types available — each suitable for a wide range of applications. Integrated Circuit Product Guide, on request to AWV Sales Dept., Private Mail Bag, P. O. Ermington, N.S.W. 2115 or Interstate Offices and Distributors.



AMALGAMATED WIRELESS VALVE COMPANY PTY. LTD.

AWV119

TOSHIBA IN PRODUCTION WITH IC RECEIVERS

Tokyo Shibaura Electronic Co. Ltd. (Toshiba), of Japan, is marketing two broadcast receivers using integrated circuit devices.

In its magazine "Toshiba Review" the company says the two models introduced, the IC-310 and the IC-70, are produced with emphasis not on miniaturisation alone, but also on getting the best performance by using ICs.

The IC-310 has been developed for AM single band use. It has a relatively large cabinet, but the space saved through the use of ICs is devoted to a large aerial core and large loud-

gain three-stage direct-coupled amplifier for AF amplification. Negative feedback from the output to terminal 3 increases the input impedance and reduces distortion. Q8 is a power drive transistor with maximum emitter current of 20mA.

The second Toshiba IC radio, the IC-70, is a compact, portable FM/AM set for two-band operation.

It uses a monolithic linear IC, TA7046P, which was developed primarily for use in the IF stage of FM/AM portable radios. The circuit is divided into three blocks: an FM/AM IF amplifier with AGC characteristic for AM; IF amplifier and limiter for FM doubling as IF amplifier and detector for AM; audio preamplifier. ■

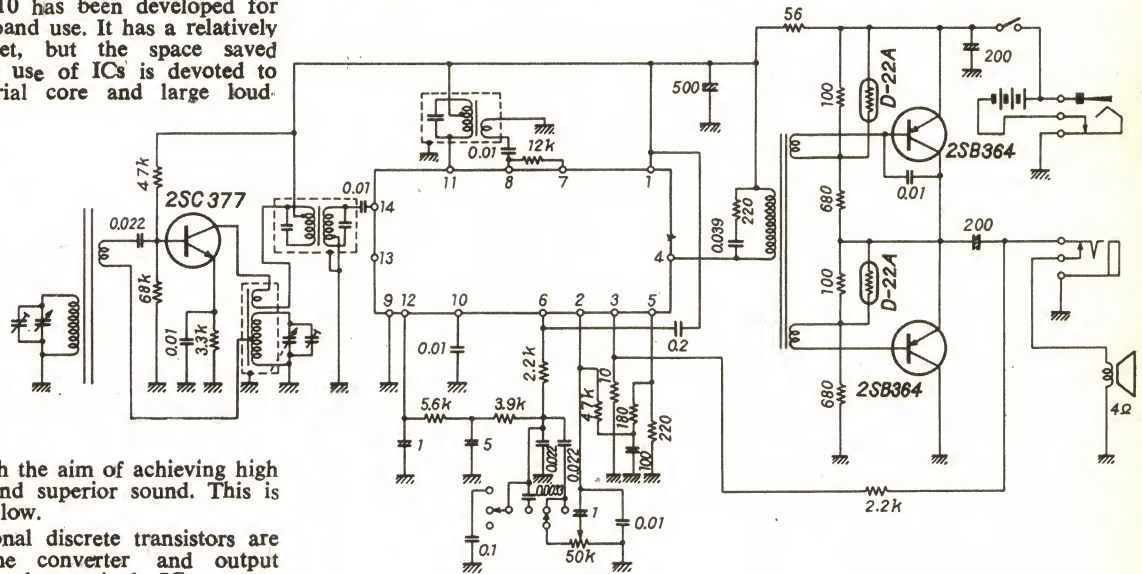

Figure 1. Circuit diagram of the Toshiba IC-310 receiver.

speaker, with the aim of achieving high sensitivity and superior sound. This is described below.

Conventional discrete transistors are used in the converter and output power stages, but a single IC operates as IF amplifier, detector and audio amplifier (figure 1). The circuit uses the Toshiba TA7049P monolithic linear IC, which is housed in a 14-lead plastic dual in-line package. This package is regarded as convenient for assembly and suitable for automatic insertion in mass production. Other merits are the ability to operate on voltages as low as 2.5V and an excellent AGC characteristic. In the receiver under discussion, a 4.5V power supply is used, and the AGC figure of merit is over 55dB.

As can be seen from the block schematic (figure 2) the TA7049P consists of three blocks, total gain being 140dB. The first block is the IF amplifier stage with AGC transistor; Q1 and Q3 constitute a direct-coupled amplifier with negative feedback; high gain is secured through connection of a bypass capacitor to terminal 10. Q2 is an AGC transistor with the collector and emitter common to Q1; as the emitter current of Q2 increases through AGC action, the emitter currents of Q1 and Q3 decrease to reduce gain.

The second block is a direct coupled two-stage amplifier with no internal bias. This may be used as a linear amplifier with a DC negative feedback between terminals 6 and 8; however, in this case, with negative feedback established between terminals 7 and 8, Q5 is biased near the cutoff point. Thus, it operates as a detector.

The third block is a low-noise, high-

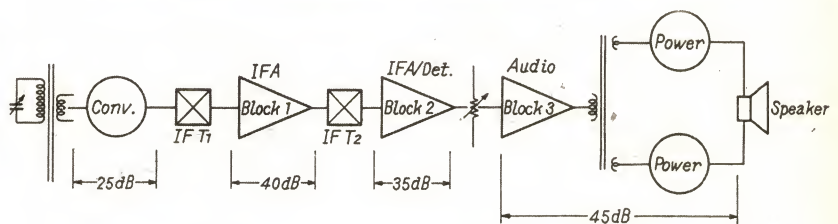

Figure 2. Block diagram of the Toshiba IC-310.

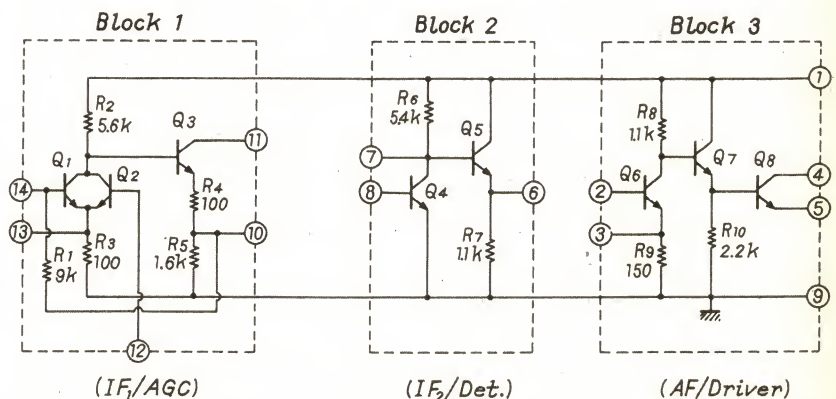

Figure 3. The circuit for the Toshiba TA7049P integrated circuit.

CHEST OF DRAWERS

Three types of Galvanised Chests measuring 17½in x 6¾in x 11½in, containing 16 drawers, each measuring 6½ x 3¾in x 2½in.

- TYPE C.D.1. With 16 undivided drawers.
- TYPE C.D.2. With 16 triple compartment drawers.
- TYPE C.D.3. With 8 triple compartment drawers, and 8 undivided drawers.
- TYPE C.D.4. A 17½in x 11½in Galvanised Chest containing 4 full-length drawers each measuring 15¾in x 6¾in x 2½in.

The Chests are finished in blue hammertone stoving enamel, are complete with identification cards and packed in strong corrugated cartons. Provision is made for all units to be bolted together in tiers.

WRITE FOR FREE CATALOGUE AND PRICE LIST OF TOOL BOXES AND CHESTS OF DRAWERS.



COLOUR TELEVISION

With particular reference to the PAL system by G. N. PATCHETT
This book now available
\$5.95



"PIPGRAS" HOLE PUNCHES

"PIPGRAS" Hole Punches are made from Alloy Tool Steel, and cut clean and accurate holes in sheet metal. They make a smooth, perfect hole without reaming or filing.

SCREW TYPE, ROUND

Supplied with "UNBRAKO" High Tensile Socket Screws and Wrenches. Cut holes in sheet metal up to 18 gauge.

Type No.	Nominal Size	Actual Size	Water Pipe Size (I.D.)	Pilot Drill Size	Price Each
32.S	¼in	0.507in	—	¼in	\$2.17
40.S	¾in	0.618in	¼in	5/16in	\$2.17
48.S	¾in	0.742in	¾in	5/16in	\$2.80
56.S	¾in	0.884in	½in	¾in	\$3.80
64.S	1in	1.008in	—	¾in	\$4.10
72.S	1¼in	1.133in	¾in	¾in	\$4.53
76.S	1 3/16in	1.172in	—	¾in	\$4.53
80.S	1¼in	1.258in	—	¾in	\$4.97
88.S	1¾in	1.382in	1in	7/16in	\$5.97

With Heat Treated, High Tensile Steel Hex. Head Bolt and Nut.

Cut holes in sheet metal up to 16 gauge.
96.S 1½in 1.512in — 9/16in \$6.68
112.S 1¾in 1.762in 1¼in 9/16in \$7.69
128.S 2in 2.014in 1½in 9/16in \$8.33

BELLPHONE



Pick up the receiver and dial push number desired.

Large \$13.50 per pair
Small \$10.12 per pair

KALTRO SVC TV-RADIO REMOTE CONTROL LISTENER



This TV-Radio Remote Control Listener is a combination of an extension speaker and a remote control station to regulate the sound of both the TV, Radio, Phono, or Hi-Fi set and the speaker incorporated in the Listener itself. In addition, up to two earphones can be attached for listening to the sound of the TV, Radio, Phono, or Hi-Fi set without disturbing others around you. Unwanted commercials can be easily cut off by merely turning down the control of the TV-Radio Remote Control Listener. A modern designed plastic cabinet with easily adjustable fingertip controls ideal for use in home, office and business. Complete with earphone, 20ft of lead wire and installation instructions.

Price \$8.75

Trade enquiries
prices available
on application

Free parking
at Rhodes

Phone:
73-0211 Rhodes
29-4451 City
73-5586 Sat. Morning.

THIS MONTH'S SPECIALS

Radar 1XR Power Supply \$30.60
Radax 05XR Power Supply \$20.40
Lapel Microphone X67 .. \$00.90
Table Microphone BM3 .. \$ 7.50

8 WATT STEREO AMPLIFIER MODEL SA-80S



SPECIFICATIONS

Output Power: 8 Watt, 4 Watts per channel.
Frequency Response: 60 to 15,000 cps. plus or minus 1 db.
Harmonic Distortion: Less than 3%.
Hum and Noise: 52 db below rated output.
Sensitivity: Phone (Crystal) 100mV 250K ohm.
Tuner 100mV.
Tube Complements: 12AX7x1, 30A5x2, 1S315x1 (Silicon Rectifier).
Dimensions: 5.1lb. 9¾in x 6¼in x 3in.

BOOK SHELF TYPE SPEAKER SYSTEM MODEL SP-4S



Speaker: 4in, 8 ohms.
Frequency Response: 70-13,000 cps.
Sensitivity: 93dB.
Power Input: 8W (Music Power).
Cabinet Size: 9¾in (H) x 6¼in (W) x 5¾ (D).
Finish: Walnut lacquer.

MODEL M6 FOUR CHANNEL TRANSISTORISED MICROPHONE MIXER



All four inputs accept standard two circuit Phone Plugs, while the output jack accepts a standard circuit Phone Pin Plug.

SPECIFICATIONS:

● Input Impedance: "Hi" Impedance for Crystal Microphone, etc. ● Gain: Approximately 6 db. ● Maximum Input Signal: 1.5 volts. ● Maximum Output Signal: 2.5 volts. ● Output for Minimum Distortion: 2 volts. ● Hum: 0. ● Battery: 9 volts.

Mono \$6.75 Stereo \$9.75

GENERAL ACCESSORIES

(A DIVISION OF ELECTRONICS INDUSTRIES)

116-118 CLARENCE ST., SYDNEY 29-4451 443 CONCORD RD., RHODES 73-0211
BOTH STORES OPEN SATURDAY MORNING FREE PARKING SPACE AT RHODES FOR CUSTOMERS



SCIENTIFIC AND INDUSTRIAL NEWS

Specimen manipulator

Hitachi Ltd., of Japan, has been licensed by the C.S.I.R.O. to manufacture a high-precision specimen manipulator developed by Mr J. C. Mills and Mr A. F. Moodie in the C.S.I.R.O. Division of Chemical Physics, Clayton, Victoria. Manipulators are used to enable a specimen to be moved and tilted into any position for examination under an electron microscope.

The recently developed manipulator has been fitted to the latest Hitachi electron microscope. Controls external to the vacuum chamber of the instrument provide movements with a fineness of adjustment of .001 micron in two directions in a horizontal plane, of 1 micron in the vertical plane, and tilts up to 40 degrees about two axes at right angles. The movements are smooth, and the specimen is stable to within half an atom diameter during any half-minute, even under the most extreme working conditions.

To avoid contamination of the high vacuum and of the specimen, no lubricants are used. For the same reason, provision is made for cooling the specimen capsule to less than -140°C . so that stray molecules are trapped on its surface. At the same time, the temperature of the specimen itself can be raised to over $1,500^{\circ}\text{C}$ by mounting it on an electrically heated palladium grid.

Safety light

Florina Delineants Ltd., of Cornwall, England, is making a new safety belt for police officers, traffic controllers and emergency service workers in darkness. Worn diagonally across one shoulder and connected to a battery carrier on the hip, the belt is visible under normal atmospheric conditions for up to 1,000 yards. Six separate lights—three at the front and three at the back—are enclosed within a flexible amber tube and flash 60 to 70 times a minute with a flash duration of 300 to 400mS. In emergency, the belt can also be laid full length on the ground to serve as a protection for accident victims until they can be moved.

The belt, known as the Florina Bandolier, has a virtually indestructible case in moulded plastic with a recessed on/off switch. The electronic apparatus slides into its own compartment. It is adjustable to the size of any man, and is powered by nickel cadmium rechargeable cells which provide six or seven hours of daily use.

The company is also marketing a safety warning barrier which can be used to block a complete traffic lane or to divert traffic around an obstruction in the middle of the highway. The maker is represented in Australia by Mr R. H. Coulkes, Willesley House, Wellington Parade, East Melbourne, Victoria.

Doctors on radio call

A radio-telephone service for medical practitioners is operating in Sydney, using equipment designed, manufactured and maintained by Amalgamated Wireless (Australasia) Ltd. The Radio Call Society Ltd., with base station and offices at Crows Nest, has been established by Mr C. P. Mann with the co-operation of the medical profession, the Australian Post Office, and A.W.A.'s engineering products division. Mr Mann, who set up similar services in nearly 20 cities in Britain, hopes to extend these facilities to other Australian capitals and to large country centres.

The service is staffed by nursing sisters who act as "radio secretaries and receptionists" and who can assess the urgency

of a call, arrange hospital admissions, secure medical services at short notice, and handle a wide variety of associated matters on a 24 hours a day basis. The society provides three types of service for doctors: radio-telephone; night and weekend deputising; telephone answering.

Automatic testing

A versatile tape-controlled test equipment, called TRACE 900, has been developed for general industrial use by Hawker Siddeley Dynamics of Hatfield, Herts., England. It automatically checks and evaluates complex electrical or electronic components or assemblies. It has been developed from the company's avionics TRACE series (Test equipment for Rapid Automatic Check-out and Evaluation), currently being used by major international airlines for testing automatic flight control systems and other equipment.

The equipment can carry out accurate tests, ranging from simple insulation and continuity checks to the most complex of test procedures, in a fraction of the time normally taken by manual or semi-automatic methods. It simulates the correct working environment of the component under test, checking the correct operation of the component or, where a fault is present, indicating the precise part to replace or repair. It provides recorded test results which can be used for evaluation and for the prediction of faults by trends observed in the recorded data. TRACE 900 maintains its accuracy by continually self-checking its operation. A self-check of any function can be inserted by the operator at will.

Air pollution in spacecraft

The U.S. aerospace firm Lockheed Missiles and Space Co. has signed a contract with the National Aeronautics and Space Administration (NASA) to design and test a device which will remove harmful elements from spacecraft atmospheres. When completed, the filter will be tested continuously for 180 days to measure how well it controls trace contaminants. Gases which poison a spacecraft's atmosphere can come from many sources inside the craft, including the men. Carbon monoxide, methane and ammonia are a few of the 150 contaminants which have been identified in spacecraft atmospheres.

In choosing the filtering material, Lockheed will examine several charcoal and chemical candidates provided by the MSA Research Corporation, a major subcontractor in the program. One material is a super activated charcoal developed by MSA that has been made highly porous to attain a high surface area in a small piece of material. One gram of the charcoal has a surface area of about 2,500 sq. yds. Besides selecting a filtering material, Lockheed must develop ways for regenerating the filtering unit once it has been used. Methods to be investigated include applications of heat and steam; others may be examined as work progresses.



Randwick communications

Six separate internal communication networks have been installed in the new grandstand at Randwick racecourse, Sydney, by Plessey Communications Systems Pty. Ltd. The scratching operator (right) notifies all totos of scratchings in a race. The 48-line non-switching unit gives direct communications with the scratching office and with other officials connected with the conduct of a race.

Proposition:

Advance=MORE MHz/\$

Resolution:

(0.1 to 1 Hz)

buy one or all three of these
NEW Timer Counters



15 MHz : TC 11, TC 12

Designed to measure frequencies up to at least 15 MHz. TC11 offers a 4-digit display with a max. gate time of 1 sec. (1 Hz resolution). TC12 offers a 5-digit display with a max. gate time of 10 sec. (0.1 Hz resolution). Both instruments may be used for counting and timing. **Freq. Measurement:** 2Hz to at least 15MHz. Gate times. TC11 0.1 mS to .1S. TC12. 0.1 mS to 10 S. **Time Measurements:** Time Units TC11 10 μ S to 1 S, TC12 10 μ S to 10 S. **Multiple Period:** 10 to 10⁵ periods. **Count Mode:** 2Hz to at least 15 mHz. **Freq. Standard:** Internal 100 kHz crystal oscillator set to 1 part in 10⁵ at room temp. Stability \pm 6 parts in 10⁵ over the temp. range 0 + 50°C. **Sensitivity:** 10 mV, 100 mV and 1 V RMS. **Display Time:** cont. variable from less than 0.1 S to at least 4 S. **Data Output:** Display data avail. Format 8421 BCD pos. going, negative true. **Power Supply Req.:** 100 to 125 V or 200 to 250 V, 45 to 65 Hz. Consumption 25 VA. **Temp. Range:** 0 to + 50°C.

TC11: \$360.

TC12: \$450 (plus Sales Tax)



32MHz : TC9

A 6-digit instrument capable of measuring frequencies up to at least 32 MHz with a resolution of 0.1 Hz. Measures time intervals with a resolution of down to 1 μ S. Integrated circuits are widely used for max. reliability. **Display:** 6-in-line numerical indicators with dec. points for freq. and multiple period. **Freq. Measurement:** 2 Hz to 32 MHz. Dec. point auto. positioned. **Time Measurement:** Timing units from 1 μ S to 10 S in decade steps. **Multiple Period:** 10 to 10⁶ periods. **Count:** 2 Hz to 32 MHz. **Sensitivity:** 3 position attenuator providing 10 mV, 100 mV and 1 V RMS sensitivities. **Freq. Standard:** Internal 1 MHz crystal oscillator, oven controlled at + 65°C. Set to 1 in 10⁶ at + 25°C. Stability \pm 5 in 10⁶ from 0°C to + 50°C. **Display Time:** Cont. adjustable from 0.1 S to 4 S, or infinite. **Data Output:** Display data avail. Format 8421 BCD positive going, negative true. **Power Supply:** 100 to 125 V, 200 to 250 V, 45 to 65 Hz, 30 VA. **Operating Temp. Range:** 0 to + 50°C.

TC9: \$578 (plus Sales Tax)



Distributed by—

jacoby, mitchell & co. pty. ltd.

469-475 Kent Street, Sydney. 26-2651

MELBOURNE
30-2491/2

ADELAIDE
53-6117

BRISBANE
2-6467

PERTH
28-1102

LAUNCESTON
2-5322

On-line computer network

An extensive on-line network, to be installed in Melbourne by Computing and Software Services Pty. Ltd., is said to be the first of its kind in Australia to enable companies to process ordinary commercial applications (such as invoicing and payroll) on their own premises while connected directly to a central computer on a bureau basis. According to the company, the few time-sharing systems currently operating or planned in Australia employ terminals which are either unprogrammed teletypes or typewriters more suitable for scientific than for general business work, or are slave computers which involve programming and installation costs as high as those of a full scale E.D.P. system.

C.S.S. has ordered a large Burroughs B3500 computing system valued at over \$750,000 for installation at its headquarters in Clayton in May, 1970. The B3500 will be linked over telephone lines to Burroughs' TC500 terminal computers in the offices of customers in Melbourne initially, with future expansion planned to include country districts of Victoria. The cost to the customer of the TC500 terminal, the telephone line charge, and computer time is expected to be as little as \$10,000 per year.

Re-entry simulation

Lockheed Propulsion Co., of the U.S.A., has carried out studies to find ways to launch re-entry study payloads with high enough speeds on relatively short, low-altitude ranges to simulate the environment of high altitude re-entry achieved by multi-stage rockets. One concept is to use gun-launched rocket vehicles consisting of a projectile and a solid-fuel rocket motor. The re-usable gun barrel serves as the first stage rocket launcher: once clear of the barrel the solid-fuel rocket fires as the second stage to drive the projectile to its maximum velocity. Existing heavy-walled rocket-assisted projectiles (RAPs) do not, however, achieve the necessary speeds for launching re-entry probes.

Speeds of over 12,000ft/sec are possible when launching lighter, thin-walled projectiles from conventional gun barrels using a concept developed by Lockheed. The concept is of a fluid-supported rocket-assisted projectile. It is said to be the only way that thin-walled rocket motors and delicate instruments can survive gun

A tape controller, developed by the Ampex Corporation in the U.S.A., permits random access of one or more videotape recorders. Known as the Model RA-4000, it permits synchronised search, cue and playback for simple, precise tape editing. A unique address is recorded to identify each frame. When required, the recorder automatically searches for a desired address, stops, cues itself ahead of the address, and waits for a playback command. The code can be recorded on the cue channel of a tape at the time of original recording, or at a later time prior to playback or editing. The address struc-

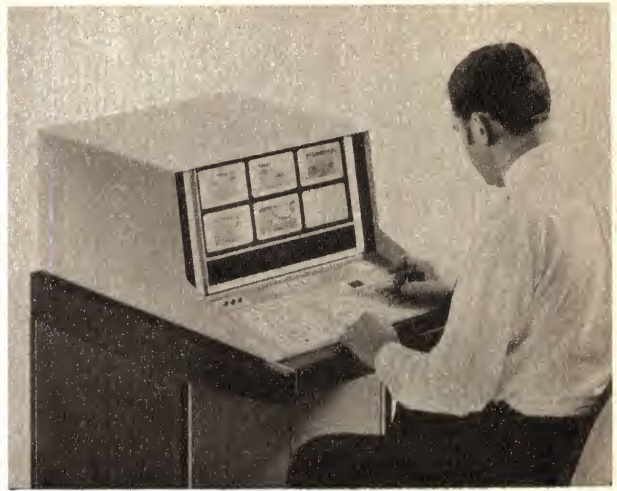

launchings. Enclosing the rocket motor in a fluid-filled sheath keeps the projectile from breaking up under the forces of firing, which reach 5,000 times the force of gravity.

W. Irian mineral search

Radio equipment supplied by Amalgamated Wireless (Australasia) Ltd. is providing a vital link in exploration by a large U.S. mining corporation of a mineral deposit on a precipitous 11,500 foot peak at Ertzberg, 65 miles inland from the swampy, southern coast of West Irian. The Indonesian Government has approved a proposal by the Freeport Sulphur organisation to explore the area and, if possible, to establish a copper-mining operation in West Irian.

The communications provide a point-to-point VHF link between a base station at Timika (eight miles east of the Indonesian village of Kokonoo) and Biak and Djajapura in north West Irian and also through the O.T.C. station at Darwin to a Freeport office in Darwin; communications with small ships and fixed-wing aircraft ferrying supplies between Darwin

ture permits identifying data to be carried over on successive tape copies.

and the base; and VHF channels for communicating with two large turbo-jet helicopters used between the coast and Ertzberg. A non-directional radio beacon is used by helicopters operating to Ertzberg as well as by planes from Darwin.

Superconductive generator

Scientists of the Toshiba research and development centre have developed the first superconductive generator in Japan. Before the 10KW generator could be completed, a special wire allowing a high current density under a high magnetic field had to be developed as well as a special cooling system to cool the wire to near absolute zero temperature and maintain this temperature. The new superconductive wire and the winding technique developed by Toshiba allows currents of over 1,000A to flow through a very small coil and generate magnetic fields in excess of 45,000 gauss. The wire forming the superconductive magnet is held at -269°C by using a liquid helium coolant. The container is hermetically sealed and vibration resistant.

Weather data receivers



This A.P.T. receiving system, installed at the British Meteorological Office, is similar to the ones to be supplied to the New Zealand D.C.A.

The New Zealand Department of Civil Aviation is to have two A.P.T. (Automatic Picture Transmission) receiving systems installed at Wellington and Fiji to gather satellite weather pictures and meteorological data. The equipment will receive and

print pictures (both daylight and infrared) obtained from the Environmental Science Service Administration and Nimbus weather satellites. Facsimile weather charts relayed from U.S.A. via geostatic satellites will also be reproduced.

Service radio in Vietnam

Australian servicemen in Vietnam will have their own broadcasts from a radio station being installed at Vung Tau. This has been made possible by contributions to the Australian Forces Overseas Fund by the public and industry. A 500W broadcast transmitter and associated equipment has been supplied by Amalgamated Wireless (Asia) Ltd., while radio station 2GB has provided the studio desk, console and associated items. The Federation of Commercial Broadcasting Stations and the A.B.C. will provide news, music and general tapes. The A.B.C. has assigned Mr Bruce Webber to visit Vung Tau to handle the station's programming. The Army has provided the studio. The station, expected to be on the air daily, will be operated by R.A.A.F. personnel and off-duty Servicemen.

Message switching

The Department of Civil Aviation will spend \$2.2 million on message switching systems to be installed at Sydney, Melbourne and Brisbane. The computer-based message switching equipment will permit the immediate processing of all operational messages relating to flight plans, weather information, and traffic movements of domestic and international airlines. These messages are then sent to any number of centres simultaneously.

PIONEER®

WORLD-FAMOUS BRAND IN HI-FI REPRODUCTION



C 3500
COMPACT STEREO SYSTEM



SX 440 SOLID STATE TUNER AMPLIFIER



SA 500 SOLID STATE AMPLIFIER

YOU DON'T SEE PIONEER

among the 'one day specials', the 'packaged deals' or marked 'even less with trade in'.

THERE IS A VERY GOOD REASON.

Your PIONEER Dealer is in business to stay - and to do this, he must give you demonstrations, sound advice, after-sales assistance, warranty service if needed and so on.

He just can't afford to have you become anything but a completely satisfied customer.

No chance here of artificially inflating prices just to offer a so-called discount.

If you want to enjoy the purest, cleanest sound of perfectly reproduced recorded music, ask your Hi-Fi Dealer or Music House to demonstrate the PIONEER range - individual players, amplifiers, speaker enclosures, or complete stereo systems.

Also for the Home Builder, every component of a Hi-Fi system, each without equal in its class.

Ask for attractive brochures giving full specifications.

SEE PIONEER! HEAR PIONEER! DEMAND PIONEER!

At Authorized PIONEER Retailers Everywhere.

All Trade Enquiries to:-

Sole Australian Importers and Representative

ASTRONICS AUSTRALASIA PTY. LTD. - ALL STATES.

MELBOURNE: "ASTOR HOUSE", 161-173 STURT STREET, SOUTH MELBOURNE. PHONE: 69 0300.

SYDNEY: 121 CROWN STREET, EAST SYDNEY. 2010. PHONE: 31 6721.

ADELAIDE: "ASTOR HOUSE", 81-97 FLINDERS STREET, 5000. PHONE: 23 4022.

BRISBANE: "ASTOR HOUSE", 50-54 LITTLE EDWARD STREET, 4000. PHONE: 2 0271.

PERTH: 14 GOLDING STREET, WEST PERTH, 6005. PHONE: 28 6111.

HOBART: 199 COLLINS STREET, 7000. PHONE: 2 2711.

INTERNATIONAL CONVENTIONS . . .

NBS measurement seminars

Seminars and workshops have been announced for the 1969-70 series of NBS measurement seminars. These are scheduled to be given at the National Bureau of Standards laboratories either in Gaithersburg, Md., indicated by (G), or in Boulder, Colo., indicated by (B). The announced topics and tentative dates are: Thermometry and Pyrometry (G), March 23-26, 1970; Force Measurements (G), April 6-7, 1970; Length, Angle, and Geometry Measurements (G), May 11-15, 1970; Radiation Quantities (G), May 12-15, 1970; Laser Power and Energy Measurements (B), December 4-5, 1969; Field Strength and Antenna Measurement (B), April 7-10, 1970; High Frequency and Microwave Noise (B), April 13-17, 1970. Each seminar includes lectures, group discussions, and laboratory demonstrations.

Further information may be obtained from the NBS Office of Technical Information and Publications, Room A500/101, Washington, D.C. 20234, U.S.A.

R and D safety

The 2nd Western Area Research and Development Safety Seminar will be held at the University of California Lawrence Radiation Laboratory, Berkeley, Calif., U.S.A., on January 26 and 27, 1970. The program will consist of presentations and panel discussions in the following disciplines: biological sciences—microbiology safety, animal care and interplanetary safety problems; medical sciences—what are the problems, medical instrumentation hazards and fire and explosions; physical sciences—laboratory wastes disposal, environmental effects and toxicology; engineering science—safety and the external combustion engine, high-pressure research and strain gauge applications. For further information contact Paul E. VanDeMark, U.C.L.R.L., Berkeley, Calif. 94720, U.S.A.

A.V.E.C. 70

A new international conference devoted to audiovisual and electronic techniques will be held in Paris from February 6 to 11, 1970. Called the Salon International des Techniques Audiovisuelles et Electroniques au Service de la Formation Permanente (A.V.E.C.), it has been created by a group of French professional bodies in these fields and is being organized by the Societe pour la Diffusion des Sciences et des Arts.

The conference will include several days of study devoted to the formation of a

permanent body and to the techniques applied to education. The conference will also present an exhibition of audiovisual and electronic equipments for teaching and leisure. This section will cover: electroacoustics; video; display and transmission of information by photo, film, projector and optical methods; publications, programs and guides; methods of instruction and teacher services. Inquiries should be addressed to: La Societe pour la Diffusion des Sciences et des Arts, 4 Rue de Presles, Paris 15e, France.

CETIA 1970

The 2nd International Control, Electronics, Telecommunications, Instruments and Automation Exhibition (CETIA) will be held in Melbourne from February 23 to 27, 1970, under the technical direction and sponsorship of the Institute of Instrumentation and Control, Australia. Three technical conferences are to be presented in conjunction with the Exhibition and located on the same premises.

One conference, presented by the sponsor and with contributions by the Australian Post Office, will deal with new developments in electronics, telecommunications and instruments. The application of non-destructive testing to the maintenance of plant and equipment is the theme of a symposium conducted by the Victorian Branch of the Non-Destructive Testing Association of Australia. Papers will relate to the aircraft industry, the railways, the chemical industry, and public utilities. The Melbourne Chapter of the Fluid Power Society is to conduct the third conference embracing fluidics, education and research, hydraulic systems, fluid power users' problems, pneumatics and logic.

Further details may be obtained from the Executive Director, The National CETIA Program, G.P.O. Box 3629, Sydney, 2001.

Radiation detectors

The latest developments in nuclear radiation detectors and their applications will be discussed at the 12th Scintillation and Semiconductor Counter Symposium to be held at the Shoreham Hotel in Washington, D.C., U.S.A., from March 11 to 13, 1970. The fields of interest to be covered include: scintillation and fluorescence phenomena; photomultipliers; semiconductor detectors; other types of detectors of ionising radiation; track imaging, spark and proportional counters; proportional position sensitive detectors; biomedical detectors; spectrometry; signal conditioning circuits; low noise preamplifiers; space applications; X-ray spectro-

scopy and detection detector array and data handling.

Further information may be obtained by contacting R. L. Chase, Chairman Program Committee, S.S.C.S., Bldg. 535, Brookhaven National Laboratory, Upton, New York 11973, U.S.A.

EM measurements

The 1970 Conference on Precision Electromagnetic Measurements will be held at the National Bureau of Standards Laboratories, Boulder, Colorado, U.S.A., from June 2 to 5. The aim of the conference is to advance electromagnetic measurements at levels of precision and accuracy appropriate to national standards laboratories. The traditional fields of direct current, low frequency, high frequency, and microwave measurements together with related physical studies provide the core of the conference subject matter. The field of precise measurements at very low temperatures will be emphasised. Other sessions will be devoted to methods for automated measurements and to the international comparison of standards.

Original papers in the following areas will be presented: direct current and low frequency measurements; time and frequency; radio frequency and microwave measurements (including coherent optical techniques); time domain measurements (pulse measurements through the entire electromagnetic spectrum); automated measurements; cryogenic electromagnetic measurements.

General questions concerning the conference should be addressed to George Goulette, Bureau of Continuation Education, University of Colorado, Boulder, Colorado 80302, U.S.A.

Magnetic recording

The Hungarian Optical, Acoustical and Filmtechnical Society will hold its 3rd Conference on Magnetic Recording in Budapest from August 11 to 15, 1970. Papers are invited discussing aspects of the theoretical and practical problems of magnetic recording on moving media (tapes, drums, discs, etc.), the design and various applications of equipment for digital, instrumentation, sound and video recording, and on the theoretical and practical questions of static magnetic memories.

Abstracts of the papers, of not more than 100 words, should be submitted by February 1, 1970, with full texts not later than May 15. Papers in English are preferred, but papers in Russian, German and Hungarian will also be accepted. An exhibition to be held at the same time as the conference will cover the same fields. Abstracts of papers and all inquiries should be addressed to: M. J. K., Optical Acoustical and Filmtechnical Society, Budapest V, Szabadsag ter 17, Hungary.

Gift to Malaysia

Philips Telecommunications of Australia Ltd. has presented the Malaysian Telecommunications Training Centre of Kuala Lumpur with a radio-telephone unit. The presentation was made by Mr I. McKenzie, representative in Malaysia of Philips Telecommunications, to the Minister of Works, Posts and Telecommunications, Tun V. T. Sambanthan (second right.) Looking on are Mr McKernan, Australian Trade Commissioner (second left) and Mr Chew Kam Pok, Director-General of Telecommunications. The 25W transistorised unit will be used in the training of technicians in modern circuitry and servicing techniques.



SOUNDWOOD

Apollo speaker system



price breakthrough
\$36.50 each.

SPEAKERS

6½" Bass Unit featuring high compliance suspension, consisting of large diameter spider and synthetic rubber pneumatic rim, allows large excursions without non-linearity.

Specially treated cone to provide sharp cut-off at the crossover frequency. Aluminium voice coil former provides long term stability and increased power handling capacity.

Soundwood 5" Dual Cone Treble Unit.

SOUNDWOOD
Apollo speaker system

MANUFACTURED BY Soundwood Products Pty. Ltd. P.O. Box 14, Frenchs Forest. N.S.W. 2086.

Satellite communications

The Post Office and the Overseas Telecommunications Commission (Australia) are conducting tests which could result in the use of satellite circuits to carry telecommunications traffic between Western Australia and the Eastern States, particularly over the coming Christmas-New Year period. The Intelsat III satellite over the Pacific Ocean is being used for the tests with the O.T.C. earth stations at Carnarvon (W.A.) and Moree (N.S.W.) transmitting and receiving simulated trunk traffic between Perth and Sydney. Depending on the outcome of the tests, the circuits could be used until the east-west microwave system is brought into service about the middle of 1970.

IMV electron microscope



Hitachi Ltd., of Tokyo, Japan, recently delivered this large IMV electron microscope to the Central Electricity Generating Board of the U.K. Over 20ft tall and weighing 20 tons, the microscope is designed for metallurgic and crystallographic studies.

New solid-state effect

Scientists at the Palo Alto, California, research laboratory of Lockheed Missiles and Space Co. have reported the discovery of a new solid-state effect, called an amplified ferrimagnetic echo, which should permit the development of a new class of exceedingly small and light microwave device. The effect results from storing first a signal and then a recall pulse at the same frequency in a magnetic compound. Within the compound the pulses (or disturbances) are mixed in such a way as to send back a distinctive echo. The ferrimagnetic echo can be used to amplify, delay, or change the shape of short pulses of microwave energy in a controlled manner.

Various types of signal processing at microwave frequencies—including delay, time compression, multiplexing, and signal correlation—have been demonstrated, using the echo effect.

Commercial TV licences

The Postmaster-General's Department has invited applications for the grant of licences for commercial television stations at Darwin, Kalgoorlie and Mount Isa. This follows an investigation by the Australian Broadcasting Control Board of the economic capacity of a number of areas to support commercial television stations.

At the public inquiries which will be held by the Board, applicants will be given the opportunity to produce convincing factual evidence on the matter. Certain other areas — the Central East area of South Australia, Geraldton, and the Central Agricultural area of Western Australia — had been considered but the Board concluded that the prospects of operating commercial stations profitably in these areas were so marginal as to justify deferring any decision at this stage. These areas will, however, be kept under review.

Blue laser



Dr Joseph F. Rando, of University Laboratories Inc., U.S.A., has developed this helium-cadmium continuous wave laser with output in the deep blue at 4416 Angstroms. The new laser incorporates an adjustment-free internal mirror design previously fitted to the company's helium-neon lasers.

normal viewing position. Levels are much lower directly in front of the picture tube, and viewer exposure can be considered negligible if a normal viewing distance of four feet or more is maintained.

British telephone service

Big savings for people who make heavy use of the telephone during the night are possible in the U.K. with the new "Midnight Line" telephone service. For £200 a year, a Midnight Line customer can make unlimited dialled telephone calls within the U.K. between midnight and 6 a.m., a period when the telephone system has ample idle capacity. By comparison, it would cost £500 for two hours' continuous traffic each night for 250 nights making dialled calls of over 35 miles at the cheapest rate. The service is likely to be used mainly for data transmission but can be used for ordinary dialled calls. The service is operated by equipment at the exchange which disconnects the customer's line from the meter recording dialled calls except when an international number is dialled. International calls, and calls through an operator, can be made but are charged at normal rates.

Colour TV radiation

A survey of 400 colour television receivers was made recently by the Canadian Ministry of National Health and Welfare to investigate possible radiation hazards. About 20 per cent of sets purchased in 1966 or earlier emitted radiation that in some degree exceeded the standard recommended by the International Commission on Radiological Protection (0.5mR/hour.) The proportion fell to 14 per cent in 1967, 8 per cent in 1968, and 4 per cent in 1969. This improvement is believed to result from action taken by manufacturers following recognition of the basic problem in 1967.

In the survey, radiation emission was observed only at the point of closest approach to the electron tubes—at the side, back and bottom of the set—not in the

Electronic exchange

The Post Office has accepted a tender of approximately \$3 million from Standard Telephones and Cables Pty. Ltd., for the supply and commissioning of Australia's first electronic trunk exchange. It will be installed in a new exchange building being erected in Pitt Street, Sydney. The exchange will carry a much greater trunk load than any presently existing exchange in Australia and will be operated under the control of a computer. The cost per unit of traffic is expected to be lower than with presently used types of exchange. The equipment was developed in Belgium, but it is hoped that, as the use of similar equipment increases in Australia, it will eventually be manufactured in this country.

Computerised train control



An experimental display console in operation in a train driver's cabin. It provides a continuous flow of useful information.

A train control system, being developed at the British Rail research laboratories in Derby, England, uses a display console in the train driver's cabin. Information displayed includes permissible and actual speeds, target distances and gradients. The information, picked up by sensing coils from a pair of insulated conductors laid

along the track, is processed by a small computer carried on the train. The computer stores the train characteristics (length, braking characteristics, and speed restrictions on rolling stock) on a punched card and will apply the emergency brake if the safety speed is exceeded. (See also "Electronics Australia," June, 1969.)

Goodmans audio suite

Comprising Maxamp 30 Amplifier, two Maxim Loudspeakers and Record Player, complete system \$557.00



Goodmans Maxamp 30, fully transistorised stereophonic high fidelity amplifier 15+15 watts, solid state.



Goodmans Maxim loudspeakers, amazingly compact, complete full range hi-fi reproduction.



The new Garrard Synchrolab SL95 complete in Teak case with tinted flexiglass lid.

URD

UNITED RADIO DISTRIBUTORS PTY. LTD.

Shop 32, Ash Street

Angel Arcade, Sydney

Telephones: 28.3718, 28.3926

OPEN SATURDAY MORNINGS

Sydney's leading High-Fidelity Specialists

Background to Capacitor Discharge

Here is a summary of capacitor discharge ignition systems; how they work, what is claimed for them, and what is currently available on the Australian market. It should answer most of the questions our readers are currently asking about this technique.

In our September, 1969, issue, in the "Reader Built It" section, we published details of a capacitor discharge ignition system which one of our readers had constructed. This article created a good deal of interest and has prompted us to follow it with a more detailed discussion of the subject.

The interest this article created was at two levels. A number of readers have asked, in effect, "what is capacitor discharge ignition?" while a number of organisations have approached us with the information that they are marketing, or preparing to market, units of this kind.

Prompted by this reaction we decided to prepare an article which would put the reader in the picture in regard to both the theoretical operation of these units, and as to what was currently available on the Australian market—at least to the extent that we have been advised so far.

Before discussing the theoretical operation of this system, it may help if we take a quick look at the conventional automotive ignition system; the one often referred to as the "Kettering system," after Charles Kettering who developed it.

In the system devised by Kettering a set of distributor points are alternately opened and closed by a cam, geared to the motor crankshaft. When the points are closed, a current flows through the primary of the coil, producing a magnetic field in and around the iron core.

The magnetic flux in the core can be considered as a form of stored energy, which is defined largely by the number of turns on the primary winding and the limit to which the current through it can rise with the points closed.

When the distributor points are subsequently opened, the current is interrupted, the magnetic field collapses and a sharp spike of voltage is induced across the primary winding. The magnitude of this voltage spike depends on the inductance, and therefore the number of turns on the primary winding, and on the rate of collapse of the magnetic field.

As the points open, the large induced primary voltage, caused by the collapsing field tends to produce an arc across the breaker point gap. Any such arc tends to sustain the current through the primary winding and, in so doing, slows the collapse of the field and diminishes the peak amplitude of the voltage spike.

In addition, it causes severe burning of the breaker points, with a conse-

quent limitation on their service life.

This dual problem is minimised, in practice, by connecting a suitably chosen capacitor across the breaker points. When the points are closed, the capacitor is shorted and is therefore completely discharged.

At the instant when the points open, the capacitor appears as a short circuit, because there is no voltage across it; what is more, voltage can only appear across it at the rate at which the capacitor can be charged. Naturally, the initial lack of voltage across the opening breaker points inhibits the formation of an arc.

The value of this capacitor is quite critical and its choice is part of the overall design of the ignition system. If the capacitor is too small, it charges too rapidly and the voltage across the still opening points rises fast enough to produce a residual arc.

If the capacitor is too large, its own charging cycle is so extended that it prolongs current activity through the ignition coil primary. In addition to retarding the collapse of the field, this may modify the timing and nature of the spark and create a second arc when the contact points close on a, perhaps, still significant induced primary voltage.

When the magnetic field is collapsing, the magnitude of induced primary voltage is approximately 200.

The ratio of primary to secondary turns in an average coil is about 1:100 and, since the collapsing magnetic field induces a voltage in both windings simultaneously, it would seem that the voltage in the secondary should be approximately 100 times that of the primary. This is in fact so and the average ignition coil would have a secondary voltage of about 20,000.

In modern cars, where designers have increased compression ratios and widened plug gaps to increase engine performance while cutting fuel consumption, this 20,000 odd volts would be sufficient to sustain good performance — if it could be maintained throughout the speed range of the engine. Unfortunately, there are inherent limitations in the standard ignition system which cause the available voltage to decrease as engine rpm climbs.

We mentioned, earlier, that a magnetic flux was created in the core of an ignition coil when the points were closed. An important factor to be considered in this regard is time — the time, in fact, that it takes for the magnetic field to assume its maximum value.

The time needed for a typical ignition coil to reach maximum magnetic flux density is about 15 milliseconds (mS) at which time the coil current reaches about 3A. This figure of 15mS may appear to be quite fast—until we start to calculate the number of sparks we have to deliver to a typical multi-cylinder engine at high speed. For example, a V8 motor running at 3,000 rpm would be required to produce 200 sparks per second. The time between each spark would be 5mS. The time for which the points would be closed between sparks would be approximately 40pc of the total, or approximately 2mS.

Which brings us to one of the basic limitations of the conventional ignition system; its inability to deliver the same spark energy at high speed as it does at low speed. In turn, this limitation points up others. Immediately we try to design a system in which the energy delivered at high speed, although still reduced, will be more nearly adequate, we find ourselves up against such practical limitations as the amount of current which can be handled by readily available breaker points, without unduly rapid deterioration.

Other considerations involve the rapidity with which the voltage builds up across the spark plug gap until it ultimately ionises the gas between the electrodes, produces a spark, and fires the mixture. It is generally considered that the shorter this time, known technically as the "rise time," the better the engine performance, although the reason, or reasons, for this have not always been adequately explained.

One line of reasoning emphasises the superiority of a fast rise time in those circumstances where one or more plugs are fouled by carbon or lead deposits, possibly to the point where they tend to misfire. In such a situation the fouling may be regarded as a resistor connected in parallel with the spark gap; a resistor which commences to dissipate the energy generated in the coil secondary from the moment the voltage commences to build up until it reaches a high enough value to jump the gap. This period is typically 100 microseconds (uS) in a conventional system.

If the fouling is bad enough, i.e. the shunt resistance low enough, it may well be that so much energy is dissipated in the 100uS period that the voltage never rises high enough to jump the gap—and the cylinder misfires. Even if the condition is not this extreme it could still mean that there

Ignition

by Philip Watson

was less energy available when the gap was breached, leading to less efficient combustion in that particular cylinder with all that this implies in terms of engine performance.

On the other hand (it is argued) a fast rise time, say 2mS, leaves only this period of time during which the energy in the secondary coil can be wasted by the shunt resistance. Thus, when the spark gap breaks down, there will be significantly more energy available than in the case of the longer rise time.

This reasoning would appear to be valid only if we pre-suppose two things: (1) That we can provide a system which will retain a rapid rise time when working into the load imposed by a fouled plug and (2) that plugs fouled to this extent are sufficiently typical as to justify the use of a complex ignition system to overcome the problem.

A more important justification for rapid rise time is based on the idea that voltage alone does not determine the breakdown distance across a spark gap but that, all else being equal, a pulse with a fast rise time will jump a larger gap than one with a slow rise time.

Experimental evidence of this was observed during the developmental work on the transistor ignition system described in "Electronics Australia" in 1964. We quote the explanation given in the April issue of that series.

Discussing the apparently anomaly whereby one transformer was able to produce a much longer spark than another having the same nominal secondary voltage, it goes on:

"This may seem a little puzzling if one assumes that voltage is the only factor determining the gap space which can be jumped. In fact, however, this is not so. Ionisation of a gap of a fixed length is not merely a matter of the voltage applied across the gap but, as well, is a function of how fast the voltage is caused to develop across the gap. In other words—it is sensitive to the 'rise time' of the voltage.

"Without going too deeply into the matter, it would appear that, the faster the full voltage is built up across the gap, the greater will be the acceleration imparted to the electrons within the gap; the greater this acceleration, the more readily will electrons break loose from their parent nuclei and begin an electron movement which will cause ionisation or 'electrical breakdown' of the gap.



The "Centi-Spark" capacitor discharge ignition system is an Australian made unit based on a Canadian design. It features particularly rugged construction internally, having been made to meet military specifications of the components in a suitable filler. Units will be available for 12V positive or negative chassis systems. It is to be fitted with a changeover switch to restore normal ignition in the event of unit failure. The makers claim it will give 100,000 miles points life and 50,000 miles plug life. Further details from Group Electronics Pty. Ltd., 47 Southern Road, Mentone, Victoria 3194. (See advertisement, page 185, September "Electronics Australia.")



Another Australian unit, this one made by Electronics Discharge Ignition Systems of Australia. It uses printed board construction supported in a block of foam rubber, a method which provides good protection against vibration while retaining ready access for service. Prototype units have been rigorously tested on racing cars—possibly one of the most demanding environments that could be chosen. Future units are to be fitted with a changeover switch to restore normal ignition, or a changeover relay for racing models. Further details from the makers, 348 Bay Road, Cheltenham, Victoria, 3192.

IGNITION BREAKTHROUGH AT LAST

Capacitor Discharge System



\$49.95

MAIL ORDER SERVICE

(Postage included)

TOP TUNE ALL THE TIME

- Easy Starting
- Improved M.P.G.
- Plug life to & past 50,000 miles
- Point life to & past 100,000 miles
- All silicon devices
- Faster acceleration
- Easy Fitting (Full Kit)
- Even Fires Fouled plugs
- Pos & Neg earth 12 volt
- Manufactured in Australia

SEND TODAY

Enclose self addressed envelope for pamphlet to:

ELECTRONIC DISCHARGE IGNITION SYSTEMS of AUSTRALIA.
348 BAY ROAD, CHELTENHAM VIC. 3192 PHONE 93-1201

"Generally speaking, it can be stated that, for a given size of gap, decreasing the pulse rise time will result in the gap being 'bridged' at a lower voltage."

Another limitation of the Kettering system concerns the wear on the distributor points. In an effort to produce as much spark energy as possible it has been necessary to strike a compromise between engine performance and points life. The compromise is a reasonable one in the circumstances, but neither requirement is fully satisfied. Engine efficiency falls off at high speed and the life of the points is limited to about 10,000 miles. While the cost of new points is negligible, the cost and inconvenience of re-timing the engine every time they are replaced is a serious objection.

One approach to overcoming these limitations is by what is now commonly called "transistor ignition." In broad terms this method retains the basic principles of the Kettering system, in that energy is stored in the magnetic field around the coil primary during the points closure period, and released when the points are opened. The difference is that, by using transistors to perform the switching function in place of the points—which now simply control the transistors—the coil designer is given a free hand to design his coil for adequate performance without being restricted to the current which the points can safely carry.

Thus the exercise becomes basically one of designing a coil which will deliver adequate spark energy at the highest likely speed, as well as having the best possible rise time. This is quite feasible, although the effort involved in the design may be considerable. For this reason, a coil which exploits the possibilities of the system to its limit can be quite expensive. Since the coil achieves its higher performance by increasing the primary current, the ignition system as a whole draws considerably more current from the car's electrical system; from seven to 10 amps, compared with about 2 amps for a normal system.

The claims made for these systems include better engine performance, particularly at high speed, lower petrol consumption, easier starting, longer plug life, and longer points life. This latter feature is considered by many to be of major importance. On the basis that the life of the points will be limited almost entirely by mechanical wear, mainly on the rubbing block, then a life of around 50,000 miles would be considered typical. This being so, it becomes worthwhile to spend time and/or money to optimise the timing of the electrical system, encouraged by the knowledge that it will remain this way for a worthwhile period.

Most of the other claims would appear to be legitimate, the only point open to debate being the degree of improvement in any one case. The most realistic approach seems to be that they will be noticeable rather than staggering. In the case of fuel consumption, for example, this may range from one to three more miles per gallon, depending on a number of factors, such as the car, the driver, the kind of driving, and so on.

More recently, a new approach to improving the Kettering system has



The "Mark Ten" capacitor discharge ignition system is manufactured in U.S.A. and marketed in Australia by TasTrade Supplies. The distributors emphasise the reliability of the instrument, pointing out that there has not been a single failure in any of the many units already sold in Australia. Among the many advantages claimed for the system is its ability to overcome points bounce in high speed multi-cylinder engines. It should also be pointed out that the unit is designed for use with tachometers and that full instructions are included to ensure correct tachometer connections. Further details from TasTrade Supplies., P.O. Box 78, Campsie, N.S.W. 2194.

been receiving a lot of publicity. This is the capacitor discharge system. This system differs in one major respect from either the Kettering or older transistor systems. Whereas both these systems store energy in the form of a magnetic field generated around the primary winding of the coil, the capacitor discharge system does not. It stores energy in a capacitor which, at the appropriate moment, is discharged into the primary winding of the coil, producing a spark in the secondary.

One of the advantages of this system is that it does not require a new ignition coil. The original coil is retained and simply made to work at a

higher input and output voltage. As explained earlier, a typical Kettering system will develop about 200V across the primary coil as the field collapses and, on the basis of a 100 to 1 turns ratio, generate about 20,000V in the secondary. By comparison, the capacitor in the capacitor discharge system is charged to between 350 and 400V which, when discharged into the same coil will produce something between 35,000 and 40,000V.

A better understanding of the broad principles can be gained by reference to the simplified block diagram. The first unit in the system is a DC to DC converter, using a pair of switching transistors, a step-up transformer, and bridge rectifier. This converts the 12V DC from the car's electrical system to between 350 and 400V DC.

Assume for the moment that the thyristor, connected between the positive and negative terminals of the inverter, is an open circuit. This means that the positive terminal of the inverter is connected directly to one side of the capacitor and the negative terminal to the other side via the primary of the ignition coil. As a result, the capacitor is charged to the same voltage as the output of the inverter. The size of the capacitor ranges from 1uF to 1.5uF.

Now let us assume that one of the pistons is moving up on the firing stroke and, as it approaches top dead

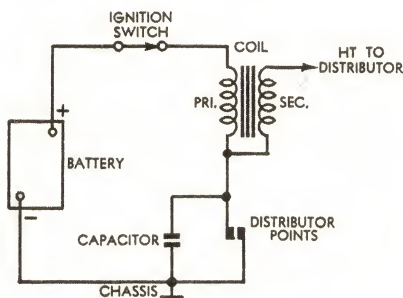

The basic principles of the Kettering system are illustrated in this drawing. Compare it with that on the next page.

New Rola C8MX deluxe brings you right down to 30Hz...



for great sound and great value!

What a choice—more bass, more top, more value. C8MX deluxe gives you the widest-range speaker at the lowest cost. Only 8" in diameter, yet with a frequency response of 30Hz-16,000Hz, C8MX deluxe gives an outstanding performance within compact enclosure dimensions. Highly efficient C8MX deluxe is the answer for budget conscious hi-fi enthusiasts. Look for it in the attractive new Blue and Gold carton.

Build your own enclosure from plans specially prepared by Rola. Ask for technical publication 54.

PLESSEY
Rola



For additional information please contact
Plessey Rola Pty. Limited
The Boulevard Richmond Victoria 3121
Telephone 42 3921 Telex 30383
NSW Plessey Rola Pty. Limited
PO Box 2 Villawood 2163 Telephone 72 0133

AR23

centre, the distributor points open at the moment a spark is required. When this happens, the trigger circuit delivers a suitable firing pulse to the gate (G) of the thyristor, changing its state from virtual open circuit to virtual short circuit.

This action does two things: First, it connects the capacitor "C" directly across the primary winding of the coil, so that the energy stored in the capacitor is transferred to the primary winding. The result is a high voltage pulse from the secondary which fires the spark plug. Secondly, the thyristor puts a dead short across the output of the inverter. This is deliberate, and is intended to so load the inverter that the primary circuit stops oscillating and secondary output drops to zero.

This is essential to allow the thyristor to "turn off," i.e., change back from the virtual short circuit to the previous open circuit condition. This can only be achieved by reducing the anode to cathode voltage to a very low value. It cannot be achieved by any manipulation of the gate voltage.

Once the thyristor turns off, the load is removed from the inverter which then recommences oscillating. Voltage is developed across the secondary and the capacitor begins to charge in anticipation of the next firing stroke. Note particularly that the capacitor commences to charge almost immediately the spark has been generated. The charging cycle does not have to wait until the distributor points close again, as in previous systems. This feature is particularly important at high speeds.

The above is necessarily a simplified description of what happens, and a number of details need to be filled in. One concerns the trigger circuit. As well as producing a pulse to trigger the thyristor, it has a number of other functions to perform. One concerns the faster rise time of the pulse. The rise time for a conventional ignition system is quoted as, typically, 100 microseconds (uS), while that for the capacitor discharge system may be as low as 2uS.

While this is an advantage for reasons already explained, it could cause the timing to be advanced by something in excess of 90uS, perhaps necessitating retiming of the engine. To avoid this, the trigger circuit incorporates a network which delays the firing of the thyristor for approximately this period. Thus the system retains both the rapid rise time and the original engine timing.

Another problem which the trigger circuit is designed to overcome is points bounce. This occurs at high engine speeds at the moment the points attempt to close. Because of the speed at which they are required to move, they may not close cleanly but open again momentarily. This could cause a triggering pulse to be passed to the thyristor gate, triggering the thyristor and creating a false spark. Quite apart from any adverse effect such a spark may have on the running of the engine, it constitutes a waste as far as that charging cycle is concerned. The capacitor will be discharged and will have to commence charging all over again.

A similar problem can be caused by the points simply rubbing together — as might be caused by any small

play in the bearings on which they move or eccentricity of the operating cam — particularly if they are not perfectly bright and clean. Any change of resistance caused in this way could cause false firing of the plug, possibly at a time just in advance of the true firing point, and which would be most undesirable.

There are a number of ways in which these problems can be tackled, and each manufacturer seems to have his own ideas on the subject. In broad terms however, most circuits

sensitive to load that it will not stop operating when the thyristor fires, otherwise the thyristor may not "turn off." Finally, it must start again reliably and rapidly once the thyristor turns off, remembering that it may have only a few milliseconds to come back into operation and fully charge the capacitor. Designing a transformer to meet all these requirements, particularly the last one, is not a simple task.

One of the practical advantages claimed for capacitor discharge ignition systems is that it involves a

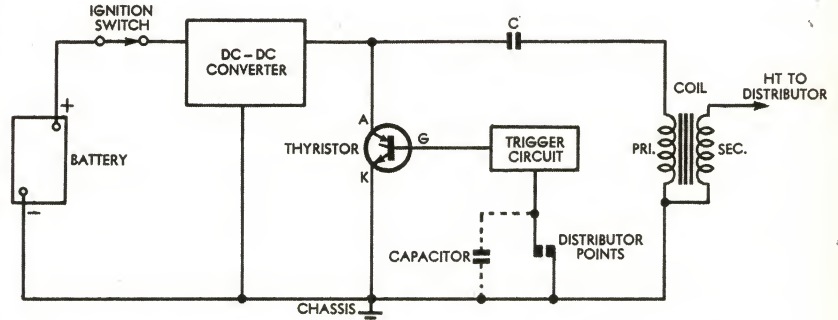

The basic principles of the capacitor discharge system. Energy from the converter is stored in "C" until the points open, then discharges into the coil primary. The capacitor across the points is optional.

appear to consist of time-constant networks which, in the process of delaying the firing of the spark, also render the system less sensitive to momentary opening of the points or variations in resistance between them.

Another important requirement concerns the inverter. This must satisfy three broad requirements. It must have a low enough internal impedance to allow it to fully charge the capacitor in the shortest time, between firing strokes, likely to be encountered in multi-cylinder high-speed engines. At the same time, it must not be so in-

minimum of changes to the existing ignition system. There is no need to provide a new ignition coil or to even remove the capacitor from across the ignition points—two essential requirements for transistor ignition. There is also a minimum change to the car's electrical wiring, making it a relatively simple matter to restore the normal ignition system in the unlikely event of a failure in the capacitor discharge system. In fact, some manufacturers are planning to equip their units with a simple changeover switch which will accomplish this with the turn of a knob.

CAPACITIVE DISCHARGE

IGNITION SYSTEM

the MARK TEN a U.S.A. topseller. In kitset form, only \$53.00.

Ideal for ALL gasoline engines on CARS, TRUCKS and BOATS.

A MUST for Every Sports or Modified Engine
SOME OF THE BENEFITS YOU CAN EXPECT . . .

- Dramatic increase in Acceleration & General Performance.
- Improved Gasoline Mileage.
- Instant Start in All Weather.
- Longer Plugs & Points Life.
- Virtually eliminates Ignition Tuneups

For further details write to:- **TASTRADE SUPPLIES**

P.O. BOX 78, CAMPSIE 2194

When ordering state 6/12 volt +ve or -ve earth system

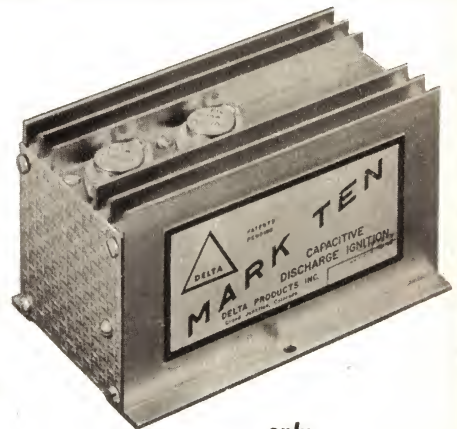

only
\$68.45 p. paid

Compact, rugged
easy-to-read

JAYEM

MULTIMETERS



Model MT220

This volt/ohmmeter is diode-protected against accidental misuse. Sensitivity is 20,000 o.p.v. on DC and 10,000 o.p.v. on AC. Measures DC voltages 0-5000V (6 ranges) and DC current 0-50mA (4 ranges); AC volts 0-1000V (5 ranges); Resistance 0-12 megohms (4 ranges); Level -20db to +62db.

\$13.50 plus Sales Tax



Model HB-100

This rugged pocket size unit has mirror-scale and high sensitivity -100,000 o.p.v. DC and 10,000 o.p.v. AC. Particularly useful for semiconductor measurements. Measures DC voltages 0-3000V (7 ranges) and DC current 0-300mA (4 ranges); AC volts 0-600V (5 ranges); Resistance 0-200 megohms (4 ranges).

\$30 plus Sales Tax

For further information contact:

jacoby, mitchell
& co. pty. ltd. **26-2651**
469-475 kent street, sydney

MELBOURNE 30-2491
ADELAIDE 53-6117
BRISBANE 2-4467
PERTH 28-1102
LAUNCESTON 2-5322



JM/30-69

Some of these points are worth considering in greater detail. It is true that the original ignition coil can be retained, but it must be realised that, by nearly doubling the secondary voltage, we are stressing the insulation of the coil to a degree that the manufacturer never envisaged. The same applies to other parts of the HT system, such as the wiring, distributor moulding, and so on. For this reason the user must be prepared to accept at least a vague risk of damage to these components in the event that their insulation qualities are only just adequate for the normal job they were expected to do.

The greatest risk in this regard will occur in those circumstances where, for one reason or another, the secondary circuit is unable to produce a spark. In the simplest case this could be due to a plug lead becoming detached from the plug. In fairness, however, it would appear that this risk is a minor one in practice and there appear to be few reported cases of such failures. On the other hand, the combination of so-called "sports coils" and capacitor discharge systems can apparently produce voltages which will very easily overtax the wiring and distributor.

Another possible change to the electrical systems involves the spark plugs, and whether their gaps should be widened or not. Authorities on transistor ignition systems have always advocated widening the gap in order to present a longer flame front and thus achieve more complete combustion. Makers of capacitor discharge ignition systems seem to vary in their opinions on this matter, some advocating widening the gap, others claiming it is unnecessary.

However, it would appear to be reasonable to widen the gap if the maximum benefit of the higher energy spark is to be achieved. On the other hand, many of the advantages of the system will still be obtained using standard gaps. It must also be remembered that, if the gaps are widened, the engine probably will not run if it is found necessary to revert to the standard ignition system at any time. The gaps will first have to be normalised.

Another point in favour of the capacitor discharge system is that, unlike the transistor system, it does not involve any increase in current consumption. Whereas transistor systems may draw up to 10A, the capacitor system uses no more, and in some cases less, than the conventional system.

In terms of actual engine performance, the claims made for capacitor discharge systems are much the same as those for transistor systems. They include better acceleration, better high speed behaviour, lower petrol consumption, easier starting, longer plug life, and longer points life. As with transistor systems, the question is not so much whether they achieve these improvements but rather to what degree.

In fact, it appears that there has been very little quantitative analysis carried out on these devices, either in Australia or overseas. There are plenty of claims based on subjective reactions and involving such things as acceleration, hill climbing ability and so on, but few based on

precise measurements under controlled conditions. Claims regarding petrol consumption also have to be treated with reserve; while figures representing "before" and "after" conditions are not hard to obtain, their value is limited unless the "before" and "after" conditions are identical in every respect, other than the ignition system. In practice, this is a difficult requirement to satisfy.

One firm which is able to quote some useful figures is Electronic Discharge Ignition Systems, of Cheltenham, Victoria. They arranged for one of their units to be fitted to a racing car and for the horsepower of the engine to be measured on a dynamometer, using both standard and capacitor discharge ignition systems. The car is owned by Mr Terry Allen, well known in Victorian motor racing circles, and the tests were conducted by his chief mechanic, Mr Claude Morton. The car is a Chevrolet Camaro. The report is as follows:

"We removed the engine for dynamometer testing, and recorded the following tests. At 6000rpm the developed brake horsepower, using standard ignition, was 505. We then connected your capacitor discharge ignition and measured 521 horsepower. We found this difficult to believe, so we made a total of three test runs, recording the same figures each time. Each horsepower we chase over 500 normally costs hundreds of dollars, so an extra 16 BHP for the price of your ignition system is really amazing."

Another test which this firm carried out is also worth reporting, although

we don't particularly recommend it for the do-it-yourself mechanic. For reasons already stated, there is a risk of damaging the ignition coil.

The test was to take a set of discarded spark plugs, aged at least 50,000 miles, and grind off the earth contact. These were then fitted to a number of cars and, somewhat to the amazement of experienced mechanics, the cars ran, and ran well. The report of one such experiment is as follows:

"Tests have been conducted on a 105E Anglia, using spark plugs with earth lugs completely removed. With the engine cold and using standard ignition it was impossible to get even a slight kick out of the engine. With capacitor discharge ignition fitted it fired first go, idled immediately, and was able to be driven away with the choke pushed in. Under normal conditions, good plugs, and standard ignition, the choke has to be used for a quarter to half a mile."

If nothing else, this proves the ability of this particular system to keep an engine running under the most adverse condition; far more adverse than would be encountered in practice. However, it would also be reasonable to expect that an ignition system which would perform in these circumstances must produce some improvement in performance when used in more realistic conditions.

Another quantitative test has been conducted by a second Australian firm, Trastrade Supplies, of Belfield, N.S.W. This concerns the problem of points bounce and the report is as follows:

"Higher engine speed is immediately

realised, especially with eight-cylinder engines, where points bounce is a problem. An example is a super-charged Simca Vedette, which suffered points bounce at 6000rpm. After fitting the Mark Ten (capacitor discharge system) the points were closed to .002in and the engine run to 8000rpm."

At the time of writing we have been advised that there are three capacitor discharge systems on the Australian market. One is the "Centi-Spark," made by Group Electronics Pty. Ltd., Mentone, Victoria; the second is the "Mark Ten" made by Delta Products Inc., Colorado, U.S.A., and distributed in Australia by TasTrade Supplies, Belfield, N.S.W.; and the third is made by Electronic Discharge Ignition Systems of Australia, Cheltenham, Victoria. Photographs and brief details of these units are shown in the accompanying panels.

Samples of all three units have been submitted to us and have been fitted to cars belonging to various members of our staff. For reasons already explained it is difficult to do any more than make subjective judgments in regard to improved engine performance. Furthermore, it has not been possible to make the same tests on all three units or fit them to identical cars.

For these reasons we have decided, in fairness to all concerned, not to comment on each unit individually but simply to sum up the joint reactions of our staff members in an effort to present an overall impression of capacitor discharge ignition.

(Continued on Page 54)

Homecrafts FOR RADIO PARTS

289 Elizabeth St. Melbourne. Phone 60 1442

PIEZO PICK-UP AND CARTRIDGES

PU-86 Pickup LP/78 T/O Crystal cartridge. Length 240mm Ea. \$2.95
 Y700 Ceramic Cartridge. Mon. LP/78 . . . \$3.00
 PU-86 Pick-up Ster-LP/78. T/O Cartridge. Length 204mm Ea. \$4.00
 Y200 Ceramic Cartridge. ST LP/78 . . \$4.00
 Y400 Crystal Cartridge. LP/45 . . . \$2.90
 Y130 Crystal Cartridge. T/O Type Ster/LP Ea. \$2.70
 Sapphire Replacement Styl. Each Ster/LP \$6.00
 Plus postage 15c.

PIEZO MICROPHONE INSERTS

MC-3 Crystal, 50-7K, 35 x 25 x 8mm. -57 DB \$1.00 ea.
 MC-7 Crystal, 100-7K. 39mm Round x 11mm. -56 DB \$1.00 ea.
 MC-8 Crystal, 50-8K. 48mm Round x 17mm. -50 DB \$1.20 ea.
 MC-9 Crystal, 50-8K. 25mm Round x 9mm. -68 DB \$1.80 ea.
 MC-33 Crystal, 50-10K, 33mm Round x 9mm. -60 DB \$1.60 ea.
 MD-5 Dynamic, 100-15K. 33mm Round x 14mm. -55 DB \$2.00 ea.
 Plus postage 20c.

TRANSISTOR SET ACCESSORIES

Magnetic Earpiece with 3.5mm Plug . . 75c
 Crystal Earpiece with 2.5mm Plug . . . 75c
 Crystal Earpiece with 3.5mm Plug . . . 75c

LAPEL TYPE CRYSTAL MICROPHONE

With 3.5mm Plug 75c ea.
 Plus postage 15c.
 Fuses for Japanese equipment 1A, 3A, 5A 5c pkt of 5 Plus postage 10c.

Michigan/Collard—Twin Heads	Track	Rec/Play	\$8.50
Michigan/Collard—Twin Heads	Track	Erase	\$3.00
Michigan/Collard—Four Heads	Track	Erase	\$8.50

12-Pin Wafer Sockets. 20c ea.
 12-Pin Plugs . 25 ea. Plus postage 10c.

OCTAL PLUG AND CORD

Ext. Socket.
 45c pr. Plus postage 10c.

ALL TYPES AMPHENOL PLUGS AND SOCKETS
 Carried in stock.
 Plugs 27c ea. Sockets 30c ea. Meall Covers for same 27c ea.
 Plus postage 10c.

HALF-INCH MINIATURE PLUGS AND SOCKETS

2, 3, 4 and 5-Pin Plugs 10c ea.
 Sockets 10c ea. Plus postage 10c.

ELECTROLYTIC CAPACITORS IN METAL CANS

16 + 16 450 VW 95c ea.
 32 + 32 450 VW \$1.30 ea.
 50 + 50 450 VW \$1.85 ea.
 50 + 50 + 50 350 VW \$1.90 ea.
 100 MFD P.V.C. Cover \$1.15 ea.
 Jacks, 2.5 and 3.5mm \$1.00 ea.
 3.5mm Plug and Cord Ext. Jack Pair . . 50c
 Metal Co-axial Plugs and Line Sockets Pr. 65c
 "Din" and "Hirschmann," 2, 3, 4 and 5-pin Plugs, Chassis and Line Sockets, carried ex stock.

P.M.G. type Plugs from 50c
 P.M.G. type Jacks from 35c
 P.M.G. Line Jacks from 55c
 Plus postage 15c.

5 CORE CABLE
 7/0076. P.V.C. insulated, P.V.C. covered.
 25c yd.

6 CORE CABLE
 same spec. as above
 30c yd.

Capacitor Substitution Box, 1,000 VW . . \$5.00
 Resistor Substitution Box, 1 Watt. Plus Post. 20c. \$4.50

TRANSISTOR AERIALS

5in extends to 39in \$1.40
 6in extends to 46in \$1.70
 6in extends to 32in \$1.00
 6in extends to 28in \$1.00
 7in extends to 39in \$1.20
 5in extends to 39in 95c
 6in extends to 4ft 6in \$1.80
 7in extends to 5ft 8in \$3.00
 Plus Post 15c.

CRYSTAL SET BUILDERS

Coils 80c Tuning Conds. . \$2.00
 Diodes 35c Terms . . Ea. 12c
 Headphones . . \$2.50 Plus Postage.

TAPE RECORDER ACCESSORIES

2 1/2in Spools 30c	3in x 600ft \$2.35
3in Spools 20c	Tape 60c
5in Spools 40c	5 1/2in x 1,200ft \$3.10
5 1/2in Spools 70c	Tape 60c
7in Spools 50c	7in x 1,800ft \$5.10
2 1/2in x 100ft 60c	Tape 60c
2 1/2in x 300ft \$1.40	5in Plastic Tape boxes 90c
Tape \$1.40	7in Plastic Tape boxes 90c

Plus postage 20c.
 See us for Tape Recorder Patch Cords, Adaptors, etc.

STEREO PLUGS AND JACKS

Metal Plugs 95c	Bakelite ext. sockets 70c
Bakelite 70c	Chassis Jacks 65c

Plus postage 10c.

MAIL ORDER SPECIALISTS

We are trying not to be smug

but it is difficult . . .



When you get reviews like this

EXTRACTS FROM
TAPE RECORDING MAGAZINE
AUGUST, 1969

"The subject of our investigation this month is a machine that will be of the greatest interest to all readers—one of the new Ferrograph Series Seven."

"The whole represents a really exciting development by this essentially traditional firm."

"From 250 to 18,000 Hz. the line is within half a dB of flat".

"These results are so good they are difficult to believe. Not so long ago they would have been quite impossible—at any price level. Overall response at $3\frac{3}{4}$ ips was again duplicated."

Ferrograph Series 7 Recorder

"Again we find a table of figures so flat that they are truly incredible. Performance is still up to this very high standard at the slowest speed of $1\frac{1}{4}$ ips."

"To check the replay amplifier we reproduced a calibration tape to show once again the best set of figures ever published by us."

"One could be forgiven for exclaiming: 'There ain't no such animal!'. Technicians are hard, unromantic people, and we would certainly have thought that a test chart like this could be no more than a flight of the fancy. But it is not. These are the figures produced by the Series Seven under conditions identical to those under which all our review machines are investigated. Congratulations Ferrograph. It is no exaggeration to say that so far as frequency response goes the new model just could not be better."

"This gives us signal-to-noise of —57 dB and distortion of 1.8 per cent. Both these figures are exemplary. That signal-to-noise reading, by the way, is unweighted and was not taken on special low-noise tape—we used the ordinary Scotch 150. Had we referred the signal to 2 per cent distortion as quoted in the specification an even better reading would have been obtained. With such a performance we were hardly surprised to find that wow and flutter was well under 0.1 per cent at $7\frac{1}{2}$ ips (the actual measurement was 0.7 per cent RMS) and only 0.12 per cent RMS at $3\frac{3}{4}$ ips. Crosstalk between tracks: 56 dB."

"The new generation Ferrographs are built to last."

"In every case the results were outstanding, as might be expected from the technical findings."

"One of the very best tape recorders we have had the pleasure of handling—a British machine that far outstrips its specification in every respect and which both user and manufacturer can be proud of."

Please send for complete review.

SOLE AUSTRALIAN DISTRIBUTORS

Leroya Industries PTY. LTD.

266 Hay Street, SUBIACO, W. AUST. 6008

We really are trying not to be smug

but it is very difficult . . .



Ferrograph Stereo Amplifier Model F307

When you get reviews like this

EXTRACTS FROM HI-FI SOUND REVIEW, AUGUST, 1969

Very neat and tidy appearance. The internal assembly is quite rugged, typically Ferrograph and very much British made.

"Profusely illustrated and very comprehensive amplifier instruction manual."

"Complete absence of crossover distortion and low harmonic distortion are probably due to advanced design of driver and output stages. Everything about this amplifier is substantial. It is ruggedly assembled, has large heatsinks for the output transistors, strong thick printed circuit boards, an all steel sub-chassis and hum screens and a large, healthy-looking mains transformer. In fact it is all very much 'Ferrograph': as with good motor cars, it's what's under the bonnet that counts. Reviewers like myself can usually find some small thing to criticise in even the best and most expensive audio equipment but here is an amplifier that seems to defy any criticism regarding facilities, performance or appearance."

"Its performance was well within the limits set by the makers' specification and I would say it has been rated very conservatively."

"The frequency response was checked at 10 watts rms and was 15 to 30,000 Hz \pm 1 dB. Only very slight distortion was apparent at between 15 and 30 Hz for the full rated power output of 20 watts per channel."

"All the tests applied to the F307 disclosed nothing but a performance well within the specified limits—and this applies to both channels. The hum and noise and crosstalk performance of the amplifier were exceptionally good."

"Although this is the first hi-fi amplifier that Ferrograph have produced for the domestic market they can of course boast considerable experience in the field of audio and particularly in tape recorders. They have done well in producing, as always, a top quality product at a reasonable price—in the best Ferrograph tradition."

Please send for complete review.

SOLE AUSTRALIAN DISTRIBUTORS

Leroya Industries PTY. LTD.

266 Hay Street, SUBIACO, W. AUST. 6008

WE HAVE DONE IT AGAIN!

Remember our "Criterion Module" system at \$300.00? It was (and still is) a great success. Now **Arrow** have launched a new system.

THE APOLLO MODULE

An "out of this world" compact stereo high fidelity system at a down to earth price. Check these features:

- ★ **NEW** DUAL 1210 Deluxe auto record player.
- ★ Shure Magnetic Cartridge.
- ★ Lafayette LA224T 30W solid state Amplifier.
- ★ **NEW** soundwood "Apollo" 2 way Speaker Systems.
- ★ Attractive teak cabinets with smoked perspex player cover.

Just **\$275** for this value-packed system puts you in the upper strata of prestige sound system owners.

SAVE \$\$\$

BUILD IT YOURSELF

For years Arrow Electronics have had hard to get manufacturers drawings and construction sheets for loudspeaker enclosures available to you, the handyman. Enclosures for Wharfedale, Goodmans, Tannoy Magnavox etc.

We have grille cloth by SABLON and COLAN also B.A.F. wadding (INNERBOND)

BOOKSHELF SPEAKER SYSTEM KITS BY WHARFEDALE \$36.00

(Also cabinet kit for above \$18.50)

Besides the fabulous **UNIT 3** kit from Wharfedale, Arrow have details of small systems by Magnavox.

PRE-CHRISTMAS SPECIAL OFFER

We have a turntable fitted with a magnetic cartridge designed for the music lover with a limited budget.

C.E.C. S.T.P. 93 TURNTABLE

Exceptional Value \$75.

12" platter, balanced arm, 3 speed.

AE **ARROW ELECTRONICS** **342 Kent St.**
SYDNEY
NOW AT 29-6731

Opposite 2UW between KING & MARKET Sts.

The first point for discussion was the time needed to fit the units. All manufacturers claim minimum fitting time as a feature of these units and one goes so far as to claim that the job can be done in 8½ minutes. It was generally agreed that this may be true—the second or third time one tackles the job. The first time there are such factors as deciding where to mount the unit, deciding what tools are needed—and finding them—which all add up to substantially more than 8½ minutes. Two members finished the job in an hour. The third surveyed the job in detail and made most of the major decisions before picking up any tools. After that he took about 15 minutes. All units worked immediately they were switched on.

Coming to performance, all members were in unanimous agreement that the units made for better starting and less use of the choke. Even when cold, engines which normally needed to be cranked for a couple of revolutions fired "first piston up" and ran smoothly with minimum choke. In one case the engine fired from cold with no choke. In all cases where the choke was needed, it could be pushed in much sooner than would normally be the case.

Apart from the easier starting, two members were convinced that they obtained better acceleration and smoother running. The third member was less sure, partly because the amount of driving possible in the time available had been limited, and partly because he may have over-reacted to a desire not to "kid himself."

Only one member was able to make any observation about petrol consumption. This involved a Holden Kingswood with 186 motor and manual transmission. On typical weekend driving, over distances of about 150 miles, it normally returns about 23 to 24 miles per gallon. The observation, based on one such trip only since the new system was fitted, suggests a return of about 28 miles per gallon, or perhaps a little more. It is emphasised, however, that observations over a much longer period would be necessary to confirm this.

This much is certain. None of the units presented installation problems, and none has given any hint of trouble since the moment of switch-on. Subjective reactions in regard to performance have all been favourable, not adverse.

In any unit of this type there is a risk of noise being generated. One source of noise is the DC-DC converter which, by magnetostriction, can generate a tone at the frequency of inverter oscillation. A second source of noise is less definite in its origin, but takes the form of a clicking sound at the firing frequency of the spark plugs.

None of the units tested gave any trouble in regard to noise. Even with the bonnet open and the engine running the sound ranged from inaudible to barely audible. In no case was there any penetration into the passenger or driver's compartments. One unit did produce a slight clicking sound, audible in the front seat passenger compartment, when it was mounted on the engine bulkhead on the passenger side.

(Continued on Page 207)

Fundamentals of SOLID STATE

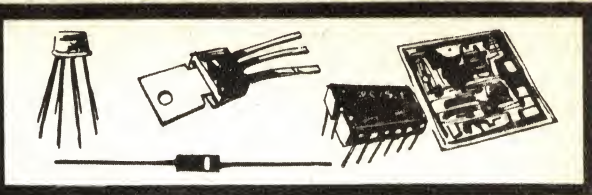

Chapter 7

by Jamieson Rowe

The unijunction — basic construction — interbase current — intrinsic standoff ratio — the peak point — carrier injection — conductivity modulation — negative resistance behaviour—the valley point—static emitter characteristics — base current modulation — field effect — static inter-base characteristics — temperature stabilisation — applications.

In the preceding chapters we have examined fairly carefully the operating principles and applications of the many varieties of P-N junction diode, which may be regarded for many purposes as the most basic type of semiconductor device in common use. Using the knowledge gained in these chapters as background, let us now turn our attention to a slightly more complex device: the unijunction.

The unijunction is quite a logical choice as the device type next examined after the basic P-N diode in a systematic treatment of semiconductor devices. It is probably the simplest of the three electrode devices and the device whose close relation to, and evolution from, the basic diode is most readily appreciated. Also an understanding of its operation involves important concepts, which are among those involved in understanding the more complex devices, so that a discussion of the device may provide a useful conceptual stepping-stone.

Although it is essentially a simple development from the basic P-N diode, the unijunction is capable of performing many other rather unique functions. It can form the basis of very simple relaxation oscillators, timers, threshold detectors, pulse generators and amplifiers, counters and information storage cells. Because of its flexibility it has found considerable use in electronic equipment of recent design, and particularly in pulse-handling and control equipment.

Other names for the unijunction are "unijunction transistor," "UJT" and "double-base diode." The latter name was that first given to the device when it was developed in 1953 at the Syracuse, New York laboratories of the General Electric Company.

Essentially a unijunction consists of a single P-N junction which differs from a normal semiconductor diode in that the material on one side of the junction is provided with not one, but two connection electrodes. This side of the junction is called the base, and its two electrodes are conventionally labeled the "base-1" (B1) and "base-2" (B2) electrodes. The material on the other side of the junction is called the emitter, and is provided with a single "emitter" (E) electrode.

At first sight it may seem rather surprising that a distinctly different and independently useful new semiconduct-

or device may be developed from the basic P-N diode, not by radical re-arrangement of the junction, or by the addition of further junctions, but rather by the fairly straightforward addition of a second connection to one of its two semiconductor regions. Yet in basic terms this is really all that the unijunction involves. The fact is that

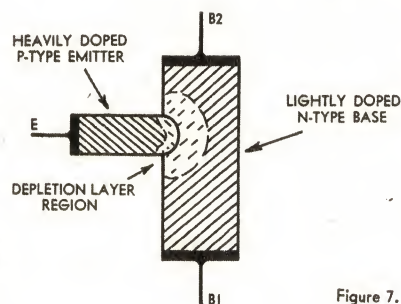
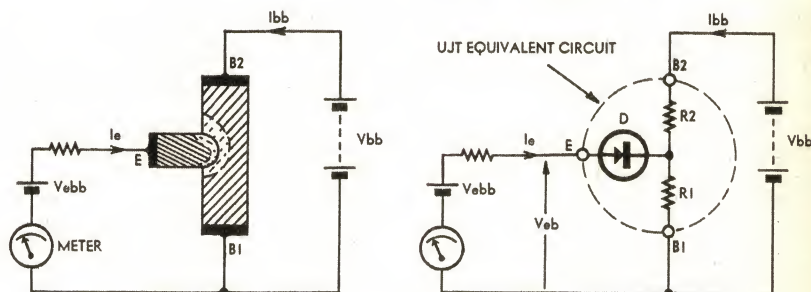

Figure 7.1



EMITTER CONDUCTS WHEN $V_{eb} \geq V_d + \eta V_{bb}$
 WHERE $V_d \approx 0.6V$ (NORMAL FORWARD VOLTAGE DROP OF P-N JUNCTION)
 $\eta =$ "INTRINSIC STANDOFF RATIO" $= R_1 / (R_1 + R_2)$
 $R_1 + R_2 =$ TOTAL INTERBASE RESISTANCE (R_{bb})

Figure 7.2

the second electrode attached to its base region allows the effective conduction characteristics of the device junction to be varied considerably from those of a normal diode, as this chapter seeks to demonstrate.

In theory, unijunctions may be made from both silicon and germanium, and with either the P-type emitter/N-type base configuration or its converse. The first devices to be produced were made from germanium, but the high minority carrier saturation currents of this material placed severe limits on device performance

and stability. As a result, unijunctions are now made almost exclusively from silicon. Also, because devices with the N-type emitter/P-type base configuration present rather difficult manufacturing problems, the P-type emitter/N-type base version has become that most widely used.

The basic form taken by most unijunctions is shown in figure 7.1. The lightly doped N-type base material is usually in the form of a rectangular bar or cube, to which non-rectifying or "ohmic" connections are made at opposite ends to form the B1 and B2 electrodes. At a point between these two electrodes a junction is formed with the heavily doped P-type emitter material, with a third ohmic connection made to the remote end of this material for the E electrode. The junction is normally somewhat closer to the B2 electrode than to the B1 electrode.

Not surprisingly, under equilibrium conditions the junction of such a device behaves in exactly the same manner as that of a normal P-N diode which we examined in previous chapters. Majority carrier diffusion takes place over the junction, a drift field is set up, and a depletion layer appears in the material on either side of the junction proper. Naturally the depletion layer will extend further into the lightly doped base than into the

heavily doped emitter, as suggested in the diagram.

If external bias is applied between the emitter and either of the two base electrodes, with the other base electrode left unconnected, the device will again behave exactly as a normal diode. Under forward bias (emitter positive) the device will conduct heavily as soon as the applied voltage is sufficient to produce significantly excess majority carrier diffusion currents — i.e., when the applied voltage exceeds about 0.6V, assuming silicon material.

Dual

NEW RELEASE 1209



DUAL 1209 HI-FI AUTOMATIC TURNTABLE

In engineering, design and operating ease, the Dual 1209 represents a new concept of automatic players in the higher range of high fidelity systems. It combines superior engineering and elegant styling in a unit that can be used in any mode: manual or automatic single play, or as an automatic changer for up to 6 records. Technical features: torsionally rigid tubular metal tonearm with low mass. Effective tonearm length: 206 m.m. Maximum tracking error, 1 deg. 45 min. Elastically damped counterbalance with calibrated increments of .01 gram. Detachable cartridge holder for all cartridges with $\frac{1}{2}$ in mounting standard. Tonearm lift serves as lock and release for cartridge holder. Silicone-damped cue control raises, lowers tonearm at any point on record, can also be used with automatic start. Continuously variable tracking force settings (0 to 5.5 grams) and anti-skating control. Anti-skating can be set even during play, and has separate calibrations for conical and elliptical styli. Pitch control, range approximately 1 semitone. All automatic operations function from 0.5 gram tracking force up. 4-pole hi-torque synchronous motor maintains speed absolutely constant with line frequency, regardless of any line voltage fluctuations. Line voltage, 110/240 volt AC. Rotary operating switches facilitate easy and vibration-free operation. Non-magnetic 10 $\frac{1}{2}$ in platter weighs 4lb. Single play spindle rotates with platter. Speeds: 33 $\frac{1}{3}$, 45, 78 r.p.m. The Dual 1209 exceeds in all its specifications the requirements of the German Industry Standard (DIN) 45 500.

Standard accessories: Rotating single play spindle, self-stabilizing changer spindle AW 3 for records of any standard size; centring disc for 7in records having large centre hole.

FRED A. FALK (SALES) PTY. LTD.

28 KING STREET, ROCKDALE, N.S.W. — PHONE 59 4783—59 7731

Distributors:

N.S.W.—All leading Electrical Houses.

VIC.—Radio Parts & Electrical Houses.

QLD.—Ron Jones P/L, 7-9 Merton Rd., Sth. Brisbane.

S.A.—Truscott Electronics & all leading Electrical Houses

W.A.—Athol M. Hill, 613 Wellington St., Perth.

TAS.—All leading Electrical Houses.

Conversely under reverse bias (emitter negative) the device will draw only a small and almost constant current, composed primarily of the minority carrier saturation currents.

If one of the base electrodes is ignored, then, the unijunction behaves simply as a normal P-N diode. However by connecting both base electrodes into a circuit in a suitable manner this behaviour can be made to change markedly.

Typically, the circuit into which a unijunction is connected is arranged to apply a bias voltage between the two base electrodes, in addition to any bias which may be applied between emitter and base. The bias polarity is normally such that the B2 electrode is positive with respect to B1.

Impurity semiconductor material is capable of significant electrical conduction even at low excitation levels, it may be remembered, the resistivity being inversely proportional to the impurity doping level. Hence the base region of a unijunction, being composed of lightly doped and therefore fairly high resistivity N-type material, will possess a finite though moderately high resistance. This is normally termed the **interbase resistance**, symbolised R_{bb} . Typical values for R_{bb} range between 5K and 10K.

When bias voltage is applied to a unijunction between the B1 and B2 electrodes a small but significant **interbase current** thus flows, as a result of the finite interbase resistance.

Just as with any other resistor passing current, the base region of the device will have a distributed voltage drop. Any arbitrary point between the B1 and B2 electrodes will therefore possess a certain electrical potential with respect to each, that with respect to B1 being positive and that with respect to B2 negative. The magnitude of these potentials will depend upon the position of the chosen point along the electrical length of the base region.

The emitter junction, being placed at such a point on the base between the two end electrodes, will therefore possess such potentials. As typical devices have the junction closer to the B2 end of the base, this means that the positive potential of the junction with respect to the B1 end will be somewhat larger than the negative potential with respect to B2.

What does this imply? Simply that, if the B1 electrode is taken as reference, the current flowing through the base region between the two end electrodes effectively provides the emitter junction with an "internal" reverse bias. Even if the emitter electrode were shorted externally to B1, the junction would still have an applied (reverse) bias equal to the voltage drop in that section of the base between the junction and the B1 electrode.

Accordingly if an external forward bias is connected to the unijunction between emitter and B1, its magnitude must be increased to a level somewhat higher than for a normal diode junction before significant current flows. This, then, is the first important way in which the behaviour of a unijunction differs from that of a normal diode: the effective "turn-on" voltage of the emitter junction may be controlled by means of a voltage applied between the B2 and B1 electrodes.

Illustration of this behaviour is given in figure 7.2. In the left-hand

diagram is shown a unijunction to which has been connected a bias voltage V_{bb} between the two base electrodes, resulting in an interbase current I_{bb} . If an adjustable source of emitter-B1 forward bias V_{eb} is connected in series with a suitable meter between the E and B1 electrodes, as shown, it will be found that the actual emitter-base voltage V_{eb} must be increased to a value somewhat higher than the usual 0.6V or so, before significant emitter current I_e flows.

As the right-hand diagram of the figure shows, this behaviour of the unijunction allows us to draw a simple "equivalent circuit" for the device. The equivalent circuit consists of a diode D representing the emitter P-N junction

which the emitter junction conducts—called the **peak point voltage** (V_p)—may be controlled by varying the interbase bias voltage V_{bb} . The higher V_{bb} , the higher the reverse bias effectively applied "internally" to the base side of the junction, and the higher V_p .

One important difference between the unijunction and a normal diode, then, is that its peak point voltage or emitter "turn-on" voltage may be electrically varied. However, this is not the only important difference between the two types of device, for other unique aspects of unijunction behaviour appear as soon as emitter current flows.

It may be remembered that the composition of the current passing across a forward biased junction

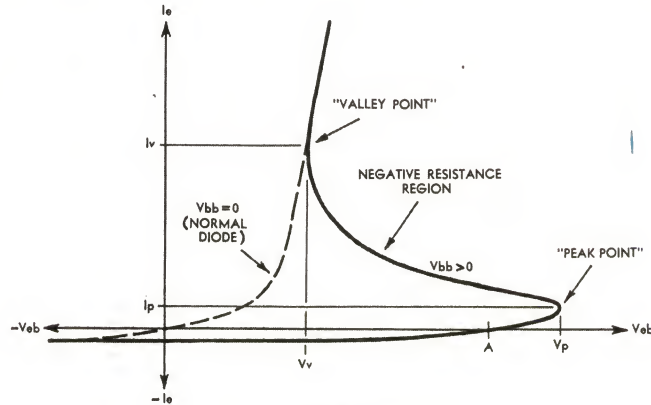

Figure 7.3

ion itself, together with two resistors R_1 and R_2 representing the resistances of the base region between the junction and either end.

The reason for deriving the equivalent circuit for the device is that it enables us to formulate a simple expression for the emitter voltage required for conduction. It should be fairly clear from the right-hand diagram of figure 7.2 that conduction will occur only when V_{eb} is increased to a level where it exceeds the sum of V_d , the "turn-on" voltage of the junction, together with the proportion $R_1/(R_1 + R_2)$ of V_{bb} .

As may be seen, the ratio $R_1/(R_1 + R_2)$ is known as the **intrinsic standoff ratio** of the unijunction, commonly represented by the Greek symbol η . As the intrinsic standoff ratio determines the proportion of the interbase bias V_{bb} which acts as "internal" reverse junction bias, and accordingly plays a major part in determining the conduction point of the emitter in a given circuit, it is an important unijunction parameter.

The inherent junction turn-on voltage V_d and the actual values of the interbase resistors R_1 and R_2 are all subject to variation between individual unijunction devices, being dependent upon doping levels and physical dimensions. However because such factors tend to influence both the R_1 and R_2 components of the interbase resistance equally, the intrinsic standoff ratio tends to be fairly constant for a given device type. Typical devices have an intrinsic standoff ratio of about 0.7, but special devices are made with values both higher and lower than this figure.

For a device with a certain intrinsic standoff ratio, it should be fairly apparent that the emitter-B1 voltage at

depends upon the impurity doping concentrations of the P-type and N-type regions involved. If one of the regions has a higher doping concentration than the other, then quite naturally the junction current will consist mainly of the majority carriers appropriate to that material.

When emitter junction current flows in a unijunction it therefore consists mainly of valence band holes moving from the heavily doped emitter region to the lightly doped base region. Only a relatively small proportion of the total forward bias current consists of conduction band electrons moving in the reverse direction, because of the relatively low impurity doping concentration in the base material.

Often this situation is described by referring to the unijunction as a device wherein the doping levels are arranged to result in a high "emitter injection ratio." The latter term describes the proportion of total junction current formed by emitter-region majority carriers (holes) effectively **injected** as minority carriers into the base region.

Because of the high emitter injection ratio of the unijunction, then, the main result of the flow of emitter current is that a large number of holes are injected as minority carries into the base region from the emitter. The base therefore finds itself with an excess of holes in the vicinity of the emitter junction.

The holes ejected from the emitter leave that region with a nett negative charge. Accordingly, an appropriate number of electrons are repelled from the emitter via the E electrode, forming the emitter current I_e . Similarly, the excess holes injected into the base region give that region a nett positive charge, and this in turn causes an appropriate number of conduction band

REVOX



The ultimate in high fidelity systems



Engineering Products Division

422 LANE COVE ROAD NORTH RYDE NSW AUSTRALIA

88 6666

AMALGAMATED WIRELESS (AUSTRALASIA) LIMITED

MELBOURNE
67 9161

BRISBANE
4 1631

ADELAIDE
72 2366

PERTH
28 6400

LAUNCESTON
2 1804

electrons to be "sucked into" the device at the B1 electrode.

Because of the electric field present in the base region due to the interbase bias V_{bb} , the holes injected into this region from the emitter drift toward the B1 end of the device. Similarly the electrons which enter the base at the B1 end to maintain neutrality drift in the opposite direction towards B2. The result is that the section of the base region between the junction and B1 finds itself with a high excess concentration of both minority carriers (holes) and majority carriers (electrons).

The presence of the excess carriers in this portion of the base region effectively lowers its resistivity, by providing a supply of current carriers additional to the relatively small number initially present in the lightly doped base material. In other words, the injected carriers cause the junction-B1 section of the base to behave temporarily as if it had been more heavily doped. This phenomenon is often referred to as **conductivity modulation**.

The result of the drop in base region resistivity is that there is actually a decrease in the reverse bias applied to the emitter junction "internally" via divider action from V_{bb} . In effect, resistor R1 in the unijunction equivalent circuit of figure 7.2 has been lower-

behaviour is illustrated in the diagram of figure 7.3, which shows for comparison the effective emitter junction forward bias characteristics for both the $V_{bb}=0$ case, where the behaviour is virtually identical with a normal diode, and the case where V_{bb} has some definite value.

It may be seen that when there is an applied V_{bb} , the emitter current remains at a very low level for applied forward bias levels considerably higher than those necessary when $V_{bb}=0$. This is due to the "internal" reverse bias applied to the junction, as we have seen. The junction does not actually reach the equilibrium of "zero bias" condition until point "A" is reached, and accordingly until this point is approached it draws only the usual reverse bias current composed mainly of minority carrier saturation currents.

As the applied emitter voltage is increased to reach and exceed the level corresponding to point "A," majority carrier diffusion currents gradually appear and the junction current begins to rise. The junction then enters conduction, and the so-called **peak point** is reached.

The junction voltage drop at this point is called the "peak point voltage" (V_p), as we saw earlier, while the corresponding current is naturally called the "peak point current" (I_p).

drop of the emitter junction reaches a broad minimum, and then begins to rise again. The minimum is normally referred to as the **valley point**, as may be seen, and the corresponding voltage and current values as the "valley point voltage" and "valley point current" respectively. It may be seen that the emitter characteristic of the unijunction at current levels above the valley point is substantially the same as that of a normal diode, or that of the device itself for $V_{bb}=0$.

As we have seen, the peak point or effective emitter junction "turn-on" point is not fixed, but is controlled by the interbase bias V_{bb} . Hence the solid curve of figure 7.3 does not represent a single and fixed emitter characteristic, but in fact a whole "family" of characteristic curves, each corresponding to a different value of V_{bb} . The dashed $V_{bb}=0$ curve will represent the "limiting case" of the family.

Figure 7.4 shows such a family of **static emitter characteristic** curves, the values given being those for a typical general-purpose unijunction device.

It is mainly by virtue of the fact that the emitter junction of a unijunction is capable of behaving as a negative resistance over portion of its characteristic that the device is able to perform many of its unique circuit functions, as will be shown shortly. However before we progress to consider the applications of the device in practical circuitry, there are further aspects of its basic operation which should be briefly examined.

The reader may have noticed that

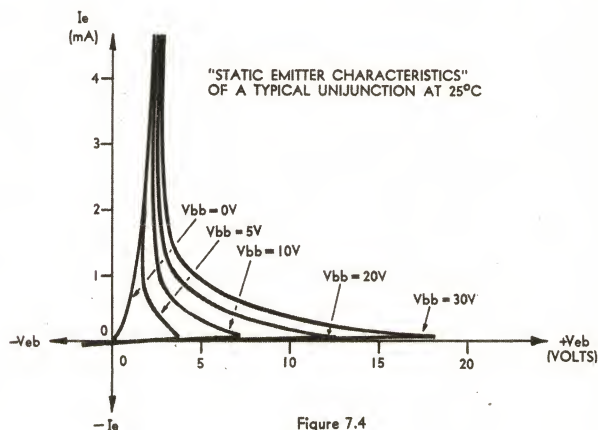

Figure 7.4

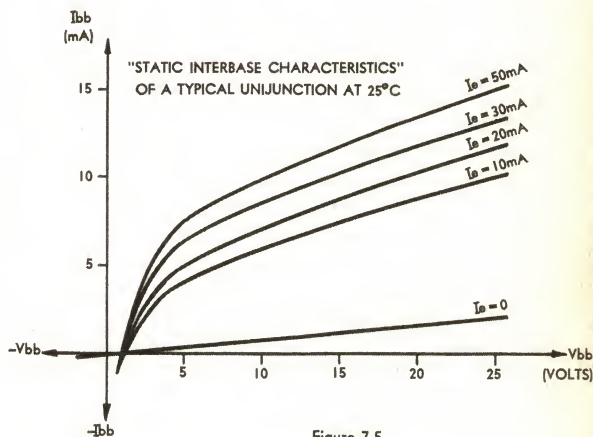

Figure 7.5

ed in value, taking with it the proportion of V_{bb} appearing as reverse junction bias. This is despite the fact that additional current is flowing through R1, due to the emitter current I_e .

As the external emitter-B1 voltage drop of the device (V_{eb}) is simply the sum of the voltage drops of the junction itself (V_d) and of the R1 portion of the base, this means that the decrease in the latter will cause V_{eb} to similarly decrease. And if the emitter current I_e is allowed to increase from its initial value, the two voltages will decrease even further.

This is rather unusual behaviour, as the observant reader will no doubt have realised. Normally, when the current passing through a circuit element is increased, its voltage drop also increases; but here we have a situation where an increase in current results in a decrease in voltage drop. In short, we have an effective **negative resistance**, as we had with the tunnel diode.

Not only does the emitter-B1 circuit of a unijunction possess an adjustable "turn-on" point, then, but it also behaves as a negative resistance as soon as emitter current begins to flow. This

With typical devices I_p has a value in the order of 2 μ A.

If the junction current is allowed to increase beyond its value at the peak point, it may be seen that the effective junction voltage drops away; in other words, the device enters its negative resistance region. In this region the voltage continues to fall with rising current, as the resistivity of the emitter-B1 section of the base is falling at a faster rate than the increase in current.

Eventually, if the current continues to rise, the resistivity of the base region does not continue falling, but "flattens out" at a low saturation level. This occurs when the concentration of excess carriers in the base reaches such a level that further injected carriers merely result in increased carrier recombination, and do not effectively contribute to current conduction.

When this occurs the effective voltage

in the foregoing discussion of unijunction conduction, reference was made only to the behaviour of the voltages and currents associated with the emitter. It may have been assumed from this that the interbase bias current I_{bb} of the device was unaffected by the mechanisms involved; however this is not the case.

When emitter current begins to flow, the interbase current is found to increase to a small but significant extent. This is partly due, as one might expect, to the drop in resistivity of the lower portion of the base as a result of the injected minority carriers from the emitter. However, it is also partly a result of a separate conductivity modulation mechanism associated with the depletion layer surrounding the emitter junction.

When the emitter junction is reverse biased, i.e., when there is low external emitter voltage V_{eb} relative to the

Make your next choice a Uher

UHER

Made in Western Germany

"The Worlds Most Reliable Name for Precision Taperecorders"
presents ANOTHER NEW

Technical Perfection in our pages of

ACTION AND SOUND

The All NEW BREED

VARIOCORD 263 Stereo

BAND RECORDER



based on the famous UHER Royal Deluxe
UHER VARIOCORD 263 STEREO

Made exactly 'to measure.'
Vary your machine in four different ways.
Your choice of 2 track and 4 track operation.

Automatic or manual level control.

Mixing of sound sources. 2 x 6 watts rms. output or 2 x 9 watts music power. 3 speeds. 2 built-in loudspeakers can be hung on wall like a picture. Optimum wow and flutter performance. Uhers exclusive tape tension comparator controls tape speed in any position.

Variocord 263 Stereo — Also available as Variocord 23 Hi-Fi 4 track

SPECIFICATIONS

- Recording-4 or 2 track
- Interchangeable head assembly
- 4 magnetic heads
- Tape speeds: 7½ ips. 3¾ ips. 1½ ips.
- Frequency range: 30-20,000 cps at 7½ ips.
30-15,000 cps at 3¾ ips.
30-8,000 cps at 1½ ips.
- Maximum reel size 7"
- Wow and flutter \pm 0.05p.c. at 7½ ips.
- Signal to noise ratio 50 db 4 track 53 db 2 track at 7½ ips.
- Residual noise after erasure 70 db at 7½ ips.
- Output power 2 x 6 watts rms. (sinewave tone)
2 x 9 watts music power
- Dimensions: 17½ x 13 x 7
- Weight: 22 lbs.

Showroom — Sales Enquiries Welcome

ATRAM PTY. LTD.

Sole Australian Importer and General Agent.
5 McLaren Street, North Sydney, Tel.:
92-4177.

Available in All States from Franchised UHER Agents

N.S.W.: John Border Photographics Pty. Ltd. 175 Liverpool St., Sydney. Tel.: 26-1106.	A.C.T.: Canberra Sound and Recording Service. 109 Majura Ave., Dickson. Tel.: 4-5980.	VIC.: Photosound Pty. Ltd., 7 Cookson St., Camberwell. Tel.: 82-7042.
N.S.W.: Milverson Sound Centre, 791 Pacific Highway, Chatswood. Tel.: 41-4365.	QLD.: A. E. Harrold Pty. Ltd., 125-125 Charlotte St., Brisbane. Tel.: 31-3081.	S.A.: Kallin Distributors (Wholesale) Pty. Ltd., 140 Gawler Place, Adelaide. Tel.: 8-7171 (11 lines).
N.S.W.: Glen Dor Camera Centre, 43 The Corso, Manly. Tel.: 92-2709.	VIC.: Atram Pty. Ltd., 1 Corr St., Moorabbin. Tel.: 95-5633.	W.A.: Alberts TV and Hi-Fi Centre Pty. Ltd., 282 Hay St., Perth. Tel.: 21-5004.
N.S.W.: Alderson Camera Store Pty. Ltd., King St. and Prince's Highway, Rockdale. Tel.: 59-2589.	VIC.: Klapp Electronics Pty. Ltd., 224 Chapel St., Prahran. Tel.: 51-4653.	N.T.: N.T. Musical and Electrical (W/S) Pty. Ltd., 54 Cavanagh St., Darwin. Tel.: 3072.

"internal" reverse bias, its depletion layer naturally extends to a significant extent into the material on either side. It tends to extend further into the base region, because of the lighter doping and higher resistivity of that material, and also in the base material itself it tends to extend further at the "top" or B2 side of the junction than at the "lower" or B1 side. This is because an electric field exists in the base due to V_{bb} , and the effective reverse bias is accordingly slightly greater at the B2 side of the junction than at the B1 side. (The shape of the depletion layer may be seen by reference back to figure 7.2)

A depletion layer, it may be remembered, is a region in a semiconductor which has been virtually stripped of available current carriers. As such, it is an effectively "intrinsic" region, capable of displaying only the rather poor conductivity of intrinsic semiconductor material. In short, it is a region effectively "converted" into very high resistivity material.

Prior to junction conduction in a unijunction, therefore, the base region of the device consists in part of effectively very high resistivity material — material considerably higher in resistivity than the remainder of the lightly doped base region. In effect, the actively conducting cross-section of the base material is virtually narrowed or "pinched" in the vicinity of the junction, as a result of the encroachment of the depletion layer.

When the emitter junction enters conduction, the depletion layer naturally contracts to correspond to the reduced potential barrier. The "pinching" of the base region is therefore reduced, and the actively conducting cross-section of the region widens. As a

result of this widening the interbase resistance falls, and the current I_{bb} rises as a result.

in and forms the basis of a number of very useful semiconductor devices. The best-known example of these is the field-effect transistor, which the reader will meet in the next chapter. Because the depletion layer of a unijunction emitter junction is basically associated with the potential barrier actually present across the junction, it is influenced both by the emitter voltage V_e and by the interbase bias V_{bb} — the latter not directly, but proportionally via the intrinsic standoff ratio. The interbase bias V_{bb} thus plays a part in determining the width of the depletion layer, and hence by means of the field effect mechanism it also influences the effective cross-section and conductivity of the base.

The interbase resistance of a unijunction is thus found to vary with the applied interbase bias voltage V_{bb} , an increase in V_{bb} causing a small but sometimes significant rise in interbase resistance from its initial value of R_{bb} . This effect is in itself quite distinct from those associated with

tion of both the emitter current I_e and the interbase bias voltage V_{bb} . It is usual to describe the relationship between I_{bb} , V_{bb} and I_e graphically, by means of the so-called "static interbase characteristics."

The static interbase characteristics of a typical general-purpose unijunction are shown in figure 7.5. As may be seen they consist, like the static emitter characteristics of figure 7.4, of a "family" of curves. In this case each curve shows the relationship between I_{bb} and V_{bb} for a specific value of emitter current I_e .

The lowest or $I_e=0$ curve shows the relationship between I_{bb} and V_{bb} when the unijunction is cut off — i.e., the initial slope of this curve represents the "nominal" interbase resistance R_{bb} . The remaining curves show how the interbase current increases moderately with increasing emitter current.

The circuit symbols usually employed for unijunctions are shown in figure 7.6. Note that the arrowhead on the emitter lead is used to symbolise the direction of forward emitter current flow according to the classical "positive charge" convention.

Being composed of impurity semiconductor material, the base region of a unijunction possesses a small but significant positive temperature coefficient of resistance at normal temperatures. It may be recalled from chapter 3 that this is due to the fact that once the impurity atoms are all ionised, further increase in excitation merely results in a reduction of carrier mobi-

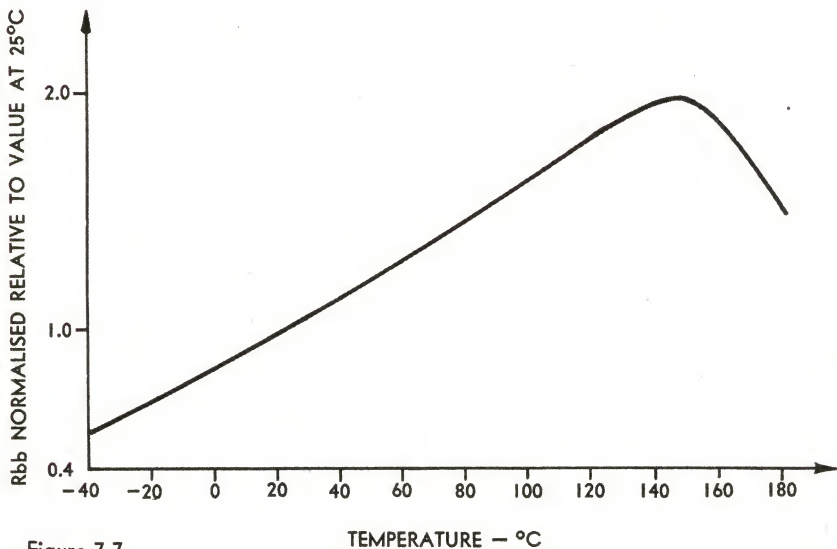

Figure 7.7

result of this widening the interbase resistance falls, and the current I_{bb} rises as a result.

It may be seen that this second mechanism responsible for the conductivity modulation of the unijunction base region by the emitter current is quite different from the minority carrier injection mechanism described earlier. It is in fact an example of a field effect mechanism, an important type of mechanism which is exploited

emitter current flow, although when appreciable emitter current is flowing the narrowness of the depletion layer causes the effect to be somewhat reduced. Naturally the fact that the interbase resistance of a unijunction varies with V_{bb} tends to provide yet another source of variation in the interbase current I_{bb} .

From the foregoing it may be seen that the interbase current I_{bb} of a unijunction is a rather complex func-

lity, and accordingly a corresponding rise in resistivity.

For a typical unijunction the interbase resistance R_{bb} increases linearly from about -40°C to about 150°C , with a temperature coefficient of about 0.8% per degree. This is illustrated in figure 7.7, where it may be seen that the value of R_{bb} at 150°C is approximately double its value at 25°C . Above 150°C the base resistivity begins to fall rapidly due to the increase in "intrinsic" carrier pairs.

As with a normal P-N junction, the inherent forward bias voltage drop (V_d) of the emitter junction of a unijunction decreases with temperature — i.e., it exhibits a negative temperature coefficient. Less forward bias is required to produce significant forward current at high temperatures than at low temperatures.

It may be seen from the foregoing that the two components of a unijunction most intimately responsible for determining the peak point voltage V_p , namely the junction itself and the base region, have temperature coefficients of opposite polarity. This is significant because it provides a means whereby

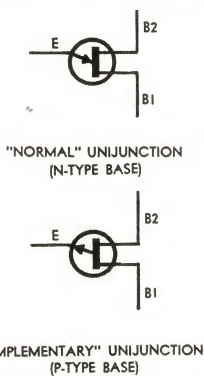

Figure 7.6

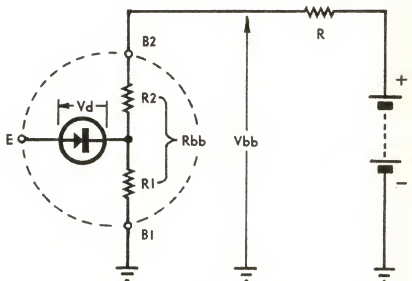
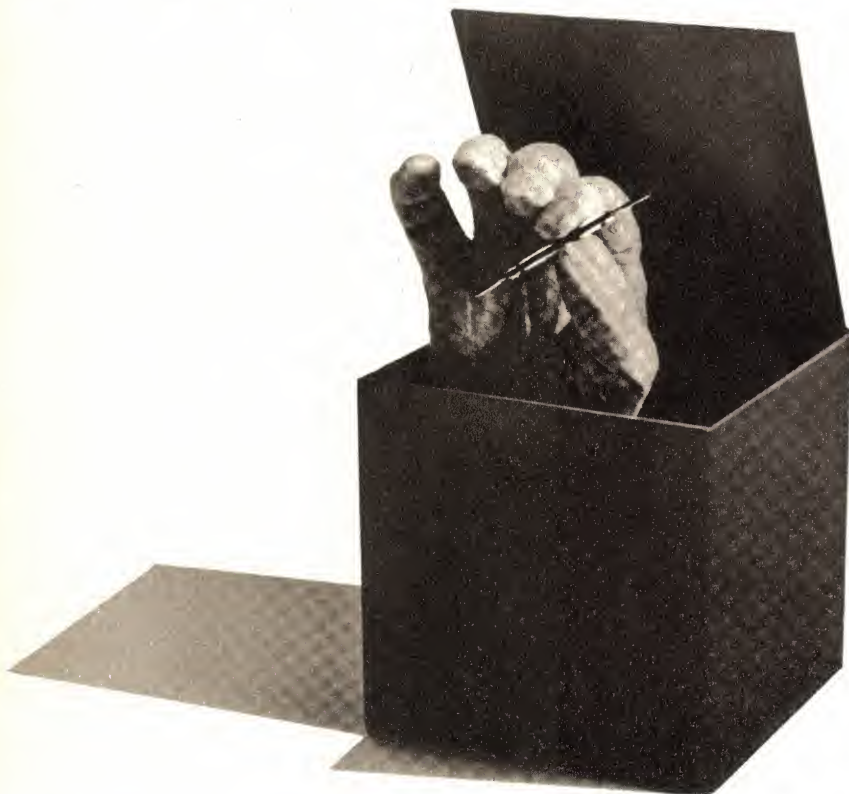

Figure 7.8

EVERY BLACK BOX SHOULD HAVE A DJINNI.



The reed switch is the greatest thing that's happened to electronic control devices since the Arabian Nights. It's encased in a little glass bottle you don't even have to rub. A coil turns it into a relay. A bar magnet makes it the most versatile electro-mechanical switch yet invented.

The reed switch is isolated in its glass container with a controlled atmosphere. It stays free of dust, damp and corrosion. There are no armatures, springs or pivots to wear. Life can easily exceed 100

million operations. Sensitivity is readily controlled. Speed is the next best thing to transistorized logic at a mere wisp of the circuit cost. Even RF switching is practical.

If this isn't magic, what is?

If you are not as familiar with magnetic reed switches as you should be, ask for technical literature. With this information at your fingertips you may devise machine, flow or control uses no other engineer has conjured up yet.

**IRH
COMPONENTS
PTY. LIMITED**

*The Components Division of
IRH Industries Limited*

IRH THE CRESCENT, KINGSGROVE, N.S.W. 2208. PHONE 50 0111

INTERSTATE TELEPHONES

MELB. VIC.	489.1088	BRIS. QLD.	70.2141
HOB. TAS.	34.2811	PERTH W.A.	8.2271
LAUN. TAS.	22.844	ADEL. S.A.	23.1971

HAMLIN

MAGNETIC REED SWITCHES.
THE FIRST AND FINEST IN THE FIELD.

the peak point voltage may be simply and effectively stabilised over a wide range in temperature.

Figure 7.8 shows how simply peak point stabilisation may be achieved. The technique merely involves the addition of a suitably chosen resistor R in series with the connection between B2 and the interbase bias supply. The resistor and the device interbase resistance R_{bb} together then form a simple voltage divider.

Because of the positive temperature coefficient of the interbase resistance R_{bb}, the division ratio of this divider rises with temperature. Hence as the temperature rises the effective interbase bias V_{bb} rises also, and with it the proportion of V_{bb} presented to the

When voltage is first applied to such a circuit, the capacitor C is initially uncharged, and thus begins to charge from the supply via resistor R. The emitter voltage of the unijunction accordingly rises from zero in the familiar exponential fashion. Until the emitter voltage rises in this fashion to the device peak point voltage, the emitter itself draws negligible current, and does not significantly influence the charging operation.

As soon as the peak point voltage is reached, however, the emitter draws current, and its input resistance drops sharply through the negative region to the low resistance "saturation" region. This discharges the capacitor rapidly, feeding its stored energy as a pulse

output waveform is available at the emitter of the unijunction, while both positive and negative pulses are available at the B1 and B2 electrodes respectively due to the currents flowing during the discharge part of the cycle.

Naturally the sawtooth at the emitter, being part of an exponential charging waveform, will not be perfectly linear. However there are a number of ways in which the non-linearity may be corrected, many of which involve replacement of the resistor R with a circuit or device which supplies a controlled constant current.

For a particular capacitor value, the frequency range over which this type of oscillator may be varied by variation in the value of resistor R is quite wide, but limited in both directions. If the resistance is made too large, the slight leakage current drawn by the device emitter becomes significant compared with the charging current, and the capacitor will not charge up to the peak point voltage. On the other hand if the resistance is too low, the emitter current will not drop below the valley point current when the device conducts. In either case, oscillation ceases.

These restrictions are not severe, and with typical devices it is possible to achieve reliable operation over a resistance range (and a corresponding frequency range) of 1000:1. The upper limit of oscillation frequency for typical devices is approximately 150KHz.

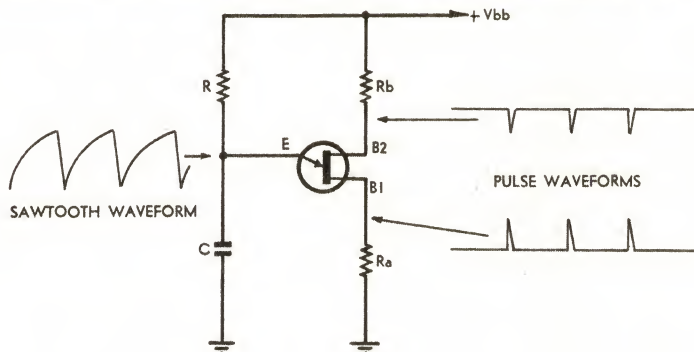

Figure 7.9

base side of the junction by the "internal" (R₁ + R₂) divider.

If the value of resistor R is carefully chosen, the rise in voltage at the base side of the junction may be made almost exactly equal and opposite to the fall in junction voltage drop V_d. The emitter peak point voltage V_p will then remain substantially constant over a wide range in temperature. With typical devices this simple method may be used to stabilise V_p to within approximately .001% per degree up to about 100°C.

The astute reader may well have realised by this stage that the simple equivalent circuit given for the unijunction in figures 7.2 and 7.8 is valid only when the device is not conducting. In fact, the device is rather difficult to represent after conduction, and a complete equivalent circuit tends to be quite complicated.

To conclude this discussion of the unijunction let us now look briefly at some of the many applications of the device.

Probably the most common application of unijunctions is in simple relaxation oscillators. These may be used to generate sawtooth-wave and pulse signals over a considerable frequency range, and may also be synchronised to perform low-cost frequency division.

The basic circuit of a unijunction relaxation oscillator is shown in figure 7.9. It may be seen that the emitter electrode is connected to the junction of a capacitor C and a resistor R, which are connected in series across the supply V_{bb}. The base of the device is also connected across the supply, by means of resistors R_a and R_b. Resistor R_b is used primarily for temperature stabilisation of V_p, as explained earlier; the purpose of R_a should become clear in a moment.

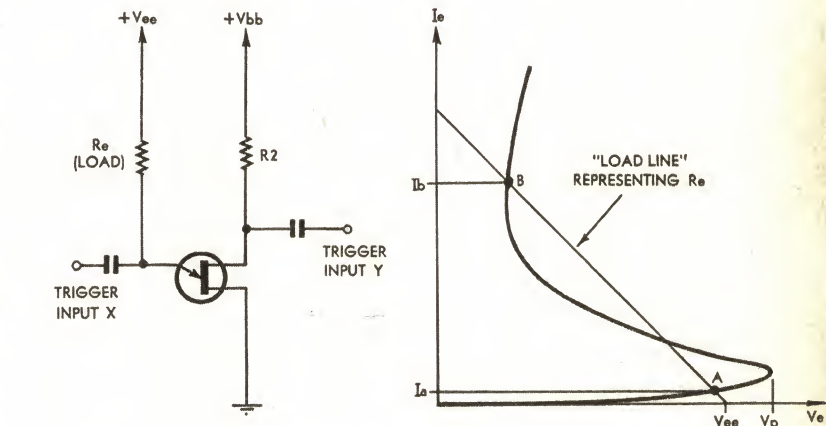

Figure 7.10

of current through resistor R_a.

Discharge current flows until the capacitor voltage drops below the value necessary to sustain the emitter current above the valley point value. The unijunction then turns off again, and the capacitor C begins to recharge via R. The cycle then repeats itself, and will, in fact, continue indefinitely as long as the supply is connected. The time taken for the capacitor voltage to reach the peak point voltage each time is determined both by the capacitor itself and the resistor R, so that the repetition frequency may be altered by varying the value of either of these components.

It may be seen that the circuit has the familiar "charge-discharge" action characteristic of relaxation oscillators. As such, it is very similar in operation to the familiar "gas tube" sawtooth wave generators using either neon lamps or gas-filled thyatron valves.

As shown in figure 7.9, a sawtooth

The basic unijunction relaxation oscillator of figure 7.9 may be synchronised to an external signal, providing its natural frequency is set to be slightly lower than that desired. Synchronisation is achieved by feeding a negative synchronising pulse to the B2 electrode of the device. The action of the pulse is to momentarily lower the effective interbase bias applied to the unijunction, so that if the capacitor is charged to a voltage even approaching the normal peak point voltage, it will conduct as a result of the temporary lowering of the peak point by the synchronising pulse.

This technique may be used to synchronise a unijunction oscillator at a submultiple of the synchronising frequency. An oscillator operated in this fashion may be used as a simple sweep generator for economy oscilloscopes or television receivers. A number of similar circuits may be cascaded to form a low-cost frequency divider system.

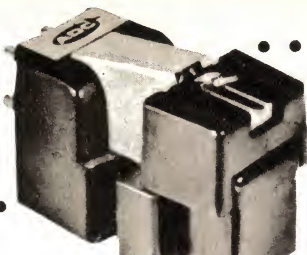
That vital first link ...  ... Should be an ADC cartridge

ADC 10E-II • Now only \$70.00

The choice of a cartridge is a most important one as even the finest equipment cannot perform well if a poor cartridge is selected. The best cartridges in the world today can be numbered on the fingers of one hand. **WHY—OUT OF SUCH A LIMITED FEW—IS ADC STILL THE BEST CHOICE?**

Here are the best reasons possible:—

Musically Speaking

● In association with other quality components, the ADC cartridge brings a breath taking experience into your lounge room. The singers or musicians suddenly come to life as if they were actually present. The definition and detail of good recording is reproduced in such a way as to give the clearest possible insight into the talents of the recorded artists.

Technically Speaking

PRICES:

ADC 220	..	\$15.50
ADC 770	\$22.50
ADC 660	\$35.00
ADC 550E	...	\$43.50
ADC 10E-11	..	\$70.00
ADC 25	\$127.50
ADC 26	} to be announced	
ADC 27		

● The production of a pickup cartridge is not simply a matter of following a formula. It is a progressive science which requires inventive genius. Peter Pritchard, who is the designer of ADC is the recognised leader in this field—not only recognised by keen enthusiasts but by other manufacturers as well. **That is why every advance in design he originates is quickly imitated by others.**

● Cartridge design has, to a large extent, become a matter of "follow the leader" and Peter Pritchard is always well out in front. Just consider the significance of these achievements. **First** to achieve lowest tip mass, **first** to introduce the benefits of the induced magnet principle, **first** in the high compliance race, **first** to produce real trackability and **first** again with the interchangeable styli conception.

● The world's leading reviewers in the July, 1969 issue of "STEREO REVIEW" (Julian D. Hirsch and Gladden B. Houck) state—"We could not critically compare each cartridge against all of the others, for reasons of time. We had to content ourselves with comparing each with the ADC 25, as representative of the best available, **and it emerged the better choice from each such comparison.**" **THIS IS NOT AN ISOLATED REVIEW.** The top ADC cartridges have been used as a **reference standard** so many times by the real experts (not the inverted comma experts!) that there must be a sound reason for it.

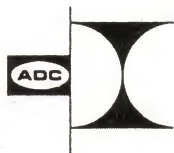

**OBTAINABLE AT ALL REPUTABLE
AUDIO DEALERS**

J. H. REPRODUCERS CO.

293 HUNTINGDALE ROAD, CHADSTONE, VICTORIA. 3148

TELEPHONE: 277-3066

Exclusive Australian Agents for — ADC Cartridges and Amplifiers, Kef speakers, J. H./G. H. Unipoise Pickup Arms, Pritchard Arms, TRANSCRIPTOR TURNTABLES and the popular J.H. Synchronous Turntable.

Actually a unijunction oscillator may be triggered into the conduction part of the cycle either by a negative pulse applied to B2, or by a positive pulse superimposed upon the capacitor voltage at the emitter. Either way, somewhat larger pulses than those necessary for triggering appear as output pulses at the B1 and B2 electrodes. Hence the circuit may be used with little modification as a regenerative pulse amplifier.

Because the basic unijunction relaxation oscillator may be arranged to oscillate at very low frequencies, it may be used as a period timer. Here the positive pulse output at the B1 electrode is normally used, being either amplified and arranged to drive a relay, or used directly to trigger in turn one of the more complex semiconductor switching devices to be described in a later chapter.

Typical unijunction timer circuits may be adjusted to any time period between a small fraction of a millisecond and a few minutes. More complex unijunction timers, still based on

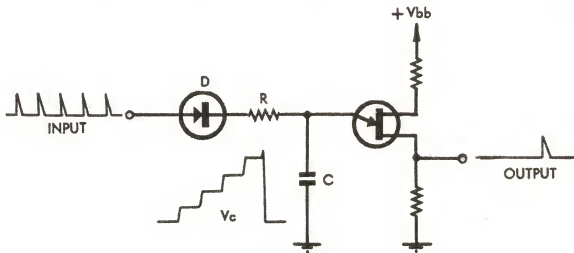

Figure 7.11

the simple circuit of figure 7.9, have been used to produce pulses spaced reliably at periods of up to one hour.

In a circuit not very different from that of the basic relaxation oscillator, a unijunction may be arranged to provide a simple bistable storage element which is capable of "remembering" the last of two types of switching pulses fed to it. A basic circuit for such a unijunction bistable element is shown in figure 7.10, together with a diagram which may be used to understand its operation.

The emitter of the device is here connected to a second fixed bias source V_{ee} , via a load resistor R_e which may in a practical case be a relay coil, or other device used to "read out" the state of the element. As before the B2 electrode is connected to an interbase bias source V_{bb} via a resistor R_2 , only in this case R_2 is used not so much for temperature stabilisation but mainly as a decoupling resistor for triggering pulses applied to B2.

The emitter supply V_{ee} is set at a value which is slightly lower than the peak point voltage V_p of the device, as determined by its intrinsic standoff ratio and the values of V_{bb} and R_2 . The value of R_e is then selected such that two stable emitter operating points are possible — one on the "cutoff" portion of the unijunction emitter characteristic below the peak point, and the other on the "saturated" portion of the characteristic above the valley point.

These points are indicated in figure 7.10 as "A" and "B," respectively, the straight line joining the two being a "load line" representing the load resistor R_e . It may be noted that both A and B correspond to stable

operating points, as they are each situated on sections of the emitter characteristic having a "positive resistance" slope. The difference between the two points is that at A the emitter current and hence the load current are but a few microamps, whereas at B they may be in the order of tens of milliamps.

Which of the two operating points applies at any given time depends upon the last triggering pulse fed to the circuit via the triggering inputs "X" and "Y." If the last pulse to arrive was either a positive pulse fed to input X or a negative pulse fed to Y, then the operating point will be "B" as the unijunction will have been switched to the conducting state. Conversely if the last pulse to arrive was a negative pulse fed to input X, the

junction is shown in figure 7.12. This is of interest because it does not take advantage of the switching or negative resistance aspects of unijunction behaviour, but rather of the fact that the interbase resistance R_{bb} varies with emitter current.

In effect, the unijunction is here used merely as a controlled-value resistor. Its interbase resistance is arranged to form an AC voltage divider with resistor R_1 , the divider controlling the proportion of an input signal applied to the input of the AC amplifier. The output of the amplifier is then rectified by diode D, which delivers only the positive half-cycles to capacitor C. The latter then discharges through the unijunction emitter circuit via resistor R_2 .

The idea is that when the output of the amplifier is low in amplitude, the

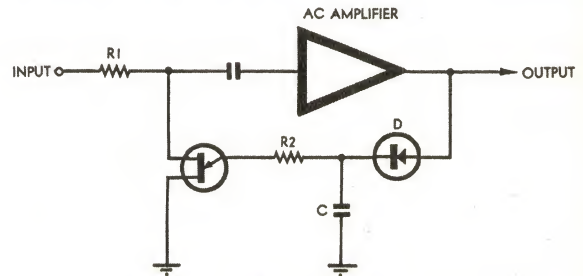

Figure 7.12

voltage developed across capacitor C will be lower than the unijunction peak point voltage, and the device will be cut off. Its interbase resistance will accordingly be fairly high (around 8K), and most of the input signal will be fed to the amplifier. However, if the output voltage from the amplifier rises to the point where the capacitor voltage reaches the unijunction peak point, the latter will conduct and its interbase resistance will fall sharply. This will cause a smaller proportion of the input signal to be fed to the amplifier, and will tend to reduce the output.

The system thus functions as an automatic output level control circuit, also called a limiter. As the interbase resistance of a typical unijunction falls to less than 100ohms at an emitter current of about 10mA, such a circuit can cope with a considerable range in input voltage, to maintain the amplifier output voltage substantially constant.

There are many unijunction applications additional to those briefly discussed in the foregoing, and some of these will be found in the literature listed below for suggested further reading. However, the few applications which have been given should help the reader to visualise the flexibility of the unijunction, and the way in which it lends itself to quite diverse applications.

operating point will be "A" because the unijunction will have turned off.

In each case the circuit will remain at point A or B until either the arrival of a pulse of the polarity necessary to switch it to the other operating point, or until power is removed. The circuit thus has the capability of being used for information storage.

A further adaptation of the basic unijunction oscillator is used for pulse counting. This is shown in figure 7.11; it may be seen that here the capacitor C is not charged up in a smooth fashion from the supply, but in a "staircase" fashion by individual input pulses applied via the diode D and resistor R.

By suitable choice of R and C, the capacitor voltage may be arranged to reach the unijunction peak point voltage only after the arrival of the last of a given number of input pulses—say five. The circuit will then deliver an output pulse for every five input pulses, and thus forms a simple pulse counter.

Yet another application for the uni-

SUGGESTED FURTHER READING

- CLEARY, J. F., (Ed.) *General Electric Transistor Manual*, 7th Edition, 1964. General Electric Company, Syracuse, New York.
- KYLE, J., "The Ubiquitous Unijunction," in *Electronics Australia*, V.29, No. 12, March 1968.
- MILLMAN, J., and TAUB, H., *Pulse, Digital and Switching Waveforms*, 1965. McGraw-Hill Book Company, New York.
- SPOFFORD, W. R. Jr., and STASIOR, R. A., "A Switch in Time," in *Electronics*, V.41, No. 4, February 19, 1968.
- SURAN, J. J., "Double Base Expands Diode Applications," in *Electronics*, V.28, No. 3, March 1955.

DEVELOPED IN AUSTRALIA for World demand

MODEL 2MBC— AN EXCITING NEW MSP TWEETER PRECISION DIE CAST AND OUT-PERFORMING ALLCOMERS

Now Available to the Australian Market!

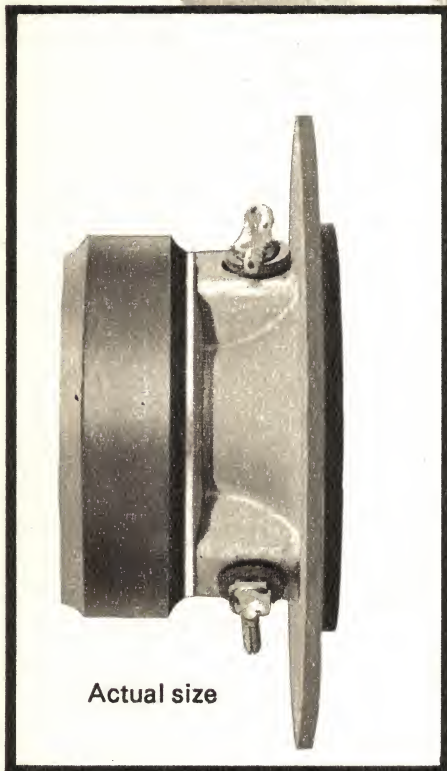

High Frequency Reproducer.

This speaker type 2MBC/15 is designed to cover the range from 5kHz to 20kHz. Its diecast housing completely seals the rear side of the cone ensuring that there is no interaction with the air pressure developed by other speakers within the enclosure.

The cone and voice-coil former are fitted as an integral unit, and this, coupled with the exponential cone shape, results in minimum total mass, high sensitivity and freedom from cone break-up and spurious responses often found in other types of construction. The overall response is substantially flat to 20kHz, and the inherent low frequency roll-off below 5kHz permits the use of a simple capacitor as the only crossover network required.

SPECIFICATIONS

Type 54814/2MBC/15HF

Frequency Response 5-20kHz.

Voice Coil Impedance:—

15 ohms: recommended crossover capacitor 2mfd.

Min. Total Flux:— 16000 lines

Min. Flux Density:— 12600 Gauss

Voice Coil Dia.:— 9/16"

Mounting Hole Centres:— 3" centres x .20" dia.

Baffle Opening:— 2-1/4" dia.

Overall Depth:— 1-1/2"



47 YORK STREET SYDNEY 2 0233

MANUFACTURERS SPECIAL PRODUCTS PTY LTD

ADELAIDE
51 0111

BRISBANE
31 0341

HOBART
3 3836

LAUNCESTON
2 1804

MELBOURNE
67 9161

PERTH
28 3425

SYDNEY
533 1277 & 29 7031

THE AESTHETICS OF AERIAL DESIGN

The design and siting of aerial structures is, in many instances, based on technical and economic aspects, with little regard to aesthetics, is the view of the author of this article. He indicates practical methods by which improvements can be made, usually without affecting either the technical performance or the cost. He considers that by giving due regard to the points raised, the visual amenities of the countryside can be preserved.

By M. F. Radford, M.A., C.Eng., M.I.E.E.



Aerials on a London house for B.B.C. and I.T.V. television, and FM sound broadcasts.

It is difficult to find a vantage point in England from which it is not possible to see an antenna. This situation has come about because antennas are a necessary part of modern civilisation and the best sites are high and unobscured. Those of us who live in the densely populated areas pass within sight of hundreds of antennas every day, and owe much to the protective mechanism in our minds which stops us from noticing every single one. Those who have the good fortune to live in areas which are as yet unspoiled, lack this protection and raise loud protests whenever any new landmark appears. This applies not only to antenna structures, but to buildings, roads, railways, airports, dams, bridges, reservoirs, in fact to any of the works of man.

With antennas however, there are additional difficulties. First, there is a lack of understanding of antenna design principles on the part of the layman, although the problems of the civil engineer and the architect are generally appreciated. As a result, the layman can offer constructive criticism of the design and siting of buildings and roads, and help the experts to arrive at an optimum, or at least a compromise, overall plan. On the other hand, the layman is afraid to offer guidance to the antenna expert since he believes his contribution will be valueless. Thus the whole burden of the artistic as well as the technical design of the antenna falls on the shoulders of the engineer.

Second, there is cost effectiveness. The engineer tries to give the best possible technical performance for the price paid and is unlikely to reduce

By arrangement with the Editor of "Point-To-Point Telecommunications," published by The Marconi Company, England.

performance in order to improve appearance, unless specifically asked to do so. The customer, frequently a public corporation or Government agency, is usually not prepared to spend substantial additional sums for the sake of aesthetics.

Third, there is the engineer himself. However liberal his early education, however broad his training, he cannot help doubting his own artistic judgment. He knows that he is conditioned by years of specialist work and that features which are associated with technical merit will seem pleasing to him, although they may seem quite the reverse to others. Such then is the extent of the problem. Where lies the answer?

It is important to choose the smallest antenna, or number of antennas, that will do the job. At HF for example, one modern wideband antenna will frequently replace several of earlier design. The saving is not only in appearance, but also in site area and the number of masts. In the television bands, one wide-band antenna will often replace two or three single-channel antennas and at the same time, give better protection from interference and ghosts.

In the microwave bands, high efficiency feeds enable smaller dishes to be used. The use of higher frequencies, where practicable, not only decreases antenna size and hence mast loading and windage, but also enables larger numbers of channels to be accommodated within a given percentage bandwidth.

So far, it seems that design trends which have purely technical origins are also likely to prove beneficial to appearance.

Frequently it is not the antenna itself which is objectionable, but the massive supporting structure. The an-

tenna alone may be insignificant in size, or may consist of almost invisible wires. One way of minimising the problem is to use one structure for mounting several antennas, not necessarily for the same purpose nor for the same operating organisation. Examples that spring to mind are antennas for television transmission combined with those for microwave links, and television transmission from a common mast or tower by different authorities on different channels such as the B.B.C. and I.T.A. The new Post Office Tower in London supports a revolving restaurant as well as microwave link antennas, and many tall buildings such as the Empire State Building in New York and the Eiffel Tower in Paris also support antennas and thus eliminate the need for separate structures.

Where a separate mast or tower is unavoidable, careful design can not only improve the appearance, but also lighten the structure, save steel, and hence money.

Recent years have seen important advances in methods of construction. Glass fibre laminates, plastics, honeycomb sandwiches, precision castings and complex extrusions have overcome their teething troubles and have become reliable and respectable. Although preferred for their reduced weight, lower production costs or improved accuracy, these techniques also contribute to cleaner, simpler designs and hence to good appearance. Shapes that are mechanically right for the stresses they bear are also, in general, artistically right. Again, it seems that technical and aesthetic considerations are working together.

A cynic might say that the best way to improve the appearance of an antenna would be to make it disappear altogether. This is in fact already being

'DELICA' MK.11 Hamband GRID DIP METER

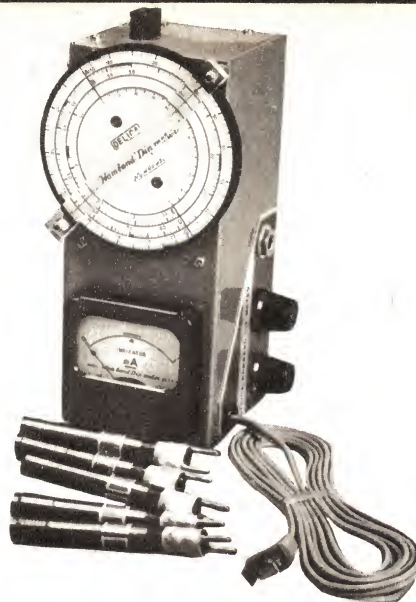

Incorporating important new features by Japan's Leading Electronic Instrument Manufacturer, A compact unit (7in x 2½in x 2½in), ideally suited to Amateur or Commercial Servicemen's requirements; the Delica offers these features:—

- CONTINUOUS COVERAGE FROM 1.3 Mc/s TO 150 Mc/s In 5 RANGES
- INDIVIDUALLY CALIBRATED TO 0.1 of 1 p.c. ACCURACY.
- Has ideal space for two additional bands.
- 1,000 cycle modulation by switch.
- Monitoring Jack provided.
- 3in. dial for easy reading.
- 3½in x ½in coils for access to "hard-to-get" areas.
- Instruction manual (12 foolscap pages) provided, giving valuable data on grid-dipping.
- Self-contained transformer to operate from 240V A.C. current.

(Spare coils available at \$2.30 each)

Price \$55.32 plus 40c postage

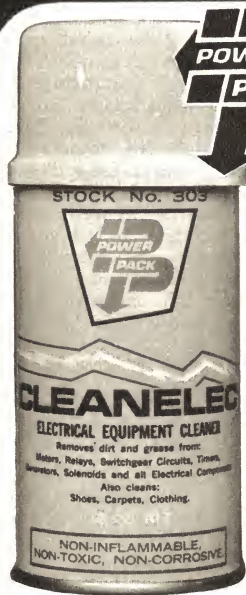

NEW!

CLEANELEC

Contact Cleaner

The latest quality aerosol product from the Powerpack people.

- Increases conductivity.
- Non-corrosive, non-toxic. Does not contain Carbon Tetrachloride. Non-inflammable.
- Safe to use on printed circuits, diodes, transistors, condensers, resistors, potentiometers, etc.
- Neutralises dust.
- Cleans away dust, flux and film from printed circuits.
- Large 12oz aerosol can. High powered, yet safe propellant means contents can be used to last drop.

PRICE \$1.98
(Add 25c postage.)
Stock No. 303.



SMITH SONS & REES LTD.,
30-32 Wentworth Ave, Sydney, 2000. Phone 20-956.
AND BRANCHES, Box 5038, G.P.O., Sydney, 2001.

Please send me I enclose \$.....
NAME
ADDRESS
..... P/Code

When you reach for
your iron—make sure it's a...

LOTRING

PICO-30TS—incomparable

THE LIGHTWEIGHT
TOOL WITH A BIG
PERFORMANCE!

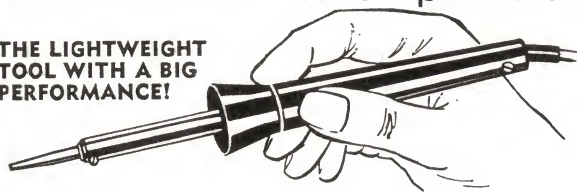

240V MAINS, NO TRANSFORMER REQ'D. Manufactured in Australia by Matson Automotive Industries. Wattage: 30. Heating Time: 1.8 minutes. Final Temperature: Designed not to exceed 410 deg. C. Will not burn out. Weight: 2½oz. Handle: Nylon. Element earthed inside handle.

Price \$5.98

LOTRING HOBBY KIT. Contains 30TS Iron — straight, angle and pokerwork bit, resin-core solder, screwdriver, file and wire brush.

Only \$7.95.

'30TS' for TRANSFORMER OR 12V BATTERY OPERATION. Completely portable. Operates from regular 12v automotive battery — or from any "hot" point in the car.

PRICE (12V) \$7.00.

HANDYMAN KIT: Containing Pico (50W) Special iron straight and angle bits, screwdriver, resin-core solder, wire brush, file. Range of specialty bits available. (Interchangeable elements available 25-120 watt)

\$7.95

(Add 25c postage for all Lotring Irons)

done, and the principle could be considerably extended.

Returning to the television band, a large proportion of domestic antennas would work equally well if installed in the loft space beneath the roof instead of on the chimney stack. Although initially the efficiency would be reduced by attenuation and reflections, performance would remain constant over the years, whereas the performance of outside antennas is gradually reduced by wind, weather, flue gas, corrosion and by penetration of moisture into cables and terminations. One has only to look at a row of town houses and count the antennas that are broken, bent, misaligned or obscured, to realise just how much gain the average domestic system has in hand.

In aircraft, high speeds have made suppressed antennas an absolute necessity. Even small protrusions cause serious increases in drag. Because of necessity, satisfactory suppressed antennas have been developed for a wide range of tasks and frequencies and are in daily use. The same techniques are now being applied to ships, where improved weather protection as well as cleaner design justifies the change.

There are many other possible ways of concealing antennas. They may be disguised as flagpoles on embassies; as roof racks on cars; they may be hidden in structures as notches or slots, or mounted flush with surfaces as printed circuit arrays. The possibilities are endless, but the art lies in knowing when to stop.

At the lower frequencies and with large antennas, complete concealment is not possible without unacceptable loss of efficiency. There remains much that can be done to make antennas less obvious. Slender masts for example, are less noticeable than towers. The siting of lower frequency antennas is seldom critical, and it may be possible to consider landscape effects when final positions are chosen. High ground is often uneven and of indifferent conductivity and there is much to be said for siting HF antennas on low lying ground, or if possible, by the sea. This enables a lower angle of fire to be achieved as well as keeping as much as possible of the antennas below the skyline.

The larger dishes, as used for tropospheric scatter and major microwave links, are also too big to hide. These too may frequently be sited just below rather than on the crest of a hill. The loss of height amounts to little more than one dish diameter, but the reduction in visibility is substantial.

There may be situations where it is worth considering the siting of dishes within conventionally shaped buildings having dielectric roof panels. This would only be worthwhile where appearance is of great importance, and where the education of public taste is such that a large familiar structure is preferred to a smaller unfamiliar one.

It has been shown that in many cases the interests of engineering and aesthetics are common, and that the fears that cost-effectiveness would encourage unattractive designs are unjustified. In the author's opinion, the best hope for the future is to concentrate on good engineering and good value. The grace of the wartime "Spitfire," the lines of a racing yacht,

Eyesore or landscape feature? Some maintain that the radome is a structure pleasing to the eye, and capable of enhancing the appearance of an otherwise featureless landscape. Others say that it is ugly, and a landscape destroyer.



the balanced proportions of a great bridge — these are the results of uncompromising optimum functional design. Compare the disastrous results of conscious styling on some modern cars and domestic goods, remembering that the styling has certainly increased the price and may also have reduced the functional efficiency.

For the rest, it is well to remember that public taste does progress. Returning to the vantage point at the beginning of the article, the medieval castle in the distance, now so romantic, was a dreadful eyesore to the peasants whose lives it once dominated. Recently in a hotel bar, the author heard a party of holiday-makers discussing a recently installed antenna with a promi-

nent radome. Although none of them knew its purpose, they did not object to it. On the contrary, they found that it added interest and a touch of science fiction to an otherwise plain landscape. Perhaps the layman is more prepared than we think to come to terms with his curious neighbour, the antenna.

Finally it is hoped that the skylines dominated by antenna structures, particularly in densely populated countries, will serve as a warning to those as yet unspoiled. Then, by a combination of good engineering and common sense, the benefits of radiocommunications may be spread with little or no loss of the natural beauty which, once destroyed, is so hard to restore. ■

Writing an article for "Reader Built It"

In recent months a number of readers have written asking "How do I submit articles for the 'Reader Built It' section?"

There are no formalities involved; simply post the article to us. However, for the benefit of intending contributors, here are a few points about the preparation of such articles. Attention to these will result in an article which will need a minimum of correction on our part and which, therefore, is much more likely to be accepted for publication.

A good idea of the kind of article we like for "Reader Built It" can be gained from studying what has already been published. An element of novelty is an advantage, since there is little point in presenting minor variations on circuits which have been presented dozens of times before in this and other journals. On the other hand, a routine circuit applied in a novel manner could be interesting.

Simplicity is another important characteristic. While we do not completely rule out complex projects, we have a natural preference for the simpler ones. First, they are easier for us to check and to present; a complex circuit takes a lot of checking and involves a lot of work for our draughtsmen. Secondly, a simple circuit is more likely to appeal to readers. They can understand it, and they are more likely to "give it a go" if the amount of money and effort involved is relatively small.

If you can arrange for an article to be typed, so much the better. This overcomes the problem of handwriting that is difficult to follow, with the ever-present possibility of mistakes, and makes it unnecessary for us to type the material ourselves. It also helps if typewritten material is double-spaced between the lines. This provides room for minor corrections. If the copy must be handwritten, PLEASE make sure that the writing is legible.

If using abbreviations, try to follow the same style as the magazine. It is not possible to list all the rules and examples which govern our style, but you can usually find an example of what you want in any recent article in the magazine. Such things might just as well be done right in the first place, since they only have to be changed if they are wrong.

Circuit or other diagrams do not need to be drawn as they will appear in the magazine, since they will normally be redrawn by our own draughtsmen anyway. But they must be clearly set out and, above all, accurate. If possible, have them checked by some independent person. Where layout is likely to be critical a sketch or photograph, suitably coded, should be submitted.

Photographs intended for reproduction must be sharp, well lit, and have good contrast. Prints should be reasonably large but, in any case, it is a good idea to submit the negative as well as the print. We can then make a print, in our own darkrooms, which is best suited for retouching, reproduction, and coding.

For readers living in the Sydney suburban area we suggest that, if appropriate, a telephone number be included in the address. While not usually needed, it can be helpful on odd occasions where it is necessary to clarify some small point.

All stories published will be paid for at ruling rates.

Forget kid gloves!

This SANWA Multimeter can take it and give you legibility and accuracy plus!

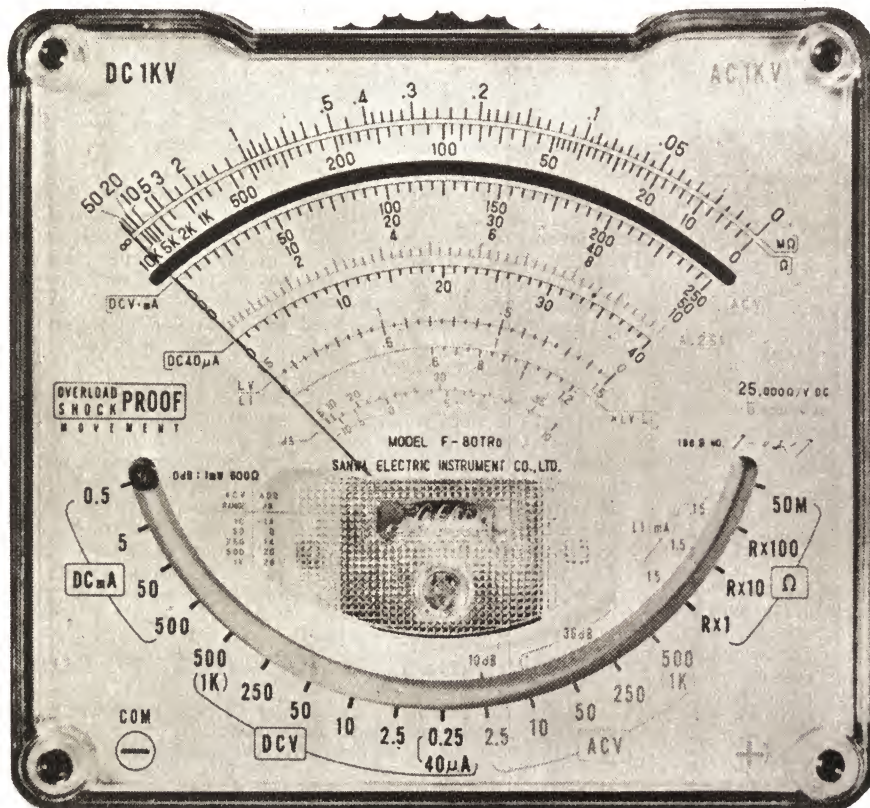

The Sanwa TR Series F80-TRD
(shown here actual size)

This unique multi-tester from Sanwa concentrates many measuring functions in a small panel area. It combines legibility and accuracy with rugged performance . . . ideal for the daily demands of "toolbox" use.

The Sanwa multi-tester has a sensitive taut band 34.5 microamp movement which is silicon diode protected against mechanical and electrical abuse. Range indication is

both novel and practical. A red ball appears against the range selected by the thumbwheel switch which may be easily operated single handed.

MEASUREMENT RANGES

DC Voltage: 0.25v-2.5v-10v-50v-250v-500v-1000v
(25kΩ/v)

AC Voltage: 2.5v-10v-50v-250v-500v-1000v (5kΩ/v)

DC Current: 40µa-0.5ma-5ma-50ma-500ma

Resistance: From 100 ohms to 250k ohms midscale
in 4 ranges

Load Current: L1-15ma-1.5ma-150µa

Load Voltage: LV-1.5v

Volume Level: -10~+10db-+5~+36db

AVAILABLE EX STOCK FROM WARBURTON FRANKI



WARBURTON FRANKI

ADELAIDE: 23-3233. BRISBANE: 51-5121. CANBERRA: 4-7755.
HOBART: 2-1841. LAUNCESTON: 2-1218. MELBOURNE: 69-0151.
MOUNT GAMBIER: 2-3841. NEWCASTLE WEST: 61-4077. PERTH:
8-4131. SYDNEY: 29-1111. WOLLONGONG: 2-5444.

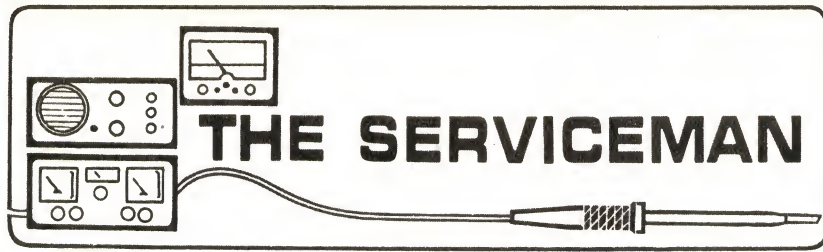

Next time a customer tells me "no picture," I'm not going to take their word for it quite so readily!

How long can a joint remain dry? For as long, I imagine, as it takes for it to gain the title "The Pub With No Beer!"

In this case, the anecdote has nothing to do with the building featured in the Australian song by that name. Nor has it anything to do with the ancient slab hut that climaxes the crazy drive through Skipper's Canyon in the South Island of New Zealand.

The thought was prompted by a service call from a very considerate elderly lady, who rang me early one Monday morning. She explained that the TV set has just faded right out during the Saturday evening feature. Rather than worry me over the weekend, she had left it till the Monday morning to seek my assistance.

Since there was no mention of anything alarming like smoke coming out of the back of the set, I simply switched it on when I walked into the room, pulled it away from the wall and prepared to take off the back plate of the cabinet.

With the plate off and the screws stowed where I could find them again, there was not the slightest flicker of a picture nor the slightest suggestion of sound — not even a trace of filter hum from the loudspeaker. In fact, the only sign of life was a cheery glow from the heater of the picture tube.

The only sign of life . . . Eh?

With something like a mental double-take, I realised that it was indeed the only sign of life. As far as I could see, every other heater was stone cold. Since I knew very well that the particular set did not use a series heater string, something had to be very wrong somewhere.

And it was.

In the particular set, there are two heater windings on the power trans-

Excessive light on a dark fault!

Though one tends naturally in these columns to feature unusual stories, day-to-day events follow a much more routine pattern—faulty valves, faulty controls, broken antenna connections, etc. Here are a couple of stories which are of the "in-between" variety.

"The set's going, but the picture's failed" was the rather contradictory message that I received.

When I arrived at the house, I was met at the door by the young man of the family, who must have been every bit of twelve years old. He hurried into the lounge room ahead of me, switched the set on and turned up the sound for me to hear.

"No picture," he said, "and the brightness is full on."

Without needing any further convincing, I pulled the set away from the wall and removed the back of the cabinet.

First check was to see if there was any EHT but, when I removed the EHT lead from the tube and brushed it against the chassis, there was barely enough to make a spark. I remembered the definition offered some time ago by a colleague:

"Hardly any erbs at all; just enough to tickle, like a one-day old beard."

The quite normal sound, that was issuing from the loudspeaker, seemed to suggest that there was nothing wrong with the normal HT supply but I plugged in a new rectifier anyway. When that did no good, I tried a new damper diode, a new line output tube, a new EHT rectifier and even a new line oscillator.

Still no difference.

It looked as if the chassis would have to come out, firstly for me to check the boost voltage and secondly to see if I could find whatever component under there was causing the trouble.

With this particular set, it is impossible to work on the chassis, connected to picture tube, without a fist-full of extension leads and a means to prop the chassis in a suitable position. Rather than get involved in this, I slipped the yoke off the tube neck and operated the set that way, hoping to find something obvious.

But no luck! The boost was obviously well down but, for the life of me, I couldn't see anything wrong that might account for it. It was beginning to look very much as if the line output transformer or the yoke was faulty.

At this point, there was nothing to do but to push the chassis back into

the cabinet, reinstall the yoke and see what I could find.

Then I remembered the lad's gesture in turning up the brightness control. Maybe, in being helpful, he had really thrown me off the track.

With the set switched on again, I closed the blinds to shut out the late afternoon sun and switched off the decorative standard lamp that was standing nearby. Then, very slowly, I turned down the brightness, peering closely at the screen.

And there it was, just the faint outline of a wedge-shaped raster, narrowing as it reached the bottom of the screen.

That's all I needed to see. The wedge of "keystone" shape was an almost certain indication that there were some shorted turns in one section of

Fred, we'll simply have to get this set fixed! ("TV Times")



the horizontal winding of the deflection yoke. The load was killing the EHT circuitry — almost.

The very low EHT voltage which resulted was just enough to put a glow on the screen, visible in a darkened room and with the brightness control at a critical setting.

Fortunately the receiver was a popular make and model and it took next to no time to grab a replacement yoke out of the truck and slip it into place.

Result? Back to normal.

Sooner or later I would have found the faulty yoke anyway, by a process of substitution but, if only I'd thought to examine the screen face more carefully, when I first entered the house, I would have been spared the always tedious job of pulling apart the chassis.

former, one to supply the picture tube, the other to supply the remainder of the heaters. Both windings terminate on a tagstrip with external leads running away to the sockets.

It didn't take long to establish that the trouble was simply due to a completely dry joint at the tagstrip supplying the valve heaters. To clean and resolder the wire was only a few moments' work. One might wish that faults were all that easy.

What intrigued me was the longevity of the fault.

At a guess, I'd say that the set was best part of ten years old and the heater wire had simply been resting in the lug for all that time, carrying amps of current and, presumably causing no bother at all.

Then suddenly, on a recent Saturday

"SO YOU'VE HEARD IT ALL" YOU'LL CHANGE YOUR MIND ONCE YOU HEAR THE MAGNIFICENT STANTON 681/EE

The fabulous Stanton 681 — the latest and most brilliant addition to the "Calibration Standard" Series. High compliance, low mass and superb channel operation, result in the Stanton 681, being hailed throughout the world as the top cartridge on the market. The mighty 681 is designed for low distortion tracking with minimum stylus force, regardless of the recorded velocity or the distance of the groove from the centre. It comes complete with individually calibrated performance data. Stanton 681T (.0007 conical stylus) \$55.00; Stanton 681/EE (.0002 x .0009 elliptical stylus) \$60.00; also available:— Stanton 500/A (.0007 stylus) \$25.00; Stanton 500/E (elliptical stylus) \$35.00



THE INCREDIBLE ACOUSTIC RESEARCH TURNTABLE



'A turntable years ahead of its time!' . . . the result of years of research. Since its introduction, the AR turntable has had a profound effect on both design and performance standards of home record playing equipment — yet it remains alone in the field! Unique, because it combines broadcast equipment performance, simplicity of operation and low cost. Its synchronous motor and belt drive make the AR turntable **INAUDIBLE** during operation. It has unusual stability — it is **INSENSITIVE** to floor vibrations or acoustic feedback. List price \$220 **FULLY GUARANTEED FOR 3 YRS.!**

When you visit our showrooms, you'll be enthralled by a magnificent hi-fi sound demonstration. And when you buy, you know you're choosing from one of the finest selections of sound reproducing equipment in Sydney. Listen at leisure to one of our best selling "value-for-money" combinations, carefully selected from the world's leading manufacturers.



1. PE2020 Turntable (Germany).
2. Stanton 500/E Cartridge (U.S.A.).
3. Sansui AU555 Stereo Amplifier (Japan).
4. Acoustic Research Model 4X speakers (U.S.A.).

The price for this superb combination is \$610.00, including delivery and installation and covered by a comprehensive and personal manufacturer's warranty.

STEREO MUSIC SYSTEMS

193 CLARENCE STREET
SYDNEY. 29-6681

A DIVISION OF:
W. C. WEDDERSPOONS
DISTRIBUTORS OF:

Acoustic Research—Bose Corp. Speakers—Monarch—Stanton—Telefunken

night, it decides to quit. Not erratically, not with any warning of trouble ahead. Suddenly it just quits cold and everything stops.

Oh that all dry joints would behave like that. Fewer servicemen would be spending part of their week "up the wall!"

And now, by way of a change, here's a story recounted by an acquaintance at a recent get-together. He works in the laboratory of a large electronic manufacturing company and, while he normally does not do repair work, these occasional jobs are inevitable to anyone in the electronic field.

Since I knew that he had had plenty of experience writing lab. reports, I

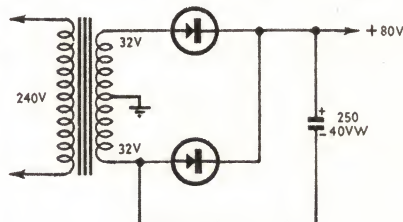

A simple error in the power supply wiring might well have carried off several transistors, but they were saved by another mistake!

asked him to write the story himself. What follows is his first-hand contribution:

"Normally, I have little to do with servicing but on this occasion I was asked to have a look at an amplifier that was described in Electronics Australia. It was the 10-plus-10 Stereo amplifier featured in the November, 1968, issue. My first reaction was to ask what was wrong with the amplifier, refer to the article and then give the owner a few clues to help him sort out the trouble.

"The owner described the amplifier as having lots of hum, which changed in quality when he turned the volume control to its maximum setting. He also stated that he could get no signal from the loudspeakers when he connected a record player with a ceramic cartridge to the system. Finally, he stated that his brother had received an electric shock, when he touched the case of the regulator transistor.

"At least the amplifier was apparently functioning but something was probably wrong with the input stage or wiring. As for his brother receiving an electric shock — this was queer. Reference to the circuit diagram showed that no more than 50 volts could be expected on the collector (case) of the regulator transistor, even allowing for poor transformer regulation.

"I was able to give the owner a few clues on how to check out the amplifier, using the finger technique. One simply injects hum into each stage by placing a finger on the appropriate input and gradually advancing the gain control. From this one can generally get an idea of the gain in each section or whether it's working at all. It's a rough and ready check but it can be quite handy at times. I also told the owner to check

(Cont. on page 205)

THE RESISTOR COLOUR CODE

A brief resume of the resistor colour code, with emphasis on low value and tolerance markings.

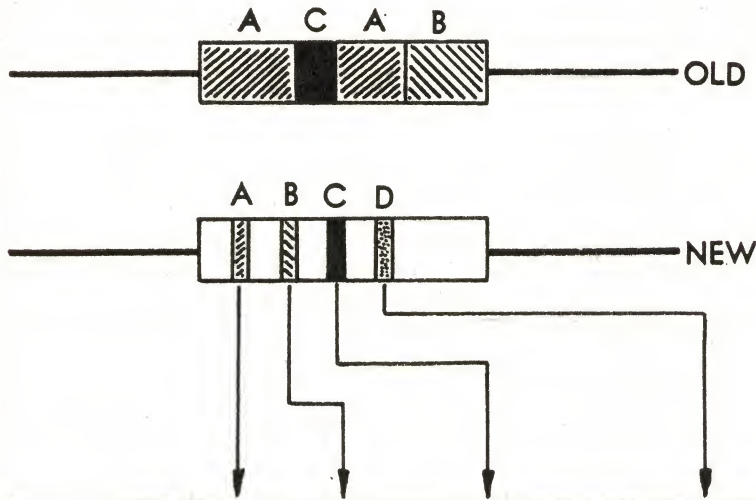

COLOUR	TENS	UNITS	MULTIPLIER	TOLERANCE
BLACK	0	0	$10^0=1$	NONE=20%
BROWN	1	1	$10^1=10$	1%
RED	2	2	$10^2=100$	2%
ORANGE	3	3	$10^3=1,000$	
YELLOW	4	4	$10^4=10,000$	
GREEN	5	5	$10^5=100,000$	
BLUE	6	6	$10^6=1,000,000$	
VIOLET	7	7		
GREY	8	8		
WHITE	9	9		
GOLD	—	—	$10^{-1}=0.1$	5%
SILVER	—	—	$10^{-2}=0.01$	10%

Examples: 47,000 ohms, 10%: Yellow, Violet, Orange, Silver.
 1,000 ohms, 20%: Brown, Black, Red.
 68 ohms, 10%: Blue, Grey, Black, Silver.
 4.7 ohms, 5%: Yellow, Violet, Gold, Gold.
 0.47 ohms, 5%: Yellow, Violet, Silver, Gold.

The majority of low power resistors in use today have an insulated body with coloured bands to designate the value and tolerance. The colour code was originally devised by the Radio Manufacturers Association (U.S.A.) to overcome the expensive problem of printing the value on the small bodies, although many close-tolerance, high stability resistors have the value, tolerance and power rating printed on them nowadays. However, for general purpose resistors, colour coding is still a cheaper and more effective method. The value is easily read and the colours are not likely to be erased by careless handling.

In the original colour code system (now obsolete) the first figure is denoted by the body colour (A). Thus, if the body colour is red, it follows that the first figure in the resistor value is 2. The second figure in the resistance

value is denoted by the end colour (B). If our previously mentioned red resistor has a violet end the first two significant figures are 27. The band or dot at the centre of the resistor (C) is the multiplier in powers of ten, i.e., it shows the number of noughts to be added after the two significant figures.

(Note that, while we have described the obsolete colour code, we do not recommend that old resistors be used in equipment unless their value is verified with an ohmmeter or resistance bridge.)

In the present system, instead of being applied to body, end and centre, the significant colours are applied as three or four parallel bands around the resistor and toward one end. The overall colour of the body has no significance whatsoever. The first two bands (A and B) designate the two signifi-

cant figures of the resistor value. The third band defines the multiplier in powers of ten, e.g., orange indicates a multiplier of ten raised to the power 3 which equals 1000.

For values of resistance below 10 ohms the third band will be either gold or silver to indicate a multiplier of one-tenth or one-hundredth, respectively.

The fourth band (D), designates the tolerance of the resistance value.

For resistors with an overall tolerance of plus or minus 20 per cent no tolerance band is used. For resistors with a tolerance of plus or minus 10 per cent the fourth band is silver and so on, as shown in the accompanying table. ■

RADIO: Unofficial history

In 1947, I was attached to an R.A.F. signals unit at Kalang Airport, Singapore, as part of an outfit which ran transmitters, receivers and diesel driven power supplies for the station. We built our own aerials and were generally steeped over our ears in RADIO—the only word which had any meaning for us.

With the war finished, we had plenty of time on our hands, and excessive stocks of equipment, so we spent much time experimenting, running "ham" stations and devising strange rigs.

Our star effort was what I claim as the world's biggest EVER receiver. This was made by my mate and myself from transmitter parts—huge triodes about 18in high, tuning coils from SWB Type 8 (each about 2ft long and 12in diameter), capacitors like bread slicers

Dangerous? Slightly so, but we were young and enthusiastic. We ended up with a two valver TRF set, tuned by a car steering wheel, operating at (as I remember) 10KV from an SWB8 power unit and diesel. Resistors were baked vitreous units. Output was to a conventional loudspeaker through a load of cascaded dropping resistors and transformers.

Efficiency—well about $\frac{1}{4}$ of 1 per cent. Still, the set was tunable, and signals were received. The whole thing occupied (without power unit) a van the size of a pantechicon. For aerial we used a triple-folded dipole which was certainly intended for more serious purposes.

Naturally, we were proud of our giant and had the "honour" of a visit from the Island's signals officer who wasn't very impressed. So we took it to pieces. He did the same to us!

This is all perfectly true. It was fun to make and it was an absolute joy for us that it worked, but, as I said earlier, it was utterly inefficient. Still, how many others among your readers have built a 40ft portable—it was on wheels, remember. (W.B., Brisbane, Qld.)

(Readers are invited to submit contributions to "RADIO: Unofficial History" and a publication fee will be paid for those used. Stories must be humorous and they must be true. Letters must be signed and the locale of the story indicated as a mark of good faith. The Editor reserves the right to re-phrase contributions as necessary to preserve uniformity of style. ■

**AMPLIFIERS — PREAMPLIFIERS — TUNERS — CONTROL UNITS —
GUITAR UNITS — INSTRUMENTS — INVERTERS — CONVERTERS —
RECEIVERS — TRANSMITTERS — REGULATED POWER SUPPLY —
TRANSISTOR AND VALVE TYPES.**

**1967
ALL WAVE
3-4-5-6-7**



**ANY PART FROM A
SINGLE RESISTOR
TO THE FULL KIT**

POPULAR KITS - TOP QUALITY - LOWEST PRICES

**INSTRUMENTS
C.R.O.**

1. 5in wide range.
2. 1963. 3in cal.
3. Audio.
4. 1966. 3in.
5. 1968—Audio.
6. Electronic SW.
7. W/band Preamp.

**MULTIMETERS
and V.T.V.M.'s**

8. 20K ohm/Volt protected M/M.
9. Probe for above.
10. Protected D.C. M/M.
11. Meterless V/meter.
12. A.C. Millivoltmeter.
13. A.C. Solid State Millivoltmeter.
14. Solid State A.F. Millivoltmeter.
15. Noise Distortion Millivoltmeter.
16. Standard V.T.V.M.
17. 1966—V.T.V.M.
18. 1968—V.T.V.M.

BRIDGES

19. Standard R/C.
20. 1966. R/C.
21. 1968 R/C and Signal Injector.

TV INST.'s.

22. Sweep and marker Generator.
23. Dual sweep Gen.
24. Silicon diode sweep Gen.
25. Silicon diode noise Gen.
26. Pattern Gen.
27. Trans. pattern Gen.
28. Wide range pulse gen

AUDIO INST.'S

29. 1960 Audio Osc.
30. 1962 High per. audio Gen.
31. Crystal locked std.
32. Electronic tuning standard.
33. 1965. Solid State audio osc.
34. Direct reading A.F. meter.
35. Sq. wave Gen.
36. 1967 transistor audio Gen.
37. Additive frequency meter.
38. A.F. tone burst gen.
- 38A. 1968. Solid state A.F. Generator.

R.F. INST.'s.

39. 6-band service oscillator.
- 39A. Trans. wave meter.
40. "Q" meter.

40A 1969 Dip Osc. Solid state.

41. G.D.O. wide range.
42. G.D.O. adaptor.
43. Trans. service osc.
44. Simple signal injector.
45. Transistorised signal tracer.
46. Transistorised osc.
47. Basic test osc.
48. Transistor test oscillator.

**MISCELLANEOUS
INST., ETC., KITS**

49. 1960 Trans. Tester.
50. 1968 Transistor test set.
51. Valve and Transistor tester.
52. Electronic Stethoscope.
53. Moisture alarm.
54. Electronic Pistol range.
55. Transistor Geiger Counter.
56. Light beam alarm.
57. Burglar alarm.
58. Flasher unit.
59. Transistor alarm.
60. Electronic switch.
61. Photo Timer.
62. Direct reading impedance meter.
63. Electronic anemometer.
64. S.W.R. Indicator.
65. Simple proximity alarm unit.
66. Pipe and wiring locator.
67. Electronic metronome.
68. Monophonic organ.
- 68A. Keyless organ.
- 68B. Theremin.
- 68C. Laser unit.
- 68D. Color organ.

BATTERY CHARGERS

69. Universal unit.
70. 1 amp unit.

REGULATED POWER SUPPLIES

71. Transistor, 9v.
72. Transistor, fully protected supply.
73. 1966 H.T. unit.
74. 1968 lab. type. 0-30v. supply
- 74A Simple Pwr. supply.

VOLTAGE/CURRENT CONTROL UNITS

75. Vari-watt unit.
76. Vari-tach. motor speed control.
77. 2KW auto-light dimmer.
78. 4KW auto. light dimmer.
79. Model train control unit.

80. Model train control unit with simulated inertia.

81. Above-hi-power.
82. No. 81 with simulated inertia.

TACHOMETER UNITS

83. 6 or 12v Std.
84. 6 or 12v Mullard.
85. 6 or 12v with dwell angle.
86. Tachometer and dwell angle unit for service stations.

TRANSISTOR IGNITION

87. Ro-Fo. 6 or 12v.
88. Hi-Fire 6 or 12v. (transformer).

POWER CONVERTERS

89. D.C.-D.C. 60w.
90. D.C.-D.C. 40w.
91. D.C.-D.C. 40w. 12v—input.
92. D.C.-D.C. 70w 12v—input.
93. D.C.-D.C. 100w 12v—input.
94. D.C.-D.C. 140w. 24v—input.
95. D.C.-D.C. 225w. 24v—input.

HIGH FIDELITY AMPLIFIERS MONO UNITS

96. Hi-Fi 3.
97. Mullard 3-3.
98. Mullard 5-10.
99. Mullard 5-10 transistor.
100. Transistor 20w.
101. Transistor 60w.

STEREO UNITS

102. Mullard 2-2.
103. Mullard (v) 3-3.
104. Mullard (t) 5-5.
105. Mullard (t) 5-5.
106. Mullard (v) 10-10.
107. Mullard (t) 10-10.
108. Philips Twin 10.
109. S.T.C. 10-10.
110. Wireless world transistor 20-20.
111. Hi-Fi 60-60.
112. Playmaster 2-2.
113. Playmaster 3 plus 3.
114. Playmaster unit 3.
115. Playmaster unit 4.
116. Playmaster 10 plus 10
117. Playmaster 101.
118. Playmaster (t) 105.
119. Playmaster (t) 113.
120. Playmaster (t) 115.
121. Playmaster (v) 118.

P.A. UNITS

122. 10 watt std.

123. 25 watt std.

124. 35 watt std.
125. 30 watt (t).
126. 100 watt std.
127. stereo P.A.

GUITAR UNITS

128. 10 watt std.
129. 25 watt std.
130. 35 watt std.
131. 50 watt std.
132. 70 watt (t).

133. Playmaster 102.

134. Playmaster 103.
135. Playmaster 40w. 118.
136. Playmaster 60w 117.
137. Guitar fuzz box.
138. Guitar Waa-Waa.
139. Reverb unit.
140. Guitar preamp.
- 140A. Guitar 50w. Solid State P/M 125.

STEREOGRAMS

141. Playmaster 105.
142. Playmaster 106.
143. Playmaster 107.
- 143a. Playmaster 124.

CONTROL UNITS

144. Playmaster No. 9.
145. Playmaster No. 10.
146. Playmaster No. 104
147. Playmaster No. 112
148. Playmaster No. 120.
149. Mullard 2v.
150. Mullard 3v.
151. Philips Miniwatt.
152. Wireless world stereo system unit.

PREAMP UNITS

153. Transistor—Mono.
154. Transistor—Stereo.
155. Transistor—Silicon. mono.

156. Transistor F.E.T. mono.

157. Transistor dyn. mic. mono.
158. Above-Stereo.
159. Playmaster 115 F.E.T. Stereo.
160. Playmaster 118 mag.
161. Sound projector.

MIXER UNITS

162. Trans. 4 ch. (1966).
163. Trans—4 ch. (1967).
164. Valve—4 ch.

TUNER UNITS

165. Playmaster u/style.
166. Playmaster No. 11.
167. Playmaster No. 114.
168. Playmaster No. 122.
169. Playmaster No. 123.
170. Philips Miniwatt.
180. Trans.—Long range.

TAPE UNITS

181. Trans. Preamp.
182. Playmaster 110 (M).
182. Playmaster 110 (S).
183. Power Unit 110.
184. Adaptor 110.
185. Playmaster 119 Adaptor.
186. Transistor V.O.X.
187. Tape Actuated relay.
188. Mullard Trans Tape Amp.

RECEIVERS

189. Fremodyne 4.
190. Fremodyne 4 R.F. Sock only.
191. Synchronyne.
192. Communications RX.
193. Deitahet RX.
194. 3 Band Double Change S/het RX.
195. Explorer VHF Transistor RX.
196. Interceptor 5 Semi-Comm. RX.
197. 1967 All-Wave 2
198. 1967 All-Wave 3
199. 1967 All-Wave 5
200. 1967 All-Wave 6
201. 1967 All-Wave 7
202. Transporta 7
203. Transistor 3 Band. 8
204. 3 Band 2V RX.
205. 3 Band 3V RX.
206. Interstate 5
207. Versatile Mantel Set.
208. All-Wave Transistor 3
209. A.B.C. 3
210. 1968 F.E.T. 3
- 210a. I/C TRF Rx.
- 210b. R.F. Preamp.
- 210c. "Q" Multiplier.

TRANSMITTERS

211. 144 MHz 50W. Linear Final.
212. 144 MHz 20W.
213. 144 MHz 75W.
214. 144 MHz 18W.
215. 144 MHz S.S.B.
216. 3 Band A.M.
217. Basic 3 Band.
218. 5 Band S.S.B.
219. 1967 S.S.B.

CONVERTERS

220. 50 MHz.
221. 144. MHz.
222. 50 and 144 MHz Crystal Locked.
223. 1965 S/W.
224. 1965 S/W 2 Band.
225. 1966 3 Band.
226. Basic S/W.

V.F.O. UNITS

227. Remote Unit.
228. 7, 8 and 9 H.F. and V.H.F.
229. All transistor.

Phone 63-3596

E. D. & E. (SALES) PTY. LTD.

Phone 63-3596

232 FLINDERS LANE, MELBOURNE, VICTORIA 3000

Public Address Units — Geiger Counters — Metal Locators — Decade Boxes — Mixers — Battery Chargers — Oscillators — Bridges — Parts Supplied for Projects in Electronics (Aust.), Wireless World, Practical Wireless, Electronics World, Electronics Illustrated, Practical Electronics, etc.

**P/M
124**



1968 Solid State. V.T.V.M.
ELECTRONICS (Aust.), Dec., 1968.

BATTERY CHARGER 1A
ELECTRONICS (Aust.), Feb., 1966



3-BAND SHORT-WAVE CONVERTER
ELECTRONICS (Aust.), May, 1966.

LAB QUALITY

Regulated Power Supply (0-30v)
ELECTRONICS (Aust.), Sep-
tember, 1968.

1966 R/C Bridge
May, 1966.



Excellent frequency response. Low distortion figure. High input sensitivity. All controls self-contained. 10 watts per channel.

PLAYMASTER STEREO 10 PLUS 10
COMPLETE KIT \$86.85



**PUBLIC ADDRESS and
GUITAR AMPLIFIERS**

10, 25, 50 and 100 watt
units



3-BAND DOUBLE-CHANGE RECEIVER
ELECTRONICS (Aust.), April, 1966.

1966 3in CRO
ELECTRONICS (Aust.), May, 1966.

Playmaster 122
Program Source.
Electronics (Aust.),
August, 1968.



FOUR-CHANNEL AUDIO MIXER
ELECTRONICS (Aust.) Feb., 1966 & 1967

3-BAND 3-RECEIVER
ELECTRONICS (Aust.), Nov., 1966.

**TRANSISTOR MILLIVOLT
METER**

Electronics (Aust.),
May, 1968.



*Enjoy your
leisure time
and build*

PLAYMASTER STEREO 3 PLUS 3
COMPLETE KIT \$54.25

**MAJOR STOCKISTS OF ALL GENERAL RADIO & ELECTRONIC COMPONENT
PARTS -- YOU NAME IT -- WE WILL QUOTE**

VALVES — TRANSISTORS — ZENER & POWER DIODES — SEMI-CONDUCTORS — DIACS — TRIACS — S.C.R.'S. — I/C'S. SPEAKERS — MICROPHONES — COILS — IFT'S. TRANSFORMERS — INST CASES — METALWORK. PLAYERS & CHANGERS — METERS — RELAYS — CONDENSERS — RESISTORS — BEZELS — STYL II — CARTRIDGES — RECORDING TAPE — PROBES — INSTRUMENTS — POTENTIOMETERS — CRYSTALS — FERRITE BEADS — CORES — BALUNS — TERMINALS — CO-AXIAL PLUGS & SOCKETS — MULTI CONNECTORS — PRINTED CIRCUIT BOARDS — COPPER WINDING WIRE — ETC. — ETC. —

Phone 63-3596

E. D. & E. (SALES) PTY. LTD.

Phone 63-3596

232 FLINDERS LANE, MELBOURNE, VICTORIA 3000



3 OF A KIND WITH A DIFFERENCE



PE31

(PE31R & PE31K) Long Play Tape
A hard wearing Long Play Polyester base tape that stands up to rough treatment, PE31 is especially designed for professional and semi-professional uses. PE31 is unaffected by changes in temperature or humidity because it's tropicalised.



PE41

(PE41R & PE41K) Double Play Tape
The universal tape for all fields of application. A tape with great flexibility on a pre-stressed polyester base. This is the all purpose tape for the amateur. As with all Agfa polyester tapes, it is unaffected by changes in temperature and humidity. Recommended for 4-track and 2-track recordings on home recording equipment.



PE65

(PE65R & PE65K) Triple Record Tape
Because PE65 is so thin any spool of PE65 WILL HOLD twice the length of longplay tape. This doubles the playing time. Like all Agfa polyester tapes, it has high resistance to wear and tear in spite of its thinness. The outstanding flexibility of Agfa PE65 ensures close contact with the recording head. Recommended especially for four-track recorders.

PE31PE31RPE31KPE41PE41RPE41KPE65PE65RPE65K?



PE31-PE41-PE65

(in Cardboard Archive Box)
Agfa PE (POLYESTER) tapes are available in the famous cardboard swivel box. This pack allows you to file your tapes in a library fashion.



PE31R-PE41R-PE65R

(in transparent economy pack)
The transparent economy packs are easy to store, and are very reasonably priced.



PE31K-PE41K-PE65K

(in attractive Novodur Plastic Swivel Type Box)
Perfect for the enthusiasts. This pack allows you to store your tapes in a neat compact library. The Novodur pack is attractive, and also permanently dust-proof and unbreakable.



Agfa Magneton Universal Mailing Cassette

3" Agfa tapes are available in this attractive, unbreakable mailing cassette. This cassette is ideal for mailing to friends interstate or overseas.

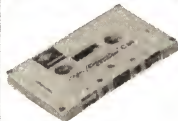

Compact Cassette

Also available are compact cassette C60 supplied with PE65 Triple-Play tape and C90 with PE85 unrecorded.

Write for FREE leaflet on Agfa Recording tapes and accessories.

AGFA-GEVAERT LIMITED

P.O. Box 48, Nunawading, Victoria. 3131

NAME..... (PLEASE PRINT)

ADDRESS.....

STATE..... POSTCODE.....

*Registered trademark AGFA-GEVAERT Antwerp/Leverkusen.

AGFA-GEVAERT LIMITED • MELBOURNE • SYDNEY • BRISBANE • ADELAIDE • PERTH

CERAMIC RESONATORS

in practical applications 3

A description of a practical IF strip, featuring sharp and narrow response curves, a BFO, an AGC system suited to AM or SSB-CW, and using ceramic resonators throughout. Built as part of a communications receiver now under development, the details are given for the benefit of those readers who would care to experiment.

By Ian Pogson

In a previous article, we looked at the characteristics of some ceramic resonators, normally intended for applications in simple broadcast receiver IF systems. Until then, it had generally been accepted that these resonators had fixed characteristics, particularly with respect to their centre frequency. Also, any deviations from this centre frequency, from one unit to another, due to maker's tolerances, had to be accepted. This presented problems when a designer desired to combine two or more of these devices, to achieve a certain performance characteristic.

It was shown that the concept of a fixed centre frequency was not valid and that, within very useful limits, the centre frequency and other relevant characteristics could be controlled quite readily. This opened up the possibility of combining two or more of these devices to achieve desired band widths and shape factors. Indeed, it was also shown that these factors could be readily controlled and that filters rivalling mechanical and crystal lattices could be produced. And all at a very attractive cost and with minimum space requirements.

In addition, it was demonstrated that these resonators could be used as an oscillator at (a nominal) 455KHz, thus suggesting its possible application in a receiver BFO. Such oscillators subsequently turned out to be very stable, while the frequency could be shifted by at least ± 3 KHz from the centre frequency of 455KHz. This gives the ceramic oscillator the advantages of both the crystal and self-excited BFOs. Once again, all at a very attractive cost.

This article will investigate the possible applications of this type resonator in the roles of IF filters of various characteristics, and as a BFO. Some of the information describes actual units which could be applied to solid state receivers. Circuits are based on our developments up to this point and are offered as suggestions and a place from which to carry on development.

We have pursued our recent findings with an eye to incorporating them into short-wave and communications receivers, which we hope to produce later on. Although the circuits shown may be subject to subsequent changes and modifications, they should be of

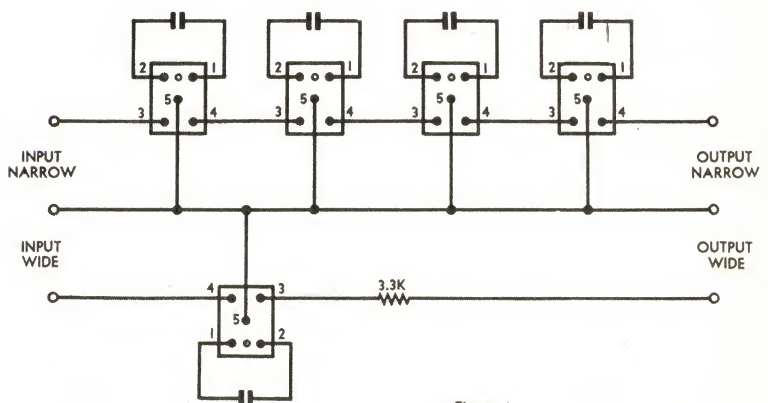

Figure 1

This block diagram shows the arrangement of the resonators and other components on the wiring board assembly. Note the 3.3K resistor, part of the output divider. At right is a typical set of curves from this system.

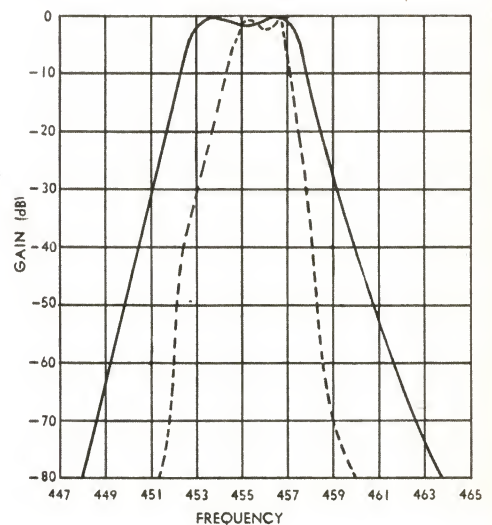

Figure 2

interest to readers who may wish to use them as they are, or for experimental purposes.

We have already developed a complete IF system, using all solid state devices and without any conventional IF transformers. This has resulted in a most compact module, capable of high performance at an attractive price.

The system to be described starts after the mixer. It includes a dual-selectivity ceramic filter assembly, followed by three IF amplifier stages. The AGC system, although relatively simple, is amplified, provides for long

and short time constants, and is capable of quite a good performance. The detector, again a very simple arrangement, provides for AM, CW and SSB reception and is highly effective. The BFO used with this detector is that which was described earlier using a ceramic resonator. It is capable of being switched for upper and lower side-band reception. Checks made so far indicate that the system, as a whole, will give every satisfaction at a moderate cost.

Let us look at the circuit diagram and discuss the various parts and func-

specialist Hi-Fi equipment

The most technically advanced sound equipment in the popular price category.



Jorgen Model A303 solid state stereo amplifier.

Specifications:

- 19 transistors, 8 diodes.
- Music power 30 watts.
- Frequency response 30-20,000 CPS \pm 2db.
- Complete in attractive polished wooden case.
- Stereo headphone jack on front panel.
- Exclusive loudness control (good bass at low volume).
- Scratch filter.
- Harmonic distortion less than 1%.
- Hum and noise level on magnetic phono — 50db.
- Sensitivity — magnetic input 3mv, tuner or auxiliary 250mv.
- Plug in tape recorder facilities.

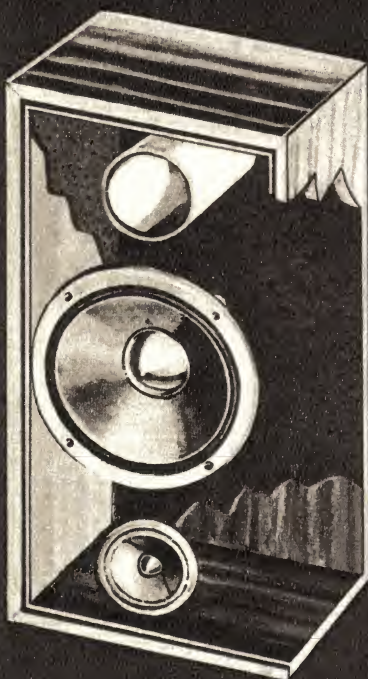

Jorgen SE50 true 2 way book shelf speaker system.

Specifications:

- 8" Woofer and 4" Tweeter high quality hi-fi speakers.
- Tuned enclosure with tube-type Bass Emitter.
- Overall response of 35-18,500 cycles.
- 3,000 CPS electrical crossover.
- 20 watts power handling capacity.
- Front cloth — choice of light (No. 6) or dark (No. 9).
- Polished wood cabinet.

Jorgen Model R400 solid state tuner amplifier.

Specifications:

- 33 transistors, 21 diodes.
- Music power 40 watts.
- Frequency response 20-20,000 CPS \pm 2 db.
- Complete in attractive polished wooden case.
- Stereo headphone jack on front panel.
- Loudness control (good bass at low volume).
- Scratch filter.
- Harmonic distortion less than 1%.
- Hum and noise level on magnetic phono — 55db.
- Sensitivity — magnetic input 2mv, auxiliary 250mv.
- Plug in tape recorder facilities.



Jorgen offers you the right combination in features and price in specialist hi-fi equipment. Australian Musical Industries are increasing their Australian dealership for Jorgen hi-fi equipment. If you want to be a new dealer for Jorgen (and you should), contact:

AUSTRALIAN MUSICAL INDUSTRIES PTY. LTD.,
 155 Gladstone Street,
 South Melbourne, Vic., 3205.
 Telephone 69 7281.
 Telegrams AMUS (Melb.).

Retail Enquiries

VIC. Brashs Pty. Ltd., N.S.W. Convoy International Pty. Ltd., Sydney. 29 6475. S.A. Savery's-Cawthorn Pty. Ltd., Adelaide. 51 3481. TAS. BBC Radio Centre Pty. Ltd., Burnie. 31 4415. W.A. Albert TV & Hi-Fi Centre Pty. Ltd., Perth. 21 5004. Suttons Pty. Ltd., Melbourne. 60 1201.

tions. For convenience, we have shown a mixer stage using a FET, but more will be said about mixers later on. There are two degrees of selectivity provided for — "wide," about 5KHz at the 6dB points, and "narrow" about 2.5KHz at the 6dB points. The complete filter assembly is made up on a compact wiring board measuring only 2in x 1 1/4in. By the time this appears in print, or shortly afterwards, we expect that boards should be available.

Figure 1, shows details of the components on the wiring board. Note the 3.3k resistor in series with the output of the wide filter section. This resistor forms part of a voltage divider which is necessary to bring the output of each filter section to the same level. The insertion loss of the multi-section narrow filter is much higher than the single section, but, with the voltage divider suggested, the sensitivity and signal strength meter readings will remain the same for both positions.

In order to adjust these two levels it is necessary, after the system is operative, to adjust the value of the resistor at the input of the following stage. The value will lie somewhere between 100 and 390 ohms, from our experience.

The circuit of figure 1 is shown in practical form in the accompanying photographs, built on a printed wiring board. In this particular unit there are four shape-correcting resistors on the narrow filter and one on the wide filter. This is more than is generally necessary and simply indicates the variable nature of individual filters. Representative curves of the two selectivity positions is given in figure 2.

Selection of the narrow or wide filter is by DC biased diodes in series with both input and output signal circuits. This method has been used by the writer in the past, with complete success. It offers the advantage that there are no long leads involved in the signal path and that the switch proper can be located at any convenient position on the front panel.

The operation of the diode switching is as follows: Consider the input side first. There are two diodes, one in each filter line, both cathodes being connected to the FET drain. On each filter side of the diodes is a 2.5MH RF choke, which becomes the drain load when required. The other end of each RF choke is terminated at a toggle or other suitable switch. This switch connects one RF choke to the positive 12-volt supply line and the other to earth. The circuit connected to the supply line has its diode connected such that it conducts and feeds the FET drain. This also allows the diode to conduct signal from the drain to the appropriate filter.

The other RF choke is connected to earth and completes the circuit where-

This circuit diagram shows how the ceramic resonators may be applied to a practical IF amplifier strip, together with the additional application of the same resonators as an oscillator for the BFO. This oscillator is highly stable and may be shifted in frequency for upper and lower sideband reception.

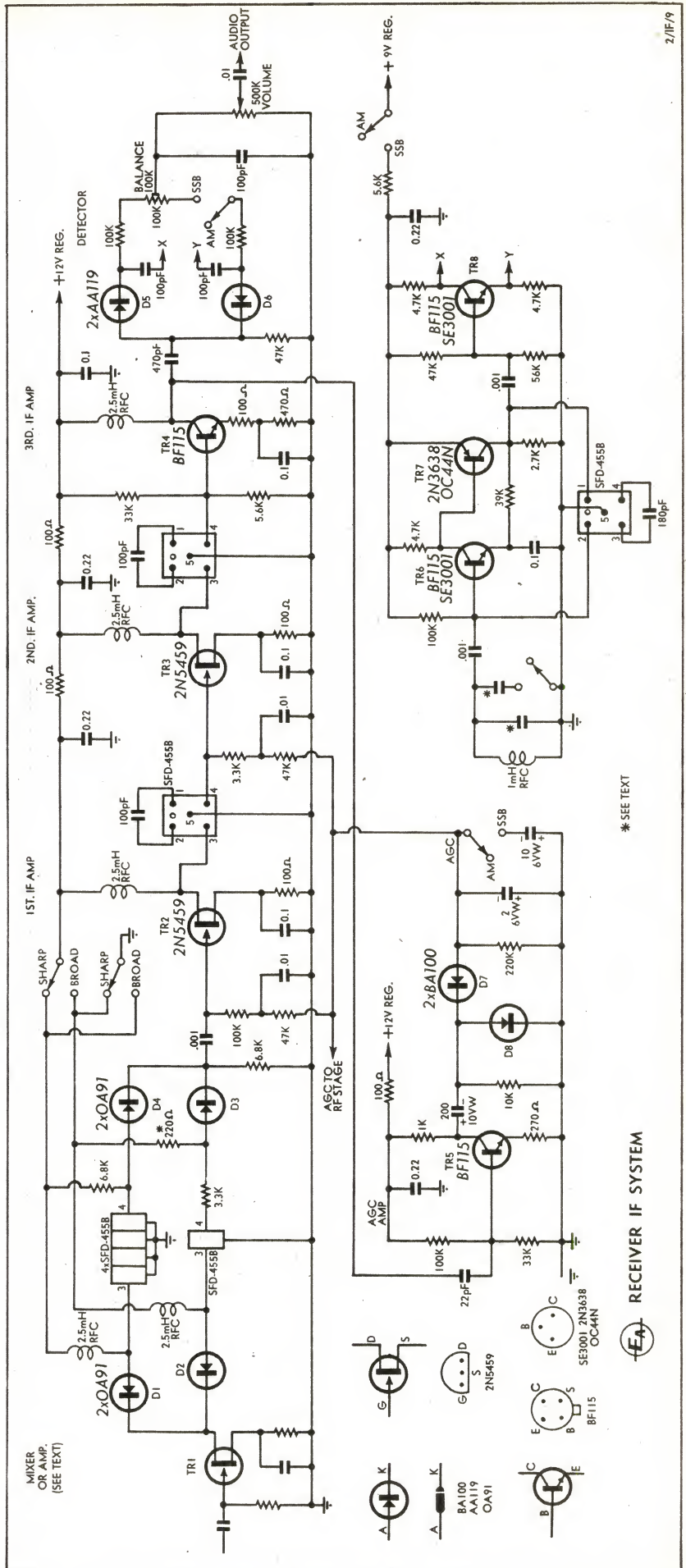

* SEE TEXT

RECEIVER IF SYSTEM

NOW AVAILABLE IN AUSTRALIA WELLER TEMPERATURE CONTROLLED SOLDERING IRONS!

Weller Temperature Control.

The tip temperature controls the iron! Using the CURIE POINT principle the ferrite pellet in the tip changes its magnetic state precisely at the control temperature.

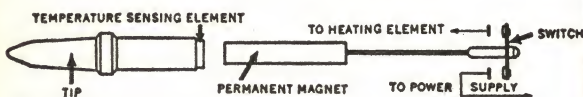

This attracts or repels the permanent magnet opening or closing the heater element switch contacts.

The only control factor is the actual tip temperature.

No matter how long a Weller W-TCP unit has been idling, it is always ready for use at the selected temperature.

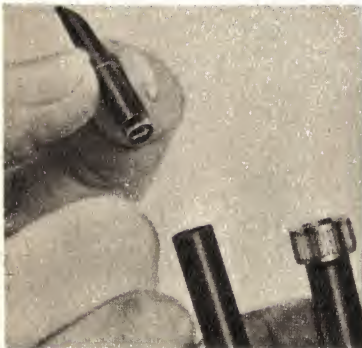

With Weller you don't change the iron—you simply change the tip.

Four temperature ranges
500°-800°F (260°-430°C)

Seven tip styles

1/32-3/16" (0.8-5.0 mm.)

Total of 24 tips available for one Weller TCP—soldering iron.

Important: Pre-tinned iron plated tips must never be filed!



Advantages of Weller W-TCP Soldering Iron

1. Temperature Control — prevents component damage—eliminates burning of solder and flux—ensures consistent results
2. Safety Factors—low voltage iron operation—burn-resistant silicone flex
3. Plated Tips—extra long-life—no filing required
4. Speed of operation—faster warm-up time
5. Less fatigue—light, well-balanced design



The W-TCP unit as illustrated is available boxed complete with—TCP-1 low voltage (24V) soldering iron—PU-1A Power Unit 240V 60W INPUT, 24V 2 Amp OUTPUT

DISTRIBUTORS:

Available from leading electrical retailers and hardware stores.

Trade Enquiries

N.S.W.

1. General Accessories Pty. Ltd.
2. Cema (Distributors) Pty. Ltd.

VIC.

1. General Accessories Pty. Ltd.
2. Cema (Distributors) Pty. Ltd.

S.A.

1. General Accessories Pty. Ltd.
2. Cema (Distributors) Pty. Ltd.

by the associated diode is reverse biased. This results in the diode presenting a high resistance between the FET drain and the other filter. By reversing the connections at the switch the opposite condition will prevail.

The foregoing looks after the input side of the filters. However, the outputs also have to be switched. This is done in a similar manner but it is somewhat modified to cope with a different set of conditions. Resistors are used from the switch to the individual diodes in this case, one being the resistor which has to be adjusted to equalise the gain, as mentioned previously. The two cathodes of the diodes are connected together as before. However, as there is no natural DC circuit return, this is created by adding a 6.8K resistor from the cathodes to earth. Switching is then effected in the same way as at the input.

The resistors used in the output circuits of the two filters are so selected that they provide about the right terminating value required. As this DC circuit must be isolated from the following FET IF amplifier gate, a blocking capacitor is introduced.

Before leaving the filter, a question may arise and is answered in anticipation. Two RF chokes are used on the input side and the economy of this may be questioned. Because of the relatively high current drawn by the FET, compared with a bipolar transistor, a drain feed of low DC resistance is necessary. The switching arrangement could be modified so that only one RF choke is necessary, but this involves complications and reduced gain. In any case, in the final application, the mixer may be so changed that this question may not arise.

The next stage uses a 2N5459 FET. These are relatively cheap and readily available. AGC is applied to the gate circuit. The drain load is again a 2.5mH RF choke, the reasons for its use being the same as for the mixer. Coupling between this and the following identical stage is by means of a slightly over-coupled ceramic filter unit. The output of the second FET stage is coupled into a third and uncontrolled IF amplifier, using a bipolar transistor. This may be a BF115 or any similar type.

There are two further points concerning this stage. A small amount of degeneration is introduced into the emitter circuit, with an un-bypassed 100 ohm resistor, so that the stage may handle a larger signal without overload. The collector load is a 2.5mH RF choke. This is used so that extra gain may be obtained from the stage.

Before leaving the IF strip, a brief comment about the reasons for using FETs in the first two stages and a bipolar transistor in the third stage. It had already been decided that, in a complete receiver design, we would be using a FET in the RF amplifier stage. This means that a negative AGC voltage would be needed. As it would introduce complications to provide control for this stage and something different for the IF stages, we decided that it would be the simplest way out to use FETs where AGC is to be applied. In the third stage, where no AGC is applied, a bipolar transistor

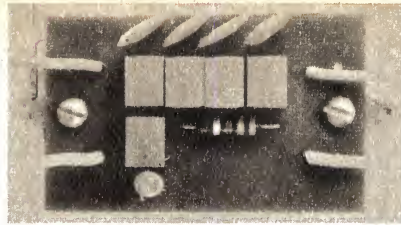

A top view of the filter assembly, showing the simple arrangement of the resonators, top coupling capacitors and 3.3K resistor. The board is shown approximately full size.



This underneath view of the filter wiring board shows the earthing lugs and a typical set of shape-correcting resistors.

offers the advantages of lower cost and higher gain.

Signal for AGC is taken from the collector of the third IF amplifier. This is fed into a AGC amplifier, using a BF115 or similar transistor. The gain of this stage is restricted by using a low value of coupling capacitance, about 22pF, and an un-bypassed 270 ohm emitter resistor. The full gain of the amplifier provides more control than necessary, and introduces a problem of BFO signal breakthrough. This gives an unwanted AGC voltage under CW-SSB reception conditions.

The AGC amplifier collector circuit provides a low source impedance for the signal, which is then rectified and gated with two silicon diodes, type BA100, or similar. Silicon diodes were selected in preference to germanium types, to provide a small amount of voltage delay, which is a worthwhile improvement. Two time constants are provided, to cope with AM and CW-SSB reception. We used tantalum 2uF and 10uF capacitors but ordinary electrolytics are satisfactory.

The detector is one which was originally described by Frederick W. Brown, in CQ for March, 1965. After checking this combined AM and CW-SSB detector, one wonders why other and more complex devices are used so commonly. As can be seen, it is about

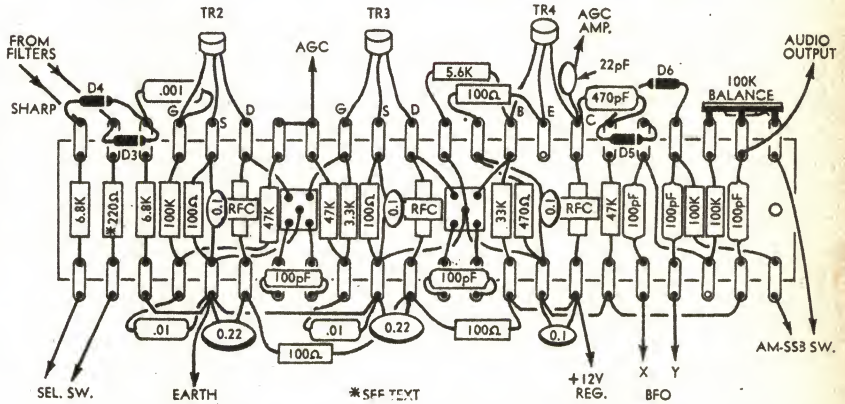

Wiring diagram of the IF strip and detector shows clearly how the components are wired in. This should be studied along with the relevant picture and that part of the circuit.

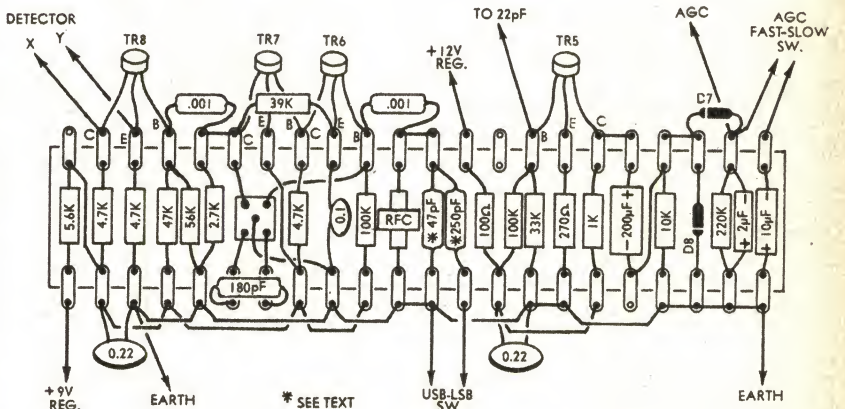

Corresponding with the opposite side of the main assembly, this is the wiring details for the BFO and AGC circuits. As with the IF strip wiring, this should also be checked against the photograph and circuit.

Who put 18 great speakers in those little bitty boxes? And why?

A company by the name of Bose put 9 full-range 4-inch loudspeakers in each of these little five-sided boxes.

After twelve years of research Bose found it was the only way to bring true concert hall sound into a living room. (Only 11% of the 901's sound reaches you directly. 89% is reflected off the walls, ceiling and floor — just as in a concert hall.)

The Bose bass is natural and full, because all 9 speakers in each box are wired to work together.

And the Bose 901 system comes complete with a unique solid-state equalizer that lets you match the sound to the acoustics of any room, and to your own personal taste. For \$750 you get both stereo speakers and the equalizer.

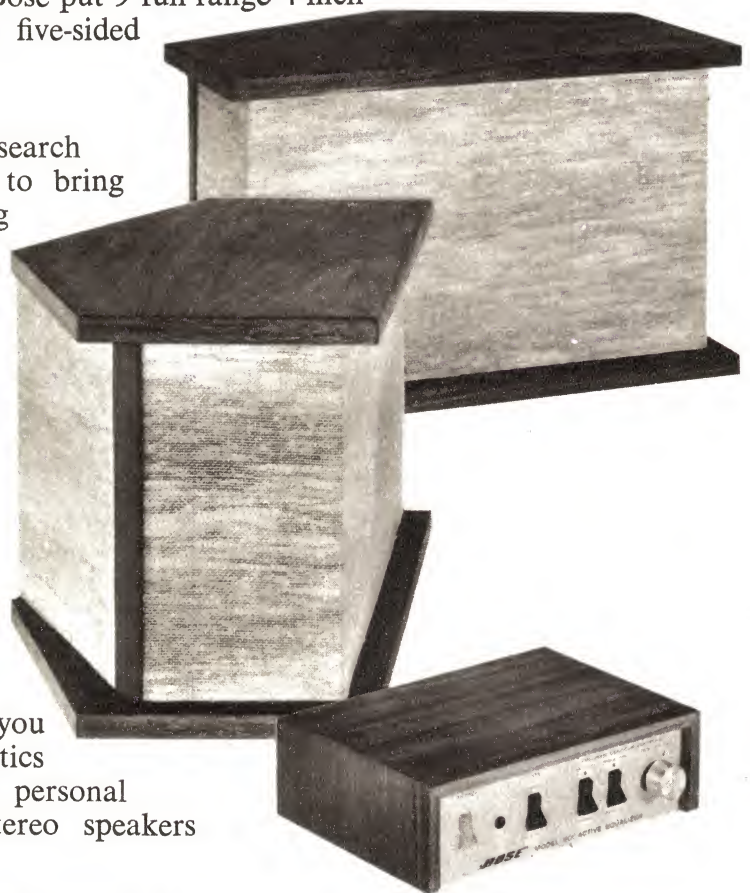

When you hear the remarkable sound of the Bose 901, you'll probably have lots more questions. So hear it at the places that can answer them.

SYDNEY		MELBOURNE		PERTH	
Stereo Music Systems	29-6681	Australian Hi Fi Electronics	34-6788	Leslie Leonard	21-5067
Kent Hi Fi	29-2745	Southern Sound	97-7245		
Sydney Hi Fi Centre	29-1082				
AUSTRALIAN DISTRIBUTORS:					
W. C. WEDDERSPOON PTY. LTD. 193 CLARENCE STREET, SYDNEY 29 6681					

as simple as it could be. It uses two diode detectors, as for AM reception, but with the diodes connected in opposite polarities. When the switch is open, only the top circuit is operative and the circuit operates as a conventional diode detector. However, with the switch closed, and no BFO injection the signals from the two diodes cancel, provided the circuit is balanced.

Under such balanced conditions no audio output will be available; the network thus exhibiting a characteristic of a product detector. When injection is introduced from the BFO, the circuit functions as a mixer, thus giving output from CW and SSB signals.

Although it may not be essential, we used a matched pair of AA119 diodes and we suggest that their inclusion would be worthwhile. Apart from the other desirable features of this detector, the switching is the simplest possible. Reasonably long leads can be run to the switch on the front panel without any problems.

The BFO is the same as described in a previous article on the subject, (October, 1969, page 49). This is among the new and exciting circuits which are emerging from our investigations into ceramic resonators. The first transistor in the oscillator may be a BF115 or any one of a number of similar types. However, the second stage must be a PNP type, connected as shown. It may be a silicon type 2N3638 or similar, but there are many PNP germanium types which can be used successfully, such as OC44N, OC170, etc. The third transistor is simply a phase splitter and such types as BF115 or similar may be used.

Although we have used a transistor in the role of phase splitter, we are looking into the possibility of using a small transformer, wound on a "balun" type of ferrite core. So far we have not concluded these investigations.

The SFD-455B ceramic resonator is situated in series with the feedback loop of the oscillator. Note that the connections to the resonator are "upside down," compared with the normal interstage coupling connections. In other words, the coupling capacitor is connected between pins 3 and 4, and the input and output are via pins 1 and 2. Also, the top coupling capacitor is larger than usual, being 180pF. These changes allow a greater frequency shift to be achieved more readily.

Frequency shift is achieved by introducing inductance and capacitance, in the right proportions, in the base circuit of the first transistor. The inductance is a standard 1mH RF choke (2.5mH will not do). Two capacitors are selected to give the required frequencies for upper and lower sideband resolution, after the system is put into operation. The two values fitted to this prototype are 68pF and 100pF. For the low frequency operation, the 100pF capacitor is switched in parallel with the 68pF unit.

At this point, we draw readers' attention to the power supply described in August, 1969. This supply could be used as a supply for this new IF system.

It is important that the BFO be fed from a well-stabilised supply. The most convenient source is the 9V



IF amplifiers, following the filter assembly, with input at right and the AM-SSB detector at the left. Note the balancing potentiometer.

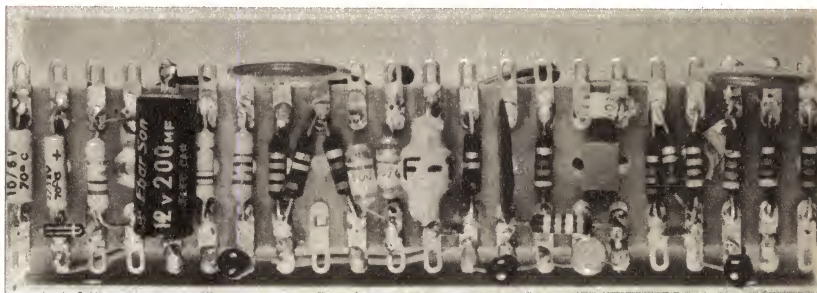

This side of the complete assembly shows the BFO components at the right, with the AGC amplifier, rectifier and time-constants at the left.

These graphs show clearly the comparative stability characteristics of the ceramic resonator, crystal oscillator and a self-excited oscillator.

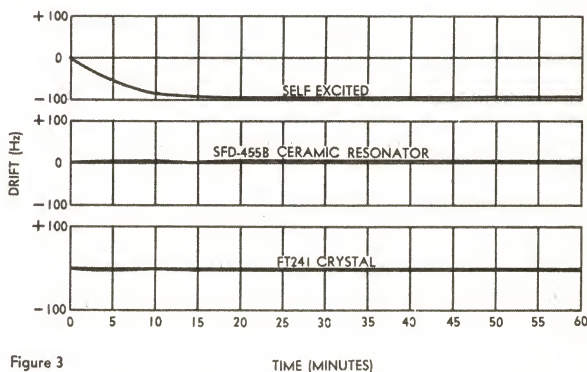

Figure 3

TIME (MINUTES)

double regulated outlet from the above power supply, which has excellent stability. However, the BFO requires no more than six volts. This gives sufficient output for the product detector, whereas higher output, as from a higher supply voltage, causes BFO breakthrough into the AGC system, which must be avoided. We used a dropping resistor to reduce the supply voltage, but the value shown may need to be modified on an experimental basis, or if a different supply voltage is used.

When switching from AM to CW-SSB reception, a simple double pole single throw toggle switch is all that is necessary. For AM reception, both poles are open; for CW-SSB, both are closed. To simplify this function still further, a three-pole switch could be

used, the extra pole being used to switch the AGC time constant.

As a matter of interest we are reproducing drift curves, comparing a self-excited and a crystal-controlled BFO, with the ceramic resonator BFO. (Figure 3.) Although the new BFO uses three transistors, it is still economical, when compared with the other types.

Although this article is not intended to be a constructional project in the normal sense, it may stimulate investigation into the possibilities of ceramic resonator application. For this reason, we will go into some of the more important constructional aspects, so that readers who wish may duplicate our original prototype.

From a constructional point of view, the printed board incorporating

TRUSCOTT'S

AUSTRALIA'S GREATEST MAIL ORDER TAPE RECORDER & HI-FI CENTRE

STOCKISTS OFF ALL LEADING BRANDS OF TAPE RECORDERS HI-FI EQUIPMENT, COMPONENT PARTS AND ACCESSORIES

NEAT MAN—THAT'S THE WAY TO ENJOY HI-FI MUSIC

TRUSCOTT ELECTRONICS are the sole Australian agents for NEAT Hi-Fi equipment. Send now for details on these outstanding products. Including test reports and reviews by the Gramophone, Hi-Fi Sound and "Electronics Australia" and ask for a T.M.Q.

Fast Mail Order Service
When ordering, please give your full address printed in BLOCK LETTERS. All Truscott equipment is brand new and fully guaranteed. Sales tax is included in all quoted prices. All orders are despatched promptly. All prices quoted are Nett. Postage and freight extra.
NOTE: T.M.Q.—Truscott Mail Order Quote.

TAPE RECORDER AND HI-FI SERVICE CENTRE

For service on all leading brand tape recorders and Hi-Fi equipment — come to the experts. Truscott's modern service centre uses only the finest servicing aids, backed up by fully trained professional technicians.

SPEAKER ENCLOSURE PADDING

Truscott's are the leading South Australian stockists of Innerbond lining and Bonded Courteille filling. Ensure dust-free padding for your speaker enclosure. Send for a T.M.Q.

AKAI TAPE RECORDERS

All latest models in stock — XV, 1710, M9, 1800, X360, 4000D, X150D, X200D. Prices slashed to an all-time low. Send now for a T.M.Q.

COMPONENT PARTS AND ACCESSORIES

Truscott's are stockists of all General Electronic components, including resistors, capacitors, plugs and sockets, solder, Scope Irons and spares, hook-up cables, valves, terminals, tag strips, matrix board, cambric spaghetti, fuses, chassis, grommets, solder, lugs, alligator clips, valve sockets, D.I.N. connectors, TV connectors, battery savers, and also a large range of semi conductors for all Japanese makes.

SAVE YOUR RECORDS . . . USE THE UNIVERSAL LUSTRE TONE ARM LIFT



LUSTRE SA-202

This beautifully finished and functional universal tone arm lift will fit all tone arms the lowering action is pneumatically damaged and extremely smooth —risk of record damage may now be eliminated—Truscott's price only \$8.00.

TAPE RECORDERS & DECKS



TESLA B46

Tesla — Akai — National
Sony — Thorn Atlas
Julliforder — BSR
Toshiba
Sanyo — AJWA
Philips — Grundig
Sandberg
Gelosio — Uher.

ACOUSTIC SPEAKER GRILLE CLOTHS

Select your speaker grille cloth from the largest range in Australia. Over 60 top-grade cloths now available to choose from. Send now for samples and a very attractive T.M.Q.

STEREO HEADPHONES



ELEGA DR-65C

Truscott's carry all the leading brand top quality stereo headphones, including Elega, Akai, Sony, Sennheiser, Sansui, Ashida-vox, Foster, etc. Send for details and a T.M.Q.

SENNHEISER DYNAMIC MICROPHONES



SENNHEISER MD421

This attractively styled Dynamic Microphone Model MD421 has been designed to meet the requirements of professional installations, which require low-priced directional studio microphones. A full range of famous Sennheiser studio microphones for amateur or professional use is available at Truscott's. Send now for specifications and a T.M.Q.

NEAT G30 PROFESSIONAL TONE ARMS

A precision-built arm, outstanding in appearance and simple to mount and use in any installation. The results obtained are far beyond those usually expected at such an extremely moderate price. Like all Neat tone arms, the G30 will accept all standard 1 1/2" mounting cartridges, including Ortofon and S.M.E. headshells without any modification. The G30 complete with tone-arm lift-lowering device is priced at only \$23.75, inc. sales-tax.

TRUSCOTT'S HI-FI COMBINATIONS

Select your Hi-Fi equipment from our vast range and send for a Truscott combination price — the lowest in Australia.

ACCESSORIES

Microphones and Stands — Tapes and Spools — Splicing Kits — Record Care Accessories — Speaker Enclosure Accessories — Cloth and Inner Baffling — Headphones — Pre-packed Leads — Plugs and Connectors — Head Cleaning Kits — Pillow Phones — Bases and Covers, and Many Others.

AMPLIFIERS



KENWOOD TK 20U

Akai — Sound —
Monarch — Lux —
Compax — Kenwood
Trio — Sony —
Tempo — Sansui
Leak — Grundig
Cosmos — Linmark.

TURNTABLES

DUAL 1009F



Dual — JH — Neat — BSR — PE —
Compax — Labcraft — Goldring — Sony.

TONE ARMS AND CARTRIDGES

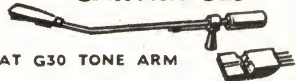

NEAT G30 TONE ARM

NEAT V70 CARTRIDGE

Neat — ADC — Ortofon — All Balance
— Goldring — Decca — Audio Technica
— Dual — Shure — Micro — S.M.E.

SPEAKERS

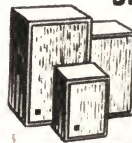

Soundmaster —
Wharfedale — Tesla
— Philips — Rola
— Kenwood
— Sansui — Akai
— Leak — Magnavox
— Goodmans.

SOUNDMASTER SPEAKER SYSTEMS

NEW MODEL DUAL TURNTABLES

Stocks are now available of the new Dual Hi-Fi turntables, models 1210, 1212, 1209 and 1219. Send now for details of these outstanding turntable and ask for a T.M.Q. All other model Dual turntables stocked.

HI-FI TRANSCRIPTION TURNTABLE COMBINATION

Consists of the one and only JH Synchronous Turntable, the new Neat G30 Tone Arm with lifting/lowering device, Neat V70 magnetic cartridge, and hand-finished cased TEAK wooden base. Retail \$96.00. Truscott's price only \$77.50. If assembly required — add \$6.00.

TAPE RECORDER BELTS

Belts available to suit most models of Telefunken, Uher, Philips, Cossor, Stella, Grundig, BSR, Ferguson, Walter and Korting Recorders. When ordering, it is most essential to state the correct make and model of recorder.

NEAT V70 MAGNETIC CARTRIDGES

A top-performance, high-quality magnetic cartridge that outperforms many more expensive cartridges. When used with the Neat G30 tone-arm, an excellent low-priced combination is obtained. The V70 is priced at only \$11.25 inc. sales-tax.

PE34 TRANSCRIPTION TURNTABLES

Limited stocks are still available of this very popular German Hi-Fi transcription turntable. Buy now, at only \$69.50 inc. sales-tax, and avoid disappointment — as stocks are going fast. All other models P.E. turntables stocked.



TRUSCOTT ELECTRONICS

AUSTRALIA'S GREATEST TAPE RECORDER & HI-FI CENTRE
62-64 HINDMARSH SQ. ADELAIDE, 5000 Phone: 233024 233278

the ceramic filters is straightforward and needs very little comment. Apart from the individual filter units there are only the five top coupling capacitors and one 3.3K resistor. Make sure that the "dots" on the filters are orientated correctly. The 47pF capacitor may be a ceramic NPO, or a Styroal, as used on the prototype. The 27pF capacitors are not available in Styroal and NPO ceramics should be used. They may be either disc or tubular types.

The filter output components, first, second and third IF amplifiers, and the detector, are assembled on a piece of miniature tag board, 5½in long and having 22 pairs of tags. The AGC components and the BFO are together assembled on a second piece of tag board the same size.

The two assemblies are mounted back-to-back, secured by two screws, to an aluminium panel between them, which serves as both a shield and a mounting bracket for the final assembly. The unit is then ready to be dropped into a place with all the other sections of a complete receiver.

The aluminium panel is 5½in long, 1-7/8in high and with a 5/16in foot. Two holes are provided near the ends of the foot for mounting purposes. The holding screws are at the fourth hole in from each end, with the boards about ¼in apart. Instead of using spacers, we used screws of sufficient length and nuts against all faces. We fitted a solder lug against the outside face of the AGC-BFO board and soldered it to the nearest earth lug. This brings the earth leads on the boards to the chassis or other framework of the complete receiver.

In addition to the two mounting holes, there are five more holes in the aluminium panel, to allow leads to pass from one unit to the other. These are for earth, positive 12 volts supply, AGC voltage, AGC take off from third IF amplifier for the AGC amplifier, and the BFO leads to the detector.

Assembling and wiring the two strips is not difficult and the builder is rewarded with two neat assemblies in quite a short time. As always, care must be taken to make good soldered joints, but individual components must not be overheated in the process.

Details of the wiring are shown in the wiring diagrams and photographs. However, a few finer points may need elaboration. The ceramic resonators are mounted directly on the tag boards and between the relevant tags on the boards. A little care must be used in mounting, as it is necessary to drill five holes fairly accurately. Only holes large enough to pass the leads should be drilled. The resonator leads are passed through the holes and the other leads and components are then soldered to the opposite side. This is sufficient to hold the resonators in place.

The FETs are type 2N5459, made by Motorola. All of the bipolar transistors, except the PNP type in the BFO, may be any of a number of different silicon NPN types. We have found types BF115, BC108 and SE3001 to be satisfactory. No doubt others could also be used. As mentioned before, the PNP transistor may be a 2N3638, OC44N, OC170, etc. Only good quality components should be used for best results.

The smaller values of capacitors may be Styroal, or similar. The 0.22uF and 0.1uF by-pass capacitors may be low voltage ceramics, such as the Redcaps, or mylar types, rated at 150 volts or less. The .01uF AGC capacitors must be low leakage types such as Styroal or mylar.

As mentioned earlier, we have a few comments on mixers which may be used to precede the filter. Originally, we tried a 2N5459 FET, as being perhaps one of the simplest approaches to this problem. However, for our particular application, this arrangement left something to be desired. Perhaps it is a characteristic of this type but, although the gain was satisfactory at the broadcast frequencies, it fell off rapidly at the higher frequencies. Also, quite a lot of local oscillator component appeared at the mixer drain. This is of no consequence in the circuit as it stands but we have a noise silencer in mind for this position and the oscillator component seriously affected the silencer operation.

For some time we have had a healthy respect for the "ring" mixer. This consists of four diodes in a balanced circuit and has certain desirable characteristics. The gain (or loss) is virtually constant over a wide frequency range and, as it is balanced, local oscillator components do not appear at the IF output. It would seem then, that this arrangement would meet the need at hand, except that it has no gain of its own. To counter this the mixer could be followed by a simple bipolar transistor amplifier. At this point of our experiments, this circuit looks promising.

So much for construction, mixers, etc. Having built the IF system, we have to make sure that it functions correctly, then set the pass bands of the two filters to the desired shape. At this stage, we feel that the most satisfactory way of doing this is to use a 455KHz sweep generator and a CRO. We are hopeful that a simpler way may be found, but time has not allowed us to make a thorough investigation.

Equipment needed is a sweep generator which sweeps 455KHz, and a CRO. These are set up in the usual way. A marker generator is not really necessary, the object being to get the pass bands of the correct shape and band width. Any deviation from the nominal frequency of 455KHz has to be accepted. This will not amount to more than a KHz or so anyway.

A peak-to-peak detector probe may be used, taking the output from the collector of the third IF amplified, the output from the probe being fed into the vertical amplifier of the CRO. Alternately, the built-in AM detector may be used, feeding the audio output to the CRO via a shielded lead.

After the alignment process nothing must be done to the circuitry of the complete IF strip which will in any way upset the final pass band shapes. This applies in particular to components associated with the two coupling ceramic resonators, between the first and third IF amplifiers. Any change in component values can change the overall result. As an example, the 100 ohm resistor in the emitter of the third IF amplifier must not be removed, by-passed, or altered



Tanner-James QUALITY COMPONENTS

Terminals

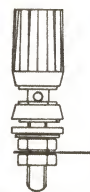

CAT. No. D7

15 amp. 250 volts
4mm top socket.
Captive & Free rotating head. Nickel plated brass. Nylon insulant. 6 standard colours.

32c List

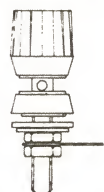

CAT. No. D8

30 amp. 250 volts
4mm top socket.
Captive & Free rotating head. Nickel plated brass. Nylon insulant. 6 standard colours.

48c List

4mm Plugs



CAT. No. D35

4mm single stacking plug. Silver plated contacts. Screw wire connection. Fully insulated. 6 standard colours.

28c List

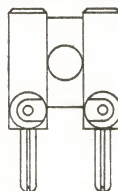

CAT. No. D41

Twin 4mm stacking plug. ½in. centres. Silver plated contacts. Screw wire connections. 6 standard colours.

70c List

**MADE IN
AUSTRALIA**

by

Tanner-James

Pty. Ltd.

34 STAFFORD STREET
HUNTINGDALE VIC. 3166

TEL: 544 8830

components with a purpose *

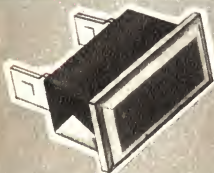

Neon
Indicator Lamps
Telite



Cordless
Programming
Boards

Sealstro



Magnetic
Reed Switches
HAMLIN

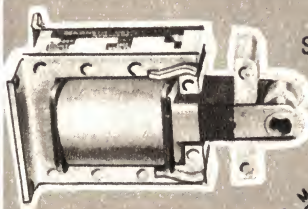

Solenoids



Potentiometers



Toggle Switches

NKK

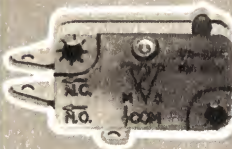

Micro Switches

Mulon



Relays



Precision Film Resistors

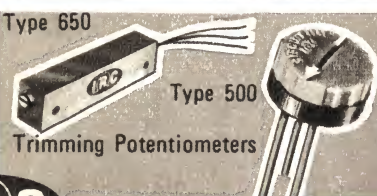

Type 650

Type 500

Trimming Potentiometers

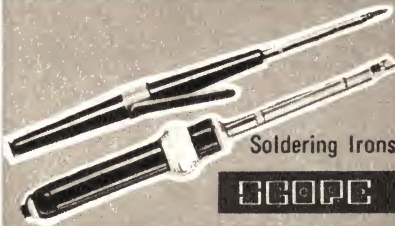

Soldering Irons

SCOPE



Wirewound Resistors



Power Rheostats

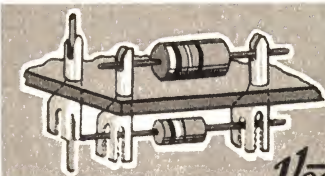

Matrix Boards and Kit-sets

Vector

* your complete satisfaction

INTERSTATE AGENTS & REPRESENTATIVES

MELBOURNE
I R H Components Pty. Ltd.,
Phone 489-1088

BRISBANE
K.H. Dore & Sons
Phone 2-1391 (except Magnetic Devices)

PERTH
Simon Holman & Co.
Phone 8-2271

HOBART & LAUNCESTON
W.P. Martin Pty. Ltd.,
Phone 34-2811 22-844

ALSO
Underhill Day & Co.
Phone 70-2141 (Magnetic Devices only)

ADELAIDE
Collett & Cant Pty. Ltd.
Phone 23-1971

IRH
COMPONENTS
PTY. LIMITED

THE COMPONENTS DIVISION OF IRH INDUSTRIES LIMITED

THE CRESCENT,
KINGSGROVE,
N.S.W. 2208.
TEL. 50 0111



in value. If any such change must be made, then the alignment must be checked and adjusted if necessary.

Assuming that we are set up for alignment, we suggest that you dispose of the broad position first, as being the simplest. Adjust the level of the display on the screen to a convenient size and make sure that there is not so much signal being fed into the system as to cause overload anywhere along the line. This could look like an ideal curve but is not the true story.

Unless you are extremely lucky, the display on the screen will look "lopsided." The technique is to use resistors and capacitors of various sizes to make exploratory checks. The resistor values will normally range between about 10K and 1K, with the capacitors from about 22pF to 100pF or more. Start with either a capacitor or a resistor, of any value in the above range. Connect it between earth and pin 1 or 2 of the resonator and note the effect on the screen. Careful observation, together with a few tests, will soon give you the idea. Before long you will have decided on the correct value of resistor or capacitor, and the terminal to which it must be connected, to give the best pass-band shape.

More than likely, a resistor will give the best result. In some cases it may be necessary to connect a resistor or capacitor to both pins. We had one case where it was necessary to connect a 6.8K resistor and a 100pF capacitor, in parallel, from one pin to earth, with a second resistor of 12K from the other pin to earth. This was an extreme case.

Now switch to the sharp filter position. It may be necessary to readjust the gain of the CRO vertical amplifier. The same principles apply as before, but the procedure is somewhat more involved in that there are many more combinations possible. However, this may sound worse than it really is in practice. Proceed as before, with a resistor or capacitor from each of the pins 1 and 2 to earth, and note the effect.

At this point, a certain amount of guesswork as well as judgment must be applied. Connect the component which looks most promising, in that it will have resulted in an improved, if not a correct, pass band shape. If improvement is still called for, proceed as before. More than likely, a component will be soon found which gives the final correction. If only an improvement can be effected, then connect it into circuit and proceed along the same lines. When the final pass band is achieved, all the corrective components are wired permanently to the copper side of the board.

This description may give the impression that the task is a tedious one. This is not the case and the correct shape can normally be obtained in a shorter time than it has taken to write the detailed instructions!

There is still one adjustment to make. This involves introducing the correct amount of attenuation at the output of the broad filter, so that when switching from broad to sharp, there is no change in gain. This can be done readily with the sweep still set up. Adjust the low value resistor (shown as 220 ohms) to the value to equalise the gain.

Using the sweep setup, the BFO can be set, at least approximately, to the correct frequencies on each side of the pass band of the sharp position. Assuming a capacitor of 68pF or so across the 1mH inductor, switch on the BFO and see where the centre frequency lies. It should be at about the centre of the bend at the bottom of the pass band. Adjust the capacitor to give this result. Now add another capacitor, 100pF or perhaps more, across the capacitor just decided. The new value should shift the BFO centre frequency to the corresponding bend on the other side. These positions may be subject to slight change under listening conditions.

If facilities for sweep alignment are not available it may be possible to make an approximate check using an ordinary signal generator, though we imagine that the process will be very tedious. The technique is to sweep the generator slowly across the pass band

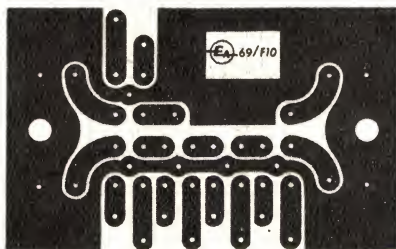

The pattern of the printed wiring board for the filter illustrated on page 81. It is reproduced exact size.

by hand, noting the readings on an output meter. The output meter may take two forms. It may be a conventional type, measuring recovered audio in conjunction with a modulated signal from the generator, or the signal may be unmodulated and the AGC voltage monitored with a VTVM.

So far, over the past few months, we have described a power supply, an audio amplifier, and now a complete IF strip and filters. These, it is hoped, will form the basis of a complete high stability, full coverage, solid state receiver, in the foreseeable future. ■

PRICES SLASHED!

Hi-Fi Equipment, Radios, Recorders, Players, Electrical Goods, Cameras, Overseas and local supplies arranged.

MANDARIN CO. INTERNATIONAL

Box 1414M, G.P.O., Melbourne, or P.O. Box 3581, HONG KONG.

PRINTED CIRCUITS

MAKE YOUR OWN AND SAVE MONEY. New easy method. No chemicals. No mess. Kit \$3 including full instructions.

Post and packing 40c. Mail Order Catalogue 25c refunded with first order.

B. M. ROBBINS

Box 129 CARLINGFORD, N.S.W., 2118

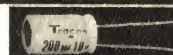

ELECTROLYTIC CAPACITORS

Miniature Type			Top Grade		
Type	Price	Type	Price	Type	Price
25VW 1-9	10-99	10VW 1-9	10-99		
5mf 16c	13c	5mf	12c	11c	
10mf 18c	14c	10mf	13c	11c	
25mf 20c	16c	25mf	14c	12c	
50mf 21c	18c	30mf	15c	13c	
100mf 25c	21c	50mf	17c	14c	
200mf 29c	23c	100mf	19c	15c	
500mf 40c	35c	200mf	25c	21c	
1000mf 60c	53c	500mf	33c	27c	
2000mf 95c	85c	1000mf	49c	42c	

100 off prices on application. For resistor prices see classified section. Prompt service. Pack and post 10c any order.

KITSETS AUST.

Box 176, P.O., Dee Why, 2099, N.S.W.



**DEITRON
ELNA
CAPSTAN
UNIVERSITY
A & R**

?

Pages 101 to 108

AUSTRALASIAN TRAINING AIDS PTY. LTD., MANUFACTURERS OF MILITARY AND CUSTOM BUILT ELECTRONIC RANGE EQUIPMENT. PRESENT ATA PISTOL TIMER MARK III.

1. GENERAL.

The above illustrated timer has been developed and perfected to provide for the shooter a highly accurate exposure timing function and a simple-to-operate, compact, long-term reliability unit. Accuracy is the keynote of the timer, the accuracy figure being so high that no stopwatch or other mechanical time check device can measure it. The unit itself is a time standard and will not vary with changes of temperature and a unit supply voltage. Silence of operation is another advantage of the unit. Count-down of seconds is accomplished by a flashing lamp and causes no distraction to firers and range operators.

2. DATA SUMMARY.

Power Supply for Timer Unit. 12-volt vehicle battery. The timer will operate from 8 volts to 15 volts DC.

Operating Temperatures. From 32 deg. F. to 130 deg. F.

Timing Accuracy. From minus 0% to plus 0.04% of the selected time.

Protection Devices.

(a) Reversed Battery Leads: Should the battery leads accidentally be connected in the reverse direction, the timer will not operate nor is any damage caused to the unit.

(b) Timer Fuse: The fuse protects the unit from damage should a fault or short circuit occur within the unit.

(c) Down Range Protection: Should a short circuit or fault occur in the frame control wiring or the cable linking the timer to the frames, the timer has an inbuilt automatic "turn-off" facility which turns off the timer, thus preventing further damage to the frame wiring or the timer unit itself.

Operating Modes. The timer unit enables Rapid Fire, Centre Fire and Standard Match shooting practices to be run at the times recognised by international rules. Up to three target frames can be commanded either separately, or in any combination of frames required. The Range Function switch controls the type of practice required, and the Frame Selection Switch controls the number and combination of frames required.

161-169 Fallion Street, Albury, N.S.W.

Telephone: 25-1405, 25-1410.



Broadway
Electronics
introduces
the
self-service

INSTROL



The 10-Plus-10 is a high quality solid-state stereo amplifier (10 watts RMS per channel). This, and other amplifiers featured in Electronics Australia, are available in either kit form or built and tested.

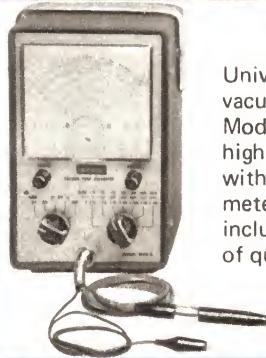

University, general purpose, vacuum tube/Voltmeter – Model MVA6 – A high impedance, high stability instrument, with a large easy-to-read meter. Our new showroom includes a large display of quality test equipment.



The Electronic Tool Kit, an inexpensive, yet most comprehensive outfit. The complete kit fits snugly into a strong attractive zip-fastening carrying satchet. Price – only \$12.50 (postage \$1.00 extra).



Popular Instrol-Playmaster 40 watt and 60-watt RMS Guitar Amplifier, in kit form or ready built. Complete with all optional extras.



Instrol-Playmaster 115, solid-state, Stereo Amplifier, one of the many Electronics Australia projects available. Detailed descriptions together with full technical specifications and price details of all types of electronic equipment and kits are available free. Tick and send coupon for catalogue required.

ELECTRONICS CENTRE

Everything for hobbyist and technician

OPEN NOW...

Revolutionary
new concept

FEATURING!

- (1) Large audio demonstration section to enable you to hear your favourite Instrol-Playmaster and other Electronics Australia projects.
- (2) Ready-packaged Kits for Instrol-Playmaster projects, other Electronics Australia projects and Test Equipment Kits.
- (3) Large range of test equipment, service parts and allied components.
- (4) Hire Purchase Terms available for most Kits and ready-built Units.
- (5) Self-service display area so that you can see for yourself and choose the many component parts available.
- (6) Modern book section, including many of the famous Howard Sams technical books.
- (7) A large service department to accurately diagnose and repair your equipment.
- (8) Sydney's largest Hi Fi and audio centre.
- (9) Already on display - the new E.A. Project - Musicolour sound control of coloured lights.
Available as built unit or in kit form.



The Transistor Audio Oscillator.
December 1967.
This and many other instrument kits are available - strictly to "E.A." specifications.



Instrol-Playmaster 124 Stereogram.
This is a combination of 3-Plus-3 stereo amplifier and a solid state broadcast tuner. All major stations for six States are engraved on the attractive silver label.



We are now stocking a large range of robust and attractive meters, including edge-wise types. Meters with special scales to suit "E.A." projects also available.



The Instrol Educational Electronic Kit, a must in this electronic age. Learn the basic principles of computers, communications, etc. Priced at - \$16.90 (Post 85c).

INSTROL ELECTRONICS CENTRE

91a York St. (between King & Market St.)

Phone: 29-4258
SYDNEY, N.S.W.
2000

for descriptive leaflet post coupon

Please include postage stamp.

Playmaster
 Toolkit
 Microphone
 Metalwork
 Test Equip. Kits
 Cannon Connectors

Name _____
Address _____
Postcode _____

NEW PLAYMASTER CONTROL UNIT



Features IC Operational Amplifier

Here is the latest addition to the Playmaster range of audio equipment. A fully solid-state control unit incorporating a dual linear integrated circuit and providing equalisation according to CCIR and RIAA specifications for tape replay and magnetic disc pickups.

By Anthony Leo

Over the years ELECTRONICS Australia has described numerous high fidelity audio amplifiers for both mono and stereo systems. In these projects, especially those having the title "Playmaster," we have attempted to present designs which are reliable and easy to build, without compromising performance or being too far ahead or too far behind established practice.

Particularly before the advent of transistorised circuitry, most stereo valve amplifiers which we described were of a modular style, consisting of a power amplifier and power supply chassis, and a separate control unit attached to the power chassis by a multi-wire cable carrying signal and supply voltages. The power chassis was usually housed out of sight in the cabinet, with only the control unit accessible to the user.

Typically, a valve control unit in a medium-priced system provided pre-amplification for a crystal or ceramic pickup cartridge, along with controls for volume, treble, bass and balance. There was normally a switch to select the pickup or various other high level signals from radio tuner or tape recorder and, sometimes, an additional switch function to select mono mode, stereo or reverse stereo.

In a more pretentious system, intended for use with a low output magnetic cartridge, the control unit was called upon to provide additional gain and frequency compensation, as required by all magnetic or velocity-dependent cartridges.

With the advent of solid-state circuitry and printed wiring techniques, both contributing to reduced dimensions, there was a trend toward integrating control and power amplifiers in one cabinet to form a unit style amplifier, intended to stand in full view on a shelf. The style has certain advantages, in that it is self-contained and easily moved.

In designing and building a transis-

torised unit amplifier, it is necessary to anticipate and forestall problems with hum and stability, brought about by proximity of power supply, high level and low level stages. While these problems are common to valve designs there are other more subtle stability problems peculiar to solid state designs, arising largely from the heavy "earth" return currents flowing in the power amplifier section.

Stability problems can be minimised and hum pickup from power transformers eliminated, by simply reverting to the separate control unit and power amplifier approach. In this way, power amplifier and high sensitivity control stages can have independent earth return systems and isolated metalwork, electrically connected only at one selected earthing point.

Also, separate units can offer a significant advantage for the home constructor with a somewhat easier construction, simpler chassis metalwork, and a layout which is less important in ensuring complete amplifier stability. This is important because, while layout can be uniformly maintained in a mass production situation, it is one aspect of our projects which cannot

be controlled as closely as we would like.

Against this general background we are presenting here a solid-state stereo control unit with a view to presenting a companion power amplifier, of perhaps 25 watts per channel, in a subsequent issue. The two units should provide a most satisfactory system for the audio enthusiast to construct.

However, it would be quite feasible to consider using the control unit with an existing valve or transistor power amplifier. Equally, it would be possible to use circuitry from the control unit in a new or existing unit amplifier; the suggestion is made, however, with the reservation that constructors should have sufficient background to handle problems, of the type already mentioned.

Over the years, Playmaster control units have evolved a fairly standardised form of presentation in respect to controls and connection facilities and, with suitable metalwork readily available, there seemed little reason to introduce major changes.

Consequently, the new control unit has been designed around the same style and presentation that was first



An enlarged photograph of the integrated circuit is shown above. It is a 14-lead dual in-line package with a locating slot at the right hand end.

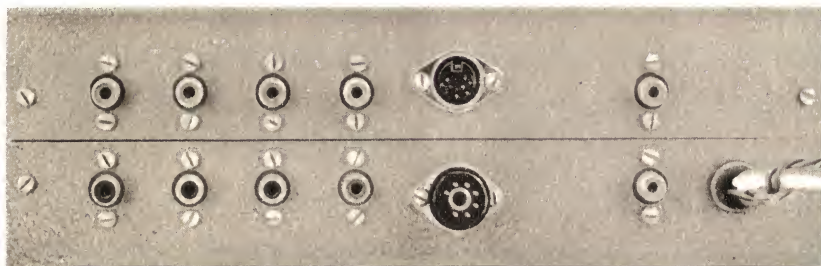

A rear view of the control unit is shown above, with connections being left to right: Radio 2, Radio 1, Disc, Tape, 5-pin DIN socket for tape input/output, 7-pin socket for tuner connections. Two coaxial connectors, on the extreme right, are for high level "flat" output.

2x8C107

BZY95/C36

μA739C

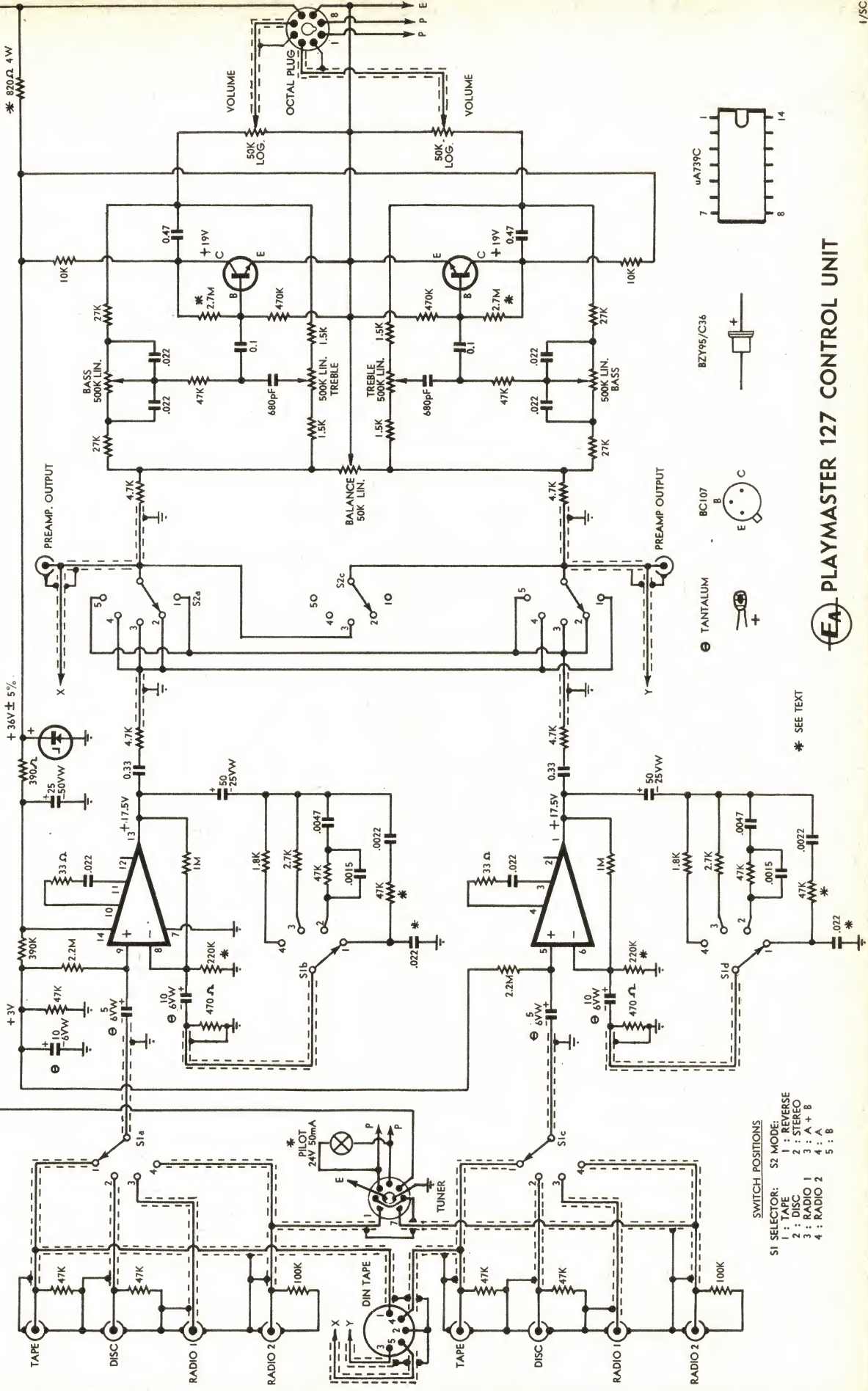

- SWITCH POSITIONS
- S1 SELECTOR: S2 MODE:
- 1 : TAPE
 - 2 : DISC
 - 3 : RADIO 1
 - 4 : A + B
 - 5 : B
- 1 : REVERSE
 - 2 : STEREO
 - 3 : A + B
 - 4 : A
 - 5 : B

* SEE TEXT

PLAYMASTER 127 CONTROL UNIT



THE MARK
OF QUALITY

POWER TRANSFORMERS

TYPE NO.	PRIMARY VOLTS	H.T. VOLTS	H.T. mA	LOW TENSION SECONDARIES	DIMENSIONS		
					MTG.	H. W.	L.
PF619	240	150/150	30	6.3V-1.8A	VO	2 $\frac{5}{8}$ x 2	x 1 $\frac{7}{8}$
PF299	240	285/285	40	6.3V-2A 6.3V-tap 5V-2A	VO	3 x 2 $\frac{1}{2}$ x 3	
PF201	240	225/225	50	6.3V-2A	VO	3 x 2 $\frac{1}{2}$ x 2 $\frac{1}{2}$	
PF151	230, 240	285/285	60	6.3V-2A C.T. 6.3V-tap 5V-2A	VC	4 $\frac{1}{8}$ x 3 $\frac{1}{4}$ x 3 $\frac{3}{4}$	
PF1460	230, 240, 250	250/250	80	6.3V-2A C.T. 6.3V-2A 6.3V-tap 5V-2A	VC	4 $\frac{1}{8}$ x 3 $\frac{3}{4}$ x 3 $\frac{5}{8}$	
PF170	230, 240	285/285	80	6.3V-2A C.T. 6.3V-2A 6.3V-tap 5V-2A	VC	4 $\frac{1}{8}$ x 3 $\frac{3}{4}$ x 3	
PF130	230, 240	285/285	100	6.3V-2A C.T. 6.3V-2A 6.3V-tap 5V-2A	VC	4 $\frac{1}{8}$ x 3 $\frac{3}{4}$ x 4 $\frac{1}{8}$	
PF152	230, 240	285/285	125	6.3V-3A C.T. 6.3V-2A 6.3V tap 5V-2A	VC	4 $\frac{7}{8}$ x 3 $\frac{7}{8}$ x 3 $\frac{1}{2}$	
PF174	230, 240	285/285	150	6.3V-3A C.T. 6.3V-3A 6.3V-tap 5V-3A	VC	4 $\frac{7}{8}$ x 3 $\frac{7}{8}$ x 3 $\frac{3}{4}$	
PF142	230, 240	325/325	150	6.3V-2A C.T. 6.3V-2A 6.3V-tap 5V-3A	VC	4 $\frac{7}{8}$ x 3 $\frac{7}{8}$ x 4	
PF175	230, 240	385/385	150	6.3V-2A C.T. 6.3V-2A, 5V-3A	VC	4 $\frac{7}{8}$ x 3 $\frac{7}{8}$ x 4 $\frac{1}{2}$	
PF1067	230, 240	400/400	180	6.3V-2.5A C.T. 6.3V-4A C.T. 5V-3A	VC	4 $\frac{7}{8}$ x 3 $\frac{7}{8}$ x 5	
PF1412	230, 240	300/300	200	6.3V-3.5A C.T. 6.3V-3A, 5V-3A	VC	4 $\frac{7}{8}$ x 3 $\frac{7}{8}$ x 4 $\frac{3}{4}$	
PF140	200, 230,	385/385	200	6.3V-3A C.T. 6.3V-3A, 5V-3A	VC	4 $\frac{7}{8}$ x 3 $\frac{7}{8}$ x 4 $\frac{1}{4}$	
PF814	200, 230, 240	1000/1000 or 750/750 or 500/500	200	5.8V-0.3A	VO	5 $\frac{1}{8}$ x 6 x 4 $\frac{5}{8}$	
PF171	200, 230	385/385	250	6.3V-4A C.T. 6.3V-3A, 5V-3A	VC	4 $\frac{7}{8}$ x 3 $\frac{7}{8}$ x 5 $\frac{1}{4}$	
PF1193V	200, 220, 240	295/295	275	6.3V-9A 6.3V-tap 5V-3A	VC	4 $\frac{7}{8}$ x 3 $\frac{7}{8}$ x 5 $\frac{1}{4}$	
PF1129	220, 230, 240	235/235	330	6.3V-4.5A 6.3V-4.5A 6.3V-2A	VC	5 $\frac{1}{8}$ x 4 $\frac{1}{2}$ x 3 $\frac{3}{4}$	

Also available—transformers for special applications

AGENTS:

VICTORIA:
Ferguson Transformers Pty. Ltd.
181-183 Hawke Street,
West Melbourne, 3003.
Phone 329-7437, 329-6415.

TASMANIA:
Associated Agencies Pty. Ltd.,
25 Barrack Street,
Hobart, 7000.
Phone: 2-1843.

SOUTH AUSTRALIA:
Wm. M. Mathew Pty. Ltd.,
12 French Street,
Adelaide, 5000.
Phone: 23-6202.

WESTERN AUSTRALIA:
Athol M. Hill,
613 Wellington Street,
Perth, 6000.
Phone: 21-7861.

QUEENSLAND:
Keith Percy & Co. Pty. Ltd.,
Waterloo Street,
Newstead, 4006.
Phone: 51-5461.

A.C.T.:
Errol Nazer Pty. Ltd.,
84 Barrier Street,
Fyshwick, 2600.
Phone: 9-0325.

FERGUSON TRANSFORMERS PTY. LTD.

331 HIGH STREET, CHATSWOOD, N.S.W. • POST OFFICE BOX 301, CHATSWOOD. TELEPHONE: 40-0261 (8 LINES).

An inside view of the control unit is shown at the right. Most of the components are mounted on the printed wiring board, with the exception of the resistors mounted on the input sockets. Note that incoming supply leads are terminated first at the tuner socket.

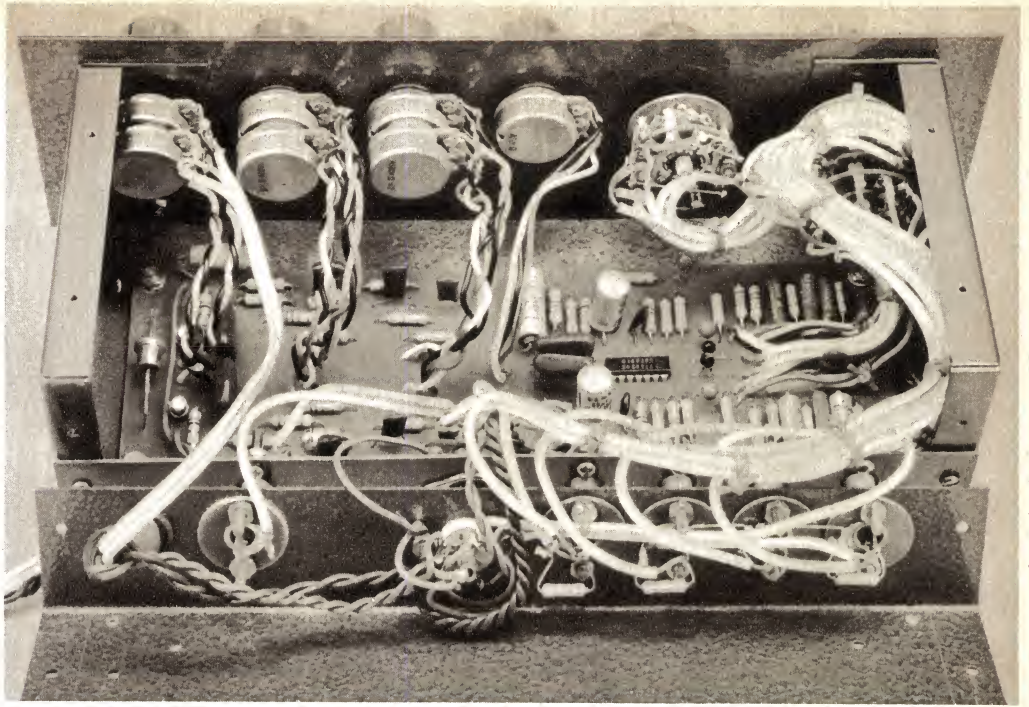

used for the transistorised Playmaster 112 control unit, described in the December, 1965, issue. This provides four basic controls: volume, treble, bass, and balance, and two selector switches. A "mode" selector switch has positions for "reverse stereo," "stereo," "mono," "left channel" and "right channel." The second "selector" switch allows the selection of one of four signal sources: "tape," "disc," "radio 1" and "radio 2." Logically, readers may ask why we have designed a new solid-state control unit along the same lines as an existing unit, which already provides adequate facilities and performance. The reason is the economy in circuitry and consequently the saving in overall cost made possible by using a recently available integrated circuit.

Heart of the new control unit is the relatively low cost linear integrated circuit, type uA739C, manufactured by Fairchild Semiconductor. The fourteen lead dual in-line type package contains two separate but identical operational amplifiers, having a common internal supply arrangement derived from an external supply voltage which can be up to 36V.

Up to the present time, integrated circuits have not been extensively used in low level audio preamplifier circuits because of their relatively poor noise performance compared to preamplifiers using discrete transistors. But the new Fairchild integrated circuit, which has been designed specifically for low level applications, represents considerable progress in the development of linear integrated circuits.

The specified typical noise figure for each integrated operational amplifier is only 2dB, measured between 10Hz and 10KHz. This means that, over the specified frequency bandwidth, the operational amplifier degrades the input signal-to-noise ratio by only 2dB. This compares more than favourably with a single typical low-noise transistor which has a noise figure quoted as 1.8dB.

By way of explanation for readers

who may not be acquainted with the terminology, an operational amplifier is a DC coupled amplifier having very high voltage gain and a wide frequency response, and with its input, output and feedback terminals readily available. By suitably arranging a feedback network, an operational amplifier can be made to perform various operations, including frequency dependent amplification and impedance transformation.

Because of its very high voltage gain,

the behaviour of an operational amplifier is determined predominantly by the external feedback components selected by the circuit designer. An operational amplifier is normally shown in circuit diagrams as a triangle with input, output and feedback terminals, as illustrated in figure 1.

The operational amplifier, as shown, has two input terminals, one is termed a "non-inverting" input because signals applied to this input are amplified and appear at the output without being

Specifications:

INPUTS: Four inputs per channel are provided; tape head, magnetic pickup cartridge, ceramic/crystal pickup, high level radio input.

- (a) Tape—This input has a nominal sensitivity of 4mV for an output of 250mV at 1KHz, and provides CCIR compensation for tape speeds of 15ips, 7½ips, 3½ips and 1-7/8ips.
- (b) Disc—The disc input provides RIAA equalisation and has a nominal sensitivity of 3mV for an output of 250mV at 1KHz and an overload capability of 70mV at the same frequency.
- (c) Radio 1—This input has a nominal sensitivity of 70mV for an output of 250mV at 1KHz, and an input impedance of 2M and as such it will accept ceramic and crystal cartridge inputs.
- (d) Radio 2—This input has a nominal sensitivity of 100mV for 250mV output with a flat frequency response, and an input impedance of 100K.

NOISE: Signal to noise ratios using 250mV at 1KHz as reference.

Tape input—Better than 48dB.

Disc input—Better than 54dB.

Radio inputs—Better than 60dB.

DISTORTION: Measured at 1V RMS output level.

Tape input—Less than 0.1 per cent.

Disc input—Less than 0.1 per cent.

Radio inputs—Less than .08 per cent.

STONE CONTROLS:

Bass control—12dB boost or cut at 60Hz.

Treble control—15dB boost or cut at 10KHz.

FREQUENCY RESPONSE:

With tone controls flat:

Tape input and disc input, CCIR and RIAA equalisation within 3dB from 40Hz to 15KHz.

Radio inputs:—3dB at 15Hz and 150KHz.

SUPPLY VOLTAGE and CURRENT:

The control unit will operate from a supply voltage between 50 and 60 volts with a current drain from 15 to 30 milliamps. For higher supply voltages see text.

Celestion

Studio Series



"DITTON 10's" AND "DITTON 15's" ARE ONCE MORE IN LIMITED SUPPLY
 The Celestion Ditton 15 measures only 21in x 9½ in x 9½ in and incorporates the HF 1300 Mark II tweeter, a new type of bass drive unit and the revolutionary auxiliary bass radiator. Many favourable reviews have been published — ask for your copies! "Hi-Fi Sound" — "It was difficult sometimes to realise that so small a loudspeaker was really producing such well-defined low frequency sounds. It goes without saying that the treble performance was fully up to standard of the HF 1300." "The Gramophone" — "The listening tests made an excellent impression. Treble was bright and forward; the bass was clean and powerful enough to produce a good balance." "Hi-Fi News" — "The quality of bass sound was above average, plenty of bass, but always clean and clear... a very wide range of programme material was enjoyed and nothing caught it out or gave cause for reservation."

The Celestion Ditton 10 measures 12in x 6¾ in x 8¼ in and features a specially designed bass unit and the well-known Celestion tweeter. Both 5 and 15 ohm impedances are available. One review of the Ditton 10 in "Records And Recording" says, "On a wide range of music it proved to be a clean-sounding speaker with the sort of characteristics which would make it one of the most popular in its class."

Prices:
 "Ditton 15in" (Inc. Sales Tax) **\$64.50**
 "Ditton 10" (Inc. Sales Tax) **\$94.50**

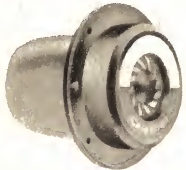

THE FABULOUS "DITTON 25" ARRIVES IN AUSTRALIA

The new "Ditton 25" reproduces the complete range of musical frequencies with utmost realism, five units covering the range from 20 Hz to 40 kHz. The bass speaker is acoustically coupled to a 12in diameter Auxiliary Bass Radiator—a proven combination. Size of the enclosure is 32in x 14in x 11in. Impedance is 4-8 ohms. Write or call for further details. Encel price (Inc. Sales Tax) **\$195**

THE NEW MODEL HF 1300 MK. II TWEETER

A further development of the popular HF 1300 Tweeter which was patterned on the well-known GEC BSC 1853 Tweeter. Frequency response is 2 kHz to 15 kHz, plus or minus 2 dB, and extends well beyond the latter frequency. Impedance is 15 ohms at 10 kHz. Recommended cross-over frequency is 3kHz. This tweeter adds "sparkle" to any speaker system. Including Sales Tax **\$19.50**

CELESTION CO-AXIAL HIGH FIDELITY LOUDSPEAKERS

Limited supplies of both 12in Celestion speakers—the CX 2012 at \$64.50 and the CX 1512 at \$44.50—are available from time to time. Demand from world markets and limited specialised production have restricted supplies to Australia; if you've been waiting for one of these fine co-axial units, order from Encel's now! Both prices include sales tax and orders will be filled in strict sequence.

Encel

ELECTRONICS (STEREO) PTY. LTD.

Head Office:
 431 Bridge Rd., Richmond, Victoria 3121.
 Tel. 42 3762.

Sydney Store: Ground Floor, 25M Building
 257 Clarence Street, Sydney, N.S.W. 2000.
 Tel. 29 4563, 29 4564.

*Wholesalers *Trade-ins accepted

Australia's Greatest Hi-Fi Centre

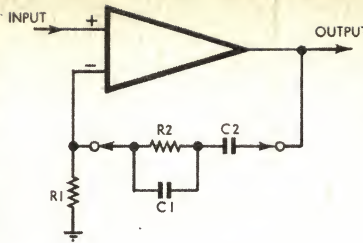
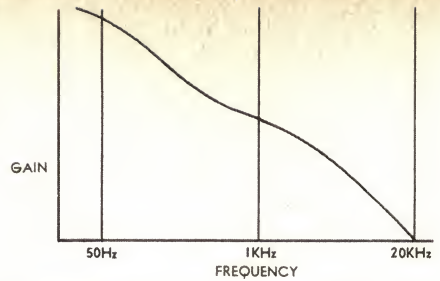

Figure 1



A simplified operational amplifier schematic with a basic feedback network is shown above. The double time constant feedback network is responsible for the RIAA amplitude frequency characteristic of bass emphasis and treble de-emphasis shown alongside.

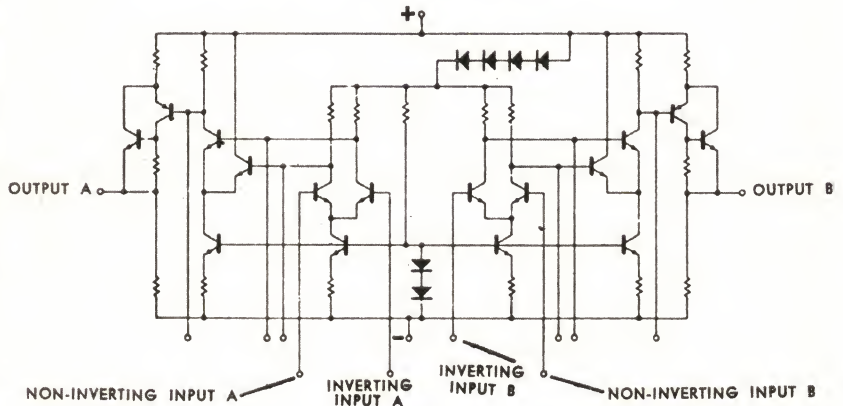

Figure 2

Internal circuitry of the dual operational amplifiers is shown in the diagram above. In essence each amplifier, one on either side of centre, consists of two cascaded differential pairs with a compounded output pair which have a degree of short-circuit protection.

inverted in phase. Signals to the other input are amplified and appear at the output inverted in phase; consequently this is termed the "inverting" input.

The inputs have been indicated with a plus sign for the non-inverting input and a minus sign for the inverting input according to convention. Negative feedback is applied by connecting a network from the output to the inverting or negative input.

In figure 1 we have shown a feedback network having a double RC time constant to provide frequency compensation for a magnetic phono pickup. A small gain - versus - frequency diagram adjacent to the circuit shows how the operational amplifier's voltage gain varies with frequency, providing the bass boost and treble de-emphasis which are essential in the use of a magnetic pickup.

In fact, with small circuit changes effected by switching feedback components, the same operational preamplifier can be used to provide frequency compensation and/or gain for magnetic pickups, magnetic tape replay heads, ceramic cartridges and microphones.

By thus removing C1 from the feedback network, the amplifier can provide compensation for magnetic tape replay heads. By eliminating both capacitors (C1 and C2) the amplifier will have a flat gain/frequency response; with the feedback then simply consisting of a voltage divider formed by R1 and R2, the operational amplifier's voltage gain is approximated by the expression R2/R1.

The internal circuitry of an operational amplifier need not be shown in

the ordinary case, because it is of no consequence in the overall amplifier behaviour. However we have included a schematic of the integrated circuit for readers who may be interested; this is shown in figure 2.

The two inputs, inverting and non-inverting, for each of the operational amplifiers are provided by a differential amplifier arrangement. The differential pairs for each amplifier are supplied in common via a series arrangement of four diodes from the positive supply.

The diodes provide a shift in the DC level in the integrated circuit so that the output stage can deliver maximum output voltage swing.

Following the input differential pair, a second pair provides further gain and delivers drive signal to the output stage. The output stage, which consists of a PNP and an NPN transistor in a compound connection, is protected against short-circuit conditions.

An important requirement for any integrated circuit is that it must be stable and free of oscillation and/or peaks in its frequency response. Stability is ensured by reducing the voltage gain to unity at a frequency before internal phase rotation causes otherwise negative feedback to become positive and cause oscillation. The frequency where the gain is brought to unity is well outside the required audio spectrum, as demonstrated by the specification of 150KHz for the "radio" inputs.

Three terminals connected to various parts of the internal circuitry are provided for stabilisation. In the control unit a step-circuit consisting of a 33

It has been said that **NOVA** is the best small computer in the world, but this is hardly reason for wanting more than one at a time. One **NOVA** has an inexhaustible range of applications from process control, data collection, data concentration, education, mathematics, engineering, architecture, science, communications, instrumentation to medicine and more. **NOVA**, the best small computer in the world, can be described as a 16-bit word general purpose computer. **NOVA** has four accumulators, two of which may be used as index registers. It offers a choice of core or read-only memory of 1K, 2K, 4K, 8K, and up to 32K 16-bit words (or twice that many 8-bit bytes). **NOVA** comes in a desk top console or a 5¼" tall standard rack mount package. Both the desk and rack versions hold up to 20K 16-bit words of memory or interfaces for a large number of peripheral devices. **NOVA** has the most flexible I/O facility ever built into a machine of its class. **NOVA** includes a high-speed data channel and automatic interrupt source identification as standard equipment. With all this what would you do with more than one **NOVA** anyway. One **NOVA** with a 4K 16-bit word configuration complete with interfaces, ready for connection to a teletype or other peripheral devices costs \$7,950. However, the versatile **NOVA** can be configured much smaller or bigger than this. Fairchild backup **NOVA** with a special department to supply peripheral equipment, systems support, software packages and of course service. If you would like to see more of **NOVA** give **Wayne Fitzsimmons** a call in Melbourne on 723 4131, or in Sydney, **Tony Webster** on 43 7508, in Adelaide, **Peter Walker** on 51 7083, in Auckland, N.Z., **Ray Crutcher** on 57 9307.

**“one is company,
three
is a crowd!”**



FAIRCHILD
AUSTRALIA PTY. LTD.

420 Mt. Dandenong Road, Croydon, Victoria, Australia. Telephone: 723 4131

ADCOLA

"M" SERIES PRECISION SOLDERING & DE-SOLDERING TOOLS

"The soldered joint is the link between components in the most scientifically designed and developed apparatus the world has ever known. One faulty joint can upset the functioning of the apparatus."

"The first important decision in Radio or Electronics is the careful selection of a Precision Soldering Tool."

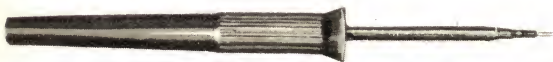

M20 1 OZ. 1/8" DIA. TIP:

FOUR "TRICLAD" TIP SIZES

MICRO MINIATURE ELECTRONICS
6 volt, 12 volt, 24 volt, 32 volt, AC/DC



M64 3 1/2 OZS. 3/16" DIA. TIP:

FOUR "TRICLAD" TIP SIZES

RADIO AND TV ASSEMBLY AND
SERVICING
230-250 volt and all lower voltage
ranges AC/DC



M207 4 OZS. 1/4" DIA. TIP:

TWELVE "TRICLAD" TIP SIZES

RADIO AND TV SOLDERING AND DE-
SOLDERING
230-250 volt and all lower voltage
ranges AC/DC

PRECISION MADE
THOROUGHLY TESTED
ACCURATELY CALIBRATED
EASILY APPLIED
EFFICIENT AND RELIABLE
CORRECT TIP TEMPERATURE
RIGHT TIP SIZE AND SHAPE
LIGHT WEIGHT
FINE BALANCE
FINGERTIP GRIP
SLIM BARREL
CONSTANT OPERATION
MAINS VOLTAGE APPROVED
AVAILABLE ALL VOLT RANGES
NO TRANSFORMER NECESSARY
STANDARD IN R.A.N.
STANDARD IN ARMY
STANDARD IN R.A.A.F.
STANDARD IN P.M.G.
STANDARD IN COMPUTER FIRMS
STANDARD IN SPACE TRACKING
AUSTRALIAN MADE
SERVICE IN ALL STATES
QUALITY GUARANTEED

ADCOLA

Available from all Principal Radio and Electrical Components Suppliers

Further information is available from:

N.S.W.: Adcola Products Pty. Ltd., 17 Burwood Rd., Burwood, N.S.W. 747-1606

S.A.: F. R. Mayfield Pty. Ltd., 11 Halifax Street, Adelaide. Tel.: 8-4131.

QLD.: T. H. Martin Pty. Ltd., 56-74 Edward Street, Brisbane. Tel.: 2-0555.

W.A.: Everett Agency Pty. Ltd., 17 Northwood St., West Leederville. 6007. Tel. 8-4137

ADCOLA PRODUCTS PTY. LIMITED, 22 FIRTH STREET, DONCASTER, VICTORIA. 3108.

Tel.: 848-3777.

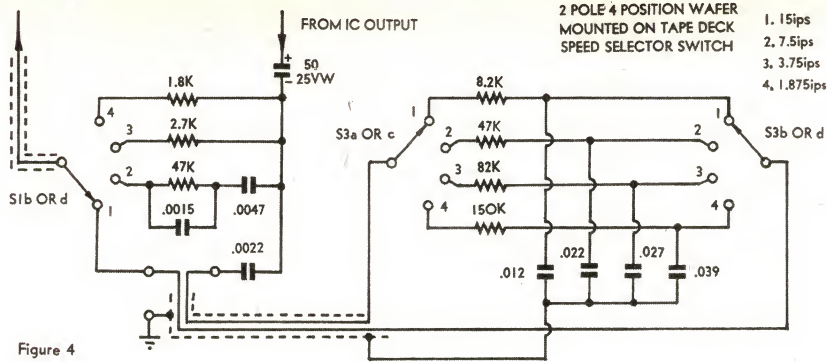
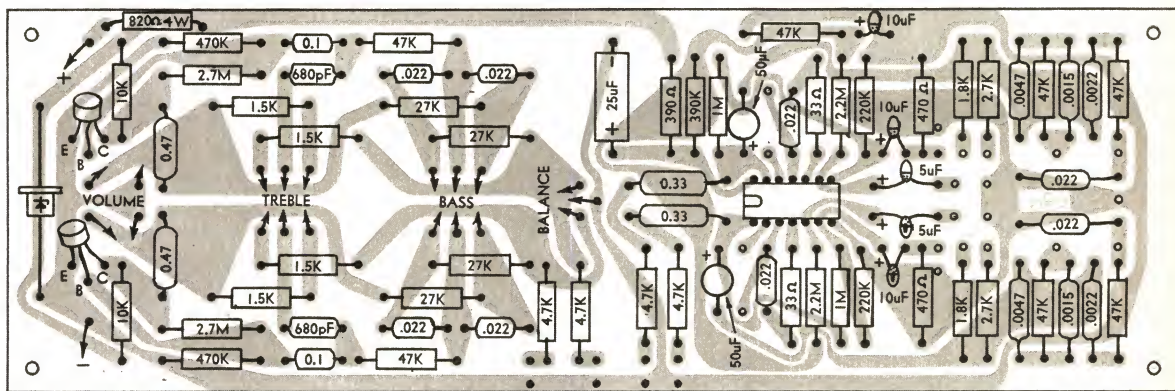

Figure 4

The circuit modification shown above will allow the control unit to provide correct CCIR tape compensation for all four tape speeds commonly used, whereas the prototype provided compensation for a single speed.

Component layout on the wiring board is shown below. It is very important that the components are correctly positioned as an error can be difficult to find and ultimately correct.



ohm resistor and a .022uF capacitor is connected between two terminals for stabilisation; the third terminal is not used.

As can be seen in figure 3, each operational amplifier, shown again with a triangle symbol, is used as a separate preamplifier in each stereo channel. A common supply of 30 volts is supplied to pin 10, while the negative supply return and ground is connected to pin 7.

Bias to the non-inverting inputs (+) of both amplifiers is supplied via 2.2M resistors from a common voltage divider consisting of a 390K resistor from the 30-volt supply and a 47K resistor to ground. To prevent cross-coupling of signal from one input to the other and to reduce hum input the bias divider is decoupled by a 10uF tantalum electrolytic capacitor.

Negative bias feedback is applied to ensure that the amplifier's bias conditions remain within reasonable limits over a range of temperature and supply voltage variations. The negative feedback is applied from the output to the inverting input (-), input via a voltage divider consisting of a 1M and 220K resistor.

The four feedback networks for tape replay, magnetic phono cartridge and the two "radio" inputs are also connected from the output to the inverting input of the operational amplifier. The networks are essentially in parallel with the bias feedback network, but the degree of AC feedback is determined almost totally by the switched networks because of their relatively low impedance compared with the bias

network.

The tape replay compensation network (1) consists of two capacitors, .022uF and .0022uF, and a 47K resistor providing correct compensation for a tape speed of 7½ inches/second. Following commercial practice, we have provided compensation for one speed only, the speed selected being the one most suitable for high-quality reproduction of music.

Should it be necessary, a modification can be incorporated that will allow the control unit to provide correct compensation for all tape speeds. This calls for the use of a two-pole four-position wafer switch, in addition to those already used in the control unit, plus some extra components.

Figure 4 shows the wiring changes which are necessary for the modification. The two variable components in the tape compensation network are left off the printed wiring board and a two-wire shielded cable is connected in their place. The other end of the shielded cable is connected to the two-pole wafer switch, which may well be mounted on the speed-change switch-spindle on the tape deck.

The various compensation resistors and capacitors are then mounted on the switch. The resistors can be mounted between the switch contacts while the capacitors can be wired from the switch contacts to a common tie point on a tagstrip. The common tie point for the capacitors is then earthed to the printed wiring board via the shielding braid in the cable. It is important to connect the capacitor earths only to the wiring board earth and not

to earth on the tape deck; with this in view, the common tie point on the tagstrip should not be connected to the metal tape deck.

The networks are switched in turn across a 470-ohm resistor, which value determines the amount of feedback applied and consequently the operational amplifier sensitivity. The feedback voltage appearing across this resistor is coupled to the inverting input by a 10uF tantalum electrolytic capacitor.

In addition to frequency compensation a tape replay head and magnetic cartridge should operate into the correct loading impedance. The basic 2.2M input impedance of each operational amplifier, set by the bias resistors to the non-inverting inputs, may be modified to the required value by shunting resistors across the input sockets.

A load resistance of about 47K is suitable for most tape heads and magnetic cartridges, but the value may be

selected in accordance with manufacturers' recommendations.

The "Radio 2" input is shown with a loading resistor of 100K shunting the input socket. However, this value is only nominal and may be adjusted to suit particular requirements; for instance, with some radio tuners it may be advantageous to omit the 100K resistor altogether giving an input impedance of 2.2M ohms causing minimal loading of the tuner's output.

No loading resistor is provided at the "Radio 1" input, as this is intend-

**DEITRON
ELNA
CAPSTAN
UNIVERSITY
A & R
?
Pages 101 to 108**

B & O
DANISH SIGN
OF QUALITY

THE ULTIMATE IN SOUND

FOR THOSE WHO CONSIDER QUALITY AND DESIGN BEFORE PRICE

THE BEOLAB 5000 SERIES is the most advanced high fidelity equipment ever built for the home. You have never heard such thrilling perfection in music reproduction.

Bang & Olufsen spent three years developing this high fidelity audio system. It comprises the Beolab 5000 stereo amplifier, the Beomaster 5000 FM tuner, two specially

designed pressure chamber loudspeakers, the Beovox 3000 or 5000, and the high frequency sound diffuser, Beovox 2500 Cube.

Made for those who demand the ultimate in audio quality, the Beolab 5000 series combines superb efficiency and complete facilities with typical B&O compactness and elegance.



BEOLAB 5000

2x60 watts R.M.S. silicon transistor amplifier. Power available to reproduce full original volume at all frequencies in association with loudspeakers of normal efficiency (1-2%). Cursor type controls in place of knobs for slide-rule accuracy in setting. Comprehensive variable inputs, duplicated phono & Din, and Din outputs. Elegant long low free-standing cabinet in teak or rosewood finish.
Frequency response: 20 Hz-20 kHz \pm 1.5 dB.
Distortion: Less than 0.6% at all frequencies from 20 Hz-20 kHz.
Size: 18 1/2" x 3 7/8" x 9 7/8"

BEVOX 5000 PRESSURE-CHAMBER SPEAKER

The Beovox 5000 loudspeaker satisfies the most critical audiophile and fully complements the quality of the Beolab system. Seven units are incorporated: one bass, two mid-range, and four tweeters.
Size: 29" x 18 1/2" x 12 1/2"
Power Handling Cap.: 30 watts R.M.S., 60 watts music power.
Frequency response: 30 Hz-18 kHz.
Choice of teak or rosewood finish.
Available in matched pairs only.



BEVOX 2500 CUBE

An ingenious high-frequency sound diffuser with six tweeter units set into an elegant cube. Gives complete spatial distribution of the highest frequencies.
Size: 3 3/4" x 3 3/4" x 3 3/4" x 11" high.
Power Handling cap.: 60 watts music power.
Frequency response: 2-18 kHz.
Available in matched pairs only.

Bang & Olufsen high-quality audio products have added a whole new dimension to sound reproduction. Sophisticated developments in electronics have been clothed by the world-famous talents of Danish industrial artists. The result is audio equipment you will proudly give the place

of honour in your home.

And from the modern electronic equipment housed in these small, slim and elegant cabinets comes all the brilliant colour of true and faithful sound - yours for a lifetime of listening pleasure, with the compliments of Bang & Olufsen.

Sole Australian Agents

G.R.D.

INSTRUMENTS Pty. Ltd., 6 Railway Walk, Camberwell, Vic. 3124. Tel. 82 1256

ed for crystal and ceramic cartridges which normally require a high impedance. The sensitivity of this input is quite adequate for the modern low output ceramic cartridges, while having sufficient overload capability to cope with the higher output of crystal cartridges.

The normal "Disc" input has adequate sensitivity for even the lowest magnetic cartridge output while, at the same time, having a sufficient overload capability. The nominal input sensitivity is 4mV but an input of 70mV is necessary before overloading of the preamplifier takes place. At the point of overload, the control unit will deliver an output voltage of approximately 4V RMS.

The overload capability of the integrated operational amplifiers is closely related to the bias conditions. For maximum signal output voltage and overload capability the DC voltage at the output pins 1 and 13 should be about 17.5V, which voltage may be adjusted by varying the value of the 220K resistor marked with an asterisk. An increase in the resistor value will decrease the output voltage and vice versa.

Signal from the preamplifier is taken to the "Mode" switching network via 0.33uF metallised polyester capacitors. The value of these coupling capacitors is important in that they attenuate frequencies below about 20Hz, thereby helping to reduce the level of low frequency noise generated within the integrated circuit, together with rumble from the turntable and pickup.

From the switching network, signal is taken to the tone control stages which consists of a single BC107 feedback amplifier. The networks are similar to those used in numerous other equipment and warrant little comment except to point out that the collector voltages may require some adjustment to the voltage specified on the circuit diagram. This can be done by altering the values of the 2.7M bias resistors.

The available bass boost can be increased to some extent by reducing the value of both .022uF capacitors associated with the bass control. The actual value used can be selected to

suit the user's particular requirement but, in any case, it is not advisable to reduce these capacitors to less than .0082uF.

The control unit has been designed to operate from a minimum supply of 50V with a current drain of 15mA. Of this, approximately 8mA is required by the integrated circuit, 4mA for the two transistors and 3mA avalanche current for the zener diode. In addition to voltage regulation, the zener diode is used for filtering and, to do this effectively, it must be operated in the avalanche condition.

Some increase in supply voltage can be tolerated with the zener diode maintaining a constant 36V supply to the control unit circuitry. The diode is able to do this by increasing its avalanche current and so increasing the voltage dropped across the 820 ohm 4-watt resistor which is connected in series with the positive supply rail.

But there is a maximum current which the zener diode can safely pass without exceeding its maximum power-dissipation capability. In this circuit the diode current should be limited to 30mA thus providing an adequate safety margin. With the 820-ohm dropping resistor, 30mA allows a maximum supply voltage of 60V. Thus the control unit may be operated from an external supply of from 50 to 60 volts.

However, this does not preclude operation from the higher voltages necessarily used in valve equipment. To operate the control unit from a voltage higher than 60V, additional resistance must be added in series with the 820 ohm 4-watt resistor. The additional resistor should be mounted in the power amplifier with which the control unit is being used.

A table of resistor values is given below allowing the control unit to be operated from voltages between 60 and 360 volts. Note that the resistors should be used in addition to the 820 ohm 4-watt resistor, as we have already stressed.

Voltage	Resistance	Dissipation
60V to 80V	680 ohms	2 watt
80V to 120V	2.2K (2K)	4 watt
120V to 200V	4.7K (5K)	10 watt
300V to 360V	10K	20 watt

Where the unit is to be operated from a supply voltage between 200

approved & accepted

by leading manufacturers and
Government Departments.

ELNA

Electronic Components

- Electrolytic Capacitors
- Polyester Capacitors
- Carbon Potentiometers

Australia's largest selling imported capacitors are produced by one of the world's major components manufacturers.



Write or phone for
illustrated brochure

SOANAR ELECTRONICS

PTY LTD

A. & R.-Soanar Group Company.

VIC.: 45 Lexton Rd, Box Hill. 89 7323.
NSW: 82 Carlton Cres. Summer Hill.
798 6999.
QLD: R. A. Venn Pty Ltd, Valley. 51 5421.
SA: Scott Thompson Pty Ltd, Adelaide.
23 2261.
WA: Everett Agency Pty Ltd, West Leederville. 8 4137.

PARTS LIST

- 1 Set of metalwork.
- 1 Printed wiring board, 69p9.
- 1 4-pole 4-position rotary wafer switch.
- 1 3-pole 5-position rotary wafer switch.
- 1 50K 1in. potentiometer.
- 1 50K plus 50Klog. ganged pot.
- 2 500K plus 500K 1in. ganged pot.
- 1 Pilot lamp, see text.
- 10 Co-axial insulated audio connectors.
- 1 5-pin DIN socket.
- 1 7-pin socket.
- 1 Octal plug, cable type.
- 8 Knobs.

SEMI-CONDUCTORS

- 1 Integrated circuit, Fairchild type uA739C.
- 2 BC107 silicon transistors or equivalent.
- 1 BZY95/C36 zener diode (36 volt) or equivalent.

RESISTORS

- 2 2.7M, 2 x 2.2M, 2 x 1M, 2 x 470K, 1 x 390K, 2 x 220K, 2 x 100K, 11 x 47K, 4 x 27K, 2 x 10K, 4 x 4.7K, 2 x 2.7K, 2 x 1.8K, 4 x 1.5K, 1 x 820 ohm 4 watt, 2 x 470 ohm, 1 x 390 ohm, 2 x 33 ohm.

CAPACITORS

- 2 50uF 25VW electrolytic.
- 1 25uF 50VW electrolytic.
- 3 10uF 6VW tantalum electrolytic.
- 2 5uF 6VW tantalum electrolytic.
- 2 0.47uF LV plastic.
- 2 0.33uF LV plastic.
- 2 0.1uF LV plastic.
- 8 .022uF LV plastic.
- 2 .0047uF LV plastic.
- 2 .0022uF LV plastic.
- 2 .0015uF LV plastic.
- 2 680pF polystyrene.

MISCELLANEOUS

- 1 Grommet to fit a 3/8in hole, connecting wire, stereo shielder wire, solder, nuts and bolts, etc.

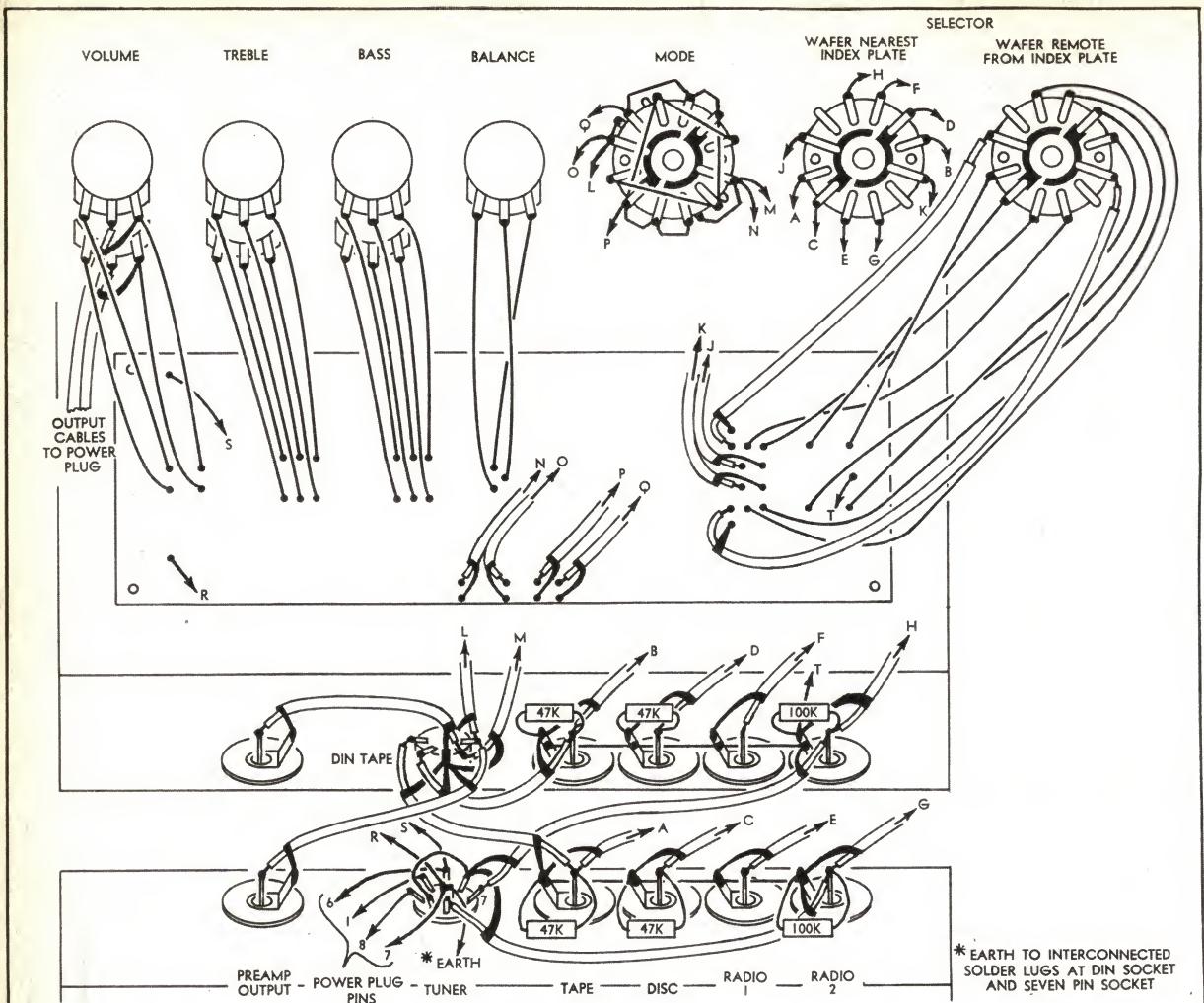

A complete wiring diagram of the control unit with the printed board in position is shown above. Allow plenty of lead length from the wiring board and input sockets to the switches and be careful to make correct connections by systematically following the wiring diagram.

and 360 volts, a 10K 20W resistor is required, as indicated in the table above. However, the resistance may be made up from two separate resistors, either connected in series or in parallel. For either series or parallel connection both resistors should be 10-watt devices. For series connection they both could be 4.7K, and for parallel connection they both should be 22K.

Construction of the control unit should be straightforward with the printed wiring board eliminating all the hard work. A diagram of the wiring board is included, clearly showing the positions of all components. This, together with a wiring diagram, should allow the assembly with minimum difficulty, eliminating points of possible ambiguity.

It would be best to start with the printed wiring board and leave the mechanical assembly to last. Normal procedures for printed wiring board assembly apply, with particular care being necessary when wiring transistors. Be careful not to heat the transistors excessively and, if necessary, use a pair of long-nose pliers to hold their leads separately as each one is soldered — this will absorb excess heat.

Other passive components—resistors, capacitors, etc., are not as critical to heating, but care should still be taken when soldering these components. Also,

the leads of resistors and capacitors should not be bent acutely near the component.

Take particular care that the components on the wiring board are in the correct position. An error in a wiring board assembly can be particularly difficult to trace.

After wiring the smaller components, the potentiometers can be fitted with short (approximately 4½ in) lengths of hookup wire. But first cut the shafts as short as is necessary to allow the knobs to fit flush against the front panel.

Now wire the selector and mod switches using stereo shielded cable where indicated in the circuit and wiring diagrams. This is most easily done with the wiring board and switches out of the metal case. Allow sufficient lead lengths so that the switches can be placed in their respective positions on the front panel without straining the leads.

There are quite a few shielded and unshielded leads connecting the switches to the wiring board, making a rather bulky wiring form. We tied the leads in two forms, one for each switch, using plastic form tying material. Incidentally, it is far better to have the leads a little too long than not long enough.

With the wiring completed thus far,

the wiring board with switches and potentiometers can be mounted in the metalwork, but, do not secure the board as you may have to move it to complete the remaining wiring. This consists of a third wiring form connecting the input sockets to the selector switch and the various power leads. Also, the tuner and tape sockets can be wired at this stage.

The leads in the cable connecting the control unit to amplifier are terminated on the tuner socket. Two separate pairs of leads then connect the board and pilot lamp to the tuner socket, while the signal leads are terminated directly at the volume potentiometers.

A separate pilot lamp supply is required, voltage depending upon the lamp used. DC is preferable, as an AC supply may cause hum problems in the control unit. We used a 24V pilot lamp supplied by I.R.H. components Pty. Ltd. (Telite type FP11/SD/FRH). However, other 6 or 12V pilot lamps could be used.

Finally, an earthing system similar to the prototype should be followed. In this, all the coaxial input sockets are insulated from the metalwork, but connected to the wiring board earth by a short length of hookup-wire. However, the wiring board earth is connected to the metalwork by the negative power connection which is terminated on the tuner socket and then connected to a solder lug fastened under a nut. Note that this is the only connection of the wiring board earth to the metalwork.

Deitron

Cable Address: "DEITRONICS", SYDNEY. Phone:

ELECTRONICS (Sales) Pty. Ltd.

31-5430
31-6786

4-6 TAYLOR ST., TAYLOR SQUARE, DARLINGHURST, N.S.W., 2010

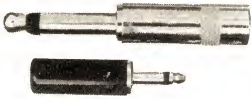

LIFT
OUT



1970

DEITRON PARTS & EQUIPMENT TRADE CATALOGUE



ELNA	POTENTIOMETERS ELECTROLYTIC & POLESTESTER CAPACITORS.
CAPSTAN	PLASTIC STACKMASTER STORAGE CABINETS
UNIVERSITY	TEST INSTRUMENTS
A & R	POWER SUPPLIES & BATTERY ELIMINATORS
PIHER	HIGH STABILITY CRACKED CARBON RESISTORS
SOANAR	SILICON EROXY RECTIFIERS & BRIDGE RECTIFIERS
DEITRON	FERRITE RODS, SPEAKERS BATT. CARRIERS, PVC GANGS IF'S PLUGS & SOCKETS
DEITRON	MULTITESTERS, SIGNAL INJECTORS, SIGNAL TRACERS.

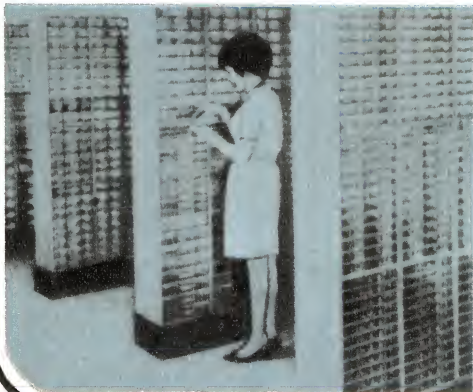

1. All prices are nett and include Sales Tax.
2. For further information on any item listed write to be placed on the mailing list.
3. Quantity prices will be supplied on application.
4. A representative is available upon inquiry.



Deitron

ELNA

ELECTROLYTIC CAPACITORS

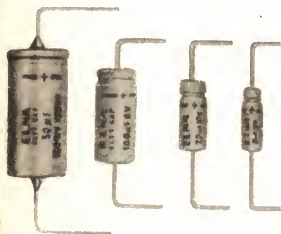

TYPES RA RT
Standard Pigtail Types
All Types PVC Sleeved

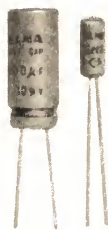

TYPE RB
Sub-miniature for
Rapid Neat
P.C.B. Mounting

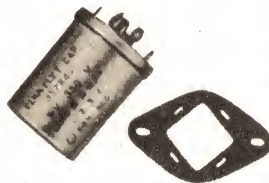

TYPE RD
STD. Twist Lug
Fully interchangeable

- Welded connections
- All types ex-stock
- High ripple rating
- 2-year guarantee
- Compact-Robust
- Low cost
- Low leakage
- Extended shelf life



TYPE RG
Standard 1 3/8in Can
PVC Sleeved
Interchangeable

M.F.D.	Volts Work	Volts Surge	Type	Length Inches	Dia. Inches	Ripple IMA
1	350	400	RT	.45	.2	30
2	12	14	RA/RB	.5	.2	10
2	25	30	RA/RB	.5	.2	10
2	50	63	RA	.6	.2	10
4	500	550	RT	1.15	.6	130
5	10	12	RB	.45	.2	10
5	12	14	RA/RB	.5	.2	20
5	25	30	RA/RB	.5	.2	25
5	50	63	RA	.6	.2	30
8	500	550	RT	1.55	.7	250
10	10	12	RB	.45	.2	10
10	12	14	RA/RB	.5	.2	10
10	25	30	RB	.6	.2	40
10	50	63	RA	.75	.3	40
16	500	550	RT	1.90	.85	300
24	500	550	RT	1.90	.95	350
25	25	30	RA/RB	.5	.4	130
30	10	12	RB	.45	.3	50
30	12	14	RA/RB	.6/.45	.2/.3	100
32	500	550	RT	1.90	.95	400
50	10	12	RB	.45	.3	60
50	12	14	RA/RB	.6/.5	.3/.4	200
50	25	30	RA/RB	.8/.7	.4/.4	250
50	50	63	RA	.9	.5	350
50	150	185	RT	1.15	.7	400

M.F.D.	Volts Work	Volts Surge	Type	Length Inches	Dia. Inches	Ripple IMA
50	350	400	RT	1.90	.95	400
50+50	350	400	RD	1.90	1 1/8	500
100	10	12	RB	.5	.4	200
100	12	14	RA/RB	.8/.7	.4/.4	300
100	25	30	RA	.9	.5	350
100	50	63	RA	1.55	.5	350
100	200	250	RT/R6	1.9/1.9	.95/1 1/8	1A
100	350	400	R6	1.9	1 1/8	1A
200	350	400	R6	3.2	1 1/8	1A
250	12	14	RA/RB	.9/.7	.5/.5	400
250	25	30	RA/RB	1.15/.6	.6/	500
250	50	63	RA	1.9	.7	600
500	6	8	RA	1.55	.5	600
500	15	18	RA	1.15	.6	800
500	25	30	RA/RB	1.55/.7	.7/	800
500	50	63	RA	1.9	.85	1A
1000	15	18	RA	1.55	.7	1A
1000	25	30	RA/RB	1.55/.85	.85/	1A
1000	50	63	RA	2.30	.95	1.5A
1000	63	125	R6	1.90	1 1/8	1.5A
1000	100	125	R6	3.20	1 1/8	1.5A
2000	15	18	RA	1.90	.85	1.5A
2000	25	30	RA	1.90	.95	1.5A
2000	35	45	R6	1.75	1 3/16	1.5A
2000	50	63	R6	1.90	1 1/8	2A
2200	63	80	R6	2.40	1 1/8	2A

Deitron

Cable Address: "DEITRONICS", SYDNEY.

'Phone: 31-5430

ELECTRONICS

31-6786

4-6 TAYLOR ST., TAYLOR SQUARE, DARLINGHURST. N.S.W., 2010

Deitron

ELNA

CARBON POTENTIOMETERS

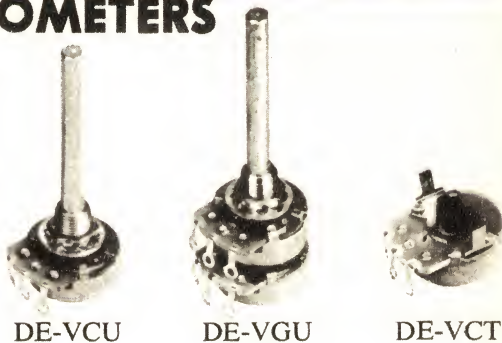
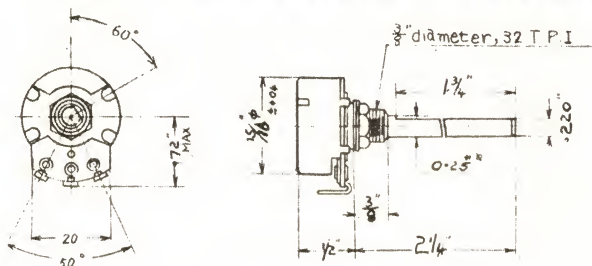

- Element — smooth low-noise .25 watts.
- Element—carefully bonded to phenolic base
- Switch — robust DPST 250V 1A
- Each control sealed in individual plastic bag for dust-free protection and storage
- Rotational noise—less than 20mV.
- Voltage rating—1000 VAC (1MIN)
- Total rotation 300°
- Tapers — Std. Aust "A" (Lin.) "C" (Log)
- Resist tolerance ± 20 p.c.

Type	STOCK RANGE OF VALUES	Price ea	10-99
DE-VCT	TAB MTD. "A" Taper. Screw driver slot front and rear for easy access. 500, 1K, 2K, 3K, 5K, 10K, 20K, 25K, 50K, 100K, 250K, 500K, 1M, 2M, 2.5M, 3M, 5M.	50c	40c
DE-VCU	("A") 500, 1K, 5K, 10K, 25K, 50K, 100K, 250K, 500K, 1M, 2M, 3M, 5M. ("C") 1K, 5K, 10K, 25K, 50K, 100K, 250K, 500K, 1M, 2M, 500K Tap 40K, 1M Tap 400K.	70c	50c
DE-VCS	STD 2.1/4" Bush mounted DPST Switch control (LOG 'C') 1K, 5K, 10K, 25K, 50K, 100K, 250K, 500K, 1M, 2M, 500K Tap 40K, 1M Tap 400K.	1.20	90c
DE-VGU	("A") 2x10K, 2x25K, 2x50K, 2x100K, 2x250K, 2x500K, 2x1M, 2x2M. ("C") 2x10K, 2x25K, 2x50K, 2x100K, 2x250K, 2x1M, 2x2M.	2.50	1.80

POLYESTER FILM CAPACITOR

- Tolerance (Cap.) ± 10 p.c.
- Working voltage 100VDC (to .27Mfd)
- Test voltage 200VRC (from .27Mfd)
- Test voltage 2.5 x W.V.
- Insulation resis (20°C) 50,000 M. OHMS
- Temp. range -25° to $+85^\circ$ C
- Power factor .8 p.c. Max. (1 kc)
- Construction High grade tin foil Epoxy coating

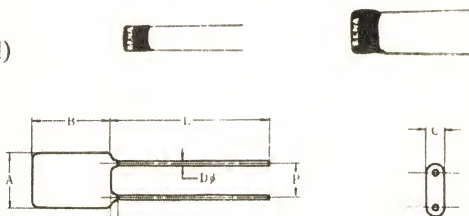

MFD	VDCW	A"	B"	C"	P"	D"	Trade	10-99	MFD	VDCW	A"	B"	C"	P"	D"	Trade	10-99
.001	100	.2	.43	.1	.1	.014	10c	8c	.039	100	.3	.5	.12	.24	.2	10c	8c
.0015	100	.2	.43	.1	.1	.014	10c	8c	.047	100	.35	.5	.15	.24	.02	12c	10c
.0022	100	.2	.43	.1	.1	.014	10c	8c	.056	100	.35	.5	.15	.24	.02	12c	10c
.0033	100	.22	.43	.1	.1	.014	10c	8c	.068	100	.35	.5	.2	.24	.02	12c	10c
.0039	100	.22	.43	.1	.1	.014	10c	8c	.082	100	.43	.5	.2	.26	.02	12c	10c
.0047	100	.22	.43	.1	.1	.014	10c	8c	.1	100	.43	.54	.25	.27	.02	15c	12c
.0056	100	.22	.43	.1	.1	.014	10c	8c	.15	100	.43	.54	.25	.27	.02	15c	12c
.0068	100	.27	.43	.1	.1	.014	10c	8c	.22	100	.6	.6	.25	.40	.025	15c	12c
.0082	100	.27	.43	.1	.1	.014	10c	8c	.33	200	.76	.64	.3	.64	.03	18c	15c
.01	100	.27	.48	.12	.2	.014	10c	8c	.39	200	.76	.66	.3	.64	.03	23c	20c
.015	100	.27	.48	.12	.2	.014	10c	8c	.47	200	.76	.68	.35	.64	.03	25c	22c
.022	100	.3	.48	.12	.24	.014	10c	8c	1	200	1.1	.72	.4	.96	.03	35c	30c
.033	100	.3	.48	.12	.24	.014	10c	8c	2	200	1.1	.88	.5	.96	.04	55c	45c

Deitron

Cable Address: "DEITRONICS", SYDNEY.

Phone: 31-5430

ELECTRONICS

31-6786

4-6 TAYLOR ST., TAYLOR SQUARE, DARLINGHURST. N.S.W., 2010

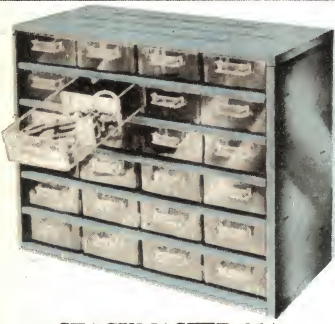

STACKMASTER 24A
12½in wide x 10½in high x 6in deep,
24 drawers each 2½in wide x
1½in high x 5½in deep.



STACKMASTER 16A
12½in wide x 7½in high x 6in deep,
16 drawers each 2½in wide x
1½in high x 5½in deep.



STACKMASTER 12A
12½in wide x 5½in high x 6in deep,
12 drawers each 2½in wide x
1½in high x 5½in deep.



STACKMASTER 24F
Drawers 5in wide x 2in high x
5in deep.



STACKMASTER 16B
Drawers 5in wide x 1in high
x 5in deep.



STACKMASTER 12C
Drawers 2in wide x 2in high x
5in deep.

To increase storage,
additional tiers
available for both
sizes of Jiffy
cabinets

SINGLE TIER JS-4A

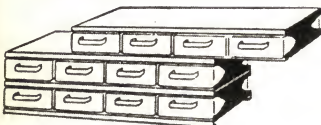

JIFFY 12C
11½in wide x 5½in high x 6in deep
8 drawers each 2½in wide x 2in high x
5½in deep



JIFFY 12A
11½in wide x 5½in high x 6in deep
12 drawers each 2½in wide x 1½in high
x 5½in deep.

- All cabinets finished in rustproof zincseal with grey enamel coating.
- Wrap-around frame with shelves tongued, slotted and spot-welded.
- For ease of use, drawers hang open without falling out, because of back-stop on drawer and lip on cabinet.
- Additional cabinets lock on securely by tongue and slot.
- Resistant to breakage because made of toughened polystyrene.
- Clear, easy to keep clean.

Model No.	STM 12A	STM 12B	STM 12C	STM 12D	STM 16A	STM 16B	STM 16E	STM 16F	STM 24A	STM 24B	STM 24C	STM 24D	STM 24E	STM 24F	JC 12A	JC 12C	JS 4A
No Draws	12	6	8	4	16	8	8	4	24	12	16	8	12	6	12	8	4
Drawer W"	2½"	5½"	2½"	5½"	2½"	5½"	2½"	5½"	2½"	5½"	2½"	5½"	2½"	5½"	2½"	2½"	2½"
Drawer H"	1½"	1½"	2"	2"	1½"	1½"	2½"	2½"	1½"	1½"	2"	2"	2½"	2½"	1½"	2"	1½"
Drawer D"	5½"	5½"	5½"	5½"	5½"	5½"	5½"	5½"	5½"	5½"	5½"	5½"	5½"	5½"	5½"	5½"	5½"
Post N.S.W.	60c ea.				80c ea.				\$1.00 ea.				50c ea.		30c		
Post Int'ate	85c ea.				\$1.25 ea.				\$1.50 ea.				75c ea.		40c		
TRADE PRICE	\$5.20 ea.				\$6.80 ea.				\$9.00 ea.				\$4.50 ea.		\$1.50		

Cable Address: "DEITRONICS", SYDNEY.

Phone: 31-5430
31-6786

Deitron

University



MVA-6 \$47.50

TE-20D \$41.40

UC-3 \$115.00

TE-22D \$43.70

MVA-7 \$51.75

Model MVA-6 vacuum tube Voltmeter
AC-DC Volts, 7 ranges to 1.5KV; P.P. volts, 7 ranges to 4KV, DB (1mW-600) 10db to plus 65db; ohms .2 to 1000M.

Trade Price \$47.50 (Post \$1.20, Interstate \$1.80).

Model Te-20D Signal Generator
7 Bands 120Kc-500Mc (6 Fundamental and 1 Harmonic) Xtal Socket for: Self calibration or Marker Generator.

Trade Price \$41.40 (Post \$1.20, Interstate \$1.80).

Model TE 22D Audio Generator
Sine 20cps-200Kcs. Square 20cps-150Kcs. Output volt 7V max. (1K imp). Freq. response plus 1.5db 20cps-150Kcs.

Trade Price \$43.70 (Post \$1.20, Interstate \$1.80).

Model UC-3 3" Oscilloscope
Vertical 100mV P.P./CM at 1Kc. Freq. Char. 1.5cps to 1.5Mcs. Horizontal 900 MV P.P./CM (at 1Kc). Wide sweep 10 CPS-300Kcs. Continuously variable.

Trade Price \$115.00 (Post \$2.00, Interstate \$3.50)

Model MVA-7 High sensitivity VTVM
AC volts 1mV-300V 10 ranges db range —40 to —50db 10 ranges. Input impedance 10 meg. Accuracy 5cps. —1.2Mcs plus or minus 2db.

Trade Price \$51.75 (Post \$1.00, Interstate \$1.60).

WRITE FOR FURTHER INFORMATION.

Deitron

A&R

REGULATED POWER SUPPLY TYPE PS104

AC ADAPTOR PS 82

AC ADAPTOR PS 64

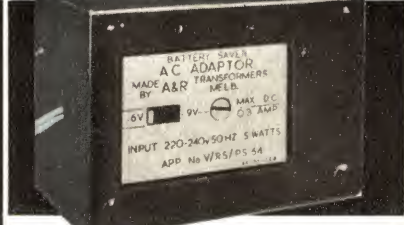

Designed primarily for Tape Recorders where a regulated voltage supply is necessary to prevent speed variation with load changes. A versatile Power Supply with a range of output Voltages making it ideal for Design Testing and Repair of Transistor Radios, Amplifiers, Record Players, Test Equipment, etc. It is also eminently suitable for use in Schools, Universities, Government Departments and Industry.

Provides unlimited operation of Battery operated Transistor Radios from 220/240V. A.C. Mains at negligible Power Cost.

- Unlimited operation of Battery operated Transistor Equipment from 240 Volt AC Mains at negligible power cost.
- Ideal for 6 or 9V Transistor Radios, Tape Recorders, Transistorised Small Amplifiers and Test Equipment.
- Approved by Electric Supply Authorities.
- Maximum Voltage limited to 8.75V or 11V at low current to protect transistors and capacitors.
- Filtered to ensure hum-free operation.
- 6 or 9V (nominal voltage) selected by external switch (300mA).

SPECIFICATIONS
Input Voltage 240 Volts, 50 Hz
Output Voltage 4.5V, 6V, 7.5V, 9V or 12V D.C. by Selector plug. Max Current 0.5A
Protection Electronic Overload Protection
Regulation Approx 10% on 12V Range
Ripple Approx 5% on all other Ranges
Less than 100 mV R.M.S. under all conditions.
Circuitry All silicon solid state.
Size 4 ins. wide by 2 1/2 ins. high x 5 1/2 ins. deep
Weight 2 lbs. 7 ozs.
Approval Approved by Electric Supply Authorities

- 6 or 9 Volt (Nominal Voltage) selected by external switch at a maximum current of 0.1 amps.
- Double Insulated for absolute safety.
- Approved by Electric Supply Authorities.
- Handsome Ivory cabinet complete with 3-pin power point plug, and radio lead with plug.
- Measures a compact 3 1/2 in x 2 1/2 in x 2 1/2 in.
- Suitable for any 6 or 9 Volt Battery Operated Transistor Equipment.

Price \$8.90 Post 60c.
Int. State 90c.

TECHNICAL SPECIFICATIONS
Input 220/240V 50Hz.
Output D.C. 7.75/11V over no load to full load current range.
Output D.C. 5.6/7.75V over no load to full load current range.
Ripple Voltage 6V Output 1.5 p.c. max.
Ripple Voltage 9V Output 0.5 p.c. max.
Dimensions 3 1/2 in x 2 1/2 in x 2 in.

All types of transformers available. For Electronics Australia projects etc.

Price \$14.09 Post 40c.
Int. State 70c.

Write for further information on A & R Transformers.

Price \$21.45 Post \$1.00.
Int. State \$1.60.

Cable Address: "DEITRONICS", SYDNEY.

Phone: 31-5430
31-6786

Deitron

ELECTRONICS

4-6 TAYLOR ST., TAYLOR SQUARE, DARLINGHURST. N.S.W., 2010

Deitron

PIHER

HIGH STABILITY INSULATED CRACKED - CARBON RESISTORS 70 deg. C



APPLICATION

These resistors are for any application which requires a high degree of stability and accuracy in any climatic condition. The stability of carbon film resistors is far superior to that of carbon composition type resistors. They combine high stability, resistance to climatic conditions, very low noise level with small dimensions and **reasonable price**. These carbon film resistors are not liable to an appreciable resistance change when dip soldered. They are therefore very suitable for use in conjunction with printed wiring.

RESISTANCE, TOLERANCE, POWER RATING

The minimum and maximum resistance for each type is listed in Table 1. Tolerance is plus or minus 5% of the resistance on the unloaded state. The resistance values are scaled in the E12 series (12 values between 1 and 10 viz; 1.0, 1.2, 1.5, 1.8, 2.2, 2.7, 3.3, 3.9, 4.7, 5.6, 6.8, 8.2: the values can be multiplied by any integral power of the 10). The power rating of each type is listed in Table 1. Full rated power is permissible to an ambient temperature of 70 deg. centigrade with a linear derating to zero at 150 deg. cent.

70°C HIGH CRACKED CARBON ± 5%

Type	Watts 70° C	Watts 40° C	Volts Max.	OHMS Min.-Max.	L"	D"	L1"	D1"	Price	Over 100
RJ	.125W	.25W	200V	10 - 1M	.28"	.08"	1.20"	.02"	8c	5c
RK	.5W	.75W	500V	10 - 10M	.40"	.15"	1.20"	.03"	8c	5c
RL	1W	1.5W	750V	10 - 10M	.60"	.24"	1.20"	.03"	10c	7c

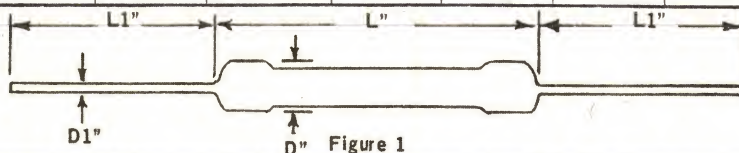

Deitron

EPOXY SILICON RECTIFIERS AND BRIDGE RECTIFIERS

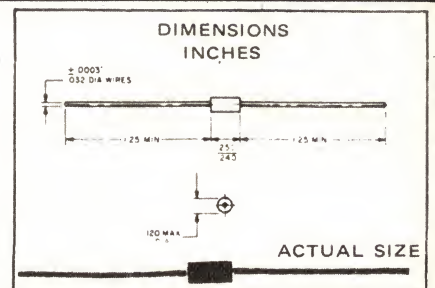

Type	PIV (V)	I (25°C)	Rev. I	Length	Width	Diam.	Thick	Price	10-99
EM4005/SD-05	50v	1A	5uA	.23"		.12"		35c	25c
EM401/SD-1	100v	1A	5uA	.23"		.12"		38c	27c
EM402/SD-2	200v	1A	5uA	.23"		.12"		40c	30c
EM404/SD-4	400v	1A	5uA	.23"		.12"		48c	35c
EM406	600v	1A	5uA	.23"		.12"		62c	55c
EM408	800v	1A	5uA	.23"		.12"		80c	70c
EM410	1000v	1A	5uA	.23"		.12"		\$1.10	90c
BRIDGE MB1	100v	2A	5uA	.6"	.6"		.22"	\$1.85	\$1.50
" MB2	200v	2A	5uA	.6"	.6"		.22"	\$1.95	\$1.75
" MB3	300v	2A	5uA	.6"	.6"		.22"	\$2.15	\$1.90
" MB4	400v	2A	5uA	.6"	.6"		.22"	\$2.25	\$2.00
" MB6	600v	2A	5uA	.6"	.6"		.22"	\$2.85	\$2.50
" MB8	800v	2A	5uA	.6"	.6"		.22"	\$3.57	\$3.25
" MB10	1000v	2A	5uA	.6"	.6"		.22"	\$4.70	\$4.20

Deitron

Cable Address: "DEITRONICS", SYDNEY. Phone: 31-5430

ELECTRONICS

31-6786

4-6 TAYLOR ST., TAYLOR SQUARE, DARLINGHURST, N.S.W., 2010

Deitron

Cable Address: "DEITRONICS", SYDNEY. Phone: 31-5430

ELECTRONICS

31-6786

4-6 TAYLOR ST., TAYLOR SQUARE, DARLINGHURST. N.S.W., 2010

FERRITE RODS

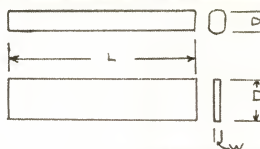
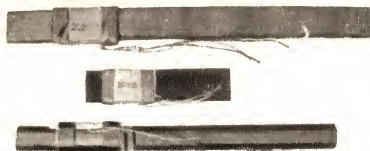

Type	L	D	W	Postage	Price	Type	L	D	W	Postage	Price
DE-FR-100-8	100	8		10c	90c	DE-FR	140	15	4	10c	\$1.25
DE-FR-120-8	120	8		10c	\$1.00	DE-FR	140	12	4	10c	\$1.00
DE-FR-120-10	120	10		10c	\$1.00	DE-FR	55	13	5	10c	90c
DE-FR-140-10	140	10		10c	\$1.15	DE-FR	60	13	5	10c	90c
DE-FR-160-10	160	10		10c	\$1.25	DE-FR	50	14	5	10c	90c
DE-FR-180-10	180	10		10c	\$1.40						
DE-FR-200-10	200	10		10c	\$1.60						

PVC TUNING GANGS



Type	L gth.	Width	Dpth.	No. of Gangs	No. of Trimmers	Capacitance	Price
DE-PVC-2Z	16	16	11	2	2	126 pf -126 pf	2-50
DE-PVC-2X	20	20	12	2	2	142 pf - 60 pf	2-00
DE-PVC-2JT	25	25	18	2	2	270 pf 1 270 pf	2-80
DE-PVC-2J	25	25	15	2	—	270 pf - 270 pf	2.50
DE-PVC-2R	30	30	19	2	—	335 pf - 335 pf	3.00
DE-PVC-3R	30	30	28	3	—	335pf 335pf 335pf	3.60

IF (455 KHz) COILS

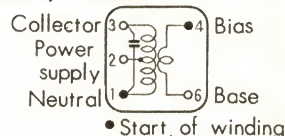
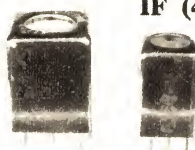

Type	L	W	Primary Z	Secondary Z	Price
DE-1FT-10-10-1	10	10	50K	500 oHm	\$1.00
DE-1FT-10-10-2	10	10	30K	500 oHm	\$1.00
DE-1FT-10-10-3	10	10	20K	5K oHm	\$1.00
DE-1FT-7-7-1	7	7	50K	500 oHm	\$1.00
DE-1FT-7-7-2	7	7	30K	500 oHm	\$1.00
DE-1FT-7-7-3	7	7	20K	5K	\$1.00

BATTERY CARRIERS



Type	Batteries	Price
DE-BC-2S	2 x UM3	60c
DE-BC-4S	4 x UM3	40c
DE-BC-4SL	long type 4 x UM3	50c
DE-BC-6S	6 x UM3	80c
DE-BC-8S	8 x UM3	\$1.00

MINIATURE VOLUME CONTROLS



TYPE	RESIST-ANCE	DIA-METER	USE	PRICE
DE-VC-1	5K	16mm	Universal	35c
DE-VC-3	5K	12mm	Universal	40c
DE-VC-4	5K	10mm	Universal	55c
DE-VC-2	5K	16mm	National Type	40c
DE-VC-5	5K	16mm	Sharp Type	55c
DE-VC-6	5K	16mm	Universal	55c

MINIATURE SPEAKERS



Type	Size	Voice Coil	Power	Postage	Price
DE-S-2-8	2"	8 oHm	.100 mW	10c	2.00
DE-S-2½-8	2½"	8 oHm	200 mW	10c	2.00
DE-S-2½-8	2½"	8 oHm	300 mW	10c	2.50
DE-S-2½-8	2½"	8 oHm	300 mW	10c	2.50
DE-S-3-8	3"	8 oHm	500 mW	10c	3.00
DE-S-3½-8	3½"	8 oHm	500 mW	10c	3.25
DE-S-4-8	4"	8 oHm	800 mW	10c	3.50

PLUGS AND SOCKETS



Plugs	Price	Sockets	Price
DE-DP-2	2 pin din 35c	DE-DS-2	2 pin din 25c
DE-DP-3	3 pin din 35c	DE-DS-3	3 pin din 25c
DE-DP-5	5 pin din 40c	DE-DS-5	5 pin din 30c
DE-P-3	3.5 m/m 20c	DE-J-3	3.5 m/m 15c
DE-P-4	chrome phone 50c	DE-J-4	phone 30c
DE-BP-1	Banana 15c	DE-BS-1	Banana 15c

Cable Address: "DEITRONICS", SYDNEY. Phone: 31-5430

ELECTRONICS

31-6786

4-6 TAYLOR ST., TAYLOR SQUARE, DARLINGHURST. N.S.W., 2010

Deitron

Deitron

Cable Address: "DEITRONICS", SYDNEY.

Phone: 31-5430

ELECTRONICS

31-6786

4-6 TAYLOR ST., TAYLOR SQUARE, DARLINGHURST, N.S.W., 2010

DE-200H



D.C.V. : 5-25-50-250-500-2.5K (20K Ω /V)
 A.C.V. : 10-50-100-500-1000 (10K Ω /V)
 D.C.A. : 50 μ A-2.5 mA-250 mA
 A.C.A. :
 Ohms : 0.6K — 6M
 db : -20/0/+22
 Accuracy : \pm 3% for D.C. \pm 4% for A.C.
 Battery : 1 x 1.5V
 Size : 4 1/2" x 3 1/2" x 1 1/2"
 Weight : 10 oz.

Price \$11.50

Postage: 50c Interstate; 80c

DE-MVA-4



: 2.5-10-50-250-1000 (20 K Ω /V)
 : 2.5-10-50-250-1000 (8 K Ω /V)
 : 50 μ A-2.5 mA-25 mA-250 mA
 : 10K-100K-1M-10M
 : -20/0/+22,+22/+36
 : \pm 3% for D.C. \pm 4% for A.C.
 : 3 x 1.5 V
 : 6" x 4-3/16" x 2 1/2"
 : 1.34 lbs.

Price \$16.50

Postage: 55c Interstate; 85c

DE-MVA-100



: 0.5-2.5-10-50-250-500-1000 (100K Ω /V)
 : 2.5-10-50-250-1000
 : 10 μ A-250 μ A-2.5 mA-25 mA-250 mA-10A
 : 0-10A
 : 20K-200K-2M-200M
 : -20/0/+62
 : \pm 3% for D.C. \pm 4% for A.C.
 : 2 x 1.5V + 1 x 22.5V
 : 7" x 5 1/2" x 3"
 : 3 lbs.

Price \$39.50

Postage: 60c Interstate; 90c

DE-CT-500



20,000 OHM/VOLT DC
 10,000 OHM/VOLT AC
 D.C.V. DC Volts:
 0-2.5, 0-10, 0-50,
 0-250, 0-500, 0-5k.
 A.C.V. AC Volts:
 0-10, 0-50, 0-250,
 0-500, 0-1k.
 D.C.A. DC Amperes:
 0-0.05m, 0-5m,
 0-50m, 0-500m.
 Ohms:
 0-12k, 0-120k,
 0-1.2M, 0-12M(60)
 db
 -20 to plus 62db.

\$14.95

Postage 50c. Interstate 90c

DE-500 SIGNAL TRACER

**\$4.50**TRACES AF
OR RF
SIGNALS

DE-250B SIGNAL INJECTOR

**\$5.50**

SIGNAL TRACER DE-350

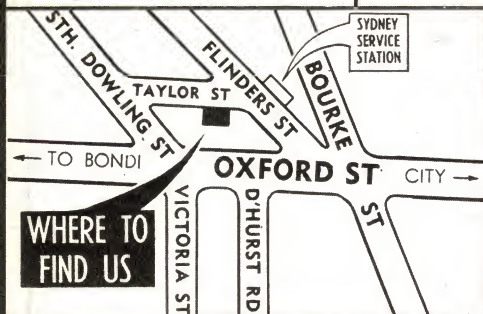

GAIN
Over 70db (variable).
ATTENUATION
0-20, 0-40, 0-60db.
INPUT IMPEDANCE
AF over 70K ohms.
RF over 100K ohms.
OUTPUT IMPEDANCE
8 ohms. (Ext. Speaker.)
600 ohms unbalanced at output socket.
FREQUENCY RESPONSE
3db points, 700 cycles—100 Kilocycles.
SIZE
5 7/8" (length), 3 3/8" (width), 2 3/8" (depth).

\$27.50 Post 60c Int. 90c

ALL COMPONENTS
AND TEST EQUIPMENT
ARE GUARANTEED
FOR 90 DAYS

SERVICE & SPARES
AVAILABLE FOR
TEST EQUIPMENT

Deitron

Cable Address: "DEITRONICS", SYDNEY.

Phone: 31-5430

ELECTRONICS

31-6786

4-6 TAYLOR ST., TAYLOR SQUARE, DARLINGHURST, N.S.W., 2010

100W—Plus GUITAR LOUDSPEAKER SYSTEMS

The information in this article should be of interest to readers who have an ambition to own and operate an electric guitar system in the 100-watts-plus class. Loudspeakers to handle power of this order are not cheap — but they are available.

With the ever-increasing popularity of musical instruments relying on electronic amplification, there has come a demand for progressively higher orders of audio power output. Manufacturers of power amplifiers have had to meet this but, more particularly, it has posed a tremendous challenge for those concerned with the manufacture of loudspeakers.

There is a reason for this.

If an operator tries to obtain from an amplifier more power than it is capable of delivering, it overloads and produces distortion so unpleasant that the operator is forced to reduce the level. Very rarely does the amplifier suffer any damage from the treatment.

However, if a loudspeaker system is operated at more than an advisable level, the onset of distortion is not nearly so abrupt or so obvious. The system may therefore be operated for a significant time at a level which will ultimately produce physical damage to the voice coil and/or cone system. When this happens, often quite suddenly, the loudspeaker has simply been "wrecked" and only complete reprocessing can put it right again.

Because loudspeaker systems capable of handling very large amounts of audio power are necessarily bulky, heavy and costly, there is a very common tendency for performers to use systems at or above their nominal safe power handling capacity. The result is that loudspeaker system failure is a fairly familiar occurrence, particularly among "pop" groups playing to large, noisy audiences.

As recently as August last, we made a number of suggestions involving available 12-inch loudspeakers and combinations of loudspeakers which could be mounted in enclosures to cope with the 50 to 60 watts (RMS) available from our own Playmaster guitar amplifiers.

For those who may require a loudspeaker system to operate at a substantially higher power level than this, the availability in Australia of high-powered music-system loudspeakers by J. B. Lansing will be of special interest. While there are a number of loudspeakers in the range, the two which are of particular interest are the 15-inch units: type D130F, a general-purpose loudspeaker and type D140F, with accent on bass and performance.

The manufacturer's literature claims that the loudspeakers are easily capable of coping with 75 RMS watts and, presumably under properly baffled conditions, have absorbed up to 250 watts RMS without damage or distortion. The Australian distributors, Auriema (Australasia) Ptv. Ltd., normally refer to them as 100-watt units.

In addition to boasting a high power handling capacity, the loudspeakers have very large magnets and edge-

wound strip voice coils, ensuring high power sensitivity.

The manufacturers suggest that, for optimum performance, the D130F and D140F loudspeakers should be mounted in an enclosure with an internal volume of not less than 4.5 cubic feet. If it can be of 6 cubic feet or more, so much the better. With multiple loudspeakers, the volume should ideally be proportionately increased.

While very large enclosures may be practical for fixed installations, as for an electronic organ, they are not very practical for portable work. Appreciating this and also the low-frequency limit of guitars and other portable instruments, J.B.L. have suggested vented enclosures of much smaller dimensions for their D130F and D140F loudspeakers.

The general observations on cabinet work which follow and the specific designs are taken from literature issued by the J.B. Lansing Company. The material should be of prime interest to those who have a requirement for a loudspeaker system to handle an output in the range 100 to 200 watts RMS. Even with lower-powered amplifiers, such a loudspeaker system could be attractive; because of good

efficiency, sound output for a given input would be high and there would be no danger of loudspeaker overload or damage.

The cabinet for a high-power system must be well built and all joints should be true and tight. Lock-mitre joints glued under clamps are ideal if access is available to the necessary milling machinery.

All joints should be reinforced with glued blocks running the entire length of the joint and screwed at 4-inch intervals to each surface to ensure an airtight cabinet. Small leaks can introduce objectionable whistles and hisses and, in the aggregate, affect the bass response by negating efforts to seal the enclosure (where this is intended) or by adding to the effective area of the vent.

All panels larger than 15in x 20in should have 1in x 3in braces glued on edge every 10 inches and secured by screws. If the extra weight can be tolerated and the effect allowed for on internal volume, the cleats can be increased with advantage to 2in x 4in, particularly with large panels. Reproduction of bass notes benefits from rigid enclosure construction.

Because the baffle panel tends to be weakened by the cutouts, it should be braced regardless of its size. Needless to say, the braces should be located so as not to interfere with the mounting of the loudspeaker(s) or the proper functioning of the vent.

The enclosure should be constructed from material not less than $\frac{3}{4}$ -inch

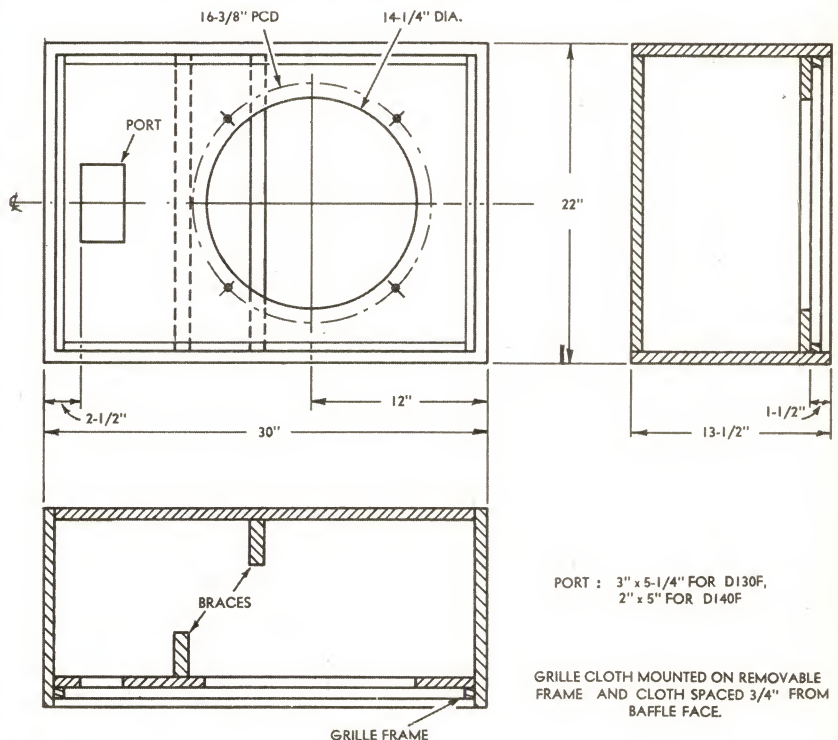

Suggested design and dimensions for an enclosure to suit a JBL D130F or a D140F loudspeaker. Note the different port sizes. The dimensions assume the use of $\frac{3}{4}$ -inch panels. If thicker panels are used, the external dimensions must be increased to maintain the same internal volume.

R.C.S. SPECIALS



**NEW IMPROVED
30 WATT**
NOMINAL
54w MAX.

12v All Transistor P. A. AMPLIFIER

WIRED READY TO OPERATE
15 ohm output, No. 591D . . . \$62
125, 250, 500 ohm, 592D . . . \$62
Dimensions: 6 1/2" in. w. x 3 1/2" in. h. x
8 1/2" in. d. For 240V. op. \$33 extra.

10 WATT P.A.
Inputs 5 MV and 100 MV 10w R.M.S.
at 1%. Frequency 40cy.—30Kc. For use
with 1 4 ohm, 2 8 ohm or 4 16 ohm
speakers in parallel. Same cabinet and
dimensions as 30w above, complete with
240v power supply.

Wired and tested, No. 485 . . \$40
Freight extra in both cases.



R.C.S. COMPLETE DO-IT-YOURSELF KITS

Peak reception,
low price. No ex-
pensive test equip-
ment. Everything
fits. 1964 RF
Transports ' 7.
Complete kit — No. 640 . . . \$43.50
Portable car radio. Identical to 640
above, plus extra switch and car coil
etc. No. 642 . . . \$46.00
(Write for booklet on 640 and 642.)
Postage \$1.

NEW TRANSISTOR PREAMP KIT
SIZE 3 x 2 x 1in. 2 req. for Stereo.
LOW IMP. Input 2 trans 672C \$6.50
Wired ready for use. 672D . . \$8.00
HIGH IMP. 2 tran. 680C . . \$6.50
Wired ready for use. 680D . . \$8.00
HIGH IMP. silicon 3 tran 682C \$8.00
Wired ready for use. 682D . . \$9.50
Postage 10c each. Write for data.

HI-FI BROADCAST TUNER UNIT 4 TRANSISTORS — HI SENSITIVITY.



R.F. mixer, I.F., pwr. dectr. stages, adjustable aerial
coupling. Complete as illust. wired and tested with 641
dial, knobs and switch pot No. 474D. \$31. Postage \$1.
WHISTLE FILTER for above set for 8Kc band width (can
be altered to 9, 10 or 11Kc). No. 128, \$4. Post 10c.

PRINTED CIRCUITS

For all R. and H., E.A., Mullard, Philips and other designs.
Clearly coded. White letters and numbers, easy assembly
and service, polished and resined for easy soldering. With
blueprint parts list.
SPECIALS: To your drawing — write for particulars and
drafting aids.

New Printed Circuits	Number	Recent Designs
726 3 x 3 or 10 x 10 w stereo 68/A8 . . . \$2.80	722 Mullard pre-amp. \$3.00	725 Protected supply \$2.50
736 B/C tuner EA . . . \$2.50	734 EA 69 01 gold p. organ . . . \$5.00	737 AWA 10/25W amp \$2.50
69/TS . . . \$2.50	709 Pre-amp. 67-PS \$2.50	684 Pre-amp. 65-P10 \$2.50
727 E and A wide band tuner 68/8T . . . \$3.20	740 Crystal clock 68-10CL \$5.00	741 Guitar amp 69 PS \$3.00
728 Audio osc., EA . . . \$3.20		
68-09 . . . \$3.20		
718 Mullard main amp. \$2.50		

Immediate dispatch. Postage 10c.

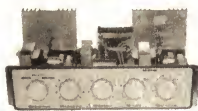

10W STEREO

**MULLARD 10 x 10
watts R.M.S.**

With output transistor **PROTECTION**. Frequency response
40cy. to 30Kc. Distortion 0.5%. Treble, bass, boost 20dB
Complete kit of parts No. 480C . . . \$74.00
Wired and tested No. 480D . . . \$79.00
With hi-fi tuner and whistle filter. \$35 extra. Freight extra.
Write for brochure. For special Sat. demo. ring 59-6550.

MAGNETIC STEREO PRE-AMP

In 5Mv out 250Mv. Bass and
treble 20dB. No. 724C \$29
Wired ready for use . . . \$31
Postage 30c each.
For crystal ceramic
No. 722D \$27



TRANSFORMER



Tap 6v and 9v D.C. at
100 millamps.

Filter, condensers, rectifier, resistor,
case, etc. \$6.50. Post 10c.

PERSONAL PORTABLES 2 TRANSISTORS

Range 30 miles.
200 with short
aerial and earth.
Earpiece only, no
speaker.
Do-it-yourself kit
No. 666C . \$9.00
Postage 20c.

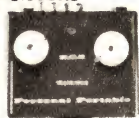

1 TRANSISTOR — 1 DIODE
593C Do-it-yourself kit. \$5. Post 10c.

DIAL KITS SCALE GOLD WITH WHITE LETTERS.

Size 6 3/4 x 2 3/4 in.
● No. 459 to match 300 pf gang.
Price \$4.50
● No. 461 to match 200 pf gang.
Price \$4.50
Post 20c.

NEW AUDIO AMPLIFIER



4 transistors.
1/2 or 1 watt.
Small size, cabi-
net 3in x 2in x
1in plus 1c.
Suitable crystal
P/up. Inter-
com. m i c r o-
phone. radio,
etc. (9 volt.)

**DO-IT-YOURSELF KIT 665 \$10 (Post
10c). Wired ready for use 665D \$11.50.**

COILS & IF's 455 Kc

Aer. R.F., OSC. and IF's . . \$1.80 ea.
Ferrite Aer. \$2
No. 255 Universal tape OSC. coil \$6
Postage 10c. Write for details and price.

R.C.S.

Order by Mail Order, Postal Note or Money Order (add post.), direct to —
RADIO PTY. LTD., 651 FOREST ROAD, BEXLEY, N.S.W., 587-3491, 587-5385

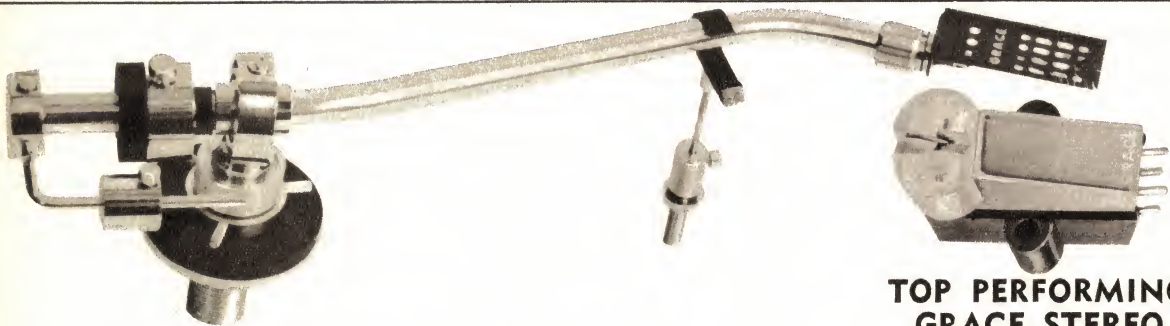

A NEW, PRECISION MADE TONE ARM — THE GRACE MODEL G-545

Although they've been available only a few months, Grace tone arms are already
prized by the audio enthusiast. This new model, the G545, is a winner . . . it
will track down to 1/4 gram with suitable cartridges and features a gimbal type
gyroscopic bearing system. An ultra light weight head shell is supplied . . .
and the new arm shape reduces tracking error to the point where this factor
may be disregarded.
The main counter balance weight is divided into two for easier, more precise
balancing. Sub-weight adjustment sets stylus pressures from 0 to 3 grams.
The arm accepts all Ortofon/SME type headshells without modification and all
"New Generation" cartridges. Tracking ability of this fine tone arm is best
demonstrated with stylus pressures below one gram. Ask for an EMQ or call at
Encel Stereo Centres in Melbourne or Sydney for a demonstration.

TOP PERFORMING GRACE STEREO CARTRIDGES

Model F-8M. With an output of 7 mV. and
a frequency response of 5-35,000 Hz., the
Grace F-8M stereo cartridge tracks down
to 1/2 gram—recommended stylus pressure
being 1 1/2-2 1/2 grams. An elliptical diamond
stylus 0.2 x 0.8 mil. is standard equip-
ment. tip mass is 0.75 m/grams and total
cartridge weight is only 6 1/2
grams. Cross talk is less than
—30 dB. at 1 kHz. Inc. S-Tax
\$39.50

MODEL F-8L. Output of this fine profes-
sional standard stereo cartridge is 5
mV. and frequency response 5-35,000 Hz.
An elliptical diamond stylus is standard
equipment (0.2 x 0.8 mil.); the stylus is
easily changed. Cross talk is less than
—30 dB. at 1 kHz. Stylus pressure re-
commended is 1 1/2-2 1/2 grams.
Total weight of the cartridge
is 6 1/2 grams. Inc. Sales-Tax.
\$39.50

MODEL F-8C. The frequency response of
this new Grace cartridge is 20-25,000 Hz.
and output is 5 mV. Recommended stylus
pressure is 1 1/2-2 1/2 grams, cross talk is less
than —30 dB. at 1 kHz. Tip mass is
0.55 m/grams; the elliptical diamond stylus
measures 0.2 x 0.8 mil. Musical
performance is quite out-
standing. Inc. Sales-Tax.
\$49.50

ENCEL

**ELECTRONICS (STEREO)
PTY. LTD.**

Head Office:
431 Bridge Rd., Richmond, Victoria 3121. Tel. 42 3762.
Sydney Store: Ground Floor, 2SM Building,
257 Clarence Street, Sydney, N.S.W. 2000. Tel. 29 4563, 29 4564.
Australia's Greatest Hi-Fi Centre *Wholesalers *Trade-ins accepted

thick, either plywood or particle board. While specific dimensions are given in the accompanying drawings, the proportions may be varied if desired, provided the internal volume remains the same. It is desirable, however, that no dimension be more than about three times any other dimension. An enclosure measuring 12in x 24in x 48in would not satisfy this stipulation.

Portion of the internal surface area of the enclosure should be lined with a soft, fluffy, absorbent material. The exact amount and placement of the acoustic damping material can be varied to give the degree of mid-range brightness that is required. The less padding used, the brighter and more "live" will be the mid-range. The usual practice is to cover half the internal surfaces so that a padded wall faces an unpadded wall. The lining can be attached to the cabinet walls by using spots of glue, upholstery tacks or staples. If there is any danger of the padding not staying in place, it can be held lightly under muslin pinned with upholstery tacks to the cabinet walls.

Ordinary 1-inch acoustic glass wool is quite effective as a damping medium but other soft, fluffy, absorbent material will do equally well, such as Innerbond, bonded Courttelle, etc. These can be purchased from the larger hi-fi dealers. We do not recommend absorbent building board, foam rubber, foam plastic, rock wool, acoustic tile, cork, cotton, rubberised rug padding, underfelt or other semi-solid material.

Where more than one loudspeaker is used, they should be connected in parallel and in phase, so that both cones move in the same direction at the same time. This will normally involve connecting the energising leads from the amplifier to one loudspeaker and then extending the leads so that each one connects also to the corresponding terminal on the second loudspeaker.

The leads should be taken out of the cabinet through snugly fitting holes, or via terminals or a connector which provides an airtight seal. If this precaution is not taken, air leakage may produce an objectionable hiss or whistle.

It is desirable to mount the D130F or D140F loudspeakers from the front of the baffle using an MA15 mounting kit, which consists of four small cast clamps and a gasket. Mounting the loudspeaker(s) in this fashion allows the baffle to be glued permanently in place. (The MA15 mounting kit is available from the Australian distributors).

If, for any reason, rear mounting is preferred, the baffle must be removable. It is essential that it fit snugly in place and be held by stout screws not more than 6 inches apart. Note that, for rear mounting, the baffle opening must be reduced to 13½ inches.

Note that the plans provide for the grille cloth to be supported on a separate removable frame. It should have as open a weave as possible and be stretched tightly enough to ensure that it will not flap against the baffle of the loudspeaker frame at any level of sound reproduction. If the cloth does touch another surface, it will produce a loud buzz and adversely colour the reproduction quality.

Before fixing the grille in place, the enclosure can be tested under high-

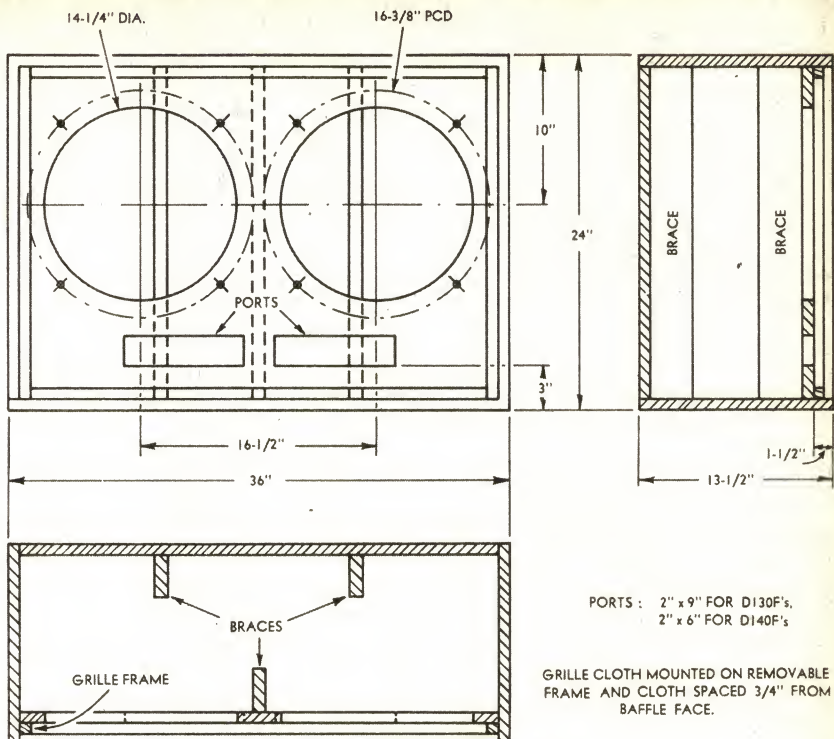

Suggested design and dimensions for an enclosure to house two JBL type D130F or D140F loudspeakers. Note that three braces are specified, two on the rear panel and one on the front panel between the loudspeakers. The diagram assumes that the loudspeakers are mounted on the face of the baffle with clamps.

power conditions for rattles, buzzes, whistles, etc. While the system is operating at high volume, run a hand over every surface of the cabinet, noting any areas which seem to be vibrating noticeably as a distinct area. In some cases, it may be necessary to install additional bracing to hold the sector more rigid.

While the cone of a high-powered loudspeaker, particularly that of the D140F woofer, may travel from ¼-inch to ½-inch peak to peak with heavy drive, it is desirable that the suspension not be stressed unnecessarily.

Needless stress can be occasioned if the loudspeaker is driven hard without a baffle, or when mounted in a baffle

that contains large panel areas capable of flexing.

Cone excursion can be aggravated by low frequency instability in the amplifier, causing the cone to be "pumped" while it is simultaneously trying to reproduce very low frequencies. Careless use of bass boost can increase any tendency to low frequency feedback and instability, driving the cone at a rate too low to be heard and contributing nothing to the reproduction of actual musical frequencies.

Australian Distributors for J. B. Lansing loudspeakers are Auriema (Australasia) Pty. Ltd., 443 Kent St., Sydney, 2000.)

GE Semiconductor Devices

Available through leading radio stores in all states
Revised prices for American types

2N2160 U.J.T.	\$2.49	SC50D Triac 15A ..	\$10.09
2N2646 "	1.79	SC141D " (Plastic) 6A	3.64
2N2647 "	4.92	SC146D " " 10A	4.69
A15D Diode 3A/400V	1.82	ST2 or ER900 Diac ..	1.22
D13TI P.U.J.T.	1.59	PA230 I.C. 800 mw Amp.	3.67
D13T2 "	3.31	PA222 " 1W Amp. ..	9.29
C106B1 S.C.R. 200V	2.36	PA237 " 2W Amp. ..	6.44
C106F1 " 50V ..	1.95	PA246 I.C. 5W Amp.	9.09
C106Y1 " 30V ..	1.70	TD717 Tunnel Diode	2.39
C20D " 7.4A/400V	5.15	3N84 S.C.S.	3.47
SC40D Triac 6A	6.65	PA40 8A/400V Bridge	5.88
SC45D " 10A	8.60	PB40 25A/400 " ..	9.10

All prices include sales tax and postage within Australia

Distributors: **WATKIN WYNNE PTY. LTD.**

32 Falcon Street, CROWS NEST, N.S.W. 2065. Phone 43-1912 43-2107



FORUM

The incredible Ovshinsky affair

The Australian electronics industry has had its share of controversy, but nothing like the affair that blew up in the U.S.A. last November, raged for a time, and has been simmering below the surface ever since. From the numerous reports which have been written on the "Ovshinsky Affair" we have chosen the following as being a complete and factual summary of the events which surround the controversy and the subsequent reactions.*

The article, by James Lydon, is presented here by arrangement with "Electronics Illustrated." The story goes:

If you have it, flaunt it. So say the advertising experts. Stanford R. Ovshinsky isn't the most humble person around in the scientific community today, but why should he be. He may have one of the best things going in semiconductor electronics. Then again, he may not. Even the professionals are undecided at this moment.

Mr Ovshinsky is the author of several papers on glassy semiconductors—also called Ovonic devices—that exhibit what he has termed the Ovshinsky Effect. The big guns in the semiconductor industry (Bell Labs, RCA, Texas Instruments, etc.) have been working on glass devices off and on since the early 60s but Ovshinsky seems to be the first to have made a full-time thing of it. Now that he has announced the Ovshinsky Effect and its future applications, many people in the scientific and technical-press communities are mad at him for not telling it like they think it really is.

Glass semiconductors differ from the silicon and germanium materials you are familiar with. Silicon and germanium are crystalline substances which provide an abundance or lack of electrons at positive-negative junctions. Current flows according to the bias placed on the junction. Glass semiconductors, however, are amorphous (disordered) materials. They exhibit a high resistance to applied signals until a critical voltage (dependent on the design) appears at the two terminals of the glass layer; at this point resistance practically disappears. Thus, an Ovonic device acts like a semiconductor switch. You turn it on or off by applying the correct voltage. Also, the devices are said to be unaffected by radiation—

a possible point of interest for the military.

Problem is, glass semiconductors work according to little known principles so the whole thing is highly theoretical. The technology of amorphous materials is not fully understood (crystal growers, take note!) and it is impossible to reproduce stable devices with any uniformity. This puts the Ovshinsky Effect back in time to when the transistor was still suffering growing pains. At the moment many experts are disenchanted with Ovonics. Its sudden presentation to the Press on Friday, November 8, 1968, had a lot to do with this state of affairs.

Presentation is the key word. These days, how you sell an item is just as important as the worth of your product. Part of this hectic scene is the Press kit. Between pieces of glossy cardboard bearing a company's name, reams of data sheets, photographs and

other miscellaneous and sundry items are stuffed until the folder will hold no more.

Such was the package that greeted a few technically unprepared reporters at the November 8 Press conference sponsored by Energy Conversion Devices, Inc., the company headed by Mr Ovshinsky. Since only 11 of 25 reporters invited from the consumer Press showed up, remaining Press kits were mailed to publications selected with great care.

When scientists at Bell Telephone Labs picked up a copy of the "New York Times" on the following Monday (Veteran's Day and a public holiday in the U.S.A.), they were probably mesmerised by a three-column headline on the front page which heralded a new era in physics.

According to the "Times" story, the phenomenon whereby glass becomes a semiconductor was called the Ovshinsky Effect; and it had thus far yielded switches, computer memories and thin-film semiconductors, the latter having been heretofore considered impossible in the industry. These Ovonic devices were termed a breakthrough in a new branch of physics that would make possible a whole new line of ultra-miniature gizmos—desk-top computers, flat TV sets you can hang on your wall, ultra-fast switches, everything for a better world.

Shades of Shockley! The Bell scientists probably recalled that the announcement of their transistor some 20 years ago got a mere four inches of space on the inside pages of the "Times." And the transistor effect was hot news at the time.

In Washington, one could imagine Russian diplomats scanning the front page of the "Washington Post" for news of the Paris peace talks. You guessed it! They read still another angle on the same story—a glass mini-switch had been announced at a Press conference in Troy, Michigan. This story implied that the new device was a forerunner of a revolution in electronics similar to that started by the transistor. It probably appeared to the Russians and some other foreign diplomats that the Americans had again widened the technology gap.

On Wall Street the quiet of the holiday was shattered by a banner headline in the esteemed "Wall Street Journal" which pulled readers into a story announcing cheap, easy-to-make glass versions of transistors. Investment brokers, mutual fund managers, bank clerks and elevator operators underlined the name of Energy Conversion Devices and started a telephone marathon that would last well into the week. Indeed, the one-two punch of the "Times" and "W.S.J." stories was



Stanford R. Ovshinsky, self-educated inventor who claimed a major scientific breakthrough with his "Ovshinsky Effect."

* Reprinted from "Electronics Illustrated Magazine." Copyright 1969 by Fawcett Publications, Inc.

Ovshinsky Effect: A Big Bang

Transistors face an invisible foe
Can a relatively made film of glass do the work of two transistors?
New patent for junctionless semiconductor switch says a...

News' Is Old-Hat but Still Market Jumps
BY GEORGE SIDERS
News Editor

Amazing New Transistor
Use Lead Film

Glassy Electronic Device May Surpass Transistor

The Threshold Switch
New Component for Ac Control

Memory Cell May Start Electronics Revolution

Ovshinsky Effect: The Tumult and the Shouting Die

Current Electronics
New Materials May Lead to an Inexpensive Glass Version of Items Such as Transistors

ATOMS AND MEN
'News' Is Old-Hat but Still Market Jumps

Supper's bulletpoint continues to fly at Ovshinsky

THE WALL STREET JOURNAL, Monday, November 11, 1968

FERRIER MOVING COIL METERS

METERS FOR ELECTRONICS AUSTRALIA PROJECTS



MODEL T3—250 TACHOMETER METER



MODEL RM4 TACHOMETER METER



MODEL AP PANEL METER

All ranges and scales available
Full details posted on request.

Ferrier Electrical Instruments
45 ALBANY STREET, CROWS NEST.
PHONE 43-5596. N.S.W. 2065.

We manufacture a variety of meters for
MICROAMPERES, AMPERES, VOLTS, MILLIVOLTS,
OHMS, MULTIMETERS, TACHOMETERS and special
purposes. Meter bench stands and boxes.

America's leading newspapers, financial journals and trade publications gave extensive coverage to the announcement of the "discovery" of the "Ovshinsky Effect," although Energy Conversion Devices, Inc., had been advertising the devices in the trade press for several years.

enough to drop the stock values of every major semi-conductor manufacturer when the exchanges opened the following day.

Throughout the country the story of the new science was told by the odd reporters who had been among the select group at the Troy Press parley. The "Boston Globe," aiming for the egghead community of the Massachusetts Institute of Technology, and Harvard, proclaimed that Ovshinsky had made a discovery "missed by the world's great industrial laboratories and university physicists." Filled with pride, the "Detroit News" sounded off with "Troy Ovonic Inventor Eyed for Nobel Prize." Finally, suburban America was filled in by the Associated Press which put the story on its wire.

Only a monetary crisis in France could knock the story off the front pages of the Paris "Herald," yet it had no trouble biting a good swatch of newsprint inside. The "Herald" picked up the "Times" story and ran it whole — the Ovshinsky effect had become a snowball effect, adhering to a little known law of Newton that publicity begets more publicity unless acted upon by an external fact. Feedback from the tidal wave was not long in coming.

Phones rang all day at Energy Conversion Devices in Troy. Ovshinsky—overwhelmed by sudden fame—had a tough time handling the calls. A Milan magazine called about an interview, an Australian news service asked for a taped report, radio reporters from C.B.S. sought material, and invitations to speak at universities poured in. Was impresario Sol Hurok waiting in the wings?

The Dow Jones News Service (in a frenzy of activity after the "Times" and "W.S.J." stories) began to record the scramble for Energy Conversion stock that occurred when the Street

opened for business Tuesday. Traded over-the-counter E.C.D. shares opened at 105 from a low of 58 on the previous Friday. The asking price soared to 150 before trading ended; small fortunes were won and lost almost instantaneously before some Tuesday afternoon quarterbacking knocked the price of E.C.D. down to 75—still much higher than the pre-Press conference ice.

The first of the more cautious quarterbacks was Bache and Co., which issued a caveat to its investors on the basis of a dubious attitude that its investigators found among experts in the electronics industry.

Meanwhile, financial reporters for the "Times" (who not too willingly inherited the follow-up assignments from the science desk) started a probe but were unable to come up with much support for the enthusiasm of the Monday story. Ovonic devices, they found, were apparently not up to snuff, and a licensing agreement between E.C.D. and I.T.T. (cited in the initial story) had gone a little sour. If there were red faces around the science desk they were to get redder still.

The "Wall Street Journal," homing in on fiscal aspects, reported in its follow-up that Energy Conversion was up tight, having sustained sizable losses during the last two years. Most of the firm's income, the journal said, was derived from private investors and contracts. The company had only one profitable year in its eight years of operation, the "W.S.J." noted dryly.

As the "Times" and "W.S.J." continued to examine and meditate upon the Ovonic Wonder, "Newsweek" magazine, with more lead time, checked with its own inputs and discovered that the technical Press had not been invited to the Troy Press conference. For some reason, a subject as abstruse as amorphous semiconductors was restricted to the lay Press. It was almost

CARDIOID DYNAMIC MICROPHONE



Model B1092

Designed for Professional studio or stage use □ Rugged diecast body quickly detached from holder when required □ Dual 50Kohm & 600ohm impedance □ **Frequency response:** 50 to 12,000Hz □ **Sensitivity:** - 72db ± 3 at 600ohm, - 52 db ± 3 at 50K ohm □ Complete with 10 ft. shielded lead & dual impedance plug □ Ask for details on other models, also desk & floor stands to suit your requirements.

AVAILABLE FROM YOUR USUAL RETAILER.



SOLE AUSTRALIAN AGENTS

ADELAIDE BRISBANE
HOBART MELBOURNE
PERTH SYDNEY

The World's Most Versatile Circuit Building System!

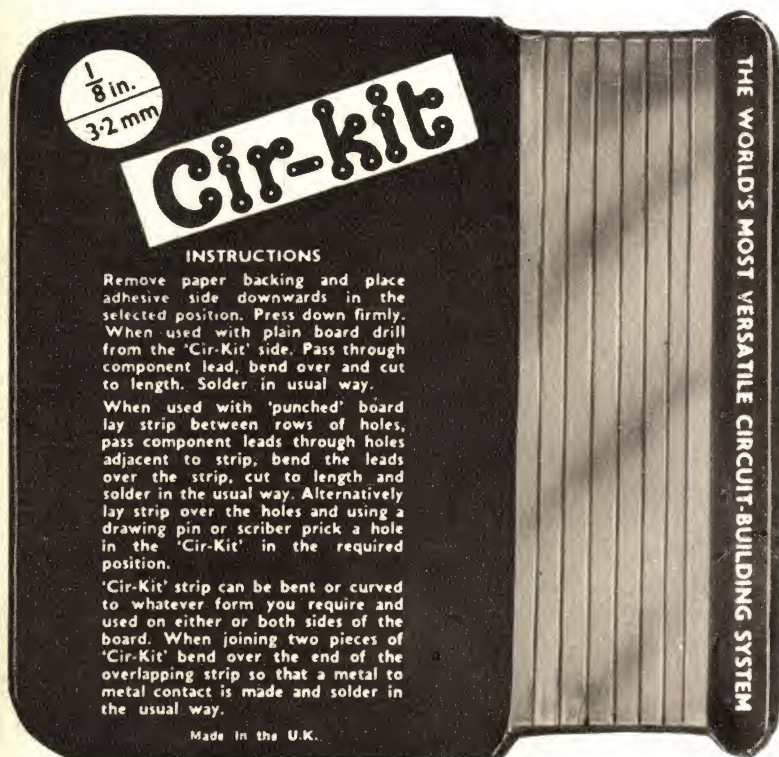

SIZES: 1/8" and 1/16" WIDTHS
LENGTH: 100ft. roll, 5ft. CARD

IDEAL FOR PROTOTYPE AND PRODUCTION CONSTRUCTION

USEFUL FOR WIRING REPAIRS

☆ NO DRILLING ☆ FAST ☆ NO MESS

Available from all Leading Radio Houses

Marketed by—

ZEPHYR PRODUCTS PTY. LTD.

70 BATESFORD RD., CHADSTONE, VIC., 3148
Telephone 56-7231



MANUFACTURERS OF RADIO AND ELECTRICAL EQUIPMENT AND COMPONENTS

like inviting "Better Homes and Gardens" to speed trials at Indy.

Why trade and technical reporters were snubbed was soon to emerge, much to the discomfort of the national Press. For what had been brought back from Troy as hot copy had actually been circulating for years in the staid pages of trade magazines. Over the past five years Ovshinsky had been plying trade journals with reports of his efforts in glassy materials, explaining their potential use as semiconductors. He had examined hundreds of compositions and had worked relentlessly to build practical devices since founding the company in 1960.

An in-depth piece on the Ovonic switch ran four years ago in "Control Engineering Magazine." About this time, Ovshinsky began an advertising campaign in several trade journals wherein he described his devices and invited readers to send for a brochure on basic Ovonic principles. To reach a broader audience, the advertisement also ran in "Scientific American" in December, 1964.

Two years later, "Electronics," another industry magazine, carried a detailed feature on Ovshinsky's new science and its alleged promise. The term Ovshinsky Effect was used here for the first time. The article emphasised the fact that Ovshinsky was far from alone in the field and that research at Bell Labs had created a rather volatile patent situation.

Despite this publicity, much of which he generated himself at seminars and meetings of professional societies, Ovshinsky was unable to get a rise out of the electronics industry. There was no backlog of orders at Troy. No one was knocking down his doors.

Confident, and still trying to get Energy Conversion into the black, the 46-year-old, self-educated inventor renewed his advertising campaign in the autumn of 1967 by running three full-page display ads in "Electronics," "Control Engineering" and "Scientific American." The copy this time stated the speeds of his switches and proclaimed the new field of Ovonic physics and technology. A photo of the switch in the advertisement was later handed out at the Press conference—a cardinal sin in any Press agent's book.

It is not an unfair assumption that if trade and technical reporters had been present at the Troy briefing they would have tempered much of the hysteria that appeared in Monday's newspapers. Indeed, the more journalists studied the circumstances of the Press conference, the more it took on the guise of a vacuum. To begin with, it had been held on the eve of a three-day holiday weekend; there was no opportunity for the reporters to check out the claims with leading industrial organisations. Since only 11 reporters had the story none of them could afford to sit on it without risk of being scooped. It was a case of mass psychology, par excellence.

Ovshinsky claims to have had a good reason for choosing Friday. On the following Monday the details of his Ovonic theory (explaining the materials he was working with and had recently patented) were to appear in the "Physical Review Letters," a highly respected organ of the American Physical Society. Being published in the "Letters," for a non-physicist, was no mean accomplishment and

Buzz Phrases.....

Dear Sir,

I noted on page 75 of your September issue a reference to a Honeywell Buzz-Phrase kit, which would allow anyone to write meaningless but "well balanced grammatically correct sentences packed with state-of-the-art terminology."

I am quite certain that the author of a paper in the Proceedings I.R.E.E. Australia (July, 1969, page 210) did not use the Honeywell kit. However, as far as most of his would-be readers are concerned, he may just as well have. ("Member")

Adaptive Global Search in a Time-Variant Environment using a Probabilistic Automaton

Summary

Carrying out a real time search for the global minimum in an unknown and randomly time-varying multi-modal performance index surface contaminated by system and measurement noise is a problem beyond the scope of conventional hill climbing techniques. A variable structure automaton, capable of controlled learning by reinforcement of probabilistic search patterns is described. Concurrent global and local evolutionary searches are proposed, together with test criteria for relaxation to purely local search and reversion to re-learning on a global basis when surface structure changes are detected. Hybrid computer simulation results are presented to indicate the degree of success achieved in applying the proposed adaptive scheme.

Ovshinsky felt some chest-pounding was justified.

The only snag was that while a copy of the "P.R.L." paper was in the Press kit, its jargon was beyond the grasp of the reporters. Anticipating this, a ten-page explanation of the treatise was also in the kit and in plainer language it unfolded the story of Ovonics, much of which was by now old hat. Probably an all-time record for length, it was lifted almost bodily into newspaper stories. No one took the time to examine the copy.

If Ovshinsky had anything going for him that Friday, it was undoubtedly the all-star cast of physicists, including a Nobel laureate, which endorsed his work. Three of them briefed reporters at the conference and it appeared to bother no one that one was an officer of the company and the others consultants to E.C.D. (one a shareholder).

Though Ovshinsky was stunned by the magnitude of the Press coverage—"I had expected a blurb in the Sunday papers," he said afterward—he did not help his cause any by refusing to say who was buying his Ovonic devices, reportedly being turned out at the rate of 150,000 a day at Troy. This prompted "Newsweek" to ask in its weekend story, "Did Ovshinsky have anything or didn't he?"

Top brass at some of the U.S.A.'s leading daily papers, a trifle anxious over the stock market reaction, undoubtedly put the same question to their science editors.

The "New York Times" science desk, however, stuck to its guns. "In my opinion, the Ovshinsky story merited page one on the basis of his paper in the "Physical Review Letters," said Henry Lieberman, chief of the "Times" science desk. "My reporter tried to check it out at Bell Labs but they gave him a lot of double talk. I called them myself and they were afraid to say anything for publication."

Mr Lieberman added that the "Times" "was only interested in the scientific aspects of Ovshinsky's work and not the technology, and if 20 physicists think it's great stuff, that's good enough for me."

George Trigg, senior editor at "Physical Review Letters," noted that when the Ovshinsky manuscript was submitted it was assumed the work had no previous history at least not on the scale that was later discovered. "If we had known that some of it had appeared in advertisements we would have turned it down," said Trigg. Apparently the referees at "P.R.L." were caught napping.

In any event, there emerged out of it all an exuberant inventor—self-educated and without formal technical education—whose name and company were catapulted around the world in no more time than it takes to write a headline. ■

TRANSISTOR SERVICE

All Japanese and local sets repaired

including . . .

Aristone	Aurora	Belair
Berlin	Crown	Fujiya
General	Hitachi	Kenco
Mariner	Mitsubishi	Nanaola
National	Nivico	Sanyo
Sony	Spica	Standard
Sharp	Toshiba	Yashica

We do not sell spare parts

PETER G. BROUGHTON
211 George Street, Sydney.
Tel. 27-5831 (3 lines)

the first

in circuit Field Effect Transistor tester plus Complete in circuit transistor/diode tester



Regular Transistor Bi-polar Testing

Beta (h/fe) measured at 50 Hertz.

RANGE	BETA	IC
Lo Power X1	1-50	2.0 Ma
X10	10-500	2.0 Ma
Hi Power X1	1-50	20 Ma
X10	10-500	20 Ma
Special RF X1	1-50	Special RF 0.2 Ma

Leakage (I CBO) measured at V/CB equals 4V, I/E equals 0.

One range 0-100 microamps lower 1/2 of scale.
100-500 microamps upper 1/2 of scale.

Field Effect Transistors

Transconductance (Gm) measured at V/DS equals 5V, V/GS equals 0.

RANGE	Gm
X1	0-5000 Micromhos
X10	0-50,000 Micromhos

Gate Leakage (IGSS) measured at VGS — 4V, V/DS equals 0.
One range 0-100 microamps lower 1/2 of scale
100-5000 microamps upper 1/2 of scale
Zero Bias Drain Current (I/DSS) Measured at V/DS — 5V, V/GS — 0

General Electrical: 220/250 VAC, 50/60 Hertz at 10 watts.

Physical: 9 1/2" High x 7 1/2" Wide x 6" Deep.
Weight: 9 pounds.

- Checks Field Effect Transistors for gate leakage I/GSS. The TF-151 gives you leakage current of an FET in microamps directly on the meter. This gate leakage is very important as many FETs will not function when the leakage is too great.
- Checks regular transistors, high power, low power and the critical RF types in or out of circuit for actual AC beta. Just dial the function knob to the left, set the cal knob and push the gain button. Actually measures the ratio of AC signal on the base of the transistor to that obtained on the collector.
- Checks regular transistors for leakage or I/CBO. The TF151 also gives you leakage current (I/CBO) of any transistor in microamps directly on the meter.
- Checks diodes in or out of circuit. The TF151 checks diodes in the circuit with a speedy "go or no go" indication. Out of circuit testing measures the actual front to back conduction in microamps.
- Complete protection. A special circuit in the TF151 protects even the most delicate transistors and FETs, even if the leads are accidentally hooked up to the wrong terminals of the FET or Transistor while in circuit.

\$140.00 plus tax

ELMEASCO Instruments Pty. Ltd.

P.O. Box 334, BROOKVALE, N.S.W. 2100. Tel. 93-7944

P.O. Box 213, MT. WAVERLEY, VIC. 3149. Tel. 82-6159

WORLD'S BEST HI-FI EQUIPMENT FOR THE CHEAPEST PRICES



Technical Specifications:

Power Output, continuous sine wave:

25 watts per channel, 8 ohms

Power bandwidth: 20—25,000 Hz

Frequency response: 20—20,000 Hz

plus/minus 1dB

Harmonic distortion: less than 0.5% at

1 kHz, measured at 25 watts output

plus/minus 1dB

Crosstalk: better than 40 dB.

THIS MONTH'S SPECIAL OFFERS:

UNIT 1: The latest Armstrong Model 521, illustrated and described above, England's most perfect stereo integrated fully transistorised amplifier, P.E. 34 turntable, belt-driven hydraulic controlled lowering device, Empire 808 cartridge, frequency response from 10 to 20,000 cycles, 2 Goodman's 10-inch Twinaxlette loudspeakers. **Total Price \$390.00**
The same with the Armstrong 426 fully transistorised tuner/amplifier, 15-watt RMS per channel, frequency response from 20—20,000 cycles plus/minus 1 dB less than 1/2% distortion on the full 15-watt RMS \$80

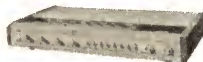

UNIT 2: Schaub-Lorenz (associated with ITT) Model 4000 tuner/amplifier made in

Germany, 25-watt per channel is the most beautiful looking tuner/amplifier available on the world market (sole agents for Australia — Recorded Music Salon), ERA MK4 turntable, Empire 888E cartridge, frequency response from 10—30,000 cycles, 2 Heco fully imported speaker systems in boxes, separate bass and tweeter. **Total Price \$540.00**
The same with Jordan Watts loudspeakers, frequency range on axis: 30—17,000 Hz plus/minus 3 dB, 25—20,000 Hz plus/minus 6 dB (also on axis) 30 degree off axis: 30—17,000 Hz plus/minus 6 dB, with cabinets. **Less \$40.00**

UNIT 3: Sansui 222 stereo amplifier complete with Dual 1210 4-speed turntable and cartridge, plus 2 Goodmans 10in Twinaxlette loudspeakers. **Total Price, \$277.00.**
The same with Kenwood TK150U amplifier, **less \$20.00.**

UNIT 4: Armstrong 127 integrated tuner-amplifier, PE34 turntable with Decca Deram cartridge included, 2 Wharfedale 8in RSDD loudspeakers. **Total Price, \$288.00.**

The same with the Armstrong 227 tuner-amplifier 10-watt RMS per channel, frequency response from 30-20,000 cycles plus/minus 1 dB less than 1/2% distortion measured at 8-watts RMS. **Add \$30.00.**

UNIT 5: Ampex Model 2163 tape Recorder combines magnificent 4-track stereo sound, unmatched Ampex engineering quality and versatile new recording features. Records and plays back in two directions, tape monitor, with Armstrong 421, 15-watt per channel RMS fully transistorised stereo amplifier, frequency response from 20—20,000 cycles, plus or minus 1 dB, less than 1/2% distortion on the full 15-watt RMS (Ampex recommends Armstrong amplifiers to be used with their tape decks or tape recorders), 2 Jordan Watts loudspeakers. **Total Price, \$950.**

UNIT 6: Harmon Kardon Model 210 tuner/amplifier 50-watt output, most advanced integrated stereo tuner/amplifier from the U.S.A., frequency response plus/minus 1 dB: 8-25,000 Hz at 1 watt (normal listening level); 10 — 23,000 Hz at full rated power, 2 Empire Model 2000 loudspeakers, frequency response from 30 — 18,000 Hz. Components: 10-inch high-compliance woofer with 2in voice coil. M'd-range/tweeter direct radiator, less than one foot square and 16 1/2 inches high. Power handling capacity: 60 watts undistorted, world's most compact speaker system from the U.S.A., ERA Mk.3 turntable, Empire 888TE cartridge, frequency response from 6 — 32,000 cycles. **Total Price \$1,350.00**

UNIT 7: Empire Model 9000M Grenadier loudspeakers, frequency response from 20 to 20,000 Hz, Components: 15-inch high-compliance woofer. Mid-range direct radiator and ultrasonic domed tweeter, both coupled to Empire's wide-angle acoustic lens. Maximum Power Handling Capacity: 100 watts, undistorted, Impedance 8 ohms. Schaub-Lorenz Model 4000 tuner/amplifier 25-watt per channel, ERA Mk 3 turntable, Empire 888VE cartridge, frequency response from 6 to 32,000 cycles. **Total Price \$2,000.00**



UNIT 8: P.E. 2020 turntable with Empire diamond magnetic cartridge Model 808, frequency response from 10 — 20,000 cycles, Sansui 222 stereo transistorised amplifier. **Total Price, . . \$251.00**
Plus 2 Jordan Watts loudspeakers, frequency range on axis: 30 — 17,000 Hz plus/minus 3 dB, 25—20,000 Hz plus/minus 6 dB (also on axis) 30 degree off axis: 30—17,000 Hz plus/minus 6 dB. **Plus \$100.00**

Trade and wholesale Enquiries welcome — we forward goods to any part of Australia.

RECORDED MUSIC SALON

C. PINCZEWSKI

TRUE FIDELITY

23 COLLINS STREET,
MELBOURNE 3000.

Telephone 63-6257

Apparent-Wind-Direction Indicator for small boats*

The simple device described in this article will be welcomed by any of our readers who sail in small craft. Easy to construct and install, it will give continuous indication of the difference between apparent wind direction and boat heading.

by M. I. Pope, B.Sc., Ph.D.

It is perhaps surprising that research into the performance of sailing boats has only been carried out on a significant scale in the past two decades. In the United Kingdom, substantial advances in this field¹ are due to the work of the Department of Aeronautics and Astronautics at Southampton University.

One of the problems encountered in obtaining optimum windward performance in sailing dinghies and yachts, is to achieve a compromise between the ability of a boat to point as closely as possible to the direction of the apparent wind, and yet maintain a relatively high speed through the water. The various factors which determine a yacht's pointing ability are too numerous and complex to discuss here, but a detailed explanation will be found in a recent book by C. A. Marchaj.² Considerable difficulty is often experienced in assessing how small adjustments to the hull and rigging of a boat have affected the windward performance; it is here that the use of water speed and apparent-wind-direction indicators can be helpful.

The equipment described here is light in weight and of low cost. A

simple wind vane is used to rotate the moving plates of an air-spaced variable capacitor which in turn alters the time constant in a multivibrator. This assembly is attached to the mast head of the boat and a light, 3-way lead connects it to a transistorised differential voltmeter mounted, together with the batteries, in the boat's cockpit. A circuit diagram of the two units is shown in figure 1. Any change in the angle between the fixed and moving plates of the capacitor alters both the frequency and the mark-space ratio of the multivibrator output signal, but has little effect on the amplitude. However, operation of the indicator depends only on the change in the mark-space ratio. The output signal from the multivibrator is not electrically integrated, but is fed directly to the differential voltmeter, which relies on the inertia of the moving coil microammeter to give a steady reading; this method has been found entirely satisfactory in practice.

By a suitable choice of component values, an approximately linear relationship has been obtained between the angle of separation of the fixed and moving plates of the capacitor, over the range 10 to 100 degrees,

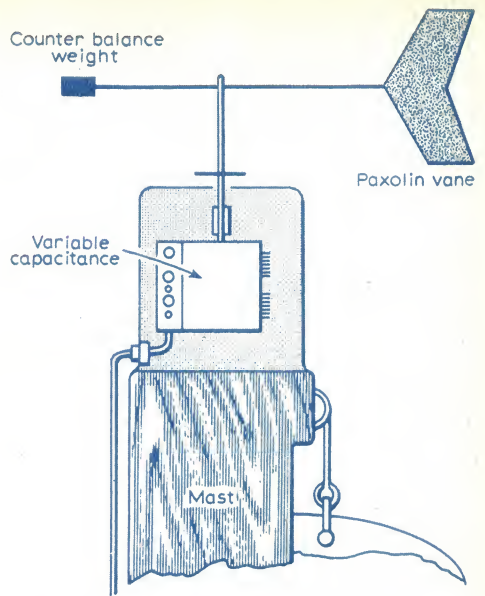

Figure 3. Diagram of the mast-head unit, showing the wind vane and the capacitor unit.

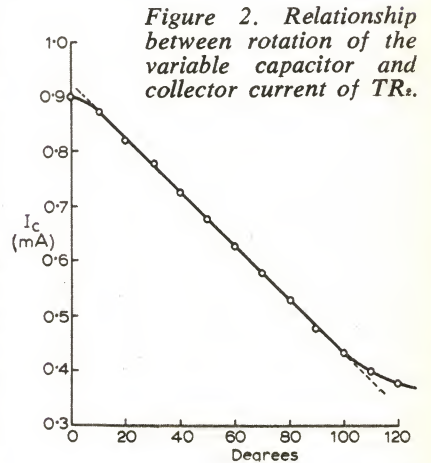

Figure 2. Relationship between rotation of the variable capacitor and collector current of Tr₂.

and the indicated collector current of Tr₂, as measured by a moving coil milliammeter (figure 2). The voltage change at the collector of Tr₂ is measured by the centre-zero differential voltmeter directly in degrees.

The mast-head unit was built around a two-gang 500pF air-spaced tuning capacitor, of the type used in portable transistor radios; the associated com-

Mast head unit

Cockpit unit

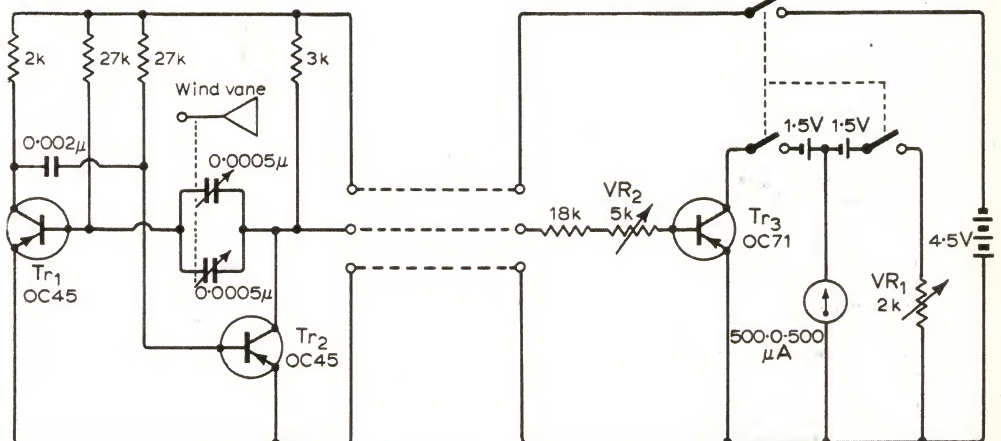

* By arrangement with the Editor of "Wireless World," London.

Figure 1. The circuit diagram of the apparent-wind-direction indicator. Note the simplicity of design and the few components needed to construct the device.

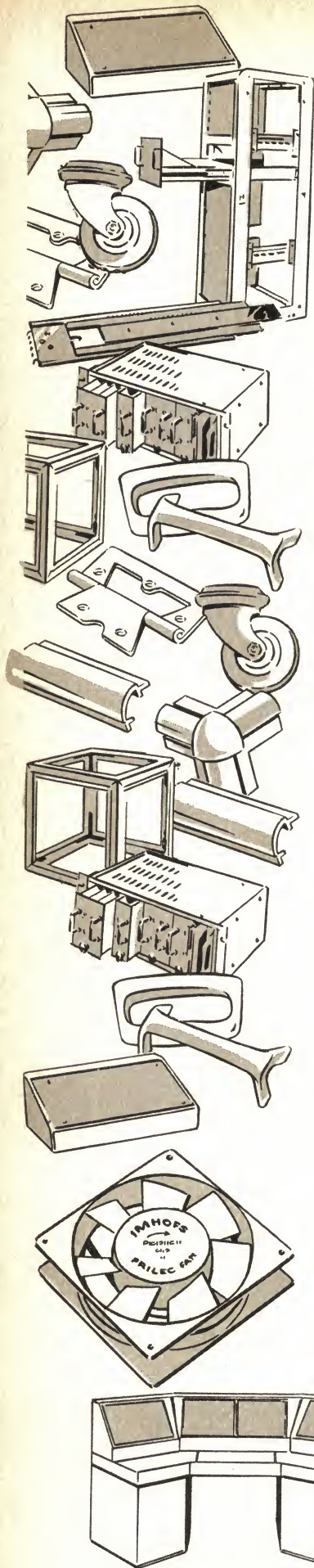

Got a housing problem?

LET'S HEAR ABOUT IT

We can house your instruments in any size or shape of cabinet you need.

Aladdin can supply a whole range of beautifully modern Imhof racks, cases and consoles in a whole range of standard or custom-built styles. Attractive Imhof handles in a variety of styles and finishes.

Imlok framework for cases can be ordered already assembled or delivered ready for easy self-assembly.

Next time you've got a housing problem, call us: Aladdin Industries. We'll put you in good shape.

IMLOK & IMHOF

Aladdin

INDUSTRIES PTY. LTD.
43 Bridge Road, Stanmore.
2048. Phone 51-2826.

688

ponents being mounted on a printed circuit board attached to the capacitor. To reduce friction to a minimum, one of the wipers making contact with the moving plates of the capacitor should be removed and the ball races supporting the moving plates should be dismantled and degreased before being assembled and lubricated with a trace of clock oil. Take care not to over-tighten the end bearings! Good electrical contact between the moving plates and the body of the capacitor is ensured by soldering a light, flexible coil of copper braid between the two. Also, a stop screw should be fitted to the spindle to limit rotation to 110 degrees. The capacitor, together with its associated components, is mounted vertically in a light metal case, as shown in figure 3.

The wind vane is formed by joining a Tufnol extension spindle to the capacitor shaft. The upper end of this shaft is drilled to carry a horizontal 16SWG steel rod, about 10in long. A "Paxolin" vane was mounted at one end of the rod, which was counter-balanced by a lead weight.

To set up the apparatus, the wind vane is adjusted so that the capacitor plates are 55° open when the vane is pointing directly ahead of the boat; the microammeter can then be set to zero using the 2K-ohm potentiometer VR₁. The wind vane is then moved so as to point 45° either side of the ahead position, and the gain of Tr₂ set by the 5K-ohm potentiometer VR₂, to make the microammeter read to + or - 450µA as appropriate. The meter should now give a direct reading of the angle between the heading of the boat and the direction of the apparent wind, 1° being equivalent to 10µA.

The apparatus has been tested on a racing dinghy and found to operate satisfactorily under conditions of steady winds and reasonably calm water. In more disturbed water, instability of the boat caused some hunting of the wind vane, with consequent fluctuation in the meter readings. However, it is reasonable to suppose that this effect could be greatly reduced by improvement in mechanical design of the mast-head unit. In any event the relative stability of a keel boat should enable even the existing prototype apparatus to function satisfactorily in disturbed waters.

REFERENCES

1. "Annual reports of the Advisory Committee for Yacht Research," University of Southampton, Department of Aeronautics and Astronautics.
2. Marchaj, C. A., "Sailing Theory and Practice" (1964) Adlard Coles, London. ■

Basic Electronics

An introductory text for those seeking to learn the elements of electronics theory and practice before proceeding to more formal instruction or undertaking more advanced constructional projects. It is designed to give a basic insight into electronics in general, but more specifically with the aspects of it concerned with sound radio, television and sound reproduction. Those who work through this book will have a basic knowledge from which to progress to more specialised branches of the science of electronics.

Available from the editorial offices of "Electronics Australia." Price \$2.20, posted.



A READER BUILT IT

An easy-to-build metal detector/pipe locator

We frequently receive requests for constructional details of a metal locator. We have indicated that in our view these items are of limited usefulness, and for this reason we have been reluctant to publish an article on the subject. However, interest has remained high, and for this reason we are glad to be able to publish this design from a reader for the benefit of those who are still interested in the subject.

The circuit is straightforward, and should cause no difficulty to an experienced constructor. This unit is sensitive enough to detect a coin about the size of a 10c piece at a depth of about 2in, and can also detect large masses of metal to a depth of about 2ft. It will prove invaluable to detect buried pipes, heavy cables, and so on.

The circuit consists of two oscillators, one of fixed frequency, the other variable. The signals from these oscillators are fed to a detector, then to a mixer and filter, and finally to an audio frequency amplifier and crystal earpiece. (See the block schematic.)

It will be obvious that if the frequencies of the two oscillators vary slightly, they will beat together and produce an audio frequency beat note which will be heard at the earpiece. The variable frequency oscillator coil inductance will change when it is in the vicinity of metal. This causes the frequency of the oscillator to change, thus varying the beat note previously referred to.

The unit should not be housed in a metal case, as this will affect its operation. The search head may be

constructed on a piece of plywood of suitable size, provided with four wooden pillars at the corners on which the oscillator coil is wound. A wooden cover may be placed over the coil to prevent it from being damaged while in use. A hole should be left in this cover for adjustment of the trimmer.

USING THE LOCATOR: The beat note may be set so that the frequency either increases or decreases in the presence of metal, depending on which side of the null point the variable capacitor C(b) is set. In the author's experience, it is preferable to set this

capacitor so that the presence of metal is indicated by a rise in frequency. When construction is completed, C(b) should be set at about half mesh, and C(a) should be adjusted to obtain near zero beat frequency. When the device is brought near to any metal item, a sharp rise in the audio frequency will be heard.

A large number of beat frequencies notes can be obtained by adjusting C(c). The strongest one obtained by experiment should be used. Any further adjustments of frequency can now be made by using C(b). It may

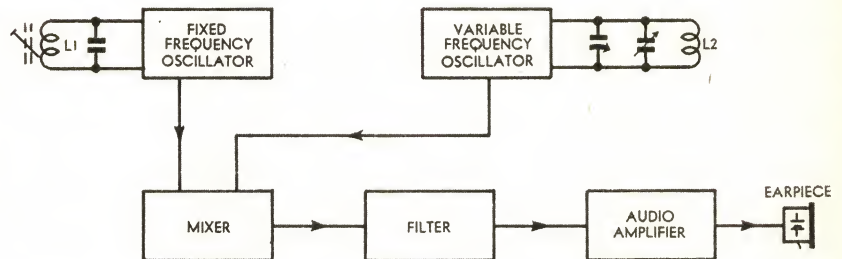

Block schematic for the metal detector. The variable frequency oscillator at right is the search head.

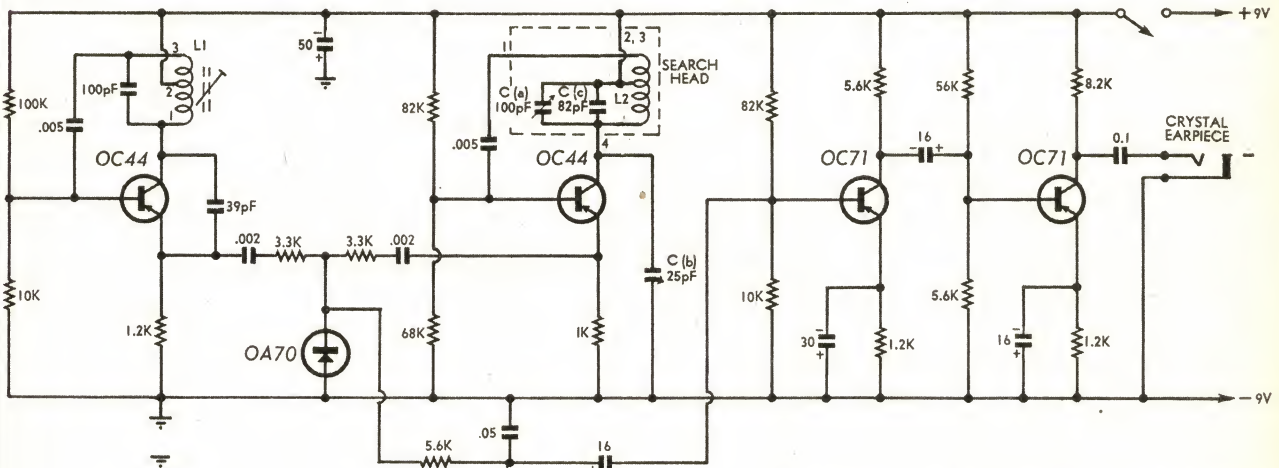

The circuit for the metal detector. All resistors are $\frac{1}{2}$ -watt, 5 or 10 per cent types.

your money buys more

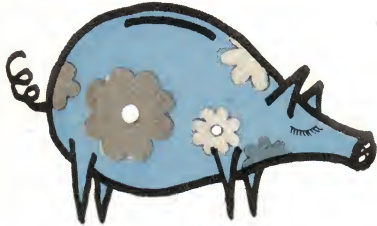

when you choose a

SCOPE

soldering iron



Both irons are beautifully presented in a handy reusable plastic pouch-pack, complete with one spare tip and two spare elements.

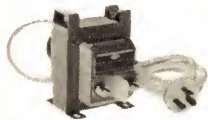

TRANSFORMER BY NATRONICS

Both operate on voltages from 2.5V to 6.3V A.C. or D.C. or from 240V A.C. mains through a NATRONIC Scope Transformer" fitted with 6ft. 3-core flex and 3 pin mains plug.

Fully approved by electricity authorities APP. No. N/360/6894 - 5

IRH
COMPONENTS
PTY. LIMITED

The Components Division of IRH Industries Limited

THE CRESCENT, KINGSGROVE, N.S.W. 2208. PHONE 50 0111

INTERSTATE TELEPHONES

MELB. VIC.	489,1088	BRIS. QLD.	2,1391
HOB. TAS.	34,2811	PERTH W.A.	8,2271
LAUN. TAS.	22,844	ADEL. S.A.	23,1971

AVAILABLE FROM ALL MAJOR ELECTRICAL WHOLESALE AND HARDWARE STORES — THE FULL GUARANTEE APPLIES ONLY WHEN THE IRON IS USED WITH THE APPROVED 'SCOPE' TRANSFORMER. MANUFACTURED BY NATRONICS PTY. LTD.



SCOPE DELUXE



SCOPE STANDARD



MINISCOPE

ECONOMY

Consumes current only whilst in use. Scope De Luxe performs all the functions of other irons from 40 to 150 WATTS.

MINISCOPE—up to 75 WATTS.

LABOUR SAVING

Fast warm up — always ready, cuts wiping, retinning and filing of tips to a MINIMUM.

VERSATILITY

Copes with all soldering jobs—from miniature components to large solder lugs. Can even be operated from a 6 volt car battery

CONTROL

Temperature control at your finger tips. Heat only when, where and as much as needed.

CONVENIENCE

Ideal for those almost inaccessible spots. No burning of adjacent insulation.

SPEED

ONLY 5 to 6 seconds' initial heating up time from cold, then practically instantaneous.

MINI WEIGHT

Scope De Luxe weighs only 3½ ozs. complete. Miniscope 1½

GUARANTEE

Fully guaranteed with time tested dependability.

SAFETY

Low voltage operation. Heat sensitive components protected.

LESS MAINTENANCE

Longer tip life. NO expensive heating elements to replace. Maintenance without special tools. Spare tips and elements readily available from your Scope Distributor.

VOTED FIRST BY A HOST OF SATISFIED USERS.

Please Post — free illustrated SCOPE literature

NAME _____

ADDRESS _____

CITY _____ POSTCODE _____

Coil details

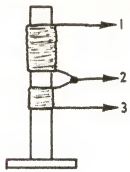

L1 (right) consists of 115 turns of 38SWG enamelled wire scramble wound on a $\frac{1}{4}$ in diameter slug-tuned former, and tapped at 15 turns. L2 (above) is the search-head coil and should be bunch wound with 50 turns of 36SWG enamelled, single cotton-covered wire, tapped at 10 turns, and varnished.

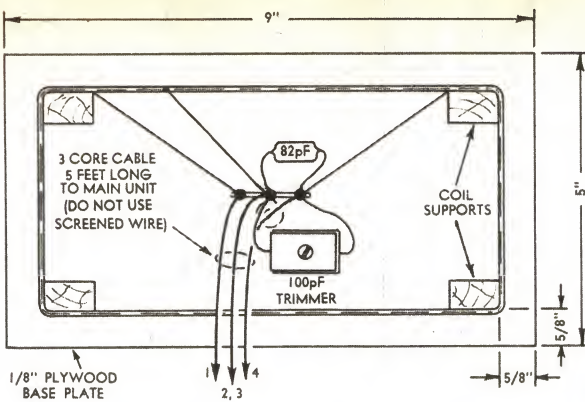

be found in practice that a large value of C(a) or C(c) is necessary.

(Submitted by Mr L. Timbs, 163 Neale Street, Bendigo, Victoria.)

EDITOR'S NOTE: Our contributor has not given any information as to the way the search head is mounted

for convenience of search. However, most readers will already be familiar with the usual method employed, of mounting the search head at the end of a pole, and using this arrangement to sweep the ground ahead, the user remaining in a standing position.

Crystal Set Uses Old IF Windings

Our younger readers are always interested in crystal sets, which is often their first introduction to electronics. This design is simple, and economical.

I have been experimenting with crystal receivers and find this one the simplest and the best suited to my conditions.

In most circuits the tuning capacitor and tuning coil are in parallel, but this is not essential. In the circuit shown the primary coil and a variable capacitor are connected in series to form the tuned circuit. Coupling to the detector and earphones is by means

former in half between the two windings. From one coil remove about 25 per cent of the wire and also the iron core slug. This becomes the secondary coil. The primary coil is untouched.

Slide each winding to the end of the former and mount them as shown. The crystal detector is a simple diode and the earphone is a high impedance crystal earpiece.

(Submitted by: Mr N. Skrabal, Government Road, Orroroo, S.A. 5431.)

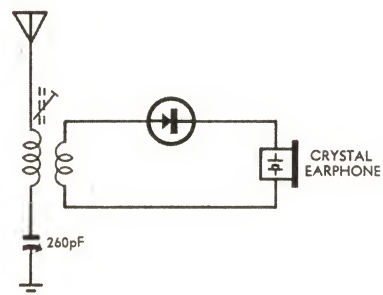

The circuit is unconventional, but perfectly practical.

of a secondary coil and the coupling can be varied by varying distance between the two coils.

The two coils are made from an old IF transformer as used in superhets. This should be a relatively modern one, since the very early superhets used IF systems around 175KHz and are unsuitable.

Dismantle the transformer and remove the capacitors on either side. Unsolder the wires and cut the coil

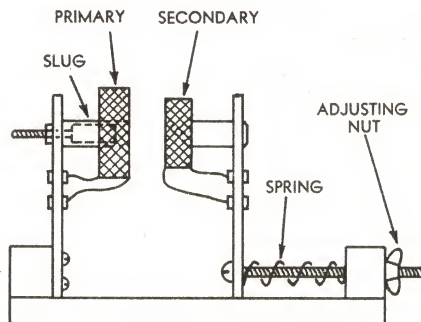

A suggested variable coupling system. There is plenty of room for experiment here.

(Editor's Footnote: "Reader Built It" articles are published for the general interest of experimenters and as a source of ideas. Based on readers' contributions, they have not been tested in our laboratory and we cannot accept responsibility for them.)

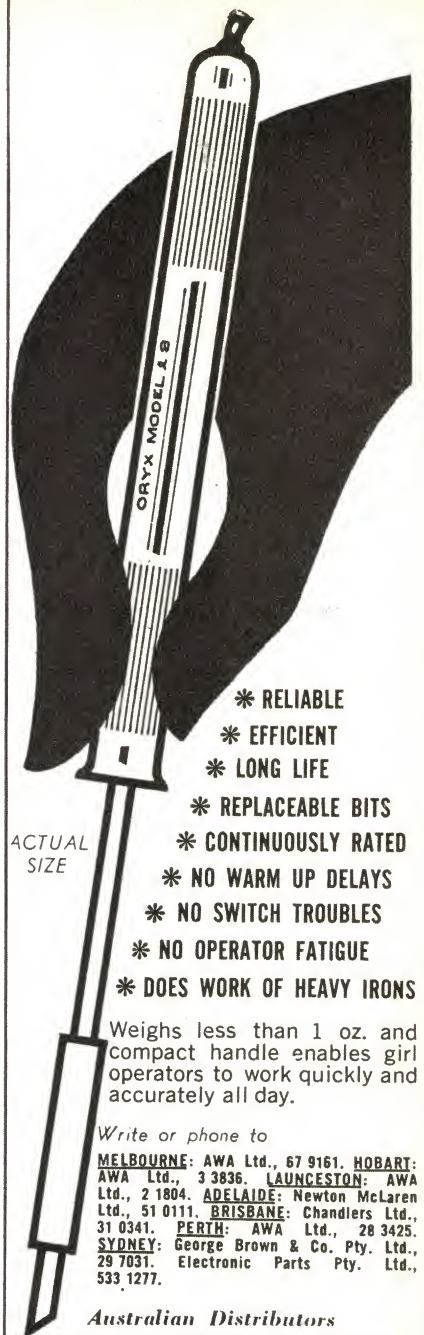

- * RELIABLE
- * EFFICIENT
- * LONG LIFE
- * REPLACEABLE BITS
- * CONTINUOUSLY RATED
- * NO WARM UP DELAYS
- * NO SWITCH TROUBLES
- * NO OPERATOR FATIGUE
- * DOES WORK OF HEAVY IRONS

Weighs less than 1 oz. and compact handle enables girl operators to work quickly and accurately all day.

Write or phone to

MELBOURNE: AWA Ltd., 67 9161. HOBART: AWA Ltd., 3 3836. LAUNCESTON: AWA Ltd., 2 1804. ADELAIDE: Newton McLaren Ltd., 51 0111. BRISBANE: Chandlers Ltd., 31 0341. PERTH: AWA Ltd., 28 3425. SYDNEY: George Brown & Co. Pty. Ltd., 29 7031. Electronic Parts Pty. Ltd., 533 1277.

Australian Distributors
MANUFACTURERS SPECIAL
PRODUCTS PTY. LTD.

47 York Street, Sydney. 2 0233, Ext. 284

WANTED

BY ALL
PRODUCTION ENGINEERS

ORYX

miniature
soldering instruments



**IF YOU ARE IN THE
MARKET FOR SOUND
EQUIPMENT COME AND
SEE JACK & MIKE AT
Allied Music Systems**



WE SPECIALISE IN TOP QUALITY, TOP BRAND NAME EQUIPMENT ONLY

**ALL THE FAMOUS NAMES.... Akai, Sansui, Revox, Sony, Kenwood,
Philips, Toshiba, National, Fisher, Craig-Pioneer, Dokorder.**

cartridge cassette tape phono radio

**TRADE-INS ACCEPTED & WE SELL ON TERMS
FOR THE CASH PRICES**

**FEEL FREE TO WANDER IN AND TALK TO US AT OUR
SHOWROOM AT 210 CLARENCE ST., SYDNEY..... NOW!
FOR AN OBLIGATION FREE QUOTE ON THE EQUIPMENT YOU
ARE THINKING ABOUT**

BUYING WALKIE TALKIES?

IT'S NOT EASY! Best way is an 'on site' demonstration, preferably with competition from brand 'x'—then you **KNOW** which does the job. We know you'll pick **TELECON** — not just because it's best in performance, but for service, spares and reliability too. Don't take our word—ask some of the 50 Government Departments (and others) that use them. Better still, ask for a demonstration—now. (User list and pamphlets available on request.

**FROM .1 to 5 WATTS,
AND ALL PRICES FROM
\$40 TO \$400. VHF AND
UHF TYPES TOO.** Or perhaps you need a radio page-system — or antennae — or test equipment. We should mention, we have the best equipped workshop for repairs, and spares to keep your equipment running for at least five years.



Australasian Agents:

Strato Communications Pty. Ltd.,

25 WENTWORTH ST., PARRAMATTA, N.S.W. 2150

Telephone 635-9856, 635-5569.

**TEDCO PTY. LTD.,
579 Murray St.,
Perth, W.A. 6000**

**HOMECRAFTS-TAS.,
199 Collins St.,
Hobart, TAS. 7000**

**AUSTRALIA SOUND &
TELEVISION CO., P/L.,
35-39 Yarra Bank Road,
South Melbourne.VIC. 3000**

**FRED HOE & SONS P/L.,
Block 23, Industries Road,
Salisbury North, Brisbane.
QLD. 4107**

HOW TO MAKE A SENSITIVE MICROPHONE

By J. F. DUNN

This instrument will probably appeal to many readers as it costs so very little to make, and the articles necessary for its construction are so easily obtainable. It works on the same principles as the telephone and will be found to be very interesting and instructive.

The sounding-board may be made of a cigar box, the top of which must be planed down to one-sixteenth of an inch and cut to about five inches square. A good glue should be used to fix the sounding-board together, as brads, etc., will decrease the sensitivity of the instrument. When finished, the board should be about three-quarters of an inch high. The legs are best made about a quarter of an inch by a quarter of an inch by three-sixteenths of an inch, and can be glued to the four corners. A small piece of felt fixed on the legs will prevent the jolting of the object upon which it stands from affecting the instrument.

The carbon pencil is about a quarter of an inch in diameter and about four inches long. A small hole must be drilled half-way along the pencil to allow a piece of steel wire to be inserted. This should fit tightly into the carbon and should protrude about a quarter of an inch each side, the ends having a knife edge filed on them. The carbon block upon which one end of the pencil rests should be made about one inch by one half inch by one quarter inch, and should be fixed on the board by two small brass screws. The rest upon which the carbon pencil swings is made of thin brass sheet bent into two right angles. Two holes are drilled to take the screws fixing it on to the board, and two others to receive the knife edge. The slider is made of thick brass wire bent as shown in figure 1. One terminal is connected by a thin wire to the rest, and the other to the carbon block.

The connections for single and duplex telephones are shown in figures 2 and 3.

The principle of working of the microphone is quite simple, and it will

be well for the reader to understand it before attempting to construct the instrument.

When the vibrations of the voice, or other sound source, hit the sounding board they cause it to vibrate. Consequently the pressure between the two carbons varies according to the magnitude of the vibrations. The resistance to the current, therefore, is constantly changing, and consequently the

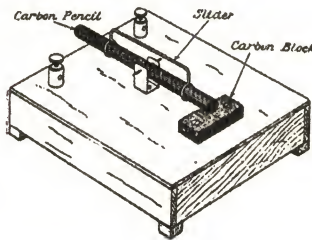
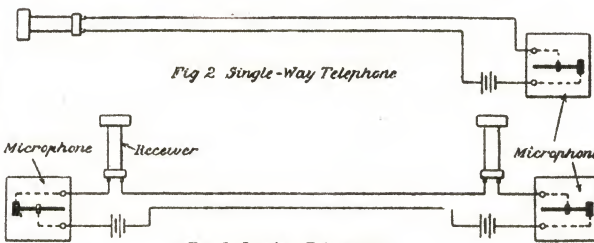

Figure 1. General view of the simple microphone.



Diagrams for connections for single and duplex telephones.

current which passes through the receiver also changes, so producing sounds similar to those hitting the sounding-board. The reader probably knows that the slightest change in the pressure between two pieces of carbon greatly changes the resistance to the passage of an electric current passing between them.

By placing the instrument in a concert hall the music, etc., can be heard quite distinctly at any distance provided that the battery is of sufficient strength to overcome the resistance of the line. (A two-cell dry-battery supplies quite enough current for ordinary purposes.) This is only one of the many uses to which this instrument can be put, and no doubt the reader will find others.

up to ten times longer life



MAXELL Alkaline Dry Cell - this unique new design concept features high capacity and durability that surpasses the performance of the world's top dry cell batteries. The construction of the Maxell Alkaline Dry Cell differs greatly from conventional types of carbon ZINC cells. However, the Maxell Alkaline cells can be used where you normally use a carbon ZINC cell. MAXELL ALKALINE CELLS are especially suitable where there is a demand for increased current, combined with durability and little voltage drop. Even near the end of the cell life the discharge capacity is large and stabilized.

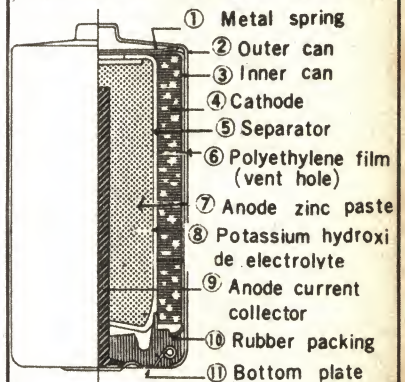

Exclusive new construction minimises leakage. Double cans are used and rubber sealing with the unique spring safety device. (see diagram)

Interior drying is prevented by hermetic sealing, therefore long storage periods are possible (over two years). Even then Maxell Alkaline cells are in the same condition as when they left the production line. These cells will withstand severe temperature changes. Rigid tests have shown extremely stabilized capacities from the low temperature of -4F to the high temperature of 150F at which temperatures dry cells would fail to operate satisfactorily.

Prices:

AM1 75c
AM2 50c
AM3 40c

Trade enquiries to
TASMANEX PTY. LTD.
376 Pittwater Road, Harbord 2096

In 1921, the magazine "Sea, Land and Air" had a section going in which they published small construction items submitted by readers. Entitled "Junior Mechanics Section," it was similar in intention to our own "Reader Built It" section. The item described above would hardly qualify for the title "microphone" nowadays, but one of our own staff members who constructed a similar device in his youth testifies to its sensitivity. Perhaps some of our younger readers would like to try their hand at reproducing it. The "receivers" shown in the diagram would probably have been telephone-type earpieces.

NEW Releases!

IN HI-FI STEREO EQUIPMENT BY CLASSIC

NEW 24 WATT R.M.S. TRANSISTOR AMPLIFIER WITH INBUILT A.M. TUNER



MODEL C250

\$118.00 FREIGHT EXTRA

DIMENSIONS 15½in x 4½in x 11in deep.
Cover finished in teak or walnut wood grain.
Incorporates 24 low noise silicon transistors plus 5 diodes.

SPECIFICATIONS:
POWER OUTPUT. 12 watts per channel 24 watts R.M.S. total (48 watts music power).
FREQUENCY RESPONSE. 20 Cycles to 20,000 ± 1db.
HARMONIC DISTORTION. Less than 1% at 10 watts.
HUM AND NOISE. Aux. 70db. Mag. 50db.
INPUT SENSITIVITY. Mag. 3mv. Aux. 200mv.
SPEAKER IMPEDANCE. 8 ohms.
EQUALIZED. Mag. RIAA.
TONE CONTROLS. Bass 50c/s ± 12db. treble 10kc. ± 12db.
LOUDNESS CONTROL. 50c/s 10db.
SCRATCH FILTER. (High filter) at 10kc. 9db.
PROVISION FOR TAPE RECORDER. Record or play back with standard din plug connection.
TUNER. This unit can be supplied with either valve or transistor tuner with a coverage of 530 to 1,600 K.C. Calibrated dial available for all States.

COMPACT STEREO SYSTEM



Cabinet Dimensions
18in x 12in x 7in

Above amplifier and tuner in attractive timber cabinet with hinged tinted perspex cover fitted with the new Garrard 60 Mk. II changer or SP25 Mk. II player with Pickering AC2 magnetic cartridge plus two Playmaster bookshelf speakers.

Available in teak, walnut or maple. Oiled finish.

\$260.00 FREIGHT EXTRA



CABINET DIMENSIONS
18 x 14½ x 8½



Dimensions: 14in x 8½in x 8½in.

MULLARD MAGNAVOX MINI SPEAKERS

These units designed by Mullard and Magnavox engineers compare favourably with imported B/S Speakers costing more than twice the amount and are ideal where space is limited. Incorporates the Magnavox 6WR 6-inch Speaker and the new 3TC Mk. II tweeter frequency response, 50 to 18,000 cycles. Power rating max. 8 watts. Available in 7½ or 15-ohm impedance.

\$27.00

Post and Packing: N.S.W. \$1.50. Interstate, \$2.00.

NEW BOOKSHELF SPEAKER SYSTEMS

PLAYMASTER BOOKSHELF SYSTEM

Available in 15 ohms or 8 ohms.

\$30.00

Post and Packing: N.S.W. \$2.00, Interstate \$2.50.

PLAYMASTER SUPER BOOKSHELF

Using two of the new Magnavox 6WR Speakers and one 3TC tweeter. Dimensions: 19½in x 10in x 8in.

Available in 8 or 15 ohms.

\$40.00

Post and Packing: N.S.W. \$2.00, Interstate \$3.00.

ALL SPEAKER UNITS FINISHED IN OILED WALNUT, MAPLE OR TEAK.

CLASSIC RADIO

245 PARRAMATTA ROAD, HABERFIELD, N.S.W. PHONE 798-7145

NEW ALL TRANSISTOR STEREO AMPLIFIERS ULTIMATE IN DESIGN-LONG DEPENDABILITY USING ALL SILICON TRANSISTORS 36 WATTS-RMS

SPECIFICATIONS:

POWER OUTPUT: 18 watts per channel R.M.S.
Total output 36 watts R.M.S.

FREQUENCY RESPONSE: From 20 cycles to 20,000
± 1db.

HARMONIC DISTORTION: Less than 1 per cent at
14 watts output.

HUM AND NOISE: Aux, 70db, Mag, 50db.

INPUT SENSITIVITY, Mag, 3mv, Aux, and tuner
200 mv.

SPEAKER IMPEDANCE: 8 oms.

EQUALISED: Mag, RIAA.

TONE CONTROLS: Bass 50 c/s ± 12db. Treble
10 kc/s ± 12db.

LOUDNESS CONTROL: 50 c/s 10db.

SCRATCH FILTER: (High filter) at 10 kc/s 9db.

RUMBLE FILTER: (Low filter) at 50 c/s 5db.

PROVISION FOR TAPE RECORDER. Record or
play-back with din plug connection.

PROVISION FOR HEADPHONES with headphone/
speaker switch on front panel.



MODEL C300/20

\$119.00 FREIGHT EXTRA.

DIMENSIONS: 16½in v 5½in x 11in deep.

Mounted in oiled walnut or teak veneered cabinet,
with metal trim and matching knobs.

THE CIRCUIT INCORPORATES regulated power
supply with transistor switching protection for
output transistors. 26 silicon transistors plus 5
diodes are used.

**ABOVE AMPLIFIER
WITH INBUILT A.M.
TUNER**

\$144.00 FREIGHT
EXTRA

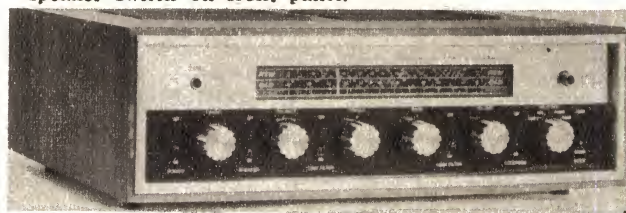

MODEL C300/20/T

12 WATT RMS PER CHANNEL VERSION OF ABOVE AMPLIFIERS AS PREVIOUSLY ADVERTISED
ALSO AVAILABLE. \$134.00 WITH TUNER.

NEW ALL-TRANSISTOR A.M. TUNER WITH PRE-AMPLIFIER



DIMENSIONS: 10½in. x 3in x 5½in.

Suitable for use with all transistor or valve Hi-Fi amplifiers, tape recorders or
P.A. amplifiers. **\$40.00**

SPECIFICATIONS:

Frequency coverage 530 to 1,600 K.C. Inbuilt aerial, provision for external aerial.
240 volt A.C. operation. Output variable from 50mv to 1.5 volts. Timber cabinet
finished in teak or walnut. Band width 9K.C.



\$118.00

FREIGHT
EXTRA.

**MODEL C200V. BASED ON THE
PLAYMASTER 118 WITH TUNER**

Dimension 16½in x 5½in x 11in.

CABINET IN OILED WALNUT OR TEAK WITH
METAL TRIM.

This amplifier is based on the Playmaster 118 circuit as featured in "Electronics Australia," to which has been
added the following features:

- Inbuilt high gain A.M. tuner with a coverage of 530 to 1,600 K.C.
- Loudness control giving bass boost at low volume.
- Provision for tape, record and play-back, with din connector.
- Calibrated dial available for all States.
- EM84 tuning indicator giving accurate tuning with ease.

POWER OUTPUT: 9 watts per channel R.M.S. FREQUENCY RESPONSE: 20 to 20,000 cycles incorporating
Ferguson O.P.412 gain oriented output transformers. VALVES USED: 4-6GW8, 12AX7 or 12AU7, 6AN7,
6N8, EM84 and 2 silicon diodes.

CLASSIC RADIO

245 PARRAMATTA ROAD, HABERFIELD, N.S.W. PHONE 798-7145

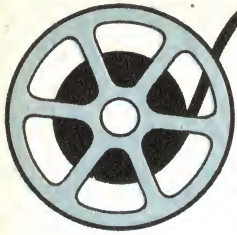

AUDIO TOPICS



CHANGING IDEAS ABOUT LOUDSPEAKER SYSTEMS

This article was prepared largely at the instigation of a reader who expressed himself as thoroughly confused by trends in the design of loudspeaker systems. How do the various factors interact: Enclosure size, loudspeaker size, air loading, frequency response, power output rating, and acoustic efficiency?

By W. N. Williams

To examine these and other factors in detail and to explain fully their inter-relationship would occupy more space than is available in a single, short article. What we can do, however, is to look at the trends which have been evident, particularly over the past couple of decades, and see how they have brought about an acceptance of loudspeaker systems that are quite different in concept from what was once accepted as appropriate and necessary.

As a class, loudspeakers are rather inefficient devices. To put it another way, it might be said that loudspeakers are not nearly as sensitive as they should be. The acoustic power actually made available to the listener is commonly less than 10 per cent of the electrical power fed to the loudspeaker — representing a power loss of more than 90 per cent.

Despite this rather gloomy observation, the efficiency (or sensitivity) of loudspeakers relative to each other is still a very important consideration. Other things being equal, a loudspeaker exhibiting an efficiency of 9 per cent would normally be preferred to one exhibiting an efficiency of 6 per cent. Both would be preferred to one with an efficiency of 3 per cent, and so on.

In those radio receivers, tape recorders, etc., which are operated from batteries, loudspeaker efficiency is a vital matter. To minimise the weight and bulk of batteries — and the ultimate operating costs — the audio power stage is normally operated at as low a voltage and current as possible. This sets a severe limit on the audio power which the stage will deliver and the loudspeaker must be as efficient as possible if it is to transduce this limited electrical power into a useful level of acoustic power.

For mains operated equipment, designers can be more generous in the design of the audio system but, at the same time, users normally expect much more from it. They will accept obviously limited performance from a port-

able battery-powered device but not from something that is larger, more pretentious, and mains powered.

Because of this and the cost-penalty that usually attaches to higher-powered circuitry, loudspeaker efficiency still comes into the picture. If loudspeaker "A" is more efficient (more sensitive) than loudspeaker "B," and has no serious disadvantages, then loudspeaker "A" is the one which the designer will favour.

Up till a few years ago, this same sort of thinking was very evident also in the high fidelity market — the one which particularly concerns us in these pages.

Thus, while the power output rating of high fidelity amplifiers has normally been well above that of even mains-powered receivers, high fidelity fans as a class are more given to listening critically at a higher level

and to "turning up the wick" occasionally to impress visitors.

In such a situation, a higher efficiency loudspeaker will usually show up better because, for the electrical drive power available, it will produce an even louder sound — if that is what the owner is seeking!

Somewhat more realistically, for a desired level of sound in the listening room, an amplifier feeding an efficient loudspeaker can operate at a lower level than one feeding a less efficient loudspeaker. Under such conditions, one would hopefully expect the amplifier to contribute somewhat less distortion and to cope the better with transient peaks.

It is interesting to relate these observations to typical figures. Assume, for example, that loudspeaker "A" has a 3 decibel advantage in efficiency (or sensitivity) over loudspeaker "B." Heard in a listening room, loudspeaker "A" would produce the same level of sound from a 5-watt amplifier, before system overload, as would loudspeaker "B" operating from a 10-watt amplifier. For ordinary listening, loudspeaker "B" would require twice as much drive power as would "A" for the same sound level.

In other words, a 3dB difference in loudspeaker sensitivity is equivalent to a 2:1 difference in amplifier power rating.

Up till a few years ago, most domestic high-fidelity systems had a power output of about 10 watts per channel steady-tone (commonly referred to as RMS). Most were used in conjunction with 12-inch loudspeakers with better than average sensitivity — high-fidelity models bearing familiar names like Rola, Goodmans, Wharfedale, etc. The loudspeakers were commonly mounted in fairly large vented enclosures, which utilised radiation from the rear of the cone to reinforce output in the bass region.

With amplifiers of this power level and relatively efficient loudspeaker systems, there were few complaints about the adequacy of the sound level available for domestic listening.

The complaints were almost invariably of another kind: the loudspeaker systems were too large for the domestic scene, particularly when two were involved, as for stereo listening. In due course, this brought about a revolution in the thinking surrounding loudspeakers and, among other things, involved the question of loudspeaker efficiency. But first, a few technical points.

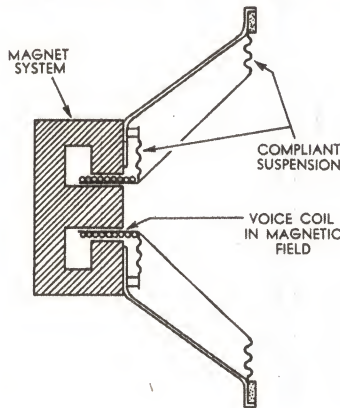

A much simplified diagram of a moving coil loudspeaker. A vital factor is the distance the cone has to travel to produce the required acoustic output. This vitally affects the length of the voice coil and, as a result, the acoustic efficiency.

The accompanying diagram illustrates the basic principles of a moving coil loudspeaker. The moving coil (or voice coil) is wound on a former, cemented to the apex of the cone; complaint suspensions near the apex and the periphery of the cone allow the coil and cone assembly to move backwards and forwards.

The voice coil operates in an intense magnetic field across the air gap of a magnet system. The interaction of this fixed magnetic field with that created by the audio currents through the voice coil produces the drive, which causes the voice coil to move back and forth; this carries the cone with it, propagating sound pressure waves into the surrounding air.

The voice coil has to be made deliberately longer than the dimension of the adjacent pole face so that the same number of turns will be in the magnetic field, irrespective of whether the voice coil is at a median position or near either extreme of its travel. If matters were otherwise, the drive to the voice coil would diminish towards the peak of each excursion; the peaks of the acoustic output wave would be flattened, resulting in distortion.

Unfortunately for efficiency, the turns on the voice coil which are outside the magnetic field at any instant absorb power from the electrical drive signal but contribute virtually nothing to acoustic output.

In developing a loudspeaker, it is necessary for the designer to envisage the role which it is likely to fill, the acoustic level at which it will be expected to operate, and the likely order of cone excursion.

A loudspeaker, which is intended to operate with low-powered portable transistor equipment, would not normally be called upon to handle a high power level but it would be required to exhibit the highest possible sensitivity. In such a loudspeaker, the voice coil would most logically be designed with as few "idle" turns as practicable and be accommodated in a gap with the smallest practical clearance between the coil and the pole faces.

Logically, it would have as high a magnetic flux as possible across the gap, calling for the strongest magnet practicable.

"Practicable" is the key word in the last sentence. Though there have been a number of important advances in the technique of fabricating loudspeaker magnets, it is still true that the strength of a magnet is linked closely with its size, its weight and its cost.

The designer of a small, economy loudspeaker, has to do his best, within the limitations of a small, economy magnet system.

When a loudspeaker is intended for more pretentious equipment, involving an expectation of higher level sound, more electrical drive and more emphasis on bass response, the basic design concepts must be enlarged. The voice coil would be made longer, to allow for greater cone excursion. The dimensions of the gap would be increased to accommodate a larger coil and give it rather more clearance. To produce an adequate magnetic flux density across the larger air gap, a larger and more expensive magnet would be fitted.

At the same time, the remaining dimensions of the loudspeaker would be increased to accommodate a larger cone, having a nominal diameter of 6, 8, 10 or even 12 inches.



NEW from QUAD

SOLID STATE

303 POWER AMPLIFIER AND 33 CONTROL UNIT



QUAD has introduced two new models, the SOLID STATE Quad 303 and Quad 33. What's new in these models? . . . 30 watts power rating (R.M.S.) per channel with frequency response of—1 db, 20 to 35,000 Hz. Fully silicon transistorised.

Entirely new circuit design provides outstanding high quality reproduction and output circuit protector which cannot be accidentally upset by misuse, overdriving, shorting or disconnecting speakers. Distortion is less than 0.03% at any level up to 45 watts per channel into an 8 ohm load at 700 Hz and is 10 times lower than in the best of valve amplifiers. With the professional look and the professional touch, the price of these two new Quad units is \$486.00.



QUAD ELECTROSTATIC LOUDSPEAKER

Using closely coupled moving elements some 200 times lighter than the diaphragms of moving coil loudspeakers, and being entirely free of cabinet resonances and colouration, this loudspeaker overcomes the usual major problems of loudspeaker design and provides remarkably natural reproduction of sound. The real test is to listen to the music it reproduces—a comparative demonstration is strongly recommended.

**QUAD for the closest approach
to the original sound.**

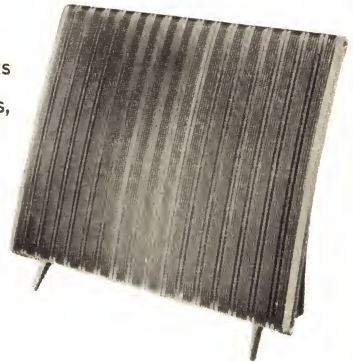

Please send me a copy of the new QUAD leaflet.

NAME

ADDRESS

BRITISH MERCHANDISING PTY. LTD.
49-51 York St., Sydney. Telephone 29-1571.
(sole Australian agent.)

Peter Clarke says:
Compare these lower
than usual prices



ADD-A-KIT WAY TO HI-FI STEREO POWER

TAPEDECKS

National RS766	\$172.95
Sharp RD712	\$165.95
Tandenburg 1641X	\$367.00

All Akai and Sony Tape decks at a special cash price.

AMPLIFIERS

Fisher TX100	\$377.00
Leak ST30	\$198.00
ST70	\$298.00
Sharp STA31	\$219.95
Sansui AU555	\$185.95
AU350	\$247.95
5000	\$413.95
Monarch SA500	\$112.95

All Kenwood and Akai Amplifiers with special cash prices.

TURNTABLES

Elac 610	\$105.00
Elac 50H	\$150.00
Thorens TD150A	\$125.00

All Dual, Garrard and other turntables with special cash prices

SPEAKERS (for pair)

A.R. 4X	\$274.00
Fisher XP55	\$200.00
XP7	\$385.00
JBL Lancer 77	\$450.00
Leak Mini Sandwich	\$198.00
Wharfedale Denton	\$132.80

All other brands of speakers special cash prices

Magnetic Sound

INDUSTRIES

387 GEORGE ST., SYDNEY I door **29-3371**
 from Kodak
 Parramatta Branch, 20 Macquarie St., 635-0830 opp. Astra Theatre.

The use of a larger cone has certain inherent advantages over and above the obvious one of the equipment manufacturer being able to advertise "giant 12-inch loudspeakers."

A larger cone "couples" more effectively to the surrounding air and tends to propagate sound waves better at the lower frequencies. In the usual poorly baffled situation it produces a more "full," satisfying tone. And, because it couples to a greater quantity of air, a larger cone can produce a given level of sound output for less to-and-fro movement than a smaller cone.

In practice, typical competitively priced 12-inch loudspeakers can produce an ample level of well-balanced sound for the average domestic situation and exhibit an order of acoustic efficiency (sensitivity) at least equal to, and generally greater than, small loudspeakers. It is, therefore, quite wrong to assume, as many do, that ordinary 8, 10 and 12-inch loudspeakers are harder to drive than smaller ones. In fact, it is a common experience to find that transistor radios and tape recorders can be made to sound vastly better by simply feeding their output into a large, sensitive external loudspeaker.

The time-honoured 12-inch "prestige" high-fidelity loudspeakers which we referred to earlier carry this general design philosophy to something approaching an economic limit.

They have a large, carefully designed and sometimes multiple cone system, intended to exhibit a wide, smooth frequency response.

The suspension system is designed to allow fairly extensive excursions of the cone and voice coil, anticipating that such a loudspeaker will most likely be called upon to operate at a high sound level and produce a generous output in the bass region.

In anticipation of substantial cone excursion, the voice coil is made long enough to ensure that it will not run out of the gap.

Because of the longer voice coil, a loss of sensitivity might be expected, but the traditional prestige high fidelity loudspeakers invariably used large and expensive magnets, which more than made up for the loss. Almost invariably such loudspeakers are more efficient than the less pretentious units in the same manufacturer's range.

Loudspeakers in this general class were — and still are — an excellent proposition for a domestic high fidelity system and there are plenty of enthusiasts who would think of using nothing else. Their waning popularity has little to do with performance but a lot to do with physical size, as we have already noted.

An enclosure which will not prejudice the low-frequency performance of a 12-inch high-fidelity loudspeaker needs to have an internal volume of not less than 5 and preferably up to 9 cubic feet! It usually takes a good deal of solid talking to justify one such enclosure in a living-room, let alone two for a stereo system. Quite apart from the actual space problem, cabinets of this size are very obvious items of furniture and are necessarily costly, if finished in the appropriate manner.

Manufacturers and designers of high-quality stereo systems clearly had to find a way around this very real problem and in the face of a long-accepted

concept that loudspeaker systems could only be as good as they were big!

When this idea first gained acceptance, it was not far from the truth. While a few designers anticipated the principles which have since become popular, the majority of compact loudspeaker systems were very disappointing by comparison with larger and conventional units. It is only during the past few years that compact systems have been developed in any variety,

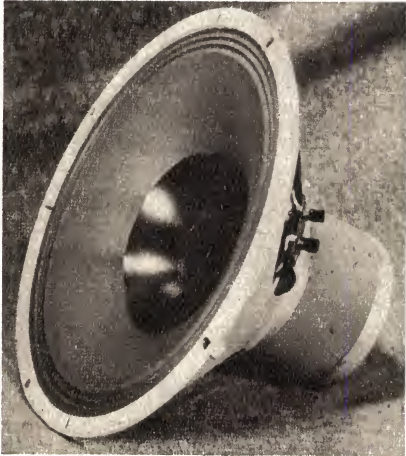

A typical 12-inch full-range, high efficiency loudspeaker, as produced some years ago by Goodmans. This class of loudspeaker works well in a large enclosure. As enclosure size is reduced, however, air loading on the large cone tends to push its natural resonance up from an acceptable 45-odd Hz to a figure that becomes progressively less acceptable.

capable of meeting the needs of most high-fidelity listeners in a domestic situation.

There is far more to designing a compact system than mounting a conventional loudspeaker—even a good loudspeaker—in a box of restricted size. Consider, for example, the situation which obtains for a conventional, 12-inch, high-fidelity loudspeaker, as already discussed.

Most of these have a natural cone resonance in the region 40 to 50Hz.

If they are mounted on a large flat baffle or in a large, open-backed cabinet, the natural resonance of the cone assists the response in the region where it might tend to diminish due to interaction of the front and rear radiation. The general balance may not be perfect but it will certainly not be unpleasant.

If mounted in a large sealed enclosure, say 9 cubic feet or more, the cone resonance may be shifted up a few Hertz by the air loading on the rear of the cone, but the results will still sound good.

If mounted in a properly designed vented enclosure, of 6 cubic feet or more, radiation from the rear of the cone is put to good use, producing a bass response which will be impressive, even if a little "lumpy."

It is not far from the truth to say that, given a big enough baffle system, be it flat, infinite, sealed or vented, a large top-quality loudspeaker will

sound pretty good anyway. Such loudspeakers are surprisingly non-critical!

However, problems arise — and multiply — when an attempt is made to meet high-fidelity requirements with such a loudspeaker mounted on or in a scaled-down baffle system.

If it is mounted on a small flat baffle or in a small open-backed cabinet, radiation from the rear of the cone must substantially cancel that from the front over the low frequency range. The juxtaposition of walls and floor may help, rather randomly, to preserve some of the bass response and further assistance may possibly be had from bass boost in the amplifier. In general, however, the compromise is so great as to be normally unacceptable.

On the other hand, if an attempt is made to complete the enclosure so as to contain the rear radiation from the cone, the air enclosed behind the cone adds "springiness" to the whole moving system and significantly raises its natural resonance, both in frequency and prominence. From 45Hz, it may easily rise to well over 100Hz.

The "full" bass quality, which a 45Hz resonance may lend, becomes "boomy" for a resonance around 90Hz and "tubby" for a resonance around 120Hz.

The behaviour of the system as a

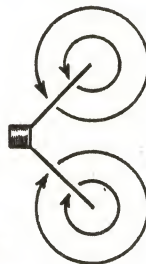

The role of an enclosure is to prevent the loudspeaker from merely pumping air around the edge of its own cone — an effect that becomes more evident at progressively lower frequencies. The smaller the enclosure is made, the harder it is to secure the desired isolation without upsetting the behavior of the loudspeaker, due to the "springy" loading of the air trapped behind the cone.

whole can be manipulated to some extent by the use of a vent, port, acoustic resistance, tuned filter, etc., but the plain fact emerges that a conventional high-fidelity 12-inch loudspeaker is just not suitable for mounting in a compact enclosure.

Appreciation of this fact has led some designers to produce loudspeakers having a similar order of cone area but with a suspension system so compliant that the natural resonance of the moving system is in the region 15 to 20Hz. Mounting such a loudspeaker in a compact enclosure has an inevitable effect on the resonance, but pushing it up only to an acceptable 50-odd Hz.

This, in fact, is the design concept behind a large number of high quality loudspeaker systems, which might more aptly be described as compact, rather than small. Some of the loudspeakers have cone systems moulded from foamed plastic, a material for which the designers claim special advantages.

AKG

K20



More details from
your dealer or

**Engineering
Products
Division**

SYDNEY 88 6666	MELBOURNE 67 9161
BRISBANE 4 1631	ADELAIDE 72 2366
PERTH 28 6400	LAUNCESTON 2 1804

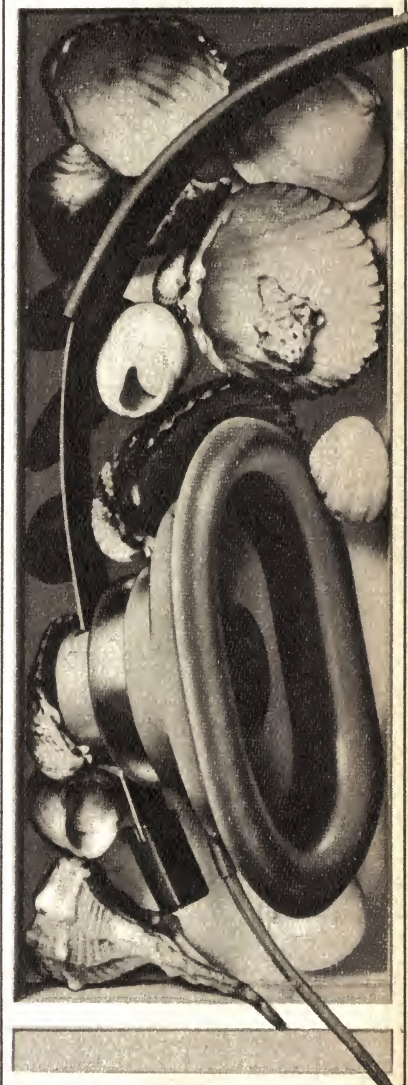

LEAK HI-FI

Craftmanship & Quality

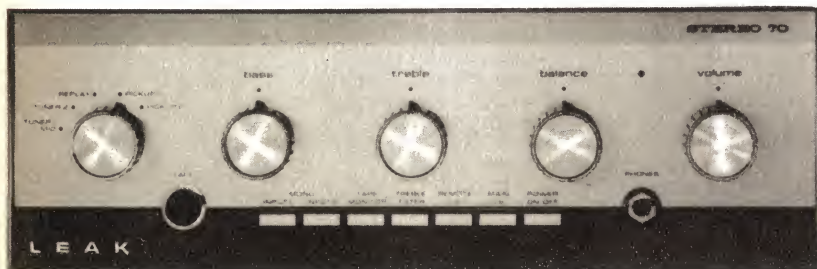

LEAK 'Stereo 70' Amplifier. \$298.00

The 'Stereo 70' is full of latent power — up to 35 watts r.m.s. per channel. Distortion is a mere 0.1% at 1,000 Hz for all power outputs up to 25 watts r.m.s. per channel. In addition, this extra output enables a pair of loud-speakers to be connected apart from the two in the main listening room. Elegantly finished in black and silver, or an attractive teak case is also available for shelf mounting.

Other brand new features are a head-phone socket for those who prefer to listen to stereo that way, and a DIN record/replay socket on the front panel for a portable tape recorder together with the standard inputs at the back of the amplifier.

All this, backed by the famous LEAK craftsmanship and reliability, makes the Stereo 70 the most technically advanced amplifier available.



LEAK 'Stereo 30 Plus' Amplifier. \$198.00

The new Stereo 30 Plus combines the long proven circuitry of the Stereo 30 with a new range of silicon transistors and facilities up-dated to meet today's needs:—

This, backed by the famous LEAK craftsmanship and reliability, makes the Stereo 30 Plus the most technically advanced 15-watt amplifier available.

Power Output (both channels sinewave driven):

15 watts r.m.s. each channel into 8 ohm loudspeakers.

See and hear LEAK Equipment today at leading Hi-Fi Stores and sound centres. For leaflets and information write to:

H.J. LEAK (AUST) PTY. LTD.

P.O. BOX 14 FRENCH'S FOREST, N.S.W. 2086

PHONE 94 4902

At the same time, many have adopted the idea of filling the interior of the enclosure with a fluffy acoustic filling. This effectively adds mass and resistance to the entrapped air, restraining the rise in both frequency and amplitude of the resonance. The result is a system which can be very smooth down to and below the bass resonant frequency. It lacks the inherent — if rather lumpy — reinforcement which a vented system gives in the bass register, but it lends itself well to modest boost from the amplifier, if the listener judges this to be desirable.

If the objective is to produce a still smaller loudspeaker system, while preserving a low bass resonance, it becomes necessary to use a smaller cone. This is due to the fact that the effect of the enclosed air is largely proportional to the area of cone against which it can push.

Appreciation of this fact has led designers to produce a whole array of loudspeakers intended for high fidelity applications, ranging down in size through a nominal 10-inch diameter, to a mere 3 or 4 inches. All have been designed with a very low natural frequency of resonance, which will rise to some higher but acceptable frequency when the loudspeaker is mounted in a sealed and filled cabinet of suitable size.

It is appropriate to mention here that, while the size of the enclosure largely determines the behaviour of the loudspeaker at the bass end, the cushion of entrapped air also helps protect the cone against excessive drive. It is most unwise to operate a low-resonance high-compliance loudspeaker in an enclosure which is not properly sealed or which is larger than recommended by the manufacturer.

While it is possible, by such means, to produce scaled-down loudspeaker systems having a wide frequency response, it is essential that they be able to produce an adequate sound level in the listening room.

A given sound level may be produced by a larger cone vibrating through a small distance, or a smaller cone vibrating through a greater distance. In other words, the smaller the cone, the greater will its excursion need to be for a given sound level.

In view of this fact, loudspeakers intended for use in small high fidelity systems have a cone suspension intended not only to ensure a very low frequency of resonance, but also to allow considerable excursion either side of the at-rest position before the structure is restrained. In most such loudspeakers, the cone is supported around its periphery by what is called a "roll surround," moulded from neoprene or other soft rubber-like material.

As might be expected, a "long-travel" cone system makes it imperative that the voice coil be unusually long so that, at all times, a fixed proportion of the turns are within the magnetic field. It also means that a greater than usual proportion of the turns will always be outside the field, absorbing power but contributing nothing to acoustic output. A marked loss in efficiency is the inevitable result, the loss being compounded if the designer elects to open the gap a little to give greater clearance for the hard-working system.

To help offset this loss of efficiency,



A typical, modern 6-inch low frequency drive unit, as produced by Rola. Because of its reduced cone area, it can be used in a smaller enclosure than, say, a 12-inch unit.

it is normal to fit such loudspeakers with large and expensive magnets which may, in fact, rival the size of the cone housing. In practice, the offset is only partial and it is usual to find that acoustic efficiency diminishes with size.

As we have already stated, such units are intended to go into sealed enclosures of an appropriate size, filled internally with a fluffy acoustic material. This has the desirable effect of damping resonance and absorbing acoustic reflections within the enclosure; in so doing, it reduces sonic components which would otherwise add to the loudness of the output. At the same time, it imposes an air loading (or a restraint) on the rear of the cone, making further inroads on efficiency, particularly at the lower frequencies.

In all this discussion, little or no reference has been made to the high frequency end of the spectrum. This is simply due to the fact that the problem of reducing loudspeaker system dimensions is essentially one of preserving low-frequency response. The behaviour of a system in the middle and upper register is controlled by quite separate aspects of cone design, the use of tweeter cones, separate tweeter loudspeakers, cross-over networks and so on.

In general terms, the broad characteristics of modern compact loudspeaker systems can be summarised as follows:

MIDDLE AND UPPER RESPONSE: No inherent limitations. It will be as smooth and as wide as the designer has been able to make it.

LOW FREQUENCY RESPONSE: Smooth and substantially free from doubling or tripling effects within the intended power range. The output usually tapers off towards the low frequency end, the loss becoming more apparent as the size of the system is reduced. Good balance can usually be restored by using bass boost; half the bass boost available in an average amplifier will usually suffice for a "bookshelf" size enclosure, less for the larger compacts.

EFFICIENCY (OR SENSITIVITY): Noticeably lower than for systems using large loudspeakers and large vented enclosures. For high quality domestic listening, the power available to drive them should be 10 watts RMS per channel, or more. Fortunately, amplifiers with this order of power output are commonplace and there is no special problem in making up for the loss of efficiency which is almost inherent in a compact loudspeaker system.

POWER RATING: Because efficiency is so deeply involved, the power rating is related only vaguely with the actual sound level which a system can deliver. However, for good quality domestic listening, a compact loudspeaker system should be capable of accepting 10 watts RMS per channel or more.

OVERALL EVALUATION: If space were no problem, most high fidelity enthusiasts would prefer to use large high fidelity loudspeakers mounted in large (though not necessarily vented) enclosures. However, tradition and visual impact is a factor in this preference and the sound from the best modern compacts (from say 1 to 3 cubic feet) bears direct comparison with the larger types at likely domestic listening levels. If lack of room space or cost forces the listener to select from the still smaller variety (say under 1 cubic foot), there is no need to be dismayed; a well designed bookshelf size system, with a good amplifier and half bass boost can give extremely satisfying reproduction. ■

Specific questions:

It would appear that air loading on a loudspeaker increases its power handling capacity. Is this true?

In general, yes. If operated without a baffle system, a loudspeaker tends merely to pump air due to low-frequency energisation, from one side of the cone to the other. The cone reaches the limits of its travel with a minimum of drive without, in fact, propagating much of the energy into the listening area. The cone and suspension system may easily be damaged, particularly if the latter is highly compliant. A baffle system imposes a work load on a cone, causing it to propagate low frequency energy over a greater distance. It minimises useless cone travel and allows the assembly to accept and utilise more drive power.

Does loading on a cone, as by a small sealed enclosure, reduce efficiency? Wouldn't one get as much acoustic output from the same loudspeaker by allowing it to operate with less restriction at higher efficiency?

The purpose of sealing an enclosure is to contain the radiation from the rear of the cone and prevent it from interfering adversely with the frontal radiation. At the same time, however, it so affects the behaviour of the loudspeaker as to require a special design approach. Loss of efficiency is part of the special approach required; it is not just a matter of air loading by the small enclosure. Operating the loudspeaker without an enclosure would not change its inherent efficiency all that much but it would leave the cone unprotected against extremes of travel and it would allow bass cancellation to occur.

SONICS

LOW COST, HIGH PERFORMANCE SPEAKER SYSTEMS FROM ENCEL ELECTRONICS!

Separate speaker systems are essential if you wish to exploit the full potential of your amplifier, tape recorder or radio. Sonics speaker systems are beautifully finished in selected walnut/teak veneers, are styled to blend with period or modern decor and are extremely effective from an audio point of view. The following models are the most popular.

MODEL AS-57: Bookshelf type—Measuring 15 1/2" x 5 1/2" x 8 1/2", this enclosure is compact and most effective. The speaker unit is an oval wide range loudspeaker. Priced at only... **\$22.50**

MODEL AS-60E: Although only 18 3/8" x 12 3/8" x 5 1/2" the AS-60E is fitted with a bass/mid-range speaker and a separate high frequency reproducer. An excellent speaker system which has proved very popular with audio enthusiasts. Hand finished teak/walnut cabinet. Inc. **\$27.50** Sales Tax.

MODEL AS-61: A true "Slimline" enclosure with four bass/mid-range speakers and a high frequency reproducer. Measures only 4 3/8" depth; height is 21 3/8" and width is 17 1/2". Finish is teak/walnut and the legs are detachable. Probably the most popular multiple speaker system ever offered at this price in Australia, Inc. Sales Tax. **\$39.50**

MODEL AS-202: A 3-speaker, 3-way system which measures 20 1/8" x 11 5/8" x 11 5/8". The AS-202 is a recent addition to the Encel Sonics range. An 8" woofer and a 6 1/2" mid-range speaker are incorporated — and a high frequency reproducer completes the speaker complement. Will handle 10 watts R.M.S. with ease. Beautiful hand finished teak/walnut cabinet. Inc. Sales **\$46.50** Tax.

MODEL AS-220: A most effective 3 way speaker system with an 8" bass reproducer, a 6 1/2" mid-range speaker and a high frequency reproducer. Cabinet size is 20 1/8" x 11 5/8" x 11 5/8" and the front grille features a timber fret which matches the teak/walnut veneer cabinet. Handles 10 watts R.M.S. easily. Inc. sales tax... **\$56.50**

MODEL AS-303: A magnificent hand finished teak/walnut speaker system with three speakers and a 3-way crossover network. A 12" woofer with a one throw voice coil provides excellent bass response, a 6 1/2" mid-range speaker covers the middle ranges and a horn type tweeter comes in at 5kHz. Power handling capacity is over 15 watts R.M.S. Extremely wide frequency response free of coloration. Size 25 1/2" x 14 1/2" x 11". Inc. **\$69.50** Sales Tax.

MODEL AS-251: This is a new deluxe 3-way speaker system with a 10" bass reproducer, a 6 1/2" mid-range speaker and an exponential horn tweeter. A 3-way crossover network assures smooth response over the total range of 40-20,000 Hz. Dimensions are 13 1/2" x 22 1/2" x 11 1/2" and finish is oiled teak/walnut veneer. Inc. Encel price including Sales **\$78.00** Tax.

MODEL AS-330: The deluxe system of the Sonics range. It is a 3-way system with three speakers including a 12" bass reproducer, a pair of mid-range speakers and two exponential horn type tweeters. The attractive cabinet is hand finished in teak/walnut figured veneer, has a most attractive timber fret grille and measures 15 3/8" x 25 1/2" x 11 5/8". Overall frequency response is 30-20,000 Hz. Carefully selected crossover frequencies provide a smooth and musical performance over the frequencies specified. Encel price inc. sales tax is... **\$98.50**

IMPORTANT: All "Sonics" enclosures are 8 ohms impedance.

SONICS STEREO HEADPHONES

The popular Model HS-304 offers fatigue free listening on a personal basis... the headset is very comfortable even over lengthy periods. Price? Only \$12.50.

Encel ELECTRONICS (STEREO) PTY. LTD.

Head Office:

431 Bridge Rd., Richmond, Victoria 3121. Tel. 42 3762.

Sydney Store: Ground Floor, 25M Building

257 Clarence Street, Sydney, N.S.W. 2000.

Tel. 29 4563, 29 4564.

*Wholesalers *Trade-ins accepted

Australia's Greatest Hi-Fi Centre

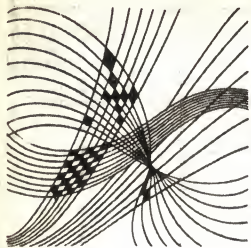

CLASSICAL RECORDINGS

Reviewed by Paul Frolich

HANDEL: Overtures and Sinfonias. (Overtures to Solomon, Berenice, Teseo, Ariodante, Esther, Rinaldo, Sosarme; Sinfonias from Solomon, Jephtha, Rinaldo) English Chamber Orchestra; conductor Richard Bonyng. Decca stereo SXL 6360.

There is one thing one must not forget for one minute while listening to this disc—indeed, it would be difficult to forget it: all the music heard has been “edited and prepared for performance” by Mr Bonyng. I have never failed to admire this conductor, nor have I failed in gratitude for his endeavours to unearth unjustly neglected music for our greater delight; and it is fair enough to claim that most of the music here presented does fall into that category of neglected music.

Scholarship is a wondrous thing and arrangements and editing are very necessary for music which has been inadequately preserved in print. Handel has, of course, suffered quite dreadfully at the hands of nineteenth-century editors who set out to make his scores suitable for performance by a full symphony orchestra. Now, it is usual for conductors to go the opposite way and to attempt reconstruction of period performances by using only the forces available to the composer in his day. Reconstruction of a style is, however, even trickier and it is unfortunate that the result of a Bonyng being let loose can be just as dreadful as anything Hamilton Harty managed to do.

Mr Bonyng has become preoccupied with ornamentation and this leads him into all kinds of unjustifiable details and byways. Ornaments, beyond certain established and standardised embellishments, were usually the prerogative of vocal or instrumental soloists, who improvised them. I cannot accept the way in which arrangers such as Bonyng are now writing elaborate ornaments into a score.

This novel way of “preparing for performance” becomes quite preposterous when whole orchestral sections are expected to reproduce such details faithfully and in unison. I have not done the amount of reading and research that I am sure Mr Bonyng has undertaken but I positively cannot find any evidence to support the editorial excesses he has indulged in.

Apart from other drawbacks, some of the languid appoggiaturas and other frills mar the lovely line of Handel's instrumental writing, detract one's attention from the beauty of the music

and hide the quality of the orchestra's excellent playing. If, after all this, I can still claim to have enjoyed the disc, this is because so much of the music is simply not available on any other disc I know of. I recommend the record for everyone's attention; the music is beautiful in any guise, the playing is wonderfully good and the recorded sound absolutely first-rate.

★ ★ ★
MAHLER: Das Lied von der Erde. Maureen Forrester, contralto; Richard Lewis, tenor; Chicago Symphony Orchestra; conductor Fritz Reiner, RCA Victrola stereo VICS 1390.

This version of the “Song of the Earth” was first issued about 1962 and had been deleted for some years now, without ever having been released on the Australian market before this. Now, on the budget-price Victrola label, it is probably one of the greatest Mahler bargains ever to be offered here.

This version of Mahler's great tragic work—really his 9th symphony, though he never called it that—is not ideal in every respect. Reiner, who died in November, 1963, had been brought up in the shadow of the Mahler tradition without, himself, ever being a member of the close circle of Mahler disciples.

If conductors Bruno Walter and Klemperer could claim to conduct Mahler as the composer himself might have conducted it or approved of its being interpreted, Reiner could not; he merely belonged to the handful of conductors devoted to Mahler's memory, who loved his music, understood it at their own, very personal, level and rarely conducted it other than very well.

Though the last touch of authenticity is missing, few listeners are likely to be aware of this; what they might notice, though, is a touch of urgency, almost of pushing the music along too quickly here and there. This lack of leisureliness is not painfully obvious, but a little irritating all the same. Miss Forrester and Mr Lewis, fine and sensitive singers both, cannot quite match Ferrier and Patzak, who were steeped in the Mahler tradition and had been trained by Bruno Walter. In addition, none claims that the Chicago orchestra of a decade ago was the equal of the Vienna Philharmonic.

All these are details which, I think, must be considered by a buyer; they are rather minor in some respects and

do not detract from the genuine value of this recording. I should imagine that every true Mahler fan will wish to own one of the Bruno Walter recordings of this great work, but he might well also want to have another version for comparison of details and for that purpose, at any rate, this bargain issue must get first preference. The quality of the recording is excellent and the performance, in general terms, a very commendable one.

★ ★ ★

RACHMANINOFF—Aleko—A Suite from the opera. With Simon Estes, bass-baritone.

HAVHANESE — Floating World — Ukiyo.

MUSSORGSKY — Daybreak (Introduction to “Khovantchina”). Andre Kostelanetz and his Orchestra. CBS stereo SBR 235306.

My eyebrows did go up a little when I saw Kostelanetz on the CBS release sheet in a spot where, normally, I expect to see Bernstein or Ormandy. Kostelanetz is, of course, a recognised conductor of very varied fare and he has appeared with many orchestras the world over. Nevertheless his real fame is in the light music field, where his numerous appearances with his orchestra have made him almost a byword.

My misgivings were not, in fact, wholly unjustified. The Rachmaninoff work, which takes up the whole of side one, was previously unrecorded and could well have remained so, I feel. It is easy to understand why the 17-year-old student was awarded a medal by his Conservatorium teachers after he composed this opera of gypsy love and pride in the space of one month. Young Rachmaninoff certainly did not kick over the traces, he observed every possible convention and copied the methods and manner of his teachers with slavish faithfulness.

What I regret is that there is not the hint of anything personal to distinguish this music, nothing that marks it as being Rachmaninoff's rather than, say, Mussorgsky's of a quarter-century earlier. If it is absolute pastiche, it yet makes for pleasant enough listening and Mr Kostelanetz' orchestra plays it with polish and finesse. The Mussorgsky piece, which fills up side 2, is almost as unimportant musically; at any rate, it is a fine piece of atmospheric, brilliantly played and quite splendidly recorded.

This brings me to the Hovhanses, the only item worth hearing with attention and, judging by the response of the players (however well they might do out of light music, they are obviously musicians foremost), fascinating to play. This is the first Hovhanses piece I have heard; all I know of the composer is that he is in his late fifties and that his name has cropped up in musical journals for some decades. The notes on the sleeve give no details of composition, but by the sound of it, the work could not have been created more than 18 years ago; if Mr Hovhanses is a cautious composer, it might be very recent indeed.

As does a great deal of the more successful contemporary music the world over, this score owes a lot to an interest in Oriental, particularly Japanese, music. There are the usual

tone clusters, free rhythms, slides, extensive use of brass and percussion and to quote the composer "... wild sounds of controlled chaos." This piece is among the most approachable of its kind and some of it may put listeners in mind of Sculthorpe's "Sun Music I." Whether Mr Hovhaness' score is wholly original, or perhaps merely a collection of quotes from others, I am not in a position to say, but I incline to give him the benefit of the doubt.

The performance, controlled, chaotic, interesting throughout, is, as far as I can tell in the absence of a score, quite excellent. The recorded sound, in all three works, is superlatively good and mention should be made of the splendid singing by Simon Estes.

★ ★ ★

DELIUS: Songs of Sunset; Cynara; An Arabesque. Janet Baker, mezzo-soprano; John Shirley-Quick, baritone; Liverpool Philharmonic Choir; Royal Liverpool Philharmonic Orchestra; conductor Charles Groves. HMV stereo ASD 2437.

This record, enhanced by sensible notes from the pen of Eric Fenby (Delius' amanuensis), and accompanied by the full texts of the Dowson and Jacobsen works, is a valuable addition to the limited amount of Delius' music currently available on the market. For me, this music will ever be full of magic and enchantment, but I am sensible of the fact that, particularly among the young, Delius enjoys at best a qualified vogue; indeed there are many otherwise quite discerning listeners who genuinely cannot get into rapport with Delius' thoughts.

Be warned: if you don't care for Delius, this disc is not likely to change your attitude. For those of us who love Delius and his instant poetry, this record fills a major gap in the catalogue. As far as I know, the "Songs of Sunset" had never been recorded before; they represent Delius at his pastoral best, and they are superbly sung and played.

The Arabesque was written for Beecham in 1915, recorded by him many years ago and has been generally forgotten, quite unjustly. "Cynara" was an old fragment, forgotten by the composer, which Fenby resurrected and helped Delius complete at Beecham's behest in 1919. These two works, both of them quite worth knowing, usefully fill the second side of the disc; both are distinguished by Mr Shirley-Quirk's moving and beautiful singing.

Throughout both sides, all vocal and orchestral performances are excellent and a credit to Mr Groves' love for Delius. Although there are some minor flaws of balance, the recording is very good by normal standards.

★ ★ ★

SIBELIUS: Symphony No. 4 in A Minor, Op. 63; Tapiola, Op. 112. Vienna Philharmonic Orchestra; conductor Lorin Maazel. Decca stereo SXL 6365.

Previous references to Mr Maazel's Sibelius recordings have been universally favourable and this impression is unchanged after hearing this disc which, I believe, completes the set. Mr Maazel recorded all Sibelius' symphonies and most of his tone poems

NEW from SHURE

We couldn't leave well enough alone

We have improved the trackability of the V-15 Type II in the bass register—without affecting its excellent treble. Result: Where, in the past, you may have been required to increase tracking forces to track heavily modulated bass drum, tympani, organ pedal, bassoon, tuba, or piano passages . . . you can now play these passages without increasing tracking force . . . without bass flutter or IM distortion . . . and double (or even triple) record and stylus tip life.

You can modify your present V-15 Type II

You may attain this higher bass trackability by installing the IMPROVED VN15E Stylus. These improved cartridges and styli can be identified by the Shure label on the stylus grip which is in red letters against a silver background.

V-15 Type II Cartridges & replacement Styli

Model No.	Description	Price
V-15 Type II	Improved Dynetic Cartridge . . . Biradial Elliptical Stylus	\$87.50
VN15E	Elliptical Stylus for V15 Type II	\$38.00
V-15 II-7*	Dynetic Cartridge . . . ".0007" Spherical Stylus	\$87.50
VN7	Spherical Stylus for V15 II-7	\$38.00



*This model already incorporated the improvements in the V-15 Type II when introduced.

New reduced prices on the popular elliptical M55E and M44E cartridges and Styli



M55E elliptical cartridge	\$27.50
N55E stylus	\$18.90
M44E elliptical cartridge	\$24.00
N44E stylus	\$16.70

Remember the N55E and N44E styli can be used in any M44 series cartridge. You can upgrade any M44 series cartridge by replacing with the elliptical styli.

Contact your local Hi-Fi dealer or any of the following for more information:

N.S.W.: Audio Engineers, 342 Kent Street, Sydney.

W.A.: Athol M. Hill Pty. Ltd., 613-15 Wellington Street, Perth.

QLD.: Ron Jones Pty. Ltd., 7-9 Merton Road, Wolloongabba, Brisbane.

VIC.: Audio Engineers (Vic.), 2A Hill Street, Thornbury, 44-3295.

THE MAGNIFICENT WORLD

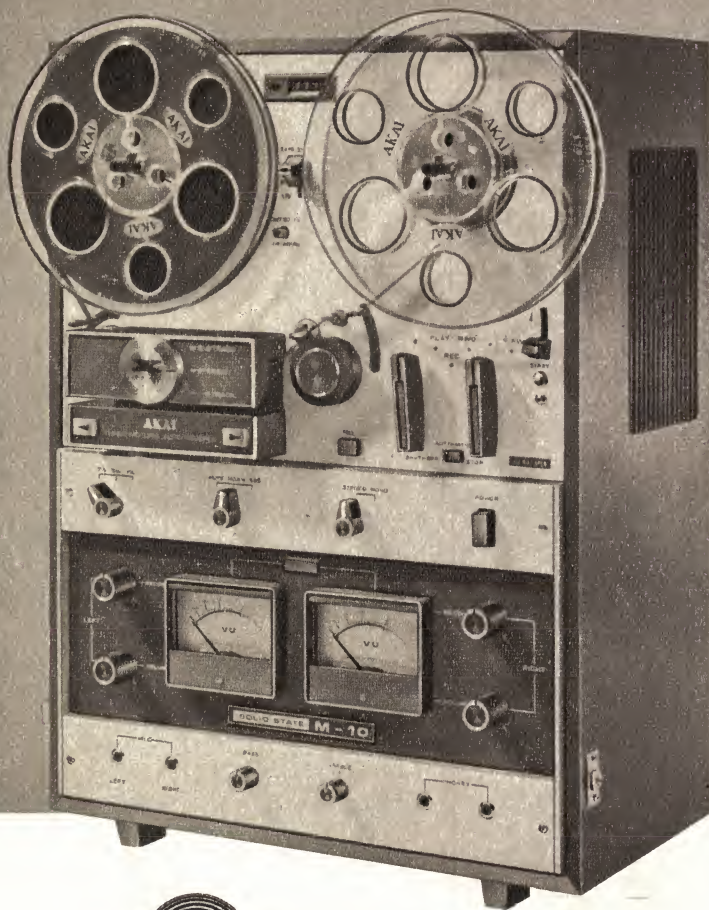

NEW Model M-10

THREE MOTORS AUTO. REVERSE TAPE RECORDER—M-10

*CROSS-FIELD HEAD *3 motors *Sensing tape continuous reverse (Auto. reverse) *Manual reverse *3 speeds, 3 heads *3 speed capstan drive motor *Automatic stop/shut off *Automatic pinch wheel release *Automatic lever release *4 track stereo/monaural recording and playback *40W music power solid state amplifier with two integrated circuits *Fine vinyl leather or wooden cabinet *For increased stereo enjoyment, use the matching speaker SW-160 (4 way, 60 watt input)

Prove it by the sound!
..... prove it with

AKAI[®]
CROSS-FIELD HEAD

AKAI AUSTRALIA PTY. LTD. 276 Castlereagh St., Sydney, N.S.W./146 Burwood Rd., Hawthorn, VICTORIA/399 Montague Rd., West End, Brisbane, QUEENSLAND/8 Arthur St., Unley, S.A./579 Murray St., Perth, W.A. HOMECRAFTS: Petrie St., Canberra, A.C.T. J.B. YOUNG: Giles St., Kingston, A.C.T.

with the Vienna players who, by tradition, are far from being exponents of Sibelius' music, which has remained little-played in Central Europe.

In general terms, Mr Maazel's version of the 4th symphony is another of his great successes and I assume that most listeners will be thoroughly pleased with this record. The exceptions, I suspect, will be those few who still hanker after the kind of performances we got from Beecham on the recordings for the Sibelius Society.

Though I cannot, now, claim to remember the Beecham readings with any clarity, it was they which made me acquainted with the composer's work and I have some reservations about Maazels' interpretations. Sibelius, I believe, must be played with an intimation of harshness and the sweet tone of the Vienna strings makes the music a little too approachable; it was this same characteristic, by the way, which marred Karajan's reading with the Berlin Philharmonic.

Taken all-round, Mr Maazel's view of the score may well be the correct one and I admit that there are many dark, even stark, moments which come close indeed to ideal Sibelius interpretations. If I still fail to find sufficient bleakness in Maazel's reading of the symphony, I have no criticism at all to offer for Tapiola which I have never heard to greater advantage. The orchestral playing is, of course, very beautiful throughout and the quality of the recording is first-rate. For the present, I imagine, these must be regarded as among the best performances on disc of both works.

* * *

HAYDN: The "Creation" Mass. April Cantelo, Helen Watts, Robert Tear, Forbes Robinson; Choir of St. John's College, Cambridge; Academy of St. Martin-in-the-Fields; directed by Robert Guest. Argo stereo ZRG 598.

This is the final disc in the Argo set of late Haydn Masses. The full title of this one is "Missa Solemnis in B Flat Major" and it is a worthy conclusion to a marvellous series of great eighteenth-century works which have remained almost unknown to modern listeners; this, in part, because they are no longer thought of as church music, yet not truly suited for concert performance.

In this, as in earlier works of this series, particular attention has been lavished on the choir. In size, it is similar to the choirs available to Haydn at Eisenstadt and the singing of the Cambridge group is truly excellent even if, here and there, a little overpowered by the strings. While this apparent unbalance will irritate choral devotees, it seems justified by the fact that the orchestral score in this Mass is exceptionally beautiful, varied and interesting.

In many ways, this Mass may be considered as an instrumental work rather than one for voices; however fine the choral singing (and it is very fine), one's attention focuses on the orchestra. The singing of the soloists, also, is quite excellent though they, in turn, are given few occasions for individual display in this score.

The interest, which musically is very considerable, is amplified by quite excellent sleeve notes which help to explain Haydn's rather surprising use

of the playful opening theme for the Kyrie and other background details. Anyone hearing this work in the context of other Masses of the same period will continue to marvel at Haydn's unflinching inventiveness and feeling for beauty. For the music as such, for the standard of performance and, far from least, the very high quality of the recording, this disc must be hailed as one of this year's three-star occasions.

* * *

SCHUMANN: Symphonies No. 3, Op. 97 ("Rhenish") and No. 4, Op. 120. Vienna Philharmonic Orchestra, conductor Georg Solti. Decca stereo SXL 6356.

It is said that this recording had a rather mixed reception overseas and this rather puzzles me. It is true that Solti is probably not the ideal conductor for Schumann (Kubelik might fit that description best perhaps), but then neither was Boult, the only other conductor to have coupled these two works; as a rule, for the same price, we get only one of the symphonies on one disc, with some filler thrown in. Boult's version, which I heard with restrained enthusiasm, is now over a decade old and sounds it; besides, it used the London Philharmonic, certainly no match for the Viennese players.

Considering the interpretations as such, we must accept the fact that Solti treats Schumann's occasional romantic exuberance with a certain caution and his tempi are decidedly slow in some sections. These drawbacks, if drawbacks they are, are more than outweighed by great delicacy in phrasing and by a meticulous attention to the finest details in the scores. I am satisfied that these points add up to truly first-rate performances, quite apart from the undisputedly fine orchestral playing and excellent recorded sound.

* * *

SCHUMANN: Carnaval, Op. 9; Etudes Symphoniques, Op. 13. Bruno-Lionardo Gelber, piano. HMV Concert Classic stereo SXCP 20108.

As a rule, only reissue items turn up on this low-priced label and I must confess to some puzzlement; this

recording certainly has not been previously issued by EMI and Gelber had appeared on the same label in recent performances of Beethoven concerti. One must assume that, being relatively little known, this artist has agreed to appear on bargain issues and that this need not necessarily reflect on his artistry. This was proved by the outstanding critical success he scored with his Beethoven concerti.

Having carefully listened to this disc, I reluctantly concluded that the low price was indeed justified: however good Gelber may have seemed in Beethoven (discs I have not myself heard), he cannot manage Schumann with any comfort and ease.

Gelber's technique is excellent and he seems to play with considerable assurance, but in his dry interpretations there is hardly a trace of Schumann's poetic romanticism. Not only is he prosaic, but Mr Gelber even fights shy of any real dramatic commitment, as will be noticed at the end of "Carnaval."

On the whole, the 12 Etudes fare better, since here the pianist may with some justice claim preoccupation with technical problems. In many respects, Gelber's playing is exemplary and I've no doubt that aspiring students will find it useful to heed, with his clean touch and neat organisation. But if you really want to know what may be found in these Etudes, you will have to go back to Richter. The recorded sound is clean, good and pleasant.

* * *

STRAUSS: Don Juan Op. 20; Salome: Final Scene. Inge Borkh, soprano; Chicago Symphony Orchestra; conductor Fritz Reiner. RCA Victrola stereo VICS 1392.

The first thing that must be said about this re-issue is that, at the newly reduced Victrola price, it is a remarkable bargain. Reiner's version of "Don Juan" first came my way late in 1964, about a year after the conductor's death, and I found it worthy of praise then, both as a performance and as a quality recording.

Five years later, the recording proves to have lasted well. This is by no means the best of Strauss' tone-poems and it has been the subject of

(Continued on Page 138)

ACOS

REPLACEMENT LONG LIFE CARTRIDGES

Acos 90 Series — a family of pick-up cartridges, covering all the main types needed today, each fitted with Diamond Stylus at no extra cost.

- GP91-1 MONO CRYSTAL Stereo Compatible .. \$5.95
- GP91-2 HIGH OUTPUT MONO CRYSTAL Stereo Compatible .. \$5.95
- GP92 MONO CERAMIC Stereo Compatible .. \$6.55
- GP93 STEREO CRYSTAL .. \$7.55
- GP94-1 STEREO CERAMIC .. \$7.95
- GP94-5 STEREO CERAMIC FOR TRANSISTOR AMPLIFIERS .. \$8.95

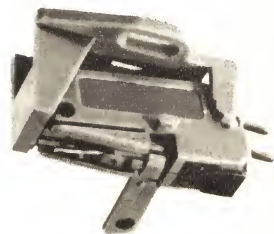

fitted with
DIAMOND
Stylus at no extra cost.

TECHNICAL DATA SHEETS SENT FREE ON REQUEST

Sole Australian Agents:

AMPLION (A'SIA) PTY. LTD.

29 Majors Bay Rd., Concord,
Sydney, N.S.W. Phone 73 1227

With a BSR X3M
'compatible' cartridge,
almost any mono
record playing
equipment can take
stereo records
(without damaging
them)

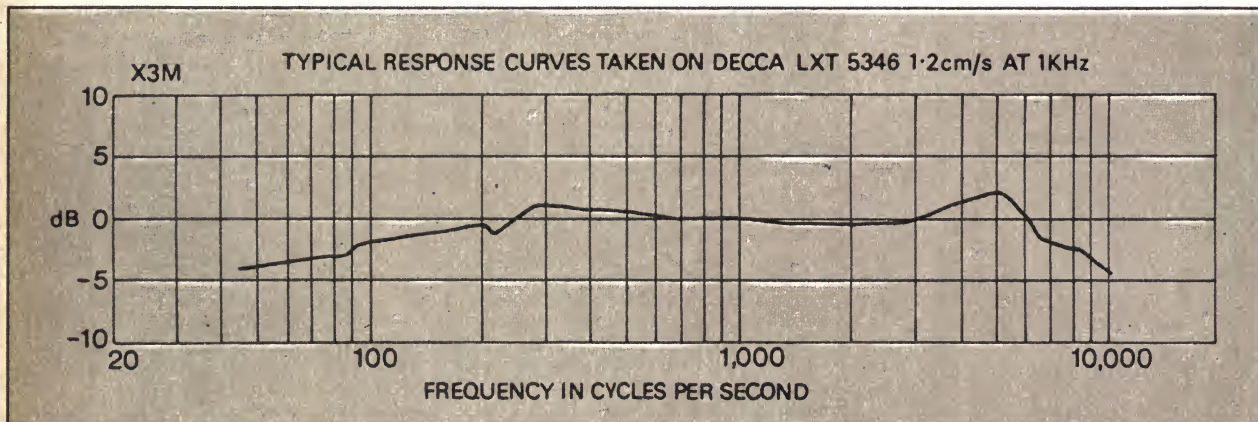
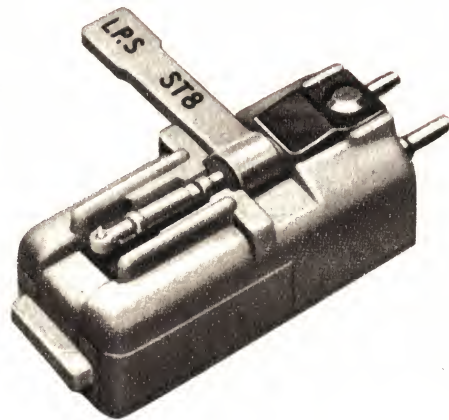

Why compatible cartridges?

An increasing number of record companies are now making stereo LP records only. Until now these records could not be played on a mono player without distortion and damage to the records.

When playing stereo records the stylus tip moves vertically and horizontally following groove contours. Mono records have grooves which only move the stylus horizontally so old mono cartridges will not allow vertical movement of the stylus. Playing stereo records with old mono cartridges will damage the vertical component of the groove irrevocably.

The X3M 'compatible' cartridge, designed and perfected by BSR, is the answer to this problem. For a small outlay it allows you to play both stereo and mono records without harming either. Retail price, \$6.00.

TECHNICAL DATA X3M

Output: 350 mV \pm 2 dB
 1 KHz test record Decca
 LXT 5346 at 1.2 cm/s
 Frequency Response: See typical curves above
 Dynamic Compliance:
 Horizontal 3.0 x 10⁻⁶ cm/dyne (\pm 20%)
 Vertical 1.0 x 10⁻⁶ cm/dyne (\pm 20%)
 Equivalent Capacity: 800 pF
 Nominal
 Recommended Loading: 2 M. ohm 100 pF
 Stylus Pressure: 4-6 grammes
 depending on pick-up arm
 Measuring Temperature: 20° C 68° F
 Colour: Beige



BSR (A/ASIA) PTY. LTD.
SOUTHERN SECTION INDUSTRIAL ESTATE
ST. MARY'S, N.S.W.
PHONE: 623-0375, 623-0376



DISTRIBUTORS:
GOLDRING ENGINEERING (A/ASIA) PTY. LTD.
443 KENT STREET, SYDNEY, N.S.W.
OFFICES IN ALL CAPITAL CITIES.

BSR:P100

Now BSR McDonald Total Turntable



BSR McDonald 600

Every BSR McDonald automatic turntable is precision made in Great Britain to the most exacting specifications. Upon their arrival in Australia, every model is unpacked and re-tested under actual playing conditions. That's why BSR service calls are the lowest in the industry—and perhaps that also explains why BSR sells more turntables than anyone else in the world.

The BSR McDonald 600 encompasses every fine feature one could desire in an automatic turntable.

- Heavy cast, specially balanced turntable.
- Dynamic anti-skate control applies continuously corrected compensation at all groove diameters.
- Cueing and pause control lever allows for exact positioning of stylus on record and permits you to interrupt listening and reposition to same groove.
- Micrometer stylus pressure adjustment permits $\frac{1}{3}$ gram settings from 0 to 6 grams.
- Automatic lock on tone arm after last record is played.
- Dynamically balanced 4-pole induction motor has high torque, constant speed design—assuring minimum rumble and wow.
- Low mass tubular aluminium tone arm perfectly counter-balanced both horizontally and vertically.
- Resiliently mounted, coarse and fine vernier adjustable counter-weight.
- Tone arm is jam-proof even if it is held during the cycling operation.
- Clip-in cartridge holder, provides universal mounting and quick change. (Optional)

BSR McDonald 600—\$114 (with C1/ST4 cartridge).



BSR (A'Asia) Pty. Ltd.,
Southern Section Industrial Estate,
St. Marys, N.S.W.
Phones: 623-0375, 623-0376

Wholesale Distributors

Goldring Engineering (A'Asia) Pty. Ltd.
N.S.W.: 443 Kent Street, Sydney, 29-5802
Vic.: 162 Pelham Street, Carlton, 34-5105,
Qld.: 415 Adelaide Street, Brisbane, 2-3247
W.A.: 32 Northwood Street, Leederville, 8-4988
S.A.: Farley & Fahy Pty. Ltd., 75-77 Wright St.,
Adelaide, 51-5117







Goodmans

The Greatest Range - The Greatest Name

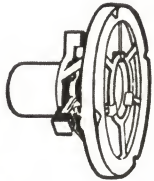
Goodmans High Fidelity loudspeakers meet your every requirement, and Goodmans name is your guarantee of excellence.

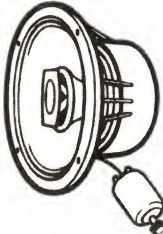
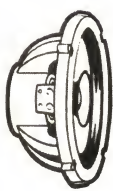
From Goodmans range, you can select your own personalised system - to suit your amplifier output, room size, pocket and ear. Choose, too, the cabinet style you prefer from the range of recommended designs.

Our range of single unit full range High Fidelity speakers is illustrated here - each, when correctly housed, a complete High Fidelity system. Find out all about them. And Goodmans 'Stage-built' and Multiple Speaker systems, using the world-famous Audiom Bass speakers with mid- and high frequency units. And the special Audioms for Public Address work and Musical Instrument amplification.

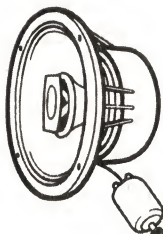
				
AXIETTE 8 8" - 6 watt	AXIOM 80 9½" - 6 watt	AXIOM 201 12" - 15 watt	TRIAxiOM 212C 12" - 15 watt	
				
TWINAXIETTE 8 8" - 6 watt	AXIOM 10 10" - 10 watt	TWINAXIOM 10 10" - 10 watt	AXIOM 301 12" - 20 watt	TRIAxiOM 1220c 12" - 20 watt

All available in 15-16 ohm versions.
watt rating shown is r.m.s. For American rating, double the figure shown.

Goodmans for High Fidelity

For full particulars, write to the Sole Australian Agent:

British Merchandising Pty Limited

Shaw House, 49-51 York Street, Sydney.

Telephone: 29 1571 (3 lines)

relatively few satisfactory performances; Reiner's remains one of the best of them. He dealt with the score lovingly, with great attention to colourful details. There are more exciting readings by other conductors (Ormandy, Mehta, Maazel and Karajan among them), but there is not really a great deal that would make any of these a strong favourite.

As far as the "Salome" scene is concerned, I think listeners will find it wholly adequate. This is not, in my view, great music and far from Strauss' best operatic effort. The hysterics of this scene, musically as much as theatrically, are certainly not everybody's meat and I daresay Miss Borkh has been out-screamed and out-hammered by many another soprano. All the same, she sounds pretty good, as does the orchestra and if the conductor perhaps found it a little distasteful, he did not allow his feelings to show by any skimping of effects.

Allowing for the age of the recording, the sound quality of the disc is really remarkably good and listeners without great hi-fi ambitions will find nothing to complain of. In any event, with both quantity and quality, you couldn't go far wrong at this price!

★ ★ ★

BRITTEN: Songs and Proverbs of William Blake, op. 74; Dietrich Fischer - Dieskau, baritone. The Holy Sonnets of John Donne, op. 35; Peter Pears, tenor. Both cycles accompanied by Benjamin Britten, piano. Decca stereo SXL 6391.

These two song cycles cover a great stretch of Britten's creative activity. The Sonnets date from 1945, the Blake texts were not completed until 1965; the songs of opus 35, though all too rarely heard, had been previously recorded with moderate success and it is a joy to hear them again, still showing Pears as a master of his art, in a very much better version.

The performance, on this occasion, is all anyone could wish for and I find that the spiritual impact of Donne's verses comes through much more powerfully than before. The recorded sound is in keeping with this great occasion, and the recording, if it achieves nothing else, again testifies to Britten's supremacy among current accompanists.

Blake's mysticism has attracted many composers and Britten's interest in Blake's writings comes as no surprise. Any composer who admits to preoccupation with spiritual values and the search after innocence, cannot escape the thrall of Blake's poetry and it seems to me that Britten, in this cycle, gives us the fullest and frankest declaration of his personal values.

The songs are individually preceded by the Proverbs which are used to set the tone and the mood for what follows; the cycle itself moves widely, from anger, through tenderness and compassion back to innocence. Fischer-Dieskau's singing, on this occasion, is beyond the reach of criticism and the near-perfection of his English is matched by the perfection of Britten's pianism. Recording quality is among Decca's best and I am satisfied that even those usually averse to Britten and his musical method and manners must succumb to the patent sincerity and complete commitment evidenced in this music. ■

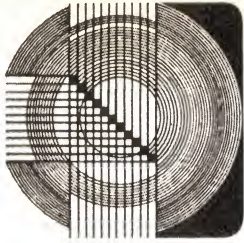

DOCUMENTARY RECORDINGS

APOLLO 11—WE HAVE LANDED ON THE MOON. Produced by Capital Records from official NASA tapes. Narration by Paul Haney. Stereo SENC 9562.

Interest: Historical souvenir.
Performance: Not applicable.
Quality: Poor sound, naturally.
Stereo: Insignificant.

A disc such as this, recalling the greatest adventure so far in the history of mankind, cannot fail to be completely absorbing. Realising this, the producers have allowed the events to unfold with a minimum of narration. During the actual events of the launch of Apollo 11, and the landing, moon walk and take off, the contributions of the narrator are minimal, amounting to an occasional word of explanation. Earlier in the disc, where a few minutes' playing time are devoted to a brief account of some of the events which led up to Apollo 11, the narrator plays his most important role.

As a souvenir of a great achievement, this disc will sell by the million. I am sure it would have sold well as a top price disc, but E.M.I. have issued it under their \$2.50 Encore label, which should ensure its success even further. (H.A.T.)

THE POEMS OF DAME MARY GILMORE, read by Shulamita Rovkin, and with interview with Dame Mary Gilmore. Calendar (Festival) Mono R66/572.

Interest: Great Australian poet.
Performance: Rather lightweight.
Quality: Good.

Whatever disadvantages this disc has, and there are some, it deserves attention as one of very few records of Australian poetry in general, and the work of Dame Mary Gilmore in particular. It also provides a rare opportunity to have on disc some of Dame Mary's own comments on her poems and her recollections of the Australia of her childhood.

The interview with Dame Mary which starts the disc provides a background of the circumstances which gave rise to some of the poems—the lamplighter who married a doctor's daughter, to the scandalisation of the local community, but who confounded the gossip mongers by inheriting an earldom, a story commemorated in "The Countess of X"; her explanation of the poem "Tend to the Grass," that the weakest of things, in sufficient numbers will eventually overcome the strongest, even as the grass will grow back over a path worn by the feet of man when he ceased to go that way; her advice to young poets to seek out and write about the simple things; these and other examples give an insight into the philosophy which Dame Mary brought to her task, and the understanding of which makes the

meaning of her poems so much clearer.

In her reading of the poems, Shulamita Rovkin has some fine moments, and on the whole does very well, providing flashes of interpretive insight and good characterisation, but getting out of her depth in some of the more philosophical and sorrowful poems. In "Eve Song" and elsewhere she sounds rather like a young and earnest school teacher reciting for her class. The excitement of "Boolee, the Bringer of Life" provides more scope for her talents, and she does well here. In "Eternal Chaos and Eternal Law" the deep reflective thought of a lifetime is possibly rather more than she can comfortably handle. One could go through each poem in this way, indicating some readings as entirely satisfying, others lacking in interpretive strength, but to little purpose. At its modest \$2.95 price tag, the disc is well worth having as one of the few recorded examples of the work of a great Australian. (H.A.T.)

LAUGHTER UNLIMITED, Volume 3. Mono. E.M.I. Columbia OSX-7900.

Interest: Comedians, 78 r.p.m. era.
Performance: Still enjoyable.
Quality: Quite acceptable.

Once upon a time, radio stations used to play records by Reginald Dixon, Peter Dawson and Bing Crosby. Now and again, by way of a change, they would play a comedy record. There weren't all that many comedy records and they became very well known. But people didn't mind. They'd wait for the punch lines that they knew off by heart!

You can tell people who lived in those days because they now have grey hair—or no hair at all. You can also pick them out because they still repeat those funny lines to one another—and laugh uproariously, to the puzzlement of their juniors.

"Funny fishes, earls!" Ha, ha, ha.
"I want two dozen danner nipkins," to which the correct reply is: "Danner nipkins, Madam?"
"I took a man to His Majesty's annoyed . . . King's Cross" Ho, ho, ho.
"A fer 'orses" . . . "B for mutton" . . . "I fer Novello" and so on, an array of phrases and a style of humour which coloured the speech and the outlook of a generation.

In this third volume of "Laughter Unlimited," E.M.I. have resurrected an excellent assortment of these 78 r.p.m. recordings. Try your memory on these: Digging H-io-les (Flanagan and Allen)—Double Damask (Cicely Courtneidge)—The Oldest Chorus Boy (Cyril Richard)—The Riddle Scene (Leslie Henson, Fred Emney)—Keeping Up The Old Traditions (Western Bros.)—The Low-down on Hamlet (Bernard Miles)—Gert

and Daisy and the Knothole (Elsie and Doris Waters)—Eels (Jack Warner)—Surrealist Alphabet (Clapham and Dwyer).

By any standards, these were gifted entertainers. Maybe their style will be too dated for the present generation but, if your hair is greying, you'll thoroughly enjoy the experience of meeting them again on this new LP. (W.N.W.)

GREAT MOMENTS IN RADIO.

Jack Benny. Stereo, Festival SFL-933,295. Also in Mono FL-33,295. Interest: Radio, pre-television.

Performance: Bits and pieces.
Quality: Obviously dated.
Stereo: Contributes nothing.

Jack Benny reminisces about the soap operas and the commercials that once characterised American radio. Unless my memory for titles is worse than I think, most of them would be unknown in this country and unlikely to stir nostalgic memories. What makes matters worse is that the sound quality is quite poor by modern standards not due to any fault in Festival processing but simply because early transcriptions were that way.

On side 2 the sound of "The Lone Ranger" is heard briefly but a fairly long segment of "The Shadow" alone demonstrates the fact that old-time radio serials could build suspense.

Undoubtedly the historic highlight of the record is a recording of the broadcast when the dirigible Von Hindenburg crashed in flames at its Lakehurst terminal. But, overall, of only limited interest to Australian listeners. (W.N.W.)

SARABAND RECORD PLAYER



- Synchronous motor, belt drive.
- Heavy non-metal 12" platen.
- 14" arm with anti-skating and viscous bearing damping.
- Magnetic head with patented anti-distortion construction.
- Output 20 watts R.M.S. per channel; auxiliary ins and outs.

SEND TODAY FOR YOUR "SARABAND" BOOKLET

M.B.H. AUDIO SALES,
33 MARLBOROUGH ROAD,
HOMEBUSH, N.S.W. 2140

can you afford to buy anything less than SANSUI?



Illustrated this month: Sansui Model 350 Tuner/Amplifier, 60 watts music power.

Twelve months from now you will have forgotten precisely how much you paid for your Sansui Amplifier. Price will have become irrelevant. The only important factor in your mind will be how satisfied you are — how glad you paid that little bit more for the first class workmanship that has been put into your Sansui.

On the other hand, if you bought something that was a "bargain" and maybe only bought it because it was cheap, you will most likely regret it for ages. Measure it this way: Over a ten year period of enjoyment and complete satisfaction with your amplifier, is it worth jeopardizing all this to save a few dollars?

12 models to choose from

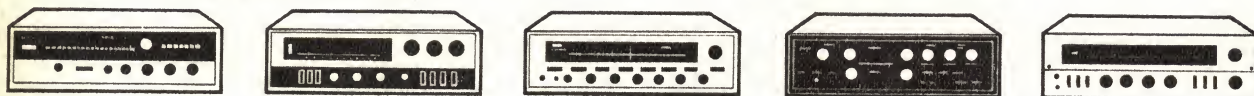

... and appearance wise they look what they are . . . top performance combined with smart styling.

SANSUI

Imported direct from Japan and distributed by Magnecord Sales and Service, 276 Castlereagh St., Sydney 2000. Phone 61 9881.

M1839



VARIETY FAIR

By HARRY TYRER, FORBES CAMERON, NEVILLE WILLIAMS

Devotional recordings

JUST A CLOSER WALK WITH THEE. Ella Fitzgerald with the Ralph Carmichael Choir and Orchestra. Stereo, World Record Club, W.R.C. S/4540.

Interest: Ella's first devotional album.

Performance: Full of appeal.

Quality: Virtually flawless.

Stereo: Normal.

Seeing this album on the display stand, one might be forgiven for assuming that it would be characterised by the heavy mannerisms and emotions often associated with Negro female soloists. But such is not the case.

Under the skilled hand of Ralph Carmichael, the orchestra and chorus present a beautifully blended, gently rhythmic background above which Ella sings, sometimes "straight," sometimes with beautifully judged and characteristic variations. I found the result full of appeal and I doubt that many would react differently.

The generous program contains fourteen numbers: Abide With Me — Just A Closer Walk — The Old Rugged Cross — Brighten The Corner — I Need Thee Every Hour — In The Garden — God Be With You — God Will Take Care Of You — Church In The Wildwood — Throw Out The Lifeline — I Shall Not Be Moved — Let The Lower Lights Be Burning — What A Friend We Have In Jesus — Rock Of Ages.

A highly successful album. Recommended for all age groups. (W.N.W.)

★ ★ ★

THE HAPPY GOSPEL Of The Happy Goodmans. Stereo, Canaan CAS-9644—LP (From Sacred Productions Aust., 181 Clarence Street, Sydney and other capitals).

Interest: Up-tempo "Convention" Gospel.

Performance: Polished.

Quality: Clean sound.

Stereo: Well exploited.

This imported American album comes to hand adorned with a gold "Grammy Award Winner" seal. Listening to it, it is not hard to understand why.

The "Happy Goodmans" are a mature, 5-strong family group—Vestel, a female vocalist, and a male vocal/instrumental quartet. By reason of their varied talents, the group finds no difficulty in presenting a dozen numbers, unified in style and yet with no sense of monotony or repetition.

This is not to say, however, that

their appeal will be universal. With an accent on rhythm, much of the music is in modern up-tempo style, with touches of blues and spiritual, familiar these days on rally and convention platforms. If you're one of the many who have an ear for music in this style, I doubt that you'll hear a better example. The vocal work and instrumental backing are alike excellent.

The titles: Hallelujah — The One Who Died For Me — Pity The Man — The Keys To The Kingdom — Welcome Home — When They Ring The Bells — Great Is The Lord — I See The Light — I'm Willing, Lord — O Come, Angel Band — Saviour, Gently Take Me Home — Joy For Your Soul.

The Happy Goodmans are well named. They look happy and they sound happy. Recommended — provided your tastes are not too formal. (W.N.W.)

★ ★ ★

INSPIRATION. Tammy Wynette. Produced by Billy Sherrill. Compatible stereo, Epic Stereorama (CBS) ELPS-3572.

Interest: Well known songs of faith.

Performance: Very professional.

Quality: Clean, very clean.

Stereo: Good.

Most noticeable quality of Tammy Wynette's voice is a break at the beginning of accented syllables, such that her vocal chords almost seem to "switch on" a split second after the word is breathed. It's not the kind of vocal gimmick that would win an eisteddfod but that is not necessarily synonymous with success. There is no doubt about Tammy Wynette's professional ability, while Billy Sherrill must

get top marks for his appropriate arrangement and backing.

The inspirational songs on the album are mostly well proven favourites: You'll Never Walk Alone — Count Your Blessings Instead Of Sheep — Just A Closer Walk — I Believe — Battle Hymn Of The Republic — How Great Thou Art — He's Got The Whole World In His Hands — It Is No Secret — Crying In The Chapel — He — May The Good Lord Bless And Keep You.

If you know and like Tammy Wynette's style, you'll need no convincing about this album. If you don't know her or have reservations about popular style Gospel, you better listen to a couple of tracks before you buy. It may irk or enchant. (W.N.W.)

★ ★ ★

NO GREATER LOVE. Keum Ja Kim. stereo, Word WST-8454 - LP. (From Sacred Productions Aust., 181 Clarence Street, Sydney and other capitals.)

Interest: Young Korean soloist.

Performance: Promising teenager.

Quality: Good.

Stereo: Not important.

On previous occasions, we have reviewed in these columns albums by the Korean Orphan Choir, a group of children trained and sponsored by World Vision Inc.; children who never fail to charm with their sweet voices and quaint accents.

Keum Ja Kim showed early promise as a child soprano and was featured as a soloist. Now a teenager, with the experience of three tours and some three years' further training in the U.S.A., the one-time little waif is now featured on her own solo album. As Kurt Kaiser observes in the jacket notes, her voice is still maturing but she copes well with the ordeal of having to sing a dozen straight numbers with only solo piano as support.

The hymns: There is No Greater Love—As Refreshing As The Summer Rain—Jesus, The Very Thought Of Thee—When I See My Saviour—In Times Like These—Sweet Hour Of Prayer—Overshadowed—Poor Little Lost Lamb—How Lovely Are Thy Dwellings—When He Cometh—He Brought New Life To Me—Fill My Cup, Lord.

To those who have any of the Korean Choir albums, this album is likely to have an appeal beyond the mere performance. It will have a personal quality, the more so because the titles seem to reflect the emotions of a little orphan girl, given the opportunity to live. (W.N.W.)



W.H.M. WOW & FLUTTER METER

Suitable for tape, disc or film; audio, data or video recorders. Facilitates doppler investigation in loudspeaker systems. Favourably reviewed in the trade press. Available to B.S.I. or D.I.N. standards and for various mains voltages. Fully guaranteed. Price \$180 plus sales tax.

Leroya Industries PTY. LTD.

266 Hay Street, SUBIACO. W. AUST. 6008

SOLE AUSTRALIAN DISTRIBUTORS

TRADE ENQUIRIES ONLY

★ LUSTRE TONE ARMS

★ MICRO CARTRIDGES

See review on Page 119 of February, 1969 Issue, "Electronics Australia."

★ COMPAX AMPLIFIERS

★ LUX AMPLIFIERS

★ PML MICROPHONES

★ LONDON MICROPHONES

★ GRACE TONE ARMS AND CARTRIDGES

★ CELESTION GUITAR SPEAKERS

★ PRL TANGENTIAL FANS

★ MICRO DUST PICKUPS

★ PLANET P.A. AMPLIFIERS

★ SOUND AMPLIFIERS

★ COMPAX TUNERS

★ SONICS SPEAKER SYSTEMS

Trade supplies only available from:

INTERNATIONAL DYNAMICS (AGENCIES) PTY. LTD.

4 Duke St., Abbotsford, Victoria. 3067. Tel. 42 4403

INTERSTATE DISTRIBUTORS. Queensland:

STEREO SUPPLIES
100 Turbot St., Brisbane, Qld. 4000.
Tel.: 21-3623.

South Australia:

CHALLENGE RECORDING CO.

65 Henley Beach Rd., Henley Beach Sth., S.A., 5022. Tel. 56-2585.

MUSIC OF THE JEWISH PEOPLE.

Leo Roth, tenor; Werner Buschnakowski, organ; Leipzig Synagogue Choir and members of the Leipzig Radio Symphony Orchestra conducted by Werner Sander. World Record Club Stereo S/4583.

Interest: Jewish devotionals.
Performance: With feeling.
Quality: Excellent.
Stereo: Normal.

"Traditional music of the home and the synagogue" says a subtitle on the sleeve, and I expected some tracks to be popular songs, similar to those featured in "Music of a People," released by World Record Club some months ago. But no, the contents are almost entirely devotional in character, the texts being mainly from the Bible, or the Jewish prayer book. The items are: W'schomru, concerning the obligatory rest on the Sabbath — Has-

chkiwenu, an evening prayer for protection during the night — Schwufi Nafshi, from Psalm 116 — Kol Nidrei a penitent prayer for the Day of Atonement — K'Wakorasi, concerning the Jewish belief in destiny being based on a psalm verse, a lament on the sufferings of the Jewish race — Tal, a Passover petition — Ani Hadal, a wedding song — Oif'm Pripitschek, a folk song, apparently without religious significance — Ssissu W'ssimchu, from a prayer book text.

Much of the music is remarkably similar in melodic and harmonic treatment to the psalm music of the Christian churches, but is plaintive and tending to sadness, in contrast to the feelings of hope and joy which motivate the Christian communities. It is splendidly performed, as one would expect, but I feel that in general the disc will appeal mainly to those of the Jewish faith (H.A.T.)

Instrumental, Vocal and Humour . . .

OVERTURES OF OLD VIENNA.

The Vienna Philharmonic Orchestra conducted by Willi Boskowsky. Decca (E.M.I.) Stereo SXL 6383.

Interest: See title.
Performance: Superb.
Quality: Excellent.
Stereo: Good spread.

This is the second in what presumably will be a series of discs by Willi Boskowsky, the first, "Dances of Old Vienna," having been reviewed recently. For this new release, Boskowsky has at his command the magnificent Vienna Philharmonic, so the results could hardly fail to be completely satisfactory. The program starts with a sparkling performance of Johann Strauss' overture to "Die Fledermaus" and continues with overtures to: The Merry Wives of Windsor (Nicolai) — Donna Diana (Reznicek) — Prinz Methusalem (Johann Strauss) — Der Opernball (Heuberger). This is all entirely delightful music and the Vienna Philharmonic under Boskowsky provide a champagne performance which cannot fail to please. The Decca engineering is of their typically high standard. (H.A.T.)

★ ★ ★

THE BEST OF THE WORLD'S GREAT MELODIES. Vilem Tausky conducting the Studio 2 Symphony Orchestra. Stereo, Columbia TWO 258.

Interest: Well-known operatic snippets.
Performance: Smooth, round.
Quality: Clean but lacks sparkle.
Stereo: Normal.

How often, says the jacket notes, people are haunted by a melody that they know well but cannot place. For this album Vilem Tausky has selected 10 such melodies which his listeners can enjoy—and identify.

And how well known they are: Prelude to Act 1, Carmen (Bizet)—Habanera, Carmen—Entr'Acte to Act 4, Carmen—Gypsy Song, Carmen—Dance of The Comedians, The Bartered Bride (Smetana) — Pre-

lude to Act 1, La Traviata (Verdi)—Your Tiny Hand Is Frozen, La Boheme (Puccini)—Intermezzo, Cavalleria Rusticana (Mascagni)—Barcarolle, Tales Of Hoffman (Offenbach)—Spanish Dance No. 1 (De Falla).

Those with wide range equipment will note some lack of sparkle and sheen at the top end but the sound is nevertheless very clean and the surface good. Hand-picked for those who like tuneful snippets from the classics. Playing time is just under 40 minutes. (W.N.W.)

★ ★ ★

THE ENJOYMENT OF MUSIC. Various artists and orchestras. His Master's Voice (E.M.I.) Stereo SOELP.9543.

Interest: Classical sampler.
Performance: Top ranking.
Quality: Excellent throughout.
Stereo: Normal.

Full marks must go to E.M.I. for this extremely skilful piece of sales promotion. For the company, it provides an opportunity to bring some very fine discs before the public notice; for the record buyer, it offers an opportunity to obtain performances by some of the world's outstanding artists, in recent performances, for \$2.50. The stated object of the disc is to broaden the musical horizons of people with limited knowledge of the classics, and in this it succeeds extremely well, as it ranges from the baroque of Bach to the modern, but entirely melodic, style of Carl Orff and Gustav Mahler; from the solemnities of Beethoven's third symphony to the light hearted "Vilja" from Lehar's "Merry Widow." There are 11 tracks in all, each of substantial duration, and there is not space to list them all, with their artists.

However, I will mention some of the tracks which particularly appealed to me: Top of the list is the finest performance I have yet heard of Liszt's "La Campanella" by the English pianist John Ogden; Janet Baker's performance with the Halle Orchestra/Barbirolli of "Ging Heut' Morgen" from Mahler's

"Songs of a Wayfarer" should prove an eye-opener for those who have not discovered the delights awaiting them in this composer's output; and Elisabeth Schwarzkopf's "Vilja" from her recording of "Merry Widow" is as near perfection as I ever expect to hear. Take my advice and buy this disc — you will not regret it. (H.A.T.)

★ ★ ★

THE WORLD OF JOHANN STRAUSS. The Vienna Philharmonic Orchestra conducted by Willi Boskowsky. Decca (E.M.I.) Stereo SPA 10.

Interest: Strauss melodies.
Performance: Ideal.
Quality: Very good.
Stereo: Normal.

As this disc sports a \$2.50 price tag, I assume it is a reissue from the Decca catalogue, although the sound quality is good enough to place it as fairly recent vintage. Personally, I can think of no better combination than this to play the music of Johann Strauss. Boskowsky is a specialist in the music of his native Vienna, and has under his baton one of the world's finest orchestras whose members must surely know more about the way to play this music than any other group. The program is a very pleasing one: Blue Danube—Pizzicato Polka—Roses from the South — The Hunt—Thousand and One Nights — Tales from the Vienna Woods — Egyptian March—Vienna Blood—Perpetuum Mobile — Voices of Spring. I was particularly pleased to find that the waltzes were played complete with preludes and postludes, instead of the truncated versions often found in performances of this type. A first rate bargain. (H.A.T.)

Excellent value

SOUTH PACIFIC. Rogers and Hammerstein II. Louie Ramsey, Charles West, Isabel Lucas, Brian Davies, Sharon Sefton, Stephen Ayres, The Mike Sammes Singers. Compatible Stereo, Music For Pleasure. MFP-A-8071.

Interest: Popular musical.
Performance: Plenty of vim.
Quality: Clean.
Stereo: Well spread.

Without as much as looking at the jacket, it was apparent from the first track that this was one from the Mike Sammes Singers in good form. The sound is forward and clean and the performance itself full of zest — yet very well disciplined.

Set on a Pacific island during World War II, the show has a flimsy story line but a procession of tunes that have had plenty of airing since they were first heard in 1947.

On this album you hear: Dites-Moi — A Cockeyed Optimist—Some Enchanted Evening—Bloody Mary—There Is Nothing Like A Dame—Bali-Ha'i— I'm Gonna Wash That Man Right Outa My Hair—In Love With A Wonderful Guy—Younger Than Springtime —Happy Talk—Honey Bun—This Nearly Was Mine.

If you don't already have a South Pacific album in your collection this one at the MFP price is well worth grabbing. (W.N.W.)

ALL TURNTABLES ARE NOT CREATED EQUAL!

There are a few outstanding versions which have fired the enthusiasm of the Hi-Fi Buffs.

For those who appreciate fine precision workmanship



The Thorens TD150/TD150A — 2-speed, anti-magnetic 7½lb turntable, double synchronous motor.

A good turntable deserves a good arm!



Thorens TP14 with ultra light shell. Ballbearing horizontal and vertical plane with anti-skate.

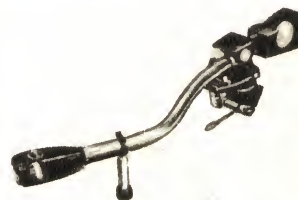

Ortofon RS-212 precision built to the highest standards, with built-in anti-skate and "Hi-Jack" as standard accessories.



The NEW **Silcron** turntable does away with rumble—one of the headaches of normal 2 speed turntables. (Shown here with the Ortofon RS-212 tonearm.)

To Mastersound Sales, 400 Kent St. Sydney 2000 N.S.W. Please send post free:

----- NEW SILCRON Turntable/s at \$44.00

I enclose cheque / P.N. value \$ -----
(Do not send postage stamps)

NAME -----

ADDRESS -----

MASTERSOUND SALES PTY. LIMITED
400 KENT STREET,
SYDNEY. 29-1527

brand five

magnetic recording tape

DISCOUNT PRICES!

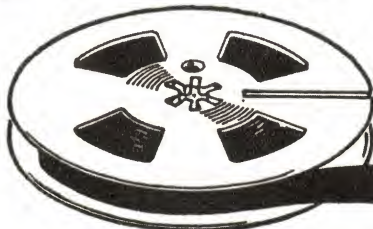

AUSTRALIA'S BEST VALUE!

from

DIRECT TAPE DISTRIBUTORS

OUR PRICE

"BRAND 5"—unconditionally guaranteed and manufactured to highest USA professional standards. It's sensationally priced at half that of comparable tapes.

"BRAND 5" has high remanence iron oxide emulsion coated to highest grade Acetate or Mylar base material.

"BRAND 5" ensures unmatched results in high fidelity mono and stereo recordings, with certain protection against head wear, squeal and gumming of heads.

LENGTH	TYPE No.	DESCRIPTION & MIL. THICKNESS	NORMAL PRICE	OUR PRICE	
7" REELS					
1200'	15D7	1.5 ACETATE	6.60	3.00	
1800'	10D7	1.0 ACETATE	7.25	3.25	
1800'	10D7M	1.0 MYLAR	9.15	3.99	
2400'	5D7M	.5 MYLAR	10.40	4.75	
2400'	5D7MT	.5 TENSIL MYLAR	11.90	5.25	
3600'	5D7MS	.33 MYLAR	13.20	6.75	
5 1/2" REELS					
1200'	10D57	1.0 ACETATE	5.50	2.55	
1200'	10D57M	1.0 MYLAR	6.00	2.95	
1800'	5D57M	.5 MYLAR	8.90	3.75	
5" REELS					
600'	15D5	1.5 ACETATE	3.40	1.80	
900'	10D5	1.0 ACETATE	4.15	1.98	
900'	10D5M	1.0 MYLAR	5.32	2.25	
1200'	5D5M	.5 MYLAR	6.95	2.50	
1200'	5D5MT	.5 TENSIL MYLAR	8.70	2.75	
1800'	5D5MS	.33 MYLAR	9.60	3.75	
CORRESPONDENCE TAPES					
3 1/2" REELS					
900'	3D32MS	.33 MYLAR	3.90	1.95	
3" REELS					
150'	15D3	1.5 ACETATE	.95	.50	
225'	10D3	1.0 ACETATE	1.20	.65	
225'	10D3M	1.0 MYLAR	1.65	.70	
300'	5D3M	.5 MYLAR	1.95	.85	
600'	3D3MS	.33 MYLAR	3.30	1.60	
CASSETTES			C30	3.10	1.55
			C60	3.50	1.65
			C90	4.75	2.65

SAVE over

50%

SEND THIS COUPON WITH YOUR ORDER TODAY!



DIRECT TAPE DISTRIBUTORS

BOX 3040, G.P.O. SYDNEY, N.S.W. 2001

Please send me BRAND 5 Tape/s as per attached list.

I enclose \$..... covering purchase price

PLUS Postage and Packing @ 10 cents per reel.

Any surplus postage will be refunded.

D/E2

NAME.....

ADDRESS.....

STATE..... CODE.....

JOHANN STRAUSS' GREATEST HITS. The Philadelphia Orchestra conducted by Eugene Ormandy. Stereo, CBS, SBR-235324.

Interest: As per title.
Performance: Vigorous.
Quality: Good.
Stereo: Normal.

To listen to this record is one thing. To find anything original to say about it is quite another. The standing of the Philadelphia Orchestra is not to be questioned nor is the reputation of its conductor, Eugene Ormandy. And who can gainsay that these are Johann Strauss' greatest hits: The Blue Danube Waltz—Tritsch-Tratsch Polka—Tales From the Vienna Woods—Voices Of Spring—Pizzicato Polka—The Emperor Waltz.

Critical ears might rate the quality as a trifle coarse and might note a trace of rumble on the inner tracks of side but, in the average listening situation, it will sound exactly as intended: sound of symphonic proportions and music that seems timeless in its appeal. (W.N.W.) ★ ★ ★

EIGHTEEN HIT MOVIE THEMES. —Various Artists United Artists (Festival) Stereo SUAL 932.969 (also in Mono).

Interest: As above.
Performance: Reasonable selection.
Quality: Well recorded.
Stereo: Normal separation.

This LP contains eighteen themes from recent popular films, played by a variety of orchestras and artists.

They, for example, include successful songs like "Goldfinger" (Count Basie); "A Man and a Woman" and "Live for Life" (Francis Lai); "In the Heat of the Night" (Buddy Morrow); "What's new Pussycat" (Henry Jerome); "The Good, the Bad and the Ugly" (Ennio Morricone); "Thunderball" and "You only live Twice" (John Barry).

On the assumption that there is a ready market in Australia for this kind of album, this would appear to represent very good value. The quality of the musicianship is pretty high throughout and most of the themes are reasonably interesting.

Modern Bach

PLAY BACH AUX CHAMPS-ELYSEES. London Globe (E.M.I.) Stereo. Two disc set in double folded sleeve. SLB 1035/6.

Interest: "Modern" Bach.
Performance: Skillfully executed.
Quality: Very good.
Stereo: Normal.

The Play Bach group, comprising Jacques Loussier on piano, Pierre Michelot on bass, and Christian Garros on drums, must be very well known in Australia, following five previous releases on L.P. and a personal tour here recently. However, for the benefit of those who are not familiar with the work of the group, I will explain that they attempt to present the music of Bach in a "modern interpretation." This may be taken to mean that their performances contain elements of a modern progressive jazz style, although the original Bach baroque style is always present.

This particular set was recorded during a live performance at the Theatre Champs Elysee in Paris, and is presented complete with tuning up

In-addition, the album plays for no less than 51 minutes without any diminution in the recording quality. Why, I wonder, do we have to put up with 12in L.P.s which play for under 40 minutes? (T.F.C.).

★ ★ ★
THE WINDMILLS OF YOUR MIND. Billy Vaughn. Stereo, Dot (Festival) SZL-933.365. Also in Mono ZL-33.365.

Interest: Billy Vaughn "with it."
Performance: The Vaughn touch.
Quality: Clean.
Stereo: Normal.

If you're a Billy Vaughn fan from some time back, you'll wonder what's happened to that lilting melodic sax, at least for the first half-dozen numbers. But Billy, it appears, has cocked an ear recently to the charts and whooped things up a bit, even though the sounds remains unmistakably Vaughn.

His selections: The Windmills Of Your Mind—Traci's Tracks—Help Yourself—Time Of The Season—Traces—Wichita Lineman—Promises, Promises—Soulful Strut—The Way That I Live—Glad She's A Woman—Heaven—You Gave Me A Mountain.

My tip is that parents will prefer Vaughn as he was—the kids, Vaughn as he is. Playing time is just over 30 minutes. (W.N.W.).

★ ★ ★
THOROUGHLY MODERN MILLIE. Original sound track album, with Julie Andrews and Carol Channing. Calendar (Festival) Stereo SR66-9628.

Interest: Soundtrack music.
Performance: Definitive.
Quality: Excellent.
Stereo: Good spread.

The release of this original film soundtrack disc on the Calendar label at this time is a shrewd move by Festival, since they have almost certainly sold as many discs of the full price first release by now, yet the film is still fresh enough in the minds of most people to make a release on an economy label attractive. Of all the discs containing this engaging music,

session and audience applause. The program comprises: Prelude No. 1 (from the "Well Tempered Clavier" set) —Italian Concerto —Partita in E minor — Invention No. 5 — Prelude No. 2 — Chorale "Sleepers Awake" — Prelude No. 12 — Concerto in D minor. This is a very ambitious program indeed for such a treatment — the three major works requiring 14 minutes, 20 minutes and 17 minutes respectively. However, the audience apparently appreciated it and show their enthusiasm by clapping at every break, even in one place in the middle of a movement.

For established Play Bach fans, the set can be safely recommended, since the recording is of good quality. Those who are just becoming interested in the group would do better to consider one of the earlier Play Bach recordings, the contents of which are less adventurous and the renderings less experimental (in the current set, the bass dominates the melodic line for five minutes at a time in some places). (H.A.T.)

Regulated Power Supply
BATTERY ELIMINATOR

SPECIALLY FOR LARGER BATTERY OPERATED TAPE RECORDERS



TYPE PS104

Designed primarily for Tape Recorders where a regulated voltage supply is necessary to prevent speed variation with load changes. A versatile power supply with a range of output voltages making it ideal for design, testing and repair of Transistor Radios, Amplifiers, Record Players, Test Equipment, etc. It is also eminently suitable for use in Schools, Universities, Government Departments and Industry.

SPECIFICATIONS

Input Voltage	240 Volts, 50 Hz
Output Voltage	4.5V 6V 7.5V 9V or 12V D.C. by Selector plug. Max. Current 0.5A
Protection Regulation	Electronic Overload Protection. Approx. 10% on 12V Range. Approx. 5% on all other Ranges
Ripple	Less than 100 mV R.M.S. under all conditions.
Circuitry	All silicon solid state.
Size	4 ins. wide by 2 1/2 ins. high x 5 1/2 ins. deep
Weight	2 lbs. 7 ozs.
Approval	Approved by Electric Supply Authorities

Manufactured by

A. & R. ELECTRONIC EQUIPMENT

COMPANY PTY. LTD.,

42-46 LEXTON ROAD,
BOX HILL, VIC., 3128.

Phones 89-0238, 89-0239.

AGENTS IN ALL STATES

- N.S.W. SOANAR ELECTRONICS PTY. LTD.
82 Carlton Cres., Summer Hill. Ph. 798-6999.
- QLD. R. A. VENN PTY. LTD.
71-73 Doggett St., Valley, Bris. Ph. 51-5421.
- S.A. SCOTT THOMPSON PTY. LTD.
93 Gilles St., Adelaide. Phone 23-2261.
- W.A. EVERETT AGENCY PTY. LTD.
17 Northwood St. W. Leederville. Ph. 8-4137.

SONY[®] FROM MELBOURNE'S

LEADING TAPE RECORDER SPECIALIST



SONY . . . TC 560. New E.S.P. auto reverse stereo tape recorder

- The Sony E.S.P. (Electronic Sensory Perceptor) completely automatic tape reversing system with newly developed three heads and two capstans.
- Functions as a "stereo music centre."
- Lid-integrated high-compliance roll-edge speakers.
- Servo-controlled tape transport.
- AC/DC 2-way operation either in vertical or horizontal position.
- Single-lever control for easy operation.
- Retractable pinch roller for simple tape threading.
- Extremely compact in a beautiful leatherette covered wooden cabinet.
- Noise suppressor.
- 4 track.
- 3 speeds.
- 20-21,000 HZ at 7½ IPS.
- Wow & Flutter 0.15 at 7½ IPS.
- Power output 10 watts RMS (20 watts music power).
- Separate bass and treble controls.
- Magnetic pickup input.

Scoop purchase of this latest 1969 superb Sony, model TC 560, brings the price down to nearly half.

Check our amazingly low prices on the entire range of Sony.

DOUGLAS TRADING P/L

Inc. City Hi Fi — Tape Recorders (Vic.) — BJD Electronics

191 BOURKE STREET, MELBOURNE 3000—PHONE 63-9321

this one must be regarded as the definitive one, and of course it has the delectable Julie Andrews herself in the title part.

Taken purely as entertainment, it does suffer in some measure from the need to make repeats to go the full distance of an LP (the title piece is played four times). However, on the whole, the disc should prove attractive as a \$2.95 release of a still popular selection:

The tracks include three performances by Miss Andrews of the theme song, plus an orchestral version; a medley of songs of the twenties; and the feature songs: Jimmy — The Tapioca — Jazz Baby — Jewish Wedding Song — Poor Butterfly, and so on. If you liked the film, you will like the disc. (H.A.T.)



OUT PATIENTS

TWENTY-ONE TROMBONES—Urbie Green. Project 3 (Festival) Stereo SPJL 933,046 (also in Mono).

Interest: Mainly for trombonists.
Performance: Weak material.
Quality: Superbly recorded.
Stereo: Good separation and balance.

When I reviewed the first 21 Trombones album (SPJL 932,775), I said that "the thought of no less than 21 trombonists playing together is a little daunting . . . but the album turns out surprisingly well."

This second L.P. is not quite as appealing, mainly because of unsatisfactory material. On the first, ballads predominated but the tunes here are rather more rocky and less suited to the lush, smooth sound of the trombones. The best tracks, indeed, are Ellington's "Mood Indigo" and Harold Arlen's "I Gotta Right to Sing the Blues," while Bobby Hebb's tune "Sunny" is very well orchestrated.

The musicianship is again impeccable and Urbie Green takes several polished and technically superb solos. The arrangements by Lew Davies make the most of the limited sound. But for all that, I doubt if the album will find wide appeal. The playing-time of 30 minutes for a \$5.75 issue is also of no help. (T.F.C.)

FOR PETE'S SAKE — Pete Fountain. Coral Records (Festival) Stereo SCL 933,088 (also in Mono).

Interest: Mainly for Fountain followers.
Performance: Competent.
Quality: Well recorded.
Stereo: Normal separation.

Despite the "Bourbon Street" publicity which surrounds the New Orleans clarinetist, Pete Fountain, he is not a jazz musician of any real substance. His playing has been influenced by Benny Goodman and it has much in common with Acker Bilk on his more commercial recordings.

But he is a very accomplished technician and his popularity all over the world cannot be disputed. On this album, the latest in a flood of Pete Fountain L.P.s to be released on the Australian market, he is featured mainly with his regular small group.

The tracks vary from jazz standards like "Bill Bailey" and "High Society" to popular favourites like "My Blue Heaven" and "You're Nobody 'Til Somebody Loves You." The album also includes a very Bilkish "Stranger on the Shore" and a quintet version of "Lady Be Good" on which Fountain's playing

"Hepworth—come and dig this crazy beat!"—"TV Times")

is reminiscent of Benny Goodman. The album, which plays for 38 minutes, is well produced and the music is very professionally played, if slightly on the dull side. It will, doubtless, appeal strongly to Pete Fountain's many admirers. (T.F.C.)

THIS MAGIC MOMENT. Earl Grant. U.S.A. Decca (Festival) Stereo SDL-933,400. Available in Mono.
Interest: Organ and piano.
Performance: Superb style.
Quality: Excellent.
Stereo: Normal.

Despite the limited opportunities the gramophone record offers for him to display his wide range of talents, Earl Grant is still able to provide a high level of entertainment—or else why should his discs consistently sell by the million. This latest issue has all the hallmarks of this experienced entertainer—first and foremost his exquisite handling of his own organ and piano solos, plus the topline team of supporting instrumentalists and arrangers which lift his discs way above average. The program here comprises: The Dock of the Bay—The Sound of Silence—The Importance of the Rose—Michelle—Let It Be Me—Turn Around, Look at Me—This Magic Moment—Theme, "Valley of the Dolls"—This Guy's In Love With You—My Special Angel—Love is Blue. Some of these numbers are tending to date now, which makes one suspect that this disc is possibly a little late being released in Australia. (H.A.T.)

ENTERTAINMENT GREATS—16 World Famous Artists. Calendar (Festival) Mono R66-605.

Interest: Variety of music.
Performance: One good side.
Quality: Mainly acceptable.

This is a remarkably varied collection of tracks ranging from the Andrews Sisters' "Rum and Coca-Cola" and the Ink Spots' "To Each His Own" at one extreme; to Liberace's "Moon River" and Wayne King's "They Say it's Wonderful" at the other. Indeed, it is difficult to comprehend such a diversified musical taste.

Side one of the album is by far the more interesting. Apart from the Andrews Sisters and Ink Spots' tracks, it includes the late Judy Garland's "Meet Me in St. Louis," Nat Cole's "Sweet Lorraine" and the Mills

"INNERBOND"
(Regd.)
BONDED ACETATE FIBRES
FOR PACKING IN
SPEAKER ENCLOSURES

A new resilient Bonded Wadding made from ultra fine Cellulose Acetate Fibres that gives high efficiency for Sound Absorption.

"INNERBOND" is light, clean, dust-free and easy to handle. Because all the fibres are bonded "INNERBOND" will hang as a "curtain" and will not fracture or break down due to vibration.

"INNERBOND" is odourless, highly resistant to attack by bacteria or fungus and is vermin repellent; "INNERBOND" at 16oz sq. yd. has a normal thickness of 1" and at this density is recommended as a packing in Speaker Enclosures for Sound Absorption.

- STOCKISTS:**
SYDNEY: Arrow Electronics Pty. Ltd. 342 Kent St.; Broadway Electronics (Sales) Pty. Ltd., 32 Gieble Point Rd.; G.R.B.E. Convoy International Pty. Ltd., 449 Kent St.; Ence Electronics Pty. Ltd., 257 Clarence St.; Kent Hi-Fi 432 Kent St.; Mastersound Sales Pty. Ltd., 400 Kent St.; Radio Despatch Service, 869 George St.; Peter Shalley Electronics Pty. Ltd., 127 York St.; Stereo Music Systems, 193 Clarence St.; Circuit Components (A/s/a) Pty. Ltd., 460 Bexley Rd., BEXLEY; Classic Radio, 245 Parramatta Rd., HARBURFIELD; Dyna Stereo Pty. Ltd., 331 Prince's Hwy, ST. PETERS; Albert Wright Radio Service, 795 New Canterbury Road, HURLSTONE PARK; H. B. Radio Products, 103-105 Catherine St., LEICHHARDT.
NEWCASTLE: Martin de Launay Pty. Ltd., King and Darby Streets; Dynamic Sound, 587 Hunter Street.
WOLLONGONG: Electron Parts Pty. Ltd., 82 Kelra Street; Martin de Launay Pty. Ltd., 270 Kelra Street.
MELBOURNE: J. H. Magrath and Co. Pty. Ltd., 208 Little Lonsdale Street.
BRISBANE: A. E. Harrold Pty. Ltd., 123 Charlotte Street; Brisbane Agencies, 78 Wickham Street, Fortitude Valley.
IPSWICH: Robert N. Smallwood, 205 Brisbane Road, Booval.
NORTH QUEENSLAND: Alvin Communications and Electronics, 38 Peggall St., Pimlico, Townsville.
ADELAIDE: Duncan Agencies, 57 Woodville Road, Woodville; General Accessories, 81 Flinders Street; Trustcott Electronics, 62-64 Hindmarsh Square.
PERTH: Atkins (W.A.) Ltd., 894 Hay Street; Carlyle and Co. Pty. Ltd., 1 Milligan Street; General Accessories, 46 Milligan Street.
HOBART: Homecrafts-Tasmania, 199 Collins Street.
If unobtainable
For 1 sq. yd. as above send \$2.00
For 2 sq. yds. as above send \$3.75
For 4 sq. yds. as above send \$6.50
Postage paid in Australia and Territories to the manufacturers.
WONDER WOOL PTY. LTD.
87 JAMES STREET, LEICHHARDT. N.S.W., 2040.
Box 548 — G.P.O., Sydney. 2001.
Phone: 56-2780.

LITTLE SHORT OF REVOLUTIONARY

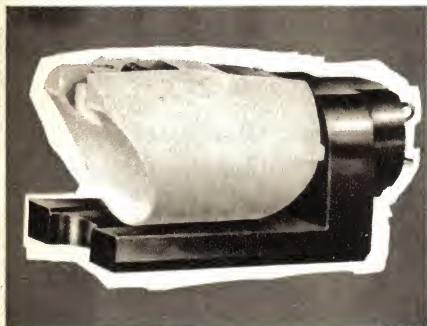

DECCA Deram

MICROGROOVE "CERAMIC" CARTRIDGE
fitted with diamond stylus
for stereo or mono microgroove records

Micrographs of a groove recorded with a 10 KHz signal taken from three copies of a Decca stereo frequency test record SXL 2057.

UNPLAYED MICROGROOVE



AFTER ONLY 1 PLAYING
with a good, average-priced
cartridge. Arrows show damage

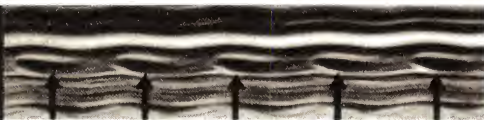

NO DAMAGE AFTER 250
PLAYINGS with Decca Deram.



THE DECCA DERAM DOES LESS DAMAGE AFTER 250 PLAYINGS THAN THE AVERAGE CARTRIDGE DOES AFTER ONLY ONE

The Decca Deram has a tip mass of 0.6 milligramme; its compliance is 9×10^{-9} cms/dyne (lateral) and 5×10^{-9} cms/dyne (vertical); tracking weight 2.5 gms.; frequency response ± 3 dBs 18Hz to 18KHz. Output 50MV/CM/Sec.

Retail Price
\$12.60

Sole Australian Agent:

BRITISH MERCHANDISING PTY. LTD.

Shaw House 49-51 York St., Sydney, N.S.W. Telephones 29.1571 (3 lines)

Brothers' "You Always Hurt the One You Love." Side 2, on the other hand, is frankly mediocre with dull tracks by artists like Mitch Miller, Grady Martin and Carmen Cavallaro.

Whether this L.P. is worth the Calendar price of \$2.95 depends very much on how much duplication is involved and individual reactions to the remarkable variety of music which is covered. The playing-time is 44 minutes. (T.F.C.)

★ ★ ★
WHAT A WONDERFUL WORLD.

Harold Smart at the Thomas organ. Stereo, Festival SFL-933,231. Also in Mono FL-33,231.

Interest: Three-manual Thomas.

Performance: Dexterous.

Quality: Normal.

Stereo—Fully exploited.

Featured here is the big Thomas entertainment organ, with horseshoe console, three manuals, full pedal keyboard and, presumably, full percussion facilities. The soloist is Harold Smart, a stage, radio and TV performer, who certainly has all the digital dexterity needed to put the organ through its paces.

On the eleven tracks he presents a medley of some twenty-six titles, too numerous to mention, but including a lot of well-known show tunes and other hits, "for dancing and easy listening."

For those who like to study voicings, a couple of loose sheets accompany the record indicating the tabs used and their distribution to the two stereo channels.

All this will doubtless interest keyboard technicians of the popular organ but I have my doubts about those who are more interested in "easy listening." Against a relentless percussion beat, the sound is busy—at times almost frantic—plainly electronic and entirely reliant on artificial sustain and reverberation.

Perhaps the truth is that it's just not my kind of organ music. (W.N.W.)

★ ★ ★

ROMANTIC GUITAR. Mario Parodi, guitar. Festival Stereo SFL-932,-883.

Interest: Classical guitar.

Performance: World class.

Quality: Excellent.

Stereo: Not significant.

Mario Parodi must rank with the world's great experts in the techniques of guitar playing, but in addition he is an artist in the full sense of the word. In this recital, recorded in Argentina, he presents a very pleasing program of works: Liebestraum (Liszt)—Prophet Bird (Schumann)—Waltzes, Nos. 9 in A Flat, 14 in E minor, 7 in C sharp minor (Chopin)—Malaguena from "España" (Albeniz)—Study in Blue and White (Parodi)—Claire de Lune (Debussy)—Fur Elise (Beethoven)—Allegro Comodo (Parodi)—Cradle Song (Brahms). While this selection has obvious appeal to those who favour the lighter classics, it will be regarded as a must for anybody with an interest in classical guitar playing. The only item in the whole recital with which I did not wholeheartedly approve was the Debussy piece, written for piano, which I regard as impossible to transcribe for any other instrument because of the need to preserve the exact nuances of tone and delicacy of touch of the original. Technically, the disc is excellent. (H.A.T.)

For the most **critical** listener—

SONY® TC-630



3 heads, 3 speeds — Magnificent Sound Reproduction

FEATURES

■ Versatility—functions independently as a tape recorder, amplifier and deck ■ 3 heads—recording, playback and erasing ■ Complete stereo music control centre with multiple inputs for phono, tuner, microphone and auxiliary ■ 40 watt total power output, both channels (20 + 20) ■ High precision solid state circuitry ■ 160 kHz—high bias frequency ■ Echo effect recording and sound-on-sound recording ■ Two easy-to-read VU meters, noise suppressor ■ 4 digits tape counter with reset button ■ Sliding-type recording volume control, recording button for each channel ■ Automatic shut-off switch, self-release instant stop ■ Two lid speakers, and jacks for external speakers—speaker switch for P.A. ■ Two headphone jacks: fixed and variable sound level monitoring ■ Flexibility of vertical or horizontal operation ■ Compact in size and professional in performance.

SPECIFICATIONS

Recording systems: 4 track stereo/mono recording playback

Reel capacity: 7" or smaller

Frequency response: 30-22,000 Hz at $7\frac{1}{2}$ ips
30-13,000 Hz at $3\frac{3}{4}$ ips
30-10,000 Hz at $1\frac{7}{8}$ ips

Bias frequency: 160 kHz

Flutter and wow: 0.009% at $7\frac{1}{2}$ ips
0.12% at $3\frac{3}{4}$ ips
0.16% at $1\frac{7}{8}$ ips

Power output: 15 watts RMS per channel

Signal to noise ratio: 50dB

Dimensions: $17\frac{7}{8}$ " x 20" x $11\frac{5}{8}$ "

Weight: 46 lbs. 3 oz.

SONY®

Distributed by:

jacoby, mitchell & co. pty. ltd.

SYDNEY • MELBOURNE • BRISBANE • ADELAIDE

To: Jacoby, Mitchell & Co. Pty. Ltd., 469-475 Kent St., Sydney, 2000.
Please send me information on Sony Tape Recorders and nearest Sony retailer.

NAME

ADDRESS

JMS/6-69 EA1169

Tony Fenelon again

TONY. Featuring Tony Fenelon at the Dendy Wurlitzer Organ. Stereo, Festival SFL-933,500. Also in Mono FL-33,500.

Interest: Fine organ recital.
Performance: Outstanding.
Quality: Full, round.
Stereo: Adds dimension.

Some years ago I recall having reviewed the recording of a farewell performance by Horace Weber on the big Wurlitzer in Melbourne's Capitol Theatre. Plagued by mechanical troubles after a long period of idleness and in an environment that seemed to absorb all the sparkle from the sound, the performance was in sorry contrast to the occasion, 40 years previously, when the same organist first introduced the instrument to Melbourne theatregoers.

It is hard to believe that this is the same instrument, now owned by the Theatre Organ Society of Australia and re-installed in the Dendy theatre. Or is it the same—after society mem-

bers have spent countless man-hours re-building, re-wiring and re-installing the instrument, ready for the final professional attention of Messrs. Hill, Norman and Beard Ltd.

And here it is, sounding on record as smooth, round and responsive as any Wurlitzer I have ever heard, in the capable hands of that very talented young Australian organist, Tony Fenelon.

The program, in traditional theatre style: Mrs Robinson—Spanish Eyes—Sabre Dance—Theme From "The Big Country"—Quando, Quando—Unchained Melody—El Cumbanchero—Yesterday—Flapperette—When I'm Sixty-Four—Boom Bang A Bang—What Kind Of Fool Am I!

It is evident from the start and finish of each track that noise ambience in the theatre is fairly high but the actual music stays well above it, the sound itself is excellent in distribution and balance. Another "must" for Wurlitzer organ enthusiasts. (W.N.W.)

FOLLOW. Nina and Frederick. Columbia (E.M.I.) Stereo SCXO 6311.

Interest: Modern folk music.
Performance: A little tedious.
Quality: Good standard.
Stereo: Normal.

Nina and Frederick fans have been used to hearing them sing standard folk songs from the established repertoire. This disc is quite different. In the first place, the material has all been composed by Frederick, and a lot of it is very off-beat material, couched in the seemingly meaningless language used by many contemporary folk singers. The first song, called "The Zodiac," is an allegory based on the 12 astrological houses. The second is a very long song, in four parts, but sung without pause, although I cannot detect any thread of continuity in the sections. The sections are called: Now is All—Just Like a Rose—Finding Amber—Why Pain How Love. The first two are love songs couched in extravagant language, the third is a meditation on death and the last contrasts the nasty side of life brought about by mankind with the natural joys which abound. This should give a fair idea of what the disc is all about—the rest of it is pretty much the same.

On first hearing, I thought it all rather mediocre stuff, but this impression may change with further hearing. It is largely rescued by the sweet, warm voice of Nina, who, although she appears to be taking the lesser role, in fact tends to dominate the vocals without effort. A disc which you should try to hear before buying, I think. (H.A.T.).

★ ★ ★
THE WARM ROMANTIC VOICE OF FRANCOISE HARDY. Disques Vogue (Festival) Stereo SVL-933,201. Available in Mono.

Interest: French singing star.
Performance: Appealing.
Quality: High standard.
Stereo: Good spread.

An excellent Disque Vogue recording of the talented and popular Francoise Hardy, the third to be released by Festival within a few weeks. I have already indicated my appreciation of

the songs anyway—young love. She sings of the day when Mr Right will come along, of the little heart which beats for one person alone, of the love that is no more—in fact, very much the same as young singers in every land. But the way she expresses these sentiments is entirely natural and devoid of gaucheness. I enjoyed the disc enormously, and so did all those who have since heard it with me.

The French titles, for the benefit of those who understand them, are: Ce Petit Coeur—Il se Fait Tard—Tout Ce Qu'on Dit—L'Amitie—En t'Attendrant—Je T'Aime—Ce N'est Pas une Reve—Que Mal Y-at-il a Ca—Tu Peux Bien—Le Temps des Souvenirs—Je Pensais—Dis Lui Non. (H.A.T.)

★ ★ ★
LOOKING BACK: Nat King Cole. EMI Encore Series Stereo SENC 9421.

Interest: 1950's material.
Performance: Very good.
Quality: Acceptable recording.
Stereo: Adds little.

Five years after his tragic death, the popularity of Nat King Cole seems to be as great as ever.

The material on this album was originally recorded in the 1950s, but producer Dave Cavanaugh has added additional backings to the eleven tracks to achieve a more contemporary sound. This is not a technique with which I have much sympathy but the enhancing of the original backings has been done with skill and sensitivity.

Nat Cole himself was in excellent voice on these tracks, which include "Time and the River," "Midnight

No moving parts to wear. Noiseless everlasting service.



VALRADIO TRANSVERTERS

(Transistorised D.C. Converters/inverters)

A wide range of models is available, ranging from 30 watts to 1,000 watts continuous rating. Inputs of 12, 24, 50 and 110 volts D.C. are catered for, and Outputs can be either sine wave or square wave. For full details and prices, contact

Leroya Industries PTY. LTD.

SOLE AUSTRALIAN DISTRIBUTORS
266 HAY STREET, SUBIACO, W. AUST. 6008

Flyer," "Send for Me," "If I May," and "Again." Despite the passing of the years, his singing still sounds as fresh and personal as ever.

Allowing for the budget-price of \$2.50, the playing-time is still a bit thin at 25 minutes. But readers who enjoyed Nat King Cole's singing will probably want to add this LP to their collections. (T.F.C.)

★ ★ ★

THE ONE AND ONLY SAM COOKE.
RCA Camden Series Stereo CAS 2264.

Interest: Mixed material.
Performance: Not his best.
Quality: Fair recording.
Stereo: Normal spread.

I have long suspected that the legend of the late Sam Cooke has tended to overtake his talents. Aside from that, this album contains 10 very ordinary tracks taken, I feel sure, from a number of recording sessions around the late 1950s. However, no details are given.

The songs are a curious mixture and are unrepresentative of his previous "Soul" sound. They include "Jamaica Farewell," "Little Girl Blue," "They Call the Wind Maria" and two spirituals, "Trouble in Mind" and "Swing Low, Sweet Chariot."

There is very little excitement or tension throughout the 30 minutes of the album and the backings are generally unimaginative. Even at the budget price of \$1.99, I find it hard to recommend this LP. (T.F.C.)

★ ★ ★

JAN PEECE CONCERT AT CARNEGIE HALL. Sunset (Festival) Stereo SUS-96-048.

Interest: Popular tenor.
Performance: Stylish.
Quality: Good.
Stereo: Provides atmosphere.

This is a reissue on Festival's economy price Sunset label, but unfortunately there is no sleeve note to indicate when the performance took place, or other details one likes to have about a live performance; even the pianist who accompanies throughout is not named. I must admit at the start that I am no great admirer of Jan Peerce, since I find the slight rasp which puts an edge on his voice irritating. For those who are not so affected, this is an extremely interesting and well-balanced program, comprising: Tu Lo Sai (Torelli) — Che Vuol' Innamorarsi (A. Scarlatti) — No, Oh Dio, from Calpurnia (Handel) — Che Fiero Costume — (Legrenzi) — Der Doppelgänger; Ungeduld (Schubert) — Die Mainacht; O Liebliche Wangen (Brahms) — Poema en Forma de Canciones (Turina) — Psalm 137 (Bloch) — The Drooping Corn (Rachmaninoff) — Blow, Blow Thou Winter Wind (Quilter) — E Lucevan Le Stelle, from "Tosca" (Puccini).

This is an extremely intelligently chosen program, obviously intent in avoiding as much as possible works which are too often included in recitals, yet containing many which would be familiar to the reasonably experienced listener. Particularly interesting is the Turina work, which is a set of four love poems, forming a kind of miniature song cycle. The effect of this beautiful music is slightly marred by a section of the audience who were unfamiliar with the work and persisted in clapping before the ending. The

recording, originally by United Artists, is of good standard, but the soloist appears to be rather too distant from the microphone—although this could be taken as providing a more natural atmosphere for a live performance. (H.A.T.)

★ ★ ★

THE WORLD OF MAX BYGRAVES,
Decca Stereo SPA. (\$2.50 series).

Interest: Music hall songs.
Performance: With style.
Quality: Good.
Stereo: Some normal, some reprocessed.

Max Bygraves is much better known in England than here, despite a personal tour of Australia recently. His natural habitat is the music hall stage, but shortage of opportunities to appear in that environment has made him a nightclub and television performer. Here he sings mostly old music hall numbers such as those which took him to the top of the bill at London's famous Palladium—old numbers which will certainly bring back nostalgic memories to older readers: Tulips from Amsterdam — Heart — You're a Pink Tooth Brush Girl — Ten Pretty Girls — Consider Yourself — Who Made the Morning — You Need Hands — Teddy Bears' Picnic — Fings Ain't Wot They Used To Be — It's a Sin to Tell a Lie — Is it True What They Say About Dixie — Underneath the Arches. If these tunes mean anything to you, I think you will enjoy this performance by a genial, likable personality. Some tracks appear to be fairly modern and in genuine stereo, others have been reprocessed from mono, but sound quality is good. (H.A.T.)

Popular Jazz

THE WORLD'S GREATEST JAZZ BAND — Yank Lawson and Bob Haggart. Project 3 Total Sound (Festival). Stereo SPJL 933,222 (also in Mono).

Interest: Some jazz, but mainly commercial.
Performance: Polished.
Quality: Superbly recorded.
Stereo: Well balanced.

While disregarding the extravagant claims of the album title, it is still true that the Yank Lawson/Bob Haggart band contains some of the finest jazz musicians on the scene today. It includes, for example, Billy Butterfield and Lawson on trumpets, Lou McGarity and Carl Fontana on trombones, Bud Freeman and Bob Wilber on reeds and an outstanding rhythm section of Ralph Sutton (piano), Clancy Hayes (banjo), Haggart (bass) and Morey Feld (drums).

But for reasons best known to the producer, Enoch Light, the tracks include unsuitable pop numbers like "Up, Up and Away," "Ode to Billy Joe," "Sunny" and "Taste of Honey." The only song in this category which is at all successful is "Mrs Robinson."

By contrast, the potential of this star-studded band is demonstrated on jazz standards like "Panama," "Honky Tonk Train" (an excellent feature for pianist Ralph Sutton) and "Limehouse Blues" on which Lawson, Butterfield, Freeman and Wilber solo well.

But by far the best tracks on the LP

MICRO CARTRIDGES
PROVIDE EXCELLENT PERFORMANCE
AT
MODEST COST

In each price range MICRO cartridges offer outstanding performance . . . and Encel prices are extremely modest. Two of the most popular magnetic "induced magnet" cartridges are the Series 2100 and the Series 3100. MICRO's ceramic cartridge, the Model SC-303, has been a best seller in Australia.



MICRO MODEL 2100/5 MOVING MAGNET STEREO CARTRIDGE

With an input sensitivity of 5 mV the new Model 2100/5 features a conical diamond stylus (0.5 mil.), a tracking angle of 15 deg. and a frequency response of 10-28,000 Hz plus or minus 3 dB. Stylus pressure recommended is 1-3 grams; channel separation is 30 dB at 1 kHz. Listening tests indicate that most music lovers imagine the 2100/5 costs twice the Encel price . . . inc. Sales-Tax \$14.50.

MICRO SERIES 3100 STEREO CARTRIDGES

This is one of the most popular stereo cartridges ever sold by Encel Stereo Centres. Frequency response is 20-28,000 Hz and channel separation is 28 dB. New standards of performance for low priced cartridges have been set by this well designed moving magnet cartridge—read this excerpt from the "Electronics Australia" review, page 119, Feb., '69 issue. "The frequency response checked out at plus or minus 2 dB from 30 Hz to 20 KHz." "Separation between channels was very good at 35 dB at 1 KHz and never less than 38 dB over the range from 500 Hz to 20 KHz." This is very good performance indeed. Two models are available . . . the VF-3100. E with an elliptical diamond stylus and the VF-3100/5. Both MICRO Series 3100 cartridges track at 1 1/2 grams.

THE MICRO SC-303 CERAMIC STEREO CARTRIDGE

With a frequency response of 20-15,000 Hz the new Model SC-303 ceramic cartridge features a tracking angle of 15 deg. and a diamond stylus is standard. Performance is excellent when one considers the low Encel price of only \$6.90 inc. Sales-Tax.



MICRO DUST PICK-UPS—ONLY \$3.50.

Removing the dust from your records is greatly simplified with the Micro dust pick-up which removes the dust as the record plays. An ideal gift. Inc. Sales-Tax \$3.50.

Encel
ELECTRONICS
(STEREO) PTY. LTD.
Head Office:
431 Bridge Rd., Richmond, Victoria 3121.
Tel. 42 3762.
Sydney Store:
Ground Floor, 25M Building,
257 Clarence Street, Sydney, N.S.W. 2000.
Tel. 29 4563, 29 4564.
*Wholesalers *Trade-ins accepted
Australia's Greatest Hi-Fi Centre



THE WORLD FAMOUS LUX SQ-1220 STEREO AMPLIFIER

Although available only during the last year or so, the LUX SQ-1220 is already regarded as one of the world's classic solid state stereo amplifiers . . . it's been acclaimed in the U.K., the United States, Europe and Australia. Ask for copies of the reviews! This outstanding silicon transistor stereo amplifier is rated at 50 watts R.M.S. in each channel into an 8 ohm speaker load. Frequency response is 10-50,000 Hz. \pm 1 dB. Distortion is so low it is difficult to measure even at high outputs. Separate bass and treble controls are provided for each channel; low and high filters, frequency selectors, provision for tape monitoring and a headphone jack are all standard. The external case of the SQ-1220 is hand crafted from selected palisander veneer. Listen to the audio excellence of this fine amplifier—write or call for unabridged specifications. Encel price (inc. sales tax) is only

\$350

TECHNICAL SPECIFICATIONS

Power amplifiers:
Output: 50 watts R.M.S. into an 8 ohm load.
Frequency response: 10-50,000 Hz. \pm 1dB.
Distortion: Within 0.1% at 30 watts R.M.S. into 16 ohms.
Input sensitivity: 730 mV. at 20 watts R.M.S.

Pre-amplifiers:
Frequency response: 20-20,000 Hz. \pm 1 dB.
Distortion: Within 0.1% (1V/1 kHz.)
Input sensitivity: Tape head — 2 mV.
Mag. p.u. 2 mV. Aux. 1 — 110 mV.
Aux. 2 — 750 mV. Tape monitor — 200 mV.
Signal to noise: Tape and phono —60 dB.
Aux.—75 dB.

FINE AMPLIFIERS IN THE LUX RANGE

LUX MODEL SQ-505 SOLID STATE STEREO AMPLIFIER

Rated at 30 watts R.M.S. per channel, the all new Lux Model SQ-505 is a silicon transistor unit. Power transistors are designed to withstand temporary short circuits and overloading—overall frequency response is 10-50,000 Hz. plus or minus 1dB. in the power amplifier and 20-50,000 Hz. plus or minus 2dB. in the pre-amplifier. Controls and features include volume, balance, mode selector, treble/bass controls, filters, tape monitor, headphone jack, exclusive A/B speaker systems selector, etc. All in all the Lux SQ-505 is a very fine amplifier and an excellent performer.

\$259

LUX MODEL SQ-606 SOLID STATE STEREO AMPLIFIER

With an output of 30 watts R.M.S. per channel, the handsome new Lux Model SQ-606 is an all-silicon unit with 27 silicon transistors. Power transistors are designed to withstand temporary short circuits and overloading. Overall frequency response is 10-50,000 Hz. \pm 1dB. Acoustic performance is quite outstanding. Controls and features include volume, balance, mode selector, treble/bass controls, filters, tape monitor, headphone jack, etc. The Lux Model SQ-606 is an excellent stereo amplifier with extremely musical characteristics. It's attractively priced at (inc. S. T.)

\$219

LUX SOLID STATE STEREO AMPLIFIER Model SQ-77TW

Using silicon power transistors the SQ-77TW is rated at 30 watts R.M.S. in each channel with a 4-6 ohm speaker load. Frequency response is 10-50,000 Hz. plus 0, minus 3dB. Input sensitivity is 1.8 mV for magnetic pickup or tape head, aux. inputs being rated at 200 mV and 800 mV. Controls include stereo volume, stereo balance, mode switch, treble and bass (separate controls for each channel), input selector, headphone jack and switch, tape monitor switch, rumble and scratch filter switches, etc. Price inc. S.T.

\$169



ENCCEL
ELECTRONICS (STEREO)
PTY. LTD.

Head Office:

431 Bridge Rd., Richmond, Victoria 3121. Tel. 42 3762.

Sydney Store: Ground Floor, 2SM Building.

257 Clarence Street, Sydney, N.S.W. 2000. Tel. 29 4563, 29 4564.

Australia's Greatest Hi-Fi Centre *Wholesalers *Trade-ins accepted

are the two ballads "Baby, Won't You Please Come Home," which features the trumpeters; and Gordon Jenkins' beautiful "This Is All I Ask." For the specialist jazz collector, this album will, I am sure, be a major disappointment, but the average listener will no doubt appreciate the fine musicianship and superb recording quality. The playing-time is 36 minutes. (T.F.C.)

★ ★ ★

AUSTRALIAN JAZZ—George Golla and John Sangster. Universal Record Club. Stereo U-1001.

Interest: Two superb local musicians.

Performance: Beautifully played.

Quality: Reasonable recording.

Stereo: Badly balanced.

The Universal Record Club has produced for its members a composite LP featuring two of Sydney's leading musicians — vibist and percussionist John Sangster, and guitarist George Golla.

The six tracks on the Sangster side come from John's first Festival LP called "The Trip" (SFL 932,438); while the Golla tracks have been taken from George's second album "Wives and Lovers" (SFL 933,125) for the same label. I have reviewed both these LPs in these pages.

I am a little uncertain about the reasoning behind this particular grouping. But for Club members, who possess neither album, this would obviously be a useful introduction to contemporary Sydney music and a very attractive purchase.

On few tracks do Golla and Sangster really extend themselves as jazz soloists but the music is always interesting, easy and pleasant listening, and, of course, superbly played by some of the leading musicians in Sydney. Given the limitations of a re-issue of this kind, it can be warmly recommended. (T.F.C.)

★ ★ ★

SOUTH SIDE SWING—Earl Hines Orchestra. Festival Jazz Heritage Series Calendar. Stereo SR66-9652 (also Mono).

Interest: Vintage Hines (1934-35).

Performance: Excellent.

Quality: Reasonably good sound.

Stereo: Meaningless.

I reviewed this album in the June 1968 issue, when it was first released in Australia at Festival's normal price of \$5.75. At that time, I concluded that the album could be warmly recommended to all readers with an interest in the classic big bands of the 1930s. Now that Festival have made this album available in their \$2.95 Calendar series, it becomes even more of a bargain.

The 16 tracks were made at three sessions in 1934 and 1935, when the Hines Band was at its first great peak. This was about halfway through the twelve-year residency, which Hines held at Chicago's Grand Terrace. Earl Hines himself was in magnificent form on these sessions and there are several fine solos from Omer Simeon, Trummy Young and Darnell Howard. Also noteworthy are the arrangements by Cecil Irwin, Jimmy Mundy and Quinn Wilson, particularly for the brass section.

At this price, and with a playing-time of 46 minutes, most Australian collectors will want to add this LP to their shelves. (T.F.C.)

AFRICAN RIPPLES—Fats Waller. RCA Vintage Series, Mono LPV 562.

Interest: Jazz, mainly 1938.

Performance: Another good Waller reissue.

Quality: First-class remasterings.

"African Ripples" is the fifth in the series of RCA Vintage Waller reissues, produced by Mike Lipskin. It must be said that, while it is a very welcome and interesting collection, the overall quality of the music is not as high as on the previous four Waller reissues.

Nine of the 16 tracks, from 1938, are by his regular group with Herman Autrey on trumpet and Gene Sedic on clarinet and tenor. They include "Something Tells Me," "If I Were You," "Fair and Square" and "Yacht Club Swing."

Three other tracks from the same year, "In the Gloaming," "Hold My Hand" and "Let's Break the Good News," feature Waller with a Big Band but this was not a complete musical success. Much the same assessment applies to "Every Day's a Holiday," which Waller recorded in Hollywood towards the end of 1937 with a pick-up quintet.

The album is completed by three piano solos from 1929 and 1934 but only the latter, the title track, is of real consequence. The playing-time of this very enjoyable, if hardly essential, collection of rarer Waller tracks is 48½ minutes. (T.F.C.)

★ ★ ★

BLUES ROOTS—The Dave Brubeck Trio featuring Gerry Mulligan. CBS Stereo SBP 233665.

Interest: Their second L.P. together.

Performance: Disappointing, but . . .

Quality: Bright recording.

Stereo: Well balanced.

This is the second album by the Dave Brubeck Trio and baritone player Gerry Mulligan — the first, "Campadres" (SBP 233585) was recorded last year, during concerts in Mexico.

This is, however, a disappointing L.P., mainly because of the leader's uninspiring form. All the tracks are blues and Brubeck has never really shown an aptitude for convincing solos on the blues. Mulligan plays very well but the outstanding musician on these sessions was the superb drummer, Alan Dawson. He receives solid, if unspectacular, support from Jack Six on bass.

The most successful tracks are the haunting composition by Mulligan "Journey" and Mercer Ellington's "Things Ain't What They Used to Be." The two Brubeck compositions, "Movin' Out" and "Cross Ties" are not quite up to his usual standard. The remaining tracks are a jaunty "Limehouse Blues," a rather pretentious composition called "Broke Blues" by the producer, Teo Macero, and a Brubeck/Mulligan tune, "Blues Roots," which never really gets off the ground.

There are flashes of keen cut-and-thrust between Mulligan and Brubeck on occasions, but the old Brubeck failing of heavy-handed, unimaginative soloing dominates too many tracks. Despite this, the remarkable rapport between Mulligan and Dawson—and the playing-time of 50 minutes—may make this a worthwhile purchase for readers who enjoy Brubeck's music. (T.F.C.)

COMPLETE HI-FI RADIOGRAM-TAPE RECORDER ALL IN ONE

MODEL TR9

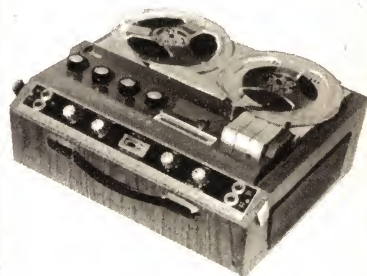

AS AN AMPLIFIER . . .

- Frequency response, 20-20000 cps.
- 7 Watts RMS. output per channel.
- Distortion less than .25%
- Separate treble and bass controls.

AS A RADIO . . .

- Being fully transistorised, can be switched on all day at full output without heat problems. Program can be recorded on tape without any external connections.

AS A TAPE RECORDER . . .

- Freq. response 30-18000 cps.
- 3 speeds. Meter level indicator.
- Push button operation.
- Superimposing.

PRICES:

- 2 track mono, \$159.00
- 4 track mono, \$169.00
- 4 track stereo, \$230.00

RADIO TUNER CAN BE FITTED TO ANY OF THE ABOVE MODELS FOR \$28 EXTRA.

TAPE DECKS

for the home constructor. COLLARO (Magnavox) tape decks complete with record/play and speed change switch wafers fitted . . .

2 tracks, \$48. 4 tracks, \$55. SPECIAL LOW IMPEDANCE HEADS for transistorised tape amplifier circuits (Mullard) available).

CLASSIC TAPE RECORDERS

93B LIVERPOOL ROAD, SUMMER HILL, N.S.W. Telephone 79-2618

Now YOU can enter
The Wonderful
World of Electronics
with

TECHNIPAC

The Complete Training System

TECHNIPAC didn't 'just happen.' It is the result of many years of experience, research and design in the field of Electronics training. TECHNIPAC is a unique combination of the theory and practical application of Electronics presented and arranged in a simple, logical and effective manner. Whether you are a beginner or have some knowledge or experience in Electronics, the TECHNIPAC system is designed to meet your individual requirements. Find out *NOW* how you can enter *the Wonderful World of Electronics*—through the **TECHNIPAC SYSTEM**

Technical Training International Pty. Ltd.

Archer House, 75 Archer St., Chatswood, N.S.W. 2067. Tel 41 4444.

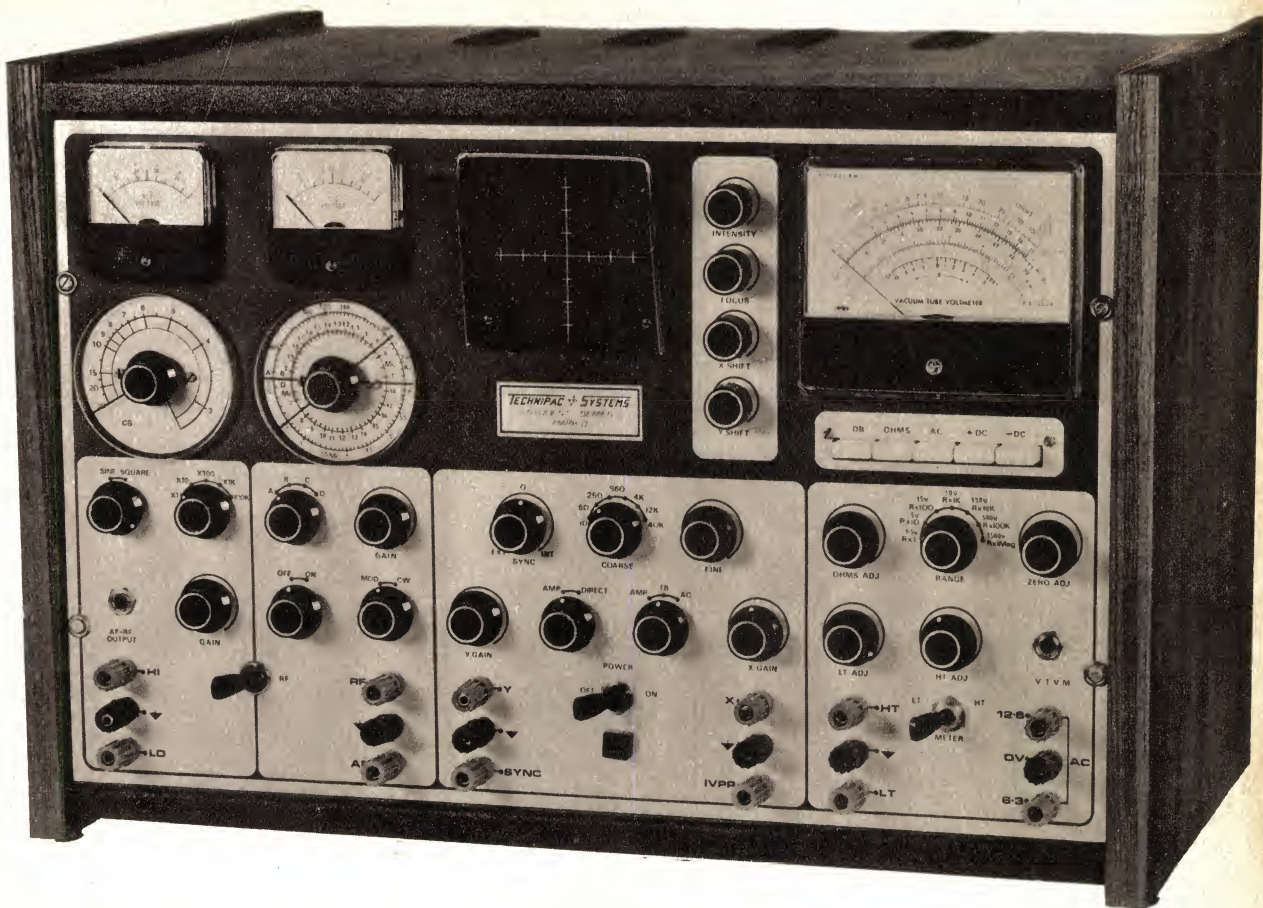

Illustrated above is the **TECMARK II TEST EQUIPMENT CONSOLE**. It incorporates a DC/AC power supply with a stabilized LT. section, vacuum-tube voltmeter, oscilloscope, audio frequency generator and an R.F. generator.



To: **TECHNIPAC SYSTEMS DIVISION**,
 Technical Training International,
 P.O. Box 328, Chatswood, N.S.W. 2067.
 Please forward full details immediately,
 including illustrated *brochure* on Technipac.

NAME: _____ AGE: _____

Address: _____ Postcode: _____

TRADE REVIEWS AND RELEASES

Pidcam Pistol Target System

Australasian Training Aids Pty. Ltd. have drawn attention to their Pidcam Pistol Target System, which has been developed for all international standard requirements.

The company contacted us as a result of inquiries from readers published in our correspondence columns. They say that considerable forethought and care has gone into the design of the unit, to give it the convenience and versatility desirable in a pistol target system.

Basically, the system consists of target frames in groups of five, operated by an accurate timer. Each target frame approximates in outline and dimensions the shape of the human body. For shooting practice, or in competitions, the frames are presented individually, collectively, or in any combinations, for a pre-determined period of time, during which the firer must aim and shoot. The targets are then automatically turned away from the shooter.

The target operation is controlled by a timer unit, called the ATA Pistol Timer Mark III. The manufacturer's literature says that accuracy is the keynote of the timer, the accuracy figure being so high that no stop watch or other mechanical time checker can measure it. Accuracy will not vary with change of temperature and supply voltage. The count down from the start of the actuation cycle to the exposure of the frames is indicated by a flashing lamp, so there is no noise distraction for firers and range operators.

The timer operates from a nominal 12V DC supply (such as a car battery) but will operate successfully from any voltage between 8V and 13V. Timing accuracy is from -0 to +.04 per cent of the selected time.

Integrated circuits are used in the timer's electronics. The timing function is based on a very stable high-frequency crystal oscillator.

Protection devices include prevention of damage from reversed battery leads; a fuse to protect the unit should a fault or short circuit develop; "Down range protection" which automatically turns off the timer should a fault or short circuit occur in the frame control wiring or in the cable linking the timer to the frames.

Targets are pneumatically operated, either from a compressed air bottle or from an air compressor unit. Turning takes only one-fifth of a second and is carried out without noise or vibration. Frames can easily be assembled by unskilled personnel, either singly or joined together to form a two or three-unit installation.

The timer can be set for rapid fire, centre fire, or standard match fire.

RAPID FIRE: Shortly after the system's actuator button is pressed, the frames will be exposed for exactly 4, 6 or 8 seconds, the time being selected by a "range function switch." The time between operation of the actuator switch and exposure of the frames is random, and thus unpredictable. The delay lies between 2 and 4 seconds.

CENTRE FIRE: One operation of the

actuator button will expose all the targets simultaneously. When the shooters are ready, a second press will turn the

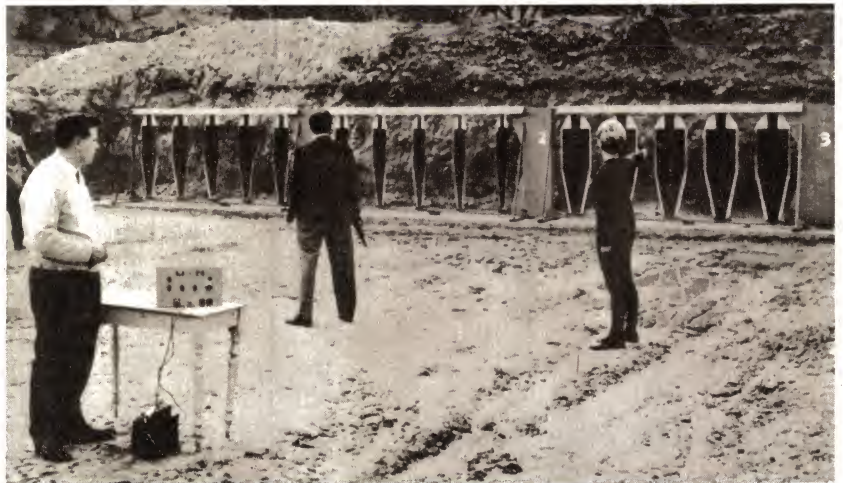

The Pidcam target system in use.

Security Locks for Burglar Alarms

Following publication of last month's article on burglar alarm installations we have received a letter from Wilson Manufacturing Pty. Ltd., makers of the "Wilsonia" No. 202 and No. K02 key operated switches mentioned in this article. The letter draws attention to another switch of this general type which is now available. Here is the relevant portion of the letter. "We recently commenced production of a high security burglar alarm switch as an alternative to the No. K02 and No. 202. "This is "Wilsonia" No. HS20 and, as you will see from the accompanying leaflet, it incorporates an ABLOY lock

cylinder — very highly regarded by the Police Crime Prevention Squad — and a micro switch which provides for an additional circuit if required (single pole, double throw).

"This unit, because of these features, is recommended for high risk installations. The method of fixing, involving a hexagon nut on the rear of the switch, is an additional safety measure, since it leaves the switch flush at the front when activated.

"We enclose two photographs of the switch, showing it in both the unlocked and activated positions."

The ABLOY lock mechanism is made in Finland, and the makers claim that it cannot be picked. The switch is normally activated by pushing in the key cylinder. This may be done without the key. Since the switch is a double throw type, the unit is equally suitable whether the setting function involves opening or closing a circuit. The position of the key cylinder gives a clear indication of which position it occupies at any time. If desired the lock may be modified so that both the activate and unlock functions require the use of the key. This involves a slight extra cost.

An extension set is available which enables the switch to be mounted in walls up to 11in thick.

Further details may be obtained from the manufacturers at Box 279, P.O. Marri-ckville, N.S.W. 2204.



The HS20 switch, unlocked (left) and locked.

High Compliance Loudspeakers From Rola

Plessey Rola Pty. Ltd. have recently released two high-compliance loudspeakers with a nominal diameter of 6½ in. They are the 65MX, a wide-range, twin-cone unit, and the 65M, a medium-throw woofer unit intended for use in conjunction with a tweeter.

Both loudspeakers use the same alnico magnet assembly, enamelled steel chassis and cone suspension system consisting of a very flexible synthetic rubber roll surround and large diameter spider. The magnetic flux density in the voice coil gap is 9000 gauss. Both loudspeakers are available with nominal impedances of 8 or 15 ohms.

The 65M woofer invites comparison with the more expensive Rola 6½ inch woofer, the C65-O, which has a massive ceramic magnet and a heavier cone. The use of the smaller magnet assembly in the 65M woofer has apparently forced some compromise in voice coil dimensions and magnetic damping but, surprisingly, the overall sensitivity is much the same. As could be expected, the bass definition is not as good as with the C65-O, the bass having a somewhat boomer quality.

The power rating for the woofer is 10 watts RMS in a sealed enclosure. Rola recommend an enclosure with internal dimensions of approximately 16 x 9½ x 8 inches which gives a useable bass response down to around 40Hz. Since the free air resonance of the cone is a nominal 35Hz, we felt that it could be used to advantage in a smaller enclosure. We subsequently tried it in a Playmaster "Point Four" enclosure, which has an internal volume of approximately 0.4 cubic feet, as against the recommended enclosure volume of 0.7 cubic feet. This reduction in enclosure will limit the lower bass response to an estimated 50Hz but, equally, it should give an extra margin of power handling capability.

The power handling capability of a small, high-compliance woofer is one of its most important characteristics. Because of the small diameter the cone must make long excursions and because of inherently lower sensitivity it must handle large amounts of power. For this reason, it was gratifying to find that the Rola 65M woofer, when installed in an enclosure with a volume of 0.4 cubic feet, was able to give a good account of itself even at high power levels. The bass response is certainly quite adequate with "half bass boost" applied from the average amplifier.

Tweeters which will suitably complement the Rola 65M woofer are the Rola 3DX or Magnavox 3TC, both the same impedance as the woofer. The crossover frequency should be at 5KHz. The result is a system capable of good quality sound for an economy price.

We also tested the Rola 65M wide range twin-cone unit. It has a power rating of 7 watts RMS when installed in a sealed enclosure. It did not have the extended high frequency response of a system with separate tweeter and there was a tendency to emphasise the midrange. As could be expected, intermodulation was more evident at higher loudness levels. All in all, though, it gives a good per-



formance commensurate with its modest size and cost. It would be most suitable for use with medium quality tape recorders, television receivers or record players.

Retail prices including tax, are \$11.95 for the 65MX wide range unit and \$11.00 for the 65M woofer. They are available from normal retail outlets. Inquiries regarding performance, specifications and trade prices should be directed to Plessey Rola Pty. Ltd., The Boulevard, Richmond, Victoria, 3121. (L.D.S.)

Miniature Amplifier

A miniature outside-broadcast amplifier has been introduced by RCA for use by radio stations when broadcasting sports and other commentaries.

Called the TA-125 Portable Outside Broadcast Amplifier, the new unit is easy to use, requires no set-up, weighs only 24oz, and is small enough to be carried in the palm of the hand. The amplifier is capable of delivering +8dBm into a 600-ohm load and is fitted with automatic gain control. Foolproof operation is

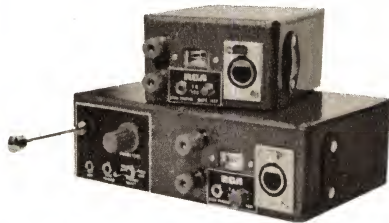

achieved by using a microphone plug-switch which switches off the amplifier when the plug is removed. Features: binding posts for P.M.G. pairs connection; level and battery metering; crystal earpiece monitoring; silicon transistor circuitry; housed in a rugged durable case.

The TA-125B consists of a standard TA-125 but with the inclusion of a single-channel pretuned off-air receiver for monitoring purposes. A telescopic antenna, monitoring level control, and provision for magnetic phones if required, are incorporated in the receiving section.

Full information is available from RCA Ltd., 11 Khartoum Road, North Ryde, N.S.W. 2113, or 2/4 Stevenson Street, Richmond, Vic. 3121.

If you want

STEREO EQUIPMENT

You'll deal better with
H. B. RADIO SALES

NOVEMBER SPECIALS

KENWOOD TK250 AMPLIFIER/
2 Wharfedale unit 3 speaker systems. Dual 1019 player on platform, Shure magnetic \$398.00

KENWOOD 150 AMP, 2 Magnavox
10in speaker systems in Teak. Garrard AT60 on platform, with Shure M44G \$275.00

SANSUI 555 2 Wharfedale Super
10 speakers in R3 teak cabinets, Dual 1019 player, Shure M44G, platform and cover \$465.00

MONARCH SA 500. 20W RMS—
Low and High Filter controls. 2 Peerless 10in speaker systems. Dual 1210-Shure M44G-platform-cover. \$312.00.

MAGNAVOX 8WR, 1.6 cf
cabinet \$30.50
CABINET KIT and SPEAKER
\$21.00

MAGNAVOX 10WR and 3TC,
complete \$43.00
CABINET KIT and SPEAKERS
\$31.00

MAGNAVOX 12WR, 3TC, complete
. \$44.50
CABINET KIT and SPEAKERS
\$33.00

PEERLESS 10in 2cf cabinet \$57.50
CABINET KIT and SPEAKER
\$47.00

W'DALE GOLD. 10 in R3
cabinet \$65.00
CABINET KIT and SPEAKER
\$52.00

Special quotes for other speakers.
Available in Maple, Walnut or Rosewood colours. Teak veneer \$1 extra for Slimline and Bookshelf KITS. \$2.50 extra for other KITS.

SPEAKER UNITS
PLAYMASTER, complete . \$31.00
CABINET Kit and Parts . \$24.20
POINT 4, complete . . . \$35.00
CABINET Kit and Parts . \$25.00
PLAYMASTER SUPER . . \$42.00
CABINET Kit and Parts . . \$32.50
Wharfedale Unit 3 (large) \$54.00
CABINET Kit and Parts . \$44.00

Packing charge \$1 per order.
Freight payable on delivery.

Send for Stereo Catalogue

H. B. RADIO SALES

Established 37 years.
103-105 Catherine Street,
LEICHHARDT, SYDNEY
Telephone 56-5580

Watch for Special
CLAYBRIDGE
Announcement in
December issue

Watch for Special
CLAYBRIDGE
Announcement in
December issue

Watch for Special
CLAYBRIDGE
Announcement in
December issue

Watch for Special
CLAYBRIDGE
Announcement in
December issue

Watch for Special
CLAYBRIDGE
Announcement in
December issue

Watch for Special
CLAYBRIDGE
Announcement in
December issue

Watch for Special
CLAYBRIDGE
Announcement in
December issue

Watch for Special
CLAYBRIDGE
Announcement in
December issue

Watch for Special
CLAYBRIDGE
Announcement in
December issue

Watch for Special
CLAYBRIDGE
Announcement in
December issue

Watch for Special
CLAYBRIDGE
Announcement in
December issue

Watch for Special
CLAYBRIDGE
Announcement in
December issue

Watch for Special
CLAYBRIDGE
Announcement in
December issue

STOP PRESS

SOUND

THE BIG NAME IN FULLY IMPORTED TUNER / AMPLIFIERS!

With specifications that demand attention and effective quality control in manufacture, the SOUND series of amplifiers offer outstanding value and they're exclusive to Encel Stereo Centres. Encel prices include sales tax and trade-in valuations on your old equipment (see samples below) make the changeover cost extremely modest. Ask for a valuation on your current equipment.



SOUND MODEL SAQ-203 12 WATTS R.M.S. OUTPUT \$74.50 INC. SALES TAX.

Here is one of the most popular amplifiers ever sold by Encel Stereo Centres. Frequency response is 30-20,000 Hz. and input sensitivity suits magnetic cartridges at 3 mV. Output is 12 watts R.M.S. or 30 watts E.I.A. peak power. Eighteen low noise transistors and diodes are incorporated in the circuit. All necessary controls provide flexibility of operation; a headphone jack is provided on the attractive front panel. Speaker matching terminals permit use of 4, 8 or 16 ohm speaker systems. This is an ideal compact stereo amplifier for use with tape recorders, or for building into bookshelves and cabinets. Encel price is only, inc. sales tax

\$74.50



STOP PRESS!

EXCERPT FROM ENCEL LABORATORY REPORT: Our laboratory test report indicates that frequency response is substantially flat, being down 2 dB. at 20 Hz. and only 1 dB. at 20 kHz. Square wave response is excellent and shows little variation in the audible ranges.



SOUND MODEL SAQ-505X 50 WATTS R.M.S. OUTPUT ONLY \$119.50 INC. SALES TAX!

With a power output of 50 watts R.M.S. into 8 ohm speaker systems, the Sound SAQ-505X represents outstanding Encel value. Frequency response is 20-20,000 Hz. plus or minus 1 dB. and extends well beyond this range. Sensitivity suits magnetic cartridges at 3 mV. and 20 low noise transistors and diodes are used in the circuit. Tumble-type switches control Tape Monitoring, Loudness, Rumble and A.C. Power. All other desirable controls are incorporated. Price is only \$119.50 inc. sales tax. Write for complete data and unabridged technical specifications. **\$119.50**

ENCEL

ELECTRONICS (STEREO) PTY. LTD.

Head Office:

431 Bridge Rd., Richmond, Victoria 3121. Tel. 42 3762.

Sydney Store: Ground Floor, 2SM Building.

257 Clarence Street, Sydney, N.S.W. 2000. Tel. 29 4563, 29 4564.

Australia's Greatest Hi-Fi Centre *Wholesalers *Trade-ins accepted



Section of Air Conditioned Screening Room at

TEL-LEIGH-TUBES PTY. LTD.

(Sydney & Melbourne)

Manufacturers of Premium Quality T.V. Picture Tubes

WRITTEN TWO YEARS' GUARANTEE

Free daily delivery around Sydney and Melbourne. Tubes despatched daily to Country and Interstate customers. Please send old tubes to Petersham Station, N.S.W., or Highett Station, Victoria.

N.S.W.: Tel-Leigh-Tubes Pty. Ltd.,
51 Reuss St., Leichhardt.
Sydney, N.S.W. 2040.
Ph. 56-8498

VICTORIA: Tel-Leigh-Tubes Pty. Ltd.,
32-34 Graham Rd.,
Highett, Victoria. 3190.
Ph. 95-4086

ACTIVE RECEIVING ANTENNA

An active receiving antenna for the frequency range 100 to 156MHz has been devised by Rohde and Schwarz, Munich, West Germany, in co-operation with the

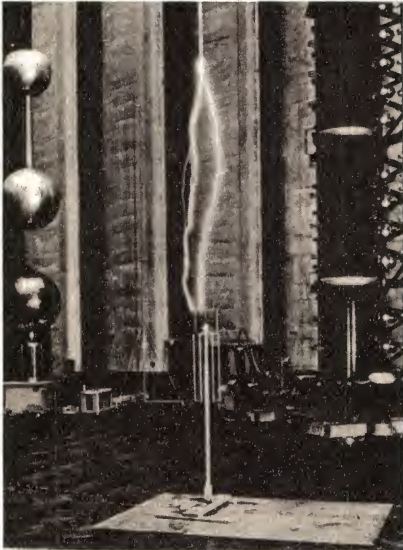

An active receiving antenna, type HA 430/141, undergoes a lightning test in the high-tension house at the Technical University of Munich.

Electronics Department of the Technical University of Munich. All measurements and tests carried out to date have shown very good results. The antenna, which is equipped with active elements, is intended for use in air-traffic control and features: low-noise; low cross-modulation; immunity to lightning and other environmental influences; and a remarkable compactness.

Electrically the antenna, type HA 430/141, constitutes a highly capacitively loaded, double-folded monopole. The passive antenna portion (top plate) is designed so that the antenna itself acts as a band-pass filter in the operating frequency range. This obviates the need for filters between the passive portion of the antenna and the amplifier. The band-pass filter heavily suppresses mixture products and cross modulation by frequencies outside the operating frequency range. The arrangement of the active element (transistor amplifier) permits optimum matching to the antenna with the noise figure at a minimum.

The small active antenna boosts the received RF signals with only a small rise in noise temperature. Even in the case of long and lossy cables between the antenna and the receiver, the good receiving characteristics are not affected. If, for example, a receiver with a noise figure of 7 is connected to the antenna via a 150ft cble. the noise temperature of the overall system is less than 2.5.

The safety requirement, which is essential for practical application, calls for protecting the incorporated electronic circuit against destruction by lightning. In the centre of the antenna, below a

circular plate of 12in diameter, a transistor amplifier is housed in a metal cylinder and connected to the top plate via a series resonant circuit with a very low series capacitance. The top plate is supported by two outer metal rods which, at the same time, are used for connection to earth and to the basket-shaped counterweight. The supply voltage is applied to the transistor amplifier via a coaxial cable (run through the support's tubing) which is also used for the transmission of the received and amplified RF signals.

If lightning strikes directly, the current flows via the two outer metal rods, and the space in which the sensitive transistor circuit is located remains free from magnetic fields. If lightning strikes only in the vicinity, the electronic circuit remains practically free from lightning current since the circuit is arranged similar to the neutral arm of a balanced bridge.

Further details may be obtained from the Australian agents for Rohde and Schwarz: Astronics Australia Pty. Ltd. 161-173 Sturt Street, South Melbourne, Vic. 3205.

STUDIO ELECTRONIC FLASH

The Solapak Mark 3 studio electronic flash, made by Courtenay, in the U.K., is available through the Australian agents, R. H. Wagner and Sons Pty. Ltd.

This electronic flash outfit consists of a number of independent units which look like extra deep reflectors. Each unit is plugged into the mains like a photo flood. One unit is connected to the synchronising socket on the camera and, when the release is pressed, all the flashes go off at exactly the same moment, although there is no direct connection between them.

A sensitive photo-electric cell is mounted on the back of each reflector to pick up the initial pulse of light and trigger the circuit with nominally zero delay. An extension head can be plugged into the unit so that the charge can be divided between the two heads. There is an extension photo-cell socket for

Indicator Tubes

Rodan numerical indicator tubes, manufacturer by Okaya Electric Industries of Japan, are available in Australia through Plessey Ducon Pty. Ltd., P.O. Box 2, Villawood, N.S.W., 2163.



Models GR-110 and GR-110P (similar, but for pulsed operation) provide digits 0-9 each with decimal point in 10mm high characters. The GR-100P operates from pulses of 50 to 500 uS width with a duty cycle of 1/10. Elfin indicators models MG-17 (7-bar segments) and MG-19 (9-bar segments) provide 0-9 each with decimal point in 11.5mm high characters.



use when the unit is so positioned that the light from other flashes cannot reach it. The unit gives an output of 300 joules on full power, but can be switched to give 200 or 100 joules. A 100W modelling light retains its full brilliance whether the unit is working at full or reduced power.

Inquiries should be addressed to R. H. Wagner and Sons Pty. Ltd., 524 Finders Street, Melbourne, 3000.

BETTER RADIO RECEPTION FOR ONLY 20 Cents

Published by Eddystone, a complete guide how to get the best results from your receiver, contains 24 pages, with illustrations; covers propagation, aerials, interference, and other useful data.

Write now with 20 cent postal note to:

R.H. Cunningham
PTY. LTD.

608 Collins Street, Melbourne,
Victoria, 3000

STOP

Let music make your Xmas holiday even more enjoyable. Listen to your favoured songs in your car, on the beach, or at your home, through the famous German COMBIPHON combined Cassette-Taperecorder and FM-SW-MW radio-receiver.

A MECCA 8-track car stereo player for only \$69.80 for use with 2 or 4 Loudspeakers, or choose one of the powerful portable Receivers like the GRUNDIG Satellite, NORDMENDE Globetrotter, the AKKORD or BLAUPUNKT All Wave Radio.

Call or write for information at

VICTOR'S HI-FI CENTRE

Corner 77 Wentworth Ave, and
196 Elizabeth St., Sydney.

Tele.: 61-2967, 61-6031.



BWD/5

MODEL bwd 602 11 FACILITIES IN 1 COMBINATION INSTRUMENT

The only instrument in the world that provides a complete range of 4 signal sources, 7 power supplies and 2 amplifiers integrated into 1 low-cost unit. Check these specs then upgrade your Laboratories or Workshop with a bwd 602.

PRICE **\$289**
+ TAX.

0.5Hz to 500kHz Sine and Square Oscillator (0.1% distortion from 100Hz to 25kHz also!)
8 watt Power Oscillator 0.5Hz to 20kHz
± 1 Amp ± 15V Square Wave Generator.
Amplitude Modulated Oscillator.
8 Watt Power Amplifier DC—20kHz.
X5 to X100 operational amplifier.
1 to 12V 2 Amp stabilised DC supply.
12 to 24V 1 Amp " " "
0 to 300V 35mA " " "
0 to 50V 1mA " " "
6.3V 15V and 55V AC outputs

B.W.D. ELECTRONICS PTY. LTD.,

333 BURKE RD., GARDINER, VIC. PHONE 25 4425

127 BLUES POINT RD., NTH. SYDNEY. PHONE 929 7452, ALSO PHONE 23 1922 IN S. AUST. AND 23 3847 IN W. AUST.

PRE-PAK electronics

SHOP-BY-PHONE SERVICE
69-5922

MAIL ORDER DEPT.
P.O. BOX 131,
KINGSGROVE, N.S.W. 2208.

SALES CENTRE,
103 Regent Street,
REDFERN, N.S.W. 2016.

24 HOUR
DESPATCH SERVICE

Send 20c in stamps or a postal order for our latest information packed catalogue which will be sent to you by return mail. Our low prices cannot be beaten. All parts new and guaranteed.

COMPUTER BOARDS

Containing a variety of NPN and PNP germanium transistors and a host of other components, these 4" x 2½" boards are supplied with free technical information on all parts. Each board has a minimum of 4 transistors.

100 boards 20c ea.

25-99 boards 25c ea.

10-24 boards 30c ea.

1-9 boards 35c ea.

Pack and Post 50c for 100, 25c for 10 up, or 10c for up to 9 boards.

SPRING CLEARANCE SALE

For personal shoppers only. Hundreds of bargains are on display at our Sales Centre and you name your own (reasonable) price.

PACK AND POST 10c ANY ORDER

Sales Centre open
Mon. to Sat. 8.30 a.m.-5.30 p.m.

Magnetic Pre-Amp Kitset
As in E.A., Oct., 1965.
All parts supplied.
Use for pick-up or tape heads.
Mono **\$4.90** Stereo **\$9.00**

MODULAMPS . . . ea. \$4.00

Small 1W transistor audio amplifiers by Pre-Pak.

Supply volts . . . 6-12v DC.
Input sensitivity 1v P-P.
Freq. response 50Hz-20KHz.

BARGAIN PAKS

D1 5 OA91 diodes .. **\$1.00**

D2 5 1N914 diodes .. **\$1.00**

SR1 5 1N4001 rect. .. **\$1.50**

SR2 5 100 PIV 1A rect. **\$1.50**

SR3 4 400 PIV 1A rect. **\$1.50**

SR5 2 EM408 rect. .. **\$1.50**

T3 3 BC148 trans. .. **\$1.50**

T4 2 BC149 trans. .. **\$1.50**

PROFESSIONAL CARTRIDGE RECORDER

The CT81 cartridge tape-recorder, the latest addition to the CT80 family developed in Australia by Plessey Electronics, has been purchased by the Independent Television Authority (I.T.A.) in the U.K. to provide promotional and standby announcements.

The CT81 is rack-mounted and includes a peak program meter, three cue tones, and other special requirements to meet the needs of the I.T.A. operations. Separate replay and record heads enable the unit to replay while recording for A-B monitoring purposes.

All electronic circuits are on plug-in circuit boards ensuring easy access for maintenance. An extender board allows access to the components on the circuit boards under operating conditions. Reliability is ensured by using all silicon semi-conductors and by vacuum encapsulating transformers and chokes in epoxy resin. All rotating shafts are self lubricating and all mechanical assemblies are precision engineered for long and trouble-free life.

Like other models in the CT80 series, the CT81 has an integral direct-drive capstan motor, solenoid and puck wheel assembly. The puck wheel actuating arm and solenoid are mounted on a precision machined casting, and both the puck wheel and actuating arm are fitted with lubricated bearings. In this separate assembly, the puck wheel capstan pressure can be pre-set and locked prior to fitting to the main unit to virtually eliminate puck wheel pressure problems.

The three cue tones on the CT81 operate as follows:

The 1000Hz standard stop cue, available on all CT80 models, is automatically



recorded with each depression of the record button. This cue pulse is detected on replay and automatically stops and re-cues the tape.

An 8000Hz auxiliary cue to operate associated relays within the unit can be recorded on the tape during the initial recording. The relay contacts available via the remote control outlet may then be used to perform such functions as operating a separate tape unit, activating indicator lights, starting a film projector, or operating a slide projector.

A 150Hz end-of-message cue pulse is recorded when the end cue button is depressed. This cue may be used in a similar way to the "auxiliary" cue, but is normally used to detect and indicate the end of a message.

For remote operation, all switching functions and indicator lamp connections are extended to a multi-way plug and socket at the rear of the unit.

Inquiries should be addressed to Plessey Electronics Pty. Ltd., 13-17 Botany Street, Redfern, N.S.W. 2016.

PULSE - HEIGHT DETECTOR

Varian has introduced a series of microwave pulse-height detectors for making precise measurements of short-duration pulses. Designated the VSZ-9900 series, these units detect fast risetime, narrow-width pulses and register a corresponding output pulse 1μS long. The output is used to drive an internal counter or external registering device.

The detectors are said to be particularly useful in determining spike leakage power in TR tubes, detecting missing pulses in magnetrons, and making peak power measurements of pulsed transmitters. Operating with a tuned crystal detector and precision attenuator, these devices can be triggered by extremely low power.

Characteristics of the detectors are: input triggering voltage plus 30mV; maximum peak input level 2V; rise time 500pS; minimum pulse width that can be detected 500pS; maximum pulse width 40 μS; maximum pulse recurrence rate 20,000 pulses per second.

The series comprises three models offering a variety of package options.

TRADE CORRECTION

REGULATED BATTERY ELIMINATOR. Reviewed in the July, 1969, issue of "Electronics Australia." A. and R. Electronic Equipment Co. Pty. Ltd. has advised that this power supply, type P.S. 104, is fully equipped with silicon transistors.

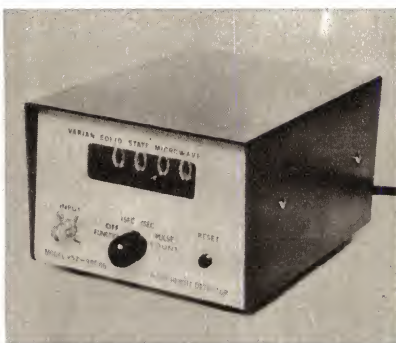

The VSZ-9900A consists of a detector with a power supply. Its output connects into an external digital counter with either positive or negative pulses. Peak amplitude of the output pulse is 1V and nominal bandwidth is 1μS. The "B" model consists of the detector, power supply, and a digital counter which has both pulse frequency and total pulse count capability. The "C" model consists of the detector only, and has a positive output.

The test arrangement for making transient measurements requires an RF source, the device to be tested, a precision attenuator, and a crystal detector, the output of which is fed into the pulse height detector.

Further details can be obtained from Varian Pty. Ltd., 38 Oxley Street, Crows Nest, N.S.W. 2065.

"OXFORD"



THE METALWORK

SPECIALIST



HEATING SYSTEMS

PTY. LTD.

24 O'RIORDAN STREET,

ALEXANDRIA



WE ARE

MOVING TO

19 The Boulevard,

Caringbah 2229

Phone 524-0782

Convoy

FOR SOUND SATISFACTION

449 KENT ST.
(near Town Hall)
Sydney. 29-6475

THE SOUND EXPERTS

Let us supply you with sound tailored to your individual requirements from Sydney's widest range of high quality equipment.

New **Peerless**

Professional *High Fidelity*

New shipment just arrived from Denmark — complete new range with fully improved specifications.



Cameo Mark II

with aluminium voice coil formers in tweeter for flat frequency response extended spatial sound diffusion, very low distortion, high power capacity, at no increase in price. Cabinet size 21" x 11" x 9".

New Bass 12" 30 cycle cone resonance 146,000 total gap flux.

NEW TWEETER 2½ with aluminium voice coil former

New Mid-range 5 x 7" 250 to 4,500 closed back.

New Crossover 12 db/octave low pass, band pass and high pass filter on printed circuit specially designed for this system with crossover frequencies 500 and 3,500 cps.

TEAC

Convoy is proud to announce that we are now distributing Teac Tape Decks and Tape Recorders in New South Wales, to add to our fine range of semi-professional Tape Recorders, with new models such as the Teac '800', A.1200, Stereo Tape Deck combining 3 quality motors and 3 precision heads to provide outstanding performance, operating with simplicity of an all push-button (solenoid) system and many features such as stereo sound on sound, etc.

ON DISPLAY--Systems from \$200 to \$2000

We invite you to visit our showroom where only quality guaranteed equipment is offered.

CONVOY TECHNOCENTRE

TRADE RELEASES—in brief

DISTRIBUTORS CORPORATION PTY. LTD., 24 Johnston Street, Fitzroy, Vic. 3065. Distributors for NH Research Inc., U.S.A. Power Source, model 6120. A sinusoidal power source for the calibration of AC laboratory instruments. Features: silicon solid state construction except for power output stages; over-voltage and over-current circuitry to protect unit and instruments under test; power output 200W; frequency range 10Hz to 100KHz, accuracy 1pc of setting, and resolution three digits above 100Hz (two digits to 99Hz); maximum distortion .03pc from 400Hz to 1KHz, .05pc from 50Hz to 10KHz, and degrading to 1pc at 100KHz; current adjustable by front panel controls in 0.2, 0.4, 0.8, 2.0, 4.0, 8.0 and 20A stages; voltage controls are a five digit ratio transformer with decade attenuator and 10-turn vernier, taps are at 16, 40, 80, 160, 400, 800 and 1600V.

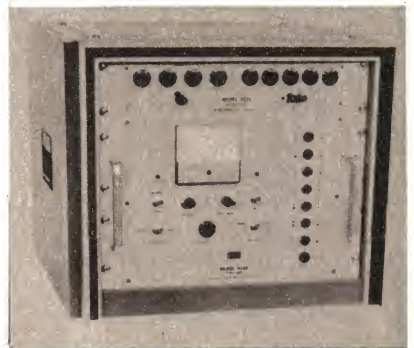

NH sine wave power source.

RCA LTD., 11 Khartoum Road, North Ryde, N.S.W., 2113. **Sound Distribution Amplifier, type TA-102C.** Designed and manufactured in Australia to meet the requirements for sound distribution, isolation, and level recovery applications in television and sound broadcasting, this amplifier is already being exported to the U.S.A. Features include: silicon transistors throughout; plug-in module design; feedback stabilised; five high-level outputs from either a single matching or from a bridging point; 600-ohm matching or bridging, balance input operation; test jacks on input, output, and supply rail; extremely stable and reliable performance.

E.M.I. (AUSTRALIA) LTD., Commercial and Advanced Electronics Division, 14-18 Parramatta Road, Homebush, N.S.W., 2140. **Blood Flowmeter, type SFMB-1.** An electromagnetic flowmeter intended mainly for measurement of phasic and mean flow in surgically exposed blood vessels. It works on the principle that the voltage induced in a conducting fluid which moves through a magnetic field is proportional to the velocity of that field. Based on a design by the University of Sydney (Surgery Dept.), the SFMB-1 employs square-wave transducer-drive current and amplifier gating.

NOYES BROS. PTY. LTD., 243 Angas Street, Adelaide, S.A. 5000. Australian distributors for Crompton Parkinson products. **AC Induction Motors.** The entire range of continuously rated AC induction motors of 25HP and above are fitted with embedded thermistors at no extra charge. Thermistor protection can be provided on smaller motors down to ½HP at a nominal extra cost. The embedded thermistors provide a simple yet effective means of protecting the motor against damage by overheating while permitting maximum utilisation of the motor's capabilities. Further information may be obtained from any branch of Noyes Bros. throughout Australia.

SOLARTRON AUSTRALIA, 112 High Street, Kew, Vic. 3101. **Data Transfer Unit.** Enables any digital instrument to be converted to a data logger at comparatively low cost. It has been designed for use with a wide range of strip printers, typewriters, teletypewriters, paper tape punches, or magnetic tape recorders, any two of which can be driven simultaneously. The punched paper tape or incremental magnetic tape recorder output can be used for processing by a digital computer. If required, scanner head units can be incorporated to monitor up to 20 different sources or, if two digital data sources are in use, to switch 10 signals to each. A digital clock can be included to allow scanning at selected time intervals and to provide time data for the



output mode. The unit automatically samples at the maximum rate possible. The practical limit of the unit with a scanner is about 150 samples per second; without a scanner it is about 6,000 samples per second.

ASTRONICS AUSTRALIA PTY. LTD., 161-173 Sturt Street, South Melbourne, Vic. 3205. Agents for Rohde and Schwarz, West Germany. **Automatic IC Tester, type ICMA.** Checks switching operations between inputs and outputs of digital circuits. Cycle time for logical function checks is 100µs per parameter: for measurements on relay circuits (current and voltage), it is about 8ms per parameter. A word generator delivers the necessary high and low logic levels for the input and output of the test item. A programmable level converter adjusts the input and output levels to suit the logic configuration tested. The actual and nominal levels of the signals are monitored on an analog comparator. Digital comparators check for coincidence between true and nominal input and output signals. Once the comparisons have been completed, an error store records whether go or no-go is to be assigned to the connection. The go/no-go readout is displayed immediately and is available for further evaluation at output sockets.

WARBURTON FRANKI INDUSTRIES (SYDNEY) PTY. LTD., 372 Eastern Valley Way, Chatswood, N.S.W., 2067. Agents for Narda Microwave Corporation, U.S.A. **Microwave sweep Generator, model 9500.** Covers frequency range from 1.0 to 12.4GHz in a single sweep without plug-in heads. Features: all solid state; can sweep in any combination of any selected portion or the total range; semi-automatic for making settings by frequency programming wheels; push-



buttons to set frequency limits and functions; all operational logic internal on plug-in printed circuit boards; four modes of operation—CW, dF, start/stop, and external frequency control; for systems use, both frequency and amplitude are programmable; digital programmed power supply can activate operation directly from a computer permitting a single interface; external programming has correlation of 1V equal 1GHz, 2V equal 2GHz, etc.

IRH COMPONENTS PTY. LTD., The Crescent, Kingsgrove, N.S.W., 2208. Agents for Emerson and Cuming Inc., U.S.A. **Eccoshield SV Tubing, type NI.** Flexible gasketing to control electromagnetic and RF interference with electronic equipment cabinets, microwave cavities and other electrical and electronic metal enclosures. The conductive tubing, which forms the outer part of the gasket, is a vinyl resin loaded with pure silver. A neoprene inner tubing assures good compression and recovery characteristics, and provides additional strength and expedience in forming butt joints of the outer conductive coating.

ALWAYS RELY ON R.D.S.

SPECIALS

R Matched prs., AC127/128 trans., \$1.20 nett.
D 200V pl diodes at 500MA, 25c nett each.
S STD Stereo plug 3290, 45c nett.
 DPDT Rocker switch No. 16, 45c nett.
 DPDT Slider switch 3570, 19c nett.
 P53p Stereo plug. Line jack. 80c nett.
 Pkts. mixed pots & conds. Great value. \$1.00 nett.

Compax Turntable. \$39.50 nett

The Independent Wholesaler

RADIO DESPATCH SERVICE

Radio and Electrical Distributors

869 GEORGE STREET, SYDNEY.

Corner George and Harris Streets
 Telephone 211-0816, 211-0191

Open Saturday mornings

EDDYSTONE EC10

Transistorised Communications Receiver

Completely Portable --- Battery Operated



**RUGGED
 COMPACT
 LIGHT!**
 Designed for Commercial and Amateur use. Ideal for marine purposes and remote operational areas. Covers citizens band

Write for fully illustrated technical brochure

Sole Agents:

R.H. Cunningham
 PTY. LTD.

608 Collins St., Melbourne, Vic. 3000. Phone 61-2464
 64 Alfred St., Milson's Pt., N.S.W. 2061. Phone 929-8066

34 Wolva Way, Balga, Perth, W.A. 6061. Phone 49-4919.
 L. E. Boughen & CO., 30 Grimes Street, Auchenflower, 4066. Phone 74097.

WORLD FAMOUS HI-FI STEREO EQUIPMENT COMES TO

ADELAIDE

- ★ LUX AMPLIFIERS
- ★ GRACE tone arms — magnetic cartridges
- ★ CELESTION co-axial loudspeakers
- ★ REVOX tape recorders
- ★ COMPAX belt drive turntables

An exciting new range of Hi-Fi Stereo equipment is now available to the South Australian enthusiast. Our comprehensive market research assures that we offer the best value for money and our realistic low prices are backed by guaranteed after-sales service.

New Speaker Kit Handles 15 Watt R.M.S.

Careful technical research has developed a new 2-way speaker kit capable of handling 15 watt r.m.s. (8" bass and 2" tweeter). Overall frequency response is 30-20,000 cycles and the kit sells for a modest \$23.50 (including crossover network). The kit can be used in vented enclosures up to 3 cu. ft. and also gives outstanding performance in less than 1 cu. ft. (infinite baffle).

LUSTRE Tone Arms, RICHARD ALLAN Loudspeakers, SOUND Amplifiers, PEERLESS Loudspeakers, SONICS Speaker Systems, P.E. Turntables, MICRO Magnetic Cartridges, KALTRO Loudspeakers, PLANET P.A. Amplifiers, COMPAX Radio Tuners, LONDON Microphones, LOUDSPEAKER CABINETS, GRILLE CLOTH, etc.

Challenge Recording Co.

6 GAYS ARCADE,
ADELAIDE

(off Adelaide Arcade)

Phone 23-2203

UNITED TRADE SALES

PTY. LTD.

POWER SUPPLIES

600V. 400 mA. Complete with 2 x 866A Rectifiers, 2 x 500mA Filter Chokes on 19in Rack Panel. Good condition. Weight approx 50lb.

\$15.00.

Freight extra.

VALVE SPECIALS

833A.	\$6.00 (use	6S7J.	60 cents.
872A	75 cents.	5V4.	\$1.00.
6SL7.	\$1.00.	6AL5.	30 cents.
6SN7.	60 cents.	6AU6.	\$1.00.
6A8G.	\$1.50	6J6.	30 cents.
6J8.	\$1.75	6K7.	50 cents.
6K8.	\$1.00.	6J7.	50 cents.
6B8.	\$1.50.	813.	\$6.00.
6U7.	60 cents.	807.	70 cents.
6SK7.	75 cents.	5U4.	\$1.00.
6AC7.	20 cents.	5R4.	\$1.00.
6X4.	60 cents.	12AT7.	50 cents.
6X5.	75 cents.	815.	70 cents.
6AM6.	65 cents.		

Postage extra.

RECEIVERS

AWA Type 1C8388 — 2.5MHz to 22MHz.
14 Tubes B.F.O. 455KC. xtal filter.
A.V.C. Fast and Slow S meter.
Octal tubes. Separate power supply.
With speaker. Plug in coils.
Nice clean condition, weight approx 60lb.

A bargain at \$50.
Freight extra.

NU-METAL SHIELDS

To suit 5BP and other 5in CRTs mfd. by Magnetic Shields Ltd. Brand-new, \$5 ea. plus 30c pack. and post.

TAPE HEADS

Cassette Recorder Type Replay Heads. 2-track Mono Current Manuf.

New \$1.50 ea.

PLUS 10c pack. and post.

CAPACITORS

80 for \$2 in Poly Packed Bags. Mixed values only.

TRIO TR2E

2-METRE TRANSCEIVER

- Triple conversion receiver with crystal locked second and third oscillators for maximum selectivity and sensitivity.
- Separate VFO tuning for both receiver and transmitter.
- Nuvisor RF amplifier.
- Provision for crystal locking of the transmitter.
- 12 volts DC (internal transistor power supply) and 230-240 volts AC operation.
- Noise limiter and squelch.
- 17 tubes, 4 transistors and 7 diodes.
- 1 microvolt sensitivity for 10 db. S/N ratio at 14 6 Mc.
- "S" meter, RF output meter and netting control.

Price: \$282.

3,000 TYPE RELAYS.

Large range. Only 50c each.

COMPLETE RANGE OF METERS.

	P25s	24sq.	
100uA . . .	\$6.95	1mA . . .	\$4.50
500uA . . .	\$5.25	50mA . . .	\$4.50
10mA . . .	\$4.50	S'meter . . .	\$5.25

MULTIMETERS, 200H, 20K ohms per volt, \$11.25, incl. tax. CT 500 20K ohms per volt, \$15 incl. tax. CT 330 20,000 ohms per volt, \$17.25.

COSSOR 1049 Double Beam Oscilloscopes in good condition. Fully checked.

\$85.

Freight extra.

TRANSISTOR V.H.F. CONVERTER

Tunable 108-136 Mhz Aircraft Band 1F-600Kc to 1,000Kc. No connecting wires needed, 9V Battery, self-contained, just place alongside broadcast radio. Price only \$14.40 plus 45c postage.

TRANSISTORS

2SC73, 2SD65, 2T76, OC66, 2T65 25c ea. or in 100 lots 20c ea.

LSG11 SIGNAL GENERATOR

120KHZ to 260 MHZ New in sealed carton \$35, postage \$1.

MILLER TRANSISTORISED IF STRIPS

455 Kc Selectivity 5 Kc at 6db down. Power 6 Volts 2mA gain 50db.
Price: \$9.70.

RESISTORS. Mixed Values only in Bags; \$2 per 100, or 50 for \$1. 3,000 Type Relays. New stocks. 50c each. Plus postage.

WANTED BUY:

RECEIVERS, TRANSMITTERS
TEST EQUIPMENT.

All prices subject to alteration without notice. All items PLUS POSTAGE.

280 LONSDALE STREET,
Melbourne. Phone 663-3815.

(Opposite Myers)

VITRAMON PTY. LTD., P.O. Box 140, Rockdale, N.S.W., 2216. **Quadrature coupler.** Applications include matched detectors, PIN modulators, SPDT and DPST switches, balanced amplifiers, and balanced mixers. Features: balun design gives octave bandwidth from VHF to

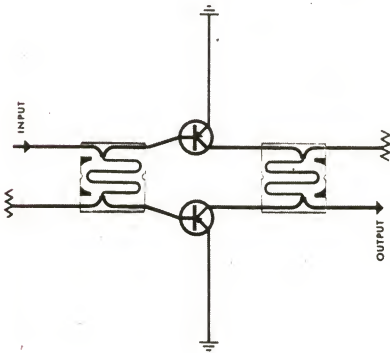

G-band; size .04cu.in; packaged in alumina microstrip; power rating 300W from -55 to +71 degrees C; minimum isolation -25dB; main line VSWR 1.25; insertion loss under 0.2dB; coupling amplitude balance 0.5dB; phase balance 2pc.

HEWLETT-PACKARD AUSTRALIA PTY. LTD., 22-26 Weir Street, Glen Iris, Vic. 3146. **Hybrid Hot-Carrier Diodes, types 5082-2810/11.** Typical applications include: mixer and detector to 3GHz; logarithmic circuits (e.g. analog multipliers, signal compressors); high-speed sampling circuits; pulse steering circuits. Features: low junction capacitance 1.2pF; high forward conductance 20 to 35mA at 1V; low turn-on voltage 410mV at 1mA; peak inverse voltage 20V (type 5082-2810) and 15V (type 5082-2811); nearly logarithmic forward V/I curve.

RAYCHEM CORPORATION, Menlo Park, California, U.S.A., has established an Australian subsidiary, Raychem Pty. Ltd., located at 129 Queen Street, Alexandria, N.S.W. 2015 telephone 69-7974. Mr Anthony B. Maple-Brown has been appointed general manager of the new organisation. Mr Maple-Brown, a native of Sydney, has been with Raychem in California since January, 1969. Previous appointments have been with Conrac Corporation in Los Angeles, the Livingston Group in London, and Television

TEKTRONIX AUSTRALIA PTY. LTD., 80 Waterloo Road, North Ryde, N.S.W. 2113. **Dual-beam Oscilloscope, model R5030.** High gain LF oscilloscope with differential as well as current input. Features: sections of controls colour coded to outline functions; simplified switching; scale factors read out via fibre optics; each beam has full scan of 8 x 10 divisions (1.27cm per division); readouts indicate current or voltage deflection factors plus time as set by deflection controls; with any control in uncalibrated position, the variable knob shows red and scale factor readout shows a greater-than sign



Tektronix oscilloscope model R5030.

Corporation Ltd. in Willoughby, N.S.W. Raychem manufactures heat-shrinkable tubing and moulded parts, high temperature airframe wire, special devices and heating devices.

HAWKER SIDDELEY DYNAMICS, Hatfield, Herts, England. **Mynapak.** A second generation interconnection system for integrated circuits with applications in the data transmission and handling, and control engineering fields. In a package measuring approximately 2in x 1in x 0.16in, Mynapak can contain up to 25 ICs and 25 other thick film and chip components to customer's specifications. The package has 40 leads in dual in-line format on 0.1in centres. Mynapak can dissipate up to 6W without a heat sink.

H. ROWE & CO. PTY. LTD., 7 Flinders Court, Melbourne, 3000. Agents for British Physical Laboratories, U.K. **Transistorised Universal Meter, model TVM 1070.** Features: uses silicon planar transistors; stable instrument with freedom from drift and temperature inaccuracies; 43 AC and DC ranges with linear scales; ranges selected by a single colour-coded and clearly marked control; cabinet includes storage space for leads and probe.



B.P.L. Universal Meter.

COMPUTER ACCESSORIES PTY. LTD., 5 Badham Street, Dickson, A.C.T. 2602, has appointed Mr John Beetham as systems adviser of its newly formed Melbourne branch. Mr Beetham will advise on computer peripheral equipment and supervise the supply and servicing of this equipment from the Melbourne branch to computer users. He is a communications engineer and was formerly with Siemens Industries Ltd. where he specialised in systems design and the preparation of remote control keyboard machines.

in front of scale factor; a "Locate" function associated with the time-base magnifier allows operator to pick out where on the trace he is using a magnified sweep; trigger circuit includes peak-to-peak auto circuit and a combined trigger level/slope control; beam finders on intensity controls; lamps to indicate operating mode; input sensitivity 10uV/div; differential inputs for each beam with 100,000:1 common mode rejection ratio; current probe inputs for each beam with deflection factors of 1mA to 200mA/div; constant bandwidth of 1MHz at all deflection factors. When in the peak-to-peak auto triggering mode, the operator can go through the maximum excursions of the displayed signal on either slope and never reach an untriggerable position on the control. The first in a new series of non-plug-in oscilloscopes, the R5030 is available as a rack-mounted version that requires only 5 1/2 in of rack or as a low-profile cabinet model.

SIMPLIFY INTRICATE WORK with

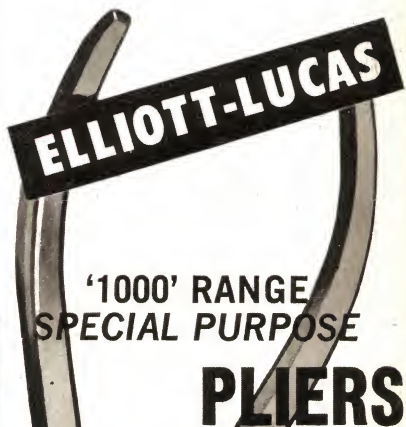

Designed specifically for instrument and electronic technicians to handle fine, precision work, the Elliott-Lucas 4 1/2" size '1000' series is available in Box Joint or Single Joint Tools. All bright finish, in individual Display Packs or in Plastic Tool Roll sets of three or six.

DIAGONAL CUTTING NIPPERS

SNIPE NOSE PLIERS

SNIPE NOSE SIDE CUTTING PLIERS

FLAT NOSE PLIERS

ROUND NOSE PLIERS

END CUTTING NIPPERS

Australian Representatives:

THOMAS C. BROWN

& CO. PTY. LTD.

Sydney • Melbourne • Adelaide
Brisbane • Perth

TCB/82

testing testing testing

FOR THE ADVANCEMENT
OF BETTER TRANSFORMER AND
COIL DESIGN



Telecomponents transformers and coils are tested and retested—subjected to the industry's most rigid quality control procedures and manufactured in accordance with the highest standards. We pride ourselves on being small enough to give close personal attention to your needs—big enough to meet your production demands.

TELECOMPONENTS

PTY. LTD.



A Hawker Siddeley Company

Head Office and Factories — Brookvale: N.S.W. Phone 93-0221,
Melbourne: 387-1899. Brisbane: 68-4344. Adelaide: 57-8153

61FB4781/969

PRE-CHRISTMAS SPECIALS

STEREO-AMPS

Bogen 150	\$225
J. G. Twenty	\$115
Sanyo DC60	\$195
Trio TK400	\$165
Akai 5000	\$225
Sansui AU70	\$225

RECORDING TAPES

RCA 5½" x 900' AC	\$2.00
Mastertone 7" x 1800' Pol.	\$3.00
OCL 5" x 1200' Pol.	\$1.95
RCA MT 7" Reels Boxer	65c

B.A.S.F. scoop buy specials at wholesale, reserved for personal shoppers only.

STEREO PHONES

Hosiden	\$ 7.50
Akai	\$18.75
Toshiba	\$22.00
Sansui	\$21.00

GRAMS

Hitachi 1 piece	\$199
Hitachi 4 piece	\$268
Tempo 3 piece	\$199
Regal 3 piece	\$149
Toshiba 3 piece	\$164
Electra 1 piece	\$ 59

TAPE RECORDERS

Sony TC230W	\$225
Grundig TK23	\$ 95
Grundig TK14	\$ 65
Oki 333	\$175
Oki 300	\$145
National 780S	\$275
Hanimex 4 Track	\$168
Sharp RD709	\$399

SPEAKERS IN ENCLOSURES

Tempo 5 Way	\$39
Tempo Miny	\$29
Kenwood Miny	\$45
Sony 103	\$50
Leak	\$99
National 8" Twin	\$35
National 10" 3 way	\$75

WALKIE-TALKIES

Contact 1 watt	\$80 ea.
Nikka 1 watt	\$65 ea.
Fujitsa 100 mw	\$39 ea.
Ralmar 100 mw	\$23 ea.
Communicator 100 mw	\$19 ea.
Tokai TC9 100 mw	\$35 ea.
Tokai TC11 100 mw	\$45 ea.
Tokai Pt51 100 mw	\$49 ea.
Seiwa 100 mw	\$25 ea.

★ ALL GOODS PLUS POST-
AGE TO COUNTRY CLIENTS.

PETER SHALLEY Electronics Pty. Ltd.

127 YORK STREET (just near Town Hall) Sydney 29-7021 29-3767

PLASTIC STORAGE BOXES

CARTEX P T Y. LTD., 375 Kent Street, Sydney, 2000. **Termotex Box System.** Manufactured in Denmark, the system consists of a series of strong plastic boxes fitted with partitioned clear plastic drawers for storage of small items, such as nuts and bolts. Boxes are fitted together by an inconspicuous form of dove-tailing, and drawer handles have plastic covered slots for identification labels. Each box has counter-sunk screw holes for fastening to walls. Special mounting plates are available so that boxes can be hung from shelves. The boxes, in different styles with adjustable partitions, are 5.14in wide x 2.88in high x 6.48in deep. A larger box, twice the size of the standard box, is also available. Supplies should be

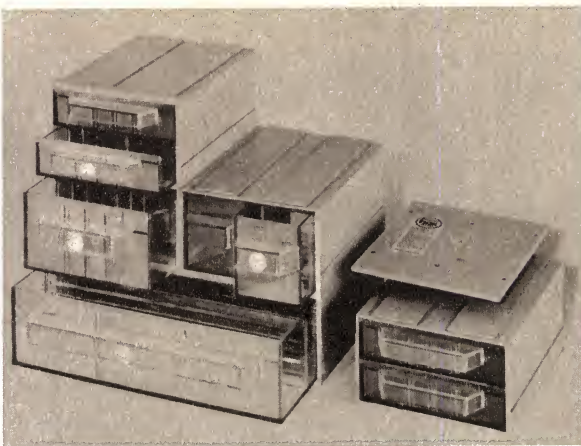

A selection of Termotex boxes with a self mounting plate fitted to the right hand box.

available through normal trade channels. Trade inquiries should be on company letterhead.

ASTOR RECORDS, a division of Electronic Industries Ltd., 161 Sturt Street, South Melbourne, Vic. 3205, has obtained from MCA Records International of U.S.A. the manufacturing and distribution rights for the immediate release of material from the English MCA and American UNI catalogues. The material from these catalogues will be released in Australia under a newly-formed MCA label. Astor Records will also be granted the Australian and New Zealand rights for the American Decca and Kapp group of labels from January 1, 1970.

FAIRCHILD AUSTRALIA PTY. LTD. has moved its Sydney office to Regent House, 37-43 Alexander Street, Crows Nest, 2065, phone 43-7508.

RELAYS PTY. LTD., 15 Hume Street, Huntingdale, Vic. 3166, has appointed Mr A. D. Phillips as assistant general sales manager. Mr Phillips was previously manager, engineering sales, for Australian General Electric Pty. Ltd. in Melbourne.

TAPE RECORDERS PTY. LTD., 49-51 York Street, Sydney, 2000, has announced the change in name only of its principal, Thermionic Products Electronics Ltd., to Rascal-Thermionic Ltd. The Thermionic range of equipment includes both analog and digital magnetic tape recording systems for military, civil and industrial applications.

PHILIPS INDUSTRIES LTD., 69-79 Clarence Street, Sydney, 2000, has announced that Mr H. D. Huyer, the new company chairman and managing director, has arrived in Sydney to take up permanent residence in Australia. Mr Huyer's predecessor was Mr A. J. W. van Agt who relinquished his post after four years in Australia because of ill-health. Mr van Agt has returned to Eindhoven, Holland, where he has taken up a new appointment. Prior to this assignment, Mr Huyer was with Philips in Greece, Nigeria, Singapore, South Africa, Egypt and Pakistan.



Mr H. D. Huyer.

IBM AUSTRALIA LTD., Bradfield Highway and Kent Street, Sydney, 2000, has appointed Dr Frank Barr-David as director of data processing marketing for the Australia/New Zealand region. He succeeds Mr A. K. Kapp, who returned recently to the U.S.A. Dr Barr-David, an Australian with a doctorate degree in chemical engineering from Yale University, has been with the headquarters of IBM World Trade Corporation in New York as assistant to the vice-president of marketing. Prior to this assignment he held positions with IBM in Sydney and Melbourne.

B.W.D. ELECTRONICS PTY. LTD., 331-333 Burke Road Gardiner, Vic. 3146, has appointed Mr Larry Yuille as marketing manager of the non-destructive testing equipment division which will directly distribute the full range of Lectroflux magnetic particle inspection equipments.

HONEYWELL PTY. LTD., 863 Bourke Street, Waterloo, N.S.W., 2017, has announced the following appointments: Mr Reg J. Rawlings, C. Eng., M.I.E.E., as marketing manager of the Micro Switch division, and Mr R. N. Carroll as product manager of the same division. Prior to this appointment, Mr Rawlings was for eight years national manager, electronics division, Australian General Electric Pty. Ltd.

VITRAMON PTY. LTD., 534-536 Princes Highway, Rockdale, N.S.W. 2216, has initiated part-Australian manufacture of high-stability, high-reliability, MIL-approved porcelain and ceramic capacitors for defence, aerospace and other applications. Hitherto, all capacitors of this type were fully imported. Vitramon plans to increase progressively the Australian content until total local manufacture is achieved.

PLESSEY ROLA PTY. LTD., The Boulevard, Richmond, Victoria, 3121, has appointed Mr Ian M. Cairncross as sales manager of the special products unit responsible to the general sales manager, Mr Maurice Smith. Mr Cairncross has had several years' experience in the electrical and electronic wholesaling field.

RESISTORS

1/2w 4c each or \$3.00 per 100

POLYESTER CAPACITORS

.001mf — .01mf 7c each
all values available

ELECTROLYTIC CAPACITORS

all values — 5mf — 12c
Send for list.

SPECIAL — NEW GREY PLASTIC CABINETS — Suit. instruments or kits
5 1/2" x 4" x 3" only
25c each or 10 for \$2.

S. E. WILLIS TRADING CO.
38 RIVERSDALE RD., 82-5787
CAMBERWELL JUNCTION, VIC. 3124

AUSTRALIAN PAPER MANUFACTURERS LIMITED

MARYVALE MILL

INSTRUMENT ENGINEER

Australia Paper Manufacturers Limited has a vacancy for a qualified Engineer at its Maryvale Mill near Morwell, 100 miles east of Melbourne.

The mill which is situated in a pastoral/industrial region of about 60,000 population manufactures pine and eucalypt pulps as well as finished papers for the packaging industry.

The successful applicant, who will be required to have experience or knowledge of pneumatic and electronic instrumentation, will be responsible to the Control Systems Engineer for the installation and maintenance of all instruments and control systems.

Salary will be negotiated according to qualifications and experience and assistance will be provided with relocation expenses. A commencing salary of \$6,000 is envisaged, and we will pay more for the right man.

Staff conditions include 3 weeks annual leave, a Superannuation scheme and excellent sick leave cover.

Written applications, stating full particulars of qualifications and experience, should be addressed to:—

PERSONNEL SUPERINTENDENT,
Australian Paper Manufacturers Limited,
P.O. Box 37, MORWELL. 3840.

TECHNICAL BOOKS AND PUBLICATIONS

Handbook of Semiconductors, Instruments

HANDBOOK OF TRANSISTORS, SEMI-CONDUCTORS, INSTRUMENTS AND MICROELECTRONICS. By Harry E. Thomas. First printing, 1968. Published by Prentice-Hall, Inc., Eaglewood Cliffs, N.J., U.S.A. Hard covers, high-quality binding; 453 pages, 9½ x 6½ inches, freely illustrated by diagrams, circuits and tables. Australian price \$17.40.

The author of this book, Harry E. Thomas, is an experienced author and lecturer, having held appointments with the Massachusetts Institute of Technology, Temple University and Fairleigh University. He holds the B.S. and M.S. degrees and has performed supervisory engineering assignments for I.T. & T. His background and experience certainly qualify him to produce a book of this nature.

It is well described by its title "Handbook." While it contains a certain amount of connective and explanatory text, it is more particularly a medium for diagrams, tables and circuits relevant to the subject. As such, it should be a valuable source of reference for advanced students, advanced technicians and practising engineers, supplementing more organised tuition.

The first three chapters cover the basic physics of solid-state devices and technology. The chapter headings: "Semiconductor Physics" — "Transistor Physics. Construction And Action" — "Semiconductor Materials and Junction Formation." All this is compressed into 40 pages.

Chapters 4, 5 and 6 deal with diodes and power rectifiers, special diodes (tunnel, zener, varactor, backward, etc.), controlled diodes (SCRs) of one type and another, and unipolar transistors (FETs). These chapters are concerned not only with the physics and operation of such devices,

but with performance data, ratings and circuit applications.

Chapters 7 and 8 cover transistor types, construction terminology, ratings, characteristics. Their practical application to basic amplifier and oscillator circuits follows in chapter 9, with switching, digital and pulse applications in chapter 10.

Configurations and techniques for testing transistors and diodes are covered in further chapters spanning some 54 pages.

Sundry other semiconductor devices share a chapter on "Microwave, Photo and Thermal Devices." Reference is made here to such things as microwave applications, thermistors, Hall generators, etc.

Other chapters deal at some length with the new breed of laboratory instruments which have made their appearance with semiconductor technology. And, finally, there is a chapter on microelectronics and integrated circuits.

Towards the end of the book, some 50 pages are devoted to appendices. These include a number of to-be-expected items such as the international system of units, other units and constants, conversion factors, semiconductor abbreviations symbols, tables, etc. However, there is also supplementary material on such subjects as parametric amplifiers, wide-band video amplifiers, laser types and terminology, etc. Last item in the book is a brief — perhaps inappropriately brief — index.

The book is well printed and well produced and must be adjudged as a useful addition to any technical library. Our copy came from Prentice/Hall of Aust. Pty. Ltd., 242 Pacific Highway, Crow's Nest, 2065. (W.N.W.).

RADIO ENTHUSIASTS

Learn amateur radio in your spare time.

Whatever your interests are in amateur radio, there's a Stott Radio course for you. Easy to follow. Practical. Modern. Guidance all the way by top-flight radio engineers.

Radio for amateurs

Learn the exciting skills of building modern radio receivers. Learn about the latest advances in electronics, design, construction and operation.

Let Stott's show you how.

Amateur Operator's Certificate Course: Broadcasting is fascinating. Stott's offer an entirely new course that enables you to sit for the Amateur Operator's Certificate of Proficiency Examinations with complete confidence.

Get full details now on Stott's Radio Courses.

POST THIS COUPON TODAY

Stotts



TECHNICAL CORRESPONDENCE COLLEGE

159 Flinders La, Melbourne. 383 George St, Sydney
290 Adelaide St, Brisbane. 45 Gilles St, Adelaide.
1130 Hay St, Perth.

Please send me, free and without obligation, full particulars of your courses in Radio for Amateurs.

Mr Mrs Miss.....

Address.....

Age.....

No sales representative will call

EA 1169

RCA Integrated Circuit Handbook

RCA LINEAR INTEGRATED CIRCUITS. Handbook published by Radio Corporation of America and available from Amalgamated Wireless (Australasia) Pty. Ltd., Rydalmere, 2116. Paper cover, 351 pages, 8½ x 5in. Fundamentals, applications and specifications for RCA linear integrated circuits. Price \$3.

Although written primarily for advanced technicians, designers and engineers, this handbook of integrated circuit applications begins commendably at a fundamental level. While only brief, the fundamental introduction is the basis for a more detailed treatment of most aspects of linear integrated circuit applications.

Tabled in the list of contents as "General Considerations" the introductory section deals with integrated circuit fabrication and presents some comparisons between integrated circuit and discrete component fabrication techniques. Various thermal and voltage limitations are explained and reasons for the various internal circuit configurations are given.

The differential amplifier is basic in the design of most integrated circuitry and this essential configuration is treated in some detail. In the section devoted to this configuration, its basic characteristics are given together with a fundamental explanation of the effects of emitter degeneration, voltage and current off-sets and the requirement of constant current sinking.

A third section deals with the extension of differential pairs into complete integrated operational amplifiers. All aspects of the operational amplifier building block are dealt with, from general considerations and basic operational amplifier theory to the more practical aspects of phase compensation and circuit stabilisation.

The remaining two-thirds of the book are devoted to descriptions and typical applications of RCA linear integrated circuits. A table of device types and their intended applications, given at the beginning of this section, will be most helpful in the selection of suitable devices.

Device applications include DC, audio and video amplification. Considerable treatment of integrated circuits for RF applications is given; applications include IF amplification and detection. Included are integrated circuits for specialised applications; for example, a device performing the three operations of IF amplification, detection of frequency modulation and audio preamplification.

Another specialised device is an integrated array of diodes intended for such applications as balanced mixer, ring modulator and series-shunt RF gating. Yet another useful device is an array of independent transistors used individually but as a composite electronic building block.

The handbook concludes with a comprehensive table of specifications and data for approximately 43 separate linear integrated devices, together with physical specifications for the various package configurations.

Although the binding leaves a little to be desired by way of strength, the handbook nevertheless contains a wealth of valuable information useful at both engineering and technician level. In summary, it is a technical publication which I can thoroughly recommend. (A.J.L.)

FET projects

FET PRINCIPLES, EXPERIMENTS AND PROJECTS, by Edward M. Noll. Published by W. Foulsham and Co. Ltd., London, 1969. Hard covers, 5½in x 8½in, 272pp., many circuits and diagrams. Price in Australia \$6.80.

Now that high performance field-effect transistors are readily available at low cost, it is not surprising that both professional designers and amateur experimenters are using these devices in ever-increasing numbers. One might perhaps be permitted the suspicion that, apart from the low cost and ready availability of the devices, further significant factors responsible for their rapid acceptance might be

their relative novelty and their similarity to thermionic valves. The latter factor, quite understandably, seems to make them of particular interest to those "old timers" who have never quite adjusted to the bipolar transistor.

To be fair, FETs do offer a number of distinct advantages over bipolar devices. There are thus quite valid and objective reasons for their growing applications.

Because FETs differ in their operation from both bipolar transistors and thermionic valves, despite similarities to both, their effective use requires an understanding not only of the basic principles involved but also of the implications of these principles concerning practical circuit design and operation. A number of books have been published in the past few years with the aim of providing this information, and most of them have been fairly successful — although many have been pitched at a rather high level.

This latest addition to the field appears to be one which should be of particular interest to amateur experimenters and students. It is pitched at a moderate technical level and, while dealing with basic principles, it has a strong practical orientation.

The author, Edward M. Noll, is a well-known and accomplished technical writer—one of his previous books is the familiar "Television for Radiomen." He is therefore well qualified to produce a book of this type.

The book commences with a brief and somewhat sketchy introduction to FET device operation and construction. However, after this slightly weak start it progresses to more practical matters, and the text becomes more satisfying. Successive chapters deal with AC amplifiers in general, audio amplifiers and oscillators, high frequency amplifiers and oscillators, communications and special circuits. Then follows a chapter on basic mathematics applying to FET circuit design, and finally three chapters devoted to practical construction projects. The latter include audio amplifiers, timers, broadcast band and short-wave tuners, and low power amateur transmitters.

With the exception of the initial theory section the text appears to be well written, and provides a considerable amount of valuable information regarding FETs and their applications. There are criticisms which may be made, however, and probably the most important as far as this reviewer is concerned is the lack of discussion of parameter spread and its relevance to the designability of quiescent operating point. Interpretation of data sheets is not adequately covered, nor is there sufficient treatment of the very useful mutual conductance characteristic—very often of far more practical use than the V_d - I_d curves.

Despite these criticisms the book contains much useful material, and should be of both interest and value to many seeking a practically orientated guide to field effect devices.

The review copy came from the Australian agents for Foulsham-Sams, who are Grenville Publishing Company Ltd. This firm advises that the book is already in stock at all major bookstores. (J.R.)

Simple projects

104 SIMPLE ONE-TUBE PROJECTS.
By Robert M. Brown. Published by TAB Books, Blue Ridge Summit, PA.17214. Stiff paper covers, 192 pages 8½in x 5in, circuit diagrams only. Price in Australia \$4.95. Hard cover edition \$8.70.

After a series of books detailing simple transistor projects, it is a change to find one devoted exclusively to valves. The format is the same, however. Each project has an impressive sounding title, a circuit, a parts list and a small amount of text which is as much concerned with selling the idea as it is with giving the constructor much needed information.

Circuits which are elementary, even

Important!

Closer channel spacing for V.H.F. Mobile Radiotelephone Services

Changeover must be made by 31st December, 1969

Licensees of V.H.F. land and harbour mobile radiotelephone services operating in 30 kc/s channelling areas are advised that if they have not already installed base station equipment which meets the Australian Post Office Specification for 30 kc/s channelling operation they must do so by 31st December, 1969.

Licences issued in respect of services which have not met this requirement by that date WILL BE SUSPENDED until the necessary equipment changes have been effected. Licences falling due for renewal during the suspension period will be cancelled.

Operation of a service while the relative licences are suspended is illegal.

Licensees whose services operate within 30 kc/s channelling areas and who have not already arranged for installation of approved equipment should do so immediately.

Further details may be obtained from the Superintendent, Radio Branch, G.P.O., in your Capital City.

Australian Post Office

TRANSFORMERS FOR PROJECTS

Specialists in the small-batch production of high-quality Transformers for industrial and entertainment equipment. Transformers can be produced for any project published, or to your own special requirements.

Facilities available for vacuum impregnation in a wide variety of materials or complete encapsulation in Epoxy or Polyester resins.

Trade and retail enquiries handled throughout Australia, New Zealand and the Pacific Islands.

TRANSFORMER WINDERS LIMITED

37 CRUMMER ROAD, AUCKLAND, NEW ZEALAND.

LET THE WORLD OF POSTAL EDUCATION TRAIN YOU FOR A TOP JOB

BRANCHES THROUGHOUT THE WORLD

Great Britain, Canada, Israel,
Singapore, Hong Kong, Thailand,
India, Ceylon, South Africa, Sudan,
Kenya, Rhodesia, Zambia, Tanzania,
Malawi, Lebanon, Malta, Italy,
Netherlands, U.S.A., Australia,
New Zealand, British West Indies.



TODAY

there are wonderful Opportunities for the forward-looking man and woman. However, the best jobs go to those who have the foresight to prepare themselves by proper training. British Institutes have already trained some 300,000 men and women who have reached the top of the ladder. Therefore, it is up to YOU to make something of yourself. Don't delay, act NOW. Remember that an enquiry places you under no obligation but could be the turning point in YOUR career.

CHECK THESE FEATURES:

- Modern streamlined methods . . . you learn the fast way and make rapid progress.
- Courses based on STANDARD TEXTBOOKS . . . Lessons and Model Answers written and planned by experts.
- We provide all necessary text-books which remain your own property.
- Moderate fees payable by small monthly sums. Written guarantee.
- Courses can be "tailored" to individual requirements.

OVER 500 COURSES offered by British Institutes include:—

TECHNICAL

Aero Engineering
Air Conditioning
Architecture
Arch. Drawing & Design
Auto. Engineering
Building (all branches)
Carpentry & Joinery
Chemical Engineering
Civil Engineering
Computers
Die & Press Tools
Diesel Engineering
Draughtsmanship
Electrical Engineering

Elec. Installations
Electrical Machinery
Electricity Supply
Electronics
Foremanship
Foundry Practice
Garage Management
Geology
Hydraulics
Illuminating Eng.
Industrial Chemistry
Jig & Tool Design
Machine Drwg. & Design
Maintenance Eng.
Management

Marine Engineering
Mechanical Eng.
Metallurgy
Municipal Engineering
Naval Architecture
Painting & Decorating
Petroleum Technology
Plastics
Production Engineering
Radio Engineering
Radio Servicing
Refrigeration
Reinforced Concrete
Road Engineering
Rubber Technology

Sanitary Engineering
Structural Engineering
Surveying
Telecommunications
Television Servicing
Timber Technology
Tracing
Welding Technology

COMMERCIAL

Accounting
Advertising
Auditing
Banking
Book-keeping
Business Management
Commercial Art
Commercial Law

Computer Programming
Costing
Data Processing
Economics
Fiction Writing
Journalism
Office Management
Personnel Management
Salesmanship
Secretaryship
Shipping
Travel

GENERAL

European Languages
Mathematics
Shorthand
Typewriting

And many other Subjects.

Details of Engineering and Commercial Exams., Certs. of Competency, Matriculation, etc.



**SECURE
ONE OF
THESE
BOOKS**

**POST
COUPON
NOW!**

British Institute of Careers

Dept. B169 College House,
113 Pacific Highway, North Sydney, 2060

I am interested in _____
Please send me the appropriate Career-Book.

Name (Please print) _____

Address _____

Occupation _____ Age _____



**BRITISH
INSTITUTE
OF
CAREERS**

In association with
British Institute of
Engineering Technology

THE B.I.C. GROUP LEADS THE WORLD IN POSTAL TRAINING

primitive, all get a build-up, with fact giving place to eloquence. Lest I seem to be exaggerating, consider an item on page 86. Here, a "Powerful Guitar Amplifier" turns out to be a single 6BM8, that would be hard put to it to produce better than 3 watts. But the reader is told:

"With this inexpensive, yet powerful one-tube guitar amplifier, all you need is a regular run-of-the-mill classical guitar and a few hours of patient practice to become a guitar virtuoso."

Sabicas, here I come! Certain circuits might work but I can't see why; and the text doesn't help to clear up the problem. Others I find unconvincing, such as those which show a 6AQ5 driven by a crystal microphone. Still others are inappropriate in Australia, because they have to do with CB equipment or non-acceptable transmitting devices. Having said as much, it must be admitted that the author faces no easy task in finding over one hundred one-tube circuits.

Included in the items are such things as: VLF receiver—modulation 'scope—Q multiplier—screen modulator—capacitor

checker—electroscope—signal generator—Geiger counter—grid dipper—SSB detector, etc.

With 104 circuits to choose from, the hobbyist must "strike oil" with some; enough, we would hope, to justify the purchase price for the paperback edition.

Like most other books of its type, this one must be regarded as a source of ideas. Some of them will be rewarding; others are almost certainly doomed from the outset. Our copy came from Grenville Publishing Co. Pty. Ltd., 401 Pitt Street, Sydney, 2000. (W.N.W.)

Digital servicing

SERVICING DIGITAL DEVICES, by Jim Kyle. Published by W. Foulsham and Company Ltd., Slough, England, 1968. Hard covers, 5½in x 8-5/8in, 144 pp., illustrations and diagrams. Price in Australia \$4.40.

The stated aim of this recent Foulsham-Sams release is to provide the electronics

service technician with the specialised knowledge needed to become competent at digital equipment servicing. The author acknowledges that most computer installations are serviced by manufacturer-trained and employed personnel, so that by implication his book is not aimed at turning the reader into a computer technician; however, he points to the growing numbers of non-computing digital equipment coming into use, and suggests that it is this equipment to which the book is orientated.

Within this rather limited context, and as far as it goes, the book seems to be moderately successful. It provides a useful basic introduction to the various concepts involved in digital circuit operation, a brief survey of various types of digital equipment, an introduction to functional systems, a brief discussions of servicing equipment and trouble-shooting techniques, a look at diagram interpretation and symbology, and a discussion of digital terminology and jargon.

The trouble is that, to this reviewer, the book doesn't go nearly far enough or deep

Microwave diodes

PHYSICS OF MICROWAVE SEMI-CONDUCTOR DIODES, by S. N. Ivanov, N. A. Penin, N. E. Skvortsova and Yu. F. Sokolov. Published by Iliffe Books Ltd., London, 1969. Hard covers, 5½in x 8-5/8in, 163 pp., many diagrams. Price in U.K. 60s.

The authors of this book are all semiconductor research physicists working at institutions in the U.S.S.R. In their preface they suggest that the aim in writing the book has been to integrate the vast amount of theoretical and practical knowledge concerning microwave behaviour of non-linear elements which has been amassed to the present day, ordering and systematising it to produce an up-to-date and thorough treatise on the subject. The publisher claims that they have succeeded in this aim to the extent that the book represents the first really comprehensive treatment of microwave diodes for twenty years.

Although this reviewer cannot profess the background which would be necessary to judge the validity of this claim, it would certainly appear that the book presents a most systematic and coherent treatment of its subject. The material is up to date, its exposition concise and orderly, and there is much use of experimental material in illustrating and justifying theoretical deductions.

The text is divided into but two chapters. The first develops the theory of the P-N junction to cover low lifetime and narrow base situations, deriving circuit models applicable to actual devices wherever possible. The second chapter then builds upon these concepts in dealing with specific devices, dealing in turn with square-law detectors, tunnel diodes, parametric diodes and switching diodes. The book ends with a list of some 41 references, book titles for suggested further reading, and an index.

As a whole the book gives every evidence of being well conceived and very carefully executed. Its four authors certainly seem to have produced a work which should be of considerable interest and value to anyone

either working with, or concerned with the theory of, microwave devices.

A book which may be highly commended, then, not only to microwave engineers, but also to solid state physicists and senior research students.

The review copy came direct from the publisher, and no information was supplied regarding local price and availability. However if past experience is a guide, copies should be available from the larger bookstores by the time this review appears. (J.R.)



**CONVERTERS
FOR AIRCRAFT,
MARINE, FIRE,
AMATEUR BANDS**

**SOLID STATE RF FET CONVERTER
CRYSTAL CONTROLLED—1mHz BAND-
WIDTH INTERNAL OR EXTERNAL
BATTERY. CONVERT YOUR CAR
RADIO OR HOME RADIO INTO
SENSITIVE VHF RECEIVER.**

\$24.75 Incl. Tax. Crystal—\$5 extra.
Freight 35c

STATE EXACT LISTENING
FREQUENCY

S. E. WILLIS TRADING CO.,
38 RIVERSDALE ROAD,
CAMBERWELL JUNCTION, VIC. 3124.
Phone 82-5787

SORRY — NO C.O.D.

ELECTRONICS—Books

VOLTAGE AND POWER AMPLIFIERS by Robert Sentz Price: \$4.70
Treats applications of transistors and tubes to voltage and power amplifiers. The approach is integrated in that both transistor and tube applications are considered, but there is a distinct emphasis on transistor applications throughout.

FEEDBACK AMPLIFIERS AND OSCILLATORS by Robert Sentz and Robert Bartkowiak Price: \$4.70
Presents the general or "classical" theory of feedback as applied to electronic amplifiers and then treats single amplifiers by incorporating the feedback element into the equivalent circuit. Both transistor circuits and vacuum-tube circuits are given, but the transistor circuits are emphasised. The Nyquist criteria are offered along with examples of stable and unstable Nyquist plots.

SPECIAL SEMICONDUCTOR DEVICES by Walter Sowa and James Toole Price: \$4.35
The book introduces the reader to a broad range of devices, covering photo-multipliers, solar cells, and photo cells and their spectral response characteristics. Questions and Problems, and References accompany each chapter.

ELECTRONIC POWER SUPPLIES by Joseph Grabinski Price: \$4.35
The principal objective is to provide a clear understanding of power supply circuits and the wave forms associated with these circuits. This book is written in a clear, concise manner with special attention given to those subjects which are normally most difficult to understand. Mathematical developments are presented in an orderly step-by-step progression, with no steps omitted.

SEMICONDUCTOR AND TUBE ELECTRONICS: AN INTRODUCTION by James Brazee Price: \$11.55
This book systematically presents a graphical and numerical introduction to the analysis and utility of electronic devices. The graphical method of device analysis enables the student to visualise the theoretical aspects of device features and their application potential.

ELECTRONIC CIRCUITS by Samuel Seely Price: \$15.20
Professor Seely introduces the reader to the theoretical as well as the practical aspects of semiconductor and tube-driven circuits. The most important devices available for circuit applications are introduced by a discussion of the operation of various classes of electronic circuits.



HOLT, RINEHART AND WINSTON (AUST.) PTY. LTD.,
79 Whiting Street, ARTARMON, N.S.W. 2064.



Choose from the full range of quality Palace stereo equipment.

A NEW SOPHISTICATED STEREO TAPE DECK OF UNCOMPROMISING QUALITY.

4-Track Stereo & Monaural Record/Playback

Separate Record/Playback & Erase Heads

Built-in Solid State Stereo Record/Playback Preamplifiers

Records 4-Track Stereo or Mono from FM, AM, FM Stereo or Phono Sources, Live from Mikes

Push Button 2 Speed $3\frac{3}{4}$ & $7\frac{1}{2}$ I.P.S.



SA80S 4W RMS COMPACT STEREO AMPLIFIER



AM-296 10W RMS SOLID STATE AMPLIFIER



AM-320 16W RMS SOLID STATE PREMAIN AMPLIFIER



AM-323 HIGH POWER 40W RMS SOLID STATE PREMAIN AMPLIFIER

SOLE AUSTRALIAN REPRESENTATIVES.

GENERAL ACCESSORIES

VIEW THE FULL RANGE OF PALACE STEREO EQUIPMENT NOW AT YOUR LOCAL STATE BRANCH SHOWROOM.

General Accessories
153 Sturt Street
South Melbourne 69 0300

General Accessories
81 Flinders Street
Adelaide 23 4022

General Accessories
443 Concord Road
Concord West 73 0211
and Sydney

General Accessories
46 Milligan Street
Perth 21 2501

Homecrafts - Tasmania
199 Collins Street
Hobart 2 2711

General Accessories
50 Little Edward Street
Brisbane 2 3093

enough. At the moment, all it really does is give the reader a bare smattering of the terms and concepts involved, with very little real insight or in-depth knowledge.

For example, very little text is devoted to the detailed description of logic element operation, whereas one would think that this would possibly be the most essential knowledge by the would-be digital service technician. Similarly only switch contact logic, diode logic and resistor-transistor logic are described, yet these types are rapidly being eclipsed by more complex forms such as TTL and CML or ECL. The important matter of logic polarity convention is not presented clearly and concisely as a topic in its own right, but rather in a sketchy and incidental fashion at various places distributed somewhat randomly through the exposition.

Apart from a very brief passing example, virtually no space is devoted in the book to a treatment of the operating principles of common digital measuring instruments such as DVMS, counters and frequency meters. This seems particularly disappointing in view of the fact that these are likely to be the main pieces of equipment handled by the "independent" digital service technician.

The sections devoted to servicing equipment and techniques also seem to this reviewer to be disappointingly brief and shallow. No mention is made, for example, of logic level indicator probes and their use. I could find no discussion of such practicalities as wire-wrap and solder connection problems, or desoldering tools and the removal of ICs and other components from boards. The material which is given is useful, but it doesn't seem to go nearly far enough.

In fact this last comment would seem to make a good summary of the book as a whole. It does contain material likely to be of value to the would-be digital service technician, but such a reader will likely find that after reading it there will still be much about digital equipment that he will wish, and need, to know.

The review copy came from the Australian agents for Foulsham-Sams, who are Grenville Publishing Company. This firm advises that copies are available at all comprehensive bookstores. (J.R.)

Audio systems

AUDIO SYSTEMS HANDBOOK By Norman H. Crowhurst. First edition 1969. Published by TAB Books, Blue Ridge Summit, PA. 17214. Stiff paper covers, 192 pages, 8 1/2 x 5 1/2, illustrated by circuits and diagrams. Price in Australia \$6.15; for the hard cover edition, \$9.95.

One gathers from the title, the preface and the publisher's leaflet that this book has been written primarily to assist those whose concern is with audio systems, as distinct from others who concern themselves with the internal circuitry and construction of audio devices. What are the considerations when connecting microphones to amplifiers to loudspeakers? What is meant by gain, loss, impedance, decibels? What is meant by equalisation? What are some of the special services that find their way into audio systems?

In seeking to answer these and other questions the author breaks the subject up into the following chapters: Amplifiers — Equalisers, Mixers and Filters — Distribution Systems — Program Sources — Special Devices — The Complete System — Commercial Sound — Studios — Loud-speaker Systems.

So much for the coverage and, with an author as well known as Norman Crowhurst, I expected that the writing of a review would be purely routine. But, somehow it didn't turn out that way. The author's familiarity with the subject is never in doubt and I had no cause to question any of his statements. But the material doesn't fall at all easily into the pattern of a carefully planned, systematic book.

In the first chapter, the author devotes a good deal of space "talking around"

impedance and decibels as subjects which puzzle non-technical users of audio systems. It is difficult to escape the conviction that it would have made easier reading to come to grips with the subject more directly.

In contrast with this cautious approach up front, there are other treatments in the book, as for example that on compensation and cross-over networks, which would appear to probe far deeper than an audio systems man would need.

Yet again, there are large sections of the book which are practical and relevant. My reaction is that the book is best seen as a series of inter-related articles biased towards the use of audio in commercial and public address applications. As such, it will appeal to people in this field although, of course, it contains quite an amount of background information for those with a general interest in audio. Our copy came from Grenville Publishing Co. Pty. Ltd., 401 Pitt St., Sydney. 2000. (W.N.W.)

LITERATURE—in brief

TELECOMMUNICATION JOURNAL, Vol. 36, No. 10, October, 1969. Available from the Publications Service, International Telecommunication Union, Place des Nations, Geneva 20, Switzerland. Contents: "Electronic automatic switching equipment with recorded program control — The Pericles Project" by L. J. Libois and P. Lucas; "A new concept in domestic satellite communications" by R. P. Gifford; "The land mobile services in the Federal Republic of Germany" by K. R. Binz and G. J. Strunz.

Under the heading "Ideas and Achievements" is a study of "Error in electrostatic actuator calibration of condenser microphones." Other items in this section are "Simple prism may be the key to miniature laser circuits," and a report on the use of a transportable satellite earth station on the occasion of the visit of Pope Paul VI to Uganda. The section on "Union Activities" includes news of the opening of an ITU seminar on modern telecommunication techniques which dealt especially with developments in satellite technology and space application.

STANDARD TIME AND FREQUENCY: ITS GENERATION, CONTROL AND DISSEMINATION FROM THE NATIONAL BUREAU OF STANDARDS, by John B. Milton. National Bureau of Standards Technical Note 379, issued August, 1969, 27 pages, 35c U.S. Order from the Superintendent of Documents, U.S. Government Printing Office, Washington, D.C. 20402. U.S.A. This note describes some of the current work of the NBS time and frequency division. Topics include the generation of the computed NBS time scales, their translation into real working clocks, and the use of these clocks in co-ordination efforts with other standards laboratories.

The co-ordination of clocks and frequency standards, the measurement and control of LF and VLF radiated phase, and the method of co-ordinating the Fort Collins master clock with that of NBS Boulder, are also described. The publication also discusses the relation of frequency and time interval.

TECHNICALITIES, September 1969. Published by Technico Electronics, Carrington Road, Marrickville, N.S.W. 2204. Contents: Electrofil glass-tin-oxide resistors; Corning power resistors, glass capacitors, and digital memory modules; Signetics integrated circuits; Bell magnetic field sensors; Technico printed circuit news; Trymetrics 4-digit digital voltmeter; Bell eddy current tester; Pacific Measurements AC/DC log converter; Simpson VTVM; Dytronics phase sensitive voltmeters; Princeton Applied Research low noise preamplifier, lock-in amplifiers, data recording system; Intermeasurements programmable oscillographic recorder; Rustrak strip chart recorder.

PLAN YOUR FUTURE

CHOOSE a career in the field of ELECTRONICS* — the Nation's most progressive and fastest expanding industry.

✳ Advancement in this modern science demands technical ability, a sound knowledge of basic principles and applications.

YOU can master the subject by training at the MARCONI SCHOOL and be ready to grasp the opportunities that occur in the three fundamental branches of Radio-technology.

KNOW WHERE YOU'RE GOING

A = APPLIED SERVICING

Comprehensive training in the maintenance and repair of radio and television receivers offers substantial rewards to competent technicians. Marconi School training covers all aspects of radio and television receiver circuit applications, practical exercises in fault finding and alignment procedures.

B = BROADCASTING

A thorough and practical grounding is available to students in broadcasting transmitter performance standards and maintenance techniques, with individual instruction in station operation and studio control and testing.

C = COMMUNICATIONS

Combines all the foregoing, together with radio aids to navigation, mobile telephony, marine service application and international wireless telegraph regulations, qualifying the successful student for the Commonwealth Government Certificate of Proficiency and the Marconi School Diploma in Radiotechnology.

Classes are conducted at 21 Pier Street, Sydney (at the foot of Goulburn Street).

Daily: 9.30 a.m. to 4.30 p.m.

Evenings: 6 p.m. to 8.30 p.m.

or by Home-Study Courses (except practical instruction on equipment).

STUDY NOW

Send for training syllabus. There is no obligation.

NAME.....
ADDRESS.....

the MARCONI SCHOOL of wireless

G.P.O. Box 2516, Sydney

A Service of Amalgamated Wireless (Australasia) Ltd.



Like being proud of their Kangaroo, Sato's large variety of electrical parts is the favorite choice by Australians. Your inquiries are welcome.

SATO PARTS

SATO PARTS CO., LTD. HEAD OFFICE: EBISU, SHIBUYA-KU, TOKYO, JAPAN TEL: (442) 8506~8
BANK ACCOUNT: MITSUBISHI BANK

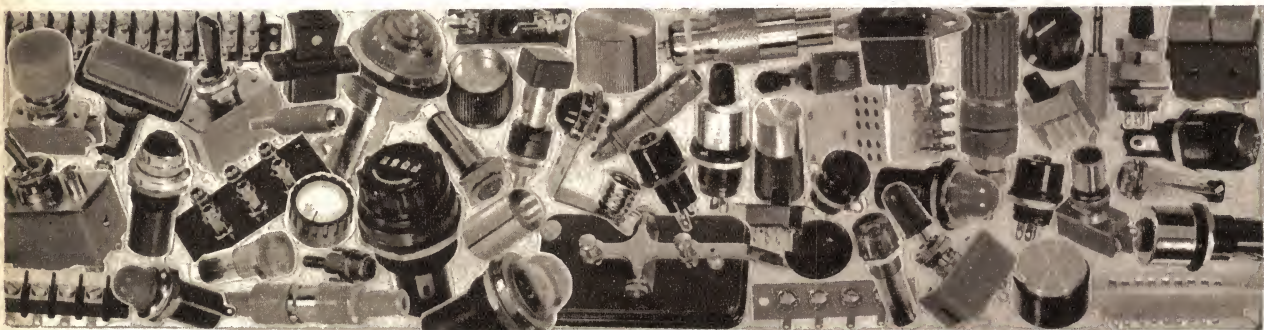

A vast range of SATO Parts

- For manufacturers
- For TV
- For radio
- For instruments
- For amplifiers
- For kitset builders
- For sound equipment
- For industry
- For stereo equipment
- For educational purposes
- For electronics
- For tape recorders

Distributed by



GENERAL ACCESSORIES

(A DIVISION OF ELECTRONICS INDUSTRIES)

116-118 CLARENCE STREET, SYDNEY 443 CONCORD ROAD, RHODES — 73-0211
BOTH STORES OPEN SATURDAY MORNING

BUSINESS GUIDE TO TASMANIA

TASMANIA, A BUSINESSMAN'S HANDBOOK: INFORMATION ABOUT INVESTMENT IN TASMANIA. Fifth edition, 1969. Published by the Tasmanian Directorate of Industrial Development and Trade, Hobart. Soft covers, 7in x 9½in, 106 pp., many photographs (some in colour), tables and two maps. Copies can be obtained free on application to International Public Relations Pty. Ltd., 23 Hamilton Street, Sydney, 2000.

The handbook was first published in 1960 as a reference for businessmen and industrialists who make decisions on investment and expansion. This edition provides up-to-date information on the Tasmanian economy and way of life.

Contents: Geography — location, climate, population; Way of life in Tasmania

—a prosperous island, leisure, housing, education, the press, television and broadcasting, the constitution; Resources —Hydro-Electric Commission, industrial fuels, water, minerals, non-metallic minerals, fuel minerals, construction materials, forests, industrial land; Industries—secondary industries, the main companies, primary industry; State Government assistance; Trade; Transport and communications — sea transport, overseas shipping services, air transport, road transport, rail transport, specialised services, telecommunications, and postal services; Commercial law and finance — industrial conditions, the Australian tariff, import licensing, company law, securities and the Stock Exchange, banking and finance, exchange control, taxation.

MICROWAVE WATER LOAD CATALOG, Spring, 1969. Published by Varian Electron Tube and Device Group, U.S.A. Inquiries to Varian Pty. Ltd., 38 Oxley Street, Crows Nest, N.S.W., 2065. The 16-page catalogue describes the firm's extensive line of microwave water loads including: high power miniature loads of the ceramic block type; very high power, very broadband loads of the glass tube type; high power broadband compact loads of the Teflon wedge type; and high power broadband coaxial loads. Also included is a description of Varian's line of calorimeters, and calorimetric measurement information.

ECCOTHERM THERMALLY CONDUCTIVE DIELECTRIC MATERIALS. Published by Emerson and Cuming Inc., Canton, Mass., U.S.A. Available from the Australian agents, IRH Components Pty. Ltd., The Crescent, Kingsgrove, N.S.W. 2208. A folder describing the Eccotherm line designed for bonding, encap-



ulating, coating or sealing electrical and electronic components where a high rate of heat transfer is a consideration. The folder presents illustrated application data on each product and includes information on typical uses, form of product, mix preparation, cure temperature and properties of the cured products.

TELECOMMUNICATION JOURNAL, Vol. 36, No. 9, September, 1969. Available from the Publications Service, International Telecommunication Union, Place des Nations, 1211 Geneve 20, Switzerland. Contents include an illustrated report on the activities of the Technical Co-operation Department of the I.T.U., in connection with the United Nations Development program, current projects, number of experts recruited, fellowships awarded, and so forth. Other articles are: "Mobile communications via satellite," by W. Cardullo and C. Dirian; "International accounting in the international automatic telephone service," by Z. Rafalowicz; and "Present and future airline telecommunications requirements."

Under the heading "Ideas and Achievements," information is given on the Explorer-41 (IMP-7) satellite and on the special exchange for the Stockholm taxi

service. The section on "Union Activities" includes a report about the meeting of C.C.I.R. International Working Party IV/1 on efficient use of the geo-stationary satellite orbit, the announcement of a seminar on frequency management, and news of arrivals and departures of technical co-operation experts.

O.M.R. — ORGANIC MAGNETIC RESONANCE. A new international journal published by Heyden and Sons Ltd., Spectrum House, Alderton Crescent, London, N.W.4, England. This publication is devoted specifically to all branches of magnetic resonance as applied in the field of organic chemistry, and will include papers on N.M.R., N.Q.R., E.S.T., and the more recently developed technique of ion cyclotron resonance (I.C.R.). A feature of this journal is the Spectral Supplement in which the spectra are reproduced on a large scale with the experimental conditions fully specified in a uniform format.

MI CONTACT, Issue 12 (E). Published by Marconi Instruments Ltd., England. Inquiries to Amalgamated Wireless (Australasia) Ltd., P.O. Box 96, North Ryde, N.S.W., 2113. Contents: M.I. enters digital voltmeter market; New marketing structure; Switched UHF attenuator; G.P.O. orders for PCM test gear; Low cost frequency measurement to 500MHz; Marconi Chairman retires; Exhibition news: Gunn diode covers 8.0 to 10.5GHz; New X-band frequency meter; TF 2334 rejection filter; New double pulse generator; Differential DC voltmeter with built-in calibration check.

NEW TECHNOLOGY, No. 32, September, 1969. Published by the British Ministry of Technology and the Central Office of Information. It is obtainable free on application to the Central Office of Information, Hercules Road, Westminster Bridge Road, London, S.E.1, U.K. Contents: Tribology at Swansea; Advisory committee on legal units of measurement; Testing materials by exposure—"down under" and at home; Staying on top—with the help of collaborative R. and D.; Metrication Board Steering Committees; News; Statistical indicators.

TELECOMMUNICATION NEWS, No. 2, May, 1969. Published by The Marconi Co. Ltd., England. Inquiries to Amalgamated Wireless (Australasia) Ltd., P.O. Box 96, North Ryde, N.S.W., 2113. Contents: MARS and the World Weather Watch: Britain's largest electronics group; Marconi communications for Argentine army; Marconi and radio astronomy; Higher quality HF radio-telephony with "Lincomplex"; Important U.S. order for Marconi A.R.O equipment; Manager, radio communications; Marconi communications for Fiji airport; Marconi to market new G.E.C. receiver; Two giant earth stations well advanced; Across the China Sea; More Marconi transmitters for Switzerland; Goonhilly 2 makes its bow in the fog. Big U.K. defence order for space communications; Marconi in South America: Transatlantic Marconidata link.

★ PRACTICAL NIGHT CLASS TRAINING for Careers in Radio, T.V. & Electronics

Trained technicians are wanted urgently. It's in your hands to train NOW for a successful future. A.R.T.C. Practical Night Classes (established nearly 40 years) provide individual practical workshop training.

- Commence at any time.
- No previous knowledge required.
- Proceed at your own pace.
- Modern technical electronic training.
- New Australians welcome, the COURSE is specially simplified.
- Low in cost and you pay for the COURSE not the time taken.

College open for enquiries Monday-Friday 9 a.m. to 5 p.m. and until 7 p.m. on Monday and Thursday nights.



POST COUPON FOR FREE BOOK
'Careers in Radio, T.V. & Electronics'
Name

Address

AUSTRALIAN RADIO & TELEVISION COLLEGE Pty.Ltd.
E.S. & A. Bank Building, cnr.
Broadway & City Rd.,
BROADWAY. (opp. Grace Bros.)
Phone: 211-4224

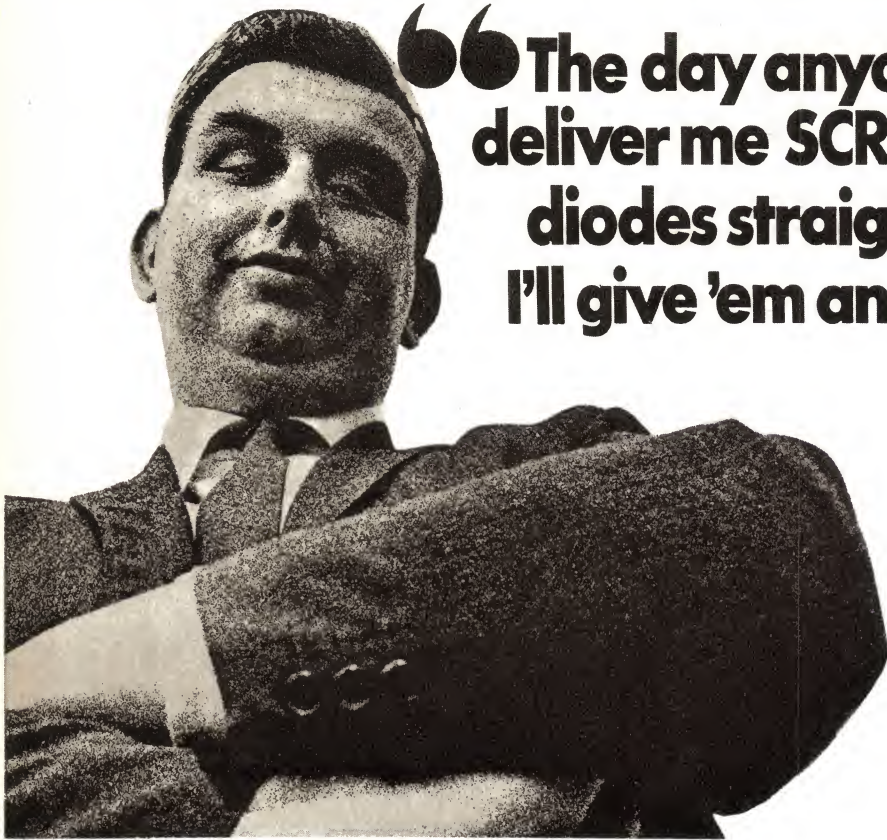

“The day anyone can deliver me SCR's and diodes straight away I'll give 'em an order.”

Start writing!

STC and NEC have combined in an exclusive marketing agreement to provide them all by the plane-load! Ready now for delivery.

Silicon controlled rectifiers, avalanche rectifiers, TRIAC's, DIAC's and unijunction transistors are included. The complete and widely accepted range of NEC SCR's and power diodes are immediately available to you under this exclusive agreement.

Additional information on new products geared to the dynamic and competitive Japanese Power market, is also immediately available to you. Information on the 3000V 600 amp diodes and matching SCR's to a cheap reliable range of TRIAC's.

Order now from STC, sole Australian market outlet.

Call or telex (collect) your order direct to STC Components Division.
 Phone Sydney 602-1314, 602-1329, 602-1369; Melbourne 480-1255;
 Brisbane 47-4311; Adelaide 51-3731;
 Perth 21-6461. Or telex Sydney 20328.

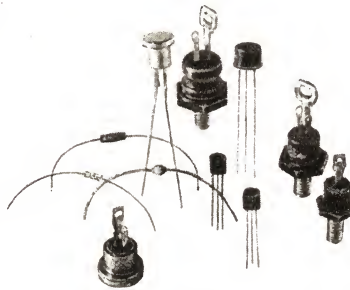

For more details and free brochures fill in the coupon:

Please send me information on

NAME

COMPANY

ADDRESS

POSTCODE

Standard Telephones & Cables Pty. Limited
 Moorebank Avenue, Liverpool N.S.W. 2170

AN **ITT** world-wide telecommunications and electronics
 ASSOCIATE



U546A



AMATEUR BAND NEWS AND NOTES

Quarter Century Wireless Association

A chapter of the Quarter Century Wireless Association, the first outside the United States of America, has been formed in Australia.

by Pierce Healy, VK2APQ

The inaugural meeting of the Sydney Chapter of the Quarter Century Wireless Association Inc. was held on Wednesday night, September 17, 1969, at the Combined Services Club, 5 Barrack Street, Sydney.

The following officers were elected:—
Chairman — H. Caldercott VK2DA
Secretary — G. Wilson VK2AGO
Treasurer — B. Anderson VK2AND

The Quarter Century Wireless Association, Inc., was founded in 1947 and subsequently established as a non-profit membership corporation in the State of New York dedicated to:—

1. Fostering and developing friendship and co-operation among amateur radio operators of more than 25 years' standing.
2. Taking a general interest in all matters affecting or involving amateur radio.
3. To sponsor such actions as may be deemed proper in their interest.

Since its inception in 1947, the Quarter Century Wireless Association has grown from the original 54 charter members to over 4300 active members worldwide, and to 37 Chapters located within the United States. Chapters which are self-supporting entities of Q.C.W.A., comprise ten or more Q.C.W.A. members who reside within the same geographical area.

Any current licensed amateur radio operator, who submits satisfactory proof that he or she was licensed as such 25 or more years ago, is eligible to apply for membership in Q.C.W.A.

Australian amateur operators with the above qualification are invited to join the Sydney Chapter. Meetings will take the form of a monthly dinner and get-together on the first Wednesday of each month, January excepted, at 6.30 p.m. at the Combined Services Club, 5 Barrack Street, Sydney. Interstate and overseas Q.C.W.A. members will be specially welcome.

For further particulars, phone the Secretary, 43-2427 (Sydney), or write to 31 Glenview Street, Greenwich, New South Wales, 2065.

Membership subscription fees to the Q.C.W.A. (payable with application) are:—

Joining fee — \$3.00
3 year subscription — \$5.00

or
Life membership — \$28.00

A gold plated pin or button engraved with your call sign can be supplied to members for \$2.50.

Q.C.W.A. members receive a numbered

.....
News and notes of Divisional and Club activities submitted for inclusion in these columns should be forwarded direct to Pierce Healy, 69 Taylor St., Bankstown, N.S.W. 2200.

certificate (issued chronologically) of membership, dues and identification cards, yearbook and roster (every two years), supply of Q.C.W.A. stamps and Q.C.W.A. decal, and the Q.C.W.A. newsletter, which is normally issued quarterly. Members can participate in the activities of the Chapter, "on-the-air" round tables, and other operating events, including the annual QSO Party, which is usually held in February.

Officers of the Quarter Century Wireless Association Inc. are:—

President — Clarence Seid W2KW/
KV4AB

Vice president — Frank A. Gunther
W2ALS

Treasurer — Fred. W. Huff W2AMB

Secretary — David Talley W2PF
President — Emeritus — John Di Blasi
W2FX

Directors

Jack G. Anderson — W2BJL

George W. Bailey — W2KH

Art E. Miligan W8ALP

J. Albert Stobbe — W2WZ

Dr. A L. Walsh — W2BW

General Manager

A. J. Gironda — W2JE

AMSAT

The Radio Amateur Satellite Corporation (AMSAT) is a non-profit scientific organisation set up to provide satellites for experimentation and communication by radio amateurs throughout the world. The vast organisation hopes to tap the East Coast (U.S.A.) reservoir of scientific and technical talent existing among amateurs, many of whom are professionally associated with advanced communications and space programmes. AMSAT has the support of Project OSCAR and hopes to engage in activities jointly with that group.

The AMSAT organisation plans to design, build and launch communication satellites to operate in the VHF and UHF amateur bands. It intends to encourage and sponsor supporting activities and related experimentation by interested individuals and groups. Projects undertaken by local radio clubs, may, for example, include design and construction of satellite ground stations for command, monitoring, and tracking, as well as two-way communication.

Or a local group may volunteer to build and test an important spacecraft subsystem, such as a command receiver. Another organisation may provide computing facilities for determining orbital parameters. AMSAT's programs will be designed to offer a sufficient scope of activities for almost every individual amateur and group of amateurs.

The first AMSAT undertaking is the launching of AUSTRALIS-OSCAR A. After its launch, this satellite will be known as AUSTRALIS-OSCAR V. This activity is being conducted in co-opera-

tion with Project OSCAR and Project AUSTRALIS. The satellite was built by a group of Australian amateurs and sent to Project OSCAR for launch in 1967. Plans called for launching in 1968, but the launch was indefinitely delayed.

AMSAT has been discussing with NASA the possibility of launching the satellite as piggyback on a suitable NASA mission which, it is hoped, will achieve a medium altitude circular polar orbit. The satellite is a 35lb battery operated, magnetically stabilised spacecraft which will transmit "HI" each minute, on two and ten metres for an expected life of over two months. It will be the first amateur satellite to employ any form of stabilisation.

In addition to the AUSTRALIS-OSCAR activities, effort is being directed by AMSAT towards development and launch of advanced amateur communications satellites, including spacecraft capable of supporting two-way communication for a period of several years. Power will be provided by solar cells or a nuclear isotope power system. Placed in a near-synchronous orbit the satellite's positions will gradually shift so that antenna pointing will require changing at infrequent intervals.

At the same time, the satellite will be available to virtually every populated part of the earth in the course of a week or two. Line-of-sight communication will be possible from the satellite to nearly one third of the earth's surface at any one time. The availability of such a semi-permanent communications facility should provide sufficient incentive and justification for many amateurs the world over to make the necessary preparations to use the spacecraft repeater.

The AMSAT group is also assessing the availability and means of obtaining surplus hardware from now completed space projects with the objective of adapting suitable usable components and subsystems for amateur satellite use. Specific tasks, aimed at getting preliminary design information have been assigned to the various clubs and groups which form the nucleus of AMSAT.

Direct participation in AMSAT's programs by all interested radio amateurs is invited. Membership is open internationally to individuals and to clubs or groups having a desire to support AMSAT's objectives, through contributions of time, services, equipment, or by financial support. It is not intended that geographic location be a bar to membership. On the contrary, it is hoped that AMSAT members will soon be found throughout the U.S.A. and the rest of the world.

The above resume on AMSAT plans, by C.A. (Cap) Petry, W3AWN, appeared in Vol. 1 Number 1 of AMSAT Newsletter.

AUSTRALIS OSCAR V

At the time these notes were being written, the Australis satellite was scheduled for launching in late November. A report on the testing of the satellite at AMSAT headquarters by Jan King, K8VTR, Projects Manager appeared in the AMSAT Newsletter, as follows:

The AUSTRALIAN-OSCAR A package arrived at AMSAT on April 14th of this year and was scheduled to undergo a number of environmental and functional tests in preparation for a possible launch

LEADER TEST INSTRUMENTS

SINE-WAVE / SQUARE WAVE AND COMPLEX



LAG - 55

Budget priced unit indispensable for any serious audio measurements.

Specifications:

Frequency Range	20-200,000Hz in four 10 : 1 bands
Calibration Accuracy	Within $\pm 2\% \pm 2\text{Hz}$
Sine Wave Output	20-200,000Hz; level constant within $\pm 0.5\text{dB}$ below 100kHz; Output 5 V rms below 100kHz
Square Wave Output	20-20,000Hz; Output 10 Vp-p
Complex Wave Output	Above 5,000Hz combined with line frequency
	Amplitude ratio 4 : 1 (low to high) ; Output 10Vp-p

AUDIO SIGNAL GENERATOR WITH METERED OUTPUT AND FREQUENCY METER

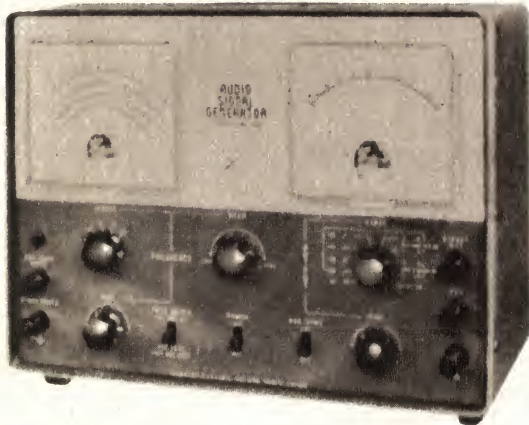

LAG - 66

Top quality Leader Unit.

Specifications:

<u>Generator</u>		<u>Frequency Meter</u>	
Frequency Range	11 to 110,000Hz in 4 bands in 6 ranges	Range	10 to 110,000Hz in 4 ranges
Output Voltage	600 Ohms: 0-1 V in 6 ranges 10k Ohms: 0-10V in 2 ranges	Input Impedance	200,000 Ohms, approx.
Distortion	Less than 0.3%, 20 to 20,000Hz	Accuracy	$\pm 1.5\%$, full scale; 10 to 11,000Hz

FROM ALL GOOD TRADE HOUSES
WHOLESALE ENQUIRIES ONLY TO
SOLE AUSTRALIAN REPRESENTATIVES:
ASTRONICS AUSTRALASIA PTY. LTD.,
ALL STATES.

on a Thrust Augmented Delta Launch vehicle. To date, a number of tests have been completed on A-O-A by AMSAT members of the Goddard Space Flight Centre. They may be listed in the order in which they were performed.

Radio Frequency Interference Test: With all systems in their normal operating mode, the spacecraft was tested for all RF emissions from 10KHz to 1GHz. Measurements were made in a heavily shielded enclosure using an accurately calibrated automatic sweeping receiver. During the test it was found that while all transmitter harmonics and sub-harmonics were at least 30dB down, many of these emissions were still above the stringent NASA specification level. Subsequently, filters were designed and fabricated by AMSAT members to further reduce the harmonic content of the transmitter outputs.

Telemetry Sensor Calibration: All seven channels of the telemetry system have been calibrated under simulated flight conditions. Calibration curves have been prepared for voltage, current, and temperature measurements as well as determination of the dark current for the orthogonally oriented earth sensors. Considerable care has been taken to determine how a given changing parameter may affect the telemetered value of others (e.g. how does a change in battery voltage affect the telemetered temperature measurements?)

Subsystem Thermal-Vacuum Test: Each subsystem of the satellite was placed in a thermal vacuum chamber where both temperature and pressure can be accurately controlled to simulate a space-like thermal environment. The test was run over a three day period. A series of 24-hour temperature "soaks" were conducted at 25, 10 and 40 degrees C. The pressure during this period was always less than 5×10^{-6} mm of Hg. Difficulty occurred during this test with the command receiver. As the pressure of the chamber was reduced, the receiver audio output became greatly distorted. It was determined that the first IF stage was being detuned during the vacuum condition.

The problem could be overcome by a slight detuning of the IF transformer. The exact cause of this malfunction is not fully understood, and the problem is still being worked on. No other problems were encountered during the vacuum testing.

At the present time the condition of the transmitters is as follows:

VHF 2-metre transmitter. Power output to antenna: 40mW. All harmonics: -50dB.

HF 10-metre transmitter. Power output to antenna: 180mW. All harmonics: -65dB.

Command receiver. Sensitivity: 1 microvolt. Bandwidth: 8KHz at -6dB.

NEW ZEALAND

The New Zealand Association of Radio Transmitters announces that to draw greater attention to the Cook Bi-Centenary Celebrations, celebrating Captain James Cook's first landfall in the Pacific Ocean at Gisborne, New Zealand, on October 9, 1769, the New Zealand Post Office has authorised the optional use of the prefixes ZM1; ZM2; ZM3; ZM4; ZM5 (in place of ZL1; ZL2; ZL3; ZL4; ZL5) from October 1, 1969, to December 31, 1970.

ZM Cook Bi-Centenary Award

The N.Z.A.R.T. have announced a special award to commemorate the Cook Bi-Centenary. The rules are as follows:—

1. During the period October 1, 1969, to December 31, 1970, applicants must contact 50 different stations using the prefix "ZM," with at least one station each from districts ZM1 to ZM4.
2. Applicants must forward a check list of stations contacted with FULL LOG DATA which has been certified correct by two other amateurs, — No QSL cards required.
3. Post to N.Z.A.R.T. Awards Manager, ZL2GX, 152 Lytton Road, Gisborne, New Zealand, with three I.R.C.s cover mailing costs. Extra must be sent if airmail is required.
4. Endorsements will be made for CW, phone and band of operation.

WIRELESS INSTITUTE ACTIVITIES

The minutes of the 1969 Federal Convention held in Canberra last Easter were circulated to divisions late in September. Transcribed from tape recordings, the minutes contained lengthy reports on the various aspects of Institute activities, the interim constitution of the Region III Association, and highlights of the discussion on agenda items by delegates from the six divisions of the Institute.

Appreciation of the work done by members of Federal Executive and those who assisted in compiling the publication, has been expressed by divisional councils.

The next Federal Convention is scheduled to be held Easter, 1970, in Adelaide. Members are advised that items which they consider should be submitted for the agenda should be sent to divisional secretaries before the end of January, 1970.

NEW SOUTH WALES

At the September meeting of the New South Wales Division, President Gordon Clarke, VK2ZXD, announced that a decision had been reached to proceed with the development of the Wireless Institute Centre, 14 Atchison Street, Crow's Nest.

This matter has been discussed a number of times over the last few years, but recently architectural advice on the present building, and the commencement of a multi-storey building on the eastern side of the premises, has made the matter one of some urgency.

In order that council may obtain the very best advice and guidance on the subject, invitations have been sent to a number of members who have considerable knowledge and experience in the fields of investment, building and finance, to assist in the formation of a Financial Control Committee. After the committee has considered a number of proposals, members will be advised of the plans and action to be taken.

Blue Mountains Branch

The Annual Field Day of the Blue Mountains Branch of the Wireless Institute of Australia will be held on November 23, 1969, at the Lawson Swimming Pool picnic grounds. The grounds are across the railway line from the Western Highway, near Lawson Railway Station.

The program of events is as follows: Registration commences at 10 a.m. Fee \$1.50 adult males, children free.

10.15 a.m. to 11.00 a.m.: All-band scramble. All nets may be used as well as any mode. One log per band. Separate prize for VHF and HF highest scorers.

11.30 a.m. to 12 noon: Hidden transmitter hunt for pedestrians within the grounds on 144MHz.

12 noon to 1.00 p.m.: Lunch.

1.00 to 2.00 p.m.: 144MHz hidden transmitter hunt for mobiles.

2.30 p.m. to 3.30 p.m.: 146MHz FM "Talk-In" hidden transmitter hunt. Two transmitters, both must be found.

4.00 p.m.: Presentation of prizes.

Ice-cream, soft drinks and hot water will be available.

There will be raffles and lucky number prizes.

For an enjoyable day in the mountains, take the family to the Blue Mountains Field Day on November 23.

Hunter Branch

Nearly 120 members and visitors attended the September meeting of the Hunter Branch, to see Lionel Swain, VK2CS, and Allan Fairhall, VK2KB, presented with Life Membership and Certificates of the Wireless Institute of Australia.

The following report on the proceedings was given by Keith Howard, VK2AKX, during a broadcast from the Hunter Branch station, VK2AWX.

The meeting, held in the Riddell Theatre, at the Newcastle Technical College, Tighes Hill, on Friday night, September 5, was opened by the Branch President, Gordon Sutherland, VK2ZSG. He introduced the Federal Councillor, New South Wales Division, Pierce Healy, VK2APQ who was to make the presentation. Representatives of the local Press and local radio and television stations were in attendance.

In presenting the awards, Pierce recalled the early days of radio, 40 years or so ago and the part played by both Lionel and Allan.

Listeners will be interested to know that Lionel Swain, VK2CS, was among the first amateurs, and certainly the first Newcastle amateur, to broadcast music transmissions on the amateur band. He was also the inaugurator of the Newcastle and District Radio Society, formed in October, 1922.

Lionel used to transmit musical programs every Sunday. Younger listeners may not realise that in prewar years music transmissions were permitted. Among other notable achievements, he was one of the first Australian amateurs to make a trans Pacific contact.

In referring to Lionel's music transmissions, note was also made of a young electrical apprentice who used to call on

Technical Editor at W.I.A.

Members and visitors attending the VHF and TV Group meeting, held at the Wireless Institute Centre, 14 Atchison Street, Crows Nest, were given a most interesting and informative lecture by Jamieson Rowe, B.A. (Syd.); B.Sc. (Tech., N.S.W.); M.I.R.E.E., Technical Editor, Electronics Australia.

The subject of the lecture was "Lasers and their Application." The discussion was illustrated by a series of slides and a practical demonstration.

The lecture traced the history of the development of light amplification by stimulated emission of radiation back to the work of Albert Einstein, who, in 1917, first assumed that such a phenomenon was possible. The work done in the late 1950s was then discussed and the subsequent developments which led to the techniques of today. This was followed by a thorough treatment of the principles of laser operation and the various types of laser now available. This discussion adequately prepared the audience for the descriptions of some of the applications for which lasers are now being used.

The applications covered were communication, machining and cutting, holography and the recent Apollo laser experiment. A laser model, which was featured by the lecturer in Electronics Australia (issues of August and October, 1969) was demonstrated, and the audience was amazed at the low percentage of modulation needed for communication by a laser beam.

This was the first lecture on lasers given at a Wireless Institute meeting. The appreciation of those present was shown by the hearty round of applause given in support of the vote of thanks given by Jim Webster, VK2ZCW.

a Monday night on his way to tech. to report on the quality of Lionel's Sunday night broadcast. His name was Allan, and he is at the time of writing the Minister for Defence.

In addition to calling on Lionel on his way to Tech., Allan would call on another Newcastle amateur, Max Spitzkowsky, VK2MS, on his way home. It was here that he learnt the Morse code. Having duly obtained his amateur licence, Allan received a letter, along with other amateurs, from the P.M.G.'s Department offering "B" class licences to those who wished to have one. Because about \$400 was needed to build a commercial transmitter, and it was during the economic

Registered Trade Mark

ELECTROLUBE 2A-X

**IMPROVES ELECTRICAL CONTACTS
INCREASES RELIABILITY AND
LOWERS MAINTENANCE COSTS**

SAFE ON POLYSTYRENE, P.V.C. MAKROLON,
PAINTS, NATURAL AND SYNTHETIC
RUBBER NON-HAZARDOUS VAPOUR

Write for free Products Summary on the range of electrical and mechanical oils and greases

RFA

RICHARD FOOT (Australia) PTY. LTD.
63 Hume St., Crows Nest, N.S.W. Tel. 43-0326.

Available from leading
electrical wholesalers.

AUDIO-TECHNICA

Approach to  the Original
"Natural Sound"

TONE ARMS

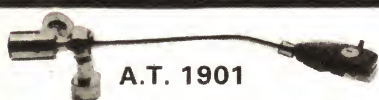

A.T. 1901

A low cost arm with simplified mechanism; but maintains precision bearings. Universal type, accepts standard plug-in heads. Direct reading calibration of stylus pressure. Overall length: 275 mm. Tracking error: less than 3°3'. Recommended Cartridge Weight: 5.5-17 grams.

List Price: \$18.75



A.T. 1503

Specially selected materials are used to manufacture this extraordinarily durable mechanism. Universal type plug-in heads. Calibrated stylus pressure. Overall length: 340 mm. Tracking error: less than 1°55'. Recommended Cartridge Weight: 8-28 grams.

List Price: \$46.75

ALSO AVAILABLE

A.T. 1005. Universal Type. Standard plug-in heads. 322 mm. arm length.
List Price: \$37.50.

A.T. 1007. Arm length 330 mm. Accepts Cartridges 3.5-22 grams.
List Price: \$65.95.

Most people prefer "natural sound". And natural sound starts with Audio Technica.

All Audio Technica lightweight pick ups will reproduce the groove, the whole groove and nothing but the groove. This is the reason why Audio Technica cannot help sounding natural if the record and the rest of the reproducing equipment are of equally high quality.

Extreme clarity, precise reproduction of transients, complete lack of colouration, vivid presence — natural sound is immediately apparent to the listener.

AudioTechnica is used by the leading manufacturers producing a variety of stereo equipment and in hundreds of thousands of homes where people listen to music.

Whether you are amateur, musician or technician, you will appreciate the truly rewarding experience that Audio Technica pick ups offer you. They are the closest approach to the original natural sound.

MAGNETIC CARTRIDGES



A.T.-66

DM (Duexciting Magnet) type Stereo Cartridge. Frequency response 20-20,000 Hz. Channel separation: 25 db at 1 kHz. Output voltage 4 mV at 1 kHz. 5 cm./sec. r.m.s. Load resistance 50 K. Tracking force 0.5-2.5 grams.

List Price: \$8.50



A.T.-33

VM (V—Magnet) type Stereo Cartridge. Unique wired damper mechanism supports lightweight moving element. Frequency response 20-20,000 Hz. Channel separation 27 db at 1 kHz. Output voltage: 5 mV at 1 kHz. 5 cm./sec. r.m.s. Load: 50 K. Tracking force 0.5-2.5 grams.

List Price: \$13.95

ALSO AVAILABLE

A.T. 21S DM type Stereo, low tracking (spherical stylus) \$11.50

A.T. 21X (elliptical stylus) \$26.90

A.T. 35S (spherical stylus) \$30.95

A.T. 35X (elliptical stylus) \$41.95

AUDIO-TECHNICA

Distributed by: **JACOBY, MITCHELL & CO. PTY. LTD.**

469-475 Kent Street, Sydney. 26-2651

MELBOURNE 30-2491/2 ADELAIDE 53-6117 BRISBANE 2-6467

JACOBY, MITCHELL & CO. PTY. LTD.
469-475 Kent St., Sydney, N.S.W., 2000.

Please send me information on Audio Technica Products and nearest Audio Technica Retailer.

NAME

ADDRESS

POSTCODE

EA/1169

JM/18(A)69

depression years, few amateurs accepted the offer.

However, Allan was one of those who did and the Newcastle station 2KO came into being, located at Kotara (hence the call sign). After struggling for some time, the station eventually became successful and Allan was associated with it until World War II, when he volunteered his services to the Ministry of Munitions (it is understood on a unpaid basis). He remained associated with the Ministry until after the war when he entered Parliament, becoming Minister of the Interior and Public Works, Minister for Supply, and lately Minister for Defence.

In very interesting and humorous replies, both men acknowledged the honour bestowed on them and spoke of their experiences and the Wireless Institute of Australia.

Among the remarks made by the two Life Membership holders, there emerged some very interesting facts about the early days of radio in the Newcastle district. Allan said that his Kotara station ran on a power of only six watts and it must have been the lowest powered broadcast station ever licensed in Australia.

One very important point was made by Allan, at the very end of his speech. This concerns every amateur in Australia and is a very important point to be observed if we are to protect our hobby. He pointed out that it is useless for individuals to attempt to influence the policy making of governments. The only sensible way to approach the administration was to present a united front formulated by a strong national association. It should be the aim of every member in the audience to see that every amateur in Australia was a member of the Wireless Institute of Australia.

Only in this way would amateurs succeed in protecting the frequency bands which they hold.

Concluding the report, Keith made this observation: "This is wise advice from somebody who is in the very seat of government in this country. It should be a warning to all who pursue the hobby of amateur radio to make every effort to induce all amateurs to become a member of our own amateur radio organisation, the Wireless Institute of Australia, which is the world's oldest amateur radio organisation."

QUEENSLAND

At a Special General Meeting of the Queensland Division held in August, the final act was completed towards the incorporation of the division as a registered company. This was the transfer of assets of the unregistered body to the new incorporated company of the W.I.A. Queensland Division. This action has brought the Queensland Division into line with all other divisions of the Institute.

All correspondence and inquiries regarding the Division should be addressed to the Hon. Secretary, W.I.A., Qld. Division, Box 638 G.P.O., Brisbane, 4001.

WESTERN AUSTRALIA

The organisation of WICEN in the West Australian Division is progressing. In the September issue of the "W.A. Bulletin" the WICEN co-ordinator, Ted Gabriel, VK6TG, outlined the basic plan, in which the State is divided into two zones:-

- A: The Northern Zone.
- B: The Southern Zone.

The Northern Zone is all that area north of an East-West line through and including Geraldton. The zone incorporates the North-West emergency net controlled from Carnavon by VK6CT, and includes Christmas Island and Cocos Island.

The Southern Zone is the rest of the State under the control of WICEN Head-

Pierce Healy (right) pins the life membership badge of the W.I.A. on Allan Fairhall watched by Lionel Swain, the foundation secretary of the Newcastle Radio Club, who was also made a life member. (Photo by courtesy "Newcastle Herald.")



quarters and is divided into the following network areas:

1. Perth (WICEN HQ); 2. Narrogin;
3. Albany; 4. Bunbury; 5. Goldfields.

Each area network is under the control of an area co-ordinator or a deputy and he will be responsible for its organisation assisted by headquarters and the WICEN co-ordinator.

It should be noted that WICEN networks are open to ALL AMATEURS, whether members of the W.I.A. or not.

The following is a schedule of WICEN emergency frequencies:-

- Day 3600KHz Long range mainly winter use.
- Night 3600KHz Suitable for short range.
- Day 7100KHz Mobile net.
- Night 7070-7080KHz Medium to long range.
- Day/Night 14100KHz Long range to

Northern Zone mobiles and short range local.

Day/Night 21400KHz Long range to Northern Zone mobiles and short range local.

Day/Night 28500KHz Long range to Northern Zone mobiles and short range local.

Channel B 52.656MHz FM WICEN channel mobiles.

Channel A 52.525MHz FM Alternate traffic channel.

Channel C 52.765 FM Alternate traffic channel.

Channel — 52.586 AM mode to be confirmed.

146.00MHz FM WICEN Channel mobiles.

144.50MHz AM WICEN Channel mobiles.

An invitation is extended to all amateurs to "Join the team."

CHAN NEL LOCK

DIAGONAL CUTTER 41G



PLASTIC GRIPS

Sole Australian Distributor.

Little Champ PRECISION PLIERS

Finest quality precision pliers for delicate bench work. Handy gripping tools for work in electronics, model making and watch repair. Polished steel finish with blue plastic grips.

Complete range 41G to 49G inclusive.

Write for Illustrated Brochure.

Available From Wholesalers All States!

S.C. 11/11/69.

Selectronic Components

17 BARRY STREET,
BAYSWATER, VIC. 3153
Phone 729-2992

RECORDING TAPE

Cheapest in Australia

7"	2,400ft -----	\$3.50
7"	1,800ft -----	\$2.75
5"	1,1200ft -----	\$2.25

COMPACT CASSETTES

Made in U.S.A.

C.60	-----	\$1.25
C.90	-----	\$2.00
C.120	-----	\$2.75

GENUINE B.A.S.F.

C.60	-----	\$2.25
C.90	-----	\$3.00
C.120	-----	\$3.75

BRAND NEW, BOXED GUARANTEED



RADIO MART

338 PITT STREET,
SYDNEY

All Mail
Box 4913 G.P.O. 2001

DESPITE the initial reservations felt by many people, particularly with reference to servicing, the printed circuit is now firmly established in most types of electronic equipment, ranging from the incredibly cheap pocket radios that have flooded the country in recent years, to some of the most sophisticated professional equipment available. Its origins lie in weaponry — a heritage unfortunately common to many good "electronic" ideas, but printed circuitry is, and indeed has been for some time, an attractive system for the amateur who constructs his own equipment, for it solves the mechanical problems of component mounting and eliminates the chores of wiring — as well as facilitating a neat and workmanlike job. For the amateur who has so far shied away from etching his own boards, a new system is now available, which is both economical and easy to use, yet with care, is capable of excellent results. Known as Cir-kit, the system utilises bakelite boards, similar to those used commercially, in conjunction with self-adhesive copper strip. This is 1/16in or 1/8in wide — easily cut with scissors or a model knife — and attaches to the boards rather like a piece of Sellotape. The adhesive is very efficient, although the bond is not quite as good as that on pre-laminated boards — which means that care is needed when soldering not to overheat the copper. However, anyone who is competent to solder a transistor or capacitor without causing damage should have no trouble, and the adhesive improves with aging, so that long-term stability is satisfactory. Layouts can normally be planned using the theoretical circuit diagram as a guide, and boards may be pre-punched or drilled according to requirements. With the pre-punched board, the strip can either be laid over the holes, and then punched through with a small drill or a watchmaker's screwdriver, or it can be laid alongside the holes and component leads are inserted through the board, folded over and soldered (see photo). The former method permits a more compact layout.

A few tips on planning layouts. Always be sure that the component spaces you allocate are adequate — it is preferable to purchase the bits before embarking on this task, although capacitors are available in literally dozens of shapes for board mounting and resistors are more or less of standard size, dependent on ratings. Avoid siting adjacently on to your layout components which are in different stages — as this can lead to instability. If instability does occur, of course, Cir-kit does permit alterations to be made, although it is as well to investigate the problem before redesigning sections of the board for it may not prove necessary.

The excellence of the system, however, lies in its versatility, for it enables the home constructor to produce a wiring board on a one-off basis for most of the circuits described in this and other journals, and while it will no doubt encourage many to "try their hand," it will also enable many who already build their own equipment to achieve neater, more reliable results with a minimum of fuss.

**AVAILABLE ALL LEADING
RADIO HOUSES.**

(SOLE AGENT)



ZEPHYR PRODUCTS PTY. LTD.

70 BATESFORD ROAD, CHADSTONE, VICTORIA—PHONE 56-7231

MANUFACTURERS OF RADIO & ELECTRICAL EQUIPMENT & COMPONENTS

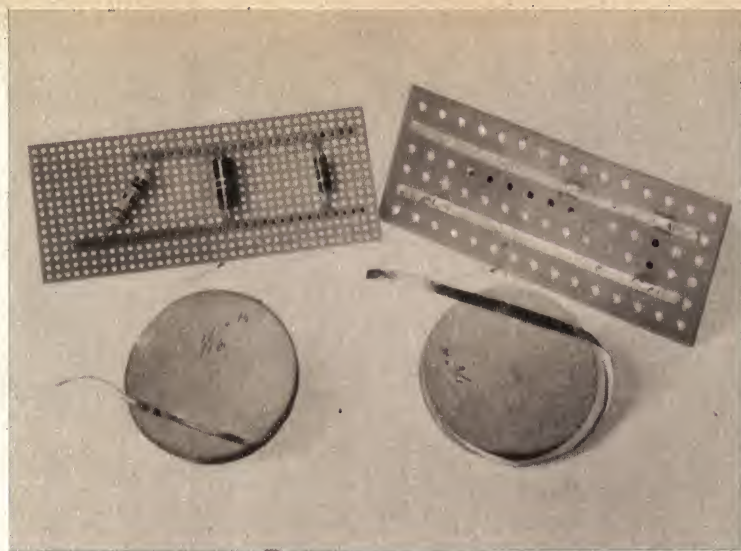

INSTANT CIRCUITS

A new method of making component boards using self-adhesive copper strip.

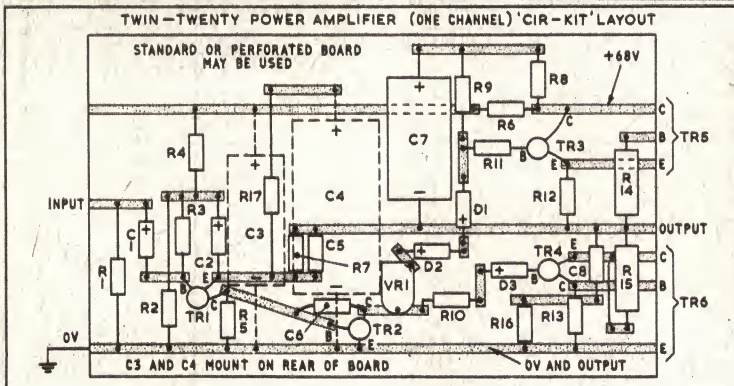
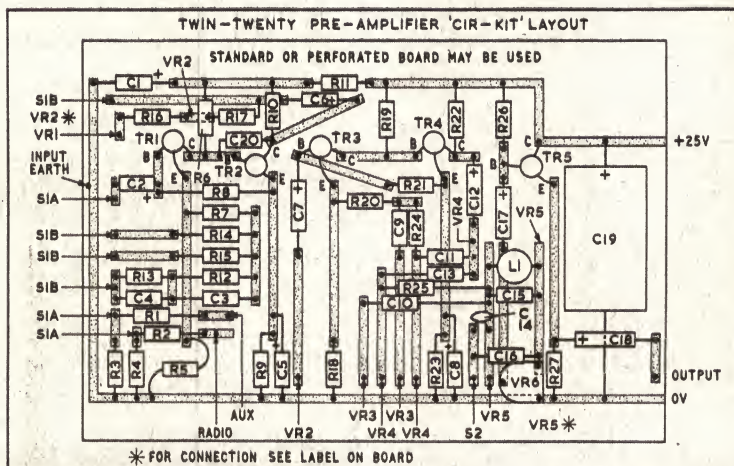

BREAKING OUT OF THE NET

Here is a short note of interest to operators who wish to extend the capabilities of their six-metre fixed frequency units, received from Keith Woodward, VK2BAU. Keith explains:—

Three receiver crystals would allow operation from 52.0MHz to 52.30MHz; 53.00 MHz to 53.30 MHz and 53.70MHz to 54.00MHz, covering all the popular sections of the band.

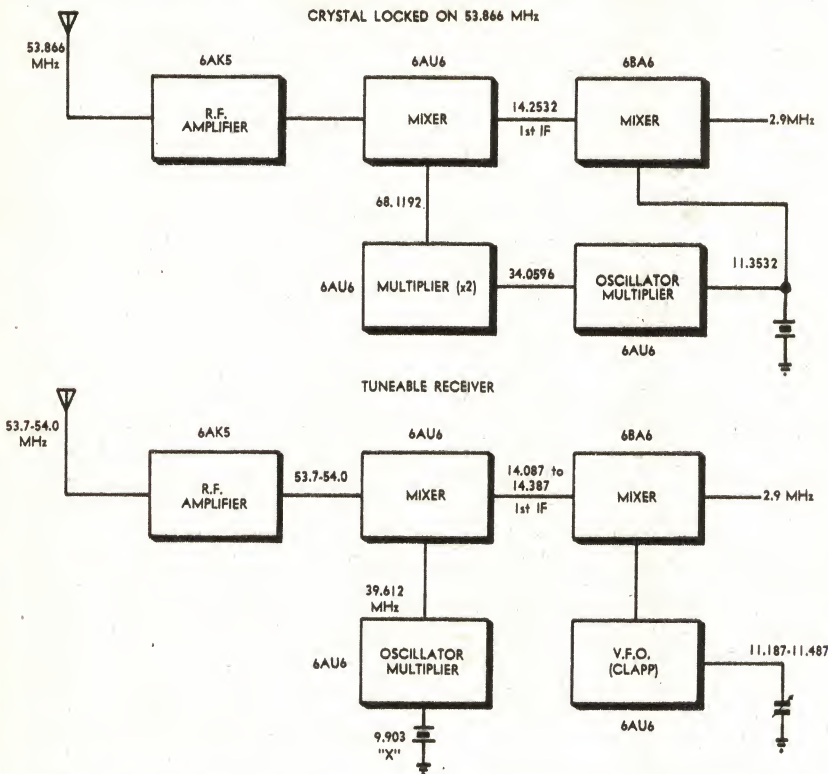

This is not an article to debate the merits of net operation versus tunable operation but one which will allow the six-metre operator to enjoy both.

The popularity of 53.866MHz has caused unavoidable pile-ups and many stations are now fitting the alternative channel 53.687MHz. This is only an immediate solution for net frequency users. A method of shifting about the full 2MHz of the band would be a step in the right direction. It is highly desirable to have the full band working, not only to satisfy the requirement "Use them or lose them," but also to encourage DX working.

Keith is at present preparing a full article on several modifications for the Pye Reporter series of transceivers. This will give preliminary details of a system for making the receiver tunable in conjunction with switched transmitter frequencies. The system suggested is a crystal-locked front-end and tunable intermediate frequency. The first IF transformer is relatively broad in tuning and will allow a shift of 300KHz with little drop-off in response.

It is suggested that the normal crystal-locked oscillator in the receiver be altered to a Clapp VFO with a tuning range of 300KHz. This not only keeps within the response of the first IF transformer but allows a reasonable bandwidth.

The original multiplier stage is changed to a crystal oscillator-quadrupler giving sufficient injection for good mixer operation yet using relatively cheap crystals. By switching this crystal, 300KHz segments of the band may be selected. If the transmitter crystal switch is ganged with the receiver switch it can be used to select a transmit frequency falling within the 300KHz segment covered by the receiver.

A suggested combination to cover the Sydney net frequencies and the Wollongong frequency is given in the block diagram. The system shown will allow the use of a 11.3532MHz crystal to set up the system before changing to VFO operation.

$$X = \frac{f - (V + 2.9)}{4}$$

where

X = crystal fundamental frequency

f = lowest frequency to be tuned in MHz

V = lowest VFO frequency in MHz

e.g.

$$\begin{aligned} X &= \frac{f - (V + 2.9)}{4} \\ &= \frac{53.7 - (11.187 + 2.9)}{4} \\ &= \frac{53.7 - 14.087}{4} \\ &= 9.90325\text{MHz} \end{aligned}$$

CALLING ALL PROSPECTIVE AMATEURS

The Wireless Institute of Australia was established in 1910 to further the interest of Amateur Radio. With over 45 years experience, who could be more experienced in the teaching of this subject?

We are a non-profit making Organisation. Correspondence Courses are available at any time. Personal Classes commence in February of each year.

For further information write to:
THE COURSE SUPERVISOR, W.I.A.,
14 Atchison Street,
CROWS NEST, N.S.W.

BRIGHT STAR CRYSTALS

PREFERRED BY LEADING MANUFACTURERS
THROUGHOUT THE COUNTRY FOR —

ACCURACY - STABILITY - ACTIVITY - OUTPUT



All types of Crystals Available
Such as DC11, FT 243 HC6U CRA
B7G, HC18U, ETC.
TOLERANCES: .0015%, .002%,
.003%, .005% ETC.

Consult us for Crystals for any Mobile Radio.
Prices depend on tolerance and frequency
required.

DISCOUNT FOR QUANTITY ORDERS

Established 36 Years



AMATEUR AIRCRAFT and ULTRASONIC CRYSTALS also AVAILABLE

Our new Factory employing the most modern equipment
allows us to offer you **PROMPT DELIVERY** for all your
CRYSTAL requirements.

DEVOTED EXCLUSIVELY TO THE MANUFACTURE OF

PIEZO ELECTRIC CRYSTALS

Contractors to Federal and State Government Departments

REPRESENTATIVES AUSTRALIA AND NEW ZEALAND: Messrs. CARREL & CARREL
BOX 2102, AUCKLAND.

MESSRS ATKINS (W.A.) LTD.,

894 Hay Street, PERTH.

MESSRS. A. E. HAROLD PTY. LTD.,
123-125 Charlotte Street, BRISBANE.

MESSRS LAWRENCE & HANSEN

ELECTRICAL (VIC.) PTY. LTD.,

34 Brisbane Street, HOBART,
and 29 St. John Street,
LAUNCESTON, TASMANIA.

BRIGHT STAR RADIO

546-5076

LOT 6 EILEEN ROAD, CLAYTON, VICTORIA

546-5076

REALISTIC PERFORMANCE REALISTIC PRICE



REALISTIC DX 150

ALL SOLID STATE - 4 BAND COMMUNICATIONS RECEIVER

A big professional looking set that makes exciting news for amateurs . . . the DX150 gives realistic reception on SW/CW/SSB/AM-Broadcast bands; obsoletes tube receivers with their warm-up delay; banishes dependence on AC main power . . . the DX150 will run on dry cells if current fails or is not available; will operate from a car's cigarette lighter or any 12V DC service. 240V AC power supply is built-in, of course.

Over 30 semi-conductors—Product detector for SSB/CW, plus fast and slow AVC—variable pitch BFO—illuminated electrical bandspread fully calibrated for amateur bands—Cascade R.F. Stage—ANL for RF and AF—Zener stabilised—OTL audio—illuminated "S" meter—Built-in monitor speaker plus front panel jack for external (optional) matching speaker.

Attractive silver extruded front panel, solid metal knobs, grey metal cabinet, size 14 1/2" x 9 1/4" x 6 1/2" . . . a truly Realistic performer at a realistic price.

\$229.50

**Brings in the
whole wide world of
SW/CW/SSB/AM-
Broadcast**

**240V AC or 12V DC
operation.**

CONSULT YOUR LOCAL RADIO DEALER, OR

MAIL THIS COUPON *today*

Please forward free illustrated literature and specifications on Realistic.

Name.....

Address.....



(A unit of Jacoby Mitchell Holdings Ltd.)

375 EASTERN VALLEY WAY, ROSEVILLE, N.S.W.
Cables and Telegraphic Address: 'WESTELEC',
Sydney. Phone: 40 1212

YOUTH RADIO SCHEME

NEW SOUTH WALES

On Sunday, November 30, a Y.R.C.S., activities day will be held at the Wireless Institute Centre, 14 Atchison Street, Crow's Nest. Proceedings will commence at 12 noon and finish at 5 p.m. The program will include contests, making printed circuit boards, construction projects and a demonstration of amateur television.

Y.R.C.S. club members are invited to attend. The Centre is 200yds from St. Leonards Railway Station.

Maitland Radio Club

Late in September, the Maitland Radio Club held a presentation evening, when the District Inspector of Schools, Mr C. H. J. Hargreaves, presented Elementary Certificates to five members who were successful at the examination held recently for club members.

The five successful members were: Mrs E. Berman; R. Phee; I. McTackett; K. Murray sen.; John Murray.

John, who is only nine years old, gained honours in the Y.R.C.S. examination and because of the special significance of his pass (being the youngest member to do so), he was presented with a soldering iron as an incentive prize. John is a pupil of the Tenambit Primary School.

Mr Hargreaves commented on the example set by Ken Murray, John's father, who joined the club to foster in his son an interest in radio.

The Morse telegraphy training section of the club was pleased to receive from the Australian Radio and Television College in Sydney, a complete Morse training unit, used during the war to train service personnel. Bill Plant, VK2AMM, the Morse code instructor, advises that the equipment, which is of the punched paper type, is capable of training at least eight students simultaneously. It uses up to eight different tapes, enabling beginners to join advanced students in one classroom.

Bill Plant is also the editor of the club's magazine "MRC News," which is now in its second year of publication. The colour of the cover has been changed to enable readers to distinguish the issues for each year. The magazine is widely read among clubs around Australia and copies are being sent to four overseas countries.

The Maitland firm Agserv Pty. Ltd. has donated a 70ft steel tower to the club, which will be erected at the club's Maize Street headquarters.

Further information about the club may be obtained by writing to the Secretary, Box 54, P.O. East Maitland, N.S.W., 2323; or by telephoning Maitland 33-7286, STD area code 049.

Westlakes Radio Club

Congratulation have been extended to Colin Mackie, a committeeman of the Westlakes Radio Club, who has been notified of his admission to Fellowship of the Australian College of Dental Surgeons. Colin is very active in amateur radio affairs, being vice-chairman of the Hunter Branch. Now that his school exams are over, Colin's next target is the amateur Operator's Certificate of Proficiency examination next February.

Keith Howard, VK2AKX, officer in charge Junior Radio Certificates, advises that the following candidates have been successful in recent Junior grade examinations:

Philip John Gibbs, Marist Bros. High School, Parramatta, Credit

(Cont. on page 188)

ROSS HULL MEMORIAL CONTEST

The Federal Contest Committee of the Wireless Institute of Australia invites all Australian and overseas amateur operators and shortwave listeners to participate in the 1969-1970 Ross Hull Memorial VHF/UHF Contest, which is held annually to perpetuate the memory of Ross Hull whose interest in VHF/UHF did much to advance the art.

A Perpetual Trophy is awarded annually for competition between members of the Wireless Institute of Australia in Australia and its Territories, inscribed with the name and life work of the man whom it honours. The name of the winning member of the W.I.A., each year is also inscribed on the Trophy. In addition the member will receive a suitably inscribed certificate.

OBJECTS:

Australian amateur operators will endeavour to contact as many other amateurs in Australia and overseas under the following conditions.

Date of Contest:

From 0001 hours Eastern Australian Time, December 6, 1969, to 2359 hours Eastern Australian Time, January 11, 1970.

Duration:

Any seven calendar days within the dates mentioned above, not necessarily consecutive. These periods are to be at the convenience of the operator. A calendar day is from 0001 hours E.A.T. to 2359 E.A.T.

Rules:

1. There are two divisions, one of 48 hours duration and one for seven days. In the seven-day division, there are three sections:—

- Transmitting, Open.
- Transmitting, Phone.
- Receiving, Open.

2. All Australian and overseas amateurs may enter the contest whether their stations are fixed, portable or mobile.

3. All amateur VHF/UHF bands may be used, but no cross-band operation is permitted. Operators are cautioned against operating transmitting equipment on more than one frequency at a time, particularly when passing cyphers. Cross-band operation to assist contest working is prohibited.

Such operation will be grounds for disqualification. Cross mode contacts will be permitted.

4. Amateurs may enter for any of the transmitting sections. The seven-day section winner is not eligible for the 48-hour award.

5. Only one contact per band per station is allowed each calendar day.

6. Only one licensed amateur is permitted to operate any one station under the owner's call sign. Should two or more operate any particular station, each will be considered a contestant and must submit a separate log under his own call sign.

7. Entrants must operate within the terms of their licences.

8. Cyphers: Before points may be claimed for a contact, serial numbers must be exchanged. The serial numbers of five or six figures will be made up of the RS (telephony) or RST (CW) report plus three figures commencing in the range of 001 to 999, for the first contact and will then increase in value by one for each successive contact. When a contestant reaches 999 he will then commence again with 001.

9. Entries must be set out as shown in the example, using only one side of the paper. Entries must be postmarked not later than February 9, 1970, and clearly marked "Ross Hull Contest" and addressed to: Federal Contest Manager, Box N1002, G.P.O., Perth, W.A. 6001.

10. Scoring for all sections will be based on the attached table. Distances must be shown in the log entry as shown in the example. Failure to make this entry will invalidate the particular claim. Some typical distances are given in the attached table.

11. Logs: All logs shall be set out as in the example and in addition will carry a summary sheet showing the following information:

Name

Address

Call sign Division

Claimed Score

Operating Dates (7 calendar days)

Highest score over a 48-hour period was points.

Operating period:

From hrs. E.A.T. /.....

To hrs. E.A.T. /.....

Declaration: I hereby certify that I have operated in accordance with the conditions of my licence and abided by the rules of the contest.

Signed

date

12. Entrants not abiding by the rules of this contest will be disqualified.

13. The ruling of the Federal Contest Committee of the W.I.A. will be final. No dispute will be entered into.

14. Awards: Certificates will be awarded to the winners of each section in each VK and overseas call area. The VK contestant who returns the highest score in the transmitting section and who is a financial member of the W.I.A., will have his name inscribed on the trophy which will be held by his division for the prescribed period. A certificate will be awarded to the contestant who shall not be the trophy winner and who returns the highest scoring log covering a period of any consecutive 48 hours.

Also, certificates will be awarded for operating in the Ross Hull Contest and breaking any Australian VHF/UHF distance record.

Receiving Section:

1. Short-Wave Listeners in Australia and overseas may enter for the contest, but no transmitting station may enter.

2. Contest times and logging of stations on each band are as for the transmitting sections. However, there is no 48-hour sub-section.

3. To count for points, logs will take the same form as for transmitting sections, but will omit the serial number received. Logs must show the call sign of the station heard (not the station worked), the serial number sent by it, and the call sign of the station being worked.

Scoring will be on the same basis as for transmitting stations, i.e. on the distance between the listener's station and the station heard. See examples given. It is not sufficient to log a station calling "CQ."

4. A station heard may be logged only once per calendar day on each band for scoring purposes.

5. Awards: Certificates will be awarded to the highest scorer in VK and overseas countries.

EXAMPLE OF TRANSMITTING LOG (Brisbane Station)

Date/Time E.A.T.	Band MHz	Power Emission	Call Sign	RST/No Sent	RST/No Rec'd	Dist. Miles	Points Claimed
24th Dec. 0110	52	A3(a), 50W.	VK7ZAI	59001	59004	1110	10
0110	52	A3(a), 50W.	VK4NG	58002	57051	330	10
0230	144	A3, 150W.	VK5ZK	55003	55043	990	25
0235	144	A3, 150W.	VK3ZJQ	45004	46021	850	25

EXAMPLE OF RECEIVING LOG (Perth S.W.L.)

Date/Time E.A.T.	Band MHz	Call Heard	RST/No Sent	Station Called	Dist. Miles	Points Claimed
2nd Jan. 1000	52	VK5ZDX	59221	VK8KK	1330	10
1025	52	VK2ZCF	58195	VK6ZAA	2040	20
1100	432	VK6ZDS/6	57061	VK6LK/6	60	25
3rd Jan. 0500	144	VH5ZHJ	44102	VK6ZCN	1330	50

SCORING TABLE

Distance	52MHz	144MHz	432MHz	575MHz	Higher
Up to 25 miles	1	1	2	5	20
25 to 50 miles	1	1	10	20	50
51 to 100 miles	2	5	25	60	100
101 to 200 miles	5	10	50	125	200
201 to 300 miles	15	15	75	175	250
301 to 500 miles	10	20	100	250	300
501 to 1050 miles	5	25	200	300	350
1051 to 1500 miles	10	50	250	350	400
1501 to 2500 miles	20	100	300	450	500
2501 to 3500 miles	35	200	400	500	600
3501 to 5000 miles	50	300	450	550	650
5001 miles and over	100	400	500	600	700

DISTANCE TABLE

	SYDNEY	CANBERRA	BRISBANE	MELBOURNE	HOBART	ADELAIDE	N. ZEAL.	DARWIN	PERTH
SYDNEY	0	160	460	460	650	710	1300-1500	1950	2040
CANBERRA	160	0	600	290	530	670	1300-1500	1930	1940
BRISBANE	460	600	0	850	1110	990	1500-1700	1790	2240
MELBOURNE	460	290	860	0	400	400	1500-1700	1930	1720
HOBART	660	530	1110	400	0	710	1300-1500	2280	1880
ADELAIDE	710	670	990	400	710	0	1900-2100	1620	1330
NEW ZEALAND	1300-1500	1300-1500	1500-1700	1500-1700	1300-1500	1900-2100	0	2550	3000-3200
DARWIN	1950	1930	1790	1930	2280	1620	2550	0	1650
PERTH	2040	1940	2240	1720	1880	1330	3000-3200	1650	0

TUDOR RADIO

L. E. CHAPMAN
ESTABLISHED 1940

103 ENMORE ROAD, ENMORE, N.S.W.
PHONE 51-1011
NEW POSTAGE RATES
PLEASE ADD EXTRA

Knobs long shaft, push on. Dozen \$1.20
Knobs for concentric shaft. Dozen \$1.20
250 mixed screws. BA, Whit., self-tapper
bolts, nuts, etc. \$1 bag plus 25c post.
Crystal microphones, good quality, ideal
tape recorders, etc. \$2.80.
Transistor speaker transformers, single
ended, 5 watt. \$1.50.
Pick up shielded Wire . . . 20 cents yard.

SPEAKERS

MSP 8-inch dual cone . . . \$6.50
MSP 12-inch dual cone . . . \$8.50
MSP 7 x 5 15 ohm . . . \$4.00
MSP 3½-inch 3 ohm . . . \$2.00
Rola 6 x 4 15 ohm . . . \$3.50
Rola 5 x 3 15 or 27 ohm . . . \$2.50
Rola 5B 3 ohm . . . \$2.00
MSP 6 x 9 15 ohm . . . \$5.00
3-inch single cone 15 ohm . . . \$4.20
6 x 4 33 ohm . . . \$3.00
MSP 20 Watt . . . \$19.75
MSP 12-inch 8 ohm . . . \$8.50
MSP 2-inch 15 ohm . . . \$2.00
MSP 8-inch dual cone, 8 ohm . . . \$6.50
MSP 12-inch-3.5 ohm . . . \$6.00
MSP 4-inch large magnet
8 ohm . . . \$2.50
MSP 3-inch 150 ohm . . . \$2.50
MSP 3-inch 15 ohm . . . \$3.00
National 8-inch built-in tweeter
and crossover network . . . \$14.75
MSP Electro Dynamic, 8in, \$4, or 6 x 9.
MSP 6 x 2 15 ohm, \$3.
MSP 6 x 4 15 ohm, \$3.50.
Peak 607 16 cm Hi-Fi
Dual Tone 6in . . . \$7.50
MSP 20-watt radial beam 12pqb \$21.50
Magnavox 8 ohm 4in tweeter . . . \$2.50
2 gang tuning condenser . . . \$1.00
Peak H50 horn type tweeter . . . \$12
MSP 8-inch speakers . . . \$4
Pioneer 15-inch 8 ohm 60 watt . . . \$40
SPEAKER CABINETS complete with
radial beam MSP 20 watt speaker and
horn type tweeter with cross over net-
work . . . \$70 each
Solid oiled teak 23½ x 17 x 12.

RADIOGRAM CHASSIS 4 valve in-
cluding valves and speaker, \$15.50.
Size 10½ x 3 x 5.



**SMALL
2-GANG
TUNING
CONDENSERS**

Complete with direct drive scale \$1.75
TV IF STRIPS . . . \$5 each.

ENGLISH PANEL LAMP with toggle
switch 75 cents.



English push-button on/off switches,
75c each. Pack and post 10c.

Peak CX50 high compliance 8 in 8 ohm
speakers . . . \$28

TRANSISTOR AMPLIFIERS. Peak
stereo in oiled teak cabinets 3½ watts
per channel . . . \$39

POWER TRANSFORMERS 200 mil
385 aside . . . \$8
Curled expanding shielded wire approx.
7 yards . . . \$1.50

Miniature valve sockets 7 and 9 pin
15 cents each.

Speaker Crossover network Condensers
2 MFD — 60 cents.

Philips IFT's 455KC 75c each
Aerial and oscillator coils . . . 50c each

Scope soldering iron, standard; mini
scope. Scope De Luxe. Vibra scope;
National scope transformer.

Transistor IFs, medium size, 75c each

RECORD CHANGERS

B.S.R. UA25 \$25.00



**PORTABLE PHILIPS RECORD
PLAYER \$7.75 6 VOLTS**

Speaker transformers 15,000 and 25,000
to 3 ohms 6 watts . . . \$1.50 each
5,000 to 3 and 15 ohms . . . \$1.25 each
Transistor speaker chokes \$1.50 each
Here's value in pots.

Pots, single log and linear:
3K, 7½K, 10K, W.W., 20K, 25K, 50K,
100K, 200K, 250K, 500K, 1 Meg,
2 Meg. Dual Concentric Switch Pot
\$1.25

Pots 25,000 dual ganged switch pots,
\$1.25

1.5 Meg. Dual Concentric . . . \$1.00

Pots dual ganged 10K, 50c. 1 Meg.
\$1.25

Pots concentric. 100K + 50K, 100K +
2½K, 100K + 10K, 250K + 250K,
500K + 500K, 1 Meg + 1 Meg,
1 Meg + 500K. Various others
2 Meg 50c each



TAPE RECORDER CASE \$7.00
Tuning condensers 2 and 3 gang \$1.00



STEREO AMPLIFIER KIT SETS

TU 10, 3.5 watt per channel . . . \$19

TU 11, 3.5 watt per channel, has facili-
ties for tape and microphone chan-
nels \$23

TU 12, 5 watt per channel . . . \$22.00

TU 13, 5 watt per channel, with TU 11
facilities \$27

Each kit set includes valves and all
components. Front face plate, if re-
quired, \$1 extra.

Single stage amplifier kit set:
5 watt per channel \$22.00

Transistor ear plugs 3 for \$1.00

Tag strips, mixed types . . . Dozen, 60c

Switches, oak 4 position . . . 50c each

2 position 40c each

½ and ¼ AMP. FUSES \$3.50 100.

Din Plugs, 3 or 5 pin 50c each.



PORTABLE RECORD PLAYERS
Cost \$42. \$19.50 each.

ELECTROS:

	3 in one	
50	250	415
8	350	415
10	350	415
	75 cents each.	



**METAL RECTIFIER, 150 watt, ½ amp,
\$1 each.**

All types \$3.50 to \$20.00 plus post.
TV aerial lead in 10c yard
Tuning Condensers, 2 gang or 3 gang
—\$1 each.

2 amp fuses \$3.50 per 100
Special, 12in speaker, 2 ohm Rola, \$6.00
pack and post, 75c.

Transistor plastic outer case, 50c each
Transistor carrying straps . . . 20c each

Stereo pick-up arms, with Xtal, \$6.00 ea.
Metal rectifiers for battery and electric
portables 50c each, post 10c

Pilot lamp holders 60c per doz.

TV or cabinet castors . . . 4 for \$1.00

100 Mixed Knobs including TV channel
changers \$10.00

240v AC Record Changers, stereo
\$21.50, Mono \$20.00. Pack and post,
N.S.W. \$1.50, interstate \$2.50.

Gramophone motor and pick-up, 240v
AC \$11.50. Pack and post, N.S.W.
\$1.00, interstate \$1.50.

OA 70 diodes 40c ea.

Morganite and IRC resistors. At least
33 values. Suit transistors, radios, TV
etc., \$2.00 per 100. Pack and post, 25c.

3, 5, and 10 Watt IRC wire wound
resistors. Many values.
20c each, 12 for \$2.00

100 mixed condensers, micas, ceramics,
tubular. Fresh stock.
\$2.00. Pack and post 25c.

50 + 24, 350 vw + 100 mf 25 vw,
75c each

30, 30mf 300 vw 350vp . . . 75c each

Many others. Invaluable for service.

2 meg. Lin Pots 50c

R.C.A. 7 INCH TAPE SPOOLS 75 cents

**ALPHA 200VAC ½ amp push-on
switches, 30c each. Ideal for fridges.**

90 deg. **PICTURE TUBE SOCKETS**
25c each. 152 valve sockets, 25c each.

Transistors AC127, 2N384, 2N217,
2N218, OC71, OC75.

\$1.00 each. Post and pack 5c.

THREE WATT AMPLIFIERS,
complete with speaker.
NEW. \$10.00.

Electros 1.8 x 0.9 MF — 20c each

AUDIO TRANSFORMERS

18-4294, 28-4536 75 cents each

PILOT LIGHTS, Plug in . . . 10 cents

SWITCH WAFERS

20 cents each.

**3 USED TRADED-IN B.S.R. RECORD
CHANGERS**

New cartridges \$15.00

NEW GRAMOPHONE MOTORS,

For 4-speed Turntables . . . \$2.50 each

TRANSISTOR speaker and Case, Plastic,
5-inch speaker with plug and lead, \$4
each. Pack and Post 25 cents.



**Stereo Head Phones, good quality —
\$9.75.**

NEW VALVES

12 AU7 ..	\$1.25	SSJ7	\$1.25
6SA7 ..	\$1.25	6BH5	—
6BU8 ..	\$1.25	6D6	\$2.00
6M5 ..	\$1.25	EL33A	\$2.00
6BM8 ..	\$1.50	6B4	\$2.00
1S5 ..	\$1.00	17Z3	\$1.50
1T4 ..	.50	QVO4-7	\$2.00
6CJ6 ..	\$1.50	1954	\$2.00
6L18 ..	\$1.00	12AX4	—
ECL85 ..	\$1.25	G.T.B. ..	\$1.50
SP61 ..	\$1.00	9A8	\$1.50
UU9 ..	\$1.00	6W6	\$1.50
12BE6 ..	\$1.00	6ACT	—
6AU4 ..	\$1.25	12AN7	\$1.25
6U9 ..	\$1.25	12AH8	—
6Y9 ..	\$1.25	6ES6	—
6X9 ..	\$1.25	6N7	—
6AQ5 ..	\$1.25	6DA6	—
1B3 ..	\$1.50	6CJ6	\$1.50
1S2 ..	\$1.50	6T8A	—
5AS4 ..	\$1.25	UL84	\$1.50
6DQ6 ..	\$1.50	EL81	\$1.50
12AT7 ..	\$1.25	EF39	—
12Ax7 ..	\$1.75	6CH5	\$1.25
6B8 ..	\$1.25	17 BFH	\$1.50
6C H6 ..	—	6BX7	\$1.25
6AU5 ..	—	12FR8	\$1.00
6SL7 ..	—	6CK5	\$1.25
6BW8 ..	—	3OAE3	\$1.50
6DC8 ..	—	6AH4	\$1.25
6CK6 ..	—	UCL82	\$2.00
6V9 ..	—	6JN8	\$1.25
6BH8 ..	—	EF41	\$1.50
35W4 ..	—	50EH5	\$1.50
6BC8 ..	—	6CD8	\$1.25
PCL81 ..	\$2.50	25Z5	\$1.50
12AH8 ..	\$1.25	UF 41	\$1.50
6DC8 ..	—	7AN7	\$1.50
6BN4 ..	—	UF 41	\$1.50
PCL 83 ..	\$2.00	X148	\$1.50
12FX8A ..	\$1.50	EY86	\$1.50
6DS8 ..	\$1.25	6BA8	\$1.50
9U8 ..	\$1.50	PCC 85	\$1.50
ECH 42 ..	\$1.25	15A6	\$1.50
6ET6 ..	\$1.25	Z759	\$1.50
1AR11 ..	\$2.50	EY 51	—
6DJ8 ..	\$1.50	1U4	\$1.00
7FC7 ..	\$1.50	6DB5	\$1.25
UY 85 ..	\$1.50	PCF 80	\$1.25
12AQ5 ..	\$1.25	6S2	\$1.25
12AV6 ..	—	23Z9	\$1.50
6BD7 ..	\$1.25	EF6	\$1.25
6AM8 ..	—	6AM5	\$1.25
6AT6 ..	—	EM85	\$1.25
ECH35 ..	\$2.00	EA50	\$1.25



TV IF COILS, IDEAL FOR COIL FORMERS .. \$1 dozen



SPEAKER CABINETS

13 x 6 1/2	\$5.00
10 x 6 1/2 x 4 1/2	\$3.50
12 1/2 x 8 1/2 x 6	\$5.00
Fuse holders	50 cents dozen
Octal valve sockets	50 cents dozen
Chokes 18 Henry 30 mil.	\$1.50
M.S.P. 6in SPEAKERS, 3 or 15Ohm	\$4.00



TV PORTABLE voltage doubler power trans. C. Core. 240 volt 77V 1 amp. 6.3 Volts 8 amps, \$6.

DIAL DRUMS, 5 inch, 3 1/2, 3 3/4 50c ea.
NATIONAL SPEAKERS, 8 inch built-in Tweeter, Crossover network .. \$14.75
 10 inch Bass, mid range Tweeter combined .. \$32
ELECTROS 20 MFD 200 P.V. — 20c



TV POWER TRANSFORMER, \$8.
 300 mil. Two 6.3 windings, 200 volt secondary for Bridge Type Rectifier.

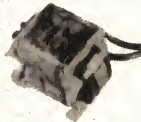

50 M CHOKE \$1.
 Pack and Post 30 cents
 Interstate 60 cents.
300M Choke \$2.50



VOLTAGE DOUBLER POWER TRANSFORMER, 200 mil 240 volt x 105-110 secondary 6.3V 15 amp. . \$8



BATTERY SAVER, 6 or 9 volt DC 100MA \$8.50; 300 MA, \$10.00.



SPEAKER ENCLOSURE, complete with 8in M.S.P. dual-cone speaker, 8 or 15 ohm .. \$15.80
 Cabinet without speaker .. \$10
 Cabinet size 16 x 10 x 8.

TRANSISTOR EXTENSION CABINETS

Complete with 5-inch speaker and lead. **\$3.50**



INDOOR TV AERIALS \$1.50
 Pack and Post 25c.

STEREO AMPLIFIER 10 watts per channel solid state AT6 Garrard record changer, oiled teak cabinet, complete unit .. \$125
 Same unit with Garrard 3000 changer. **\$115.**

TAPE RECORDER COUNTERS \$1.75

POTS

1 meg. Dual Ganged Log .. \$1.25
 1 meg. Dual Ganged Lin .. \$1.25
 1/2 meg. Switch Pot double pole log .. 75c

6 VOLT PILOT LIGHT, screw-in .. ea. 10c

RESIN CORE SOLDER 5 yards 75c

H.M.V. TRANSISTOR AMPLIFIER AND SPEAKER
 9 volt .. \$15.00

15 INCH M.S.P. SPEAKERS.
 Dual cone 8 ohm .. \$55.00

AMPLIFIER OR TUNER CABINETS, oiled teak 10 1/2 x 5 1/2 x 3 .. \$2 each
 Pack and Post, 30 cents.
 Interstate 60 cents.

GOODMANS SPEAKER

Axiom 10 15 ohm 20 watt .. \$20
 1000 UF 10 volt condensers 50 cents

GOODMANS AXIETTE 101 8 inch 15 ohm .. \$12

STEREO SPEAKER LEAD, 10 Cents yd.

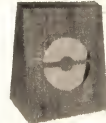

SPEAKER BOX, unpolished, suit 8in speaker \$3.75. Pack and post 50 cents.
 2N 1108, 2N 1110, 2N 1111. Transistors .. 50 cents each



GARRARD PLUG IN STEREO CARTRIDGE, \$6.00



ROBINSON SOLDERING

IRONS, 30 WATT .. \$6.00
 40 watts .. \$6.00
 60 watts .. \$6.25

2 ONLY TRADED-IN STEREO AMPLIFIERS. \$18 each.
 3 1/2 watts per channel.

CAR RADIO PUSH BUTTON TUNERS .. \$4.50
 Pack and Post 30c, interstate 60c.

Pots 50 ohm switch .. 50 cents each.

American or Japanese 2 pin power plugs rubber complete with 2 1/2 yards flex 50 cents. Pack and post 10 cents.

MICROPHONES MAGNETIC OR CRYSTAL .. \$1.75

SPEAKER CABINET, 16 x 10 x 8, complete with 6 inch M.S.P. dual cone Speaker tweeter, 3 inch and Crossover network .. \$18.75

MAGNAVOX 8 WR, 10 WR 12 WR. Tweeter 3, 4 or 5 inch.

Speaker Plugs, 4 pin .. 15 cents
 Speaker Sockets .. 15 cents

PUSH PULL AUDIO TRANSFORMER, 10,000 CT 15 ohm .. \$3.00 each

RADIOGRAM CHASSIS STEREO Complete with valves 3 1/2 watts per channel .. \$25

TRANSISTOR DRIVE and OUTPUT TRANSFORMER 23 to 15 ohm. 75 cents a pair.

MSP 6 inch dual cone — \$5.50 each. MSP 3 inch tweeter — \$3.75.

MULLARD BOOKSHELF SPEAKER CABINETS, \$10 each.

STEREOGRAM CHASSIS, 5 watt per channel, complete except speakers. \$35.

LAFAYETTE HA-600

Transistorised Communications Receiver



HA-600T \$199.50

2 FIELD EFFECT TRANSISTORS 10 Transistors
7 Diodes 1 Zener Diode

5 BANDS 150-400 KC, 550-1600 KC (Broadcast Band),
1.6-4.8 MC, 4.8-14.6 MC, 10.5-30 MC.

This new receiver, Model HA-600, combines the latest solid state electronics with attractive modern appearance to achieve a superb blend of performance and style. Advanced circuitry utilises two Field Effect Transistors in the mixer and oscillator stages to assure high sensitivity with lowest noise factor. 10 Transistors, 7 Diodes plus 1 Zener Diode complement the F.E.T.'s to provide top performance with exceptional stability. Series Gate noise limiter and automatic volume control provide efficient noise and audio blasting suppression. Built-in variable BFO permits clear reception of code and single sideband signals. Continuous electrical bandspread calibrated for amateur bands 80 to 10 metres facilitates tuning.

- Operates from 12 volts DC (negative ground) or 220-240 volts 50 cps. (17 watts).
- Two Mechanical Filters for Exceptional Selectivity.
- Product Detector for SSB/CW.
- Huge Edge Illuminated Slide Rule Dial with "S" Meter.
- Electrical Bandspread Calibrated on Amateur Bands 80 to 10 metres.
- Engineered by Lafayette to their highest quality standards.

SPECIFICATIONS: Sensitivity: 1 uV at 10db signal to noise ratio. Selectivity: + or - 2 KC at 6 db down + or - 6KC at 60 db down. Intermediate Frequency: 455 KC. BFO Frequency: 455 KC + or - 2.5 KC. Antenna Impedance: 50-400 ohms. Audio Power Output: 3 Watts at 4 ohms. Speaker Impedance: 4, 8 and 500 ohms. Headphone Impedance: 8 ohms. **CONTROLS:** Function, BFO, Volume, Band Selector, RF Gain, Antenna Trimmer.

LAFAYETTE ELECTRONICS

Division of Electron Tube Distributors Pty. Ltd.

All mail enquiries and orders to:

**VICTORIAN SALES CENTRE
AND HEAD OFFICE,**

**94 HIGH STREET, ST. KILDA,
VIC., 3182. Ph. 94-6036**

LAFAYETTE Communications receivers are also available from:

RADIO HOUSE PTY. LTD., 306 Pitt Street,
6 Royal Arcade, 760 George Street,
Sydney, N.S.W. 2000.

TISCO AGENCIES, Overend and Hampton
Streets, Woolloongabba, Q'land 4102.

- Paul Lorentson, Westlakes Radio Club, Credit
Phillip Connolly, Penrith High School, Pass
Earl Conning, Arthur Phillip High School, Credit
Stuart Brown, Arthur Phillip High School, Pass
Phillip John Cheetham, Arthur Phillip High School, Credit
Frank Collini, Marcellin College, Randwick, Credit
Peter Connolly, Marcellin College, Randwick, Credit
Ross Tester, Cowra High School, Credit
Roger Foote, Cowra High School, Pass
George Pangas, Cowra High School, Pass
Bill Byrnes, Arthur Phillip High School, Credit
Panytos Tsambos, Arthur Phillip High School, Pass
Michael Latta, Arthur Phillip High School, Pass
Ligh Aanenaen, Arthur Phillip High School, Pass

Marcellin College Radio Club Randwick

At present there are 20 very keen and active members of this club. The leader is Peter Vernon, a sixth form student who has his full callsign, VK2BPV. Peter demonstrated amateur radio to many of the members and gave them their first experience of going on the air. When he operated his station portable at the school, seventeen contacts were made in all, two of them being with Czechoslovakian amateur stations.

Present plans of club members are to complete a six-metre unit to enable them to join in the lunch time school nets on 53.866MHz.

The names of two members of the club, Peter Connolly, and Frank Cellini, appear in the list of successful candidates for the Y.R.S. Elementary Certificate included in these notes.

VICTORIA

The Camberwell Grammar School Radio Club has been praised by the Y.R.S. Supervisor in Victoria for the high standard attained by club members in recent Examinations for Y.R.S. Certificates. The club now has a tally of 15 certificates in the various grades. Three members will be attempting the Senior Certificate exam in November. The average marks gained in the exams to date is 84 per cent.

With two licensed members in the club, Chris Holliday, VK3JU, and Mike Goode, VK3ZYY, the club station is active on the HF and VHF bands. To date more than 150 contacts have been made. The third member of the club to sit for the A.O.C.P. Exam, Tim Robinson, is eagerly awaiting the results of the August exam.

SOUTH AUSTRALIA

During the school holidays, a display of communication equipment in the Adelaide Town Hall provided the opportunity for the South Australian Division of the W.I.A. to show some of the aspects of amateur radio, including that of the Youth Radio Scheme.

With the aid of the Elizabeth Amateur Radio Club, a display was set up showing examples of practical projects by club members, lesson material, notebooks, etc. Many of the young visitors, and some not so young, showed great interest in the official W.I.A. station VK5WI which was operating from the hall.

The display, organised by the Crippled Children's Association to publicise their annual fund-raising appeal, also included exhibits of communication equipment used by the Fire Brigade, Police, Emergency Fire Services and others.

Two members of the Elizabeth Amateur Radio Club were successful at a recent examination for the Y.R.S. Intermediate Certificate. Paul Philbrook gained Honours and Paul Clemence a Credit.

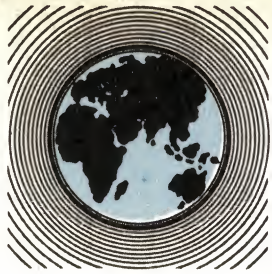

LISTENING AROUND THE WORLD

The Ideal Reception Report

After a survey of international short-wave stations, the European DX Council recently made its findings known on what short-wave stations want to receive from their listeners.

by Arthur Cushen

At the recent European DX Council meeting at Halmstad in Sweden, I was one of a panel which discussed the reception report and the basic items which are needed to prove the reception of a station by a distant listener. These findings were based on a survey conducted around the world. Answers to the questionnaire were submitted by 21 stations. From the replies received the 10 basic items necessary in a report were found.

It is not necessary to mention the wavelength (in meters) when the frequency is reported (in KHz). All larger stations know the SINPO code, so it is not necessary to explain this on the report. Exact and thorough information on any interference heard is essential to the stations. If possible the interfering stations should be identified and their frequency and the influence on the reception quality given. Do not bother to report your local weather as the reception conditions are mainly governed by the ionosphere.

All of the stations agreed on these minimum requirements:

1. Name and address of sender clearly written.
2. Name of the station reported.
3. Frequency in KHz (or KC).
4. Date, and time in GMT.
5. Language of the program.
6. Program details from at least 15 minutes of listening.
7. Reception quality in SINPO.
8. Interference description.
9. Type of receiver.
10. Type of antenna.

It should be noted that the above results are valid for reports to stations with a foreign service, while home service stations, including those in Latin America, may not have the same interests in reception reports.

THE SINPO CODE

Much controversy is caused by the use of the SINPO code.

You can't be interested in DXing for very long, says an item in a recent issue of "Contact," before you will make the acquaintance of the SINPO code — the group of five figures, which is generally to be found in a DX bulletin, summarising the quality of reception of some station or other. The code is an almost universal way of indicating to a radio station, or other DXers, the way in which you heard a broadcast. It causes a great deal of discussion wherever DXers meet, but often DXers are not too clear about the way in which it should be used.

The word SINPO is derived from the initial letters of the five factors which

Notes from readers should be sent to Arthur Cushen, 212 Earn Street, Invercargill, N.Z. All times are GMT. Add 8 hours for Perth, 10 hours for Sydney 12 hours for Wellington.

you are measuring in your report. "S" stands for signal strength; "I" for interference; "N" for noise; "P" for propagation disturbance; and "O" for the overall merit of reception.

The scheme of the code is that we report each of the five factors in one figure only, which runs from 1 to 5. The designation 5 represents the best possible conditions of reception, while designation 1 means that reception was virtually impossible. However, in practice, there is more to it than that, so let us look at the various factors in turn.

In arriving at the rating we give "S," it is very important to remember that it is the signal strength which is being reported and not the amount of noise which is coming out of the loudspeaker. I find it useful in assessing this quality to think of "S5" as being the report for the strongest local station I can hear and "S1" as being the report for the very weakest station I can hear on a clear channel—one that is just barely audible. Then "S2" indicates the weak station, "S3" the average one, and "S4" the very good signal.

Next let us look at "I," "N," and "P" together—these items, interference, noise and propagation disturbances are all factors which lead to deterioration of a signal from the point of listening pleasure. In assessing these, we take "5" in each case as representing the rare event of a received signal not being affected at all, whereas "1" represents deterioration so obvious that you will certainly classify it as very severe. The figures, "4," "3," "2" then represent increasing severity of the particular factor between the extremes of "absent" and "very severe." Some DXers get a bit confused between the exact meaning of "I," "N," "P" — "I" means interference from another radio station; "N" represents noise whether originating from your neighbour with an insuppressed electric drill or from static noise from a thunderstorm or from any source whatsoever; "P" stands for propagation disturbance, and represents fading and distortion of all kinds which are attributable to the behaviour of the signal being transmitted.

That leaves us with "O" for the overall merit of the signal. This is the listener's own subjective assessment of the extent to which the signal is capable of being understood and enjoyed. Of course, it represents to a great degree a summing-up of the four factors which have gone before, and "O5" stands for reception which is well up to the quality of a very powerful local station under good conditions, whilst "O1" means that overall quality was very poor indeed. Between these two extremes, "O4" will mean very good DX reception, "O3" the sort of overall merit which is tolerable and "O2" that the quality was poor but mainly readable.

The great thing that the DXer who is not familiar with the SINPO code must avoid is spreading the figure 5 all over the ratings. If you stop to think for a moment you will realise that it is very seldom that any DX signal is as strong as that from your local high-power domestic service station. The best rating that you can give to that local station is "S5" so a short-wave station getting "S5" will be rare. The same consideration applies to reports of "I," "N," "P"—when did you last hear a short-wave station which did not suffer from some kind of interference noise or fading? With the increased use of the short-wave broadcasting bands, the exclusive use of a channel is a rarity, so heterodynes and "splash" interference from an adjacent channel are commonplace. It is an unfortunate fact that all SW broadcasting is prone to fading and other kinds of disturbance. So, if you are thinking of awarding a "5" for any factor, I suggest that you ask yourself whether the signal is really as strong as a "local" and absolutely clear of interference, noise or fading—if there is the slightest doubt, then a "4" is the true rating. By all means mention in a report that you nearly gave a "5."

HCJB'S NEW OUTLETS

Station HCJB in Quito, Ecuador, has been observed at our listening post using two new frequencies in an expanded service at 0700GMT. This program in the past has been beamed to the South Pacific, but is now also on the air for listeners in North America and Europe.

The frequency of 9710KHz has been heard with a gospel program in the Dutch language at 0600GMT and in Spanish at 0630GMT. English programs commence on this frequency at 0700 and are heard as well on another new frequency, 11735KHz. The best signal from HCJB is on the frequencies beamed to the Pacific, 11920, 9745, and 6050KHz. At 1930GMT HCJB is using the 13-metre band frequency of 21460KHz.

HCJB's DX Party Line is now broadcast on new frequencies as follows:

GMT	kHz
0230	15255, 11915, 11755
	9745, 9710
	15415, 17880, 21460
1930	6050, 9745, 11920

The transmission at 0230GMT is beamed to North and South America, at 1930GMT to Europe and India, and at 0930GMT to Australia, New Zealand and Europe.

THE VOICE OF THE PHILIPPINES

A verification has been received by Mervyn Branks, Invercargill, N.Z., which gives details of this new station, reported in our last issue. From July 1 the Government of the Philippines took over the facilities of the Voice of America at Malolos, and is using the station on both medium and short-wave.

The medium-wave station on 920KHz uses the power of 50KW, and is on the air 2100-1600G.M.T.

The short-wave stations are on the air 2200-0200 and 0900-1400GMT and the frequencies and powers are as follows:

KHz	KW
9555	7.5
9580	50
11950	50

NEW RANGE OF RESISTORS CONDENSERS AND POTENTIOMETERS

The resistors are mainly I.R.C. and Morganite and are in a wide range of values from 100 ohms to 3 meg. in 1/4, 1 and 2 watt and include wire wound. LIST PRICE \$9.00 per 100. OUR PRICE \$2.00 per 100. Post and packing 35c extra.

The condensers are in most popular brands and include Polyester, Paper, Mica, Ceramic and Electrolytic in values up to 8mfd. LIST PRICE \$11.00 per 100. OUR PRICE \$2.00 per 100. Post and packing 65c.

The pots, are all current types and include switch pots, and dual concentric, tandem, tab pots, etc. LIST PRICE \$12.00 per dozen. OUR PRICE \$2.50 per dozen. Post and package 60c extra.

FREE With each lot of resistors, condensers or pots. we will supply one new valve. Type 6U7G, 1T4, 6K7G, or 6X5GT.



LEADER SIGNAL GENERATOR 15G11

240V A.C. operated, 6-band 120KC to 390 Megs. Provision for crystal. Post N.S.W., 75c; Interstate, \$1.25. **\$32**

NEW TRANSISTOR 8 KIT SET

SPECIAL PURCHASE ENABLES US TO OFFER THIS KIT SET AT \$24.00

- Complete kit of parts with circuit and full instructions.
- Eight transistors.
- Magnavox 5X3 speaker gives excellent fidelity.
- High sensitivity, suitable for city or country use.
- Heavy duty battery for economical operation.
- Modern design, plastic cabinet with gold trim.
- Dial calibrated for all States.
- Available in colours of off-white, red, black.

Post N.S.W., \$1.25; Interstate, \$1.75.



DIMENSIONS
9" x 5" x 3" deep

New Electrolytic Condensers

These condensers are miniature pigtail type insulated new stock in packets of 12, each packet containing: 3 86mfd 300 V.W., 2 32 mfd. 300 V.W., 1 25 mfd. 450 V.W. and 6 low voltage electrolytics. \$2.50.

Post and packing 20c extra.

NEW IMPORTED 4" P.M. SPEAKERS

Available with a 4 or 16 ohm voice coil. \$2.00. Post and packing 30c extra.

NEW ENGLISH & AMERICAN TRANSISTORS AT 1/2 LIST PRICE PACKET OF 12 FOR \$3.00

Ideal for the experimenter and service man. Each packet of 12 contains 3 each of the following types.

Mazda XA 101. Equivalent OC45
Texas 2N1108. Equivalent OC44
Texas 2N1111. Equivalent OC75
Texas 2N1110. Equivalent OC45

Post and packing 25c extra.

NEW 240V ELECTRIC MOTORS

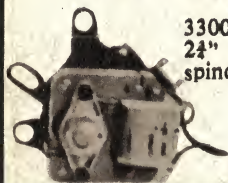

3300 R.P.M. Size 3 1/2" x 2 1/2" x 3 1/2", including spindle.

\$2.75

plus 60c postage



SOLID STATE GUITAR AMP.

Here is a fully solid state guitar amplifier rated at a nominal 50 watts continuous power. Featuring two totally independent tone control channels and tremolo facility, the amplifier offers unique flexibility in a light and compact unit. (Featured in July-August issue Electronics Aust.)



Complete kit of parts to Electronics Aust. specifications supplied with foot control switch and lead for remote tremolo. Cabinet finished in black vinyl and control panel in black and silver with matching knobs.

COMPLETE UNIT WIRED and TESTED **COMPLETE KIT OF PARTS**

\$114.00

\$98.00

USED HIGH-SPEED 240V. AC/DC MOTORS

These 240V A.C. or D.C. motors are 1/8 H.P. with a speed of 7,000 r.p.m. and are ideal for small drills, grinders, etc. Dimensions: 5 1/2 in x 3 1/2 in, with 5/16 in spindle \$3.75

Postage N.S.W., 50c; Interstate, 85c.



NEW 25 P.A. AMPLIFIERS

\$61.00

These amplifiers are suitable for installation in clubs, schools, restaurants, factories, etc. Wherever the amplification of speech or music is required.

SPECIFICATIONS

Nominal power 25 watts ● Inputs two microphone and pickup radio with separate controls and mixing facilities ● Tone control. ● Microphone sensitivity 6MV, pick-up or radio 150MV. ● Frequency response 30 to 18,000 C.P.S. ● Output impedance Line output (100, 166, 250, 500 ohms) or can be supplied with V.C. output (2, 3, 7, 8, 15 ohms). ● Dimensions 11 in x 6 in x 8 in. Weight 25W 23lb. Freight extra.

ROTARY SWITCHES

Single Bank 11 x 1, 4 x 2, 3 x 3 69c, Single Bank 2 x 1, 35c. Two Bank 3 x 3 \$1.20.

Rocket Switches D.P.D.T. 55c

Rocket Switches S.P.D.T. 45c



A TRANSISTOR PREAMP FOR MAGNETIC PICK-UP OR TAPE HEAD

Using 3 transistors per channel as featured in Electronics Aust. Complete kit of parts including transistors. P.C. board and resistors and condensers.

Circuit and full details supplied.

Stereo Kit \$12.00.

Mono Kit \$6.50

240V Power Supply \$7.00.



NEW MIDGET POWER TRANS. \$3.75

40mA prim., 240v. Sec 225 x 225 with 6.3v Fil. Winding. 30mA 240v. Prim. Fil. Winding.

Postage: N.S.W., 25c; Interstate, 45c.

150 x 150v. Sec. with 6.3v.

Postage: N.S.W., 35c; Interstate, 60c. **\$3.75**

NEW AMERICAN TWIN TELESCOPE TV AERIAL.

Extends to 36in, each section can be used singly for car or portable \$1.50. Post 20c. SINGLE TELESCOPIC Aerial, 12in extends to 33in, 60 cents. Post 10c.

NATIONAL RADIO SUPPLIES

332 PARRAMATTA ROAD, STANMORE, N.S.W. PHONE 56-7398

The verification came in the form of a letter from the National Media Publicity Section of the Philippine Government. The use of the Malolos station has been given to the Philippine Government, as the Voice of America is now using the high-powered station at Tinang.

POINT-TO-POINT RECEPTION

From time to time readers have asked for the inclusion of material concerning point-to-point radio stations. In our opinion, listening to material from such stations runs close to contravening radio regulations, as Australian and N.Z. radio licences specify that this type of material is confidential, and should not be passed on. Reports to the stations concerned will accordingly not be verified.

Recently, the Swiss Broadcasting Corporation gave this item a good look over, and concluded that listeners should be persuaded not to write to these stations. In any case, there are large numbers of short-wave and medium-wave stations capable of being received, which value reports from listeners. The radio regulations say that if someone picks up a point-to-point transmission they must not make use of its content either personally or by passing it on to another person. Most of the point-to-point stations belong to Government agencies such as the Post Office and Post and Telegraph authorities, and do not want reports. Some stations do distribute QSL cards; for example, the Swiss Telephone and Telegraph Service does acknowledge reports, but is not keen in doing so.

To counter this type of report the Swiss PTT has recently come up with the announcement "This is a point-to-point communication, and not a broadcasting service" to deter listeners from sending reports to the station. Firstly, the station says, they are of no use, they know exactly how reception conditions are from their distant customers; and secondly, the station is unwilling to verify, as some of the material involved is confidential.

B.B.C. USES KHZ

In the September issue, reference was made to the Voice of America still using kilocycles, and this is one of the few remaining International short-wave stations to continue to use this frequency reference.

On September 7 the B.B.C. switched to the use of MHz and KHz for its microphone announcements. In recent months the B.B.C. has been using the MHz and KHz style in its frequency schedules and other material in printed form, and feels that the short-wave audience is now well enough informed on this matter not to be confused by the use of this frequency reference on the air.

NEW ENGLISH BROADCASTS

Two countries have recently commenced English broadcasts for the first time. They are Saudi Arabia and Tunisia. Bryan Clark, Wellington, N.Z., reports the reception of Jeddah, Saudi Arabia, with an English program from 0430 to 0530GMT. The station is using 11855KHz, and has news in English at 0445GMT.

Radio Tunisia has been heard with an English news bulletin at 0645GMT when using 11900KHz. The broadcasts from Tunisia for local consumption are all in Arabic and can be heard from 0600 to 0700 and again from 1700 to 2300GMT. An additional frequency of 11970KHz has also been heard carrying these programs.

STATIONS DO VERIFY

In the June issue we listed a number of stations which are not regular verifiers to reports from short-wave listeners. This has resulted in some comment about some of the stations listed.

Chris Davis, Featherston, N.Z., says that he has reported Radio America at Lima, Peru. This station has verified his report of a recent date in 19 days. The verification was in the form of a personal letter, and it listed date, time and frequency.

Miss Ann Nevback, Fremantle, W.A.,

NEW SCHEDULES OPERATING

RADIO KUWAIT

A verification we have received from the Kuwait Broadcasting Service, P.O. Box 397, Kuwait, lists the following schedule.

GMT	KHz	KW	Language
0225-2100	1345	200	Arabic
0400-1500	9520	50	Arabic
0400-0600	4967	10	English
0400-0600	15370	250	English
1600-1900	15345	250	English
0900-1100	21590	250	Arabic
1300-1905	21685	250	Arabic

RADIO FIJI SCHEDULE

The Fiji Broadcasting Commission in Suva, has recently introduced an additional medium-wave frequency, which has resulted in some program changes. The present transmission schedule is:

English		
GMT	KHz	Location
1800-1030	560	Suva
1800-1030	1320	Lautoka
1800-2115	3230	Suva
0345-1030	3230	Suva
2115-0345	6005	Suva

Fijian Hindi		
GMT	KHz	Location
1800-1030	710	Suva
1800-1030	890	Lautoka
1800-1030	930	Sigatoka
1800-1030	1470	Rakiraki
1800-2130	3284	Suva
0330-1030	3284	Suva
2130-0330	5955	Suva

Note: programs from Sigatoka and Rakiraki carry services in English at times. A program is on the air in English, 2000-2400GMT on Saturday, on 840 and 4756KHz.

Calls have been assigned to the short-wave stations as follows: VRH8 (3230), VRM9 (3284), VRH4 (4756), VRH6 (5955) and VRH7 (6005).

reports verification in 1963 from Radiodifusora, Venezuela. The station call was YVKB and it was operating on 4890KHz. Our own verification from YVKB is in the form of a card and was issued by the station in 1949.

RADIO CLUB RETIMED

The B.B.C. World Radio Club program has been retimed for reception in the Pacific area, and is now heard on Sunday at 0815GMT, instead of 0930GMT, as previously. The best reception is on 7150, 9640, 11955 and 15070KHz.

This program provides technical information for short-wave enthusiasts in language comprehensible to non-technical listeners. Membership is open to all who write in with a problem, question, or suggestion about short-wave broadcasting to World Radio Club, B.B.C. Bush House, London WC2.

V.O.A., TINANG

The Voice of America recently commenced to operate from its new relay station at Tinang, in the Philippines. The station will eventually consist of ten 250KW transmitters broadcasting on short-wave. The present transmission schedule of the three 250KW transmitters now in operation is as follows:

GMT	KHz
0830-1700	9665
1000-1700	11965
0800-1700	15105

The Voice of America has also under construction a new relay station at Kavala, in Greece. This will have 10 250KW transmitters and 22 diplexed curtain antennas for improved coverage of East Europe, Central U.S.S.R., the Middle East, South Asia and North Africa. In addition, the Kavala station will have a 150KW medium-wave transmitter for improved coverage of the Balkans and Southern Ukraine.

RADIO SUDAN

The present schedule of Radio Sudan as reported in "World Bulletin" shows that they are using the new slogan of "The Broadcasting Service of the Democratic Republic of the Sudan." Programs

are in Arabic and are as follows:

GMT	KHz
0400-2200	764, 961, 4994, 7200, 11835, 15789
1600-1900	4994, 15789

The second transmission is beamed for the Southern Provinces.

SUNSPOTS DECLINE

The sunspot count has shown a steady decline over the past six months according to a report from Switzerland, from the observatory at Zurich, and its stations in Locarno and Arosa. The predictions of the smoothed monthly sunspot count are as follows:

August 96, September 94, October 92, November 90, December 88, January 87.

RECENT VERIFICATIONS

ISLE OF MAN: Our verification from the Isle of Man came in the form of a white card with station details on one side and the address on the other. The station uses the slogan "Manx Radio" and it is the only local radio station licensed for commercial broadcasting in the British Isles. The station operates on 1295KHz during daylight hours and on 1594KHz during darkness. The program is carried on 89MHz, using FM. The present schedule is 0600-1900GMT. The power of the transmitter is 2KW, but the aerial pattern is such that less than 200 watts is radiated towards Wales. The address of the station is P.O. Box 22, Douglas, Isle of Man.

SPAIN: Our verification from Radio Zaragoza which operates on 872KHz on medium-wave was in the form of a letter and pennant. The station has the call-sign of EAJ-101. The power of the station is 20KW, and the address is Avenida Marina Moreno 21, Zaragoza, Spain.

COSTA RICA: Our reception of station TIQ "Radio Casino" reported in a recent issue as using 5955KHz and heard with English at 0500GMT, has resulted in a verification card and pennant. The card gives the power of the station as 1KW and says they use an inverted V aerial. The station is located at Puerto Limon and has the mailing address Apartado 287.

HOW TO STOP SMOKING Quickly and Easily!

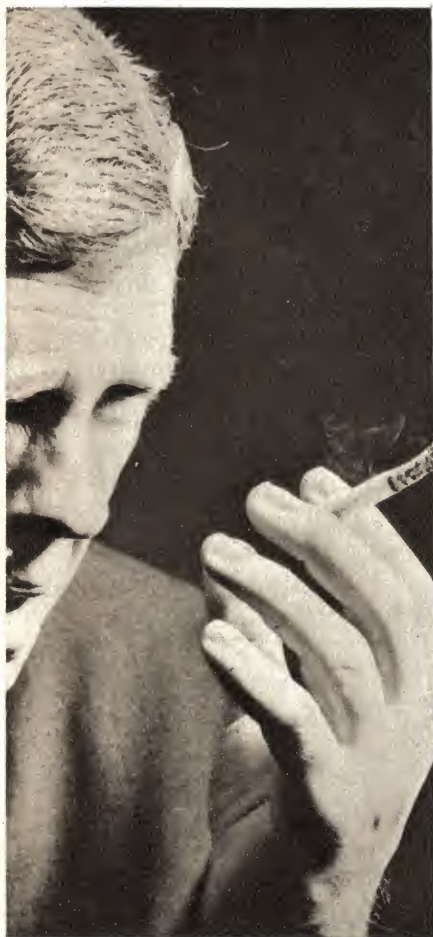

**"ONLY APAL
PROVED
SUCCESSFUL"**

"I can honestly say that I have now lost the craving for cigarettes. I smoked 35 a day at one time, and only your Apal has proved successful. I'm saving more and feeling better! Thank you so much for your 'great little cigarette.' Should this letter be of use to you, you have my permission to use it.—Joe Walton, 63, Fecitt Brow, Blackburn, Lancs.

'Apal The Only Way'

"... I might add that Apal is without doubt a life saver and the only REAL way to cure the smoking habit.—Mr Roy P. Douglas, London.

**"APAL MOST
SUCCESSFUL, EASIEST"**

"After using several methods to stop smoking, I found that the Apal was the most successful and easiest way, the beauty of it is that it is always available should the urge to smoke arise again. If you care to use this for advertising purposes you can print my name and address, too. I will back it up.—Mr J. B. Shave, 70 Elmes Road, Moor-down, Bournemouth, Hants.

HUNDREDS OF LETTERS

Now you can positively finally stop smoking FOREVER without effort. Never again need you burn money and risk your health. Thousands upon thousands have already given up smoking FOREVER with the aid of an amazing new anti-smoking aid called APAL. Every week hundreds of letters of testimony pour into the Bedford headquarters of Apal. Smokers of 40, 50, 60 a day, smokers for 30 or 40 years, have stopped smoking in 24 HOURS without any effort or ill effects!

**PROOF! The original
copies of these
unsolicited letters are in
our files in Sydney and can
be inspected on request**

"HIGHLY RECOMMENDED"

"You have been highly recommended to me by a few of my workmates who have stopped smoking by the use of your product."

Mr R.W.L., Baigownie, N.S.W.

"WONDERFUL TREATMENT"

"I am writing this to let you know how pleased I am to stop smoking with the aid of Apal. Thank you for your wonderful treatment."

Mr N.P., Lae, T.P.N.G.

"100% BETTER"

"Thanks to your wonderful treatment I feel 100% better in health, as well as my pocket."

Mr N.L., Dookie Agricultural College, Vic.

"WORKED WONDERS"

"I am writing to let you know that your Apal worked wonders on me. I have only had it two days and have completely given smoking away."

Mr F.W.A., Mount Dutton, S.A.

- ★ NO WILL-POWER!
- ★ NO EFFORT!
- ★ NO TENSION!
- ★ NO NERVES!

Apal is an imitation cigarette cleverly developed and perfected in the laboratories of the Health Culture Company after many years of research. You never light Apal. You simply put it in your mouth when you feel you want a smoke. It has a cool, soothing taste and will take away the craving instantly! It is perfectly harmless and is NOT habit forming.

FREE BOOK COUPON

The Apal Company, Dept. E3,

109-119 Liverpool St., Sydney, N.S.W.

Please send me THE TRUTH ABOUT SMOKING without any obligation. I enclose 5c stamp for postage.

Name (Mr, Mrs, Miss)

(BLOCK LETTERS)

Full Address

E.L.1/11/69

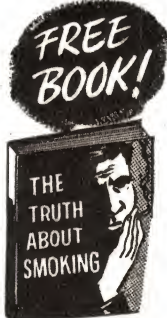

FLASHES FROM EVERYWHERE

EUROPE

BELGIUM: The English program called "Belgium Speaking" is broadcast at 2205-2215GMT on 9550, 9660 and 1175-KHz. The program is repeated at 0050-0100 on 6125, 9660 and 11715-KHz. The frequency of 9660KHz is a new one for Brussels.

SWEDEN: The program "Sweden Calling DXers" is received well on 15105KHz on Tuesday at 1245GMT. Two other broadcasts are also well received when Stockholm uses 11910KHz. These transmissions are heard at 2100 and 2300-GMT when programs are beamed to the Far East. The Russian service from Radio Sweden can be heard on 11965-KHz from 0830 to 0900GMT at good level though some jamming is evident.

AFRICA

ANGOLA: "World Bulletin" reports that the regional station at Serpa Pinto has been observed to close at 1930GMT on 4880KHz. The station has been carrying the programs of the "Voice of Angola." Radio Diamang, Dundo, now opens at 1630GMT on 4770 and 9615KHz. This sign-on time is 90 minutes earlier than previously.

CONGO (Democratic): Radio Kinshasa has been observed on 11720KHz using 10KW from 0400 to 1100GMT, after which they switch frequency to 11795-KHz. The program continues on this channel to 1300GMT. The full frequency list used for the period 0400-1300GMT is 838, 1338 on medium - wave, and 4880, 7115, 9775, and 15245KHz. Radio Bukavu, on 4839-KHz now has a transmission from 0400 to 0630GMT for morning reception in the area.

CONGO (Republic): O.R.T.F. at Brazzaville now has a new 90-minute transmission in English from 0500 to 0630-GMT. The frequencies used are 11970 and 15445KHz. The program in French, 0500 to 0810GMT, is now on 3232, 4795, 5970, 7105, 9730, 11725, 15190 and 21500KHz. The program on Sunday is extended to 1100GMT on these frequencies. The local program from Brazzaville is on the air at 0430GMT and announces as 6115, 4765KHz on short-wave and 1475KHz on medium-wave.

ASIA

U.S.S.R.: Radio Tashkent, Uzbekistan, has forwarded its latest program schedule for its broadcasts in English. The station is on the air 1200-1230GMT and the second program is 1400-1430GMT. Two frequencies are used, 9600 and 11925-KHz. Radio Tashkent is conducting a quiz program based on the Life of Lenin.

BURMA: Burma Broadcasting System, at Rangoon, is now using the recently tested frequency of 9730KHz and this channel has replaced 6035KHz. The program on this channel is on the air 0230-0730GMT, the last 30 minutes being in English.

MONGOLIA: Radio Ulan Bator has issued a schedule showing that English is now broadcast 1220-1250GMT on 9540KHz and 7540KHz, and that the service at 2200-2230GMT is on 11850 and 11810KHz.

NORTH VIETNAM: Bob Padula of Melbourne reports a recent schedule to hand from the "Voice of Vietnam" at Hanoi. English broadcasts are now listed as being on the air at 0500, 1000, 1300, 1530, 2000 and 2300GMT. The frequencies listed, which are not all on the air with each transmission, include 1240KHz on medium-wave, and 9840, 7416, 7360, 15018 and 10224KHz.

PAKISTAN: Radio Karachi's service to Europe is carried on two frequencies, 11675 and 15250KHz. The service in English is broadcast from 1945-2030-GMT. Radio Karachi has also been noted on the new frequency of 9705-KHz at 0245GMT, and at this time has a news bulletin in English. On 21590KHz, Karachi continues to also provide good reception with news at 0800GMT. This is one of the most reliable signals in the 13 metre-band.

THE AMERICAS

PERU: Cyril Anderson of Perth reports that Radio Union, Lima, on 6115KHz has verified his reception. This station is well received at around 0600 and also at 1100GMT. The reply came in the form of a pennant, as well as a few words in Spanish on a business card, expressing thanks for the reception report. The verification came to hand in three weeks, and the report was in Spanish. Two IRC's were sent to cover return postage.

BRAZIL: A report in "World Radio Bulletin" advises that Radio Aparecida is now offering a special QSL diploma to those DXers who submit correct reports covering 9635 or 4985KHz. Reports must be in the form of a tape, and include an announcement which must appear on the tape. The address is Praca NS Aparecida 315, Brazil.

HONDURAS: According to "Sweden Calling DXers" a 24 hour station is now in operation, using the slogan "Radio Tic-tac." The station operates on 980KHz on medium-wave and 4950 and 6035KHz on short-wave. The station call-sign is HRTL and the address is Apartado 771, Tegucigalpa, in Honduras.

COLOMBIA: Radio HJEX at Cali has been heard at our listening post with an extended schedule and sometimes runs all night. The station has been heard with its slogan "Radio Pacifico" on 6055KHz with news in Spanish at 0500. The station on occasions plays "Just a Song at Twilight," and then signs off with a national anthem.

BROADCAST BAND NEWS

GILBERT AND ELLICE ISLAND: According to a report in the Japanese "Short Wave Club" bulletin, the transmitters of the Gilbert and Ellice Island Broadcasting Service are to be moved to a new site. Radio Tarawa will commence to operate soon with a new 10KW transmitter on medium-wave, using 844-KHz. The station's new site is on Bairiki Island, instead of its present location of Betio Island. In addition the 2KW short-wave transmitter is to be moved from Nanikaal Island to Betio, and during the transfer period, the station will be off the air. This will affect the short-wave broadcasts on 4912KHz.

PERU: Radio Loreto, at Iquitos, has recently increased power from 1KW to 10KW. The station, reported in a certification that this new power was now being used on 1380KHz, and has been on the air to as late as 0700GMT.

HONG KONG: According to a report in the "New Zealand DX Times" from Tony Magon on board H.M.N.Z.S. Otago, he paid a visit to Radio Hong Kong. Tony says the commercial service of Hong Kong has changed frequency from 1530KHz to 1170KHz. The station is on the air from 2300-1600GMT and is using the power of 10KW. The Chinese program is on 1150KHz and is on the air for the same hours and it also uses 10KW. Test transmissions of the Chinese program have also been heard on 850KHz.

PHILIPPINES: A test transmission has been heard from DYWN on 1470KHz. The test was heard at 1430GMT and the station announced "You are listening to a test transmission from the new powerful action station DYWN broadcasting from Westing University Building in Bacolod City."

The full address of the Voice of the Philippines on 920KHz is National Media Broadcasting Centre, Public Information Office, Manila. Verifications are signed by Ernesto G. Madrid, Manager.

SERVICE

BILL TURNBULL offers you service on Hi Fidelity equipment tape Recorders, Communication Receivers and Electronic Test Equipment.

25 years experience
All work guaranteed

BILL TURNBULL
11 ELLALONG ROAD,
CREMORNE, N.S.W. 90 4825

BARGAIN PACKS!

SEMI-CONDUCTOR PACKS. BRAND NEW AND TESTED. SILICON AND GERMANIUM.

10—Audio Type, Similar BC108	\$2.95
10—Audio Type, Similar BC109	\$3.00
10—RF Type, Similar BF115	\$2.95
10—RF High Gain	\$2.95
10—RF Low Noise VHF	\$3.50
10—Audio Output, Matched pairs	\$3.25
5—Pair Complementary Output	\$3.25
1—NPN Output, 2N3055/BDV20	\$2.00
1—PNP RF IF Type, Sim. AF116, AF-117, each	.35
OR 10 for	\$3.00
1—PNP Power Output, Sim. 2N301, 2N2148	\$1.30
1—PNP Audio, Sim. OC70	.40
FETS	
MPF 102	\$1.10
MPF 105—2N5459	\$1.10
MPF 106—2N5458	\$1.30
2N3819	\$1.10
T158—2N5345	\$1.10
UNIJUNCTION, 2N2160	\$1.10
SCR C106	\$1.20

SILICON RECTIFIERS

50v, 25c ea. or 10 for	\$2.25
100v, 25c ea. or 10 for	\$2.25
200v, 25c ea. or 10 for	\$2.25
400v, 50c	
600v, 55c; 800v, 60c;	
3 Amp 100v Surge Protected ea.	75c

DIODES

OA90 Type, 25c ea. or 10 for	\$2.30
OA91 Type, 25c ea. or 10 for	\$2.30
OA95 Type, 27c ea. or 10 for	\$2.50
BA100, each	.30



7W Stereo Amplifier, 50-20,000 Hz. In oiled timber Cabinet. \$34.50 Complete.

STEREO HEADPHONE SPECIAL



BRAND NAME — 8 Ohm. Wide Range \$6.00.

TAPE DECKS—Van Der Molen Cassette Decks from \$27

RECORDING TAPE, POPULAR MAKE, AT WHOLESALE PRICES

3in 150ft	.50
3in 225ft	.70
3in 300ft	.85
3in 600ft	\$1.80
5in 900ft	\$1.98
5in 1200ft	\$2.50
5 1/2in 1200ft	\$2.55
7in 1200ft	\$3.00
7in 1800ft	\$3.25
7in 2400ft	\$4.75
7in 3600ft	\$6.75
PHILIPS TYPE CASSETTES	
C60 60 Min	\$1.65
C90 90 Min	\$2.65
C120 120 min	\$3.30

INTEGRATED CIRCUITS

SINCLAIR 1C-1D	\$11.25
GE 1W RMS	\$3.19
GE 2W RMS	\$5.37
GE 10W Audio 5W RMS	\$8.57
BHA Special 'is' RMS PHILIPS Pre-amp and Tape. MOTOROLA. FAIRCHILD—Flipflop, etc. PRICES ON APPLICATION. STATE REQUIREMENTS.	\$2.00

TRANSISTORISED TUNERS UNIT 10—With RF Stage and Power Supply, 8KHz bandwidth — \$31. Plus tax.

NEW WIDE BAND TUNER Based on Playmaster Design. Ceramic Filters, Tuning Meter, Whistle Filter, etc. \$62 plus tax. Teak Cabinet \$6 extra.

SOLDER SPECIAL!! RESIN-CORED "SUPER FAST" 2 1/2lb Reels. ONLY \$2.75

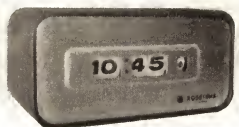

DIGITAL CLOCK
240V, 2W,
12 Hour, plus Seconds.
SPECIAL — \$11.75.

MURATA CERAMIC FILTERS

SF 455A, ea	.32
SF 455D, ea	.75

ALL COMPONENTS, TRANSISTORS AND DIODES AT SPECIAL PRICES. SEND S.A.E. FOR DETAILS.



SMALLEST RADIO KIT IN AUSTRALIA
1 5/8in x 1 5/8in x 1 5/16in
Uses Silicon Transistors and High Impedance Magnetic Earphone.
5-Stage Reflex Circuit and Ferrite Aerial.
Complete Kit with Instructions. \$6.75.
Batteries required: 2 Mercury Cells type RM675.

SPECIAL!!! 1ST RELEASE 8 TRANSISTOR RADIO KIT! USES SILICON TRANSISTORS AND DIODES. COMPLETE WITH INSTRUCTIONS. Carrying Case and earphone, \$16.50. Wired. Tested, \$18.50. Post & pack. 75c.



NEW 1969 TRANSISTOR RADIO KIT



6 Silicon Transistors and complete with instruction book, carrying case and earphone. Special Price \$11.25
Wired \$13.50
Post and pack. 75c.

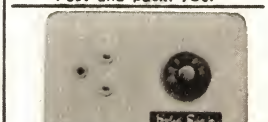

BOYS' CRYSTAL SET KIT
Complete with Plastic Cabinet, earphone and Instructions \$2.50



TRANSISTOR MODULES
10 Watt RMS, 25W RMS, 65W HI FI Amplifiers. Pre-amp Tone Control Stage, etc. REDUCED PRICES. SEND FOR NEW PRICE LIST.

S. E. WILLIS TRADING CO.

38 Riversdale Road, Camberwell Junction, Vic., 3124.
Phone 82-5787. Please Include Freight. Sorry, No. C.O.D.



RADIO

WEEKENDS & AFTER HOURS 98-5956.

136 VICTORIA ROAD MARRICKVILLE — 51-3845

KAISE VOLT-OHM-MILLIAMMETER
MODEL SK-100



HIGH SENSITIVITY
100,000 Ohms per Volt DC
10,000 Ohms per Volt AC

SPECIFICATIONS:
● DC Volts: 0.6, 3, 12, 60, 300, 600, 1200V.
● AC Volts: 6, 30, 120, 300, 1200V.
● DC Current: 12uA, 300uA, 6mA, 60mA, 600mA, 12A.
● AC Current: 12A.
● Resistance: 20K ohms, 200K ohms, 2M ohms, 20M ohms.
● Decibels: Minus 20 to plus 17, 31, 43, 51, 63.
● Accuracy: DC plus minus 3%, AC plus minus 4% (of full scale).

● Overload Protected by Dual Silicon Diodes
● Double-jewelled plus minus 2% Meter
● Plus minus 1% Temperature-stabilised Film Resistors.
● Polarity Changeover Switch
● Scale with Mirror

Price \$34.75. Post 75c. Interstate \$1.00.

MODEL SK-7
4K Ohms per Volt D.C.
2K Ohms per Volt A.C.

SPECIFICATIONS:
D.C. Volts: 10, 50, 250, 1000.
A.C. Volts: 10, 50, 250, 500, 1000.
D.C. Current: 250uA, 10mA, 250mA.
Resistance: 20K (x10) 2 meg (x1000).
Decibels: 2db cps plus 62db.
\$9.75.
Post 50c. Interstate 75c.

MODEL SK-70
30K OHMS PER VOLT D.C.
10K OHMS PER VOLT A.C.

D.C. Volts: 0.5, 2.5, 10, 50, 250, 500, 1000.
A.C. Volts: 10, 50, 250, 500, 1000, 500mA.
D.C. Current: 50uA, 5mA, 50mA, 500mA.
Resistance: 7K, 70K, 700K, 7 meg.
Decibels: Minus 10 cps plus 62 db.
OVERLOAD PROTECTION.
\$19.95
Post 50c. Interstate 75c.

MODEL SK-140
20K OHMS PER VOLT D.C.
10K OHMS PER VOLT A.C.

SPECIFICATIONS:
D.C. Volts: 2.5, 10, 50, 250, 1000.
A.C. Volts: 10, 50, 250, 500, 1000, 250mA.
D.C. Current: 50uA, 25mA, 250mA.
Resistance: 40K, 4 Meg.
Decibels: Minus 20 db cps plus 62db.
\$11.95
Post 50c. Interstate 75c.

MODEL SK-60
50K OHMS PER VOLT D.C.
10K OHMS PER VOLT A.C.

SPECIFICATIONS:
D.C. Volts: 0.25, 2.5, 10, 50, 250, 500, 1000.
A.C. Volts: 10, 50, 250, 500, 1000, 500mA.
D.C. Current: 25uA, 5mA, 50mA, 500mA.
Resistance: 10K, 100K, 1 Meg, 10 Meg.
Decibels: Minus 10 cps plus 62 db.
OVERLOAD PROTECTION.
\$22.75.
Post 50c. Interstate 75c.

MODEL SK-55
30K OHMS PER VOLT D.C.
14K OHMS PER VOLT A.C.

SPECIFICATIONS:
D.C. Volts: 0.6, 3, 12, 60, 300, 1200.
A.C. Volts: 12, 60, 300, 1200.
D.C. Current: 60uA, 12 mA, 300mA.
Resistance: 10K Ohms, 1 M ohm, 10 M ohms.
Decibels: Minus 10 cps plus 23 db.
OVERLOAD PROTECTION.
\$18.75.
Post 50c. Interstate 75c.

MODEL SK-20
20K OHMS PER VOLT D.C.
10K OHMS PER VOLT A.C.

SPECIFICATIONS:
D.C. Volts: 0.25, 2.5, 10, 50, 250, 1000.
A.C. Volts: 10, 50, 250, 1000, 250mA.
D.C. Current: 50uA, 25mA, 250mA.
Resistance: 7K, 700K, 7 Meg.
Decibels: Minus 10 cps plus 22 (at A.C./10V) plus 20 cps plus 36 (at A.C./50V), Upper freq. limit 7 Kc.
OVERLOAD PROTECTION.
\$13.50

MODEL SK-80
30K OHMS PER VOLT D.C.
10K OHMS PER VOLT A.C.

SPECIFICATIONS:
D.C. Volts: 0.5, 2.5, 10, 50, 250, 500, 1000V.
A.C. Volts: 10, 50, 250, 500, 1000V.
D.C. Current: 50uA, 5mA, 50mA, 500mA.
Resistance: 5K, 50K, 500K, 5 Meg.
Decibels: Minus 10 cps plus 62 db.
OVERLOAD PROTECTION.
\$16.45
Post 50c. Interstate 75c.

MODEL SK-44
30K OHMS PER VOLT D.C.
10K OHMS PER VOLT A.C.

SPECIFICATIONS:
D.C. Volts: 0.6, 3, 12, 60, 300, 600, 1200, 3000.
A.C. Volts: 6, 30, 120, 300, 1200.
D.C. Current: 30uA, 6mA, 60mA, 600mA.
Resistance: 10K ohms, 1 M ohms, 10 m ohms, 100 M.
Decibels: 20 cps plus 17, 31, 43, 57, 63.
OVERLOAD PROTECTION.
Post 50c. Interstate 75c.
\$19.25

DYNAMIC MICROPHONES



Model UDM-105 CARDIOID
(Uni-directional)
Impedance: High 50K ohms—Low 600 ohms. Sensitivity: -60db/1,000 cps. Frequency Response: 150-10,000 cps.
\$16.95

Model DM-108
(Uni-directional)
Impedance: 50K ohms. Sensitivity: 57db/1,000 cps. Frequency Response: 100-10,000 cps.
\$11.95

P.A. SPEAKERS
8 WATT.
8in Units in Waterproof Projection Horns.
15 Ohm Voice Coils.
\$15.25
In Double-ended Flares. Duolateral Coverage.
\$17.25
Line Output Transformers to suit, \$1.75 extra.

AMPLIFIERS
Public Address Range 240V-AC



MINIATURE P.A. AMPLIFIER
15 WATTS OUTPUT

Multi Match Ferguson O.P. transformer input for crystal mike and pick-up with electronic mixing P.P. EL-84 output ... \$42.50
30 Watt. As above, EL-34 P.P. ... \$57.50
40 Watt. As above, EL-34 P.P. ... \$85.50
60 Watt. As above, 6D06 P.P. ... \$105.50

LINE OR VOICE COIL. SOLID STATE 240V A.C.
20 Watt ... \$49.50
50 Watt ... \$69.50
50 Watt 240 A.C. plus 12V. D.C. Plus Self Battery Charging. \$95.00.

All have inputs for 2 microphones or 2 Magnetic or Crystal P.U. With Mixing.

LOW LOSS MIC. CABLE
15c per yard or \$10 per 100yds.

50 WATT SOLID STATE GUITAR AMPLIFIER
E.A. July & August Issue. Kitset, including Cab./net.
\$98.00
Wired and Tested.
\$114.00
Speaker Enclosures to suit
4 M.S.P. Speakers.
\$104.00
2 Pioneer 15in Speakers.
\$94.00

STEREO RECORD CHANGERS
Latest Model. 4-speed.
\$28.75
De Luxe Model. Fully machined and balanced. Heavyweight turntable. Ceramic Cartridge.
\$34.00
Post: N.S.W. \$1.25. Interstate \$1.75.
De Luxe Model with mechanical cueing device. Calibrated stylus. Pressure control. Adjustable counter balance. Two spindles.
\$46.50
Fully Auto. Player All Refinements Magnetic Cartridge, \$65.

TAPE CASSETTES
TENSILISED MYLAR

C 60	...	\$1.65
C 90	...	\$2.45
C 120	...	\$3.25
Head Cleaners	...	\$1.75

Post. 10c per unit.

HORN TWEETER CT-3
2,000-20,000 Response
20 Watts Power
Sensitivity 110 dbw.
Weight 134lb.
\$8.95

V.T.V.M. MODEL TE-40 MILLIVOLTER
Spec. A.C.V. Inv.—300 Vrms. 10 ranges. Accuracy 5 cps-1 2 mc. plus-minus 2db. 10 cps-1 mc. plus-minus 1db. 20 cps-250 KC. plus-minus 0.2db.
dB. Scale: 40-30-20-10-0, 10, 20, 30-40, 50 dBm, 240 V.A.C.
\$48.75

MODEL TE-65 V.T.V.M.
DC. V. 0-1, 5-5-15-50-150-500-1,500 V. Rms. A.C.V. 0-1.5 5.5-15-50-150-500-1,500 V. Rms. 0-1-4-4-14-40-140-400-1,400-4,000 V. P.P. Resistance: RX10 100 1K 10K. 100K, 1M, 10M, Decibel—100db. minus-plus 65dB.
240 V.A.C.
\$43.75
TECH. P.V. 58, \$40.50.

ORGAN KEYBOARDS
49-Note. Complete with Switching System.
\$72.00
13-Note. Pedal Claviers. Complete with Switches.
\$39.95

SPECIAL: Semi-finished Strombers Organ Cabinets to suit above.
\$19.50
Organ Stools ... \$14.50

HI-FIDELITY TWIN CONE SPEAKERS
Aust. made. 8 to 16 ohms.
6in .. \$9.00 12in .. \$11.75
8in .. \$7.50 Postage:
8in .. \$9.00 N.S.W., 50c.
10in .. \$10.75 Interstate 80c.

NEW SPEAKER SPECIALS

2in	8 to 15 ohms	\$2.75
2 1/2in	4 x 2in	\$3.30
2 3/4in	5in x 3in	\$3.50
2 3/4in	6in x 4in	\$3.50
3 1/2in	7in x 4in	\$4.25
3 1/2in	8in x 6in	\$5.95
3 1/2in	N.S.W. 25c.	
6in	Interstate 40c.	

NEW RECORDING TAPE
Most Popular Brand Correspondence ... 50c

3in Mylar L.P. 300ft	...	\$1.05
3 1/4in Mylar D.P. 600ft	...	\$1.25
5in Mylar L.P. 900ft	...	\$2.50
5in Mylar D.P. 1200ft	...	\$3.15
5 3/4in Mylar L.P. 1200ft	...	\$3.15
5 3/4in Mylar D.P. 1800ft	...	\$4.70
7in Mylar L.P. 1800ft	...	\$4.70
7in Mylar D.P. 2400ft	...	6.25
7in Mylar T.P. 3600ft	...	\$7.00
7in P.V.C. 1200ft	...	\$2.50

Postage: N.S.W. 15c. Interstate 25c.



GUITAR AMPLIFIERS

10-Watt, Two-Channel, with Twin Cone Speaker . . . \$53.55
 14-Watt, 4 Inputs, Bass and Treble Boost, 2 Twin-cone Speakers, \$63
 17-Watt, 4-Channel, Bass and Treble Boost, Two Twin-cone Speakers . . . \$76.25

35 WATT

4-Channel, Bass and Treble Boost, 4 Twin-cone Speakers . . . \$109.05
 Vibrato with foot control and 2 preset controls for frequency and intensity. \$10.50 extra on above models.

ELECTRIC GUITAR

Pickup Units . . . \$8.75
 Accordion Pickup Units . . . \$8.75
 Harmonica Pickup Units . . . \$1.95
 Post: N.S.W. 40c, Interstate 75c.

FUZZ BOX

FUZZ BOX, E. AND A. AUG. WIRED AND TESTED. \$15.
 Post 75c.

REVERB UNIT

COMPLETE WITH AMPLIFIER. E.A. October Issue. Kitset \$39.95. Wired and tested, \$41.95.



MULLARD MAGNAVOX

BOOKSHELF ENCLOSURE

Maple, Teak or Walnut Complete \$24.75
 SUPER BOOKSHELF \$36.75.

Post: N.S.W. 50c, Interstate \$1.00. CABINETS ONLY. R.H. BOOKSHELVES, \$11.50. MULLARD, \$10.95. BOOKSHELF UNITS 6in 8in 10in 12in \$27.75 \$33.50 \$35.50 \$36.50

PLAYMASTER 106 AND 107



Feb. and March Elect Aust. 106

WIRED AND TESTED \$94.75

107

WIRED AND TESTED \$83.75

P.V.C. TWIN FLEX

7/010 . . . \$4.95
 Per 100 Yards.
 300 Ohm TV Ribbon, per yd 10c

PIGGY BACK GUITAR AMPLIFIER

Excluding Speakers
 30 Watt . . . \$79.75
 45 Watt . . . \$99.75
 60 Watt . . . \$119.75
 4 Inputs, Bass and Treble Boost
 Vibrato if required, \$10.50 extra.

PIGGY BACK GUITAR AMPLIFIER

Complete with Speakers & Cabinet
 30 Watt Lead . . . \$136.75
 30 Watt Bass . . . \$146.75
 45 Watt Lead . . . \$156.75
 45 Watt Bass . . . \$166.75
 30 Watt Lead . . . \$218.00
 60 Watt Bass . . . \$234.00
 Vibrato if required extra \$10.50

14 pus 14 WATT

With Reverberation. May be used as 28-watt or as 14-watt plus 14-watt Reverb. Two 9 x 6 Woofer Speakers, Two 9 x 6 Twin-cone Speakers, 4 Channels, Bass and Treble Boost. Foot Vibrato control included.

\$163.50

10 PLUS 10 STEREO AMPLIFIER

E.A. November, Kit Set . . . \$59.75
 Wired and tested . . . \$69.75



119 STEREO TAPE ADAPTER

Suits all Playmaster Stereo amplifiers and others that accept crystal P.U.

Kitset . . . \$79.00
 Wired and tested . . . \$96.00

TAPE DECKS B.S.R.

2 Tracks, 3 1/4 I.P.S.

\$25.50

4 Track, 3 Spd Stereo, \$41.50



240V A.C. POWERED SOLID STATE STEREO

T.S.138

18 Transistor, 15-watt per channel, Inputs for Tape, Mag. P.U., Ger. P.U., Radio Aux. Freq. Range 30c to 20KC. Max. Sensitivity 3 MV. Speaker matching 4 to 15 ohms.

\$78.00

SONATA

SOLID STATE STEREO AMPLIFIER.

20 WATT R.M.S. PER CHANNEL
 Inputs for mics, Magnetic & Ceramic Pick-ups, Tuner & Tape Heads. Outputs to 8V Speakers & S.H. Phone Controls, Bass, Treble Balance, Volume Loudness, Top and Low Filter.

\$89.50

11 1/2" FULLY BALANCED PICK UP ARM

COMPLETE WITH MAGNETIC Stereo Cartridge . . . \$19.50
 Arm less Cartridge . . . \$11.50
 Mag. Cartridge only . . . \$9.50

WIDE BAND OSCILLOSCOPES

SPECIFICATIONS

VERTICAL AXIS

Deflection Sensitivity (at 1 kc) 0.1 V p-p/cm.
 Frequency Characteristics, 1.5 cps—1.5 MC.
 Input Impedance, 2 M ohms 25pF.
 Calibration Voltage IV p-p/cm.

HORIZONTAL AXIS

Deflection Sensitivity 0.9V p-p/cm.
 Frequency Characteristics 1.5 cps—800 KC.
 Input Impedance 2 M ohms 20 pF.
 Sweet Oscillator (5 Range) 10 cps—300 KC.
 Synchronisation Devices Internal (Positive and Negative, External).
 Power 240v AC 50/60 cps.
 Cathode Ray Tube 3KF1F.



5 Mes Bandwidth Push-Pull vertical and Horizontal Amplifiers, 8 positions, high sensitivity, vertical Amplifier Frequency Compensated on all positions. Calibrated .02 to 600 volts. Hard time base, 20 cycles to 75K. Latest American R.C.A. circuitry. Complete with probe.

3-inch \$102.75; 5-inch \$118.75

PLAYMASTER 115

The new Solid State Stereo-Amplifier. April issue.
 Wired and tested . . . \$104.00
 Kit Set . . . \$90.00
 Pre-amp to suit magnetic Cartridge . . . \$12.00



AUTOMATIC RHYTHM BOX

12 RHYTHMS, 9 PERCUSSIVE INSTRUMENTS, 240v. A.C. OPERATION.

\$145.00

3" VERNIER DIAL

8:1 Ratio \$2.95, Post 25c.



T.O. 2" OSCILLOSCOPE

IDEAL TV AID
 240V-AC, 2 BPI CRO Tube
 Vert Sen, 10V P-P/CM. 50V P-P/CM.
 Vert Input Imp. 2 Meg. 25pf
 Vert Freq. 2 cps/1 Meg. 3DB
 Sweep Freq. 2 ranges, 60 cps—75 KC.
 \$64.50.

SIGNAL GENERATOR

De Luxe Model TE20D.
 Freq. Range 120 KC—500 Mcs. 7 Bands, Accuracy 2 per cent. Output 8V. Provision for Xtal Suitable for self-calibration Marker generator. Printed circuit. 240 T.E.20. \$25.50. \$28.50 V.A.C.

15-INCH HI-POWER SPEAKER

Imported 30 Watts R.M.S. \$30.00
 Local 50 Watts R.M.S. . . \$50.00

L.S.G. 11 SIGNAL GENERATOR

FREQ. RANGE IN 6 BANDS
 120KC—130MCS.
 Calibrated Harmonics, 120MCS—390MCS.
 R.F. Output over 100,000UV. 120KC—38MC.
 Mod. Freq. 400 and 1000CPS. Crystal Osc. 1.15MCS.
 A.F. Output, 3 to 4 Volts.
 A.F. Input, 4V approx.
 240 V. A.C. Operation.
 \$31.75. Post 75c.

T.E. 46 RESISTANCE-CAPACITANCE

Bridge and Analyser.
 Capacity 20pf to 2000mf.
 Resistance 2 ohms to 200 megs.
 Also tests power factor, leakage, impedance, transformer ratio, insulation resistance to 200 megs. at 600V.
 Indications by eye and meter.

\$49.75

G.D.O. UNITS

Post: N.S.W. 50c, I'state 75c.
 T.E. 15 Transistorised, 7 Band, 360 Kc to 270 Mega.
 \$35.75

TV BOOSTER

240VAL. Especially designed for fringe area reception. Also up to 3 TV sets can be operated off common aerial for improved signal strength. \$15.95 Post Free.

NEW GRAMMO MOTORS

240V. A.C.
 3 Speeds, \$2.75.
 Post: 40c.

VOLT. A.C.

VARIABLE TRANSFORMER.
 0-260V, 10 amp. . . . \$49.50
 0-260V, 5 amp. . . . \$37.50
 0-260V, 2 1/2 amp. . . . \$25.50

NEW RH (Radio House) RANGE OF MULTIMETERS

Model RH-80 \$18.00 Postage 50c



20,000 Ohms per Volt DC
10,000 Ohms per Volt AC

Specifications:
DC Volts. 0.5, 2.5, 10, 50, 250, 500, 1000 V
AC Volts. 10, 50, 250, 500, 1000 V
DC Current: 50 μ A, 5mA, 50 mA, 500 mA
Resistance. 5 k Ω , 50k Ω , 500k Ω , 5 Meg Ω
Decibels. -10 + 62 lb
Accuracy. DC \pm 3%, AC \pm 4% (of full scale)
Batteries. Two 1.5V dry cells. Size AA, "Eveready" 915
● Overload-protected by dual silicon diodes. ● Mirror scale.
● Double-jewelled \pm 2% meter. ● \pm 1% temperature-stabilized film resistors.

Model RH-100 \$39.75 Postage 75c

100,000 Ohms per Volt DC 10,000 Ohms per Volt AC
● Overload Protected by Dual Silicon diodes ● Double-jewelled \pm 2 per cent Meter ● \pm 1 per cent Temperature-stabilised Film Resistors ● Polarity Changeover Switch ● Mirror scale, instruction for operation with circuit diagram.



SPECIFICATIONS:
DC Volts: 0.6, 3, 12, 60, 300, 600, 1200V (100,000 Ω /V)
AC Volts: 6, 30, 120, 300, 1200V (10,000 Ω /V)
DC Current: 12 μ A, 300 μ A, 6mA, 60mA, 600mA, 12 amps DC and AC Current 12 amps.
Resistance: 20K Ω , 200K Ω , 2M Ω , 20M Ω
Decibels: -20 to + 17, 31, 43, 51, 63.
Accuracy: DC \pm 3 per cent, AC \pm 4 per cent (of full scale)
Batteries: Two 1.5V dry cells, size AA, "Eveready" 915



Actual Size

MINI-TORCH

With fob keyring, attractive gold finish case. Simply squeeze. Illuminates car and house locks. \$4 posted anywhere.



TAPE RECORDER

\$20.50

BOOK TYPE

The latest model portable Tape-recorder. 4 transistor, 3in reels, 2 tracks. Instruction manual. Size 10 $\frac{1}{2}$ in x 7in x 1 $\frac{1}{2}$ in. Just open the book and record. Supplied complete with tape, microphone and batteries. Special discount price, \$20.50, posted anywhere.

Model RH-20 \$15.00 Postage 50c



20,000 Ohms per Volt DC
10,000 Ohms per Volt AC

Specifications:
DC Volts: 0.25, 2.5, 10, 50, 250, 1000 (20,000/V)
AC Volts: 10, 50, 250, 500, 1000 (10,000/V)
DC Current. 50 μ A, 25mA, 250mA
Resistance. 7k Ω , 700k Ω , 7M Ω
Decibels. -10 +22 (at AC/10V) +20 +36 (at AC/50V). Upper frequency limit 7kc.
Accuracy. DC \pm 3%, AC \pm 4% (of full scale)
Batteries: Two 1.5V dry cells. Size AA, "Eveready" 915
● Overload-protected by dual silicon diodes.
● Double - jewelled \pm 2% meter. ● \pm 1% temperature-stabilized film resistors.

Model RH-55 \$20.00 Postage 50c



30,000 Ohms per Volt DC
14,000 Ohms per Volt AC

SPECIFICATIONS:
*DC Volts: 0.6, 3V, 12V, 60V, 300V, 1200V (30,000 ohms/V).
*AC Volts: 12V, 60V, 300V, 1200V (14,000 ohms/V).
*DC Current: 60 A, 12mA, 300mA.
*Resistance: 10K ohm, 1Meg ohm, 10Meg ohm.
*Decibels: -10 db +23 db.
*Meter Sensitivity: 23 A.
● Overload-protected by dual silicon diodes. ● Mirror scale.
● Double-jewelled \pm 2% meter. ● \pm 1% temperature-stabilized film resistors.

Model RH-60 \$25.00 Postage 50c

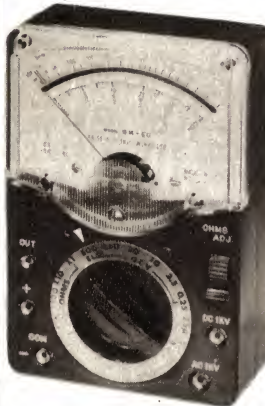

50,000 Ohms per Volt DC
10,000 Ohms per Volt AC

Specifications:
DC Volts: 0.25, 2.5, 10, 50, 250, 500, 1000 V
AC Volts. 10, 50, 250, 500, 1000 V
DC Current. 25 μ A, 5 mA, 50 mA, 500 mA
Resistance: 10 k Ω , 100 k Ω , 1 Meg Ω , 10 Meg Ω
Decibels. -10 +62 db
Accuracy: DC \pm 3%, AC \pm 4% (of full scale)
Batteries. Two 1.5 V dry cells. Size AA, "Eveready" 915
● Overload-protected by dual silicon diodes. ● Mirror scale.
● Double-jewelled \pm 2% meter. ● \pm 1% temperature-stabilized film resistors.

Just arrived. New stocks of the latest model Crystal Radios. Price \$3.95 plus postage 35c. Complete with earphone, aerial clip and attractive plastic case.

RADIO HOUSE PTY. LTD.

306-308 PITT STREET: 6 ROYAL ARCADE & 760 GEORGE STREET, SYDNEY

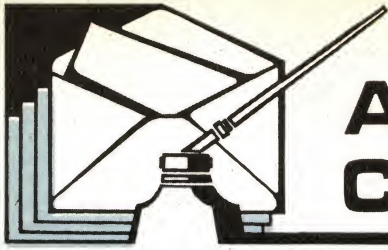

ANSWERS TO CORRESPONDENTS

IGNITION SYSTEMS: I have been reading your magazine for many years and its informative articles have been a tremendous help to me. I would like to bring to your attention a system called "capacitor discharge ignition" which has been marketed by Delco-Remy and used in G.M.C. vehicles for many years. I am sure that a practical article on this subject would be appreciated by many of your readers. (R.T., Thornbury, Vic.)

● Presumably by now you will have seen the item in the "Reader Built It" section of the September issue, which gave details for the construction of capacitor discharge system. The publication of this has evoked considerable interest, and we are following this up in this issue with a review of a number of commercially built units.

WORLD RADIO HANDBOOK: In the section "Listening Around the World" in your August, 1969, issue, reference is made to a book titled "The World Radio Handbook." Could you please tell me the name of the publisher so that I may obtain a copy. (G.F.H., Rockhampton, Qld.)

● The World Radio and Television Handbook is published by the World Radio and Television Handbook Co. Ltd., Hellerup, Denmark. We reviewed the 1969 edition in our February, 1969, issue. Copies of the book should be obtainable through most technical booksellers, or can be ordered from our short-wave correspondent, Arthur Cushen, 212 Earn Street, Invercargill, New Zealand.

SIMPLE RADIO: I wish to make a simple radio set. I am 14 years old and have had no previous experience. Could you please forward one or two simple radio set designs with a list of the necessary parts. Also, can you tell me where the parts are obtainable in Brisbane. (J.U., Coorparoo, Qld.)

● We have published several articles, describing projects of the type you request. The latest of these was in July, 1969, describing the construction of simple crystal and transistor sets. Copies of this article are available through the Information Service for the usual 20c fee. (Please quote ref. 4/TR1/11.) We suggest you examine the advertisements in any issue of "Electronics Australia" where you will find firms offering components to readers interested in building up our projects.

P.A. AMPLIFIER: Can you tell me where I can obtain the circuits of amplifiers for a public address system and of transceivers. I would prefer both to be transistorised. (M.P., Leura, N.S.W.)

● We published the design of a 30W transistor P.A. amplifier in May, 1968 (File No. 1/PA/26). Copies of this article are available through the Information Service for the usual 20c fee. We have not published the circuit for a transistorised transceiver.

TV TUBE REJUVENATOR: Can you explain what a TV tube rejuvenator is? The tube in my set, though fairly new, was becoming dark, with whites frosty. I was ready to buy a new tube when a friend loaned me his "rejuvenator" which

simply plugs on to the end of the failing tube. This machine glows as the cathode of the tube warms up, showing cathode emission. When the switch is thrown, the light flashes and then glows as before. The result is a virtually new tube, when the set is reconnected and turned on again. Presumably higher than normal voltages are connected to the electron gun assembly. This being the case, do you think that the rejuvenating process could be detrimental to the tube? (A.D., Epping, N.S.W.)

● In a sense, rejuvenation is a repeat of the process in the tube factory by which cathodes are activated in the first place. The tube is run under abnormal voltages for carefully controlled periods of time, "flashed" to remove particles which might later cause shorts and so on. Your tube may have responded well to the rejuvenation because it was fairly new, although one may reasonably ask why it had seemingly failed so soon. The impression in the service industry seems to be that rejuvenators can give a limited lease of life to a limited percentage of failing picture tubes. However, there is an attendant risk that the treatment may alternatively dispatch a tube once and for all, either by burning out the heater or welding grid to cathode—a very embarrassing situation for any well meaning serviceman! The preferred method seems to be to fit a "brightener" which runs the heater at somewhat above normal voltage. Either that, or fit a new tube!

MODEL CONTROL: Have you published any circuit details of transmitters and receivers for the control of model aircraft? (G.C., Aspley, Qld.)

● We published articles in December, 1965, and January, 1966 (File No. 3/MC/3 and 4) which described the construction of a radio-control system for model aircraft. Copies of these articles are available through the Information Service for the usual 20c each.

ELECTRONIC ORGAN: Is it possible for you to supply all the data relating to the building of the Stromberg-Carlson Playmaster electronic organ, which was referred to in a recent issue? I believe that these organs are ideal for home construction, and that the finished model is a little "honey." If you could let me know the cost of these back numbers, I would be only too pleased to forward the money. I would also like to tell you that your magazine is great and it really does cover the field extremely well. It seems to include almost everything. (A.G., Stratford, N.Z.)

● Thank you for your kind words, A.G. We do try to cater for a wide range of readers, from beginners to engineers, in as many fields of interest as possible. We published a series of nine articles (1961-62), describing the electronic organ and copies of these are available through the Information Service for 20c each, a total of \$1.80 (File Nos. 1/EM/1 to 9). However, we must caution that there may be difficulty in obtaining some of the parts necessary for the construction. A later article described the construction of the chokes (the most difficult components to find). This article — Chokes, Switches, and Diodes for Electronic Organs—was published in September, 1964, and is available for 20c (File No. 1/EM/13). In its day and for the cost of the parts the

"ELECTRONICS Australia" Information Service

As a service to readers "ELECTRONICS Australia" is able to offer: (1) Photographs, dye-line prints and other filed material to do with constructional projects and (2) A strictly limited degree of personalised assistance by mail or by reply through the columns of the magazine. Details are set out below:

PROJECT REPRINTS: For a 20c fee, we will supply data, as available from our files. The amount of data available varies but in no case does it include material additional to that already published in the magazine. For complicated projects involving material extracted from more than one issue, an extra fee may be requested. As a rule, requests for project data will be answered more speedily if the projects are positively identified and the request is not complicated by questions requiring the attention of technical personnel. Where articles are not on file, we can usually provide a photostat copy at 20c PER PAGE.

PHOTOGRAPHS, DYE-LINE PRINTS: Original photographs are available for most of our projects, from 50c plus 8c postage for a 6in x 8in glossy print. In addition, metalwork dye-line prints are available for most projects for 50c each; these show dimensions and the positions of holes and cut-outs but give no details of wiring.

BACK NUMBERS: A fairly good selection is available. On issues up to six months old the cost is the face value, plus 5c surcharge. From seven to 12 months, 10c surcharge; over 12 months, 20c surcharge. Package and postage is 10c extra per issue. Please indicate whether a PROJECT REPRINT may be substituted if the complete issue is not available.

REPLIES BY POST: This provision is made primarily to assist readers in matters relating directly to articles and projects published in "ELECTRONICS Australia" within the last 12 months. Note, however, that we cannot provide lengthy answers, undertake special research or modifications to basic designs. A 20c query fee must be enclosed with letters to which a postal reply is required; the inclusion of an extra fee does not entitle correspondents to special consideration.

OTHER QUERIES: Technical queries which fall outside the scope of "Replies by Post" may be submitted without fee and may be answered through the columns of the magazine at the discretion of the Editor. Technical queries will not be answered by interview or telephone.

COMMERCIAL EQUIPMENT: "ELECTRONICS Australia" does not maintain a directory of commercial equipment, or circuit files of commercial or ex-disposals receivers, amplifiers, etc. We are therefore not in a position to comment on proposed adaptation of such equipment, or on its general design. "ELECTRONICS Australia" does not deal in electronic components. Prices, specifications or other assistance must be sought from the appropriate advertiser or agent.

REMITTANCES: These must be in a form negotiable in Australia. Where the charge may be in doubt, an open cheque, endorsed with a limitation, is recommended.

ADDRESS: All requests for data and information, as set out above, should be directed to The Assistant Editor, "ELECTRONICS Australia," Box 2728 G.P.O., Sydney, N.S.W. 2001: 5/69

BATTERY CHARGERS



\$18.50 Pack, post \$1.25

• Charges 6V and 12V Batteries overnight • High 4-amp. charge rate • 12 months written GUARANTEE.

Top quality! Top performance! A fantastic direct deal from top manufacturer. They are usually sold at \$30.00. Finest quality components: steel case. Charges 6v. and 12v. batteries from 240v. A.C. mains. Complete with fuse, ammeter, long lead with alligator clips for battery terminals and long flex with 3-pin plug. Units are brand new in carton and have passed strict electrical authorities test.



Famous
200 H Model
20,000
OHMS
MULTIMETERS
\$9.75
P & P 50c

Extremely sensitive 20,000 ohms complete with full instructions and probes with overload protection RANGES:— D.C. VOLTAGE: 5-25-50-250-500-2.5K (20,000 ohms per volt). A.C. VOLTAGE: 10-50-100-500-1000 volts (10,000 ohms per volt). D.C. CURRENT: 0-50 uA, 0-2.5 MA, 0-250 MA. RESISTANCE: 0-6K, 0-6mg. (300 ohm and 30K at centre scale). CAPACITANCE: 10 uF to .001 uF, .001 uF to 1 uF. DECIBELS: -20 to +22DB

NIFE BATTERIES—95c

(Pack, despatch and post 10c ea.) Brand new! Nickel iron, spill-proof, leak-proof cells—Lasts forever, 4 A.H., 1.2 volts. Sizes 3 1/2" x 2 1/2" x 1 1/2". Couple together for any voltage—superb for spotlights, lamps, bells, flash equipment, etc. Set of 10 gives 12 volts 4 A.H. \$7.95 (Pack post \$1); Set of 5 for 6 volts, 3.95 (Pack post 50c).

Large size 1.5 volt 15 amps. hours: 8" x 4" x 2" \$2.75. Post 75c. Set of 8 for 12 volt \$20. Freight \$4. Set of 4 for 6 volt \$10. Freight \$2.50.

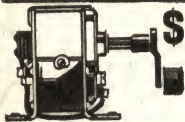

\$2.45

HAND GENERATORS

Brand new in cartons, gives 100V AC, ideal for line testing (megger). P & P 50c.

A.C.

FAN

\$2.75



Post 30c. Small but very powerful 240v. mains motor by "VARLEY" England. With 4" 3 blade fan, ideal for cooling equipment or as extractor fan. Self-aligning bearings, silent but very efficient. Mounts from back or front. Brand new. Motor separate \$2.45. Post 30c.

240v. Electric Pumps



BRAND NEW \$8.75
No. 102 direct English purchase from a famous manufacturer. We purchased their entire stock of these ABSOLUTELY BRAND NEW in carton 240-volt electric motorised pump unit. Usually sell for \$25.00. Full 3 MONTH GUARANTEE. Special Neoprene impeller pump will handle corrosive fluids, fuel and water. Pumps 300 400 g.p.h. To be gravity fed and will lift to 8'. Ideal for fuel or water transfer, fountains, fish ponds, etc. Pump entirely non-corrosive. Rush your order now as stocks will not last at this price. Pack, post 75c.

\$73 BRAND NEW 2.5 h.p. OUTBOARD MOTOR

12 months warranty
SPECIAL FIRST RELEASE
'TAS'SEA HAWK MK. II

The new 1969 version of the original Sea Hawk outboard. Powerful enough to drive a 12ft. boat at 10 m.p.h. 35lb. static thrust equal to 3 h.p. model of well known make. Uses only 1 pint fuel per hour. Weighs only 23lb. Spares will always be available. Write for full information. (also used for mixing Urea and molasses, does not affect leg assembly.) Freight \$2.50

HALF-PRICE SPECIAL HI-FI RECORDING TAPE

Fantastic purchase of "Mylar" professional recording, computer tape (the best money can buy). Famous 3-name brand (one we can't mention due to huge price reduction). Silicone lubrication. Suits all tape recorders, hi-fi and stereo. Selling well under half price. Post 10c each.

3" 225' 65c
5" 600' \$1.50
7" 1200' \$2.50
Also long play 5 1/2" 900ft. — \$2.25. 7" 1800ft. — \$3.25.

Empty spools 3" 35c; 5" 65c. Post 10c each.



CRYSTAL MICROPHONES
\$1.40

CM21 CM62
CM21 for desk or hand, high sensitivity load resistance 500K-1M ohms, with 5' lead and plug, \$1.40 P & P 10c. Crystal mike smaller size lapel clip, CM62 response 100-9000 Kc's, 3' lead and plug, 69c, P & P 10c.



Fantastic New Item!
PEN TELESCOPE \$1.95
10-Power pocket telescopes. 4 1/2" closed; 8" long extended. Very clear image. Has clip for pocket. Closed, can also be used as a 50-Power microscope. Post free. Use also for inspecting record stylus needles.

Mail orders to
DIRECT DISPOSALS
36 HELEN ST. VALLEY
BRISBANE, 4006
3 shops Brisbane
Phone 5 4833

DIRECT DISPOSALS

Tremendous SAVINGS



Brand new Army "L" FIELD TELEPHONES

\$15.50 (2 for \$29)

Made by L. M. Ericsson 6 MONTHS' GUARANTEE Pack freight \$1 extra per phone, housed in completely rust proof metal case. Has long distance ringing generator complete with bell. As used by P.M.G. linesmen and the Army. Ideal for property to property, house to house or shed, line testing, fire fighting communications, etc. Range over 20 miles; use fencing wire (just insulate on posts). Absolutely brand new in original wax sealed cartons. Govt. cost over \$100. Size 10" x 5 1/2" x 5". Battery set 80c extra per phone.



RECORDING TAPE

P & P 20c.

Top quality Philips type cassettes by famous maker sells at half price. Individually packed in plastic library box. C60 (60 min. recording time), \$1.75; C90 (90 min. recording time), \$2.65.

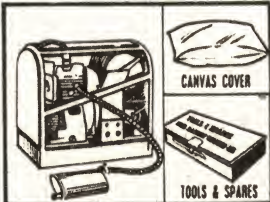

PORTABLE PETROL ELECTRIC GENERATING SETS—\$59.00

12-18V., 80 Watt D.C. (5 amps.) Made for British Govt. to exacting specifications, at a cost of \$180, are absolutely brand new, packed in original makers wood Cases. Has small 4-stroke petrol. motor direct coupled to alternator with rectifier for converting A.C. to D.C. Makes for extremely lightweight unit, only weighs 35 lbs. Is complete with set of tools and spares. Use for small lighting plants, charging batteries on boats, caravans, huts, properties, (Pack freight \$6 in Aust.).

Spares comprise piston rings, valves, gaskets, spark plugs (2), carb. jets and needle, spanners, etc. — everything for an overhaul in years to come.

"Cutler Hammer" TOGGLE SWITCHES

Post pack 10c). 4-Pole, 3-way (3 position) panel switches (centre off). Handles 10 amps. at 12 or 24/32 volts D.C. Ideal for panels, control boards, 75c.

ANTENNAE RODS — 69c post 10c
6 Section telescopic, chromed brass, fits most transistor radios, extends from 5 1/2" to 27", female threaded base.



Famous Make and Brand New INTERCOMS \$9.50

Post 50c. Two station intercommunication system comprising master and sub-station. A faultless unit with volume control and connecting wire. Fully transistorised. Has press-button buzzer on each station. Operates up to 1/2-mile. Battery operated. Neatly packed in cartons.

COMPUTER BOARDS

Enormous purchase from famous computer manufacturer. Each board comprises at minimum 4 transistors and up to 6 transistors, plus host of resistors, diodes, capacitors, etc. 4 Boards with minimum of 16 transistors \$2 (post 20c); 8 Boards with minimum of 32 transistors \$3.50 (post 25c). Special price for quantity.

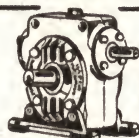

\$15

GEARBOXES

2 ratios available 10.5 to 1 and 14.5 to 1, made by David Brown "Radicon" England. Very robust construction, has two driving shafts at right angles and oil filler plug. Unit is drilled for 4-bolt fixing, size 4 1/4" x 4 1/4" x 3 1/2". 7/8" and 3/4" dia. x 1 1/2" long shafts (cost over \$100 to make). Bargain 100 only. (Pack and Post \$1.)

INDUCTION MICROPHONES

Will pick up sound waves from a distance. Has suction cap, long cord and plug for tape recorder, etc. Sticks to wall or case of telephone for recording speech. \$1.25.

G.P.O. RELAYS type 3,000, brand new, \$1.50 p. and p. 20c.

AIRCRAFT REVERSE CURRENT RELAYS, 12V and 24V, 60 amp. D.C. Brand new in packet, \$9.50.

AIRCRAFT DESIGN MOVEMENTS 0-90 degrees + and — in 24V (or 12V), \$1.20 p. and p. 20c.

POCKET RADIOS, Germanium principle, \$1.99.

'BENDIX' Aircraft Starter Solenoids, 24V 200 amp. D.C., new \$5, p. and p. 25c.

English Neon Indicator Lamps with inbuilt resistance, 10 for \$1.

New 0-50 moving coil Voltmeters \$4.50; Ammeters \$6.95, p. and p. 30c.

English 240V Voltage reducers (dimmers) for theatre lights, etc. (Used in the film "Alfie") 1,000 watt, as new \$45. Freight \$5.

English 240v tinner fits into ordinary light socket, for 25 watt bulb, 75c; for 40 watt bulb, 85c. Post 10c. Great for displays.

Micro switches 10 amp. 125v AC 5 amp. 240v AC, 95c. P & P 10c.

New 4 AMP 3-18 volt SELENIUM RECTIFIERS Full wave Current English make. Brand new. Converts A.C. to D.C. \$1.00, post 25c. 2 1/2 AMP. 65c (Post 15c).

DIRECT DISPOSALS — AUSTRALIA'S TOP MAIL ORDER SPECIALISTS

Money cheerfully refunded if not completely satisfied.

ANSWERS - continued

organ was good value but the design and concept is dated by the standards of 1969.

TRANSISTORISED RADIO CONTROL: Would you consider publishing details of an up-to-date radio-control system for models, either transistorised or using integrated circuits? Please accept my compliments on a fine magazine. It has many features which I find make very interesting and enjoyable reading. (N.S.B., Holland Park, Qld.)

● Not only have we considered the idea, N.S.B., but one of our staff members is currently developing such a system. It uses modern circuitry and an integrated circuit, and we hope to be able to publish details soon. Thanks for the compliments.

COMMENT ON ARTICLES: Upon reading the September issue of your magazine, I feel compelled to venture some comments on two of your articles. (Then follow five pages of comment on the subject of ceramic filters and PET pre-amplifiers, in which the writer variously agrees and disagrees with aspects of the subjects, raises new matter and expresses ideas which have sprung from close reading of the articles. Editor.) (B.R., Kingston, Tas.)

● The articles have obviously set you thinking at length and what you have written has taken a good deal of time to set down. However, while we are fully aware of this, we cannot undertake to match your effort. To reproduce your letter and drawings in these columns and to comment on all the aspects you have raised would occupy several columns of space. Or, if we bypassed this problem and set it all out in a personal letter, quite a few man-hours would go into studying your letter closely, commenting on the matters raised and debating those with which we did not agree. You can rest assured, however, that the letter was read by the authors concerned and your reactions and ideas noted in case they should have relevance to future articles.

WARPED RECORDS. I am very conscientious about the care of my records, and have taken great care to keep them in first-class condition. Can you advise me of any method of removing warp, or for preventing this condition? (N.T., Marrickville, N.S.W.)

● Dealing first with the second part of your question, warp is usually caused by bad storage, particularly when discs are left lying over at an angle, placed in heaps on a surface that is not completely flat, and by heat. The correct way to

store records is in an upright condition, in specially designed storage boxes or in a record cabinet. They should be kept in a cool place, where direct sunlight cannot fall either on the records or the storage boxes and cabinets. Storage boxes and compartments of cabinets should be kept full to keep the discs upright. Where there are not sufficient discs to completely fill a compartment, some form of packing could be used, such as magazines or books. We have heard of a method of curing warp, but we have not tried it ourselves, so we cannot vouch for its effectiveness. The method consists of placing a disc on a perfectly flat surface, covering it with a piece of heavy plate glass, then placing the lot in direct sunlight for an hour or two. The set up is then covered and allowed to cool. This is supposed to cure warp, but not severe ripple caused by excess heat. Try it on a disc which you don't particularly care about.

ANTENNA SYSTEM: In the diagram is a novel antenna I dreamed up. The idea is to achieve a perfect impedance match and broadband characteristic — just something to get away from the old dipole and folded dipole configurations. To date I cannot see how this antenna could phase itself; in other words I cannot place the standing waves on it and see how they would react. I wonder if you could, before I spend money buying the coaxial cable necessary to build it. I like your magazine a lot. It started me off on the hobby four years ago. (P.V., Dover Heights, N.S.W.)

● Your thinking about the antenna system would appear to be back-to-front. You seem to have assumed that something made up from all coaxial cable should have the attributes you seek but you can't explain why. The more usual and valid approach is to visualise a system which should theoretically produce a desired result and then to translate it into a physical thing. There is no good reason to assume that an antenna should have desirable properties just because it is constructed from coaxial cable. To work out the behaviour over various frequency bands would be a time-consuming—and probably futile — exercise. A tremendous amount of research has gone into antenna design, but the "old dipole and folded dipole configuration" remain popular because they are fundamental.

OTHER MAGAZINES: Thank you for a fine magazine. I look forward to the beginning of each month when I can buy my copy. In each issue I notice, usually, at least one letter asking for some project that you haven't yet run. Sometimes constructional articles of the required projects have appeared in other magazines on the bookstalls and I feel that, between

GET YOUR LOWTHER LOUDSPEAKER AT ENCEL'S AND SAVE!



PM 6 Mk. 1

Gap flux: 17,500 gauss.
Total flux: 196,000 maxwells.
Frequency range: 20-20,000 Hz.
Impedance: 15 ohms.
Capacity: 20 watts.
Weight: 7 lb.

The special design of the PM 6 drive unit preserves the fundamental to harmonic relationship throughout the entire audio range, thereby ensuring smooth, natural sound. Designed especially to meet the requirements of horn-loaded operation, the PM 6 should never be used as a conventional direct radiator.

PM 7

Gap flux: 19,650 gauss.
Total flux: 250,000 maxwells.
Frequency range: 20-20,000 Hz.
Impedance: 15 ohms.
Capacity: 20 watts.
Weight: 9 lb.

The generation of 19,650 gauss from such a small mass is the culmination of years of research to improve both available magnetic materials and construction techniques. The increased force in conjunction with a new patented speech coil of very high efficiency give an overall attack and transient response which has never before been achieved in such a compact unit. The PM 7 may be used as an alternative to the PM 6 in all Lowther systems where maximum efficiency and optimum performance characteristics are required.

Extracts from review in "Hi-Fi News"
"On switching on, the first action was to turn down the volume control due to its high sensitivity. . . . Even more striking than this was the remarkable high note response. The effect of this was to bring all sounds closer to the listener as it were. . . . the source appeared to approach closer than the writer has ever experienced before. . . . a remarkably smooth top response."

Call or write now for a special Lowther price—you'll save more at Encel Stereo Centres in Melbourne or Sydney!



Here is a cross section of the Lowther Acoustica speaker enclosure. Plans will be provided or complete cabinets are available in your choice of several popular polished or oiled finishes. Prices on request.

Encel ELECTRONICS (STEREO) PTY. LTD.

Head Office:
431 Bridge Rd., Richmond, Victoria 3121.
Tel. 42 3762.
Sydney Store: Ground Floor, 25M Building
257 Clarence Street, Sydney, N.S.W. 2000.
Tel. 29 4563, 29 4564.

Wholesalers *Trade ins accepted
Australia's Greatest Hi-Fi Centre

Electric Therapy

I refer to the matter raised in Forum, in the September issue on "How To Lose Weight".

I think that the person concerned was wise to be cautious but, as a retired X-ray and electro-medical engineer, I would like to add my comment.

As far as I know, the term "Galvanic" is still used in medical circles to indicate direct current, which is used to treat certain conditions. Unfortunately, unqualified persons have, from time to time, treated persons with electrical modalities and brought discredit to the method.

In the hands of properly qualified persons, medical specialists and physiotherapists, various electrical modalities have proved—and are proving—of great benefit to patients, where such methods are justified.

One might cite the case of a bad fracture of a limb which has had to be set and immobilised in plaster for some time. On recovery, it is sometimes found that the muscles of the limb have atrophied through disuse and the patient is unable to use the limb. Treatment by pulsed currents of the correct waveform and intensity will, in short time, tone up the muscles and help restore movement.

Incidentally, Professor Leduc was a medical specialist practising in Nantes, France, around the turn of the century. He used electricity in cases where its use was indicated. (J.F., Monbulk, Vic.)

IRH Components Pty. Limited introduce Sealectro products for modern electronics.



Sealectro card, stub or badge readers

The Sealectro Static Punched Card or Stub Readers (80 x 12 or 51 x 12 cards) are suited to a wide and growing range of programming and matrix switching applications wherein immediate programme change and low volume programme store are requisite. Some samples are: Low-cost automation, machine tool control, automated testing, process control, function simulation. The Badge Reader (10 x 10 card) is designed for Personnel identification, Credit status, Data collection and transmission.



SEALECTOBOARD programme boards

The most flexible and reliable programming system, cord or cordless styles, single or multi-pole switching, programming by shorting pins or component interposition e.g. Diodes for back-feed elimination. Applications include: Analogue Computers, Naval Communications Channelling, Data Logging, Function Simulation, Pattern Generation, Factory Automation, Nuclear Power Control.



PRESS-FIT

teflon terminals

The PRESS-FIT terminal range includes a broad line of types and sizes of Stand-offs, Feed-throughs, Receptacles, Test Point Jacks, Probes and Plugs, Transistor Sockets, Transistor Holders, Bushings, Taper-pin Receptacles and special types for welded or wire-wrap connections. PRESS-FIT terminals are available in the ten E.I.A. colours - white, black, brown, grey, blue, violet, green, yellow, red and orange.



sub-miniature
R.F. connectors

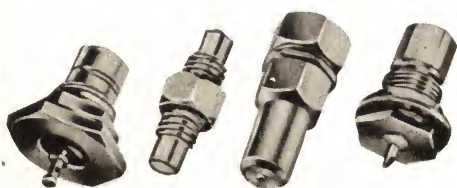

The widest range of Sub-miniature Coaxial Connectors, in screw-on, snap-on and slide-on styles. Conform to MIL-C-22557/A 50 ohm patterns available for RG-196/U or RG-188/U cables, and also for the equivalent semi-rigid cables. Hermetically sealed bulk-head mounting connectors suitable for pressurised equipment. A full range of BNC, TNC and C type adapters is also included in the ConheX range.

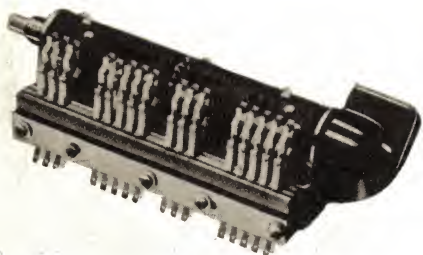

ACTAN

programming switches

Drum type programming switches permanent or field adjustable. Manual or timing motor or stepping solenoid actuated. Extreme versatility of contact arrangements enable up to 60 discrete programmes per switch.

IRH COMPONENTS

PTY. LIMITED

The Components Division of
IRH Industries Limited

IRH THE CRESCENT, KINGSGROVE, N.S.W. 2208. PHONE 50 0111

INTERSTATE TELEPHONES

MELB. VIC.	489 1088	BRIS QLD.	70 2141
HOB. TAS.	34 2811	PERTH WA.	8 2271
LAUN. TAS.	22 844	ADEL S.A.	23 1971

ANSWERS - continued

As little as 10 years ago, a large number of amateur phone stations would have been found using class-B modulators and it would be a reasonable bet that the output valve would have been a 6N7. There is also a good chance that the essential components for a class-B modulator are lying forgotten in junk boxes or discarded chassis. Here is the circuit for a typical 10W class-B modulator, as published in the December, 1959 issue. The article points out that the modulator could be used directly with a carbon microphone but it also shows a standard preamplifier and a full-scale preamplifier/clipper, which could be used with a crystal or dynamic microphone. This last was originally featured in the December, 1957 issue. Copies of both articles are still available for 20c each. Inquiries should be addressed to the Assistant Editor, Electronics Australia, Box 2728, G.P.O., Sydney, 2001.

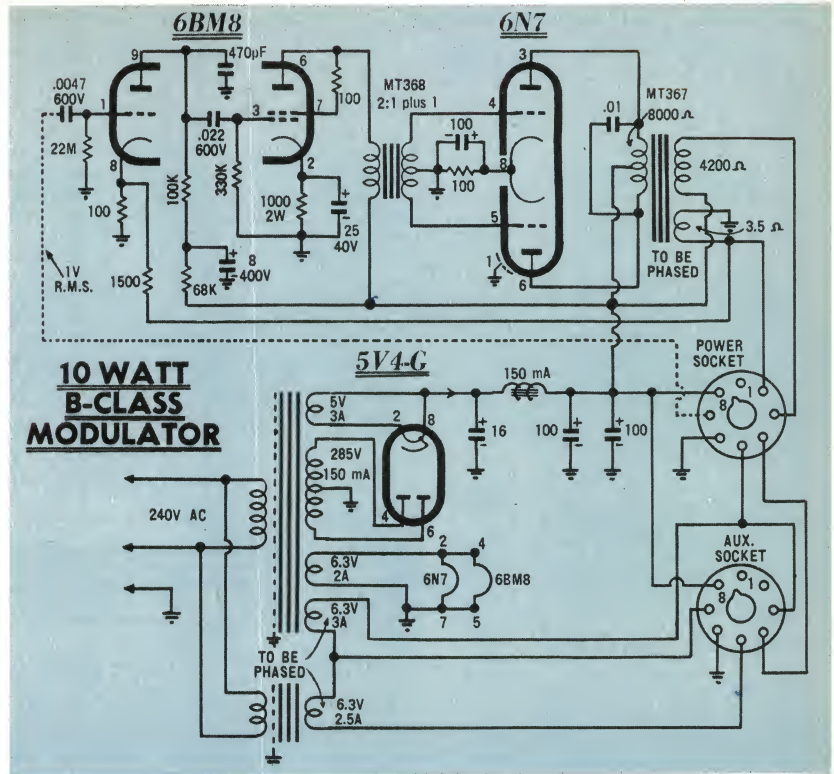

the various magazines available, Australian enthusiasts are well catered for. Would it be asking too much for you to suggest that readers purchase certain of these other magazines? (J. Mc.D., Geelong, Vic.)

● Thanks for the encouraging remarks and for the suggestion. We have no false ideas that E.A. is the only magazine that readers should buy or that readers should only build what is described in this magazine. In a very real way, the various magazines and textbooks complement one another in spreading and maintaining activity in a common interest. Good luck to them. The better they are, the harder we have to work to compete. They keep us on our toes. However, to say the least, it would be unconventional to promote actively the sales of another journal selling competitively on the bookstalls. There is the point also that, to suggest articles in other journals, it would be necessary to index them for reference, evaluate the articles and make decisions as to whether they should or should not be recommended for Australian hobbyists. This is a task that we would prefer not to inherit.

YOUNG READER: I'm only 12 years old and I read your magazine every month. I think it's just great. Could you please publish my name and address, as I would like to hear from a person of about my own age interested in amateur radio. (David Robble, 4 Dover Street, Levin, New Zealand.)

● We are glad you like the magazine, David, and we have published your name and address for any young readers to contact you directly.

READER'S SUGGESTIONS: I have only recently become a subscriber to your magazine and find it extremely interesting. I have a couple of suggestions which you may find worthwhile. First, have you considered a binder for storing copies of your magazine? Second, some months ago, you published the design for a Theremin. Could this be modified for use as a burglar alarm and, if so, what would be the effective range? Also, purely as a matter of academic interest, would it be possible to detect the presence of such an alarm system? (A.J.D., Albert Park, Vic.)

● Binders for "Electronics Australia" are available for \$2 each plus 25c postage from Photosales, John Fairfax and Sons Ltd., Box 5025, G.P.O., Sydney, 2001. The principle of the Theremin could possibly be adapted for use as a burglar alarm, but the design as published is unlikely to be stable enough for this use. The presence of an RF field could certainly be detected by anyone — provided they were looking for it!

TRANSISTORISED TRANSMITTER: Would you please consider describing a fairly simple transistorised transmitter for the amateur bands. I have searched through your past issues in search of a suitable design, but have found only valve circuits. (J.W., Wollongong, N.S.W.)

● It is true that we haven't described such a design in the past, J.W., mainly for the reason that suitable transistors have not been readily available at reasonable prices until relatively recently. Now that this situation is somewhat more favourable, we will certainly look into the possibility of producing a project along these lines.

MW AND LW: Recently I obtained a radio receiver which can operate on both medium and long waves. Can you tell me the difference between these two waves. (G.A., Rosewater, S.A.)

● The main difference between these two wave-bands is the range of frequencies covered. Medium-wave covers from about 500 to 1600KHz (for broadcasting in Australia), while long wave covers frequencies below about 300KHz. This band is not used for broadcasting in Australia.

INFRARED PHOTOGRAPHY. I am a radio technician and a keen amateur photographer, and I am very interested in infrared photography—also seeing at night with the aid of infrared. Any information you can give me on the subject and availability of equipment—kits to be built and such like—would be very gratefully accepted. The article on a capacitor

discharge ignition system in your September issue was very timely. The system in my car is not adequate, and you have provided me with an excellent alternative. My thanks to the writer, and my thanks also to the staff of "Electronics Australia" for the excellent coverage of subjects. (A.K., R.A.A.F. Richmond, N.S.W.)

● We are afraid we cannot assist you on an individual basis with equipment for infrared experiments, but we shall continue to publish articles of interest in this field as they become available. The equipment we have discussed in the past all seems to be highly specialised, and would presumably be outside the financial resources of most people. We know of no kits of parts for the use of home constructors. We are pleased to hear you found the item on a capacitor discharge ignition system useful, also that you are pleased with the magazine in general.

COMPUTER BOARDS

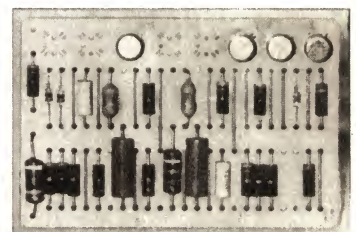

TRANSISTORS 15c Each.

Resistors, Diodes, Capacitors Free.

8 BOARDS WITH A MINIMUM OF 30 TRANSISTORS \$4.00

25 BOARDS WITH A MINIMUM OF 100 TRANS. \$12.00

Technical information supplied with goods. Minimum order \$1.50. Please add Postage.

COLSTOK ELECTRONICS
Box 178, KELLERBERRIN. 6410

SOUND PROJECTORS

Cinevox Prefect and Harbour and Heath 16mm in good working order. 240v operated, complete with speaker and amplifier. **from \$90.00**

CIRCULAR SLIDE RULE

3 3/4in diameter. Will do the same work as the conventional slide rule. Instruction book included. **\$1.25 each**
Post 10 cents.

REFLECTOR GUNSIGHT

Contains these lenses:
1 Lens 1in Focus, 1 1/4in diam.
1 Lens 1 11/16in Focus, 1 1/4in diameter.
1 Air-spaced Lens, 1 1/4in diam.
1 Filter Lens, 1 Graticule.
1 Lampholder. **\$1.85**
Post.: N.S.W. 30c; Interstate: 40c.

P.M.G. TYPE TELEPHONES

Standard desk type with magneto bell calling device. Range 30 miles. Uses standard batteries at each phone. Any number can be connected together on single line. **\$23.00**

(2 TELEPHONE SETS)

30c cartage to rail. Freight payable at nearest attended railway station.

Please note we are now able to include 1/2 mile of telephone cable FREE with each set of Phones.

BATTERY CHARGERS

240 volt A.C. Input. Each battery Charger will charge either 6 or 12 volt batteries.
2 amp. without meter, **\$13.75**
2 amp. with meter, **\$15.75**
Post N.S.W. 70c; Interstate 95c.

MINIATURE ELECTRIC MOTORS

1 1/2 to 3 volts D.C. Ideal for model boats, cars, planes, etc. Strong torque. Only **65 cents each** or **10 for \$4.00.**
(Post 7c).

TRANSCIVER

(2-way radio) R.C.A. America RT 68, 24 volt, operated 10 watt output 38-54 megacycles F.M. crystal locked. Transmitter and receiver using frequency synthesiser in 100 K/cs: step 10 channel per meg/cycle with power supply. Leads, mike and headphones \$45, 60c cartage to rail. Freight payable at nearest attended railway station.

TRANSCIVER

(2-way radio) 62 set ideal small ships, Hama, etc. 6 to 10 megs. Crystal locked or V.F.O. controlled. 5 watt output. Complete with antenna, headphones and mike \$60, 60c cartage to rail. Freight payable at nearest attended Railway Station.

HEAD PHONES

Low impedance moving coil fitted with rubber muffler to reduce external noise, fitted with press to talk, dynamic hand microphones. Ideal for use with all types of transceivers. \$3.50 pair. Same with black felt muffler, \$4.50 pair. Post N.S.W 25c; Interstate 30c.

12 VOLT D.C. DESYNN INDICATOR AND TRANSMITTER UNIT.

Suitable for aerial rotation indicator, etc. 0-360 deg., weatherproof mountings. **\$5.00 per set.**
Postage: N.S.W., 95c; Interstate \$1.67.

16'6" WHIP AERIALS

6-Piece, brand new, \$5.75. 60c cartage to rail. Freight payable at nearest attended railway station.

AVO MULTI METER

Type CT 38 **\$75.00**

A.W.A. AUSTRALPHONE

Transceivers 12 V New Complete Station. 1.6 to 10 megs on transmit. 0.54 to 16 megs on receive. **\$150.00**



P.M.G. Phone Jack and plugs, 25c each. 45c the pair. Post 7c.

NIFE CELLS

1.2 Volt fully charged. 4in x 3in x 1in 4 AH. **\$1.00 each**
Post. N.S.W., 25c; interstate 35c.

WALKIE TALKIE TWO-WAY RADIOS

P.M.G. Approved Citizen Band. 9 Transistor. \$79.00 per set of 2. Post. N.S.W. 50c; interstate, 60c.



P.M.G. TYPE KEY SWITCHES. 45c each. Post. 15c.

BC 221

Frequency Metres **\$55.00**



45 x 40 coated Lens with tripod. **\$10.95**

30 x 30 Power Coated Lens Brand new. **\$3.75**

60 magnification with a 60mm coated objective lens. With tripod. **\$23.00**

As illustrated. Postage, 95c; Interstate \$1.20.

HIGH STABILITY RESISTORS

I.R.C. brand new, usually 80c ea. 50 assorted values for only **\$3.75**
Post 15c.

RECEIVER 8C A.W.A.

With ABC and D Coils. Complete with all spares. **\$90.00**

522 TRANSCEVERS

100 to 150 m/cs. **\$35.00**

TYPE S POWER SUPPLY

(240 Vac supply for AT 5-ARB) suit most types of Disposal transmitters and receivers outputs 250 volt, 10ma 550 volt 200ma, 300 volt 100ma, **\$30.00**

TELEPHONE WIRE

21 gauge copper, plastic covered. Ideal telephone or bell wire. 1,320ft coil of twin (equal 1/2 mile) \$7 per coil. Post. N.S.W. 70c; Interstate \$1.20.

SCOOP PURCHASE

Gramo Motors. New. Made in U.S.A. 4-speed 240 volt A.C. 50 cye. Only **\$2.75 each.**
Post. N.S.W. 30c; interstate, 40c.

CO-AXIAL SWITCH

70 ohms 4 positions, can be motor driven completely waterproof 70 ohms type connectors. Housed in metal case 9in x 8in x 8in \$5.00 each. Post N.S.W 70c. Interstate \$1.20.

ASTRONOMICAL TELESCOPE

3 1/2in reflector 126 X magnification. Complete with 4 X finder and equatorial mount. **\$59.00**
Post \$1.50.

VALVES BRAND NEW IN CARTONS

Special discount for quantity

807	75c	X61M	\$2.20
65N7GT	95c	CV850	\$1.50
8989	\$1.00	1H6G	30c
5U4G	95c	832	\$5.00
77	\$1.00	6AK5	\$1.50
EF50	35c	6X4	\$1.00
6U7	75c	12SK7	50c
5Y3	\$1.75	VR65	25c
6C4	50c	VT4C	75c
2 x 2	75c	AU5	\$1.00
6AG5	80c	80	\$1.25
12AU7	\$1.00	6AK5W	\$1.50

CATHODE RAY TUBES

3FP7	\$2.95	5BP1	\$3.50
31P1	\$2.95		
V1669 4/1	\$2.95	CY2184	\$2.95

PLEASE ADD POSTAGE ON ALL ARTICLES

TELESCOPES

30 x 40 with Tripod **\$7.95**
Post N.S.W., 70c; interstate \$1.20

PETROL MOTOR GENERATOR SET

BRAND NEW EX-ARMY 300 watt, 15 volts, 20 amps. Made in Canada, Complete with tools, instruction book, spares, etc. Only **\$75.00**
\$1 cartage to rail, freight payable at nearest attended railway station.

C.M.A. CABLE

240 volt 3/.036 black, new and perfect. 100yd rolls **\$3.00;** 6 or more. **30c cartage to rail.**
\$2.50
Frequency Counter Cintel type 388. **\$250.00**

VIBRATORS, 6 volts, 7-pin 75c each.

UNISELECTORS, 4 BANK, \$4.00 Post. N.S.W., 25c; interstate, 30c.

INSTRUMENT TRIPODS, sturdy, wooden frame, Telescope. Extend to 4ft 6in **\$13.00**

SELSYN MOTORS MAGSLIP Mk. II **\$5.25 ea.**

No. 19 TWO-WAY RADIOS Sold a sis without power supply, leads, accessories, etc. Only **\$15.** Or complete with above gear, **\$35.**

BINOCULARS

PRISMATIC. Coated Lenses Brand new. Complete with case.
8 x 30 **\$18.75**
7 x 50 **\$22.15**
10 x 50 **\$23.07**
12 x 50 **\$23.95**
20 x 50 **\$26.80**
Post. N.S.W., 70c; Interstate, \$1.20

3000 TYPE RELAYS

P.M.G. 200 Ohm — 1,500 Ohm Coils, **\$1.25 each.**

A.W.A. AMPLIFIERS

240 VAC with pick up Terminal. Used in good order Ex Studio. **\$15.00**

MINE DETECTORS

Ex A.M.F with Instruction Book. Complete in wooden case. Ideal for plumbers, councils for locating buried pipes, etc. Freight payable at nearest attended railway station. **\$39.00**

4 DIGIT RELAY COUNTERS

50-volt D.C., suit slot car. Lap counters, etc. **\$1.25 each.** Post 13c.

ALTEC STUDIO MICROPHONES

639B Western Electric, top grade, original cost **\$250.** Ideal Broadcast Studio, music recording, Church and play recording, etc. Fraction of original cost. Price on Application.

240 VOLT

522 POWER SUPPLY

Supplies all necessary voltages to operate 522 transceiver from 240 V A.C. Complete and ready to plug in **\$30.00.**

SPECIAL lucky dip valve offer, 15 new valves in cartons for only **\$2.00.** We haven't got time to sort them, so you reap the benefit. Post 60c.

SOLENOIDS

Plunger Type 12V 300M.A. Suit electric camera control, miniature trains, radio, etc. **\$1.25.** Post. 10c.
200 Mill. amp., 24 volt, 1/8in push movement. **\$1.25.** Post 10c.

LENSES

TOP GRADE ACHROMATIC 2in DIAMETER, 20in FL ideal as telephoto lens, telescope objectives. **\$13.**
Postage 46c.

CONDENSER LENS

2 1/4in DIAM. 2in FL. **\$1.50 each** or **\$2.50 per pair.** Post 21c.

CONDENSER LENS

1 1/4in DIAM. 1 1/2in FL. **50c each.**
Postage, 17c.

FOUR CHANNEL BRANCHING AMPLIFIER

With 4in Vu, meter GLORAD. Complete with Portable Power Converter. 600 ohm balanced input and output. Ideal for outside broadcasting, etc. **\$39.50**

MONITOR SPEAKER UNIT

Ex-A.B.C. consisting of low resistance 8in speaker in Acoustic Labyrinth Baffle Box, complete with 10-watt amplifier, 600 ohms plus 8dbm input, 240 volt A.C. operated. **\$37.50**

TEN CHANNELS VHF TRANSCIVER

Types TR1934 100-125 meg/cys. and TR1935 125-150 meg/cycles. 28 volt DC operated AM single crystal locks both TX and RX on same channel complete with generator. **\$33.00**

RECORDING TAPE

EX-GOVERNMENT SURPLUS STOCK. Topgrade. 600ft on 5in spool, \$1.45, post 13c. 150ft on 3in spool, 65c, post 9c.

TELEPRINTER PAPER TAPE

8 1/4in x 6 5/8in Full Page **\$1.50 per roll.**

WHEATSTONE BRIDGE

Top grade In Multiples up to 1000 **\$65.00**

Deitch Bros.

70 OXFORD STREET, SYDNEY, 2010

SORRY, NO C.O.D.

ANSWERS - continued

SOLID STATE: Is the series of articles "Fundamentals of Solid State" available in book form, and if so how it is obtainable. I won't stop buying "Electronics Australia," but this is the sort of textbook I need. (R.J.R., Altona, Vic.)

● This series has not been published previously. It is currently being written for the magazine by our Technical Editor, Jamieson Rowe. We may, if there is sufficient demand, publish the chapters in book form some time after the series is completed but we have no firm plans in this direction at present.

SIMPLE TRANSMITTERS: I would like to compliment you on the excellent material printed in every issue. I am 15, and have gained much knowledge from "Electronics Australia." Will you consider publishing a constructional article on a simple transmitter? Many boys of my age are preparing to tackle the P.M.G.'s examination for the amateur operator's certificate of proficiency and want circuits for simple AM and SSB transmitters. (A.S., Wollongong, N.S.W.)

● We could well be overdue for a simple AM transmitter and we will certainly look at the possibilities of publishing a suitable project. The last circuit of this type we published was in the February, 1965 issue (A Basic 3-band AM Transmitter, File No. 2/TR/37). Since it may be a few

months before we can arrange to publish another circuit, you may care to have a look at the earlier one. Reprints of the article can be had through the Information Service for 20c. (Please quote file number.) We published a series of articles on the construction of an SSB transmitter in our issues of January to March, 1967 (File Nos. 2/TR/41, 42, 43) but this is anything but simple. A somewhat less complicated circuit could well be a possibility for an article at some future date but, of necessity, an SSB transmitter is fairly complicated.

INTERFERENCE: I have found that the most effective way of reducing man-made static is to use a receiver with a balanced aerial input and a centre-fed antenna. It is most effective against noises other than that caused by breakdown of insulators on the HT lines. The antenna needs to be above the house wiring but, in my case, it is sufficient to have it under the peak of the roof, just under the tiles. I have also found that, where a balanced aerial primary is not available, the scheme is still worthwhile, with the twin lead connecting between the aerial terminal and earth. I am looking forward to a solid-state communications receiver. In my opinion your magazine is the best of its type, published here or overseas. (J.E., Como, W.A.)

● Getting the antenna above electrical house wiring and minimising signal pick-up by the down lead can certainly help against interference. The trouble with leakage from the HT wiring is that it is radiated and becomes just like another RF signal. The tendency these days is to favour unbalanced, coaxial input. This might suggest the use of a coaxial down lead, even with a rather indeterminate length of wire above it. Alternatively, it is easy, these days, to produce a broadband balun which will allow a balanced down lead to feed into a coaxial or unbalanced aerial input circuit. Work on the solid-state receiver is coming along nicely. Thanks a lot for the nice remarks about the magazine.

CONTINUITY TEST: It is possible to verify whether there is a break in the winding of a coil, a choke or a wire-wound resistor by making a continuity test. For this, you require a battery and a voltmeter or, failing that, a flashlight bulb or a pair of headphones. (R.W., Sebastopol, Vic.)

● The idea of a continuity test is a very old one and is mentioned in most elementary electronic textbooks. It is also the basis of the resistance scales in all multi-meters. However, you appear to have worked it out for yourself. Good for you. If you can continue to think one step ahead of your reading, it will augur well for your future in electronics.

(Continued on page 207)

Burglar Alarm

FOOT TRAPS AND MAINS SUPPLY: Reference the article, "Transistorised Burglar Alarm" in the October issue, written by myself. There are some points I wish to raise. The article, as you presented it, states that foot traps are most suitable when the house is to be vacant for some time. This is . . . contrary to what I wrote. In fact, foot traps afford a simple and quick method of protection. I feel that your statement may mislead readers into rejecting this added protection. Suggestions are also made for the use of mains power, using batteries as a standby in the event of mains failure. I would point out that to convert from the original circuit to the transistorised circuit requires the addition of only four components at a total cost (retail) of less than \$2. The components required to run the original circuit from the mains cost much more than this (about \$6 by my calculation), are bulkier, and require the provision of a power point. Because of the very low current drain, the batteries would last as long in the transistorised circuit as they would in the converted circuit. So, where is the point in running the original circuit from the mains? (The author).

● The points you raise are quite valid and accurate, the only matter for debate being their relative importance. Quite frankly, we consider the average reader is perfectly capable of making his own decision as to which of a number of alternatives is best suited to his requirements. Where one may feel that foot traps are unnecessary except for long periods of absence, others would welcome the opportunity to use them on every occasion. All we did was make the technical information available. Much the same reasoning applies to the power supply situation. While your cost structure may be valid on the basis of new components, many readers could produce most of the parts from their junk box. Granted, the same reasoning could apply to the transistorised system, so that the final choice by any individual may well be based on what was already available. Once again, we simply provided the information; the reader can make up his own mind.

CHOOSE THE BEST - IT COSTS NO MORE



O. T. LEMPRIERE & CO. LIMITED. Head Office: 27-41 Bowden Street, Alexandria, N.S.W.
and at Melbourne • Brisbane • Adelaide • Perth

EXPLORATION UNLIMITED

- Telescopes
- Microscopes
- Binoculars
- Astronomical books, charts, atlases
- Build-it-yourself kits
- Celestial globes
- Scientific weather equipment

**SEEK OUR EXPERT ADVICE
ENJOY OUR FRIENDLY SERVICE AND
BIG PRICE SAVINGS**



ELECTRONIC WEATHER EQUIPMENT

- Electric wind speed generator.
- Instant wind direction indicator.
- Barometer
- Hygrometer
- Thermometer



Prompt mail order service
All goods fully guaranteed.

WRITE OR CALL FOR OUR FREE CATALOGUE NOW

AMATEUR ASTRONOMERS SUPPLY CO.
Dept. E 11A-B Clarke St., Crows Nest,
Sydney 2065 Phone 43-4360

HAM

RADIO SUPPLIERS Mail Order Specialists

323 ELIZABETH STREET,
(2 Doors from Little Lonsdale Street)
MELBOURNE, VIC. 3000
TELEPHONES: 677329, 674286

1B3GT (DY30)	\$1.45
1C7	.50
1D4	.75
1F5	\$1.00
1K5	.50
1K7	.50
1L4	.50
1L5	5 for \$2.00
1LN5	\$1.00
1M5	.50
1P5	.50
1O5	.50
1R5	\$1.80
1S2 (DL86)	\$4.45
1S4	\$1.00
1S5	\$1.70
1T4	\$1.00
1X2 A/B	\$1.90
2D21	\$1.20
3S4	\$1.00
3V4	\$1.70
5AR4 GZ34	\$2.45
5AS4	\$1.30
5R4GY	\$2.00
5T4	\$1.75
5U4GB	\$1.30
5V4 (GZ32)	\$1.50
5Y3GT	\$1.20
5Z3	\$1.50
6A8G	\$2.00
6AB7	\$1.00
6AC7 ea.	.50
6AD8	or 5 for \$2.00
6AE8 (X79)	\$3.50
6AG5	.20
6AG7	or 12 for \$2.00
6AJ5	\$1.75
6AK5 (EF95)	\$2.55
6AL3	\$1.55
6AL5	.75
6AM5	or 3 for \$2.00
6AM6	or 3 for \$2.00
6AN7/A	1.55
6AQ5	\$1.30
6AR7GT	\$1.80
6AU4GT/A	\$1.50
6AU6	\$1.30
6AV6	\$1.20
6AX4	\$1.50
6B6	\$2.00
6B8	\$3.00
6BA6	\$1.40
6BE6	\$1.40
6BH5	\$1.35
6BK8 (EF86)	\$2.00
6BL8	\$1.50
6BM8	\$1.60
6BQ5 (EL84)	\$1.50
6BO6GTB/	
6C6	\$2.50
6CQ7A	\$1.50
6BV7	\$1.35
6BX6	\$1.35
6BY7	\$1.95
6C4	.50
6C8	or 5 for \$2.00
6CA4	\$1.00
6CA7/EL34	\$3.00
6CB6	\$1.40
6CD6G/A	\$4.50
6CG7	\$2.50
6CH6	\$2.40
6CK5	\$2.00
6CK6	\$1.40
6CM5	\$2.20
6CQ6	\$2.20
6CQ8	\$1.40
6CS6	\$1.50
6CW4	
(NUVISTA)	\$2.75
6DC6	\$2.40
6DC8	\$1.90
6DO6A	\$2.20
6DO6B	\$2.55
6D58	\$1.80
6DT6	\$1.40
6DX8	\$1.65
6EA8	\$1.55
6ES6	\$1.80
6ES8	\$1.80
6F8G	\$1.25
6G8G	\$2.50
6GV8	\$1.70
6GW8	\$1.70
6H6GT	.20
6H8	or 12 for \$2.00
6HG5	\$1.50
6HS8	\$1.50
6J5GT	\$1.00
6J6	.75
6J7G	or 3 for \$2.00
6K6	or 5 for \$2.00
6J8G	\$3.00
6K6	\$1.00
6K7	.50
6K8GT	\$1.25
6K8	Metal \$2.00
6KV8	\$1.75
6LB6	\$2.90
6L7	.50
6M5	\$1.35
6N3	\$1.20
6N7	\$1.00
6N8	or 10 for \$2.00
6O7G	\$1.40
6R3	\$2.50
6R3	\$1.55
6S2	\$1.85
6SA7GT	\$2.20
6SC7	.75

6SF5	.75
6SF7	.75
6SH7	.50
6S7	or 5 for \$2.00
6S7	or 3 for \$2.00
6SL7GT	\$2.00
6SN7GT	\$1.00
6SQ7GT	\$2.10
6SS7	.75
6U4GT	\$2.00
6U7G	.75
6U7G	or 3 for \$2.00
6UB/A	\$1.55
6V4	\$1.05
6V4	\$1.05
6V6GT	\$1.75
6X2	\$1.95
6X4	\$1.00
6X5GT	\$1.50
6Y9	\$1.90
7A8	.35 or \$2
7C5	8 for \$2
7E6	.50 or \$2
7E6	5 for \$2
7H7	.50 or \$2
7W7	.50 or \$2
9A8	\$1.90
9U8	\$1.75
12A6	.50 or \$2
12A6	5 for \$2
12AH7	.50 or \$2
12AT7	.50 or \$2
12AU6	5 for \$2
12AU7	\$1.50
12AV6	\$1.45
12AX7/ECL83	.75
12BE6	\$1.60
12BY7/A	\$1.75
12C8	.50
12J5	.50
12SA7GT	\$1.00
12SC7	.50
12SH7	.50
12SK7	.50
12SN7GT	\$1.00
12SR7	.50 or \$2
12SR7	5 for \$2
16A8	\$2.00
35B6	\$1.00
19	.50
30	.50
42	\$2.50
47	.50
57	.50
58	.50
78	\$1.00
80	\$1.50
100TH	\$3.00
717A	\$1.25
807	\$1.00
808	\$1.00
832A	\$7.00
866A	\$1.00
954	50c or \$2
955	5 for \$2
956	.50
958A	50c or \$2
1625	5 for \$2
1629	50c or \$2
5636	.75
9006	25c or \$2
BA50	10 for \$2
ECC35	12 for \$1
ECH35	\$2.00
EF85/6BK8	\$2.00
EL35 (6CA7)	\$3.00
EM84	\$1.50
EY91	.50
KT61	\$3.90
KT66	\$4.75
KT68	\$5.30
RL18	.75 or \$2
UL41	3 for \$2
VR150	\$1.00
(volt Reg.)	\$1.25
2D21	\$1.20
2E26	\$4.60
2X2/879	.75
6CW4	
NUVISTA	\$2.75
6DQ5	\$4.75
75C1 Volt.	
Reg.	\$2.25
100TH	\$3.00
90 Reg.	\$2.50
108C1/OB2	\$2.50
150C4/OA2	\$1.65
Reg.	\$7.00
832A	\$1.00
866/A Reg.	\$2.00
807	\$2.85
884	\$2.85
885	\$2.85
2051	.50
5763	\$2.55
616A	\$2.20
6146B	\$6.25
OA2/150C4	\$1.65
OB2/108C1	\$2.50
QEO3/10	\$2.55
QEO3/12	\$2.65
QEO3/20	\$17.00
QEO6/40	\$12.95
QVO4/7	\$1.50 or 3 for \$3.75

ALSO OTHER
TYPES AVAILABLE,
P.O.A.



MODEL OL-64D MULTIMETER, 20,000/OPV, DC Volts: 0-0.25/1/10/50/250/500/1000V at 20K/OPV, 5000 volts at 10K/OPV, AC Volts: 0-10/50/250/1000V at 8K/OPV, DC/A: 50uA/1mA/50mA/500mA/10 amps. RESISTANCE: 0-4K/400K/4M/40Megohm, DB Scale: -20 to plus 36db. Capacitance: 250PF to .02uF, Induct. 0-5000H, size: 5 3/4 x 4 1/8 x 1 3/4 in.
PRICE: \$19.50 post 30c.



MODEL 200H MULTIMETER, 20,000 opv, DC Volts: 0-5/25/50/250/500/2500V (20,000 opv) AC Volts: 0-15/50/100/500/1000V (10,000 opv) DC/Amps: 50uA/2.5mA/250mA, Resistance: 0-60K/6M ohm (scale centre 300 ohm-30K ohm. Capacitance: 10uF to .001uF/.001uF - .1uF, D3 scale 20 db to plus 22 db. Size 4 1/2 x 1 1/8.
PRICE: \$11.25 post 30c.



NEW MODEL US-100, Overload protection, Shockproof Movement, polarity switch DC volts: 0.25/1/25/10/50/250/1000V (20K/OPV AC Volts: 0-2.5, 10/50/250/1000V (5K/OPV), DC/Amps: 1mA/25mA/500mA and 10A, AC/Amps 10A, RESISTANCE: 0-50M/ohms (centre scale 50) R X 1/10/100/1K/10K, db scale -20 to plus 10 plus 22/plus 35/plus 50db.
PRICE: \$28.75 post 40c.
Mirror Scale



MODEL C-1000 POCKET MULTIMETER, 1000 ohms per Volt, AC Volts: 0-10/50/250/1000 (1000 opv) DC Volts: 0-10/50/250/1000 (1000 opv), DC Current: 0-100mA, Resistance: 0-150K ohms (3K centre), 2 colour scale, Range Selector Switch, Dimens.: 3 1/2 x 2 1/4 x 1 1/4.
PRICE: \$6.50 post free



MODEL CT500 MULTIMETER, 20,000/OPV, DC Volts: 0-2.5/10/50/250/500 5000V (20K/OPV) AC Volts: 0-10/50/250/500/1000V (10K/OPV) DC/Amps: 5uA/5mA/50mA/500mA, RESISTANCE: 0-12K/120K/1.2Meg/12Megohms, (scale centre: 60/600/6K/60K, DB scale: -20db to plus 62db (5 ranges). Size: 5 1/2 x 3 5/8 x 1 3/4 in.
PRICE: \$14.95 post 30c.



MODEL CT330 MULTIMETER, 20,000/OPV, DC Volts: 0-6/6/30/120/600/1.2K/3K/6K Volts, AC Volts: 0/6/30/120/600/1.2K Volts (10K/OPV), DC/Amps: 0-0.06/6mA/60mA/600mA, RESISTANCE: 0-6K/600K/6M/60M/600Megohm. (30/3K/30K/300Kohms) centre scale: Capacitance: 50 uf to .01 uf .001 to 0.2 uf. Decibels: -20 to plus 63db size approx: 5 1/2 x 3 5/8 x 1 3/4.
PRICE: \$16.75 post 30c.



NEW LAFAYETTE SOLID STATE HA600 RECEIVER

5 BAND AM/CW/SSB AMATEUR AND SHORT WAVE. 150 Kc/s-400 Kc/s and 550 Kc/c-30 Mc/s. F.E.T. front end • 2 mechanical filters • Huge dial • Product detector • Crystal calibrator • Variable BFO • Noise limiter • S Meter • 24in Bandspread • 230V A.C./12V DC, neg. earth operation • RF gain control. Size 15in x 9 3/4in. 8 1/4in. Wt. 18lb. S.A.E. for full details.
PRICE \$199.50



"KEW" KYORITSU MO 65 METERS, NEW
Size: 3/4 inch, mounting hole 2 1/2 inch, 1/2 inch deep.
All plus Postage 20c.
1 mA, 5 mA, 10 mA, 25 mA, 50 mA, 100 mA, 150 mA, 250 mA, 500 mA.
\$4.50
1 amp DC \$4.50
5 amp DC \$4.50
10 amp DC \$4.50
30-0-30 amp DC \$5.25
15v DC, 30v DC, 300v DC \$4.50
300 volts AC \$5.50



STEREO HEADPHONES
Large rubber earpiece, full audible frequency, 100-15,000 cycles.
\$9.00 Inc. Tax.

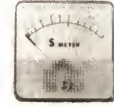

P25 2 1/4 inch square, clear plastic face, 2 1/8 inch mounting hole, 3/4 inch deep.
50 uA \$5.75 15 volts d.c. \$5.50
100 uA \$5.75 25 volts d.c. \$5.50
500 uA \$5.25 500 volts a.c. \$5.50
1, 5, 10, 20, 50 "S" Meter \$5.75
250 and 500 mA \$5.00 "VU" Meter \$6.50



MR3P 3 3/8 inch square, clear plastic face, 2 3/4 inch round mounting hole, 1 1/2 inch deep.
50 uA \$7.00 50-0-50 uA \$5.75
100 uA \$6.75 15 volts d.c. \$5.75
500 uA \$6.50 25 volts d.c. \$5.75
1, 5, 10, 25, 50 30 volts a.c. \$5.75
100, 250 and 500 mA \$5.75 "VU" Meter \$8.25

S.W.R. METERS, MODEL KSW-10
Specifications.—Standing Wave Ratio: 1:1 to 1:10. Accuracies: Plus or minus 3 per cent, scale length. Impedance: 52 ohms and 75 ohms. Meter: 0-100 DC microamperes.
Price \$19 Inc. tax.

THE SERVICEMAN — continued

all his wiring closely for mistakes. Anyway, the upshot of it was that he had no success and he practically begged me to fix it for him, offering to pay for my time.

"Not having the heart to refuse, I agreed and set to work on it at the first available opportunity. On removing the cover, I was very surprised indeed. The wiring was a complete shambles and bore little resemblance to that depicted in the original article. I must say I was rather dismayed, having been assured that the owner had followed to the letter the instructions in the article and used good wiring practice.

"I wonder just how many technicians there must be who shudder when some hobbyist asks them to fix a piece of gear that they have attempted to build. I shall be more careful in future!

"I decided that I would not attempt to rewire the amplifier but merely remedy the main cause for its failure to operate properly and charge him a suitable fee. He could then tidy up the wiring to the original specification. As an afterthought, I made a list of points which should be attended to.

"When the amplifier was turned on, I found that there was, indeed, a lot of hum from the loudspeakers but I could get no signal through from the input sockets. I decided on a voltage check and found 80 volts on the collector of the regulator transistor and 37 volts at the emitter. I switched off hastily and began to check the wiring. No wonder the owner's brother had received a shock. The cause of the high voltage and hum was a mistake in the wiring of the rectifiers. The negative lead for the first filter capacitor had been connected to one side of the transformer's centre-tapped secondary instead of to the earthed centre-tap itself.

Fortunately, in spite of the overload, the regulator transistor was still working. However, the output voltage of 37 volts was too high for the safety of the four output transistors, which should have had a supply of no more than 30 volts. Correcting this simple fault in the rectifier circuit brought the voltages down to the correct figures and eliminated the excessive hum from the loudspeakers. However, I was still unable to get a signal through from the input sockets but all stages appeared to working correctly.

"A close check showed that a wiring mistake in the selector switch was shunting all signals to chassis. After fixing this, the amplifier worked well, although I was sure that it was not working as well as the prototype because of the bad wiring layout.

"One angle to the situation did intrigue me. The fault in the rectifier wiring meant that applying a strong signal to the input stages would almost certainly have meant the end of the regulator transistor and four output transistors. However, because of the mistake in the selector switch wiring, no signal could be applied. It was just lucky that I fixed the power supply fault first, instead of rewiring the selector switch.

"As well as I can remember, the following were the points the owner needed to remedy before putting the amplifier into permanent service:

"The leads for both driver transistors should have been sleeved to prevent shorts. The flag heatsinks for both driver transistors were supposed to be secured to L-shaped heatsinks which, in turn, were to be secured to the printed board. The emitter bypass capacitors for both these transistors were 12-volt units instead of the 2.5-volt units specified; consequently, they were much too large in physical size.

"The right-channel earth return was not connected to the 'common' earth point. Indeed, the common earth point had been moved from the specified position. The position of a common earth point in the circuit of a transistor stereo amplifier can drastically affect stability and distortion.

"The electrostatic shield of the power transformer had been cut off short instead of being connected to chassis. The earth lead of the mains cord had not been connected to the chassis. The power transformer was installed in the chassis the wrong way round.

"Groups of leads had been 'laced' together with tinned copper wire. If the original layout had been followed and 'figure 8' shielded stereo input cable had been used, there would have been little need for lacing.

"The emitter resistors for the output transistors were 1-watt units instead of the 1/2-watt units specified; they were, therefore, much too large for the space allocated to them."

Such then was the story, recounted by my friend from the electronics laboratory. If there's a moral to be drawn, I'd put it this way:

Home builders should not take liberties with constructional information. Following instructions should help ensure that the project will work as intended but, if outside assistance does need to be sought, an accurate copy of the original will help a third party put things in order.

If a constructor elects to vary a design, he must be prepared to take the full responsibility for his "initiative," if that is the right word!

Notes & Errata

10-PLUS-10 STEREO AMPLIFIER with overload protection (April 1969): Recent information to hand indicates that the C106Y1 thyristor has a reverse voltage rating which is a little low when operating in conjunction with a zener diode that is on the high side of its tolerance. The C106F1 or BT100A thyristors can be substituted, with advantage.

PLAYMASTER 115 Amplifier (April 1967): The Mode switch was specified in the parts list as a 3-pole, 4-position type. It should be a 3-pole, 5-position type.

ELECTRONIC DESPATCH

P.O. BOX 149, AUBURN 2144
9-1 DAILY AND SAT.
16 SHERIDEN ST., GRANVILLE,
MAIL ORDERS WELCOME

Please Add Postage

TRANSISTORS

BC 107 70c	BF 115 70c
BC 108 60c	BF 179 . . . \$1.50
BC 109 75c	200V Video Amp.
BC 148 55c	AD161/162 \$3.60
BC 178 65c	Matched Pair
AD 161 . . . \$1.80	AD 162 . . . \$1.80
Matched Pr. \$3.60	Matched Pr. \$3.60
2N 3055 . . \$2.50	UJT D13T1 \$1.20
OCP 71 . . \$3.50	2N5459 (MPF 105) . . \$1.20

Photo Transistor Field Effect Trans.
THE ABOVE TRANSISTORS ARE ALWAYS IN STOCK

SPECIALS GERMANIUM PNP

2N 442 . . \$2.00	2N 513B . \$4.00
2N 456A . \$2.50	1c 25A 1B 7A
1c 7A 1B 3A	BV CBO — 80V
BV CBO —	150W 300KHz
40V 150W	BV CBO 45
430 KHz	1c 500MA
2N526	SCR BTY/400R 6A/400V \$3.75.
(2b526) . . 40c	
25pF HV . . 40c	
225 MW 6.5MHz	

COMPUTER BOARDS

10c per transistor, 2c per diode.
Heat sinks to suit 5 can 10c
Computer edge connectors 16piv
0.15 pitch 50c
8 connectors in one block . . \$1.00
Plug-in cards for wire connection
with gold-plated contacts 25c

SPECIAL POLYESTER CAPACITORS

160V 5c in the following values:
.001, .01, .047, .068, .1, .15, .18, .22,
.33, 4.47, .68.

SPECIAL PAPER CAPACITORS

.27 500V. 10c. .47 250V. 10c.
1uF 250V. 15c.
Light dependent resistor ORP12, 60c
Voltage dependent resistor 150V. 10c

ELECTROLYTIC CAPACITORS

500 MFD	1500 MFD
200V . . \$1.00	100V . . \$2.00
4000 MFD	4000 MFD
60V . . \$2.50	75V . . \$3.00
5000 MFD	8000 MFD
90V . . \$5.00	55V . . \$4.00
11,500 MFD	15,000 MFD
18V 4 . . \$1.50	12V . . \$1.75

REED SWITCHES HAMLIN

Max 1A DC Max 250V DC 15W. 80c

POLAR TRIMMERS

19pF 30c 100pF 60c
25 pF HV 40c
Vernier dials No. 11 set 50c
Bell wire .036 PVC and forti-

san lapped:
Twin, per yard 3c
Single, per yard 1 1/2c
Coil 880 yards single \$10.00
Coil 440 yards twin \$10.00
TE 18 Grid dip meter \$34.00
SE250 signal injector \$4.50
SE200 minilab tester with 200uA.

Meter provides seven test functions in the (1) unit.

- (1) Resistance substitution.
 - (2) Capacitance substitution.
 - (3) R.F. signal generator.
 - (4) Audio generator. (5) D.C. volts.
 - (6) A.C. volts, 4 ranges to 500V.
 - (7) R.F. Field strength indicator.
- Compact 6in. x 3in. x 3 1/2in. \$15.00
High voltage sintercels. Small tubular selenium rectifier stacks for HV low current supplies.
K3-30 2040 Piv 1MA (15c.) } All
K3-20 1360 Piv 1MA (10c.) } stock.
K3-70 4760 Piv 1MA (20c.) }
N8-15 1020 Piv 5MA (20c.) } new

MARKET PLACE

Send your ads for this page on the form from page 208

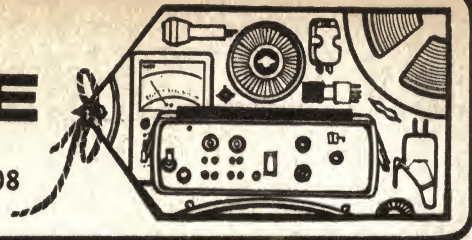

FOR SALE

TAPE Recorder, Collaro deck, Mullard amp. Integral Playmaster tuner and time clock. Spare amp. for stereo. \$70. Melbourne. 87-2518.

RECORDING TAPE, 5 x 1200 \$2.00; 7 x 2400 3.65. Cassettes C60, \$1.55. BASF, \$1.90. 15 brands to choose from — full lists free. All accessories, stereo headphones, \$8. Let us quote for hi-fi needs, recorders, radio, etc. We have the best brands at lowest prices in everything for home, work or pleasure. A. 1, Mail Orders, Box 15, Footscray, Vic., 68-4436.

STEREO Supplies, Brisbane for sound value and advice on Lux, Sound, Sonics, Compax, Celestion, Dual, P.F. and all brands. Precut speaker enclosures at better prices. 100 Turbot Street. Phone 21-3623.

CRYSTALS, New 500KHz, \$3.85. Waltham Dan, 96 Oxford St, Darlinghurst, N.S.W. 31-3360.

NEW CRO tubes, 38P1, \$4.85. Waltham Dan, 96 Oxford St, Darlinghurst, N.S.W. 31-3360.

EMI AFONIC. New low noise tape. You will never have to buy cheap and nasty tapes again. Prices, literature, Mail-order. Duratone Hi-Fi, Box 129, Curtin, A.C.T. Phone Canberra 81-2549.

TAPE Recorder, Minaphon attache, cassette, battery/ mains transformer, pigskin shoulder carrier. Phone Sydney 37-7772/32-5444.

NOMBREX Inductance bridge 1uH to 100H. As new \$3. Ring Sydney 31-3273.

CUSTOM built transformers: power, audio, etc., single or quantity production. Amplifiers, P.A. systems, battery chargers, rectifiers, electric motors, transistor radios, general engineering, fitting and turning, sheet metal work, etc. Parkinson Transformers, P.O. Box 523, South Brisbane. Telephone 87-2033.

832A VHF transmitting tubes, new and with sockets. Ideal for metres, \$3.25 each posted. D. Eates, 14 Fulton Avenue, Christchurch 1, New Zealand.

CUSTOM built hi-fi cabinets including Playmaster 1.3 speaker system. Available kit form, completely assembled, separate components. Enquiries welcome. Robert N. Smallwood, Sound Specialist, 205 Brisbane Road, Booval, Qld., 4304. Phone 82-1550, anytime.

MODEL engineering. Mill engine for beginners. Blue print, castings, \$11.50. Bolton, 72 King Street, Sydney, Catalogue, \$1.50.

TAPE recording yearbook, (English) lists recorders, equipment, clubs, Borwick, Judd. Hi-fi stereo articles, \$1.75 post free. B. T. Lovett, 5 Glover Street, Willoughby, N.S.W. 2068.

GRAMMOND CTR28 transceiver. Suit small ships, \$150. RF26 converter 50-60MHz, \$15. D. Presland, 32 River Terrace, Bundaberg, Qld.

TAPEDECK 3-speed 3-head 4-track. Collaro \$40. R. Young, Box 1331, Boroko, Papua-New Guinea.

AUDIO Mixer E.A. Feb, 1966, 2 mic, and 2 PU channels, built and tested, \$27. P. Dooley, 6 Wallis St, Horsham, 3400.

COMMAND 'r'cvrs. xmitters, TU10B coil boxes, valves, conds., sundries, all to clear. Blencowe 38 Kirkwood Ave. Seaforth Vic 786-1102.

ONLY from J. Cain can you buy the completely silent Compact III turntable free from the tinkle as described in Electronics, 17 Powell Street, Reservoir, Melbourne, Vic. 3073. Phone 47-6680.

CELESTION Ditton 10 hi-fi speakers, teak cabinets, \$85 a pair. Sydney 524-7879.

FOR SALE

FREQUENCY meters, BC221 in original sealed cartons. Few left with AC/DC supply Inbuilt earphones, charts manual, spare valves \$70 cash. Advise transport. G. B. Lance, 123 Webster Street, Ballarat, 3350.

INTEGRATED radio circuit TAD100, \$5.86. Integrated output amplifier circuit TAA300, \$4.95. Post/pack any order, 10c. Send SAE for electronic catalogue. Hobipak, P.O. Box 224, Carlton South, Vic., 3053.

RESISTORS. Top grade, 5pc 1/4W and 1/2W types. Both 4c each or \$3 per 100. 1 ohm to 10M, 1W 7c or \$5.50 per 100. 5 ohm to 1M. We supply to your list. 10c pack/post any order. Kit-sets Aust. Box 176, P.O. Dee Why, N.S.W., 2099.

TAPE recording magazine, popular English monthly. Free introductory copy, send 9c S.A.E. to 5 Glover St., Willoughby, N.S.W. 2068.

TRANSISTOR bargains. This month only. New, marked and boxed AC128, BC108, BC109, OC44, OC71 and OC72 all 40c each. OC22, OC26, OC29, AD140 and AD149 all \$1.10 each. 10c post/pack any order. Kit-sets Aust., Box 176 P.O. Dee Why, N.S.W., 2099.

Classified Advertisers

For the January issue your advertisement must reach our office by December 5th, 1969. Please address your advertisement to the Advertising Manager, "Electronics Australia," Box 2728, G.P.O., Sydney, N.S.W. 2001.

COMPONENT specials, 2 1/2in 8 ohm speaker, \$1.20. 6in long ferrite rods, 45c each. Tag strips, 8-pln, \$1 per doz. OA81 diodes 17c. Alligator clips 10c each or \$1 per doz. All top quality, new. 10c pack/post any order. Kit-Sets Aust. Box 176, P.O., Dee Why, N.S.W., 2099.

POLYESTER Capacitors, 100V, 10pc tol. Ideal for P.C. board work miniature. New, top quality. .001, .0022, .0033, .0047, .0068, .01uF all 7c each. .022, 8c. .033, 9c. .047, 10c; .068, 11c; .08, 11c. .1uF, 12c. .22uF, 16c. .33uF, 20c. .47uF, 25c. 10c pack/post any order. Prompt service. Kit-Sets Aust. Box 176, P.O., Dee Why, N.S.W., 2099.

NEW OC71, 2N3658, 6 for \$2 or 50c ea. OC44, 45, 72, 84, BC108, 109, 2N5638A, AC128, 5 for \$2 or 50c ea. 2N3642, 3643, OC171, 2N370, 371, AF116N, 117N, BF115, 2N3694, AC127, 60c ea. Power types 2N176, \$1 ea. 2N301, \$1.20 ea. OC72, 29, 35, 36, \$1.50 ea. 2N3055, BDY20, \$1.80 ea. 40250, \$1.60 ea. OA210, EM404, 1N4004, 40c ea. OA211, BY100, EM410, 70c ea. UJT 2N2160, FET 2N4360, \$1.10 ea. MPF105, 2N5459, 90c ea. BA100, 25c ea. OA81, 85, 91, 95, 12 for \$2 or 20c ea. No S.A. Sales. Post and pack 15c. Custom Electronics, Box 1452, G.P.O., Adelaide, 5001.

ADC 10E MkII, Shure, M75E, etc. Special price also speakers, speaker kits, and all audio equipment. Quotations Sudana Products, P.O. Box 44, Turramurra, N.S.W. 2074.

FOR SALE

SELL all back issues "Electronics Australia" in stock at all times, 1939-63, 90c; 64 to date, 60c; post free. F. Welr, 56 O'Connor St., Haberfield, Sydney, N.S.W. 2045. Phone 798-7569. Wanted to buy copies also.

BARGAINS, 2N3055 \$1.80, matched pr. \$3.90. 2N3053 \$1.20, BC108-109 50c, BC107 65c. AD151/162 \$2.70, AC187/188 \$1.80. AC127/128 \$1.40, BF115 65c, OA91 25c. OC71-72-44-45-171, all 50c ea. MPF105 \$1.10. Sil diodes studs 6A 400V 60c. Min. types 1A 800V 60c. 1A 400V 40c. Ganged stereo pots \$70k + 470k log or lin, 47k 47k log \$2 ea. 470k log single 65c. Post 5c any order. Sorry no C.O.D. T & M. Electronics, Box 57, P.O., Haberfield, N.S.W. 2045.

BURGLAR ALARMS, 12V, 150uA transistor control units, \$12, plus 15 p.c. s.t. Unit on 4 x 2 plate and case, \$16, plus s.t. 4 1/2V rotary sirens, \$10.50. All above plus 60c p.t. and post. Foil tape terminals, mats, key switches, bells, reed switches, infra-red ray unit. Complete quote and installation service to insurance requirements. EDORE ENTERPRISES, P.O. Box 42, Doncaster, Vic. 3108.

PHILIPS TV power transformers, voltage doubler, \$7 ea. Also, Philips tuners with valves, new type AGO2643, \$5 ea. Electronic Developments and Service P./L., 12-16 Queen St. Chippendale, N.S.W., 69-5448.

CHANNEL Master "Telstar" transistorised aerial booster amplifiers, ideal for fringe or low signal areas, Channel Master automatic antenna rotators. Ideal where a number of channels are received from different directions. Excellent for the ham rig. \$40 ea. J. Alden, 21 Oxford St., Glen Innes, N.S.W. 2370.

READER SERVICE

ELECTRONIC ORGANS. Do not build yourself an organ without first finding out about the superb Schober (U.S.A.) Assemble-it-Yourself Kits. Inquiries to Schober Organs (Australia), 124 Livingstone Ave., Pymble, N.S.W. 2073. (Mail only, please.)

PRE-RECORDED TAPE hired to members of Australian Tape Recording Society, Bi-monthly release. "The Microphone" newspapers, round robins, sales, service, tape-sponding. Send Sc, 9ln x 4ln S.A.E. to ATRS, Box 9, P.O., Crow's Nest, N.S.W. 2065, or phone (2) 43-6681, after hours.

DUPLICATING, James E. Smith Duplicating Service for photostats, photo copies, electronic stencils, addressing service, extensive duplicating coverage. Customers wanted. P.O. Box 48, Albion, Qld. 4010. Phone 67-6612.

TRANSFORMERS wound. Output or mains and specials to orders. Reply with S.A.E. Paris Radio Electronics, 7a Burton St., Darlinghurst, N.S.W. 31-5273.

TOP quality discs from your tapes. Any quality, all sizes and speeds. We guarantee our work to comply with R.I.A.A. and A.B.C.B. standards. Enquiries welcome. Write for details A.A.V.R., 87a Mullens St., Balmain, 2041. Phone 82-5158, Sydney.

REPAIRS to receivers, transmitters, construction, testing; TV alignments; Xtal conv., specialised electronic equip. Eccleston Electrics, 146a Cotham Rd., Kew, Vic., 80-3777.

TAPE to disc service. Take advantage of W. and G. Records' professional experience when next needing a tape to disc service. W. and G. Record Processing Co., 195 A'Beckett Street, Melbourne, Tel. 329-7255.

TV PICTURE TUBES, Sure Brite Pty. Ltd., now at 52 King St, Newtown, N.S.W. Now the largest factory of its kind in N.S.W. Daily delivery Sydney, suburbs, and to railway station. Lowest prices in Sydney to the trade. Duds bought. Send all duds to Sydnam station freight paid. Customer sales rear of building. Phone 519-3403, 51-5928. Brisbane area: 1120 Oxley Rd., Oxley, 79-6828.

RADIO TV tape service, all spares available, trade discounts on parts. Amplifiers, microphones, Nichols Radio, 91 Wellington Street, Launceston, Tas.

WANTED

3-MOTOR tapedeck, drive motor synchro, without preamps or heads, State condition, price. P.O. Box 187, Gouburn, N.S.W.

INTEGRATED circuit Westinghouse W.C.183.T. or circuit diagram for same. Hilton, 10 St. James Ave., Mont Albert, Vic. 3172.

WANTED. Wanted all types of surplus or redundant stocks of electronic components and instruments. Manufacturers please forward lists or advise by phoning Sydney 337-3230. Will view and pay on spot. Electro Disposals.

HI-FI STEREO

It pays to get a DURATONE QUOTE on: SONY KENWOOD WHARFEDALE SANSUI DUAL LABCRAFT J.H. TANDBERG DYNACO QUAD PEERLESS SILCRON etc. etc. also LUX SOUND

MAIL ORDER: BOX 125, CURTIN, A.C.T.

CANBERRA. Phone 81-2549.

ANSWERS - continued

CRYSTAL SET AMPLIFIER: Have you published a one-valve amplifier for use with a crystal set? (R.W., Sebastopol, Victoria.)

● Chapter 10 of our "Basic Electronics" book contains details of crystal sets with both valve and transistor amplifiers. This chapter was originally published in our May, 1964, issue. Copies of this issue are available for 55c (including postage), or copies of the complete "Basic Electronics" are available for \$2.20 (including postage).

COLOUR TV: I am enclosing a clipping from the "Northern Territory Times" in which Mr Graham Warner, managing director of Electronic Industries Ltd., says that any new TV station erected at Darwin should be equipped for colour at the outset. Your comment would be interesting. (T.R., Darwin, N.T.)

● Colour equipment would cost more to purchase, install and setup than monochrome equipment and the difference might be more than could readily be absorbed in an economically borderline situation. Mr Warner is a TV colour optimist at the head of a big electronic empire. High initial outlay may look less forbidding to him than to someone on the spot who actually has to lay out the money. Another point is that, while 1971 has been tipped for colour, it would not necessarily be for other than the major capitals.

FUEL CELLS: Re the issue for September, p. 27 "Are Fuel Cells On The Way Out?" This is to be expected and may well be the case. There have been many attempts to produce fuel cells since before the turn

of the century when Jacques and Borchers hoped to get certain reactions from heated carbon electrodes. Their expectations were doomed to disappointment, however. But in a recent discovery, British research has shown a possible line of attack which has so far been overlooked. (E.C., Heidelberg, Vic.)

● As you probably have observed, there has been a spate of articles in the popular Press about fuel cells and fuel-cell powered cars "just around the corner." They were triggered off by reference to fuel cells in space vehicles, etc. In the face of this highly coloured material, it seemed relevant to publish the article which indicated that firms which should have been all keyed up were, in fact, quite pessimistic about the commercial future of fuel cells, as distinct from very specialised space applications. Presumably, the new line of attack you refer to must have come later than the conference which gave rise to the article, otherwise it would have produced a more optimistic note.

ALL-WAVE RECEIVER: Have you ever published a two or three transistor all-wave radio. I've often read in your magazine where reprints can be obtained for 20c. Is that just the circuit diagram or the whole article concerning the subject? If the former, what is the extra cost for the whole article? While writing, I must congratulate you on such an informative magazine. (C.J.H., East Corrimal, N.S.W.)

● Thank you for your comments, C.J.H., we try to keep everybody informed with the latest developments and also to help beginners to get started in the hobby or study of electronics. We published a two-transistor all-wave receiver in June, 1960.

CAPACITOR DISCHARGE IGNITION

(Continued from page 54)

All else being equal, it would seem preferable to mount any of these units on the inside of the mudguard, rather than the bulkhead. In such a position there is little chance that any unit, including the one referred to above, would create any audible noise in the car in any circumstances.

One final point concerns the reliability of these units and, more importantly, how easy it is for the normal ignition system to be restored. Although none of the units submitted were so fitted, at least two manufacturers have indicated that they plan to fit a changeover switch to future models, and this would seem to be a worthwhile provision.

Apart from this, all manufacturers point out that a change back to normal ignition is a very simple process, normally involving the changing of only two leads. This is true as far as it goes, and is fine for the driver-mechanic who is fully familiar with ignition systems in general and this one in particular. But what about his wife or daughter should the system fail when they are driving the car? Or, for that matter, what

about the mechanic who is called in to help in such an emergency?

It would seem to us that the least that should be done with any such unit is to provide an instruction plate, prominently displayed, worded as follows:

"AUTO ELECTRICIAN"

"In the event of failure of this unit, normal ignition may be restored by . . .", and giving a simple, detailed explanation of what leads should be changed. This should enable any mechanic, and most amateur mechanics, to get the engine running again in no more than a couple of minutes.

Which about sums it all up. We have tried to present as much information as we have been able to gather and sort out in the time available, and we have tried to be completely objective in our assessment of the individual units submitted to us and, from this, of capacitor discharge ignition as such. It will be up to the individual to decide whether what they offer to him is worth the cost involved.

(File No. 4/TR2/3.) We gave details of a three-transistor receiver using a FET detector in March, 1968 followed by an article in April converting this receiver to a plug-in all-wave version (File No. 4/TR3/3 and 4.) We can supply complete articles covering constructional projects published since December, 1959 inclusive (including those above) for the fee of 20c each. For earlier constructional projects, we can supply only the circuit diagrams and essential photographs and diagrams for the 20c fee. We can, however, supply complete articles for these earlier projects and other articles in photostat form for 20c per page. See the rules for the "Information Service" on the first page of this section.

NEW EQUIPMENT CABINETS



MODEL 192. Record storage or equipment cabinet. 36in wide, 21in high, 15½in deep, plus 9in legs.

Record bins: 14in high, 8½in wide. Horizontal shelf 5½in high. Features: Sliding doors, mitred corners, semi-square legs.

Price complete maple, teak, etc. \$57.60
Kit of parts (maple) \$31.50; teak \$6 extra. Packing \$1.00.

New Player Platform model 175 is 16in x 14in x 3½in. Price \$7.50 for maple or walnut. Kit of parts \$4.00. Teak, 50c extra. Perspex cover, 3½in or 5½in high, \$8.20 and \$1.50 extra if required hinged.
Please specify cut out required.



MODEL 186

New Player Cabinet model 186 is 9½in high, 16in wide, 16½in deep and 5½in above shelf. Finished with tinted perspex top. Price: \$22.00 for maple or walnut or teak.

Kit of Parts \$13.50.
Teak: \$1.00 extra (kits only)
Height of this model can be increased to take various amplifiers. Tailored cut out. Ask for quotation. F.O.R. Packing \$1.

Write for Catalogue and Player Guide

H. B. RADIO SALES

103-105 CATHERINE STREET,
LEICHHARDT, SYDNEY.
TELEPHONE 56-5580

STOP PRESS

Watch for Special
CLAYBRIDGE
Announcement in
December issue

SANSUI

AMPLIFIERS ARE POPULAR BECAUSE THEY OFFER GREATER PERFORMANCE AT A MODERATE COST.

For over a quarter of a century Sansui has been Japan's leading manufacturer of high quality stereo amplifiers . . . today this progressive company is recognised as a leading *international* manufacturer. Over 75% of Sansui's total production sells rapidly on world markets — irrevocable proof of the acceptance of Sansui quality and reliability.

Simon Gray proudly presents three of Sansui's best selling high fidelity solid state stereo amplifiers.

SANSUI MODEL

AU 222

— 46 WATTS

Using low noise silicon transistors throughout, the Model AU-222 features a frequency response of 20-30,000 Hz. ± 1 dB. and a power output of 46 watts (music power). Input sensitivity suits magnetic cartridges at 2 mV. Performance of this compact stereo amplifier is quite outstanding and every desirable control is incorporated. List price is \$180 inc. sales tax.



SANSUI MODEL

AU 555

— 60 WATTS

Total music power is 60 watts and frequency response is 20-80,000 Hz ± 1 dB. Input sensitivity suits magnetic cartridges at 2 mV. Advanced circuitry is employed — low noise silicon transistors are used throughout. Controls are extremely flexible — audio quality is superb. List price is \$217 inc. sales tax.

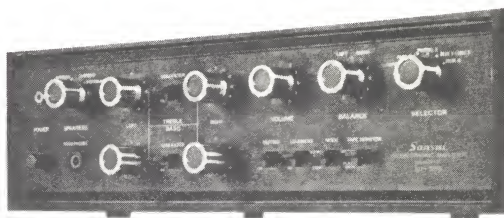

THE NEW
SANSUI MODEL

AU 777A

— 70 WATTS

An extremely fine, all silicon transistor, stereo amplifier with a frequency response of 20-100,000 Hz ± 1 dB. at normal listening levels. Power output is 70 watts (music power) and input sensitivity suits magnetic cartridges at 2 mV. All desirable controls are incorporated. Price is \$321 inc. sales tax.

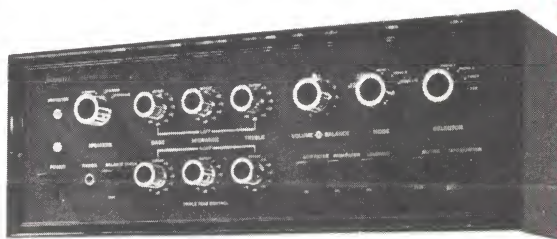

Every Sansui amplifier has many unique advanced features and offers flexibility and control unsurpassed in its price range. We invite you to see your nearest Sansui amplifier supplier and listen to these fine amplifiers. Ask for complete unabridged specifications. Examine the construction of Sansui equipment closely — engineering and electronics reflect Sansui's quality control in manufacture. Above all, listen. Hear the extraordinary difference Sansui quality makes!

SGS 10/69



Australian National Distributors:

Simon Gray Pty. Ltd.

Head Office: 28 Elizabeth St., Melbourne, Vic. Tel. 63 8101*
Sydney Office: 22 Ridge St., North Sydney, N.S.W. 929 6816
Canberra Office: 31-33 London Circuit, Canberra City, A.C.T. Tel. 49 6050

INTERSTATE REPRESENTATIVES:

N.T.: Pflitzner's Music House, Smith Street, Darwin. Tel. 3801
Q'land: Sydney G. Hughes, 154-158 Arthur St., New Farm, Brisbane. 58 1422
S.A.: Eilco Sales Pty. Ltd., 7-9 Osmond Terrace, Norwood, S.A. Tel. 63 4844
Tas.: K. W. McCulloch Pty. Ltd., 57 George Street, Launceston. Tel. 2 5322
W.A.: Athol M. Hill, 613-615 Wellington Street, Perth. Tel. 21 7861

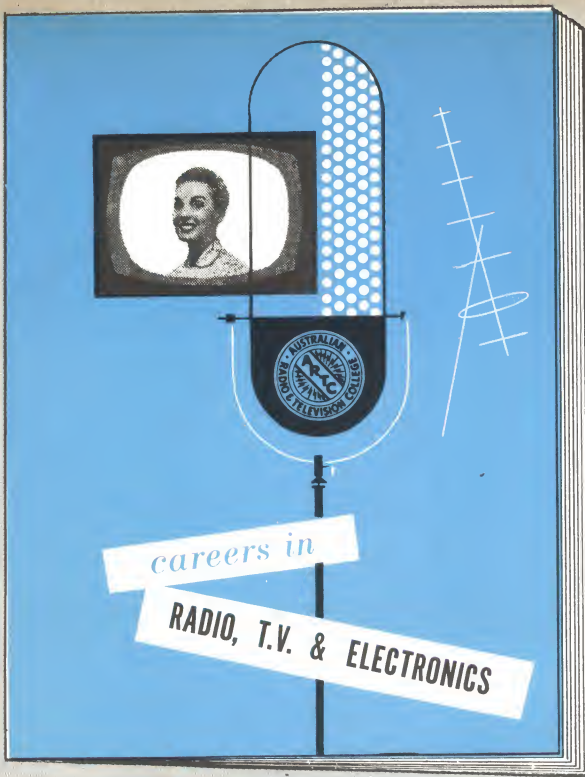

THIS FREE BOOK COULD BE THE TURNING POINT IN YOUR CAREER

ASK YOURSELF THESE 3 QUESTIONS

1. Am I in a dead-end job?
2. Can I use my spare time to get ahead?
3. Am I capable of earning more money?

If the answer is yes, there is room for you in radio-television. Does your job really offer security — worthwhile prospects? If not, now is the time to do something about it. Send the coupon below for the free booklet "Careers in Radio, TV & Electronics" which shows you just how A.R.T.C. training can help you to a bright future with good prospects.

TRAIN AT HOME OR AT THE COLLEGE

With A.R.T.C. you can obtain the training you need at the benches and lecture halls of Australian Radio and Television College or in your own home by correspondence . . . you can be taught every important aspect of radio-television, details of the fundamental principles of Electronics.

GET INTO ONE OF THESE PROFITABLE CAREERS IN RADIO/TELEVISION

There is a profitable career for you in the many phases of radio-television including manufacturing, radio servicing, television servicing, research, sales, broadcasting and television executive, armed forces. A.R.T.C. can help you gain one of these much-sought-after positions, but remember, it is only the trained men who succeed and A.R.T.C. can give you the complete training which is necessary for success in Electronics.

Make Spare-Time Money

If you wish, you can make your spare time earn money for you by training at home and many students make extra money after only the first few weeks. However, if it is not convenient for you to train at home, then you may use the modern A.R.T.C. workshops. The course is intensely practical and individual. Safeguard your future . . . mail the coupon today.

A.R.T.C. CAN TRAIN YOU AS IT HAS THOUSANDS OF OTHERS!

Thousands of ambitious men have realised the benefits offered by A.R.T.C. training and are now making money in radio. You can join the ranks of the skilled men. . . and it costs only pence a day.

MAIL COUPON NOW

You are invited to mail the coupon below which can be your first step towards securing a job or business of your own with good prospects, security and big money. A.R.T.C. will mail to you, by return, at no obligation to you, the big free booklet "Careers in Radio TV & Electronics." This booklet will show you definite steps you can take for a better job . . . how you can succeed in life. Post the coupon, phone or call NOW.

AUSTRALIAN RADIO AND TELEVISION COLLEGE PTY. LTD.

E. S. & A. BANK BUILDING,

Cnr. Broadway and City Road, Sydney.
(Opp. Grace Bros.) Phone 211-4244 (3 lines.)



AUSTRALIAN RADIO & TELEVISION COLLEGE PTY. LTD.,

206 Broadway, Sydney, N.S.W.

Dear Sir,

Please send me, without obligation, your free booklet, "Careers in Radio, TV and Electronics."

NAME

ADDRESS