

ELECTRONICS

Australia

October, 1969



40¢

"Radio-controlled" lions at Warragamba, N.S.W.

LIGHTS RESPOND TO MUSIC ● "TALKING" LASER BEAM
FM IN NEW ZEALAND? ● TREASURE LOCATORS DEBUNKED



NATIONAL CASSETTE RECORDERS

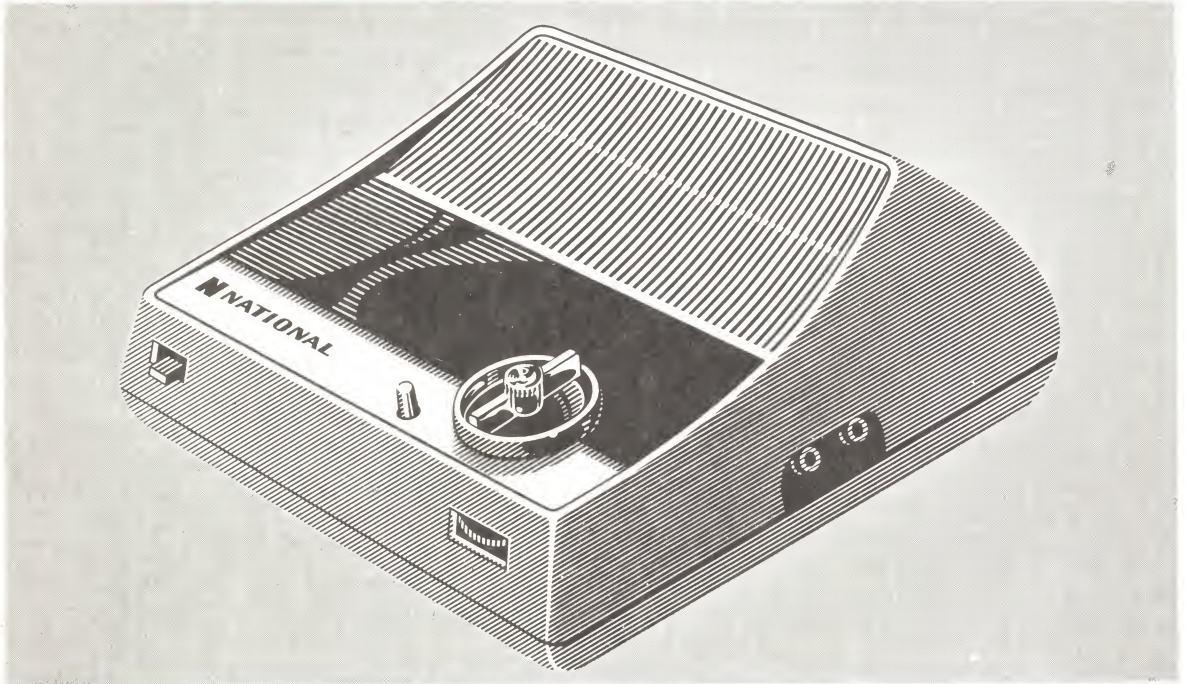

Meet the performance giants — up to 3 watts from brilliant new circuits!

National cassette recorders outperform and out-feature the field. With highly advanced circuits, (including IC in the incredible mini-model) plus automatic volume control*, you can get a National cassette recorder to suit you exactly — including models with dual power! Here's the line-up . . .

Illustrated above:

RQ205S
1.6W music power. 7 solid-state devices. Battery op. 8 $\frac{1}{2}$ " x 4" x 9 $\frac{1}{4}$ ". (Available in Red or Cream).



RQ219S
2W music power. 9 s/s devices. Battery op. 5 $\frac{1}{2}$ " x 2 $\frac{3}{4}$ " x 10 $\frac{1}{4}$ ".



RF7270
Car radio/cassette portable. 3W music power. 27 s/s devices. 10 $\frac{3}{8}$ " x 10 $\frac{1}{4}$ " x 3 $\frac{3}{8}$ ".

* All models except RF7270



RQ203S
2.5W music power. 7 solid-state devices. Dual power. 9 $\frac{5}{8}$ " x 3" x 9 $\frac{1}{4}$ ".



RQ210S
600mW music power. 9 s/s devices. (Integrated Circuits). Battery op. 3 $\frac{1}{2}$ " x 6 $\frac{3}{8}$ " x 1 $\frac{7}{8}$ ".



RQ230S
2.5W music power. 10 s/s devices. Has a.m. radio, dual power. 10 $\frac{5}{8}$ " x 2 $\frac{3}{4}$ " x 8 $\frac{5}{8}$ ".



RQ204S
1.6W music power. 6 solid-state devices. Battery op. 8 $\frac{5}{8}$ " x 2 $\frac{3}{4}$ " x 10 $\frac{5}{8}$ ".



**SEND COUPON
FOR FREE INFORMATION TO:**

HACO DISTRIBUTING AGENCIES PTY. LIMITED
57/69 Anzac Parade, Kensington, N.S.W. 2033.

NAME.....

ADDRESS.....

.....POSTCODE.....

S669



ELECTRONICS Australia

incorporating RADIO, TELEVISION and HOBBIES

ABC certified circulation in excess of 47,000

volume 31, number 7

AIRPORT NOISE: *Do pilots using Australian airports disregard noise problems? New equipment could answer this question positively and pin-point the actual offenders — if any. (Page 16.)*

MUSICOLOUR UNIT: *On a small scale, it can be used in the home with a stereogram. Pop groups can arrange it to provide a full psychedelic display on stage. It may have a therapeutic application in aiding the deaf to speak. (Page 70).*

SINGLE SIDEBAND IN 1925: SSB — “duck-talk” to amateurs — is a system that is only now taking over in the communications scene. But they had SSB working across the Atlantic in 1925. “Pages From The Past”. (Page 83).

THICK TAPE OR THIN TAPE? *There have been many arguments in tape recorder circles as to whether thin tape gives a better treble response than thick tape. An article on page 108 suggests that it is a matter of head design, tape speed, and the system of bias used.*

Editorial Office:
12th Floor, 235-243 Jones Street,
Broadway, Sydney, Australia.
Phone 2-0944.

Postal Address:
Box 2728, G.P.O., Sydney, 2001, Australia.

Advertising:
Manager, Selwyn Sayers,
Sales Exec., Howard Jenkins
Sydney Representative, Bill Summons.
Office: 8th Floor, 235-243 Jones Street,
Broadway, Sydney. Phone 2-0944.
Melbourne Representative, Clarrie Levy.
Office: 392 Little Collins Street,
Melbourne, 3000. Phone 67-8131.

Circulation:
Alan Parker, Manager.
Office: 9th Floor, 235-243 Jones Street,
Broadway, Sydney. Phone 2-0944.

Subscription Rates: See back page.

Representation:
Melbourne—John Fairfax and Sons Ltd., 392 Little
Collins Street, 3000. Phone 67-8131.

Brisbane—Sungravure Pty. Ltd., 78 Elizabeth Street,
4000. Phone 2-6688.

Adelaide—John Fairfax and Sons Ltd., 104 Currie Street,
5000. Phone 51-3502.

Perth—Sungravure Pty. Ltd., 454 Murray Street, 6000.
Phone 21-8217.

Newcastle, N.S.W.—Associated Newspapers Ltd., 22
Bolton Street, 2300. Phone 2-3696.

London—John Fairfax and Sons (Aust.) Ltd., Reuter
Building, 85 Fleet Street.

New York—The Sydney Morning Herald Ltd., 1501
Broadway, New York, N.Y., 10036.

Distribution:
Distributed in N.S.W. by Sungravure Pty. Ltd., Jones
Street, Broadway, Sydney, N.S.W.; in Victoria by Sun-
gravure Pty. Ltd., 392 Little Collins Street, Melbourne;
in South Australia by Sungravure Pty. Ltd., 104 Currie
Street, Adelaide; in Western Australia by Western Press;
in Queensland by Gordon and Gotch (A'sia) Ltd.; in
New Zealand by Truth (N.Z.) Ltd.; in Tasmania by
Davies Bros. Ltd., “Mercury,” Hobart.

Copyright. All rights reserved.
Devices or arrangements shown or described herein may
embody patents. Information is furnished without re-
sponsibility for its use and without prejudice to patent
rights.

CONTENTS — OCTOBER, 1969

features

- 3 Editorial—colour for \$80
- 10 Developments in radio astronomy
- 15 Proposed TV centre 850ft above Sydney
- 16 Computer monitors airport noise
- 18 N.Z. inquiry into FM broadcasting
- 21 Dual purpose converter/teaching aid
- 23 Keeping other planets free of earth germs
- 24 Studying the Martian environment

technical digest

- 27 Closed circuit TV in mine drama
- 29 Erasing holograms magnetically
- 31 Miniature TV camera as artificial eye

technical articles

- 40 Fixed tuned converter for aircraft beacons
- 45 Gas laser for light-beam communication
- 49 Ceramic resonators, Part 2
- 53 Fundamentals of solid state, Chapter 6
- 67 Audio system for solid-state receiver
- 70 Sound control of coloured lights
- 81 Heavy duty line filter
- 83 Single-sideband in 1925 (historical)
- 98 Transistorised burglar alarm

regular features

- 33 Scientific and industrial news
- 88 Forum
- 92 Serviceman
- 95 Radio: unofficial history
- 105 Reader built it
- 108 Audio topics—cross-field bias
- 116 Record reviews—classical
- 121 Record reviews—documentary
- 125 Record reviews—devotional, popular, jazz
- 140 Trade reviews and releases
- 153 Technical books and publications
- 161 Amateur band news and notes
- 173 Listening around the world
- 181 Answers to correspondents
- 190 Market place—classified adverts.
- 192 Index to advertisers
- 69 Notes and errata

We proved Philips Fine Wire Bulk Packs save you time and money in 12 different ways.

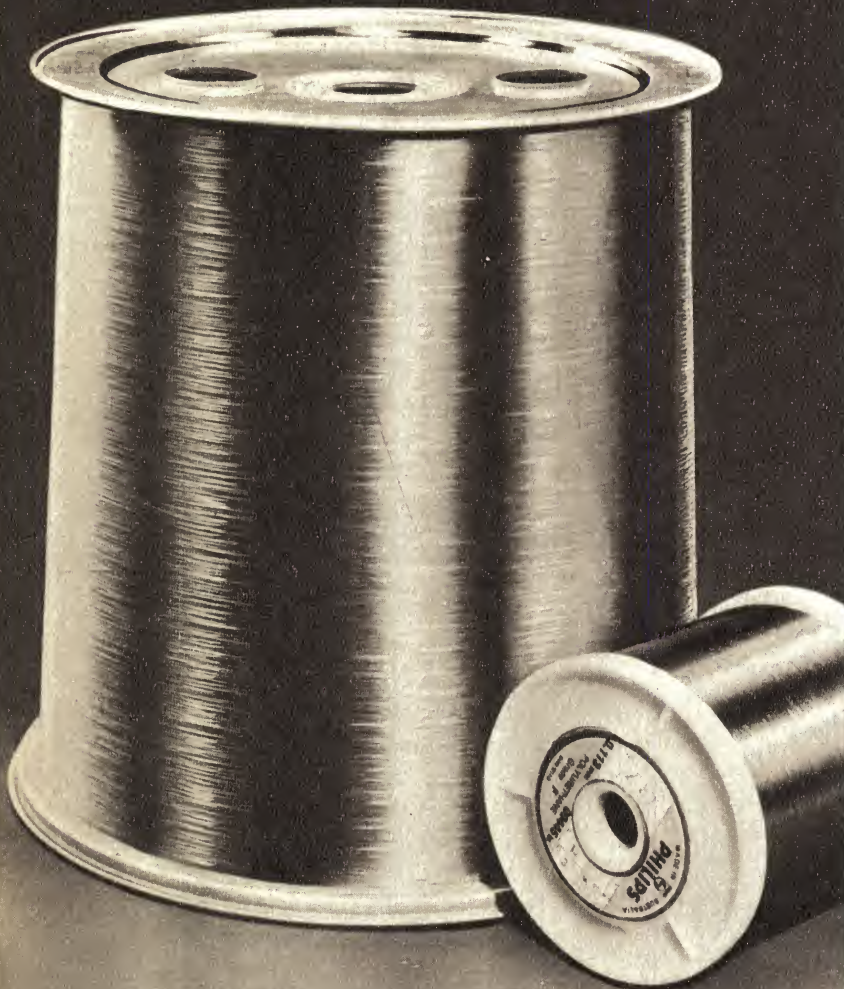

We made test runs winding sixteen coils to a "stick" with a standard Leeson Multi-winding machine to demonstrate the efficiency and economy of Philips Fine Wire Bulk Packs over conventional spooling. These are the results:

- Almost unlimited take-off speed.
- Virtually unlimited take-off acceleration rate.
- No over-run on rapid stops.
- Constant wire tension from "full" to "empty".
- Five to seven times the weight of wire as on conventional spooling.
- One continuous length of wire in each Bulk Pack.
- Handling costs lowered.
- Reduced number of joins and machine stops.
- Down time for spool changing considerably improved (machine dead-time decreased by some 7½%).
- Greatly reduced short-end wire wastage.
- Simpler tensioning devices means fewer adjustments.
- Better winding space factor and more uniform windings.

We can now supply wire as fine as 0.080 mm. on Bulk Packs. If you want more information (and even more ways we can save you money) contact:

"Miniwatt"

ELECTRONICS DIVISION OF PHILIPS
ELECTRICAL PTY. LIMITED

Sydney • Melbourne • Adelaide
• Perth • Canberra • Brisbane.



EDITORIAL VIEWPOINT

by Neville Williams

Colour for \$80 . . .

It is perhaps not surprising that, with heightened interest in colour television, there should be a flush of tall stories to match. The "best" effort to date comes from Queensland. It concerns a visitor to the Royal Brisbane Show, who had a long conversation with someone there allegedly concerned with a colour television display. The visitor was informed that a standard black-and-white receiver could be converted to colour for about \$80, provided it was not more than a couple of years old. The matter did not rest there. I quote from a letter which the conversation inspired:

"I would like to see this gone into fully as TV repair firms will certainly take advantage of the gullibility of the public and their lack of knowledge of such matters. They will exploit the situation to the full. The public should be told the real cost of such a changeover (\$80) and the oldest that a set can be to be changed over successfully."

I have no reason to doubt the sincerity of the writer, a member of our own Company's printing staff. Then what kind of a person would have volunteered this misinformation and inspired this kind of suspicion?

In fact, a three-colour picture tube alone is likely to cost two or three times the \$80 mentioned. To this would have to be added an expensive yoke, totally new deflection circuitry and E.H.T., plus mounting hardware, alignment magnets etc. In the chassis proper, a maze of colour sensing circuitry would be needed, terminating in three-channel video drive. The cost of parts alone would have to be reckoned in hundreds of dollars.

Whether all these new or additional components could be accommodated physically in an existing chassis is a pertinent question but, even assuming that they could, the labour cost for virtually rebuilding a receiver would be enormous. The total would almost certainly exceed the cost of a new, mass-produced colour set.

It is just possible, of course, that the conversation might have been misunderstood by the correspondent and that his informant was really trying to say that monochrome receivers could be up-dated to produce good quality black-and-white pictures from colour programs, free from spurious patterns due to beats between picture, sound and colour information; that modifications and readjustment might cost up to \$80, being therefore not warranted on other than fairly new receivers.

This isn't as preposterous as the idea of converting to colour reproduction but we would hope that it isn't borne out in practice either. As we mentioned last month, tests in Sydney and Melbourne have revealed no tendency to malfunction on the part of typical Australian-made receivers, either old or new. Nothing has emerged to support the idea that viewers will be involved in costly modifications to their present receivers.

If the informant was, in fact, talking about compatibility, one must question the source of his information. If he was talking about conversion to colour, then he was talking rubbish!

EDITOR

Neville Williams
M.I.R.E.E. (Aust.)
(VK2XV)

ASSISTANT EDITOR

Philip Watson
A.M.I.R.E.E. (Aust.)
(VK2ZPW)

TECHNICAL EDITOR

Jamieson Rowe
B.A. (Syd.)
B.Sc. (Tech., N.S.W.)
M.I.R.E.E. (Aust.)

TECHNICAL STAFF

Ian Pogson (VK2AZN)

Harry Tyrer (VK2ZHH)

Anthony Leo (VK2ZHK)

John Horsfield

Robert Flynn

Leo Simpson

ON SALE

THE

FIRST MONDAY

OF EACH MONTH

On the cover

We took a fancy to this picture showing a couple of the lions at Sydney's Lion Park, adjacent to the Warragamba storage dam. Our excuse for using it on our front cover is that the patrol vehicles, as shown, are fitted with a VHF radiotelephone system manufactured by Philips Telecommunications of Australia Ltd. Close supervision is necessary, not only to protect visitors to the park but to prevent cannibalism amongst the lions, each valued at about \$1,000.

Broadway Electronics introduces the new

INSTROL HI-FI

the largest HI-FI showroom in Australia.

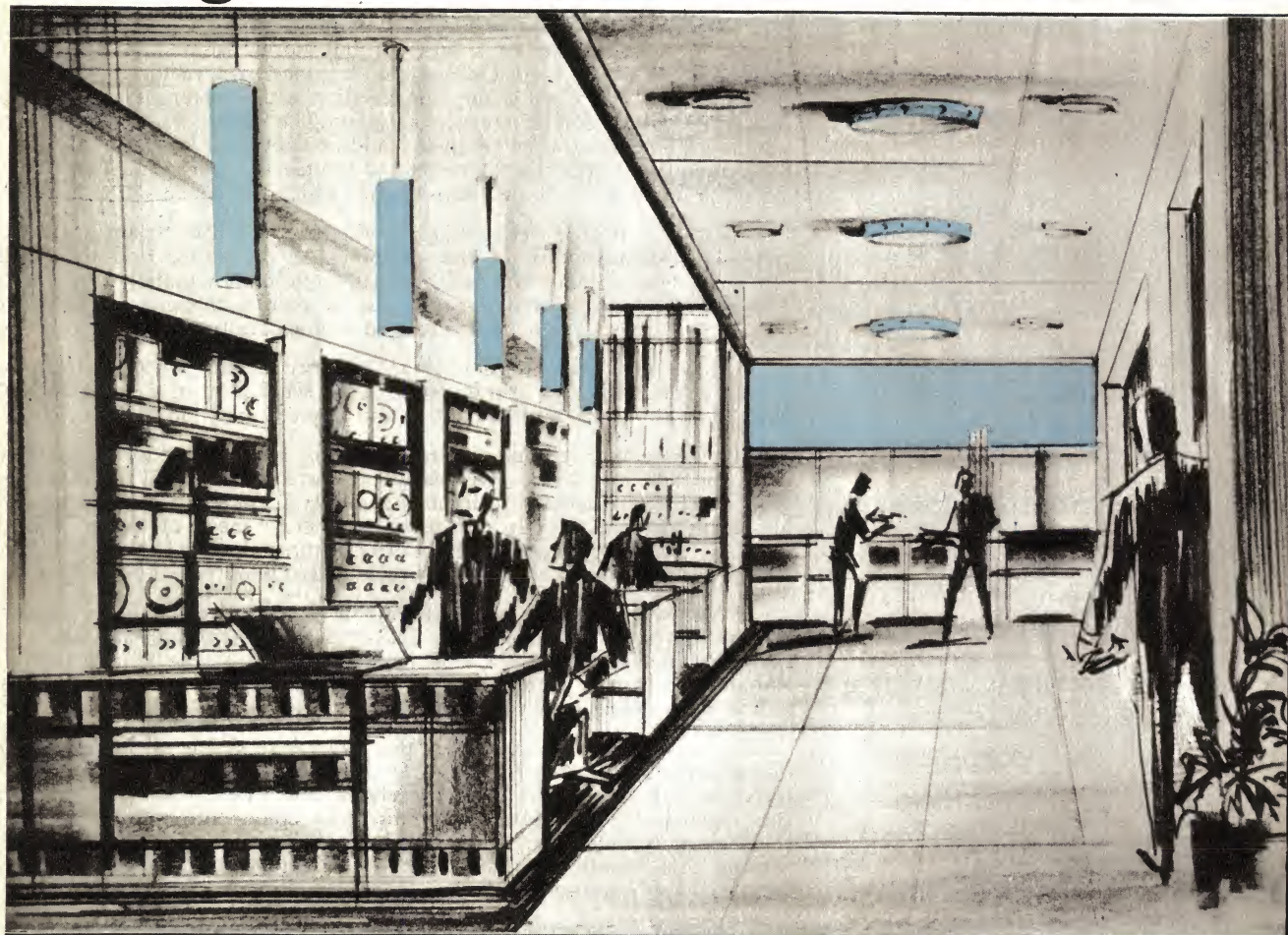

A visit to the new Instrol Centre is an experience that will satisfy the most critical hi-fi enthusiast.

Hi-Fi, Accessories, Tape Recorders, Furniture in fact the ultimate range available in one large modern Showroom.

For those readers who are at present unable to see this exciting display for themselves, we suggest you ask for our free descriptive and illustrated Cabinet Catalogue, or our Hi-Fi Catalogue.

The Instrol Hi-Fi Centre includes the largest possible range of Hi-Fi furniture –

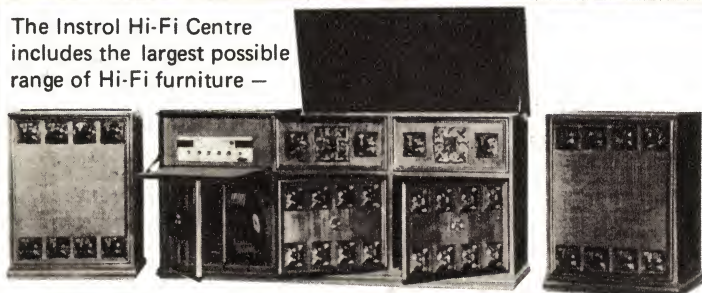

over 50 different cabinets and enclosures are on display. Should you be unable to visit our new exciting Showroom, ask for our free descriptive Cabinet Catalogue. (Pictured above is the new "Flamenco" Setting).

for descriptive leaflet post coupon

Please include postage stamp.

Name _____

Address _____

Postcode _____

Instrol Cabinets Hi-Fi Equipment

INSTROL
HI-FI CENTRE
 91^a York St. (between King & Market St.)

CENTRE

91a York St. (between King & Market St.)



Wharfedale Unit-3, Goodmans Sherwood, Leak Sandwich. Just some of the magnitude of speaker systems on display. All major brands, including Wharfedale, Goodmans, Instrol, Playmaster, Magnavox, Leak, Pioneer, etc.



The new DUAL 1200 series Turntables are being demonstrated at our exciting new centre. Full range of other players also on display.

At last . . . A Tape Recorder Centre, with trained personnel, to serve you. Choose from our wide range of Sony, Akai, Tandberg, etc. . All available for demonstration at the new Instrol Hi-Fi and Tape Recorder Centre.



The Kenwood TK 250U — one of many Stereo Amplifiers being demonstrated. Perhaps you prefer something more elaborate, such as the Kenwood KA6000, Sansui AU777 or Leak Stereo 70. Whatever you desire in Amplifiers or Tuners, our new Showroom will satisfy.

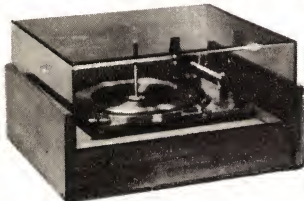

The Instrol range includes a wide variety of Player Stands and combination Amplifier-Player Cabinets. High quality perspex covers (clear and tinted) are also available, some hinged, others separate. In addition to our standard range, we can supply cabinets and perspex covers to your individual specifications. Grill cloth, innerbond, stylii, recording tape . . . in fact all accessories are available ex stock.

You would never believe that so much Hi-Fidelity equipment was in existence until you visit our New Instrol Centre. All leading brands of Tape Recorders, Turntables, Amplifiers and Speakers, as well as the full range of famous Instrol Hi-Fi furniture — all on display and demonstration under one roof. Pictured here is the Instrol "Queen Anne" Hi-Fi Setting.

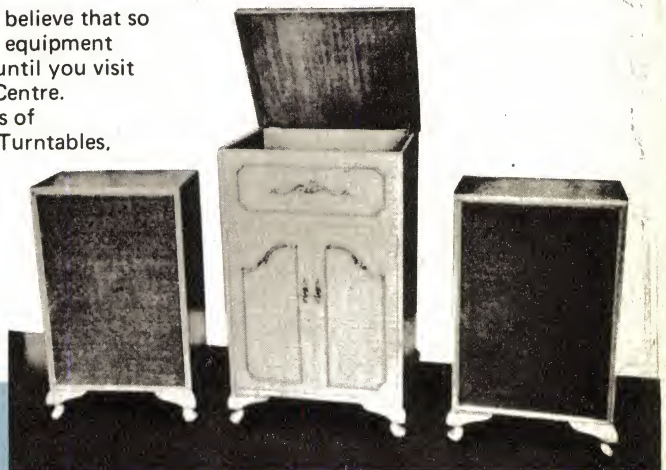



Goldring

Trendsetters in sound equipment

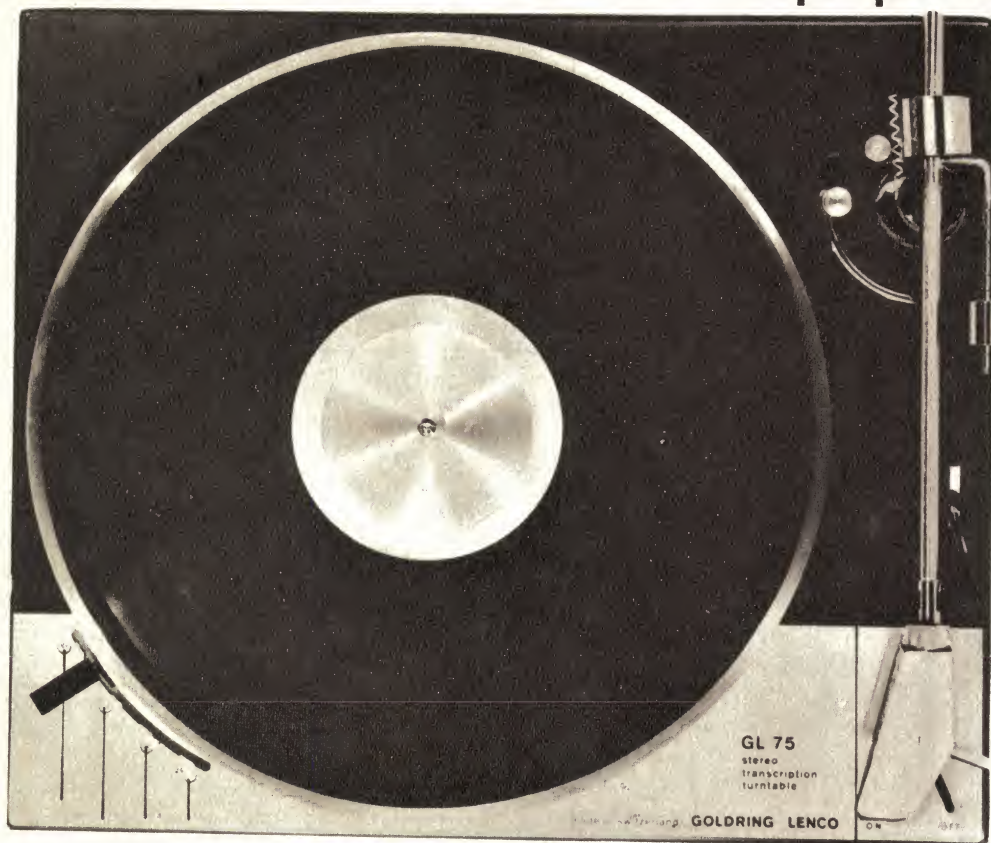

Latest release, Swiss made precision transcription unit GL75

Integrated transcription motor unit and arm, built to instrument standards of quality and appearance. The drive system is the unique Goldring-Lenco constant velocity 4-pole motor with conical shaft coupled to the underside of the turntable by a knife-edged idler (automatically disengaged by the on/off switch, which is fully click-suppressed and also operates a turntable brake). The turntable is die-cast from non-ferrous material, weighs 9 lb and is dynamically balanced. Speed is continuously variable from

86-30 rpm and from 18-15 rpm with adjustable positive stops for the four standard playing speeds. There is only 0.2% change of speed for 10% mains voltage change.

The transcription arm is the Goldring-Lenco L75 with knife-edge bearings, full balancing facilities, calibrated stylus pressure adjustment, and 'anti-skating' bias compensation. It is lowered hydraulically by a lever fitted to the deck plate. Shock-damping mountings are supplied with the unit.



Goldring '800' series free field stereo cartridge

800: In this cartridge a very lightweight tube of magnetic material lies in a "free field" generated by a fixed source coupled to a low mass diamond point. It features low mechanical impedance (tracks at 1 to 3 grams), screening from external hum fields, gold-plated contacts. Stylus is replaceable. Rivals finest in the world. Frequency response 20-20 kHz, compliance 20×10^{-6} .

800E: Using the same cartridge body as the standard model, an elliptical diamond stylus is fitted. Compliance is substantially increased resulting in brilliant linear, resonant free, performance. Frequency response 20-20 kHz, compliance 30×10^{-6} .

GOLDRING ENGINEERING (AUSTRALASIA) PTY. LTD.

N.S.W.: 443 Kent Street, Sydney. 29 1275. Vic.: 162 Pelham Street, Carlton. 34 5105. Qld.: 415 Adelaide Street, Brisbane. 2 3247. W.A.: 32 Northwood Street, Leederville. 8 4988. S.A.: Ernsmith, 77 Wright Street, Adelaide. 51 5117.

From the ever-widening range of hi-fi equipment available from Goldring.

There's an AIWA microphone to solve your recording problem.

AIWA DM.57 DYNAMIC MICROPHONE—Impedance: 60 and 50K. Frequency Response: 100-13,000 cps. Sensitivity: 75 db's. Dimensions: 7½" x 1½". Weight: 14 ozs. **\$18.50**

AIWA DM.17 OMNI-DIRECTIONAL DYNAMIC BOOM MICROPHONE—Impedance: 50K or 50Ω. Frequency Response: 70-14,000 cps. Sensitivity: 75 db's. Dimensions: 5½" x 1½". Weight: 10½ ozs. **\$18.50**

AIWA DM.51 DYNAMIC MICROPHONE. Impedance: 50Ω or 50KΩ. Frequency Response: 50-15,000 cps. Sensitivity: 55 db's. Dimensions: 10" x 1½". Weight: 29 ozs. **\$27.00**

AIWA DYNAMIC NON-DIRECTIONAL MICROPHONE DM.13—Impedance: 50K or 50Ω. Frequency Response: 60 c's-14,000 cps. Sensitivity: 55 db's. Dimensions: Length 10½". Weight: 18½ ozs. **\$29.00**

AIWA UNI-DIRECTIONAL DYNAMIC MICROPHONE DM.47—Impedance: 50Ω or 50K. Frequency Response: 40-18,000 cps. Sensitivity: 75 db's. Dimensions: 5½" x 1½". Weight: 18 ozs. with cord. **\$36.00**

AIWA DM.10 DYNAMIC DESK MICROPHONE—Impedance: 50KΩ or 50Ω. Frequency Response: 60-13 Kc's. Sensitivity: 75 db's. Dimensions: 7¼" x 1½". Weight: 11 ozs. without stand. **\$16.80**

AIWA DM.14 DYNAMIC MICROPHONE—Impedance: 50Ω or 50K. Frequency Response: 90 c's-14,000 cps. Sensitivity: 75 db's. Dimensions: 3¼" x 1½". Wt. 10 ozs. **\$12.50**

AIWA DM.67 CARDIOD DYNAMIC MICROPHONE — Impedance 50Ω or 50 KΩ. Frequency response 100 > 12000 CPS with 15 dB. Front to rear separation. Sensitivity: 74 dB. Dimensions: 5½" x 2" max. Weight: 8 ozs. **\$33.00**

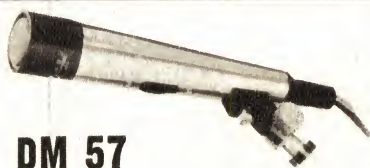

DM 57



DM 17



DM 51



DM 13



DM 10



DM 47



DM 67



DM 14



Distributed by:
GOLDRING
ENGINEERING (A'ASIA) PTY. LTD.

N.S.W.: 443 Kent St., Sydney, 2000. 29-1275.
VIC.: 162 Pelham St., Carlton, Vic. 3053. 67-1197.
QLD.: 415 Adelaide St., Brisbane, Qld. 4000. 23247.
W.A.: 32 Northwood St., Perth, W.A. 6007. 84988.
S.A.: 77 Wright St., Adelaide. 5000. 51-5117.

GE:P345

Whether requirements call for or an entire stereo system,

Choosing the right component is as easy as selecting one of these three professional control amplifiers from Sansui—the 70 watt AU-777, 60 watt AU-555 or 46 watt AU-222.

They look professional. They perform that way, too. With wider power bandwidths, lower distortion factors, independent pre- and main amplifier sections, two phono inputs, and controls designed to get the best out of the most extensive audio system.

Ask your nearest authorized Sansui dealer for a personal demonstration soon.

AU-777 70 watts. Power Bandwidth: 20 to 50,000Hz. Distortion: less than 0.5%. Channel Separation: better than 50dB.

AU-555 60 watts. Power Bandwidth: 20 to 30,000Hz. Distortion: less than 0.5%. Channel Separation: better than 50dB.

AU-222 46 watts. Power Bandwidth: 20 to 20,000Hz. Distortion: less than 0.8%. Channel Separation: better than 50dB.

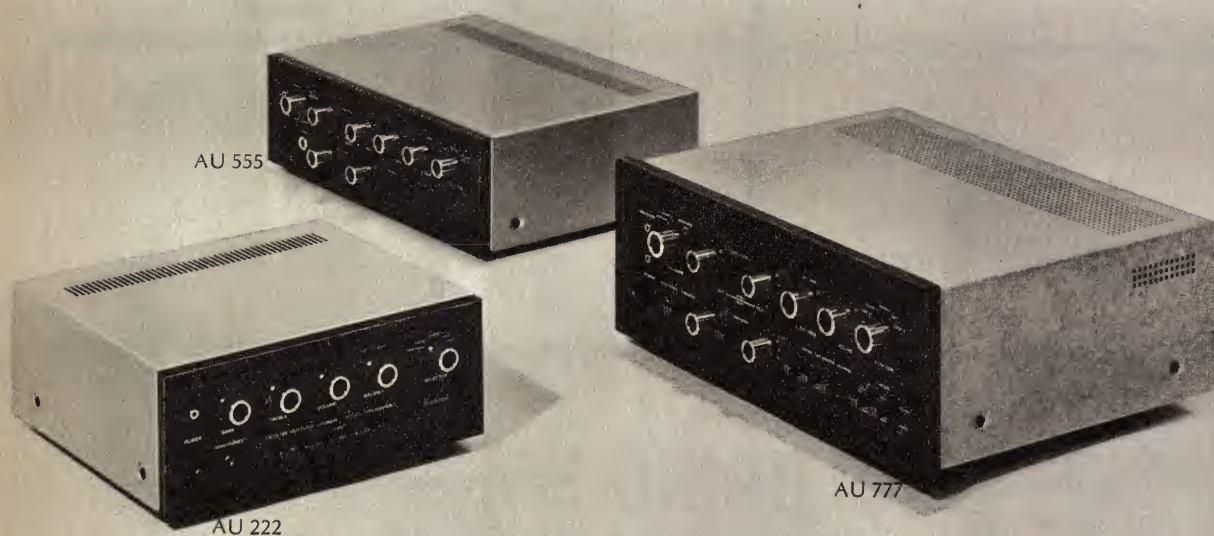

AU 555

AU 222

AU 777

your stereo a single component Sansui fills them better.

Choosing the right system is as easy as selecting this matching set of Sansui components.

The 36 watt solid state Sansui 300 AM/FM Multiplex Stereo Tuner Amplifier forms the heart. It features an advanced FET frontend for top FM sensitivity and selectivity, a wide 30 to 25,000Hz power bandwidth and less than 1% in distortion.

Next comes the rich-sounding SP-50 2-way 2-speaker system. It combines a quality 8-inch woofer with a 2-inch horn tweeter in Sansui's unique pipe-duct bass reflex enclosure for 50 to 20,000Hz in frequency response. Handles up to 25 watts in input.

Sansui's precision SR-2020BC 2-speed manual turntable opens a whole new world of quality in stereo record reproduction. Helping to make this possible is an accurate 4-pole synchronous motor, direct belt-drive system, static-balanced tubular tonearm, induced magnet cartridge and diamond stylus.

For private listening or monitoring, the Sansui SS-2 moving-coil stereo headphone set brings a new kind of sound purity and comfort to the stereo enthusiast. Frequency response is from 20 to 18,000 Hz and distortion is less than 1% at 1mW input.

Whether your stereo requirements call for a single component or fully compatible stereo system, your Sansui dealer can help you fill them better.



WANTED—a radio telescope on Mars

Radio astronomy has taken another big step forward with the establishment of a system with a 5,000-mile baseline, by using in combination existing radio telescopes in the U.S.A. and Sweden.

By Jorma Hyypia

(Reprinted by arrangement with "Elementary Electronics")



in mind—to measure more accurately the size and distance from earth of those objects in interstellar space that generate radio signals. As we shall see, the accuracy of measurement is related directly to the size of the baseline established for the measuring system.

Radio astronomers have been considering the establishment of such systems for years, in view of the need for the best possible angular resolution when studying radio signals from space. Initially, baselines of a few hundred yards were established, but the limitations of such systems were too severe for really accurate work. The only feasible solution was to lengthen the baseline, so that, with the two base points as far apart as possible, the triangle formed by the lines of reception of the antennas and the distance between them would allow a more precisely defined angle of interception of the triangle's arms. This allows the point of interception to be more precisely determined, and more accurate measurements to be made.

Although the value of the long baseline for radio astronomy has been recognised for many years, only recently has the establishment of such a system become a practical reality. The snag has been the virtual impossibility of synchronising and correlating in time relationship the two separate sets of information recorded at the two widely separated points with the high order of accuracy essential for the operation. Without this order of accuracy, the data obtained could not be combined and compared with the precision necessary for reliable interpretation.

Before considering in detail the U.S.A./Sweden system, let us consider the relative merits and disadvantages of optical and radio telescopes.

The principal function of a radio telescope is to collect and concentrate weak electromagnetic energy from outer space to permit detection and measurement. Ideally, a telescope of either kind (radio or optical) should collect energy from one direction while rejecting stray waves coming from other directions. This is anything but easy to accomplish.

In optical telescopes, light diffraction creates a blurring effect which distorts images; points of light—those of distant stars, for example—are imaged as tiny discs of light rather than what they really are. If two stars are very close together, their disc images may merge to such a degree that two stars appear as a single source of light. The ability of an optical telescope to separate such close objects and reveal them in the form of distinct, separate images is called the resolving power of the telescope.

In either an optical or radio telescope, the theoretical limit of resolving or "image-splitting" power is dependent

The C.S.I.R.O.'s radio telescope at Parkes, N.S.W., which could be used in the type of experiment described in this article.

on two basic factors; the size of the collecting element (lens, mirror, or antenna) and the wavelength of the light or radio energy received. The larger the collector, and the shorter the wavelength, the better the resolving power of the instrument.

Radio telescopes are hampered even more by wave diffraction than are optical telescopes because radio wavelengths are from ten thousand to ten million times longer than light waves. Thus, a radio telescope having an antenna of 200in diameter cannot possibly exhibit angular resolution comparable to that obtained with an optical telescope having a mirror of the same dimensions.

To take a concrete example, the wavelength of light in the yellow-green (maximum visibility) portion of the spectrum is about 5560 Angstroms or roughly 20 millionths of an inch. The shortest radio wavelength so far used with the super radio telescope is 6cm, or almost 2.4in.

Let's see what these large differences in wavelengths mean in terms of resolution, using optical and radio telescopes of equal size. One will have a 200in diam. mirror; the other a 200in diam. antenna. The ratio of mirror diameter to the wavelength of light is 10,000,000; the ratio of antenna size to radio wavelength is about 83 (200 divided by 2.4). It thus should be clear that the optical system has a theoretical resolving power over 120,000 times greater than that of the radio telescope because of the difference in wavelengths used.

One way to improve the resolving power of a radio telescope is to use the shortest possible wavelengths. Obviously, there is a limit to how far you can go in this direction. Also, it's not always desirable to reduce the wavelength because very often relatively longer wavelengths are needed to obtain specific types of information from outer space. Thus the only practical solution is to increase the size of the telescope — which means increasing the size of the antenna.

The table below, showing the resolving powers of optical telescopes and the super radio telescope, reveals what can be accomplished by increasing antenna size. Remember that the smaller the angular resolution, the greater the resolving power.

The 0.0006 arc seconds of resolution achieved with the radio telescope was under conditions wherein a 6cm radio wavelength was used with an antenna system virtually several thousand miles long (extending from West Virginia to Sweden). This degree of resolution is about 50 times greater than is theoretically possible using the 200in Palomar telescope; it's also some 100,000 times greater than that of the average human eye.

(The pupil of the human eye has a diameter of about 3mm and the minimum angle of resolution is theoretically

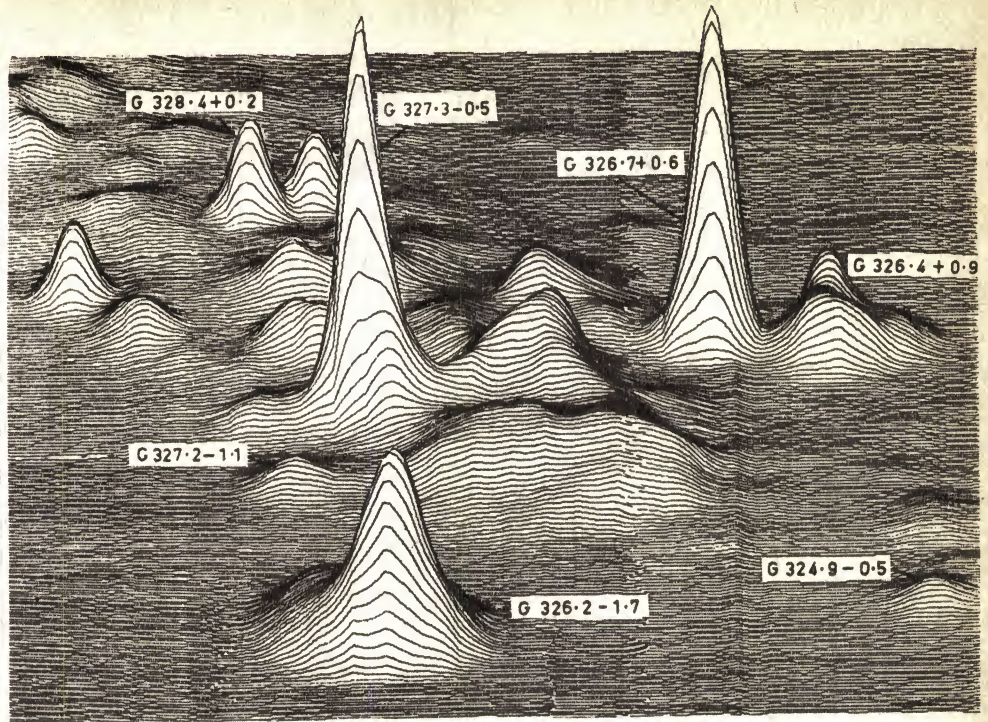

A contour map of the intensities of radio sources picked up by an Australian radio telescope. This map was produced by the C.S.I.R.O.'s computer in Canberra.

about 47 angular seconds. However, because of optical defects and limitations of the retina, the average eye is not able to resolve objects less than 60 angular seconds apart.)

The fantastic resolving power of the big radio telescope can be visualised another way. This resolution is equivalent to the ability to measure the size of a postage stamp in Sweden as seen from West Virginia, or to measure the size of an automobile on the moon!

Single radio telescopes can measure angular distances in the sky with resolutions comparable to that of the human eye. Years ago, radio astronomers learned how to improve the resolution of radio telescopes by linking two or more instruments together by means of cable or radio communications. But such linkages are of limited usefulness because the telescopes must be within a few hundred miles of each other. The high cost of cables and the complexity of radio linkages limit practical application of this method of telescope pairing.

Successes with these earlier cable- and radio-linked telescopes indicated that the resolution of radio telescopes could be improved if the VLB (very long baseline) could be extended to international or intercontinental proportions. This new idea was put to practical test only a year ago by the National Radio Astronomy Observatory, working in collaboration with scientists from Arecibo (Puerto Rico), the Massachusetts Institute of Tech-

nology, and the University of California. This first successful VLB experiment involved telescopes in Puerto Rico, California, Massachusetts, Maryland, and Canada, among others.

The new international telescope system that evolved from these initial experiments makes use of four widely separated instruments. The largest of these is a 140ft diameter telescope at the National Radio Astronomy Observatory, Green Bank, W. Va. Three smaller telescopes, each 85ft in diameter, are at the following locations: Chalmers University of Technology, Onsala, Sweden; Massachusetts Institute of Technology, Cambridge, Mass.; the University of California, Hat Creek, Calif.

The trick was to synchronise these telescopes without using cable or radio connections. This was done by feeding the radio signals, captured by each telescope, into individual tape recorders while simultaneously calibrating the recorded observations with the aid of ultra-precise atomic clocks. (figure 2).

Tape recording of radio telescope signals is a standard procedure, used even when telescopes are operated as single units. But now, the integration of accurate atomic clock timing systems into this standard technique makes it possible to compare with great accuracy data obtained by telescopes at several widely separated locations.

The four telescopes in the new system line up roughly in an east-west direction. This orientation is important because it becomes possible to syn-

Comparative Resolving Powers of Optical Telescopes

Instrument	Arc Seconds	Angular Degrees
Super radio telescope	0.0006	0.000000166
200in Mt Palomar telescope	0.03	0.0000083
40in Yerkes telescope	0.14	0.000039
Human eye	60.00	0.0166

PLESSEY

Miniature lever key switches

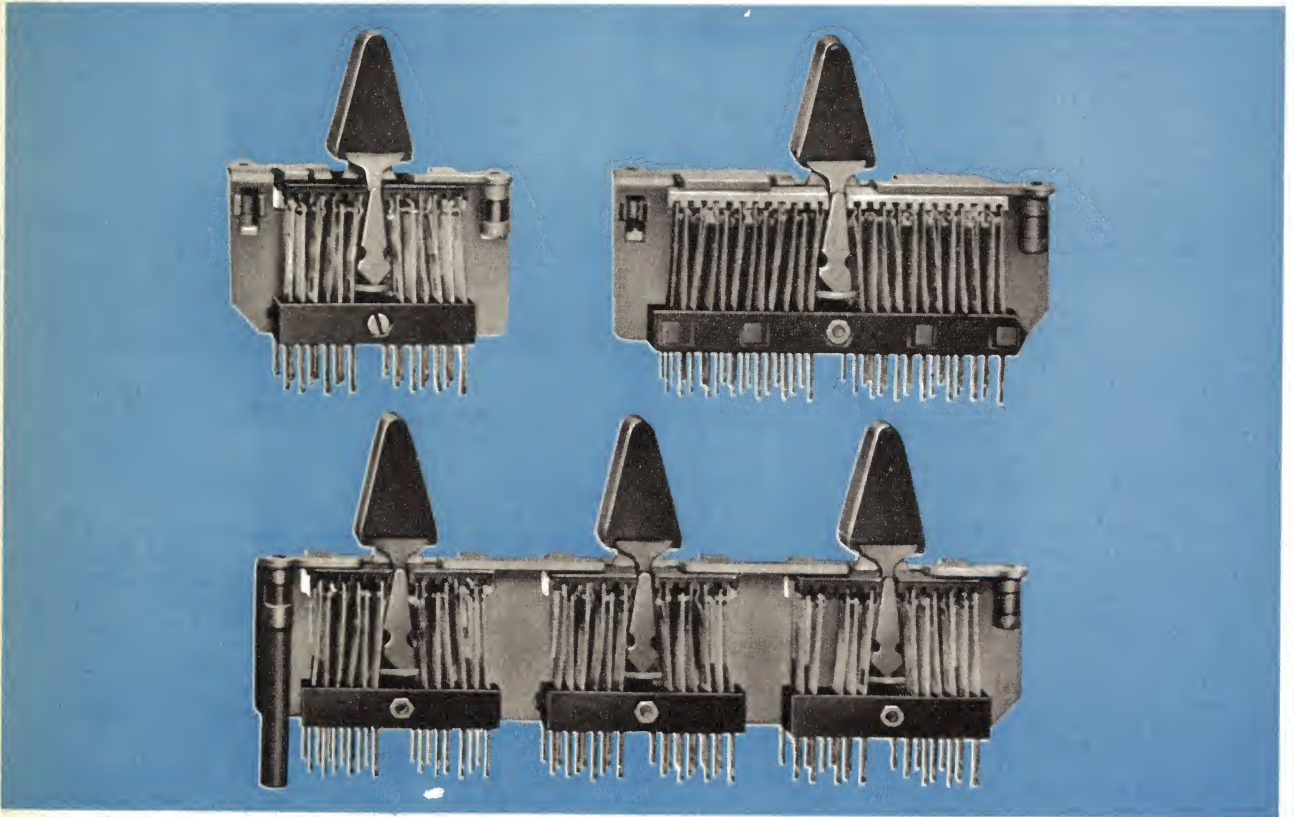

Illustrated above Top left. Single action key type N9300 Series. Top right. Large capacity key type N9900 Series. Bottom. Multiple key unit.

The Ducon Division of Plessey Components Group offer a range of miniature lever key switches with the following features:—

Design Designed to meet the most demanding electrical, mechanical and styling requirements, these compact, space saving switches provide a ready solution to light-current switching problems. All are fully tropicalised and meet the requirements of both British Post Office Specification D2162 and Interservices RCL 153 Pattern 3.

Contacts There is a wide range of contact arrangements which are adequate for most general applications. Switches are normally supplied with silver

contacts. However, gold, platinum or palladium are available if required.

Key Handles Handles are available either in a standard black with ivory insert or from a choice of many self-colours with contrasting tip inserts to provide easy identification.

Reliability Extended life tests have indicated negligible wear or loss of contact pressure after one million operations.

Dimensions Width $39/64$ " , Depth $2-3/16$ ". Height — Single unit $13/4$ " , 2 unit $31/4$ " , 3 unit $43/4$ " , 4 unit $61/4$ " .

A standardised range is available ex stock. Literature is available on request to:—

PLESSEY
Components



Plessey Ducon Pty Limited
Box 2 PO Villawood NSW 2163
Telephone 72 0133

Melbourne 42 3921
Brisbane 2 3287
Adelaide 76 3434
Perth 21 4821/21 7867

chronise the scanning of selected sections of sky by utilising the rotation of the earth as a sweep mechanism. Each individual telescope antenna can also be moved to alter its altitude; it thus becomes possible to scan successive strips of the sky. The time-calibrated, tape-recorded scan data are then correlated with the aid of high-speed digital computers to produce a radio-wave "picture" of the sky that is very much like one that would be obtained if an antenna several thousand miles in diameter had been used.

The only way to increase still further the already phenomenal resolution of the super telescope would be to lengthen the baseline. To a degree, this could be done by using instruments in certain other parts of the world. But the amount of improvement over the present system would not be especially dramatic.

The only alternative would seem to be that of extending the baseline into outer space by placing one of the telescopes on the moon. In light of recent advances in space science, such a feat cannot be ruled out as a very real possibility. Data collected by the moon-scope would be taped, and the information would then be telemetered to receivers on earth.

An earth-and moon-based system would of course require the solving of some knotty problems. So long as the chain of telescopes remains on earth, strip scanning of the sky is relatively simple because the rotation of the earth synchronises all the telescopes. But a telescope on the moon would obviously have to be synchronized with earth-based instruments in some other way. This would be difficult, but not necessarily impossible.

The mean distance from earth to moon is about 238,000 miles. This would provide a baseline almost 50

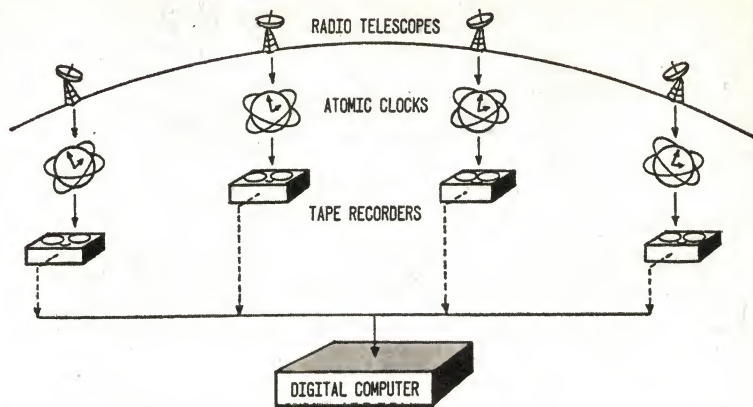

times longer than the one now used on earth. The improvement in resolution could be most impressive. And if that isn't enough, the system might be extended even further — to Mars, say, in which case the baseline could be as long as 248 million miles!

Aside from improving resolution by creating a larger synthetic antenna, there may be other advantages in placing part of the telescope system outside of the earth's atmosphere. There isn't much point in building optical telescopes much larger than the 200in Palomar instrument. Reason: the advantages of a bigger telescope would be largely negated by image distortion created by atmospheric disturbances; moreover, far smaller telescopes placed into earth-orbiting observatories can do better work than much larger ones on earth.

In like manner, radio telescopes operating on the airless moon may function much better because they would be relatively free of those envi-

Cable and radio links have been successfully used to connect radio telescope over short distances (below.) The development of highly accurate atomic clocks now permits radio telescope thousands of miles apart to be used (above.)

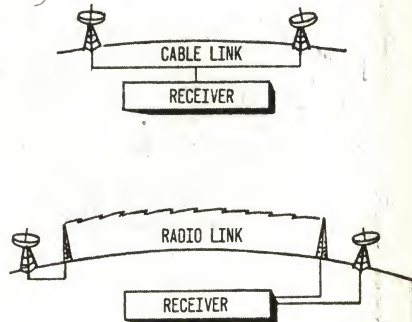

ronmental interferences that plague radio reception on earth.

In January, 1968, the new telescope was put to use. One of its first jobs was to "split" quasars, those intrinsically bright radio sources that some astronomers believe may be located in the far extremities of the observable universe. If the sizes of the component parts that make up a quasar can be determined accurately, astronomers will have an easier time trying to figure out what mechanisms in these objects generate such stupendous amounts of radio energy.

For quasar splitting, the astronomers used the Swedish and the West Virginia telescopes to pick up 6cm radio waves emanating from the brightest known quasar (identified as 3C273). It was already known that this quasar has a complex structure.

But just how complex is it? The new telescope has provided many of the answers in its first attempt at quasar splitting. But it can't provide the full answer. At least one component of the quasar is so small it still defies measurement. From theoretical considerations of the radio spectrum of 3C273, and because the energy source is known to vary in radio intensity, astronomers predict that this remaining component may have a diameter of about one ten-thousandth of a second of arc (that's about 3×10^{-6} part of an angular degree!).

Elated as the astronomers are with the proven capabilities of the new telescope, they readily admit that bigger ones are needed. Said one: "To measure it (the remaining component of quasar 3C273) accurately, astronomers will have to reduce the wavelength of their observations, or separate the antennas used in the experiment even further than they now are."

A large mass of glowing hydrogen gas, about 6,000 light years away from earth, is located in the constellation of Cassiopeia — the "Queen" of the skies. This mass of gas, known as W-3, is a source of radio energy. Near the edge of W-3 are other speck-like sources of radiation that intrigue astronomers.

The width of the emission lines of these tiny sources



The world's largest radio telescope, with a 300ft diameter disc, is at Greenbank, West Virginia. The Green Bank site is the American leg of the U.S.A./Sweden very long baseline experiment.

Choose from the
Taylor
 range of
Multimeters

- for • HIGH SENSITIVITY
 • ACCURACY
 • FOOLPROOF OPERATION

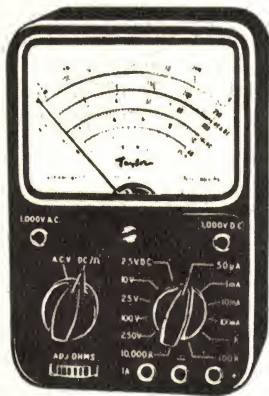

(Left) Model 127A: SENSITIVITY: 20,000 Ω/V d.c., 1,000 Ω/V a.c. RANGES: d.c. current—50 μ A to 100mA. d.c. volts—0.15 to 1,000. a.c. current—100 μ A. a.c. volts—10 to 1,000. Resistance—0 ohms to 20 megohms (3 ranges). Decibels—10 to +62 db. ACCURACY: D.C. ranges— \pm 3%. A.C. ranges— \pm 4%.

(Right) Model 88B: SENSITIVITY: 20,000 Ω/V d.c., 2,000 Ω/V a.c. RANGES: d.c. volts—0.1 to 2,500. 25 kv with adaptor Model 488. a.c. volts—1 to 2,500. d.c. current—0.05 to 10A. a.c. current—1 to 10A. Resistance—1 ohm to 50 megohms (5 ranges). Decibels—10 to +68 db (8 ranges). Capacitance—1,000 pF to 100 μ F (4 ranges). Inductance—0.2 to 20H (2 ranges). ACCURACY: D.C. ranges— \pm 2%. A.C. voltage ranges— \pm 3%. METER: 5" mirror scale. OVERLOAD PROTECTION: automatic mechanical cutout.

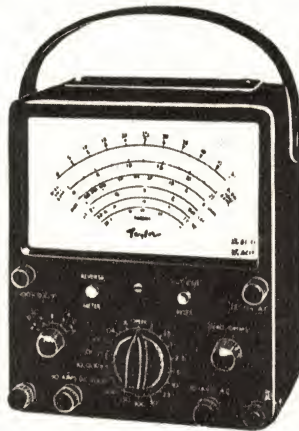

(Left) Model 100A: SENSITIVITY: 100,000 Ω/V d.c., 5,000 Ω/V a.c. RANGES: d.c. voltage—5 to 2,500. High voltage probe for 25 kv a.c. voltage—10 to 2,500. d.c. current—10 μ A to 10A. Resistance—0 ohms to 200 megohms (4 ranges). Decibels—10dB to +62db (5 ranges). ACCURACY: D.C. ranges— \pm 2%. A.C. ranges— \pm 3%. METER: 8 μ A M/C with mirror. OVERLOAD PROTECTION: automatic mechanical cutout. REVERSE POLARITY. Also available: Model 101. A simplified version of the 100A, without the 2,500 V measuring ranges, the Overload Protection Switch and Polarity Reversal Switch.

of OH (hydroxy molecule) radiation indicate that the radiating gas must be very cold—perhaps only a few degrees above absolute zero (—459.72F.) On the other hand, the amount of radio energy received from these sources implies that the temperature is well over a million-million degrees!

Contradictory? Yes—unless it can be demonstrated that the radiation is emitted because of some non-thermal mechanism such as a giant space maser. To prove or disprove the maser theory, astronomers and physicists must have reliable measurements of the sizes of these radiating objects. The super telescope was designed to do just this.

The first results of the OH experiments (using 18cm wavelength) show that one of these tiny specks exhibiting OH emission has a diameter of only four-thousandths of a second of arc (10^{-8} degree). If the object is 6000 light years away from us—and astronomers believe it is—the measured diameter indicates that the "speck" would fit easily inside the orbit of planet Jupiter. Put another way, the object would cover less than one ten-thousandth of the distance from earth to the nearest star. In astronomic terms, this is a very small object indeed, considering the energy it packs. It represents the smallest angular diameter ever measured for a source of stellar radiation.

A short while after these experiments had been concluded, the Green Bank telescope in West Virginia was used to detect a previously unobserved line of microwave radiation (6.3cm wavelength) in the W-3 radiation region of constellation Cassiopeia.

The astronomers who made the discovery state: "The strength of the new 6.3cm emission line from the OH molecule confirms that the gas is radiating by a non-thermal emission mechanism . . . Just how the maser phenomenon is produced in interstellar space remains a mystery, but the new discovery of OH radio emission will hopefully help unravel the mystery."

When the techniques of VLB radio astronomy have been further refined, many other experiments of great interest to astronomers, physicists, and geophysicists will become possible.

The system can be used to test general relativity involving the bending of light waves near the edge of the sun. Atomic clocks on different continents may be synchronised to an accuracy of one one-hundredth of one-millionth of a second of time (up to 100 times better than currently used techniques permit). Geophysicists will be able to measure intercontinental distances with an accuracy better than a few inches; such precise measurements will lead to better understanding of earth tides and continental drift. And the system may be used to study irregularities in the rotation period of the earth as well as changes in the direction of the earth's rotation axis.

Long ago, Archimedes expounded on the marvels of mechanical leverage, saying: "Give me a place to stand on and I will move the earth." Modern astronomers might well paraphrase Archimedes by saying: "Give us a place to put our instruments and we will measure the universe." One day, the astronauts may take astronomers to the moon and say: "Prove it!"



Send now for further information to:

Jacobus, Mitchell & Co. Pty. Ltd.

469-475 Kent Street, Sydney. 26-2651

MELBOURNE
30-2491/2

ADELAIDE
53-6117

BRISBANE
3-6467

PERTH
20-1102

LAUNCESTON
3-5322

JM/21-68



Proposed TV Centre 850ft above Sydney

Sydney's proposed Centrepont tower, designed to rise to a height of 850ft above the site, and to be the City's tallest structure when completed, may accommodate a unique communications centre for radio and television coverage, microwave links and perhaps even laser beam systems.

The communications centre would be sited at the very top of the 850ft structure, above the rotating restaurants, in a circular room with a diameter of about 50ft. This would have a surrounding platform which would presumably have provision for weather protection, particularly against wind, which could be severe at that height.

One possibility being considered is to have a high-level television platform equipped with zoom lens TV cameras, giving a bird's eye view of the city and Harbour for the coverage of important events. This would be used in conjunction with portable television systems which could be carried around in a back-pack arrangement by one man for ground level coverage, interviews and crowd scenes. Signals from these portable systems would be transmitted by in-built link equipment to the communications centre.

The great height of the tower lends itself to line-of-sight communications systems. Apart from the city and suburbs, this would extend to the mountain ranges to the north and west, eastwards far out to sea, and to Port Kembla in the south.

Currently, a model of the tower is undergoing wind tunnel tests in Canada. The results of these tests may show the feasibility or otherwise for the use of the tower for a communications centre. These tests have already established the basic soundness of the

design from the point of view of safety and convenience of the users.

The tests were conducted in the Boundary Layer Wind Tunnel at the University of Western Ontario, using an aeroelastic scale model designed to simulate the stiffness, distribution of masses and physical exposure to wind of the real tower. Preliminary results of the tests indicated that the tower, as designed, would be aerodynamically stable and that the level of vibration could be kept at a comfortable level. The tests also showed that there should be no problems of metal fatigue.

The wind tunnel tests should also establish the suitability or otherwise of the tower for some of the systems proposed for the communications centre. The amount of sway at the top of the tower may cause problems with the long focus zoom lenses which television cameras in such a location would have. If and when practical laser beam systems become available, the precise alignment involved would create problems in an unstable situation such as that involved here. ■

BELOW: Mr Alex Wargon, (right) the structural engineer responsible for the Centrepont tower design, looks on while tests are carried out on the model of the tower in a simulated environment in the wind tunnel at West Ontario.



COMPUTER SYSTEM MONITORS

The problems of noise in relation to aircraft movement will come under discussion at an international gathering of experts to be held in Montreal, Canada, in November. While there appears to be no overall solution in sight at present, data gathering on the subject is a continuing process. This article, condensed from "Hewlett-Packard Journal," Vol. 20 No. 11, describes a system for monitoring airport noise in terms of identifiable take-offs and landings.

Jet travel is a necessity in our society. Unfortunately, jet aircraft are awfully noisy beasts, and no one knows this better than the people living near our larger airports. They are disturbed and annoyed, so much so that the control of noise during takeoffs and landings has become a major problem for airports. To deal with the noise problem, three approaches are being taken. The first is to develop quieter aircraft, the second is to place stricter controls on the planning of airport locations and surroundings, and the third is to develop special flight patterns and techniques for use around airports.

Designing quieter aircraft has the advantage of attacking the problem at its source. The aircraft industry is working closely with government agencies to develop standards for aircraft noise performance. These standards will become obligatory for future aircraft designs.

The second approach to controlling airport noise, placing stricter controls on the planning of housing around airports, can realistically be applied only to new airports. Since industry likes to locate near airports, and since people like to live near their work, airports tend to attract industry

and housing, and planning is required to prevent noise problems. Many older airports have problems because there has been little or no planning. In the future those concerned will have to ensure that planners have the data they need to make intelligent decisions about controls.

The third approach to the airport noise problem is to develop special flight patterns and techniques, consistent with safety requirements, to reduce the noise level in those cases where people already live close to the airport. This involves such things as bringing aircraft in on a steeper approach when landing, avoiding flying over certain areas, and taking off under reduced power. In extreme cases flying hours may have to be restricted to certain hours in the day. This last step is a drastic one, but some airports in Europe have already been forced to take it.

Regardless of which approach is taken to control airport noise, there is a need for monitoring, measuring, and analysing the noise. Measurement and analysis are the first steps in enforcing standards, in gathering information for planners, and in keeping track of local conditions so flight patterns can be altered to minimise noise.

The Hewlett-Packard Model 80500A Aircraft Noise Monitoring System is designed to measure the sound level at a number of locations in or around an airport and then

Figure 1. Sample of a printout for the 17-point monitoring system at Stuttgart Airport, Germany.

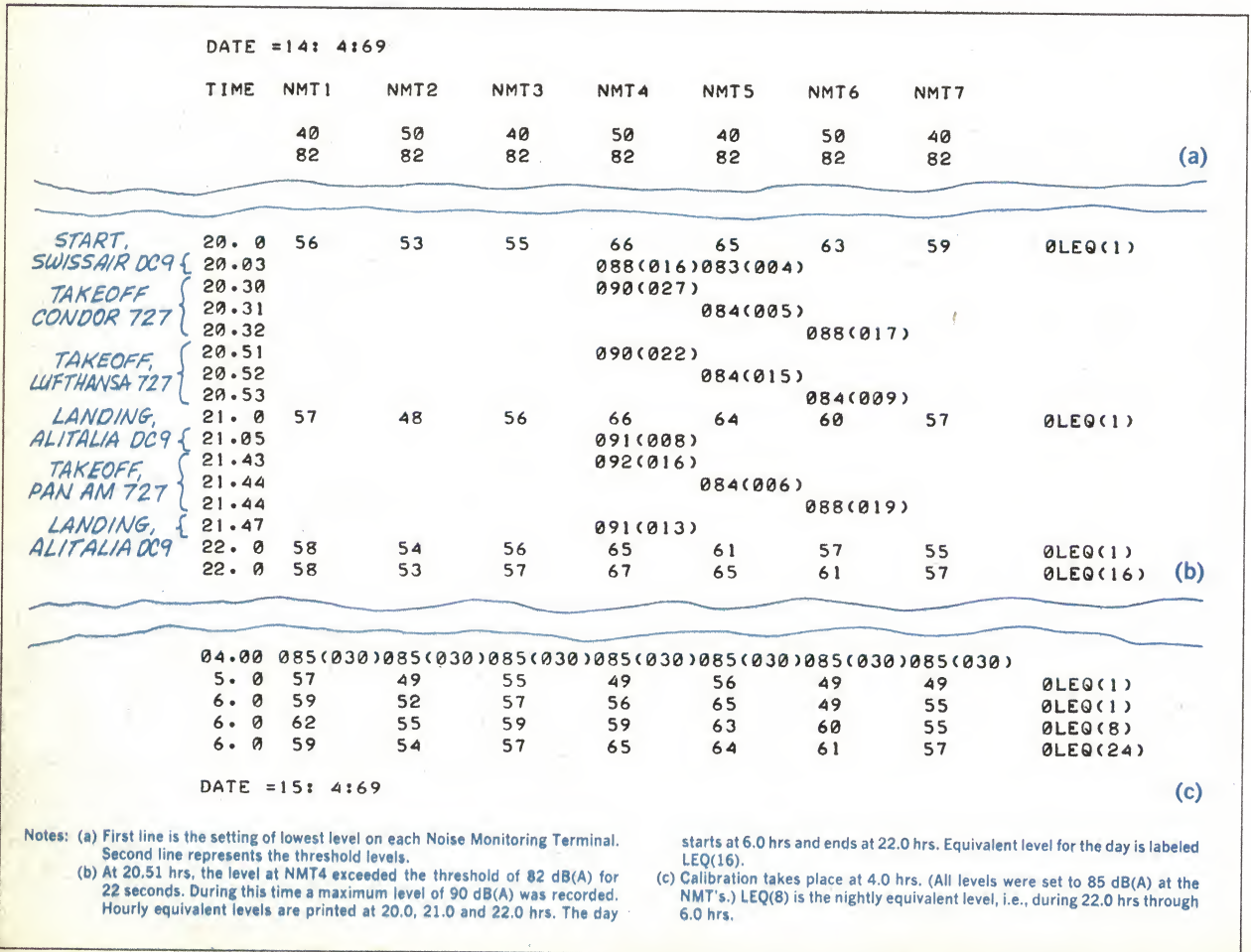

AIRPORT NOISE

By Wisu T. Kaspuskar

and Christopher J. Balmforth

immediately process the data at a central location to provide results in the optimal form for evaluation by relatively untrained personnel. The results can be used to determine effective methods of reducing the annoyance to neighbours of the airport and to detect unusually low-flying or deviations from preset flight routes. The system can even identify evasive manoeuvres that a pilot might perform to avoid detection. An important advantage of the system is that meaningful results are available while an offending aircraft is still in the vicinity of the airport. Corrective action, such as scheduling an inspection of the aircraft or technique, can be initiated as soon as a violation is detected.

The system continuously monitors the noise around an airport, analyses the sound, and records the results. Whenever sound levels defined as "excess" occur, the equipment prints out the time of the occurrence, the terminal number at which the excess was observed, the amount and duration of the excess, and calibration information (see figure 1). It computes equivalent sound pressure levels hourly and daily, using different weighting factors for day and night observations.

The monitoring system consists of a number of noise monitoring terminals and a central processing unit containing a digital computer. There can also be one or more mobile units, which in their simplest form may consist of a sound level meter and a tape recorder.

Each noise monitoring terminal determines the sound pressure level of aircraft noise in its vicinity and sends this information to the central processing unit by telephone line. There can be a large number of terminals (e.g. 48) in the system and the central processing unit will still be able to sample every terminal once each second.

In the terminal are primarily standard Hewlett-Packard instruments. Aircraft noise is picked up by a condenser microphone assembly which is suitably wind and weather-protected. The microphone assembly consists of a condenser microphone cartridge which produces an output voltage proportional to the incident sound pressure level, and a solid state FET preamplifier which has virtually unity gain, very low noise and low microphonics, a high input impedance and a low output impedance. To protect the microphone from effects of humidity a heater is included. The heat is localised close to the cartridge and a minimum of excess heat is conducted to the solid-state FET preamplifier.

The standard program for noise monitoring is written in FORTRAN with assembler subroutines. ALGOL and BASIC compilers are also provided with the system. Suitably programmed, the system can conform to existing as well as future laws pertaining to aircraft noise control.

Data and instructions are fed into the system via the teleprinter keyboard or the optional high-speed punched-tape reader. Standard plug-in cards provide the inter-faces between the computer and the peripherals. A valuable feature of the aircraft noise monitoring system is that the owner also has a powerful general-purpose computer too use for off-line computations. For normal measurements a minimum of staff attendance is required since the data do not have to be manually processed; results are calculated by the computer and recorded by the teleprinter or tape punch. Tapes may also be processed later to provide



The central processor for an airport monitoring system. This can scan each noise monitoring terminal once each second, process the data obtained, and present the results in the optimal form for evaluation by relatively untrained personnel. It can be adapted to future regulations and noise evaluation methods simply by changing programs.

additional statistical data or to check the validity of complaints about excessively high noise levels during specified periods of time.

The Mobile Unit subsystem contains a Model 8062A Impulse Sound Level Meter, which is identical to the one used in the Noise Monitoring Terminal except that it contains rechargeable batteries for truly portable operation. Also included is a microphone assembly with wind shield, and a precision sound level calibrator.

Mobile units are typically used to monitor the noise level at points where noise monitoring terminals are not presently located. They may also be used to record aircraft noise on a portable instrumentation analog tape recorder for extensive analysis at a later time. For this purpose a high-quality portable tape recorder plus a battery-operated microphone power supply are recommended as additions to the mobile unit. ■

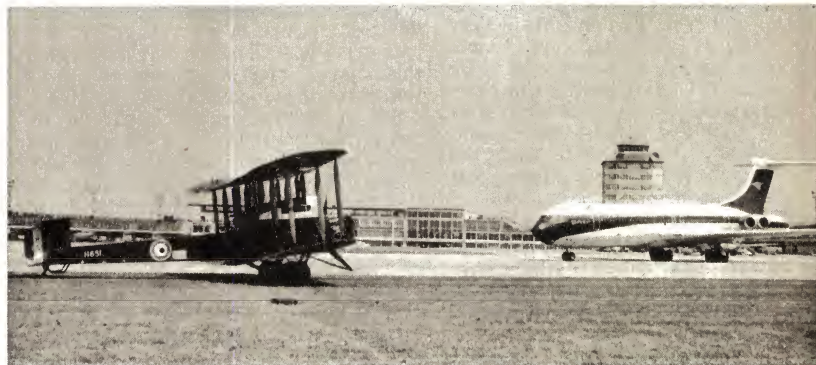

This picture illustrates dramatically the difference in size and power of the aircraft of 50 years ago and now. On the left is a replica of the Vickers Vimy in which Alcock and Brown made the first trans-Atlantic flight in 1919. At right is a B.O.A.C. VC-10 about to take off from Manchester Airport for a trans-Atlantic crossing.

N.Z. INQUIRY INTO FM SERVICE

When the present TV and AM sound broadcasting networks are completed, the New Zealand Broadcasting Corporation intends to seek the establishment of an FM service. However, the final decision on the introduction of such a service will rest with the Minister for Broadcasting.

By B. S. Furby, M.N.Z.E.I.*

The N.Z.B.C. made known its intentions towards the end of a public inquiry about FM broadcasting held in Wellington by the N.Z. Broadcasting Authority, the organisation set up late last year to license private broadcasting. The authority, at the request of the Minister of Broadcasting, was seeking answers to these questions:

1. What is frequency modulation?
2. What are the technical advantages and disadvantages of frequency modulation?
3. In what respect is the extension of broadcasting to include a frequency modulated type of service necessary or desirable in the public or national interest?

The inquiry was a public one, open to anyone to attend or submit evidence. Nine individuals or organisations gave oral evidence, and 36 written submissions were received. These included submissions from prospective private broadcasters and high-fidelity enthusiasts.

All submissions agreed that FM is a superior system to AM, but differed in the degree of desirability. While agreeing on the superiority of FM, the New Zealand Broadcasting Corporation contended that its AM service was not yet fully exploited, and while some areas of the country experienced difficulties in reception, these would be attended to as part of the development program. FM would not solve all present reception problems, and VHF would be costly for national coverage. (The corporation has 47 stations in New Zealand, and there is only one private station in the country.)

The N.Z. Post Office, which confined itself to answering only the first two questions, definitely confirmed that the 90-94MHz VHF band is being held for broadcasting if required. (This had previously been in question in some quarters, and New Zealand has a very high density of radio-telephone services which can always make use of more bandspace.) Standardisation with overseas was given in some submissions as a reason for wanting this band rather than a UHF band, and the N.Z.B.C. preferred VHF as offering less propagation problems.

The Post Office also called attention to capture effect problems in fringe areas of varying signal strengths, where receivers would lock on to unwanted signals. The N.Z. Electronics Insti-

tute, however, pointed out the possibility of directional aerials on VHF which would lessen this effect.

Several witnesses complimented the N.Z.B.C. for the high technical standards the corporation has set and maintained. The 10KHz frequency range of the service, which the corporation claimed is not fully exploited, was questioned by witnesses who suggested that no commercial tuners exist capable of receiving this limit on AM without adjacent signal interference.

Witnesses agreed that typical domestic AM receivers are designed to receive only 5KHz, and have inherent distortion because of diode detection; that FM gives better results with domestic receivers than AM; and, during cross-examination by the N.Z.B.C. counsel, that expensive equipment is needed to realise the full potential of FM, including stereo.

Europe and America, the N.Z.B.C. suggested, had introduced FM because of interference on the AM medium-frequency band. Although FM had been operating in some countries for some years, AM was still highly popular and the expected phasing out had not yet begun.

The counter arguments to the N.Z.B.C. were that interference among New Zealand's own stations and from Australia's could only increase, even if not at present as serious as it is overseas.

Mr T. R. Clarkson, a retired Assistant Engineer-in-Chief of the N.Z. Post Office, advocated introducing FM for engineering reasons. Pointing out that broadcasting had developed on AM for historical reasons, he gave several points in favour of FM and VHF as against AM and asked that FM be introduced now in readiness for the future. Because valves are obsolescent, and are being replaced by solid-state devices, people are buying new receivers. Mr Clarkson suggested that this change presents the ideal opportunity to introduce AM/FM receivers. Lack of channel space could be relieved by changing to FM, and less power would be needed for FM services. He reminded the authority that broadcasting is a technically based medium, and must depend on its technical efficiency to do its work effectively.

Cost of AM/FM receivers featured in the inquiry. The Newlands Broadcasting Society gave itemised costs of an AM/FM set, showing the extra for FM as adding 20 per cent to the cost of a domestic receiver. The N.Z. radio and Television Manufacturers' Association suggested a 40 per cent increase for FM stereo and that an FM only receiver would cost about the same as an AM one. New Zealand

has a national problem through lack of overseas exchange, and any decision to change the broadcasting system must take into account the effect of imports. In this light, the Newlands Broadcasting Society, while agreeing with the N.Z.B.C. that there is little public demand for FM, considered this as really an advantage because there would be only a gradual demand for FM receivers which would not strain the country's resources.

Mr Clarkson had previously referred to the lack of public interest in FM and had compared it with the lack of interest in railway locomotives. "The passengers are not interested in whether the main trunk express is drawn by diesel or steam locomotives," he said. "They are confident that those responsible for the service have made the best choice in their interests. That is what we are asking for with FM."

While FM is limited to line of sight (suggested as an advantage for local services) it is capable of being extended for regional or national services. This was a point introduced by the N.Z. Electronics Institute, which also suggested that such relays would be better than the existing "wide-band" lines in use for the national services at present. The institute thought the N.Z.B.C. with its existing network of television repeaters would be well placed to provide national FM with these facilities.

In agreeing with this, the N.Z.B.C. pointed out it would be even better placed when the present 90 per cent television coverage had been extended to cover the country completely. The Post Office had expected that 20 channels could be provided on the 90-94MHz band, and the corporation estimated that 10 channels would be required for national coverage. While it did not object to the other 10 being used by others, it did not consider that the whole band should be dissipated among small local stations so that national FM services would become impossible. The first services should be experimental and non-commercial. The corporation particularly drew attention to the danger of FM being poorly introduced so that the system got a bad image with the public, and failed to be accepted.

Prospective private broadcasters, while agreeing about the merits of FM, were anxious to begin operating on AM where they will be assured of listeners. No one seemed to expect AM to disappear completely, although its role in the future was seen as confined to news, sport, weather and limited entertainment. Three organisations (in Auckland, Wellington and Otago) expressed interest in operating FM only stations, and a few applicants for AM licences stated a willingness to provide additional FM services. Two submissions suggested 50 years as a round figure for the time when broadcasting would be nearly all FM.

The Radio and Television Manufacturers' Association has four priorities: 1. National coverage of the present single-channel television service; 2. A second TV channel; 3. Colour TV; 4. FM stereo broadcasting. The first is

* The author is convenor of the Newlands Broadcasting Society, in Wellington, a group which has taken the initiative in seeking to have FM sound broadcasting introduced in New Zealand.



THE NEW LUSTRE MODEL ST-510 TONE ARM . . . TRACKS AT LESS THAN 3/4 GRAM . . . AND COSTS ONLY \$19!

Orders for the new Lustré Model ST-510 tone arm are now being filled. Miniature ball races are used throughout, the head shell accepts all standard 1/2" mounting cartridges, finish is satin chrome and anodised aluminium. An outrigger bias adjustment is fitted and stylus pressure is adjusted with the counter balanced weight. The Model ST-510D is fitted with a lifting/lowering device and costs \$24.50. The Model ST-510 (without lift), Inc. sales-tax is priced at \$19.



SAVE YOUR RECORDS . . . USE THE UNIVERSAL LUSTRE TONE ARM LIFT

This beautifully finished and functional universal tone arm lift will fit all tone arms . . . the lowering action is pneumatically dampened and extremely smooth. Risk of record damage may now be eliminated. Including Sales-Tax.

\$8.50

CONNOISSEUR STEREO CARTRIDGE — ONLY \$12.50.

Designed to effectively load any amplifier or tape recorder, the Connoisseur Model SCU-1 ceramic stereo cartridge has an extremely wide frequency response and is fitted with a diamond stylus. Ask for copies of reviews.

\$12.50

SAVE ON SANSUI AMPS AND SPEAKERS

Popular Sansui models are in stock . . . amplifiers and speaker systems. Write for your EMQ or call at your nearest Encel Stereo Centre.

CANBERRA ENQUIRIES FOR ENCEL EQUIPMENT

If you live in Canberra and you want further information on Encel equipment, please phone. Canberra 81-1667.

TAPE SPLICERS . . . ONLY \$2.50!

We've just made a special purchase of tape splicers . . . and while the stock lasts this easy-to-use unit is priced at only \$2.50. Save time and fidgeting—and frayed nerves: order now!

SAVE MORE ON ALL LEADING MAKES OF TAPE RECORDER.

Encel Stereo Centres stock all best makes . . . Akai, Sony, National, Toshiba, Truvox, Philips, Revox, Tandberg, Miny and many more. You'll be wise to secure an Encel price before you commit yourself elsewhere. Save at Encel's.

LOOKING FOR AN ADC CARTRIDGE? SEE ENCEL ELECTRONICS WITHOUT DELAY!

A full range of renowned ADC cartridges is now available and Encel prices cannot be advertised. However you can overcome this tragedy by writing for a personalised quote or a trade-in valuation. You'll save more at Encel Electronics!

DUAL TURNTABLES ON SPECIAL OFFER

Write or call for a very special Encel Dual proposition. We are not allowed to advertise prices; various models available include the 1015, 1019, 1219 and 1210. You'll save more at Encel Electronics!

SEE A COMPLETE AUDIO RANGE AT ENCEL STEREO CENTRES!

Apart from the many exclusive Encel lines you'll find a vast range of high quality equipment at Encel stores in both Sydney and Melbourne. Here are a few of the manufacturers represented: Trio-Kenwood, KEF, Sony, ADC, Wharfedale, Ortofon, National, Toshiba, Shure, Akai, Sansui, Philips, Nivico, BSR, Garrard, and many more. Be sure to get an Encel EMQ (Encel Mail Quote) . . . you'll save much more at Encel Electronics!

TRADE-IN AND TRADE-UP!

When purchasing equipment from Encel Electronics, be sure to ask for a trade-in valuation on your old equipment. If your old equipment is in good working order, the cost of your current purchase can be reduced considerably. Bring in your amplifier, tape recorder, tone arm, etc. . . and save more than ever at Encel Stereo Centres!



SONICS STEREO HEADPHONES — FROM \$9.50.

The popular Model HS-304 offers fatigue free listening on a personal basis . . . the headset is very comfortable even over lengthy periods. Price? Only \$12.50. The Models HS-303 and HS-303H (High Impedance) are also available . . . frequency response is 20-15,000 Hz and the price only \$9.50. All models have foam rubber earpads.

From **\$9.50**

TWO HIGH-QUALITY LONDON MICROPHONES FOR USE WITH YOUR TAPE RECORDER

LONDON LM-100. An omni-directional dynamic dual impedance microphone with a response of 50-15,000 Hz. An ideal general-purpose unit . . . robust and designed to withstand studio or field use. Ask for complete specifications. Encel price inc. sales tax.

\$9.75



LONDON MODEL LM-200. A dynamic cardioid dual impedance microphone with balanced output and a frequency response of 50-15,000 Hz. Discrimination at 180 deg. eliminates unwanted background noise. Natural recordings are possible even under unfavourable acoustic conditions. Weight is only 4 1/2oz including the cable. Ask for complete specifications. Encel price inc. sales tax.

\$16.85

COMPAX SOLID STATE TUNERS

A high quality wide band AM tuner, the Compax represents outstanding value. Output suits all amplifiers and tape recorders. The external teak finish case is optional. Price with case is \$46.50 inc. sales tax. Encel price without case is only **\$43.60**

DEMAGNETISE YOUR TAPE HEADS AND IMPROVE TAPE PERFORMANCE!

Simply plug the tape head demagnetiser into any AC power point and pass over the heads. Takes only five seconds and can make a world of difference. Two models—single and double probe. Both **\$4.50** (inc. Sales tax)



TRUVOX R44 PORTABLE AC RECORDER

The R44 is extremely popular — it's fully transistorised and features interlocking controls, a VU meter for positive indication of recording level and an output of 8 watts I.H.F.M. into an 8 ohm speaker load. Three speeds — 7 1/2, 3 3/4 and 1 7/8 i.p.s. Takes 7in spools. Frequency response is 40-15,000 Hz plus-minus 3 dB. at 7 1/2 i.p.s. Wow and flutter is less than 0.15% at 7 1/2 i.p.s. Independent microphone and radio/pickup controls allow easy mixing of program material. See the review in "Amateur Tape Recording," Oct., '66, and "Audio and Record Review," Aug., '66. Ask for copies of reviews. Price inc. Sales Tax.

\$149

SPECIAL SLASHED PRICES ON SHURE CARTRIDGES.

If you're waiting to buy a new Shure cartridge be sure to get Encel's bargain basement price before you make your purchase. We are not at liberty to advertise our low prices.

SAVE MORE ON RECORDING TAPE!

A wide range of high quality recording tape is always in stock at Encel Stereo Centres. Brands available include BASF, Philips etc. Write or call for your personal price.



CONNOISSEUR TURNTABLES NOW AVAILABLE IN KIT FORM OR READY ASSEMBLED AT SLIGHTLY HIGHER COST

In the United Kingdom Connoisseur turntable kits were an overnight success; supplies are now available at Encel Electronics. The Connoisseur B.D.1 turntable is a precision engineered product expressly designed to give uncompromising performance at modest cost. It incorporates belt drive which virtually eliminates noise and vibration. Two speeds (33 and 45 r.p.m.) are featured and speed changes take only seconds. The slow speed synchronous motor has an extremely small field and will not affect the most sensitive magnetic pick-ups. Write for EMQ's (Encel Mail Quotes) or call at Encel Stereo Centres in Melbourne or Sydney . . . at the time this issue went to Press, prices had not been finalised.

CONNOISSEUR BD-2 TURNTABLES ARRIVE SOON!

Australia's first supplies of the Connoisseur Model BD-2 turntables arrive soon at both Encel Stereo Centres. Write for details and prices.

SEE THE NEW GRUNDIG STENORETTE AT ENCEL'S!

If you need a dictating system, be sure to see the Grundig Stenorette Model L at Encel Stereo Centres in Melbourne or Sydney. This fine tape cassette machine features a remote control microphone so you can control recording, playback, forward and backward facilities without moving from your chair. Ask for the complete details and for your special Encel price. Your new Stenorette will cost you far less than you thought possible!

GRUNDIG PORTABLE/OFFICE DICTATING SYSTEMS

Away from your office you use the Grundig EN3 electronic notebook and record your reports, notes, memos and instructions on an instant loading 44 minute cassette. In the office the AC operated Grundig EW3 transcriber offers every desirable facility for speedy typing of recorded matter. Ask for a special price in both units at Encel Electronics stores in Melbourne or Sydney.

ENCEL
ELECTRONICS (STEREO)
PTY. LTD.

Head Office:

431 Bridge Rd., Richmond, Victoria 3121. Tel. 42 3762.

Sydney Store: Ground Floor, 2SM Building,

257 Clarence Street, Sydney, N.S.W. 2000. Tel. 29 4563, 29 4564.

Australia's Greatest Hi-Fi Centre *Wholesalers *Trade-ins accepted

SCOPE

... gives you a

HEAT

ALL THE HEAT IS WHERE IT SHOULD BE ...



Both De Luxe and Miniscope Irons are beautifully presented in a handy re-usable plastic pouch-pack, complete with one spare tip and two spare elements.

WHY? Because the world famous Scope iron has a solid carbon heating element that gives you heat right at the copper tip PLUS longer worry free service — no wire wound element to suddenly burn out.

PLUS these other exclusive Scope features

ECONOMY: Scope Irons consume current only whilst in use. Low maintenance cost.

A spare tip, and two carbon heating elements are supplied with the iron.

VERSATILITY: Scope Irons conveniently operate on 2.5V to 6.3V A.C. or D.C. also from 240V A.C. MAINS through a "NATRONIC" Scope transformer.

SPEED: 5 to 6 seconds from cold, complete temperature control at your fingertips. Heat only where, when and as much as needed.

Miniscope and De Luxe operate on voltages from 2.5 V. to 6.3 V. A.C. or D.C. or from 240 V. A.C. mains through a "NATRONIC Scope Transformer" fitted with 6-ft. 3-core flex and 3 pins mains plug. \$7.65

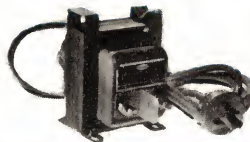

AVAILABLE FROM ALL LEADING RETAILERS, AUTOMOTIVE SUPPLIERS, HARDWARE STORES, ELECTRICAL WHOLESALERS — NATION WIDE. THE FULL GUARANTEE APPLIES ONLY WHEN THE IRON IS USED WITH THE APPROVED 'SCOPE' TRANSFORMER. MANUFACTURED BY NATRONICS PTY. LTD.

AUSTRALIAN & OVERSEAS AGENTS:
IRH COMPONENTS PTY. LIMITED
 A Subsidiary of IRH Industries Limited

THE CRESCENT KINGSGROVE, 2208, N.S.W. 50 0111
 VICTORIA I. R. H. Components 143 Christmas Street, Fairfield. Phone 489-1088
 TASMANIA: W. P. MARTIN PTY. LTD. 202 Argyle Street, HOBART.

S. AUSTRALIA: COLLETT & CANT PTY. LTD. 103 Halifax Street, ADELAIDE.

N.Z.: H. W. CLARKE (N.Z.) LIMITED 42-46 Cable Street, WELLINGTON, C.3

N.Z.: H. W. CLARKE (N.Z.) LIMITED 10 Teed St., New Market, AUCKLAND, S.E.1



W. AUSTRALIA: I. W. HOLMAN & CO 249 James Street, PERTH

QUEENSLAND: K. H. DORE & SONS 505-507 Boundary Street, BRISBANE

ALSO TOWNSVILLE AND ROCKHAMPTON

VOTED FIRST BY A HOST OF SATISFIED USERS.

Please post-free illustrated literature and specifications

My Name _____

My Address _____

City _____ Postcode _____

being completed, and Ministerial statements have suggested that the second two may be held back. The R.T.V.M.A. representative stated clearly to the Authority that the association's priorities did not mean that if some were delayed, FM should also be held back. His industry considered that FM would give freedom from interference, and all-round, better performance.

FM as a possible export, the use of sub-carriers for education purposes, and comparative costs of AM and FM transmitters were minor topics in the inquiry which did not appear to be clearly resolved. However, FM as extending the prospects for electronics in New Zealand was advanced in two submissions as possibly contributing to lowering the country's "brain drain."

The N.Z.B.C. provided a demonstration of AM and FM. Station 2YB, on 800KHz, was used for the AM and the WNTV1 sound channel on 45MHz provided the FM. The demonstration was considered inconclusive by other parties and the N.Z.B.C. agreed that it had served to demonstrate the capabilities of AM.

In a separate demonstration, not forming part of the inquiry, the Newlands Society was licensed to give a public demonstration of FM, including stereo, on 93MHz with a 150mW transmitter for a week in Wellington. These are the first stereo transmissions of FM in the country.

The inquiry concluded its public hearings on August 20, with the Authority's counsel summing up the evidence. He considered that it had not been firmly established that FM is the only way to provide a broadcasting service, but it had been established that the introduction of FM is desirable for reasons of audio quality and frequency space. While FM offered a limited-line of sight service, this could be an advantage with local services. Dollar for dollar, FM gives the public more value than AM. He concurred with the N.Z.B.C. that a similar situation to television might possibly arise, where an enormous and immediate demand for receivers had occurred after the introduction of television to New Zealand. Also, he pointed to the N.Z.B.C. suggestions that if the introduction of FM were mishandled it could set back the system with the public, and that FM could mean a loss of revenue to the N.Z.B.C.

The authority will report its conclusions to the Minister, but whatever its findings are the final decision about introducing FM to New Zealand will still rest with him. Similarly the Minister will decide if the Authority's report should be published.

Several expressions of praise for the fair and comprehensive way in which the Authority conducted its inquiry were made by participants. The chairman had permitted considerable latitude in the cross-examinations of witnesses by all presenting oral submissions. Certainly an interesting precedent has been set, in considering a possible step in broadcasting and radio in public view, instead of behind closed departmental doors. Press coverage contributed to educating the public about FM, and arousing some interest, even if some of the technicalities suffered in their interpretations by non-technical reporters. ■

DUAL-PURPOSE CONVERTER/TEACHING AID

A 14KW solid state converter installed at the Sydney Technical College has the dual role of supplying power to other teaching equipment and at the same time allowing students to watch its operation.

The makers, the industrial electronics division of Pye Industries Ltd., Marrickville, N.S.W., say the unit is the only one of its kind in the world. The converter was built to rigid specifications laid down by the N.S.W. Department of Technical Education and has been installed at the School of Industrial Electronics at Sydney Technical College. It is a 415V three-phase device to convert mains AC to DC. Although designed to handle 14KW, it can be easily modified to have a capacity of more than 100KW.

Some of the main points of the specification were:

- The unit had to be of more rugged construction than imported models of converters available commercially, to withstand heavy use during instruction of students.
- It had to be able to withstand short-circuiting of output without damage.
- It had to contain a large number of built-in safety devices in a number of areas to cope with unfavourable circuit conditions which might arise during instruction periods.
- It had to provide an infinitely variable direct current output of from 0 to 280V at 0 to 50A.
- It had to have an inbuilt control to enable a constant current output characteristic of some predetermined current value to be provided if desired at a selected voltage level.

- It had to have extremely good regulation both with reference to load and mains variations.

- Means had to be provided whereby if a load being supplied by the unit created a voltage in excess of a certain value (as in regenerative motor operation) the excess was dissipated harmlessly.

The unit is housed in an internally lit cabinet measuring about 4ft high, 3ft deep and 3ft wide, which has been designed for handling by means of a fork-lift truck. This cabinet is considerably larger than that of converters of comparable output available commercially.

Circuits which would normally be incorporated in a system only several inches square are displayed on large side panels within the unit located behind lockable glazed doors. These panels are about 2ft square, one on

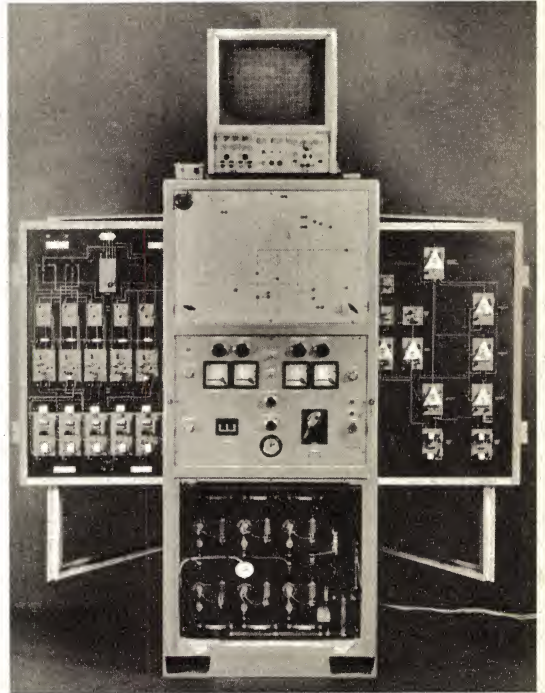

each side of the unit, and can be swung out on hinges after the glazed doors are opened so that all major systems are visible from the front of the unit for class instruction. The left hand swinging panel carries the pulse forming and shaping circuit boards of the converter. The right panel carries the control and sensing elements and amplifiers.

Mounted at the upper front of the unit is a panel approximately 3ft wide by 2ft high which carries on its surface a simplified wiring diagram of the circuitry used. The panel also carries sets of small indicator lamps located at strategic positions in the simplified diagram circuitry.

A large screen oscilloscope mounted on top of the converter is arranged, in conjunction with selector switches, to display electrical conditions at selected points in the converter circuitry. These points are simultaneously indicated on the simplified diagram by the illumination of appropriate indicator lamps. A panel located behind another glazed opening at the lower front of the unit carries the main power thyristors, surge limiters and fuses.

The direct current output of the unit is independent of earth, though either side, positive or negative, may be earthed if desired. This output is available at terminals located at the rear of the unit and is adequately filtered to reduce ripple to an extremely low value.

With minor modifications the device can function as a high gain power amplifier. ■

These RCA Triacs will turn you on

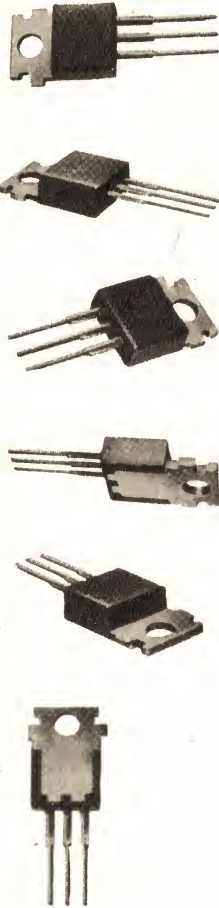

Choose New RCA 8 Amp Triacs for On-Off or Variable Phase Control of Power Into Resistive or Inductive Loads

Now's the time to think in terms of more than electro-mechanical controls and turn on with Triacs! Not just any triac — but the new RCA-40668 and RCA-40669. Both feature the unique RCA hermetic chip in the popular, easy-to-mount RCA "plastic TO-66" package.

Use the RCA-40668 for 120 V per 1-kW capability, the RCA-40669 for 240 V per 2 kW. With either, look what you get:

■ Commutating dv/dt capability of 10 V per μs (typ.) permits opera-

tion into inductive loads.

■ Critical rate of rise of off-state voltage — 300 V per μs (typ.) for 40668 and 250 V per μs (typ.) for 40669 — minimizes false triggering caused by line transients.

■ 85 A single-cycle in-rush current capability handles start-up surge loads readily.

■ 8 A (RMS) capability at a case temperature of 80°C.

■ 4 modes of gate control allow design flexibility and simplicity with either positive or negative DC logic.

For relay replacement, relay protection, motor speed controls and the like — in switching or phase control applications — for use in such devices as comfort control systems, vending machines, appliances — turn to and turn on with RCA Triacs.

For technical details on these and all RCA Triacs write to Amalgamated Wireless Valve Co. Pty. Ltd., Private Mail Bag, P.O. Ermington 2115 or Interstate Offices and Distributors.



AMALGAMATED WIRELESS VALVE CO PTY LTD

Keeping other planets free of earth germs

THE "BUG" KILLERS

"Can microbes from Earth survive in space and in the environments of other planets?" This question is receiving urgent attention following international agreement to prevent contamination through space probes and manned landings, and is the subject of a research program being conducted at the Boeing Company laboratories in the U.S.A.

By Wes Robinson

Imagine sterilising a bullet in a laboratory, loading it into a germ-free rifle breech, firing the rifle and hitting the target with a lead slug still as clean as the moment it came out of the laboratory.

A comparable feat of far greater magnitude faces space scientists who are planning to send unmanned spacecraft to other planets. By international agreement, the United States has committed itself to land only sterile probes on the soil of neighbouring planets. A craft landing on Mars, for example, must be 99.9999 per cent clean. The reason: man doesn't want to reach the surface of a distant planet only to re-discover transplanted biology from his own planet.

The killing of micro-organisms on a spacecraft can be almost as much a matter of bookkeeping as it is microbe warfare. Contamination samples are taken from the first stages of spacecraft assembly through to the completed vehicle. Results of the "bug-count" sampling are fed into a computer, which keeps records of the microbial buildup. As the spacecraft becomes more complex, organisms begin to be added between attached surfaces, and bug counts must be taken with greater frequency. The sterilisation heat cycle for a particular planetary landing vehicle will be based on the computer-calculated germ-load for that vehicle.

Counting the number of micro-organisms on a spacecraft bound for another planet is tough enough, but biologists also must predict all possible events which might affect the lander's sterility on its outward journey. Each potential event, such as a meteorite striking the vehicle and dislodging some bugs still alive but trapped within the structure, is assigned a "probability number" based on analysis and research. A computer then adds up all these probabilities and comes out with an overall probability figure for contaminating a particular planet with a particular spacecraft at a particular time.

Sterilisation is an absolute term — either you have it or you haven't. To achieve it requires that a spacecraft literally be baked at 257 degrees Fahrenheit. This requirement has caused problems.

No large interplanetary vehicle ever has been oven-baked completely, although small vehicles and parts of larger spacecraft have. Certain spacecraft materials tend to resist heat and in so doing, may protect "bugs" that have lodged under the sur-

faces of those materials. Some strains of micro-organisms are difficult to kill with heat. And heat can make some spacecraft materials unacceptably brittle.

These and other problems have led engineers to ask the advice of biologists, metallurgists, manufacturing specialists and research scientists before they put even preliminary designs on paper.

At Boeing, the task of spacecraft sterilisation begins in the laboratory. Here, Dr Richard Olson and a small staff of assistants grow "bugs" — batches of micro-organisms — and then think of ways to get rid of them. In the search for methods of sterilisation, the microbes are baked, smashed, irradiated and subjected to rarified atmospheres. The results of this mayhem are catalogued and routed to others studying planetary quarantine.

Dr Olson's group is concentrating on killing one strain of germs in particular, a tough little bug of the aerobic (oxygen-liking) spore-forming classification called *Bacillus subtilis*. From an aerospace biologist's point of view, spore-forming organisms are troublesome. The spores resist the sterilising effects of dry heat and prove to be much tougher to kill than normal cells. Dr Olson believes that if these aerobic spores can be eliminated, all other organisms automatically will be destroyed in the process.

Boeing's sterilisation research work is directly applicable to the proposed Viking project, a National Aeronautics and Space Administration assignment to land an unmanned probe on the surface of Mars in 1973. A team composed of researchers and designers from Boeing, General Electric and Hughes Aircraft is hoping to win the Viking bid over teams headed by McDonnell Douglas and Martin Marietta. Although GE's primary concern will be with the spacecraft's entry into the Martian atmosphere, the company's sterilisation experience on the now-cancelled Voyager program also will prove valuable.

Experiments also have helped describe and suggest solutions to the sterilisation problem. Boeing researchers, for example, found that micro-organisms buried within a solid propellant fuel might survive some rocket firings. However, certain liquid rocket propellants turned out to be self-sterilising. Researchers also discovered that the broad panels of solar cells, used to generate electric power on a



Colonies of micro-organisms, grown under laboratory conditions, for use in the tests being conducted in the Boeing research laboratories.

space flight, could provide shade and comfort to some germs. Solar cells are a spacecraft necessity, so Boeing is examining a potential antidote: the intense ultraviolet radiation in space may be a natural bug killer.

"The trip through the disagreeable environment of space might very well help us decontaminate some parts of the spacecraft," Dr Olson said.

There are other tests, too — violent tests. Dr Olson and his staff have loaded test samples with micro-organisms, then drop-hammered them onto a steel base plate with the force of a locomotive crunching into a concrete wall at 100 miles an hour. The purpose is to see how many organisms would live if hard impact on a planetary surface becomes inevitable. Dr Olson also has put germs into plastic bullets and fired the bullets into sterile steel canisters at velocities of 550 to 3,100 feet per second. The findings: the higher the impact force, the fewer organisms live through it.

Boeing also conducted tests to see if micro-organisms, given a reasonably comfortable entry and landing, could actually survive in a Martian environment. Data from Mariner 4, a spacecraft which flew to within 2,400 miles of Mars, set the specifications for simulating the environment of another planet — a trace of water, basic limonite soil, a 70 per cent carbon dioxide atmosphere, strong sunlight, low temperature and a reduction of atmospheric pressure. A mixture of organisms, including *Bacillus subtilis* spores, spent eight days and nights in this environment, provided by a space chamber. Dr Olson found that as long as the micro-organisms are shaded in some way and not exposed directly to solar radiation, they will survive.

However, the Boeing biologist had some encouraging words. "We know very little about Mars, only the information Mariner 4 managed to give us," Dr Olson said. "That probe showed there is probably less than one per cent water on the planet. If this is true, terrestrial organisms most likely will not be able to grow and spread."

Even so, Dr Olson and his group are working hard to make the odds one million to one against an Earth bug finding a new home on some other world.

STUDYING THE MARTIAN ENVIRONMENT

A massive amount of information was sent to Earth by telemetry from the two Mariner space missions which passed close to Mars in July and August. Scientists of the National Aeronautical and Space Administration in the U.S.A. have since been scrutinising the data obtained in minute detail. This article examines the functions and operation of some of the experiments carried on the missions.

The purpose of the 1969 missions was to study the surface and atmosphere of Mars to establish the basis for future experiments in the search for extra-terrestrial life, and to develop technology for future Mars missions.

The two 850lb spacecraft, named Mariners VI and VII, were launched in February, as a follow-on to the 1964-65 missions and as a precursor to the 1971 and 1973 missions. In 1971, two Mariners will orbit Mars for three months, to transmit a continual stream of data to earth by telemetry. This will be followed in 1973 by one of the most eagerly awaited events in the history of space exploration, rivalling the moon landing — the soft landing on the Mars surface of two instrument modules, which will carry television cameras to give man his first direct view of the surface of another planet.

Six scientific experiments were carried by the space probes:

- Television
- Infrared spectrometer (IRS)
- Ultraviolet spectrometer (UVS)
- Infrared radiometer (IRR)
- S-band occultation
- Celestial mechanics.

Of these, the last two are highly specialised, and will not be considered in this article.

A sharp increase in data return was achieved over the earlier Mars missions. The television pictures returned contained 3.9 million bits of information in each picture, compared with only 240,000 bits from the 1965 mission. In 1965, the transmission bit rate was 8-1/3 bits per second; in 1969 it was 270 bits per second.

TELEVISION. The object of the television experiment was to photograph the surface and atmosphere features over as much of the planet as possible, to determine if there are basic differences between the light and dark areas, to learn more about the seasonally ranging dark markings, and seek physical clues to the planet's origin and evolution.

Two colour TV cameras were carried: camera A, with medium resolution, had a wide-angle lens, and was fitted with green, blue and red filters to delineate colour differences; camera B was fitted with high resolution narrow angle lens and had a yellow colour filter to reduce haze. The announced program was for a series of up to 80 pictures to be taken as the spacecraft approached the planet, and for a series of 24 close-up pictures of the surface, taken at a closing range from approximately 6,000 to 2,000 miles from the surface. The trajectory was chosen to allow the close-up photographs to cover

as many as possible of the various types of features observed on Mars.

INFRARED SPECTROMETER. This instrument was designed to determine the presence in the lower Martian atmosphere of molecules that suggest biochemical processes, affect temperatures on the surface, and limit the amount of ultraviolet reaching the surface; and to detect variations in the composition of the atmosphere, particularly water vapour, relative to geographic locations.

The instrument covered about the same areas as the TV cameras to help determine the composition of the light and dark areas visible on Mars. Data from this experiment can also be compared with some of the results from the ultraviolet spectrometer concerning the composition of the Martian atmosphere. The infrared wavelength region detected by the instrument (1.9 to 14.3 microns) was selected to allow detection of the presence of water, carbon dioxide, methane, ethylene and acetylene, as well as other molecules. The presence of organic molecules would have lent evidence to the existence of either present or past life on Mars.

The presence of sulphur-dioxide and hydrogen-sulphide would have indicated possible Martian volcanic activity, a valuable clue to the history and internal structure of Mars.

The detection of ozone molecules, correlated with data from the ultraviolet spectrometer experiment, would have provided information on the amount of UV reaching the surface. Ozone is a strong absorber of UV.

The distribution of any water vapour present in the atmosphere was to be correlated with ground features to possibly determine differences between light and dark areas. Any large variations in the distribution of water vapour would indicate possible future landing sites for life detection equipment.

Analysis of the data can also yield information on photo chemical processes, surface temperatures, reflected sunlight, emissivity of surface and possibly chemical composition of the surface.

Light enters the infrared spectrometer through a telescope, is focused, split into two beams and directed to the two detectors. The latter are both cooled for maximum efficiency. The channel 1 detector is cooled by liquid hydrogen to below -400°F. The channel 2 detector is cooled by a radiator plate which is exposed to the cold of space to maintain the detector at about -240°F.

The wavelengths reaching the detectors are selected by rotating filters. The filter assembly rotates every 10 seconds

to complete one scan of the wavelength region being examined.

The energy of the light reaching the detectors is registered as a voltage change across the detectors. This analog signal is processed and converted to two pulses which are separated in time proportionate to the analog signal.

In these Mars missions, the pulses were converted to binary values and stored in a digital recorder for transmission to Earth after the flyby. Engineering measurements on the experiment, critical voltages, temperatures and gas pressures, were transmitted to Earth in real-time, every 4.2 seconds. These values are of importance in analysing the experimental data.

The cooling system for the channel 1 detector employed two 600psi gas bottles storing hydrogen and nitrogen. Gas delivery to the cooling unit was shortly before encounter. On command, explosive devices opened valves to begin the gas flow. The same command started a filter wheel motor.

ULTRAVIOLET SPECTROMETER. The ultraviolet spectrometer was designed to identify gases in the upper Martian atmosphere by detection of various molecules, atoms and ions, and to determine their amounts.

Identification of the gases present in the Mars atmosphere can determine if the atmosphere is the result of condensation of solar material, and therefore primordial in origin, or was formed by gases released from the planet, as on Earth, or a combination of the two. The composition, and therefore the origin and evolution of the atmosphere can reveal the age and evolution of the planet itself. A study of the atmosphere can also determine the environment in which life forms, if present on Mars, would have to exist.

A lack of oxygen, for instance, would mean that life forms must have developed some means of obtaining oxygen other than from the atmosphere. The lack of a shielding layer of ozone, which on Earth filters out the ultraviolet wavelengths that are deadly to life forms, would indicate that a life form on Mars would require its own protection to exist or would exist under a protective layer of soil or rock.

An ultraviolet spectrometer identifies different species (molecules, atoms and ions) by the wavelengths of light that they absorb or emit. Each species absorbs the energy of light, which is composed of a number of different wavelengths, at one or more wavelengths and re-radiates the absorbed light at the same or longer wavelengths. An atom re-radiates the wavelength it absorbs. The spectrometer can detect certain wavelengths and thus identify the species.

UV studies of Mars have not been made from Earth because UV cannot penetrate our atmosphere. Brief studies have been made from balloons and sounding rockets above the atmosphere. The Mars mission represents the first attempt to utilise a UV spectrometer to identify gases in the Martian atmosphere, and to provide data on atmospheric density, temperatures relative to

altitude and the amount of UV which strikes the surface of Mars.

The operation of the UV spectrometer is as follows. The light to be analysed is focused and collimated (light rays made parallel) by mirror elements in the instrument and directed to a grating which diffracts the light into its separate wavelengths. The diffracted light is again focused by a mirror element through slits and on the detectors. The two detectors are photo-multiplier tubes, each sensitive to different regions of the wavelength spectrum. One tube responds in the 1100 to 2150 Angstrom region, the other from 1500 to 4350 Angstroms.

The grating is ruled or grooved with 2160 rules per millimeter, and is mechanised to rotate. Because each wavelength is diffracted at a different angle, the rotation directs the separated wavelengths to the detector sequentially. The known position of the grating in time allows determination of the wavelengths striking the detectors.

The light reaching the detectors is converted to a voltage proportionate to the amount of light. The voltage is processed and stored for transmission to Earth after the fly-by.

INFRARED RADIOMETER. This experiment provided temperature measurements of the surface of Mars by detection of thermal radiation in the infrared portion of the electromagnetic spectrum.

The instrument was boresighted with the TV cameras to allow correlation of surface temperatures with terrain features and clouds. The object was to provide a map of the surface relating temperature variations to surface features. The presence of frozen water (permafrost) on Mars would have indicated a possibility of localised moist areas on the surface. However, the results of the experiment indicated that water could not exist on the Mars surface, because the atmospheric pressure was too low. Ice would not actually melt in this low pressure, but would go from the solid state to vapour in one step.

Data from this experiment seem to indicate that the Martian poles are covered with frozen carbon dioxide, not frozen water, as was considered possible.

The IRRs aboard both spacecraft were programmed to scan the Martian surface across the sunlit portion and into the dark side — in effect from late morning to early evening.

The data obtained was required to show the cooling rates and the daily variations in temperatures as the surface absorbs heat from the sun during the day and loses heat during night hours. It was also required to determine whether the surface is solid, like rock, or composed of loose material like sand or dust. Data on the dark side of Mars was particularly required, as this is not obtainable from Earth.

Two detectors in the instrument each provided 30 readings every 63 seconds. Of the 30 readings, 27 were of planetary temperature; two were calibration readings; and one was an engineering measurement on the instrument temperatures or voltages. The calibration readings were made from an internal source of known tempera-

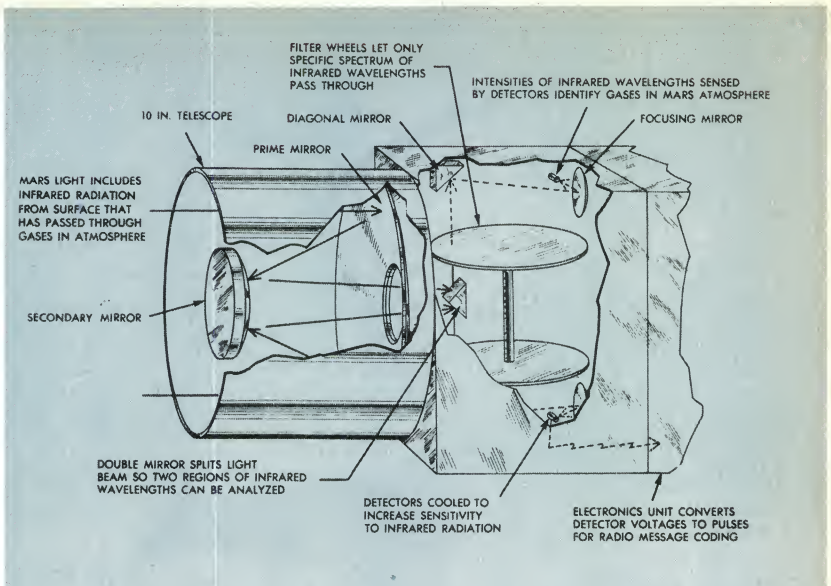

Infrared spectrometer, to identify gases in lower atmosphere.

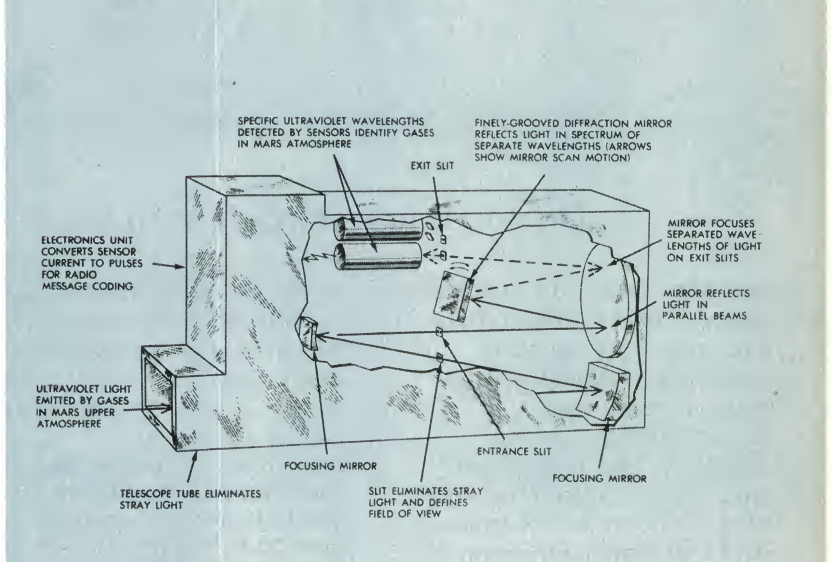

Ultraviolet spectrometer to identify gases in upper atmosphere

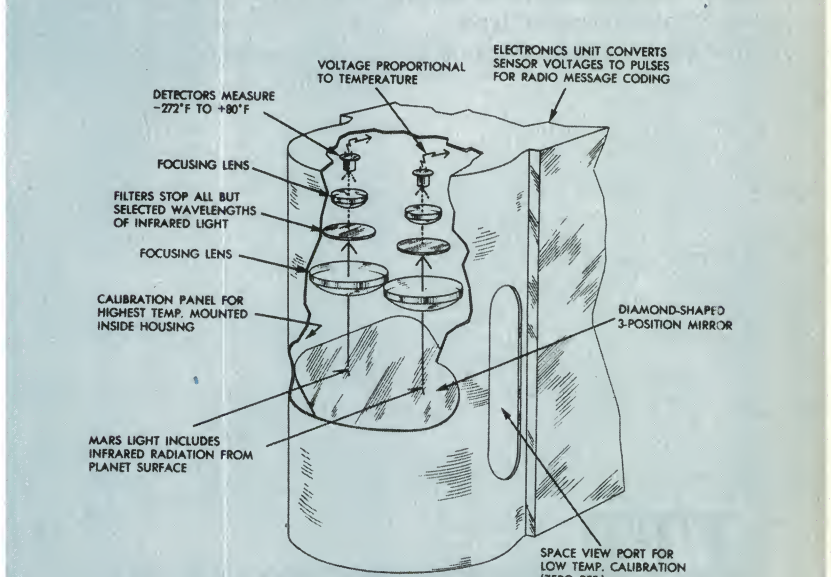

Infrared radiometer, to measure surface temperature.

(Continued on page 191)

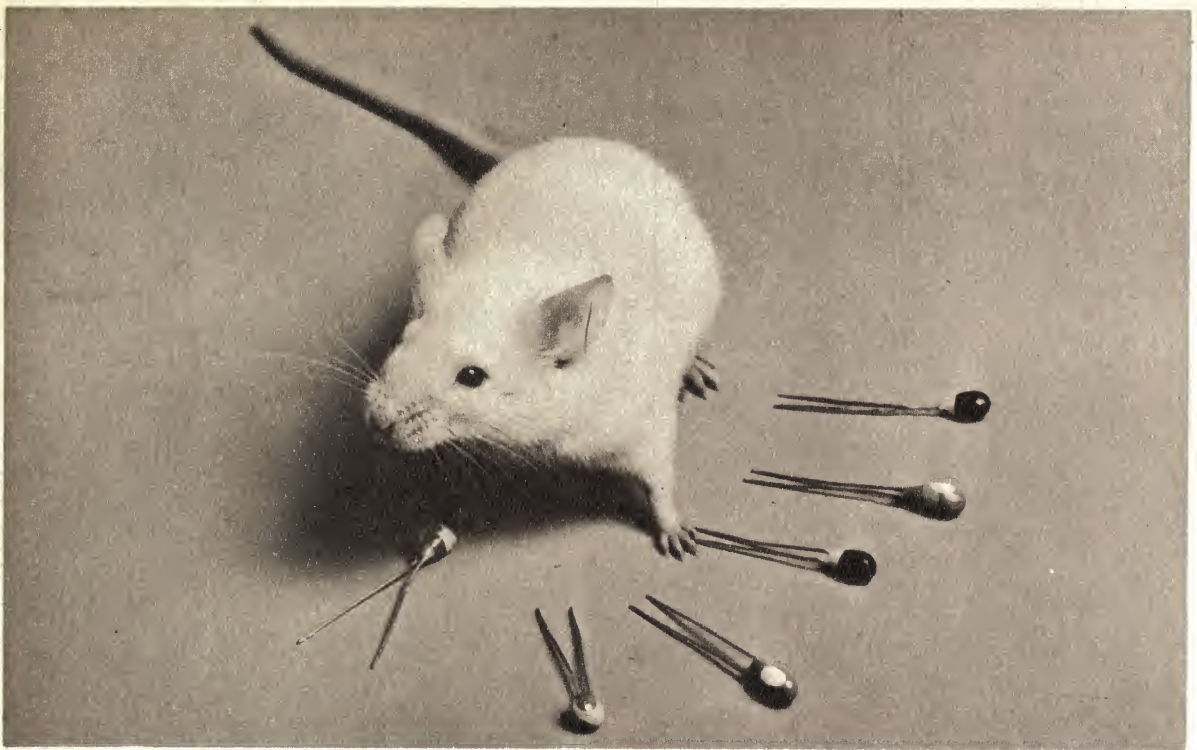

Do you have a circuit for a $68\mu\text{F}/3\text{V}$ mouse?

Meet Alice. She tried to make history. Tried to polish off one of our new TAG tantalum capacitors. (It would take her weeks to get through a conventional electrolytic capacitor). TAG looked just right. Sort of mouse size. And that's the point: where space is limited, or if miniaturisation is your aim, you'll find one tiny TAG capacitor will do the same job as the normal electrolytic type. Actual size is about the same as

a match head. Just small enough to save you a lot of sweat. And time. And money. We have a free booklet that tells you all about TAG. To get your copy, simply contact:
Components Division, Standard Telephones & Cables Pty. Limited, Moorebank Ave, Liverpool, N.S.W. 2170. Phone Sydney 602.0333 or phone Melbourne 480.1255, Canberra 49.8667, Brisbane 47.4311, Adelaide 51.3731, Perth 21.6461, Newcastle 61.5172, Wollongong 2.7974.

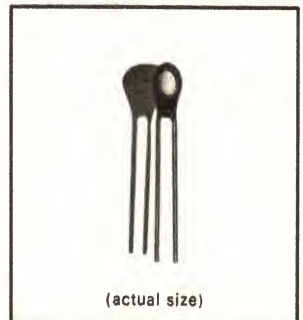

(actual size)

TAG Tantalum Capacitors
 3 to 35V., $0.1\mu\text{F}$ to $100\mu\text{F}$,
 .30" to .38",
 -55°C . to $+85^{\circ}\text{C}$.

AN **ITT**
 ASSOCIATE

world-wide telecommunications and electronics



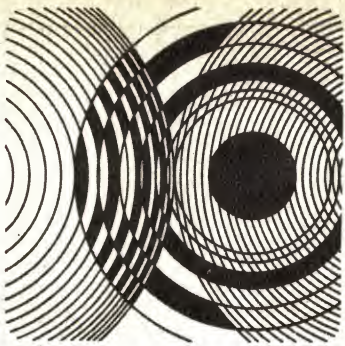

TECHNICAL DIGEST

Closed-circuit television in mine drama

When subterranean water flooded a gold mine in South Africa, closed-circuit television played a major role in the reclamation of gold reserves worth millions of dollars.

On October 26, 1968, a miner, working on a slope between the fourth and sixth levels of Number Four shaft of West Driefontein Gold Mine, heard the rockface beginning to "talk." This is a mining term to describe the creaking, groaning sounds heard in mine workings. These noises are the first warning of an impending rockburst. The miner promptly withdrew his team and reported to his shift boss. He was ordered to withdraw even further.

As the working area was evacuated, water burst through a fissure in the rockface in what was later described as an "atomised" spray. It was considered impossible to seal off the fissure and the mine was evacuated; two thousand workers were hoisted to the

surface within four hours. Only emergency crews remained below to deal with the flood which was to become a torrent as more than 85 million gallons a day roared from Number Four shaft into the mine.

So began a 25-day drama in which South Africa's richest mine, with known gold reserves of R1200 million (approximately \$A1,000 million), fought to conquer a flood that threatened to close it for at least two years.

Men worked in strongly flowing water that was sometimes chin high. At one stage, they had to cope with winds howling along drives and through shafts at up to 100 miles an hour as the floods disrupted the ventilation system. Incredibly, no one was

killed, and there were no reports of serious injury.

It was a drama that held all South Africa and the rest of the world in suspense, demanding from the men engaged in the struggle the maximum in courage and endurance against appalling risks. It demonstrated once again South Africa's supreme mining and engineering skill.

West Driefontein also gave closed-circuit television its most dramatic role in South Africa. It was installed to keep vital plugs under surveillance when the flooding Number Four shaft was sealed off from the rest of the mine.

West Driefontein's flood came as a complete surprise. Miners had blasted a drive and drilled at least 16 times without mishap through the "dry" fissure that was to spring such a costly and spectacular leak.

But the groundwork for the flood was prepared millions of year ago by nature when she overlaid the rich gold-bearing reef of the Far West Rand with a layer of treacherous dolomite that is, on average, 3000ft thick.

Diagrammatic cross section of West Driefontein gold mine.

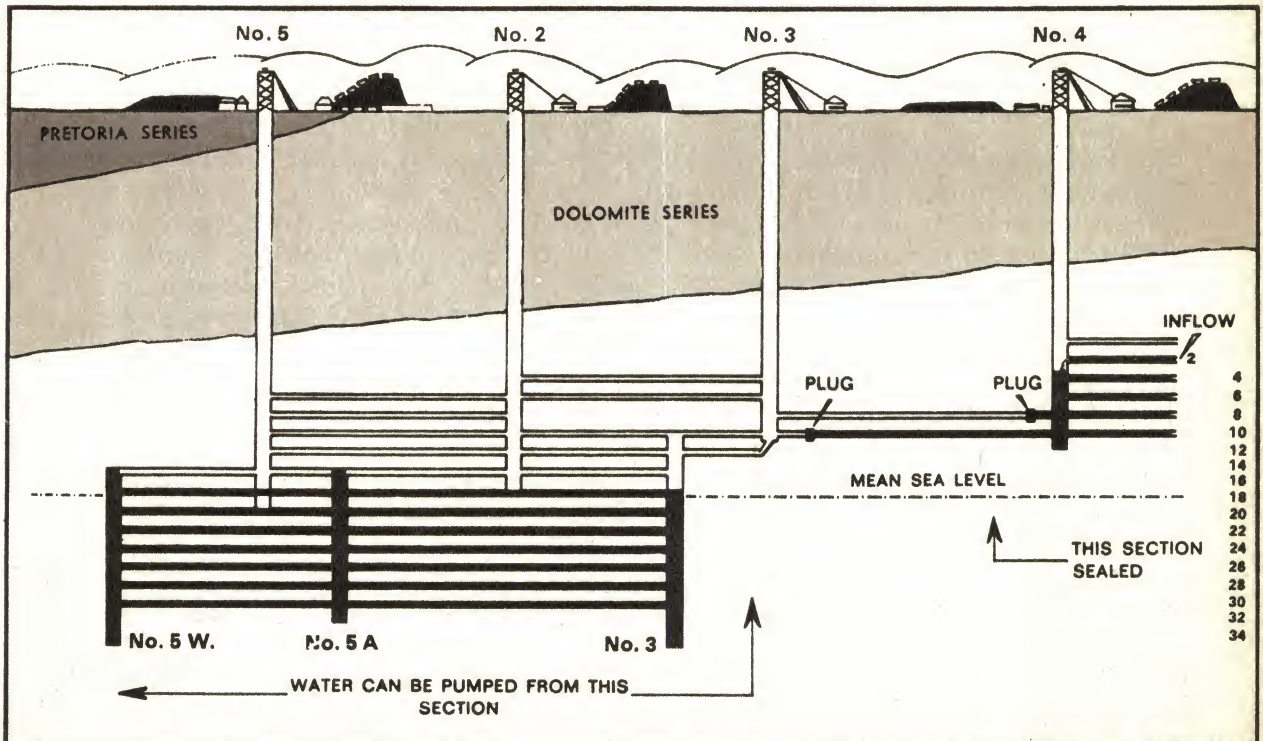

Simon Gray
proudly presents
the "SILCRON" . . .
an all-new
precision built Australian turntable



ONLY
\$44.50!

With a wow and flutter specification of less than 0.04% the new SILCRON two-speed turntable combines precision engineering with the proven design principle . . . BELT DRIVE.

The most sophisticated stereo cartridges and tone arms may be used with this high-performance turntable. Speed accuracy is absolute as a substantial 12-pole sealed synchronous motor provides the motive power. A unique speed change mechanism of robust design permits changes from 33 $\frac{1}{3}$ to 45 r.p.m. in less than one second. Cast from aluminium, the 12" diameter turntable itself is machined to fine tolerances and dynamically balanced. An anti-static rubber mat is fitted as standard equipment. The actual drive belt is pure latex and drives the turntable around its perimeter where a deep groove is machined into the turntable edge. Depth required below the motor board is only $\frac{3}{4}$ " and height above can be as little as 2". No other turntable on the Australian market offers as much value and as much performance as the new SILCRON . . . which is backed by the national sales/service network of Simon Gray Pty. Ltd. Ask your favourite hi-fi dealer for a SILCRON demonstration!



Australian National Distributors:
Simon Gray Pty. Ltd.

Head Office: 28 Elizabeth St., Melbourne, Vic. Tel. 63 8101*
 Sydney Office: 22 Ridge St., North Sydney, N.S.W. 929 6816
 Canberra Office: 31-33 London Circuit, Canberra City, A.C.T. Tel. 49 6050

INTERSTATE REPRESENTATIVES:

N.T.: Pfitzner's Music House, Smith Street, Darwin. Tel. 3801
 Q'land: Sydney G. Hughes, 154-158 Arthur St., New Farm, Brisbane. 58 1422
 S.A.: Eilco Sales Pty. Ltd., 7-9 Osmond Terrace, Norwood, S.A. Tel. 63 4844
 Tas.: K. W. McCulloch Pty. Ltd., 57 George Street, Launceston. Tel. 2 5322
 W.A.: Athol M. Hill, 613-615 Wellington Street, Perth. Tel. 21 7861

Through the centuries, this dolomite was slowly eroded into huge caverns that filled with water. The eroding action of water on the dolomite made the Far West Rand countryside unstable. Voortrekkers (pioneers) who settled on the rich farmland of the Western Transvaal, noted huge grass-covered depressions caused by caved-in earth. The area in which West Driefontein is situated the Voortrekkers called Gatsrante (literally): "The Hills of Holes".

The age-old instability of the dolomite and the huge underground lakes that it held have bedevilled mining operations from the beginning. Sudden cave-ins, known in South Africa as "sink holes," have claimed many lives and caused incalculable damage. Early prospecting and mining in the Gatsrante was thwarted by the flood risk. The first shaft, sunk in 1910, was drowned by floodwaters from a fissure. As a result, exploration was discouraged for years.

In the late 1930s, Goldfields of South Africa, the gold mining company founded by Cecil Rhodes which owns the West Driefontein mine, pioneered new methods of prospecting in what is now known as the Far West Rand Goldfields. It then introduced the cementation process, the now famous system of plugging water-laden fissures with huge quantities of cement — as much as half a million buckets of cement to a fissure.

The dolomite structure has been particularly savage to West Driefontein in the sixteen years of its existence. In 1962, after ten years of operation, in which West Driefontein earned the sobriquet of the richest gold mine on earth, a "sink hole" (subsidence) opened up on the property and swallowed the giant reduction works.

Now it was flooding. As emergency teams struggled by the light of their helmet lamps to dam the flood with sandbags, increasingly gloomy reports gave the mine 39 days' grace, then 28, and finally a bare 13 days. More pumps were borrowed and brought from other mines. Neighbouring mines began drilling towards the drowning mine, intent on helping to pump out the rising flood.

The pumps had a Herculean task. The mine used 36 giant pumps at a time but these were never able to do more than pump out about 70 million gallons a day against an inflow of about a 100 million daily.

When it became apparent that pumping would never win the race against time, engineers decided to surrender Number Four shaft to the flood and intensify the battle to save the rest of the mine, which normally produces 85 per cent of the total monthly output of gold.

To do this, it was decided to concentrate on "plugging" the two drives, on Ten and Twelve levels, linking Number Four shaft to the rest of the mine.

Never-say-die, was the motto: "We'll pump the mine dry even if it's connected to the Indian Ocean," the miners cried, as they worked up to their necks in the fast flowing water.

On Twelve level, pipes to take the flood water were laid and packed with rock. The 6000 cubic feet of grout (a mixture of sand and cement) had to be pumped in under pressure of up to 4000lb per square inch.

When the time came to close the

Holograms can be erased magnetically

RCA has developed a new technique for producing holograms that can be erased by the field from an electromagnet.

The holograms — called phase holograms — are produced on a special magnetic surface through the interaction of both the heat and light inherent in a laser beam.

The significance of the new RCA technique is that it could make possible an optical computer memory able to store 100 million bits of data in a film one inch square that could be read out, erased and re-used repeatedly.

That compares with present experimental techniques based on the use of photographic film or similar photosensitive materials which cannot be erased.

By contrast the new RCA technique makes it possible to "write" information into a magnetic film in 10 billionths of a second, and to erase it in 20 millionths of a second.

An extremely thin film of manganese bismuth, a magnetic material, is deposited in a single-crystal layer two-millionths of an inch thick on a base of mica.

The film is then subjected to a strong magnetic field that forces all its magnetic atoms to line up with their north poles in one direction, their south poles in the other.

Next, the light from a pulsed laser is split into two beams, one going directly to the film and the other going first to the information bit pattern to be recorded and then to the film.

At those points when the two beams interfere constructively (add their powers together) the heat from the laser beams warms the magnetic material sufficiently to allow its magnetic atoms realign themselves so

that the north poles of those in the heated portions now point in the same direction as the south poles in the unheated portions.

Where the two beams interfere destructively (and to cancel each other) nothing happens.

Thus, a magnetic pattern is created in the film that corresponds to the interference pattern created by the converging laser beams, and a magnetic hologram is born.

The magnetic hologram can be read out in two ways, either by transmitting a laser beam through it, or by reflecting the beam from it.

The hologram can be erased simply by electronically pulsing a nearby wire coil that subjects the film to a strong magnetic field and forces the magnetic atoms to line up, as at first, with all north poles in one direction, all south poles in the other.

So far, there is no indication that the process causes any thermal decay or other type of fatigue in the material. Apparently, the write-erase cycle can be repeated indefinitely and because of the inherent redundancy of holographic storage, dust or minor imperfections in the magnetic film do not seriously affect the hologram readout which can be detected, or read, by light sensitive devices, including the human eye.

In his development work the magnetic holograms were made using a Q-switch ruby laser with a 200-microjoule, 10-nano-second pulse, and were read out with a continuous wave helium neon laser. They can also be made and read out with infrared lasers. ("Electronics Weekly," 6/8/69.)

valves on the pipes controlling the flow of flood water through the "plugs," men would do the job. But they could not be expected to remain in the danger area to see if the "plugs" would hold. There was one medium that could do the job—closed-circuit television.

The Goldfields group already had Philips television units in use elsewhere for security purposes. So they turned to Philips again with an urgent order for closed-circuit television equipment. Initially, the engineers wanted a camera to watch the "plug" on Twelve level. Once the valves were closed, this was expected to bear the greatest pressure — between 14 and 15,000 tons on a 10ft square surface.

Within 36 hours, Philips television engineers and the mine's own engineers had bolted a weatherproof type PM 1000/04 camera to the hanging wall and linked it with 10,500ft of low-loss coaxial cable to a 23in monitor on the surface.

About 5000ft of cable was bolted to the Twelve level hanging wall back to Number Three shaft. Another 5000ft was then installed up the shaft to the control offices. It was by far the longest CCTV link installed in South Africa. A PM 1370/02 video correction amplifier had to be installed near the monitor to compensate for the cable losses.

Mine engineers were delighted with the clarity of the picture. Later, a second camera with a similar length of coaxial cable was installed on Ten level to keep another "key plug" under surveillance.

On November 18, South Africa held its breath as the mine management announced that the huge valves were to be closed. The use of CCTV in the crisis quickly became "glamour" news and everyone knew that engineers would be scanning the plug faces on the television screen hour by hour.

The "Johannesburg Star" described the drama of the 14-man crew being watched on the screen by engineers on surface as they closed off the valves with these words: "A miner below turned towards the camera, gave the thumbs-up sign and jubilation spread through the building." West Driefontein's men had won.

Two days later, men were mining again on Twelve level. The mine was back in limited production. The pumps were at work de-watering the section of the mine that had been used as a reservoir while the "plugs" were being built. Eight-five per cent production capacity within four months was predicted. And engineers set about salvaging Number Four shaft, drowned in a huge volume of flood water. ("Philips Sound + Vision," No. 26.) ■

RACAL

ELECTRONICS PTY. LIMITED



Airmec

AM/FM Modulation Meter type 409

Carrier range 3-1500MHz
AM 0 - 100% in 3 ranges
FM 0 - \pm 600 kHz in 6 ranges

Switched noise filter incorporated
Fully stabilised power supplies
Built-in FM calibrator

Available from stock for \$710

RACAL

ELECTRONICS PTY. LIMITED

SYDNEY—47 Talavera Rd., North Ryde, N.S.W. 2113. Ph. 88-6444

MELBOURNE—Suite 22, 553 St. Kilda Rd, Vic. 3004. Ph 51-5726



MINIATURE TV CAMERA MAY SERVE AS ARTIFICIAL EYE

Research being conducted in Britain may eventually lead to the development of a miniature television camera linked directly to the brain, which may be used as an artificial eye for blind people.

In an operation performed at Addenbrookes Hospital in Cambridge, a surgeon, Mr W. S. Lewin, implanted tiny electrodes into the brain of a blind patient and subsequently passed minute electric currents through them. The effect was to cause the patient to see points and patterns of light. The surgeon was assisted by a physiologist, Professor Giles Brindley, who is now working at the Psychiatric Institute at the Maudsley Hospital, London.

They were operating with the full co-operation of their patient, a 52-year-old woman who had been a nursing sister until she lost her sight a few years before. Eighty minute radio receivers were surgically connected to the brain cells of her visual cortex, the part of the brain responsible for sight. The receivers were embedded in a cap of silicone rubber which was fitted between the scalp and the skull. This cap was connected to another one, slipped under the skull and actually fitted over the visual cortex. From this inner cap, 74 tiny platinum electrodes contacted the brain cells. When the radio signals were sent to the receivers, 39 of the electrodes actually caused a visual sensation, in the form of a small spot of white light, described as being like a star in the sky and about the size of a grain of sago held at arm's length. Some electrodes produced pairs of stars, or even three or more.

The doctors have now been experimenting with this patient for well over half a year, obtaining the information they need for more elaborate systems of artificial vision. The apparatus, especially the platinum electrodes used, is very delicate and complex. A second set is now being assembled, ready for another patient who is anxious to undergo the same operation. Meanwhile, a more elaborate system is being planned as a replacement for the first patient.

Professor Brindley and Mr Lewin hope in the next stage to link the receivers to a television camera. From the data obtained so far they believe that it will be possible to arrange their electrodes so as to spell out letters by patterns of glowing dots in the visual cortex. It already looks as though blind people could learn to read print or even handwriting as fast as sighted people, so training should present no problem. Much further in the future lies the ultimate target of restoring sight as opposed to merely providing a reading machine. That is a long way away but since the doctors themselves have talked about developing a "visual prosthesis" one can assume that the ultimate aim of the Cambridge doctors is to provide an artificial equivalent of the human eye.

Addenbrookes Hospital is not the only centre in Britain where work contributing to this end is being carried out. At the National Institute for Medical Research at Mill Hill, in North London, Dr Delisle Burns has been investigating how individual brain cells work together to build up a visual picture of the outside world. One of the main problems to solve is how the brain recognises contrast in the visual field outside of the animal, that is, how a nerve cell in the brain can signal to the rest of the nervous system that it is representing the light side of a dark border or the dark side of a light border. The first problem in this sort of experimental work is to find a cell at all and this is done by thrusting into the surface of the brain of an anaesthetised animal a very small recording electrode, the tip diameter of which is about two microns, one ten-thousandth of an inch. This tip has to be placed so that it will record what might be described as the private life of one individual nerve cell. The electrode then records when the cell is stimulated, as shown by it firing off a nervous message, as well as when the cell is resting and doing nothing. The animal is then shown various visual patterns and the cell's response is noted.

One thing which has already emerged from this work is that different nerve cells respond to light-dark interfaces running in particular directions and not to interfaces with other orientations. For example, one particular cell will respond to an interface running from north west to south east, but does not fire at all if the border is swung round until it points north and south. But a neighbouring cell only 30 microns away will respond only to a north-south orientation.

At the National Physical Laboratory Dr Christopher Evans and other workers had been investigating the same kind of problem from a slightly different point of view, concerned with the way in which groups, or rather chains, of brain cells concerned in vision worked together. Their research suggests that rows of five or six cells linked in lines running in various directions are used to respond to light-dark interfaces running in the same direction. A very crude start has been made on plotting the visual cortex in terms of these different structural elements, responding to differently orientated interfaces in the outside world.

Surgeons have enough information at least to know approximately where to plant electrodes in attempts to restore a very crude form of sight. They are much less certain of exactly

what form of electrical stimulation to feed in through the electrodes. Here, the kind of work going on at the National Institute of Medical Research is showing promise. And, of course, the information obtained at Addenbrookes from a human subject, who has been able to describe—as experimental animals cannot—the effects of the experiment, has been enormously valuable to the scientist working with animals.

Once the problems have been solved, it should be—relatively speaking—simple to join the right kind of television camera to the brain. Dr Burns has estimated that this could conceivably happen within three or four years. It will then be perhaps as expensive and rare as a heart transplant is today. But as experience develops, it is likely that cheaper and simpler ways of performing the operation will be developed.

Helping the progress of this kind of research is its practical implications, both in contemporary medicine and, perhaps surprisingly, in business. Research into the structure of the visual cortex has already been used to show how a pair of eyes is lined up to ensure that someone sees single instead of double and this has had direct bearing on the treatment of squint, a common affliction of children. Scientists and engineers who are trying to design better reading machines are finding it extremely useful to learn from the organisation of the brain. At the National Physical Laboratory, research on human vision is proceeding hand-in-hand with the development of a reading machine called Cyclops 3, designed to read letters neatly printed by the human hand, which will use a scanner made up of five linked but separate elements corresponding in some ways to linked chains of nerve cells in the human brain. (See "The 2-ness Of The 2," in the December, 1968, issue.)

Dr Burns' work could have similar application. As he put it recently, "There is a very direct and obvious connection between our efforts to find out how animals or men recognise the patterns put in front of them and the efforts on the part of computer engineers to design a computer to recognise your or my signature on a cheque. If I can find out how an animal recognises patterns in its visual field, I may be helpful to the man who is trying to design a computer to do very similar jobs. Likewise, if the computer designer gets home first, he may suggest ways to me in which a man or animal does the same job. I can then investigate whether his method is the method in fact used in biology."

More and more engineers, including electronics engineers, are coming to realise how much they can learn from the extraordinarily efficient systems produced in living things by the driving force of natural selection. (Spectrum 1969/No. 60.)

Eveready re-chargeable Nickel Cadmium batteries can do hundreds of cycles.



'Eveready' Nickel-Cadmium cells have an incredibly long life: they can be stored charged or uncharged, they are completely sealed, they can be trickle charged, and their charge discharge cycle life extends into hundreds.

Cell sizes range from 20mah to 23ah in button, cylindrical and rectangular forms.

Contact your nearest Union Carbide Sales Office or write to Union Carbide Australia Limited, 167 Kent Street, Sydney, 2000. Please ask for technical literature.

EVEREADY BATTERIES Products of **UNION CARBIDE**
'Eveready' and 'Union Carbide' are registered trade marks.

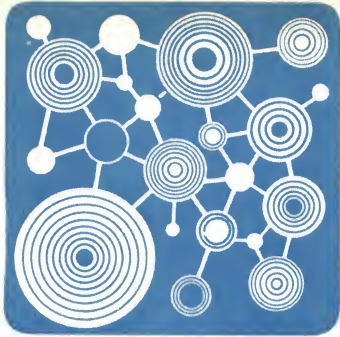

SCIENTIFIC AND INDUSTRIAL NEWS

International power fair

Nor-Power 70, an international fair of equipment and services required in building and operating a power plant, is to be held in Oslo, Norway, from May 18 to 23, 1970. The fair will include: hydro, thermal, and nuclear power plants; special operating equipment for power plants and industry; and equipment for room heating. There will be limited facilities for exhibiting household electrical appliances, snow-melting equipment, electric cars, etc. Nor-Power 70 is organised by the Norwegian Trade Fair Committee in co-operation with the Norwegian Watercourse and Electricity Board and the Association of Norwegian Electrical Power Plants to mark the fiftieth anniversary of the Norwegian Trade Fair. It is the first of its kind to be held in Scandinavia.

Various seminars will be arranged in conjunction with the fair. The following subjects will be discussed: prognoses of future electrical energy demand; optimisation of power plant operation; master control of grid systems; modern ideas in projection of hydro-electric development; electric room heating. Inquiries should be addressed to Nor-Power 70, Toggst 10, Oslo, Norway.

Airport transit system

An automatic transportation system for the ground movement of passengers is being installed by Westinghouse at the Seattle-Tacoma International Airport on the west coast of the U.S.A. It consists of nine computer-controlled vehicles, each carrying 106 passengers, operating underground services to six intra-airport passenger "stations." The electrically powered vehicles will be rubber-tired, and run on concrete rights-of-way. The vehicles will follow an I-shaped guide rail (located in the middle of the running surface), to which they are positively locked through their guidance systems.

The service will operate on two loops, one on either side of the main passenger service, with a shuttle service between the two loops. The system has been planned to carry 1200 passengers every five minutes. Passengers at any of the stations will wait less than two minutes for a vehicle. In addition to providing project management, design engineering, and maintenance service, Westinghouse will supply the automatic train control and communication system, guideways, television monitoring systems, and power distribution systems.

Cleaning high-voltage insulators

A device for cleaning the insulators of high-voltage wires with high-pressure jets of water has been adopted in the Donetsk area of the U.S.S.R. Previously the cleaning was done by hand. The insulators had to be wiped at 1200 support points along the power lines at least twice a year. The time spent on this was about 6000 hours annually with a loss of electricity, which had to be cut off during the cleaning operation, of about 230MWH. Power does not have to be cut off using the new machine, named the TTsM-1 after the initials of its three inventors Tarasenko, Tsyb, and Musatov. The physical safety of the operator is guaranteed since the water

is directed on to the insulators in separate spurts (about 15 per minute), and there is no direct connection between the operator and the power lines.

The apparatus consists of a slide valve distributor with a piston and directing cap connected to a tank with a capacity of about 22 gallons. It can be mounted on any vehicle containing a water tank and a pump — they are using fire engines in the Donetsk region. The method is said to have given considerable economic savings, and an increase in labour productivity of four to five times.

Symposium on submillimetre waves

The Polytechnic Institute of Brooklyn has announced that the twentieth in its Microwave Research Institute series of annual international symposia will be held in New York City from March 31 to April 2, 1970, on the topic of submillimetre waves. The purpose of the symposium is to bring together those who approach the submillimetre wave region of the spectrum from the microwave region and those who view it from the optical region. The areas to be covered include long wavelength lasers, nonlinear effects in semiconductors, thermal and quantum detectors, and parametric interactions. Implications for components and applications to systems will be considered.

Prof. Benjamin Senitzky, chairman of the symposium committee, will welcome contributed papers up to December 1, 1969. A 500-word abstract should be submitted with explanatory material and/or essential results included as appropriate. Papers discussing work at millimetre or infrared wavelengths are welcome if the results show promise of future submillimetre wave use. Papers are solicited in the following areas: long wavelength lasers; non-linear and non-reciprocal interactions; semiconductor sources; transmission techniques; detectors and amplifiers; systems techniques. Papers on other novel techniques in the region are also welcome. Address all correspondence to Jerome Fox, Executive Secretary, MRI Symposium Committee, Polytechnic Institute of Brooklyn, 333 Jay Street, Brooklyn, N.Y. 11201, U.S.A.

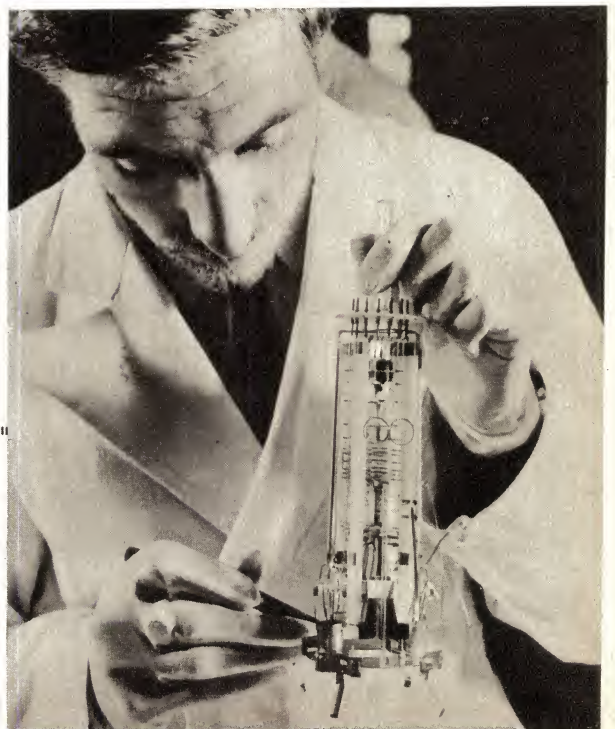

Electron gun for storage CRT

An electron gun assembly for a storage cathode-ray tube is inspected during its manufacture at the English Electric Valve Co. Ltd., Chelmsford, England. The features claimed for this storage tube are: ability to store a picture for up to half an hour; very high brightness for viewing in direct sunlight without hoods; variable persistence permitting the tube's use as an ordinary CRT if required; variable brightness.

The assembly comprises a writing gun and two flood guns. When fitted into the storage tube, the writing gun modifies the charge on a mesh (just behind the screen) which is then illuminated by electrons from the flood guns. Electrons pass through the mesh in a pattern determined by the writing gun to give a long-lasting picture on the screen.

MILLIONS



Mullard

SMALL SIGNAL & SWITCHING DIODES

wide range · fast delivery · low cost

Millions of Mullard small signal and switching diodes have been supplied — and are still being specified — for an increasing number of industrial

applications. Many of the types listed below are also produced to CV specifications for use in military and other Government equipments.

Germanium Gold-Bonded Diodes

Type No.	Max. P.I.V. (V)	IFM (mA)	Max. Recovered Charge (pC)
AAZ13	8	100	30
AAZ33	15	240	80
AAZ32	30	150	150
AAZ30	50	400	500
AAZ42	70	400	400
AAZ17	75 (Surge)	150	900
AAZ15	115	250	1800

Germanium Point Contact Diodes

Type No.	Max. P.I.V. (V)	IFM (mA)	Max. Operating Frequency (MHz)
AAZ11	90	150	—
AA119*	45	100	60
OA90	30	45	100
OA91	115	150	100
OA95	115	150	100

* Available in matched pairs

Most of these low cost diodes are available for rapid delivery. For full technical data, price and delivery information, let us have details of the types you require.

Silicon Junction Diodes

Type No.	Max. P.I.V. (V)	IFM (mA)	Typical IR Max. P.I.V. (MA)
OA200	50	250	0.02
OA202	150	250	0.01

Silicon Whiskerless Diodes

Type No.	Max. P.I.V. (V)	IFM (mA)	Max. Reverse Recovery Time (nS) +
BAX13	50	150	4
IN4148	75	—	4
BAX12	90	800	60
BAX16	150	300	120
BAX17	200	300	120

Silicon Epitaxial Planar Diodes

Type No.	Max. P.I.V. (V)	IFM (mA)	Max. Reverse Recovery Time (nS) +
IN4009	25	75	2
IN3604	75	150	2
BAY38	50	225	4
IN914	75	75	4
IN3064	75	225	4

+ Under specified conditions

Mullard

Mullard-Australia Pty. Ltd.

35-43 Clarence Street, Sydney, N.S.W. 2000. Phone: 29 2006
 123 Victoria Parade, Collingwood, Vic. 3066. Phone: 41 6644
 St. Paul's Tce. and Light St., Bowen Hills, Qld. 4066. Phone: 51 5151
 Associated with MULLARD LIMITED, LONDON

M223

Acoustic gas valve

A surface vessel can locate and operate underwater gas pipeline valves any time of day and night, without divers, by using an acoustic valve operating system developed by the Electro-Dynamics Division of the Bendix Corporation, California, U.S.A. Called AVOS, the system allows a shipboard operator to locate a selected gas valve from a distance up to three miles, and to open or close that valve from half a mile. The range to the valve and the actual status of the valve are automatically displayed and updated. Bendix believes this is the first practical system of this type to have been developed.

AVOS has four functional units: the shipboard equipment which includes display and controls; a towed unit including a transducer assembly; the underwater unit at the valve consisting of a hydraulic valve actuator, transponder command actuator, battery power supply, and limit switch assembly; and a hand-held homing unit to allow a diver to reach a valve quickly for maintenance or repair. All components, including the battery, are designed for a five-year life expectancy.

Medical analysis

The Cavendish Bio-Medical Centre in London is Britain's first independent medical screening service linked to computer analysis, and is claimed to be the most advanced of its kind in Europe. Patients,

identified only by a screening number, are examined in complete privacy. The Centre's own Modular One Computer processes the results of the various tests and examinations to provide quick and accurate results.

A complete series of 11 medical examinations together with some 30 ancillary tests (including electro-cardiograph examination, Chest X-ray, weight and body measurement, skin examination, incipient tumour investigation, ophthalmic tests, aural examination, and blood tests) take as little as two hours to complete. The findings of each test and examination are entered on a personal screening card and passed to the computer for final analysis. The computerised print out of the complete examination results is then forwarded to the patient's own doctor for his interpretation.



A hearing test is conducted with an automated audiometer at the Cavendish Bio-Medical Centre in London.

Drawing maps by computer

A newly installed Gerber Co-ordinate Digitiser at Engineering Computer Services Pty. Ltd. (St. Leonards, N.S.W.) is being used almost exclusively to convert information from aerial survey photos into numerical form suitable for punching into computer input cards. The punched cards are then fed to an IBM 1130 computer connected with a data plotter and the end product is a geographical map of the area photographed. Basically the Digitiser is a two-unit instrument supported by a computer output device which measures and automatically records sequence numbers and X - Y co-ordinate data from maps.

The installation comprises a control console and an adjustable chart table. An enlarged map of the photographed area is mounted on the table. Using the aerial photo as original copy and the map for translation, the operator guides the reading head attached to the table across the map in line with the path of the aerial camera. The movement of the reading head activates the display turret of the control console which displays the current reading head position and allows the operator to edit visually the digital information as it is recorded and punched into cards by an IBM 29 card punch.



An operator guides the reading head across a map while using the Gerber Digitiser.

FIRST AUSTRALIAN BROADCAST

A reminder from Amalgamated Wireless (Australasia) Ltd. draws attention to the fiftieth anniversary of one of the major milestones in the history of radio in Australia which fell in August this year

On August 13, 1919, Australia's first public demonstration of wireless telephony was given by Amalgamated Wireless (Australasia) Ltd. before the Royal Society of N.S.W. at 25 Elizabeth Street, Sydney.

On the other side of the city, on the top floor of the then A.W.A. wireless works at 97 Clarence Street, the transmitting station was located with an aerial on the roof. The transmitter was a single-valve experimental model built by A.W.A. employees.

As transmitting valves were not available in Australia, a single receiving valve of the Marconi Q type was used. It consisted of a glass envelope which had filament connections at either end, while the electrical connections

of the grid and anode were slotted into the glass on either side of the envelope.

The program was a recording played from Clarence Street on a hand-wound gramophone, the horn of which was placed directly in front of a solid-back carbon microphone. The transmission was received at the Royal Society's rooms using a loop aerial which was orientated towards Clarence Street to obtain the maximum signal.

A report of the proceedings said: "The music played from Clarence Street was clearly transmitted and heard in all parts of the hall." This was made possible by a roughly constructed loudspeaker consisting of a telephone earpiece fitted into a metal horn.

nels in the police system. The contract also includes pocket radio-telephone systems for the police and security headquarters.

Mobile radio conversion

The target date for the changeover of all VHF mobile radio-telephone networks from 60KHz channelling equipment to the 30KHz type has been extended to 31 December, 1969. About 1,500 radio base stations throughout Australia were required to change to the new equipment by 30 June, 1969, but many licensees could not obtain the new equipment in time. About 300 stations were still to be converted at the end of July, 1969. There are now almost 8,000 VHF radio-telephone base stations in Australia with some 70,000 mobile units working with them.

Nucleonic fuel gauge

Engineers at the nuclear laboratory of Lockheed-Georgia Co., Marietta, Ga., U.S.A., are perfecting a nucleonic fuel gauge for commercial aircraft. With this concept, gamma radiation sources of krypton 85 and associated detectors would be installed in aircraft fuel tanks. The amount of fuel in the tank would affect the amount of radiation transmitted from source to detector, thus providing an accurate measurement of fuel remaining in the tank. A simple digital indicator in the flight station would provide a continuous reading for the pilot and flight engineer.

Meet the McMurdo Connector Range!

The world's finest and most reliable
range of connectors, plugs and sockets

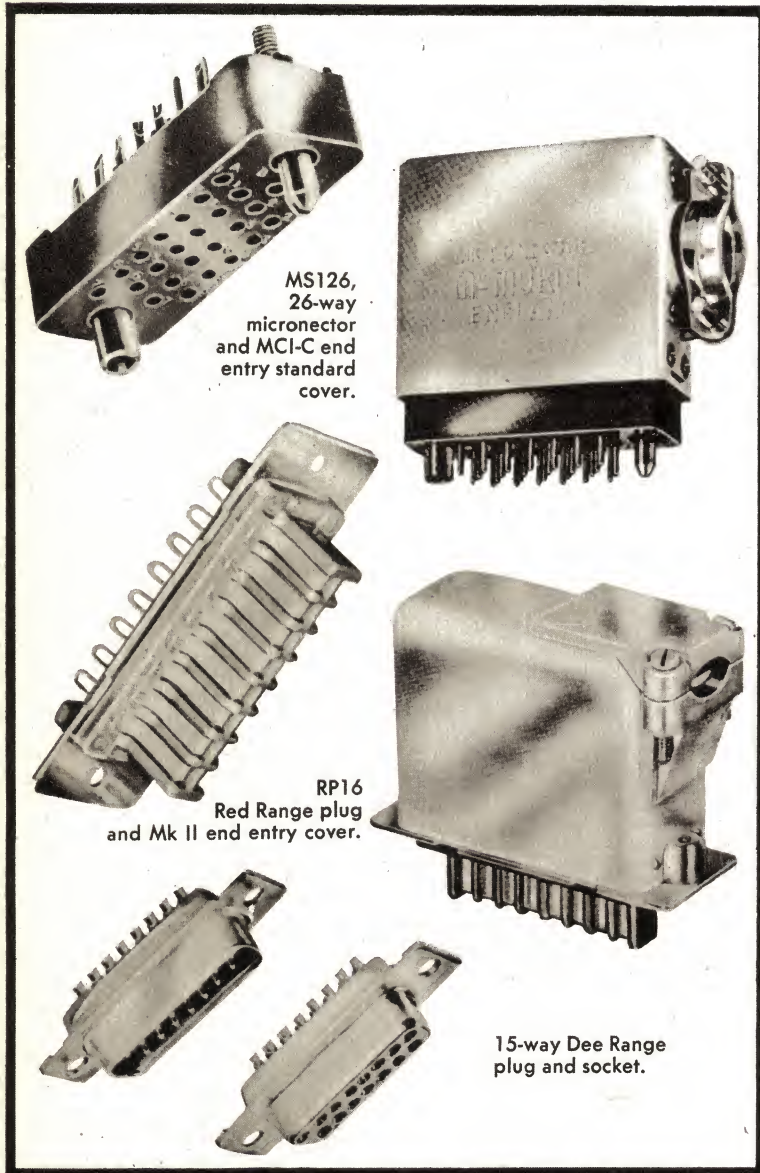

MS126,
26-way
microneconnector
and MCI-C end
entry standard
cover.

RP16
Red Range plug
and Mk II end entry
cover.

15-way Dee Range
plug and socket.

MICROCONNECTORS

A range of miniature plugs and sockets for rack, panel and line mounting. Available in 9, 14, 18, 26, 34, 41 and 51 ways. Bodies in moulded nylon PF. Plug contacts—gold over silver on hard brass. Socket contacts—gold over silver on phosphor bronze. Maximum contact resistance—0.0025 ohms. Current rating per contact—7.5 amps. Working voltage (sea level)—750V. Covers are of extruded aluminium with cad. plated riveted steel. Cable clamps for top or end entry. Also obtainable as Unitors Pattern 103 approved to D.E.F. 5325-1. Cert. No. 1693.

AVAILABLE EX-STOCK.

RED RANGE CONNECTORS

A range of connectors for rack or panel mounting having extremely low insertion and withdrawal force. Available in 8, 16, 24 and 32 ways. Barrier or dowel polarisation of plugs to socket ensures correct contact. Bodies in moulded nylon PF. Plug contacts—gold over silver on copper. Socket contacts—gold over silver on phosphor bronze. Contact resistance—0.005 ohms. Max. current rating per contact—5 amps. Working voltage (sea level)—800V. Moulded polythene covers for barrier polarised versions have universal cable clamps for top or end entry. Also obtainable with screw latches.

AVAILABLE EX-STOCK.

DEE CONNECTORS

For use in all types of miniaturised equipment. Available in 9, 15, 25, 37 and 50 ways. Polarisation by keyed steel masks. Plug and socket bodies are moulded nylon PF. Plug contacts—gold over silver on brass. Socket contacts—gold over silver on phosphor bronze. Max. contact rating—5 amps. Contact resistance—0.003 ohms. Working voltage (sea level)—350V.

AVAILABLE EX-STOCK.

You should know more
about McMurdo Connectors — write or phone
McMurdo today.

MCMURDO

McMURDO (AUSTRALIA) PTY. LTD.
Melbourne and Sydney.

Head Office and Factory:
15 Edinburgh St., Huntingdale, Vic. 3166
Tel.: 544 3033

Hydro-electric power scheme for N.S.W.

A total of 400MW of pumped storage hydro-electric power will be incorporated in the Kangaroo River-Fitzroy Falls section of the Shoalhaven (N.S.W.) Water Supply Scheme. The scheme is located about 15 miles to the north-west of Nowra on the South Coast of N.S.W.

The scheme is being undertaken jointly by the N.S.W. Electricity Commission and the Metropolitan Water Sewerage and Drainage Board. Expenditure by the Electricity Commission on the joint scheme is expected to be about \$15 million and the Water Board's share will be about \$41 million.

Most of the construction work will be carried out in the period 1971-1976 after which 240MW of power will be available. A further 160MW will be added during construction of the second stage of the scheme in about 1990.

The pumped storage principle involves supplying electricity during off-peak periods to drive electric motors and pumps to raise water from a low level reservoir to a high level reservoir.

During periods of peak demand for electricity the water previously pumped can be released from the upper reservoir to drive hydro-turbines connected to the electric motors which then act in reverse as power generators. The cycle can be repeated as often as required using the same volume of water.

In this case the lower reservoir will be on the Kangaroo River and will be known as Lake Yarrunga. The upper reservoir will be near Fitzroy Falls. There will be two power/pumping stations to raise

water through the 2,000ft difference in altitude and to make use of the fall for producing peak load electricity. The lower of these two stations will be called Bendeela and the higher will be called Kangaroo Valley.

When the stations are producing power they will feed into the Electricity Commission's transmission system and, on other occasions, electricity will be drawn from the system to provide the energy for pumping for both the Water Board's requirements and for pumped storage purposes.

The facilities such as dams, pipelines and pumping stations to be used for pumped storage power purposes will also be used to pump water from the Shoalhaven River to Fitzroy Falls Dam for supply to Sydney.

Bendeela Power/Pumping Station will be completed with the full power installation of 80MW by 1976. The two 40MW hydro-turbines will operate in reverse as pumps. Total flow when pumping will be 2,000 cubic feet a second, and when generating, 2,450. Power when pumping will be 86MW and when generating, 80MW.

Kangaroo Valley Power/Pumping Station building will be complete by 1976 but only two of the four 80MW generating units will be installed at that time.

ganism and vandalism, especially on "one-man" buses. As well as security, however, the radios will be used to report breakdowns, accidents, and traffic jams. The equipment consists of 20W VHF FM transmitter/receivers capable of covering the whole area of operation of the Coventry bus service. The equipment is fully transistorised, except for "quick-heat" valves used for the transmitter power output and driving stages.

Simple recorder



A new tape recorder system developed in U.K. by E. J. Arnold and Son Ltd., Leeds, is particularly suitable for use in schools and colleges. Up to 12 sets of headphones can be used with a single machine, and the system offers facilities for programmed tape techniques and for use in a language laboratory. For language tuition, the master track is isolated from accidental erase, the students' responses being recorded on a separate track. Master tracks can be individually recorded from microphone, disc or radio, or selected from a library. Provision is made for independent track playback or full mixing of instructions and responses. The system is based on the "Packette" cartridge which contains standard 1/4 in recording tape and operates on the sealed-in spool-to-spool principle. Playing time is 80 minutes per cassette.

CCTV for Randwick

A large-scale closed circuit television system has been installed by Amalgamated Wireless (Australasia) Ltd. at Randwick racecourse in Sydney. There are 50 monitors on four floors of the new \$4.6 million grandstand and in various locations in the racecourse area. These monitors show totalisator odds prior to a race, dividends and correct weights, as well as placings on the "in field" indicator. Facilities are included for showing, between races, "off-air" television pictures such as major sporting events.

Four Marconi vidicon cameras are used. Two of these televise odds from the members' totalisator area; one shows dividends from the legger tote house; and the fourth is focused on the "in field" indicator. All cameras are remotely operated from the legger totalisator house.

company, Associated Network Ltd. The New Zealand Broadcasting Authority, an independent body which will allocate warrants for future commercial stations, has sought applications only for private radio stations on a regional basis. Government policy, which the authority is required to heed, is that there should be no further television channels until satisfactory primary coverage of the country is completed. (See also story, page 18.)

Radio for bus crews

In Coventry, England, 37 corporation buses are to be fitted with G.E.C. mobile radio communication systems to give the crews contact with their new traffic control centre in the heart of the city. The system is designed to provide the crews with a measure of protection against hooli-

TV translator station

A commercial television translator station is to be established for the Upper Hunter area of N.S.W. following a recommendation of the Australian Broadcasting Control Board. The station, to operate on Channel 10 with horizontal polarisation, is to be established by Newcastle Broadcasting and Television Corporation Ltd. (NBN) and relay the programs of that station. A site for the establishment of the station has been selected 6 1/2 miles west-north-west of Aberdeen, adjacent to a feature called "The Lookout." The new station is expected to ensure satisfactory service for about 16,000 people in the area, including the towns of Muswellbrook, Scone, and Aberdeen.

Commercial b'casts in N.Z.

Four of the largest firms in New Zealand have filed a bid for a national radio and TV network to compete with the State-owned New Zealand Broadcasting Corporation. The four companies — Wright, Stephenson and Co. Ltd.; J. Watie Canneries Ltd.; U.E.B. Industries Ltd.; and Kerridge-Odeon Corporation Ltd. — propose the formation of a public

Carrier telephony equipment order

Carrier telephone equipment to a value of \$307,000 for the Postmaster - General's Department is under construction at the South Australia plant of Philips Telecommunications of Australia Ltd. The order includes channel modem and carrier supply equipment, group modem and negative impedance repeaters. Here, a P.M.G. inspector watches as a Philips technician carries out a final system test of carrier equipment after the individual units have been checked and tested.

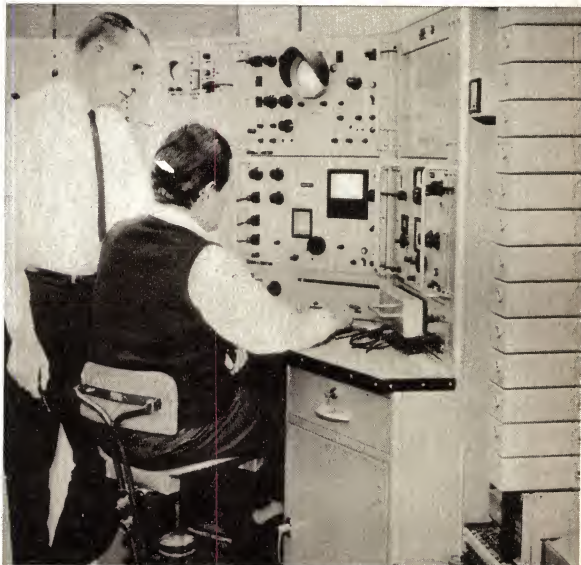

DESPITE the initial reservations felt by many people, particularly with reference to servicing, the printed circuit is now firmly established in most types of electronic equipment, ranging from the incredibly cheap pocket radios that have flooded the country in recent years, to some of the most sophisticated professional equipment available. Its origins lie in weaponry — a heritage unfortunately common to many good "electronic" ideas, but printed circuitry is, and indeed has been for some time, an attractive system for the amateur who constructs his own equipment, for it solves the mechanical problems of component mounting and eliminates the chores of wiring — as well as facilitating a neat and workmanlike job. For the amateur who has so far shied away from etching his own boards, a new system is now available, which is both economical and easy to use, yet with care, is capable of excellent results. Known as **Cir-kit**, the system utilises bakelite boards, similar to those used commercially, in conjunction with self-adhesive copper strip. This is 1/16in or 1/8in wide — easily cut with scissors or a model knife — and attaches to the boards rather like a piece of Sellotape. The adhesive is very efficient, although the bond is not quite as good as that on pre-laminated boards — which means that care is needed when soldering not to overheat the copper. However, anyone who is competent to solder a transistor or capacitor without causing damage should have no trouble, and the adhesive improves with aging, so that long-term stability is satisfactory. Layouts can normally be planned using the theoretical circuit diagram as a guide, and boards may be pre-punched or drilled according to requirements. With the pre-punched board, the strip can either be laid over the holes, and then punched through with a small drill or a watchmaker's screwdriver, or it can be laid alongside the holes and component leads are inserted through the board, folded over and soldered (see photo). The former method permits a more compact layout.

A few tips on planning layouts. Always be sure that the component spaces you allocate are adequate — it is preferable to purchase the bits before embarking on this task, although capacitors are available in literally dozens of shapes for board mounting and resistors are more or less of standard size, dependent on ratings. Avoid siting adjacently on to your layout components which are in different stages — as this can lead to instability. If instability does occur, of course, **Cir-kit** does permit alterations to be made, although it is as well to investigate the problem before redesigning sections of the board for it may not prove necessary.

The excellence of the system, however, lies in its versatility, for it enables the home constructor to produce a wiring board on a one-off basis for most of the circuits described in this and other journals, and while it will no doubt encourage many to "try their hand," it will also enable many who already build their own equipment to achieve neater, more reliable results with a minimum of fuss.

**AVAILABLE ALL LEADING
RADIO HOUSES.**

(SOLE AGENT)



ZEPHYR PRODUCTS PTY. LTD.

70 BATESFORD ROAD, CHADSTONE, VICTORIA—PHONE 56-7231

MANUFACTURERS OF RADIO & ELECTRICAL EQUIPMENT & COMPONENTS

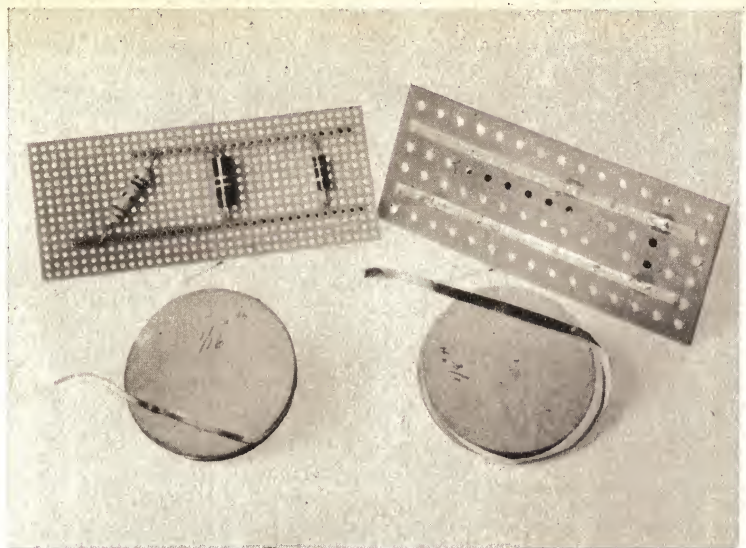

INSTANT CIRCUITS

A new method of making component boards using self-adhesive copper strip.

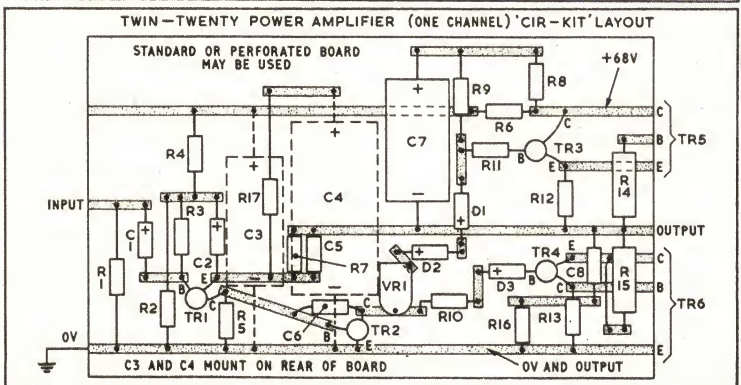
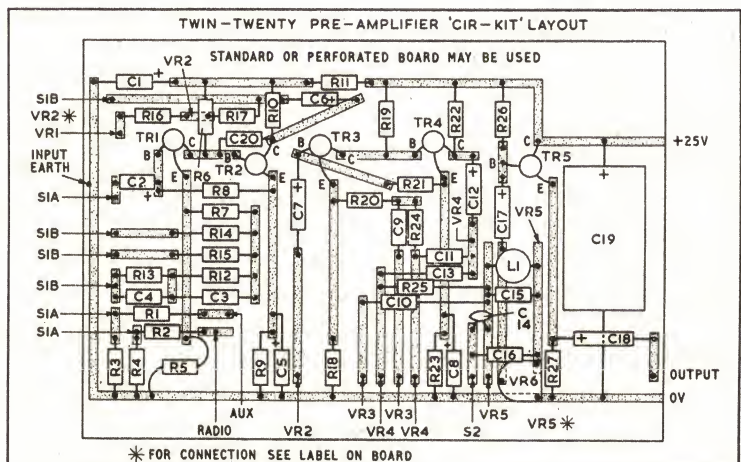

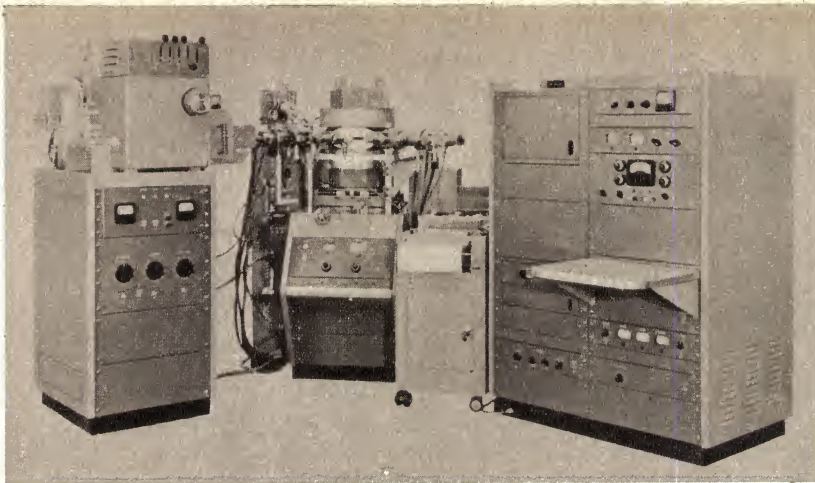

A mass spectrometer of this type is being used by scientists at the National Aeronautics and Space Administration of the U.S.A. for the analysis of the lunar samples brought back by the Apollo II astronauts. A Hitachi RMU-6 Mass Spectrometer System, it is installed at the lunar receiving laboratory in Houston where the first samples of the moon rocks arrived on July 25.

Extension study courses

New courses to be presented by the Division of Postgraduate Extension Studies, University of New South Wales, are: Instructional TV Production, Computers at Work, part 1.

The former, to commence in late October or early November, is of five TV lectures over Television University, VITU, and three live seminars. In addition, the course will include opportunities for experimental productions.

Computers at Work consists of six one-hour lectures over Radio University, VL2UV, and one seminar over Television University, VITU. The course will commence in early November. Tape recordings of the lectures are available where a class or group wishes to enrol, or for

people beyond the range of the radio broadcasts.

Further information on these and other radio, television, and tape courses can be obtained from the Division of Postgraduate Studies, P.O. Box 1, Kensington, N.S.W. 2033 — telephone 663-0351, extension 2691.

I.T.U. has 137 members

Mauritius became the 137th member country of the International Telecommunication Union (I.T.U.) on July 30, 1969. The I.T.U. was founded in 1865, and in 1947 became the United Nations specialised agency dealing with telecommunications. The headquarters are in Geneva, Switzerland.

Dragline contract

Westinghouse Electric Corporation, Buffalo, U.S.A., has won a contract to supply electrical equipment for four huge draglines to be used to remove overburden from the Bowen Basin coal deposits in North Queensland. Two of the draglines, each powered by electric motors totalling 4000HP, will scoop up 65 tons of earth with each pass of their 45 cubic-yard buckets. The other two, each powered by electric motors totalling 6400HP, will scoop up 90 tons of earth with each pass of their 60 cubic-yard buckets. They will be built by the Bucyrus-Erie Co. of the U.S.A.

Delivery of the equipment, including static control systems and motor generator sets for conversion of AC supplies to dragline requirements of DC, is planned to begin shortly. Westinghouse has established an Australia-wide service for its dragline electrical equipment through its associate, Johns and Waygood Perry Engineering Ltd.

Colour TV for Taiwan

RCA colour TV broadcast equipment is being shipped to Taiwan for installation at a new television station that will broadcast the country's first colour programs later this year. The station will broadcast approximately seven hours each day with an additional five hours on Sunday. The programming will be divided about equally between live and film presentations. Arrangements have been made to revive satellite transmission so that Taiwan viewers will be able to watch programs and events originating in the U.S.A. and elsewhere.

Instrumentation recorder

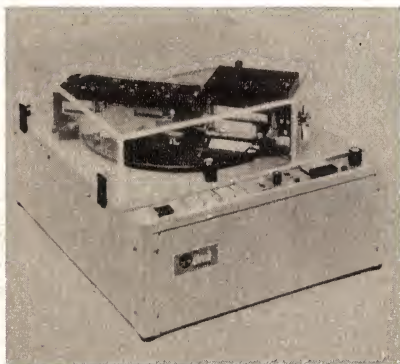

An American company, Data Memory Inc. of California, has introduced a magnetic disc recorder to replace tape loop devices in instrumentation work. Designated the IDR-100 Instrumentation Disc Recorder, it will record transient signal events over 20-second real time duration, and then replay the entire disc or repetitively reproduce any 25ms part for hours or longer to allow constant analysis without degradation. It has a sine-wave recording bandwidth of 2MHz and an equivalent pulse response of 4MHz.

HI-FI

A budget-priced system for those who want to enter the wonderful world of High-Fidelity sound . . .

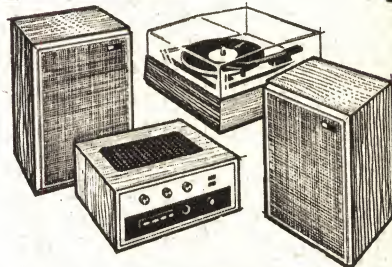

It is impossible for us to know what you personally look for in a Hi-Fi system, but we can guarantee that we have just the set-up you are looking for.

For example, this system, comprising a Rogers Cadet Amplifier with 2 Goodmans Ten/Ten loudspeakers and Garrard Record Player. At \$398, it is one of the best buys in Hi-Fi; terms available. Come in and let our experts help you with your choice.

URD

UNITED RADIO
DISTRIBUTORS PTY. LTD.

SHOP 32, ASH STREET,
ANGEL ARCADE, SYDNEY
Telephone 28-3718 28-3926

Please forward details of
High Fidelity Systems, including
Rogers Cadet/Goodmans Ten-Ten.

Name

Address

State

Fixed Tuned Converter For Aircraft Beacons

As an aid to air navigation, the Department of Civil Aviation provides a network of non-directional radio beacons set up across the Australian continent. Known as NDBs they are used in conjunction with advanced radio-navigation aids in commercial and private aircraft.

By Anthony Leo

Radiating on frequencies below the broadcast band, between 200 and 413KHz, the NDBs make continuous transmissions of their identification in Morse code at all hours of the day and night.

There is an NDB located at the primary aerodrome in each capital city which, in addition to identification, transmits local and current weather information and the preferred runway directions being used. This information is vital in any commercial or private operation into or out of the aerodrome.

The transmitted weather information includes details of the prevailing wind, its velocity, direction, and cross-wind component, QNH (altimeter pressure setting in millibars), and the "dry bulb" temperature. Additional information relating to cloud cover visibility and local hazards (birds on the runway for example) are given.

Over the past few months the writer has been taking flying lessons at Bankstown aerodrome and this prompted development of a low-frequency converter for listening to Sydney NDB. While the information transmitted by the NDB applies to Mascot aerodrome specifically, it is nevertheless a very useful indication of the weather conditions at Bankstown, approximately 12 miles away.

In the initial stages of flight training the prevailing weather conditions may ground the student pilot, although they may at the same time be quite suitable for a more experienced pilot. Wind velocity is perhaps the most important parameter in this regard; something which cannot be accurately ascertained by a simple observation, as can visibility or cloud cover.

Thus, it can be extremely handy to have some reliable weather information which, if it suggests doubtful conditions, can instigate a phone-call to the flying school and perhaps save a long drive to the aerodrome if conditions are unsuitable.

Later, when flying solo, advance knowledge of the weather conditions and the wind in particular enabled the writer to determine beforehand which runway directions would be used and what crosswinds could be expected. While it is arguable whether prior knowledge of runways in use is necessary, it is very comforting and a boost in confidence for the "green" student pilot to be clued-up before he gets in the aeroplane and makes initial contact with the tower.

The low-frequency converter was designed to go with a car radio and, as it was used in the Sydney area, it was fixed tuned to Sydney NDB only. It would be a relatively simple matter to modify it for reception of other NDBs throughout Australia, but more of that later.

Naturally enough, the desire to use simple and economic circuitry in the converter was paramount. In order to satisfy this requirement the design has avoided the use of special components and is centred around parts easily obtained over the counter. This applies particularly to the coils, which are standard units used in transistor broadcast receivers.

However, adequate overall sensitivity

of figure 1 as it requires a minimum number of components.

But when we used the converter in a car installation its performance was not entirely adequate. During the day it was usable, although the noise level was somewhat high, but at night the performance was not satisfactory. Although the poorer nighttime performance is contrary to what might be expected, it does correlate with information given in the Visual Flight Guide (a DCA publication) which gives information relating to all the NDBs in Australia and the territory of Papua and New Guinea.

In the light of this, we decided to add an extra stage to provide amplification at the signal frequency

A photograph at the right shows the low frequency converter of figure 2 housed in a small passivated steel box. The power and switching leads are brought out through a grommeted hole. The aerial input (lower) and converted output connections are made via coaxial sockets.

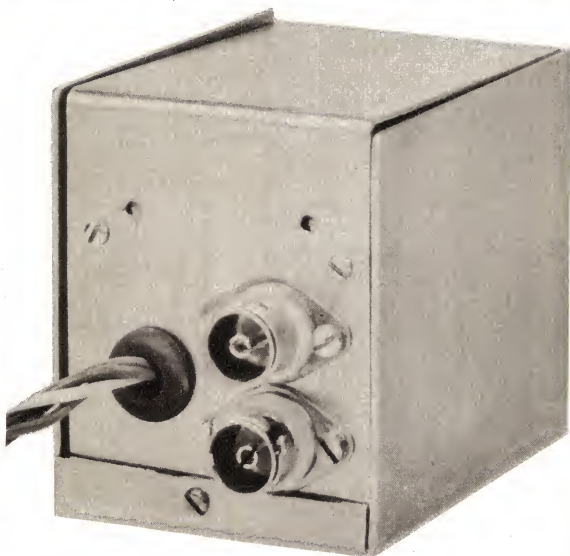

of the converter/car radio combination is also very important, as the signal levels involved are not very high. The beacons radiate only modest power, nowhere near that of a broadcast station, and the dimensions of a car aerial are necessarily restricted.

Initially, we made a converter simply using one transistor as a self-oscillating mixer (figure 1) similar to that used in an ordinary broadcast receiver. It worked quite well when connected to a standard broadcast receiver and a reasonable length of aerial, allowing the reception of Sydney NDB (317KHz).

If readers want to make a converter just to connect to their home broadcast receiver we suggest they use the circuit

(317KHz.) Thus we evolved the circuit shown in figure 2.

As the converter was to be used regularly we decided to install it permanently in the aerial line to the car-radio, rather than be faced with the inconvenience of connecting and disconnecting when required. Hence we had to provide some means of switching the receiver either directly to the aerial for normal broadcast reception or through the converter for low frequency reception.

However, switching the aerial cables presented an immediate problem because the converter had to be mounted in a rather inaccessible position under the dashboard. While it would be possible to have an aerial

switch box remote from the converter, it would be very cumbersome and would introduce a risk of interference from the ignition and a possible loss of signal.

However, the switching problem was overcome by using a network of diodes at the converter input and output terminals to perform the switching function. With this arrangement only DC voltages are switched outside the converter's case to make the change-over from broadcast to low frequency reception.

This method takes advantage of the semiconductor diode's behaviour in the conditions of forward and reverse bias. When a forward biasing DC voltage is applied to a diode it will allow the unimpeded flow of radio frequency (RF) currents, but with a reverse bias the diode is in effect switched off and presents a high impedance to the flow of RF current.

The circuit diagram is shown with the switch in the position for converter operation where diodes D1 and D3 are forward biased while D2 is reverse biased. Signal from the aerial passes into the converter through D1 and the converted output goes to the receiver's aerial-input through D3; D2 presents a high impedance between converter input and output.

With the switch in the position for normal broadcast reception diodes D1 and D3 are switched off, and D2 is switched on allowing signals from the aerial to bypass the converter and go directly to the receiver input.

Signals from the aerial are coupled into a tuned circuit connected to the base of T1. A standard intermediate-frequency transformer, normally tuned to 455KHz, has been used here by increasing the tuning capacitor to 820pF so that it resonates at 317KHz. A similar tuned circuit provides a collector load for T1 and couples into the base of transistor T2.

Transistor T2 performs the dual role of local oscillator and mixer to produce a frequency capable of being received by a broadcast receiver. The oscillator coil is tuned to about 1,000KHz with an 82pF capacitor across the primary winding.

When the signal frequency (317KHz) is heterodyned with the local oscillator

frequency (1,000KHz) in the mixer transistor there are, in addition to the original 317 and 1,000KHz, sum and difference products at 1,317KHz and 683KHz respectively at the collector. A tuned circuit in the collector, resonant at 683KHz, provides some rejection of the other three unwanted frequencies.

The collector's resonant circuit could be just as easily tuned to the "sum" frequency product of 1,317KHz, but we found that the overall sensitivity was higher with the converter output tuned to the lower frequency product

of 683KHz. The coil used at the output was a standard "transistor" aerial coil fixed tuned with a 100pF capacitor.

As a matter of fact, the sensitivity of the converter when used in conjunction with a rather mediocre car radio was such that the Sydney NDB was received with surprisingly little noise from as far away as Newcastle.

The prototype we made was designed to be used in a car with a negative chassis system, but there should be no problem in using it with the opposite polarity convention if it is properly modified. While we did not

AERODROME	FREQUENCY (KHz)	C1 (pF)	C2 (pF)
Adelaide, S.A.	362	680	120
Brisbane, Qld.	302	1000	100
Darwin, N.T.	344	680	100
Hobart, Tas.	362	680	120
Launceston, Tas.	242	1500	68
Melbourne, Vic.	356	680	120
Perth, W.A.	400	560	120
Sydney, N.S.W.	317	820	100

Alternative values for C1 and C2, in either of the circuits below, will permit reception of the other major airport beacons shown. Note that there are two "C1s" in figure 2.

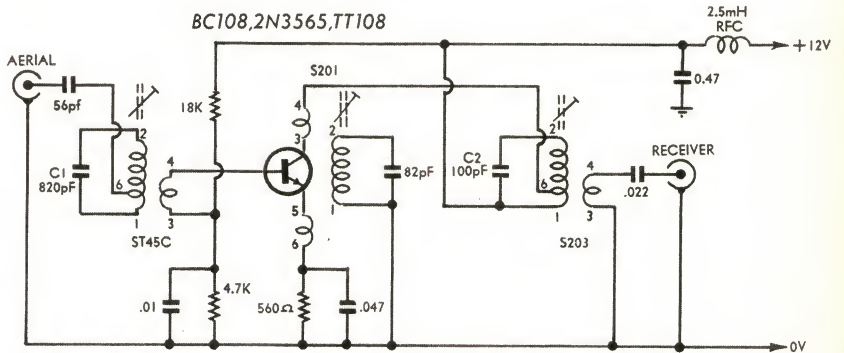

Figure 1

Above: A single transistor self oscillating converter, suitable for use with standard broadcast receivers. Almost any general purpose audio or IF transistor with a reasonably high cutoff frequency could be used.

Below: A higher gain converter using two transistors and suitable for use with a car radio. Note the use of the diodes to switch the input and output connections. This may be considered optional and omitted if not required.

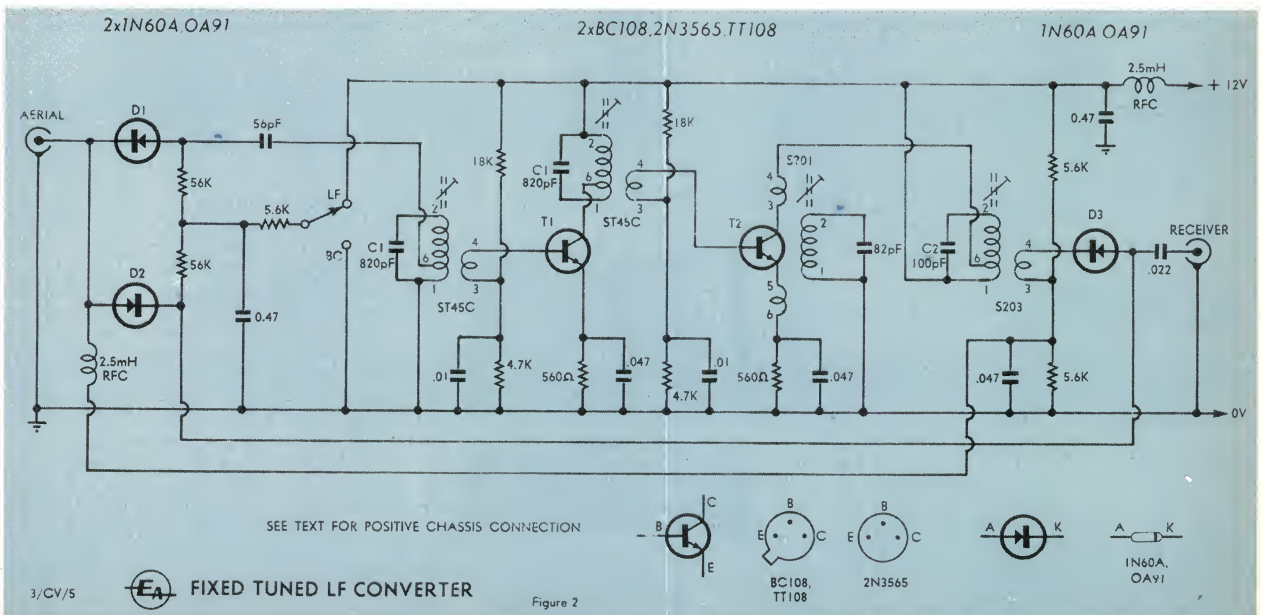

Figure 2



Sub-Miniature switches

The best the World can offer

TYPE	MODEL	CIRCUIT	250 V.A.C. RATING	CIRCUIT ARRANGEMENT
ROTARY	MRY-106	1 POLE	1A	1-6 USABLE POSITIONS
	MRX-108	1 POLE	1A	1-8 USABLE POSITIONS
	MRX-204	2 POLE	1A	1-4 USABLE POSITIONS
	MRX-402	4 POLE	1A	2 POSITION
TOGGLE	S-2012	SPDT	5A	ON-ON
	S-2013	SPDT	2A	ON-OFF-ON
	S-2022	DPDT	5A	ON-ON
	S-2023	DPDT	3A	ON-OFF-ON
	S-2025	DPDT	3A	ON-MOM ON
	S-2042	4PDT	5A	ON-ON
PUSH BUTTON	S-2043	4PDT	3A	ON-OFF-ON
	SB-2011	SPDT	2A	ON-ON (MOMENTARY)
	SB-2061	DPDT	3A	ON-ON (MOMENTARY)
	SB-2065	SPDT	2A	ON-ON (DOUBLE ACTION)
SEE SAW	SB-2085	DPDT	3A	ON-ON (DOUBLE ACTION)
	SW-3012	SPDT	3A	ON-ON
LAMP LIGHTED	MLB-2061*	DPDT	3A	ON-ON (MOMENTARY)
	MLB-2085*	DPDT	3A	ON-ON (DOUBLE ACTION)

*THE MLB SERIES OF LAMPLIGHTED SWITCHES ARE AVAILABLE WITH RED, GREEN AND TRANSPARENT BUTTONS. THE LAMP VOLTAGES AVAILABLE ARE:— 6V, 12V, 18V, AND 24V.

POST TODAY

Please supply Sub-Miniature and Standard switch catalogue.

NAME.....

ADDRESS.....

IRH
COMPONENTS
PTY. LIMITED

A Subsidiary of IRH Industries Limited

THE CRESCENT,
KINGSGROVE,
N.S.W. 2208
TEL. 50 0111

IRH 692 R

actually do this, it would be simply a matter of using PNP transistors rather than NPN, and wiring the diodes opposite to that shown. The transistors which would appear to be most suitable are, 2N3639, 2N3638 or AY1110.

Although the converter as presented is tuned to Sydney NDB on 317KHz it is possible to modify it to receive other NDBs on different frequencies. While it is not possible to list all beacons and their frequencies we can list those at primary aerodromes. (Figure 3.) Also shown in figure 3 are the modified values of C1 and C2 for the reception of the respective NDBs.

We constructed the converter in a small passivated steel box measuring 3in x 2½in x 2in. A "U" shaped bracket was used as a miniature chassis, being held in position with four small self-tapping screws. Construction details are quite easily seen in the accompanying photographs.

Passivated steel has an advantage in that components can be soldered directly to it, thus avoiding the use of solder lugs. However, steel is not as easy to

PARTS LIST

FIGURE ONE

Metalwork, see text

- 1 IF transformer, ST45C.
- 1 Oscillator coil, S201.
- 1 Aerial coil, S203.
- 1 2.5mH RFC.

TRANSISTORS

- 1 BC108 or 2N3565 or TT108.

RESISTORS

- 1 18K, 1 x 4.7K, 1 x 560 ohms.

CAPACITORS

- 1 0.47uF, 1 x .047uF, 1 x .022uF,
- 1 x .01uF, 1 x 820pF, 1 x 100pF,
- 1 x 82pF, 1 x 56pF.

FIGURE TWO

Metalwork, see text

- 2 IF transformers, ST45C.
- 1 Oscillator coil, S201.
- 1 Aerial coil, S203.
- 2 2.5mH RFCs.

TRANSISTORS

- 2 BC108 or 2N3565 or TT108.

DIODES

- 3 1N60A or OA91.

RESISTORS

- 2 56K, 2 x 18K, 3 x 5.6K, 2 x 4.7K,
- 2 x 560 ohms.

CAPACITORS

- 2 0.47uF, 3 x .047uF, 3 x .01uF,
- 1 x 100pF, 1 x 82pF, 1 x 56pF.
- C1 and C2, see text.

work with as aluminium and, depending upon circumstances, constructors may have to use the latter and fit solder lugs for chassis connections.

Aerial input and output connections are made via coaxial connectors while lengths of hook-up wire are used for the positive voltage connection and switch wiring. Negative voltage return is made via the braid in the coaxial cables.

Ideally, the alignment or tuning of the converter should be carried out using an RF signal generator and we will detail this procedure. However, some constructors may not have access to a generator so we will give an alternative alignment procedure later.

Connect the converter output to the aerial input of a broadcast receiver, tuned to 1MHz, and then inject a

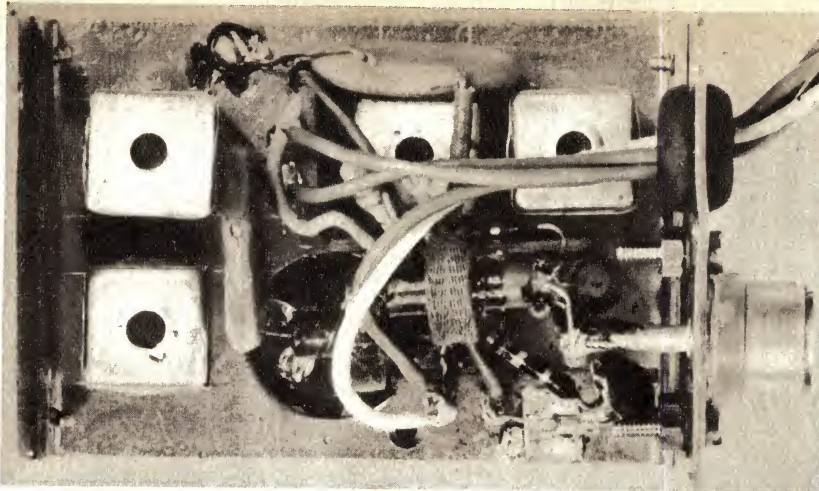

Plan view of the converter showing the coils and other major components. The coil at bottom left is the S201 oscillator coil, above it the S203 output coil, centre the 2nd ST45C and at right the 1st ST45C.

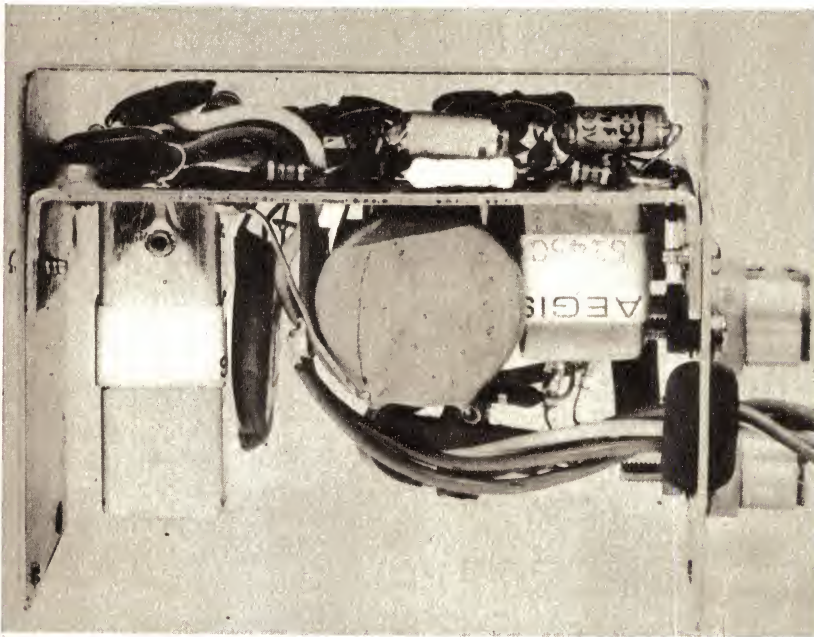

Side view of the converter showing the position of the sub chassis and the disposition of components on either side of it. The long can is the S203 and the one marked ST45C is the first of these two.

1MHz signal into the receiver by holding the generator output lead near the aerial circuitry of the receiver. Adjust the converter oscillator coil to give 1MHz local oscillator frequency which will be indicated by a "beat" note from the receiver; a result of the signal generator and converter oscillator heterodyning to produce an audible product in the receiver.

With the local oscillator in the converter set to 1MHz connect the generator to the converter input and set it to 317KHz. A signal should now be heard when the receiver is tuned to 683KHz. If the converter is to be tuned to one of the other frequencies listed then the generator should be set at that frequency rather than 317KHz. Also, the product frequency tuned on the receiver will not be 638KHz, but it will be the difference between 1MHz and the particular NDB frequency.

With the receiver set to the particular difference or converted frequency, tune the output coil (S203) for maxi-

mum signal level in the broadcast receiver. Make sure that the generator output is kept low so that the received signal is weak (just above the receiver noise), otherwise the peak in converter coil tuning will be masked by the automatic gain control of the receiver.

Now peak the coils in the base and collector circuits of T1 at the same time reducing the signal level from the signal generator. At all times the signal level to the receiver should be just above the residual noise. At this level the automatic gain control circuitry will not be operative and a small change in RF level will produce a corresponding change in audio level.

If a generator is not available, connect the converter to a receiver and set the receiver to 1MHz using the dial scale. Now, tune the converter's local oscillator to 1MHz which will be evident by a marked reduction in receiver noise due to a gain reduction caused by the large level of RF from the oscillator. In addition, there will be

an audible effect as the oscillator frequency is swept past 1MHz.

Now, retune the receiver to the predicted difference or converted frequency, 683KHz for Sydney NDB or the difference between the NDB frequency and 1MHz. With the receiver thus set, attach as large an aerial as possible to the converter input. The NDB should then be heard as the receiver tuning is adjusted about the predicted dial frequency.

With the receiver tuned to the NDB reduce the amount of aerial so that the received signal is just above the receiver noise level. Then peak the converter coils for maximum output, beginning with the output coil (S203), at the same time reducing the aerial or input signal level so that the received signal level is just above the noise level, for the reasons just explained.

If it happens that the NDB is received in a position on the receiver dial that is occupied by a strong local broadcast station, there might be a chance of interference from the broadcast station. In this event, the converter can be tuned either side of the broadcast station, by changing the oscillator frequency slightly, to a quiet section of the dial. The stated oscillator frequency of 1MHz is nominal and may be altered as necessary.

PREVIOUS SIMILAR PROJECT

"A Low Frequency Converter," March, 1969, File No. 2/CV/21. A crystal locked low frequency converter covering from 160 to 400KHz in conjunction with the tuning range of a broadcast receiver. Solid state, battery operation.

FLASHLITE

BALL POINT PEN S-88



Lights up automatically when pen cover is in position for writing.

\$2.00

posted.

Bright illumination. Modern shape with silver finish. You can write when it is dark. Spare parts available. Battery, 15c. Pen refill 15c. Globes 15c.

RADIO HOUSE PTY. LTD.
306-308 Pitt Street, Sydney

also at
6 Royal Arcade & 760 George Street, Sydney.



SUNWOOD SPEAKER SYSTEMS

Model AS 57

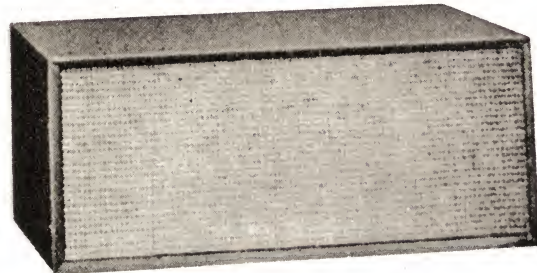
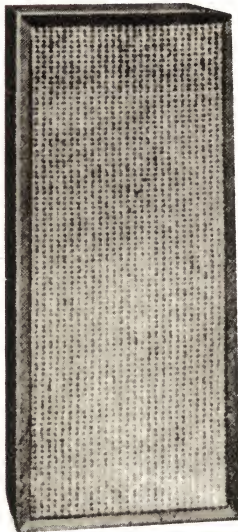

\$46 pair

This compact speaker system of narrow proportions features a twin cone oval speaker 7" x 5" providing exceptional performance in a moderate price bracket. The cabinet is finished in hand-rubbed oiled walnut. Perfect for compact systems or as extension loudspeakers for tape recorders.

Speakers Mounted:

Four 6½" Low resonance Speaker
One 2½" Cone type Tweeter
With Built-in Network

Power Handling Capacity:

15 watts

Voice Coil Impedance:

8 ohms

Frequency Response:

100 - 18,000 c/s

Enclosure:

17¾" wide x 23¾" high
Walnut hand-rubbed oil finished
with pair of detachable legs.

Shipping weight:

8.2 kgs.

Model AX 122

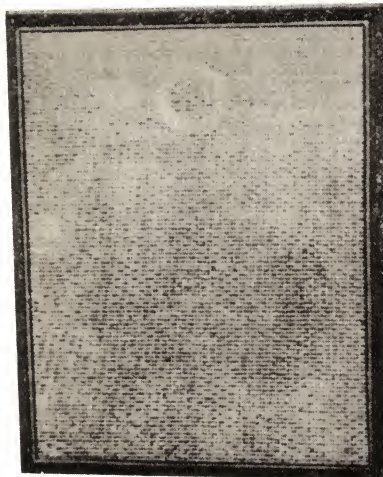

\$154 pair

A slimline enclosure incorporating a two way speaker system. The low frequency speaker is a 12" unit of heavy cast construction providing clean distinct bass. The tweeter unit is a wide angle 3" metal diaphragm type, operating through a network incorporating an external level control. An outstanding system of moderate price.

Crossover:

12" Woofer
3" Metal cone tweeter
2-Way Network, Crossover at
2000Hz at 6db per octave.

Power Handling Capacity:

up to 20 watts (Music Input)

Voice Coil Impedance:

8 ohms

Frequency response:

40 - 20,000 Hz

Enclosure:

17¾" wide x 23¾" high x 7¾" deep
Walnut hand-rubbed oil finished.

Hear these Superb Systems now:
Available from quality Hi-Fi Dealers or the Australian Agent;
General Accessories 161 Sturt St South Melbourne 69 0300

BRANCHES IN ALL OTHER STATES

Using a Gas Laser for Light-Beam Communication

A simple transistor modulator connected to the helium-neon gas laser described in the August issue allows audio signals to be impressed on the output beam, and detected at distances exceeding 150ft in daylight. A coherent optical link on 500,000,000MHz!

by Jamieson Rowe

The use of a light beam as a carrier of intelligence is a concept which has intrigued many experimenters, and has provided motivation for a considerable number of magazine articles describing optical communications links. The present article briefly describes another link of this type, one which employs a rather novel method of internal electrical modulation of a helium-neon gas laser.

A variety of light sources and modulation methods have been used in previous light beam communications links. The systems used have generally employed current modulation of small gas discharge lamps, incandescent lamps, or more recently, light-emitting semiconductor diodes. Arc lamps and lasers have also been used with external electro-optical modulators to produce higher power systems, but usually these have been confined to research situations because of the highly complex and expensive equipment involved.

When operated on their discharge "plateau," normal gas discharge lamps are capable of being modulated fairly linearly over a modest dynamic brightness range. However, the available light output tends to be very low, and as the discharge tends to be physically diffused, focusing into a narrow beam can be quite difficult.

Small incandescent lamps have the advantage of higher light output, and also that the light source tends to be more compact and hence better suited for matching into optical systems. However, the frequency response tends to be rather poor, due to the thermal inertia characteristics of the lamp filament. Only by using thin and physically rather fragile low-inertia filaments has it been possible to obtain a response adequate for voice-frequency signals.

The recently-developed light emitting semiconductor diodes have proved somewhat more suited for the purpose than either gas-discharge or incandescent lamps, possessing high output, a low source area and a potential frequency response of hundreds of megahertz. Using such diodes, television signals have been carried over distances as great as 30 miles. However, as yet these devices are rather expensive, and generally must be provided with special cooling arrangements if high output is to be achieved.

The output from lasers, being concentrated into narrow parallel beams, is potentially well suited for optical communication. Because of this, considerable work has been done with laser beams modulated externally using electro-optical devices such as the Kerr

and Pockels cells. However, little appears to have been done to exploit the fact that the gas laser, being a discharge device, can be modulated internally by varying the discharge current.

While testing the small demonstration gas laser described in this magazine in the issue of August last, it occurred to the author that discharge modulation of the device might provide a basis for a practical light-beam communications link. Lack of time prevented following up the idea before the original article was published, but since then we have been able to try out the scheme and verify that it does in fact work quite well.

The depth of modulation possible before distortion becomes evident is not very great, but is quite useful nonetheless. Using a simple transistorised modulator unit to impress signals upon the laser beam, together with a crude receiving end employing a small silicon photodiode in a cardboard mailing tube (without lenses), we were able to transmit voice messages and music over distances greater than 150 feet in daylight, with good clarity and quite low noise.

Our impression is that communication over considerably larger distances would be practical if a more efficient receiving system were employed. Such a system could employ filters or other means to reduce the masking effect of ambient illumination, together with efficient optics to concentrate the full laser beam on the active region of the photodiode.

We are publishing brief details of our experimental setup in view of the possibility that other experimenters may care to develop the system further. The information may also be of interest to the casual reader as it illustrates yet another application of laser devices in modern electronics.

As may be seen in the circuit, modulation is achieved simply by means of a small transformer wired in series with the cathode return of the EOA-9040 laser tube. Audio signals developed across the transformer secondary are thus effectively superimposed upon the supply voltage connected across the tube and its swamping resistance, and thus the tube current is modulated.

It should be noted that the modulation is achieved without disturbing the 6.3V supply to the tube heater, an important factor in maintaining correct tube operation.

The modulation transformer is a small 5K/15ohms loudspeaker transformer, connected with the 5K winding used as secondary. Audio signals could be supplied to the 15-ohm winding from any convenient amplifier or radio receiver; however, for the purposes of test we wired up the simple

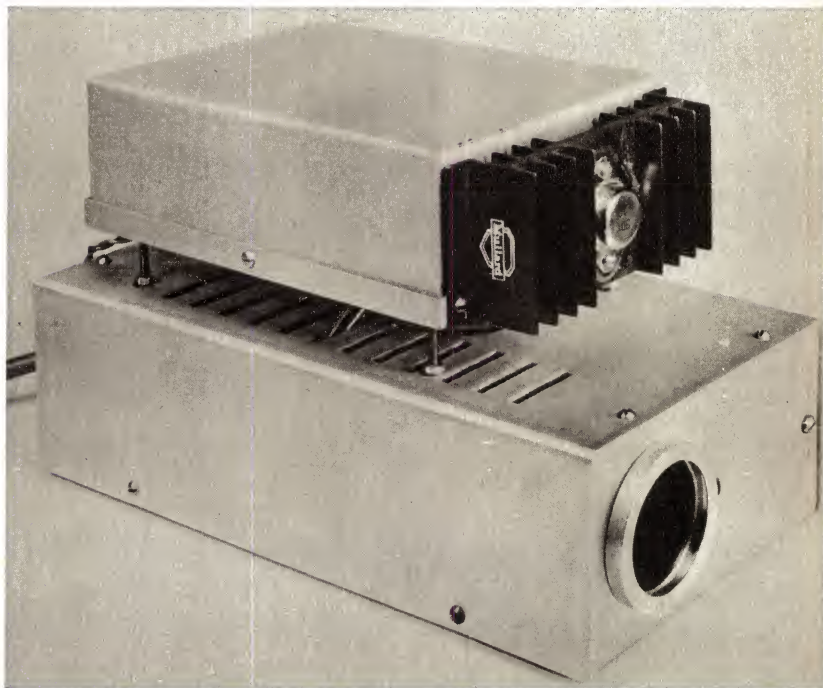

The experimental modulator unit described in this article is shown here mounted "piggy-back" on the lid of the prototype laser unit described in the August issue.

"Par Excellence"

— MEANS SOMETHING TO US —

If "par excellence" means something to you (audiowise) you will be looking for our superb agency lines at all reputable dealers. Before we accept an agency we carefully consider the performance of the product offered — it simply must offer something extra before we are prepared to market it. The serious enthusiast can be assured that if J.H. Reproducers Co. is the agent, then the instruments offered are compatible with the finest audio equipment. Consider, for example, two recent agencies we have accepted:

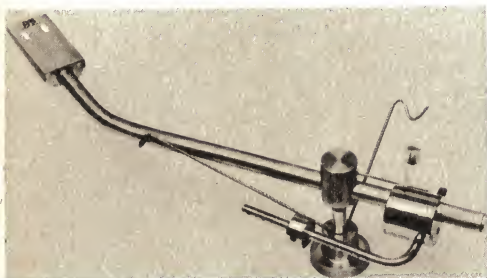

AN ARM DESIGNED FOR FINE EQUIPMENT.

"G. H." UNIPOISE PICKUP ARM

This fine arm is an excellent example of British craftsmanship. It is a unipivot design of immeasurably low bearing friction. It balances dynamically in all planes and will track the most badly warped discs. It is one of few unipivot designs with enough science in it to make possible the provision of bias compensation. The slotted headshell is of fixed variety and assures the user that the stylus is always in a vertical plane, whereas, almost every other arm we know of needs a lot of fussy adjustment in this important detail. A CONNOISSEUR'S CHOICE.

PRICE \$40



Featuring proximity switch, Neon strobe, independent suspension of arm which floats in a silicon fluid and anti-acoustic feedback legs.

"TRANSCRIPTOR" PRODUCTS

Introducing the Rolls-Royce of turntables—the Transcriptor Reference Turntable (we've taken off the hinged perspex cover to give you a better view of it). It comes ready to plug in, has hydraulically controlled speed variation of less than .00005 per cent (yes, that's the correct number of noughts) and optional extras of unparalleled quality. This unit turns to perfection and no known instrument can fault its performance.

PRICES:

Turntable — \$242 Sweep Arm — \$12
Fluid Arm — \$60 Stylus Brush — \$7
Stylus Scales — \$9

(See fine reviews and advertisements in "HI FI News" and "Gramophone")

STOP PRESS

Have you seen the July 69 issue of "STEREO REVIEW" in which the world's most respected reviewers state, "we could not critically compare each cartridge against all of the others . . . we had to content ourselves with comparing each with the ADC-25, as representative of the best available, and it emerged the better choice from each such comparison."

J. H. REPRODUCERS CO.

293 HUNTINGDALE ROAD, CHADSTONE, VICTORIA. 3148

TELEPHONE: 277-3066

Exclusive Australian Agents for — ADC Cartridges and Amplifiers, Kef speakers, J. H./G. H. Unipoise Pickup Arms, Pritchard Arms, TRANSCRIPTOR TURNTABLES and the popular J.H. Synchronous Turntable.

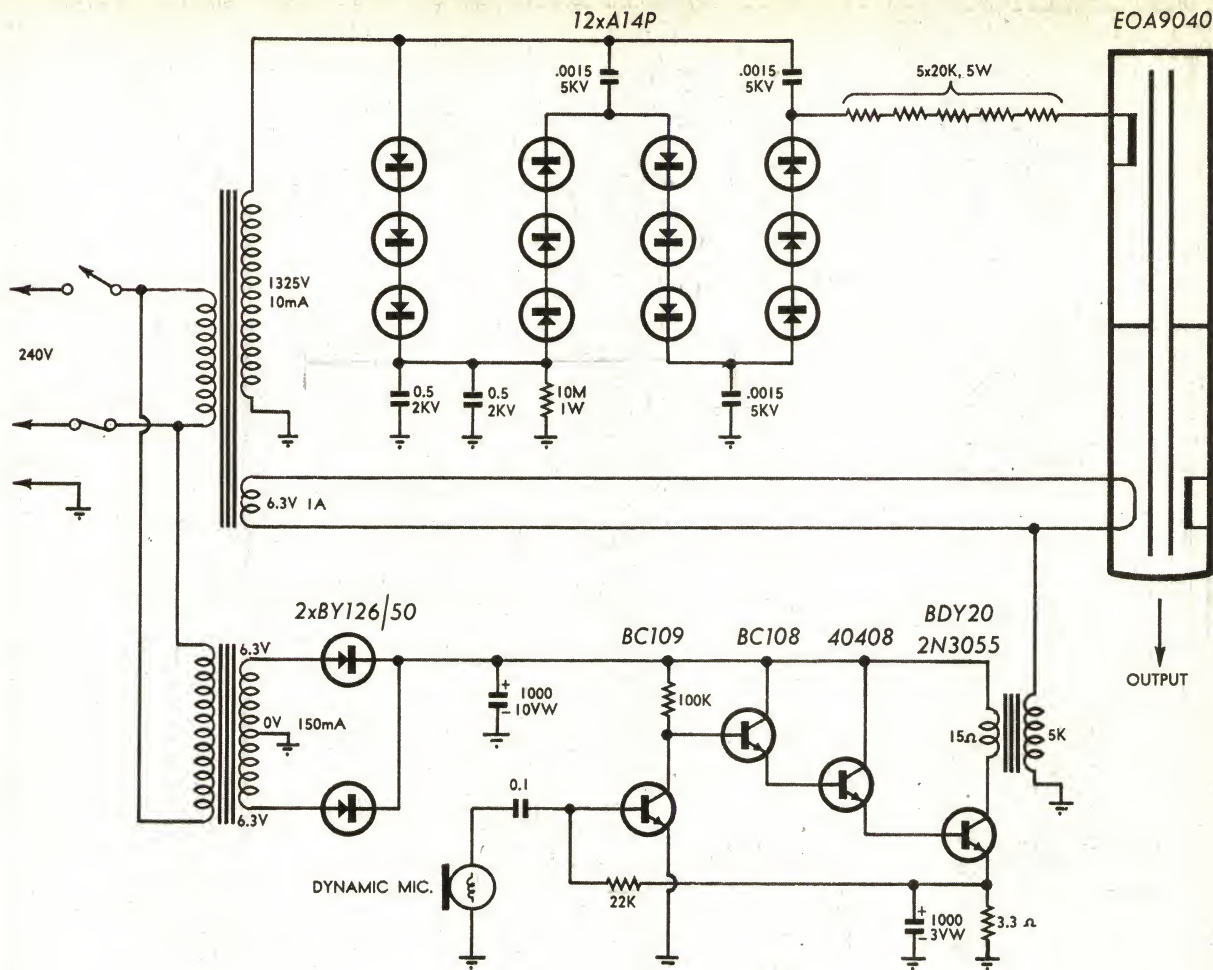

(EA) MODULATED GAS LASER

2/MS/19

The circuit of the complete modulated laser, showing both the simple modulator unit and the minor changes made to the laser power supply circuit. The additional 0.5uF HT filter capacitor is mounted in the modulator case, as space is not available in the main laser case.

transistorised amplifier shown. It employs four silicon NPN transistors in a class-A compound DC-coupled circuit, and drives the modulation transformer directly from a medium-output dynamic microphone.

A small full-wave rectifier circuit based on a miniature 12.6V CT power transformer supplies the amplifier with approximately 8V DC at about 130mA. The primary of the transformer is connected in parallel with the existing laser power transformer.

In the laser power supply itself two modifications have been made to achieve optimum modulation characteristics. A second 0.5uF/2KV reservoir capacitor has been added in parallel with the existing unit, to reduce supply ripple. This is necessary to ensure that 50Hz hum does not degrade the modulating signals.

The second modification has been to add a fifth 22K/5W resistor to the discharge tube swamping resistance, to reduce the quiescent operating current. This is necessary in order to allow linear modulation on both positive and negative signal peaks, and ensures that maximum use is made of the modulation characteristic of the tube.

As may be seen from the photograph, the experimental modulator unit was

housed in a small utility case mounted via spacers to the lid of the original laser case. The output transistor of the modulator was fitted outside the case on an extruded radiator, although this is not really necessary.

Inside the utility case are mounted the modulating transformer, the modulator power transformer, and the modulator circuitry. Also inside the case is the additional 0.5uF/2KV laser power supply capacitor, for which room is not available inside the main case. Heavily insulated wires connect this component in parallel with the existing unit in the main case. The remainder of the wiring is uncritical, and may be wired using any convenient layout.

The additional laser tube swamping resistor is connected directly to the tube anode connector inside the main case. Care should be taken when positioning this component to avoid arcing over to the case. Note also that the spring connector disc used for connecting to the tube anode pin should be detached from the tube and held by heat-absorbing pliers during the soldering operation.

The photodiode used at the receiving end of the experimental link was a type SC1 silicon photovoltaic device, available from the Imported Components Division of Plessey Ducon Pty.

Ltd. Measuring only 0.185in x 0.08in, it delivers a signal at roughly crystal microphone level, and is simply connected to the input of a suitable audio amplifier.

When experimenting with the modulated laser, the same safety procedures should be adopted as were stressed for the original laser unit. Avoid looking directly into the laser beam with the naked eye, except perhaps when at a distance sufficient for the beam to have spread to a diameter considerably greater than that of the eye iris.

RESISTORS

1/2w 4c each or \$3.00 per 100

POLYESTER CAPACITORS

.001mf — .01mf 7c each
all values available

ELECTROLYTIC CAPACITORS

all values — 5mf — 12c

Send for list.

SPECIAL — NEW GREY PLASTIC
CABINETS — Suit. Instruments or kits
5 1/2" x 4" x 3" only
25c each or 10 for \$2.

S. E. WILLIS TRADING CO.

38 RIVERSDALE RD.,
CAMBERWELL JUNCTION, VIC. 3124

SANSUI

AMPLIFIERS ARE POPULAR BECAUSE THEY OFFER GREATER PERFORMANCE AT A MODERATE COST.

For over a quarter of a century Sansui has been Japan's leading manufacturer of high quality stereo amplifiers . . . today this progressive company is recognised as a leading *international* manufacturer. Over 75% of Sansui's total production sells rapidly on world markets — irrevocable proof of the acceptance of Sansui quality and reliability. *Simon Gray proudly presents three of Sansui's best selling high fidelity solid state stereo amplifiers.*

SANSUI MODEL

AU 222

— 46 WATTS

Using low noise silicon transistors throughout, the Model AU-222 features a frequency response of 20-30,000 Hz. \pm 1dB. and a power output of 46 watts (music power). Input sensitivity suits magnetic cartridges at 2 mV. Performance of this compact stereo amplifier is quite outstanding and every desirable control is incorporated. List price is \$180 inc. sales tax.



SANSUI MODEL

AU 555

— 60 WATTS

Total music power is 60 watts and frequency response is 20-80,000 Hz \pm 1 dB. Input sensitivity suits magnetic cartridges at 2 mV. Advanced circuitry is employed — low noise silicon transistors are used throughout. Controls are extremely flexible — audio quality is superb. List price is \$217 inc. sales tax.

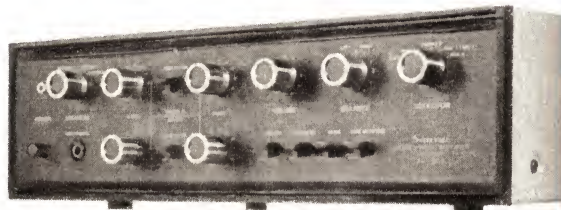

THE NEW
SANSUI MODEL

AU 777A

— 70 WATTS

An extremely fine, all silicon transistor, stereo amplifier with a frequency response of 20-100,000 Hz \pm 1 dB. at normal listening levels. Power output is 70 watts (music power) and input sensitivity suits magnetic cartridges at 2 mV. All desirable controls are incorporated. Price is \$321 inc. sales tax.

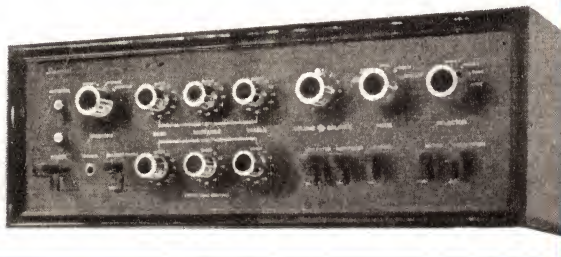

Every Sansui amplifier has many unique advanced features and offers flexibility and control unsurpassed in its price range. We invite you to see your nearest Sansui amplifier supplier and listen to these fine amplifiers. Ask for complete unabridged specifications. Examine the construction of Sansui equipment closely—engineering and electronics reflect Sansui's quality control in manufacture. Above all, listen. Hear the extraordinary difference Sansui quality makes!

SGS 10/69



Australian National Distributors:

Simon Gray Pty. Ltd.

Head Office: 28 Elizabeth St., Melbourne, Vic. Tel. 63 8101*
Sydney Office: 22 Ridge St., North Sydney, N.S.W. 929 6816
Canberra Office: 31-33 London Circuit, Canberra City, A.C.T. Tel. 49 6050

INTERSTATE REPRESENTATIVES:

N.T.: Pfitzner's Music House, Smith Street, Darwin. Tel. 3801
Q'land: Sydney G. Hughes, 154-158 Arthur St., New Farm, Brisbane. 58 1422
S.A.: Elco Sales Pty. Ltd., 7-9 Osmond Terrace, Norwood, S.A. Tel. 63 4844
Tas.: K. W. McCulloch Pty. Ltd., 57 George Street, Launceston. Tel. 2 5322
W.A.: Athol M. Hill, 613-615 Wellington Street, Perth. Tel. 21 7861

CERAMIC RESONATORS

as oscillator control elements . . . 2

Last month, in the first part of this article, we discussed the possibilities of 455KHz ceramic resonators for use in high-performance band-pass filter systems for short-wave and communications receivers. This month, we have a look at the possibilities of using the same resonators as the controlling unit for beat frequency oscillators.

By Ian Pogson

Facing up to the proposition, we referred to the Murata Technical Report on Ceramic resonators and studied the frequency versus impedance curve, reproduced here as figure 7. It will be seen that the series resonance point is nominally at 455KHz, the impedance (resistance) being of the order of 20 ohms or less. On this basis, we reasoned that the device should oscillate in the series mode. On studying the curve further, we noted that the parallel or antiresonance point occurred at about 495KHz. Clearly, this point would be of little value.

In some respects the curve is similar to that of a quartz crystal, but the series and parallel resonant frequencies are much further apart. Also, the resistance at series resonance is generally higher with a quartz crystal—which emphasises the possibility of using the ceramic resonator in a series configuration.

The first test was with a single element unit, type SF455B, in the circuit as shown in figure 8. This setup was successful in that the resonator did oscillate. A further check showed that the frequency in this case could be changed from 450KHz with the series trimmer shorted to 456.8KHz, with the trimmer adjusted to the point where any further reduction resulted in unreliable oscillation. This was very encouraging. The possible change in frequency of 6KHz could be very useful, although the actual range covered did not straddle the likely pass band of a practical IF strip, using the same type of filter.

In further evaluating the circuit, we were influenced by a report that this particular resonator is no longer being made.

These facts led us to consider the use of the double units with which we had previously conducted the filter experiments. We turned our attention to the successful crystal oscillator, which had been developed some time ago in our laboratory and which we have since used in several projects. The type of circuit which evolved is shown in figure 9; initially, we did not have the coil and capacitors in the base of the first transistor.

Overall, results were so encouraging that we decided to investigate means

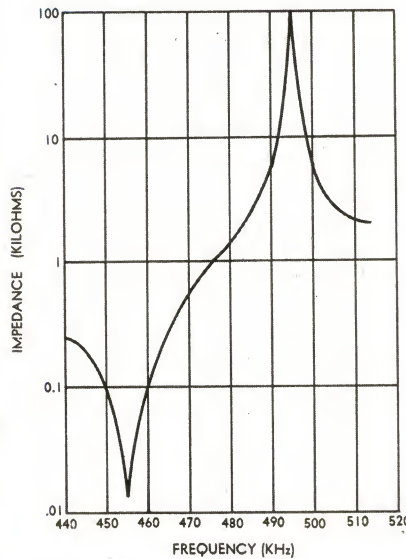

Note the similarity in shape of the frequency - impedance curve of the ceramic resonator and that of the quartz crystal.

Shown is the fully developed BFO circuit. Note carefully the connections to the ceramic resonator.

of shifting the resonant frequency, at least by a sufficient amount so that it could be adjusted to one side of the pass band of the IF filter, when this oscillator was to be used as a BFO.

During the investigation, several important points emerged. It was found that quite a large frequency shift could be achieved, ± 1 KHz or so, by adding inductance and capacitance in suitable

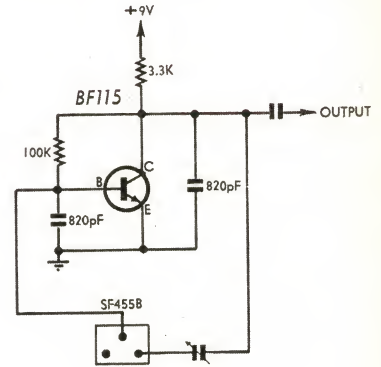

This is the first circuit tried, with limitations described in the text.

proportions, in the base circuit of the first transistor. Rather fortuitously, the optimum value of inductance turned out to be about 1mH, near enough to the inductance of an ordinary IF transformer winding. Even with the 100pF shunt capacitor still across the winding, a significant upward frequency could be achieved. By adding extra capacitance across the combination, the frequency could be shifted by about the same amount in the opposite direction.

Although this could be described as most encouraging, we felt that the amount of shift so far obtained, although useful, still left something to

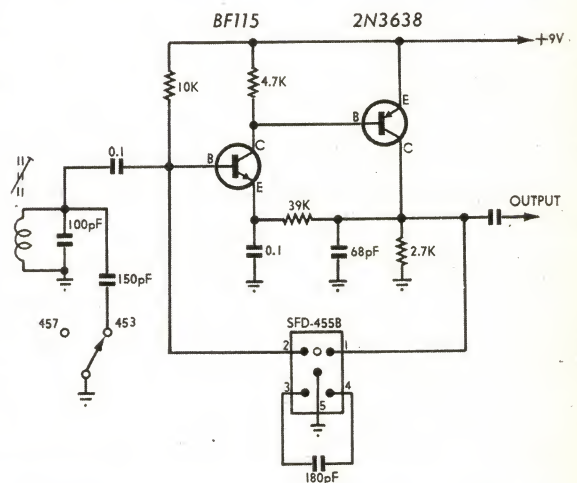

be desired. Subsequently, it was found that if the functions of terminals 1-2 and 3-4 were reversed, a considerable increase in frequency shift could be obtained. Coupled with this, it was also found necessary to increase the top capacitive coupling to 180pF. Under these conditions, as actually depicted in figure 9, we were able to achieve quite readily a frequency coverage from 452 to 458KHz.

reliable
pre-tested
tight performance
NEWMARKET

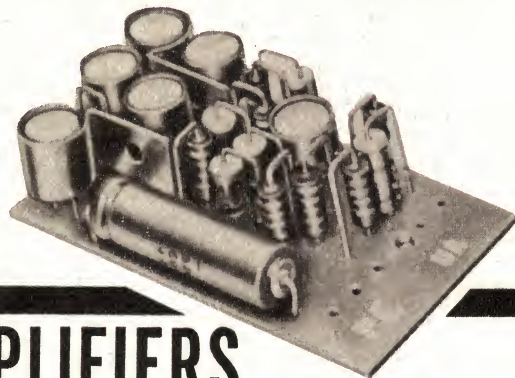

PACKAGED CIRCUIT AMPLIFIERS

The Newmarket PC range provides *Development Engineers* with reliable pre-tested units of tight performance specifications to incorporate in any equipment at minimum cost. Use of such units not only obviates the need to develop purpose-made amplifiers for every job, but cuts down the number of small

components that company *Buyers* have to buy and maintain in stock. Each unit is guaranteed for 12 months and replacement units are supplied if any fault develops. Our guarantee also enables the manufacturer to guarantee his product to the ultimate user.

some applications

MODEL No. PC 1

Stethoscope Amplifier.
General Purpose Audio Amplifiers and Drivers.
Intercomm Amplifier.
Telephone Amplifiers.
Laboratory Instrument Amplifiers.
Back Projector Audio Amplifiers.
Loudspeaker Amplifier.
Hospital Board Control Units Intercomm Amplifiers.

MODEL No. PC 2

Modulator Driver Stage.
Intercomm.
Church Hearing Aid Amplifier.
Office Dictating Machines.
Door-Caller Monitor Amplifier.
Inter-Office Communication Amplifier.
Tape Replay Amplifier.
General Purpose Audio Amplifiers and Drivers.
Telemetry Audio Amplifier.
Radio Receiver Audio Amplifier.
Telephone Amplifiers.
Educational Equipment Audio Amplifiers.
Laboratory Instrument Amplifiers.
Language Laboratory Amplifiers.
Tape Recording Amplifiers.
TV Aerial Riggers Intercomm Amplifier.
Loudspeaker Amplifier.
Radio Concentrator.
Mine Communication Amplifier.

MODEL No. PC 3

Disc Talking Book.
DC Relay Driver.
Telecommunications Conference Monitor Amplifier.
Sound-level Meter Amplifier.
Close Background Music Amplifier.

Sound Reinforcement Amplifier.
General Purpose Audio Amplifiers and Drivers.
Low Power Battery Stereo.
VHF Communications Receiver Audio Amplifier.
Radio Receiver Audio Amplifier.
Telephone Amplifiers.
Heating and Ventilating Control Amplifier.
Laboratory Instrument Amplifiers.
Museum Portable Commentary Equipment System.
Radio Relay System Amplifier.
Loudspeaker Amplifier.

MODEL No. PC 4

Battery Record Player.
General Purpose Amplifiers and Drivers.
Office Dictating Machines.
Telephone Amplifiers.
Pay TV Control Circuits Amplifier.
Stereo Listening Booth Amplifiers.
Laboratory Instruments Amplifiers.
Loudspeaker Amplifier.
Radio Relay System Amplifier.

MODEL No. PC 5 Plus

Salesman's Portable Cine Projector Audio Amp.
Meter Type Galvanometer Amplifier.
Helmet Intercomms: (a) Diving Suits, (b) Crash Helmets, (c) Pilots' Helmets.
Car Radio Audio Amplifier.
Communications Receiver Audio Amplifier.
Lecturer Non-interruption Monitor.
Erotogetic Amplifier.
Small Public Address Portable Amplifier.
Servo Amplifier (Hydraulic Valve Control).
General Purpose Amplifier.
Fault Finding Tone Detector Amplifier.
Tape Replay Amplifier (Aircraft Ground Equipment).
Automation Drive Amplifiers.
Colour Television Receiver Audio Amplifier.
Tape Recorder Replay Amplifier.
Hi-Fi Amplifier.

Vibration Test Amplifiers.
Telephone Intercomm System.
Office Dictating Machines.
Telephone Amplifiers.
Fire Detection Equipment Amplifier.
Mines Telephones Amplifiers.
Cigarette Manufacturer Production Test Equipment Amp.
Instrument Audio Amplifier.
Sound Reinforcement Intercomm Amplifier.
Null Detector Instrument Amplifier.
Public Address Amplifier.
Mobile and Fixed Transmitter Modulators.
Telephone System Audio Amplifier.
High Power P.A. Driver Amplifier.
TV Camera Channel Talk Back Amplifier.
Sound Intercomm Amplifier.
Industrial Test Instrument Amplifier.
Burglar Alarm Audio Amplifiers.
Transceiver Audio Amplifiers.
Laboratory Instrument Amplifiers.
Airport Loudspeaking System Amplifier.
Pocket Paging System Amplifier.
Carrier System Mains Intercomm (Portaphone).
Loudspeaker Amplifiers.
Electronic Organ Power Amplifier.

MODEL No. PC 7 Plus

Tape Language Laboratory.
Telephone Dictating Machine Amplifier.
Automation Drive Amplifiers.
Control Amplifier for Textile Machinery.
Radio Receiver Audio Amplifier.
TV Receiver Audio Amp.
General Purpose Amplifier.
Telephone Amplifier.
Laboratory Instrument Amplifiers.
Tape Language Laboratory Amplifier.
Loudspeaker Amplifier.

specification details

PERFORMANCE DATA	PC1	PC2	PC3	PC4	PC5	PC7	PC7+ /12	PC9
Power Output mW	150	400	400	400	3W	800	800	Pre-amp
Input Sensitivity mV	50	1	5	150	5	5	5	1V
Input Impedance ohms	1.5K	1K	2.5K	220K	1.5K	1.5K	1.5K	1M
Output Impedance ohms	40	15	15	15	3	8	15	600
Supply Voltage—volts	9	9	9	9	12	9	12	9
Typical Distortion %	2	3	3	3	3	3	3	1
Frequency Response	300-15K	200-12K	200-12K	200-12K	50-12K	50-12K	50-12K	20-20K
Overall Dimensions All ¾ in. high	2x1	2½x1½	2½x1½	2½x1½	5½x1¾	3x1¾	3x1¾	2x1

Circuits are of transformerless, complementary symmetry type, operating off Standard Voltages. Can be wire-in or plug-in as required.

tecnicco ELECTRONICS

53 Carrington Road, Marrickville, N.S.W.
18 Normanby Rd., South Melbourne, Vic.

SYDNEY: General Accessories Limited, 443 Concord Road, Rhodes 2138; G. Brown & Co. Pty. Ltd., 267 Clarence Street, Sydney 2000. NEWCASTLE: Martin de Launay Pty. Limited, King and Derby Streets, Newcastle 2300. WOLLONGONG: Electronic Parts Pty. Limited, Keira Street, Wollongong 2500. MELBOURNE: Radio Parts Pty. Limited, 562 Spencer Street; Warburton, Franki Limited, 220 Park Street 3000. BRISBANE: General Accessories Pty. Limited, 50 Little Edward Street 4000. ADELAIDE: General Accessories Pty. Limited, 81 Flinders Street 5000. PERTH: General Accessories Pty. Limited, 46 Milligan Street 6000.

One vital question still had to be answered: How would the stability of such an oscillator compare with a crystal oscillator, or even a good self-excited oscillator? Obviously the next task was to find out.

To make the test as realistic as possible, we decided to check, not at 455KHz, but at 453KHz, where the frequency had to be "pulled" by an amount likely to be met in practice. Measurements were taken over a period of one hour, against the frequency counter. From the moment of switching on, there was no significant drift. Indeed, the frequency stayed within a

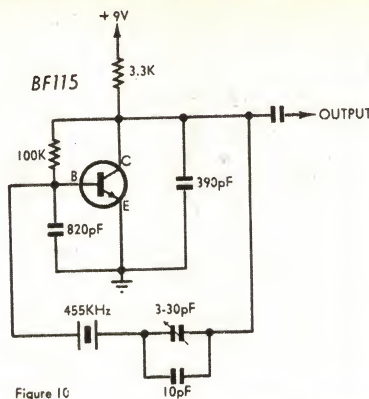

Figure 10

Shown above a typical 455KHz crystal oscillator circuit, used as a comparison.

At left, a stable 455-KHz self-excited oscillator, also used for comparison.

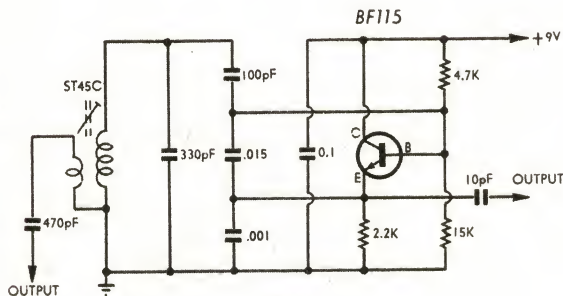

Figure 11

These three curves show clearly the performance of the new ceramic resonator, against the crystal oscillator and self-excited circuits.

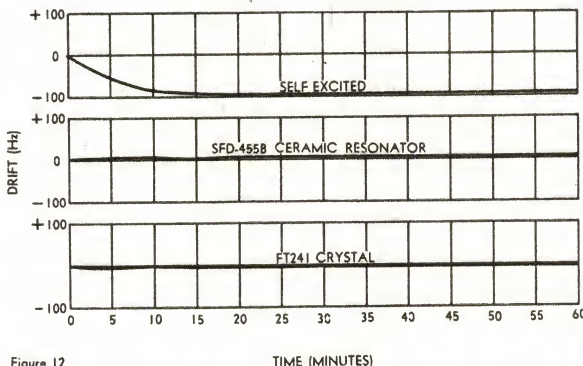

Figure 12

couple of Hz of the initial reading, for the whole hour. The resultant curve is shown in figure 12.

By way of interest, and to make the test more complete, we decided to make comparisons with a typical crystal locked BFO and a self-excited BFO. The circuits of the test oscillators are shown in figures 10 and 11, respectively. The results of these two checks are shown also in figure 12.

Close scrutiny of the curves for the ceramic resonator and the FT241 crystal shows that there is a slight negative drift with the ceramic resonator and a slight positive drift with the crystal. However, the drift in each case is so small that it would be of little consequence in practice. It is also interesting to note the performance of the self-excited oscillator, particularly after a warm-up period of 20 minutes. After this time, this oscillator is almost as stable as the other two. At the same time, it must generally be conceded that the self-excited oscillator is more likely to be upset by environmental conditions.

Before leaving our comparisons between the ceramic oscillator and the crystal counterpart, it may be worth looking at the temperature coefficients of the two elements. Here again, we refer to the Murata Technical Report, which gives the temperature coefficient

of the ceramic unit as less than 50 parts per million, per degree Celsius; it also gives a figure of less than 10 parts per million, per degree Celsius, for a crystal. In round figures, therefore, we could expect a long-term stability with temperature, for the ceramic oscillator, to be about one-fifth that of a typical crystal — which should still be very satisfactory.

The point which emerges is that a stable BFO, perhaps not quite as good as a crystal controlled BFO, is possible at a very moderate cost. Furthermore, where two crystals would normally be required for upper and lower sideband reception, the same two functions can be performed by only one ceramic unit, thus making the cost factor even more attractive. In addition, it should also be possible to make the ceramic BFO continuously adjustable in frequency over its full range with a suitable variable capacitor.

These considerations hold good promise for the development of low cost, high performance short wave and communications receivers. We expect to make immediate use of this information for the development of receiver IF strips and BFOs. In addition, the possibility of using a ceramic filter assembly and ceramic oscillator for the carrier for an SSB generator is too promising to be overlooked.

MICRO CARTRIDGES PROVIDE EXCELLENT PERFORMANCE AT MODEST COST

In each price range MICRO cartridges offer outstanding performance . . . and Encel prices are extremely modest. Two of the most popular magnetic "induced magnet" cartridges are the Series 2100 and the Series 3100. MICRO's ceramic cartridge, the Model SC-303, has been a best seller in Australia.



MICRO MODEL 2100/5 MOVING MAGNET STEREO CARTRIDGE

With an input sensitivity of 5 mV the new Model 2100/5 features a conical diamond stylus (0.5 mil.), a tracking angle of 15 deg. and a frequency response of 10-28,000 Hz plus or minus 3 dB. Stylus pressure recommended is 1-3 grams; channel separation is 30 dB at 1 kHz. Listening tests indicate that most music lovers imagine the 2100/5 costs twice the Encel price . . . inc. Sales-Tax \$14.50.

MICRO SERIES 3100 STEREO CARTRIDGES

This is one of the most popular stereo cartridges ever sold by Encel Stereo Centres. Frequency response is 20-28,000 Hz and channel separation is 28 dB. New standards of performance for low priced cartridges have been set by this well designed moving magnet cartridge—read this excerpt from the "Electronics Australia" review, page 119, Feb., '69 issue. "The frequency response checked out at plus or minus 2 dB from 30 Hz to 20 KHz." "Separation between channels was very good at 33 dB at 1 KHz and never less than 38 dB over the range from 500 Hz to 20 KHz." This is very good performance indeed. Two models are available . . . the VF-3100, E with an elliptical diamond stylus and the VF-3100/5. Both MICRO Series 3100 cartridges track at 1 1/2 grams.

THE MICRO SC-303 CERAMIC STEREO CARTRIDGE

With a frequency response of 20-15,000 Hz the new Model SC-303 ceramic cartridge features a tracking angle of 15 deg. and a diamond stylus is standard. Performance is excellent when one considers the low Encel price of only \$6.90 inc. Sales-Tax.



MICRO DUST PICK-UPS—ONLY \$3.50.

Removing the dust from your records is greatly simplified with the Micro dust pick-up, which removes the dust as the record plays. An ideal gift. Inc. Sales-Tax \$3.50.

Encel

ELECTRONICS (STEREO)PTY. LTD.

Head Office:

431 Bridge Rd., Richmond, Victoria 3121.

Tel. 42 3762.

Sydney Store: Ground Floor, 25M Building.

257 Clarence Street, Sydney, N.S.W. 2000.

Tel. 29 4563, 29 4564.

*Wholesalers

*Trade-ins accepted

Australia's Greatest Hi-Fi Centre

LET THE WORLD OF POSTAL EDUCATION TRAIN YOU FOR A TOP JOB

BRANCHES THROUGHOUT THE WORLD

Great Britain, Canada, Israel,
Singapore, Hong Kong, Thailand,
India, Ceylon, South Africa, Sudan,
Kenya, Rhodesia, Zambia, Tanzania,
Malawi, Lebanon, Malta, Italy,
Netherlands, U.S.A., Australia,
New Zealand, British West Indies.



TODAY

there are wonderful Opportunities for the forward-looking man and woman. However, the best jobs go to those who have the foresight to prepare themselves by proper training. British Institutes have already trained some 300,000 men and women who have reached the top of the ladder. Therefore, it is up to YOU to make something of yourself. Don't delay, act NOW. Remember that an enquiry places you under no obligation but could be the turning point in YOUR career.

CHECK THESE FEATURES:

- Modern streamlined methods . . . you learn the fast way and make rapid progress.
- Courses based on STANDARD TEXTBOOKS . . . Lessons and Model Answers written and planned by experts.
- We provide all necessary text-books which remain your own property.
- Moderate fees payable by small monthly sums. Written guarantee.
- Courses can be "tailored" to individual requirements.

OVER 500 COURSES offered by British Institutes include:—

TECHNICAL

Aero Engineering
Air Conditioning
Architecture
Arch. Drawing & Design
Auto. Engineering
Building (all branches)
Carpentry & Joinery
Chemical Engineering
Civil Engineering
Computers
Die & Press Tools
Diesel Engineering
Draughtsmanship
Electrical Engineering

Elec. Installations
Electrical Machinery
Electricity Supply
Electronics
Foremanship
Foundry Practice
Garage Management
Geology
Hydraulics
Illuminating Eng.
Industrial Chemistry
Jig & Tool Design
Machine Drwg. & Design
Maintenance Eng.
Management

Marine Engineering
Mechanical Eng.
Metallurgy
Municipal Engineering
Naval Architecture
Painting & Decorating
Petroleum Technology
Plastics
Production Engineering
Radio Engineering
Radio Servicing
Refrigeration
Reinforced Concrete
Road Engineering
Rubber Technology

Sanitary Engineering
Structural Engineering
Surveying
Telecommunications
Television Servicing
Timber Technology
Tracing
Welding Technology

COMMERCIAL

Accounting
Advertising
Auditing
Banking
Book-keeping
Business Management
Commercial Art
Commercial Law

Computer Programming
Costing
Data Processing
Economics
Fiction Writing
Journalism
Office Management
Personnel Management
Salesmanship
Secretaryship
Shipping
Travel

GENERAL

European Languages
Mathematics
Shorthand
Typewriting

And many other Subjects.

Details of Engineering and Commercial Exams., Certs. of Competency, Matriculation, etc.



**SECURE
ONE OF
THESE
BOOKS**

POST
COUPON
NOW!

British Institute of Careers

Dept. 8169 College House,
113 Pacific Highway, North Sydney, 2060

I am interested in _____
Please send me the appropriate Career-Book.

Name (Please print) _____

Address _____

Occupation _____ Age _____



**BRITISH
INSTITUTE
OF
CAREERS**

In association with
British Institute of
Engineering Technology

THE B.I.C. GROUP LEADS THE WORLD IN POSTAL TRAINING

Fundamentals of SOLID STATE

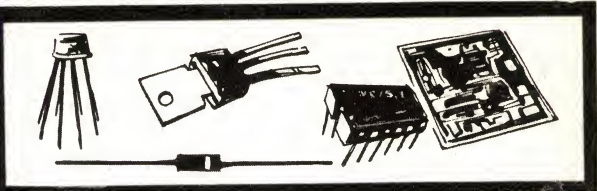

Chapter 6

by Jamieson Rowe

Zener diodes — breakdown voltage — power dissipation — temperature coefficient — reference diodes — compensation — zener applications — varicaps — capacitance range — Q-factor — varicap applications — varactors — frequency multiplication — parametric amplification — tunnel diodes — back diodes — applications — photo-diodes — light-emitting diodes — injection lasers.

Increasing the reverse bias voltage applied to a P-N junction diode eventually results in a phenomenon known as "breakdown," as we have seen in previous chapters. When breakdown occurs the normally very small and almost constant reverse bias current of the device suddenly and rapidly increases. It may be remembered that one of a number of mechanisms may be responsible for this rise in current, depending upon the doping levels and the construction of the device.

The mechanisms of breakdown do not involve inherent damage to the device, as we have noted. However, a diode which has entered this region of operation is capable of heavy conduction, while at the same time tending to maintain an appreciable voltage drop. The region therefore tends to be one of high power dissipation, and consequently of potential device damage.

In addition to the risk of device damage, there is the further consideration that in the breakdown region the behaviour of a device represents a significant departure from that of an "ideal" diode. It should therefore not be surprising that in a great many diode applications, considerable care is taken to ensure that device breakdown cannot occur.

Despite this there are certain applications in which diode breakdown is not avoided, but in fact intentionally planned. The reason for this is that, provided the device dissipation is kept below damage level, the voltage drop of a P-N junction in the breakdown region tends to be substantially constant, and independent of current level. A diode which is operating in the breakdown region may thus be used as a voltage regulating or limiting element, with applications similar to those of gas-discharge regulator tubes.

Although many "orthodox" semiconductor diodes may be used in this fashion, their usefulness as voltage regulators or limiters is generally rather limited. This is because with many devices there is a tendency, noted earlier, for breakdown to occur unevenly and in a localised manner at

some specific point on the crystal die. Breakdown current thus tends to be concentrated in a small area, causing localised overheating and damage, even at relatively low power levels.

Some years ago, device manufacturers found it possible to obviate this problem by careful control of doping level, doping gradients and the cleanliness levels maintained during the various fabrication processes. This enabled them to produce devices designed specifically to be capable of

ever, it is widely used to describe all devices designed for breakdown operation.

Zener diodes are fabricated almost exclusively from silicon, because of the higher temperature/dissipation capability of this material compared with the other commonly used semiconductors. They are made in many of the physical packages used for "orthodox" diodes, including most of those shown in the previous chapter. The breakdown characteristic of a typical device is shown in figure 6.1.

By varying doping levels and gradients, device manufacturers are able to provide circuit designers with zener diodes having breakdown voltage figures ranging from about 3V to above 200V. For convenience, device types are usually given a nominal breakdown voltage designation according to the familiar logarithmic "preferred value" series used for resistors, capacitors and other components, and a similar toler-

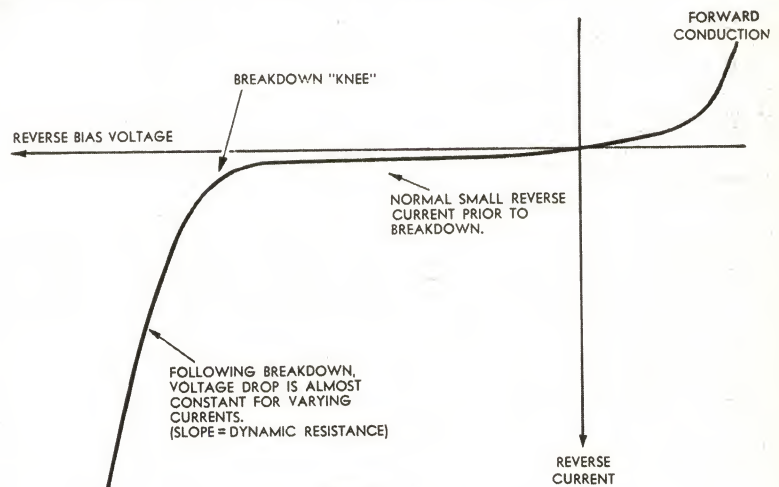

Figure 6.1

continuous operation in the breakdown region. At first these devices were capable of only modest power dissipation but, in recent years, the techniques have been further developed and power capability has risen significantly. (The same development in techniques has resulted in the appearance of the "transient protected" rectifier diodes mentioned in the previous chapter.)

The names given to devices specifically intended for breakdown region operation are "breakdown" diodes, "regulator diodes," "reference" diodes, and "zener" diodes (often contracted to "zeners"). The last of these terms should strictly only be applied to devices whose breakdown is due to the field-effect of Zener mechanism; how-

ever, the term "zener" is widely used to describe all devices designed for breakdown operation.

Because of these factors, it is usual for the nominal voltage of a zener diode to be quoted for a particular current level, and for a specific am-

can you afford to buy anything less than SANSUI?



Illustrated this month: Sansui Model AU 555 Amplifier, 60 watts music power.

Twelve months from now you will have forgotten precisely how much you paid for your Sansui Amplifier. Price will have become irrelevant. The only important factor in your mind will be how satisfied you are — how glad you paid that little bit more for the first class workmanship that has been put into your Sansui.

On the other hand, if you bought something that was a "bargain" and maybe only bought it because it was cheap, you will most likely regret it for ages. Measure it this way: Over a ten year period of enjoyment and complete satisfaction with your amplifier, is it worth jeopardizing all this to save a few dollars?

12 models to choose from

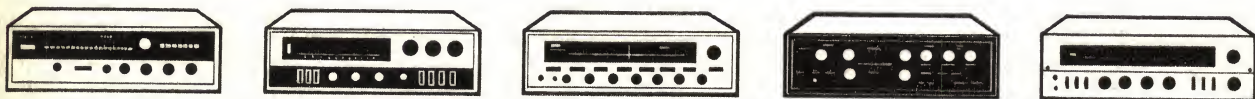

... and appearance wise they look what they are . . . top performance combined with smart styling.

SANSUI

Imported direct from Japan by: Magnecord International Pty. Ltd., Chapman House, 210 Clarence St., Sydney 2000. Tokyo Office: Tokyo Ginza Building 5-6 Chome, Ginza, Tokyo.

bient temperature. The behaviour of the device at other current levels and temperatures may then be described in terms of a current-voltage characteristic and/or a dynamic resistance figure, together with a temperature coefficient. The dynamic resistance of a device is the slope of the characteristic following breakdown, as indicated in figure 6.1; the temperature coefficient will be discussed shortly.

For most zener diode applications, a parameter of importance almost equal to that of nominal breakdown voltage is the device power dissipation rating. As with "orthodox" diodes, this rating determines the operating current levels at which the device may be operated for a given ambient temperature.

Currently available devices have continuous dissipation ratings ranging from a modest 200mW to more than 350 watts. High power devices have been developed with transient power dissipation ratings as high as 100KW for periods less than 100uS. The higher power devices often use a multiple-chip construction, with a number of crystal dice connected in parallel and/or series inside a common package.

Most manufacturers provide a number of ranges or "families" of zener diode devices, each range having a common package and an appropriate dissipation rating. Thus a manufacturer may provide a 400mW range, a 1W range, a 5W range, and so on, each range consisting of a series of device types covering the nominal breakdown voltage range.

It should be fairly clear that because of their differing breakdown voltages, the devices of a particular zener diode range having a common dissipation rating will have differing maximum current ratings. Thus in a 1W device range a nominal 10V device would have a maximum current rating of 100mA, while a 33V device would have a maximum current rating of only 30mA.

The temperature coefficient of zener diode breakdown voltage is quite often of importance, particularly in applications where a device is required to maintain a potential difference at substantially constant current over a wide temperature range. The name "reference diode" is sometimes reserved for devices intended specifically for this type of application.

It happens that the two main mech-

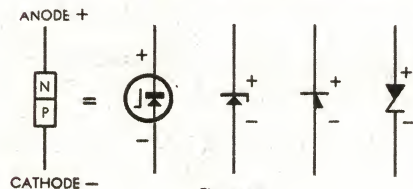

Figure 6.2

anisms responsible for P-N junction breakdown have opposing temperature coefficients. The field-effect or Zener mechanism responsible for low voltage breakdown (<6V) has a negative temperature coefficient: voltage falls with rising temperature. Conversely the avalanche mechanism responsible for high-voltage breakdown (>10V) has a positive temperature coefficient: voltage rises with rising temperature. In each case, a typical figure (absolute) is 5mV/°C.

Because of the opposing temperature coefficients of the two mechanisms,

cancellation tends to occur at the midpoint of the range of transition between the two—which occurs at roughly 6V. Hence devices whose breakdown voltage is close to 6V tend to exhibit a very low temperature coefficient and are accordingly well suited for use as reference diodes.

Although many applications requiring a zener diode of low temperature coefficient can be arranged to employ a device with a breakdown voltage around 6V, this is not always the case. However, where the requirement is for a higher breakdown voltage, and this is a fairly common situation, there is fortunately another way of achieving high temperature stability.

It may be remembered that a forward biased P-N junction has a negative temperature coefficient, its forward voltage drop falling with temperature. Because of this, it is possible to effect-

for zener diodes are shown in figure 6.2. It may be seen that in most cases the symbol attempts to indicate that the N-type side of the junction is connected to the positive supply polarity, in contrast with the connections for an "orthodox" diode. For a zener diode the N-type electrode is therefore the "anode," and the P-type electrode the "cathode."

Most applications for zener diodes are in power supply circuitry, where the devices are commonly used either as straightforward shunt regulators or as reference sources for feedback-type voltage or current regulating circuitry. Basic configurations for these applications are shown in figure 6.3.

Figure 6.3 (a) shows a simple shunt regulator. Here the relatively constant voltage drop of the zener diode when operating in the breakdown region is used to provide a stabilised voltage

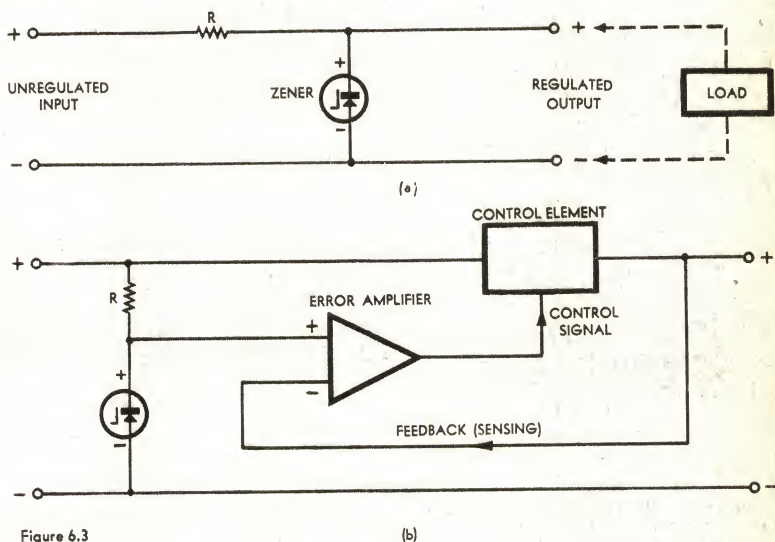

Figure 6.3

ively cancel the positive temperature coefficient of a zener diode of breakdown voltage higher than 6V by connecting in series with it one or more suitably designed or carefully chosen forward biased diodes. The combination will then exhibit a slightly higher effective breakdown voltage, but with a very low temperature coefficient.

Taking advantage of this idea, some device manufacturers have combined forward and reverse-biased dice inside standard packages to produce highly stable reference devices covering a wide range of nominal "breakdown" voltage. A typical device of this type has a nominal zener voltage of (11.7V ± 5%) at a specified current of 7.5mA, with a temperature coefficient of only 25uV/°C over the temperature range from -55°C to +150°C.

The same technique may be used with separately packaged devices, and circuit designers frequently combine zener and forward-connected diodes to obtain a low effective temperature coefficient at a certain voltage, using low-cost devices. Actually the technique is quite a flexible one because the forward-connected junctions used to compensate the zener need not be diode devices, but may well consist of any suitable junctions forming part of one of the more complex devices which we shall be meeting in later chapters.

The circuit symbols commonly used

source despite any variations in the unregulated input voltage and the load circuit current. In this type of circuit the resistor R is chosen so that the diode current has a value sufficient to permit the device to effectively "absorb" current changes due to loading or input variations, without exceeding the device dissipation ratings.

In figure 6.3 (b) is shown the somewhat more complicated scheme normally used where either very high accuracy regulation, or regulation at high power levels is required. Here the zener diode is used simply to provide a stable reference voltage source, against which the output quantity (in this case voltage) is compared. An error amplifier then provides a control signal proportional to any difference between the two, and this signal is used to correct the output signal by means of a power control element. As one might expect, a low temperature-coefficient "reference" device is often used in this type of circuit, to achieve the highest possible stability.

Zener diodes are particularly well suited for this type of application, possessing many advantages over the gaseous discharge regulator tubes formerly used. They are physically smaller and more rugged, and are available in a much wider range of nominal voltage and power dissipation ratings. Not only this but they have a lower dynamic resistance, giving

in the final analysis



this heath transistor tester excels

Heath IM-36 brings you up-to-date facilities for transistor analysis. Four lever switches select the desired test on any transistor or diode after initial setting of voltage and current range switches. Tests under a wide variety of conditions are feasible for both Gain and Leakage measurements. Divider resistors for current ranges are 1% precision. The high-quality, easy-to-read, zero-centre meter features a 10 microampere movement for maximum sensitivity for all measurements.

Internal power provides all necessary test voltages . . . up to 9 volts in 1.5 volt steps. Tests virtually all commonly used transistors. High-

voltage or high-power transistors may be analyzed completely through the use of external power.

- Measures current gain (Beta) up to 400.
- Unmatched in performance, quality, and price.
- Ideal for servicing, design work, incoming inspection, production testing, etc.
- Provides complete DC analysis of PNP and NPN transistors.
- DC gain (Beta) is read directly on calibrated scales.
- 15 μ A basic range for leakage (1cbo, 1ceo.) tests.

Phone for further information to the instrumentation specialists



WARBURTON FRANKI

ADELAIDE: 56-7333. BRISBANE: 51-5121. HOBART: 2-1841.
LAUNCESTON: 2-1318. SYDNEY: 29-1111. WOLLONGONG:
2-5444. MELBOURNE: 69-0151. MOUNT GAMBIER: 2-3841.
NEWCASTLE WEST: 61-4077. PFRTH: 8-4131.

better regulation, and the further advantages that their characteristic lacks both the "ignition voltage" peak and the negative resistance segment which complicate the use of gas regulator tubes.

There are many uses for zener diodes other than as voltage regulators and reference sources. For example they are often used either singly or in combination for signal clipping and limiting, using configurations similar to that shown in figure 5.8 of the previous chapter. A single zener diode may be used for asymmetrical clipping, while two identical devices connected in inverse series may be used for symmetrical clipping.

Other applications include threshold circuits which change state when a voltage passes a critical level, circuits which effectively shift the zero reading of a meter movement to correspond to a finite applied voltage ("zero suppression"), and circuits in which

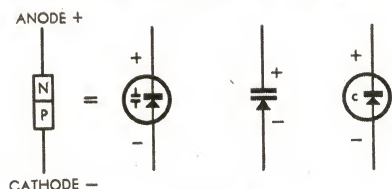

Figure 6.4

capacitance variation over a useful range. The crystal die structure and package construction also tend to introduce excessive series resistance and inductance, degrading performance at high frequencies. With germanium devices the saturation current also tends to be excessive.

Aware of the limitations of normal diodes for this type of application, and recognising the potential interest by circuit designers in devices which would lack the limitations, device manufacturers have in recent years developed diodes specifically designed to give optimum performance as voltage-controlled capacitors. These devices have become known as "varicaps," "varactors," or "variable capacitance diodes."

Commonly used varicap circuit symbols are shown in figure 6.4.

Probably the most important parameter of varicap diodes is the useful capacitance range, which is roughly the range available between the forward conduction and reverse breakdown points. In some devices the useful range may be less than this, because of non-linearity at low and forward bias voltages.

Depending upon the doping levels and doping gradients employed, the useful range of a varicap diode may

be kept to a very low level. As a result, typical modern varicap devices exhibit a Q factor of between 200 and 500 at medium and high frequencies.

At very high frequencies the Q factor of typical devices tends to fall, because series inductance contributed both by the crystal die and its package tends to reduce the effective device capacitance. To minimise this effect, varicaps intended for use at very high frequencies usually employ a very small crystal die mounted in a special low-inductance package.

As the width of the depletion layer of a reverse biased P-N junction is temperature dependent, the capacitance of a varicap is similarly dependent. In applications where this temperature dependence is a problem, zener or forward-biased diodes can be used to produce a compensating opposite temperature variation in the controlling voltage.

Varicap diodes have many applications, some of which are illustrated in basic form in figure 6.5.

Probably the most common use for the devices is to permit remote adjustment of the resonant frequency of tuned circuit, as illustrated by the circuit of figure 6.5(a). Here the varicap effectively forms a parallel tuned cir-

the device is used as a DC coupling element having substantially constant voltage drop.

Let us now turn from the zener diode to consider another important type of "special" semiconductor diode.

As we saw in the previous chapter, a P-N junction has inherent self-capacitance. The depletion layer which forms in the vicinity of the actual junction acts as a dielectric separating the remaining P-type and N-type regions, forming an "inbuilt" parallel-plate capacitor. The usual names given to this capacitance are "depletion layer capacitance" or "junction capacitance."

It may be remembered that the width of the depletion layer varies with applied bias voltage, so that the junction capacitance similarly varies. It has a high value at zero bias, when the depletion layer is relatively narrow, rising still further to an effective maximum at a value of forward bias just short of device "turn-on." Conversely as the depletion layer widens with increasing reverse bias, the junction capacitance falls and reaches an effective minimum at a point just short of reverse breakdown.

Provided that the voltage applied to a P-N junction is kept inside the range between forward conduction and reverse breakdown, this variation in junction capacitance in fact constitutes the main change in junction behaviour with applied voltage because, within this range, the net current drawn by the junction as a whole remains very small and almost constant. Broadly speaking, then, a P-N junction is potentially capable of acting as a voltage-controlled variable capacitor.

While most semiconductor diodes may be used in this fashion with some success, the usefulness of a typical "orthodox" device as a variable capacitor tends to be rather limited. Because the device has usually not been designed with this application in mind, the doping levels and gradients used do not generally result in smooth

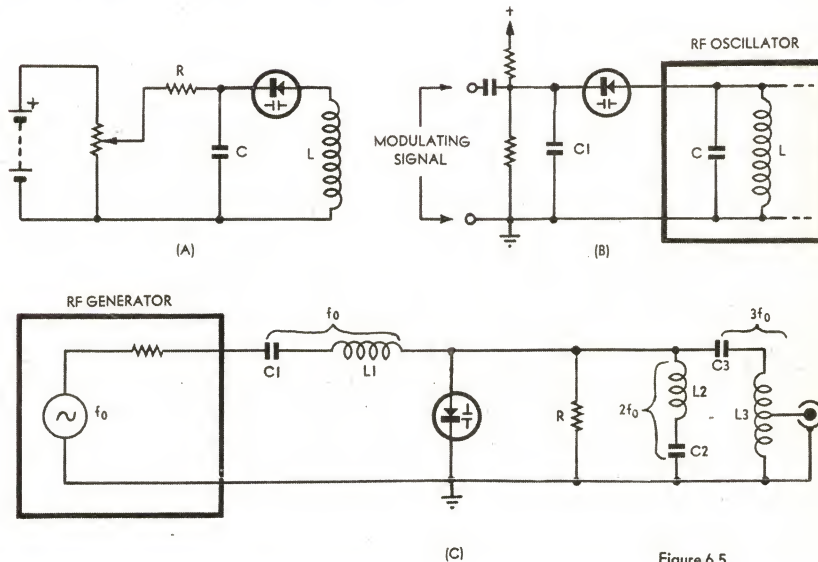

Figure 6.5

cover a capacitance ratio of from 4:1 to about 35:1. A typical device has a range of from 260pF—10pF over the reverse bias range 0—10V.

A second important parameter of varicap diode performance is the device "Q" factor or figure of merit, which is a measure of the quality or "purity" of the capacitance provided by the diode. As one might expect, the Q factor of a device is inversely proportional to the losses, the main components of which are the effective series resistance and the saturation and leakage currents.

Most varicap devices are fabricated from silicon material, in order to achieve low saturation current levels. Careful control of cleanliness during manufacture is used to ensure that leakage currents are kept to a similarly low level. And by using appropriate doping gradients and construction techniques, the series resistance of the device chips and packages can also be

kept to a very low level. As a result, typical modern varicap devices exhibit a Q factor of between 200 and 500 at medium and high frequencies.

A similar configuration is often used for automatic frequency control (AFC) of oscillators. Here the varicap is usually connected not as the sole capacitance of the oscillator tuned circuit, but rather as a "trimming" element. The control voltage fed to the device is not derived from a manually adjustable source, but from a frequency comparator or other circuit used to monitor the oscillator frequency. The arrangement is such that if the oscillator frequency tends to drift away from its correct value, the control voltage fed to the varicap will

TRUSCOTT'S

AUSTRALIA'S GREATEST MAIL ORDER TAPE RECORDER & HI-FI CENTRE

STOCKISTS OFF ALL LEADING BRANDS OF TAPE RECORDERS HI-FI EQUIPMENT, COMPONENT PARTS AND ACCESSORIES

NEAT MAN—THAT'S THE WAY TO ENJOY HI-FI MUSIC

Truscott Electronics are the sole Australian agents for Neat Hi-Fi equipment. Available from your local Hi-Fi store or direct from agents. Listed below are just two of the Neat range of products.

Neat G30 Professional Static Balance Tone Arm. New release now fitted, with lifting/lowering device.

A precision built unit, outstanding in appearance and simple to mount and use in any installation. The results obtained are far beyond those usually expected at such an extremely moderate price. It will accommodate all standard cartridges and the tracking weight is easily adjusted to the particular one in use.

Neat V70 Moving Magnet Cartridge: The V70 is a top performance, high quality magnetic cartridge that out-performs many more expensive cartridges. When used with the Neat G30 tone arm, an excellent low priced combination can be obtained. Send now for reviews and test reports by the Gramophone, Hi-Fi Sound and Electronics Australia on both the G30, V70 and all other Neat tone arms and cartridges.

Fast Mail Order Service

When ordering, please give your full address printed in BLOCK LETTERS. All Truscott equipment is brand new and fully guaranteed. Sales tax is included in all quoted prices. All orders are despatched promptly. All prices quoted are Nett. Postage and freight extra.

NOTE: T.M.Q.—Truscott Mail Order Quote.

ACCESSORIES

Microphones and Stands — Tapes and Spools — Splicing Kits — Record Care Accessories — Speaker Enclosure Acoustic Cloth and Inner Baffling — Headphones — Pre-packed Leads — Plugs and Connectors — Head Cleaning Kits — Pillow Phones — Bases and Covers, and Many Others.

COMPONENT PARTS AND ACCESSORIES

Truscott's are stockists of all General Electronic components. Including resistors, capacitors, plugs and sockets, solder. Scope irons and spares, hook-up cables, valves, terminals, tag strips, matrix board, cambric spaghetti, fuses, chassis, grommets, solder, lugs, alligator clips, valve sockets, D.I.N. connectors, TV connectors, battery savers, and also a large range of semi conductors for all Japanese makes.

AMPLIFIERS



KENWOOD TK 20U

Akal — Sound —
Monarch — Lux —
Compax — Kenwood —
Trio — Sony —
Trio — Sony —
Tempo — Sansul —
Leak — Grundig —
Cosmos.

TURNTABLES

DUAL 1009F



Dual — JH — Neat — BSR — PE —
Compax — Labcraft — Goldring.

TONE ARMS AND CARTRIDGES



NEAT G30 TONE ARM

NEAT V70 CARTRIDGE

Neat — ADC — Ortofon — All Balance —
Goldring — Decca — Audio Technica —
Dual — Shure — Micro.

SPEAKERS

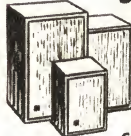

Soundmaster —
Wharfedale — Tesla —
Phillips — Rola —
Sansul — Kenwood —
Leak. Akai —

SOUNDMASTER SPEAKER SYSTEMS

SONY TC 200B TAPE RECORDER



Vertical or Horizontal Operation. Hi-Fi Stereo Tape Recorder. Features Complete 4 track stereo and mono tape recording and playback system. Sound on sound recording. Two complete full range satellite speaker systems. Individual VU meter and volume controls for each channel. Light weight (only 27lb). Two Sony high quality dynamic microphones. Compact carry case, beautifully styled in black and Ivory decor. Truscott's price only \$190.

HI-FI TRANSCRIPTION TURNTABLE COMBINATION

Consists of the one and only JH Synchronous Turntable, the new Neat G30 Tone Arm with lifting/lowering device, Neat V70 magnetic cartridge, and hand-finished oiled TEAK wooden base. Retail \$96.00. Truscott's price only \$77.50. If assembly required — add \$6.00.

TAPE RECORDER BELTS

Belts available to suit most models of Telefunken, Uher, Phillips, Coscor, Stella, Grundig, BSR, Ferguson, Walter and Korting Recorders. When ordering, it is most essential to state the correct make and model of recorder.

TAPE RECORDER AND HI-FI SERVICE CENTRE

For service on all leading brand tape recorders and Hi-Fi equipment — come to the experts. Truscott's modern service centre uses only the finest servicing aids, backed up by fully trained professional technicians.

SPEAKER ENCLOSURE PADDING

Truscott's are the leading South Australian stockists of Innerbond and Bonded Courtelle. Ensure dust-free padding for your speaker enclosure. Send for a T.M.Q.

STEREO HEADPHONES

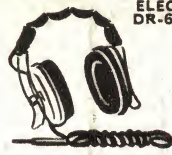

ELEGA DR-6SC

Truscott's carry all the leading brand top quality stereo headphones. Including Elega, Akai, Sony, Sennheiser, Sansul, Ashida-vox, Foster, etc. Send for details and a T.M.Q.

SENNHEISER DYNAMIC MICROPHONES



SENNHEISER MD421

This attractively styled Dynamic Microphone Model MD421 has been designed to meet the requirements of professional installations, which require low-priced directional studio microphones. A full range of famous Sennheiser studio microphones for amateur or professional use is available at Truscott's. Send now for specifications and a T.M.Q.

220S MULTIMETERS

D.C. Volts 5, 25, 125, 500, 2500.
A.C. Volts 10, 50, 250, 1000.
Current: 0-250 μ A, 0.250 mA.
Resistance: 0-10K, 0.1 MEG.
Truscott's price only \$7.95.

SAVE YOUR RECORDS... USE THE UNIVERSAL LUSTRE TONE ARM LIFT



LUSTRE SA-202

This beautifully finished and functional universal tone arm lift will fit all tone arms. The lowering action is pneumatically damped and extremely smooth — risk of record damage may now be eliminated — Truscott's price only \$8.50.

TAPE RECORDERS & DECKS



TESLA B46

Tesla — Akai —
Sony — National —
Thorn — Atlas —
Julliforder — BSR —
Toshiba —
Sanyo — AIWA —
Phillips — Grundig —
Tandberg —
Geloso.

CAR RADIO SPECIAL "SOUNDMASTER 8"



The new super sensitive push-button all transistor car radio, featuring 8 trans. — 3W output — push-button tuning — built-in noise suppression — high quality speaker — suit any model car — Truscott's price only \$55.00. If aerial required add \$4.00.

ACOUSTIC SPEAKER GRILLE CLOTH

Truscott's now carry over 50 top grade cloths to select from. Send now for samples and a T.M.Q.

P.E. TURNTABLES

Model P.E. 34. Limited stocks available of this very popular German Hi-Fi transcription turntable. Send now for details, and a very attractive T.M.Q. All other model P.E. turntables stocked.

PHILIPS 82 DICTATION MACHINES

Limited stocks available of this very efficient dictation machine — complete with all accessories. Send now for details and a T.M.Q.

AKAI TAPE RECORDERS

All latest models in stock — XV, 1710, M9, 1800, X360, 4000D, X150D. Prices slashed to an all-time low. Send now for a T.M.Q.

TRUSCOTT'S HI-FI COMBINATIONS

Select your Hi-Fi equipment from our vast range and send for a Truscott combination price — the lowest in Australia.



TRUSCOTT ELECTRONICS

AUSTRALIA'S GREATEST TAPE RECORDER & HI-FI CENTRE

62-64 HINDMARSH SQ. ADELAIDE, 5000 Phone: 233024 233278

change by a suitable amount and in the appropriate direction to correct the tendency.

A related use for varicaps is in circuits designed for frequency modulation (FM) of RF oscillators. A basic circuit of this type is shown in figure 6.5(b). It may be seen that the device is here connected to the tuned circuit LC of the oscillator, with DC reverse bias applied via a resistive divider to bias it approximately at the midpoint of its capacitance range. The modulating signal is then superimposed on the DC bias, swinging the varicap capacitance above and below its quiescent value. Capacitor C1 acts as an RF bypass only, connecting the varicap effectively across the tuned circuit; its value is chosen to represent a negligibly high impedance at modulation frequencies.

By using a device having a carefully tailored voltage/capacitance law, and with careful circuit design, the swing in capacitance due to the modulation signal can be made to produce a linear swing in the resonant frequency of the oscillator tuned circuit. The oscillator output frequency is accordingly frequency modulated in a suitably faithful fashion.

This type of circuit has been used both as the heart of FM radio transmitters and also as the basis for linearly-swept RF signal generators used for tuning alignment of receivers filters and other RF equipment. In the latter case the modulating signal used to swing the oscillator frequency is generally a very low frequency sawtooth waveform, or alternatively a very low frequency sinewave, typically at just a few Hertz.

A class of varicap applications somewhat different from those illustrated in figure 6.5(a) and (b) are those in which the voltage/capacitance characteristic of the device is used, not to allow "external" variation of the capacitance present in a tuned circuit, but to allow the device to be used as a non-linear reactance. In this type of application the signals presented to the diode are deliberately made large enough to cause its capacitance to vary significantly during the signal cycle.

Devices used for this type of application are generally somewhat larger than those intended for the former class of application, and are expected to withstand somewhat higher voltage and current levels without damage. The term "varactor" is often used to distinguish them from the lower power devices. An example of a varactor device application is given in figure 6.5(c), which shows a passive frequency multiplication circuit. Such circuits are coming into common use at very-high and ultra-high frequencies, as they offer a simple, convenient and economical means of generating useful power levels at frequencies above those at which other devices operate at peak efficiency.

Basically this type of circuit relies upon the fact that the non-linear reactance of the varactor distorts the input signal, and thus generates strong harmonic components. A tuned circuit is then used to select the desired harmonic, which becomes the output signal. Because the harmonic generation is produced by a varying reactance, which is ideally a lossless circuit element, the conversion efficiency

of such a multiplier tends to be quite high — in the order of 75 per cent, with modern devices.

Typical varactor diodes have a voltage/capacitance law which causes the even harmonics of the input signal to predominate. Thus the efficiency of varactors multipliers tends to be highest when they are used for frequency doubling, quadrupling, and so on. However, odd harmonic multiplication can be performed by using a circuit configuration which forces the diode to first generate a carefully chosen even harmonic near the desired odd multiple, and then act as a mixer to produce the desired output by heterodyning with the fundamental input.

The latter circuit is in fact illustrated by the circuit of figure 6.5(c), which shows a basic frequency tripler.

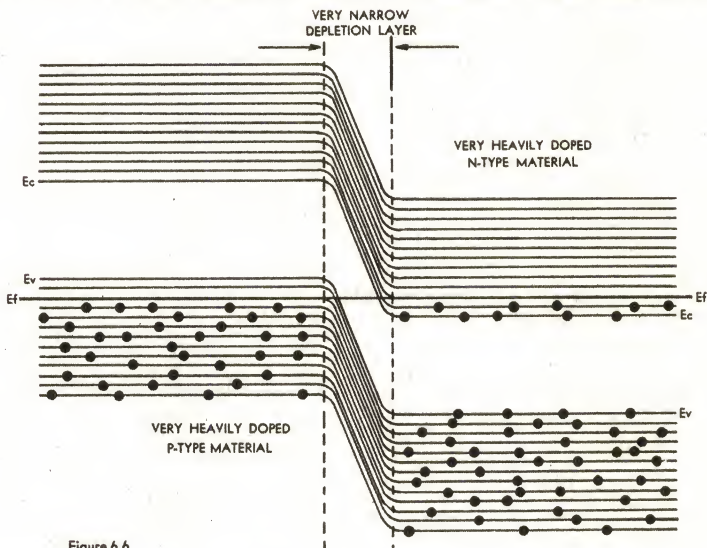

Figure 6.6

Here an input series tuned circuit L1-C1, tuned to the fundamental frequency F_0 , is used to match the input RF generator to the very low impedance presented by the varactor. A second tuned circuit L2-C2 forms an "idler" circuit, being tuned to the second harmonic $2F_0$ and designed to ensure that a heavy current of this frequency flows through the diode in addition to the fundamental. The non-linearity of the device then causes the two to mix together, producing the third harmonic $3F_0$, and this is selected by the third tuned circuit L3-C3 which transfers it as output signal into the load circuit. Resistor R is used as a DC return to permit the varactor to develop self-bias by conduction on signal peaks, in conjunction with C1, C2 and C3.

Using modern silicon varactor devices in this type of circuit, tripler efficiencies approaching 70 per cent can be achieved with careful design. A representative device is capable of delivering 27W into a well-matched load when driven by 40W input, and when tripling from 150MHz to 450MHz.

A further important use for varactor diodes is the parametric amplification of very weak RF signals, especially at ultra-high frequencies. Here, the non-linear reactance of the device is used to amplify the signals; while so doing, it contributes very little to the noise level because, as a reactance, it is ideally incapable of generating noise. In practice, some noise tends to be introduced by leakage currents and inevitable device and circuit resistances

but, nevertheless, parametric amplifiers using varactors are capable of very low noise operation at extremely high frequencies.

The zener diode and the varicap-varactor diode are probably the most commonly encountered "special" semiconductor diodes. However these are by no means the only types which have been developed. The remainder of this chapter will accordingly be devoted to a brief look at some of the many other types of specialised diode device, and at their applications.

Tunnel diodes are diodes in which the semiconductor material forming the P-N junction is so heavily doped with impurities that the atoms of the impurity elements are sufficiently close together to be no longer isolated from one another. As a result the impurity-

derived carriers no longer occupy in the ground state single donor and acceptor energy levels in the forbidden energy gap (figures 3.3, 3.6), but rather two multi-level bands which in fact extend to and blend with the valence and conduction bands of the host material. This may be seen in the diagram of figure 6.6.

Because of the blending of these "impurity bands" into the host material valence and conduction bands, there are in such material, in the ground state, effectively filled energy levels in the N-type material conduction band, and similarly there are effectively empty energy levels in the valence band of the P-type material. Because of this the Fermi level in the N-type material actually passes through the new widened conduction band, while that of the P-type material passes through the widened valence band. Consequently when a P-N junction is formed in such material it has the rather unique equilibrium energy diagram shown in figure 6.6.

There are two important things to note about this diagram. The first is that because of the heavy doping levels, the depletion layer is extremely narrow — typically $0.1\mu\text{m}$ or less. The second thing to note is that in both materials there are empty energy levels immediately above the highest filled energy levels. Because of this both materials are capable of exhibiting virtually metallic conduction, and hence have an extremely low resistivity.

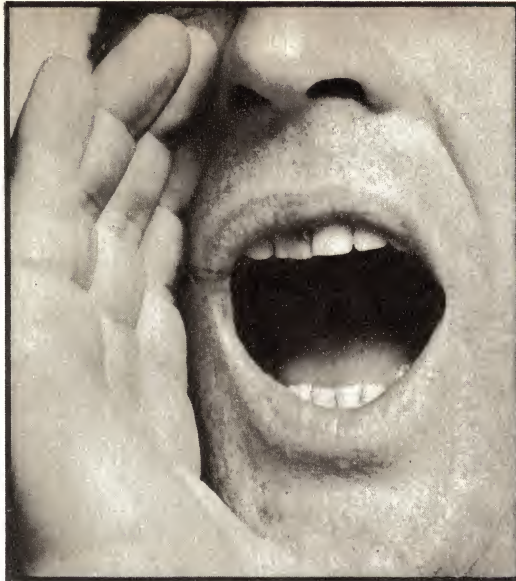

no shouting needed:



TOA MEGAPHONES

If you've got something to say, if you direct traffic, train a team, fight a fire, direct construction, start a race, make a movie, or simply sound off.

TOA amplifiers are lightweight, easy to operate, rugged and fully transistorised.

TOA equipment delivers high efficiency, long life and the kind of full colour sound that stretches carrying power even under the most difficult conditions.

ER308 hand-operated pistol type. Fully transistorised, battery operated. Maximum output is 16 watts. Special mic construction makes it

feed-back proof. This enables maximum volume. Projects voice up to 1,000 yds. Weight, 3.5 lb.

ER64 shoulder type. Details as ER308.

ER45 shoulder type as ER64. Plus equipped with emergency alarm. Red all over and covered in reflective red tape which glistens in the dark.

ER65 shoulder type as ER64. Maximum output 20 watts (most powerful in the world). Can be installed as stationary type. Projects voice to 1,500 yds. Weight, 6.5 lb.

All models are leakproof and backed by the unrivalled AWA sales and service organisation.



AMALGAMATED WIRELESS (AUSTRALASIA) LIMITED

Australia's National Wireless Organisation



TOA ELECTRIC CO. LTD.
Public Address Equipment

AMALGAMATED WIRELESS (AUSTRALASIA) LIMITED: Sydney, Newcastle, Canberra, Brisbane, Melbourne, Hobart, Launceston, Adelaide, Perth; and also Chandlers Pty. Ltd., Queensland, and Newton McLaren Ltd., South Australia.

The very narrow depletion layer and correspondingly abrupt potential barrier of this type of junction are of paramount importance, because it so happens that when two conducting regions are separated by an exceedingly narrow barrier, electrons are apparently able to transfer from one side to the other virtually instantaneously, and without having previously acquired the energy necessary to surmount the barrier in the usual way.

The mechanism responsible for this rather surprising behaviour is as yet imperfectly understood, although it can be accommodated by the rather abstract concepts of quantum mechanics. Because the effect is almost as if the electrons had "tunnelled through" the barrier, it has been given the name **electron tunnelling**, and hence the name "tunnel diode" used to describe a device which exploits the effect.

Because of the tunnelling effect, a device with the energy diagram of figure 6.6 conducts heavily if small voltages are applied to it, in either direction. If forward bias is applied, this results in the lifting of the occupied energy levels in the conduction band of the N-type material so that they become opposite the vacant

valence band and become opposite the forbidden gap in the material.

As this occurs, the current drawn by the device falls to a minimum. Then it eventually begins to rise again due to normal carrier diffusion from the occupied N-type conduction band to the vacant P-type conduction band. This becomes possible as the former band finally approaches the latter.

In the reverse bias direction, this type of action does not occur, as filled energy levels in the P-type material valence band are simply raised to become opposite a greater and greater number of empty levels in the N-type material conduction band. The current drawn by the device thus continues to rise steeply.

The net result of the foregoing is that a tunnel diode has the rather

performed at extremely high frequencies.

Back diodes or "tunnel rectifiers" are closely related to tunnel diodes, differing only in that the doping levels and gradients employed are arranged to produce a negligible current peak in the forward characteristic. The device still retains the extremely high reverse-bias conductivity of the tunnel diode, however, so that for small signals it presents a very low resistance in the reverse direction and a relatively high resistance in the forward direction.

Because of this, the back diode actually provides a much closer approximation to an "ideal" diode than does any other device — for small signal excursions. The only catch is that it provides these desirable characteristics in

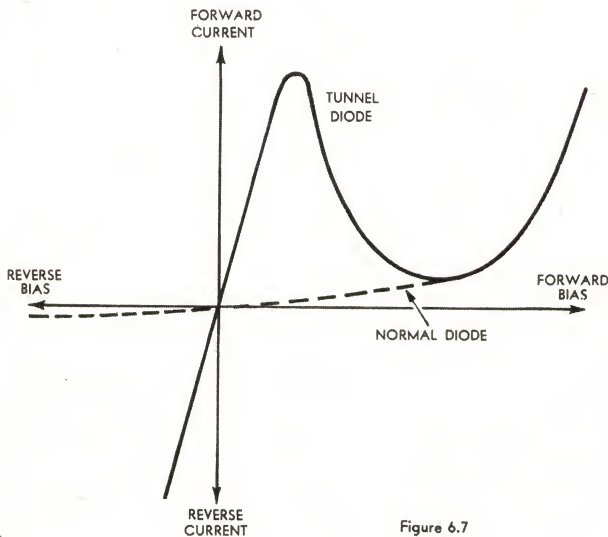

Figure 6.7

energy levels in the valence band of the P-type material. A flood of electrons is thus able to tunnel through the depletion layer from N-type to P-type, and the current rises rapidly.

Conversely if reverse bias is applied, this effectively raises the occupied energy levels in the valence band of the P-type material so that in this case it is they which become opposite vacant energy levels in the conduction band of the N-type material. This again allows a flood of electrons to tunnel through the depletion layer, but in this case they flow from the P-type material to the N-type material. Once again the current rises very rapidly with applied voltage.

If the applied bias voltage is increased in the forward direction, the current passed by the device is found to reach a peak value and then decrease with increasing voltage—exhibiting a negative resistance characteristic. The reason for this is that as the occupied conduction band levels in the N-type material are effectively raised further, they are eventually raised beyond the level of the vacant levels in the P-type

unique voltage-current characteristic shown in figure 6.7. In the reverse bias direction, it presents a very low and almost linear (or "Ohmic") resistance, while in the forward bias direction it first presents a very low resistance, then a negative resistance, and finally a roughly exponential characteristic similar to that of a conventional diode.

Note that in the foregoing description of tunnel diode operation we have spoken only of electron carriers. In fact, these are the only carriers involved in tunnel diode operation because, in the partially filled energy bands of such highly doped material, the concept of a hole has little meaning.

Many of the applications of tunnel diodes are designed to exploit the negative resistance behaviour which they exhibit between the "peak" and "valley" of the forward bias characteristic. By suitable biasing, and in appropriate circuitry, a tunnel diode can be arranged so that its negative resistance either amplifies small signals, or cancels the losses in a resonant circuit to produce continuous oscillation. Both these functions can be

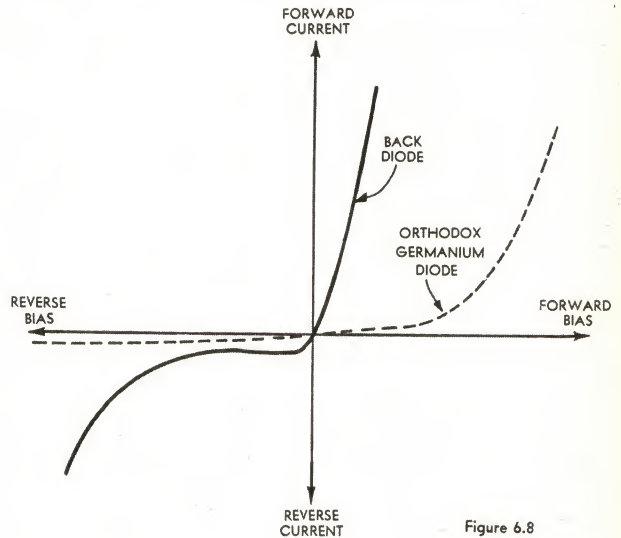

Figure 6.8

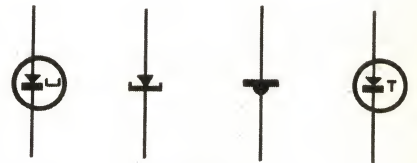

Figure 6.9

"reverse" so that, for convenience, the concepts of "forward bias" and "reverse bias" are applied in the opposite sense to normal: the N-type material becomes the "anode," and the P-type material the "cathode." The device characteristic then becomes that shown in figure 6.8, drawn for comparison on the same axes as the characteristic of an "orthodox" diode.

It may be seen that for small excursions either side of the equilibrium or zero bias condition, the back diode characteristic is somewhat closer to the ideal than the orthodox diode characteristic. For this reason back diodes find extensive use as rectifiers and detectors for very low amplitude signals, particularly at ultra-high frequencies.

The most commonly used circuit symbols for tunnel diodes and back diodes are shown in figure 6.9. Both types of device are normally represented by the same symbol, which may be reversed or otherwise modified in the case of the back diode.

Junction photocells are P-N diodes constructed in such a fashion that light radiation may easily be allowed to

Who put 18 great speakers in those little bitty boxes? And why?

A company by the name of Bose put 9 full-range 4-inch loudspeakers in each of these little five-sided boxes.

After twelve years of research Bose found it was the only way to bring true concert hall sound into a living room. (Only 11% of the 901's sound reaches you directly. 89% is reflected off the walls, ceiling and floor — just as in a concert hall.)

The Bose bass is natural and full, because all 9 speakers in each box are wired to work together.

And the Bose 901 system comes complete with a unique solid-state equalizer that lets you match the sound to the acoustics of any room, and to your own personal taste. For \$750 you get both stereo speakers and the equalizer.

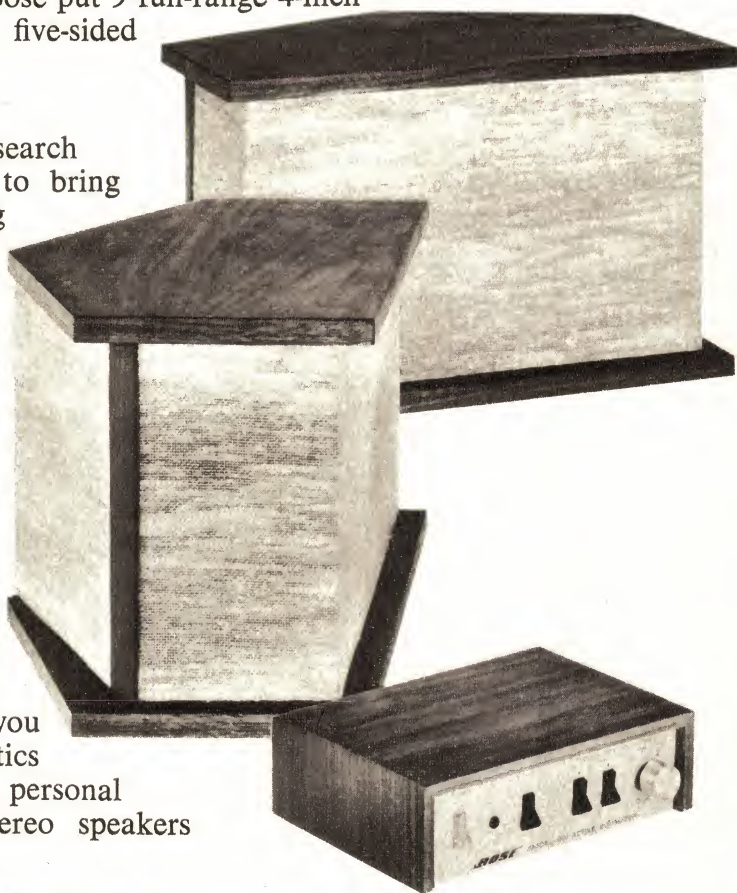

When you hear the remarkable sound of the Bose 901, you'll probably have lots more questions. So hear it at the places that can answer them.

SYDNEY		MELBOURNE		PERTH	
Stereo Music Systems	29-6681	Australian Hi Fi Electronics	34-6788	Leslie Leonard	21-5067
Kent Hi Fi	29-2745	Southern Sound	97-7245		
Sydney Hi Fi Centre	29-1082				
AUSTRALIAN DISTRIBUTORS:					
W. C. WEDDERSPOON PTY. LTD. 193 CLARENCE STREET, SYDNEY 29 6681					

illuminate the depletion layer region. When this occurs electron-hole carrier pairs are created in the region by the incident light photons, and these light-produced carriers are swept in either direction respectively by the depletion layer field. The result is that the drift current of the junction exceeds the diffusion current, and equilibrium is disturbed.

One effect of this change is to cause a net EMF to appear across the terminals of the device, with the P-type material becoming positive because of surplus holes, and the N-type material becoming negative because of surplus electrons. A junction photocell may

cation in light-sensing situations such as punched-tape and punched-card scanning.

Light-emitting diodes or "LED's" may be regarded as devices which operate in opposite way to junction photocells. These devices are designed so that they can be operated at very high forward conduction current densities, in which condition large numbers of holes and electrons recombine in the depletion layer region to produce significant light radiation.

Light emitting diodes are used as sources in optical communications systems, as highly rugged and reliable "solid state lamps," and as the heart

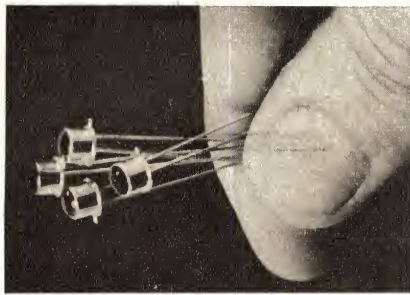
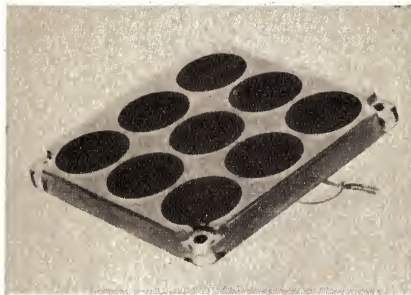

At left is a small array of silicon solar cells, each measuring about one inch in diameter. Such arrays are used as energy sources for low-power electronic equipment, both on the earth and in space craft. At right are shown compact light-emitting diodes intended for use as high reliability "solid state" lamps.

thus be used as a converter of light energy into electrical energy, and when used in this fashion it is usually called a **photovoltaic diode**.

Arrays of large photovoltaic diodes are used to convert solar radiation energy into electrical energy to power electronic equipment. Such arrays are often called **solar cells**. Both photovoltaic diodes and solar cells are usually made from silicon material, as the wide forbidden energy gap of this material provides a higher output voltage than most other semiconductors.

A second consequence of the change in equilibrium of a junction photocell, when it is illuminated, is that the conductivity of the device falls. Thus if such a diode is connected to a source of reverse bias, its reverse current will vary in direct proportion to the incident radiation. Diodes designed to be used in this way are usually called **photo-resistive diodes**, and find appli-

cation in light-sensing situations such as punched-tape and punched-card scanning. **Light-emitting diodes** or "LED's" may be regarded as devices which operate in opposite way to junction photocells. These devices are designed so that they can be operated at very high forward current densities, sufficient to create the conditions necessary for the production of coherent light output. Such devices are then called **junction or injection lasers**.

There are many other types of "special" semiconductor diode, including devices which employ a structure rather more complex than the simple P-N junction. Some of these are designed to act as very high-speed switches, or as variable resistors, or as specialised waveform shaping or frequency mixing elements. Yet another type is used as a magnetic field detector. Unfortunately space restrictions will not allow more than this brief acknowledgment of the existence of these devices here, and interested readers are referred to some of the references listed below.

SUGGESTED FURTHER READING

- BURFORD, W. B., and VERNER, H. G., **Semiconductor Junctions and Devices**, 1965. McGraw-Hill Book Company, Inc., New York.
- BRAZEE, J. G., **Semiconductor and Tube Electronics**, 1968. Holt, Rinehart and Winston, Inc., New York.
- EVANS, J. P. (Ed.), **Voltage Regulator (Zener) Diodes**, 1966. Mullard Limited, London.
- IVANOV, S. N., et al., **Physics of Microwave Semiconductor Diodes**, 1969. Iliffe Books Ltd., London.
- MORANT, M. J., **Introduction to Semiconductor Devices**, 1964. George G. Harrap and Company, London.
- ROWE, J., "Understanding Tunnel Diodes," in **Radio, Television and Hobbies**, V.22, No. 11, February, 1961.
- , "The Junction Laser," in **Electronics Australia**, V.28, No. 12, March, 1967.
- SURINA, T., and HERRICK, C., **Semiconductor Electronics**, 1964. Holt, Rinehart and Winston, Inc., New York.
- Also "Solid State Diodes," a special section in **Electronics World**, V.82, No. 1, July, 1969.

NEW EQUIPMENT CABINETS

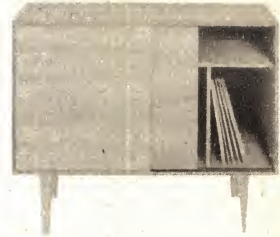

MODEL 192. Record storage or equipment cabinet. 36in wide, 21in high, 15½in deep, plus 9in legs. Record bins: 14in high, 8½in wide. Horizontal shelf 5½in high. Features: Sliding doors, mitred corners, semi-square legs. Price complete maple, teak, etc. \$57.60. Kit of parts (maple) \$31.50; teak \$6 extra. Packing \$1.00.

New Player Platform model 175 is 16in x 14in x 3½in. Price \$7.50 for maple or walnut. Kit of parts \$4.00. Teak, 50c extra. Perspex cover, 3½in or 5½in high, \$8.20 and \$1.50 extra if required hinged. Please specify cut out required.



MODEL 186

New Player Cabinet model 186 is 9½in high, 16in wide, 16½in deep and 5½in above shelf. Finished with tinted perspex top. Price: \$22.00 for maple or walnut or teak.

Kit of Parts \$13.50.

Teak: \$1.00 extra (kits only)

Height of this model can be increased to take various amplifiers. Tailored cut out. Ask for quotation. F.O.R. Packing \$1.

Write for Catalogue and Player Guide

H. B. RADIO SALES

103-105 CATHERINE STREET,
LEICHHARDT, SYDNEY.
TELEPHONE 56-5580

DRAKE



MODEL W-4 R F WATTMETER \$63.00 plus Sales Tax

Reads forward and reflected power directly in watts (VSWR from nomogram). Two scales in each direction. 200 and 2,000 watts full scale. Calibration accuracy plus/minus (5% of reading plus 2 watts) on 200 watt scale, plus/minus (5% of reading plus 20 watts) on 2,000 watt scale. Size: 5½in H x 3½in W x 4in D.

For further information contact:
ELMEASCO INSTRUMENTS PTY. LTD.
P.O. Box 334, Brookvale 2100, 93-7944.
P.O. Box 213 Mt. Waverley, 3149, 82-6159.

Broadway
Electronics
introduces
the
self-service

INSTROL



The 10-Plus-10 is a high quality solid-state stereo amplifier (10 watts RMS per channel). This, and other amplifiers featured in Electronics Australia, are available in either kit form or built and tested.

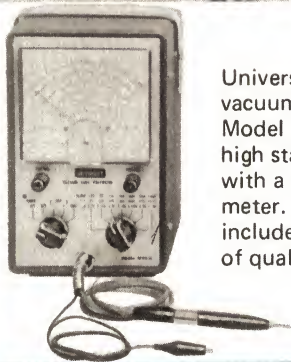

University, general purpose, vacuum tube/Voltmeter – Model MVA6 – A high impedance, high stability instrument, with a large easy-to-read meter. Our new showroom includes a large display of quality test equipment.

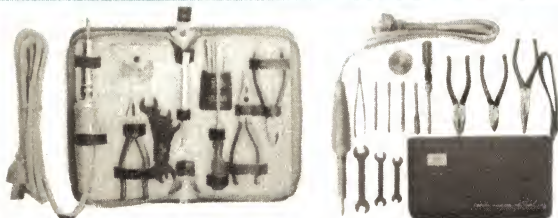

The Electronic Tool Kit, an inexpensive, yet most comprehensive outfit. The complete kit fits snugly into a strong attractive zip-fastening carrying satchet. Price – only \$12.50 (postage \$1.00 extra).



Popular Instrol-Playmaster 40 watt and 60-watt RMS Guitar Amplifier, in kit form or ready built. Complete with all optional extras.



Instrol-Playmaster 115, solid-state, Stereo Amplifier, one of the many Electronics Australia projects available. Detailed descriptions together with full technical specifications and price details of all types of electronic equipment and kits are available free. Tick and send coupon for catalogue required.

ELECTRONICS CENTRE

Everything for hobbyist and technician

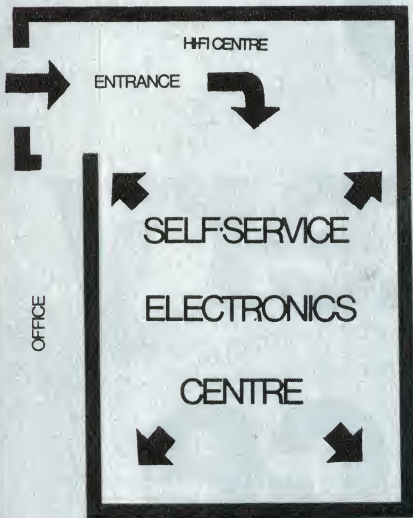

OPEN NOW... Revolutionary new concept **FEATURING!**

- (1) Large audio demonstration section to enable you to hear your favourite Instrol-Playmaster and other Electronics Australia projects.
- (2) Ready-packaged Kits for Instrol-Playmaster projects, other Electronics Australia projects and Test Equipment Kits.
- (3) Large range of test equipment, service parts and allied components.
- (4) Hire Purchase Terms available for most Kits and ready-built Units.
- (5) Self-service display area so that you can see for yourself and choose the many component parts available.
- (6) Modern book section, including many of the famous Howard Sams technical books.
- (7) A large service department to accurately diagnose and repair your equipment. (This department operates under close association and arrangement with the specialised technical staff of the Australian Radio and T.V. College).
- (8) Sydney's largest Hi Fi and audio centre.

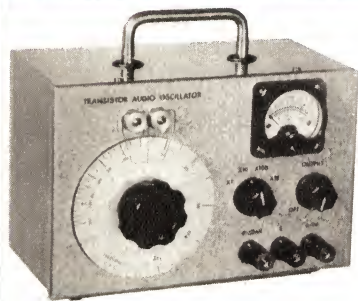

The Transistor Audio Oscillator.
December 1967.
This and many other instrument kits are available - strictly to "E.A." specifications.



Instrol-Playmaster 124 Stereogram.
This is a combination of 3-Plus-3 stereo amplifier and a solid state broadcast tuner. All major stations for six States are engraved on the attractive silver label.



We are now stocking a large range of robust and attractive meters, including edge-wise types. Meters with special scales to suit "E.A." projects also available.



The Instrol Educational Electronic Kit, a must in this electronic age. Learn the basic principles of computers, communications, etc. Priced at - \$16.90 (Post 85c).

INSTROL ELECTRONICS CENTRE

Phone: 29-4258

91a York St. (between King & Market St.)

for descriptive leaflet post coupon

Please include postage stamp.

- Playmaster
 - Toolkit
 - Microphone
 - Metalwork
 - Test Equip. Kits
 - Cannon Connectors
- Name _____
- Address _____
- Postcode _____

How to put a battery in its place

Silver is the Eveready low-priced battery for torches and transistors used occasionally.

Red is the Eveready medium-priced battery for transistors, torches and appliances used frequently.

Gold is Eveready's new alkaline battery. Gives up to—10 times more service in toys; 7 times in industrial torch use; 6 times in cameras; 5 in tape recorders and record players; 4 times in flash guns and 3-4 times in transistors.



SILVER

RED

GOLD



BATTERIES Products of



Eveready & Union Carbide are registered Trade Marks

E121R

AUDIO SYSTEM FOR SOLID-STATE RECEIVER

In the August issue, we presented a power supply for solid-state receivers. We now present an audio system also suitable for use in a solid-state receiver design, having a power output of between 1.5W to 3W, according to conditions, and an input sensitivity of about 250mV.

By Ian Pogson

The power supply already described will deliver 17.5V for an audio stage, 12V for most of the other stages, and 9V for the oscillators, in a typical receiver. We have been experimenting in our laboratory with other self-contained stages which could be used in a receiver design, and decided that the next logical step was to proceed to the final design of an audio system. The amplifier to be described is simple and efficient. Although designed primarily for use in receivers, it will lend itself readily to many other situations.

Some of the requirements were set down arbitrarily, some others naturally had to fit in with an overall receiver design. Firstly, economy and efficiency were given a high priority. Economy dictates that the number of components be kept to a minimum, particularly with expensive items such as output and driver transformers. This requirement is met very well by the complementary symmetry mode of operation. As with this technique the output stage is operated class B, the efficiency requirement is also met.

The complementary symmetry mode therefore takes care of these two important requirements very nicely. A

further advantage is that a power output of 2.5W into 8 ohms is possible, more than ample for a short-wave or communications receiver. On the other hand, if this amount of power is not needed, the amplifier can be run at lower level, and the current requirement is correspondingly less.

A basic design which was readily available is the one published in the "Miniwatt Digest," March/April, 1968. The circuit as presented, uses a complementary-symmetry pair of transistors, types AC187 and AC188, in the output. The driver is a BC158 and the preamplifier, a BC148. DC coupling is used between the three stages.

Some of the specifications for this

circuit are as follow: With a supply voltage of 17.5, the rated power output is 2.5 watts into an 8 ohm load. This is reduced to 1.8 watts into a 15 ohm load. Total harmonic distortion at rated output and at 1KHz is 1 per cent, into either 8 or 15 ohms. Sensitivity for the rated output is 240 millivolts and the input impedance is 1.1M.

Our final version of this design is very similar but we did make some small changes to suit our purpose. The output electrolytic and the one in the emitter circuit of the preamplifier have been increased in value. Instead of the original BC158 driver transistor, we have used a 2N3638. Because of basic

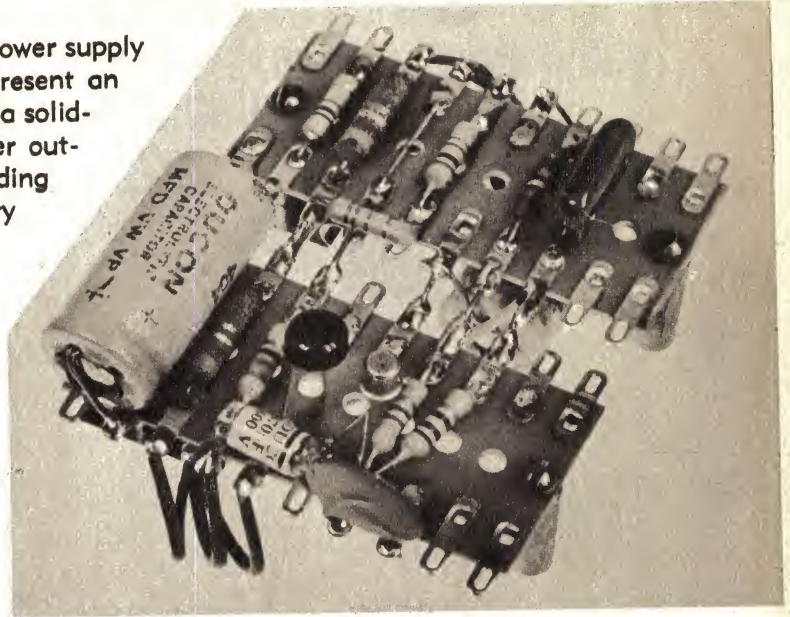

Top view, showing layout of the components

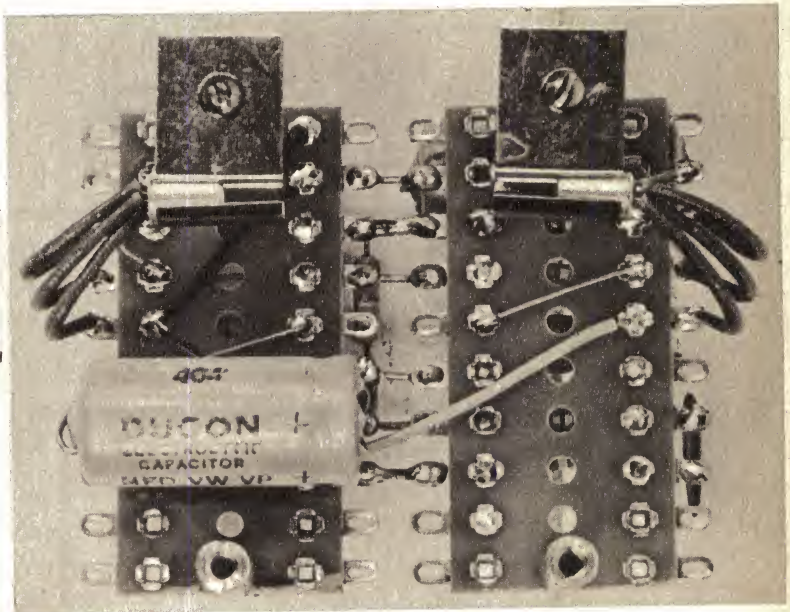
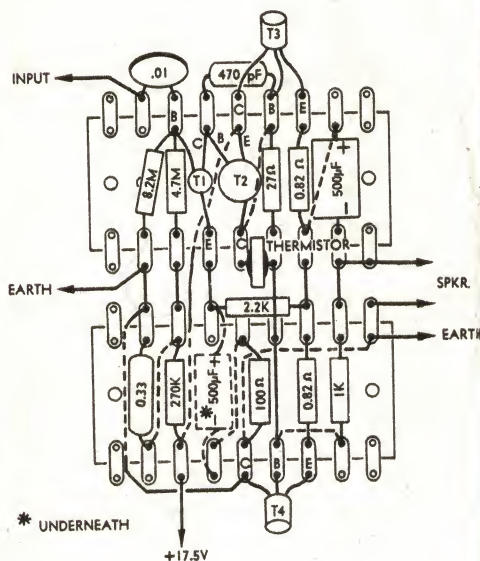

At left, the layout diagram gives details of component disposition. The photograph at right shows

an underside view of the amplifier. Note the anchorage for the heatsinks of the output transistors.

A SPECIAL OFFER

FROM TWO OF EUROPE'S LEADING MANUFACTURERS OF SOUND EQUIPMENT

TESLA

INCIS

TAPE RECORDERS

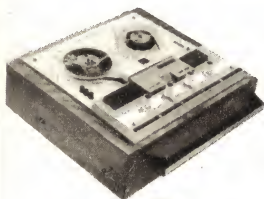

MODEL B43A. A four-track, fully transistorised, stereophonic tape recorder. Synchronous recording, multiple synchronous recording and simultaneous play-back of two tracks. Three speeds. Housed in an elegant timber or teak case. **\$196.**

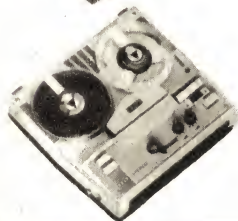

MODEL B46. Records stereo or mono with remote-control facilities. Records at 3 $\frac{3}{4}$ i.p.s. and plays back through your own stereo system. 2-tone plastic case. Fully transistorised. Complete with microphone, tape, spare fuses, plugs, lead and built-in speaker. **\$124.**

TAPEDECK



MODEL V34. Mechanism only, with two heads, 4 track, 3-speed, automatic stop and pause control. Takes up to 7" reels. Operates upright or flat. **\$68.**

LOUD SPEAKER UNITS

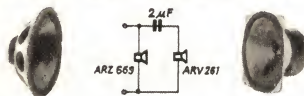

MODEL ARZ 668. 8" rolled-edge cone woofer. Impedance 4 or 8 ohms. Resonant frequency 28 cps. Price **\$6.** 4" tweeter. Impedance 4 ohms. Range within 6-17 KC/S. **\$5.50.**



MODEL ARS 720. 2 speakers in each cabinet. 10-watt rating with crossover network. Cabinet dimensions: 19" x 13" x 4 $\frac{1}{2}$ ". **\$36 each.**

CASSETTE PLAYERS

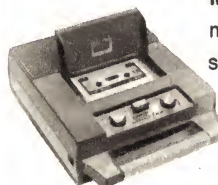

MINI STAR. Battery or mains operation. Takes standard cassettes. Ideal for the teenager. In a range of bright colours. **\$49.**

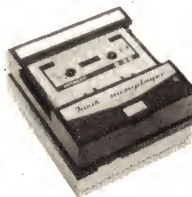

CAR PLAYER. Simple operation. Takes standard cassettes, **\$49.** Voltage-reduction cable, **\$4.93.** Car bracket, **\$4.93.**

AMPLIFIER

Supraphon Studio 1 stereo amplifier. 10 watts per channel R.M.S. **\$161.**

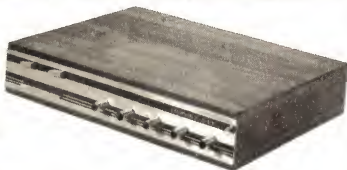

TURNTABLE

All-balance arm. Stroboscopic speed indicator. Hydraulic arm lift. Fine speed adjustment. Price without cartridge. **\$108.**



RADIO AERIALS

Lockdown, top-cowl and motorized models from **\$2.20.**

CHARMAC PTY. LTD.

Representatives for Tesla Czechoslovakia.
33 Bridge Road, Eltham 3095. 439 9517.

- ALL PRICES INCLUDE TAX
- ALL UNITS AVAILABLE IMMEDIATELY
- MAIL ORDERS ACCEPTED

AUDIO-LEC OF AUSTRALIA PTY. LTD.
Representatives for Incis of Milan, Italy.
33 Bridge Road, Eltham 3095. 439 9517.

Please send details on

NAME

ADDRESS

.....POSTCODE

CH891

differences between this transistor and that originally specified, we found it necessary to add a 470pF capacitor between the base and collector. The 18 ohm resistor between the two output transistor bases has been replaced with a 27 ohm resistor and a B8-320-101/50E thermistor, in parallel. A BC108 is used for the preamplifier.

The overall performance of our amplifier is substantially the same as the original design. Suffice to say that, for such a small number of components, it offers very good value indeed.

Let us take a look at the circuit

er is coupled from the output transistor emitters, via a 500uF electrolytic. The value of this capacitor is kept high in the interest of low frequency response.

Construction of this little audio amplifier is about as simple as it could be. We used two pieces of tag board, each with 10 pairs of tags, alongside each other. This arrangement allows for a more or less logical layout of components. Full details of the wiring and general disposition of all components can be seen on the wiring diagram.

Although we have used a board with 10 pairs of tags, actually only seven pairs are used on each board. On the output end, we allowed one spare pair for physical reasons, while two pairs each at the other end allow for an extra preamplifier stage to be fitted, where this is needed.

As a convenient way of mounting the complete unit, we have fitted four 3/8in long brass spacers, one to the

The circuit diagram shows the economy of components achieved with the design.

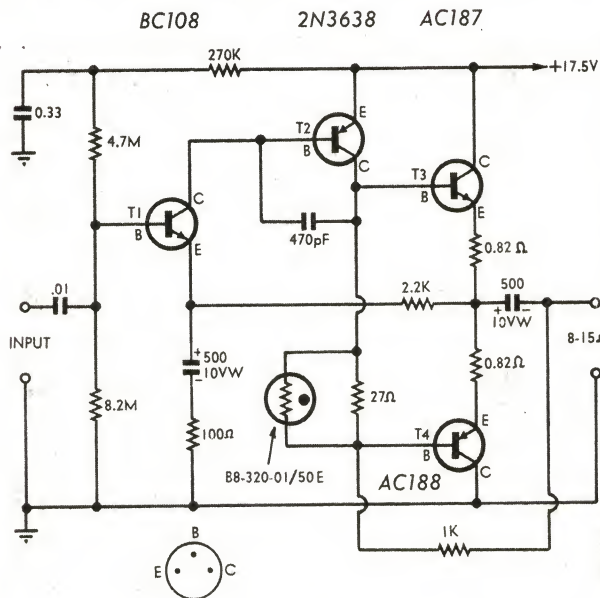

and consider it in a little more detail. The preamplifier is operated at a very low current level. The bias resistors of 4.7M and 8.2M, together with the negative feedback, result in an input impedance of about 1M. The 100 ohm resistor in the emitter of the BC108 and the 2.2K resistor form a voltage divider which determines the amount of negative feedback, while the electrolytic capacitor performs the function of DC blocking. The latter must be large enough not to affect the low frequency response any more than necessary.

The 2N3638 driver transistor base-emitter junction becomes the collector load for the BC108. The 1K resistor is, in turn, the collector load for the 2N3638 which drives the bases of the two output transistors. The 27 ohm resistor and the thermistor, in parallel, determine the quiescent current of the two output transistors. The loudspeak-

end hole of each board. A likely way for the assembly to be mounted would be on the chassis of a complete piece of equipment. This makes an ideal condition for fixing the two output transistors, already fitted with flag heat sinks. The hole in each heat sink can be lined up with the screws fixing the spacers to the chassis. In this way, the chassis becomes an extra heat sink. If this is not done, it would be wise and, indeed, necessary, to fit a piece of aluminium at least 2in x 4in, in place of the chassis.

All the rest of the components, except the 500uF electrolytic in the BC108 emitter, are mounted on top of the boards. The electrolytic is swung underneath, simply for wiring convenience. It should be noted that the thermistor which is shown in the circuit diagram, does not appear in the photographs, as this item was added after the photographs were taken. ■

Notes and Errata:

CAPACITOR DISCHARGE IGNITION SYSTEM, Reader Built It, September, 1969, page 105. Our apologies are due to the contributor of this item for omitting to credit authorship. The article was supplied by Mr N. G. Harlick, P.O. Box 6327, Wellesley Street, Auckland, New Zealand.

KEYLESS ORGAN, January 1969, page 40: Moviecol Enterprises Ltd. of London claim to have rights over "an electronic musical instrument of the kind frequently referred to as a port-

able keyless organ." Cited is Australian patent application No. 35859/68. They state that they have no objection to the "Electronics Australia" project being built by keen amateur constructors. However, anyone desiring to manufacture the unit for resale should consider their position in relation to the abovenamed patent application.

SIMPLE TRANSISTOR TEST CIRCUIT, Reader Built It, July, 1969, page 107. The meter calibration table shows a current of 0.19mA for a beta of 10. This current should have been given as .09mA. ■

ALWAYS RELY ON R.D.S.

SPECIALS

**R
D
S**

Matched prs., AC127/
128 trans., \$1.20 nett.

200V pl diodes at 500MA,
25c nett each.

STD Stereo plug 3290,
45c nett.

DPDT Rocker switch No.
16, 45c nett.

DPDT Slider switch 3570,
19c nett.

P53p Stereo plug. Line
jack. 80c nett.

Pkts. mixed pots & conds.
Great value. \$1.00 nett.

Corner George and Harris Streets
\$39.50 nett.

The Independent Wholesaler

RADIO DESPATCH SERVICE

Radio and Electrical Distributors

**869 GEORGE STREET,
SYDNEY.**

Corner George and Harris Streets
Telephone 211-0816, 211-0191

Open Saturday mornings

SERVICE

TRADE-RETAIL

To all brands of transistor
radio, tape recorder, record
player, TV and specialising
in Hi-Fi Stereo equipment.
(Trade pick-up and delivery
available).

DEITRON ELECTRONICS SERVICE DIVISION

4-6 TAYLOR ST., DARLINGHURST
31-5430 31-6786

RESISTORS

(Carbon Film ± 5 P.C. Tol.)

1/4W: 4c each or \$3.00 per 100

1/2W: 4c each or \$3.00 per 100

1W: 7c each or \$5.50 per 100

Range: All values between 1 ohm and
10Meg.

Note: We supply to your list. Post/Pack,
10c any order. Our new catalogue now
available.

KITSETS AUST.

Box 176, P.O. DEE WHY, 2099, N.S.W.

The MUSICOLOUR— sound control of coloured lights



Here is a way of obtaining a musical kaleidoscope from your favourite records. This device audio-modulates coloured 240-volt lamps to give vibrant, colourful displays that, for exciting effect, rival the strobe lamps used in discotheques. It can be fed from a domestic amplifier system, from a guitar or organ in a musical group, or from a "background music" amplifier in a discotheque.

by Leo Simpson

The variety and colour of the displays available are endless and indeed, the effects are very hard to describe in print. You can be sure that this is one of the most eye-catching and work-stopping electronic devices ever thought up. Some ideas for building suitable displays are given at the end of this article.

The Musicolour is a light modulating device often referred to in American electronic magazines as "Colour Organs" or "Light Organs." The term "organ" is not always appropriate but appears to have grown out of the origin of these devices. In the 1930s, when they first appeared, they were invariably associated with musical organs in some form. Since then the term "organ" has been borrowed to describe these devices, regardless of the source of music with which they are used.

Basically, this device splits an incoming audio signal into three frequency bands, hereafter referred to as the high, medium and low channels. The signal derived from each channel is used to control a Triac — a semiconductor device which supplies AC power to the coloured lamps in direct proportion to the amplitude of the derived signal.

In planning to use Triacs directly in the mains circuits, we had to solve the problem of providing complete isolation between the Triacs, which would be at mains potential, and the audio input circuits, which must be associated with Triac gates. In no circumstances must there be any significant danger of the mains voltage appearing at the input terminals.

One simple way of providing complete isolation is to apply the audio control signal to a small incandescent lamp which, in turn, varies the resistance of an LDR (light-dependent resistor). The LDR can then form part of the trigger circuit for the Triac or other power control device.

Unfortunately, there are a number of disadvantages in the LDR system.

One is the amount of power required to drive the lamps which, after allowing for losses in frequency divider networks, etc., would amount to many watts. Thus a fairly substantial amplifier would have to be provided. However, the most serious disadvantage is that the range of smooth control from the lamp/LDR system is too small—a small variation in the signal will take the 240V lamps up to full brilliance. The effect of the music signal is to merely flash the lamps in synchronism with the signal.

The method of isolation we finally chose was to use a small mains transformer, 240V to 12.6V C.T., working backwards. That is, the audio is applied to half the 12.6V winding and is stepped up in the 240V winding. One of the prime reasons for using a mains transformer, rather than an audio type, is that, apart from providing a convenient turns ratio at a modest cost, such transformers have a high quality of insulation between windings. The transformer we used (PF2851) is made to particularly high insulation specifications — the same specifications as laid down for transformers used in battery chargers, model trains, and

SPECIFICATIONS

LOAD:

Up to 1,000 watts per channel, 2,400 watts total (see text). Fluorescent lamps must not be used.

SENSITIVITY:

Requires an amplifier with a power output of at least two or three watts into eight or 16-ohm loads.

FREQUENCY COVERAGE:

Low Channel — Up to 300Hz.
Medium Channel—300Hz to 2KHz.
High Channel — Above 2KHz.

WARNING:

Persons subject to epileptic seizures or migraine headaches should not watch the Musicolour display — or any other pulsating light display.

similar "appliance" applications. Any other transformer used in this role should be of similar quality.

Frequency splitting for the three channels is accomplished by a few components in what is effectively the secondary (240V winding) of the transformers. The low channel handles signals below about 300Hz, the medium or "middle" channel covers the range from 300Hz to 2KHz and the high channel covers the range above 2KHz. While this is certainly not an even division of the audible spectrum, it is, for this purpose, a reasonable one, on the basis of obtaining the best effect from music signals.

In the low channel, the frequencies above 300Hz are attenuated by a step circuit consisting of a 2.2K resistor and 0.1uF capacitor in series. The signals below 300Hz are rectified by a simple half-wave rectifier and the DC output is applied to the 0.1F capacitor in the triac triggering circuit. In the medium channel, frequencies above 2KHz are attenuated by a step circuit consisting of a 2.2K resistor and .027uF capacitor. Frequencies below 300Hz are attenuated by a .0047uF capacitor feeding a half-wave, voltage doubler rectifier. In the high channel, frequencies below 2KHz are attenuated by a .001uF capacitor feeding a half-wave voltage doubler rectifier.

The sensitivity of each channel is adjusted by a 300-ohm potentiometer and the overall sensitivity of the Musicolour is adjusted by another 300-ohm pot, which also carries the mains switch. To ensure that the Musicolour presents a reasonable impedance to the output of the amplifier at all pot. settings, a 12-ohm resistor is connected in series with the 6.3V winding of each transformer.

At this point, it may help to describe the operation of the Triac. A Triac provides a simple means of controlling AC power where rectification is not required. Although its operation and internal construction are complex it can be regarded as a pair of thyristors connected in inverse-parallel with a common gate electrode and common case.

In essence, the Triac is a bidirectional switch which after being triggered into conduction, stays "on" until the supply voltage decreases to zero or reverses in polarity, when it turns off and can be switched on again. Used with AC, a Triac can be triggered into

conduction at any point on either half cycle by a low voltage signal of either polarity applied between the gate electrode and terminal 1 (anode 1). Note that, since the Triac is a bi-directional device it has no anode or cathode as such. The two end terminals are normally referred to as "anode 1" and "anode 2" or "terminal 1" and "terminal 2."

(Reference: "Keeping Up With Semiconductors" Electronics Australia, November 1966, Reprints available. File No. 8/KS/4.)

As the Triac is a switching device which is either fully conducting or "off," the only means by which it can be used to obtain variable control of power is to use it as a very rapid switch which closes for variable periods of time during each half-cycle of the AC voltage waveform — by adjusting the instant during the half-cycle when it triggers into conduction. The oscilloscope waveforms, which will be referred to later, will help in understanding this concept of power control.

While there are many methods of varying the triggering point of a Triac, the most satisfactory one is known as

"phase control." This involves applying to the gate electrode a sharp pulse of current whose phase, relative to the AC waveform, can be varied. This is done by means of a capacitor which is charged while the Triac is in the non-conducting state. The time the capacitor takes to charge will depend on its size, the resistance in series with it and the voltage supplied to it. In the Musicolour, the resistance and the size of the capacitor are constant, and the triggering point of the Triac is varied by varying the DC voltage fed to the capacitor; but more of that later.

To use this arrangement to provide a sharp, variable-phase trigger pulse for the Triac gate, it is necessary to arrange for the capacitor's charge to be fed to the gate via a voltage sensitive breakdown device—one which conducts only when the voltage across it reaches a certain value. The device used is a Diac, a three-layer symmetrical breakdown diode which is an open circuit until the applied voltage rises to its breakdown voltage, whereupon it breaks down to a low resistance and triggers the Triac.

One problem we encountered with our initial version of the unit was that

the triggering tended to be rather erratic, so that the lamps flickered erratically, no matter what the input frequency. This effect was cured by fitting the 680K resistor connected from the active line of the mains to the timing capacitor. This establishes a threshold triggering level of voltage across the capacitor, and also provides a slight increase in triggering sensitivity.

It also has another beneficial effect. Since the voltage applied to the timing capacitor is unidirectional (i.e. pulsating DC) the Triac will tend to trigger more on one half cycle of the mains supply than the other. This characteristic can be put to good use, since it effectively increases the range of the control of the lamps. The threshold voltage provided by the 680K resistor makes this effect even more pronounced, since its polarity aids the pulsating DC voltage on one half cycle, and opposes it on the next.

Referring to the oscilloscope diagrams, we can see the effect of applying various levels of audio signal to the input transformers. The dotted lines represent the sinusoidal waveform of the mains voltage while the solid line represents the voltage waveform applied to the coloured lamps. At low audio signal levels, the Triac fires late in one half-cycle only, so that a train of pulses with a repetition

The circuit is relatively simple, all three channels having a similar configuration. The three filament transformers, working backwards, provide both a step-up for the signal voltage, and complete isolation between the input terminals and the 240V lamp circuits.

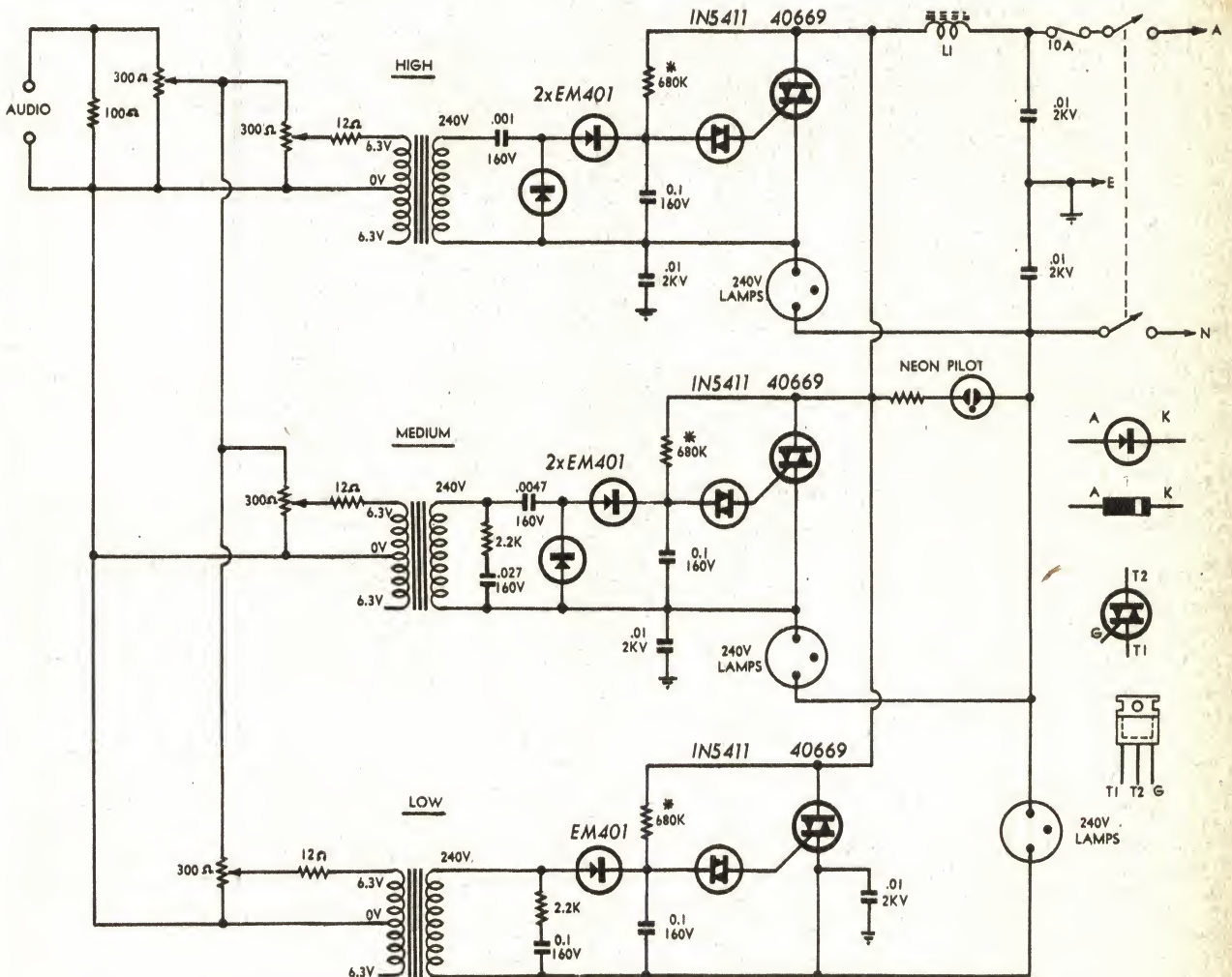

EA MUSICOLOUR

* MAY NEED ADJUSTMENT

L1: 50T, 18 B&S ENAMELLED COPPER WIRE, CLOSE-WOUND ON 2-1/2" LENGTH OF 3/8" DIA. FERRITE ROD.

2/PC/8

It's a *Now* world!

Remember when you could only have one type of wire wound resistor?

Now you have the choice of *FIVE* styles



1. Vitreous coated Wire wound
1.5 to 14 watts.

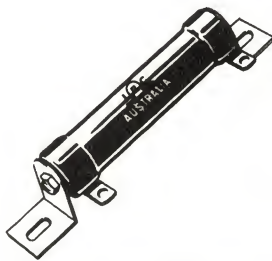

2. Tubular, fixed and adjustable Wire wound 3 to 200 watts with "Pyrosil" coating.

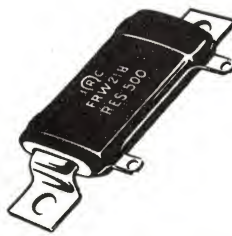

3. Flat Wire wound with "Pyrosil" coating 20 to 75 watts.



4. Ceramic case Wire wound
Fireproof inorganic construction 5 to 15 watts.

Now another *IRC* first, *NEW ASW SERIES*

Axial weldable leads

Low T.C. close tolerance winding

Pyrosil coating

Welded Termination

ASW Series

2w - 5w - 7w and 10w

Supersedes the old fashioned AA/AB
"Radio" type wire wound resistors.

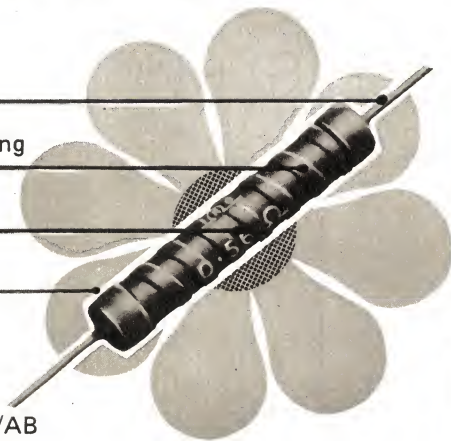

**IRH
COMPONENTS
PTY. LIMITED**

A Subsidiary of IRH Industries Limited

THE CRESCENT, KINGSGROVE, N.S.W. 2208. PHONE 50 0111

INTERSTATE TELEPHONES

MELB. VIC.	489.1088	BRIS. QLD.	70.2141
HOB. TAS.	34.2811	PERTH W.A.	8.2271
LAUN. TAS.	22.844	ADEL. S.A.	23.1971

Check your literature file is up to date on the complete IRC Resistors range.

2227

rate of 50Hz is applied to the lamps. At a higher audio level, the Triac fires earlier in the one half cycle. At higher levels, again, the Triac begins to fire late in the second half cycle and so on. The resulting effect is that the audio signal is able to control the brightness of the lamps over a very wide range.

The Triacs used in the Musicolour are plastic encapsulated economy units with three leads, and are specifically intended for mounting on printed wiring boards. They are made by RCA, being designated type 40669. They have a continuous "on-state" current rating of 8-amps, and a maximum "off-state" voltage rating of 400V which suits them for operation on the 240V AC mains supply. Their triggering sensitivity is typically 1.25 volts at about 25mA. The thermal resistance from the junction to the flange of the case is quite low, enabling high power operation. The Diacs used are also made by RCA, type 1N5411.

The .01uF capacitors at various points in the circuit and the inductor in the active line of the mains are for interference suppression. In operation, triacs switch on in about 1 or 2 microseconds, the current rising from zero to whatever the load permits within this period. This rapid rise in current produces radio frequency interference extending up into the range of several Megahertz. The resulting interference

will effect the broadcast band and the lower shortwave bands. With the filtering components used here the level is well below that produced by most commutator motors used in domestic appliances.

The capacitors used for this job must be suitable for use across the AC mains. For this role in the past we have used ceramic capacitors with a DC rating of 2KV; a figure which provided a good safety margin. Another type which is suitable for this role is the Ducon CDX102. This unit is specifically designed as a mains filter capacitor, making it an ideal choice.

The interference suppression components reduce the interference radiated from the mains wiring but there is still some interference radiated from the wires running to the lamps. This can be minimised by keeping the wires as short as possible or, where the wires are installed permanently, it can be eliminated by running them in earthed metal conduit.

The sensitivity of the Musicolour is such that it will drive lamps to full brilliance when fed with a signal of about 1 volt RMS. This will require an amplifier capable of at least 2 or 3

watts into an 8 or 15 ohm load. While this amplifier may be one of the amplifiers in a stereo system, with the Musicolour in parallel with one of the speakers, the signal level required is such that the listening level will be rather high. In fact with high efficiency speakers a listening level resulting from 1 volt RMS may be downright uncomfortable.

The most convenient way of using the Musicolour is to drive it with a separate low power (2 or 3 watts) amplifier which is fed with signal from across the volume control or tape outlet of the amplifier driving the loudspeakers. If a stereo system is used the Musicolour amplifier can be fed from both channels via the mixing arrangement shown in the accompanying diagram. The 220K resistors are for maintaining good separation between channels of the stereo amplifier. The advantage of using a separate amplifier to drive the Musicolour is that it enables sufficient signal to be fed to the Musicolour regardless of the listening level.

Each channel can control up to 1000W. This can be made up of any combination of incandescent lamps, but fluorescent lamps do not lend themselves to simple forms of power con-

Below: A wiring diagram of the complete unit, showing the location of all components. The printed board is viewed from the component side, with the grey overprint showing the copper pattern on the reverse side.

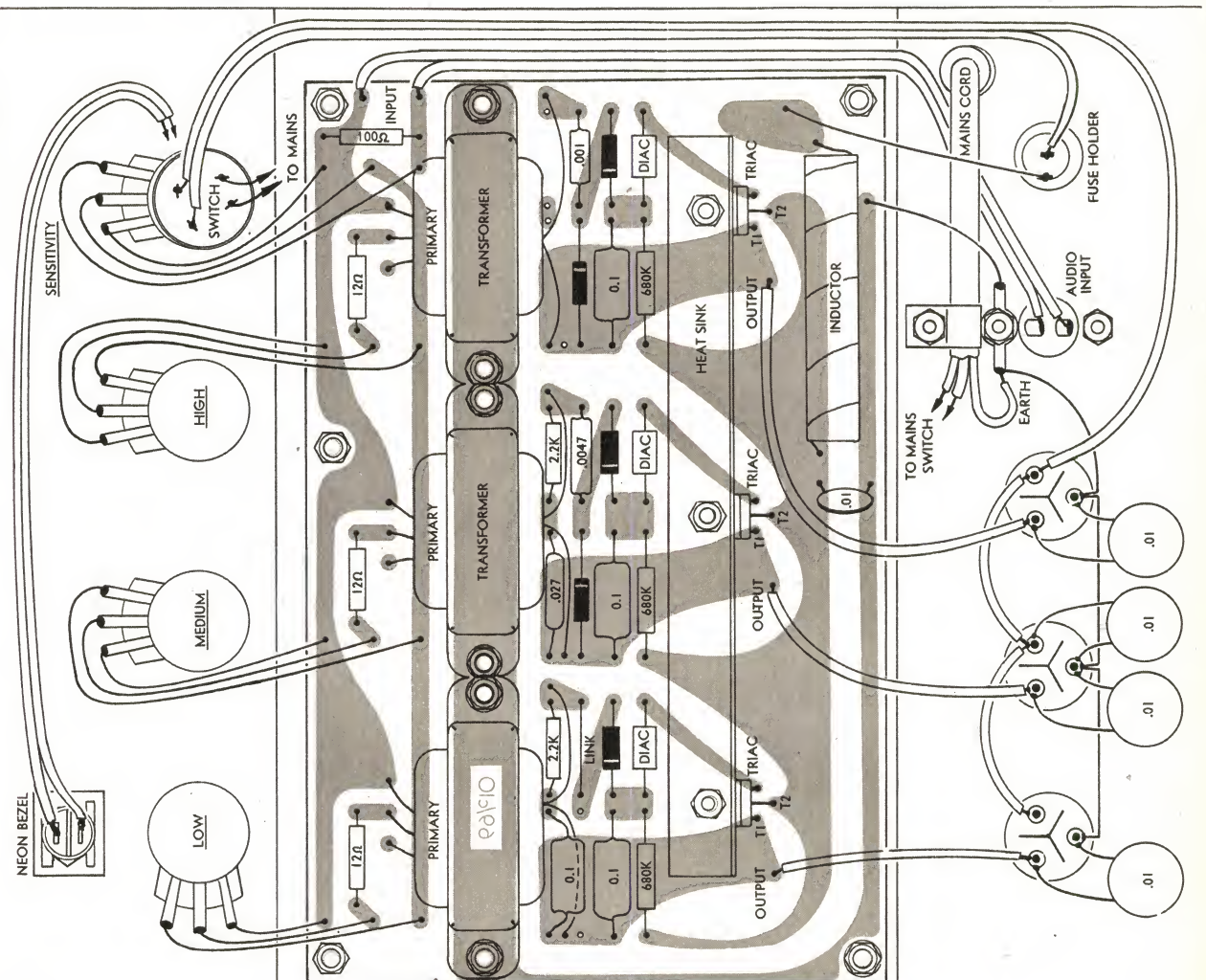

National Semiconductor

Our drum beater

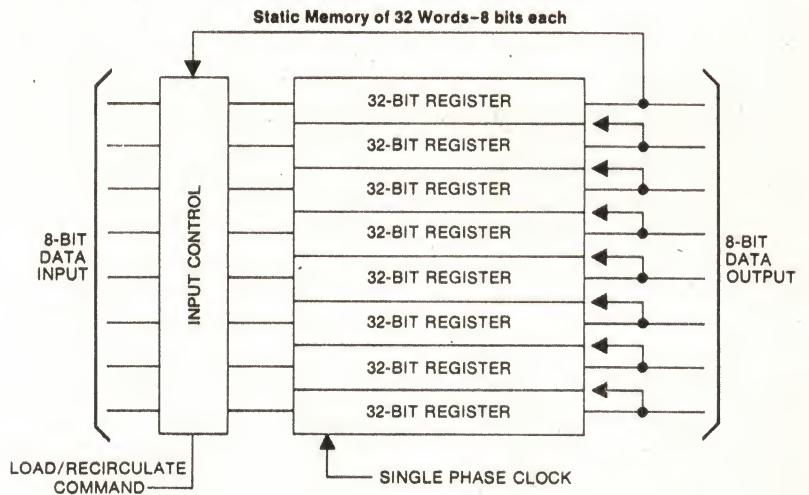

MM 505	DUAL 32-bit static register	4 pieces at \$30.00*each	\$120.00
MM 582	DUAL digital multiplex switch	4 pieces at \$ 8.00*each	\$ 32.00
		8 pieces	TOTAL \$152.00

*100 to 999 price

A drum memory as reliable as this would cost at least \$563.91. Our kit delivers now for \$152.00. For more on this, write

RUTHERFORD ELECTRONICS PTY. LTD.
TELEPHONE 848-3033, P.O. BOX 30, NORTH BALWYN, VICTORIA, AUSTRALIA, 3014.
SYDNEY: 612118. ADELAIDE: 232703. PERTH 23-1194.

trol and cannot be used. Note also that, although each channel can handle 1000W, it is unlikely that the system, as a whole, will be called upon to handle a total of more than 2400W.

This limitation is more one of associated equipment than of the unit itself. Most mains power outlets have a maximum current rating of 10 amps which automatically limits the rating to 2400 watts. This rating should not be exceeded. Anyone who has used a 2400 watt radiator will know how hot the wall socket can become.

Note also that the mains switch on the rear of the sensitivity potentiometer has a rating of only 2 amps. If a total load of more than 500 watts is to be used the pot. switch should be deleted and a larger switch fitted in its place. One of the most suitable and least expensive switch is a domestic flush wall-mounting 10A type. This could be mounted on the cover of the Musicolour.

The rating of 1000 watts may seem conservative, since the 40669 Triacs are rated at 8A and are in fact, capable of controlling 2000 watts. However, the "cold" resistance of an incandescent lamp can be as small as one-fifteenth of the "hot" resistance which means that very high surge currents will flow at the moment of switch-on.

At switch-on from cold a 1000 watt incandescent lamp load will have resistance of about 4 ohms which will mean that its surge current will be 60 amps RMS. Since the 40669 Triac has a surge rating of 85 amps RMS for one full cycle at 50Hz, 1000 watts is the maximum incandescent lamp load which can be handled with a reasonable margin of safety.

If a small amplifier cannot be found to drive the Musicolour, one featured in the article "Powered Loudspeaker for Portable Recorders" in the September, 1969, issue of "Electronics Australia" is eminently suitable. (File No. 1/MA/48.)

The prototype Musicolour was assembled on a modified chassis originally used for the 3-plus-3 Stereo Amplifier, August, 1968. It is U-shaped, measuring 7-7/8 x 5-5/8 x 3 inches and has wrap-over cover. These chassis are available from most kitset suppliers at a very reasonable price, although we assume that metalwork expressly intended for the Musicolour will be available at a similar price shortly after this issue goes on sale.

Three recessed, three-pin sockets, made by Bulgin, are mounted on the rear panel of the chassis for each of the three-channel outputs. A two-pin socket is used for connection of the audio signal. Also accommodated on the rear panel is the fuseholder and the grommetted hole for the mains cord.

The majority of components, including the three miniature power transformers and three Triacs, are mounted on a printed wiring board measuring 7-1/8 x 4 1/2 inches. The exceptions are the potentiometers and four suppression capacitors. The three patterns on the wiring board, one for each channel, have been deliberately made similar, to permit maximum flexibility in modifying the frequency splitting characteristics, should this be desired.

The printed board pattern will be

supplied to interested board manufacturers and boards should be available shortly after this issue goes on sale. The pattern is coded 69/c10.

The Triacs are manufactured with an integral flag heatsink to aid heat dissipation. Actually, the heat dissipation of the Triac is small—approximately 1 watt per amp. This means that if the Triac is controlling a 1000-watt load its internal dissipation will be a maximum of 4 or 5 watts. The flag is electrically connected to terminal 2 of the Triac—so that, in the Musicolour, it is connected directly to the mains supply. The Triacs are soldered directly into the printed board and the flags attached to a common L-shaped heatsink which is secured to the board by 1/8-inch screws and nuts. As well as improving the heat dissipation of the Triacs, this heatsink provides stiffening for the board so that it is not bowed by the weight of the transformers.

The L-shaped heatsink is made from a piece of 18-gauge aluminium, 5 1/2-inches long by 1 1/2 inches wide, bent

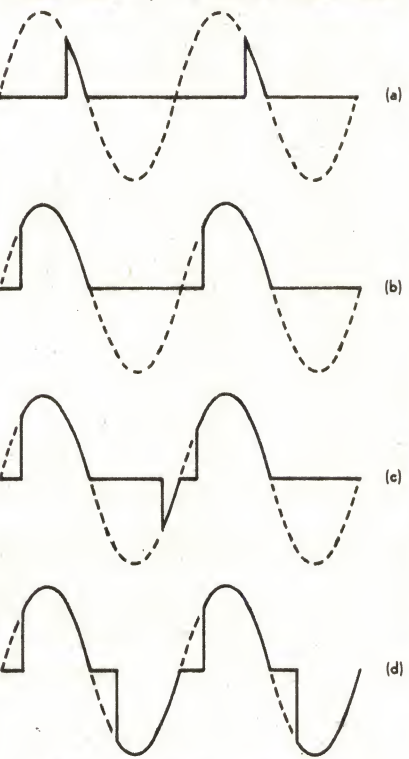

These diagrams, drawn from CRO patterns, show a progressive increase in power to the load, ranging from late triggering of one half cycle (a) to early triggering of both half cycles (d).

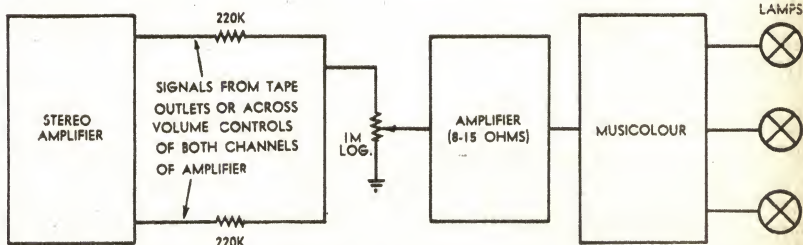

Block diagram showing how the Musicolour and its associated amplifier may be connected to a stereo amplifier. Signals are mixed for the visual display but remain separated in the speaker outlets.

so that it has a half-inch flange. The three holes to mount the heatsink on the board are drilled along a line 9/32 inches from the outer edge of the half-inch flange. The Triac mounting holes are drilled along a line 1/4 inch from the top of the heatsink.

Care should be taken to ensure that all the other components on the board are not in physical contact with the heatsink because it is connected to the mains supply. This applies particularly to the metal case of the Diacs.

The transformers are spaced off the printed board by the thickness of two washers so that no undue stress is placed on the board when the transformers are screwed down. While one half of the 12.6V winding is not actually connected into the circuit it is soldered into the appropriate "spot" on the board to avoid loose wiring.

The interference suppression inductor L1 is not available commercially, but is quite easily made. Start by winding a layer or two of thin insulation tape on 2 1/2 inch length of 3/8-inch diameter ferrite rod. If a full length ferrite rod has been purchased it can be cut by filing a nick right around the circumference of the rod and then snapping it as if it were of glass—do not try to saw the rod. Close wind 50 turns of 18 B&S enamelled wire over the insulation tape. Then wind insulation tape tightly over the rod in a couple of layers. This last step is important—if it is not wound tightly the inductor will make an audible noise due to the large currents being switched by the Triacs. The finished unit is mounted directly on the printed board.

To solder the inductor into circuit the pigtailed must be tinned properly. The enamel coating on the wire must be thoroughly removed with a knife or razor blade before attempting to "tin" the wire. If this is not done the resulting joints will be cold and the operation of the unit will be unreliable. The connecting wires from the mains switch to the board and from the board to the three outlet sockets should not be of light gauge hookup wire. Use heavy gauge wire as used in the main power cord. This latter, in turn, should conform to the supply authority regulations.

A suitable order of assembly will make construction easier. Proceed as follows: First, connect suitable lengths of hookup wire, to those points on the board which are to be wired to components not mounted directly on it, such as the potentiometers. About four inches should be sufficient in most cases. Next mount the components on the board. Do not bend the pigtailed to close to the bodies of the components, otherwise they may fracture.

Let Noyes Specialists assist you select your Electrical Equipment

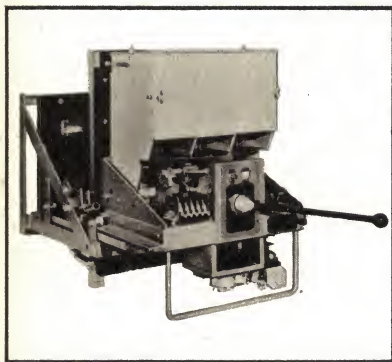
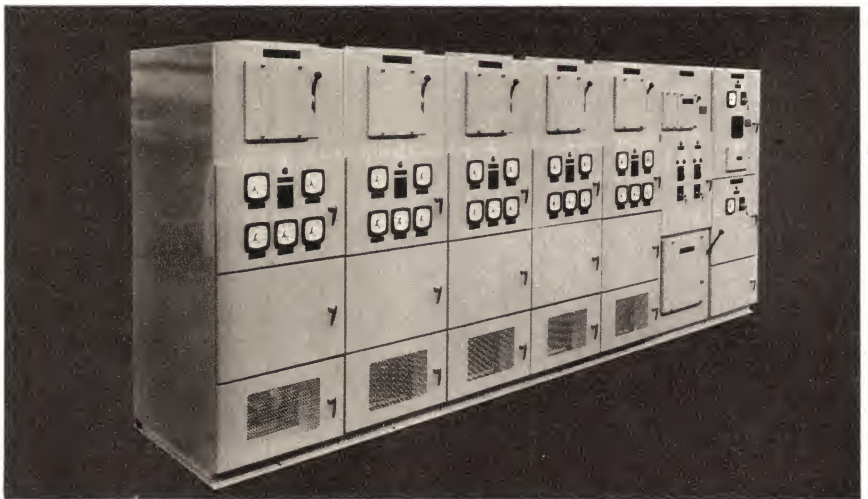
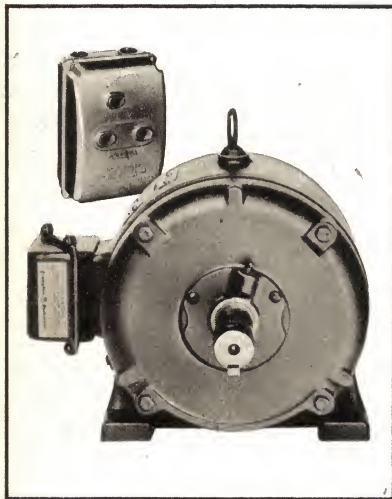

Crompton Parkinson

WORLD FAMOUS FOR QUALITY

Choosing the right electrical equipment is a job for specialists and Noyes Bros., with over 40 years' practical experience have a wealth of technical knowledge at your disposal. Our engineers welcome requests for discussion of customer problems.

MOTORS and STARTERS

Electric motors— $\frac{1}{8}$ to 10,000 h.p., 110 to 6,600 V. Squirrel cage, slip-ring, auto-synchronous and direct-current types, with all forms of enclosure. Crompton Parkinson starting and control gear.

INSTRUMENTS

Crompton Parkinson Instruments, incorporating taut ribbon suspension, now manufactured in Australia for a wide range of duties, together with Current and Instrument Transformers to match.

CIRCUIT BREAKERS

Crompton Parkinson Air Break Circuit Breakers—A.C. and D.C. types of high fault capacity for totally enclosed or open panel mounting in withdrawable or fixed designs.

CONTROL SYSTEMS

Since 1921, Crompton Parkinson Control Equipment Plant has specialised in the design and construction of complete electrical systems to meet requirements beyond the capacity of standard units.



Literature available on request.

Noyes

NOYES BROS. PTY. LIMITED
 Sydney Melbourne Brisbane Adelaide Perth Hobart Canberra Newcastle
 Tamworth Wollongong Geelong Mackay Townsville Launceston Burnie

HAWKER SIDDELEY COMPANY

When attaching the L-shaped heatsink ensure that the board has been drilled correctly so that the securing screws are well clear of the copper pattern. Fit the screws so that the nuts are on the component side of the board.

Check the board carefully, then fit the components to the main chassis. The rubber feet are secured with a screw and nut, the nut being held in the foot itself. The potentiometer shafts should be cut to suit the knobs used. The mains cord is passed through a grommeted hole in the rear of the chassis and anchored by a clamp underneath the audio input socket. The earth wire is connected to the chassis via a solder lug which is secured to the chassis by one of the nuts which retains the audio input socket. When terminating the mains cord, the earth wire should be left with a loop of slack so that, if the cord is strained to the limit, the earth lead will be the last to break.

Proper earthing of the chassis is the most essential step in the construction of the Musicolour. If it is not properly earthed a wiring mistake or component failure could make the chassis "live" and lethal!

Care is particularly necessary where the equipment is to be used in a public situation, in association with a public address system, musical instrument amplifiers, coloured spotlights, festoon lighting, etc. In these circumstances, the Musicolour unit itself should be checked by a qualified electrician, along with the lighting fixtures to be connected to it.

Four suppression capacitors are mounted at the output sockets, where their operation is most effective. The earth return for the suppression capacitors is tinned copper wire run across the third terminal of the output sockets and down to the soldering lug where the mains earth wire is terminated.

Having installed all the mains wiring, the board may now be mounted. It is mounted using one-eighth inch screws and nuts, with two nuts used to space the board at least ¼-inch from the chassis. The connections from the board to the rest of the wiring may now be made. Note that neither side of the input wiring is connected to chassis, to avoid earth loop problems.

The pilot light is a neon bezel with a current limiting resistor incorporated. If the neon bezel without a limiting resistor is on hand a resistor of 150K should be connected in series with it. The neon bezel we used is moulded in red plastic. It is made by Telite and distributed by I.R.H. Components Pty. Ltd. The supply for the neon bezel is taken directly from the switch pot, which may not be readily apparent from the photograph.

Before the unit is connected to the display lamps and power applied several checks should be made. First and most important, check that there is a direct connection between the earth pin of the mains plug and the chassis. Then, with the unit's mains switch turned on, check that there is a high resistance between the active and neutral line of the mains cord, between the active and earth wire and the neutral and earth wire. Also check that there is a high resistance between all pins of the three output sockets. In each case the resistance should be at least 1 megohm as measured on

the average multimeter. If not, you have faulty connections or components. Do not apply power until all these checks are positive.

Finally, do not work on the Musicolour when power is applied. The Triac heatsink and several other exposed points inside the chassis have the mains directly applied to them. **IF YOU IGNORE THESE PRECAUTIONS**

there is an optimum setting of the sensitivity controls for the particular music program is use. If the signal level is too high the lamps will glow continuously and all lamps will tend to glow, regardless of the input frequency. If the signal level is too low the lights may be extinguished for most of the time. A little experimentation with the controls will produce the most varied

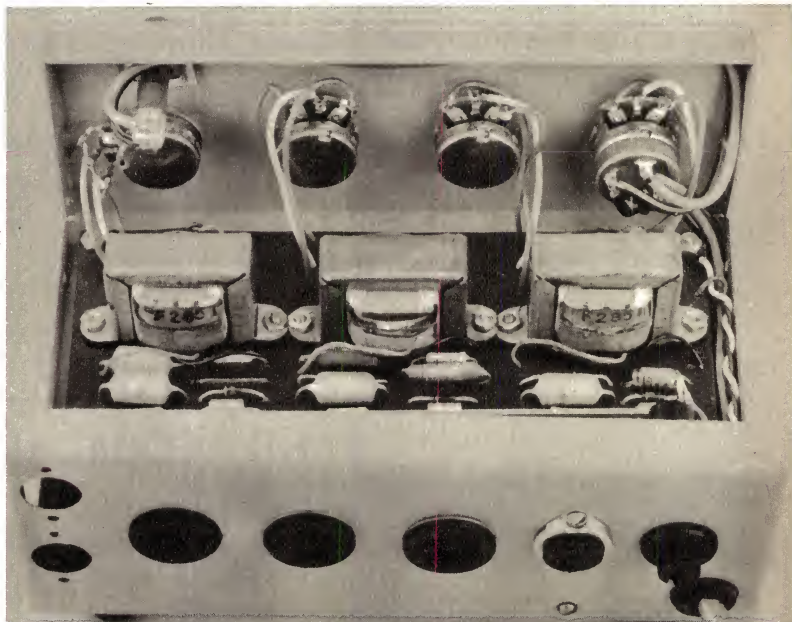

View from rear and above showing portion of the printed wiring board, the three transformers and minor components. Note the three recessed outlet sockets on the rear panel. Compare this with the wiring diagram.

YOU MAY NEVER BE ABLE TO IGNORE THEM AGAIN.

When the unit is working it may be found that the lamps glow slightly when no audio signal is being fed into the unit. This glow may be eliminated by increasing the value of the 680K resistor in the offending channels. It is unlikely that this adjustment will be necessary.

In operation, it will be found that

display for each program. The records or programs which give the best display are those with a wide dynamic range and a strong rhythm accompaniment. "Pop" records can be very disappointing as they are recorded with a lot of compression.

Many different approaches are possible to the construction of the Musicolour although we do not recommend that readers modify the circuit unless

PARTS LIST

- 1 Chassis with overall dimensions 7-7/8 x 5-5/8 x 3 inches.
- 1 metal cover with dimensions to suit chassis.
- 3 power transformers, 240V to 12.6V, centre-tapped, with 2-1/16 inch mounting centres. (Special insulation. See text).
- 1 printed board, 69/c10.
- 1 L-shaped heatsink to suit printed board.
- 1 ferrite rod inductor (see text).
- 3 Bulgin recessed 3-pin sockets and plugs.
- 1 2-pin plug and socket.
- 1 screw-in fuseholder and 10 amp fuse.
- 1 neon bezel with current limiting resistor.
- 4 rubber feet.
- 4 knobs.

SEMICONDUCTORS

- 3 40669 Triacs.
- 3 1N5411 Diacs.
- 5 EM401 silicon power diodes.

CAPACITORS

(Higher voltage ratings may be used.)

- 4 x 0.1uF/160VW polyester.
- 1 x 0.027uF/160VW polyester.
- 5 x 0.01uF/2KV (see text) ceramic disc.
- 1 x 0.0047uF/160VW polyester or polystyrene.
- 1 x 0.001uF/160VW polyester or polystyrene.

RESISTORS and POTENTIOMETERS

(½ watt rating)

- 3 x 680K, 2 x 2.2K, 1 x 100 ohm, 3 x 12 ohm.
- 3 x 300 ohm (lin.) potentiometers.
- 1 x 300 ohm potentiometer with rotary switch (see text).

MISCELLANEOUS

Mains cord and plug, grommet and mains cord clamp, 1-8in screws and nuts, connecting wire, spaghetti sleeving, solder, etc.

Make your next choice a Uher

UHER

Made in Western Germany

"The Worlds Most Reliable Name for Precision Taperecorders"
presents ANOTHER NEW

Technical Perfection in our pages of

ACTION AND SOUND

The All NEW BREED

VARIOCORD 263 Stereo

BAND RECORDER



Variocord 263 Stereo — Also available as Variocord 23 Hi-Fi 4 track

SPECIFICATIONS

- Recording-4 or 2 track
- Interchangeable head assembly
- 4 magnetic heads
- Tape speeds: 7½ ips. 3¾ ips. 1½ ips.
- Frequency range: 30-20,000 cps at 7½ ips.
30-15,000 cps at 3¾ ips.
30-8,000 cps at 1½ ips.

Showroom — Sales Enquiries Welcome

ATRAM PTY LTD.

based on the famous UHER Royal Deluxe
UHER VARIOCORD 263 STEREO

Made exactly 'to measure.'

Vary your machine in four different ways.
Your choice of 2 track and 4 track operation.

Automatic or manual level control.

Mixing of sound sources. 2 x 6 watts rms.
output or 2 x 9 watts music power. 3
speeds. 2 built-in loudspeakers can be
hung on wall like a picture. Optimum
wow and flutter performance. Uhers ex-
clusive tape tension comparator controls
tape speed in any position.

- Maximum reel size 7"
- Wow and flutter \pm 0.05p.c. at 7½ ips.
- Signal to noise ratio 50 db 4 track 53 db 2 track
at 7½ ips.
- Residual noise after erasure 70 db at 7½ ips.
- Output power 2 x 6 watts rms. (sinewave tone)
2 x 9 watts music power
- Dimensions: 17½ x 13 x 7
- Weight: 22 lbs.

Sole Australian Importer and General Agent.
5 McLaren Street, North Sydney, Tel.:
92-4177.

Available in All States from Franchised UHER Agents

N.S.W.: John Border Photographics Pty. Ltd. 175 Liverpool St., Sydney. Tel.: 28-1106.	A.C.T.: Canberra Sound and Recording Service. VIC.: 109 Majura Ave., Dickson. Tel.: 4-5980.	Photosound Pty. Ltd., 7 Cookson St., Camberwell, Tel.: 82-7042.
N.S.W.: Milverson Sound Centre, 791 Pacific Highway, Chatswood. Tel.: 41-4365.	QLD.: A. E. Harrold Pty. Ltd., 123-125 Charlotte St., Brisbane. Tel.: 31-3081.	S.A.: Kallin Distributors (Wholesale) Pty. Ltd., 140 Gawler Place, Adelaide. Tel.: 8-7171 (11 lines).
N.S.W.: Glen Dor Camera Centre, 43 The Corso, Manly. Tel.: 92-2709.	VIC.: Atram Pty. Ltd., 1 Corr St., Moorabbin. Tel.: 95-5633.	W.A.: Alberts TV and Hi-Fi Centre Pty. Ltd., 282 Hay St., Perth. Tel.: 21-5004.
N.S.W.: Alderson Camera Store Pty. Ltd., King St. and Prince's Highway, Rockdale. Tel.: 59-2589.	VIC.: Klapp Electronics Pty. Ltd., 224 Chapel St., Prahran. Tel.: 51-4683.	N.T.: N.T. Musical and Electrical (W/S) Pty. Ltd., 54 Cavanagh St., Darwin. Tel.: 3072.

they are experienced constructors. Firstly, if there are several mains transformers on hand which have 6.3V or centre-tapped 12.6V secondaries they could be pressed into service but it may not be possible to install them on the board. If contemplating such an approach, it would probably be necessary to completely re-design the layout. It is also essential that the inter-winding insulation of such transformers be at least as good as those used in our version.

If you cannot afford to build the three-channel version of the Musicolour in one step, a two-channel version can be built. The low channel will be the same as the low channel in the three-channel version. The high channel will be similar to the high channel in the three-channel version but with the .001uF capacitor increased to .0027uF. This will result in a crossover frequency of approximately 400Hz.

A slight increase in sensitivity of the Musicolour may be obtained by not connecting the "cold" side of the potentiometers, i.e., using them as variable resistors instead of voltage dividers. However, this will mean that the sensitivity controls are capable of only a slight range of attenuation.

The Musicolour could be built with its own driving amplifier in a common case. If the driving amplifier was the Powered Loudspeaker unit, as suggested earlier, they could both be accommodated in metalwork similar that used for the 10-Plus-10. The 10-Plus-10 case would serve as is, but the chassis would require some minor modifications. However, these would be well within the scope of the home workshop.

The Musicolour could be used with guitar amplifiers. In a musical group it might be possible to have one channel per guitar, which could make for some exciting effects.

As noted previously, the possibilities for displays are endless and are limited only by the reader's imagination. The ideas outlined here are only a guide and we will be interested to hear from readers who have thought up other ideas.

Most of the displays can be built around 25-watt or 40-watt coloured globes. These are available from Philips and other manufacturers in colours such as red, yellow, green and blue. It is interesting to note that the blue lamp will not appear nearly as bright as the red and yellow types. This is because the eye is less sensitive to the blue end of the spectrum, and tungsten filaments emit most of their light in the red and yellow region of the spectrum. This means that a blue filter stops most of the light. In general then, the power needed for the blue lamps will be two or three times that needed for red and yellow lamps.

The displays should be arranged so that the lamps are not viewed directly. Looking directly at bright lights is tiring, to say the least. The basic materials needed to make interesting patterns are crinkled aluminium foil and frosted, fluted or patterned glass.

The simplest possible display is to mount three coloured lamps on a board and place them behind a stereo system cabinet so that they light the wall behind it. We suggest red for the low channel, blue for the medium channel and yellow for the high channel.

Another idea is to mount a number of lamps in a row along a board, place frosted glass in front of them and mount the whole display on top of the stereogram, organ or in the particular "interest point" in the room. Lights can be placed inside a cabinet, with crinkled aluminium foil behind them, and frosted glass in front. The result is a portable, completely enclosed display.

hours. Retail price is \$3.17, including tax.

Many interesting displays could be obtained with these spotlamps aimed against walls, using beam splitting mirrors and rotating reflectors such as are seen in some night clubs. As we said before, your imagination is the only limit on the display you achieve. Build the Musicolour for an exciting Christmas.

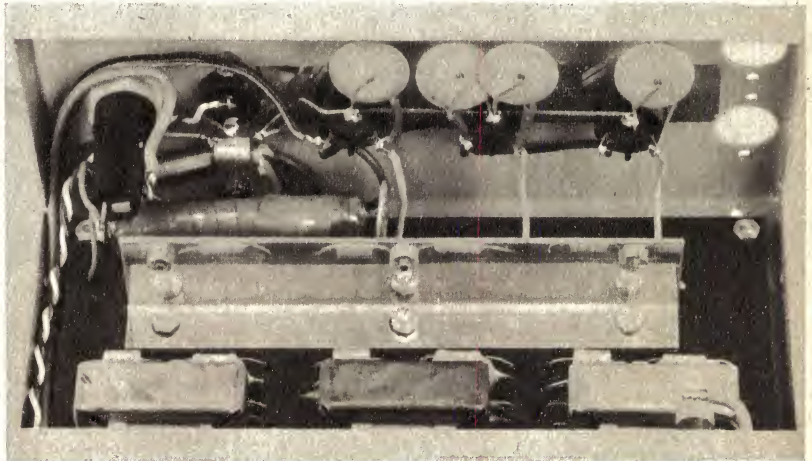

View from front and above showing the aluminium heatsink, the interference suppression inductor in the left rear corner, and the suppression capacitors against the rear of the box.

Another interesting idea is to install an assortment of coloured lamps in an inverted, frosted "fish-bowl" or one of the large coloured bowls used for floral displays and the like. The power of the lamps would have to be kept fairly low for this display.

One of the most obvious tricks would be to modulate strings of "Christmas tree" lights. These could be strung around the house for the most novel Christmas decorations in your district. Another Christmas decoration for people with fluted glass doors is to have lights playing behind the doors. You certainly would have extra visitors while it was on.

For higher power displays, on stage for musical groups or in discotheques, coloured spotlights will be required. While you can buy your own spotlights and use gelatin filters to colour them to taste, coloured spotlights are marketed by Philips Electrical Pty. Limited and available from many trade houses which specialise in lighting. The lamps are in the Philips Comptalux range and are available in red, yellow, green and blue. The remarks we made above about the brightness of different colours still hold for these lamps.

The Comptalux coloured lamps are of pressed-glass construction with an internal reflector. A weatherproof, coloured silicone lacquer coating is applied to the outside face of the bulb. The glass bulb is 3/16in thick and they can be used without the need for any special surround. They use an Edison screw base. The lamps can be used indoors or outdoors and, enclosed in a watertight fitting, for underwater lighting. They are available with a 100 watt rating only, but are highly efficient because of the integral reflector construction. They are available in several voltage ratings and provided these are not exceeded, have a life of 2,000

FOOTNOTE

Quite coincidentally, while preparing the "Musicolour" article for publication, we received a letter from a reader who is a teacher responsible for auditory training of children at a school for the deaf. He was seeking some method whereby he could present a visual interpretation of speech in terms of, at least, loudness and, if possible, frequency content.

He had already experimented with a voice-operated control unit for a model train set, whereby the speed of the train was governed by the loudness of the voice. However, while this was useful to a degree, it had many obvious limitations, including the fact that the train, or any mechanical device, would be relatively sluggish in its response as well as being responsive only to loudness and not to frequency.

It occurred to us that the "Musicolour" might be just what was needed in this application. The visual impact of coloured lights is high—thereby tending to hold the attention of young subjects—the response is relatively fast, and the set-up indicates both loudness and frequency.

Whether the frequency bands we have chosen for musical presentations would be best for speech would have to be determined experimentally. It may well be that the bands could be narrowed and fitted into the most useful part of the speech spectrum, say from 300Hz to 3500Hz. Alternatively, it might be desirable to provide more but narrower bands in order to improve the frequency indication. This would involve more components, but should be possible and might well be justified.

While we are not in a position to conduct these experiments ourselves, we offer the suggestion for the benefit of anyone with a similar problem. ■

Stanton Calibration and Broadcast Standard Cartridges

The newest & finest cartridges from U.S.A.

Designed and manufactured especially for applications where imperfection or fragility cannot be tolerated, Stanton cartridges are audibly and measurably superior, as shown by the following reviews.



Stanton Calibration Standard Cartridge

Type 681EE

"The tracking was excellent and distinctly better in this respect than any other cartridge we have tested"
"The frequency response of the Stanton 681EE was the flattest of the cartridges tested, within ± 1 dB over most of the audio range".

HIRSCH-HOUCK REPORT "HI-FI/STEREO REVIEW" JULY 1968.

"The 681's low-mass stylus assembly is probably responsible for the cartridge's superb tracking performance at such low forces as one gram".

"Its frequency response shows a wide range response that is free of peaks. Even the usual high frequency resonant peak is well damped".

"This is the best channel separation figure at this frequency that we've measured over the years".

"The 681EE is not at all susceptible to hum pick-up".

"The 681EE stands among the top few cartridges on the market". "AUDIO" DECEMBER, 1968.

Type 681L

Low Impedance version of 681EE especially developed for Radio and Television Stations.

Type 500E

Stanton Broadcast Standard Cartridges.

"The Stanton 500E is designed for use in broadcast stations and other applications in which it will be in use for extended periods of time.

"We found that it performed well at the minimum figure of 2 grams".

"The IM distortion was under 1% up to about 20 cm/sec, and with the force increased to 3 grams it was only 1.5% at 27.1 cm/sec. This is

Exceptionally good performance. The tracking of the Stanton 500E was very good when operating at the 2 gram force".

HIRSCH-HOUCK REPORT "HI-FI/STEREO REVIEW" JULY 1968.

Type 500A

Identical to 500E but with 0.7 mil. conical stylus. Full specifications and Test Reports Available on Request.

SOLE AUSTRALIAN DISTRIBUTORS

Leroya Industries PTY. LTD.

266 Hay Street, SUBIACO, W. AUST. 6008

Interstate Distributors

*VICTORIA

CADENZA ELECTRONIC DISTRIBUTORS PTY. LTD.

2A Hill St., Thornbury.

Phone 443295.

*NEW SOUTH WALES

W. C. WEDDERSPOON PTY. LTD.

193 Clarence St., Sydney.

Phone 296681.

A LINE FILTER FOR HEAVIER LOADS

Line filters have been described on a number of occasions in the past, at the request of readers, the most recent being in the January, 1968, issue. In all cases, however, these have been relatively light duty filters intended to connect in the mains supply line of a radio or television receiver. The anticipated load would be a couple of hundred watts at the most.

In some instances, the use of a line filter at the receiver has proved helpful in combating interference. More often than not, however, the benefits, if any, have been marginal.

In fact, as we have pointed out on occasions, one can expect only limited success against interference with a filter connected in the supply line to a receiver. Interference on a supply line tends to be radiated into the normal aerial-earth input system and only secondary benefit is gained by bypassing and filtering adjacent to the power socket.

Undoubtedly, the best approach is to install a line filter in the supply line to the device producing the interference. It reduces the amplitude of interference signal being fed into the line and therefore being radiated from the line into the input circuit.

In many cases, however, the source of interference may not be identifiable, or it may not be accessible. Even where it is accessible, the load current

Two views of the completed filter. It was made up to meet an industrial interference situation which could not be met in any other way.

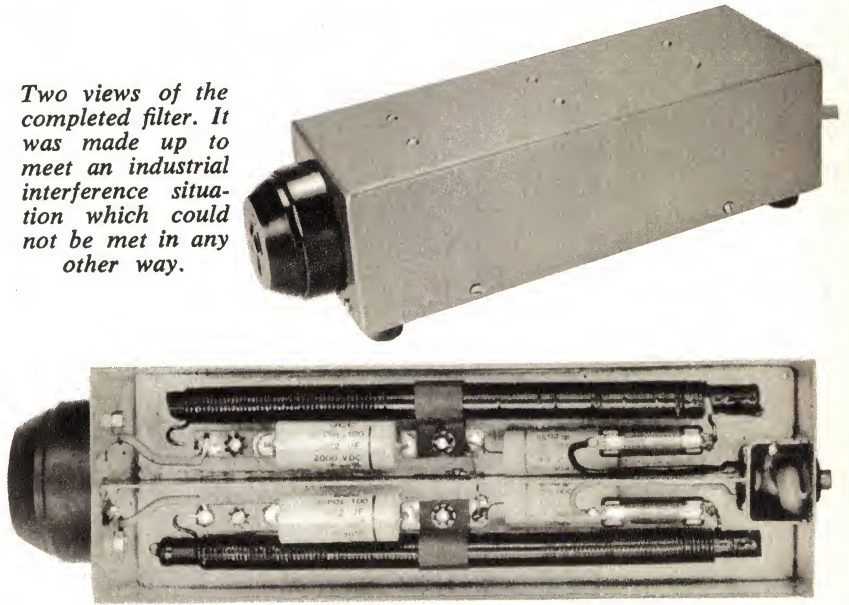

A general purpose line filter does not have to incorporate critical component values. Rather does it have to meet broad requirements as well as possible.

It is normal practice to install inductors in series with each mains lead, so that the effectiveness of the filter

turn-to-turn and to the former by any suitable coil dope or lacquer.

In the unit illustrated, the inductors were circled in the centre by a fibre strap, supported by an insulating pillar. Two other pillars supported, at one end a fuse holder and, at the other, a copper lug. The respective ends of the inductors were further supported by the ends of the windings soldered to the fuseholders and/or lugs. If desired, the ends could be supported further by fibre straps.

With the gauge of wire mentioned earlier, there would be approximately 15 feet of wire on each inductor, representing a DC resistance of about .06 ohm each. With a 1KW load, representing a current of about 4 amps, the dissipation would be a modest 1 watt per inductor. For heavier load currents, it would be desirable to increase the gauge of wire to reduce the IR drop or to wind on two conductors side by side, with the same objective in view. Attention could also be given to the choice of impregnant to ensure greater tolerance to heating.

As far as the capacitors are concerned, a prime requirement is that they must be able to operate reliably with 240VAC applied continuously. If capacitors are used which are intended and rated for DC applications, a wide voltage margin is essential; a rating of

(Continued on page 189.)

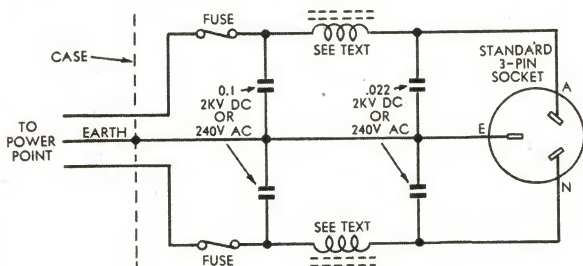

The circuit is conventional for a line filter, the main difference being in the current-carrying capacity of the inductors.

may be too high to permit the installation of a line filter of the type commonly suggested for—or sold for—radio and television receivers.

The line filter described here arose from a situation in our parent company where interference being radiated from a particular piece of equipment was penetrating into nearby electronic industrial control equipment. Because the offending unit was under a hire/maintenance arrangement, it was not practical to experiment with suppression capacitors connected internally. Any suppression had to be in the form of a filter installed between the equipment and the power socket.

And obviously, the filter had to be capable of carrying the full load current without introducing significant voltage drop and without, itself, overheating.

The unit described here was constructed by one of our company electricians and the ideas are presented primarily as a suggestion to other electricians faced with a similar situation. Units constructed by readers not familiar with electrical wiring practices should be inspected by a qualified electrician before being put into use.

is not dependent on having a particular lead as the active or neutral.

The inductors should introduce as much inductance as possible in series with the supply lines, within the limits imposed by inductor dimensions and cost, and by ohmic resistance. Shunt capacitance across the inductors should be as low as possible and coupling between the two inductors should preferably be minimised.

In the filter shown, the inductors are wound on standard ferrite aerial rods of the type used in portable radio receivers and measuring approximately 8in long by 3/8in diameter. The rods provide a former on which the inductors can be wound and, by increasing the inductance, make their own contribution to filtering efficiency.

Enamelled copper wire, typically about 16 B & S or 18 SWG can be wound directly on to the rods, substantially filling them, as apparent from the photograph. The end turns can be anchored initially by the old trick of running a loop of tape under the adjacent half-dozen turns, passing the end of the wire through the loop and pulling the tape tight. When completed, the wire can be sealed rigidly

GLIDING

Would you like to learn to fly a modern, high performance, all metal sailplane. A rare opportunity now exists to join an established club.

Write to:

K. L. RHODES,
40 CANOON ROAD,
TURRAMURRA. 2074.

TEAC



The Hi-Fi enthusiast is buying it — you should be stocking it

Next to owning studio recording equipment (which TEAC also make), the Hi-Fi enthusiast is hard pressed to match the performance of the magnetic tape system pictured here.

TEAC A-4010S tape deck is one of our finest, has three motors, all touch-button solenoid operation, automatic reverse, four heads, four amplifiers and a lot of other features.

Selling at \$525 (Australia).

TEAC AS-200 integrated amplifier combines a 120-watt (RMS) continuous power output for a very wide dynamic range and

natural sound. High frequency distortion is less than 0.5% and frequency response is 20 to 80,000Hz.

Selling at \$351 (Australia).

TEAC LS-350 3-way 3-speaker system was specially designed by TEAC for tape systems. It's a thing of beauty with full 12-inch woofer—and it easily handles 40 watts.

Selling at \$139 each (Australia).

Enthusiasts are serious about the way their music sounds—that's why they buy TEAC.

If you don't have TEAC on your floor, you're going to disappoint a

lot of people, including yourself. Australian Musical Industries are increasing their Australasian dealership for TEAC. If you want to be selling TEAC, or if you're not quite convinced, contact us and we'll help you make a worthwhile decision.

AUSTRALIAN MUSICAL INDUSTRIES PTY. LTD.

155 Gladstone Street
South Melbourne, 3205
Telephone 697281. Telegrams
AMUS (Melb.)

Trans-Atlantic Radio Telephony

By G. C. B. ROWE

Trans-Atlantic telephony by radio will probably be opened to the public within the next twelve months if present plans do not go awry. The apparatus is fully described below.

Transatlantic radio telephony is about to become a reality. According to unofficial announcements from responsible sources, the American Telephone and Telegraph Company will open some time next year telephone service between the United States and England with a radio link across the Atlantic. The method of transmission used is known as the "single side band eliminated carrier" method, which was first described in the October, 1923, number of the Bell System "Technical Journal" by H. D. Arnold and Lloyd Espenschied.

For some years past, experiments have been carried on from a transmitting station at Rocky Point, L.I.,

to a receiving station in England, looking toward a gathering of the necessary data upon which commercial service could be founded.

Of course, there is a great difference between the use of code and the use of modulated radio between two points separated by as great a distance as New York and London. However, engineers of the American Telephone and Telegraph Company, in conjunction with the Radio Corporation of America, have installed the experimental station, and have gone about plotting curves of noises and signals against power and season and weather conditions so that they may know thoroughly just what conditions will have to be met when the station is finally opened for commercial traffic.

The link will be worked in conjunction with the long distance telephone lines in this country and the telephone service of England, which is under the authority of the Governmental Post Office Department.

At the present time, it is understood that the English concern is completing plans for the actual station which is to be used for the connecting on that side. Up to the present time, all the work has been carried on as one-way traffic, transmission being made only from the United States and picked up in England. What troubles are going to be experienced or what powers will have to be used in order to connect England and the United States is not yet known. The Rocky Point station, at which the experiments to date have been carried out, has a consumption of 200 kilowatts.

All this work is being carried on with a long wavelength, in the neighbourhood of 1,600 metres. It is supposed that the commercial traffic will

also be carried on in the neighbourhood of the same frequency. One very important point in connection with the work is the fact that the wavelength channels in this neighbourhood are greatly restricted. It has been considered necessary for the minimisation of interference to adopt a system which eliminates the carrier and one side band. Only one side band is actually transmitted, a synthetic carrier being supplied at the receiving station through a local oscillator.

The system for the transmission of signals may be grouped into three parts (see figure 1) as follows: The low power modulating and amplifying stages, shown in the light lines; the high power amplifiers, that are shown in heavy lines, and to the right; and the rectifier that supplies the power amplifier with high voltage direct current, shown in the lower right-hand side of the diagram.

Let us consider first the low power portion of the system. The voice currents are fed into a balanced type of modulator circuit and are modulated with a carrier current of about 33,000 cycles. The result of this action is to produce in the output circuit of the modulator No. 1 modulated current representing the two side bands, the upper one extending from 33,300 to 36,000 cycles and the lower band from 32,700 down to 30,000 cycles. These two components are impressed upon a band filter circuit, which selects the lower side band to the exclusion of the upper one and of any remaining part of the carrier, with the result that only one side band is impressed upon the input of the second modulator. This second modulator is provided with an oscillator which supplies a carrier current of 88,500 cycles. The result

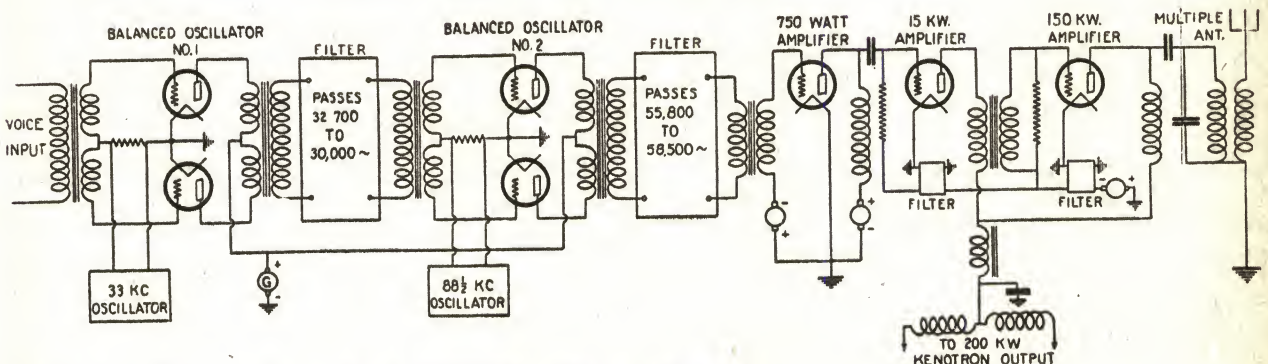

Figure 1. Circuit diagram of the transmitter used in the trans-Atlantic radio tests. The two filters pass only single side bands.

NEW **SONY** TC-540



Thrilling realism with "quadradiial" sound system

MODEL TC-540: The ultimate in stereo performance is yours from SONY's quality solid-state tape recorder TC-540 with 4 track stereo/mono recording and playback operation. "Quadradiial" sound system, uniquely designed separate speakers—two high compliance low frequency speakers are installed in baffle enclosures on each side of the recorder case and the two satellite high frequency speakers in the split lids, which can be separately placed up to 16 feet apart, for maximum effect in stereo.

Individual bass and treble tone controls for your personal listening preferences, speaker monitoring volume control, three tape speeds, retractable pinch roller for ease of tape threading, easy sound-on-sound recording, line/microphone mixing recording with optional microphone mixer, automatic sentinel shut-off switch, either vertical or horizontal operation and noise suppressor for reduction of hiss are only a few of the many outstanding features.

You will be fascinated by the full range stereo performance from dynamic fortissimo to thrilling pianissimo.

SONY®

Distributed by:

jacoby, mitchell & co. pty. ltd.

SYDNEY • MELBOURNE • BRISBANE • ADELAIDE

Specifications

Recording system: 4-track stereo/mono recording and playback. **Power requirements:** 100, 110, 117, 125, 220 or 240V AC 65 watts, 50/60 Hz. **Tape speeds:** 7½ ips, 3¾ ips, 1⅞ ips. **Reels:** 7" or smaller. **Frequency response:** 30-20,000 Hz at 7½ ips • 30-13,000 Hz at 3¾ ips • 30-10,000 at 1⅞ ips. **Flutter and wow:** 0.09% at 7½ ips • 0.12% at 3¾ ips • 0.16% at 1⅞ ips. **Harmonic distortion:** 2%. **Signal-to-noise ratio:** 50dB. **Power output:** 5W per channel (20W total dynamic power). **Speakers:** Two built-in speakers 4" x 8" and two lid-integrated speakers 4" diam. **Recording time (1,800' tape):** 4-track stereo 6 hrs. at 1⅞ ips • 4-track mono 12 hrs. at 1⅞ ips. **Fast forward and rewind time:** Within 2 min. 20 sec. (1,200' tape). **Inputs:** MICROPHONE • Sensitivity -72dB (0.19mV) • Impedance 600 ohms LINE • Sensitivity -20dB (0.078V) • Impedance Approx. 100k ohms. **Outputs:** LINE • Sensitivity 0dB (0.775V) • Impedance 100k ohms EXTERNAL SPEAKER • Sensitivity 11.2dB (2.83V) • Impedance 8 ohms MONITOR • Sensitivity 11.2dB (2.83V) • Impedance 8 ohms (or 10k ohms). **Rec/PB connector:** INPUT—Sensitivity -40dB (7.8mV), Impedance 10k ohms OUTPUT—Sensitivity 0dB (0.775V), Impedance 10k ohms **Dimensions:** 19-11/16" x 9-15/16" x 15-7/16". **Weight:** 41 lbs. **Accessories:** Two microphones F-96, empty reel R-7A, connection cord RK-74, two reel caps, motor pulley, power cord, head cleaning ribbon, splicing tape PS-2, demonstration tape, SONY oil OL-1K. **Optional accessories:** Telephone pick-up TP-4S, microphone mixer MX-600M, MX-6S, stereo headset DR-3A, DR-3C.

To: Jacoby, Mitchell & Co. Pty. Ltd., 469-475 Kent St., Sydney, 2000. Please send me information on Sony Tape Recorders & nearest Sony retailer.

NAME

ADDRESS

MS/1-68/EA1069

of modulation between the single side band and this carrier current is to produce a pair of side bands that are widely separated in frequency, the upper one representing the sum of the two frequencies, extending from 118,500 to 121,100 cycles, and the lower one representing the difference between the two frequencies, extending from 58,500 to 55,800 cycles. In this second stage of modulation there is a relatively wide separation between the two side bands, which facilitates the selection at these higher frequencies of one side band to the exclusion of the other. Another important advantage is that it allows a range of adjustment of the transmitted frequency without changing filters. This is accomplished by varying the frequency of the oscillator in the second step. In the present case the frequency desired for transmission is that corresponding to the lower side band of the second modulator. This lower band is, therefore, selected by means of the filter indicated. This filter excludes not only the other side band, but also any residual of the 88,500-cycle unmodulated carrier current which may get through the second modulator circuit if it is imperfectly balanced.

The selected side band is then amplified before it is applied to the transmitting antenna, this being carried out in three stages. The first stage increases the power to about 750 watts. This amplifier employs in its last stage three vacuum tubes rated at 250 watts each and operating at 1,500 volts.

The output of the 750-watt amplifier is applied to the input of the larger power amplifier system, beginning with the 15 KW amplifier shown in figure 1. This consists of two water-cooled tubes in parallel, operating at approximately 10,000 volts. The output of this amplifier is applied by means of a transformer to the input of the 150 KW amplifier, which consists of two units of 10 water-cooled tubes each, all operating in parallel at about 10,000 volts.

The high-voltage D.C. supply is furnished by a large vacuum tube rectifier unit rated at 200 KW. It employs water-cooled tubes similar to those used in the power amplifiers, except that they have but two electrodes. The rectifier operates from a 60-cycle, three-phase supply and utilises both sides of the wave. The two sets of rectified waves are combined by means of an inter-phase reactor, which serves to smooth out the resultant current and, by distributing the load between the tubes of adjacent phases, to increase the effective load capacity of the rectifier. The ripple is further reduced by the filtering retardation coil and the condensers, shown in the diagram.

In the method of transmission ordinarily employed in radio telephony by which the carrier and both side bands are sent from the transmitting station and received at the distant end, detection is readily accomplished merely by permitting all of these components to pass through the detector tube. The detecting action, whereby the voice frequency currents are derived, is

accomplished by a remodulator of the carrier with each side band.

With the present eliminated carrier method of transmission the side band is unaccompanied by any carrier with which to remodulate in the receiving detector. It is, therefore, necessary to supply the detector with current of the carrier frequency obtained from a local source. Thus, if a current of the original carrier frequency, 55,500 cycles, is supplied to the detector, it will remodulate, or "beat" with, the received side band of 55,800 to 58,500 cycles and a difference-frequency band of 300 to 3,000 cycles, i.e., the voice frequency band, will result.

However, the arrangement used, which is not quite so simple as that, is shown schematically in figure 2. Reception is carried out in two steps, the received side band being stepped down to a lower frequency before it is detected. This stepping down action is accomplished by combining in the first detector the incoming band of 55,800 to 58,500 cycles with a locally generated current of about 90,000

it employed directly at the received frequency, since by adjusting the frequency of the beating-down oscillator the filter is, in effect, readily applied anywhere in a wide range of received frequencies.

The receiving method, therefore, enables the filter circuit and also the intermediate frequency amplifier, to be designed for maximum efficiency at fixed frequency values without sacrificing the frequency flexibility of the receiving set.

Although this system was used for the reception of signals in London, it is quite possible to receive the single-side-band transmission by means of a regular heterodyne receiving set. Even a self-regenerative set will suffice under certain conditions. It is necessary to adjust the frequency of the oscillator very carefully to that of the transmitter, otherwise serious distortion of the received speech will result. Also, it is necessary that the tuning be not too sharp if ordinary tuned circuits, and not filter circuits, are employed.

It might be expected that some difficulty would be experienced in maintaining the frequency at the receiving end in sufficiently close agreement with the sending frequency. In

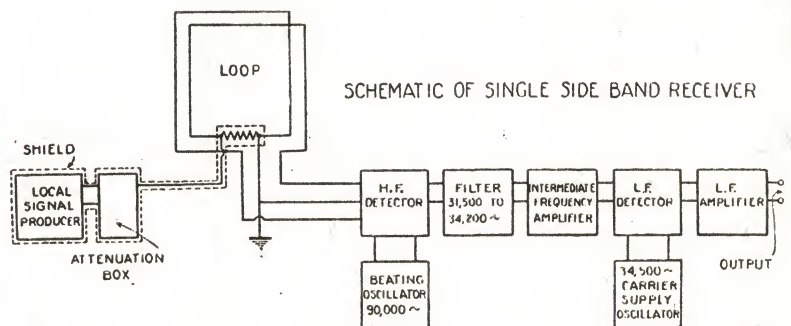

Figure 2. The diagram of the receiving set is easily understood if it is borne in mind that the carrier wave is supplied by local oscillators instead of one broadcast from the transmitting stations.

cycles. In the output circuit of the detector the difference frequency band of 34,200 to 31,500 cycles is selected by a band filter, passed through an amplifier and then to the second detector. This detector is supplied with a carrier of 34,500 cycles which, upon beating with the selected band, gives in the output of the detector, the original voice frequency band.

The object of thus stepping down the received frequency is to secure the combination of a high degree of selectivity with flexibility in tuning. The high selectivity is obtained by use of a band filter. It is further improved by applying the filter after the frequency is further stepped down, rather than before. To illustrate this improvement, assume that there is present an interfering signal of 60,000 cycles, 1,500 cycles off from the edge of the received telephone band. This is a frequency difference of about 2½ per cent: but after each of these frequencies is subtracted from 90,000 cycles, the difference of 1,500 cycles becomes almost five per cent. Furthermore, the filter is not required to be a variable frequency as would be the case were

the tests, no particular difficulty was found, the oscillators at the two ends being so stable that only a slight re-adjustment of the receiving oscillator was required. With the development of more stable oscillators, doubtless the frequency with which readjustments are required will be further reduced. If serious distortion of the received speech is to be avoided, the two frequencies must be within about 50 cycles, an accuracy of 0.1 per cent at 50,000 cycles.

If, after suppressing the carrier, both side bands were transmitted, their reception would require perfect synchronism between the carrier resupplied at the receiving end and that eliminated at the sending end, a condition which is practically impossible to meet without transmitting some form of synchronising channel which is, indeed, much the same as transmitting the carrier itself. If the receiving carrier is not synchronised, the two side bands will interfere with each other upon being detected. By eliminating one side band, this interference is prevented and reception may be

University

TEST SET

Matching front cases 5½" x 9" with engraved label
all units complete with leads, and instructions.

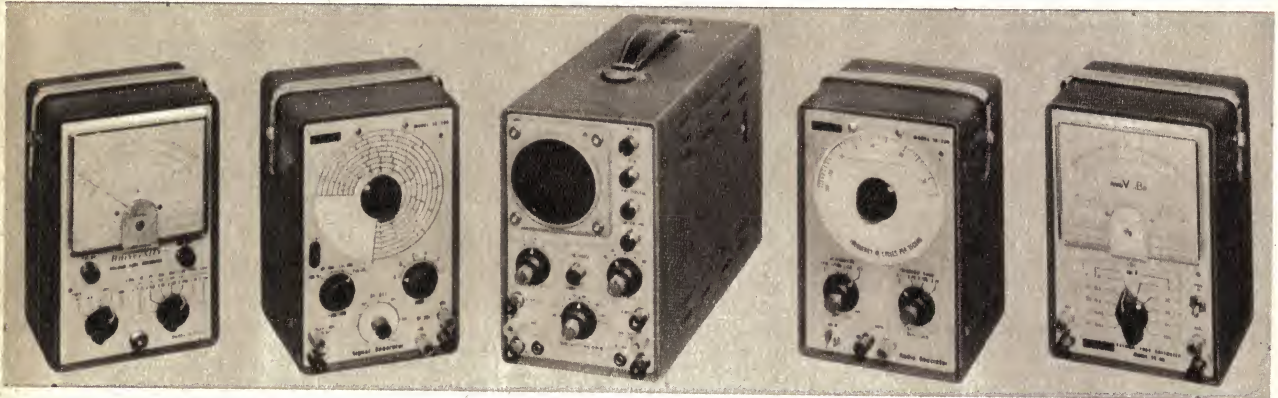

Specifications (as illustrated left to right):

Model MVA-6 vacuum tube Voltmeter

AC-DC volts 7 ranges to 1.5V; P.P. volts, 7 ranges to 4KV;
DB (1mW-600) 10db; to + 65db; ohms .2Ω to 1000MΩ.

Trade Price \$42.00

Model USG20D Signal Generator

7 Bands 120Kc-500Mc (6 Fundamental and 1 Harmonic) Xtal
Socket for: Self calibration or Marker Generator.

Trade Price \$36.00

Model UC 3 3" Oscilloscope

Vertical 100mV P.P./CM (at 1Kc) Freq. Char. 1.5 cps to 1.5
mcs Horizontal 900 mv P.P./CM (at 1KC). Wide sweep 10 cps
—300 Kcs Continuously variable.

Trade Price \$100.00

Model UAG 22D Audio Generator

Sine 20 cps-200Kcs. Square 20cps-150Kcs. Output 7V max
(1K imp) Freq. response + 1.5db 20cps-150Kcs.

Trade Price \$38.00

Model MVA-7 High sensitivity VTVM

Ac volts 1m V-300V 10 ranges. db range-40 to + 50db 10
ranges Input impedance 10 meg. Accuracy 5 cps-1.2 Mcs. ±
2db.

Trade Price \$45.00

(all above prices are subject to 15% sales Tax)

UNIVERSITY GRAHAM INSTRUMENTS PTY. LTD.

106 BELMORE ROAD, RIVERWOOD, N.S.W. 2210

Telephones: 53-8758, 53-0644 (5 lines)

Telegrams & Cables: Requip, Sydney.

REPRESENTATIVES

S.A.: Compar Dist.

33 Market St.,

ADELAIDE, S.A. 5000

51-6263.

QLD.: Keith Percy & Co.

Pty. Ltd.

Waterloo St.,

NEWSTEAD, Bris.,

Qld. 4006.

51-5461.

VIC.: Eastern Instrument
& Electronic Service
Pty. Ltd.

3 Carroll Cres.,

Glen Iris,

MELB., VIC. 3164.

Phone: 20-6953.

W.A.: Atkins (W.A.) Ltd.,

894 Hay St.,

PERTH, W.A. 6000

21-0101.

TAS.: W.P. Martin &
Company

202 Argyle St.,

HOBART. 7000.

34-2811.

And 150 Wellington

St., LAUNCESTON.

7250. 22-844.

AUSTRALIA'S LEADING MANUFACTURER & IMPORTER OF ELECTRICAL INSTRUMENTS

carried on with a locally supplied frequency which is only approximately equal to that of the suppressed carrier. The two may differ by as much as 50 cycles before the quality of the received speech is greatly impaired. The importance of the carrier suppression method of eliminating the one side band, will, therefore, be appreciated.

The present system eliminates one side band while still in the low-power stage. While it would be possible to do this selecting after they have both been raised to the full transmitting power, this would require the use of a filter of high-power carrying capacity, which would make the filter very costly and also render the system inflexible to change of wave-length. The present system overcomes both of these difficulties by filtering out one side band at low power levels and by the use of the double modulation method.

Another very important reason for the transmission of a frequency band as narrow as possible lies in the difficulty of constructing an antenna to transmit more or less uniformly at these long waves a band of frequencies which is an appreciable fraction of the main carrier currents. For example, in the ordinary method of transmission an antenna which was intended to transmit a 30,000 cycle carrier and its two speech side-bands would need to be designed to transmit all the frequencies from 27,000 to 33,000 cycles, a band which is equal to 20 per cent of the carrier frequency. This band is considerably wider than that given by the resonance curve of a highly efficient long-wave antenna.

To accommodate both side bands would require flattening out the resonance curve either by damping, which means sacrifice in power efficiency, or by special design of the antenna, possibly throwing it into a series of interacting networks and causing it to become a rather elaborate wave filter. The importance, from the antenna standpoint, of narrowing the frequency band required to be transmitted is, therefore, evident.

It is extremely important that the received signal be affected as little as possible by changes in the transmission efficiency of the medium. The voice frequency currents produced at the receiving end, after detection, are proportional to the product of the carrier wave and the side band. If the carrier, as well as the side band, is transmitted through the medium, then a given variation in the transmission efficiency of the medium will affect both components and will change the received speech in proportion to the square of the variation, as compared with the first power, if only the side band is transmitted and the carrier supplied locally. Thus it will be seen that the omission of the carrier from the sending end and the resupplying of it from the constant source at the receiving end, gives greater stability of transmission.

EDITOR'S NOTE: We are indebted to Mr A. W. Terry, of Inglewood, Victoria for this interesting story from "Radio News". Mr Terry informs us that he has been a reader of our magazine since its inception. ■

The pictures below were made available to us by Mr F. P. O'Grady, formerly Director General of the Postmaster General's Department. Mr O'Grady makes this observation: "In spite of our pride in the growth of our knowledge in the fields of science and engineering, we may not have quite succeeded in matching the imaginative ideas of our friends in those far off days. If it is a surprise to see a TV telephone booth in 1892, what about wide-screen cable television, complete with sound in 1879?"



EDISON'S TELEPHONOSCOPE—Transmits Light As Well As Sound. Every evening, before going to bed, Pater and Materfamilias set up an electric camera-obscura over their bedroom mantelpiece and gladden their eyes with the sight of their children at the Antipodes and converse gaily with them through the wire.

("Punch's Almanack," December 9, 1879.)

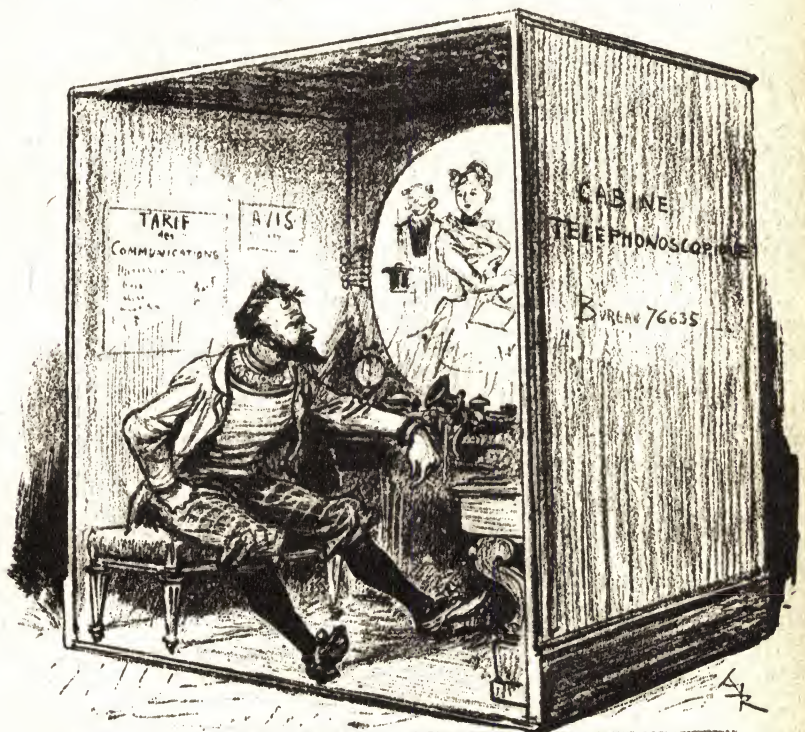

SULFATIN ACCAPARE LA CABINE DU TELE. (A. Robida: "Le Vingtieme Siecle." La Vie Electrique Librairie Illustree, Paris, 1892.)



FORUM

Treasure locators debunked — we hope!

Fairy stories like "Little Red Riding Hood" and "Jack And The Beanstalk" have been around for quite a while now. So also has been the one about treasure locators. In case you haven't heard it, we tell it below:

Conducted by the Editor

Once upon a time, a man was sunning himself on a surf beach, when he noticed a commotion in a picnic group nearby. Everyone seemed to be scratching feverishly in the sand.

From snatches of conversation borne to him on the wind, he gathered that a member of the party had lost her engagement ring. He could see a teenage girl sobbing bitterly while the others searched.

But in vain. Two hours later, with the light beginning to fade and the incoming tide washing across the sand, the party gathered up their belongings and made their way homewards. The ring, it seemed, was lost for ever.

That night, the man lay awake on his bed, thinking of what he had seen. Surely, he reasoned, a lot of people must lose rings, coins and other valuables in the sand. And surely there must be some way of finding them.

Suddenly he recalled an article he had seen once in an overseas magazine about a treasure locator. He remembered a picture of a man wearing headphones, walking along a beach and waving a disc-like gadget on the end of a stick.

That was the very thing he needed. What a wonder nobody else had got on to the idea! It wouldn't be all that expensive and what did it matter anyway — with the chance of picking up coins and jewellery?

The next day being Sunday, he searched through a big stack of "Electronics Australia." He couldn't remember a treasure locator described but, somewhere, somehow, they must surely have described one of the things.

But all he could find was a plumbers' pipe tracer, a thing that required the user to clip a wire on the pipe he was trying to trace. What a crazy idea!

It reminded him of the advice he was given when a very small boy. "You can catch any bird you like, provided you first put a pinch of salt on its tail!"

Disappointed, he nevertheless dashed off a letter to the Assistant Editor, enclosed 20c worth of stamps, and waited for the constructional data to come back through the post.

But alas. What came back was his 20c with a brief note which said that the magazine had never described a treasure locator and that the Assistant Editor had the gravest doubts that such a device was even practical.

The man was very puzzled. Why would they be trying to put him off when he could distinctly remember having seen articles in other magazines? They must be lazy, ignorant or have some ulterior motive.

So he tore up the letter, put the unused stamps in his wallet and lived unhappily ever after.

That's the fairy-tale.

But it isn't really a fairy-tale. It has been compounded from a number of people who have thought and reacted along these lines.

What's more, here's a letter from one of them:

Dear Sir,

Your answer to a reader's request for publication of a metal (treasure) locator circuit leaves me (and probably many others) with the feeling that your reasons for not doing so are far from sincere. Or at least there must be other reasons which you do not wish to make public.

You stated that, although there were many request from readers for such a circuit, you had concluded that the potential instrument's range-sensitivity limitation would not be of much interest to anyone.

Please let me put you straight on this point, Sir.

Practically anyone interested enough knows the approximate limitation of coin detectors. But they would still like to build one.

In the U.S.A. people are so "disappointed" with the instruments that manufacturers of metal locators are making big business out of them.

It seems that someone down your end has the old dour Scots' attitude of putting a brake on anyone wanting to have a bit of fun.

About three years ago I sent to America and paid for a circuit which I received but, as all the items were quoted in American terms, I was not

able to build the instrument. I wrote to Australian firms but they kept putting me off by saying "not available."

There is an instrument by Min-Rad of Melbourne for prospectors, etc., but the minimum price for the cheapest version is \$110. There are also ex-Army mine detectors (unsuitable) available for about \$40.

The pipe and wire tracer that you refer readers to is totally unsuitable for the purpose for which it is required. We would first have to find one end of the coins, jewellery, etc., to clip one lead of the instrument on to them.

Otherwise, thank you for a really good magazine.

Yours Sincerely,

E.C. (Warilla, N.S.W.)

Well, now, let's get a few things straight.

There are such things as metal locators. To this extent we are in agreement.

Most of them involve the use of two RF oscillators. The inductor for one of them is wound in the form of a loop mounted at the end of a wooden or plastic wand.

The two oscillators are normally set so that they are at zero beat, or produce an easily observed audio tone in a pair of phones which the operator wears. When the "search" coil is brought close to a piece of metal, its inductance changes and the beat either moves away from zero or away from the otherwise constant tone.

The big questions are: How large a piece of metal? How close? What change in tone?

Before ever being associated with a magazine, I witnessed a couple of efforts to build metal locators in the fond hope that they would be sensitive enough to qualify for the description of "treasure finders." These efforts, like others which followed, proved abortive and damped any enthusiasm one might have had for the idea.

Then in 1965 an overseas magazine came to our notice with an article so inviting, so challenging that, even allowing for gross exaggeration, the device had to be more effective than anything we'd ever seen.

So a member of our technical staff was set to work to build the thing wire for wire, part for part.

It located metal, all right. Unerringly, we could detect a large pair of bull-nosed pliers on the bench from two inches or so above them.

But a coin? A ring? You'd have to be joking!

I don't know about the large number of non-disappointed Americans or the big-business manufacturers, or the successful designs which we might have missed. But I do know that this was

just another highly commended design that we couldn't make work in a worthwhile fashion.

So we turned our attention in another direction and produced a device that did work, for people who might need it for particular purposes. We loaned it to a plumber for a while and made sure that it would trace out service pipes under typical suburban lawns. We watched our own company electricians use it to trace wiring buried in concrete walls.

Our correspondent's theory about Scottish ancestry is interesting and, strangely enough, it might indicate that a similar factor is operating in the editorial staff of the American magazine "Electronics Illustrated." The last issue to hand carries a report on a treasure-locator kit, which had been submitted to them for review.

They acknowledged that assembly of the kit was a very simple matter involving no more than a couple of hours' work one evening. Presumably, there was no problem either in setting up the search and reference oscillators so that they would heterodyne as intended.

The rub came when performance was evaluated and we quote their observations word for word:

"Have we found any treasure yet? Nope. We tried to find a hammer head but there was a tone when the search head got close to wet grass. This prevented our getting a fix on the head some 2 inches below, on the ground.

"The locator was a great aid in finding buried 20-penny nails used as markers on a dry tennis court. The nails were spotted at $\frac{1}{2}$ to 1 inch. On a wooden floor, the locator detected a quarter at $1\frac{1}{2}$ inches."

(We're not too sure about the size of 20-penny nails but a quarter is roughly the size of an Australian 10c coin.)

So there you are. A just-issued American do-it-yourself kit which will detect a coin all of $1\frac{1}{2}$ inches away—provided it is resting on the surface of a dry wooden floor! Rest it on a wet surface and you wouldn't find it, even if it were the size of a hammer head!

Having in mind the acres of sand on a typical Australian beach, feet deep and most of it moist with salt water, I don't fancy anybody's chances of picking up much treasure with such a gadget, irrespective of the fact that it is new, American . . . etc.

Are we justified, in the face of such reservations, in encouraging readers to spend money on such a project? If this is the level of its performance, can such a device be said to offer its constructor a chance to "have some fun"?

We doubt it.

Better devices may come to light, of course. We saw a report recently of a do-it-yourself metal locator devised by someone in the RCA organisation. We're chasing the details and, if it looks in any way promising, we'll do something about it.

But, in the meantime, we're not going to encourage readers to waste their money.

To change the subject completely, two matters are to hand having to do with licensing and regulations. The first, under the heading "Citizens Band" sets out the attitude of the Postmaster-General's Department to the term. It is widely used in overseas

"CITIZENS BAND"—OFFICIAL STATEMENT

As the outcome of recent prosecutions by the Post Office for the illegal use of imported low-powered 27MHz radio transceivers, there have been renewed representations to the Postmaster-General (Rt. Hon. A. Hulme) to extend the licensing of radio services under the Wireless Telegraphy Act and Regulations to include the establishment and operation of what are commonly known in certain other countries as Citizens' Radio Services.

The rules relating to the operation of "Citizens' Radio Services" differ in each of the countries where they have been authorised. In general, however, they provide for private short-distance radiocommunication for the business or personal activities of the licensees. The transceiver units employed are of relatively low power and the radio frequencies used, which are shared, are selected from a number set aside for the purpose.

Various categories of this type of service are authorised in the United States of America. Those which employ frequencies in the 27MHz band are comprised of mobile stations with a power limitation of 5 watts but they may be used at fixed locations as required. Distances over which communication may take place extend up to 150 miles. The stations must not be used, however, "for engaging in radiocommunication as a hobby or diversion, that is, operating the station as an activity in and of itself," nor for international communications. Certain other restrictions apply, also.

Following many applications for approval to employ imported low-powered transceiver equipment manufactured for use in "Citizens' Radio Services," the Post Office decided in 1961 that licences should be granted for the operation of approved classes of hand-held transceivers with a transmitting power output not exceeding one watt, when required for emergency services, to facilitate industrial, business or pastoral activities, or the conduct of sporting or other group events and for such other useful purposes as are considered to warrant the grant of licences. An additional licensing condition is that the only antenna which may be used with the units is the one supplied as an integral part of the equipment. This antenna must not be detached or extended in any way.

As at December 30, 1968, some 11,000 units of the type in question had been licensed for use in what are known here as "Handphone Mobile Services" and which are employed for many of the purposes for which "Citizens' Radio Services" are used in other countries. For example, numerous stations of this type are used by Police, Fire Brigades, Forestry Departments, Civil Defence Authorities and other public bodies and also by private individuals and organisations in connection with construction jobs, surveying, property management, boating and group activities.

The conditions under which licences may be granted for the operation of these low-powered units has ensured that in this country they are employed only for useful purposes and that the few frequency channels in the 27MHz band which can be made available are not occupied with unessential conversations to the detriment of more important messages.

Other types of low-powered services for which Australian licensing rules provide and for which approved types of equipment operating in the 27MHz band are suitable, include those which may be established within the confines of specified premises, such as manufacturing plants, services required for maritime in-shore safety by boating clubs and rescue groups and one-way paging services for use in hospitals and other similar situations. In these types of services, 5-watt base stations are permitted.

Australian licensing policy has for many years provided for the authorisation of a wide variety of other types of radiocommunication services. These include land and harbour mobile radiotelephone services operating in the very high frequency bands, that is, the bands above 30MHz, which permit communication between base stations and mobile stations in vehicles and also with personal mobile units where required. These services are employed extensively by essential public services, such as Police, Fire Brigade, Civil Defence and Ambulance Authorities and also by motor servicing organisations, repair and maintenance businesses of all types, taxi and transport fleets and many other service industries. Licences also may be obtained for the operation of stations used in the pursuit of hobbies, such as model aircraft, gliding and amateur radio.

Apart from the fact that radio services may be authorised in this country to meet all legitimate demands, the extension of licensing policy to provide for the use of common radio frequencies for the conduct of all kinds of business and personal conversations would lead, as it has done elsewhere, to a state bordering on chaos in the frequency bands concerned. It would also readily facilitate contravention of long-standing Government policy in Australia that the public telephone and telegraph systems should be the normal means of communication between individuals residing in areas where these services are available.

In the circumstances, the Postmaster-General has decided that it would not be in the public interest to extend the licensing provisions as has been suggested.

"Citizens band" therefore remains an inappropriate term as far as Australia is concerned and in fact can and does lead to misunderstandings. What is important is that in this country, low-powered 27MHz transceiver equipment will be licensed to meet utilitarian purposes, the units must be of an approved type, and unlicensed operation risks prosecution.

SOUND

HIGH QUALITY SOLID STATE STEREO AMPLIFIERS FROM ONE OF JAPAN'S LEADING MAKERS

With specifications that demand attention and effective quality control in manufacture, the SOUND series of amplifiers offer outstanding value and they're exclusive to Encel Stereo Centres. Encel prices include sales tax and trade-in valuations on your old equipment make the change-over cost extremely modest. Ask for a valuation on your current equipment.



**SOUND MODEL SAQ-203
12 WATTS R.M.S. OUTPUT
\$74.50 INC. SALES TAX**

Here is one of the most popular amplifiers ever sold by Encel Stereo Centres. Frequency response is 30-20,000 Hz. and input sensitivity suits magnetic cartridges at 3 mV. Output is 12 watts R.M.S. or 30 watts E.I.A. peak power. Eighteen low noise transistors and diodes are incorporated in the circuit. All necessary controls provide

flexibility of operation . . . a headphone jack is provided on the attractive front panel. Speaker matching terminals permit use of 4, 8 or 16 ohm speaker systems. This is an ideal compact stereo amplifier for use with tape recorders, or for building into bookshelves and cabinets. Encel price is only \$74.50 inc. sales tax.

**SOUND MODEL SAQ-505X
50 WATTS R.M.S. OUTPUT
ONLY \$119.50
INC. SALES TAX**



With a power output of 50 watts R.M.S. into 8 ohm speaker systems, the Sound SAQ-505X represents outstanding Encel value. Frequency response is 20-20,000 Hz. ± 1 dB. and extends well beyond this range. Sensitivity suits magnetic cartridges at 3 mV. and 20 low noise transistors and diodes are used in the circuit. Tumble type switches control Tape Monitoring, Loudness, Rumble and AC Power. All other desirable controls are incorporated. Price is only \$119.50

inc. sales tax. Write for complete data and unabridged technical specifications.

EXCERPT FROM ENCEL LABORATORY REPORT. Our laboratory test report indicates that frequency response is substantially flat, being down 2dB at 20 Hz. and only 1dB. at 20 kHz. Square wave response is excellent and shows little variation in the audible ranges.

ENCEL
ELECTRONICS (STEREO)
PTY. LTD.

Head Office:

431 Bridge Rd., Richmond, Victoria 3121. Tel. 42 3762.

Sydney Store: Ground Floor, 25M Building,

257 Clarence Street, Sydney, N.S.W. 2000. Tel. 29 4563, 29 4564.

Australia's Greatest Hi-Fi Centre *Wholesalers *Trade-ins accepted

literature, of course, and is also used to describe 27MHz equipment which finds its way into this country, legally and otherwise.

The Department regards the term as inappropriate in Australia and therefore a misnomer. While they will licence certain 27MHz equipment, they will do so only for specific communication requirements, even if of low-priority.

The Department does not go along with the idea that Tom, Dick and Harry should be encouraged or permitted to use 2-way radio equipment, simply because they have the inclination and the money to do so.

The second matter has much wider implications, which go right to the roots of the Wireless Telegraphy Act in Australia. The situations have been referred to in these columns on previous occasions, and concern the nature of equipment which listeners may legally own and/or operate.

A normal Listener's and Viewer's licence gives the holder the right to possess and use equipment capable of listening to broadcast entertainment radio programs and/or broadcast entertainment television programs. Ostensibly, they confer the right to receive programs only within the confines of the medium-wave broadcast band and only within the limits of the television channels.

In fact, however, a significant proportion of all radio receivers which have been manufactured and sold in Australia have included facilities for listening on the short-wave bands. This is very much an accepted activity and official bodies operate short-wave stations in Australia for local and overseas listeners.

For technical and organisational reasons, it is not very practical to confine short-wave broadcast stations and receiver coverage to tight little frequency segments; short-wave receivers are almost invariably of the general-coverage type, and short-wave broadcast stations are where you find them.

In between these stations, the listener can hardly be restrained from listening to his heart's content to all kinds of official and commercial signals, even though to do so may be outside the terms and intention of his receiving equipment licence.

This leads naturally to the contention that if the authorities accept the idea (however unwillingly) that listeners use short-wave receivers to listen to non-entertainment signals, they can hardly object if the general coverage facilities happen to extend to somewhat shorter waves than usual and into the region arbitrarily defined as VHF.

In fact, entertainment type sound signals are to be found in the VHF spectrum in the form of TV sound channels. Yet, oddly enough, the authorities are unwilling to licence equipment which will receive TV sound only. You must have the picture as well, whether or not you look at it!

Mixed up with all this is the provision of the Wireless Telegraphy Act which seeks to make it an offence for non-authorised persons to make use of information obtained by listening to non-entertainment type radio signals.

But just what does this mean?

As you might have guessed, these remarks were triggered off by a court case involving some of these very contentious matters. A report of the case,

POLICE RADIO — New court ruling

Police will press for amendments to Commonwealth laws to make it harder for the public to obtain radios capable of receiving police network messages.

Urgent action is necessary following a decision by a Sydney magistrate recently. Chief desire of police is that the monitoring of their messages by criminals should be prevented as much as possible.

Mr C. S. Rodgers, S.M. in the Special Federal Court, ruled, in effect, that any person could use a radio to listen in to police messages provided:

- The set could also receive A.B.C. and commercial station broadcasts;

- The place at which the set was used was covered by an ordinary domestic radio licence.

Mr Rodgers dealt with a prosecution against George Warner, married, public accountant of New South Head Road, Edgecliff, N.S.W., whom he found was a man of good character.

Warner was summonsed for having used a radio for the purpose of receiving messages broadcast by means of wireless telegraphy, "otherwise than as authorised under the Wireless Telegraphy Act."

He pleaded not guilty.

Sergeant D. R. Williams, of the Police Communication branch, said in evidence that on July 15 last year he and a detective went to the premises of Nova Tech Pty. Ltd. at Edgecliff.

The company sold wireless receivers which it specially ordered from Japan. "We stood at the doorway and I heard police radio traffic coming from a black transistor receiver being held by Warner," the sergeant said.

He heard Warner tell a customer: "Yes, this set will pick up all the police channels. That's what they buy them for."

The set was labelled, "Police Receiver."

Sergeant Williams said that Warner, when questioned, replied: "You can't do anything about it. I can sell as many of these sets as I like under the law as it stands."

Warner had told him the customer he was serving was a private inquiry agent who wanted to pick up police calls.

Sergeant Williams said the set received all five police radio channels on the low FM (frequency modulation) band and two on the high FM band. It could be used as a direction finder to locate radio stations. In addition, it

received broadcasts from the ordinary stations.

Warner had said he had about 50 of the radios in stock.

Mr K. G. Horler, counsel for Warner, said Warner gave a customer a demonstration of the radio for the purposes of sale. This was not "using the radio." It was not an offence to sell the radio or to be in possession of it.

Using the set could be an offence but Warner had not used it.

Mr Horler said Warner and his manager had believed, following an approach they made to a post-office official, that it was all right for them to sell the sets. However, they now had no more in stock and did not anticipate getting any more.

Mr Horler said Warner had a domestic wireless licence. This did not cover radios at the business premises. Warner was a public accountant who "sold electronic equipment from time to time."

Mr Rodgers found that Warner had used the set for the purpose of receiving messages in breach of the Wireless Telegraphy Act.

But he said the particular set was a broadcast receiver as defined in the Broadcast and Television Act. It was under this Act that domestic licences were issued, exempting the holders from provisions of the Wireless Telegraphy Act.

Although Warner's set was capable of picking up police messages, it could also be used to receive the usual broadcast programs. Therefore it could have been licensed under the Broadcast and Television Act for use at the Edgecliff premises. Had it been, Warner would not have been liable to prosecution under the Wireless Telegraphy Act.

As it was, he must find the offence proved.

Because of Warner's good character he dismissed the proceedings under Section 19B of the Commonwealth Crimes Act.

A police officer said afterwards the police had been awaiting the outcome of the case before Mr Rodgers. In view of Mr Rodgers' decision, representations would be made to have the Commonwealth Government amend the relevant laws.

obtained from one of our associated daily newspapers, is reproduced above. From the description given, it would appear that the receiver in question is of a type which has been advertised and reviewed in these columns.

The implications of the Court ruling are very significant indeed, running parallel to and even going somewhat beyond the kind of argument set out earlier.

It confirms the right of a radio listener to own and operate a receiver capable of tuning to the normal medium-wave broadcast stations, provided he has a current broadcast listener's licence.

However, it also recognises his right to use a receiver with extended coverage, taking in signals on other frequencies. These would include practices which have never been contested to our knowledge: signals from the University of New South Wales; short-wave broadcasts; amateur stations; television sound programs, as heard on imported AM/FM tuners.

Almost inevitably, the equipment will cover other signals, interspersed between those mentioned above, but the listener is not to be penalised for this technically almost inevitable fact.

As they say on television: "Very interesting . . ."

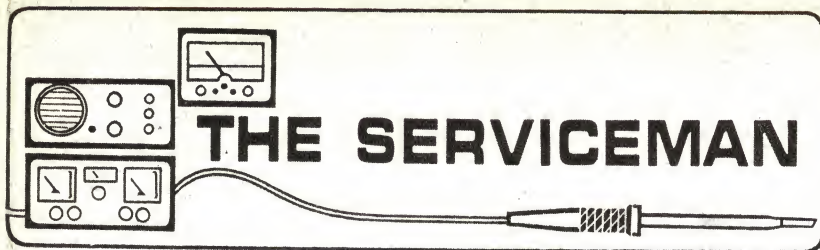

A double-sprung trap

How can a serviceman be sure that the valves he is carrying around in his service kit are sound? Probably only by testing them individually himself beforehand. This may seem to be carrying things a bit far, but at least it would avoid the kind of embarrassing situation recounted below.

The following is an experience which befell a colleague, and which is nasty enough to justify repeating as a warning. My friend is not self-employed, but works for one of the larger service organisations, a fact which tended to make the situation all the more embarrassing.

The service call seemed straightforward enough; a reasonably modern 23in receiver suffering from loss of picture. A few quick checks established that there was no EHT, so the first thing to try was a new 6CM5 line output valve. This had no effect so, in turn, my friend tried a new 6AL3 damper diode and a new 6BL8 horizontal oscillator. Still no joy.

At this point he decided that the trouble was more deep-seated and that the chassis would have to come out. That much done — and one doesn't take one of these chassis out in a couple of minutes—he gave the complete EHT circuitry a thorough going over, measuring and checking everything he could lay his prods on. He found nothing. He even tried a second new 6CM5, just in case he had been unfortunate enough to strike a faulty new valve. He wasn't really surprised when this had no effect.

As far as he could see, this left only one answer; a faulty line output transformer. Fortunately, he had a new transformer in the truck, so this was fetched and duly fitted. Since he was in something of a hurry he didn't waste any time but, nevertheless, it took him a full 45 minutes. Imagine his reaction when he switched on and nothing new happened.

This was the last straw and he was on the point of loading the set on the truck and taking it back to the workshop where someone else could solve the mystery. However, he made one last desperate gesture before giving up. He tried yet a third new 6CM5. You've guessed it, the picture came up bright and clear.

Once over the initial shock he went through the valve situation again. It was easy to establish that the owner's damper diode and horizontal oscillator valves were intact, but that his 6CM5 was faulty. But so also were the two new 6CM5s he had used for testing.

I don't know what the odds would be against getting two faulty new valves in the one service kit but they must be pretty high. They must be even higher against selecting these two in succession in the manner my friend did.

Nor was this the end of the story. My friend had fitted a brand new line output transformer which wasn't necessary. Even had his conscience permitted, he couldn't charge the customer for it, because it didn't take a genius to figure out what had really happened. But he had to account for it somehow, and the one that had come out, while intact electrically, was too old and battered to pass for a new one.

So there was nothing for it but to spend another 45 minutes — 45 minutes he could not charge to the customer — replacing the original transformer. And by the time he was finished he was ready to eat the valve manufacturer without any pepper or salt.

When he told me the story, ever anxious to tie up all the loose ends, I innocently asked whether he had been able to find out in exactly what manner the two valves had failed. I realised as soon as I said it that it wasn't the most tactful question.

"Listen," he snapped, "when you get taken for a ride like that you don't stop to ask why. I threw them back at the bloke in the store, told him what had happened, and left him to



"I've tried that."
—("TV Times")

fight it out with the makers. Oh, they'll be replaced all right, but that's not much comfort in the circumstances."

I didn't press the point. But I did take the opportunity to relate the story to a couple of other colleagues and ask whether they had had similar experiences. The first one I asked responded immediately.

"Only once," he said, with bitterness in his voice and a faraway look in his eyes. "It was in the early days of TV and I nearly pulled the set apart trying to find out what was wrong. When I realised that I had been tricked by a faulty new valve I made some pretty ripe comments about the valve manufacturer."

Later another colleague made a positive response. It seemed that one of his personal friends, who lives some distance out of his territory, has a TV set which, even though fairly long in the tooth, still gives very good results. Its only vice is that it is rather hard on 6DQ6 line output valves. So, every so often, when the picture starts to shrink sideways, my colleague takes a new one along on one of his social calls and plugs it in.

The last time he decided to be smart and do his friend a good turn. As well as the valve he put in the set he left another, still in its carton, inside the cabinet. His friend is a fairly handy sort of bloke and, having shown him how to replace the valve, my colleague was quite confident that he could do the job himself.

That was nearly 12 months ago and a few weeks back my colleague's friend called him on the phone.

"The picture's starting to shrink on my TV set again. Should I try that new valve?"

"Yes, I think so," replied my colleague, "Are you clear on what has to be done?"

His friend said he thought so, but they went over the procedure again, just to make sure. Then he went off to try it. A few minutes later he was back on the phone, with the news that the set wouldn't produce any picture at all with the new valve in it.

My colleague, thinking his friend had mistaken the valve involved, or made some other simple error, went over the whole procedure again. He was finally forced to conclude that all the right things had been done, but that the set just would not work with that valve in it. So he simply advised his friend to restore the original valve and put up with the slightly shrunken picture until his next visit, which they arranged for the following weekend.

As it turned out, my colleague's visit only served to confirm the situation. Another new valve he took along worked perfectly, but the one he had left there appeared to be completely dead. Subsequently, he took the opportunity to check it in a valve tester. Apart from the fact that the heater lit up, the valve showed no inclination to function in any way and no emission reading could be obtained from any electrode. He concluded that it most likely had an open-circuited cathode.

What does all this mean in terms of practical servicing? And to what extent can the valve manufacturer be held responsible for the cost and frustration caused by a faulty new valve? In

regard to this latter point I doubt whether we can do much more than tear our hair and call down all kinds of nasty curses upon the said manufacturer's head. While a manufacturer normally guarantees his product, and will replace it without question if it is shown to be faulty, he would be unlikely to accept any responsibility beyond that.

In terms of practical servicing there does not appear to be any easy solution to the problem, although a couple of ideas suggest themselves. One is to always use a set of known good test valves, rather than new valves, to establish the fault, fitting new valves only when its exact nature has been established. The objection to this is that one would be required to carry something like twice the number of valves to every job; a set of test valves and at least one duplicate new valve. Is it worthwhile?

Another is to carry a valve tester and check each new valve before it is accepted as a good one. There are several objections to this. The weight and bulk of the instrument would make it very inconvenient. The time needed to make a test is more than can be tolerated. And, most important, the main reason that most servicemen test valves by direct substitution is that it is quicker, more convenient, and far more accurate than the average valve tester.

So what is the answer? I'm not sure, but I imagine most of us will go on using new valves as test instruments, accepting the possibility that every once in a while we will get caught. This being so, the next best thing is to be aware of the possibility and to be prepared to doubt the "goodness" of a new valve when things don't seem to add up. If necessary endeavour to try a second, or even a third one, before pulling a set to pieces.

After all, one could never strike THREE bad valves in a row!

The comments that follow differ somewhat from my usual run of stories, in that they are not based on individual case histories. Instead, they are a collection of routine faults; the kind of fault where mention of the symptom and the brand name is enough to cause an experienced serviceman to reach for the appropriate replacement part. On the other hand, they are tricky enough to trap the beginner into a wrong diagnosis.

These comments also differ in that I have mentioned a couple of brand names. This must not be misconstrued as a condemnation of these brands or models. There isn't a set on the market that does not have its own peculiar fault or faults and which servicemen come to recognise with experience. In passing these on I do so in the hope that I may assist a beginner somewhere to recognise a tricky fault.

It is not uncommon to encounter TV sets in which the fine tuning control has drifted quite severely; and by that I mean sufficient for the customer to be able to notice it, which means that it is pretty bad. If you're a new chum you might be tempted to push an insulated screwdriver into the appropriate oscillator coil and twiddle the slug until everything comes good.

There is only one snag. In a couple of weeks you could be called back to do the job again — and yet again if you

persist with this technique, until you will finally have to do what you should have done in the first place; change the oscillator valve, which will be on the way out.

One of the worst valves in this respect appears to be the 6HG8, although the word, "worst" may not be a strictly correct term since it is simply a matter of a particular valve indicating its end of life in a manner somewhat different from that of other valves. And, since we accept that any valve has a limited life, we can hardly complain simply because it chooses to fade out in a particular manner. But one does have to be a wake-up.

Another regular fault involves HMV models M1, P1, and, possibly, other models which use the same components and circuit configuration. Symptoms are weak and distorted sound. The first time I heard it I would have been prepared to wager a week's pay to a dud picture tube that it was a leaky coupling capacitor; it sounded just like it. Some time later, when I had exhausted all other possibilities, I began to suspect the loud-speaker transformer. This proved to be the culprit and, since then, I have encountered the same fault a number of times. Nowadays, whenever that particular model develops weak and distorted sound I reach automatically for a replacement transformer.

So far I have had no opportunity to determine the nature of the failure. The transformer has an extra tapping on the secondary which is used to provide negative feedback, but whether this has anything to do with the problem I don't know. Inasmuch as the cathode returns of both the triode and pentode portions of the output valve (6BM8) are directly connected to this winding it is possible that the fault could be in this section. On the other hand, it may be mere coincidence that the transformer has this feature. In which case a more elementary fault, such as shorted turns, would be the logical suggestion.

Another trap for the unwary is a fairly regular fault in several models of the old STC TV receivers, particularly models 171 and 211.

Initially, the fault is simply lack of vertical lock, with the hold control running out of resistance before locking can be restored. The simplest cure — and the one that is resorted to by many servicemen — is to add a suitable size resistor in series with the vertical hold control. This will certainly restore the locking range, but only at the expense of linearity. A responsible serviceman has to be wary on two counts; not to fall into the same trap as a means of an easy cure, and not to be fooled into imagining that such an external resistor, if encountered, is a legitimate part of the circuitry.

The reason why so many servicemen try to get away with this trick, even though they know better, is because it is a good deal quicker and easier than doing it the right way, and because the disturbance to the linearity is only marginal in most cases. More precisely, it tends to expand the centre of the picture and crowd the top and bottom; an effect which is subtle enough to deceive all but the more discerning viewers.

But that is not the end of the story. The original fault becomes progressive-

SONICS

LOW COST, HIGH PERFORMANCE
SPEAKER SYSTEMS FROM
ENCEL ELECTRONICS!

Separate speaker systems are essential if you wish to exploit the full potential of your amplifier, tape recorder or radio. Sonics speaker systems are beautifully finished in selected walnut/teak veneers, are styled to blend with period or modern decor and are extremely effective from an audio point of view. The following models are the most popular.

MODEL AS-60E: Although only 18 3-8in x 12 3-8in x 5 1/2in the AS-60E is fitted with a bass/mid-range speaker and a separate high frequency reproducer. An excellent speaker system which has proved very popular with audio enthusiasts. Hand finished teak/walnut cabinet. Inc. **\$27.50**
Sales Tax.

MODEL AS-61: A true "Slimline" enclosure with four bass/mid-range speakers and a high frequency reproducer. Measures only 4 3/8in depth; height is 21 3/8in and width is 17 1/2in. Finish is teak/walnut and the legs are detachable. Probably the most popular multiple speaker system ever offered at this price in **\$38.50**
Australia, Inc. Sales Tax.

MODEL AS-202: A 3-speaker, 3-way system which measures 20 1/8in x 15 5/8in x 11 5/8in. The AS-202 is a recent addition to the Encel Sonics range. An 8in woofer and a 6 1/2in mid-range speaker are incorporated — and a high frequency reproducer completes the speaker complement. Will handle 10 watts R.M.S. with ease. Beautiful hand finished teak/walnut cabinet. Inc. Sales **\$46.50**
Tax.

MODEL AS-220: A most effective 3 way speaker system with an 8" bass reproducer, a 6 1/2" mid-range speaker and a high frequency reproducer. Cabinet size is 20 1/8" x 11 5/8" x 11 5/8" and the front grille features a timber fret which matches the teak/walnut veneer cabinet. Handles 10 watts R.M.S. easily. Inc. sales tax **\$56.50**

MODEL AS-303: A magnificent hand finished teak/walnut speaker system with three speakers and a 3-way crossover network. A 12in woofer with a long throw voice coil provides excellent bass response; a 6 1/2in mid-range speaker covers the middle ranges and a horn type tweeter comes in at 5kHz. Power handling capacity is over 15 watts R.M.S. Extremely wide frequency response free of coloration. Size 25in x 14 1/2in x 11in. Inc. **\$68.00**
Sales Tax.

MODEL AS-251: This is a new deluxe 3-way speaker system with a 10in bass reproducer, a 6 1/2in mid-range speaker and an exponential horn tweeter. A 3-way crossover network assures smooth response over the total range of 40-20,000 Hz. Dimensions are 13in x 22 1/2in x 11 1/2in and finish is in oil stained teak/walnut veneer. Inc. price including Sales **\$78.00**
Tax.

MODEL AS-330: The deluxe system of the Sonics range. It is a 3-way system with five speakers including a 12in bass reproducer, a pair of mid-range speakers and two exponential horn type tweeters. The attractive cabinet is hand finished in teak/walnut figured veneer, has a most attractive timber fret grille and measures 15 3/8in x 25in x 30-20,000 Hz. Carefully selected crossover frequencies provide a smooth and musical performance over the frequencies **\$98.50**
specified. Encel price inc. sales tax

IMPORTANT: All "Sonics" enclosures are 8 ohms impedance.

**SONICS STEREO HEADPHONES
FROM \$9.50.**

The popular Model HS-304 offers fatigue free listening on a personal basis . . . the headset is very comfortable even over lengthy periods. Price? Only \$12.50. The Models HS-303 and HS-303H (High Impedance) are also available . . . frequency response is 20-15,000 Hz and the price only \$9.50. All models have foam rubber earpads. From **\$9.50**

Encel

ELECTRONICS (STEREO)PTY. LTD.

Head Office:

431 Bridge Rd., Richmond, Victoria 3121.

Tel. 42 3762.

Sydney Store: Ground Floor, 25M Building

257 Clarence Street, Sydney, N.S.W. 2000.

Tel. 29 4563, 29 4564.

*Wholesalers *Trade-ins accepted

Australia's Greatest Hi-Fi Centre

RETRAVISION

OPEN DISCOUNT STORES

SANSUI From Melbourne's leading **HI-FI** specialist



800

400

777

5000

220

SANSUI



Rush this further bulk release of Sansui Model 220 tuner amplifier at the amazingly low price of \$154 tax paid.

Limited quantity reserved for mail orders

Check us last for the lowest discount prices on all tape recorders and Hi-Fi sound.

DOUGLAS TRADING P/L

Inc. City Hi Fi — Tape Recorders (Vic.) — BJD Electronics

191 BOURKE STREET, MELBOURNE 3000—PHONE 63-9321

RADIO: Unofficial history

Back in 1923, George passed the P.M.G. Mechanic - in - Training Entrance Examination and some months later, while grape-picking along the Murray, the word came to report for training in Melbourne. Sunburnt, and recovering from the ill-effects of channel water and too many grapes, he rolled his swag and boarded the train for the "big smoke."

George may have been green, but he was no mug. Still, with his swag under his arm he looked very much the boy from the country.

Arriving in Melbourne, he had hardly left the station when a respectably dressed, middle-aged man dived in front of him and picked up a small parcel lying on the footpath. "What do you suppose this is?" he asked. Falling in step with George he opened the parcel and exclaimed: "Geel! A gold ring, can't you be lucky! Receipt from Stewart Dawson's quality jeweller for £50. Oh, boy! But it's no good to me. Do you want it? £30 too much?"

George, flattered that he should even be suspected of having £30, nevertheless declined the offer. But the self-appointed benefactor was not giving up that easily. He followed George for a further 300 yards, until George had to admit that he did not have even the £2 to which the price had dropped at that stage. Upon which the frustrated philanthropist took himself off to wait for another sunburnt mug from the country with a swag under his arm. All of which gave George to think that, in the city, you would need to have your wits about you.

He found still further evidence of this shortly after taking up his new position as mechanic-in-training, at the old Telegraph Workshop behind Elizabeth Street P.O. His boss, Sid, dragged his drawer open, fossicked around muttering to himself, apparently looking for some kind of tool. Not finding it, he meditated, and suddenly "remembered" that old Bill downstairs

had borrowed it. The name he gave the mythical tool cannot be quoted here, in deference to our younger readers, but those who have worked in similar situations will have no difficulty in supplying a suitable word.

Anyway, our innocent country lad started off to recover the missing tool, being referred from one place to the other in his search. Eventually somebody took pity on him, and told him to go back to his bench, as "Sid has just picked up the missing tool himself!"

As a mechanic - in - training George spent some time in the telephone workshop where the prime activity of re-conditioning telephones was threatened by the illicit manufacture of crystal sets. The boss, Charlie, spent most of his time glaring at the trainees, ready to pounce upon any poor unfortunate attempting to divert departmental time to the furtherance of crystal receiver techniques.

Eventually Charlie relented by asking one of the trainees to build a crystal set "for his wife."

What a crystal set it was! The case from a dry cell became an excellent coil former and the whole set was housed in a cigar box. The terminals for aerial, earth, and headphones were gold lacquered in the style of the wall telephones of the day.

And the instructions were simple . . . connect the aerial terminal to a wire mattress, or a tin chimney, or a clothesline and enjoy the music!

The set would not work for Charlie. Day after day he asked for and was given advice about the catswhisker, the crystal, and so on. Everything appeared right, even to the 30-foot clothesline.

Charlie finally despatched the constructor to his home to fix the set. The boss had certainly connected the set to the clothesline but the clothesline was made of rope! (T. C., Numurkah, Vic.)

(Readers are invited to submit contributions to "RADIO: Unofficial History" and a publication fee will be paid for those used. Stories must be humorous and they must be true. Letters must be signed and the locale of the story indicated as a mark of good faith. The Editor reserves the right to re-phrase contributions as necessary to preserve uniformity of style.

ly worse, so that more external resistance has to be added, there is more loss of linearity until, eventually, one has to do what should have been done in the first place — replace the blocking oscillator transformer.

I am not sure what goes wrong with these transformers, whether it is a corrosive spot in the winding that becomes progressively higher in resistance, or whether it is a progressive breakdown in insulation, producing more and more shorted turns. In any case, this is relatively unimportant. What is important is to diagnose such faults correctly, and not to resort to "faking" to produce a quick result.

If you suspect that the transformer is faulty, there is a simple check which will help to confirm it. First get the set working and the vertical stage locked, even if you have to "fake" the circuit temporarily. Then momentarily short the plate (pin 1) of the 12AU7 blocking

oscillator valve to chassis. If, on removing the short, the picture remains locked the transformer is almost certainly intact. If, however, the picture rolls and the hold control has to be reset, then the transformer would be very highly suspect.

I mention this fault particularly because it is by far the most common example of mis-applied servicing techniques that I have struck. It seems to occur particularly in those cases where a set is covered by some kind of "insurance" contract, suggesting that the servicemen involved are adopting the old trick of employing any device, no matter how unethical, which will "cure" a fault in a minimum time and using a minimum of components. This despite the fact that such tactics must inevitably create customer dissatisfaction and reflect adversely on the serviceman concerned.

So don't be tempted.

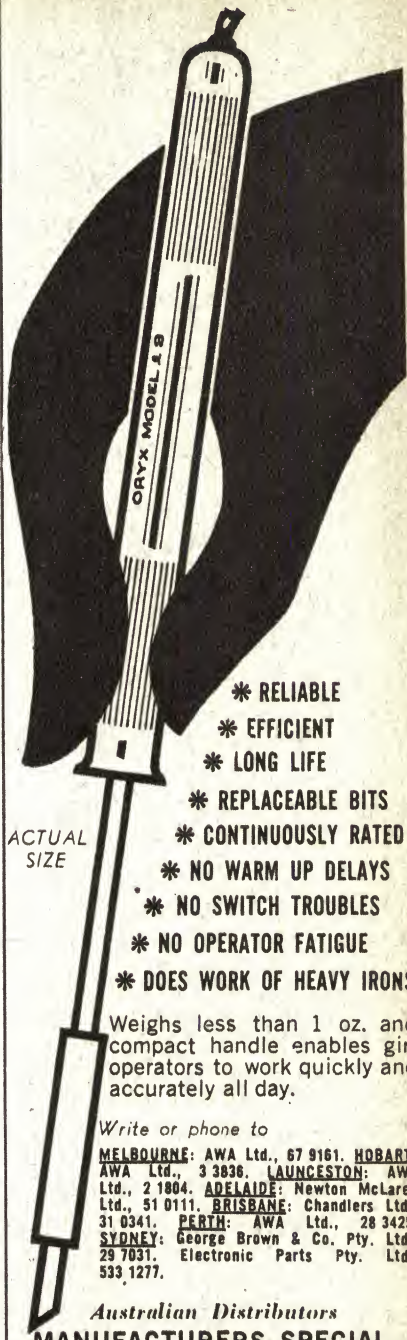

ACTUAL
SIZE

- * RELIABLE
- * EFFICIENT
- * LONG LIFE
- * REPLACEABLE BITS
- * CONTINUOUSLY RATED
- * NO WARM UP DELAYS
- * NO SWITCH TROUBLES
- * NO OPERATOR FATIGUE
- * DOES WORK OF HEAVY IRONS

Weighs less than 1 oz. and compact handle enables girl operators to work quickly and accurately all day.

Write or phone to

MELBOURNE: AWA Ltd., 67 9161. HOBART: AWA Ltd., 3 3836. LAUNCESTON: AWA Ltd., 2 1804. ADELAIDE: Newton McLaren Ltd., 51 0111. BRISBANE: Chandlers Ltd., 31 0341. PERTH: AWA Ltd., 28 3425. SYDNEY: George Brown & Co. Pty. Ltd., 29 7031. Electronic Parts Pty. Ltd., 533 1277.

Australian Distributors
MANUFACTURERS SPECIAL
PRODUCTS PTY. LTD.

47 York Street, Sydney. 2 0233, Ext. 284

WANTED

BY ALL
PRODUCTION ENGINEERS

ORYX

miniature
soldering instruments

A New Member of KENWOOD's Power



120-WATT SOLID STATE STEREO AMPLIFIER KA-4000

Introducing KENWOOD's KA-4000, the solid state stereo amplifier that's the right answer for your Hi-Fi problems. Here's 120 watts of IHF standard total music power—a power-packed instrument that's up to the most severe stereo task. Wide power bandwidth is another outstanding feature with 13 Hz to 30,000 Hz range. IM distortion is almost totally eliminated. The KA-4000 offers momentary silence with a lever type -20 dB quick response muting switch. This amazing stereo advance is further equipped with 2 dB step type tone controls and lever type high and low filter switches. The KA-4000 also has a blue light indicator for input selector switch. If you desire even more total stereo power, another member of the KENWOOD family, the KA-6000 has a booming 180 watts. If you need less power, KENWOOD's diversified range of instruments offers an amplifier with the output you need.

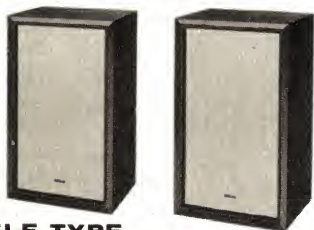

BOOKSHELF TYPE 4-WAY 5 SPEAKER SYSTEM KL-60

- * Mounted speakers: 12-inch, free-edge woofer × 1 (Bass)
6½ inch cone squawker × 1 (lower midrange)
4 inch cone squawker × 1 (higher midrange)
Horn-type tweeter × 2 (Treble)
- * Dimensions: 15"(W), 25½"(H), 11½"(D).



40-WATT SOLID STATE STEREO AMPLIFIER TK-150U

- * 5 pairs of input terminals for MAG, AUX 1, AUX 2, TAPE REC and TAPE PLAY.
- * Damping factor: 40 (at 16 ohms), 20 (at 8 ohms)
- * Dimensions: 10½"(W), 4¾"(H), 9¾"(D).



60-WATT SOLID STATE STEREO AMPLIFIER TK-250U

- * 2 sets of stereo speaker terminal speaker selector switch.
- * Dimensions: 13"(W), 4¾"(H), 9¾"

ul Stereo Family

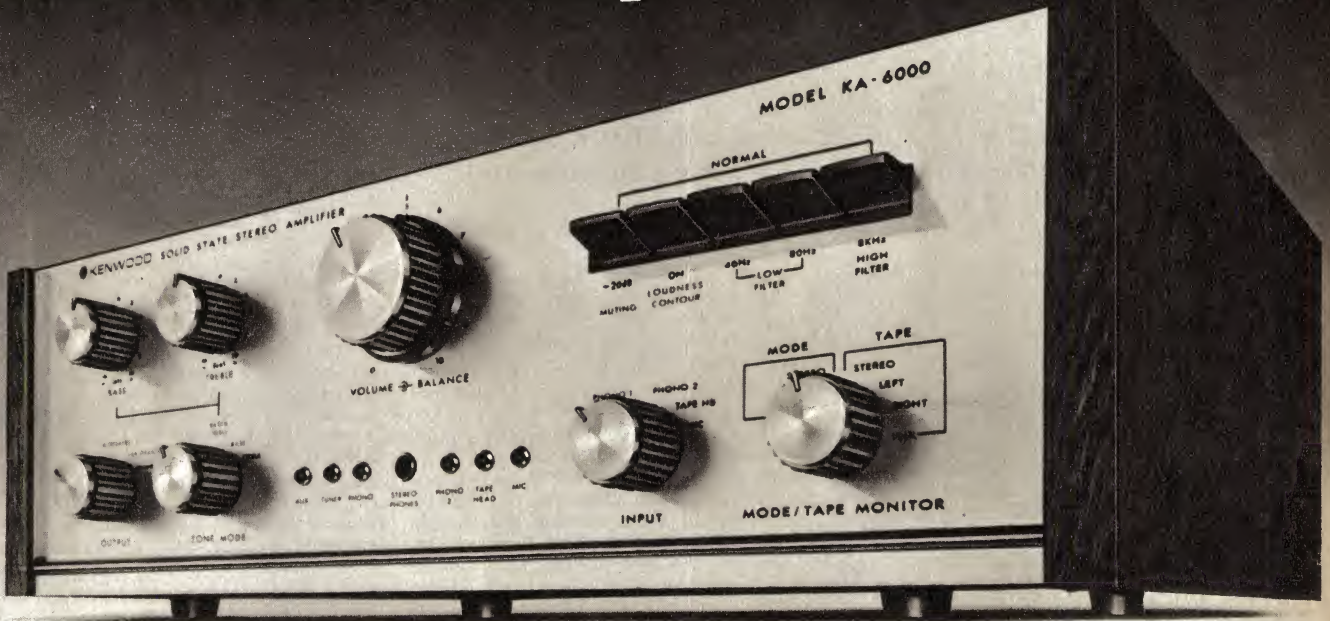

180-WATT SOLID STATE STEREO AMPLIFIER KA-6000

Special Features of KA-6000

- * Wide power bandwidth of 10Hz to 50,000Hz with very low IM distortion.
- * Exclusive Low Level Phono Inputs for the Low Level Output Cartridges, the output of which is 2 mV, 0.5 mV, or 0.05 mV.
- * 2 pairs of MAG Input Terminals for 2 sets of record players.

the sound approach to quality



KENWOOD

TRIO ELECTRONICS, INC.

6-5, 1-CHOME, SHIBUYA, SHIBUYA-KU, TOKYO, JAPAN

Sole Agent in Australia: Jacoby, Mitchell & Co., Pty., Ltd.: Head office; 469-475 Kent Street, Sydney Tel: 26-2651 Melbourne; 15 Abbotsford Street Tel: 30-2491 Brisbane; 56 Edward Street Tel: 2-6467 Adelaide; 652 South Road, Glandore Tel: 53-6117 Perth; United Australia Co., Pty., Ltd., 435 Hay Street, Subiaco Tel: 8-4665 Tasmania; K. W. McCulloch Pty., Ltd., 57 George Street, Loundeston Tel: 25-322 Newcastle; Edmunds Moir & Co., Pty., Ltd., 18 Wood Street Tel: 61-4991

Distributor in New Zealand: JOHN GILBERT & CO., Tasman Buildings, Anzac Ave., Auckland, C.I.

Ask for a catalogue or demonstration by your nearest dealer.



30-WATT FET SOLID STATE AM/FM STEREO RECEIVER TK-20U

- * F.E.T. (Field Effect Transistor) 3 Gang Tuning Condenser frontend for superior sensitivity, image rejection and cross modulation ratio.
- * Dimensions: 14 1/4" (W), 4 1/4" (H), 11 1/4" (D).

To: Jacoby Mitchell & Co., Pty., Ltd. EA
469-475 Kent St., Sydney.

Send me information on KENWOOD RECEIVER, AMPLIFIERS, SPEAKERS & name of nearest KENWOOD retailer,

NAME: _____ AGE: _____

ADDRESS: _____

front panel

A Transistorised Burglar Alarm

This article has been contributed by a reader who constructed the alarm described in September, 1967, then modified it into the improved version he describes here. There are also some suggestions on how to reduce battery consumption in the original design.

Like most people I regard my home as my castle. Having just moved into a new home—which still was not completed—one of my first thoughts was to find a way to preserve its sanctity against those who would violate it. I thought of burglar alarms, in particular an ultrasonic unit. Enquiry proved this would not be suitable. Then, in the September, 1967, issue of "Electronics Australia" appeared the article "Installing a Burglar Alarm." It was the answer to my problem.

It was not long before the alarm described was installed and operating. It was obvious that it was an excellent system, and it performed well in protecting my home. During a vacation of two weeks it was set up for the whole period, and its performance was faultless.

The one disturbing feature about it was the rather high drain from the batteries, which necessitated them being replaced every few months. I considered the possibility of running the system off the mains, via a transform-

house was broken by an attempted burglary. An electronics engineer who was conversant with the latest developments sketched the fundamentals of a transistorised circuit, leaving me to complete it.

This circuit has proved itself to be far superior to the old one, the battery drain now being about one-and-a-half milliamps. This is very little more than occurs when the batteries are not in use, so their service life should be almost as long as their shelf life. To set up the system, all that is needed is to flick on a switch. There is no button to push. The circuit is beautifully simple, and it functions perfectly.

The operation of the circuit is not difficult to follow. The BC107 is an NPN transistor, in the collector circuit of which is the main alarm relay. The door and window contacts are connected between the base and emitter of the BC107 so that, when all these contacts are closed, there will be no forward bias on the base, the

This is to ensure that the alarm will continue to operate, even if the door and window circuit is restored.

The BA100 diode across the relay coil is to suppress transient voltages which will be generated when the inductive circuit is opened and which might otherwise damage the transistor. The two BA100 diodes in series with the base are to increase the base-emitter reverse breakdown voltage which might otherwise be exceeded by voltage spikes generated by the bell or buzzer.

The switches on the doors and windows are those described in the original article, namely, dry reed switches and magnets. These switches are by far the best that are currently available, and their installation as described cannot be improved upon. However, the original article described their use in wooden door and window frames. Many houses nowadays have window frames of aluminium. Obviously, it is not possible to cut a groove in an aluminium frame, install a switch or magnet, and fill the grooves with a suitable compound. To get around this difficulty there are available small plastic cases. They come in pairs, one containing a dry reed switch, and the other a magnet. It is a simple matter to screw these cases to the aluminium frames, using self-tapping screws. The switch is wired into the system as usual.

For that matter, they can be used on wooden doors, windows and frames. Probably many people would rather adopt this method instead of the rather tedious one of cutting grooves in frames and sashes. The plastic cases are small, neat, and unobtrusive.

These cases, complete with reeds and magnets, may be purchased from burglar alarm supply companies. I obtained mine from Metropolitan Manufacturing Pty. Ltd., 45 Regent Street, Redfern, N.S.W. 2016.

Individuals will have their own ideas as to how the control unit for the system should be assembled. I will describe the unit I have made as a guide to others. All the components with the exception of the batteries are housed in a small wooden box, the box being one that is sold by all stationery shops for holding 6in x 4in office cards. The outside dimensions of the box are approximately 6½ x 5-1/8 x 5in.

I cut a piece of masonite to be a tight fit into the bottom of the box. On this "chassis" I mounted the relay, and a terminal strip. The components are soldered to the terminal strip. On the lid of the box are mounted three switches, and the buzzer. On the

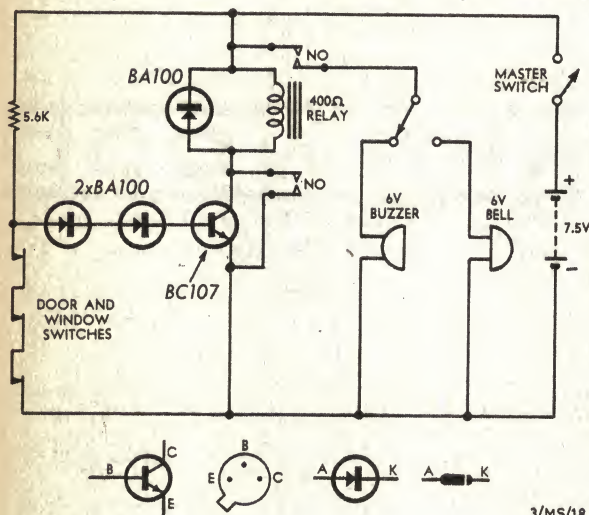

The circuit is quite simple and should offer a high order of reliability. As shown, one switch is used to select either bell or buzzer. In the unit illustrated on the next page, two separate switches are used, one for each function. Setting up is simple and the current drain very low.

er, keeping the batteries as a standby in the event of a mains failure. However, I felt that such an installation was rather clumsy, and was to be avoided if possible. The real solution to the problem was to reduce the amount of current required to run the system.

I made enquiries, and found that the system of keeping a relay energised while the alarm was set up is no longer favoured. The current concept is to leave the relay in its unenergised state, and to cause it to pull in only when the closed circuit around the

transistor will be cut off, and the relay will not be energised.

When any one of the door or window contacts is opened the base becomes forward biased by reason of the 5.6K resistor connected between it and the positive supply rail. As a result, collector current flows, the relay pulls in, and the main alarm contacts are closed energising the alarm. At the same time, a pair of auxiliary relay contacts, called holding contacts, are also closed. These are connected between emitter and collector of the transistor and serve to by-pass this component once the relay is pulled in.

back are mounted two sockets and plugs — one going to the bells, and the other to the reed switch circuit. From the box is a flex which goes to the batteries. The unit is set on a bedside cabinet, and the batteries are placed in a bottom compartment of the cabinet. The box and its contents weigh only a pound or two, and within limits can be moved about.

Without any protection system there is the matter of legitimate entry to the building without triggering the alarm. The original article described a method whereby a switch using a combination was installed. This is an excellent method, but there may be those who do not care to go to the trouble of constructing such a switch, but would rather purchase one suitable for the purpose.

Switches that are widely used for this purpose are the "Wilsonia" brand key switches. They come in two models, the "202" and the "K02." With the "202" switch the key can be withdrawn only when the switch is in the "off" position. With the "K02" model the key can be withdrawn when the switch is in either the "on" or the "off" position. Both have their applications. Both models are available either plain or waterproof. The waterproof model differs from the plain only in the addition of a rubber sheath covering the body, and a spring-loaded cap covering the key slot. For both models there is a mounting ring to enable the switch to be attached to suitable surfaces. This ring is designated part number KE3 and must be ordered as a separate item if required. These switches are normally available from automotive supply houses.

The "202" model can be used in an installation similar to that described in September, 1967. With this, it is necessary to use a parallel switch inside the front door. This inside switch should be similar to the light switch of the home. To leave the house after the system has been armed, the inside switch is flicked on. The door is opened, the key inserted in the key switch, and the latter switched on. The inside switch is then flicked off, the door closed, and the key withdrawn from the key switch. To enter the house, the reverse process is followed.

To some people this may appear a rather cumbersome procedure. For them, a different arrangement is possible. Use a "K02" switch on the front door, wired as the master switch in the circuit. When leaving the house, the system is not armed at the control panel. Instead, the front door is closed, the key inserted, the switch switched on, and the key withdrawn.

One can also have a master switch inside the house, on the control panel. The system then can be set up at night, by flicking on the inside switch. Remember, though, that a person cannot enter or leave the house while the inside switch is on without setting off the alarm. With the first system it is possible to do so.

Another possible objection to the "K02" switch system is that, if a wire leading to it is cut, the effect is to switch off the whole alarm system, leaving the house unprotected. With the "202" switch, this is not so. So, there are the pros and cons of the two systems. The reader can make his own choice as to which he prefers.



A simple foot trap unit. The circuit between the two pieces of brass is normally completed by the alligator clip, to which is attached the trip thread.

The "K02" switch has other uses. Where a lock-up garage is in use, it is logical to include the garage door in the alarm system, thus providing protection for the car while in the garage. On the other hand, most people prefer to leave the garage door open when

they take the car out, so that they may drive straight into the garage on their return.

The "K02" switch enables them to continue with this practice. It is wired in parallel with the dry reed switch guarding the garage door. Then, with the key switch on, the door may be opened and left open without setting off the alarm. This same principle may be applied to other doors in the house, such as a laundry door, or a rear porch door.

The provision of contacts on all windows and doors is in itself excellent protection for the average home. However, there may be some who would like to provide a second line of defence in case a determined burglar should breach the first line. Such a system is really most suitable for use when the house is to be empty for some time, such as when the family goes on its annual vacation.

This second line may be provided by the use of foot traps. These handy little gadgets are essentially simple. They consist of two brass strips, end to end, but separated, with the inner ends turned up. They are mounted on a plastic base. A type of alligator clip attaches to the two upraised ends, completing the circuit between the two strips. The strips are wired into the circuit. The clip is attached to a thread or wire stretching across the room or

The control unit is built in a wooden filing card box. On the lid is the master switch, a switch each for the bell and buzzer, and the buzzer. The two sockets serve the bell and window contacts respectively, while the flex at the right is for the battery.

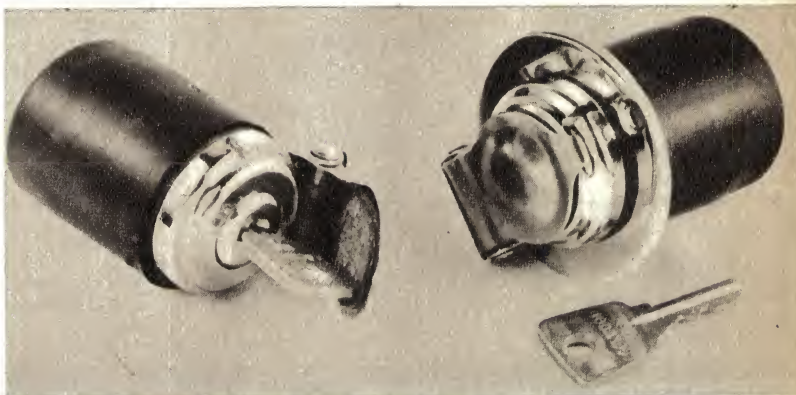

Weather-proof key switches suitable for providing legitimate access to the building. The two types shown are discussed in detail in the text. The mounting ring must be purchased separately.

Labcraft
the quality
turntable

for those who consider
QUALITY and DESIGN
before price!



Bang & Olufsen are the largest manufacturers of High-Fidelity products in Denmark. Established in 1925 they have grown to a million dollar group of modern factories producing a complete range of items for music lovers from the cartridge to the speaker system. This phenomenal growth is the result of two policies: to achieve the highest standards of design and quality.

655 TURNTABLE

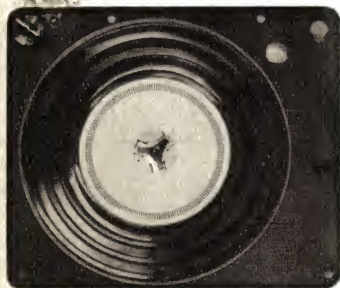

Illustrated is the attractive Labcraft turntable model 655, featuring 3 speeds (33 1/3, 45 and 78 rpm), belt drive, continuous speed variation control of app. $\pm 10\%$, spring mounted motor. Wow and flutter: 0.15% peak; Rumble: 35 db below ref. level at 1.4 cm/

100 Hz. B&O have built real quality into this turntable which will give years of outstanding and trouble free service. Two other models type 605 and 605L with the same specifications are available, the difference being a 9" platter and grey rubber mat with the 605 and a 11" platter and grey rubber mat with the 605L.



ST/L 15° ARM

The Bang & Olufsen ST/L 15° pick-up arm is statically balanced to provide a constant state of neutral equilibrium. Tracking force is presented to the record only by the adjustable spring tension. The arm has automatic compensation for the ingoing force ("skating effect") to exert equal stylus pressure on both groove walls.

B&O cartridges match the perfection of the other B&O products. Minimum crosstalk and harm. distortion; diamond stylus, 15° tracking angle; frequency response 20 Hz - 20 kHz; SP 6-7 with spherical stylus. SP 8-9, gold plated, 17 x 5 micron ell. stylus.

SP 6-8 CARTRIDGE



OTHER B&O QUALITY PRODUCTS AVAILABLE:

BEOLAB 5000

2 x 60 watts R.M.S. silicon transistor amplifier. Will reproduce full original volume at all frequencies in association with loudspeakers of normal efficiency (1-2%). Cursor type controls for slide-rule accuracy in setting. Comprehensive variable inputs, duplicated phono & DIN, and DIN outputs. Elegant long low free-standing cabinet. Frequency response: 20 Hz-20 kHz ± 1.5 dB. Distortion: less than 0.6% at all frequencies from 20 Hz-20 kHz.

B&O MICROPHONES

MD-8 Dynamic pressure mic. 50 Hz-17 kHz ± 5 dB. BM-6 Ribbon mic. Perfect fig. 8. 30 Hz-13 kHz ± 2 db. BM-7 Converts BM-6 to a BM-5 mono/stereo microphone.

BEOCORD 2000 K DE LUXE

A tape recorder with semiprofessional specification, 1 7/8, 3 1/2, 7 1/2" p.s., 4-track recording, 2 and 4 track playback, 4-channel mixer section with twin faders for mono/stereo recording gives individual control of microphone, gramophone, radio and line inputs. Facilities for multi and synchro playback and echo recordings. Output: 2 x 8 watts undistorted. Matt black on a teak or rosewood finished plinth.

BEVOX SPEAKERS

A wide range of fully imported B&O speakers of excellent quality is available. Teak or rosewood cabinets. From smallest single speaker bookshelf units to the outstanding Beovox 5000 with seven speaker units.

PRINCIPAL STOCKISTS

Danish Hi-Fi P./L., 941 Burke Rd., Camberwell, Vic.
Brisbane Agencies, Fortitude Valley, Brisbane Qld.

Mack's Electronics, 199 Rundle St., Adelaide, S.A.
Leslie Leonard & Co., London Court, Perth, W.A.

Sole Australian Agents

G.R.D. INSTRUMENTS Pty. Ltd., 6 Railway Walk, Camberwell, Vic. 3124. Tel. 82 1256

passage. When the intruder touches the thread with his leg the clip is pulled off the two strips, and the circuit is broken. These foot traps may be screwed or glued to walls, about eighteen inches above the floor, and arranged so that the threads leading to them cover all possible routes that an intruder could take. He is certain to stumble into one of them.

(Editorial note: It should be realised that simple clip contacts of this nature are considerably less reliable than the dry reed switch. Corrosion, caused by humidity and/or other contaminants can cause high resistance connections with consequent false alarms. An alternative approach is to retain the dry reed switch, held closed by a magnet which will normally cling to the glass tube quite reliably. This may then be fastened to the trip thread.)

Some homeowners may not like to disfigure their walls by attaching foot traps to them. For these another method is available. Obtain a spool of very fine enamelled wire—number 38 gauge is eminently suitable. Arrange chairs, tables, stools, etc., so that the wire may be supported by them in such a manner that it covers all the entry points and passages that an intruder may take. Run the wire around

Suitable cages are available from burglar alarm supply companies, including the same firm as mentioned previously in regard to the reeds and magnets.

However, if you wish, you can mount the bells on the interior walls of your home, out of reach of would-be intruders. The sound outside will not be as loud as if they were mounted externally, but it will be sufficient for its purpose. Mount the bells so that they are alongside and partly over air bricks in the walls. Then the sound will easily pass to the outside, being almost as effective as if the bells were mounted externally.

(Editorial note: The system just described appears to be an excellent one and the feature of low battery drain would make it a natural choice for anyone contemplating installing a new system. On the other hand, those who have already installed the September, 1967, system would undoubtedly be interested in any way in which battery drain could be reduced without rebuilding the complete system. The author of the 1967 article suggests how this might be done.)

At this stage the scheme I am about to suggest has not been tried in this application. It has been tried in one

A suggested power supply circuit for use with the 1967 system, including a battery back-up arrangement which takes over automatically in the event of a power failure.

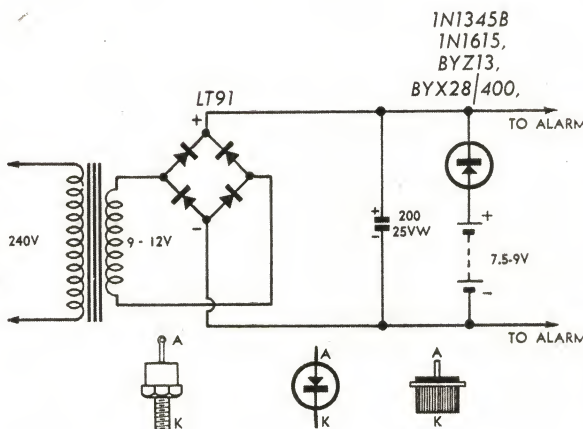

the house, using these supports, so that a burglar would stumble into it. This wire is so fine that it is for all intents and purposes invisible, and it will snap at a very light touch. The circuit is broken, and the alarm sounds.

It is axiomatic that the more noise an alarm makes the more efficient it is in protecting the property. Bells are usually used to sound the alarm, a common size bell being 10 inches diameter. Such bells draw about a half amp, or a little less. Relays are readily obtainable equipped with contacts rated at three amps. This means that up to six bells may be simultaneously sounded. Six bells make a lot of noise, and any burglar in his right senses would not stay around when they sounded off. The best plan is to buy as many bells as you can afford.

Naturally, if the bells are mounted on the external walls, their sound will be heard further afield. However, in this position the bells are vulnerable to interference by the would-be intruder. To prevent sabotage, metal cages are available to cover the bells and protect them. These cages can be wired so that any attempt to remove them triggers the alarm.

other, however, namely that of the Crystal Clock Drive Unit described in June, 1969. In fact, it was from this application that I conceived the idea of the burglar alarm application.

The idea is quite a simple one. A mains operated power supply, delivering an output voltage somewhat in excess of the nominal battery voltage, is used to operate the system while ever mains power is available. The back-up battery is connected effectively in parallel with the power supply, but is prevented from discharging into the system by means of a diode in series with one battery connection.

The polarity of the diode is such that, in the absence of the power supply, the battery will be able to discharge into the alarm network and power it in the normal way. With the power supply in circuit, however, the higher voltage from the latter effectively biases the diode so that it does not conduct. Thus the battery is effectively disconnected from the system while ever the power supply is functioning. If the power supply should fail the battery comes into circuit quite automatically, simply by reason of the fact that there is no longer any bias

up to ten times longer life



MAXELL Alkaline Dry Cell — this unique new design concept features high capacity and durability that surpasses the performance of the world's top dry cell batteries. The construction of the Maxell Alkaline Dry Cell differs greatly from conventional types of carbon ZINC cells. However, the Maxell Alkaline cells can be used where you normally use a carbon ZINC cell. MAXELL ALKALINE CELLS are especially suitable where there is a demand for increased current, combined with durability and little voltage drop. Even near the end of the cell life the discharge capacity is large and stabilized.

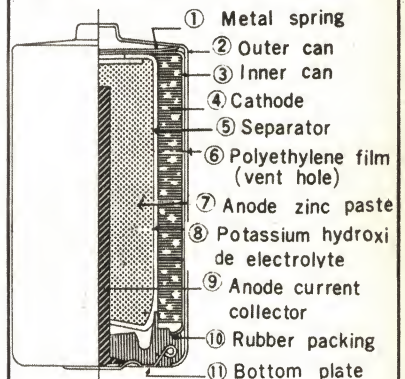

Exclusive new construction minimises leakage. Double cans are used and rubber sealing with the unique spring safety device. (see diagram)

Interior drying is prevented by hermetic sealing, therefore long storage periods are possible (over two years). Even then Maxell Alkaline cells are in the same condition as when they left the production line. These cells will withstand severe temperature changes. Rigid tests have shown extremely stabilized capacities from the low temperature of -4F to the high temperature of 150F at which temperatures dry cells would fail to operate satisfactorily.

Prices:

AM1 75c
AM2 50c
AM3 40c

Trade enquiries to
TASMANEX PTY. LTD.
376 Pittwater Road, Harbord 2096

MODEL RH-100 MULTIMETER

100,000 Ohms per Volt DC

10,000 Ohms per Volt AC

NEW RELEASE NOW AVAILABLE



PRICE \$39.75

POSTAGE 75 cents

- Overload Protected by Dual Silicon diodes
- Double-jewelled $\pm 2\%$ Meter
- $\pm 1\%$ Temperature-stabilized Film Resistors
- Polarity Changeover Switch
- Scale with Mirror and instruction for operation with circuit diagram.

SPECIFICATIONS

DC Volts: 0.6, 3, 12, 60, 300, 600, 1200V (100,000 Ω /V)
AC Volts: 6, 30, 120, 300, 1200V (10,000 Ω /V)
DC Current: 12 μ A, 300 μ A,
6mA, 60mA, 600mA, 12ADC and AC Current 12A
Resistance: 20K Ω , 200K Ω , 2M Ω , 20M Ω
Decibels: -20~+17, 31, 43, 51, 63
Accuracy: DC $\pm 3\%$, AC $\pm 4\%$ (of full scale)
Batteries: Two 1.5V dry cells, Size AA, "Eveready" 915

RADIO HOUSE PTY. LTD.

306-308 PITT STREET, 6 ROYAL ARCADE & 760 GEORGE STREET, SYDNEY

on the diode to prevent this from happening. Being a passive network, this arrangement will have a very high order of reliability.

The only objection, and it is a minor one, is that there will be some loss across the diode. To counter this it is suggested that the battery size be increased by one cell; say, to five if

governed by what transformer is most readily available, either new or already on hand.

In a system such as this the battery life would be virtually its shelf life. Which raises the question, just when should such a battery be replaced? In any system using a primary battery care must be taken to ensure that the

user is not lulled into a false sense of security regarding the battery's condition, particularly where the demands on it are minimal, as in the two systems just discussed.

In either system it would be possible for the batteries to deteriorate to the point where they would not operate the bell, or not operate it satisfactorily, even though still capable of holding the transistor system in the "armed" condition or, in the case of mains operated system, of tiding it over any blackout period.

For this reason, the battery should be checked periodically, say every six months, by connecting a dummy load across it and measuring the voltage across the load. The load should approximate the drain of the alarm bell(s) and any battery which reads less than 1.2 volts per cell should be regarded as suspect.

Remember, it is false economy to try to save on battery costs. The cost of one robbery would be many times that of a battery.

PREVIOUS SIMILAR PROJECT
 "Burglar Alarm," September, 1967 (file No. 3/MS/14).
 "More About The Burglar Alarm," Dec., 1967 (file No. 3/MS/15). ■

Plastic cases used to house dry reed switches and associated magnets. These are most useful where it is impractical to completely conceal the reeds and magnets, as described in a previous article.

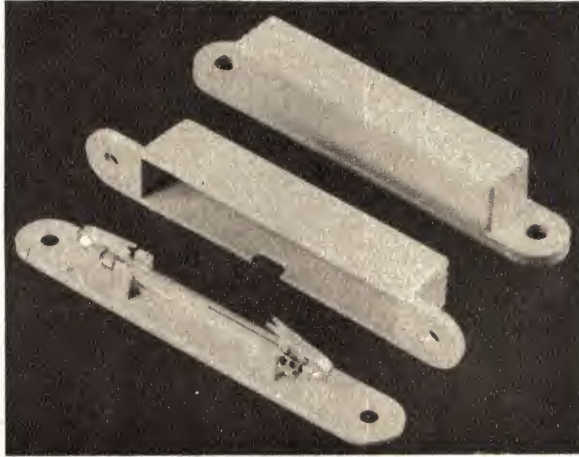

four had previously been considered adequate, or to six if five had been used previously. While making the battery slightly dearer in the first instance, this will be more than offset by the lower running cost.

In greater detail the power supply could consist of a small power transformer delivering, say, 12V at not less than 1A, a selenium rectifier such as the LT91, and an electrolytic capacitor of at least 200uF.

The diode to switch the battery needs to have a peak current rating of several amps (the peak current drawn by an alarm bell will be several times greater than the average current) together with a reasonably high voltage rating to withstand any transient voltages generated by the bell. Suggested types are BYX28/400, BYZ13, 1N1615, or 1N1345B. The ratings of all these are fairly generous, considering the application, but would appear to be justified by reason of the moderate cost and the need for high reliability.

In order to bias the battery-switching diode completely, the power supply voltage will need to be at least two volts higher than the nominal battery voltage, or perhaps a little more. A supply such as just described should be more than adequate, while the higher voltage would not be an objection as regards the alarm circuit. In fact, it would be marginally advantageous, in that it would give somewhat louder operation of the bell.

Alternatively, a transformer as low as nine volts would probably produce adequate bias for the diode under the no-load conditions which normally apply. The final choice may well be

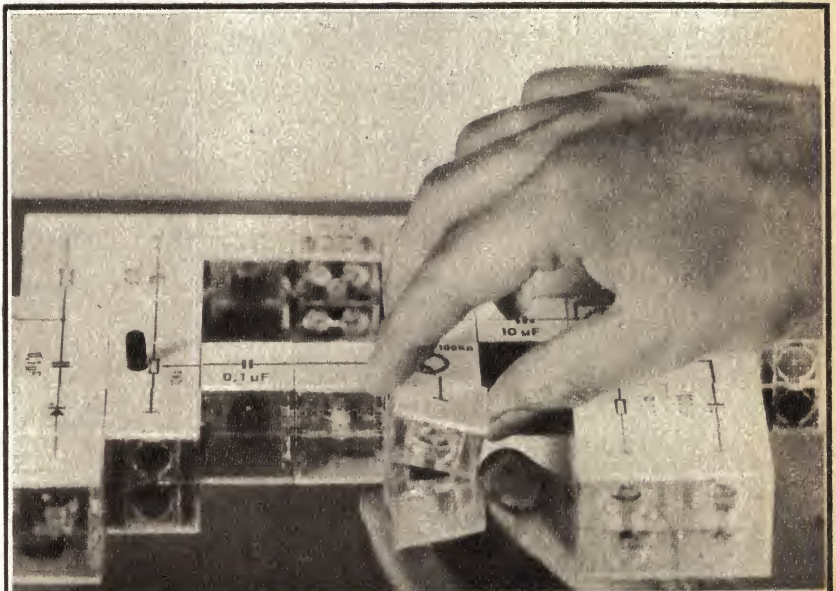

BRAUN ELECTRON: Electronic experiments using magnetic building blocks for technical minded youngsters and adults start with the MINI system — retail \$25.35.

Enquiries:—

Australian Agents

HALDEX PTY. LTD.

61 PINE STREET, CHIPPENDALE,
 N.S.W. 2008 69-6921

E. R. I.

2 Pope St., Ryde, N.S.W.
 Box 241 P.O., Ryde 2112.
 Phone 807-1036

For Australian Made
 ELECTRONIC
 RESEARCH
 INSTRUMENTS

Available shortly
 UNIVERSAL TESTING PROBE
 Digital and Analogue
 Aust. Patent Applic.
 No. 58980/69

CAPACITOR DECADES
 RESISTANCE DECADES
 PULSE GENERATORS
 POWER SUPPLIES

NEW ALL TRANSISTOR STEREO AMPLIFIER ULTIMATE IN DESIGN-LONG DEPENDABILITY USING ALL SILICON TRANSISTORS 36 WATTS-RMS

SPECIFICATIONS:

POWER OUTPUT: 18 watts per channel

R.M.S. Total output 36 watts R.M.S.

FREQUENCY RESPONSE: From 20 cycles to 20,000 \pm 1db.

HARMONIC DISTORTION: Less than 1% at 10 watts output.

HUM & NOISE: Aux. 70db, Mag. 50db.

INPUT SENSITIVITY. Mag. 3mv. Aux. and tuner 200 mv.

SPEAKER IMPEDENCE. 8 ohms.

EQUALIZED: Mag. RIAA.

TONE CONTROLS: Bass 50 c/s \pm 12db.

Treble 10 kc/s \pm 12db.

LOUDNESS CONTROL: 50 c/s 10db.

SCRATCH FILTER: (High filter) at 10 kc/s 9db.

RUMBLE FILTER: (Low filter) at 50 c/s 5db.

PROVISION FOR TAPE RECORDER. RECORD OR PLAY-BACK WITH DIN PLUG CONNECTION.

PROVISION FOR HEADPHONES WITH HEADPHONE/SPEAKER SWITCH ON FRONT PANEL.

THE CIRCUIT INCORPORATES REGULATED POWER SUPPLY WITH TRANSISTOR SWITCHING PROTECTION FOR OUTPUT TRANSISTORS. 26 SILICON TRANSISTORS PLUS 5 DIODES ARE USED.



MODEL C300/20

\$119.00 FREIGHT EXTRA

DIMENSIONS: 16 $\frac{1}{2}$ in x 5 $\frac{1}{2}$ in x 11 in deep
MOUNTED IN OILED WALNUT OR TEAK
VENEERED CABINET WITH METAL
TRIM AND MATCHING KNOBS.



MODEL C300/20/T

**ABOVE AMPLIFIER
WITH INBUILT A.M.
TUNER**

\$144.00 FREIGHT
EXTRA

12 WATT RMS PER CHANNEL VERSION OF ABOVE AMPLIFIERS AS PREVIOUSLY
ADVERTISED ALSO AVAILABLE AT \$134 WITH TUNER.

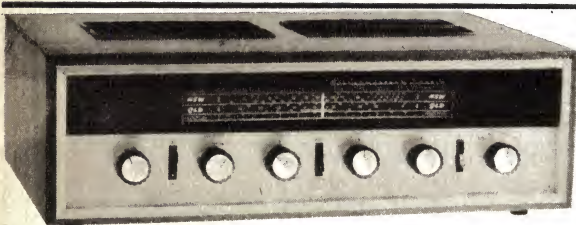

**MODEL C200V. BASED ON THE
PLAYMASTER 118 WITH TUNER**

Dimensions 16 $\frac{1}{2}$ in x 5 $\frac{1}{2}$ in x 11in.

CABINET IN OILED WALNUT OR TEAK WITH
METAL TRIM.

\$118.00

FREIGHT EXTRA

This amplifier is based on the Playmaster 118 circuit as featured in "Electronics Australia" to which has been added the following features.

- Inbuilt high gain A.M. tuner with a coverage of 530 to 1,600 K.C.
- Loudness control giving bass boost at low volume.
- Provision for tape, record and play-back, with din connector.
- Calibrated dial available for all States.
- EM84 tuning indicator giving accurate tuning with ease.

POWER OUTPUT: 9 watts per channel R.M.S. **FREQUENCY RESPONSE:** 20 to 20,000 cycles incorporating Ferguson O.P.412 grain oriented output transformers. **VALVES USED:** 4-6GW8, 12AX7 or 12AU7, 6AN7, 6N8, EM84 and 2 silicon diodes.

CLASSIC RADIO

245 PARRAMATTA ROAD, HABERFIELD, N.S.W. PHONE 798-7145



A READER BUILT IT

A Self Restoring Electronic "Fuse"

Fuses and circuit breakers have long been employed in circuits where overload can damage expensive components. Here is an all electronic unit which behaves much in the manner of a fuse, yet restores the circuit when the overload is removed.

Here is a circuit for a "transistorised fuse," designed to give overload protection, but with the additional requirement that the circuit be restored automatically when the overload is removed. The accompanying voltage/current characteristic graph of the device shows its similarity to a fuse. It is also similar in that it is a two-terminal device. However, it is suitable only for uni-directional current.

The circuit works as follows: TR3 is held saturated by reason of the base current drawn through R2. This saturates TR2 and, in turn, TR1. TR4 is cut off. Resistor R1 is typically 0.5 ohm and the total resistance between the terminals is about 1.5 ohms. The base of TR3 is held at a reference voltage of about 1.4V by the diodes D1 and D2.

If the current through the device is increased beyond 1A the voltage developed across R1 starts to cut off TR3. This reduces the base current of TR2, and thus of TR1, so increasing the resistance between the terminals. This current limiting action continues until the voltage across the circuit reaches about 5V. At this point the voltage developed across R4 commences to turn on TR4, reducing the voltage across D1 and D2. This further reduces the base current of TR3, moving TR2 and TR1 closer to cut-off.

As a result the overall resistance of the device increases, causing the voltage across it to increase, and this increases the current through TR4 still further. Thus the effect is regenerative. The steep negative resistance part of the characteristic in the 5-6V region results from this regenerative effect. When the overload is removed the above operation is followed in reverse, with negligible hysteresis. The resistance across the device when in the "open" condition is about 1000 ohms (R2). It can withstand 60V across its terminals if the polarity is as shown.

(Editorial note: The figure of 60V quoted above would seem to be an optimistic one. Even in the cut-off condition, there will be some leakage current between collector and emitter of TR3. This will be sufficient to bias the emitter-base diode of TR2 into conduction, thus allowing the full voltage across the device to appear across TR3. The 2N3638 specified has a V_{ce0} (volt-

age breakdown collector-emitter, base open) of 25V and V_{cbo} (voltage breakdown collector-base, emitter open) of 25V. A transistor which would have an adequate rating for the 60V condition would be the BCY39).

If there is a possibility that the voltage across the device could be reversed in polarity an additional protection diode may be fitted to avoid damage. The diode may be (1) in series with the device, cathode toward the negative terminal or, (2) in parallel

with the device, cathode towards the positive terminal.

Method (1) is preferable if the extra resistance and the voltage developed across the diode in the forward direction is not an objection. The diode may be another 1N4004 or similar.

The current at which the fuse "blows" may be varied by varying the value of R1. The graph shows the effect of increasing R1 to 0.75 ohm. Readers may care to experiment with the value of this resistor. Physically, R1 is made up from a number of higher value resistors in parallel.

The circuit should not be called on to pass currents in excess of about 5A. (Submitted by Mr J. K. Gerrand, 2 Norman Street, Mitcham, Victoria 3132.)

The circuit is simple and uses relatively few components. An attractive feature of the scheme is that it requires no power supply of its own, thus ensuring a high order of reliability over long periods of time. The operation of the circuit is explained in the text.

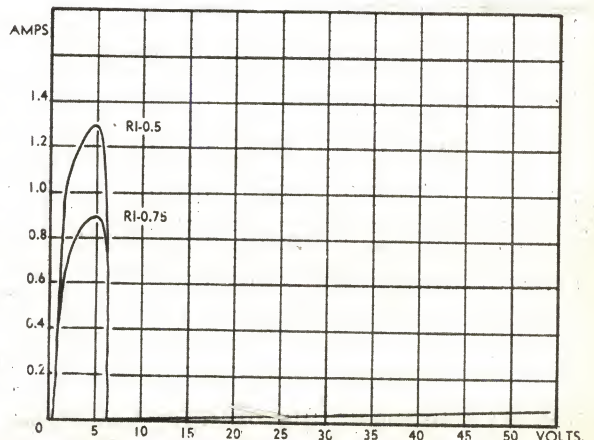
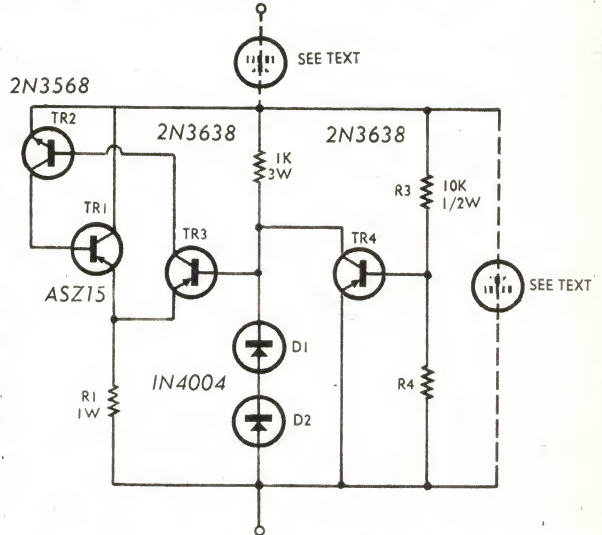

This graph shows how the current rises more or less normally until about 5 volts appears across the unit. At this point the current drops to a very low value and remains low with increasing voltage.

A REVOLUTIONARY NEW APPROACH TO CIRCUIT TESTING

the fantastic FE14 FIELD EFFECT VOLT-OHM-MILLIAMETER

- LESS CIRCUIT LOADING THAN A VTVM • ZERO WARM-UP TIME—INSTANT STABILITY • NO BOTHERSOME AC CORDS • USE IT ANYWHERE—ANY TIME
- FULL PROTECTION ON BOTH METER AND INTERNAL CIRCUITS—OVER 100 TIMES AC OVERLOAD PER SCALE.



For further information contact:

DC VOLTS

Ranges: 0 to 1, 3, 10, 30, 100, 300 and 1000 full scale $\pm .5, 1.5, 5, 15, 50, 150$ and 500 zero centre scales.

Input resistance: 15 megohms shunted by 14 PF.

Accuracy: $\pm 3\%$ full scale from 32 deg. F to 122 deg. F.

AC rejection: 30 to 300 times.

AC VOLTS

Ranges RMS: 0 to 1, 3, 10, 30, 100, 300, and 1000 full scale.

Ranges peak to peak: 0 to 2.8, 8.4, 28, 84, 280, 840 and 2800 full scale, frequency compensated.

Input impedance: 10 megohms shunted by 29PF.

Frequency response: 10 Hz to 10MHz at 3DB points.

Accuracy: $\pm 5\%$ full scale from 50 deg. F to 100 deg. F.

OHMMETER

Ranges: 0 to 1000, 10K, 100K ohms and 1000 megohms.

Accuracy: $\pm 3\%$ linear arc.

DC CURRENT MEASUREMENTS

Ranges: 0 to 100 microamps 1 ma, 10 ma, 100 ma and 1 ampere.

Accuracy: $\pm 3\%$ full scale.

Internal voltage drop: 2 volts.

\$86.00 plus sales tax

High voltage probe \$12.50

ELMEASCO Instruments Pty. Ltd.

P.O. Box 334, BROOKVALE, N.S.W. 2100. Tel. 93-7944

P.O. Box 213, MT. WAVERLEY, VIC. 3149. Tel. 82-6159

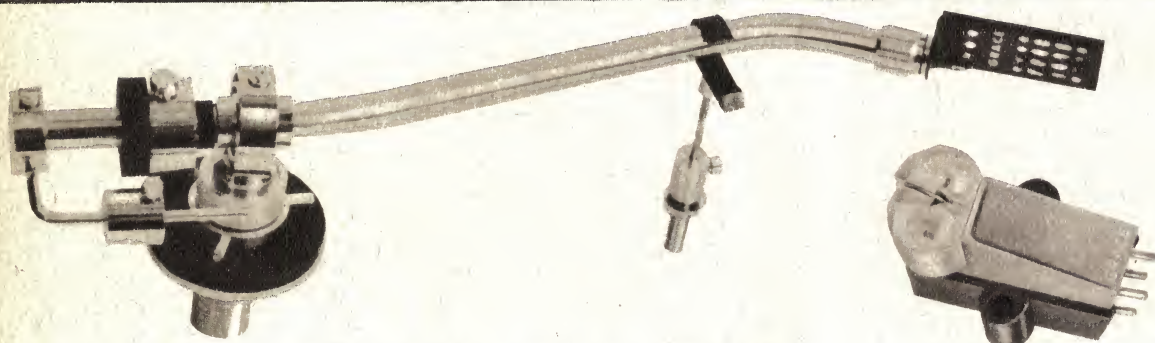

A NEW, PRECISION MADE TONE ARM—THE GRACE MODEL G-545

Although they've been available only a few months, Grace tone arms are already prized by the audio enthusiast. This new model, the G545, is a winner . . . it will track down to $\frac{1}{4}$ gram with suitable cartridges and features a gimbal type gyroscopic bearing system. An ultra light weight head shell is supplied . . . and the new arm shape reduces tracking error to the point where this factor may be disregarded.

The main counter balance weight is divided into two for easier, more precise balancing. Sub-weight adjustment sets stylus pressures from 0 to 3 grams. The arm accepts all Ortofon/SME type headshells without modification and all "New Generation" cartridges. Tracking ability of this fine tone arm is best demonstrated with stylus pressures below one gram. Ask for an EMQ or call at Encel Stereo Centres in Melbourne or Sydney for a demonstration.

HIGH PERFORMANCE GRACE STEREO CARTRIDGES

MODEL F-8M. With an output of 7 mV, and a frequency response of 5-35,000 Hz, the Grace F-8M stereo cartridge tracks down to $\frac{1}{2}$ gram — recommended stylus pressure being $1\frac{1}{2}$ -2 $\frac{1}{2}$ grams. An elliptical diamond stylus 0.2 x 0.8 mil. is standard equipment, tip mass is 0.75 m/grams, and total cartridge weight is only 6 $\frac{1}{2}$ grams. Cross talk is less than —30 dB, at 1 kHz.

MODEL F-8L. Output of this fine professional standard stereo cartridge is 5 mV, and frequency response 5-35,000 Hz. An elliptical diamond stylus is standard equipment (0.2 x 0.8 mil.); the stylus is easily changed. Cross talk is less than —30 dB, at 1 kHz. Stylus pressure recommended is $1\frac{1}{2}$ -2 $\frac{1}{2}$ grams. Total weight of the cartridge is 6 $\frac{1}{2}$ grams.

ENCCEL

ELECTRONICS (STEREO)
PTY. LTD.

Head Office:

431 Bridge Rd., Richmond, Victoria 3121. Tel. 42 3762.

Sydney Store: Ground Floor, 2SM Building

257 Clarence Street, Sydney, N.S.W. 2000. Tel. 29 4563, 29 4564.

Australia's Greatest Hi-Fi Centre *Wholesalers *Trade-ins accepted

NOVEL TV LOUDSPEAKER SYSTEM

A versatile loudspeaker system for use with a TV receiver features a variable cross-over network.

Prompted by your treatment of the C8MX De Luxe (Playmaster Point Four Enclosure, February 1968), I submit a somewhat more drastic treatment which I had given to a less pretentious unit installed in a console TV set.

Having previously re-organised the audio section to yield good frequency response and damping, a twin-cone 9 x 6 speaker was substituted for the "ordinary" unit. The sound was quite good with "presence" galore. However, Mrs Experimenter regarded it as "too piercing". A glide tone revealed the cause to be a substantial peak, judged twice as loud, in the 2-3KHz region.

It was decided that better use of the rear wave could reinforce the bass end and a small tweeter could lift the highs, to achieve better balance. However, it was thought that something would still need to be done about the middle peak.

As a first step the rear of the loudspeaker section of the console was padded and sealed to enclose about 3,000 cu. in with a 4in x 3in vent cut in the speaker baffle. At this stage a 3in tweeter was added, but left out of circuit temporarily.

Tests of the low-frequency behaviour revealed two minor impedance peaks, at 45Hz and 100Hz, in place of the substantial peak at 70Hz in free air. The bass now sounded quite firm and reasonably smooth with useful response extending to below 50Hz.

To suppress the middle peak it was planned to tune a 2mH inductor with 2uF of capacitance, and damp the circuit with a resistor. The inductor was to be wound on the same bobbin as your "Bookshelf" but with larger cheeks.

Having on hand two 4oz spools of .036 enamelled wire it transpired that the first spool wound on formed a 0.5mH unit which was terminated through one cheek; the second spool was joined to this termination and wound in the same direction to complete a 2mH inductor.

This inductor, tuned by a 2uF capacitor and damped by a 20-ohm resistor, suppressed the peak in the main speaker well enough, but I thought it to be

too "muddy". Reducing the damping resistor to 10 ohms, was more acceptable, while lashing-up the 2mH inductor and 2uF capacitor as a quarter-section cross-over produced similar results. It was also possible to use the 0.5mH tap to form a cross-over at 5KHz, restoring the "presence," and a half-section filter feeding only the main speaker causing a HF cut. The system could be made quite versatile.

For convenience three variations were chosen by use of a 3 x 3 switch as shown in the circuit to provide:

1. A true cross-over at 5KHz with a strong "presence" which is suitable for speech or solo prominence;
2. A less accurate cross-over centred on 2.5KHz with a broad valley of about 5dB giving good overall reproduction;

3. A half-section filter feeding only the main speaker, rolling-off the high frequencies at a rate approaching 12dB/octave; very useful for poorer programs and not so restrictive as the usual top cut tone control.

The inductor, switch and capacitor were mounted inside the enclosure on a small "chassis" with the switch brought out to a knob labelled "Prominent, Normal, Cut-off."

This work was done on a 15-ohm system and appropriate modifications (½L and 2C) are required for 8-ohm systems. Further, not all loudspeakers could tolerate the 5dB in mid-range. The larger value of the inductor could be trimmed back to suit particular cases. The impedance is not constant but should be well tolerated by most amplifiers. If used with a sealed enclosure it will be necessary to ensure that there is no air leak around the switch shaft.

(Submitted by: C. D. Turner, 53 Elizabeth Street, Riverstone, N.S.W., 2756.)

The simple circuit for this versatile TV loudspeaker system.

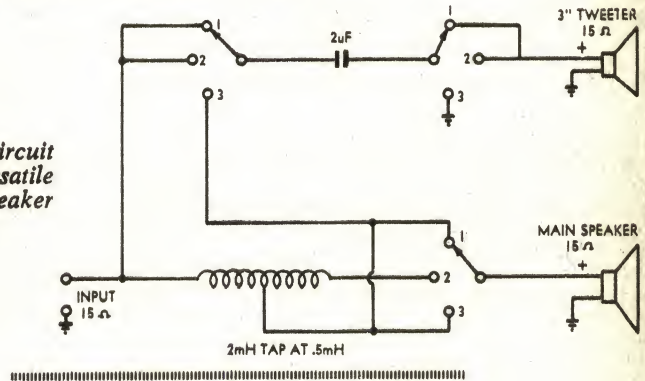

SIMPLE REFLEX RECEIVER

Getting the most out of the least number of parts has always been an intriguing exercise for the experimenter and the reflex circuit has always been one of his favourites. Here is another attempt to push this idea to its limit.

This is a description of a reflex receiver using a BC108. The performance of a BC108 in a reflex circuit is quite amazing when compared with, say, an OC45 in a regenerative detector circuit.

No external aerial and earth are necessary and the whole set can be

built as a personal earphone type receiver in a small plastic case about 2in x 1½in x ½in, although this is slightly cramped.

Fixed regeneration is provided by means of a small capacitor, made by twisting two short pieces of insulated hookup wire together. This capacitor is connected between collector and base and is adjusted by tuning to a station at the high frequency end of the band and twisting the capacitor wires together until it becomes a little difficult to tune the station "spot on." The regeneration makes selectivity very good and, once set, does not need to be adjusted again.

The RF choke, which is rather large in a commercial version, can be replaced with a home-made one without substantial reduction in performance. It consists of a few hundred turns, jumble wound on a 100K or 1M ½W resistor. The ends of the coil are terminated on the resistor pigtail.

The volume control may be omitted and replaced with a 4.7K resistor. The 2uF capacitor will then connect to the diode end of this resistor.

(Submitted by Mr P. Collen, 4/371 Dandenong Road, Armadale, Victoria 3143.)

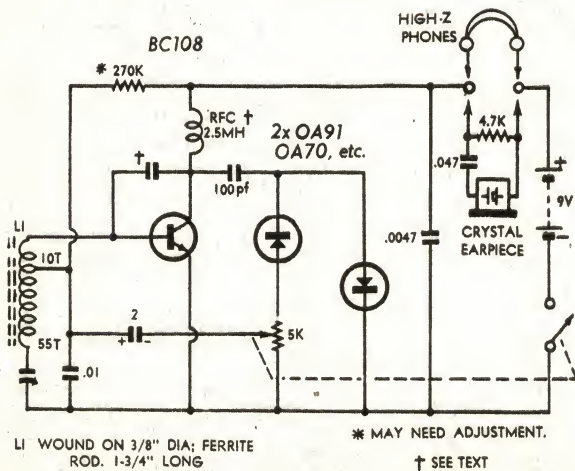

This simple reflex receiver fits into a case not much larger than a matchbox.

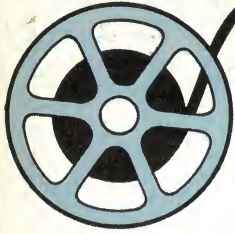

AUDIO TOPICS



CROSS-FIELD BIAS AND SLOWER-SPEED RECORDING

While concerned primarily with putting the case for the cross-field bias technique in tape recording, this article explains in some detail the complex relationships between tape speed, frequency response, signal/noise ratio and dynamic range. Involved are questions of the thickness of the oxide coating on the tape, and of bias level.

By Fritjof Brodtkorb

SUMMARY: When the wavelength of the signal to be recorded on a tape diminishes to the width of the recording zone, the effective frequency response of the system is severely reduced. To move the critical frequency upwards, the recording zone must be made narrower. The first and obvious move is to optimise head design. Beyond that, it is necessary to consider reducing bias and specifying thinner tape, or using the cross-field system of high frequency bias. The article claims a considerable advantage for the latter method.

The magnetising process. This is inherently non linear. If the tape is magnetised by the signal alone, the resulting signal played back from the tape will be severely distorted.

In the early days of tape recording, steel wire was used as the magnetic medium. It was found that the distortion could be reduced by exposing the wire to a permanent magnetic field superimposed on the signal field during recording. This resulted, however, in a strong background noise from the wire during playback.

A great step forward was taken when the permanent magnetic field was replaced by an alternating field of high frequency. At about the same time, wire gave place as the medium, to plastic tape coated with a thin layer of magnetic material.

The combination of magnetically coated tape with the high frequency

biasing technique greatly reduced the problems of noise and distortion and permitted recordings to be made of good dynamic range. Since those early days, there has been a progressive improvement in technique, in equipment and in tape itself, and the tape system has become fundamental to the sound recording industry.

Over the years a lot of effort

This close-up picture shows the record/play head at the top centre. Directly facing it is the cross-field bias head.

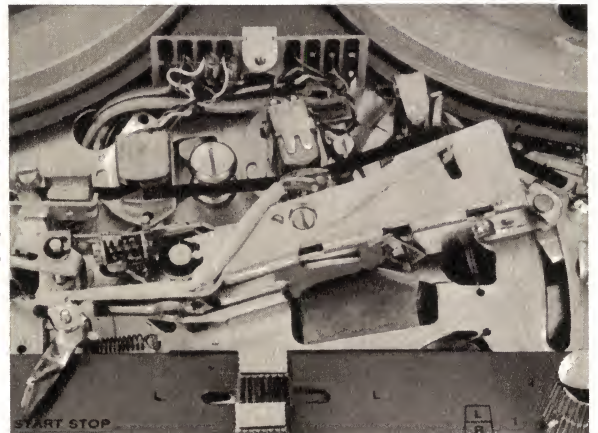

has been directed towards the use of lower tape speeds, with economy as the obvious aim. Unfortunately, however, reduced tape speed tends to involve a loss in high frequency reproduction, because the equivalent wavelengths recorded on the tape become comparable with the dimensions in the head gaps. If greater pre-emphasis and compensation is used in an effort to offset this loss, dynamic range and/or signal/noise ratio can suffer. In short, some performance has usually to be traded for the economy achieved by reducing the rate of tape travel.

These problems have been investigated at length in the Tape Recorder Laboratory of Tandbergs Radiofabrikk A/S, involving both techniques and

tapes. To appreciate what has been achieved it is necessary to take a closer look at the basic recording process.

Self-erasing. An important limitation is imposed by self-erasing, which occurs in the recording zone when the wavelength of the signal—to be recorded has diminished to the same order of magnitude as the width of the recording zone itself.

More precisely, the magnetic field will be completely or partly cancelled when the extension of the recording zone along the trailing edge of the recording gap becomes greater than or equal to half the wavelength of the signal to be recorded.

At a tape speed of 7½ips, the critical wavelength may occur at fairly high frequencies which are of no significance for reproduction of speech and music. At 3½ips and 1½ips, however, the cancelling effect occurs within the use-

ful frequency range when conventional recording techniques are used. It is therefore desirable to make the recording zone as narrow as possible (shorter extension along the tape) in order to be able to record at short wavelengths (high frequencies).

Several methods have been applied to accomplish this: (1) The design of the recording head has been improved, resulting in a narrowing of the recording zone. (2) It has been found that the frequency range can be extended by using tape with a thinner magnetic coating—the so-called triple-play tape. This is, unfortunately, accompanied by a reduction of the maximum available playback signal amplitude and, consequently, a relative increase in tape

Fritjof Brodtkorb is chief engineer of Tandbergs Radiofabrikk A/S. The paper was made available to ELECTRONICS Australia through Simon Gray Pty. Ltd., the distributors in Australia of Tandberg tape recorders. The article has also been published in a recent issue of the American journal "Audio."

noise. (3) A relatively new recording technique, cross-field bias, has been developed, giving a similar extension of the frequency range for normal coating thickness (long-play tape) without any increase of tape noise.

Reduction of Bias. For thick magnetic coating, the recording zone will contract if the bias amplitude is reduced. If the signal amplitude is maintained, however, this will cause distortion from the deepest parts of the coating, where the bias becomes insufficient. What is more, the distortion will affect the low and middle frequencies.

To minimise the effect, the signal amplitude must be correspondingly de-

thick coating because of the narrowing of the recording zone. Consequently, the frequency range is extended upwards, accompanied by a general decrease in signal level. The wider frequency range is thus obtained at the sacrifice of signal/noise ratio.

Figure 1 shows how the signal amplitude varies as a function of frequency for tapes with thick and thin coating. Curve 3 represents the thick tape with a coating of 12 microns (long-play tape), whereas curve 2 represents the thin triple-play tape with 6 microns coating thickness. Both tapes were optimally biased; that is, maximum available signal amplitude occurs at 600Hz for 3 ips. The curves were plotted using conventional recording

technique at a tape speed of 3 ips, and show the tape characteristic for constant signal recording current when played back through a flat-response amplifier. This enables the relative response for the two categories of tape to be read directly in decibels.

As shown, curves 2 and 3 intersect at 10,000Hz. At frequencies below the crossover, the thinner coating gives a loss of up to 6dB as compared to the thick coating. If the tape had been run at half the speed, the crossover frequency would have been reduced to 5,000Hz.

By switching to thin tape coating, the amplitudes of the higher frequencies are not reduced, and it might appear that a 6dB gain at higher fre-

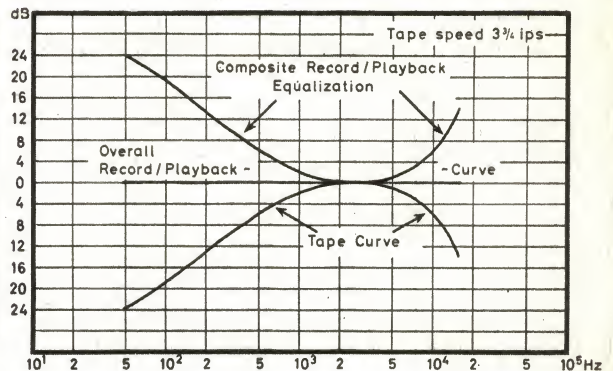
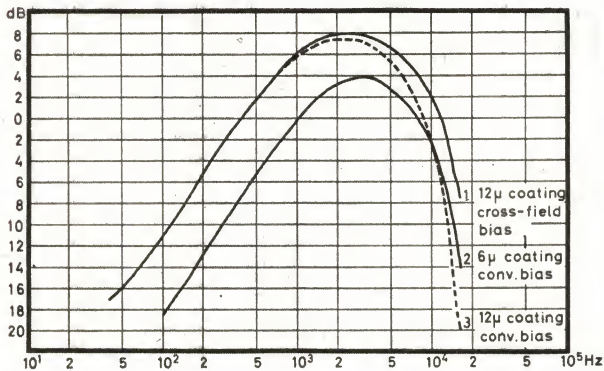

Figure 1 (left) taken at a tape speed of 3 ips, without compensation, shows that a recording on a thick coating with cross-field bias (curve 1) has a similar frequency response but a better signal/noise ratio than a conventional recording on thin coating (curve 2). Figure 2 (right) indicates how record and playback equalisation must complement the natural record curve.

creased so as to retain the same depth of penetration for the signal and bias fields. This will, in turn, reduce the available playback signal amplitude. It is thus obvious that recording at reduced bias utilises the magnetic coating poorly. It leads to less available signal relative to the tape noise, and has the further drawback that inhomogeneities in the coating are accentuated in the form of signal drop-outs.

Generally, it can be stated that the available recorded signal amplitude depends on the bulk of magnetic material being excited. In the lower and middle-frequency ranges, the signal increases proportionally to the coating thickness for all tapes in current use. The noise level is mainly determined by the surface structure of the tape and is, therefore, practically constant when the thickness of the tape is varied.

A possible method for increasing the bulk of material being magnetised would be to increase the width of the track from quarter-track to half-track. This will increase the signal amplitude by 6dB. The noise will increase only by 3dB because of its random frequency and phase relationships. The net gain in signal-to-noise ratio is, therefore, 3dB for a doubling of the track width.

Reduced Coating Thickness. In order to benefit from the possibilities associated with reduced bias and, thereby, narrower recording zone, thinner tapes with reduced coating thickness have been produced. These tapes will give a weaker signal in the lower and middle frequency range. In contrast, the higher frequencies will have larger amplitudes than those obtained with

**THE VITAL GRIP
IN PRECISION SOLDERING**

**FINE BALANCE AND LIGHTNESS
PRECISE FINGERTIP CONTROL
NO SWITCH TO DISTRACT**

See the range of Adcola "M" series solder tools illustrated in **ELECTRONICS** Australia September edition or write for a brochure to:

ADCOLA PRODUCTS PTY. LIMITED.
22 Fifth St., Doncaster, Vic. 3108. 848-3777.

ADCOLA PRODUCTS PTY. LIMITED.
17 Burwood Rd., Burwood, N.S.W. 747-1606.

T. H. Martin Pty. Ltd., 56-74
Edward St., Brisbane. 2-0555.

Everett Agency Pty. Ltd., 17
Northwood Street, West Leederville, 6007. W.A. Phone 84 137.

F. R. Mayfield Pty. Ltd., 11 Halifax St., Adelaide. S.A., 8-4131.

ADCOLA

SELECTED AS
Good Design
FOR
AUSTRALIAN
DESIGN INDEX
INDUSTRIAL
DESIGN COUNCIL
OF AUSTRALIA

**Peter Clark invites you
to visit his two floor
Hi-Fi and Tape
Recorder sound centre**



**THIS MONTH'S SPECIAL
SONY TC560 MUSIC CENTRE**



**4 Track 3 Speed Full Stereo
Frequency Response 20-21000 HZ at 7½ I.P.S.
20 Watts Total Music Power.**

**List price \$695 our price
\$459.95**

**Cash or terms, exclusive 12 month guarantee.
Free Membership to our Tape Exchange Club.**

**VISIT OUR NEW HI-FI SALON.
FOR THE BEST VALUES IN SOUND EQUIPMENT.**

**Match up your own system with exciting imported names
such as FISHER, LEAK, LANSING, AKAI, SANSUI, SONY,
SANYO, MONARCH, KENWOOD, WHARFDALE, SHURE,
SHARP.**

**PRICES OF COMPLETE SYSTEMS FROM
\$179.95. CASH OR TERMS.**

**Magnetic Sound
INDUSTRIES**

**387 GEORGE ST., SYDNEY 1 door 29-3371
from Kodak
Parramatta Branch, 20 Macquarie St., 635-0830 opp. Astra Theatre.**

quencies has been achieved as compared to the lower frequencies. This, however, is gained at the sacrifice of signal/noise ratio in the most important frequency range where a corresponding attenuation occurs, an unfortunate occurrence because the signal/noise ratio already represents a serious restriction on good sound reproduction.

The ideal solution would be to extend the frequency range at a given tape speed without deteriorating the signal/noise ratio. As explained in the following, this is possible by application of the cross-field bias recording technique.

With the conventional recording technique, the bias is superimposed on the audio signal within the one recording head.

With the cross-field technique, a bias field penetrates the coating from an extra head located on the opposite side of the tape. By carefully positioning the two heads, a bias field can be produced which is more nearly perpendicular to the surface of the tape and which produces a much narrower recording zone as a result. Full penetration can be maintained over the frequency range, even for a tape with a thick coating, while the frequency region at which self-erase occurs can be pushed upwards.

An improvement in frequency response is thus to be expected without the complications already mentioned—higher distortion or poorer signal/noise ratio.

The improvement is indicated in figure 1, where curve 1 shows the resulting frequency response for cross-field bias. Comparing it with curve 3 representing the same conditions for conventional bias, we find that the two techniques at a tape speed of 3½ips give equal amplitudes up to 1000Hz, where the curves diverge and show a difference of 5dB in favour of the cross-field technique at 10,000Hz. It can thus be stated that the cross-field technique gives the same signal amplitude at lower and middle frequencies, as compared with conventional recording, and a significant signal improvement at higher frequencies.

If we compare the curve for cross-field recording on long-play tape (curve 1) with conventional recording on triple-play tape (curve 2), we find the curves to be virtually parallel, with the latter 6dB down. This means that with cross-field bias, the frequency range for long-play tape with 12-micron coating is the same as that obtained with triple-play tape (6-micron coating) using conventional technique. The gain in signal/noise ratio, however, is directly expressed by the distance between the two curves; that is, 6dB.

To recapitulate, there are currently two ways to extend frequency range at low tape speeds. One way is to make the recording zone narrower by reducing the bias. This implies the use of thinner tape, leading to a subsequent decrease of the signal level and a corresponding increase of the relative noise level. The other possibility is to contract the recording zone by means of cross-field bias, whereby the thick tape can be used and the low noise level maintained.

Practical Cross-field. Before discussing design guidelines for cross-field

biasing, it is necessary to review how frequency characteristics of a tape recorder arise. Figure 1 shows that the frequency response of the head and the tape alone is far from being flat. The amplitude drops off radically at the upper and lower extremes of the frequency range.

At lower frequencies, the amplitude rolls off at a slope of 6dB/octave because recording has been done with a constant magnetic field. At the upper end, the signal drop is caused by the previously mentioned wavelength

pre-emphasis as desired. The only requirement is that the signal be reproduced correctly, using the standard playback curve.

Dynamic Range. If a reasonable quality is to be maintained, the tolerable amount of pre-emphasis at high frequencies with respect to the medium-frequency amplitudes is limited. The consequence of pre-emphasis is that the tape recorder will require — and accept — a reduced signal level in the pre-emphasised range in order to avoid tape saturation. A less

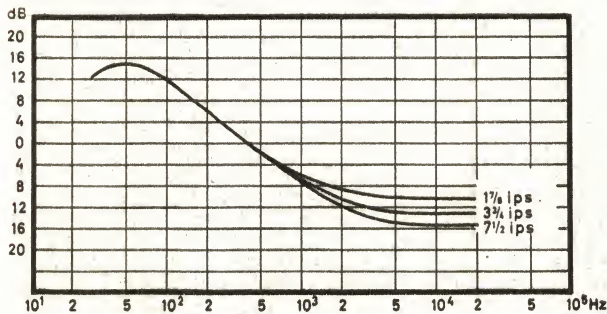
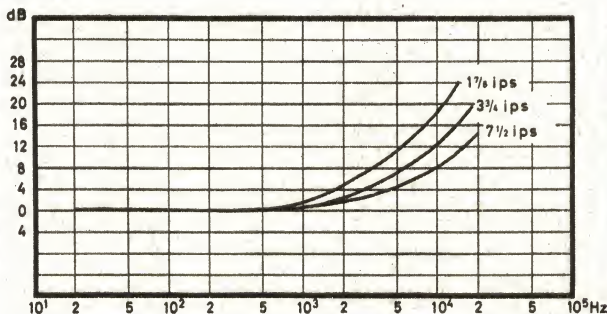

Figure 3: The standard playback equalisation curve for three tape speeds. The author points out that treble pre-emphasis, applied during recording, is at the discretion of the equipment manufacturers.

Figure 4: Typical treble pre-emphasis required by a recorder using the cross-field system. With conventional system, higher pre-emphasis may be required, with the danger of treble overload.



losses, together with head and tape losses. In order to compensate for this, the gains of record and playback amplifiers are increased at both ends of the frequency range. See figure 2.

In the lower frequency range, to the left of the tape curve peak, the playback amplifier gain is increased by 6dB/octave down, compensating for the negative slope of the tape curve shown in figure 2. The location of the peak depends on the tape speed. Therefore, the turnover frequency for the playback amplifier is set individually for each tape speed, as shown in figure 3.

The 3dB points for the frequency curves at the different tape speeds are determined by time constants specified in the international I.E.C. standard, as follows:

- 7 1/8 ips—70 μ s
(corresponding to 3dB at 2260Hz)
- 3 3/4 ips—90 μ s
(corresponding to 3dB at 1770Hz)
- 1 7/8 ips—120 μ s
(corresponding to 3dB at 1330Hz)

The dropoff at the upper end of the tape curve is caused by recording losses which can hardly be compensated for during playback because it would result in a severe increase of tape noise. In this frequency range, therefore, the signal level is raised before recording, thereby increasing the distance between signal and noise. This is the so-called pre-emphasis, which is not restricted by international standards. It is up to the individual manufacturer to develop and improve the recording technique; he can choose recording process and

pronounced pre-emphasis gives a wider safety margin against overload phenomena.

For this reason, the required pre-emphasis for obtaining the specified frequency characteristics of a tape recorder should always be stated. A flat frequency response up to 10KHz, attained by 10dB pre-emphasis, gives a far better dynamic range than if 20dB pre-emphasis were used for the same achievement.

Generally, the frequency distribution of music and speech shows that the amplitudes diminish with increasing frequencies, and it is fair to presume signal levels 10dB down at 10,000Hz as compared to 1000Hz. It will therefore be tolerable to increase the signal 10dB at 10,000Hz with little risk of tape saturation. This is supported by the fact that FM broadcast programs are submitted to such a correction before transmission. The purpose in this case is to raise the signal out of the background noise.

To nominate a limit of 10dB pre-emphasis at 10,000Hz is no longer an exaggerated quality requirement. The more modern types of music have, in fact, considerable sound energy within the higher frequency range. Therefore, recording pre-emphasis involves a definite risk of tape saturation unless the overall recording level is decreased, which will again lead to a less favourable signal/noise ratio.

Improvements at Various Tape Speeds. If in spite of the above comments a maximum limit of 10dB pre-emphasis is taken as a reference, it

AKG

KK 600

More details from
your dealer or

**Engineering
Products
Division**

<p>SYDNEY 88 6868</p> <p>BRISBANE 4 1631</p> <p>PERTH 28 8400</p>	<p>MELBOURNE 67 9181</p> <p>ADELAIDE 72 2366</p> <p>LAUNCESTON 2 1804</p>
---	---

REVOX

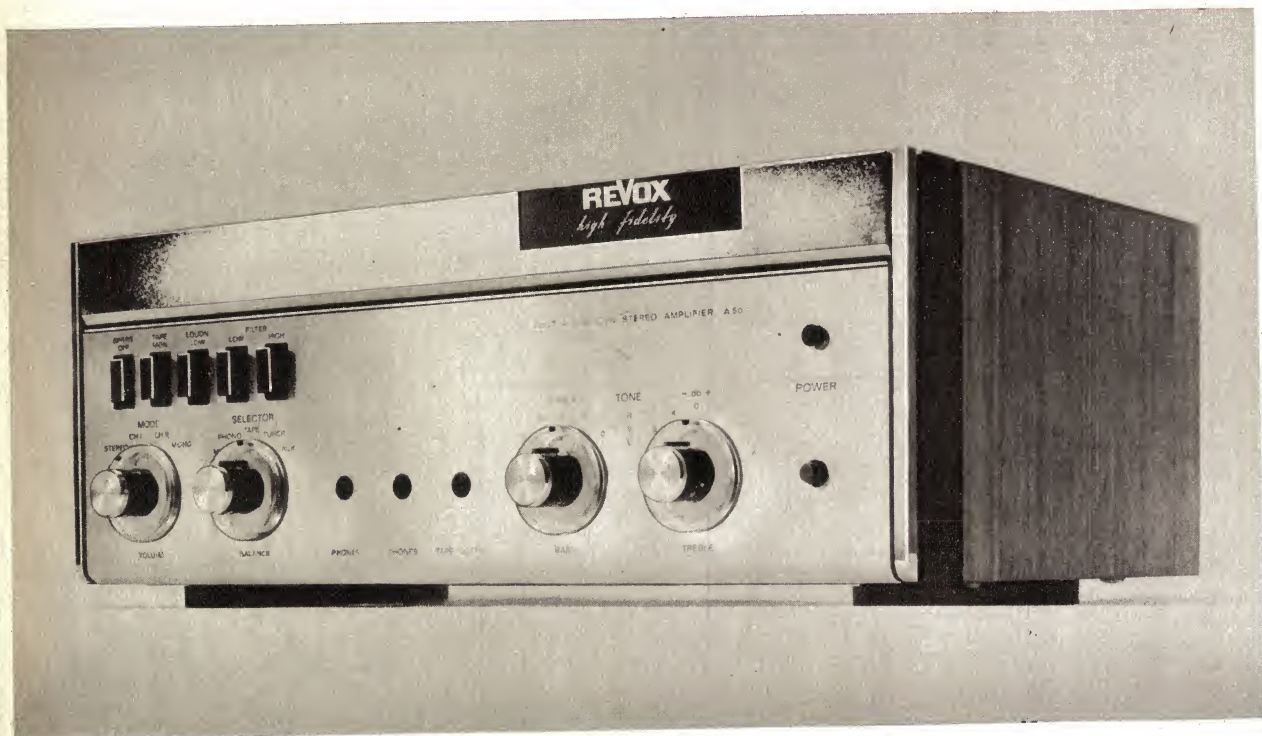

The ultimate in high fidelity systems



Engineering Products Division
422 LANE COVE ROAD NORTH RYDE NSW AUSTRALIA 88 6666

AMALGAMATED WIRELESS (AUSTRALASIA) LIMITED

MELBOURNE
67 9161

BRISBANE
4 1631

ADELAIDE
72 2366

PERTH
28 6400

LAUNCESTON
2 1804

is interesting to compare what can be achieved at tape speeds of 7½, 3½ and 1½ips by application of cross-field biasing, with the results obtained by using thinner tape coating.

We have already found that the tape curves for the two cases are virtually parallel, so that the necessary pre-emphasis curves will be equal. Thick magnetic coating will give the highest signal level and, consequently, the best signal/noise ratio.

As previously mentioned, recording losses associated with the width of the recording zone will not occur to any extent at 7½ips. This applies for cross-field as well as for conventional techniques in the relevant frequency range. At this speed, however, other frequency-dependent losses necessitate

ventional recording on thin tape. Standard I.E.C. playback curves are assumed. Cross-field recording on long-play tape at 7½ips is taken as the reference for tape noise.

Tape speed ips	Pre-emphasis at 10KHz	Tape noise level long-play tape cross-field bias	Tape noise level triple-play tape conventional bias
7½	8dB	0dB	+ 6dB
3½	12dB	+ 2dB	+ 8dB
1½	18dB	+ 4dB	+10dB

Figure 5 shows the resulting frequency curves obtained with the pre-emphasis and tape noise given in the accompanying table of playback data

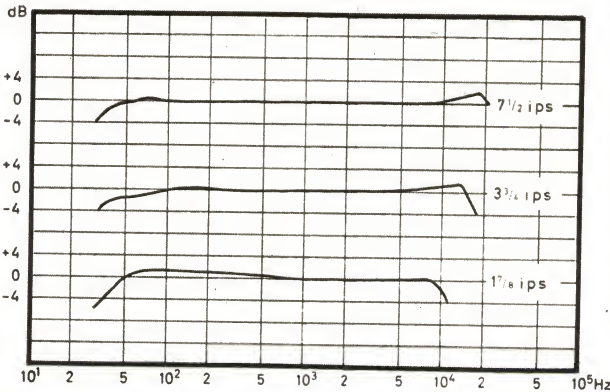

Figure 5: The overall record/replay curves for a typical recorder using the cross-field bias system. The merit of the curves must be assessed in relation to the signal/noise ratio attainable.

a pre-emphasis of 8dB. This means that the established 10dB pre-emphasis limit is nearly reached. Because the self-erasing problem within the desired frequency range at 7½ips does not arise, the cross-field will not alter the overall situation at this tape speed. The use of thinner tape will, however, give an increase of the tape noise by 6dB without any advantages in return.

If the tape speed is reduced to 3½ips, the wavelength-depending losses begin to appear. Conventional technique and thick tape require a pre-emphasis of 20dB at 10,000Hz. With cross-field technique, these losses can be reduced to a magnitude where only 12dB pre-emphasis at 10,000Hz is required. It can thus be stated that owing to the new technique, one has succeeded in keeping the wavelength losses at a level low enough to obtain a frequency response at 3½ips that is approximately equal to the one at 7½ips for conventional technique. This has been achieved without exaggerating pre-emphasis. The tape noise will, however, increase by 2dB because of the higher playback amplification required for a given signal level in the range from 2000Hz and upwards at 3½ips. See figure 3.

At 1½ips a still greater profit is gained by the new technique. A pre-emphasis that compensates for recording losses up to 10,000Hz will, with cross-field bias, have to be 18dB, which is nearly the same as needed for 3½ips by conventional biasing. Again, 2dB more noise will have to be accepted because of increased playback amplifier gain from 1300Hz and upwards. In other words, this will give 4dB more relative noise than is the case at 7½ips.

Conclusion. The following chart is a summary of playback data for cross-field recording on thick tape and con-

ventional recording on thin tape. The greatest advantage obtained by using cross-field recording on thick tape instead of conventional recording on thin tape is a reduction of tape noise. From the table it can be found that cross-field is 6dB better in this respect at all three tape speeds.

It may be of some interest to know the relative increase of the tape noise when the tape speed is reduced from 7½ips to 1-7/8ips. Taking the tabulated data for cross-field as a reference, we find that the tape noise will increase by 4dB for cross-field, as well as for conventional technique, due to the higher playback gain required at low tape speed.

Furthermore the tape speed reduction requires a 10dB higher pre-emphasis in order to maintain the frequency response up to 10,000Hz. Hence the overload safety margin in the upper frequency range is correspondingly reduced. The 8dB pre-emphasis at 7½ips will allow a program of the previously mentioned standard spectral-sound-energy distribution to be recorded at maximum level in the lower and middle frequency range, with minimal risk of saturation at high frequencies.

A pre-emphasis of 18dB is required at the reduced speed and, under the same conditions as above, the recording level at lower and middle frequencies must be reduced by 10dB in order to avoid saturation at high frequencies. The tape noise will then increase by a corresponding amount.

The increase of tape noise at low tape speed consists of one fixed amount caused by the augmented playback amplification and another amount that varies from 0 to 10dB, depending on the energy distribution of the program. The latter noise contribution is the

same for cross-field recording on thick tape as for conventional recording on thin tape because the pre-emphasis is the same in the two cases.

If the recorder has an instrument that indicates the maximum tolerable signal amplitude at any frequency, one will automatically set the record level according to the loudest tones. If the sound energy is concentrated at high frequencies, one will reduce the record level, and the relative tape noise will increase.

It can be stated that, for cross-field, the tape speed reduction from 7½ips to 1-7/8ips is accompanied by a possible tape-noise increase from a minimum of +4dB up to 4+10=14dB, depending on sound energy distribution. The corresponding figures when one switches from cross-field recording at 7½ips to conventional recording on thin tape at 1-7/8ips are: +10dB up to 10+10=20dB.

These viewpoints clearly show how important it is to consider frequency range, pre-emphasis, and tape noise as a whole when judging the quality of a tape recorder. Furthermore, these quality requirements must be considered in relation to the particular program to be reproduced.

GUEST ELECTRONICS

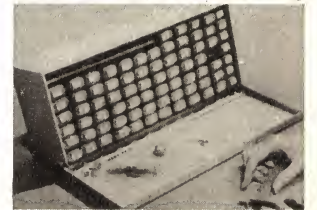

Resistor Development Pack

The first of a series, this miniature carbon film resistor development pack has been designed to meet the need for quality resistors in a comprehensive range of ohmic value, at an economic price. It is convenient and clearly labelled and will appeal to the engineers and laboratory staff requiring a range of resistors for prototype work. Each tube contains 25 resistors of the same ohmic value, the complete pack having 1925 resistors. The development pack is also suitable for "select on test" assembly, maintenance and general repair work.

\$75.00 plus Sales Tax

For further information contact:
ELMEASCO INSTRUMENTS PTY. LTD.,
P.O. Box 334, Brookvale, 2100, 93-7944,
P.O. Box 213, Mt Waverley 3149, 82-6159

POWER SUPPLIES

Do you LUST for power! Do you YEARN for complete control! Then, join the race for POWER with our laboratory and experimenter's D.C. regulated, protected power supplies . . .

We have three articles:

Article 3 \$1.50 0-62V, 3A heavy-duty, completely protected and fully metered, regulated supply (11 pages).

Article 2 \$1.00 2.40V, 1A test — bench power supply — protected, metered and regulated to 1% — cheap to build, too! Article 1 (2nd Edition) \$0.50: Seven complete power supply designs (including battery savers for radios and tape recorders) — some variable, some fixed — ranging from 1 to 25V, and up to 1A! All are regulated and very economically protected as well!

These articles are an experimenter's paradise — full of information on how to get the most out of your parts, and they are a real circuit library.

And please, please, don't show them around — make the others buy their own copies!!

Send to ES & I ELECTRONICS,
81 Prospect Rd, Summer Hill,
N.S.W., 2130.

SASE (large) for our catalogue of heat-sinks, transistors and other stuff.

**K
I
T
S**

Public Address Units — Geiger Counters — Metal Locators — Decade Boxes — Mixers — Battery Chargers — Oscillators — Bridges — Parts Supplied for Projects in Electronics (Aust.), Wireless World, Practical Wireless, Electronics World, Electronics Illustrated, Practical Electronics, etc.

**K
I
T
S**

**P/M
124**



1968 Solid State. V.T.V.M.
ELECTRONICS (Aust.), Dec., 1968.

BATTERY CHARGER 1A
ELECTRONICS (Aust.), Feb., 1966



**PLAYMASTER 116 and 117
and 125 GUITAR AMP.**

Electronics Australia
June 1967 — 40 watt
July — 1967 60 watt
July 1969 — 50 watt

3-BAND SHORT-WAVE CONVERTER
ELECTRONICS (Aust.), May, 1966.

LAB QUALITY

Regulated Power Supply (0-30v)
ELECTRONICS (Aust.), Sep-
tember, 1968.

1966 R/C Bridge
May, 1966.



Excellent frequency response. Low distortion figure. High input sensitivity. All controls self-contained. 10 watts per channel.

PLAYMASTER STEREO 10 PLUS 10
COMPLETE KIT \$86.85



**PUBLIC ADDRESS and
GUITAR AMPLIFIERS**

10, 25, 50 and 100 watt
units



3-BAND DOUBLE-CHANGE RECEIVER
ELECTRONICS (Aust.), April, 1966.

1966 3in CRO
ELECTRONICS (Aust.), May, 1966.

Playmaster 122
Program Source.
Electronics (Aust.),
August, 1968.



FOUR-CHANNEL AUDIO MIXER
ELECTRONICS (Aust.) Feb., 1966 & 1967

3-BAND 3-RECEIVER
ELECTRONICS (Aust.), Nov., 1966.

**TRANSISTOR MILLIVOLT
METER**

Electronics (Aust.),
May, 1968.



**Enjoy your
leisure time
and build**

PLAYMASTER STEREO 3 PLUS 3
COMPLETE KIT \$54.25

**MAJOR STOCKISTS OF ALL GENERAL RADIO & ELECTRONIC COMPONENT
PARTS -- YOU NAME IT -- WE WILL QUOTE**

VALVES — TRANSISTORS — ZENER & POWER DIODES — SEMI-CONDUCTORS
— DIACS — TRIACS — S.C.R.'S. — 1/C'S. SPEAKERS — MICROPHONES —
COILS — IFT'S. TRANSFORMERS — INST CASES — METALWORK. PLAYERS
& CHANGERS — METERS — RELAYS — CONDENSERS — RESISTORS — BEZELS
— STYL II — CARTRIDGES — RECORDING TAPE — PROBES — INSTRUMENTS
— POTENTIOMETERS — CRYSTALS — FERRITE BEADS — CORES — BALUNS
— TERMINALS — CO-AXIAL PLUGS & SOCKETS — MULTI CONNECTORS —
PRINTED CIRCUIT BOARDS — COPPER WINDING WIRE — ETC. — ETC. —

Phone 63-3596

**E. D. & E. (SALES)
PTY. LTD.**

Phone 63-3596

232 FLINDERS LANE, MELBOURNE, VICTORIA 3000

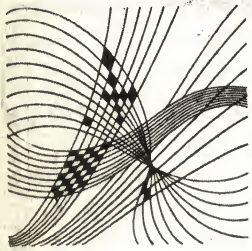

CLASSICAL RECORDINGS

Reviewed by Paul Frolich

MAHLER—Des Knaben Wunderhorn. Elisabeth Schwarzkopf; Dietrich Fischer-Dieskau; London Symphony Orchestra; Conductor George Szell. HMV Angel Stereo SAN 218.

Here is yet another version of the shortened set of "Wunderhorn" songs—12, as on the Janet Baker/Geraint Evans set, omitting "Urlicht" which was rightly included on the old Reh-fuss-Forrester disc as well as on the recent Ludwig-Berry one, which Leonard Bernstein accompanied on the piano. Although there are twenty-one songs in the complete cycle, the 12 offered here are doubtless the finest among them and arguments about the possible inclusion of some others, though they will continue for years, seem pointless.

More important than the number of songs presented is the undoubted fact that this is THE best version currently in existence of this glorious song cycle. The "Wunderhorn" songs, blending child-like naivety with the utmost aesthetic complexity Mahler was capable of, are possibly the music best suited for bringing new listeners into Mahler's fold. I could not imagine the work being more beautifully performed; there will be a few old Mahler fans who'll stick to their ancient Poell disc, but it cannot really be compared to this at all.

In order of excellence, I would name the orchestra, Schwarzkopf, Szell and Fischer-Dieskau. As far as orchestral playing is concerned, I know of no other Mahler recording which can touch this performance in sonority, accuracy and clarity. Miss Schwarzkopf's singing is so close to absolute perfection in each of the songs she undertakes that it would be churlish to try and find fault with either her singing or her interpretations.

Mr Szell, who has been making a strong bid to be recognised as a Mahler specialist, directs the music with minute care and to wonderful effect. Barbirolli, in a recent interview, accused present-day conductors of excessive attention to detail; it is attention like this, however, which makes Szell's Mahler so much more convincing than Barbirolli's. It is the loving attention given by the conductor in the same way as it was, after all, given by the composer, who endlessly polished, refined and improved his scores.

Fischer-Dieskau, although he sings as beautifully as ever he did, provides the only small disappointment. For most of the set he, too, does all anyone could wish for, but there are awkward moments, particularly in the opening "Revelge," where he tends to dramatise and allows the operatic actor

to take over from the usually discreet lieder singer. This was a mistake and a pity it should have happened—the orchestral score is more than dramatic enough—but these are very minor lapses which do not mar this very wonderful disc; in truth, many listeners may well disagree with me on this point.

A word must be said about the recording itself. Although HMV-Angel do not, as is the custom of some other companies, name their recording engineers and technical supervisors, they must be given a special vote of thanks for the truly superb balance and life-like reproduction. This, not least, firmly establishes the disc as the best Mahler recording in a long, long time.

★ ★ ★

ALFRED HILL—Concerto for Viola and Orchestra; Robert Pikler, viola; Sydney Symphony Orchestra; conductor Sir Bernard Heinze.

JOHN ANTILL—Concerto for Harmonica and Orchestra; Lionel Easton, harmonica; Sydney Symphony Orchestra; conductor John Antill. RCA Stereo SL 16372.

Australian music is really getting a shot in the arm from RCA! It is only a few weeks since their issue of two Australian trumpet concerti, played by John Robertson. Now they are following up with a disc that can be welcomed enthusiastically on purely musical grounds. I have reason to believe that RCA may continue with their policy of issuing selected local works and performances and it is my hope that they will, in time, set up adequate distribution arrangements overseas as well.

Hill's viola concerto is probably unique among Australian compositions; it has now been recorded twice! In 1962, it appeared on a monophonic HMV release, also played by Pikler and the SSO, recorded during a concert under the baton of Henry Krips. Although it was a poor recording in some minor details, I have derived much enjoyment from it over the years.

The new recording is made under greatly superior acoustic conditions (NOT in the Sydney Town Hall!) and the recorded stereo sound is, of course, incomparably better. In addition, Mr Pikler's fine playing has been further honed down; his viola seems to have obtained a new dimension of mellowness and a bigger tone. He plays the rhapsodic Andantino with deep feeling, the Finale with something approaching gypsy bravura.

This concerto is, and always has been recognised as being, an excellent example of Alfred Hill's fine musicianship and melodic inventiveness. Being a violinist himself, he has given us

one of the best works in the instrument's limited solo repertoire. It is a romantic concerto of the best kind, soundly orchestrated and it could hardly have found a more eloquent interpreter of its beauties than Mr Pikler.

While the Hill concerto is almost thirty years old, and in idiom much older than that, John Antill's concerto for harmonica is a brand-new work, especially composed for the purpose of displaying the instrument's great versatility when assisted by modern amplification methods. It is, I think, the most successful of Mr Antill's scores of recent years, not only by the skill employed to display the harmonica's interesting timbres, but also in sheer inventiveness and rhythmic variety.

The Sydney Symphony Orchestra, in both works, plays in top form, both of them are quite excellently conducted and the recorded sound is about the best I have yet heard on any disc made from a locally produced tape. I cannot speak too highly of this issue.

★ ★ ★

STRAUSS—Ariadne auf Naxos (complete). Gundula Janowitz, James King, Teresa Zyllis-Gara, Sylvia Geszty, Hermann Prey. Dresden State Opera Orchestra; conductor Rudolf Kempe. HMV Angel Stereo SAN 215-7—3 discs, boxed, with bi-lingual libretto.

The only time I saw "Ariadne" on stage, under the clear night-sky of the Festival Opera at Aix-en-Provence in 1966, I became so utterly enthralled by it as a theatrical entertainment that I could not pay sufficient attention to the music itself. It was a superb performance, with the regal Regine Crespin as Ariadne, every inch a prima donna, and with Tatyana Troyanos making her international debut in a stunning characterisation of The Composer, the very part in which Lotte Lehmann first burst upon the operatic scene.

Listening to this superb Angel set has afforded me a better appreciation of the score, probably Strauss' most entrancing one after "Rosenkavalier." The music of this delightful opera, using only a small chamber orchestra, ranges from folksy lullabies to the most grandiose of Wagnerian love-duets.

The performance itself is, I believe, as good as one is ever likely to hear anywhere. Mr Kempe appears to be the perfect conductor for Strauss, reacting to every allusion and bit of whimsy with good humour. His tempi and overall grasp of the work are excellent and he gets wonderful sound from the Dresden musicians who, of course, have a strong tradition of Strauss behind them.

The singers, without exception, are excellent. Miss Janowitz was a splendid Sieglinde in Wagner's "Walkure," another part she shares with Crespin, and her Ariadne is full-voiced, mellifluous and enchanting. James King gives the best performance of his career as Bacchus and Miss Geszty, as Zerbinetta, does not fall victim to the shrillness which often mars this shockingly difficult role. Apart from them, the finest singing is contributed by Prey, who revels in the smallest part of Harlequin.

"Ariadne" is a far from easy opera on any count and that it should have succeeded so brilliantly is almost miraculous. The old Bohm version was

very fine too, but not as magnificently sung and certainly not as spectacularly recorded. For sound, as well as excellence of performance all-round, this set will be hard to beat.

★ ★ ★

DELIBES—Lakme (complete). Joan Sutherland, Gabriel Bacquier, Jane Berbia, Emile Belcourt, Alain Vanzo, Gwennyth Annear, Monica Sinclair, and others; Monte Carlo Opera Orchestra and Chorus; conductor Richard Bonyngue. Decca Stereo SET 387-9. 3 discs, boxed, with libretto and illustrated booklet.

I must confess that I approached this opera with some trepidation. All I knew of it was the famous "Bell Song" and I wasn't sure that I wanted to know any more of that diet. After this, it was a pleasant surprise to discover that the score contains a great deal of fine music, some of it much more meritorious than that famous aria which, incidentally, proves to be dramatically quite justified in the context of the drama. "Lakme" is, in fact, quite a worthwhile opera, at least on disc and it did not really need the very elaborate article in the composer's defence which is published with the libretto. The music is a far more eloquent argument than any musicology.

This opera is, principally, Sutherland's and she sings superbly well, even with utter ease in the highest range; her singing is so great a delight that one even forgives her very poor pronunciation of consonants. All the others, whose parts are relatively insignificant, sing excellently also; Lakme's foil, the English officer Gerald, is beautifully sung by Alain Vanzo, who fits the requirements for a semi-falsetto French tenor very well indeed.

Although, as I said, everyone does very well—even to the usually rather mediocre Monte Carlo Orchestra—the real hero is, of course, Mr Bonyngue, who seems to have the whole of the score right at his finger-tips and I should think it is entirely due to him that the opera emerges as a successful piece of dramatic entertainment. In addition, mention must be made of the very brilliant recorded sound.

★ ★ ★

MOZART—Cosi Fan Tutte (complete). Leontyne Price, Sherrill Milnes, Tatyana Troyanos, George Shirley, Judith Raskin, Ezio Flagello; New Philharmonia Orchestra; conductor Erich Leinsdorf. RCA Stereo LSC 8011. 4 discs, boxed, with libretto and illustrations.

Because of its slightly fatuous libretto, this opera is not always regarded as the equal of Mozart's other stage works. Musically, however, it really is a most remarkable piece and it is also fascinating to watch on stage, with its constant shift in action. It is unusual in giving about equal opportunities to each of the six characters, dramatically as well as in the provision of singing material.

That musicians like the work is proved by the number of times it has already been recorded in its entirety; I rather think that this performance is the best one on disc yet. Casting has been so brilliantly successful that each one of the six singers is fully able to exploit the opportunities provided by Mozart and his librettist. In this regard, the 1963 Bohm version was almost as

New Arrivals!

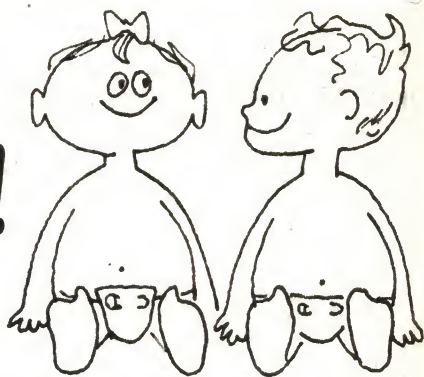

TAPE RECORDER VALUE



Arrow Electronics are proud to present the

DUAL CTG 28 Tape Deck

From the maker of turntables that have become a standard in Australia.

Check these features.

- ★ 20-21,000 CPS frequency response
- ★ Stereo or Mono record and playback
- ★ 2 superb VU meters
- ★ monitor facility
- ★ Fine German craftsmanship

At last NEW from Thorens

TD125 Thorens first electronic turntable and the latest addition to their range of fine turntables. 16, 33 1/3 and 45 r.p.m. Transistor governed 16 pole synchronous motor. Electronic speed selector. Variable control \pm 2 per cent on all speeds. Illuminated stroboscope. Built in levelling device. Dynamically balanced 7 1/2 lb 12" turntable. Belt drive system. Interchangeable pick up mounting board. Wow and Flutter \pm 0.08 per cent. Rumble — 68dB.



Write or call for full details and "Arrow Quote."

AE **ARROW ELECTRONICS** **342 Kent St.**
SYDNEY
NOW AT 29-6731

Opposite 2UW between KING & MARKET Sts.

you've never heard it so good



AR25

new Rola 65MX wide range and 65M woofer hi-fi speakers give exceptional performance - way down low, below 35 Hz*

* Measured in accordance with RETMA standards

Hi-Fi enthusiasts never had it so good. In their new series 65M speakers Rola has packed in more performance, more quality in less space for less cost. Now you can range from 30Hz to 14,000Hz in one compact, 6½" diameter speaker with the high fidelity you could normally expect only from a much larger unit. Truly, these speakers sound great:

High compliance suspension, with large diameter spider and synthetic rubber pneumatic rim for large linear excursions. Specially treated cone to give sharp cut-off at crossover frequency; aluminium voice coil former for long-term stability and increased power handling.

Power handling: 65MX — 7 watts RMS
65M — 10 watts RMS
Frequency: 65MX — 30Hz to 14,000Hz
65M — 30Hz to 5,000Hz

ROLA 65MX — a twin-cone, medium-throw loudspeaker designed to provide a compact, single unit, wide-range sound system.

ROLA 65M — a medium-throw loudspeaker designed for use as a woofer in two-speaker enclosures. The new Rola 3DX speaker is an ideal tweeter to use with the 65M for extended upper frequency response.

Enclosure plans specially prepared by Rola are available on request for both speakers.



PLESSEY
Rola



Plessey Rola Pty Limited
The Boulevard Richmond Victoria 3121
Telephone 42 3921 Telex 30383
NSW PO Box 2 Villawood 2163
Telephone 72 0133

successful, with equally well-matched singers, but the new set sports a vastly superior recorded sound, putting it well ahead.

To me, this recording was particularly exciting because of its casting of Tatyana Troyanos, a statuesque young New Yorker of Greek parentage, in the part of Dorabella. I happened to be present when, in 1966 this virtually unknown singer electrified a whole audience by her singing of The Composer in Strauss' "Adriane"; this recording confirms my earlier expression and places her firmly on a level with the great Leontyne Price herself.

This opera is a true comedy of manners and the production has given much attention to the humour and absurdity of its situations, greatly to the advantage of the comic characters, superbly sung by Raskin and Flagello. In addition to all the first-rate singing, the orchestra is also outstanding. The pace and tempo set by Mr Leinsdorf could not be better and the quality of the recorded sound is certainly among the best I've yet heard.

★ ★ ★

BRAHMS — Symphony No. 1 in C minor, op. 68. Vienna Philharmonic Orchestra; conductor Sir John Barbirolli. HMV Stereo ASD 2401.

However much one may admire Barbirolli's musicianship, this certainly is not the Brahms reading enthusiasts for "German" music have been waiting for. It has none of that typically German touch which conductors such as Klemperer or Dean Dixon employ; in fact, this is Brahms for such listeners as your reviewer, listeners who really don't care for Brahms' earnest and didactic ponderousness.

Barbirolli's interpretation of the fine score, though admittedly lacking in some of the potential excitement and dramatic build-up, compensates by being decidedly genial, in the Viennese "gemutlich" tradition which Brahms was no stranger to. Some might find this reading a little rambling, but I think this approach is wholly justifiable here, far more so than it was in Sir John's Mahler performances.

Whatever you may think of the interpretation, any listener will agree that the playing of the Vienna orchestra is simply glorious and the quality of the recorded sound is among the best to come out of the justly famed Vienna studios.

★ ★ ★

MOZART — Arias from The Magic Flute, Don Giovanni, Così Fan Tutte, The Marriage of Figaro. Hermann Prey, baritone; Dresden State Orchestra; conductor Otmav Sultner. World Record Club Stereo S/4350.

It is not unusual to find in this type of recorded recital, an orchestra and conductor somewhat inferior to the star soloist and a recording balance which heavily favours the singer. This recording, originally issued on the English Columbia label, is a laudable exception. I have heard Prey and know that he is indeed an exceptionally fine singer, invariably a dramatic success and ever at his ease with Mozart.

It is, therefore, not surprising that he does very well in what can be described as an exceptionally tasteful recital. All the same, Prey's success is not as absolute as I might have expect-

ed. The Don's serenade from Act 2 of Don Giovanni seems to have caused the singer some slight discomfort and could not properly be fitted into his vocal range, which has generally been regarded as a very wide one.

With this single reservation, I can only acclaim Prey with enthusiasm for a series of very fine performances. The Dresden Orchestra, very rarely heard on disc, provides some uncommonly stylish Mozart playing and Mr Sultner's direction combines firmness with agreeable discretion. The recorded sound glows richly and helps to make this a very enjoyable occasion in every way.

★ ★ ★

BLISS—Meditations on a Theme by John Blow; Music for Strings. City of Birmingham Symphony Orchestra; conductor Hugo Rignold. World Record Club Stereo. S/4535.

This is another of those odd cases where music is not released on a major commercial label because it is considered to be too esoteric and lacking in audience appeal, yet is then issued by World Record, a label which is generally assumed to represent middle-of-the-road collectors. Just now, Sir Arthur Bliss' music is rather in the doldrums and it was indeed a pleasant surprise to receive, this disc, containing two very widely differing works, neither of which I had heard before.

The "Music for Strings" was first performed at the Salzburg Festival of 1935 and although it is a very competently written piece, and wholly attractive, it does rather date. It is recognisably English music, very obviously of the nineteen-thirties and it offers absolutely nothing that is either new or identifiably peculiar to Bliss.

The "Meditations" are a vastly different matter. Using, as the title states, a theme by the seventeenth-century composer John Blow, the piece has, in addition, a detailed program based on the 23rd Psalm. Written for a very large orchestra, the music is infinitely varied, full of quite startling inventions and it could, in a purely English context, be described as "modern"; there is no crude adherence to any current fads discernible, however, and no one

hearing it would easily guess its vintage as being 1955.

It is always good to hear something both different and successful and I found this music quite exciting, always interesting and wholly satisfying. The Birmingham Orchestra, though not really good enough for the delicate shades of the string piece, acquits itself very commendably in the larger work and I found Mr Rignold's interpretations entirely convincing. The recorded sound is very good and well balanced and taking this with the music itself and the standard of performance reached, we have an unusual disc worthy of being commended.

★ ★ ★

STRAUSS—Ein Heldenleben (A Hero's Life). Los Angeles Philharmonic Orchestra; David Frisna, solo violin; conductor Zubin Mehta. Decca stereo SXL6382.

Since I had not heard this tone poem of Richard Strauss for a few years I found myself listening to it with fresh interest. It is the most grandiose of the composer's orchestral pieces, lusciously scored for just about everything except a grand organ. In view of the fact that Strauss claimed autobiographical status for this music, we must concede it a degree of pomposity and conceit.

Taken on its merits alone, this turns out to be very attractive music and the score, dating from 1898, contains considerable evidence that Strauss was well aware of the revolutionary changes that were to overtake European music in the next two decades. If he chose, none



**PRINTED CIRCUITS
DESIGN &
PRODUCTION**

WE MANUFACTURE P.C. TO MEET THE HIGHEST STANDARDS OF QUALITY. SPECIALISE IN LAYOUT, ARTWORK, ALL TYPES OF PRINTED CIRCUITS, CODING AND SPECIAL FINISHES.

PHOTRONIC Tel. 937664

515 PITTSWATER ROAD, P.O. BOX 195, BROOKVALE, N.S.W. 2100

ACOS

REPLACEMENT LONG LIFE CARTRIDGES

Acos 90 Series — a family of pick-up cartridges covering all the main types needed today, each fitted with Diamond Stylus at no extra cost.

- GP91-1 MONO CRYSTAL Stereo Compatible .. \$5.95
- GP91-2 HIGH OUTPUT MONO CRYSTAL Stereo Compatible .. \$5.95
- GP92 MONO CERAMIC Stereo Compatible .. \$6.55
- GP93 STEREO CRYSTAL .. \$7.55
- GP94-1 STEREO CERAMIC .. \$7.95
- GP94-5 STEREO CERAMIC FOR TRANSISTOR AMPLIFIERS .. \$8.95



fitted with
DIAMOND
Stylus at no extra cost.

TECHNICAL DATA SHEETS SENT FREE ON REQUEST

Sole Australian Agents:

AMPLION (A'SIA) PTY. LTD.

29 Majors Bay Rd., Concord,
Sydney, N.S.W. Phone 73 1227

"SO YOU'VE HEARD IT ALL" YOU'LL CHANGE YOUR MIND ONCE YOU HEAR THE MAGNIFICENT STANTON 681/EE

The fabulous Stanton 681 — the latest and most brilliant addition to the "Calibration Standard" Series. High compliance, low mass and superb channel operation, result in the Stanton 681, being hailed throughout the world as the top cartridge on the market. The mighty 681 is designed for low distortion tracking with minimum stylus force, regardless of the recorded velocity or the distance of the groove from the centre. It comes complete with individually calibrated performance data. Stanton 681T (.0007 conical stylus) \$55.00; Stanton 681/EE (.0002 x .0009 elliptical stylus) \$60.00; also available:— Stanton 500/A (.0007 stylus) \$25.00; Stanton 500/E (elliptical stylus) \$35.00



THE INCREDIBLE ACOUSTIC RESEARCH TURNTABLE

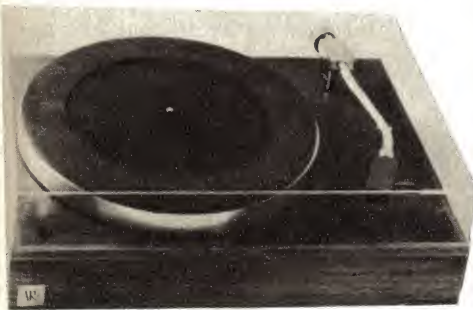

'A turntable years ahead of its time!' . . . the result of years of research. Since its introduction, the AR turntable has had a profound effect on both design and performance standards of home record playing equipment — yet it remains alone in the field! Unique, because it combines broadcast equipment performance, simplicity of operation and low cost. Its synchronous motor and belt drive make the AR turntable **INAUDIBLE** during operation. It has unusual stability — it is **INSENSITIVE** to floor vibrations or acoustic feedback. List price \$220 **FULLY GUARANTEED FOR 3 YRS.!**

When you visit our showrooms, you'll be enthralled by a magnificent hi-fi sound demonstration. And when you buy, you know you're choosing from one of the finest selections of sound reproducing equipment in Sydney. Listen at leisure to one of our best selling "value-for-money" combinations, carefully selected from the world's leading manufacturers.



1. PE2020 Turntable (Germany).
2. Stanton 500/E Cartridge (U.S.A.).
3. Sansui AU555 Stereo Amplifier (Japan).
4. Acoustic Research Model 4X speakers (U.S.A.).

The price for this superb combination is \$610.00, including delivery and installation and covered by a comprehensive and personal manufacturer's warranty.



193 CLARENCE STREET
SYDNEY. 29-6681

A DIVISION OF:
W. C. WEDDERSPOONS
DISTRIBUTORS OF:

Acoustic Research—Bose Corp. Speakers—Monarch—Stanton—Telefunken

the less, to confine himself within certain already dating conventions, this piece proves that he did so deliberately and not merely from a lack of awareness.

Being somewhat grandiloquent, the music suits the extrovert Zubin Mehta ideally. He turns in a simply magnificent and rousing performance, splendidly carried out by his orchestra, which still constantly improves. The solo violinist acquires himself brilliantly and the shining Decca sound, achieved by the English team of engineers which seems to shuttle back and forth across the Atlantic, is all anyone could wish.

★ ★ ★

CHOPIN—Sonata No. 2, B flat minor, op. 35 ("Funeral March"); Four Ballades. Witold Malcuzyński, piano. HMV Stereo SOELP-9385.

This disc, containing an unusually generous quantity of music, and at a bargain price, has a lot to recommend it—if you happen to like Malcuzyński. I admit that I do like him, but I am aware that many of the Chopin specialists compared his version of the Ballades (originally issued about five years ago) unfavourably with Rubinstein's.

Malcuzyński is not just another piano virtuoso, but an original thinker and a fine artist and as his technical ability has never been challenged he should, I believe, be afforded the privilege of creating his own interpretations, however unorthodox they may be at times.

As these are reissues, none will expect a modern, perfect sound; the age of the recording is apparent, particularly in the sonata, where a good bass is ill-matched with a rather brittle treble. Despite this, the disc does not sound disagreeable and I found much of musical interest in it; it was a pleasure to hear Malcuzyński's excellent technique once again, allied with his strong, but poetic, interpretations.

★ ★ ★

A WAGNER FESTIVAL—Tristan und Isolde: Prelude and Liebestod. Flying Dutchman: Overture. Mastersingers of Nuremberg: Prelude, Act 1. New Philharmonia Orchestra; conductor Carlos Païta. Decca Stereo Phase Four PFS-4158.

The jacket of this disc sports a gold seal proclaiming "Grand Prix du Disque" and it is issued on the electronically prestigious "Phase Four" label; all of this points, of course, to a stereo showpiece and one might be inclined to regard it more in this light and to take less notice of the music in such an instance.

The recorded sound is, in fact, of the utmost brilliance and quite uncommonly lively; however, be warned that, to enjoy it as it should be enjoyed you need a really large room and my experience showed that listening with comfort could be obtained only at a distance of at least 15ft from my speakers. At that distance it became truly wonderful and allowed full appreciation of the orchestra's quite excellent playing.

Mr Païta's direction is certainly very sound and he is clearly satisfied to give Wagner his head. The music is, of course, ideally suited for large-scale stereo effects and if your equipment is good enough and you do not yet have these pieces in your collection, I recommend this disc without reservation. ■

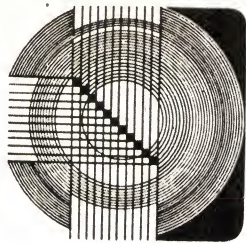

DOCUMENTARY RECORDINGS

Reviewed by Glen Menzies

THE BIG HEWER: A Radio Ballad by Ewan McColl, Peggy Seeger and Charles Parker. Produced by Charles Parker. Recorded with the co-operation of B.B.C. Radio Enterprises Ltd. Argo Mono RG-538.

This is the last of a group of four Radio Ballads released on the Argo label from a total of 10 or more which were originally broadcast by the B.B.C. "The Big Hewer" was made in 1961 and the production team recorded their material among the miners in Durham and Northumberland (the classic area of British mining going back to the Elizabethan era) in Glamorgan, Wales, and in Nottinghamshire where some of the modern pits are to be found.

In a cover note written in 1967, Charles Parker says that since the program was made some of the older mines have closed for good and quite a few of the older miners have died. He graphically describes a visit to the ancient "Adventure" pit in Durham:—

"There we stumbled and crawled mile after mile through black, stinking water to reach the workings—to see suddenly a putter loom up with his pony and loaded tram. Almost naked he was and black, and uttering the near animal noises of a man in the grip of extreme frustration and discomfort as he conjured his pony along a distorted roadway; this fantastic figure, coming along in the weird old mine . . ."

Strange indeed, and what a contrast to the awesome sounds of high speed machines at work in the more modern pits. But it also helps to highlight just how much the hard toil that is still the lot of many miners, has made the job so basically unattractive to a later generation. At the moment however, there are over 300 pits still in use in Britain with 300,000 men at work in them, in what remains to this day one of the strangest of all working environments.

"The Big Hewer" is a tribute to all miners, wherever they may be, who share the same dangers of entombment and suffocation. The miner of the title is an archetype, an ace collier (there was one in every pit) who hewed the coal by hand and was famous for his phenomenal output. With the coming of mechanisation he has now largely passed into myth but as we hear in the voices of the men, there is still a little of the archetype in all of them.

The people heard in this radio ballad speak with eloquence of the singular existence of the miners and with a strong sense of history. So fascinating are they that I would have liked more

of the purely spoken word without the many breaks for song. It is a case where the well-tried format interferes with the basic documentary content. That said, however, what remains is a very well made program.

★ ★ ★

THE WITNESSES: Written by Clive Sansom. Read by Ruth and Clive Sansom. Argo Mono DA 87.

This is the gospel story in verse form from a series of 35 poems based on the life of Christ. Written in 1950, "The Witnesses" was awarded a poetry prize in the Festival of Britain, appeared in *Poems 1951* (Penguin) and has been reprinted six times since then. Mr Sansom's later verse includes, "The Cathedral" written for the 700th anniversary of Salisbury Cathedral.

After listening to "The Witnesses," it is clear that Mr Sansom's aim is to write for the age we live in: the lines have strength and dignity and a strong sense of history, of time and place. The poems are clearly separated from each other, but the overall aim is to add to the cumulative effect as each of the witnesses contributes to the total picture of Christ's journey from birth to crucifixion.

Ruth and Clive Sansom, as the readers, have obviously read these often, the atmosphere is that of a performance of a well-loved work. The Sansoms are well known for their educational work in the field of spoken English and have a strong link with Australia through time spent in Tasmania. Joint recitals and broadcasts have helped to make them even better known in the world of the spoken word.

Side 1 of the album is shared between the readers, and I must say that my definite preference is for Clive Sansom, his being a more natural style but with a strong dramatic sense. This is a considerable asset in helping to delineate the differences in character of witnesses such as Herod, The Centurion, Peter and Judas.

A marked elocutionary style of reading and projection makes Ruth Sansom somewhat less convincing to my ears. Her witnesses do not stand apart from each other as clearly. However, the overall achievement in this album is excellent. The cycle reveals a freshness of approach to the telling of the gospel story which has a contemporary ring without falling back on self-conscious "with it" phrases in order to achieve modernity of manner and expression.

The sound is up to Argo's usual standard, and that means very good indeed.

PETER AND THE WOLF: PROKOFIEV. CARNIVAL OF THE ANIMALS: SAINT-SAENS. With Beatrice Lillie (narrator), Julius Katchen (piano), Gary Graffman (piano) and the London Symphony Orchestra conducted by Skitch Henderson. Released by the World Record Club S/4580.

A welcome release by the World Record Club of a very popular coupling, with the irrepressible Bea Lillie as narrator. I say irrepressible because Miss Lillie is not one to stick to the letter of the text. In fact, children who may have become bored with the usual straight narration of Peter and the Wolf will find here a somewhat more sophisticated approach. At the same time it sounds quite refreshing and only in a few spots is there a slight archness of manner. Miss Lillie's version is full of wicked asides and her final, "Good-night Children" sounds a little like Hermione Gingold saying, "Sweet dreams" after telling a gruesome tale.

I hadn't heard the "Carnival of the Animals" for some time and wondered how well Ogden Nash's verses had weathered the passing of time. Here again Miss Lillie has put her own stamp on them as she sweeps through Mr Nash's outrageous puns on animals' names and peculiarities, with an impressive panache. Two things in the verses have most decidedly dated—the reference to Mr Truman as a piano player and the Andrews Sisters as a typical singing group.

But these are minor points. The whole performance has so much verve and Saint-Saens' music is wholly delightful. I am certain he would have loved the added detail (omitted on the World Record Club album cover) that the record was made with the co-operation of the animals of the London Zoo. They emerge from the speakers right, left and centre in all their stereophonic glory.

With a little boosting of the volume the sound is fine. This is a most enjoyable addition to the World Record Club catalogue.

**BETTER
RADIO RECEPTION
FOR ONLY
20 Cents**

Published by Eddystone, a complete guide how to get the best results from your receiver, contains 24 pages, with illustrations; covers propagation, aerials, interference, and other useful data.

Write now with 20 cent postal note to:

**R.H. Cunningham
PTY. LTD.**

608 Collins Street, Melbourne,
Victoria, 3000

With a BSR X3M
'compatible' cartridge,
almost any mono
record playing
equipment can take
stereo records
(without damaging
them)

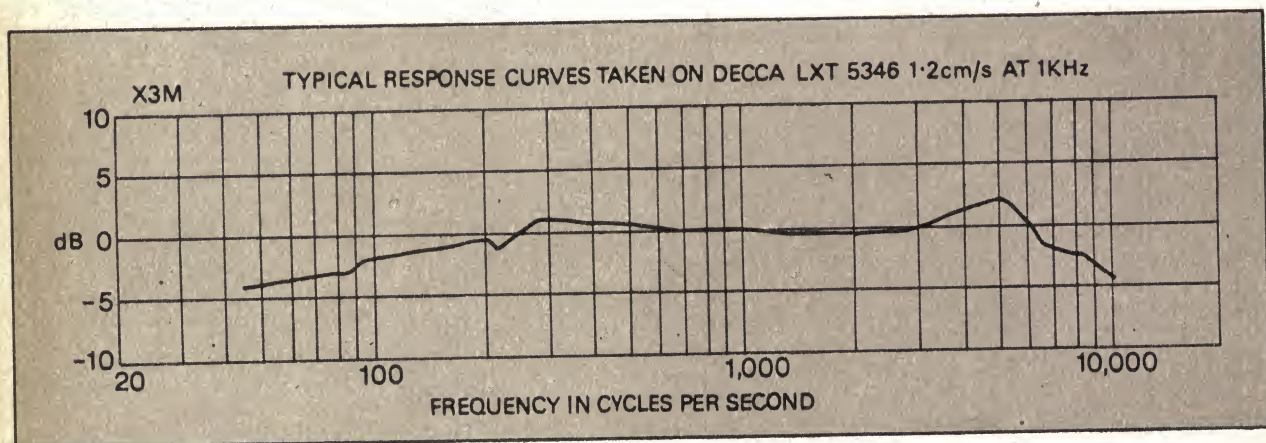
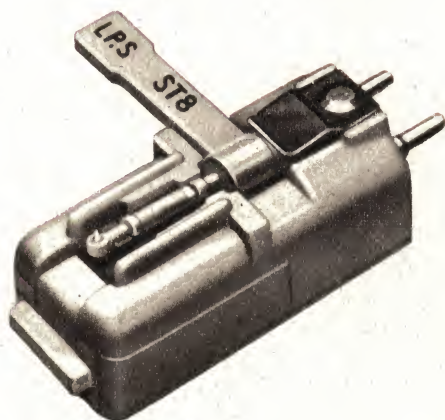

Why compatible cartridges?

An increasing number of record companies are now making stereo LP records only. Until now these records could not be played on a mono player without distortion and damage to the records.

When playing stereo records the stylus tip moves vertically and horizontally following groove contours. Mono records have grooves which only move the stylus horizontally so old mono cartridges will not allow vertical movement of the stylus. Playing stereo records with old mono cartridges will damage the vertical component of the groove irrevocably.

The X3M 'compatible' cartridge, designed and perfected by BSR, is the answer to this problem. For a small outlay it allows you to play both stereo and mono records without harming either. Retail price, \$6.00.

TECHNICAL DATA X3M

Output: 350 mV \pm 2 dB
 1 KHz test record Decca
 LXT 5346 at 1.2 cm/s
 Frequency Response: See typical curves above
 Dynamic Compliance:
 Horizontal 3.0×10^{-6} cm/dyne ($\pm 20\%$)
 Vertical 1.0×10^{-6} cm/dyne ($\pm 20\%$)
 Equivalent Capacity: 800 pF
 Nominal
 Recommended Loading: 2 M. ohm 100 pF
 Stylus Pressure: 4-6 grammes
 depending on pick-up arm
 Measuring Temperature: 20° C 68° F
 Colour: Beige



BSR (A/ASIA) PTY. LTD.
SOUTHERN SECTION INDUSTRIAL ESTATE
ST. MARY'S, N.S.W.
PHONE: 623-0375, 623-0376



DISTRIBUTORS:
GOLDRING ENGINEERING (A/ASIA) PTY. LTD.
443 KENT STREET, SYDNEY, N.S.W.
OFFICES IN ALL CAPITAL CITIES.

BSR:P100

The BSR McDonald 500 encompasses every fine feature one could desire in an automatic turntable.

- Large 11" diameter turntable
- Dynamic anti-skate control applies continuously corrected compensation at all groove diameters.
- Cueing and pause control lever allows for exact positioning of stylus on record and permits you to interrupt listening and reposition to same groove.
- Micrometer stylus pressure adjustment permits 1/3 gram settings from 0 to 6 grams.
- Automatic lock on tone arm after last record is played.
- Dynamically balanced 4-pole induction motor has high torque, constant speed design—assuring minimum rumble and wow.
- Low mass tubular aluminium tone arm perfectly counter-balanced both horizontally and vertically.
- Resiliently mounted, coarse and fine vernier adjustable counter-weight.
- Tone arm is jam-proof even if it is held during the cycling operation.
- Clip-in cartridge holder, provides universal mounting and quick change. (Optional)



The total turntable concept



A complete modular unit ready for use—ebony polystyrene base, smoke-tinted dust cover, mains and audio leads. The only complete packaged, factory-tested unit. Tested under actual playing conditions from specially selected components.



Model 500 with ceramic cartridge . . . \$103
 Model 500 with 800H magnetic cartridge . . . \$114



Southern Section Industrial Estate,
 St. Marys, N.S.W.
 Phones: 623-0375, 623-0376

Wholesale Distributors

Goldring Engineering (A'Asia) Pty. Ltd.
 N.S.W.: 443 Kent St., Sydney. Phone 29-1275
 VIC.: 162 Pelham St., Melbourne. Phone 34-5105
 QLD.: 415 Adelaide St., Brisbane. Phone 2-3247
 W.A.: 32 Northwood St., Leederville. Phone 8-4988
 S.A.: 77 Wright St., Adelaide. Phone 51-5117

Here is

LEAK HI-FI

Craftmanship & Quality

A COMBINATION OF TALENTED DESIGNERS
AND THE FINEST TECHNICAL MINDS.



LEAK 'Stereo 70' Amplifier **\$298.00**

The 'Stereo 70' is full of latent power — up to 35 watts r.m.s. per channel. Distortion is a mere 0.1% at 1,000 Hz for all power outputs up to 25 watts r.m.s. per channel. In addition, this extra output enables a pair of loudspeakers to be connected apart from the two in the main listening room. Elegantly finished in black and silver, or an attractive teak case is also available for shelf mounting. Other brand new features are a head-phone socket for those who prefer to listen to stereo that way, and a DIN record/replay socket on the front panel for a portable tape recorder together with the standard inputs at the back of the amplifier.

All this, backed by the famous LEAK craftsmanship and reliability, makes the Stereo 70 the most technically advanced amplifier available.



LEAK 'Stereo 30 Plus' Amplifier **\$198.00**
RETAIL NETT

The new Stereo 30 Plus combines the long proven circuitry of the Stereo 30 with a new range of silicon transistors and facilities up-dated to meet today's needs:—

This, backed by the famous LEAK craftsmanship and reliability, makes the Stereo 30 Plus the most technically advanced 15-watt amplifier available.

Power Output (both channels sinewave driven):

15 watts r.m.s. each channel into 8 ohm loudspeakers.



\$139.00

**LEAK Sandwich Mk. II
Speaker System**

The Sandwich cones comprise stiff aluminium skins for the outer surfaces where stresses are greatest, bonded to a thick core of featherweight, expanded plastic where stresses are lowest.

Use of this material provides immense stiffness and rigid piston action over more than six octaves and results in a remarkably smooth response free from violent peaks and troughs over a very wide frequency range. Available in mahogany, teak and walnut, this beautifully finished enclosure is still the only compact speaker system offering substantially linear frequency response.



\$99.00

**LEAK Mini-Sandwich
Speaker System**

For music lovers who cannot spare space for a full-size LEAK Sandwich, the new Mini-Sandwich provides almost identical performance, with the exception of the very lowest octave. This superlative small speaker system is designed and made exactly as its larger companion. Size: 18½" x 11" x 7". Available in mahogany, teak and walnut.

H.J. LEAK (AUST) PTY. LTD.
P.O. BOX 14 FRENCH'S FOREST, N.S.W. 2086
PHONE 94 4902

Professional Equipment enquiries to Simon Gray offices or representatives in all States.



VARIETY FAIR

By HARRY TYRER, FORBES CAMERON, NEVILLE WILLIAMS

Devotional recordings

THEN SINGS MY SOUL. George Beverly Shea with orchestra and chorus arranged and conducted by Ralph Carmichael. Stereo, RCA Victor, LSP-4120.

Interest: Bev. Shea's latest.

Performance: Good.

Quality: Right up to standard.

Stereo: Normal.

This new album of Bev. Shea's follows the pattern of his more recent releases, in replacing the rather barebones accompaniments normal on the rally platform, with orchestra, chorus and carefully worked out arrangements. Here the backing is the responsibility of Ralph Carmichael, a man of outstanding and dedicated talent.

A well chosen and varied program includes: Battle Hymn Of The Republic — You'll Never Walk Alone — Where No One Stands Alone — He'll Never Let You Fall — If We Could See Beyond Today — I'd Rather Have Jesus — How Great Thou Art — Like A River Glorious — Have Thine Own Way, Lord — Roll, Jordan, Roll — Lonely Voices — The Day Of Miracles.

One of Bev. Shea's best albums to date and one that his admirers will certainly want. (W.N.W.)

★ ★ ★

HE'S EVERYTHING TO ME. Ray Hildebrand. Stereo, Word WST-8411-LP. (Sacred Productions Aust., 181 Clarence St, Sydney, and in other capitals.)

Interest: Modern devotional.

Performance: Very good.

Quality: Completely clean.

Stereo: Normal.

At school Ray Hildebrand made a name for himself at sports and ended up as captain of a championship basketball team. Long interested in music, he wrote and sang "Hey, Hey, Paula" in 1964 which sold 3 million copies. Now he is a regional director of the Fellowship of Christian Athletes and spends a great deal of his time working with young people.

Seven of the twelve numbers of this album are his own compositions, others being by Ralph Carmichael and Kurt Kaiser. All are in a style which will have an automatic appeal to young people but that doesn't by any means mean that others will not enjoy them: Turn It Over To Jesus — It's Jesus Coming For Me — It's Free — Be Kind Tryin' — What This World Needs — All My Life — He's Everything To Me — Get To Doin' — The Man — I'm Free — Good News, Children Of God Never Die — If I

Live, Well, Praise The Lord.

Ray Hildebrand has a smooth, pleasant voice, very good diction, and a lot of ability with guitar, backed here by other instruments. Recommended for youth audiences. (W.N.W.)

★ ★ ★

THE HOLY LAND. Johnny Cash. Produced by Bob Johnson. Compatible stereo. CBS SSBP-233676. Interest: Sound documentary.

Performance: Unusual presentation.

Quality: Good.

Stereo: Normal.

A most unusual record, this. There are no jacket notes by way of explanation but I imagine that the album had its origin in a personal visit to the Holy Land by Johnny Cash and wife, complete with a high quality portable tape recorder. As they move around places of note Johnny Cash recalls and comments upon the Biblical record, against a background of crowd noises — Jews at the wailing wall, tradesmen in the little shops of Nazareth, children, pilgrims of all nations, and an Arab-owned radio. You hear the voice of the guide and, on the Mount of Transfiguration, the wind gusting into the microphone.

Every now and again, the narrative is interrupted for a song appropriate to the theme, recorded presumably in the CBS studios. Personally, I would have preferred something other than rhythm guitar accompaniment for these

numbers, but that may be an entirely personal reaction.

Having followed the route of the crucifixion journey along the via Dolorosa, Johnny Cash kneels at the spot where the Cross was erected and ends the album with the challenge song "God Is Not Dead."

There is an evident sincerity about the whole presentation and, if it is ever my privilege to undertake a similar journey, it would be an ambition to shoot a set of slides to match the narrative. An experimental album, I would say, that came off remarkably well. (W.N.W.)

★ ★ ★

FRED LOWRY Whistles your Gospel Favourites. Stereo, Word WST-8326-LP. (Sacred Productions Aust., 181 Clarence St, Sydney, and in other capitals.)

Interest: Blind whistler.

Performance: For a whistler, good.

Quality: Clean sound.

Stereo: Unimportant.

Fred Lowry has appeared with the biggest names in radio and television: Bob Hope, Steve Allen, Ed Sullivan, Jackie Gleason, Bing Crosby and Paul Whiteman, to mention a few. Here, with the simplest piano or organ accompaniment he whistles his way through fourteen well known hymn tunes: Whispering Hope — Shall We Gather At The River — Sweet Hour Of Prayer — He's Coming Soon — I Need Thee Every Hour — In The Sweet Bye And Bye — How Great Thou Art — Blessed Assurance — The Church In The Wildwood — His Eye Is On The Sparrow — Revive Us Again — Just As I Am — He Leadeth Me — Beyond The Sunset.

Fourteen tracks of the one sound might deter one and it probably would if it involved a formal instrument. But whistling isn't formal; it's what the painter is likely to do as he wields the brush and, if you like what he's whistling, who begrudges him the pleasure? And that's largely the atmosphere that Fred Lowry creates on this album — not music for formal listening but something to play in the background — while you do the painting! An informal, happy sound. (W.N.W.)

Instrumental, Vocal and Humour . . .

LA VIDA BREVE (De Falla) and Nine Tonadillas (Granados). Victorio de Los Angeles with soloists and orchestra. Piano accompaniment by Gonzales Soriano. World Record Club Stereo. S/4531-2.

Interest: Spanish lyrical drama.

Performance: Pure delight.

Quality: Excellent.

Stereo: Effective.

Described as a "lyrical drama in two acts and four tableaux," this work, together with Granados' "Goyescas," is the closest Spanish composers have come to an opera, but since both works are so short, neither really qualifies for the title. Whatever you call it, it is beautiful music, replete with the typical Spanish idiom, and beautifully sung here by the foremost interpreter of Spanish vocal music today. The part of the tragic gypsy girl, Salud, suits Victoria de Los Angeles far better than

the role of Carmen which she tackled a few years ago. Excellent support is provided by soloists of the Madrid Opera Company with the Chorus of Orfeon Donostiarra. The orchestra is the National Orchestra of Spain, conducted by Rafael Fruhbeck de Burgos, and their contribution might charitably be called competent rather than outstanding. The release at a club price provides a definite opportunity for WRC members, since this beautiful work is recorded only rarely, and at the moment I know of no competitor.

The main work takes three sides of this two disc set, and the fill is nine "Tonadillas" by Granados — again providing an opportunity, since it is seldom that one is able to obtain these delightful songs in a collection — although they often find their way singly into recitals. If anything, De Los Angeles is even better in these than in the de Falla, possibly because they

YOU NEVER HAD IT SO GOOD to make the right choice!

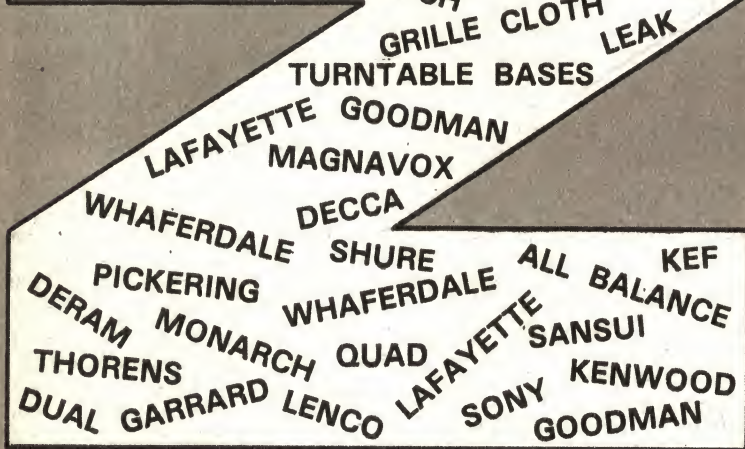
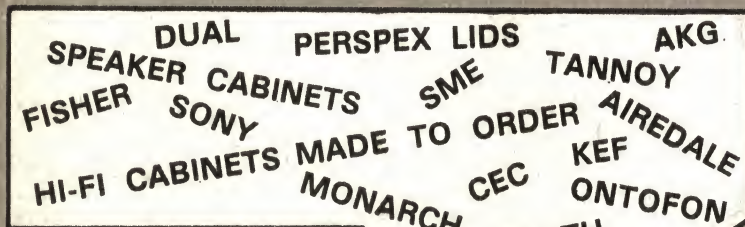
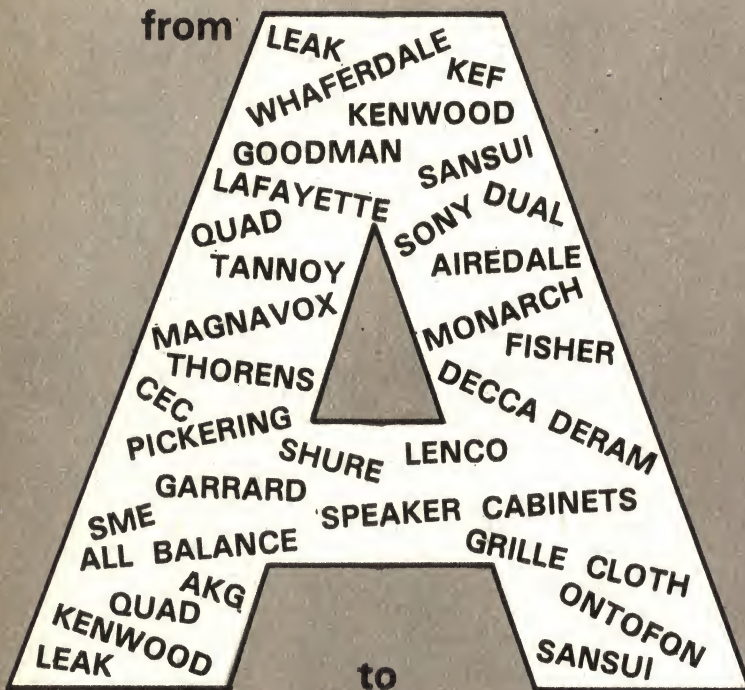

IN SOUND EQUIPMENT.

MASTERSOUND SALES PTY. LIMITED

400 KENT STREET,
SYDNEY. 29-1527

offer scope for a wider range of expression.

The discs come in separate sleeves, and a full libretto with translation (unusually free of translation errors), as well as the texts of the songs, is provided without extra charge. To my mind, this is one of the outstanding bargains from the current WRC catalogue. (H.A.T.)

★ ★ ★

THE BEST OF CARMEN DRAGON AND THE HOLLYWOOD BOWL SYMPHONY ORCHESTRA. Capitol (E.M.I.) Stereo SP 8674.

Interest: Light classics.
Performance: Fine.
Quality: Very good.
Stereo: Effective.

Virtually the entire recorded repertoire of the Hollywood Bowl orchestra has been light classics, so it is certainly no surprise to find this material in their "Best Of" record. The selection comprises: Grandada (Lara) — Serenade (Schubert) — Gypsy Dance from "Carmen" (Bizet) — Nocturne in E flat (Chopin) — Polonaise in E flat, "Heroique" (Chopin) — Funiculi, Funicula (Denza) — Songs My Mother Taught Me (Dvorak) — Intermezzo from "Cavalleria Rusticana" (Mascagni) — Hora Staccato (Dinicu-Heifetz) — Meditation from "Thais" (Massenet) — Meadowland (traditional). It has long been my impression that this orchestra plays best under the baton of Carmen Dragon, and the performance here contains nothing to make me change my mind. If you like light classics, you will find this an enjoyable experience. The sound is consistently good and the stereo spread adds atmosphere. (H.A.T.)

★ ★ ★

SWAN LAKE. Tchaikovsky. Highlights from the soundtrack of the Unitel film starring Margot Fonteyn and Rudolph Nureyev. The Vienna Symphony Orchestra conducted by John Lanchbery. Stereo, H.M.V. Encore SOEX - 9041.

Interest: As per title.
Performance: Good.
Quality: Clean, but rather "dry."
Stereo: Normal.

The copious and detailed jacket notes examine the influences which caused Rudolph Nureyev to develop a new version of "Swan Lake" for presentation at the Vienna State Opera and in the film from which this particular recording is taken. Also in the notes is a synopsis of the story which will allow those not familiar with the music to visualise the situations to which it relates.

As one would expect of the Vienna Symphony Orchestra, the performance itself is excellent though, as noted above, the sound is just a trifle "dry" and it lacks the ultimate sparkle of the best modern recordings. But it is completely clean, generous in terms of playing time and excellent value on the economy Encore label.

Included are (Act 1) Introduction — Valse — Pas de Cinq — Danse des Coupes; (Act II) Pas d'action — Dance of the Little Swans — Odette's Variation — Danse des Cygnes; (Act III) Introduction — Dance Espagnol — Danse Hongroise — Black Swan pas de Deux — Coda Finale; (Act IV) Pas de Deux. (W.N.W.)

BACH'S GREATEST HITS. Various artists. C.B.S. Stereo, SBR 235322. Interest: Popular Bach. Performance: High standard throughout. Quality: Excellent. Stereo: Normal.

I fear the aggressive title and crude cartoon style cover artwork with which this disc has been lumbered will deter many prospective buyers from what is otherwise an excellent disc, featuring first ranking artists in a selection of what undeniably are some of the most popular of Bach's works. On the other hand, it may well be a means of bringing Bach before a wider audience, such as those who have been introduced to this great composer by such recent developments as the Moog synthesiser used for the popular "Switched-on Bach."

The Philadelphia Orchestra plays in five tracks: Preludium in E Major (arranged Kreisler) — Sleepers Awake — Little Suite from "Anna Magdalena Notebook" — Toccata and Fugue in D minor — A Mighty Fortress is Our God. In the remaining tracks, Pablo Casals conducts the Marlboro Festival Orchestra in "Air on the G String"; Zoltan Rozsnyai conducts the Columbia Chamber Symphony in "Jesu, Joy of Man's Desiring" (with E. Power Biggs at the organ); and the final track is from the recent successful issue "Switched-on Bach" — the final movement of the Brandenburg Concerto in G played on the Moog Synthesiser.

This is an impressive line-up, and not surprisingly, the performances are of a high standard throughout. Despite the superficial disadvantages, a most enjoyable disc. (H.A.T.)

★ ★ ★
CHOPIN'S GREATEST HITS. Various artists. CBS Stereo SBR235323.

Interest: Popular Chopin. Performance: Consistently pleasing. Quality: Excellent. Stereo: Normal.

This disc has the same superficial disadvantages and advantages as the "Bach's Greatest Hits" disc reviewed above, on this page, namely, poor titling and artwork on the debit side and top ranking artists giving excellent performances on the credit side. Here we have, as before, the wonderful Philadelphia Orchestra under Ormandy taking the lion's share of the tracks, in five items from the "Les Sylphides" ballet music, and an arrangement of the

popular "Nocturne in E Flat." Philippe Entremont has three piano solos: the D flat ("Minute") Waltz, the "Fantaisie Impromptu" and the Polonaise in A flat. The other famous Polonaise, the "Military," is presented by the New York Philharmonic under Andre Kostelanetz. Finally, the Columbia Symphony Orchestra under Kostelanetz plays an arrangement of the Study in E Major ("Tristesse"). A popular program, certainly, and a very enjoyable one, particularly for those who prefer orchestral arrangements to piano. (H.A.T.)

★ ★ ★
MUSIC FOR STRINGS. The Soirees Musicales Chamber Ensemble. W and G Stereo WG-B.S.5227.

Interest: String classics. Performance: See review. Quality: Good.

Stereo: Compatible, well spread.

The Soiree Musicales Chamber Ensemble is a Melbourne based group, the players being members of the Melbourne Symphony Orchestra. The program consists of: Divertimento No. 1 in D (Mozart) — Serenade for Strings (Elgar) — Flute Concerto in G (Quantz) — Andante Cantabile "Serenade" (Haydn). The recording was made in Melbourne.

Compared with the leading groups overseas who regularly record these works, the Soiree Musicale Chamber Ensemble must be regarded as minor league, but that is not to say that they are not capable of providing attractive renderings of these familiar classics. Their tone is warm and full, and apart from some slight hesitations in attack, the technique of the players is secure. I particularly liked their account of the light-hearted Quantz Flute Concerto, and the Mozart work is an undemanding one, which came over well. I was not so happy about the Elgar work, but my reaction to this is undoubtedly tempered by a splendid account of the work I heard quite recently by the strings of the Bournemouth Symphony Orchestra. To my mind, this performance did not have sufficient control of dynamics, which can be so dramatic if properly handled. The Haydn "Serenade" is another uncomplicated piece, but I like it played a little faster than here.

To sum up then, a pleasant enough disc with an attractive program, competently played, and worthy of attention as an all-Australian effort. The sound quality is good throughout, but the review copy had a pressing fault on side 2 which was quite disturbing. (H.A.T.)

Don't miss this one

YOUNG PERSON'S GUIDE TO THE ORCHESTRA and Simple Symphony (Britten); Facade (Walton). B.B.C. Symphony and Royal Philharmonic Orchestras, conducted by Sir Malcolm Sargent. His Master's Voice Concert Classics Series (E.M.I.) Stereo SOELP 9499.

Interest: Modern English classics. Performance: Excellent. Quality: Very good. Stereo: Normal.

Here is another astonishing bargain from E.M.I. on their \$2.50 Concert Classics label. Any two of these three works would have been good value,

but with all three it is something not to be missed. This is all thoroughly good natured music, a far cry from the aggressively modern stuff of some contemporary composers, and should be in every collection. Sir Malcolm Sargent had a great affection for these pieces, and often presented them in the B.B.C.'s Promenade Concerts. The performance here is ideal as far as I am concerned, and I could find nothing in performance, tempos or balance to complain of. To cap it all, there is an excellent sleeve note giving the sort of information one wants to have on the music. My advice is—don't miss it. (H.A.T.)

Easy Money For You

Make money the easy way. Guaranteed Money Making plans so modern, yet so simple to follow you can't miss. Every detail revealed and explained completely. Send stamp for full free information. You'll be glad you did.

Dept. RH 48,
Box 5070 G.P.O., SYDNEY. 2001.

If you want STEREO EQUIPMENT

You'll deal better with
H. B. RADIO SALES

OCTOBER SPECIALS

KENWOOD TK250 AMPLIFIER/ 2 Wharfedale unit 3 speaker systems. Dual 1019 player on platform, Shure magnetic \$398.00
KENWOOD 150 AMP, 2 Magnavox 10in speaker systems in Teak. Garrard AT60 on platform, with Shure M44G \$275.00
SANSUI 555 2 Wharfedale Super 10 speakers in R3 teak cabinets, Dual 1019 player, Shure M44G, platform and cover \$465.00
MAGNAVOX or ROLA design slimline cabinets with 8 W.R. (V.C. 15, 8 or 3 ohms) or 8 CMX speaker fitted \$30.50
Cabinet Kit only \$11.75
MAGNAVOX 10 W.R. and 3 T.C. Tweeter in 2 C.F. cabinet, ½ in material \$43.00
12 W.R. in 3 cubic ft. cabinets \$44.00
GOODMANS design 3 CF Cabinet and Twin-axiom 10 speaker, ½ in material \$59.00
Cabinet Kit and Speaker \$46.20
WHARFEDALE design, 3 CF cabinet (R3) ½ in material and Golden 10 speaker \$65.00
Cabinet Kit and Golden 10 Speaker \$52.00

Special quotes for other Wharfedale or Goodmans speakers. Available in Maple, Walnut or Rosewood colours. Teak veneer \$1 extra for Slimline and Bookshelf kits. \$2.50 extra for other kits.

BOOKSHELF SPEAKER UNITS
PLAYMASTER, complete . . . \$31.00
CABINET Kit and Parts . . . \$24.20
POINT 4, complete \$35.00
CABINET Kit and Parts . . . \$25.00
PLAYMASTER SUPER . . . \$42.00
CABINET Kit and Parts . . . \$32.50
Wharfedale Unit 3 (large) . . . \$54.00
CABINET Kit and Parts . . . \$44.00
ROLA 1.3 Cabinet Kit with inner bond \$14.50

Packing charge \$1 per order.
Freight payable on delivery.
Send for Stereo Catalogue

H. B. RADIO SALES

Manufacturers of Quality Radio and Radio Furniture for 37 years.

103-105 Catherine Street,
LEICHHARDT, SYDNEY
Telephone 56-5580

brand five

magnetic recording tape

DISCOUNT PRICES!

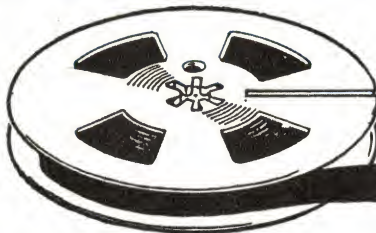

AUSTRALIA'S
BEST VALUE!

from

DIRECT TAPE DISTRIBUTORS

OUR
PRICE

"BRAND 5"—unconditionally guaranteed and manufactured to highest USA professional standards. It's sensationally priced at half that of comparable tapes.

"BRAND 5" has high remanence iron oxide emulsion coated to highest grade Acetate or Mylar base material.

"BRAND 5" ensures unmatched results in high fidelity mono and stereo recordings, with certain protection against head wear, squeal and gumming of heads.

SAVE
over
50%

LENGTH	TYPE No.	DESCRIPTION & MIL. THICKNESS	NORMAL PRICE	OUR PRICE	
7" REELS					
1200'	15D7	1.5 ACETATE	6.60	3.00	
1800'	10D7	1.0 ACETATE	7.25	3.25	
1800'	10D7M	1.0 MYLAR	9.15	3.99	
2400'	5D7M	.5 MYLAR	10.40	4.75	
2400'	5D7MT	.5 TENSIL MYLAR	11.90	5.25	
3600'	5D7MS	.33 MYLAR	13.20	6.75	
5½" REELS					
1200'	10D57	1.0 ACETATE	5.50	2.55	
1200'	10D57M	1.0 MYLAR	6.00	2.95	
1800'	5D57M	.5 MYLAR	8.90	3.75	
5" REELS					
600'	15D5	1.5 ACETATE	3.40	1.80	
900'	10D5	1.0 ACETATE	4.15	1.98	
900'	10D5M	1.0 MYLAR	5.32	2.25	
1200'	5D5M	.5 MYLAR	6.95	2.50	
1200'	5D5MT	.5 TENSIL MYLAR	8.70	2.75	
1800'	5D5MS	.33 MYLAR	9.60	3.75	
CORRESPONDENCE TAPES					
3¼" REELS					
900'	3D32MS	.33 MYLAR	3.90	1.95	
3" REELS					
150'	15D3	1.5 ACETATE	.95	.50	
225'	10D3	1.0 ACETATE	1.20	.65	
225'	10D3M	1.0 MYLAR	1.65	.70	
300'	5D3M	.5 MYLAR	1.95	.85	
600'	3D3MS	.33 MYLAR	3.30	1.60	
CASSETTES			C30	3.10	1.55
			C60	3.50	1.65
			C90	4.75	2.65

SEND THIS COUPON WITH YOUR ORDER TODAY!



DIRECT TAPE DISTRIBUTORS

BOX 3040, G.P.O. SYDNEY, N.S.W. 2001

Please send me BRAND 5 Tape/s as per attached list. I enclose

Cheque Postal Note Money Order for \$.....
covering purchase price PLUS postage and packing.
NOTE: COSTS FOR POSTAGE & PACKING:
1 reel — 10 cents; 2 or more — 20 cents.

D/EI

NAME.....

ADDRESS.....

STATE..... CODE.....

VETRARE DE CHIESA (Church Windows); THE BIRDS. Respighi. C.B.S. Stereo SBR235313.

Interest: Modern classics.
Performance: Excellent.
Quality: Very good.
Stereo: Normal.

"The Birds" has always been a popular work and consequently has been recorded fairly regularly. Conversely, the "Church Windows" suite has been neither very popular nor often recorded. One may hang on the other, of course, but I feel there is no denying that it is not one of Respighi's best efforts. The scoring is as opulent as ever, but the thematic material borders on the trite. Nevertheless, it has its moments, and in total makes for pleasant listening. As far as I know, it is the only available recording of the work in stereo. The events depicted are: The Flight into Egypt — St. Michael the Archangel (driving the rebel angels from Heaven) — The Matin of St. Clare — St. Gregory the Great ("portrayed in papal glory blessing a throng at ceremonial services," to quote the sleeve note).

The "Birds" music belongs to the suites of "Ancient Airs and Dances" which use works of the seventeenth and eighteenth centuries as thematic material. The sections are: Prelude — the Dove — the Hen — The Nightingale — The Cuckoo. This is entirely enchanting music, played with understanding and affection by Ormandy and his Philadelphia Orchestra. This is undoubtedly one of the world's great orchestras, with outstanding technique and tone. (H.A.T.)

★ ★ ★
DO YOU KNOW WHAT IT MEANS TO MISS NEW ORLEANS—Living Brass RCA Camden CAS 2271.

Interest: Studio Dixieland.
Performance: Coldly efficient.
Quality: Well recorded.
Stereo: Normal separation.

The Living Brass are a collection of accomplished New York studio musicians, who record under the direction of Ray Martin. Over the years, they have made a large number of Living Brass albums covering a wide range of popular music.

This L.P. is devoted to "traditional jazz" with standards like "Muskrat Ramble," "Tin Roof Blues," "South Rampart Street Parade" and "High Society." While the music has little to do with jazz, the album may have some appeal as lively background music. In any event, the results are smooth and professional.

Although the retail price of Camden LPs is now only \$1.99, it should be noted that the playing-time of this L.P. is a poor 28 minutes. (T.F.C.)

★ ★ ★
HERB ALPERT AND THE TIJUANA BRASS PLAY THEIR 16 GOLDEN HITS. Universal Record Club Stereo U-993. Available in Mono.

Interest: See title.
Performance: Lively and entertaining.
Quality: Excellent throughout.
Stereo: Very effective.

This exclusive release by Universal Record Club features slightly shortened versions of 16 of the most popular hits of Herb Alpert and the Tijuana Brass:



("TV Times")

The Lonely Bull — South of the Border — The Mexican Shuffle — A Taste of Honey — Whipped Cream — Spanish Flea — Zorba the Greek — Cabaret — Tijuana Taxi — What Now My Love — If I Were a Rich Man — Mame — The Work Song — Casino Royale — A Banda (Chico Barucke de Hollanda) — This Guy's In Love With You. Tijuana Brass fans will recognise the excellent value being offered here at a club price, particularly those who feel as I do, that the earlier Tijuana Brass albums are more individual and entertaining than the latest releases.

The sound quality throughout all these tracks leaves nothing to be desired, and the stereo spread is effectively used, particularly in the tracks with a background of crowd noises. (H.A.T.)

★ ★ ★
THE ONE AND ONLY TOMMY DORSEY. RCA Camden Stereo CAS 7059.

Interest: Mainly late 1930s.
Performance: Mixed but interesting.
Quality: Fair.
Stereo: Re-channelling adds little.

Tommy Dorsey led one of the greatest of the big bands of the 1930s. A superb trombonist himself, he also had the ability to attract the finest musicians, arrangers and singers to his organisation.

With one exception—a 1950 Clambake Seven recording of "Way Down Yonder in New Orleans"—the tracks on this album cover the period March 1937-June 1942.

Frank Sinatra is the featured vocalist on four ballads—"The Call of the Canyon" (1940); "Too Romantic" (1940); "A Sinner Kissed an Angel" (1941); and "Be Careful, It's My Heart" (1942).

The other singers who are heard with the Dorsey Orchestra are Jo Stafford and the Pied Pipers on "Whatcha Know Joe?"; Edythe Wright on "Lady Is a Tramp" and Sinatra's predecessor in the band, Jack Leonard, with "Turn Off the Moon." The album is completed by two big band instrumentals. Sy Oliver's arrangement of "Lonesome Road," in particular, still sounds fresh 30 years later.

Overall, then, this is an enjoyable—if mixed—re-issue which will particularly interest collectors of early Sinatra. The playing time is 32 minutes and the Camden series of L.P.s is now retailing at \$1.99. (T.F.C.)

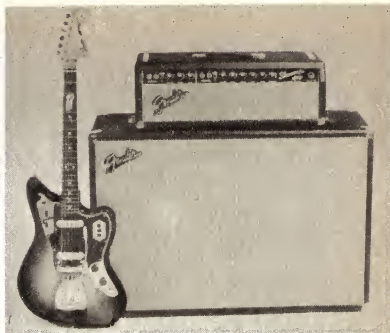

MUSICAL INSTRUMENT SPEAKERS

JBL-USA

These are the first professional-quality loudspeakers designed for use with electrical musical instruments. Their unique engineering features and careful craftsmanship provide the amazing "JBL Sound": Lowest bass, sharp mid-range, bright smooth treble, instantaneous response and effortless total sound which is not available with any other speaker, regardless of price or size. Used by The Beach Boys, The Rolling Stones, Trini Lopez and hundreds of other talented professionals, these are the same speakers used in top-quality amplifiers such as Ampeg, Echolette, Epiphone, Fender, Gibson, Kustom and Standel.



The D110F, 10", D120F, 12", and D130F, 15", create new dimensions in total sound—crisp, spacious, each note has all the bite and body needed for the most demanding assignments. The new D140F, illustrated, is specifically designed for bass guitar or organ, delivering rich, full, solid bass at any loudness level.

Trade enquiries invited.
For free illustrated brochures and the name of your nearest JBL Dealer contact

AURIEMA
(Australasia) Pty Limited
443 Kent Street Sydney 2000
Telephone 29 6144

In association with Goldring Engineering.

GE:P518

THE MAGNIFICENT WORLD



Model X-360

PROFESSIONAL STEREO TAPE RECORDER—X-360

*3 heads, 3 motors *4 track stereo/monaural recording and playback
 *4 tape speeds (1 $\frac{7}{8}$, 3 $\frac{3}{4}$, 7 $\frac{1}{2}$, and 15 ips) *3 speeds main motor
 *CROSS-FIELD HEAD *50 watt solid state amplifier *Automatic volume control (Comput-O-matic) *Automatic continuous reverse (Reverse-O-matic) *Automatic dust minder *Magnetic brake for motors *For increased stereo enjoyment, use the matching speaker SW-160 (4 way, 60watt input).

Prove it by the sound!
 prove it with

AKAI[®]
 CROSS-FIELD HEAD

AKAI AUSTRALIA PTY. LTD.: 276 Castlereagh St., Sydney, N.S.W./146 Burwood Rd., Hawthorn, VICTORIA/399 Montague Rd., West End, Brisbane, QUEENSLAND/8 Arthur St., Unley, S.A./579 Murray St., Perth, W.A. HOMECRAFTS: Petrie St., Canberra, A.C.T. J.B. YOUNG: Giles St., Kingston, A.C.T.

Australian organist

WITH A SONG IN MY HEART.

Tony Fenelon on the Wurlitzer Theatre Pipe Organ in Hoyt's Regent Theatre, Melbourne. Stereo, Crest CRT-12-SLP-022 (Sound & Film Enterprises of Aust. Pty. Ltd., 291 Tooronga Rd., Tooronga, 3146).

Interest: "Mighty Wurlitzer."

Performance: Top class.

Quality: Very good.

Stereo: Used to advantage.

This is a "must" record for anyone interested in the old-time "mighty Wurlitzer" — firstly because it is a class performance in its own right and secondly because it is presented by a young Australian organist on an instrument installed in Australia's largest cinema.

Tony Fenelon, L.Mus.A., B.Sc., established an early claim to distinction as a classical pianist but is now resident organist at the Hoyt's Regent in Melbourne. He is assistant electronics

engineer to the Royal Melbourne Hospital, is an author in the field of medical electronics and, according to a personal note from Marcus Herman, Managing Director of Crest, he was largely responsible for the setup used for this particular recording.

On the 4-manual 19-rank instrument, he presents in traditional theatre style, a generous 36-minute program; comprising 15 numbers in all. To quote a few, Serenade (from Student Prince) is followed by Espana Cani and a number of shorter numbers such as Spanish Flea, Tijuana Taxi and S'Wonderful.

On side 2 are La Golondrina—Embraceable You — Chicago — Snow White and the Seven Dwarfs (selection) — With A Song In My Heart.

Apart from an occasional bass note that sounded rather fierce (in my listening room anyway) the quality was very good indeed. As I said, a "must" for local theatre organ enthusiasts. (W.N.W.)

SWEET CHARITY —Motion Picture Sound Track. Festival. Stereo SFL933161 (also in mono).

Interest: Successful musical comedy.

Performance: Polished.

Quality: Bright recording.

Stereo: Normal separation.

At the time of writing, the film of "Sweet Charity," starring Shirley MacLaine and Sammy Davis Jun., had just been premiered in Sydney. But the original Broadway show has been a very big success in theatres all over the world, including Australia and, no doubt, the film will prove to be equally popular.

The bulk of the numbers on the film soundtrack album are taken by Shirley MacLaine and, although her singing is sometimes a little uncertain, her remarkable personality carries her through songs like "If My Friends Could See Me Now" and "It's a Nice Face." Sammy Davis has only one song on the soundtrack, the dramatic "Rhythm of Life," but he handles the exciting number very convincingly. Apart from the two stars of the film, Chita Rivera, Paula Kelly, John McMartin, Stubby Kaye and the chorus of girls are heard on the album.

This LP, which plays for 40 minutes, will be an attractive souvenir for readers who have enjoyed the stage show or the film. (T.F.C.)

★ ★ ★

ENOCH LIGHT AND THE BRASS MENAGERIE. Project 3 (Festival) Stereo SPJL-933,275. Available in Mono.

Interest: Hits for brass.

Performance: Rousing.

Quality: Excellent.

Stereo: Widely spread.

Lively and exciting, but perhaps a little rowdy in parts, this disc has a brass choir of impressive size, and obviously of considerable talent, playing up-tempo arrangements of current hits, namely: Blowin' in the Wind — I'm Gonna Make You Love Me — My Favourite Things — Wichita Line-man — The Fool on the Hill — I've Gotta Be Me — Touch Me — California Dreamin' — Both Sides Now

— Happy Ever After — Put Your Head on My Shoulders — Soulful Strut. As is often the case with Project 3 recordings, the participants are anonymous, but I am sure there are some well-known names under this cloak of anonymity. The arrangements by the experienced Dick Hyman are first rate, so is the sound quality. (H.A.T.)

★ ★ ★

MANTOVANI MEMORIES. Stereo, Decca SKLA-4977.

Interest: The Mantovani sound.

Performance: Smooth, lush.

Quality: Very good.

Stereo: Good spread.

One would assume from the title that this album is intended to stir pleasant, nostalgic memories of the Mantovani sound but there is no hint on the jacket as to whether the selections are from earlier albums or whether this is a new recording. Perhaps it isn't important, because there is no mistaking the sound and the quality of the recording is first rate.

The selections are certainly varied: Smoke Gets In Your Eyes — What A Wonderful World — The Trolley Song — Sweet Leilani — Try To Remember — Sunrise, Sunset — The Anniversary Waltz — In The Still Of The Night — Once Upon A Time — Embraceable You — How Are Things in Glocca Morra — You'll Never Walk Alone.

One that will certainly be welcomed by those who like lush sound — and doesn't everyone on occasions? (W.N.W.)

★ ★ ★

MUSIC FOR THE THEATRE ORGAN. Volume 2. Fredric Bayco. Stereo, World Record Club W.R.C. S/4539.

Interest: Pipe Wurlitzer.

Performance: Musically excellent.

Quality: Marred by building nose.

Stereo: Not startling.

Following volume 1, reviewed some time ago, I put this volume 2 on the turntable with a good deal of pleasurable anticipation. With Fredric Bayco at the console of a 4-manual Wurlitzer at the Gaumont State Cinema,

CONVOY TECHNOCENTRE TOPICS

At our Technocentre you receive friendly advice and guidance from our highly qualified consultants. An invaluable service to those building or altering a home. The equipment you buy at Convoy will serve you well for many years and have a good resale value. This is your real cost! Make sure you visit the Technocentre before you buy any item of Hi-Fi equipment.

NEW RELEASES

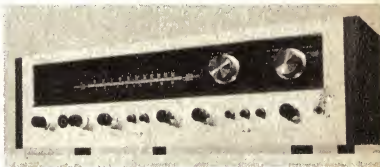

PIONEER SX440

Never has such a high performance stereo amplifier been combined with a high quality AM radio receiver.

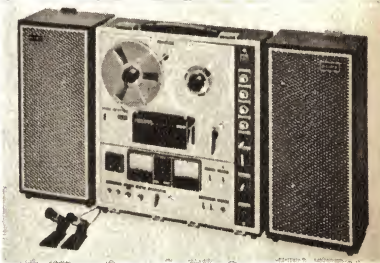

SONY 630

Leading in the new style of tape recorder. A 3-head deck (complete with sound and echo. Slider input controls. Big VU metres. Wow and flutter as low as 0.08 p.c. at 7½ i.p.s.). Combined with 2 15 W.R.M.S. amplifiers at 0.5 p.c. distortion (complete with 2 mV phono input, bass and treble controls, noise filter and speaker switch, etc.)

PEERLESS HIGH FIDELITY

Now available, "A" series 12in 3-way system an exclusive system to suit a quality Hi-Fi system.

SYSTEMS FROM \$200 to \$2,000

Lay-by now for Xmas. Select your goods from all leading makes of quality audio equipment.

Convoy

FOR SOUND SATISFACTION

TECHNOCENTRE
449 KENT STREET,
(DURITT STREET END)
SYDNEY 29-6475

Power + Reliability

Goodmans Audiom Loudspeakers

Goodmans Audiom loudspeakers are specially built for maximum reliability and efficiency, and incorporate the very latest advances in acoustic design. Each model is available in two versions:

Audiom Bass for High Fidelity multiple speaker systems, see below.

Audiom Standard for Public Address work and Musical Instrument amplification (Electric Guitars, etc.).

Bass Units

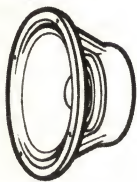

AUDIOM 51 BASS
12" - 15 watt - 15 ohm



AUDIOM 61 BASS
12" - 20 watt - 15 ohm

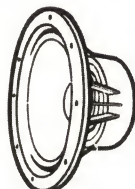

AUDIOM 81 BASS
15" - 25 watt - 15 ohm

Goodmans Multiple Speaker High Fidelity Systems

For a very low distortion, high sensitivity loudspeaker system choose a Goodmans 3-way system, employing an **Audiom Bass** unit, and pressure-driven horn-loaded Midax mid-range and Trebax high frequency units, with crossover network and attenuators, to be mounted in an enclosure of the correct design.

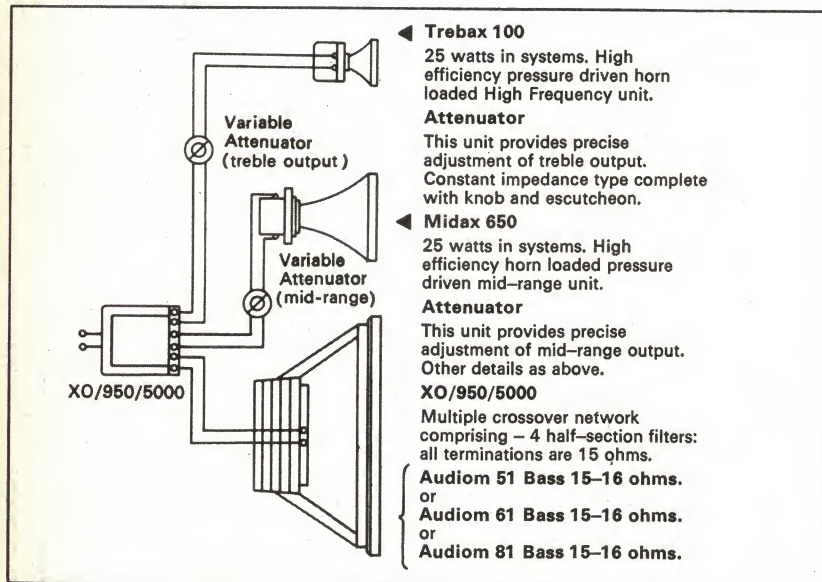

For Very High Powered Installations

Audiom 91 18" heavy duty loudspeaker, 50 watts, 15-16 ohms.
Audiom 91/100. 100 watt version of Audiom 91, 8 ohms.

For full particulars, write to the Sole Australian Agent:

British Merchandising Pty Limited

Shaw House, 49-51 York Street, Sydney. Telephone 29 1571 (3 lines)

Kilburn (London)—an instrument "kept in first class condition"—it should have been a very good album. Musically it is but technically it is not. Building and background noise intrudes badly between tracks and in the silent passages and, in an effort to keep it at bay, 10dB or more has been rolled off the top end, dulling the sound badly.

Bayco presents a light music program, avoiding the gimmicks and the sound effects which classifies as "near-vulgar whimsies": Poupee Valsante — Chanson de Matin — Parade Of The Tin Soldiers — Rosamunde — Fairy Frolic — Narcissus — Marche Militaire — Barcarolle — Dance Of The Ostracised Imp — Carminetta — Shepherd's Hey — Pierrette — Rosemary — Tarantelle. Playing time is 40 minutes.

An enjoyable performance — if you can dismiss the noise as building "atmosphere!" (W.N.W.)

★ ★ ★

HAMMOND POPS VOL. 2. Klaus Wunderlich, organ, with rhythm group. Stereo, Telefunken-Carlinia SLE-14514-P. (From Sound and Film Enterprises, 291 Tooronga Rd, Tooronga, 3146).

Interest: Hammond, listening or dancing.

Performance: Top-line performer.
 Quality: First rate.

Stereo: Good separation.

I gather that Hammond Pops Vol. 1 sold 12,000 copies and that this volume 2 is well on the way to overhauling it. I'm not surprised. Klaus Wunderlich is reputedly rated as Europe's top pop organist and the way he handles the instrument will tickle the ears of anyone interested in the electronic organ. But it's excellent listening anyway and fine for dancing.

In a generous program Wunderlich and his rhythm group spread 28 titles into 10 medleys in the following order: Fox — Slow Waltz — Beat Fox — Slow Beat — Fox — Beat Fox — Slow Rock — Rock'n'Roll — Medium Beat — Samba Beat.

The Telefunken recording lives up to the reputation of its kind, with clean, virtually flawless sound. Recommended. (W.N.W.)

★ ★ ★

THE BEST OF LAURINDO ALMEIDO. Capitol (E.M.I.) Stereo SP 8686.

Interest: Classical guitar.

Performance: Masterly.

Quality: Very good.

Stereo: Some normal, some reprocessed.

When I saw the contents of this disc, I must confess I had some doubts about how the pieces would sound arranged for guitar. The first piece (Adagio from Beethoven's "Moonlight Sonata") did as much as anything to set these doubts at rest. The skilful transcription and sympathetic performance by Almeida faithfully maintains the atmosphere of the original, and puts one in the right mood to hear the rest of the program, comprising: Arioso from Harpsichord Concerto in F minor (Bach) — Claire de Lune (Debussy) — Schon Rosmarin (Kreisler) — Pavane for a Dead Princess (Ravel) — Miller's Dance (Falla) — Preludes Nos. 2, 5, 8, 10, 11, 12 (Ponce) — Sevilla (Albeniz) — Recuerdos de la Alhambra (Tarrega) — Fandanguilla (Turina) — Tango Espanola (Albeniz).

Pleasant Island sound

SONG OF THE ISLANDS. Los Indios Tabajaras. Stereo, RCA Victor LSP-4129.

Interest: Island sound.

Performance. Smooth, romantic.

Quality: Good but slight surface crackle.

Stereo: Excellent.

According to the jacket notes, Los Indios Tabajaras frequently include an island segment in their concert programs and this has proved a popular feature with American and European audiences alike.

This album belongs entirely to the Pacific with all the titles you'd expect: Song Of The Islands — Bali Ha'i — I Will Remember You — Keep Your

In case you are wondering how Almeida copes with the tricky counterpoint in some of these pieces, I should explain that he plays some of them in two or three parts and has them dubbed together. This may seem like cheating, but the results are so good that it is not difficult to overlook this subterfuge. A disc which those with an interest in classical guitar cannot fail to enjoy. (H.A.T.)

★ ★ ★

CAUGHT IN THE ACT — Frances Faye. Universal Record Club. Stereo U962.

Interest: Night-Club performance.

Performance: Effervescent.

Quality: Good "live" recording.

Stereo: Adds little.

The singer / pianist / comedienne, Frances Faye, has appeared many times in Australian night-clubs, with very great success.

I have never had the opportunity of seeing her on stage, but I would imagine that this L.P., which was recorded some years ago at the Crescendo in Hollywood, is fairly representative of her act.

Personally, I find her humour a little distasteful at times, but I can recognise that her electric personality would be much more suited to a night-club. Although her singing and piano-playing are hardly exceptional, she undoubtedly has the ability to sell a song. The backing group, incidentally, includes the outstanding bongos player, Jack Costanzo.

For readers who are familiar with her work, the tracks on this L.P. include "The Man I Love," "Fever," "Just in Time" and "Night and Day." (T.F.C.)

★ ★ ★

BACHARACH BAROQUE. The 18th Century Corporation. United Artists (Festival) Stereo SUAL-933,379. Available in Mono.

Interest: Bacharach hits.

Performance: Very pleasing.

Quality: Excellent.

Stereo: good spread.

I put this disc on with some trepidation, not having previously encountered the 18th Century Corporation and expecting perhaps a noisy rock group. However, it is evident from the first few bars that here is a group of very talented artists who also have the advantage of a skilful arranger. Closer examination of the sleeve information revealed the names of Siegfried Schwab

Eyes On The Hands — Sweet Leilani — My Isle of Golden Dreams — Hawaiian Wedding Song — Beyond The Reef — My Little Grass Shack — Moon Of Manakoora — Hawaiian Rhapsody.

The numbers get the full treatment, with electric steel and with birds and surf in the background but Los Indios admirers will probably pick the group's characteristic touches.

Pleasant island sound. (W.N.W.)

(guitar) and Adie Feuerstein (flute) hidden away in the small type as part of the group. I previously heard these talented performers when they were members of a quartet group, but here they are part of a group of ten.

Burt Bacharach's songs which make up the program are ostensibly played in the baroque style, but I could not discern any notable baroque influences. Nevertheless, the group has a distinctive style, depending on clever scoring and close knit instrumental work to achieve a most pleasing effect. Certainly a disc which will give a lot of pleasure to the more sophisticated

Celestion LOUDSPEAKERS

*We're sorry . . . CELESTION speakers
are still in short supply*

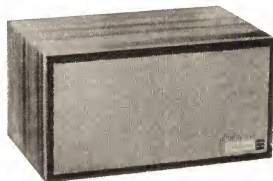

'DITTON 10' — \$64.50

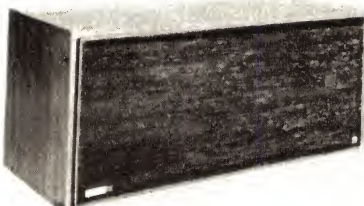

'DITTON 15' — \$69

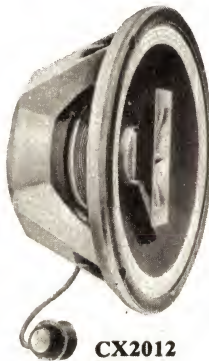

CX2012
\$64.50

But brighter skies are round the corner. Although CELESTION have been unable to supply all the world markets because of unprecedented demand for CELESTION products, a new factory is nearing completion. The new premises will double CELESTION'S manufacturing capacity.

As Australian distributors Encel Electronics apologises for the shortage of CELESTION co-axial speakers and speaker systems. Supplies of CX-2012 co-axial speakers (at \$64.50 inc. sales tax) are still limited — orders are being filled in sequence. The lower priced model CX-1512 12" co-axial speakers (at \$44.50) are available for immediate delivery.

CELESTION compact speaker systems have proven very popular in Australia. The "Ditton 10" (\$64.50) and the "Ditton 15" (\$89) are both available now . . . supplies of the new "Ditton 25" are expected shortly. Price of the "Ditton 25" is \$195 (inc. sales tax.).

A recent review conducted in Holland with 14 skilled participants placed the CELESTION "Ditton 15" ahead of 9 other internationally known compact speaker systems. Send for a copy of the test report and the resulting analysis. For complete technical specifications on all CELESTION products contact Encel Stereo Centres in Melbourne or Sydney.

Encel
ELECTRONICS
(STEREO) PTY. LTD.

Head Office:
431 Bridge Rd., Richmond, Victoria 3121.
Tel. 42 3762.

Sydney Store: Ground Floor, 25M Building
257 Clarence Street, Sydney, N.S.W. 2000.
Tel. 29 4563, 29 4564.

*Wholesalers *Trade-ins accepted

Australia's Greatest Hi-Fi Centre



THE WORLD FAMOUS LUX SQ-1220 STEREO AMPLIFIER

Although available only during the last year or so, the LUX SQ-1220 is already regarded as one of the world's classic solid state stereo amplifiers . . . it's been acclaimed in the U.K., the United States, Europe and Australia. Ask for copies of the reviews! This outstanding silicon transistor stereo amplifier is rated at 50 watts R.M.S. in each channel into an 8 ohm speaker load. Frequency response is 10-50,000 Hz. \pm 1 dB. Distortion is so low it is difficult to measure even at high outputs. Separate bass and treble controls are provided for each channel; low and high filters, frequency selectors, provision for tape monitoring and a headphone jack are all standard. The external case of the SQ-1220 is hand crafted from selected palisander veneer. Listen to the audio excellence of this fine amplifier—write or call for unabridged specifications. Encel price (inc. sales tax) is only **\$350**

TECHNICAL SPECIFICATIONS

Power amplifiers:
Output: 50 watts R.M.S. into an 8 ohm load.
Frequency response: 10-50,000 Hz. \pm 1dB.
Distortion: Within 0.1% at 30 watts R.M.S. into 16 ohms.
Input sensitivity: 730 mV. at 20 watts R.M.S.

Pre-amplifiers:
Frequency response: 20-20,000 Hz. \pm 1 dB.
Distortion: Within 0.1% (1V/1 kHz.)
Input sensitivity: Tape head — 2 mV.
Mag. p.u. 2 mV. Aux. 1 — 110 mV.
Aux. 2 — 750 mV. Tape monitor — 200 mV.
Signal to noise: Tape and phono —60 dB.
Aux.—75 dB.

FINE AMPLIFIERS IN THE LUX RANGE

LUX MODEL SQ-505 SOLID STATE STEREO AMPLIFIER
Rated at 30 watts R.M.S. per channel, the all new Lux Model SQ-505 is a silicon transistor unit. Power transistors are designed to withstand temporary short circuits and overloading—overall frequency response is 10-50,000 Hz. plus or minus 1dB. in the power amplifier and 20-50,000 Hz. plus or minus 2dB. in the pre-amplifier. Controls and features include volume, balance, mode selector, treble/bass controls, filters, tape monitor, headphone jack, exclusive A/B speaker systems selector, etc. All in all the Lux SQ-505 is a very fine amplifier and an excellent performer. **\$259**
Inc. Sales Tax

LUX MODEL SQ-606 SOLID STATE STEREO AMPLIFIER
With an output of 30 watts R.M.S. per channel, the handsome new Lux Model SQ-606 is an all-silicon unit with 27 silicon transistors. Power transistors are designed to withstand temporary short circuits and overloading. Overall frequency response is 10-50,000 Hz. \pm 1dB. Acoustic performance is quite outstanding. Controls and features include volume, balance, mode selector, treble/bass controls, filters, tape monitor, headphone jack, etc. The Lux Model SQ-606 is an excellent stereo amplifier with extremely musical characteristics. It's attractively priced at (inc. S. T.) **\$219**

LUX SOLID STATE STEREO AMPLIFIER Model SQ-77TW
Using silicon power transistors the SQ-77TW is rated at 30 watts R.M.S. in each channel with a 4-6 ohm speaker load. Frequency response is 10-50,000 Hz. plus 0, minus 3dB. Input sensitivity is 1.8 mV for magnetic pickup or tape head, aux. inputs being rated at 200 mV and 800 mV. Controls include stereo volume, stereo balance, mode switch, treble and bass (separate controls for each channel), input selector, headphone jack and switch, tape monitor switch rumble and scratch filter switches, etc. Price inc. S.T. **\$169**



ENCCEL
ELECTRONICS (STEREO)
PTY. LTD.

Head Office:
431 Bridge Rd., Richmond, Victoria 3121. Tel. 42 3762.
Sydney Store: Ground Floor, 25M Building,
257 Clarence Street, Sydney, N.S.W. 2000. Tel. 29 4563, 29 4564.
Australia's Greatest Hi-Fi Centre *Wholesalers *Trade-ins accepted

listener able to appreciate its qualities. The titles are: Do You Know the Way to San Jose — This Guy's in Love with You — Promises, Promises — I Say a Little Prayer — Walk on By — Casino Royale — Reach Out for Me — Wishin' and Hopin' — Message to Michael — Alfie — Are You There — What the World Needs Now. (H.A.T.)

★ ★ ★

JOHN GARY ON BROADWAY. RCA Dynagroove Stereo LSP-3928.

Interest: Broadway hits.
Performance: Sure to please.
Quality: Excellent.
Stereo: Normal.

Of its type, the pleasing, smooth tenor voice of John Gary rates very high with me, and apparently with a great many other people too, since this is his fifteenth disc over the space of only a few years. This latest album is devoted to hit songs from Broadway shows, and not surprisingly, John has already recorded many of them in his earlier releases. Pretty obviously, this disc will have special appeal to those who like John Gary and Broadway shows, and if the particular selection appeals, then this album can be safely recommended on the basis of the expert production, featuring the usual first-rate RCA studio orchestra and skilful arrangements, and the excellent quality sound produced by the Dynagroove process. The titles: What Kind of Fool Am I — Somebody Somewhere—A Quiet Thing — Anybody Would Love You — She Wasn't You — Small World — A Certain Girl — Where You Are — You've Never Kissed Her — Long Ago — I've Gotta Be Me. (H.A.T.)

★ ★ ★

FRANCOISE HARDY. Universal Record Club Stereo U997. Available in Mono.

Interest: Plenty.
Performance: Warmly sentimental.
Quality: Excellent.
Stereo: Three-channel type.

Another scoop for Universal Record Club — the first issue at a club price in Australia of a disc featuring the enchanting Francoise Hardy, and a very good disc it is too. In fact, side one, sung entirely in French, is identi-

cal with the first side of the Disque Vogue record released by Festival recently and reviewed in these columns last month. On side two, she sings in English, a circumstance which I am sure many people will welcome. Side 1, in French, has the following titles: All the Boys and Girls — It Flopped — The Girl With You — Oh, Oh Darling — The Time for Love — He is Everything to Me. Side 2 has, in English: Just Call and I'll be There — The Rose — Only You Can Do It — It's My Heart — Another Place — Autumn Rendezvous. One does not have to possess a very high quality crystal ball to predict that this will be one of the most popular releases by U.R.C. this year. Sound quality is excellent. (H.A.T.)

★ ★ ★

SOFT AND BEAUTIFUL—Aretha Franklin. CBS Stereo SBP 233652.

Interest: Franklin on ballads.
Performance: Tender and sensitive.
Quality: Well recorded.
Stereo: Normal separation.

This album is yet another in the Columbia re-issue series of Aretha Franklin tracks, dating from some three or four years ago. It is probably true to say that her younger admirers all over the world would have some difficulty in recognising her singing on this album, for it is very different from the explosive "Lady Soul" material of her current Atlantic recording sessions.

This is essentially a late-night ballad album and the texture of her voice at that stage was rather reminiscent of Nancy Wilson, although her phrasing and style were more mannered.

But it is a very beautiful and elegant album featuring superb standards like Cahn and Van Heusen's "Only the Lonely" and Johnny Mercer's "When the World was Young." Also included are "Shangri-La," "My Colouring Book" and "People" from "Funny Girl."

Personally, I prefer the Franklin of this period, when she sang more in the jazz idiom. This album shows clearly that her ballad style, too, was thoughtful and mature. This is, in short, an enjoyable, well-produced album by a very talented artist. (T.F.C.)

Popular Jazz

THE JAZZ STORY Vols. 1-5. Capitol Encore Mono 9349/50/51/52/53. Interest: 60 tracks, largely post-1940.

Performance: Mediocre.
Quality: Generally acceptable sound.

E.M.I. have reissued on their budget-price Encore label the five L.P.s which Dave Dexter of American Capitol put together under the title "The Jazz Story." These albums, each of which contains twelve tracks are priced at \$2.50 and are available separately.

Despite the attractive price, these five L.P.s are, in the main, disappointing. The basic problem is that American Capitol did not start to record jazz until the early 1940s, about twenty years after the first recordings of significance. Even then, the quality of the

jazz musicians who subsequently worked for the Capitol label was not outstandingly high.

Dave Dexter was, therefore, hopelessly handicapped in his efforts to compile an acceptable documentary series of the history of jazz. In addition, the presentation of the tracks is rather illogical.

Volume 1, which was intended to cover the early years of jazz in New Orleans, is poor. Most of the tracks were recorded in the 1940s, when the musicians were past their peak. There is not, indeed, a single example of genuine classic jazz. The best tracks are two 1946 Louis Armstrong recordings, "Sugar" and "I Want a Little Girl," Wingy Manone's 1944 "Paper Doll" and Eddie Miller's 1945 "Musk-rat Ramble."

"INNERBOND"

(Regd.)

BONDED ACETATE FIBRES

FOR PACKING IN

SPEAKER ENCLOSURES

A new resilient Bonded Wadding made from ultra fine Cellulose Acetate Fibres that gives high efficiency for Sound Absorption.

"INNERBOND" is light, clean, dust-free and easy to handle. Because all the fibres are bonded "INNERBOND" will hang as a "curtain" and will not fracture or break down due to vibration.

"INNERBOND" is odourless, highly resistant to attack by bacteria or fungus and is vermin repellent; "INNERBOND" at 16oz sq. yd. has a normal thickness of 1" and at this density is recommended as a packing in Speaker Enclosures for Sound Absorption.

STOCKISTS:

SYDNEY: Arrow Electronics Pty. Ltd. 342 Kent St.; Broadway Electronics (Sales) Pty. Ltd., 32 Giebe Point Rd.; GLEBE; Convoy International Pty. Ltd., 449 Kent St.; Ence Electronics Pty. Ltd., 257 Clarence St.; Kent Hi-Fi 432 Kent St.; Mastersound Sales Pty. Ltd., 400 Kent St.; Radio Despatch Service, 869 George St.; Peter Shalley Electronics Pty. Ltd., 127 York St.; Stereo Music Systems, 193 Clarence St.; Circuit Components (A/asia) Pty. Ltd., 460 Bexley Rd.; BEXLEY; Classic Radio, 245 Parramatta Rd.; HABERFIELD; Dyna Stereo Pty. Ltd., 321 Prince's Hwy, ST. PETERS; Albert Wright Radio Service, 795 New Canterbury Road, HURLSTONE PARK; H. B. Radio Products, 103-105 Catherine St., LEICHHARDT.

NEWCASTLE: Martin de Launay Pty. Ltd., King and Darby Streets; Dynamic Sound, 587 Hunter Street.

WOLLONGONG: Electron Parts Pty. Ltd., 82 Keira Street; Martin de Launay Pty. Ltd., 270 Keira Street.

MELBOURNE: J. H. Magrath and Co. Pty. Ltd., 208 Little Lonsdale Street.

BRISBANE: A. E. Harrold Pty. Ltd., 123 Charlotte Street; Brisbane Agencies, 78 Wickham Street, Fortitude Valley.

IPSWICH: Robert N. Smallwood, 205 Brisbane Road, Booval.

NORTH QUEENSLAND: Alvin Communications and Electronics, 38 Peggall St., Pinnico, Townsville.

ADELAIDE: Duncan Agencies, 57 Woodville Road; Woodville; General Accessories, 81 Flinders Street; Trustcott Electronics, 62-64 Hindmarsh Square.

PERTH: Atkins (W.A.) Ltd., 894 Hay Street; Carlyle and Co. Pty. Ltd., 1 Milligan Street; General Accessories, 46 Milligan Street.

HOBART: Homecrafts-Tasmania, 199 Collins Street.

If unobtainable

For 1 sq. yd. as above send \$2.00
For 2 sq. yds. as above send \$3.75
For 4 sq. yds. as above send \$6.50

Postage paid in Australia and Territories to the manufacturers.

WONDER WOOL PTY. LTD.

87 JAMES STREET, LEICHHARDT.
N.S.W., 2040.
Box 548 — G.P.O., Sydney. 2001.
Phone: 56-2780.

**Making your
move up to Tandberg
stereo tape quality is
easier (and lower in price)
than ever before.**



Great money saving news for music lovers!

Simon Gray Pty. Ltd. have just released the new Tandberg Model 1641X stereo tape deck in Australia. Although the list price of the 1641X is only \$367, performance is indistinguishable from the proven Tandberg Model 1241X . . . the stereo recorder that's taken the world by storm. The *money saving difference* is that the new Model 1641X is designed for use with your own high fidelity stereo amplifier and your wide range speaker systems.

Flexibility of control

Operational flexibility and controls are similar to the Model 1241X. Inputs are provided for radio tuner, dynamic microphones, stereo pick-ups.

What is the advantage of Cross Field Bias?

The new Tandberg Model 1641X stereo tape deck is fitted with the remarkable Tandberg Cross Field Bias Head. *Dramatically improved frequency responses and signal-to-noise figures are the result . . .* for example,

frequency response at 7½ i.p.s. is 20-25,000 Hz. and signal-to-noise better than — 58 dB.! Even at 3¾ i.p.s. frequency response is 20-18,000 Hz. and signal-to-noise better than — 56 dB.!

Make your own comparisons!

Compare the performance of the Tandberg Model 1641X stereo with any deck in a similar price category. You're sure to select the *extra value, the extra facilities, the extra quality and dependability* of Tandberg. See and hear the Tandberg Model 1641X at selected dealers in all states.

Abridged Specifications:

* Three speeds — 7½, 3¾ and 1½ i.p.s.
* Inputs for radio tuner, dynamic microphones, pick-ups. * Frequency response at 7½ i.p.s. 20-25,000 Hz. * Signal-to-noise at 7½ i.p.s. Better than — 58 dB. * Twin VU meters. * Wow/flutter at 7½ i.p.s. — Less than 0.10% RMS. * Fast forward and fast rewind: 2 mins. for 1200'. * Every desirable control facility. * List price — \$367 inc. sales tax.

SG-T-10/69



Australian National Distributors:
Simon Gray Pty. Ltd.
Head Office: 28 Elizabeth St., Melbourne, Vic. Tel. 63 8101*
Sydney Office: 22 Ridge St., North Sydney, N.S.W. 929 6816
Canberra Office: 31-33 London Circuit, Canberra City, A.C.T. Tel. 49 6050

INTERSTATE REPRESENTATIVES:

N.T.: Pfitzner's Music House, Smith Street, Darwin. Tel. 3801
Q'land: Sydney G. Hughes, 154-158 Arthur St., New Farm, Brisbane. 58 1422
S.A.: Eilco Sales Pty. Ltd., 7-9 Osmond Terrace, Norwood, S.A. Tel. 63 4844
Tas.: K. W. McCulloch Pty. Ltd., 57 George Street, Launceston. Tel. 2 5322
W.A.: Athol M. Hill, 613-615 Wellington Street, Perth. Tel. 21 7861

Volume 2 sets out to illustrate the spread of jazz north from New Orleans (in any event, an unacceptable piece of history). It is, without doubt, the weakest of the five. There are four completely dispensable tracks by Blue Lu Barker, Red Nichols (1956), Joshua Johnson and Ray Turner. Indeed, the L.P. would have been virtually worthless had it not been for the inclusion of a reasonably good Johnny Hodges' small group track called "Good To The Last Drop" and a 1963 recording of Earl Hines' "Deep Forest."

Volume 3, on the other hand, is very much better and is by far the best L.P. of the set. Although the tracks lack an overall theme, they include Duke Ellington's superb 1933 "Sophisticated Lady"; Fats Waller's "Flat Foot Floogie" which he recorded in London in 1938; "Blue Interlude" by the 1933 Chocolate Dandies (a first-rate track); the well-known "Nagasaki" and "Talk of the Town" by the great 1933 Fletcher Henderson Orchestra, featuring respectively Red Allen and the late Coleman Hawkins, and two 1935 Bunny Berigan tracks in "You Took Advantage of Me" and "I'm Coming Virginia."

Volume 4 — the Big Band album — reverts to mediocrity with Casa Loma, Bob Crosby and Lunceford recreations and latter-day Goodman and Harry James. The best tracks on this L.P. are a 1942 Billie Holiday recording of "Travelin' Light," which she made, unfortunately, with Paul Whiteman; a very interesting Cootie Williams Big Band track called "House of Joy" from 1945; and a 1943 recording of "Hurry Hurry" by the short-lived Benny Carter Band.

Volume 5 covers modern jazz but it is, on the whole, unbalanced and unrepresentative of the postwar years. It does include, however, a good Kenny Clarke track featuring James Moody, Tadd Dameron's "John's Delight" and the famous "Moon Dreams" by Miles Davis' influential 1949 band. But this L.P. — like the others — spotlights the limited range of the Capitol label.

Johnny Dodds: "at his finest"

JOHNNY DODDS. RCA Vintage Series Mono LPV 558.

Interest: 1926-1929.

Performance: Dodds at his finest.

Quality: Superbly recorded and remastered.

Like the great majority of RCA Vintage releases, this Johnny Dodds LP is almost beyond criticism. The music is magnificent; the technical processing and production have been carried through with skill and care; the discographical information is comprehensive; the playing time is generous at 49 minutes; and the retail price of \$3.95 represents very fine value.

The earliest recordings date from December, 1926, when Dodds recorded with the Dixieland Jug Blowers. The tracks are "Memphis Shake" and two previously unissued takes of "Carpet Alley — Breakdown" and "Hen Party Blues," a happy, boisterous and likable music with superb clarinet breaks by Dodds.

Four 1928 tracks by the Johnny

Serious jazz collectors will certainly by-pass these five albums. Indeed, the only L.P. which can be taken at all seriously is Volume 3. Mr Dexter's sleeve notes, incidentally, are notable for their trite and totally unjustified use of superlatives. (T.F.C.)

★ ★ ★

BUNNY — Bunny Berigan and his Orchestra. RCA Camden Mono CAL 7057.

Interest: Commercial big band 1937-39.

Performance: Some good tracks.

Quality: A little rough.

A Beiderbecke-type legend has evolved around the life and work of trumpeter Bunny Berigan, who died from alcoholism in 1942 at the age of 33.

He achieved enormous commercial success with his famous "I Can't Get Started" and, in addition, he was a featured soloist with Benny Goodman in 1935 and Tommy Dorsey in 1936.

He formed his own Swing Band in 1937 but, by all accounts, it was a rather rough-and-ready organisation. Nevertheless, the tracks of this LP feature outstanding musicians like George Wettling, George Auld, Dave Tough, Joe Bushkin and Buddy Rich, while Ray Conniff did the bulk of the arranging.

But dominating the band was Berigan's warm-toned, powerful and lyrical trumpet-playing, inspired by Armstrong rather than Beiderbecke.

Most of the twelve tracks on this collection are fairly commercial dance music, but "There'll Be Some Changes Made," "Little Gates Special," "Russian Lullaby," "Jazz Me Blues" and "Deed I Do" have some excellent solos, particularly by Berigan.

Collectors of Bunny Berigan will already possess most of these tracks. But readers who have a general interest in the big bands of the Swing Era may find this an attractive collection, particularly with a playing-time of 37½ minutes and a retail price of \$1.99. (T.F.C.)

Dodds Washboard Band are featured and these recordings — particularly "Weary City" — shows Dodds in magnificent form, full of expression and constructive ideas. His band included his brother on drums, Natty Dominique on cornet and Honore Dutrey on trombone and the results were the very essence of perfectly-integrated New Orleans jazz.

Just as magnificent are the six tracks from January and February, 1929, with the same front-line and Lil Armstrong on piano. These include the previously unissued "Heah' Me Talkin'" but even better are "Sweet Lorraine" and "Goober Dance."

The album is completed by three glorious 1928/29 trio tracks, "Indigo Stomp," "Blue Clarinet Stomp" and "Blue Piano Stomp," which provide ample opportunity to study Dodds' classic tone and endless stream of meaningful ideas. As readers may have gathered, I regard this L.P. as yet another essential purchase for collectors of classic jazz. (T.F.C.)

COMPLETE HI-FI RADIOGRAM-TAPE RECORDER ALL IN ONE

MODEL TR9

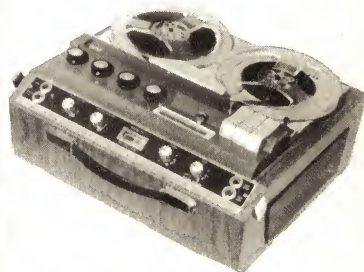

AS AN AMPLIFIER . . .

- Frequency response, 20-20000 cps.
- 7 Watts RMS. output per channel.
- Distortion less than .25%
- Separate treble and bass controls.

AS A RADIO . . .

- Being fully transistorised, can be switched on all day at full output without heat problems. Program can be recorded on tape without any external connections.

AS A TAPE RECORDER . . .

- Freq. response 30-18000 cps.
- 3 speeds. Meter level indicator.
- Push button operation.
- Superimposing.

PRICES:

- 2 track mono, \$159.00
- 4 track mono, \$169.00
- 4 track stereo, \$230.00

RADIO TUNER CAN BE FITTED TO ANY OF THE ABOVE MODELS FOR \$28 EXTRA.

TAPE DECKS

for the home constructor. COLLARO (Magnavox) tape decks complete with record/play and speed change switch wafers fitted . . .

2 tracks, \$48. 4 tracks, \$55. SPECIAL LOW IMPEDANCE HEADS for transistorised tape amplifier circuits (Mullard) available.

CLASSIC TAPE RECORDERS

93B LIVERPOOL ROAD,
SUMMER HILL, N.S.W.
Telephone 79-2618

Now YOU can enter
The Wonderful
World of Electronics
with

TECHNIPAC

The Complete Training System

TECHNIPAC didn't 'just happen.' It is the result of many years of experience, research and design in the field of Electronics training. TECHNIPAC is a unique combination of the theory and practical application of Electronics presented and arranged in a simple, logical and effective manner.

Whether you are a beginner or have some knowledge or experience in Electronics, the TECHNIPAC system is designed to meet your individual requirements. Find out *NOW* how you can enter *the Wonderful World of Electronics*—through the **TECHNIPAC SYSTEM**

Technical Training International Pty. Ltd.

Archer House, 75 Archer St., Chatswood, N.S.W. 2067. Tel 41 4444.

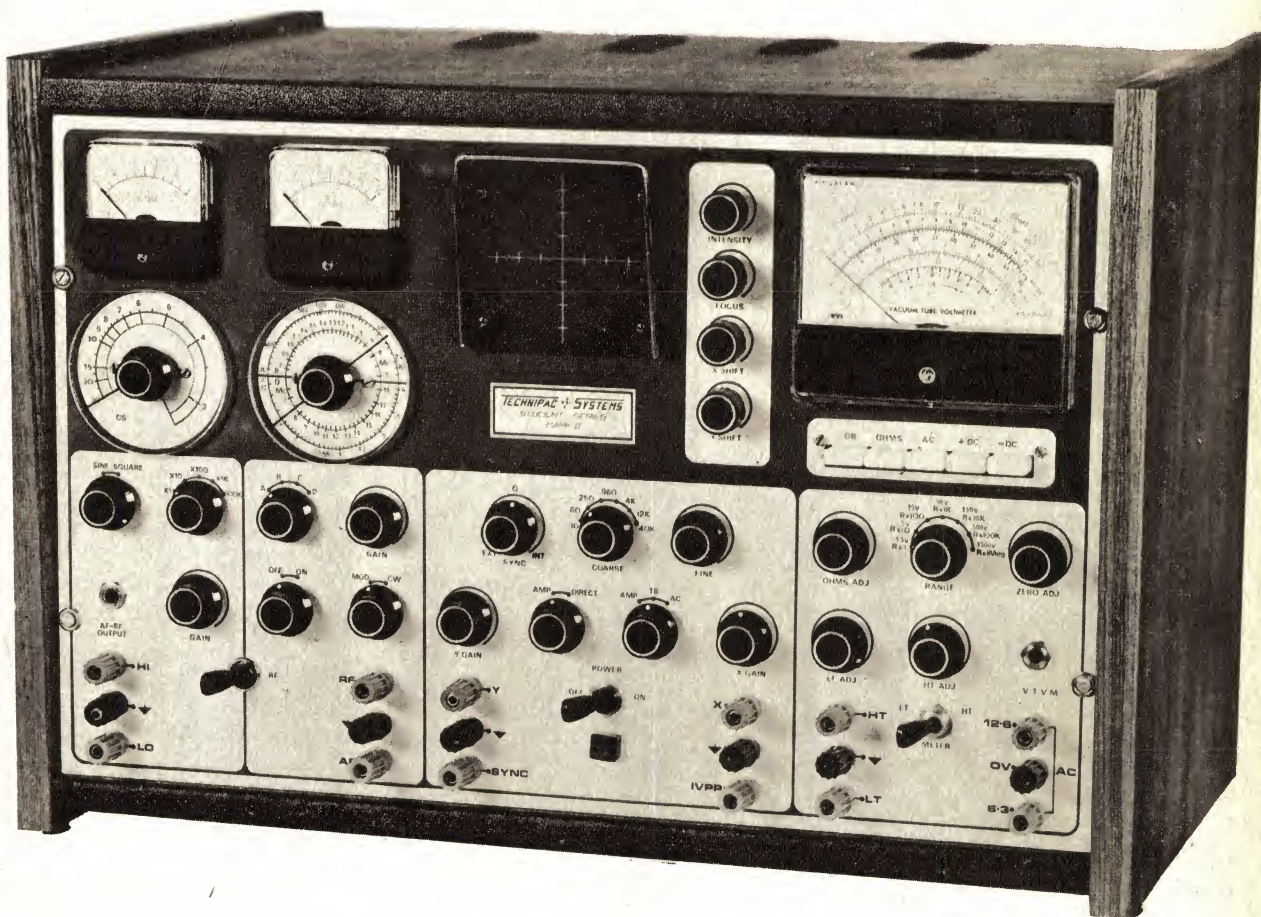

Illustrated above is the **TECMARK II TEST EQUIPMENT CONSOLE**. It incorporates a DC/AC power supply with a stabilized LT. section, vacuum-tube voltmeter, oscilloscope, audio frequency generator and an R.F. generator.



To: **TECHNIPAC SYSTEMS DIVISION**,
 Technical Training International,
 P.O. Box 328, Chatswood, N.S.W. 2067.
 Please forward full details immediately,
 including illustrated *brochure* on Technipac.

NAME: _____ AGE: _____

Address: _____ Postcode: _____

TRADE REVIEWS AND RELEASES

Revox high quality amplifier

In the April 1969 issue of "Electronics Australia" we reviewed the Revox A77 tape recorder and found it to be a very good performer. Here we review the Revox amplifier which matches the tape recorder in styling and performance.

The amplifier has a similar plastic front panel assembly, with a skin of brushed aluminium, and the same physical array of panel controls. It has a drop-down chrome plated cover which, in the recorder, concealed the tape path. In the amplifier it conceals control and other facilities which would otherwise clutter the front or rear panels.

Overall dimensions of the amplifier are 16-3/8 x 9-5/8 x 6 1/2 inches. An oiled teak case is fitted so that the amplifier is suitable for use as a free-standing unit or for installation in an equipment console.

Rotary switches cater for the usual Mode and Selector functions and also for the Bass and Treble controls; switched tone controls are an unusual feature these days, most manufacturers preferring to use potentiometers. Five push buttons cater for the "Speakers Off" mode, Tape Monitor, Loudness switch and low and high filters. Three jack sockets accommodate a tape outlet and two stereo headphone outlets.

The drop-down, chrome-plated cover conceals preset level controls for each of the inputs via the amplifier's rear panel,

for inputs from tape, tuner, microphone and magnetic cartridge, a tape monitoring input and a tape output. Two five-pin DIN sockets are provided for alternative connection of either a ceramic cartridge or a high level, "flat" source. Two three-pin sockets are provided for the loudspeaker outputs. When the usual two-pin, polarised plug is inserted in one way, the amplifier can be used with loudspeakers having an impedance of 4 to 16 ohms. When the plug is inserted the other way, the amplifier can be used with electrostatic loudspeaker systems or "100 volt" distribution systems (with transformers).

One small complaint we have here is that the labels for the various input and output sockets and for the preset level controls on the front panel are of the "self-adhesive" variety and have a somewhat improvised appearance.

The phono sockets are also rather too close together for easy manipulation of the plugs.

Removing the wooden case from the amplifier reveals high quality workmanship inside. The chassis is made of heavy



The front panel is very similar to that of the Revox tape recorder.

so that all sound sources can be set for about the same loudness level. This is a very handy feature when a variety of signal sources are to be connected. Also concealed by the drop-down cover are the fuseholders for the mains supply and for the DC supply to each channel.

The rear panel of the amplifier is a massive cast-aluminium heatsink which accommodates the output transistors, as well as the various input and output sockets, the mains input socket and the rotary mains voltage selector. A neat feature associated with the heatsink is the plastic covers over the output transistors, which obviate the possibility of shorting the DC supply at the transistor collectors to chassis.

Six pairs of phono sockets are provided

gauge cadmium plated steel. The large power transformer is unusual in that it is a twin C-core type which results in low flux leakage, less magnetising current and less weight than the more usual type. In all, 11 fibreglass printed boards are used, some plugging into others. The rotary switches for the Mode, Selector and Tone Controls are totally enclosed printed circuit switches. One could go on for quite a few paragraphs describing the many interesting features of the amplifier assembly but space does not permit. But it is a very well engineered piece of equipment.

The amplifier contains 30 transistors in all, plus 17 diodes. We were not able to refer to the circuit diagram but the output stage is a quasi-complementary arrangement using 2N3055 transistors. The DC supply to the output stages appears to consist of balanced positive and negative supplies which eliminate output coupling capacitors. As a result, there is

no resounding "thump" from the loudspeakers when the amplifier is turned on.

Rated power output of the amplifier totals 80 watts RMS (40 watts per channel) into 8-ohm loads or 50 watts RMS into 16 ohms. Distortion is rated at less than 0.1 per cent at 40 watts into 8 ohms at 1KHz and less than 0.3 per cent at 40 watts over the full range from 40Hz to 15KHz. We measured power output at 47 watts per channel into 8 ohms with both channels driven at 1KHz with total harmonic distortion less than 0.1 per cent; this was excellent. Power into 16-ohm loads was measured at 30 watts per channel. The figures were slightly increased when one channel was driven singly. Attempts to measure maximum power capability into 4-ohm loads blew the fuses but we did verify that it was in excess of 45 watts per channel.

The power bandwidth of the amplifier was very wide at 40 watts from 10Hz to 80KHz which is well in excess of the specification.

The specification for rated total harmonic distortion is a little vague as it does not indicate which inputs should be used to verify the figures. Performance at 1KHz was measured using the high level inputs. Using the low level inputs, as for magnetic cartridge, we measured better than 0.25 per cent over the range from 40Hz to 15KHz; this is also within specifications.

Square-wave response of the amplifier taken at half power level was very good, even as high as 10KHz. Stability was excellent with all types of load, even large capacitance loads causing only slight ringing of square-wave signals.

Separation between channels, referred to a level of 40 watts into 8 ohms, ranged from minus 51dB at 10KHz to minus 74dB at 100KHz; this again is excellent. Signal-to-noise ratio using the high level inputs was minus 76dB with respect to 40 watts and minus 65dB using the magnetic cartridge input.

Sensitivities of the various inputs with the preset level controls at maximum setting were very close to those specified but overload capability could have been better. The magnetic cartridge input had input sensitivity of 3mV at 1KHz and an overload capability of 50mV at 1KHz for a total harmonic distortion of 1 per cent. Increasing the permissible distortion to 2 per cent gave an overload capability of 100mV. This is no more than adequate, considering the wide dynamic range of modern records, and variations in the output of cartridges likely to be used.

The switched tone controls yielded a range of plus and minus 12dB at 12KHz and 50KHz, with adjustments in boost or cut in 4dB steps at these frequencies. The use of switches permits an easily resettable amount of boost or cut to be applied; switching transients have been well suppressed. The loudness control is unique, in that depressing the appropriate push-button reduces the gain of the amplifier by 16dB and applies fixed boost at low and high frequencies. The amount of boost does not vary with the setting of the volume control.

On actual listening test the amplifier performed very well, as was to be expected. It was very quiet at all control settings. Nor was the amplifier unduly worried by the incidence of high level RF signals which occur in our building.

In short the Revox A50 is a well engineered piece of equipment. It performs well and is pleasant to use. At the price of \$399, tax included, it is quite competitive with other amplifiers having the same order of performance and power capability.

Further information regarding the amplifier and other products in the Revox range can be obtained from the Australian distributors, Amalgamated Wireless (Australasia) Ltd., Engineering Products Division, 422 Lane Cove Road, North Ryde, N.S.W. or from normal retail outlets. (L.D.S.)

WHARFEDALE LOUDSPEAKER SYSTEMS

The Wharfedale Super Linton and Denton loudspeaker systems are compact units built around the same tweeter and woofer loudspeakers. The major difference between the two systems is the enclosure volume. Pairs of both systems were submitted to us for review by Simon Gray Pty. Ltd.

An interesting feature of these Wharfedale systems is that they are packed in pairs in the one carton—reflecting the current market trends. The grain and colouring of the veneer of the paired cabinets is closely matched and the overall exterior finish is quite impeccable.

The Wharfedale Denton measures 9-5/8 x 8-5/8 x 13-7/8 inches high while the

speakers. In spite of the above remarks the cabinets appeared to be airtight and comparatively non-resonant.

The other point of concern was the method of mounting the woofer. The chassis was provided with the usual four mounting holes around the periphery but only two 3/16 inch bolts and nuts had been used to secure the woofer in the sample Denton we examined. Time did not permit us to closely examine the other samples. We can only presume that the diecast chassis would not be warped under these conditions. Still, it did raise some doubts.

Listening tests did not, however, add to any doubts we might have had about assembly details. The treble characteristic of both system is very similar, which is to be expected since they both have the same tweeters. The upper frequency response extends to the limit of audibility, though with some evidence of taper above about 10KHz. The response is rather prominent in the region of 3 to 4KHz, which gives the overall sound a

middle heavy quality, favoured by many for its "presence."

The bass response of the Super Linton was well maintained down to below 50Hz, although just a little lumpy in the region of 70Hz. There is little need for bass boost with this system and, indeed, many listeners may prefer it without. Too much bass boost only seems to make the sound "muddy" especially on complex orchestral music.

The bass response of the Denton is well maintained down to the 100Hz mark, tapering smoothly below this so that it is possible to obtain smooth response to below 50Hz with application of about "half bass boost" from most amplifiers. Indeed, it performs so well under these conditions that it might well be reckoned as giving better value for money.

Little more can be said except that both systems are capable of very satisfying results when teamed with a good quality cartridge and amplifier. Price of the smaller Denton system is \$69.50 each, including sales-tax while the Super Linton is \$89 each, including sales-tax.

Further information regarding these and other products in the Wharfedale range can be obtained from the Australian distributors, Simon Gray Pty. Ltd., 28 Elizabeth Street, Melbourne, Victoria or normal retail outlets. (L.D.S.)

STANDARD TELEPHONES & CABLES PTY. LTD. has opened a new sales and service centre in Granville House, Cuthbertson Street, Port Moresby. The division will market a full range of S.T.C. telecommunications equipment throughout the Territory of Papua and New Guinea. In addition, the division will provide a consultative service on all matters relating to telecommunications to the Administration, the Territory's Posts and Telegraphs Department, the Australian Broadcasting Commission, and police and military forces.

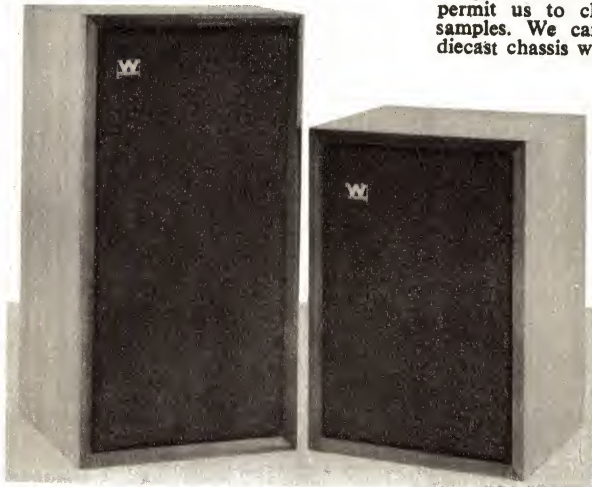

Super Linton measures 9-7/8 x 9-3/8 x 18-7/8 inches high. Both are made of 1/2-inch thick particle board and, in the case of the samples submitted, finished in oiled teak veneer. The black, gold-flecked speaker cloth is backed with foam to give a padded appearance and to inhibit cloth rustle.

Frequency response for the Denton system is conservatively rated 65 to 17KHz while that of the Super Linton is 40 to 17KHz. Nominal impedance of both systems is 8 ohms.

As stated earlier, both speaker systems use the same loudspeakers, the only difference being in the enclosure volume. The tweeter has a plastic dome and a hefty ceramic magnet. The woofer has a nominal diameter of 8 inches and is fitted with a neoprene roll surround. The chassis is a die casting and the magnet is again, a ceramic type.

The cabinets are loosely packed with bonded acetate fibre as in the case of most modern, completely sealed enclosures. The crossover network consists of a non-polarised electrolytic capacitor and two ferrite-cored inductors to give a crossover frequency of approximately 1000Hz.

We were not happy with some details of the cabinet assembly which came to light when we removed one of the cabinet backs for purposes of inspection. The cabinet backs are secured by a number of wood screws and both cabinet back and sides are rabbetted to position and seal the cabinet back without the aid of cleats. While the fit is very good, the wood screws have a somewhat tenuous hold in about 3/16in thickness of particle board. This is not a very satisfactory material for holding screws, especially if the screws have to be removed for any reason.

Overseas reviews state that the cabinet backs are glued in position but this was not the case with our samples; if the backs were glued, the cabinet would have to be "butchered" to gain access to the

"OXFORD"



RADIO CHASSIS



INSTRUMENT CASES



MINI BOXES "ALUMINIUM"



All printed and engraved panels for "Electronics Aust.," Mullard "Outlook," Philips "Digest."



Any special metalwork and panel engraving to specification.



All stock cases and chassis from our distributors in Brisbane, Melbourne, Adelaide.

HEATING SYSTEMS PTY. LTD.

24 O'Riordan St.,
ALEXANDRIA. N.S.W.
2015.
69-3764 - 69-7616

DANA ...the DVM with accuracy to 0.0025%

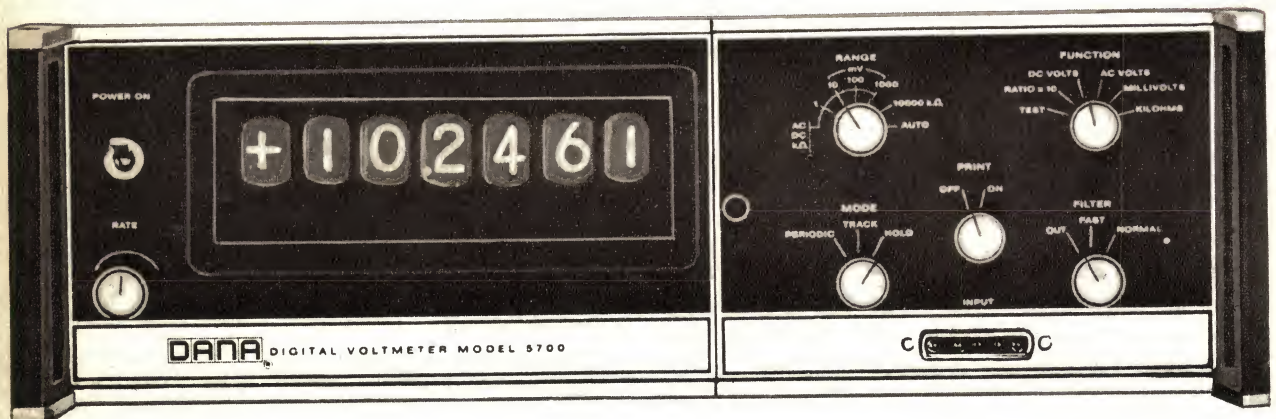

Model 5700

The first DVM to offer metrology laboratory accuracy of 0.0025% is a rugged on-the-line instrument. Premium 5-digit performance with 6th-digit overrange. DC signals can be measured with a stability of 65 parts/million per 12 months. Functions d.c., a.c., mV, ohms, ratio all autoranging: d.c. 1-1000v., a.c. 1-1000v. Noise rejection: normal mode at least 80dB, 59Hz and above; common mode 150dB, 61Hz and below.



Model 5500 The optimum combination of performance and price in a 5-digit DVM with 6th-digit overrange. 0.005% accuracy, 1mV resolution. 5 d.c. ranges, 100mV to 1000v. 65mS readings.

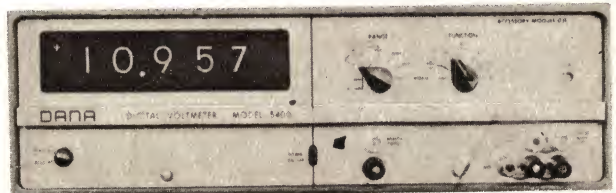

Model 5400 Versatile 4-digit DVM's with 5th-digit overrange. 0.01% accuracy. Measures in 12mS. Null balance stability. A unique group of special purpose modules is available.



The name DANA has long been synonymous with premium, high performance Digital Voltmeters. Now the full price and performance spectrum is available in Australia from:

jacoby, mitchell & co. pty. ltd.

469-475 Kent Street, Sydney. 26-2651

MELBOURNE
30/2491-2

ADELAIDE
53-6117

BRISBANE
2-6467

PERTH
28-1102

LAUNCESTON
2-5322

OSCILLOSCOPES FROM TEKTRONIX

A new generation of plug-in oscilloscopes, known as the 7000 Series, has been introduced by Tektronix Australia Pty. Ltd.

The oscilloscopes, types 7704 and 7504 form a complete measurement system consisting of two main frames and 13 plug-in units, including six amplifiers, four time-base units, and three sampling units. Two trace-recording cameras, and five voltage and current probes have been introduced as compatible accessories.

The oscilloscope main frames accept up to four plug-in units; two each vertical and horizontal. Dual-trace switching between channels is contained in the main frame amplifiers rather than in the plug-in unit. Internal "chopped" and "alternate" operations, and a modular approach to plug-in selection are said to provide a better match between instrument and application. The flexibility of the system allows an unusual range and combination of multi-trace, differential, high-gain, current, and sampling input configurations.

The bandwidth of the 7704 oscilloscope is DC to 150MHz (2.4nS risetime), while that of the 7504 is DC to 90MHz. Maximum calibrated sweep rate is 2nS/division in the 7704 and 5nS/division in the 7504.

The oscilloscopes incorporate "Auto Scale Factor Readout," which uses the CRT to display deflection factors, polarity, and any uncalibrated condition for all channels, corrected for probe attenuators and magnifiers. Other operational con-

veniences are true automatic triggering, lighted push-button switching, and functional colour coding.

Two compact, light-weight, trace-recording cameras, types C-50 and C-51, are said to offer unusual features. Differing only in the lens systems, both cameras feature a trace-brightness photometer, range-finder focusing and accurate exposure control. The shutter is electrically

actuated either remotely or by push-button on the control panel. Optional film backs can be rapidly interchanged without refocusing the camera. The C-50 is provided with an f/1.9-1:0.7 lens for general purpose trace recording. The C-51 uses an f/1.2-1:0.5 lens for high-speed writing.

Inquiries should be addressed to Tektronix Australia Pty. Ltd., 80 Waterloo Road, North Ryde, N.S.W. 2113.

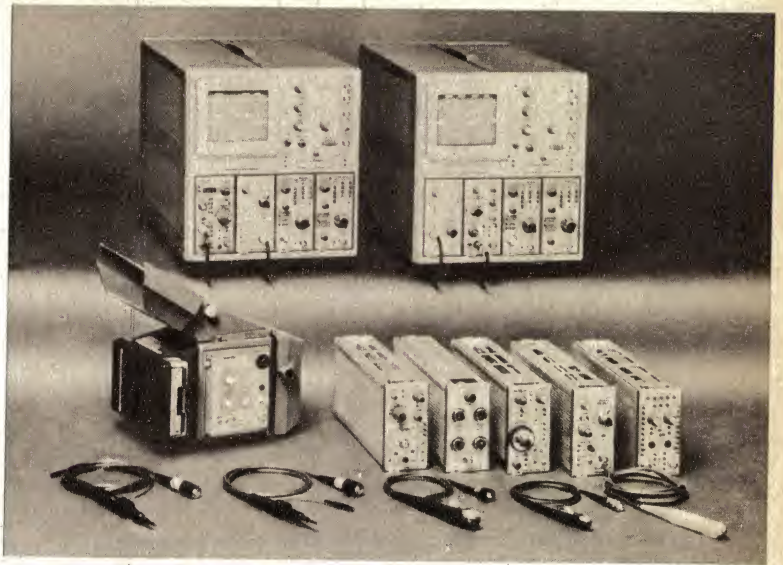

The Tektronix 7000 Series, showing the two main frames, the 13 plug-in units, one of the trace-recording cameras, and the five current and voltage probes.

MAGNAVOX LOUDSPEAKERS

We have received advice from Magnavox (Aust.) Pty. Ltd. that they have released a new version of their popular 6WR loudspeaker. Designated as 6WR Mark IV, it is pictured below.

The new loudspeaker uses the same magnet assembly and frame as the earlier marks, but has a completely different cone system.

Instead of being of plain, conical design, the new cone is of curvilinear shape and very much lighter. This reduced mass would normally have produced a rise in the natural resonant frequency of the system but this has been offset by a substantial increase in the compliance of the suspension, aimed at maintaining the system resonance in the region of 45Hz.

As with the earlier marks, a tweeter

cone takes care of the high frequency response, the extended bass and treble justifying the "WR" designation, signifying wide-range. The power output rating remains at a nominal 6 watts RMS and the loudspeaker retains about the same order of power sensitivity.

From the design and specifications, it would appear that the new model is aimed at the modestly-priced hi-fi equipment market, where a stereo pair will be driven by amplifiers having a power rating in the range 3 to 5 watts RMS. With a sensitivity to make good use of the power available, two such loudspeakers should meet all normal domestic requirements, with something to spare. If an attempt is made to push the volume level to excessive limits, the amplifiers would overload before the loudspeakers.

Unfortunately, however, the change renders the loudspeakers unsuitable for use in the very popular Playmaster "Bookshelf" enclosures, as originally described in the December, 1964 issue.

The Magnavox 6W and 6WR Mark IV loudspeakers. These are not recommended for use in the Playmaster Bookshelf enclosure, for reasons explained in the text.

The 6WR Mark III loudspeakers specified at the time had a heavier cone system, with lower compliance. Extensive listening tests established that, when mounted in the sealed and damped enclosure, they could be used quite successfully with amplifiers having a power rating in excess of 6 watts RMS. There was no suggestion that they should be deliberately or continuously over-run. The idea was rather that normal—even loud volume—domestic requirements would not involve an average level in excess of 6 watts RMS per channel. The loudspeakers could, however, cope with short-term overload on peaks without obvious distress.

With their changed characteristics and higher compliance, the 6WR Mark IV loudspeakers tend to "bottom" more readily under overload conditions in an enclosure the size of the Playmaster "Bookshelf." In bottoming, they produce a very objectionable transient "crack."

This being so, the 6WR Mark IV should be used in a Playmaster "Bookshelf" enclosure, only if the driving amplifier itself has a maximum power output of 6 watts RMS or less.

For use with more powerful amplifiers, the enclosure must be fitted with Mark III loudspeakers.

Magnavox (Aust.) Pty. Ltd. have indicated that they may produce both the Mark III and the Mark IV units, to meet the alternative applications, if the demand should warrant it. However, at the time of writing, no firm decision has been made.

As a matter of interest, Magnavox has also announced a model 6W Mark IV loudspeaker which is similar to the 6WR Mark IV except that no tweeter cone is fitted. While the overall response is not as wide as that of the 6WR, the company claims that the curve is very smooth, by reason of the curvilinear cone.

Also pictured is the 3UC tweeter, featuring a curvilinear cone and increased sensitivity. It is better suited than the 3TC unit for use with higher sensitivity woofers as, for example, the Magnavox 15in bass loudspeaker. (W.N.W.)



(Left) The Magnavox 3UC tweeter.

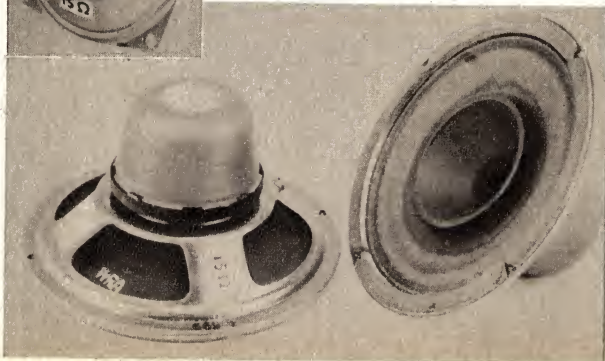

PETER SHALLEY Electronics Pty. Ltd.

New 5-WATT Base Station

JUST RELEASED

FEATURES:

- Delivers a full 5-Watt Input Power to the Final Amplifier.
- Operates on any of the 6 Citizen's Band Channels.
- Tone Call System for more effective communication.
- Stable Crystal-controlled Receiver with RF Stage.
- For short distance communications, Battery Saver slide installed.
- Variable Squelch and full series of Jacks for PA, Mic, External Speaker, External Antenna and External Power connecting.
- All Die-cast Cabinet and Leather Case



\$49.75

Also PT51 - New Release

- 11 Transistors
- All metal
- Leather case
- Sep. Spkr. and Mic.
- Ear piece
- Squelch

127 YORK STREET (just near Town Hall) Sydney 29-7021 29-3767

PRE-PAK electronics

SHOP-BY-PHONE SERVICE
69-5922

MAIL ORDER DEPT.
P.O. BOX 131,
KINGSGROVE, N.S.W. 2208.

SALES CENTRE,
103 Regent Street,
REDFERN, N.S.W. 2016.

**24 HOUR
DESPATCH SERVICE**

Send 20c in stamps or a postal order for our latest information packed catalogue which will be sent to you by return mail. Our low prices cannot be beaten. All parts new and guaranteed.

Transistor audio driver and output transformers 500mW at only . . . pr. **\$1.50**
IF Transformers 7mm x 7mm or 10mm x 10mm . **\$1.00**
or matched set of 3 . . **\$2.50**
PVC-20HB tuning gangs 1/2in x 1/2in x 1/2in . . . ea. **\$2.00**
4 x UM3 battery holders only ea. **45c**
9v 216 batt. clip ea. **10c**
10 2mf 10vw caps. . . . **\$1.00**
10 5mf 10vw caps. . . . **\$1.00**
10 30mf 10vw caps. . . . **\$1.30**
10 100mf 10vw caps. . . **\$1.60**
10 25mf 25vw caps. . . . **\$1.80**

MODULAMPS ea. \$4.00

Small 1W transistor audio amplifiers by Pre-Pak. Supply volts . . . 6-12v DC. Input sensitivity 1v P-P. Freq. response 50Hz-20KHz.

PACK AND POST 10c ANY ORDER

Sales Centre open
Mon. to Sat. 8.30 a.m.-5.30 p.m.

Magnetic Pre-Amp Kitset

As in E.A., Oct., 1965.
All parts supplied.
Use for pick-up or tape heads.
Mono **\$4.90** Stereo **\$9.00**

BARGAIN PAKS

D1 5 OA91 diodes . . **\$1.00**
D2 5 1N914 diodes . . **\$1.00**
SR1 5 1N4001 rect. . . **\$1.50**
SR2 5 100 PIV 1Arec . **\$1.50**
SR3 4 400 PIV 1Arec . **\$1.50**
SR4 4 EM404 rect. . . **\$1.50**
SR5 2 EM408 rect. . . **\$1.50**
T1 2 2N3638 trans. . . **\$1.50**
T2 6 2N4121 trans. . . **\$1.50**
T3 3 BC148 trans. . . **\$1.50**
T4 2 BC149 trans. . . **\$1.50**
T5 1 2N2160 UJT. . . **\$1.50**
BR1 1 100 PIV 1.6A bridge rect. . . . **\$1.50**
SCR1 1 C106F1 scr. . . **\$1.50**

Sensitive Multimeter From Radio House

A recent addition to the range of instruments offered by Radio House Pty. Ltd. is the RH-100 Volt-Ohm-Milliammeter. It follows what appears to be a trend towards more sensitive meters with a wider selection of ranges.

The multimeter has a sensitivity of 100K per volt on DC, -10K per volt on AC, and a resistance range with a highest reading of 20M. These are all very high figures for such an instrument.

The movement itself has a full-scale deflection current of only 9.5uA. It is a 4½ inch rectangular type, mirror-backed for convenient and accurate reading. Protected against overload by two silicon diodes, the double-jewelled movement has an accuracy of plus or minus 2 per cent. The instrument uses 1 per cent temperature stabilised film resistors throughout.

The complete instrument measures about 5in x 7in x 2½ deep, and has a carrying handle which doubles as a prop to hold the meter at an angle for bench use. Two 1.5V dry cells size AA, serving the resistance ranges, are easily replaced by removing the back of the instrument. However, the battery polarity markings in the meter are not very clear.

The RH-100 covers a wide range of readings. The full-scale deflections for the ranges are: DC volts—0.6, 3, 12, 60, 300, 600 and 1200V; AC volts—6, 30, 120, 300, and 1200V; DC current—12uA, 300uA, 6mA, 60mA, 600mA, and 12A; AC current—12A. The accuracy is plus or minus 3 per cent of full scale on DC and 4 per cent on AC. The resistance ranges are: 20K, 200K, 2M, and 20M.

There is also a series of decibel ranges for comparison of voltage levels or, if terminated across 600 ohms, for readings in dBm. The zero reference for this scale is 1mW or 0.715V across 600 ohms. The basic range covers -20 to +17dB, with additives of +14, +26, +34 and +42 for the other ranges.

A function switch on the front panel permits the selection of AC or either polarity DC. The meter has separate input sockets for the 1200V and 12A ranges for both AC and DC as well as the usual positive and common negative sockets.

The sample RH-100, illustrated, was tested in our laboratory and found easy to operate and well within the accuracy quoted. The meter should be of value for



experimenters or servicemen whether working with transistor circuits (where the low ranges and high sensitivity should be of particular value), valve circuits, or for domestic power measurements.

The sample instrument was submitted for review by Radio House Pty. Ltd., 306-308 Pitt Street Sydney, 2000. The price is quoted as \$39.75 plus 75c postage and packing. (J.H.)

3W IC Amplifier

Plessey Components have introduced to the market two integrated circuits with heatsink facilities. Both contain a pre-amplifier and power amplifier with a very high overall gain. A variety of different amplifier configurations is possible.

The integrated circuits are made by Plessey and have the serial numbers SL403A and SL402A. Physically, both ICs have the same external appearance, being an 8-lead flat package with a heavy gauge, 5/16-inch tab protruding from each end for heatsink connections. The electrical differences between the two are the lower ratings of the SL402A.

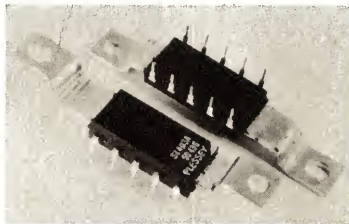

The SL403A is capable of delivering 3 watts into a 7.5 ohm-load at a total harmonic distortion of 2 per cent, with an 18-volt supply rail. Maximum operating voltage is 21V. The distortion reduces with decreased power, and the frequency response is typically minus 3dB down at 20Hz and 80KHz. A heatsink with an area of 5 sq. in of 18-gauge aluminium or equivalent is required.

The voltage gain of the preamplifier is typically 24dB while the voltage gain of the power amplifier is 26dB. The pre-amplifier output and the power amplifier input are both accessible. An interesting feature is that the preamplifier establishes the bias conditions for the power amplifier.

All the relevant data, and two possible

GET YOUR LOWTHER LOUDSPEAKER AT ENCEL'S AND SAVE!



PM 6 Mk. 1

Gap flux: 17,500 gauss.
Total flux: 196,000 maxwells.
Frequency range: 20-20,000 Hz.
Impedance: 15 ohms.
Capacity: 20 watts.
Weight: 7 lb.

The special design of the PM 6 drive unit preserves the fundamental to harmonic relationship throughout the entire audio range, thereby ensuring smooth, natural sound. Designed especially to meet the requirements of horn-loaded operation, the PM 6 should never be used as a conventional direct radiator.

PM 7

Gap flux: 19,650 gauss.
Total flux: 250,000 maxwells.
Frequency range: 20-20,000 Hz.
Impedance: 15 ohms.
Capacity: 20 watts.
Weight: 9 lb.

The generation of 19,650 gauss from such a small mass is the culmination of years of research to improve both available magnetic materials and construction techniques. The increased force in conjunction with a new patented speech coil of very high efficiency give an overall attack and transient response which has never before been achieved in such a compact unit. The PM 7 may be used as an alternative to the PM 6 in all Lowther systems where maximum efficiency and optimum performance characteristics are required.

Extracts from review in "Hi-Fi News": "On switching on, the first action was to turn down the volume control due to its high sensitivity. . . . Even more striking than this was the remarkable high note response. The effect of this was to bring all sounds closer to the listener as it were. . . . the source appeared to approach closer than the writer has ever experienced before. . . . a remarkably smooth top response."

Call or write now for a special Lowther price—you'll save more at Encel Stereo Centres in Melbourne or Sydney!



Here is a cross section of the Lowther Acoustica speaker enclosure. Plans will be provided or complete cabinets are available in your choice of several popular polished or oiled finishes. Prices on request.

Encel

ELECTRONICS
(STEREO)PTY. LTD.

Head Office:

431 Bridge Rd., Richmond, Victoria 3121.

Tel. 42 3762.

Sydney Store:

Ground Floor, 2SM Building,

257 Clarence Street, Sydney, N.S.W. 2000.

Tel. 29 4563, 29 4564.

*Wholesalers

*Trade-ins accepted

Australia's Greatest Hi-Fi Centre

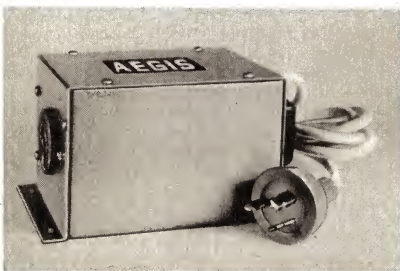

The MF.2A noise filter.

PERFECT MATES

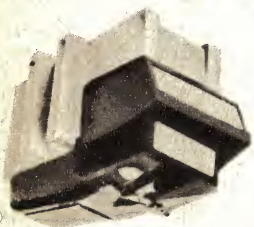

SHURE V15 Type II Cartridge . . \$87.50*

AND

SHURE **SME**

the best pick-up arm in the world

SHURE S.M.E. Precision Pick-up Arms offer all these features: • Choice of arms length Model 3009 (9") or Model 3012 (12") for still lower tracking error — of special importance with elliptical stylus • Low inertia • High precision ball races and knife-edge bearings for minimum pivot friction • Linear offset chosen for lowest distortion • Automatic slow-descent with hydraulic control • Bias adjuster, calibrated for tracking force • Exact overhang adjustment with alignment protractor • Precise tracking force from 1-5 grams applied without a gauge • Shielded output socket • Low capacity 4' connecting cable with quality plugs • Lightweight shell • Camera finish in satin-chrome gun-black and anodised alloy.

MODEL 3009/S2 \$80.00*

MODEL 3012/S2 \$85.00*



Contact your local Hi-Fi dealer or any of the following for more information:

N.S.W.: Audio Engineers, 342 Kent Street, Sydney.

W.A.: Athol M. Hill Pty. Ltd., 613-15 Wellington Street, Perth.

QLD.: Ron Jones Pty. Ltd., 7-9 Merton Road, Wolloongabba, Brisbane.

VIC.: Audio Engineers (Vic.), 2A Hill Street, Thornbury, 44-3295.

*Recommended Resale Price.

circuits and printed board layouts are presented in the application note supplied by Plessey Components. One is an amplifier with passive treble and bass tone controls, an input sensitivity of 250mV, and high input impedance. A complete amplifier would need 24 external components, including 4 potentiometers, which is quite modest compared with an equivalent discrete component amplifier.

Inquiries regarding prices and availability should be directed to the Professional Components Department, Plessey Ducon Pty. Ltd., Box 2, P.O. Villawood, N.S.W. 2613.

TRADE RELEASES—in brief

AURIEMA (AUSTRALASIA) PTY. LTD., 443 Kent Street, Sydney, 2000. Agents for Starpoint Electrics Ltd., New Malden, Surrey, England. **Push-button reed switch, type 1RB1.** A single pole, normally open switch, it uses twin circular magnets, one fixed to the switch housing and one to the moving plunger. This gives a positive snapover with a minimum of contact bounce, typically less than 1mS in operation, compared with those for a traditional microswitch (4mS) or a conventional reed switch (more than 2mS). The 1RB1 has been specially designed for printed circuit boards, and has pure nickel terminals. It is intended for rugged use, and tests have indicated that a life in excess of 10 million operations per key can be expected.

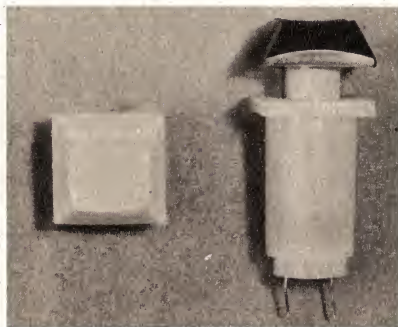

The non-inductive electrical ratings of the 1RB1 are: 100mA at 50V; 50mA at 100V; 2mA at 250V; switched power 5W. It is not suitable for switching filamentary lamps directly. Typical applications include calculating machine keyboards and computer peripheral equipment. Complete keyboards with solid state encoding to individual requirements can be supplied.

GOODFELLOW METALS LTD., Ruxley Towers, Claygate-Esher, Surrey, England. **Precision metal foils.** To meet demands from industry and research establishments for small quantities of ultra thin metal foils, Goodfellow has established facilities for the production of these foils in the thickness range from 0.00004in to 0.006in. The foils are produced with a uniformity generally better than plus or minus 2.5 per cent on nominal, and in sizes up to a usual maximum of 12in square. Foils are available in the following metals, but inquiries are invited for other metals and alloys: aluminium, cadmium, chromium, cobalt, manganese, molybdenum, nickel, nickel/iron, niobium, palladium, platinum, rhodium, scandium, silver, tantalum, tin, titanium, tungsten, vanadium, zinc, and zirconium.

CORNING GLASS WORKS, 1202 Plaza Building, Australia Square, 87 Pitt Street, Sydney, 2000. **Micro-finish IC mask glass substrates.** Made of polished, optically melted, Corning code 7059 aluminoborosilicate glass, the substrates are said to offer superior flatness and

impeccable finish. Since 7059 glass is alkali free, it is not subject to pinholes caused by alkali ion migration. The standard substrate is flat within 200 micro-inches per linear inch, and surface areas are polished to remove all chips, pits, etc. Substrates are available in all standard photomask sizes. Low expansion substrates for direct step and repeat mask generation are available as special products.

The Corning glass substrates are said to be ideal for use with metal films, such as chromium. Etched photomasks made with 7059 low-expansion glass can be thermally cycled to improve the glass-to-metal bond. The coefficient of thermal expansion for 7059 glass is 4.7 micro-inches/in/°C, compared with 9.8 micro-inches/in/°C for soda lime glass. Aluminoborosilicate substrates are relatively unaffected by strong etchants used in making masks, or by the organic solvents used in cleaning finished masks.

RUTHERFORD ELECTRONICS PTY. LTD., 62 Jackson Court, Doncaster, Vic. 3108. Distributors for National Semiconductor Corp., U.S.A. **FET choppers**, types 2N4391-3. Feature fast switching time (15nS typical), low leakage (100pA maximum), and high reliability. Suitable for uV amplifiers and meters, multiplexers, commutators, TV equipment, oscilloscopes, and AM receivers.

General purpose, low noise FETs, types 2N3069, 2N3070, 2N3821, and 2N3822. Feature: low noise figure (0.1dB typical and 20nV per root Hz at 100Hz), low leakage (20pA typical), and high gain (2000 to 4000 umhos typical). Applications include audio and video systems requiring high gain and low noise, and in multiplexers and commutators as analog and video switches.

VARIAN PTY. LTD., 38 Oxley Street, Crow's Nest, N.S.W. 2065. **High-Q reaction cavities**. A series of ruggedised, high-Q reaction cavities primarily intended for measuring FM in oscillators and signal sources in the 5.4 to 16.3GHz frequency range. They operate in the TE-0, 1, 1 mode and incorporate a new concept in spurious mode rejection to cover a 20pc frequency range with minimum Q change. Each model has two calibrated tuning micrometers, one fine and one coarse, to permit easy and precise tracking of slowly drifting sources under test. All cavities have input coupling screws so that the VSWR may be set to 1.0:1 at any frequency.

ASTRONICS AUSTRALIA PTY. LTD., 161-173 Sturt Street, South Melbourne, Vic. 3205. Agents for Rohde & Schwarz, Munich, West Germany. **Power meter adapter**. For use with signal generator type SMDF or SMDA and frequency controller type BN1413115 to form a multi-function testing station for radio-telephone equipments. The adapter measures power outputs from 10mW to 20W in three ranges. With built-in protective devices, the adapter includes a power indicator with a range of 15dB, an attenuator rated at 20W, and a mode switch,

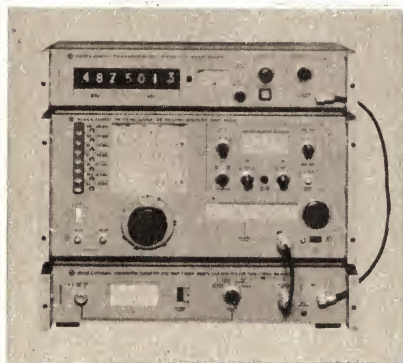

The R and S testing system for radio-telephones.

PLESSEY DUCON PTY. LTD., P.O. Box 2, Villawood, N.S.W. 2163. The **Plessey Printswitch**. Features a printed pattern which enables any contact configuration to be obtained by removal of unwanted inter-connections with a simple

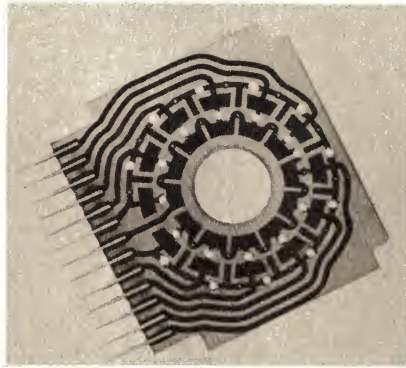

The Plessey Printswitch.

hand tool or twist drill. Arrangements not previously possible, such as shorting or non-shorting contacts on a single pole, can be easily accommodated. The Print-switch overcomes contact alignment problems by using a precision printed stator assembly made from high grade epoxy glass laminate. Rotor contact pressure is from coil springs to ensure stability within close limits. As all connections are in a single plane at standard pitch, the switches are ideal for direct insertion into a printed board or for film wiring connection. Precious metal contact materials are used exclusively on the switch. Metric spindles and bushes are standard, and the usual facilities such as concentric shafts are available.

DISTRIBUTORS CORPORATION PTY. LTD., 24 Johnston Street, Fitzroy, Vic. 3065. Distributors for Microdot Inc., U.S.A. **VHF-UHF power oscillator, model 445**. Covers the 10-2350MHz frequency range with six plug-in units with three to ten per cent overlap from each plug-in. It has a high-ratio dial with negligible backlash to give excellent resettability. Power is variable from 50mW to 50W

BARGAIN PACKS!

SEMI-CONDUCTOR PACKS. BRAND NEW AND TESTED. SILICON AND GERMANIUM.

- 10—Audio Type, Similar BC108 .. \$2.95
- 10—Audio Type, Similar BC109 .. \$3.00
- 10—RF Type, Similar BF115 .. \$2.95
- 10—RF High Gain .. \$2.95
- 10—RF Low Noise VHF .. \$3.50
- 10—Audio Output, Matched pairs .. \$3.25
- 5—Pair Complementary Output .. \$3.25
- 1—NPN Output, 2N3055/BDY20 .. \$2.00
- 1—PNP RF IF Type, Sim. AF116, AF-117, each .. \$5
- Or 10 for .. \$3.00
- 1—PNP Power Output, Sim. 2N301, 2N2148 .. \$1.30
- 1—PNP Audio, Sim. OC70 .. .40

FETS

- MPF 102 .. \$1.10
- MPF 105—2N5459 .. \$1.10
- MPF 106—2N5458 .. \$1.30
- 2N3819 .. \$1.10
- T15 88—2N5345 .. \$1.10
- UNIUNCTION 2N2160 .. \$2.00
- SCR C106 .. \$1.20

SILICON RECTIFIERS

- 50v, 25c ea. or 10 for \$2.25
- 100v, 25c ea. or 10 for \$2.25
- 200v, 30c; 400v, 35c; 600v, 55c; 800v, 60c; 1000v, 95c.

DIODES

- OA90 Type, 25c ea. or 10 for .. \$2.30
- OA91 Type, 25c ea. or 10 for .. \$2.30
- OA95 Type, 27c ea. or 10 for .. \$2.50
- Similar BA100, 21c ea. or 10 for .. \$1.90
- BA100, each .. .30

7W Stereo Amplifier, 50-20,000 Hz. In oiled timber Cabinet. **\$34.50 Complete.**

STEREO HEADPHONE SPECIAL

BRAND NAME — 8 Ohm. Wide Range — \$6.00.

PIONEER Speakers, 15in Guitar-type, 60-watt. \$30 each.

RECORDING TAPE, POPULAR MAKE, AT WHOLESALE PRICES

3in 150ft50
3in 225ft70
3in 300ft85
5in 600ft .. .	\$1.80
5in 900ft .. .	\$1.98
5in 1200ft .. .	\$2.50
5 1/2in 1200ft .. .	\$2.55
7in 1200ft .. .	\$3.00
7in 1800ft .. .	\$3.25
7in 2400ft .. .	\$4.75
7in 3600ft .. .	\$6.75

PHILIPS TYPE CASSETTES

- C60 60 Min .. \$1.65
- C90 90 Min .. \$2.65
- C120 120 min .. \$3.30

SMALLEST RADIO KIT IN AUSTRALIA
1 5/8in x 1 5/8in x 15/16in. Uses Silicon Transistors and High Impedance Magnetic Earphone. 5-Stage Reflex Circuit and Ferrite Aerial. Complete Kit with Instructions. \$6.75. Batteries required: 2 Mercury Cells. Delivery late October.

SPECIAL!!!! 1ST RELEASE 8 TRANSISTOR RADIO KIT! USES SILICON TRANSISTORS AND DIODES. COMPLETE WITH INSTRUCTIONS, Carrying Case and earphone, \$16.50. Wired. Tested, \$18.50. Post & pack. 75c.

ELECTRONIC PROJECT BROADCAST TRANSISTOR RADIO KIT with Speaker, \$11.25.

NEW 1969 TRANSISTOR RADIO KIT

5 Silicon Transistors and complete with instruction book, carrying case and earphone. Special Price .. \$11.25. Wired .. \$13.50. Post and pack. 75c.

BOYS' CRYSTAL SET KIT Complete with Plastic Cabinet, earphone and Instructions .. \$2.50

TRANSISTOR MODULES
10 Watt RMS, 25W RMS, 65W Hi Fi Amplifiers. Pre-amp Tone Control Stage, etc. REDUCED PRICES. SEND FOR NEW PRICE LIST.

INTEGRATED CIRCUITS

FAIRCHILD—Flip Flop, etc.
PHILIPS—Pre-amp and Tape MOTOROLA
G.E., 1 Watt RMS.
G.E., 2 Watts RMS.
G.E., 5 Watts RMS.
B.H.A. SPECIAL 15W RMS. Prices on application. State requirement.

TRANSISTORISED TUNERS
UNIT 10—With RF Stage and Power Supply, 8KHz bandwidth — \$31. Plus tax.

NEW WIDE BAND TUNER
Based on Playmaster Design. Ceramic Filters, Tuning Meter, Whistle Filter, etc. \$62 plus tax. Teak Cabinet \$6 extra.

DIGITAL CLOCK
240V, 2W, 12 Hour, plus Seconds. SPECIAL — \$11.75.

MURATA CERAMIC FILTERS
BF 455A, ea .. .32
SF 455D, ea .. .75

ALL COMPONENTS, TRANSISTORS AND DIODES AT SPECIAL PRICES. SEND S.A.E. FOR DETAILS.

S. E. WILLIS TRADING CO.
38 Riversdale Road, Camberwell Junction, Vic., 3124.
Phone 82-5787. Please include Freight. Sorry, No. C.O.D.

Deitron

Cable Address: "DEITRONICS", SYDNEY. Phone: 31-5430
31-6786

4-6 TAYLOR ST., TAYLOR SQUARE, DARLINGHURST. N.S.W., 2010

CASSETTE TAPES

C-60 (2 x 30 mins) . . . \$1.75
C-90 (2 x 45 mins) . . . \$2.75
C-120 (2 x 60 mins) . . . \$3.00
Post 10c each.

CAR ANTENNAS

Telescopic Lock Down 5 Section, 3' 4" . . . \$4.50
Telescopic Lock Down 5 Section, 4' 10" . . . \$6.00
Telescopic Cowl Mount 3 Section . . . \$4.00
Post 25c each.

STEREO AMPLIFIER

ELECTRONICS Australia 10-10 stereo with overload protection circuit, complete kit of parts to last nut and bolt. Beautiful cabinet \$62.50
Assembled and completed tested, \$72.50
Chassis and cabinet and front panel only for above, \$12.00.

TRANSISTORS

2N2160 unijunction . . . \$1.40
2N3646 NPN silicone . . . 50c
2N3638 PNP silicone . . . 60c
2N3638A PNP silicone . . . 70c
BC 108 NPN silicone . . . 50c
BC 109 NPN silicone . . . 55c
AC128 PNP Germanium . . . 50c
AD161-AD162 pair . . . \$2.85
C106 FI thyristor . . . \$1.25

CARTRIDGES

BSR TC8 Mono XTAL . . . \$4.50
BSR TC8 Stereo XTAL . . . \$6.90
BSR X1 Mono Ceramic . . . \$4.50
BSR CI Stereo Ceramic . . . \$6.90
Ronette Mono XTAL . . . \$4.50
Ronette Stereo XTAL . . . \$6.90
Sonotone 9TA Stereo . . . \$6.90
Japanese Mono XTAL . . . \$3.80
Japanese Stereo XTAL . . . \$5.50
CAC-Stereo Magnetic . . . \$9.00

FERRITE RODS

Round Type	Flat Type
100 x 8mm .90	4 x 15 x 140mm \$1.25
120 x 8mm 1.00	4 x 12 x 140mm
120 x 10mm 1.00	5 x 13 x 55mm \$1.00
140 x 10mm 1.15	5-13 x 60mm 90c
160 x 10mm 1.25	5-14 x 50mm 90c
180 x 10mm 1.40	
200 x 10mm 1.60	

SPEAKERS

Round Magnet	Square Magnet
2" 8 ohm 2.00	Special
2 1/2" 8 ohm 2.00	2 1/2" 8 ohm 1.40
2 3/4" 8 ohm 2.25	2 3/4" 8 ohm 1.50
2 3/8" 8 ohm 2.50	12" C12M8 10.00
3" 8 ohm 3.00	12" 12PX 20.00
3 1/2" 8 ohm 3.25	Post. 20c.
4" 8 ohm 3.30	

STEREO HEADPHONES

8 ohm. 100-15000Hz. \$9.00

BEREC CAR LIGHT

DC OPERATED FLUORESCENTS
6 volt 1.25A 6 watt \$16.00
12 volt .6A 6 watt . . . \$16.50 Post
12 volt 1 A 8 watt . . . \$16.8075c each.
12 volt 1.25A 13 watt \$18.00

VALVES

6 BQ5 ..\$1.30 6EM5 ..\$1.30
6BM8 ..\$1.50 6V4 ..\$1.00
66W8 ..\$1.50 12AX7 ..\$1.40
6EA8 ..\$1.40 Post 10c each

DIODES

IN4001 50 PIV 1A . . . 25c
EM404 400 PIV 1A . . . 30c
EM408 800 PIV 1A . . . 55c
MB101 100 PIV 2A Bridge \$1.50
OA 91 Germanium . . . 18c
OA202 Silicone . . . 45c
1N 914 Miniature silicone . 20c

TRANSISTOR PARTS

10mm IF transformers . . \$1.00
7mm IF transformers . . . \$1.00
Standard 20mm PVC gang \$2.00
Battery Carrier 4XUM3 . . 50c
Standard 5K switch pot . . 30c

PLASTIC CABINETS

Drawers Size L5 1/2" x W2 3/4" x D1 1/4".
STM12A 12 Drawers, 12 1/2" x 5 1/2" x 6" \$5.90
STM16A 16 Drawers, 12 1/2" x 7 1/2" x 6" \$7.10
STM24A 24 Drawers, 12 1/2" x 10 1/2" x 6" \$9.50
Post \$1.00 each.

R.G.S. SPECIALS



NEW IMPROVED
30 WATT
NOMINAL
34w MAX.

**12v All Transistor
P. A. AMPLIFIER**

WIRED READY TO OPERATE

15 ohm output. No. 591D . . . \$62
125, 250, 500 ohm, 592D . . . \$62
Dimensions: 6 1/2"ln. w. x 3 1/4"ln. h x
8 1/2"ln. d. For 240V, op. \$33 extra.
10 WATT P.A.
Inputs 5 MV and 100 MV 10w R.M.S.
at 1%. Frequency 40c.—30Kc. For use
with 1 4 ohm, 2 8 ohm or 4 16 ohm
speakers in parallel. Same cabinet and
dimensions as 30w above, complete with
240v power supply.
Wired and tested. No. 485 . . . \$40
Freight extra in both cases.



**R.C.S. COMPLETE
DO-IT-YOURSELF
KITS**

Peak reception,
low price. No ex-
pensive test equip-
ment. Everything
fits. 1964 RF
Transports 7.

Complete kit — No. 640 . . . \$43.50
Portable car radio. Identical to 640
above, plus extra switch and car coil,
etc. No. 642 . . . \$46.00
(Write for booklet on 640 and 642.)
Postage \$1.

NEW TRANSISTOR PREAMP KIT

SIZE 3 x 2 x 1in. 2 req. for Stereo.
LOW IMP. input 2 trans. 672C \$6.50
Wired ready for use. 672D . . \$8.00
HIGH IMP. 2 tran. 680C . . \$6.50
Wired ready for use. 680D . . \$8.00
HIGH IMP. silicon 3 tran. 682C \$8.00
Wired ready for use. 682D . . \$9.50
Postage 10c each. Write for data.

HI-FI BROADCAST TUNER UNIT 4 TRANSISTORS — HI SENSITIVITY.



R.F. mixer, i.F., pwr. dectr. stages, adjustable aerial coupling. Complete as illust., wired and tested with 461 dial, knobs and switch pot No. 474D, \$31. Postage \$1.
WHISTLE FILTER for above set for 8Kc band width (can be altered to 9, 10 or 11Kc). No. 128, \$4. Post 10c.

PRINTED CIRCUITS

For all R. and H., E.A., Mullard, Philips and other designs. Clearly coded, white letters and numbers, easy assembly and service, polished and resined for easy soldering. With blueprint part list.
SPECIALS: To your drawing — write for particulars and drafting aids.

New Printed Circuits

726 3 x 3 or 10 x 10 w stereo 68/A8 . . . \$2.80	722 Mullard pre-amp. \$3.00
736 B/C tuner EA . . . \$2.50	725 Protected supply \$2.50
69/TS . . . \$2.50	734 EA 69 01 gold p. organ . . . \$5.00
727 E and A wide band, tuner 68/8T . . . \$3.20	709 Pre-amp. 67-PS \$2.50
728 Audio osc., EA 68-09 . . . \$3.20	684 Pre-amp. 65-P10 \$2.50
718 Mullard main amp. . . \$2.50	737 AWA 10/25W amp \$2.50
	740 Crystal clock 68-10CL \$5.00
	741 Guitar amp 69 P5 \$3.00

Immediate dispatch. Postage 10c.



10W STEREO

**MULLARD 10 x 10
watts R.M.S.**

With output transistor PROTECTION. Frequency response 40c. to 30Kc. Distortion 0.5%. Treble, bass, boost 20DB
Complete kit of parts No. 480C . . . \$74.00
Wired and tested No. 480D . . . \$79.00
With hi-fi tuner and whistle filter, \$35 extra. Freight extra.
Write for brochure. For special Sat. demo. ring 59-6550.

MAGNETIC STEREO PRE-AMP

In 5Mv out 250Mv. Bass and treble 20DB. No. 724C \$29
Wired ready for use . . . \$31
Postage 30c each.
For crystal ceramic No. 722D . . . \$27



TRANSFORMER



Tap 6v and 9v D.C. at 100 millamps.

Filter, condensers, rectifier, resistor, case, etc. \$6.50. Post 10c.

PERSONAL PORTABLES 2 TRANSISTORS

Range 30 miles, 200 with short aerial and earth. Earpiece only, no speaker.
Do-it-yourself kit, No. 666C, \$9.00
Postage 20c.



1 TRANSISTOR — 1 DIODE
593C Do-it-yourself kit, \$5. Post 10c.

DIAL KITS SCALE GOLD WITH WHITE LETTERS.

Size 6 3/8 x 2 3/4 in.
● No. 459 to match 300 pf gang. Price . . . \$4.50
● No. 461 to match 200 pf gang. Price . . . \$4.50
Post 20c.

NEW AUDIO AMPLIFIER



4 transistors. 12 or 1 watt. Small size, cabinet 3 1/2 x 2 1/2 x 1 1/2 in. plastic. Suitable crystal P./up. Intercom., m.c.r. ophone, radio, etc. (9 volt.)
DO-IT-YOURSELF KIT 665. \$10 (Post 10c). Wired ready for use 665D \$11.50.

COILS & IF's 455 Kc

Aer. R.F., OSC. and IF's . . \$1.80 ea.
Ferrite Aer. . . \$2
No. 255 Universal tape OSC. Coil \$6
Postage 10c. Write for details and price.

R.C.S. RADIO PTY. LTD., 651 FOREST ROAD, BEXLEY, N.S.W., 587-3491, 587-5385

DIGITAL VOLTMETER FROM SOLARTRON

SOLARTRON AUSTRALIA, 112 High Street, Kew, Vic. 3101. Integrating Digital Voltmeter, LM.1604.

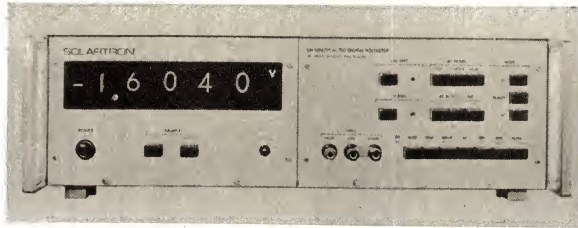

Constructed on a modular basis with a five-digit display, the instrument allows the addition of an AC converter to the basic DC instrument. Main specification features: Full scale 19999; sensitivity 1uV DC and 10uV AC; accuracy 0.005 per cent of reading plus or minus 1 digit; full accuracy on most sensitive range; input impedance 10,000M up to 20V; common mode noise rejection 174dB; series mode noise rejection 70dB

for 50 Hz plus or minus 2 per cent without filters; programmable range and function auto ranging optional. Plug-in fan-out units giving positive and negative logic BCD outputs are also available. Maximum reading rate is 25 per second. Price \$1860 for DC model.

(up to 1000MHz), to 25W (1 to 2GHz), or to 15W (2-2.35GHz). Other features include: positive no-load protection; high-Q tuned cavity which is temperature compensated; regulated power supplies; and capacity to read forward and reflected power.

HEWLETT-PACKARD AUSTRALIA PTY. LTD., 22-26 Weir Street, Glen Iris, Vic. 3146. Oscillator model 204D. A precision oscillator covering frequencies from 5Hz to 1.2MHz, it has an 80dB attenuator range to give outputs from 2.5V RMS into 600 ohms (5.0V open circuited) down to less than 250uV RMS. The attenuator is in 10dB steps with an accuracy of plus or minus 3pc. A vernier with a range greater than 10dB provides overlap on any range. Features: less than 0.1pc distortion between 30Hz and 100KHz (linearly derated to less than 1pc at high and

quadrature element provides a 0.7V audio out for plus or minus 3KHz deviation at 10.7MHz IF plus high centre frequency stability for single conversion VHF receivers. For SSB operation, the LM373 gives a self-contained audio-operating AGC system, gain stages, and double balanced product detector. In addition the LM373 may be used as: a gated video amplifier with AGC; constant amplitude or amplitude-modulated RF oscillator; balanced modulator; suppressed carrier signal generator; synchronous demodulating IF strip; or as a receiver first IF strip with balanced mixer output to the second IF.

R.C.A. LTD., 11 Khartoum Road, North Ryde, N.S.W. 2113, has appointed Mr Gary Cutler as national sales manager, Technical Products Division. Previously sales promotion manager with the division, Mr Cutler will head the sales force marketing R.C.A. broadcast and television equipment and custom-designed studio equipment.

WATSON VICTOR LTD., 95-99 Epping Road, North Ryde, N.S.W. 2113, has acquired additional land to meet future marketing and manufacturing expansion. In N.S.W., a further 3½ acres has been purchased adjoining the company's present property in Ryde, and in W.A. land has been acquired in Charles Street, Perth. During the current year \$350,000 will be spent on land and buildings to meet the planned expansion requirements. Finance for this will come mainly from the sale of existing property in Marrickville and Broadway, Sydney, and in Hay Street, Perth.

HY-Q ELECTRONICS PTY. LTD., 10-12 Rosella Street, Frankston, Vic. 3199, has announced the following additions to the board of directors: Mr D. H. Rankin, M.I.E. (Aust.), A.M.I.R.E.E. (Aust.), formerly chief crystal engineer with a prominent crystal manufacturer, has been appointed technical director; Mr R. W. Taphouse, formerly manager of the crystal division of a prominent manufacturer, has been appointed manufacturing director.

R. H. CUNNINGHAM PTY. LTD., 608 Collins Street, Melbourne, 3000, advises a change of address for the company's Queensland agent. L. E. Buoughen and Co. is now at 30 Grimes Street, Auchenflower, Qld. 4066. The phone number is 7-4097, and the postal address is P.O. Box 136, Toowoong, Qld. 4066.

WATSON VICTOR LTD., 95-99 Epping Road, North Ryde, N.S.W. 2113, has announced the following appointments: Mr William R. Bailey, A.C.A., A.C.I.S., to the post of finance controller; Mr George A. Grierson to the post of commercial controller; Mr William J. Rapp to manager of the service and installation division for Victoria and Tasmania; Mr Timothy J. Owen to the position of manager for Tasmania.



low frequencies); hum and noise less than 0.01pc of output; output amplitude very stable and flat, within plus or minus 0.05dB (0.5pc) between 100Hz and 300KHz, and within plus or minus 0.1dB (1pc) over the rest of the range; synch output on rear panel in phase with main output; synch input on front panel for synchronising the output with an external signal.

RUTHERFORD ELECTRONICS PTY. LTD., 62 Jackson Court, Doncaster, Vic. 3108. Agents for National Semiconductor Corp., U.S.A. Multiple-Mode Monolithic IF Strip, type LM373. Intended for AM, FM, and SSB IF applications and broadband video amplification. This IC is a universal subsystem which allows economical switching by a few external connections from one mode to another in a single receiver. For AM, it provides a self-contained AGC system with a 70dB range and RMS input down to 30uV. For wide-band FM, a single LC tuned quadrature circuit gives 1V audio out for plus or minus 75KHz deviation at 10.7MHz. In narrowband FM, a single quartz crystal

UNITED TRADE SALES

PTY. LTD.

NU-METAL SHIELDS

To suit 5BP1 and other 5in CRTs mfd. by Magnetic Shields Ltd. Brand-new, \$5 ea. plus 30c pack and post.

TAPE HEADS

Cassette Recorder Type Relay Heads. 2-track Mono Current Manuf.

New \$1.50 ea.

PLUS 10c pack and post.

CAPACITORS

80 for \$2 in Poly Packed Bags. Mixed values only.

VALVES

6J6 30c each. 815 70c ea. 807 70c each. 6AC7 20c ea. or 12 for \$2. 6C4 50c ea. 8020 35c ea. QS150/15 50c ea. 6H6 Metal 20c ea. QB2/250(813) New in sealed cartons, \$6 ea.

TRANSISTORS

2SC73, 2SD65, 2T76, OC66, 2T65 25c ea. or in 100 lots 20c ea.

LSG11 SIGNAL GENERATOR

120KHz to 260 MHz New in sealed carton \$35, postage \$1.

MILLER TRANSISTORISED IF STRIPS

455 Kc Selectivity 5 Kc at 6db down. Power 6 Volts 2mA gain 50db. Price: \$9.70.

TRIO TR2E

2-METRE TRANSCEIVER

- Triple conversion receiver with crystal locked second and third oscillators for maximum selectivity and sensitivity.
- Separate VFO tuning for both receiver and transmitter.
- Nuvisor RF amplifier.
- Provision for crystal locking of the transmitter.
- 12 volts DC (internal transistor power supply) and 230-240 volts AC operation.
- Noise limiter and squelch.
- 17 tubes, 4 transistors and 7 diodes. Price \$282 inc. tax.

NEW PIANO KEY SWITCHES

5 KEY, Special at \$1.00 each

P.M.G. TYPE COUNTERS

0-9999,

\$1.25 Each,

PRISMS, 6 x 2½ x 3½,

75c Each.

3,000 TYPE RELAYS.

Large range. Only 50c each.

COMPLETE RANGE OF METERS.

P25's 2½sq.
100uA .. \$6.95 1mA \$4.50
500uA .. \$5.25 50mA ... \$4.50
10mA .. \$4.50 S'meter .. \$5.25

MULTIMETERS, 200H, 20K ohms per volt, \$11.25, inc. tax. CT 500 20K ohms per volt, \$15 inc. tax. CT 330 20,000 ohms per volt, \$17.25.

RESISTORS. Mixed Values only in Bags; \$2 per 100, or 50 for \$1. 3,000 Type Relays. New stocks. 50c each. Plus postage.

TRANSISTOR V.H.F. CONVERTER Tunable 108-136 Mhz Aircraft Band 1F-600Kc to 1,000Kc. No connecting wires needed, 9V Battery, self-contained, just place alongside broadcast radio. Price only \$14.40 plus 45c postage.

WANTED BUY:

RECEIVERS, TRANSMITTERS, TEST EQUIPMENT.

All prices subject to alteration without notice. All items PLUS POSTAGE.

**280 LONSDALE STREET,
Melbourne. Phone 663-3815
Opposite Myers**

7 INTERCHANGEABLE LENSES VERSATILE MAMIYAFLEX 2 1/4" x 2 1/4"

Mamiya, known throughout the world as the most versatile and advanced twin lens reflex on the market today.

FEATURES:

- * Extraordinary close-up capabilities down to 2 1/2", used extensively for photography of switching mechanisms, circuit boards, etc.
- * Automatic-film shutter cocking, parallax compensation, exposure factor indicator.
- * Double exposure prevention.

PRICES: 80mm F2.8 or 100mm F3.5 lens and case.
C33 — \$238 C220 — \$205

Accessory Lenses:

55mm f4.5	\$178.50
65mm f3.5	\$105.00
135mm f4.5	\$99.00

Super 180mm f4.5	\$144.00
Standard 180mm f4.5	\$130.00
250mm f6.3	\$240.50

ACCESSORIES:

CDS eye level finder, focussing knob adaptors, lens hoods, filters, grip holder, single exposure back, compartment case, interchangeable lenses.

R. H. WAGNER & SONS PTY. LTD.
524 Flinders Street, Melbourne. 62 3114
43 Elizabeth Street, Melbourne. 62 3114
Shop 87, Chadstone Centre. 56 5814

Homecrafts FOR RADIO PARTS 289 Elizabeth St. Melbourne. Phone 60 1442

PIEZO PICK-UP AND CARTRIDGES

PU-86 Pickup LP/78 T/O Crystal cartridge. Length 240mm Ea.	\$2.95
Y700 Ceramic Cartridge. Mon. LP/78 Ea.	\$3.00
PU-86 Pick-up Ster-LP/78. T/O Cartridge. Length 204mm Ea.	\$4.00
Y200 Ceramic Cartridge. ST LP/78 Ea.	\$4.00
Y400 Crystal Cartridge. LP/45 Ea.	\$2.00
Y130 Crystal Cartridge. T/O Type Ster/LP Ea.	\$2.70
Sapphire Replacement Styl. Each Ster/LP Ea.	60c
Plus postage 15c.		

PIEZO MICROPHONE INSERTS

MC-3 Crystal, 50-7K, 35 x 25 x 8mm.	-57 DB	\$1.00 ea.
MC-7 Crystal, 100-7K. 39mm Round x 11mm.	-56 DB	\$1.00 ea.
MC-8 Crystal, 50-8K. 48mm Round x 17mm.	-50 DB	\$1.20 ea.
MC-9 Crystal, 50-8K. 25mm Round x 9mm.	-68 DB	\$1.80 ea.
MC-33 Crystal, 50-10K, 33mm Round x 9mm.	-60 DB	\$1.60 ea.
MD-5 Dynamic, 100-15K. 33mm Round x 14mm.	-55 DB	\$2.00 ea.
Plus postage 20c.		

TRANSISTOR SET ACCESSORIES

Magnetic Earpiece with 3.5mm Plug 75c
Crystal Earpiece with 2.5mm Plug 75c
Crystal Earpiece with 3.5mm Plug 75c

LAPEL TYPE CRYSTAL MICROPHONE

With 3.5mm Plug 75c ea.
Plus postage 15c.	
Fuses for Japanese equipment 1A, 3A, 5A	
5c pkt of 5 Plus postage 10c.	

Michigan/Collard—Twin Track Rec/Play Heads \$8.50
Michigan/Collard—Twin Track Erase Heads	\$3.00
Michigan/Collard—Four Track Erase Heads	\$8.50

12-Pin Water Socket. 20c ea.
12-Pin Plug . 25 ea.	Plus postage 10c.

OCTAL PLUG AND CORD Ext. Socket. 45c pr. Plus postage 10c.

ALL TYPES AMPHENOL PLUGS AND SOCKETS

Carried in stock.
Plugs 27c ea. Sockets 30c ea. Meall Covers for same 27c ea.
Plus postage 10c.

HALF-INCH MINIATURE PLUGS AND SOCKETS

2, 3, 4 and 5-Pin Plugs 10c ea.
Sockets 10c ea. Plus postage 10c.

ELECTROLYTIC CAPACITORS IN METAL CANS

16 + 16 450 VW 95c ea.
32 + 32 450 VW \$1.30 ea.
50 + 50 450 VW \$1.85 ea.
50 + 50 + 50 350 VW \$1.90 ea.
100 MFD P.V.C. Cover \$1.15 ea.
Jacks, 2.5 and 3.5mm 20c
3.5mm Plug and Cord Ext. Jack Pair 50c
Metal Co-axial Plugs and Line Sockets 65c
Pr. "Din" and "Hirschmann." 2, 3, 4 and 5-pin Plugs, Chassis and Line Sockets, carried ex stock.	

P.M.G. type Plugs from 50c
P.M.G. type Jacks from 35c
P.M.G. Line Jacks from 55c
Plus postage 15c.	

5 CORE CABLE
7/0076, P.V.C. insulated, P.V.C. covered.
25c yd.

6 CORE CABLE
same spec. as above
30c yd.

Capacitor Substitution Box, 1,000 VW \$5.00
Resistor Substitution Box, 1 Watt. \$4.50
Plus Post, 20c.	

TRANSISTOR AERIALS

5in extends to 39in \$1.40
6in extends to 46in \$1.70
6in extends to 32in \$1.00
6in extends to 28in \$1.00
7in extends to 39in \$1.20
9in extends to 39in95c
6in extends to 4ft 6in \$1.80
7in extends to 5ft 8in \$3.00
Plus Post 15c.	

CRYSTAL SET BUILDERS

Coils 80c	Tuning Conds. \$2.00
Diodes 35c	Terms Ea. 12c
Headphones \$2.90	Plus Postage.	

TAPE RECORDER ACCESSORIES

2 1/2in Spools 30c	3in x 600ft \$2.35
3in Spools 35c	Tape \$2.35
5in Spools 40c	5 1/4in x 1,200ft \$3.10
5 1/4in Spools 70c	Tape \$3.10
7in Spools 50c	7in x 1,800ft \$5.10
2 1/2in x 100ft 60c	Tape \$5.10
Tape \$1.40	5in Plastic Tape boxes 60c
2 1/2in x 300ft \$1.40	7in Plastic Tape boxes 90c
Plus postage 20c.			
See us for Tape Recorder Patch Cords, Adaptors, etc.			

STEREO PLUGS AND JACKS

Metal Plugs 95c	Bakelite ext. sockets 70c
Bakelite 70c	Chassis Jacks 65c
Plus postage 10c.			

MAIL ORDER SPECIALISTS

TYREE ELECTRICAL CO. PTY. LTD. announces that Mr Peter Cassano, chief engineer of the power transformers division, has been appointed as Australia's representative on the International Study Committee No. 12, Transformers, of the International Conference of Large High Tension Electric Systems (C.I.G.R.E.). This is the first time that Australia has been represented on the committee, which has only 20 members. Mr Cassano, who will serve a six-year term, is also convenor of the Australian panel of the transformer committee. He attended the 1969 meeting of the international committee held in Brighton, England, from August 24 to 29.

UNIQUE HOUSE CONSOLIDATED PTY LTD., 126 Beaconsfield Street, Auburn, N.S.W. 2144, manufacturers of Tabular educational products, is to handle on an exclusive basis the Buhl overhead projectors and Tolsen prepared transparencies formerly supplied by RCA Ltd. In addition, Unique House has been appointed Australian distributor for the RCA range of 16mm projectors, microprojectors, and other educational products. Service and maintenance will be carried out by Unique House.

MATSUSHITA ELECTRIC CO (AUSTRALIA) PTY. LTD., 321 Pitt Street, Sydney, 2000, is to distribute locally manufactured National brand television sets direct to the trade. The decision was made after consultation and agreement with Haco Distributing Agencies Pty. Ltd., who will continue to distribute all other National brand products.

Matsushita has announced the following appointments: Mr Thomas Koyama as managing director operating from the company's new factory at Penrith, near Sydney; Mr Martin van Koesveld as a director of the company; Mr Stephen Hasui as financial director; Mr D. Shigemitsu as sales manager. Mr Koyama was formerly a senior executive in the production and manufacturing division of the parent company in Japan. Mr van Koesveld was formerly managing director of

Haco Distributing Agencies Pty. Ltd. Mr Hasui was formerly in the accounts and financial control department of Matsushita's works in Osaka, Japan. Mr Shigemitsu was formerly in charge of the Oceania Section of Matsushita Electric Trading Co., the export division of the parent company.

PHILIPS ELECTRICAL PTY. LTD., 69-79 Clarence Street, Sydney, 2000, has announced the formation of a new product group, known as the Professional Sound and Television Division, split from the Scientific and Industrial Equipment Division. Both divisions correspond to similar industrial groups operating on an international basis within the Philips' organisation. Details of the two divisions are as follows:

Dr Graham Gipps is divisional manager of the Scientific and Industrial Equipment Division, which will handle scientific apparatus (Mr Garry Anderson); non-destructive testing (Mr Nick Wilson); electronic measuring apparatus (Mr Bill Robbie); and industrial apparatus (Mr Joe Ikin). Mr Harry Moses has been appointed acting divisional manager for the Professional Sound and Television Division, which will handle educational products (Mr Rod Craig); professional sound and TV equipment (Mr Joe Cornellissen); and audio products (Mr Bruce Canavan.)

AUSTRALIAN GENERAL ELECTRIC PTY. LTD. has announced the following appointments: Mr Bryan Catt as national sales manager, electronic components; Mr Ron Bowden, national sales manager, lamps, appliance control, chemical and metallurgical products.

ALLAN ELECTRONICS PTY LTD. (formerly Dunmore Allan and Co. Pty. Ltd.), 28/280 Pitt Street, Sydney, 2000, has appointed Mr Colin W. Smith a company director. Mr Smith recently retired from Plessey Rola after 30 years' service with the company. During this time, Mr Smith held managerial appointments in Melbourne and Sydney, and was regional director in Sydney at the time of the acquisition of Rola by Plessey.

Allan Electronics also announces that the company has been appointed N.S.W. agents for Central Imports Pty. Ltd., of Perth, distributors of Simpson amplifiers and associated products.

GENERAL TELEPHONE AND ELECTRONICS INTERNATIONAL INC., New York, U.S.A., has established a telecommunications marketing operation in Australia. It will operate as the Telecommunications Division of General Telephone and Electronics Australia Pty. Ltd., 1-7 Lucas Road, Burwood, N.S.W. 2134.

Canadian loop aerial

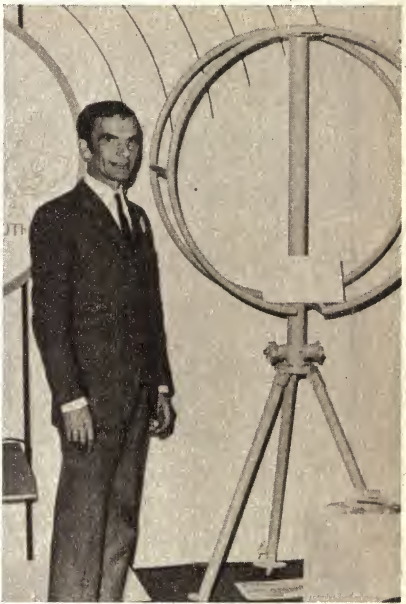

EMI Electronics Canada Ltd. displayed one element of an aperiodic loop antenna array at the recent Fifth International Engineering Show held in Melbourne. The HF receiving arrays are said to provide optimum directional and performance features over the frequency band from 2 to 32MHz. The array is not seriously affected by ground conductivity or nearby objects, and no mast structure or guys are required. Seen with the loop antenna element is Mr M. F. Bion, representative of the company's Australian affiliate E.M.I. Electronics (Australia) Ltd.



Mr Koyama Mr van Koesveld

Sylvania activities of G.T. and E. in Australia will be directed by the Sylvania Division. Mr D. A. Selve, formerly managing director of Sylvania Electric Australia Pty. Ltd., will head the Sylvania Division. Mr David J. Hutchinson, formerly with Standard Telephones and Cables Pty. Ltd., will be in charge of the Telecommunications Division with responsibility for New Zealand and New Guinea in addition to Australia.

ELECTROLUBE 2A-X Registered Trade Mark

IMPROVES ELECTRICAL CONTACTS
INCREASES RELIABILITY AND
LOWERS MAINTENANCE COSTS

SAFE ON POLYSTYRENE, P.V.C. MAKROLON, PAINTS, NATURAL AND SYNTHETIC RUBBER NON-HAZARDOUS VAPOUR

Write for free Products Summary on the range of electrical and mechanical oils and greases

RFA RICHARD FOOT (Australia) PTY. LTD.
63 Hume St., Crows Nest, N.S.W. Tel. 43-0326.

Available from leading electrical wholesalers.

MAGRATHS

MELBOURNE'S
ELECTRONIC HOBBIES
CENTRE

OCTOBER IS KIT SET MONTH

FOR THE BEGINNER

The requests for simple crystal and transistor sets over the years have been tremendous. Therefore Magraths now cater for the younger or less experienced person in electronics. What we now offer is a step by step adventure in relatively simple electronics, a complete kit of parts for simple crystal and transistor circuits as described on pages 77-81, July, 1969, Electronics Australia. Circuit (a) for a simple crystal set, \$7.50, full kit, post free.

Circuit (b) amplified crystal set, \$8.50, full kit, post free. Circuit (c) as circuit (b) with regeneration, \$10.00. We have many more such projects specially designed for the beginner at relatively low cost. With these thoughts in mind and the fact that many will be on limited budgets, we have confined our thinking mainly to the use of junk box parts and to simple breadboard construction.

'SCOPE For Speedy, Convenient, Economic Versatile Soldering

SCOPE DELUXE. Complete with pouch pack stainless steel barrel. Only 6 secs. Initial heat-up time \$5.95
SCOPE STANDARD. 6 secs. INITIAL warm-up. Performs work of irons requiring up to 150 watts . . \$5.50
MINISCOPE. Light, only 1oz 5 secs. to INITIAL heat-up time for hard to reach spots. \$5.28
VIBROSCOPE. Protects your property. Etch any metal, ferrous or non-ferrous or annealed, dull or polished. Produces deep penetration \$3.50
Matching 3.3V transformer for these Scope products \$7.65
POST FREE anywhere in Australia.

For the beginner Magrath's suggest the following items for setting up an adequate work bench —

- Soldering Irons. Both mains operated and low voltages through transformers.
- Wire strippers and cutters.
- Multimeters, etc.
- Chassis Punch Kits.
- Bench metal folding machine (to enable the bending of metals for all standard chassis, brackets, etc.)

MAGRATHS

FOR THE MORE
ADVANCED



For "ELECTRONIC" KITS

SOME CURRENTLY POPULAR PROJECTS

MULLARD 3.3 VALVE AMPLIFIER	\$71.50
MULLARD 10.10 VALVE AMPLIFIER	103.50
VACUUM TUBE VOLT METER (Electronics Aust., February, 1966)	55.00
R. C. BRIDGE, 1966 (Electronics Aust., May, 1966)	38.50
HIGH IMPEDANCE MIXER (Electronics Aust., February, 1967)	32.80
LOW IMPEDANCE MIXER (Electronics Aust., February, 1966)	28.80
PLAYMASTER 106	99.00
PLAYMASTER 111 W/B TUNER	45.00
PLAYMASTER 116, 40 Watt (Electronics Aust., June, 1967)	79.40
PLAYMASTER 117. 60 Watt Guitar Amp.	84.50
PLAYMASTER 118 STEREO AMPLIFIER (Electronics Aust., July, 1967)	82.40

PLAYMASTER 115. SOLID STATE STEREO AMP (Electronics Aust., April, 1967-	99.00
PLAYMASTER 120 HYBRID CONTROL UNIT (Electronics Aust., February, 1968)	47.30
RF TEST OSCILLATOR (Electronics Aust., March, 1968)	40.50
VARI-TACH MOTOR SPEED CONTROL	21.75
TRAIN CONTROLLED WITH SIMULATED INERTIA.	14.75
10 + 10 STEREO AMP. WITH OVERLOAD PROTECTION (Electronics Aust., April, 1969)	72.90
PLAYMASTER 124 AMP. TUNER (Electronics Aust., May, 1969)	71.00
LOW-COST POWER SUPPLY (Electronics Aust., January, 1968)	26.50

THE ABOVE PRICES INCLUDE SALES TAX.

FREIGHT FREE WITHIN AUSTRALIA.

COME TO MAGRATHS—WE'VE GOT IT!

J. H. MAGRATH & CO. PTY. LTD.
208 LT. LONSDALE STREET, MELBOURNE, VICTORIA, PHONE 663 3731

TECHNICAL BOOKS AND PUBLICATIONS

Tape year book

TAPE RECORDING YEAR BOOK, Ninth Edition. Published by Tape Recording Magazine, London. Paper covers, 88 pages, size 9½ x 5in. Price in Australia \$1.75, post free.

Although prepared for U.K. readers, much of the information contained in this book is relevant to the Australian scene.

The usual pattern of yearbooks is followed — a survey of developments since the previous issue, followed by helpful articles and lists, then a listing of tape recordings and accessories. Supplementary information, which may be of limited information to many Australian readers, concerns a list of U.K. tape recording clubs and a directory of manufacturers and agents.

The articles in this edition are entitled: The Tape Recorder in the Home. Looking at Specifications. Stereophonic Recording and Reproduction. Stereo Listening. Keeping Within the Law. On Sleep Learning.

A table of playing times for various grades of tape, and a glossary of technical terms, are also included.

Although the articles have not been read in full, sampling here and there indicates that they are clearly expressed in simple, concise language, and are more likely to interest the beginner than the experienced recordist. In the equipment listings, names and addresses of manufacturers or distributors are given, followed by a brief specification of the equipment, its main features, and the U.K. retail price. Some machines are illustrated by half-tone blocks.

This reviewer feels bound to point out that the enthusiasm of the authors (or perhaps the editor) to promote the tape recorder makes one suspect their objectivity. (Surely one cannot take the subject of sleep learning for granted.) However, this is not an uncommon situation where a hobby is concerned, and tape recordists will almost certainly go along with everything said in support of their hobby.

Our review copy was supplied by B. T. Lovett, 5 Glover Street, Willoughby, N.S.W., 2068. (H.A.T.)

Amateur licensing

HAM RADIO INCENTIVE LICENSING GUIDE. By Bert Simon, W2UUN. Published by TAB Books, Blue Ridge Summit, PA. 17214, U.S.A. Stiff paper covers, 160 pages 8½ x 5½ inches. Australian price \$4.95. Hardboard covers \$8.70.

Inevitably, a book intended to encourage would-be U.S. amateur operators will be of limited use in other countries because of substantial differences in the licensing system, regulations and examination standards and methods.

However, it would be going too far to say that this book can serve no purpose in his country.

It will find ready acceptance by those who are interested in the "politics" of amateur radio and, in particular, the comparative privileges and responsibilities of amateurs in the various countries. In this connection, the book devotes a section to

each of the five classes of amateur operator in the U.S.A., the terms of their licence, frequencies for operation, classes of emission and so on.

By way of further interest, more than half of the book is devoted to the kind of "select the answer" question used in the U.S. examinations, as well as other questions requiring circuit sketches. Instructors and club members would probably find this material a useful source for ideas and self-examination.

I can't imagine too many Australian readers wanting to part with \$8.70 for the hardbound version but the cheaper copy may be worth its purchase price to those who have a use for it along the lines indicated. Our copy came from the Grenville Publishing Co. Pty. Ltd., 401 Pitt St, Sydney. 2000. (W.N.W.)

Units and standards

UNDERSTANDING ELECTRONICS UNITS AND STANDARDS. By Earl J. Walters. Published by W. Foulsham and Co. Ltd., Slough, Bucks., England. Stiff covers, 128 pages, 8½ x 5½ inches. Illustrated by line drawings. Price in Australia \$4.25.

There seems little doubt that the average electronics technician is rather vague about units and quantities other than those with which he has everyday contact. A book which purports to plug this gap is therefore worthy of a second look.

This one has a promising title and promising chapter headings: Fundamentals; Basic Units; Current; Voltage; Energy and Power; Resistance; Capacitance; Inductance; Time; Frequency.

Unfortunately, the promise of good things to follow falters at this point in the light of closer inspection. To look through the text is to gain the impression of a startling mixture of the most elementary kind of statement with tables and formulas that seem to have migrated from a reasonably advanced environment.

By way of example, the writer introduces the idea of basic units (chapter 2) by reference to units of money: the dollar, the peso, the franc and the pound. The reader, it would seem, cannot be launched directly into the concept of units more akin to the subject matter of the book. Yet, over the page and less than 200 words away, he is confronted with the statcoulomb, the stathenry, the staffarad, and so on. Over another page and he is faced with a long conversion table from "stat" to "practical" units.

Not only is this progression potentially bewildering to the reader but it is of very dubious value. This reviewer would have to think very hard indeed to remember the last occasion when he saw any mention of "stat" quantities in current technical reading.

What about the MKS system? It does not appear even to be mentioned.

Examination of the same chapter reveals some strange statements. Page 15: "For some unknown reason the popular units of measure in the United States are the foot, the pound and the second." The reasons may not be worth exploring but they are certainly not unknown! Page 18: "Some of these practical units are excessively large and smaller subdivisions are used." Of those mentioned this could be said only of the farad!

Page 22: "Equipments using electron tubes will have currents ranging from a few milliamperes to a few amperes while the range of transistorised equipments is a few hundred microamperes to a very

few milliamperes." Has the author not heard of power transistors?

In fact, this reference, along with earlier preoccupation with the CGS system of units causes one to speculate about the age of the original American text. To be sure, the book opens with a recently written chapter for English readers but that is not very conclusive. If further cause for speculation is required, it is provided by the chapters on time and frequency, which seem to revolve around crystal standards and heterodyne methods of frequency determination. I discovered no hint of atomic clocks and no hint of digital frequency meters. The author mentions the astronomic basis of time and frequency but omits any connection with the term Hertz.

I did find, on page 23, one of the most primitive and inadequate drawings I have yet seen of a D'Arsonval meter and, over the page a calculation for a current shunt based on a 1-milliamp meter having a moving coil resistance of 0.24ohm. That's quite a meter!

I was also informed, on page 102, that "at audio frequencies, inductance standards are air-cored and wound with Litz wire to reduce the alternating current resistance." A component like this would surely be almost as rare as the meter just referred to!

To be sure, there is useful material in the book but the total impact is certainly not that of the careful, systematic, up-to-the-minute approach that the subject warrants. Definitely not recommended. Our copy from the Grenville Publishing Co. Pty. Ltd., 401 Pitt St, Sydney. (W.N.W.)

RADIO ENTHUSIASTS

Learn amateur radio in your spare time.

Whatever your interests are in amateur radio, there's a Stott Radio course for you. Easy to follow. Practical. Modern. Guidance all the way by top-flight radio engineers.

Radio for amateurs

Learn the exciting skills of building modern radio receivers. Learn about the latest advances in electronics, design, construction and operation.

Let Stott's show you how.

Amateur Operator's Certificate Course:

Broadcasting is fascinating. Stott's offer an entirely new course that enables you to sit for the Amateur Operator's Certificate of Proficiency Examinations with complete confidence.

Get full details now on Stott's Radio Courses.

POST THIS COUPON TODAY

Stotts 

TECHNICAL CORRESPONDENCE COLLEGE
159 Flinders La, Melbourne. 383 George St, Sydney
290 Adelaide St, Brisbane. 45 Gilles St, Adelaide.
1130 Hay St, Perth.

Please send me, free and without obligation, full particulars of your courses in Radio for Amateurs.

Mr Mrs Miss.....

Address.....

Age.....

No sales representative will call

EA 106.9

CHEST OF DRAWERS

Three types of Galvanised Chests measuring 17½in x 6¼in x 11½in, containing 16 drawers, each measuring 6½ x 3¾in x 2½in.

- TYPE C.D.1. With 16 undivided drawers.
- TYPE C.D.2. With 16 triple compartment drawers.
- TYPE C.D.3. With 8 triple compartment drawers, and 8 undivided drawers.
- TYPE C.D.4. A 17½in x 11½in Galvanised Chest containing 4 full-length drawers each measuring 15¾in x 6½in x 2½in.

The Chests are finished in blue hammertone stoving enamel, are complete with identification cards and packed in strong corrugated cartons. Provision is made for all units to be bolted together in tiers.

WRITE FOR FREE CATALOGUE AND PRICE LIST OF TOOL BOXES AND CHESTS OF DRAWERS.



COLOUR TELEVISION

With particular reference to the PAL system by G. N. PATCHETT
This book now available
\$5.95



"PIPGRAS" HOLE PUNCHES

"PIPGRAS" Hole Punches are made from Alloy Tool Steel, and cut clean and accurate holes in sheet metal. They make a smooth, perfect hole without reaming or filing.

SCREW TYPE, ROUND

Supplied with "UNBRAKO" High Tensile Socket Screws and Wrenches. Cut holes in sheet metal up to 18 gauge.

Type No.	Nominal Size	Actual Size (I.D.)	Water Pipe Size	Pilot Drill Size	Price Each
32.S	¼in	0.507in	—	¼in	\$2.17
40.S	¾in	0.618in	¼in	5/16in	\$2.17
48.S	¾in	0.742in	¾in	5/16in	\$2.80
56.S	¾in	0.884in	¼in	¾in	\$3.80
64.S	1in	1.008in	—	¾in	\$4.10
72.S	1¼in	1.133in	¾in	¾in	\$4.53
76.S	1 3/16in	1.172in	—	¾in	\$4.53
80.S	1¼in	1.258in	—	¾in	\$4.97
88.S	1¾in	1.382in	1in	7/16in	\$5.97

With Heat Treated, High Tensile Steel Hex. Head Bolt and Nut.

Cut holes in sheet metal up to 16 gauge.
96.S 1½in 1.512in — 9/16in \$6.68
112.S 1¾in 1.762in 1¼in 9/16in \$7.60
128.S 2in 2.014in 1½in 9/16in \$8.33

BELLPHONE



Pick up the receiver and dial push number desired.

Large \$13.50 per pair
Small \$10.12 per pair

KALTRO SVC TV-RADIO REMOTE CONTROL LISTENER



This TV-Radio Remote Control Listener is a combination of an extension speaker and a remote control station to regulate the sound of both the TV, Radio, Phono, or Hi-Fi set and the speaker incorporated in the Listener itself. In addition, up to two earphones can be attached for listening to the sound of the TV, Radio, Phono, or Hi-Fi set without disturbing others around you. Unwanted commercials can be easily cut off by merely turning down the control of the TV-Radio Remote Control Listener. A modern designed plastic cabinet with easily adjustable fingertip controls ideal for use in home, office and business. Complete with earphone, 20ft of lead wire and installation instructions.

Price \$8.75

Trade enquiries
prices available
on application

★
Free parking
at Rhodes

★
Phone:
73-0211 Rhodes
29-4451 City
73-5586 Sat. Morning.

THIS MONTH'S SPECIALS

Radar 1XR Power Supply \$30.60
Radax 05XR Power Supply \$20.40
Lapel Microphone X67 .. \$00.90
Table Microphone BM3 .. \$ 7.50

8 WATT STEREO AMPLIFIER MODEL SA-80S



SPECIFICATIONS

Output Power: 8 Watt, 4 Watts per channel.
Frequency Response: 60 to 15,000 cps. plus or minus 1 db.
Harmonic Distortion: Less than 3%.
Hum and Noise: 52 db below rated output.
Sensitivity: Phone (Crystal) 100mV 250K ohm.
Tuner 100mV.
Tube Complements: 12AX7x1, 30A5x2, 1S315x1 (Silicon Rectifier).
Dimensions: 5.1lb. 9¾in x 6¼in x 3in.

BOOK SHELF TYPE SPEAKER SYSTEM MODEL SP-4S



Speaker: 4in. 8 ohms.
Frequency Response: 70-13,000 cps.
Sensitivity: 93dB.
Power Input: 8W (Music Power).
Cabinet Size: 9¾in (H) x 6¼in (W) x 3¾ (D).
Finish: Walnut lacquer.

MODEL M6 FOUR CHANNEL TRANSISTORISED MICROPHONE MIXER



All four inputs accept standard two circuit Phone Plugs, while the output jack accepts a standard circuit Phone Pin Plug.

SPECIFICATIONS:

• Input Impedance: "Hi" Impedance for Crystal Microphone, etc. • Gain: Approximately 6 db. • Maximum Input Signal: 1.5 volts. • Maximum Output Signal: 2.5 volts. • Output for Minimum Distortion: 2 volts. • Hum: 0. • Battery: 9 volts.

Mono \$6.75 Stereo \$9.75

GENERAL ACCESSORIES

(A DIVISION OF ELECTRONICS INDUSTRIES)

116-118 CLARENCE ST., SYDNEY 29-4451 443 CONCORD RD., RHODES 73-0211
BOTH STORES OPEN SATURDAY MORNING FREE PARKING SPACE AT RHODES FOR CUSTOMERS

Transistor projects

49 EASY TRANSISTOR PROJECTS. By Robert M. Brown and Tom Kneitel. Hard covers, 64 pages 8½ x 5 inches. Published by W. Foulsham and Co. Ltd. Slough, Bucks, England. Australian price \$2.70.

Here is yet another book of simple circuits which hobbyists may wish to build up, using a couple of transistors and a handful of other parts. In fact, all the circuits shown involve one NPN germanium transistor and/or one PNP germanium transistor.

In common with most other books of its type, this one gives the circuit, values for the components and a few brief pointers about circuit operation. There is not the detail that is normally found in magazine-length construction articles.

Originally produced in the U.S.A. the book has been republished in England, with an extra introductory chapter for English readers. Observations made therein about some of the circuits would apply in this country also. It is pointed out that certain of the circuits which radiate RF would be illegal in the U.K. (also in Australia). In other circuits involving a mains connection, greater care would be needed with a 240V supply. There may also be some problem with the selection of components to replace the American catalogue items specified.

To this we might add that there could also be a problem with the behaviour of some circuits, which are stripped to the bone, and which rely on accidental rather than deliberate transistor characteristics. For example, a simple amplifier on page 15 uses a modest PNP germanium transistor with no DC return path whatever to its base. It is coupled to the input through a .047µF capacitor. Yet, despite the lack of DC return, the lack of a deliberate bias and an almost certain lack of any low frequency response, it is credited with an ability to produce "amazing room-filling sound."

But, enough of that. The 49 projects include small receivers, amplifiers, pre-amplifiers, a keyless organ, a rain alarm, a light beam communicator, a timer, geiger counter, mixer, metronome, blinker, signal injector and so on.

Problems or not, the book will certainly fill its intended role as a source of ideas for small-budget hobbyists. Perhaps the greatest cause for lament is that its roundabout journey to the Australian market has pushed its price up to the quoted figure. The review copy came from Grenville Publishing Company Pty. Ltd., 401 Pitt St., Sydney 2000. (W.N.W.)

Hi-fi directory

HI-FI YEAR BOOK, 1968/9. Editor, Miles Henslow. Hard covers, 384 pages, 8½ x 5 inches, illustrated. Published by Miles Henslow Year Books Ltd., London. Price in Australia \$2.35, plus 45c postage in Victoria, 60c postage to other States.

Although I cannot recall having reviewed a copy before, the HI-FI Year Book is apparently very much a part of the English hi-fi scene. This year it comes in hard cover form, and well printed on good quality paper. Its prime role is to provide a directory of good quality audio equipment available on the English market.

Included are the following: Pickups, arms and accessories; motors; tuners, amplifiers and tuner/amplifiers; loudspeakers and systems; tape decks, recorders, amplifiers, mixers and accessories; tape; test discs and tapes; headphones; microphones; aeriels; cabinets; complete systems; constructional kits.

Half a dozen lines or more are devoted to each item, giving details and specifications, price and distributor.

A substantial proportion of the items

will be familiar to Australian enthusiasts, although some American and Japanese products available here do not appear to be mentioned. Again, not all audio products available on the English market are listed; the Editor explains that products have been omitted which fall below the standard which a high fidelity enthusiast would seriously consider.

This listing, occupying all but 50 pages of the book would primarily be of interest to those who need to know about equipment specifications and prices and this would certainly include those concerned with merchandising hi-fi equipment.

The first fifty odd pages provide well written articles which would interest initiates to the world of audio high fidelity. Titles include "Second Generation Hi-Fi," "Audio Assessment," "Getting The Best From Your Hi-Fi" and "Hi-Fi Growing Pains." There is also a chapter on the use of Vero products, which should delight the distributors of Veroboard.

At the price quoted, the book is not expensive for anyone interested in the subject who wants to read and browse. The review copy came from Technical Book and Magazine Co. Pty. Ltd., 289 Swanston St., Melbourne 3000. (W.N.W.)

VHF-UHF Manual

VHF-UHF MANUAL, by G. R. Jessop, C. Eng., M.I.E.R.E., G6JP. Published by the Radio Society of Great Britain, London, 1969. Soft covers, 9½in x 6½in, 244 pages, many circuits and diagrams. Price in Australia \$3.70 plus postage.

This book was reviewed in our September, 1969 issue on page 153. We have been informed that copies are available from Technical Book and Magazine Co. Pty. Ltd., 289-299 Swanston Street, Melbourne, Vic. 3000.

NBS Publication

MODERN TRENDS IN ACTIVATION, edited by James R. DeVoe and Philip D. LaFleur. National Bureau of Standards Special Publication 312, Volume I 671 pages, Volume II 663 pages. Order from Superintendent of Documents, U.S. Government Printing Office, Washington, D.C. 20402, U.S.A. Price \$8.50 (U.S.) plus one-fourth to cover mailing costs.

Although copies of these volumes were not received for review, the U.S. National Bureau of Standards has supplied a summary of the contents. The two volumes report on a conference held in 1968 to discuss activation analysis.

Volume I contains the texts of two invited plenary lectures on activation analysis, and on radiochemical separations. Topics covered in contributed papers include applications of activation analysis in environmental sciences, biology, medicine, archeology, criminology, geochemistry, geology, and industry.

Volume II has the texts of three plenary lectures on nuclear reactions, on radiation detectors and data processing, and on computation methods in activation analysis. Contributed papers deal with aspects of these three general topics. Author and subject indices for the entire proceedings are given in Volume II.

Each day of the conference began with a plenary lecture on a major phase of the activation analysis technique. Because of the necessity for simultaneous sessions, synopses of the major points of discussion in each were given at the end of each day. The 15 synopses thus prepared are included in the volumes. Also included are remarks by honoured guests, Glenn T. Seaborg, R. E. Wainerdi, and V. P. Guinn.

PRACTICAL NIGHT CLASS TRAINING for Careers in Radio, T.V. & Electronics

Trained technicians are wanted urgently. It's in your hands to train NOW for a successful future. A.R.T.C. Practical Night Classes (established nearly 40 years) provide individual practical workshop training.

- Commence at any time.
- No previous knowledge required.
- Proceed at your own pace.
- Modern technical electronic training.
- New Australians welcome, the COURSE is specially simplified.
- Low in cost and you pay for the COURSE not the time taken.

College open for enquiries Monday-Friday 9 a.m. to 5 p.m. and until 7 p.m. on Monday and Thursday nights.

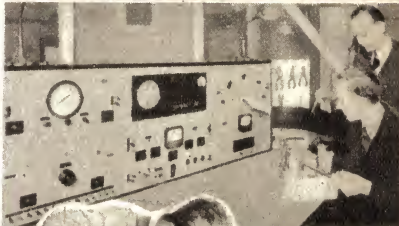

POST COUPON FOR FREE BOOK

'Careers in Radio, T.V. & Electronics'

Name

Address

AUSTRALIAN RADIO & TELEVISION COLLEGE Pty. Ltd.
E.S. & A. Bank Building, cnr.
Broadway & City Rd.,
BROADWAY. (opp. Grace Bros.)
Phone: 211-4224



**GOT PROBLEMS? COSTLY RECALLS?
DISSATISFIED CUSTOMERS? CUT PROFITS?
ENJOY COMPLETE CUSTOMER SATISFACTION
FROM FITTING GENUINE
TELECOMPONENTS PARTS**



TELECOMPONENTS

PTY. LTD.

752 Pittwater Road, Brookvale, N.S.W.



A Member of the Hawker Siddeley Group

- **SYDNEY:** Standard Components Pty. Ltd., General Accessories Pty. Ltd., Lawrence and Hanson Electrical Pty. Ltd., Electronic Parts Pty. Ltd., George Brown and Co. Pty. Ltd., Mellor Bros., Universal Car Radios Pty. Ltd., Trade Teletuners Pty. Ltd.
- **NEWCASTLE:** Martin de Launay Pty. Ltd.
- **WOLLONGONG:** Martin de Launay Pty. Ltd.

- **GOSFORD:** Lawrence and Hanson Electrical Group.
- **MELBOURNE:** Television Replacements, Radio Parts Pty. Ltd., Douglas Radio Co., General Accessories Pty. Ltd., Warburton Frankl Industries (Melb.) Pty. Ltd.
- **BRISBANE:** General Accessories Pty. Ltd., Telcon Australia Pty. Ltd.

- **TOWNSVILLE:** General Accessories Pty. Ltd.
- **ADELAIDE:** Telcon Australia Pty. Ltd., General Accessories Pty. Ltd.
- **MT. GAMBIER:** Stewart Day.
- **PERTH:** Carlyle and Co. (1959) Pty. Ltd.

No. 54

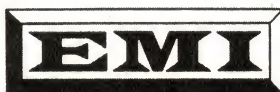

EMI ELECTRONICS (AUSTRALIA) PTY. LIMITED

have a vacancy for a

TECHNICIAN ENGINEER

or

ELECTRONICS TECHNICIAN

QUALIFICATIONS — Minimum qualification is an Electronic Technician's Certificate or equivalent.

EXPERIENCE — Preference will be given to applicants with experience in digital data systems or related equipment. A knowledge of modern digital computer technology would be an advantage and experience in one or more of the following fields could be significant :

RADAR

COMMUNICATIONS

INSTRUMENTATION

SERVO MECHANISMS

CONTROL SYSTEMS

Applications giving concise personal and career details should be addressed to :

Personnel Manager,
EMI Electronics (Australia) Pty. Ltd.,
P.O. Box 161,
ELIZABETH, S.A. 5112

LITERATURE—in brief

PRECISE MEASUREMENT OF SPIKE LEAKAGE IN GAS SWITCHING TUBES, application engineering bulletin AEB-100, May, 1969. Published by Varian Solid State Microwave Project, U.S.A. Inquiries to Varian Pty. Ltd., 38 Oxley Street, Crows Nest, N.S.W. 2065. This 4-page note describes how a microwave pulse height detector, such as the solid-state Varian VSZ-9900 series, permits accurate observation of the average spike leakage power or observation of pulses that have excessive amplitude. In addition to a general introduction, topics include: TR function and spike leakage effects; M.P.H.D. operating principles; performance of the unit; package options; calculation of the magnitude of a pulse; attenuator setting for measuring leakage; TR tube evaluation; other applications.

INDUSTRIAL RESEARCH NEWS, No. 77, September, 1969. Published by the Industrial and Physical Sciences Branch, Commonwealth Scientific and Industrial Research Organisation, P.O. Box 89, East Melbourne, Vic. 3002. Contents: C.S.I.R.O. grants licence to Hitachi; Glazing concrete; Collaboration with Western Mining Corporation; Aluminium oxide; Simple viewer.

EMERSON & CUMING INC., U.S.A., has published a folder describing the company's line of electrically conductive adhesives, coatings, and casting resins. Inquiries to IRH Components Pty. Ltd., The Crescent, Kingsgrove, N.S.W. 2208. The folder presents properties and application data on 11 types of Eccobond conductive solders and adhesives, six Eccocoat conductive coatings, and one Stycast conductive casting resin. Properties listed include cure temperature, colour, service temperature, bond strength, thermal expansion, thermal conductivity, volume resistivity, and surface resistivity.

AUSTRALIAN TELEVISION TUNER MANUAL, June, 1969. Published by Trade Tele-Tuners Pty. Ltd., 55 Hume Highway, Greenacre, N.S.W. 2190. This guide contains information on tuners used to date in receivers manufactured in Australia. It also lists Australian television stations, translator stations, and channel frequencies. Copies are available from Trade-Tele-Tuners or from any of the following agents: Battens Electrical Pty. Ltd., 290 St. Paul's Terrace, Fortitude Valley, Qld.; Martin de Launay Pty. Ltd., enr. King and Darby Streets, Newcastle, N.S.W.; Martin de Launay Pty. Ltd., 270 Keira Street, Wollongong, N.S.W.; Television Replacements Pty. Ltd., 552 Elizabeth Street, Melbourne, Vic.; Lloyd Scott, 176 Wright Street, Adelaide, S.A.

CORNING GLASS WORKS, Technical Products Division, 1202 Plaza Building, 87 Pitt Street, Sydney, 2000. A 2-page illustrated data sheet describes Corning's low cost, high-speed digital memory modules. Besides listing the performance specifications for the memory units, the sheet outlines the custom memory capabilities and provides information on how to specify Corning memory modules.

STATISTICAL ANALYSIS OF WAVEFORMS AND DIGITAL TIME-WAVEFORM MEASUREMENTS, application note 93. Published by Hewlett-Packard Co., U.S.A. Inquiries to Hewlett-Packard Australia Pty. Ltd., 22-26 Weir Street, Glen Iris, Vic. 3146. A 60-page survey of measurements that can be made with Hewlett-Packard multi-channel analysers. These analysers sample input information, convert the samples to digital form, store the digitised samples in a memory, and operate on the stored information to compute various properties of the input signal. Although primarily used in nuclear pulse-height spectrometry, they are also useful in electronics, medicine, acoustics, and other fields.

AN93 tells how to measure such things as probability density functions and probability distributions, distortion, modulation and other statistical properties of signals and noise. Among the applications discussed are analyses of sounds, noise, power, error, and nuclear pulses. Many of the methods suggested include instrument set-ups and oscillograms of actual measurements. An appendix gives details of probability theory.

MEASUREMENT NEWS, July/August 1969. Published by Hewlett-Packard Australia Pty. Ltd., 22-26 Weir Street, Glen Iris, Vic. 3146. Contents: Multichannel analyser; Low-level multiplexer; Signal analyser; Multi-bay cabinet enclosures; Digital voltmeter; Four channel vertical amplifier; AN114 A2A Video Transmission System Alignment; Caesium-beam frequency standard; DC constant current sources.

TECHNICAL COMMUNICATIONS Vol. 10, No. 98, March, 1969. Published by Mullard Ltd., U.K. Inquiries to Mullard-Australia Pty. Ltd., 35-43 Clarence St., Sydney, 2000. Contents: Spectroscopic detector amplifier for 100Hz to 10KHz; Single system IF amplifier for U.K. 625-line system; "Plumbicon" camera tubes and their applications.

INTERNATIONAL ELECTRONICS, Vol. 16, No. 2, April/May 1969. Published by International Business Publications Inc., 27 North Ward Avenue, Rumson, N.J. 07760, U.S.A. Contents:

"Stretch Paper," Electronics' Ally; Intelsat II, Calling Manila; ICs Replace Servo for Instant Readout; Moonport Communications, Foretaste of Future; Colour Mosaic, Will It Dim Out the Neon Sign?; Long-range Radiophone Proved in East Africa; Electronic Training, Anti-sub War Ashore; Key to New Solid-state Frequency Calibrator.

TECHNICAL NEWS BULLETIN, Vol. 53, No. 7, July, 1969. Published by the National Bureau of Standards, U.S.A. Inquiries to Superintendent of Documents, U.S. Government Printing Office, Washington, D.C. 20402, U.S.A. Contents: Chromium compound found ferromagnetic; Analog data via teletypewriter; Prefabricated building undergoes evaluation; Conference and publication briefs; Error in electrostatic actuator calibration of condenser microphones; NBS measurements seminars, 1969-1970 series; Standard reference materials; Density data on cryogenic fluids; N.S.R.D.S. news; Loss of colour discrimination under reduced visual conditions; Standards and calibration; Publications of the National Bureau of Standards.

TELECOMMUNICATION JOURNAL, Vol. 36, No. 8, August, 1969. Published by the International Telecommunication Union (I.T.U.), Place des Nations, 1211 Geneva 20, Switzerland. Contents include: Apollo 11 Communications, specially contributed by NASA; Underwater Communications, by J. R. Dean; Safety and Radiotelephone Communication on

Be Paid What You are REALLY WORTH!



Develop your aptitudes at your own pace, for recognition that brings HIGHER PAY. Begin YOUR Progress Today! Select the course you want and which will benefit you most. ICS will send YOU promptly—a FREE illustrated BOOK, giving FULL DETAILS.

GENERAL

Journalism—Short Stories
Writing for Radio & TV
Interior Decorating
Etiquette & Entertaining
Textiles
Photography
Mathematics
General Education
Dressmaking

DRAFTSMANSHIP

Architectural
Builders' Plan Drawing
Mechanical Structural
Surveying & Mapping

ILLUSTRATING

Still Life—Landscape
Caricature & Cartoons
Oil & Water Colour.
Fashion Drawing
Showcards & Tickets
Signwriting

COMMERCIAL

Accountancy
Cost Accountancy
General Bookkeeping
Salesmanship
Shorthand Typing

Retail Management

Commercial Management
Small Business Owner
Hotel-Motel Management
Club Administration
Window Dressing
Business Letters

BUILDING

Architecture
Building Contracting
Carpentry, Joinery
Structural Engineering
Concrete Engineering
Estimate & Quantities
Roofing, Steel Square
Timber Home Building

INDUSTRIAL

All Mechanical Eng.
Fitting & Turning
Soft Drink Manufacture
Air Conditioning
Gas or Elect. Welding
Chemistry, Plastics
Electronics
Electrical Mechanics
Radio Eng. or Service
Television
Refrigeration
Diesel Engines

Auto Mechanics

Civil Engineer
Production Management
Industrial Management
Executive Training
Modern Supervision

SPECIAL EXAMINATION COACHING COURSES

Account'cy: All Exams
Institute of Secretaries
Inst. Cost Accountants
Inst. Sales & Marketing
Metric. or Leav. Cert.
Intermediate Certificate
Senior or Junior Public
C'wealth Clerical Exams
Police Entrance Exam
Nurses' Entrance Exam
Steam Certificate
Refrigeration Certificate
Radio Examinations
Inst. Auto. Mech. Engrs.
Inst. Diesel Engineers
Shire Overseers' Exam
Engineers' Institutions.

ADVERTISING

Copywriting
Commercial Art
Advertis'g Inst. Aust.

TO INTERNATIONAL CORRESPONDENCE

Dept. 526 SCHOOLS.

SYDNEY: 400 Pacific H'way, Crow's Nest. Tele.: 43-2121.

MELBOURNE: 234 Collins Street. Tele.: 63-7327.

BRISBANE: Heindorff House, 171 Queen St., Brisbane. Tele.: 2-6125.

ADELAIDE: T. & G. Building, King William St. Tele.: W-4148.

PERTH: C'wealth Bank Building, 55 William St. Tele.: 21-7268.

NEW ZEALAND: Wellington, 182 Wakefield St. Tele.: 53-109.

Please send Free Book on

NAME (Mr, Mrs, Miss) AGE

ADDRESS

..... STATE Dept. 526

OCCUPATION PHONE

EA 10 69



“The day anyone can deliver me SCR's and diodes straight away I'll give 'em an order.”

Start writing!

STC and NEC have combined in an exclusive marketing agreement to provide them all by the plane-load! Ready now for delivery.

Silicon controlled rectifiers, avalanche reflectors, TRIAC's, DIAC's and unijunction transistors are included. The complete and widely accepted range of NEC SCR's and power diodes are immediately available to you under this exclusive agreement.

Additional information on new products geared to the dynamic and competitive Japanese Power market, is also immediately available to you. Information on the 3000V 600 amp diodes and matching SCR's to a cheap reliable range of TRIAC's.

Order now from STC, sole Australian market outlet.

Call or telex (collect) your order direct to STC Components Division.
 Phone Sydney 602-1314, 602-1329, 602-1369; Melbourne 480-1255; Brisbane 47-4311; Adelaide 51-3731; Perth 21-6461. Or telex Sydney 20328.

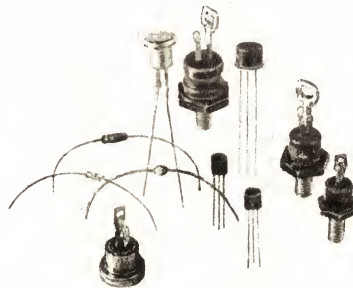

For more details and free brochures fill in the coupon:

Please send me information on

.....

.....

NAME.....

COMPANY.....

ADDRESS.....

..... POSTCODE.....

Standard Telephones & Cables Pty. Limited
 Moorebank Avenue, Liverpool N.S.W. 2170

AN **ITT** world-wide telecommunications and electronics
 ASSOCIATE



U546A

the Great Lakes, by J. W. Manning. This issue contains a wall chart describing the work of the Study Groups of the I.T.U.'s International Consultative Committees (C.C.I.R. and C.C.I.T.T.). In the section "Ideas and Achievements" information is given on computer-aided design of microcircuits, and a method of using commercial television to aid the standard broadcasts of the United States National Bureau of Standards.

DIGITALLY CONTROLLED POWER.

Published by Hewlett-Packard Co., Palo Alto, Calif., U.S.A., 22 pages. Inquiries on company letterhead to Hewlett-Packard Australia Pty. Ltd., 22-26 Weir Street, Glen Iris, Vic. 3146. Discusses the characteristics and applications of digitally controlled power sources, describes Hewlett-Packard models, gives several applications with block diagrams, gives detailed information about interfacing with Hewlett-Packard computers and other devices, and includes data sheets and forms for specifying interfaces.

NBS FREQUENCY AND TIME BROADCAST SERVICES — RADIO STATIONS WWV, WWVH, WWVB, AND WWVL.

National Bureau of Standards Special Publication 236, 1969 edition, 14 pages. Price 25c U.S. Obtainable from the Superintendent of Documents, U.S. Government Printing Office, Washington, D.C. 20402, U.S.A. Remittances must be in U.S. exchange and include an additional one-fourth to cover mailing costs. This publication gives detailed descriptions of each of eight vital broadcast services provided to the public by the N.B.S. The services are: standard radio frequencies; standard audio frequencies; standard musical pitch; standard time intervals; time signals; UT2 corrections; radio propagation forecasts; geophysical alerts. To provide users with the best possible services, occasional changes in broadcast schedules are required. Special Publication 236 is revised annually to reflect these changes.

MEASUREMENT NEWS, Jan.-Feb., 1969.

Published by Hewlett-Packard Australia Pty. Ltd., 22-26 Weir Street, Glen Iris, Vic. 3146. Contents: Pulse generating system; Computer-controlled data acquisition system; High resistance meter and picoammeter; Automatic network analyser; Current controlled RF resistor; Digital frequency meter (to 12.4GHz); Digital-analog system interface; Network analyser; Quantity discounts on strip-chart recorders; Computer controlled test system. Also noted are the application notes: AN96, direct-type frequency synthesizers; AN110, a simplified electronic boresight measuring system; AN918, step-recovery diodes.

NEW TECHNOLOGY, No. 31, August, 1969.

Published jointly by the British Ministry of Technology and the Central Office of Information. Obtainable free of charge from the Central Office of Information, Hercules Road, Westminster Bridge Road, London SE1, England. Contents: CAD at Cambridge; Sources of Finance for Innovation; Light on Sweetness; Commercial Spectropolarimeter to NPL Design; News; Statistical Indicators.

MULLARD OUTLOOK, Vol. 12, No. 3, May-June, 1969.

Published by Mullard-Australia Pty. Ltd., 35-43 Clarence Street, Sydney, 2000. Contents: Twelfth National Convention I.R.E.E.; Talk on Solid State Colour TV to 500 Service Technicians; Mullard Managing Director's Guest Address at I.R.E.E. Convention; Colour Television, Part 5; Popular Paper by Peter Mothersole; New Products; Nanofarads; Circuits Using Mullard BCY87 Family Transistors.

SPRAGUE ELECTRIC CO., North Adams, Mass., U.S.A., has published a 48-page short form catalogue which gives salient information on TTL and high-speed TTL integrated circuits, compatible MSI integrated circuit arrays, thin-film hybrid circuits, and transistors manufac-

Casting resins

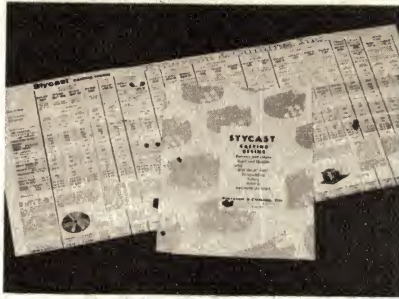

STYCAST CASTING RESINS. Published by Emerson and Cuming Inc., Canton, Mass., U.S.A. Inquiries to the Australian distributors, IRH Components Pty. Ltd., The Crescent, Kingsgrove, N.S.W. 2208. A folder describing the Stycast line of casting resins, including epoxy, polyurethane, polystyrene, and others with special properties. The folder lists such properties as viscosity, cure temperature, cured properties, specific gravity, yield strength, service temperature, and relative cost. The folder also describes the Ecomold line of moulding powders and liquids.

.....
 tured by the company's Semiconductor Division. Inquiries on company letterhead to Cannon Electric (Aust.) Pty. Ltd., 58 Cluden Street, East Brighton, Vic. 3187.

PLANAR, June/July '69.

Published by Fairchild Australia Pty. Ltd., 420 Mount Dandenong Road, Croydon, Vic. 3136. Contents: Editorial: From out of the Future comes the MuL4027; A New 5in Double Beam Oscilloscope from B.W.D.; Let's Take a Close Look at Interchangeability; Secondary Breakdown; 12-volt RF Power Transistor; Applications Brief — simple minimum package counter; A Simple Crystal Oscillator; A New Look for the Printed Word; The Micromatrix Array Approach.

GLORAD BULLETIN, No. 10, March, 1969.

Published by Glorad Engineering Services Pty. Ltd., 463 Auburn Road, Hawthorn East, Vic. 3123. Contents: Production trends; Speed and mechanical limitations; Programmer; Level alarm system; Reverser; What is an automation engineer?; Ejector unit; Adaptor; Solid state resistive relay units; Wire elongation tester; remote alarm systems; AC contactor; AC and DC reversers; Probe unit; Control unit; Irrigation control; Heat sealers; Modular counters and batchers; Temperature controller; The Australian electronics industry; DC reverser controller.

DATAGRAPH PRODUCTS.

Published by Consolidated Electrodynamics Corp., the electronic instrumentation group of Bell and Howell. Inquiries to Jacoby, Mitchell and Co. Pty. Ltd., 469-475 Kent Street, Sydney, 2000. Contains abbreviated data on: Series 7-300 galvanometers; 5-127 recording oscillograph; 5-124 recorder; 5-124P2 recording oscillograph; 3-140 voltage supply; 1-162A DC amplifier; 1-165 DC amplifier; 5-133 recording oscillograph; 23-109 processor; 5-119 recording oscillograph; 1-163 DC amplifier.

NEW DEVELOPMENTS, B044,

August, 1969. Published by Jacoby, Mitchell and Co. Pty. Ltd., 469-475 Kent Street, Sydney, 2000. Contents: Wiltron sweep generator (with plug-ins) and VSWR autotester; Comark electronic multimeters; Telonic logarithmic amplifier detector; Advance modular timer counter system, integrating digital voltmeter, and timer/counter with start/stop inputs; Alma precision wirewound resistors; Kyoritsu volt-ohm-milliammeter; Perivale surface mounting gauge; and surface thermometer; Siliconix field effect transistors; TRW pulsed argon laser. ■

PLAN YOUR FUTURE

CHOOSE a career in the field of ELECTRONICS* — the Nation's most progressive and fastest expanding industry.



Advancement in this modern science demands technical ability, a sound knowledge of basic principles and applications.

YOU can master the subject by training at the MARCONI SCHOOL and be ready to grasp the opportunities that occur in the three fundamental branches of Radiotechnology.

KNOW WHERE YOU'RE GOING

A = APPLIED SERVICING

Comprehensive training in the maintenance and repair of radio and television receivers offers substantial rewards to competent technicians. Marconi School training covers all aspects of radio and television receiver circuit applications, practical exercises in fault finding and alignment procedures.

B = BROADCASTING

A thorough and practical grounding is available to students in broadcasting transmitter performance standards and maintenance techniques, with individual instruction in station operation and studio control and testing.

C = COMMUNICATIONS

Combines all the foregoing, together with radio aids to navigation, mobile telephony, marine service application and international wireless telegraph regulations, qualifying the successful student for the Commonwealth Government Certificate of Proficiency and the Marconi School Diploma in Radiotechnology. Classes are conducted at

21 Pier Street, Sydney (at the foot of Goulburn Street).

Daily: 9.30 a.m. to 4.30 p.m.

Evenings: 6 p.m. to 8.30 p.m.

or by Home-Study Courses (except practical instruction on equipment).

STUDY NOW

Send for training syllabus. There is no obligation.

NAME.....
 ADDRESS.....

the MARCONI SCHOOL of wireless

G.P.O. Box 2516, Sydney

A Service of Amalgamated Wireless (Australia) Ltd.



STOCK TRANSFORMERS for Popular Projects!

PUBLICATION
 ELEC. AUST. FEB. 1969
 ELEC. AUST. FEB. 1969
 ELEC. AUST. JAN. 1969
 ELEC. AUST. JAN. 1969
 ELEC. AUST. DEC. 1968
 ELEC. AUST. NOV. 1968
 ELEC. AUST. OCT. 1968
 ELEC. AUST. OCT. 1968
 ELEC. AUST. SEPT. 1968
 ELEC. AUST. SEPT. 1968

MULLARD OUTLOOK
 SEPT.-OCT. 1968
 ELEC. AUST. AUG. 1968
 ELEC. AUST. AUG. 1968
 ELEC. AUST. AUG. 1968
 ELEC. AUST. JUNE 1968
 ELEC. AUST. MAY 1968
 ELEC. AUST. APRIL 1968
 ELEC. AUST. MARCH 1968
 OUTLOOK JAN. FEB. 1968
 ELEC. AUST. AUG. DEC. 1967
 ELEC. AUST. AUG. 1967
 ELEC. AUST. JUNE 1967
 ELEC. AUST. APRIL 1967
 ELEC. AUST. APRIL 1967
 ELEC. AUST. APRIL 1967
 ELEC. AUST. NOV. 1966
 ELEC. AUST. OCT. 1966

MINIWATT DIGEST
 AUG.-SEPT. 1966
 OUTLOOK MAY-JUNE 1966
 ELEC. AUST. JUNE 1966
 ELEC. AUST. JUNE 1966
 ELEC. AUST. MAY 1966
 ELEC. AUST. JULY 1969
 FAIRCHILD

PROJECT
 Solid State V.O. Meter
 Probe, Pre-Amp C.R.O.'s and V.T.M.s
 Low cost Transistor Power Supply
 Timer and Sequencer for Slide Projectors
 Tape Replay Pre-Amp.
 Acoustic Signal Unit
 Playmaster 123 Program Source
 Power Supply for Transistors in Valve Equip.
 Electronic Thermometer
 Solid State A.F. Signal Generator

Stabilised Power Supply
 3- Plus 3 Stereo Amplifier
 Playmaster 122 Program Source
 D.C.-A.C. Inverter for Fluorescent Lamps
 P.A. Amplifier Power Supply
 Solid State A.F. Millivolt Meter
 Synchronous Unit Gating
 Transistor R.F. Test Oscillator
 Stereo 10-10 Transistor Power Amp.
 All Wave Receivers 3, 4, 5, 6 and 7
 60 Watt Guitar Amplifier
 40 Watt Guitar Amplifier
 Logic and Counting Demonstrator
 Optical and Magnetic Preamp. for Sound
 Projectors
 All Silicone Playmaster Amplifier
 Stereo Public Address Amplifier
 3 Band Receiver with Switched Coils

Electronic Photo Cell Circuits
 3 Watt Transistor Stereo Amp.
 Regulated Power Supply
 Basic Stereo Amplifier
 A Battery Charger for your car
 Solid State Guitar Amplifier
 Quality 20W Stereo System

A. & R. TRANSFORMER TYPE

PT6474
 PT6474
 PT2155
 PT6474
 PT6474
 TO1
 PT5579
 PT5579 or PT6474
 PT6474
 PT5990
 PT6557
 PT2155
 PT5579
 PT2155
 PT5990
 PT6474
 PT6474
 PT6474
 PT6413
 PT2062, E7/V.C.
 PT5893, OT2842
 PT5892, OT2843
 PT2150 or 2 x PT5579
 PT1992
 PT6232, Z3252
 PT5891, Z3239, OT4005 (2 req'd)
 PT1992 Suitable Speaker Trans.
 from A. & R. Range
 PT5991
 PT5990
 PT1940
 PT1889, Z3040, K5/15 (2 Req'd.)
 PT5786
 PT5586 and TD32
 6534

**NEW
RELEASE:**

General Power Supply Transformer 6672; Pri-
 mary: 240V, Secondary: 30V, 27.5, 24, 20,
 17.5 and 15V at 1 amp. Leaflet Available.

A & R TRANSFORMERS PTY. LTD. 42-46 Lexton Rd., Box Hill, Vic. (Box Hill P.O. Box 170) Phone 89 0238



We've got the best chassis in the business . . . and the best cases & racks too!

If figures count, Celotek have a standard range of over 150 different sized electronic enclosures. And should you require a custom-built model, Celotek are the people to see.

All Celotek cases and racks are precision-made from top-quality materials. Standard finishes include blue, silver and dark grey. Special finishes are also available. Celotek prices are unbeatable and their fast, on-schedule delivery will satisfy any customer . . . large or small. So to put it briefly, if you have the equipment . . . we'll cover it!

Come, see our showroom or write for free catalogue to:

CELOTEK INDUSTRIES PTY. LTD.

800-810 Parramatta Road, Lewisham, N.S.W. 2049.
 Telephone: 560-9572.



AMATEUR BAND NEWS AND NOTES

World wide Jamboree-on-the-Air

Scouts from all over the world are expected to participate in the twelfth Boy Scout Jamboree-on-the-Air which will be held over the weekend of October 18 and 19, 1969.

by Pierce Healy, VK2APQ

This popular world-wide event, in which official participation figures show that Australia leads all other nations, brings together — in a common desire for communication between peoples of many nations — amateur radio operators, as members of an internationally recognised communications service, and members of the Boy Scouts fraternity, representing many nations and ways of life. In recent years, an increasing number of Girl Guides have been participating, also.

The Jamboree-on-the-Air has two main objects:

1. To make the 4th Scout Law live.
2. To open new fields of interest.

The average Scout has few opportunities of meeting Scouts from other countries. Although he cannot shake hands with them during this Jamboree, he can talk to them. Even if conditions for overseas radio contacts are bad, he will be able to talk to Scouts from other parts of his own country and exchange ideas.

An introduction to amateur radio may help a boy discover a latent interest which may lead him to an eventual career in electronics — radio, television, computers, space-travel, etc. It may also encourage him to work for proficiency badges relating to radio, electricity, signalling, etc.

Over the years, through participating in a Jamboree-on-the-Air, many firm and lasting friendships have been made. This applies not only to those between Scouts themselves, but also to amateur radio operators who have found a common interest with members of the Boy Scouts organisation.

There has been quite a number of Scout groups with their own transmitting stations. These are generally operated and controlled by a Scout who was spurred on by his introduction to amateur radio, to study and gain his own amateur operator's licence.

Unfortunately, unlike Australia and a large number of other countries, administrations in some areas will not allow persons other than the licensed operator to speak over an amateur radio station. However, it is pleasing to note that there is an increasing number of such administrations giving special permission each year to stations participating in the event to allow Scouts to exchange greetings with groups contacted during the 48-hour period.

Commissioner Noel Lynch of Brisbane

News and notes of Divisional and Club activities submitted for inclusion in these columns should be forwarded direct to Pierce Healy, 69 Taylor St., Bankstown, N.S.W. 2200.

has for many years been responsible for the co-ordination of Australian Scouts participating in the event. His reports to the Boy Scouts World Bureau, now located in Geneva, Switzerland, have received high praise from the world organisers.

The first Jamboree-on-the-Air was the idea of Leslie Mitchell, G3BHK, of England, a former Assistant Scout Master of the Boy Scouts of America. Les and others were concerned that so few Scouts out of the millions of members could actually participate in the face-to-face building of international friendships through such events as World Jamborees.

During the World Jubilee Jamboree of 1957 at Sutton Coldfield, England, a number of Scouts who were amateur radio operators set up a station and held what they called a "Ham-fest." The reception



The official crest of the world-wide Jamboree-on-the-Air.

and interest they created led them to enthusiastically suggest that Scouts throughout the world should try to contact each other on a fixed date each year by means of amateur radio.

The idea materialised, and on the weekend of May 10 and 11, 1958, the first Jamboree-on-the-Air was held. Les Mitchell, G3BHK, was the honorary organiser and the World Bureau assisted with publicity.

At the end of May, 1958, the Boy Scouts World Bureau, secretariat for the World Movement, was asked to take over officially the organisation of future events. This was done and the Jamboree-on-the-Air became an official event in the annual world scouting calendar.

On May 1, 1968, the bureau headquarters was officially opened in Geneva, Switzerland, having been transferred from Ottawa, Canada, by decision of the 22nd Boy Scouts World Conference. During the 1968 Jamboree-on-the-Air the International Amateur Radio Club made the club's station, 4U1ITU, available to the bureau for the full period of the event.

A copy of the official report on the 1968 Jamboree-on-the-Air, received from Noel Lynch, the Australian co-ordinator, features photographs from participating stations in all parts of the world as well

as comprehensive reports from co-ordinators in many countries.

A comment by the editor is:—"Countless Scouts have been stimulated to master Morse code signalling — an important Scout advancement requirement for many, and first step toward becoming an amateur radio operator, and many have gone on to rewarding hobbies and even careers in radio and television."

In the 1968 report the question was asked—which country would beat Australia's average of one station for every 280 Scouts and who would be the first to operate aeronautical mobile? This year's report states that the first is still unanswered, but the honour of being the first aeronautical mobile station to participate went to South Africa.

The official report lists 72 countries as having participated. Of these, 25 submitted reports on the activities of their national Scout groups showing the number of amateur stations participating in each country. Reports were received from:—

Australia	405	Nigeria	2
Austria	13	Norway	42
Denmark	2	Philippines	13
Gambia	1	Portugal	11
Finland	9	Saudi Arabia	1
Great Britain	134	Singapore	1
Ireland	7	South Africa	63
Luxembourg	8	Switzerland	13
Malaysia	2	U.S.A.	64
Mozambique	21	Vatican	1
Netherlands	9	Venezuela	46
Neth. Antilles	9	Zambia	1
New Guinea	10		

International Scout Nets

There are a number of national Scout nets meeting at regular intervals — usually weekly — on the lower frequency bands. Scout operators around the world will be particularly interested in the following, since it presents more opportunities of making long distance contacts:

Saturdays at 0930GMT — 14.29MHz operated by G3BHZ and HV3SJ.

Mainly European stations but anybody welcome.

Saturday at 1800GMT — 21.36MHz, the World Scout Net, WB6IZF net control.

World Scout Frequencies	
80-metre band - 3590KHz CW	3740KHz phone
	3940KHz U.S. only.
40-metre band - 7090KHz phone	
20-metre band - 14.09MHz CW	14.29MHz phone
15-metre band - 21.14MHz CW	21.36MHz phone
10-metre band - 28.19MHz CW	28.99MHz phone.

Region III Association

In keeping with the wish of the societies who attended the Region III Congress in Sydney during 1968, that the Wireless Institute of Australia provide the secretariat for the Region III Association, the following appointments have been made by the Federal Council of the Institute.

Chairman;	John Battrick	VK3OR
Sec. General:	Peter Williams	VK3IZ
Members	David Wardlaw	
		VK3ADW
	Michael Owen	VK3K1
	Max Hull	VK3ZS
Ex-officio	Pierce Healy	VK2APQ

LAFAYETTE *Solid State*

5-Watt 27 MHz Two-Way Radio



Model HE-20T \$169.50 (Crystals Extra)
P.M.G. Type Approved (Licence Required)

Cool Instantaneous Operation

- Crystal Controlled Transmit and Receive.
- 13 Transistors, 10 Diodes.
- 117 VAC and 12 VDC Negative or Positive Battery Ground.
- 455 KHz Mechanical Filter.
- TVI Trap.
- Pi-Network Output.
- May also be used as P.A. Amplifier with External Speaker.

This solid state transceiver is ideal for 27MHz communications. Solid state circuitry features low battery drain and provides instant operation; 5-watt transmitter input with efficient push-pull audio modulator; a Pi-network for matching the output to 30-100 ohm antennas; an extra-sensitive superhetrodyne receiver. Fine selectivity and adjacent channel rejection is obtained through a 455 KHz mechanical filter. Sensitivity: .7 uV for 10 db signal to noise ratio. Receiver also incorporates automatic floating series-gate noise limiter and variable squelch control resulting in virtually no background noise between calls. A rear mounted low-loss antenna jack accepts SO-239 type connector used with ground plane and direct mounting antennas. Complete with fused DC line cord for negative ground battery and push-to-talk mike. Size: 8 1/2 in D. x 4 1/2 in H. x 11 1/2 in W.

.5-Watt 3 Channel Walkie Talkie



- Sturdy Metal Case.
- Battery Condition Indicator.
- Built-in Call Alert.
- Switchable 3 Channel Operation.
- Range Boost for Extended Talk Power.
- Adjustable Squelch. Noise limiter.
- Superhet Receiver with 1 uV Sensitivity.
- Large, Efficient Speaker/Mike.

Lightweight 2-way transceiver includes three switchable channels. Call alert system sends or receives a pleasant alerting tone for convenient calling. 14 transistors, 1 diode, 1 varistor superhet circuit with noise limiter and variable squelch, .5 watt transmitter with range boost. Supplied with telescopic antenna, batteries, carrying strap, and crystals for 27.240 MHz.

MODEL HA-305 \$57.25
P.M.G. Type Approved
(Licence Required)

SEND REMITTANCE WITH ORDER FOR IMMEDIATE DELIVERY ANYWHERE. WRITE, PHONE OR CALL FOR DETAILED INFORMATION.

LAFAYETTE

ELECTRONICS

Division of Electron Tube Distributors Pty. Ltd.

VICTORIAN SALES CENTRE AND HEAD OFFICE,
94 HIGH STREET,
ST. KILDA, 3182, VIC.
94-6036.

To keep members informed of the activities and general news from societies within the area, the Directors of the Region 111 Association have agreed that a news bulletin covering such activities is desirable. It was therefore agreed to co-opt Pierce Healy, VK2APQ, as Editor of such a publication.

Details as to the format and frequency of publication are now being considered. The printing of the bulletin will be carried out by the Japan Amateur Radio League.

Max Hull, VK3ZS, will act as liaison officer with member societies and other interested organisations in the collection of material for publication. Max will also handle the distribution of the bulletin.

Kennedy Space Centre

From a short wave listener, Samson Voron of Coogee N.S.W., we have received news of The Space Centre Amateur Radio Society of Kennedy Space Centre, Florida and its club station WB4ICJ.

The club is issuing "Special Event" certificates to all stations who made contact with members following the launching of the Apollo 11 spacecraft on Man's successful landing on the moon.

The club's members began operating shortly after the launching and during the first 17 hours contacted 1650 stations. Among these were 235 overseas stations representing 50 countries. Transmitters were operated on 21.34MHz and 14.34MHz SSB, and on 21.15MHz and 14.035MHz CW, as well as in the 3.9-MHz and 7MHz American frequency allocations.

Operators during the period of the space mission were: Ace, W4WEU; Ambrose, W4GHV; Roy, K4DJN; Gus, W4IQM; Herb, WB4HZB; John, WA9LJX/4; Allen, W3ZNB/4; Howard, WA4ZCB; Bill, WA4WBG; Mac, WB4CAB; Dave, K4VTY; Buz, WN7LIX/4; Mark, WB4IQD. It was stated that Buz, WN7LIX is 10 years of age.

The club is confirming regular contacts with a specially designed QSL card.

Office bearers of the club are: President: Ace Goodwin, W4WEU; Vice-president: Ambrose Barry, W4GHV; Secretary-treasurer: Evan S. Howell.

Reports should be sent to: Space Centre Amateur Radio Club, P.O. Box 21073, Kennedy Space Centre, Florida 32815, U.S.A.

VALE

On Saturday, August 2nd, James Moncrieff Retallick (Crieff), VK2XO, passed away while in hospital in Sydney. Aged 72, Crieff was well known to a very large number of amateurs, being licenced in 1930 and the founder 21 years ago of the now famed Urunga Convention. He will be sadly missed by his many friends.

To his family is extended deepest sympathy from all.

VHF Channels

In response to requests for information, here are the frequencies in general use by VHF operators in New South Wales.

Six-metre Band

Frequency allocations: 52MHz to 54MHz. Net frequencies:

Area	Frequency Mode
Canberra	52.525MHz FM
Sydney	53.866MHz AM 53.826MHz AM 53.786MHz AM
Wollongong	53.982MHz AM

Two-metre Band

Frequency allocation: 144MHz to 148MHz. Net frequencies:

Channel	Frequency Mode
A	146.146MHz FM
B	146.00MHz FM
C	145.854MHz FM

Details of net frequencies used in other States are required to complete an Australia-wide schedule.

WIRELESS INSTITUTE ACTIVITIES

Participation by all States in the 1969 Remembrance Day Contest appeared to be higher than previous years. A notable feature was the high active participation by Australian Capital Territory (VK1) operators.

The new scoring table introduced by the Federal Convention last Easter was a major contributing factor to this aspect. All States are no doubt awaiting the final results from the Federal Contest Committee.

Following the retirement of Alf Seedsman, VK3IE, from Federal Executive, Ken Pincott, VK3AFJ, has been elected to fill the vacancy. Ken for many years has been editor of the institute's magazine, "Amateur Radio." Members express their thanks to Alf for the service he has given the W.I.A. and extend their best wishes for his projected overseas tour.

NEW SOUTH WALES

A larger than usual number of Hunter Branch members participated in the Remembrance Day Contest. In addition to participants on the HF band, there were several VHF stations operating from both home and portable locations.

Probably the highest score in the area was made by Bill Hall, VK2XT, who with 340 contacts during the 24 hours logged 1,064 points toward the N.S.W. State total.

Other stations were VK's 2CN; 2FC; 2CS; 2BJT; 2BSC; 2AXU; 2BJO; 2AXK from the Newcastle area with VK2RJ at Muswellbrook and VK2AMM at Maitland. Portable operation was carried out by VK2ATZ and VK2AWX with assistance from VK's 2ZCT; 2ZVF; 2ZKC; 2ZKF; 2ZYK. Operating from home locations were VK's 2ZSG; 2ZMO; 2ZWM; with VK2ZBD operating mobile.

The frequencies used were from 1.8MHz to 28MHz in the HF band, and in the 52MHz and 144MHz VHF bands.

The monthly meetings of the Hunter Branch are held in the Technical College, Tighes Hill, commencing at 8 p.m. on the first Friday of each month. Visitors are always welcome. The Newcastle Technical College is on the Maitland Road, Tighes Hill, and plenty of parking space is available.

Illawarra Branch

This branch is now publishing a monthly newsletter for members giving details of coming events. The branch is building up quite a library of books and magazines which are available on loan to members attending the monthly meetings. A maximum of two books and five magazines may be held at any one time with a time limit of one month.

Librarian Grahame Dowse, VK2AGV, 18 Davidson Avenue, Woonona, phone 84-1200, will be pleased to receive donations of books or magazines to still further increase the range available.

Wagga District Radio Club

The annual general meeting of the Wagga District Radio Club was held in the Civil Defence Headquarters on Friday night, July 25. The president's report, presented by Sid Ward, VK2SW, contained a resume of the achievements of the club during the past year.

Among the points reported were: the installation of the 146MHz base station; the HF base station in operation; five members gaining their amateur operator's licence:—

N. Jeffrey	VK2HI
Roly Mitchell	VK2BOM
Phil Bowers	VK2ZOE
Kevin Cox	VK2ZKV
Leo McKenzie	VK2ZLU

Sid also reported on the sound financial position of the club and the happy relationship that exists with the Civil Defence Organisation.

The ballots for executive and committee appointments for the coming year resulted

in the following members being elected to office;

President: Douglas Menneke.
Vice-president: Sid Ward, VK2SW.
Secretary-treasurer: Leo McKenzie, VK2ZLU.

Executive Committee: Harry Hendriks; John Tapper, VK2AQ; Phil Bowers, VK2ZOE.

Social Committee: Kevin Cox, VK2ZKV; Phil Bowers, VK2ZOE.

Technical Training Committee: Sid Ward, VK2SW; John Tapper, VK2AQ; Leo McKenzie, VK2ZLU; Phil Bowers, VK2ZOE; Douglas Menneke.

Plans for the coming year include an extension of Youth Radio Club Scheme activities. At present there is a flourishing club at the Christian Brothers School conducted by Rev. Bro. Jeffrey, VK2HI.

An invitation is extended to anyone in the district interested in amateur radio to join the club. Details may be obtained from the Secretary, 106 Ashmont Avenue, Wagga, N.S.W. 2650. Phone Wagga: 5-1198.

VICTORIA

The Geelong Amateur Radio Club has received permission from the P.M.G.'s Department to install a 146MHz translator on an experimental basis. During this period the installation must be used only when a licensed operator is in attendance. Operation will be on FM Channel 4.

Mobiles using the service will transmit on 146.4MHz and receive on 145.9MHz.

As from September 1, the club's simplex frequency will be Channel B. This will conform with other country areas and avoid interference with the Geelong translator.

QUEENSLAND

Ipswich and District Radio Club

The annual meeting of the club, held in the clubhouse at Denmark Hill, was very well attended. Visitors included: Ald. J. Finimore, Mayor of Ipswich; Mrs Jordon, M.L.A.; Mr Crieghton, W.I.A. Qld. Div. president Norm Wilson, VK4NP; vice-president Peter Brown, VK4PJ; treasurer Don Watson, VK4DZ. Several of the visiting guests spoke highly of the progress of the club and expressed their best wishes for the coming year.

The election of officers resulted in the following appointments being made: Patron: Mr W. Hayden, M.L.A.

CALLING ALL PROSPECTIVE AMATEURS

The Wireless Institute of Australia was established in 1910 to further the interest of Amateur Radio. With over 45 years experience, who could be more experienced in the teaching of this subject?

We are a non-profit making Organisation. Correspondence Courses are available at any time. Personal Classes commence in February of each year.

For further information write to:
THE COURSE SUPERVISOR, W.I.A.,
14 Atchison Street,
CROWS NEST, N.S.W.

BRIGHT STAR CRYSTALS

PREFERRED BY LEADING MANUFACTURERS
THROUGHOUT THE COUNTRY FOR —

ACCURACY - STABILITY - ACTIVITY - OUTPUT



All types of Crystals Available
Such as DC11, FT 243 HC6U CRA
B7G, HC18U, ETC.
TOLERANCES: .0015%, .002%,
.003%, .005% ETC.

Consult us for Crystals for any Mobile Radio. Prices depend on tolerance and frequency required.

DISCOUNT FOR QUANTITY ORDERS

Established 36 Years



AMATEUR AIRCRAFT and ULTRASONIC CRYSTALS also AVAILABLE

Our new Factory employing the most modern equipment allows us to offer you PROMPT DELIVERY for all your CRYSTAL requirements.

DEVOTED EXCLUSIVELY TO THE MANUFACTURE OF

PIEZO ELECTRIC CRYSTALS

Contractors to Federal and State Government Departments

REPRESENTATIVES AUSTRALIA AND NEW ZEALAND: Messrs. CARREL & CARREL
BOX 2102, AUCKLAND.

MESSRS ATKINS (W.A.) LTD.,

MESSRS LAWRENCE & HANSEN
ELECTRICAL (VIC.) PTY. LTD.,

894 Hay Street, PERTH.
MESSRS. A. E. HAROLD PTY. LTD.,
123-125 Charlotte Street, BRISBANE.

34 Brisbane Street, HOBART,
and 29 St. John Street,
LAUNCESTON, TASMANIA.

BRIGHT STAR RADIO

546-5076

LOT 6 EILEEN ROAD, CLAYTON, VICTORIA

546-5076

A vast range of SATO Parts

- For manufacturers
- For TV
- For radio
- For instruments
- For amplifiers
- For kitset builders
- For sound equipment
- For industry
- For stereo equipment
- For educational purposes
- For electronics
- For tape recorders

Distributed by



GENERAL ACCESSORIES

(A DIVISION OF ELECTRONICS INDUSTRIES)

116-118 CLARENCE STREET, SYDNEY 443 CONCORD ROAD, RHODES — 73-0211
BOTH STORES OPEN SATURDAY MORNING



Like being proud of their Kangaroo, Sato's large variety of electrical parts is the favorite choice by Australians. Your inquiries are welcome.

SATO PARTS

SATO PARTS CO., LTD. HEAD OFFICE: EBISU, SHIBUYA-KU, TOKYO, JAPAN TEL: (442) 8506~8
BANK ACCOUNT: MITSUBISHI BANK

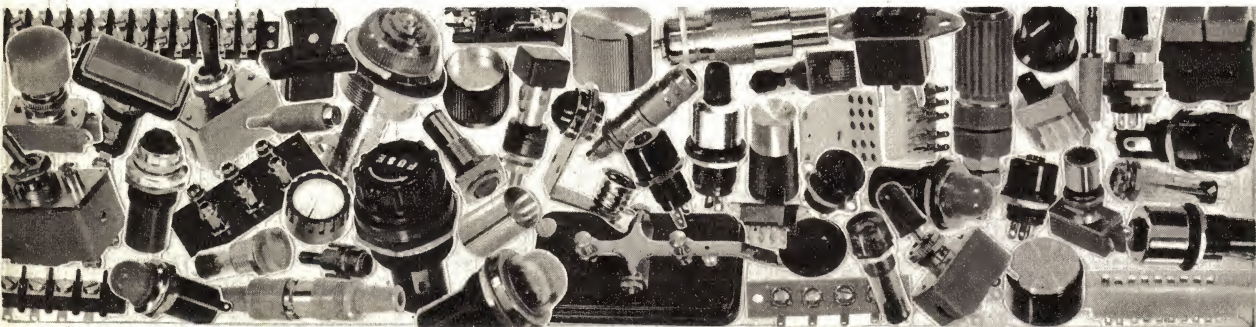

Honorary vice-presidents: Mrs Jordon, M.L.A., Mr Margison, M.L.A., and Mr Creighton.

President of the club: A. Tarbit, VK4AL
 Vice-president: G. Lloyd, VK4ZLG
 Secretary: J. Edwards, VK4ZJE
 Treasurer: W. Sues
 Station manager: W. Bryce, VK4ZN
 Assist. station manager: P. Donovan, VK4ZJN
 Public relations officer: W. Jehn, WIA-L4001

WESTERN AUSTRALIA

Ted Gabriel, VK6TG, has been appointed WICEN co-ordinator for the Western Australian Division. Planning is now under way to completely reorganise these activities on a State-wide basis.

With the rapid growth of population centres in the north-west of the State, and the ever-present menace of the cyclone season, amateurs in that area formed the North-west Emergency Network prior to the 1968-69 season. To be efficient it was realised that this small network would, in the case of emergency, require assistance from amateurs from other parts of the State, particularly from Perth.

Many amateur operators have signified their intention of participating in this organisation, but many more are required to assure its success. Mobile and portable operation facilities are most important to an emergency network, either on the HF or VHF bands, therefore the organisers would be pleased to hear from any interested persons. Details may be passed to WICEN, Box N1002, G.P.O., Perth, 6001.

VHF Group

The annual meeting of the Western Australian VHF Group was held at the end of July. Officers elected were:-

Patron: F. W. Dawson
 President: Neville Chamberlain
 Vice-president: John Lewis, VK6JL
 Secretary: Tom Berg, VK6ZAF
 Treasurer: Cedric Woods, VK6CD
 Committee: Wayne Dowie, VK6WD
 Bob Pine, VK6ZFY
 Stan Stewart, VK6SS.

The VHF Group meetings are held on the fourth Monday in each month in the D.C.A. Workshops, 86 Guildford Road, Maylands commencing at 8.00 p.m. Subscription is \$2.50 payable July 1st each year. Further details may be obtained from the Secretary, 23 Beach Street, Bicton, 6157. Phone 39-3614.

YOUTH RADIO SCHEME NEW SOUTH WALES

From Westlakes Radio Club comes the news that the building which the club has occupied for the past five years is being sold at a figure beyond the financial resources available to the club. However, thanks to the generosity of one of the members, another building approximately five times as large has been made available to the club. The new location is at 7 Anzac Parade, Teralba, and is as accessible by public transport as was the old location.

Club activities ceased at the old premises at the end of August, and it was planned to have at least some of the facilities in operation by the end of September. However the massive task of dismantling and reinstalling all the training and station equipment will probably take to the end of the year. With the increased area, plans are already in hand for expansion of facilities and to increase the membership.

There are two scales of fees for membership. Those not in receipt of an income, such as students at school or full-time students at university or other such institution, pay \$2.50 per year. All members in receipt of an income pay \$4.50 per year. There are no other charges for membership or weekly fee.

Full details regarding the club may be obtained from the Secretary, Bruce Morley, VK2ZMB, P.O. Box 1, Teralba, N.S.W. 2284. Phone Newcastle 59-1667.

AUSTRALIS TELEMETRY DATA

Although a definite date for launching of the Australian amateur satellite was not available when these notes were being compiled, it is however anticipated that the satellite could be launched within weeks.

Technical details of the project were published in the August to December, 1967, and February, 1968, issues of these notes. Those interested in tracking the satellite should refer to the notes for further information and listen to Sunday morning news broadcasts from W.I.A. divisional stations.

There has been a change in the telemetry calibration curves compared with those published in October, 1967. The new curves and formulae are given here.

Co-ordinators for the project in Australia are:

New South Wales:
 VHF and TV Group, 14 Atchison Street, Crow's Nest, 2065.

Victoria:
 Don Graham, VK2BAC, 38 Murray Drive, Burwood, 3125.

Queensland:
 Laurie Blagbrough, VK4ZGL, 54 Bishop Street, St. Lucia, 4067.

South Australia;
 Brian Tideman, VK5TN, 33 Ningana Avenue, Kings Park, 5034.

Western Australia:
 Kevin Bicknell, VK6ZBC, 48 Sanderson Road, Lesmurdie, 6076.

Tasmania;
 Peter Frith, VK7PF, 181 Punchbowl Road, Launceston, 7250.

The formulae used for the calibration graphs are:

Battery current — channel 1

$$I \text{ (in mA)} = \frac{f \text{ (in Hz)}}{9} - 63$$

Linear approximation valid up to 1400Hz.

Battery voltage — channel 3

$$V \text{ (n volts)} = 27.5 - \frac{f \text{ (in Hz)}}{80}$$

Linear approximation valid up to 1300Hz

Internal temperature — channel 5

$$T_i \text{ (in } ^\circ\text{C)} = 0.0642 \times f \text{ (in Hz)} - 34.1$$

Linear approximation valid up to 1200Hz

Skin temperature — channel 7

$$T_s \text{ (in } ^\circ\text{C)} = 0.0692 \times f \text{ (in Hz)} - 36.9$$

Linear approximation valid up to 1200Hz

AUSTRALIS OSCAR A TELEMETRY CALIBRATION CURVES

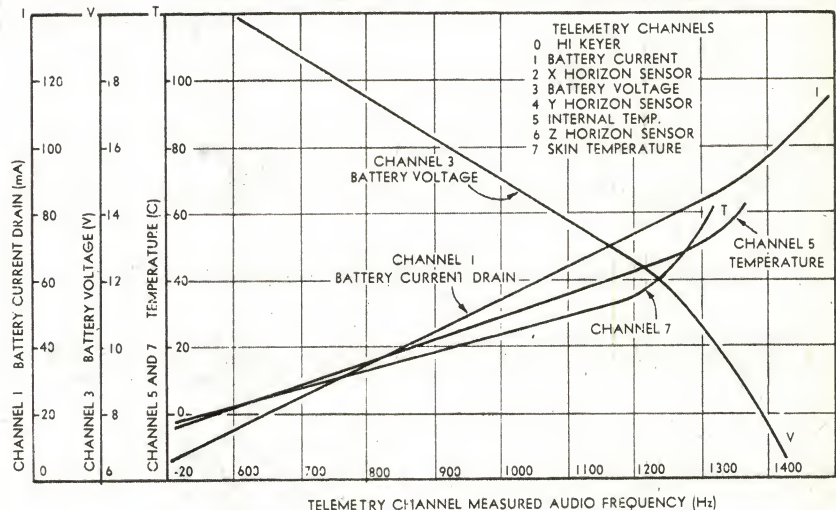

The revised calibration chart for the Australis telemetry system which can be used to determine the values of the various parameters.

VICTORIA

After completing all the preliminary requirements laid down by the Y.R.S., members of the Camberwell Grammar School Radio Club undertook examinations in their respective grades. The successful members were:

Elementary Certificate:
 Pass: G. Innes; G. Witcombe.
 Credit: D. Hart; T. Barter.
 Honours: R. Whittle; P. Everest.

Junior Certificate:
 Credit: I. Mathison; J. Warner; D. Furst.
 Honours: G. Day.

Intermediate Certificate:
 Credit: T. Robinson.
 Honours: R. Wills; C. Holliday.

Senior Certificate:
 Honours: J. Trean.

Other members of the club will be attempting the Y.R.S. examinations at the end of the school year when it is anticipated that the high standard will be maintained.

SOUTH AUSTRALIA

A new club has been formed in South Australia and has been registered with the W.I.A. Youth Radio Scheme, S.A. Division. Known as the Barossa Valley Youth Radio Club, its meetings are held at Nuriootpa each Friday night from 7.30 p.m. to 9.30 p.m. The club leader is Grant Thomas, VK5ZGI, and at present nine members are attending regularly.

One of the highlights of Y.R.S. activities in South Australia was when junior members of the Elizabeth Amateur Radio Club were weekend guests of the Port Augusta Youth Radio Club.

In addition to visiting the Port Augusta club's excellent workshop facilities, tours of inspection were made of the Thomas Playford Power Station, which generates a large percentage of South Australia's electricity, and the local radio station which serves Pt. Augusta, Pt. Pirie, Whyalla, and surrounding areas. On Sunday morning, a party of five cars travelled for a barbecue picnic to Alligator Gorge

REALISTIC PERFORMANCE REALISTIC PRICE



REALISTIC DX 150

ALL SOLID STATE—4 BAND

COMMUNICATIONS RECEIVER

A big professional looking set that makes exciting news for amateurs . . . the DX150 gives realistic reception on SW/CW/SSB/AM-Broadcast bands; obsoletes tube receivers with their warm-up delay; banishes dependence on AC main power . . . the DX150 will run on dry cells if current fails or is not available; will operate from a car's cigarette lighter or any 12V DC service. 240V AC power supply is built-in, of course.

Over 30 semi-conductors—Product detector for SSB/CW, plus fast and slow AVC—variable pitch BFO—Illuminated electrical bandspread fully calibrated for amateur bands—Cascade R.F. Stage—ANL for RF and AF—Zener stabilised—OTL audio—illuminated "S" meter—Built-in monitor speaker plus front panel jack for external (optional) matching speaker.

Attractive silver extruded front panel, solid metal knobs, grey metal cabinet, size 14 1/2" x 9 1/4" x 6 1/2" . . . a truly Realistic performer at a realistic price.

\$229.50

Brings in the
whole wide world of
SW/CW/SSB/AM-
Broadcast

240V AC or 12V DC
operation.

CONSULT YOUR LOCAL RADIO DEALER, OR

MAIL THIS COUPON *today*

Please forward free illustrated literature and specifications on Realistic.

Name.....

Address.....



(A unit of Jacoby Mitchell Holdings Ltd.)
376 EASTERN VALLEY WAY, ROSEVILLE, N.S.W.,
Cables and Telegraphic Address: 'WESTELEC.'
Sydney. Phone: 40 1212

in the Flinders Ranges. A very enjoyable time was had by the visitors.

Another new club to register with the Y.R.S. is the Birdwood Youth Radio Club. Present membership consists of six senior students from the Birdwood High School and Mr J. R. Moores as instructor.

Successful candidates in recent Y.R.S. examinations were:

Elementary Certificate:

Elizabeth Amateur Radio Club:
Pass: Harry Martin, Andrew Melville-Smith.

Credit: Peter Cheude; John Townsend.
Honours: Robert Johnson; Christopher London.

Port Augusta Youth Radio Club:
Pass: Max Geyer; Ronald Stephens;
Graeme Carse.

Credit: Brian Lock.

Honours: Ainslee Just.

Port Pirie Youth Radio Club:

Pass: Brian Martin.

Junior Certificates:

Port Augusta Youth Radio Club:

Pass: Dietmar Lindner; Lewis Kriek.

Port Pirie Youth Radio Club:

Credit: John Caldecott.

Intermediate Certificate examinations were also held recently at the Elizabeth Amateur Radio Club but official results are not yet available. It is understood that the club will be holding its presentation and visitors' night in November. Further details may be had by contacting the club's Youth Radio Officer, P.O. Box 8, Elizabeth, S.A. 5112.

Inquiries about the W.I.A. Youth Radio Scheme in South Australia may be sent to the State Secretary, Y.R.S. 18 McKinlay Street, Elizabeth Downs, S. Aust. 5113.

INTERNATIONAL DX ORGANISATION

The July issue of these notes featured an article on the proposed International Call Area Award and briefly outlining the work being done by the International DX Organisation in formulating the rules and the official list for the International Call Area Award.

These rules were adopted by the I.D.X.O. Board of Directors among whom are representatives of Australia and New Zealand. The complete board comprises:—

President: Roy F. Stevens, G2BVN
Co-ordinator: Gerard de Buren, HB9AW/WAS6QAU

Africa:

Charles Martz, TU2AY
Mike Dransfeld, 5N2AAF
Andre Saunders, 5Z4KL
Ulli Dehning, 7P8AR

Asia:

Robert A. Adams, OD5BZ
Herbert Asmussen, VS6AD
Bill L. Mitchell, XW8AX
Paddy Gunnasekera, 4S7PB

Europe:

Henrique Pessoa, CT1HX
Walter Geyrhalter, DL3RK
Claude Ronsiaux, F9MS
Roy F. Stevens, G2BVN
Franco Armenghi, I1LCK
Kjell Edvardsson, SM0CCE

North America:

Barry Goldwater, K3UIG/K7UGA
John A. Attaway, K4IIF
Jim Fisk, W1DTY
Jim Lawson, W2PV
David P. Baker, W6WX
Rev. Maxwell Whyte, VE3BWY

Oceania:

Raoul Thomas, FK8AU
Philippe Postaire Le Marais,, F08BO
David H. B. Duff, VK2EO
Jock White, ZL2GX

South America:

Joaquin Galvez, CE3ZN
William Elasmar, MD., HK3RQ
Gustavo Reusens C., OA4AV
Gastao Carlos de Almeida, PY7AOA

Geneva Headquarters Team:

Len F. Jarrett, HB9AMS/VE3EWE
Richard Kay, HB9ANW/G3QQF
Gerard de Buren, HB9AW/WA6QAU
Armin F. Loosli, PY1CYI/CE3ACL
Jon Sigurdsson, TF3JS

Details of the I.D.X.O. International Call Area Award appear opposite.

I.D.X.O. INTERNATIONAL CALL AREA AWARD

The object of this award is to stimulate and promote friendly and skilful DX operation on ALL BANDS from 1.8 to 29.7MHz, as allocated by the International Telecommunication Union (I.T.U.) to the amateur radio service.

RULES OF THE I.C.A.A.

1. The Award will be issued to all licensed amateurs in the world who qualify according to the rules as outlined below.

2. Any legal type of emission in agreement with the I.T.U. Radio Regulations may be used providing two-way communication was established after 1st January, 1969, 0001GMT.

3. All contacts must be made with licensed, land-based amateur stations authorised by the respective countries and in agreement with the I.T.U. Radio Regulations.

4. Contact information must be exchanged directly between the two stations concerned without assistance from intermediary or relay stations.

5. Single operator stations: Contacts must be made by the licensee himself with his own station.

6. Multi-operators and Club stations: These will be issued separate awards. All contacts submitted by the applicant must be made from the same Call Area.

7. Call signs not in agreement with I.T.U. Radio Regulations will not be accepted, banned countries included.

8. The official I.D.X.O. List will be used to determine valid Call Areas. It is expected that call areas will be changed very infrequently, but additions or deletions may be made at the discretion of the I.D.X.O. Board of Directors; however with the exception of the United Nations or I.A.R.C. stations, it shall be a general principle that normally uninhabited islands and places, and neutral or demilitarised zones will not be recognised.

9. A valid QSL confirmation must contain: a. Call signs of both stations involved. b. Date of contact. c. Mode of transmission. d. Band used.

Not mandatory, but highly desirable, is the time in GMT and a signal report.

10. QSL cards confirmation must be validated by two officials of the National Amateur Societies, or by two officials of their affiliated Radio Clubs, or by especially appointed I.D.X.O. Directors.

11. At any time an applicant may be requested to submit some or all QSL cards to one of the I.D.X.O. Directors.

12. The applicant may also be asked to submit photostat copies of his logs.

13. No alteration of any kind should appear on a QSL submitted for credit. This could result in disqualification of the applicant.

14. In case of any dispute a decision of the I.D.X.O. Board of Directors shall be final.

15. Categories of Awards:

1. CW. 2. Phone. 3. Mixed Modes. 4. RTTY. 17. To qualify for the Award of "CALL AREAS" of the official I.D.X.O. List a number of "POINTS" have to be reached and confirmed according to the following Classes:

Class IV, 100 Call Areas and 500 Pts.
Class III, 200 Call Areas and 950 pts.
Class II, 300 Call Areas and 1,300 Pts.
Class I, 400 Call Areas and 1,500 Pts.
Additional for Class I; Stickers will be issued by 5 Call Areas and 10 points.

18. Points: Contacts on 1.8MHz will count FIVE points, but if intercontinental, QSO's will count TEN points.

Contacts on 3.5MHz will count THREE points.
Contacts on 7MHz will count TWO points.
Contacts on 14 to 29.7MHz will count ONE point.

Only one station per band in a given call area may be submitted for points credit against a specific award class.

No cross-band contacts will be accepted for the I.C.A.A.

19. The I.C.A.A. Record Book will be available to any person against payment of THREE United States dollars or its equivalent in Swiss francs, or other convertible currency (27 I.R.C.'s). It has been designed to record the information contained in Rules 17 and 18 for all modes and is strictly a working copy which will be retained as a personal file and permanent record; it contains a tear-out order form for the Application Record Book described in Rule 20.

20. The I.C.A.A. Application Record Book has been designed to record only the total CALL AREAS worked and confirmed and the total POINTS reached on the different bands. It is valid only for one Class of Award and one Mode.

It will cost TWO United States dollars or its equivalent in Swiss francs, or other convertible currency (18 I.R.C.'s) and will be obtainable only from I.D.X.O. Headquarters in Geneva, Switzerland.

Purchase of this book, in addition to the Record Book in Rule 19, automatically confers Membership of the International DX Organisation.

21. The total cost of the two record books of Rules 19 and 20 for one Class and one Mode is FIVE United States dollars or its equivalent in Swiss francs, or other convertible currency.

Forty-five International Reply Coupons will also be acceptable from amateurs in countries which have currency exchange difficulties.

Please mention your call sign on your bank draft or personal cheque.

There will be no further charge for the actual Award.

22. All correspondence should be addressed to:

I.D.X.O., P.O. Box 543, 1211 Geneva 3 (Rive), Switzerland. Europe Banking Account: I.D.X.O. No. 81818 at Lloyd's Bnk Europe Limited, Palais des Nations, GENEVA, Switzerland.

The Rules of the International Call Areas Award were originally drafted in 1966/67, crystallised in 1968 and finally approved and endorsed by the 33 Members of the International DX Organisation Board of Directors on the 25th of May, 1969.

THE OFFICIAL I.D.X.O. LIST FOR THE INTERNATIONAL CALL AREAS AWARD (I.C.A.A.)

- 1. A2 Rep. of Botswana
- 2. AP East Pakistan
- 3. AP West Pakistan
- 4. BV Taiwan (Formosa)
- 5. BY People's Rep. of China
- 6. C2 Rep. of Nauru
- 7. C3 Andorra
- 8. CE 1 Chile
- 9. CE 2 Chile
- 10. CE 3 Chile
- 11. CE 4 Chile
- 12. CE 5 Chile
- 13. CE 6 Chile
- 14. CE 7 Chile
- 15. CE 8 Chile
- 16. CE 9 Antarctica (also KC4, VKO VPS, OR4, ZLS, BJ)
- 17. CE 0 A Easter Is.
- 18. CE 0 Z Juan Fernandez Is.
- 19. CM CO Cuba
- 20. CN Morocco
- 21. CP Bolivia
- 22. CR 3 Portuguese Guinea
- 23. CR 4 Cape Verde Is.
- 24. CR 5 Principe and Sao Thome
- 25. CR 6 Angola
- 26. CR 7 Mozambique
- 27. CR 8 Timor
- 28. CR 9 Macao
- 29. CT 1 Portugal
- 30. CT 2 Azores Is.
- 31. CX 3 Madeira Is.
- 32. CX 4 Uruguay
- 33. DL West Berlin, DOK D
- 34. DJ, DK, DL Schleswig Holstein - Hamburg, DOK E, M
- 35. DJ, DK, DL Lower Saxony-Bremen DOK H
- 36. DJ, DK, DL North Rhine - Westphalia, DOK G, L, N, O, R
- 37. DJ, DK, DL Hesse, DOK F
- 38. DJ, DK, DL Rhineland, Palatinate, Saarland, DOK K, Q
- 39. DJ, DK, DL Bavaria-Munich, DOK B, C, T
- 40. DJ, DK, DL Baden-Wuerttemberg, DOK A, P
- 41. DM East Germany
- 42. DU, DX Philippine Is.
- 43. EA Spain
- 44. EA 6 Balearic Is.
- 45. EA 8 Canary Is.
- 46. EA 9 Rio de Oro
- 47. EA 9 Spanish Morocco
- 48. E 1 Rep. of Ireland
- 49. EL, 5L Liberia
- 50. EP Iran
- 51. ET, 9E, 9F Ethiopia
- 52. F France
- 53. FB 8 Crozet Is.
- 54. FB 8 Kerguelen Is.
- 55. FB 8 Adelle Land
- 56. FB 8 New Amsterdam and St. Paul Is.
- 57. FC Corsica
- 58. FG 7 Guadeloupe
- 59. FH 8 Comoro Is.
- 60. FK 8 New Caledonia
- 61. FL 6 French Terr. of the Afars & Issas
- 62. FM 7 Martinique
- 63. FO 8 Society Is. (Tahiti)
- 64. FO 8 Austral Is. (Rapa)
- 65. FO 8 Austral Is. (Tubuai, Rimatako, Rurutu)
- 66. FO 8 Marquesas Is.
- 67. FO 8 Tuamoutou and Gambler
- 68. FP 8 0. St. Pierre and Miquelon
- 69. FR 7 Europa Is.
- 70. FR 7 Goriousses Is.
- 71. FR 7 Juan de Nova Is.
- 72. FR 7 Reunion Is.
- 73. FR 7 Tromelin Is.
- 74. FS 7 Saint Martin Is.
- 75. FW 8 Wallis and Futuna Is.
- 76. FV 7 French Guyana
- 77. G, GB England
- 78. GC Channel Is.
- 79. GD Isle of Man
- 80. GI Northern Ireland
- 81. GM Scotland
- 82. GW Wales
- 83. HA, HG Hungary
- 84. HB 8 Switzerland
- 85. HB 0 Liechtenstein
- 86. HC Ecuador
- 87. HC 8 Galapagos Is.
- 88. HH Haiti
- 89. HI Dominican Rep.
- 90. HK Colombia.
- 91. HK 0 San Andres, Providencia
- 92. HL, HM Korea
- 93. HP Panama

- 94. HR, HQ Honduras
- 95. HV Vatican
- 96. HZ, 7Z Saudi Arabia
- 97. I Italy
- 98. IP Pantellaria Is.
- 99. IS Sardinia
- 100. IT Sicily
- 101. JA, JH, JR 1 Japan
- 102. JA 2, KA 2 Japan
- 103. JA 3 Japan
- 104. JA 4 Japan
- 105. JA 5, KA 5 Japan
- 106. JA 6, KA 7 Japan
- 107. JA 7, KA 7 Japan
- 108. JA 8, KA 8 Japan
- 109. JA 9, KA 9 Japan
- 110. JA 0 Japan
- 111. JD Marcus Is.
- 112. JD Bonin and Volcano Is.
- 113. JT Mongolia
- 114. JW Svalbard
- 115. JW Bear Is.
- 116. JX Japan
- 117. JY Jordan
- 118. KB 6 Canton Is.
- 119. KC 6 Eastern Caroline Is.
- 120. KC 6 Western Caroline Is.
- 121. KG 4 Guantamo Bay
- 122. KG 6 Guam
- 123. KH 6 Marianas Is.
- 124. KH 6 Marshall Is.
- 125. KH 6 Kure Is.
- 126. KJ 6 Johnston Is.
- 127. KL 7 Alaska
- 128. KM 6 Midway Is.
- 129. KP 4 Puerto Rico
- 130. KP 6 Palmyra Is.
- 131. KR 6, 8 Ryukyu Is.
- 132. KS 4 Swin Is.
- 133. KS 6 American Samoa
- 134. KV 4 U.S. Virgin Is.
- 135. KW 6 Wake Is.
- 136. LX Marshall Is.
- 137. KZ 5 Panama Canal Zone
- 138. LA, LJ Norway
- 139. LG State of Morokullen
- 140. LU Argentina-A, B, C
- 141. LU Argentina-D, E
- 142. LU Argentina-F, J
- 143. LU Argentina-L
- 144. LU Argentina-G, N, R, T
- 145. LU Argentina-K, O, R, T
- 146. LU Argentina-H, P, S, U
- 147. LU Argentina-M, Q, U, Y
- 148. LU Argentina-V, W, Y
- 149. LU Argentina-X
- 150. LU Argentina-Z
- 151. LX Luxembourg
- 152. LZ Bulgaria
- 153. MP 4 B Bahrain Is.
- 154. MP 4 D Das Is.
- 155. MP 4 M Muscat and Oman
- 156. MP 4 M Masirah Is.
- 157. MP 4 O Qatar
- 158. MP 4 T Trucial Oman
- 159. OA Peru
- 160. OD 5 Lebanon
- 161. OE Austria
- 162. OH Finland
- 163. OH 0 Aaland Is.
- 164. OK, OL Czechoslovakia
- 165. ON Belgium
- 166. OX, XP Greenland
- 167. OY Faroe Is.
- 168. OZ Denmark
- 169. OZ 4 Bornholm Is.
- 170. PA, PE Netherlands
- 171. PJ 2, PJ 9 Curacao (Neth. Antilles)
- 172. PJ 3, PJ 9 Aruba (Neth. Antilles)
- 173. PJ 4, PJ 9 Bonaire (Neth. Antilles)
- 174. PJ 5, PJ 8 St. Eustatius (Neth. Antilles)
- 175. PJ 6, PJ 8 Saba (Neth. Antilles)
- 176. PJ 7, PJ 8 Sint Maarten (Neth. Antilles)
- 177. PY 1 Brazil
- 178. PY 3 "
- 179. PY 4 "
- 180. PY 4 " also PQ, PR, PS, PT, PU
- 181. PY 5 "
- 182. PY 6 "
- 183. PY 7 "
- 184. PY 8 "
- 185. PY 9 "
- 186. PY 0 "
- 187. PY 0 Fernando do Noronha
- 188. PZ Trindade & Martim Vaz Is.
- 189. SK, SL, SM Surinam
- 190. SM 1 Sweden
- 191. SP Poland
- 192. ST Sudan
- 193. SU Egypt (UAR)
- 194. SV Greece
- 195. SV Crete
- 196. SV Dodecanese Is.
- 197. TA 1 Turkey (Europe)
- 198. TA 2 Turkey (Asia)
- 199. TF Iceland
- 200. TG Guatemala
- 201. TI Costa Rica
- 202. TI 9 Cocos Is.
- 203. TJ Cameroon
- 204. TL Central African Rep.
- 205. TN Congo Rep.
- 206. TR Gabon Rep.
- 207. TT Chad Rep.
- 208. TU Ivory Coast
- 209. TY Dahomey
- 210. TZ Mali Rep.
- 211. UA 1 KAE Mirny Station
- 212. UA 1 KED Franz Josef Land
- 213. UA, UV, UW 1 U.S.S.R.
- 214. UA 2 U.S.S.R.
- 215. UA, UV, UW 3 U.S.S.R. (also UZ)
- 216. UA, UW 4 U.S.S.R.
- 217. UA, UV, UW 6 U.S.S.R.
- 218. UA, UV, UW 9 Asiatic U.S.S.R.
- 219. UA, UV, UW 0 Asiatic U.S.S.R.
- 220. UC 2 White Russian S.S.R.
- 221. UE 6 Azerbaijan
- 222. UE 6 Georgia
- 223. UE 6 Armenia
- 224. UH 8 Turkoman

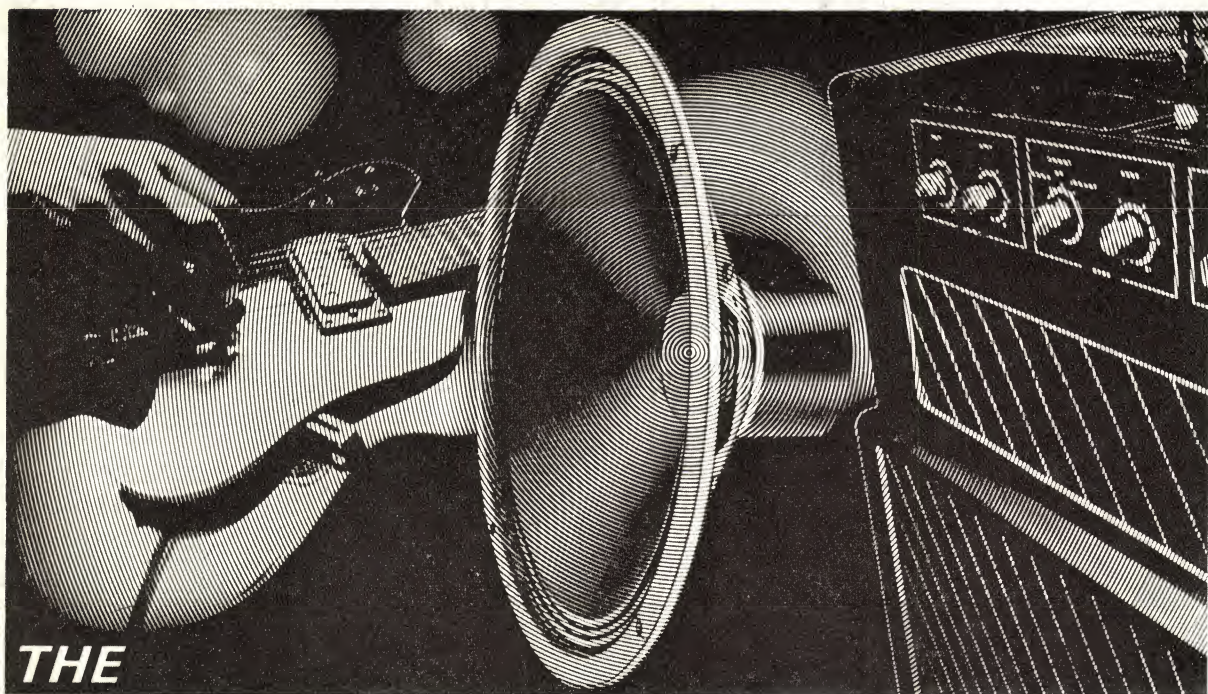

THE

BIG SOUND

MSP Hi-Flux electric guitar speakers

Sounds plucked from a guitar string have characteristics that have challenged speaker manufacturers for many years—but, now MSP can supply the speaker design that all good guitarists have been waiting for. And you can have speakers and detailed instructions of specially designed vented-enclosures for your electric guitar whether it be Lead, Rhythm, or Bass.

There are two series of speakers produced for electric guitars. Type 12UA for lead

or rhythm and type 12PQ for bass. These new speakers reproduce the full range of sound produced by a guitar and handle with ease the large power input supplied by the amplifier.

When four 12 inch Hi-Flux speakers are mounted in the specially designed enclosure the combination is rated at 60 watts and outperforms all other units tested including some very elaborate and expensive models.

More information on the extensive range of Hi-Flux speakers and recommended enclosure designs can be obtained from your nearest distributor.



47 YORK STREET SYDNEY 2 0233

MANUFACTURERS SPECIAL PRODUCTS PTY LTD

ADELAIDE	BRISBANE	HOBART	LAUNCESTON	MELBOURNE	PERTH	SYDNEY
51 0111	31 0341	3 3836	2 1804	67 9161	28 3425	533 1277 & 29 7031

225. UI 8	Uzbek
226. UL 8	Tadzhik
227. UL 7	Kazakh
228. UN 8	Kirghiz
229. UN 1	Karelo-Finnish Rep.
230. UO 5	Moldavia
231. UP 2	Lithuania
232. UQ 2	Latvia
233. UT 5	Ukrainian S.S.R.
234. VE 1	Canada, New Brunswick
235. VE 1	Canada, Nova Scotia
236. VE 1	Canada, Prince Edward Is.
237. VE 2	Canada, Quebec
238. VE 2	Canada, Ontario
239. VE 2	Canada, Manitoba
240. VE 2	Canada, Saskatchewan
241. VE 2	Canada, Alberta
242. VE 7	Canada, British Columbia
243. VE 8	North West Terr.
244. VE 8	Yukon
245. VK 1	Australia, A.C.T.
246. VK 2	Australia, N.S.W.
247. VK 2	Australia, Lord Howe Is.
248. VK 3	Australia, Victoria
249. VK 4	Australia, Queensland
250. VK 4	Australia, Willis Is.
251. VK 4	Australia, South Aust.
252. VK 4	Australia, Western Aust.
253. VK 7	Australia, Tasmania
254. VK 8	Australia, N. Territory
255. VK 8	Australia, Admiralty Is.
256. VK 8	Australia, Christmas Is.
257. VK 8	Australia, Cocos Is.
258. VK 9	Australia, Norfolk Is.
259. VK 9	Australia, New Guinea and Bismark Is.
260. VK 9	Australia, Papua
261. VO 0	Australia, Macquarie Is.
262. VO 2	Newfoundland
263. VO 2	Labrador
264. VP 1	British Honduras
265. VP 2	Anguilla
266. VP 2	Antigua
267. VP 2	Dominica
268. VP 2	Canada & Dependencies
269. VP 2	St. Kitts - Nevis
270. VP 2	St. Lucia
271. VP 2	Montserrat
272. VP 2	St. Vincent & Dependencies
273. VP 2	British Virgin Is.
274. VP 7	Turks & Caicos Is.
275. VP 8	Bahamas
276. VP 8	Falkland Is.
277. VP 8	South Georgia Is.
278. VP 8	South Orkney Is.
279. VP 8	South Shetland Is.
280. VP 9	Bermuda
281. VO 8	Agalega
282. VO 8	Mauritius
283. VO 8	Rodriguez
284. VO 8	St. Brandon
285. VO 8	Aldabra Is.
286. VO 8	Desroches Is.
287. VO 8	Farquhar Is.
288. VO 8	Seychelles Is.
289. VO 8	Chagos
290. VR 1	Gilbert, Ellis, Ocean Is.
291. VR 1	British Phoenix Is.
292. VR 1	Fiji Is.
293. VR 1	Fanning Is.
294. VR 1	British Solomon Is.
295. VR 4	Tonga Is.
296. VR 4	Pitcairn Is.
297. VR 6	Brunei
298. VS 3	Hongkong
300. VU 1	India
301. VU 4	Laccadive Is.
302. VU 5	Andaman & Nicobar Is.
303. W 1	U.S.A., Connecticut (WA, WB, WN, K, KN)
304. W 1	U.S.A., Maine
305. W 1	U.S.A., Massachusetts
306. W 1	U.S.A., New Hampshire
307. W 1	U.S.A., Rhode Island
308. W 1	U.S.A., Vermont
309. W 2	U.S.A., New Jersey
310. W 2	U.S.A., New York
311. W 3	U.S.A., Delaware
312. W 3	U.S.A., Maryland & Washington D.C.
313. W 3	U.S.A., Pennsylvania
314. W 4	U.S.A., Alabama
315. W 4	U.S.A., Florida
316. W 4	U.S.A., Georgia
317. W 4	U.S.A., Kentucky
318. W 4	U.S.A., North Carolina
319. W 4	U.S.A., South Carolina
320. W 4	U.S.A., Tennessee
321. W 4	U.S.A., Virginia
322. W 4	U.S.A., Arkansas
323. W 5	U.S.A., Louisiana
324. W 5	U.S.A., Mississippi
325. W 5	U.S.A., New Mexico
326. W 5	U.S.A., Oklahoma
327. W 5	U.S.A., Texas
328. W 6	U.S.A., California
329. W 7	U.S.A., Arizona
330. W 7	U.S.A., Idaho
331. W 7	U.S.A., Montana
332. W 7	U.S.A., Nevada
333. W 7	U.S.A., Oregon
334. W 7	U.S.A., Utah
335. W 7	U.S.A., Washington
336. W 7	U.S.A., Wyoming
337. W 8	U.S.A., Michigan
338. W 8	U.S.A., Ohio
339. W 8	U.S.A., West Virginia
340. W 9	U.S.A., Illinois
341. W 9	U.S.A., Indiana
342. W 9	U.S.A., Wisconsin
343. W 0	U.S.A., Colorado
344. W 0	U.S.A., Iowa
345. W 0	U.S.A., Kansas
346. W 0	U.S.A., Minnesota
347. W 0	U.S.A., Missouri
348. W 0	U.S.A., Nebraska
349. W 0	U.S.A., North Dakota
350. W 0	U.S.A., South Dakota
351. XE 4 A	Mexico
352. XF 4	Revilla Gigedo
353. XT 8	Upper Volta
354. XW 8	Laos
355. XZ	Burma
356. YA	Afghanistan
357. YB, YC, YD, 8F	Indonesia
358. YI	Iraq
359. YJ	New Hebrides Is.
360. YK	Syria
361. YN	Nicaragua
362. YO	Romania
363. YS, HU	El Salvador
364. YU	Yugoslavia

365. YV 1, 4 M	Venezuela
366. YV 2	"
367. YV 3	"
368. YV 4	"
369. YV 6	"
370. YV 6	"
371. YV 7	"
372. YV 8	"
373. YV 9	"
374. ZB 1	Albania
375. ZB 2	Gibraltar
376. ZC 4, 5B4	Cyprus
377. ZD 3	Gambia
378. ZD 5	Swaziland
379. ZD 7	St Helena Is.
380. ZD 8	Zascension Is.
381. ZD 9	Tristan da Cunha Is.
382. ZE 1	Rhodesia
383. ZF 1	Rayman Is.
384. ZK 1	Cook Is.
385. ZK 1	Manihiki Is.
386. ZK 2	Niue Is.
387. ZL 1	New Zealand
388. ZL 1	N.Z., Kermadec Is.
389. ZL 2	New Zealand
390. ZL 3	New Zealand
391. ZL 3	New Zealand Chatham Is.
392. ZL 4	New Zealand
393. ZL 4	New Zealand, Auckland & Campbell Is.
394. ZM 7	Tokelau Is.
395. ZP 1	Paraguay
396. ZS 1	Rep. of South Africa
397. ZS 2	"
398. ZS 2	Rep. of South Africa, Prince Edward Is.
399. ZS 2	Rep. of South Africa, Marion Is.
400. ZS 3	Southwest Africa
401. ZS 4	Rep. of South Africa
402. ZS 5	"
403. ZS 6	"
404. ZA 2, 0	Monaco
405. ZV 8	Tunisia
406. ZV 7	Rep. of Guinea
407. ZU 7	"
408. ZU 7	United Nations, Amateur Stations *
409. 4 W 1	Yemen
410. 4 X, 4 Z	Israel
411. 5A	Libya
412. 5H	Tanzania
413. 5H	Zanzibar
414. 5N	Nigeria
415. 5R	Malagasy Rep.
416. 5R	Sainte Marie Is.
417. 5T	Mauritania
418. 5U	Niger Rep.
419. 5V	Togo Rep.
420. 5W	Western Samoa
421. 5X 5	Uganda
422. 5Z 4	Kenya
423. 6 W 8	Senegal
424. 6 W 8	Jamaica
425. 7 P 8	Lesotho
426. 7 Q 7	Malawi
427. 7 X	Algeria
428. 8 P 6	Barbados
429. 8 Q	Maldives Is.
430. 8 R 1, 2, 3	Guyana

431. 9 A 1 San Marino
 432. 9 G 1 Ghana
 433. 9 H 1 Malta
 434. 9 J 2 Zambia
 435. 9 K 2 Kuwait
 436. 9 L 1 Sierra Leone
 437. 9 M 2 West Malaysia
 438. 9 M 6 Sabah
 439. 9 M 8 Sarawak
 440. 9 N 1 Nepal
 441. 9 N 5 Rep. Dem. of Congo
 442. 9 U 5 Burundi
 443. 9 V 1 Singapore
 444. 9 X 5 Rwanda
 445. 9 Y 4 Trinidad & Tobago
 446. Rep. Equatorial of Guinea
 447. HS Thailand, (after 25/6/69)
 448.
 449.
 450.

* At present the only authorised United Nations Amateur Station is 4U1ITU, IARC-ITU, Geneva, Switzerland.

The I.D.X.O. was created for the following purposes:
 To support and enforce the I.T.U. Radio Regulations within the amateur radio service.
 To promote all band operation.
 To create new interests in long-distance communication.
 To develop friendly and skilful DX techniques.
 To give all amateurs, from beginners to experienced DXers, a continuing challenge in telecommunication.
 To strengthen friendship among radio amateurs in the whole world.
 To keep abreast of, and contribute to the development of communications technology.
 To improve the art of amateur radio.

I.D.X.O. intends to achieve its progressive program by:
 1. following, supporting and enforcing the I.T.U. Radio Regulations within the amateur radio service (ICAA Rules 2, 3 and 8),
 2. omitting from its official List the prefixes which do not agree with I.T.U. Radio Regulations. The Call Areas or prefixes omitted will be included as soon as they become legal.
 3. avoiding normally uninhabited Islands and places, and neutral or demilitarised zones,
 4. putting the emphasis on 6-hand operation, saluting here the efforts of D.A.R.C.'s "W.A.E." (Worked All Europe) excellent award,
 5. taking into consideration for the first time amateur population and wide-spaced geographical areas for propagation research purposes,
 6. inaugurating a new basis system, for the first time since 1937, by counting by "call area" instead of "country." In French, it is "Region du monde."
 7. offering to the DX world an approved call areas List,
 8. designing the I.C.A.A. to be a continuing challenge to DXers at all levels.

The I.D.X.O. is entirely devoted to the welfare, the promotion and the advancement of the amateur radio service. ■



EDDYSTONE EC10

Transistorised Communications Receiver

Completely Portable --- Battery Operated



**RUGGED
COMPACT
LIGHT!**

Designed for
Commercial
and Amateur
use.

Ideal for
marine
purposes and
remote
operational
areas

Covers
citizens band

Write for fully illustrated technical brochure

Sole Agents: ***R.H. Cunningham*** PTY. LTD.

608 Collins St., Melbourne, Vic. 3000. Phone 61-2464. 34 Wolya Way, Balga, Perth, W.A. 6061. Phone 49-4919.

64 Alfred St., Milson's Pt., N.S.W. 2061. Phone 929-8056. L. E. Boughen & CO., 30 Grimes Street, Auchenflower, 4066. Phone 74097.

A.

AMPLIFICATION

C.

COMMUNICATION



E.

ELECTRONICS

RADIO

PHONE 51-3845
51-7008

WEEKENDS & AFTER HOURS 98-5956.

136 VICTORIA ROAD MARRICKVILLE — 51-3845

K 20
CT330



K 20
CT500

C.T. 330 20K OPV
D.C. Volts, 6, 6, 30, 120, 600, 1,200, 3,000, 6,000. A.C. Volts 6, 30, 120, 600, 1,200. D.C. Current .06-6, 60, 600mA. Resistance, 6K, 600K, 6meg., 60meg., D.B. minus 20 to plus 62. 5 Ranges. Specially suitable for transistor use.
\$16.45

C.T.500 20K.OPV
D.C. Volts, 2.5, 10, 50, 250, 500, 1,000. A.C. Volts, 10, 50, 250, 500, 1,000. D.C. Current, .05, 5.50, 500mA. Resistance, 12K, 120K, 1.2meg., 12meg. D.B. minus 20 to plus 62.
\$13.25

KAMODEN—100B
100,000 O.P.V.
D.C. Volts, .5, 2.5, 10.50, 2.50, 500, 1,000.
A.C. Volts, .25, 10.50, 250, 500, 1,000.
Mills., .01, .25, 2.5, 25, 250, 1D.A. Res., 20K, 200K, 2M, 20M:OHM. D.B. minus to 20 plus 62. 5 Ranges.
\$29.75 post \$1.00

P.T.34 1000.OPV
D.C. Volts., 0, 10, 50, 250, 500, 1,000.
A.C. Volts, 0, 10, 50, 250, 500, 1,000.
M.A. 1-100-500 RESISTANCE.
\$5.50 Post 50c

200H 20K.OPV
D.C. Volts, 5, 25, 50, 250, 500, 2,500. A.C. Volts, 10, 30, 100, 500, 1,000. D.C. Current, 50uA, 2.5, 250mA. Resistance, 6K, 600K. Capacitance, 2 D.B. Ranges.
\$10.95 Post 50c
Full range of Kaiser-S.K. brand at Special Prices.
Send for details.
ALL PRICES NET, INC. S-TAX

PANEL METERS



EDGE METERS, 1mA.
Scaled V. U.S.
Tuning Stereo Bal. \$2.50.
A FULL RANGE OF UNITS.
85 Types, 1/4in to 3/4in.
FROM \$3.25
Send for full list.

HI-FIDELITY TWIN CONE SPEAKERS

Aust. made, 8 to 16 ohms.
6in .. \$9.00 12in .. \$11.75
8in .. \$7.50 Postage:
8in .. \$9.00 N.S.W., 50c.
10in .. \$10.75 Interstate 80c.

AMPLIFIERS Public Address Range 240V-AC



**MINIATURE P.A. AMPLIFIER
15 WATTS OUTPUT**
Multi Match Ferguson O.P. transformer input for crystal mike and pick-up with electronic mixing P.P. EL-84 output ... \$42.50
30 Watt. As above, EL-34 P.P. ... \$57.50
40 Watt. As above, EL-34 P.P. ... \$85.50
60 Watt. As above, 6D06 P.P. ... \$105.50

**LINE OR VOICE COIL.
SOLID STATE
240V A.C.**
20 Watt .. \$49.50
50 Watt .. \$69.50
50 Watt 240 A.C. plus 12V. D.C. Plus Self Battery Charging. \$95.00.

All have inputs for 2 microphones or 2 Magnetic or Crystal P.U. With Mixing.

P.A. SPEAKERS

**8 WATT.
8in Units in Waterproof
Projection Horns.
15 Ohm Voice Coils.
\$15.25**
In Double-ended Flares.
Duolateral Coverage.
\$17.25
Line Output Transformers to suit.
\$1.75 extra.

DYNAMIC MICROPHONES



**Model UDM-105
CARDIOID
(Uni-directional)**
Impedance: High 50K ohms—Low 600 ohms. Sensitivity: -60db/1,000 cps. Frequency Response: 150-10,000 cps.
\$16.95

**Model DM-108
(Uni-directional)**
Impedance: 50K ohms. Sensitivity: 57db/1,000 cps. Frequency Response: 100-10,000 cps.
\$11.95

CARDIOD. HI. IMP DYNAMIC

DX-129 .. \$12.75
Hi Imp Dynamic DM401 .. \$8.75
Hi Imp Dynamic, DM203 .. \$8.75
Hi Imp Dynamic, DMS-3 .. \$5.50
Crystal Pencil, BM3 .. \$7.50
Crystal Lapel .. \$11.75

LOW LOSS MIC. CABLE
15c per yard or \$10 per 100yds.

PILLOW PHONES
8 ohms, \$2.50

NEW LOOK SPEAKER ENCLOSURES

Hi-Fi Freq. response. Power rating 5 watts. R.M.S. Attractive, modern, oiled teak finish. Size 14 1/2 in x 4 3/4 in x 9.

\$15.00 EACH
Post 75c. Interstate \$1.25.

50 WATT SOLID STATE GUITAR AMPLIFIER

E.A. July & August Issue.
Kitset, including Cab.net.
\$98.00

Wired and Tested,
\$114.00
Speaker Enclosures to suit
4 MS.P. Speakers,
\$104.00
2 Pioneer 15in Speakers,
\$94.00

MICROPHONE GOOSE NECKS. SATIN

9in .. \$2.75 MIC. STAND.
12in .. \$3.50 Floor Model.
18in .. \$4.35 \$11.75.
24in .. \$5.00 Table mod \$3.65

STEREO RECORD CHANGERS

Latest Model, 4-speed.
\$28.75
De Luxe Model.
Fully machined and balanced.
Heavyweight turntable. Ceramic Cartridge.
\$34.00
Post: N.S.W. \$1.25. Interstate \$1.75.
De Luxe Model with mechanical cueing device. Calibrated stylus. Pressure control. Adjustable counter balance. Two spindles.
\$46.50

Fully Auto. Player
All Refinements
Magnetic Cartridge, \$65.



HI-FI STEREO HEADPHONES

8 OHMS.
Range 25c to 17 Kc.
\$9.75
Post 35c.

240V VARIABLE POWER

Units,
0 to 20V, 1 Amp.
Fully Transistorised.
\$21.50.

TAPE CASSETTES TENSILISED MYLAR

C 60 .. \$1.65
C 90 .. \$2.45
C120 .. \$3.25
Head Cleaners .. \$1.75
Post, 10c per unit.

HORN TWEETER CT-3

2,000-20,000 Response
20 Watts Power
Sensitivity 110 dbw.
Weight 134lb.
\$8.95

V.T.V.M. MODEL TE-40 MILLIVOLTER

Spec. AC.V Imv.—300 Vrms. 10 ranges. Accuracy 5 cps-1 2 mc. plus-minus 2db, 10 cps-1 mc. plus-minus 1db, 20 cps-250 KC. plus-minus 0.2dB.
dB. Scale: 40-30-20-10-0, 10,20, 30-40, 50 dBm, 240 V.A.C.
\$48.75

MODEL TE-65 V.T.V.M.

DC, V, 0-1, 5-5-15-50-150-500-1,500 V. Rms. A.C.V, 0-1.5-5-5-15-50-150-500-1,500 V. Rms. 0-1.4-4-14-40-140-400-1,400-4,000 V. P.P. Resistance: RX10, 100, 1K, 10K, 100K, 1M, 10M, Decibel—100db, minus-plus 65db.
240 V.A.C.
\$43.75
TECH. P.V. 58, \$40.50.

ORGAN KEYBOARDS

49-Note. Complete with Switching System.
\$72.00

13-Note. Pedal Claviers. Complete with Switches.
\$39.95

SPECIAL: Semi-finished Stromberg Organ Cabinets to suit above.
\$19.50

Organ Stools .. \$14.50

NEW SPEAKER SPECIALS

8 to 15 ohms.
2in .. \$2.75 4 x 2in \$3.30
2 1/4in .. \$2.75 5in x 3in \$3.30
2 3/4in .. \$2.85 6in x 4in \$3.50
80mm .. \$2.85 7in x 4in \$4.25
3 1/2in .. \$2.95 9in x 6in \$5.95
5 1/4in .. \$3.20 N.S.W. 25c.
6in .. \$4.00 Interstate 40c.

NEW RECORDING TAPE

Most Popular Brand
3in Correspondence .. \$0c
3in Mylar L.P. 300ft .. \$1.05
3 1/4in Mylar D.P. 600ft .. \$1.25
5in Mylar L.P. 900ft .. \$2.50
5in Mylar D.P. 1200ft .. \$3.15
5 1/4in Mylar L.P. 1800ft .. \$3.15
5 1/4in Mylar D.P. 1800ft .. \$4.70
7in Mylar D.P. 2400ft .. \$6.25
7in Mylar T.P. 3600ft .. \$7.00
7in P.V.C. 1200ft .. \$2.50
Postage: N.S.W. 15c. Interstate 25c.



GUITAR AMPLIFIERS

- 10-Watt, Two-Channel, with Twin Cone Speaker . . . \$53.55
- 14-Watt, 4 Inputs, Bass and Treble Boost, 2 Twin-cone Speakers, 363
- 17-Watt, 4-Channel, Bass and Treble Boost, Two Twin-cone Speakers . . . \$76.25

35 WATT

- 4-Channel, Bass and Treble Boost, 4 Twin-cone Speakers . \$109.05
- Vibrato with foot control and 2 preset controls for frequency and intensity. \$10.50 extra on above models.

ELECTRIC GUITAR

- Pickup Units . . . \$8.75
- Accordion Pickup Units . . . \$8.75
- Harmonica Pickup Units . . . \$1.95
- Post: N.S.W. 40c, Interstate 75c.

FUZZ BOX

FUZZ BOX, E. AND A. AUG.
WIRED AND TESTED.
\$15.
Post 75c.

REVERB UNIT

COMPLETE with AMPLIFIER.
E.A. October issue. Kitset \$39.95.
Wired and tested, \$41.95.



MULLARD MAGNAVOX

BOOKSHELF ENCLOSURE

Maple, Teak or Walnut
Complete \$24.75
SUPER BOOKSHELF
\$36.75.

Post: N.S.W. 50c, Interstate \$1.00.
CABINETS ONLY.
R.H. BOOKSHELVES, \$11.50.
MULLARD, \$10.95.
BOOKSHELF UNITS
6in 8in 10in 12in
\$27.75 \$33.50 \$35.50 \$36.50

PLAYMASTER 106 AND 107



Feb. and March Elect Aust.

106

WIRED AND TESTED \$94.75

107

WIRED AND TESTED \$83.75

SOLID STATE VTVM

E.A., Dec.
Wired, Tested.
\$49.50

PIGGY BACK GUITAR AMPLIFIER

Excluding Speakers

- 30 Watt . . . \$79.75
- 45 Watt . . . \$99.75
- 60 Watt . . . \$119.75
- 4 Inputs, Bass and Treble Boost Vibrato if required, \$10.50 extra.

PIGGY BACK GUITAR AMPLIFIER

- Complete with Speakers & Cabinet
- 30 Watt Lead . . . \$138.75
- 30 Watt Bass . . . \$146.75
- 45 Watt Lead . . . \$158.75
- 45 Watt Bass . . . \$166.75
- 50 Watt Lead . . . \$218.00
- 60 Watt Bass . . . \$234.00
- Vibrato if required extra \$10.50

14 plus 14 WATT

With Reverberation. May be used as 28-watt or as 14-watt plus 14-watt Reverb. Two 9 x 6 Woofer Speakers, 4 Channels. Bass and Treble Boost. Foot Vibrato control included.

\$163.50

10 PLUS 10 STEREO AMPLIFIER

E.A. November.
Kit Set . . . \$59.75
Wired and tested . . . \$69.75



119 STEREO TAPE ADAPTER

Suits all Playmaster Stereo amplifiers and others that accept crystal P.U.
Kitset . . . \$79.00
Wired and tested . . . \$96.00

TAPE DECKS B.S.R.

- 2 Tracks, 3 3/4 I.p.s. \$25.50
- 4 Track, 3 Spd Stereo, \$41.50



240v A.C. POWERED SOLID STATE STEREO

T.S.135

18 Transistor, 15-watt per channel. Inputs for Tape, Mag. P.U. Ger. P.U., Radio Aux. Freq. Range 30c to 20KC. Max. Sensitivity 3 MV. Speaker matching 4 to 15 ohms.

\$78.00

SONATA

SOLID STATE STEREO AMPLIFIER.

20 WATT R.M.S. PER CHANNEL
Inputs for mics. Magnetic & Ceramic Pick-ups, Tuner & Tape Heads. Outputs to 8V Speakers & S.H. Phone Controls. Bass, Treble Balance. Volume Loudness. Top and Low Filter.

\$89.50

11 1/2" FULLY BALANCED PICK UP ARM

COMPLETE WITH MAGNETIC
Stereo Cartridge . . . \$19.50
Arm less Cartridge . . . \$11.50
Mag. Cartridge only . . . \$9.50

WIDE BAND OSCILLOSCOPES

SPECIFICATIONS

VERTICAL AXIS

- Deflection Sensitivity (at 1 kc) 0.1 V p-p/cm.
- Frequency Characteristics, 1.5 cps—1.5 MC.
- Input Impedance, 2 M ohms 25pF.
- Calibration Voltage 1V p-p/cm.

HORIZONTAL AXIS

- Deflection Sensitivity 0.9V p-p/cm.
- Frequency Characteristics 1.5 cps—800 KC.
- Input Impedance 2 M ohms 20 pF.
- Sweet Oscillator (5 Range) 10 cps—300 KC.
- Synchronisation Devices Internal (Positive and Negative, External).
- Power 240v AC 50/60 cps.
- Cathode Ray Tube 3KFFIF.



5 Meg Bandwidth Push-Pull vertical and Horizontal Amplifiers, 8 positions, high sensitivity, vertical Amplifier Frequency Compensated on all positions. Calibrated .02 to 600 volts. Hard time base, 20 cycles to 75K. Latest American R.C.A. circuitry. Complete with probe.

3-inch \$102.75; 5-inch \$118.75



PLAYMASTER 115

The new Solid State Stereo-Amplifier. April issue.
Wired and tested . . . \$104.00
Kit Set . . . \$90.00
Pre-amp to suit magnetic Cartridge . . . \$12.00

AUTOMATIC RHYTHM BOX

12 RHYTHMS.
9 PERCUSSIVE INSTRUMENTS.
240v A.C. OPERATION.
\$145.00

3" VERNIER DIAL

8:1 Ratio
\$2.95, Post 25c.



AUDIO GENERATOR

De Luxe Model TE-22D.
Freq. range, Sine 20 cps—200 KC. SQ, 20 cps—25KC. Output voltage. Sine 7V, SQ, TV P-P. Output Impedance 1000 ohms. Acc. 5 per cent. Distortion less than 2 per cent. 4-range attenuation. 1/1, 1/10, 1/100, 1/1K. Printed circuit, 240V A.C.
\$42.95

SIGNAL INJECTOR

Transistorised. Fountain pen-sized Unit for Signal Tracer in Radio, TV and Amplifier Service.
\$5.75. Post 25c.

TRANSISTOR AND DIODE TESTER

E.A. August, '68.
Wired and Tested.
\$57.00
KIT SET \$48.00

G.D.O. UNITS

Post: N.S.W. 50c, Interstate 75c.
T.E. 15 Transistorised, 7 Bands, 360 Kc to 270 Mega.
\$35.75

TV BOOSTER

240V.A.L. Especially designed for fringe area reception. Also up to 3 TV sets can be operated off common aerial for improved signal strength.
\$15.95 Post Free.

NEW GRAMMO MOTORS

240V. A.C.
3 Speeds, \$2.75.
Post: 40c.

T.O. 2" OSCILLOSCOPE

IDEAL TV AID
240V-AC, 2 BPI CRO Tube
Vert Sen. 10V P-P/CM. 50V P-P/CM.
Vert Input imp. 2 Meg. 25pf
Vert Freq. 2 cps/1 Meg. 3DB.
Sweep Freq. 2 ranges. 60 cps—75 KC.
\$64.50.

SIGNAL GENERATOR

De Luxe Model TE20D.
Freq. Range 120 KC—500 Mcs. 7 Bands, Accuracy 2 per cent. Output 8V. Provision for Xtal Suitable for self-calibration Marker generator. Printed circuit, 240 T.E.26. \$25.50. \$28.50 V.A.C.

15-INCH HI-POWER SPEAKER

Imported 30 Watts R.M.S. \$30.00
Local 50 Watts R.M.S. .. \$50.00

L.S.G. 11 SIGNAL GENERATOR

FREQ. RANGE IN 6 BANDS
120KC—130MCS.
Calibrated Harmonics. 120MCS—390MCS.
R.F. Output over 100,000UV. 120KC—38MC.
Mod. Freq. 400 and 1000PCS. Crystal Osc. 1.15MCS. A.F. Output, 3 to 4 Volts. A.F. Input, 4V approx. 240 V. A.C. Operation. \$31.75. Post 75c.

T.E. 46 RESISTANCE-CAPACITANCE

Bridge and Analyser.
Capacity 20pf to 2000mfd.
Resistance 2 ohms to 200 meg. Also tests power factor, leakage, impedance, transformer ratio, insulation resistance to 200 meg. at 600V.
Indications by eye and meter.

\$49.75

VOLT. A.C.

VARIABLE TRANSFORMER.
0-260V, 10 amp. . . \$49.50
0-260V, 5 amp. . . \$37.50
0-260V, 2 1/2 amp. . . \$25.50

A.

AMPLIFICATION

C.

COMMUNICATION



E.

ELECTRONICS

PHONE 51-3845
PHONE 51-7008

RADIO

136 VICTORIA ROAD,
MARRICKVILLE

DULWICH HILL, EARLWOOD, BUS STOPS AT DOOR, STOP No. 42
EVENINGS and WEEKENDS: "KALUA," Hilma Street, Collaroy Plateau 98-5956

LAB STANDARD (METERS)

7in in Cedar Cabinets.
Leather Cases.
0 to 10 amps. 0-20 amps.
0 to 50 amps. 0-250 amps.
\$10.50

COLLINS ART 13 Autotune TX

Fair condition. Not tested. Only suit persons who know units.
\$65.00

A.W.A. B.C. BAND RECEIVER CHASSIS & VALVES.

Air tested. R.F. stage. Ideal D.X. or Qser.
\$20.00

A.W.A. AUSTRALPHONE TRANSMITTER-RECEIVERS. NEW.

\$150.00

WHIP AERIALS

12ft. 3-section \$3.00
Base to suit \$1.00
Roof Mounting. Flexible Base, suit Autos. \$2.75
3ft 1in diam. Screw-together sections 85c
Set of 4 Guy Ropes with Insulators \$2.50

CHASSIS PUNCHES

SIZES, 5/8in, 3/4in, 7/8in. 1in.
1 1/8in with tapered Reamer and Carry Box.
\$5.75
Post 50c. Interstate \$1.00.

NEW POWER TRANSFORMERS

240-10V 1.3KA Auto \$21.00
124V Doubler 300MA \$6.75
130V Doubler 400MA \$7.75
145V Doubler 450MA \$9.75
150 x 150, 30MA \$3.75
225 x 225, 50MA \$4.25
193.5in C.R.O. Transformer \$12.95
150V Doubler 6003MA \$12.75

TYPE 62 TRANSCEIVER

2 to 10 megs. NEW.
\$49.50

RELAYS

Weston Microamp Meter Relays
75UA-218UA \$5.00
12 volts, DPDT, 5 amp \$2.00
12 volts, DPDT \$1.25
100pf TX var. condensers \$1.00
Hi-speed Polarised relay \$5.00
2000 ohms \$1.25
1000 ohms \$1.25

PADDED DYNAMIC HEADPHONES

100 ohms \$3.00
With 50 ohm Dyn. Mic.
\$4.50
Post 50c.

OIL FILLED CONDENSERS

.5mfd 600V 65c
2mfd 600V 65c
1mfd 600V 65c
4mfd 600V 65c
4mfd 2.5K \$3.00
1mfd 3000V \$1.70
5mfd 5K, .1, 5K, .1, 3K, A.C. \$1.50
.25 4k, .5 2 1/2K ea
4mfd 3000V \$3.50
2mfd 3000V \$2.50
1mfd 3000V \$2.00
1.25mfd 600V \$4.50
2mfd 2000V \$1.50
4mfd 1500V \$1.50
1mfd 1500V \$1.00
8mfd 60V \$1.00
1mfd 1000V \$1.00

PYE

EX-TAXI TRANSCEIVER.
Complete All valves, speaker, mic.
Clean condition.
\$32.00.

NEW C.R.O. TUBES

3AP1-906 3in \$2.75
CV112 5in \$2.00
VCR97 6in \$3.75
ACR10/VCR139A 3in \$3.00
CV1522 1 3/4in \$2.25

LIGHTING PLANTS

Johnson 1 h.p. Engine.
12V, 30 amp. Generator.
New condition. Tested.
\$72.00

NEW HEADPHONES

5 ohm \$2.25
2000 ohm \$2.25
4000 ohm \$2.50
American Lightweight \$1.25
Lapel Crystal Mikes \$1.25
Crystal Mikes with switch \$1.50
Telephone Contact Pick-up Units \$1.50
Post 25c pair.

100 YDS HOOK-UP WIRE

10 Assorted Colours.
\$1.00
Post 25c.

TYPE 1935 V.H.F. TRANSCEIVER

100 to 155 megs. New condition.
\$29.75

BENDIX FREQUENCY METERS

New, factory fresh. Modulated units. With A.C. supply.
\$75.00

TRANSISTORS

2N174 \$5.00
2N422 \$4.50
2N441 \$4.00
High-powered units for 75-watt audio, 200-watt power units or transistor ignition.

2 H.P. ENGLISH

J.A.P. PETROL ENGINES.
Tested. Perfect order.
\$39.00

NEW

34ft Vertical Collapsible Antennas.
Complete with Guys and Base Insulator.
\$7.75

NEW

DYNAMIC OR SOUND POWERED MICROPHONES
Pushbutton Operation.
Low Impedance.
\$1.25
Post 50c.

NEW

PORTABLE TRANSCEIVERS.
38 to 60 megs. RT.76/GRC.
\$21.00
S.T.C.
F.M. TRANSCEIVERS.
Ex-Fire Brigade.
Excellent condition.
\$32.00

1 3/4in. C.R.O. Units

NEW CONDITION. TESTED.
\$49.50

DUMONT 5" WIDE BAND OSCILLOSCOPE

LABORATORY MODEL.
Tested. New condition.
\$99.00

COSSOR 1 1049 DOUBLE BEAM

\$170.00

NEW MOBILE R.F. LINEAR AMPLIFIERS

2 to 10 Megs.
200 Watt P.E.P., 12v Power supply.
Easily converts to other bands.
Suitable for S.S.B.
Silver. Variable Inductance.
Sufficient reserve power for exciter.
\$15.00

No. 19 TRANSCEIVERS

2 to 8 megs, 15 valves.
New condition.
\$19.75

ALSO BRAND NEW.
\$27.00

VARIABLE POWER SUPPLY

0-20 Kilovolt, 240v A.C., 50cps Input.
\$200.00

AWA HARMONIC GENERATOR \$99.00

Provides signals of precise frequency, spaced at 1 MC-100KC-10KC. Mod. freq., 400cps.

WANTED

Communications Receivers.
Test equipment. P.A. Gear.
Large or small surplus stock.
Best prices. Call, write or phone any time.

NEW ELECTRO STATIC 5KV VOLT-METER \$49.00

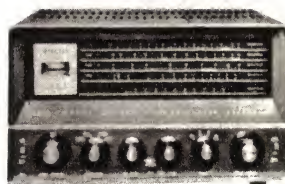

NEW TRIO JR-200 KITSET

Dial assembled. Components mounted. Full instructions and circuit. Complete in every detail. Freq. 550 Kc-31 Mcs, 4 bands. Electrical bandspread. A.N.L.-B.F.O.-A.V.C., M.V.C.-S. meter R.F. Stage.
7 Valves.
240V A.C. Operation.
\$95.00

Also available wired and tested. Including matching Speaker and Cabinet.

\$15.00 extra

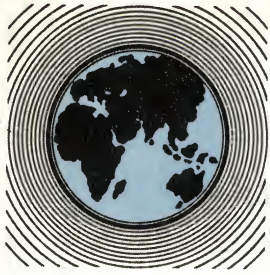

LISTENING AROUND THE WORLD

Expansion plans for Austrian Radio

Austrian Radio, in Vienna, plans to increase the power of their transmissions to give them world-wide coverage. Eventually, transmission will have the power of 500KW.

by Arthur Cushen

In an exclusive interview with the technical director of the Austrian Radio when in Europe recently, I was able to learn about the expansion plans of the short-wave service from Vienna. At present they operate four 100KW transmitters. The eventual transmitting power of the station will include transmitters of 250 and 500KW. In all, 10 transmitters will be used.

The transmissions will then include two to Europe with the coverage from 0800 to 2000GMT, and using a new log periodic antenna. During the period 0000-0600GMT a service to North America, Central America and South America will be operational. In the service to North America transmitters will be beamed in three different directions, covering the east, central and western areas, and each area will be covered with two frequencies in two bands. Central America will be covered with two transmitters, and South America will have two directional aerials each covering transmissions on two bands.

A service to other parts of the world will also be included in the extension. Services to Africa will cover South, West, Central, and East, with a service of three hours daily for each area. The services to the Near East will be increased to four hours each day. The South Asia service will be extended to the use of three bands in a two-hour program. The same transmissions will be offered to East Asia. The service to Australia and New Zealand will remain at two hours daily, but with transmissions extended to three bands instead of the single transmitter service Australasia has at present.

New aerials are planned to exploit the latest transmission techniques. These are already under way, and will be ready to coincide with the introduction of the higher power. Austrian Radio started its shortwave service in 1960 with test transmissions. Now this phase is past, and as soon as more aerial systems become available program length will be increased, and other languages introduced. It is not possible to indicate the exact timetable for the planned expansion of Austrian Radio, but it should not be long before listeners notice the increase in signal level and lengthening of the transmission schedule.

The station sends its program schedule and frequency list to all who send in reports. Reception reports on the service to Australia and New Zealand, on the period 1000-1200GMT on 17885KHz, would be welcomed. These should be sent to Austrian Radio, Shortwave Services,

Notes from readers should be sent to Arthur Cushen, 212 Earn Street, Invercargill, N.Z. All times are GMT. Add 8 hours for Perth, 10 hours for Sydney and 12 hours for Wellington.

Technical Department, P.O. Box 200, A-1043, Vienna, Austria.

VOICE OF THE PHILIPPINES

A new station with the slogan "The Voice of the Philippines" has been noted at our listening post using two frequencies, 920KHz on broadcast band, and 9555KHz on shortwave. In the past, the frequency of 920KHz has been used by the Philippine Broadcasting System as DZRP, to sign off at 1500GMT. Programs of the Voice of America followed. Likewise, on shortwave, the transmission on 6170KHz has been on a Voice of America transmitter.

This new station, when closing at 1600GMT (12 midnight in the Philippines) has a sign-off announcement which we quote in part: "Ladies and Gentlemen you are listening to the Voice of the Philippines, broadcasting on 920KHz medium wave with 50,000 watts of power, and on 9555KHz short-wave with the power of 7500 watts. The Voice of the Philippines broadcasts from 5 a.m. to 12 midnight. The Voice of the Philippines is owned and operated by the Government of the Republic of the Philippines with studio and transmitters at Malolos."

KUWAIT'S NEW CHANNELS

From Melbourne, Bob Padula reports that the Kuwait Broadcasting Service is still endeavouring to establish clear frequencies for its short-wave transmissions, and has been heard over the past week on the new 19-metre band outlet of 15430KHz. This channel was logged at sign on at 0900GMT in parallel with 21525KHz, but was blocked from 1000-GMT by a transmission of All India

Radio, also using this frequency. According to an airmail schedule just received from the station, it is indicated that there are now three channels in use for the English broadcasts, 4967KHz at 0400-0600, 15370KHz at 0400-0600 to India and Pakistan and 15405KHz to Europe at 1600-1900GMT. The Arabic transmission for North Africa is now carried on 21685KHz from 1300 to 1905GMT. A 50KW transmitter is on the air with the Arabic program from 0400-1500GMT on 9520KHz.

RADIO NEW ZEALAND SCHEDULE

The present schedule of Radio New Zealand, Wellington, includes transmissions to the Pacific and Australia, and a service on Sundays to the Antarctica.

Pacific Islands

GMT	KHz
1700-1815	6080
1700-1945	9755
1830-1945	11780
2000-2400	15110
0015-0545	15280
0600-0845	6080, 9540

Australia

2000-0545	17770
0900-1145	11830, 9520

Antartic

0815-0845	9520
-----------	------

FEBC ACTIVITIES

According to "World Radio Bulletin," the Far East Broadcasting Company, Box 1, Whittier, California 90608, has issued a booklet called "The Answer," about their radio stations which broadcast Gospel programs.

In the Philippines there are 15 transmitting stations, broadcasting 40 languages and dialects, as many as five simultaneously, 68 program hours a day. There is a full-time staff of 135, and over 9,000 letters are received per month. At San Francisco, the situation is: One station of 250KW, four languages, seven and a half program hours daily, a staff of 11, receives 1600 letters per month.

KIGALI USING 7225KHz

The Deutsche Welle relay station at Kigali, in Rwanda has been received at

NORTH KOREAN RADIO

Radio Pyongyang has recently added additional language broadcasts in its short-wave service.

GMT	KHz	Language
1900-2000	6540, 9615	English
0200-0300	6540, 15520	English
0800-0900	6540, 15520	English
1100-1200	9615, 11765	English
1400-1500	9615, 11765	English
1500-1600	9615, 11765	French
1700-1800	6540, 9615	French
2100-2200	6540, 9615	French
0100-0200	11765, 16320	Spanish
2300-2400	11765, 16320	Spanish
1600-1700	6540, 9615	Russian
0900-1000	9615, 11765	Russian
2200-2300	6540, 11765	Chinese
1000-1100	9615, 11765	Chinese
1200-1300	9615, 11765	Chinese
0300-0400	6540, 15520, 635	Japanese
0900-1500	6540, 635	Japanese
2000-2100	6540, 9615	Korean
2400-0100	11765, 16320	Korean
0400-0500	6540, 15520	Korean

STOP RUST OUTDOORS 2 YEARS -- OR MORE!

Lubricates **P**enetrates **S**tops Rust

DRY YOUR ELECTRICAL SYSTEMS
with **LPS** — the NON-GREASY ONE

**STOPS
Squeaks!**



LPS is NOT a paint, lacquer or a varnish, and will NOT damage paint, rubber, fabrics, plastics, or finishes.

Displaces Moisture Fast!

TECHNICAL INFORMATION

Physical Properties:

LPS 1

Less than .0001 inch non-greasy molecular film with capillary action that spreads evenly and easily to seal out moisture at very low cost. **Rust Inhibitor:** Protects all metals from rust and corrosion.

Water Displacing Compound: Dries out mechanical and electrical systems fast.

Lubricant: Lubricates even the most delicate mechanisms; non-gummy, non-sticky; does not pick up dust or dirt.

Penetrant: Penetrates to loosen frozen parts in seconds.

Volume Resistivity per ASTM D-257: Room temperature, ohm/cm; 1.04×10^{12}

Dielectric Constant per ASTM-877:

Dielectric Constant 2.11 Dissipation Factor: 0.02

Dielectric Strength per ASTM D-150:

Breakdown Voltage 0.1 inch gap. 32,000 volts

Dielectric Strength volts/inch 320,000 volts

Flash Point (Dried Film)

Fire Point (Dried Film) 900 degrees F

TESTS AND RESULTS: 950 degrees F

Lawrence Hydrogen Embrittlement Test for

Safety on High Tensile Strength Steels: Passed.

Certified safe within limits of Douglas Service Bulletin 13-1 and Boeing D6 17487.

Mil Spec. C-16173D-Grade 3

Mil Spec. C-23411

Passed

Passed

Swiss Federal Government Testing Authority for

Industry: Passed 7 Day Rust Test for acid and

salt water. Passed Weiland Machine Test for

Lubricity as being superior to mineral oil plus

additives.

LPS PRODUCTS CONFORM TO
FEDERAL MIL SPECS
C-23411 and/or C-16173D



LPS RESEARCH LABORATORIES, INC.
2050 COTNER AVE. • LOS ANGELES, CALIF 90025

(SOLE AGENT)



ZEPHYR PRODUCTS PTY. LTD.

70 BATESFORD ROAD, CHADSTONE, VICTORIA — PHONE 56 7231

MANUFACTURERS OF RADIO & ELECTRICAL EQUIPMENT & COMPONENTS

HOW LPS SAVES YOU TIME AND MONEY

1. LPS PROTECTS all metals from Rust & Corrosion.
2. LPS PENETRATES existing rust — stops it from spreading.
3. LPS DISPLACES moisture on metal—forms fine protective film
4. LPS LUBRICATES even the most delicate mechanisms at extreme temperatures.
5. LPS PENETRATES to free rust frozen parts, nuts, bolts, etc.
6. LPS PREVENTS equipment failures due to moisture (drives it out).
7. LPS LENGTHENS LIFE of electrical & electronic equipment—improves performance.
8. LPS RESTORES equipment damaged by water contamination & corrosion.
9. LPS PENETRATES AND PROTECTS plated and painted metal surfaces.
10. LPS PROTECTS metals from salt atmosphere, acid & caustic vapours.
11. LPS LOOSENS dirt, scale, minor rust spots & cleans metal surfaces.
12. LPS ELIMINATES squeaks where most everything else fails,

our listening post on the new frequency of 7225KHz. The station has a program in English at 0430GMT and in French at 0500GMT. Signals are not very good, due to sideband interference from the B.B.C. London, whose transmission in the European Service is on 7230KHz. Another frequency used by Kigali, 9560-KHz, is also on the air at this time, but transmissions on this channel suffer from interference from the Radio Nacional del Peru program from Lima, on 9562KHz. A further broadcast from Africa is on the air 0545-0730GMT, using 9690 and 11905KHz. The service to South America in German is now on the air 2300-0100-GMT and on 11965 and 11925KHz.

B.B.C. AWARDS CONTEST

The B.B.C. World Radio Club is conducting another contest, with a special award certificate being given to those listeners who accurately report the reception of 12 B.B.C. frequencies, from the four B.B.C. World Service outlets, before November 1, 1969.

The contest was first conducted earlier this year, and the imposing certificate in red, white and gold was received by many listeners, confirming their reception of the four B.B.C. transmitting sites, in Great Britain, Ascension, Cyprus and Singapore. The award certificate lists the frequencies and location of four stations which have been verified, and this fulfills the needs of most DXers for a specific verification of a B.B.C. transmission.

The main requirements for the award are as follows:

1. Twelve correctly logged B.B.C. transmissions, which should be sent to the B.B.C. World Radio Club, Bush House, London W.C.1, in a single envelope and recorded during the period to November 1, 1969.

2. The following details must be included: Name, address, World Radio Club membership number, date of each reception report, time in GMT, frequency in MHz and program details.

3. The 12 reports must consist of three from the East Mediterranean relay base at Cyprus, three from the Atlantic relay base on Ascension Island, three from the B.B.C. Far Eastern relay station at Tebrau, Singapore, and three from any transmitting site in the United Kingdom.

4. Reports will be judged by B.B.C. Engineering Staff, and a high standard has been requested.

Readers can obtain, free, from the B.B.C. the present complete transmission schedule. This will enable them to find the location of each transmission, and so easily sort out the best three signals from the four areas which have to be listened to.

HCJB NEW CHANNELS

Several new frequencies have been observed, at our listening post, as being now used by Radio HCJB in Quito, Ecuador. One channel, 11865KHz, beams an English program to North America prior to 0400GMT. At this time it switches to a beam to Europe and continues with a program in Romanian. The other channels, 15255 and 15325KHz, continue with English programs. Another service is in Dutch, and this is on the air at 0600-0630GMT on 6130 and 11910-KHz and at 2100-2130GMT on 15225 and 7880KHz.

The DX Party Line program is beamed to the South Pacific on Wednesday at 0300GMT to 1000GMT on 6050, 9745, 9920 and 15325KHz; and is on the air in Europe on Tuesday 1930-2000GMT on 6300 and 17880KHz. The new frequency 15300KHz is received at fair level, but 2100GMT suffers interference from radio Japan.

500KW FOR COLOGNE

A start was made in August to install the new high-powered transmitters for Deutsche Welle at Cologne in Federal Germany. The first 500KW transmitter is now in operation in time for the Olympic Games in 1970, and four more transmitters of similar power will be put into service

NEW SCHEDULES OPERATING

RADIO AFGHANISTAN

According to the Ceylon Shortwave Listeners Club, the latest schedule of Radio Afghanistan, Kabul, is as follows:

GMT	KHz	Area Served	Language
1200-1230	15415, 17780	Europe	Pushto
1230-1300	15415, 17780	Europe	Dari
1730-1800	11790, 15265	Europe	German
1800-1830	11790, 15265	Europe	English
1300-1400	4775	Afghanistan	Urdu
1400-1430	4775	Afghanistan	English
1430-1730	4775	Afghanistan	Pushto, Dari
1700-1730	7200	Afghanistan	Russian
0130-0330	6000	Internal	Pushto, Dari
0730-0830	6000	Internal	Pushto, Dari
1130-1300	6000	Internal	Pushto, Dari
0200-0400	7200	Internal	Pushto, Dari
0730-0830	7200	Internal	Pushto, Dari
1300-1700	7200	Internal	Pushto, Dari

RADIO MALAWI

A verification letter received from Radio Malawi, P.O. Box 453, Blantyre, lists the shortwave service as follows:

GMT	KHz	KW
0345-0605	3380	10
0620-1445	5995	10
1500-2105	3390	10

On Sundays, transmissions commence at 0355, and on Saturdays the close down is at 2305GMT. On medium wave to the South Region, the station operates on 764KHz with 10KW. All other transmitters have the power of 1KW. These operate on 899, 602, 692, 1277 and 908KHz.

BROADCASTS FROM VIENNA

The latest schedule of Austrian Radio, in effect until November 2, includes the use of some new frequencies.

GMT	KHz	Area Served
0400-2305	6000	Europe
1800-2000	11925	Europe
1000-1200	9770	Europe
0500-0700	7245	Europe
1300-1500	11785	Europe, North Africa
0700-0900	9245	Europe
0500-1300	6155	Europe, N. Africa, Middle East
0900-1300	7245	Europe, N. Africa, Middle East
1300-1700	9770	Europe, N. Africa, Middle East
1500-1700	11785	Europe, N. Africa, Middle East
1700-2200	6155	Europe, N. Africa, Middle East
2000-2200	7245	Europe, N. Africa, Middle East
2300-0400	6155	North America
2300-0400	9770	North America
0000-0200	15145	Central America
2300-2400	9525	South America
0200-0400	11875	South America
1800-2100	15210	South America
2000-2200	15200	East Africa
0700-1000	17855	South Africa
1600-1800	17880	South Africa
0600-1000	15410	Middle East
1700-2000	9610	Middle East
0400-0700	17715	S. E. Asia
1400-1600	17780	S. E. Asia
1000-1200	17885	Asia
1200-1400	15385	E. Asia

RADIO VERITAS, MANILA

Radio Veritas in Manila continues to operate on a test basis with programs beamed to the Asian area. The station is interested in receiving reports from listeners. These can be sent direct to Manila. Vatican Radio also has expressed an interest in reception of Radio Veritas programs in our area and reports to their chief engineer, Dr Michael Leeme, would be welcomed.

GMT	KHz	Area Served
1030-1100	15170	South Vietnam
1100-1130	15170	North Vietnam
1130-1200	15170	Thailand, Laos
1200-1230	15170	Burma
1230-1300	15170	South Vietnam
1100-1130	11830	Malaya

ENGLISH FROM COPENHAGEN

The present schedule from Radio Denmark, which uses a 50KW transmitter, is as follows:

GMT	KHz	Area Served
0145-0215	9520	North America
0815-0845	15165	Far East
1245-1315	15165	North America
1445-1515	15165	South Asia
1915-1945	15165	Africa



WARBURTON FRANKI

AUTOGUARD ANTI-THEFT ALARM Photoelectronic Beam

- A customer warning device: or
- Add an infra-red filter (supplied) flick the switch on the control and the unit becomes an INVISIBLE burglar alarm capable of protecting 30 feet.
- Light source can be installed in any position with the unique flexible coupling.
- Transistorised "Solid State" unit with no moving parts.
- Low running costs.
- Complete with wire, cable tacks, buzzer and easy to follow instructions.
- Measures only 6in x 2½in x 2in



Model 101
\$39.50
including pack and post.

METREX AUTOMATIC SOLDERING GUN

- The Metrex Automatic contains everything you need—solder, flux, heat.
- Simple one-hand operation — trigger action feeds the right amount of solder at the right temperature.
- Weighs only one pound.
- Magazine holds 10ft of solder (refills available)
- Works directly from 240v mains.



\$9.95
Plus 25c pack and post.

New low voltage model now available

Similar to above but works from Scope Transformer

\$7.95
Plus 25c pack and post.

NEW EDDYSTONE COMMUNICATION RECEIVER EB36

- Fully Transistorised. Internal Battery Supply (6 x 1050)
- A.C. Power Supply (available extra). Logging Scale. May be used as tuner for Hi-Fi system. May be used as amplifier for record playing, etc.

Frequency Coverage: Band 1, 8.5 Mc to 22 Mc, Band 2, 3.5 Mc to 8.5 Mc. Band 3, 1.5 Mc to 3.5 Mc. Band 4, 550 Kc to 1500 Kc. Band 5, 150 Kc to 350 Kc.

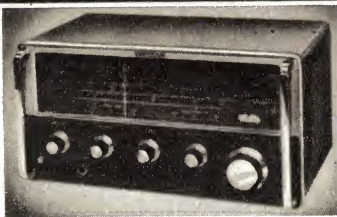

SIZE: 6 3/8in x 12½in x 8in.
WEIGHT (with batteries)
13½lb.

Full specification on request.

\$195.00
(includes freight anywhere in Aust.)

TAPE RECORDERS

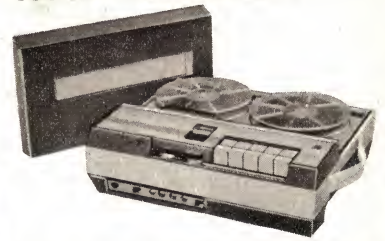

A.W.A. MODEL T225. U.A.

- 2 track, 2 speed.
- Takes 5in spools.
- Dynamic microphone has ON-OFF switch.
- Push button operation.
- Works either from A.C. mains or internal batteries.

\$89.50 including freight.

LOUD HAILERS



Geloso N2583

Microphone can be used either attached to the megaphone or remote from it as required. Literature on request.

\$59.95
including batteries and freight.

"CADET" SPEED CONTROLLER FOR ELECTRIC HAND TOOLS

Varies speed from stop to full speed with no loss of torque. Rated capacity 2 amps. Complete with flex and plug.

\$11.50 FREIGHT FREE.

INTEGRATED CIRCUITS

LM372, as used in Electronics designs. Consists of a controlled gain A.G.C. stage, a high gain amplifier and an A.M. detector. Designed for full performance between 50KHz and 2MHz.

\$4.50 including postage.



WARBURTON FRANKI

220 PARK ST., STH. MELB., VIC. Ph. 69-0151 (30 lines)

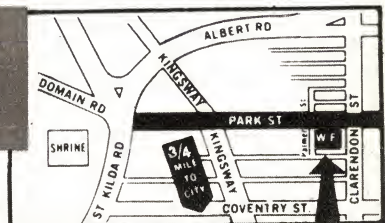

in 1971. A new relay station in Portugal will be in operation next year and will have the power of 250KW. Further relay stations are planned for Central America and South Asia. The transmissions to Australia and New Zealand from Cologne are now heard on 7130KHz at 2100GMT. This transmission in English for one hour is also carried on 9765 and 15275KHz.

The opening of the second 250KW transmitter at Kigali in Rwanda, in Central Africa has also increased the transmitting facilities at this relay base.

SIGNALS FROM PERU

Radio Loreto, Iquitos has been heard in Invercargill on the new frequency of 5050KHz to sign off at 0700GMT. The station plays popular Latin American music with frequent commercial announcements and is one of the strongest signals on this band.

According to the Danish Shortwave Club, Radio Nacional del Peru, Tacna, is being heard on 9532KHz to sign off at 0500GMT. There is severe side-band interference and best reception has been between 0200 and 0300GMT. The station has confirmed reception with a card and pennant sent by F. Malaga Munoz, R. Nac. del Peru, Administracion, Avenida Panamericanas, Casilla 113, Tacna, Peru. Radio Nacional del Peru formally operated on 9635KHz.

Radio Tacna, La Voz del Sur del Peru, is listed on 9500KHz but is now heard on 9492KHz until sign off at 0500GMT. Reports in Spanish should be sent to R. Tacna, Casilla 188, Tacna. A card will be sent verifying the signal.

Radio Continental de Arequipa has moved from the 49-metre band to 9452-KHz, and has been heard to sign off at 0500GMT. At 0300GMT the station relays a program from Radio America in Lima, followed by their own identification announcement. Radio Continental has recently increased power and is very interested in receiving reports as they want to know how they are heard in far away countries.

ABBREVIATIONS USED

One of our readers, Edwin Miller of Kalgoorlie, W.A. comments on the value he has received in the pages of DX news in enabling him to add to his verifications. He asks for a list of the abbreviations used in the pages, as he finds IRC and CRC two abbreviations he is not familiar with. The main abbreviations used are:

GMT Greenwich Mean Time
KHz Kilohertz
BC Broadcast band
SW Short-wave
KW Kilowatts
IRC International Reply Coupon
CRC Commonwealth Reply Coupon

FLASHES FROM EVERYWHERE

EUROPE

FINLAND: Radio Helsinki has been observed from 1000 to 1115 and 2000 to 2100GMT using the frequencies of 9550, 11805 and 15185KHz. For the period 1500-1830GMT the frequencies were 9590, 11805 and 15185KHz. The last half hour, 1800-1830GMT, is in English, and all transmissions close with announcements in English and Finnish.

SPAIN: Radio Nacional de Espana in Madrid has a program in French beamed to Morocco, using 6130KHz, from 0730 to 0800GMT. A further transmission 1130-1200GMT is also carried on the same channel.

SWITZERLAND: The S.B.C. at Berne has altered two frequencies for its spring schedule. The service to Africa 1715-

1915GMT now uses 21540KHz, replacing 17795KHz. In the North American service, 0130-0300GMT, 6120KHz replaces 15305KHz.

CLANDESTINE: Several stations are reported to be operating from Europe, and have been heard from time to time at good signal level. Most of these undercover stations appear to be located in Eastern Europe. "Radio Espana Independencia" is the slogan used by a Spanish-speaking station which has been on the air for over 30 years. Radio Independent Spain is on the air 1300-1400GMT on 14480 and 17700KHz, 1615 to 2300GMT on 7685, 10110 and 14480KHz, but all channels are heavily jammed. Radio Portugal Libre is being received on 11505KHz at 1900 to 1955-GMT, and has also been observed 1215 to 1245GMT on 14440KHz. Another station heard by listeners in Europe is Radio Escadia. This is on 13260KHz at 2030-2100, 2230-2300 and 2330-2400-GMT. Announcements are in French and English as well as in Basque. We verified this station on 15050KHz from an address in Paris, France.

AFRICA

LIBERIA: Radio ELWA, at Monrovia, is now using 11975KHz daily, replacing 11950KHz, and operates 0600-0730-GMT. B.B.C. news is relayed at 0600 and 0700GMT. This new channel provides fair reception in New Zealand.

KENYA: Radio Kenya, at Nairobi, has been reported from Europe with strong signals in Swahili, to close down at 2010GMT on 4935KHz. This station announces frequently in Swahili. The transmitter is reported to be of high power.

NIGER: Radio Niger, at Niamey, has made a frequency change and now uses 5050KHz, which replaces 5020KHz. The transmission times are from 0530-GMT, when opening with a flute interval signal to sign-off at 2115GMT. At times, transmission has been extended to 2300GMT.

ETHIOPIA: Radio Addis Ababa is being received at 1630GMT in English on 7290KHz. The station now confirms reports with an excellent verification card, which is dispatched promptly. Signals have also been noted on 6185-KHz in Arabic, 1430-1600GMT.

ASIA

QATAR: In the "Sweden Calling DXers" session, the new schedule for Radio Doha, at Qatar, has been announced. The station is on the air Sunday, Thursday and Saturday 0300-0600 and 1300-1900GMT. On Friday the broadcast is 0300-0735 and 1300-1900GMT. All broadcasts are in Arabic and the transmission is received on 9570KHz. The station has been assigned additional channels; these are 6135, 7150, 9550 and 11710KHz. The address of the

(Continued on page 180)



TEL-LEIGH-TUBES PTY. LTD.

(Sydney and Melbourne)

Manufacturer of Premium Quality TV Picture Tubes with

TWO YEARS GUARANTEE

Tubes manufactured by Tel-Leigh-Tubes Pty. Ltd. are subject to a series of rigid tests and quality inspections before leaving our factory. This photograph shows a tube undergoing inspection on one of our eight modern electronic testers during the tenth of sixteen checks.

N.S.W.

Tel-Leigh-Tubes Pty. Ltd.

51 Reuss Street, LEICHHARDT.

Sydney, N.S.W. 2040.

Ph.: 56-8498

Vic.

Tel-Leigh-Tubes Pty. Ltd.

32-34 Graham Road, HIGHETT

Melbourne, Vic. 3190.

Ph.: 95-4086.

Something You've Been Waiting For . . .

A SOLID STATE GUITAR AMPLIFIER

Here is a fully solid state guitar amplifier rated at a nominal 50 watts continuous power. Featuring two totally independent tone control channels and a fully transistorised Tremolo facility, the amplifier offers unique flexibility of application in a light and compact unit.

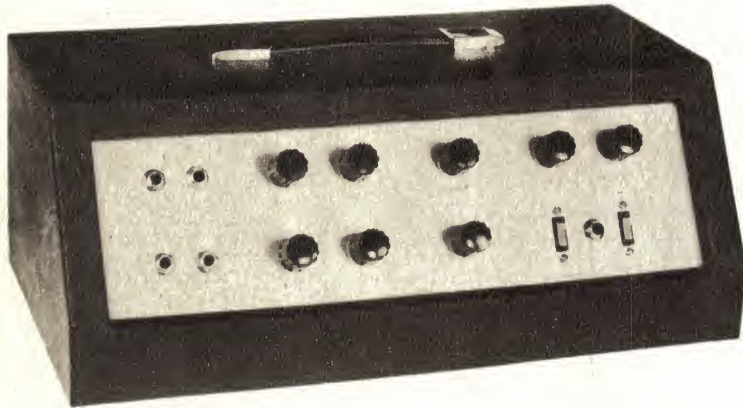

As featured in Electronics Aust. July-August issues. Complete kit of parts to Electronics Aust. specifications supplied with foot control switch and lead for remote tremolo. Cabinet finished in heavy duty black vinyl and control panel in black and silver with matching knobs.

\$98.00

COMPLETE KIT OF PARTS

\$114.00

WIRED AND TESTED

NEW TRANSISTOR CAR RADIO

New transistor six car radios with R.F. stage, of Aust. manufacture using A.W.A. components and transistors.

Available in manual models with dial calibrated for all Australian States.

Supplied with speaker (5", 6", 5" x 7" OR 6" x 9") and lockdown aerial.

MANUAL MODEL ----- \$43.00

Post and Packing N.S.W. \$1.50, Interstate \$2.50



Suitable for 6 or 12 volts for positive or negative earth. Please state type required.

NEW TRANSISTOR STEREO RECORD PLAYER

This Stereo Record Player is fitted in a durable and attractive vinyl covered case with silver trim and incorporates an 8-transistor Stereo amplifier with two Magnavox 5in x 3in speakers and B.S.R. record player (4-speed) with crystal pick-up. For 240 volt A.C. operation only. DIMENSIONS — 21" x 10" x 3½". Weight, 12lb.

\$38.00



Post and Packing extra N.S.W. . . . \$1.50. Interstate . . . \$2.50

SPEAKERS

6 inch Twin Cone 15 ohm **\$5.50** Post and pack 55c
 4 inch 15, 8 and 3.5 ohm **\$3.50** Post and pack 25c
 3½ inch 3.5 ohm . . . **\$2.50** Post and pack 25c

Speaker Transformers

\$1.50 each, or 3 for \$3.00
 7T to 15 ohm, medium size
 7T to 3.5 ohm, medium size
 6T to 2 ohm, medium size
 6T to 1.3 ohm, medium size
 5T to 15 ohm, small size

POTENTIOMETERS

1 meg plus 1 meg log.
 one inch shaft .. **\$1.60**
 .5 meg switch pot.
 D.P. **\$1.00**

NATIONAL RADIO SUPPLIES

332 PARRAMATTA ROAD, STANMORE, N.S.W. PHONE 56-7398

NEW RANGE OF RESISTORS, CONDENSERS AND POTENTIOMETERS

We have just purchased the complete stock of Resistors, Condensers and Pots, of a large manufacturer and can offer same at less than 25 per cent of list price.

The resistors are mainly I.R.C. and Morganite and are in a wide range of values from 200 ohm. to 3 meg. in $\frac{1}{2}$, 1 and 2-watt, also included are wire-wound resistor wound 2,200 ohm, 3,300 ohm, 4,700 ohm, etc.

List price \$9.00 per 100, our price, \$2.00 per 100, post. and packing 25c extra.

The condensers are in most popular makes and include Polyester, Paper, Mica, Ceramic and Electrolytic in standard values, etc.

List price \$11.00 per 100, our price, \$2.00 per 100, post. and packing 60c extra.

The potentiometers are all current types and include switch pots, dual concentric, tandem, $\frac{1}{2}$ -meg. switch, tab pots, etc.

List price, \$12.00 per dozen, our price, \$2.50 per dozen, post. and packing 50c extra.

FREE With each lot of resistors, condensers or pots, we will supply free one new valve-type 6U7G, 6X5GT, IT4, 6K7G. Resistors, condensers and pots are in packs of 100 or 12 and we regret we cannot supply to individuals lists of values or types.



LEADER SIGNAL GENERATOR LSG11

240V A.C. operated, 6-band 120KC to 390 Megs. Provision for crystal. Post N.S.W., 75c; Interstate, \$1.25. **\$32**

NEW TRANSISTOR 8 KIT SET SPECIAL PURCHASE ENABLES US TO OFFER THIS KIT SET AT \$24.00



- Complete kit of parts with circuit and full instructions.
 - Eight transistors.
 - Magnavox 5X3 speaker gives excellent fidelity.
 - High sensitivity, suitable for city or country use.
 - Heavy duty battery for economical operation.
 - Modern design, plastic cabinet with gold trim.
 - Dial calibrated for all States.
 - Available in colours of off-white, red, black
- Postage N.S.W., \$1.25; Interstate, \$1.75.

DIMENSIONS
9" x 5" x 3" deep

New Electrolytic Condensers

These condensers are miniature pigtail type insulated new stock in packets of 12, each packet containing: 3 16mfd 300 V.W., 2 32 mfd. 300 V.W., 1 25 mfd. 450 V.W. and 6 low voltage electrolytics. **\$2.50.**

Post and packing 20c extra.

NEW IMPORTED 4" P.M. SPEAKERS

Available with a 4 or 16 ohm voice coil. **\$2.00.**
Post and packing 30c extra.

POWER TRANSFORMERS

100 M.A. 285 x 285 one 6.3, one 5 Volt. Fil. \$6.00.
Post and Packing N.S.W. 60c, Interstate 80c.
40 M.A. 265 x 265 one 6.3 Fil. \$3.00
Post and Packing N.S.W. 50c, Interstate 70c.

NEW ENGLISH and AMERICAN TRANSISTORS AT 1/4 LIST PRICE

PACKET OF 12 FOR \$3.00

Ideal for the experimenter or service man.

Each package of 12 contains 3 each of the following types

Mazda XA101.	Equivalent:	OC45 RF Transistor.
Texas 2N1108.	"	OC44 OSC. Transistor.
Texas 2N1111.	"	OC75 General purpose.
Texas 2N1110.	"	OC45 R.F. Transistor.

THESE TRANSISTORS CAN BE
SUBSTITUTED FOR MANY
OTHER TYPES.

Post and Packaging 20c extra.

NEW 240V ELECTRIC MOTORS

3300 R.P.M. Size 3 $\frac{1}{2}$ " x 2 $\frac{3}{4}$ " x 3 $\frac{1}{4}$ ", including spindle.

\$2.75

plus 60c postage.



NEW MIDGET POWER TRANS. \$3.75

40mA prim., 240v. Sec 225 x 225 with 6.3v Fil. Winding. 30mA 240v. Prim. Fil. Winding.

Postage: N.S.W., 25c; Interstate, 45c.

150 x 150v. Sec. with 6.3v.

Postage: N.S.W., 35c; Interstate, 60c. **\$3.75**

NEW AMERICAN TWIN TELESCOPE TV

AERIAL. Extends to 36in, each section can be used singly for car or portable . . . \$1.50. Post 20c

SINGLE TELESCOPIC Aerial, 12in extends to 33in. 60 cents. Post 10c

USED HIGH-SPEED 240V. AC/DC MOTORS

These 240V A.C. or D.C. motors are 1/8 H.P. with a speed of 7,000 r.p.m. and are ideal for small drills, grinders, etc. Dimensions: 3 $\frac{1}{2}$ in x 3 $\frac{1}{2}$ in, with 5/16in spindle **\$3.75**

Postage N.S.W., 50c; Interstate, 85c.



NEW 25 WATT P. A. AMPLIFIERS

These amplifiers are suitable for installation in clubs, schools, restaurants, factories, etc. Wherever the amplification of speech or music is required.

• Output impedance Line output (100, 166, 250, 500 ohms) 25 W \$61

SPECIFICATIONS

Nominal power 25 watts. • Inputs two microphone and pick-up radio with separate controls and mixing facilities. • Tone control. • Microphone sensitivity 6MV, pick-up or radio 150MV. • Frequency response 30 to 18,000 CPS. • Output impedance Line output (100, 166, 250, 500 ohms) or can be supplied with V.C. output (2, 3, 7, 8, 15 ohms). • Dimensions 11in x 6in x 8in. Weight 25W 23lb. Freight extra.



NEW MINIATURE MOTORS

Ideal for models, toys, etc. 1 $\frac{1}{2}$ to 3 volts. 6,000 r.p.m. 39c each or \$3.50 per doz. Post 10c.

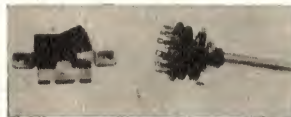

ROTARY SWITCHES

Single Bank 11 x 1, 4 x 2, 3 x 3 69c. Single Bank 2 x 1, 35c. Two Bank 3 x 3 \$1.20. Rocket Switches D.P.D.T. 55c. Rocket Switches S.P.D.T. 45c

A PREAMP FOR MAGNETIC PICK-UP OR TAPE HEADS

SUITABLE FOR USE WITH THE COLLARO OR B.S.R. TAPE DECKS

Using 3 silicon transistors as featured in October Electronics Australia complete with kit of parts including transistors mono \$7.50, stereo \$13.00, 240 power supply for above \$7.00.

Please specify if required for pick-up or tape heads.



NATIONAL RADIO SUPPLIES

332 PARRAMATTA ROAD, STANMORE, N.S.W. PHONE 56-7398

A portable solid state oscilloscope with a band of 20MHz at a maximum sensitivity of 10mV/cm. The use of solid state circuitry enables this oscilloscope to be fully operational within 15 seconds of switching on. Supply rails are stabilised against AC supply variations by a VOLSTAT constant voltage transformer.

Plug-in time bases and Y amplifiers ensure maximum versatility. There is a choice of single and dual trace, and high gain differential amplifiers, and standard or delayed time base plug-ins. All plug-ins have a unique quick action release mechanism.

A rectangular tube with a bright trace and a 10cm x 6cm display area, together with 200 nanoseconds of signal delay, ensure that the leading edge of any suitable waveform is clearly visible.

Solid State Oscilloscope OS2000

• 20 MHz • 200nS • Portable



Send for full information now to:

jacoby, mitchell
& co. pty. ltd. 26-2651
469-475 kent street, sydney

MELBOURNE	30-2491
ADELAIDE	53-6117
BRISBANE	2-6467
PERTH	28-1102
LAUNCESTON	2-5322

JM/23-63

station is Radio Doha, P.O. Box 1414, Doha, Qatar.
LAOS: The "World Radio Bulletin" reports that Radio Laos at Vientiane is operating on 640 and 6130KHz on medium wave and short wave. The station broadcasts in Laotian, 2330, 0530 and 1200GMT; French 0000 and 1230GMT; and Vietnamese 1330GMT. An English lesson program from Thursday to Sunday is at 1245GMT.
CEYLON: The All Asian Service of Radio Ceylon broadcasts in English 0130-0330GMT on 9720, 15230KHz and 1230-1700 on 15230, 7190KHz; and in Hindi 0130-0430 on 7190, 11800KHz.

THE AMERICAS

NICARAGUA: Station YNRG, located at Bluefield, has been heard at our listening post on 5955KHz. The station signs off at 0425GMT with a march. Reception is also possible at 1130GMT, at which time its program is in English.

BROADCAST BAND NEWS

FIJI: The new medium-wave station of the Fiji Broadcasting Commission on 1470-KHz is now in operation and carrying the Indian-Fijian programs. This station is on the air 1800 to 1030GMT, with the power of 2KW. The transmitter located at Rakiraki, on the northern coast of Viti Levu relays programs from Suva. The signal in New Zealand is best at opening at 1800-GMT, as in the evening transmission period, around 0800GMT, interference is experienced from the two Australian signals on 1470KHz.

PHILIPPINES: A new station broadcasting from Manila has been heard on 1150KHz. The call is DZVL and the station has been received to sign off at 1500GMT. The frequency of 1150-KHz is also used by Japan and U.S.S.R., and this causes some interference to DZVL. This station, which has the power of 1KW, has been received from as early as 1400GMT, with music and some commercial announcement. It is listed in the new Summer Edition of the "World Radio Handbook" as using 1160KHz, and as being a station of the Chronicle Broadcasting Network.

Another change is the new "Voice of the Philippines," using the former facilities of the Voice of America and broadcasting on 920KHz. Station sign off is at 1600GMT and the announcement indicates broadcasts are from 2100 to 1600GMT. A short-wave frequency, 9555KHz, is used in parallel. The studios of this new station are at Malolos, site of the Voice of America relay station.

INDIA: Our reception of a strong signal on 1130KHz in early August brought to our notice what appears to be a new program format for All India Radio. Previously, A.I.R.'s overseas service was carried only on short-wave, but this new service, from a transmitter at Calcutta, is announced as beaming programs to South Asia. The A.I.R. recently announced the installation of a 1MW transmitter at Calcutta, and it is presumed this is the transmitter being received. The program is in English, including music and announcements to 1452GMT, then follows a program summary and A.I.R. news in English at 1455GMT. When closing at 1500GMT the station gives details of the programs for the following day, which opens at 2330-GMT. Interference on the frequency is from West Australian and Japanese stations using the channel.

Another new Indian station has been heard on 570KHz. Our reception has been on Sunday at 1530GMT when 2YA Wellington, N.Z. is silent. This station is located in the Calcutta area and carries programs of the Eastern Region.

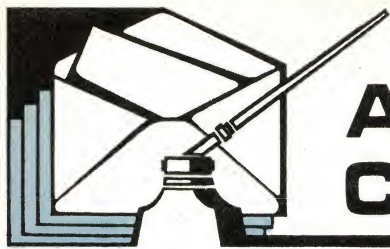

ANSWERS TO CORRESPONDENTS

SW CONVERTER: Have you published a circuit for a converter covering aircraft frequencies in the VHF band? Can you tell me where I can obtain a kit for an electronic organ of reasonable size? (P.B., Cairns, Qld.)

● We have never published a circuit specifically for the aircraft VHF bands. However, some of the converters we have published for amateur bands could possibly be adapted, for example the one described in our March, 1963, issue, designed for 50MHz or 144MHz (File No. 2/CV/17). We also draw your attention to the Fremodyne Four VHF receiver described in our March, 1967, issue, which covers 30 to 250MHz (File No. 2/SW/40). Reprints of these articles can be obtained from the Information Service, by quoting the file numbers, the charge being 20c for each article. We do not know what you consider "reasonable size" for electronic organs. However, we suggest you contact Schober Organs (Australia) 24 Livingstone Avenue, Pymble, N.S.W. 2073.

DESIGNING A SUPERHET: I am designing a five-valve superheterodyne receiver for the broadcast band, but I have a problem selecting the appropriate values of resistance and capacitance for the local oscillator. (D.D., Cremorne, N.S.W.)

● We suggest that you swallow your pride and use a design that is tried and true. We have several five-valve receiver designs available through the Information Service and we would be glad to help in this way.

LIKES TRANSISTOR IGNITION: I refer to your reply to L.T., St. Lucia, Qld., in the June issue. I fitted your transistor ignition circuit, using the Rofo coil when it was first released, and then finally used the July, 1964, circuit on my 1960 Holden station sedan, and found several points outstanding.

1. Engine performance and gear range improved.
2. Fuel economy improved by an average of 8 per cent.
3. Mechanical life of spark plugs and points improved (60,000 miles), replacement of these being due purely to mechanical wear and not electrical failure.
4. Easy starting from cold and even when wet (in flood water).
5. Engine tune-up reduced to a minimum.
6. Minimum combustion deposits in combustion chamber. My first valve grind was at 84,000 miles.

These results were obtained, even though a fair amount of caravanning was involved, so I support and recommend the system. I regard this as one of the most successful projects featured in "Electronics Australia." (M.C.C., Salisbury, S.A.)

● The results you list are a little more optimistic than our own observations of the system. However, the fact remains that there is very little interest in transistor ignition at the present time. The improved performance has to be evaluated against the added cost, complexity, interference with maker's warranty, and long term reliability, and the general verdict appears to be that there is not sufficient of the former to justify the latter. However, we are very glad to hear of the successful results you have obtained with the design.

ELECTRO FLASH: I want to construct an electro flash for my camera. Can you tell me what is available and how much it costs. (S.M., East Keilor, Vic.)

● We published a series of four articles from September to December, 1966. Copies of these articles are available through the Information Service for 20c per article. (Please quote file Nos. 3/EF/7 to 10.)

ORGAN CHOKES: I have been unable to obtain Stromberg Carlson tone generator inductors. Can you tell me where I can purchase them. (R.L.L., Port Augusta, S.A.)

● After making inquiries, we have been unable to find any commercial source of these chokes. However, we did publish full winding details for chokes of this type in an article, "Chokes, Switches and Diodes for Electronic Organs," published in September, 1964. The article may be obtained through the Information Service for the usual 20c fee. (Quote File No. 1/EM/13.)

TEN WATTS NOT ENOUGH? I would like to congratulate you on a fine magazine. I especially enjoy your "Serviceman" and "Reader Built It" articles. I want to build a hi-fi stereo amplifier, and while I like your Playmaster 115, I feel that its 10 plus 10 power rating is a little modest. I am sure many other readers would join me in wanting a higher power amplifier of at least 20 or up to 35 watts per channel. Have you ever published a design for a transistorised control unit with an output of about 0.8V. How does the fine tuning control on a radio receiver work. Could you describe such a unit which would be attached to an ordinary short wave radio. (I.A.G., Brisbane, Qld.)

● We can only assume that you have never heard 20W of audio, since this amount of output, if played in the normal domestic environment for which our amplifiers are designed, would just about "lift the roof off." Normal listening level in the home would be unlikely to exceed about 2W per channel without becoming uncomfortably loud. Moreover, most domestic loudspeaker systems are designed to handle about 10W maximum. Another point which may not be generally understood is that the response of the human ear to sound levels is logarithmic and the difference between 10W and 20W is a mere 3dB, or barely noticeable. Those who require higher levels of output for special applications, such as electric guitar amplification and public address work, are well catered for in the magazine.

Before we can answer your question of the fine tuner for a radio, we require some better description of the device you have in mind. Television receivers are fitted with fine tuning controls, but to the best of our knowledge, it has not been the practice to fit such devices to broadcast receivers. Some receivers have band-spread tuning, to facilitate tuning on short wave bands, but this is an integral part of the circuitry, and to attempt to modify an existing receiver to provide the same facility would involve major alterations. We do not normally publish information relating to the modification of commercially built equipment.

The Playmaster 112 described in our December, 1965, issue should meet your requirements for a fully transistorised control unit. Although the specification shows a nominal output of 250mV, the unit will deliver well over 2V before the onset of serious distortion.

"ELECTRONICS Australia" Information Service

As a service to readers "ELECTRONICS Australia" is able to offer: (1) Photographs, dye-line prints and other filed material to do with constructional projects and (2) A strictly limited degree of personalised assistance by mail or by reply through the columns of the magazine. Details are set out below:

PROJECT REPRINTS: For a 20c fee, we will supply data, as available from our files. The amount of data available varies but in no case does it include material additional to that already published in the magazine. For complicated projects involving material extracted from more than one issue, an extra fee may be requested. As a rule, requests for project data will be answered more speedily if the projects are positively identified and the request is not complicated by questions requiring the attention of technical personnel. Where articles are not on file, we can usually provide a photostat copy at 20c PER PAGE.

PHOTOGRAPHS, DYE-LINE PRINTS: Original photographs are available for most of our projects, from 50c plus 8c postage for a 6in x 8in glossy print. In addition, metalwork dye-line prints are available for most projects for 50c each; these show dimensions and the positions of holes and cut-outs but give no details of wiring.

BACK NUMBERS: A fairly good selection is available. On issues up to six months old the cost is the face value, plus 5c surcharge. From seven to 12 months, 10c surcharge; over 12 months, 20c surcharge. Package and postage is 10c extra per issue. Please indicate whether a PROJECT REPRINT may be substituted if the complete issue is not available.

REPLIES BY POST: This provision is made primarily to assist readers in matters relating directly to articles and projects published in "ELECTRONICS Australia" within the last 12 months. Note, however, that we cannot provide lengthy answers, undertake special research or modifications to basic designs. A 20c query fee must be enclosed with letters to which a postal reply is required; the inclusion of an extra fee does not entitle correspondents to special consideration.

OTHER QUERIES: Technical queries which fall outside the scope of "Replies by Post" may be submitted without fee and may be answered through the columns of the magazine at the discretion of the Editor. Technical queries will not be answered by interview or telephone.

COMMERCIAL EQUIPMENT: "ELECTRONICS Australia" does not maintain a directory of commercial equipment, or circuit files of commercial or ex-disposals receivers, amplifiers, etc. We are therefore not in a position to comment on proposed adaptation of such equipment, or on its general design. "ELECTRONICS Australia" does not deal in electronic components. Prices, specifications or other assistance must be sought from the appropriate advertiser or agent.

REMITTANCES: These must be in a form negotiable in Australia. Where the charge may be in doubt, an open cheque, endorsed with a limitation, is recommended.

ADDRESS: All requests for data and information, as set out above, should be directed to The Assistant Editor, "ELECTRONICS Australia," Box 2728 G.P.O., Sydney, N.S.W. 2001: 5/69

NEW RH (Radio House) RANGE OF MULTIMETERS

Model RH-80 \$18.00 Postage 50c



20,000 Ohms per Volt DC
10,000 Ohms per Volt AC

Specifications:

DC Volts. 0.5, 2.5, 10, 50, 250, 500, 1000 V
AC Volts. 10, 50, 250, 500, 1000 V
DC Current: 50uA, 5mA, 50 mA, 500 mA
Resistance: 5 kΩ, 50kΩ, 500kΩ, 5 MegΩ
Decibels. -10 + 62 lb
Accuracy. DC ±3%, AC ±4% (of full scale)
Batteries. Two 1.5V dry cells. Size AA, "Eveready" 915
● Overload-protected by dual silicon diodes. ● Mirror scale.
● Double-jewelled ±2% meter. ● ±1% temperature-stabilized film resistors.

Model RH-50 \$31.00 Postage \$1.00



Modern Design. 33 Micro-Amp Meter.
30,000 Ohms per Volt D.C.
13,000 Ohms per Volt A.C.

SPECIFICATIONS

DC VOLTAGES 0-0.25-1-2.5-10-25-100-250-500-1,000 at 30,000 ohms per volt.
AC VOLTAGES: 0-2.5-10-25-100 - 250 - 500 - 1,000V at 15,000 ohms per volt.
DC CURRENTS: 0-0.5-5-50-500 mA, 0-12 A.
Resistance: 0-60K - 6M - 60M (350, 35K, 350K at mid-scale).
Decibels: Minus 20 to plus 56dB (0 dB equals 1mW 600 ohms).
Audio Out: Capacitor in series with AC Volt ranges.
Short Test: Internal buzzer.
With leather case \$38.00.
Accessory: 1 pr. heavy test leads.



MINI-TORCH

With fob keyring, attractive gold finish case. Simply squeeze. Illuminates car and house locks. \$4 posted anywhere.



TAPE RECORDER

\$20.50

BOOK TYPE

The latest model portable Tape-recorder. 4 transistor, 3in reels, 2 trays. Instruction manual. Size 10 1/4in x 7in x 1 1/4in. Just open the book and record. Supplied complete with tape, microphone and batteries. Special discount price, \$20.50, posted anywhere.

Model RH-20 \$15.00 Postage 50c



20,000 Ohms per Volt DC
10,000 Ohms per Volt AC

Specifications:

DC Volts: 0.25, 2.5, 10, 50, 250, 1000 (20,000/V)
AC Volts: 10, 50, 250, 500, 1000 (10,000/V)
DC Current. 50 uA, 25mA, 250mA
Resistance. 7kΩ, 700kΩ, 7MΩ
Decibels. -10 +22 (at AC/10V) +20 +36 (at AC/50V). Upper frequency limit 7kc.
Accuracy. DC ±3%, AC ±4% (of full scale)
Batteries: Two 1.5V dry cells. Size AA, "Eveready" 915
● Overload-protected by dual silicon diodes.
● Double - jewelled ±2% meter. ● ±1% temperature-stabilized film resistors.

Model RH-55 \$20.00 Postage 50c

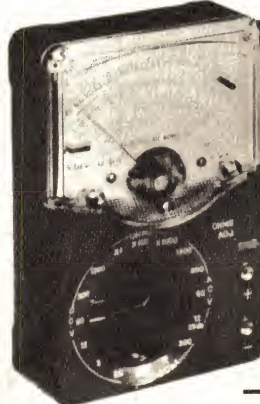

30,000 Ohms per Volt DC
14,000 Ohms per Volt AC

SPECIFICATIONS:

*DC Volts: 0.6, 3V, 12V, 60V, 300V, 1200V (30,000 ohms/V).
*AC Volts: 12V, 60V, 300V, 1200V (14,000 ohms/V).
*DC Current: 60 A, 12mA, 300mA.
*Resistance: 10K ohm, 1Meg ohm, 10Meg ohm.
*Decibels: -10 db +23 db.
*Meter Sensitivity: 23 A.
● Overload-protected by dual silicon diodes. ● Mirror scale.
● Double-jewelled ±2% meter. ● ±1% temperature-stabilized film resistors.

Model RH-60 \$25.00 Postage 50c



50,000 Ohms per Volt DC
10,000 Ohms per Volt AC

Specifications:

DC Volts: 0.25, 2.5, 10, 50, 250, 500, 1000 V
AC Volts. 10, 50, 250, 500, 1000 V
DC Current. 25 uA, 5 mA, 50 mA, 500 mA
Resistance: 10 kΩ, 100 kΩ, 1 MegΩ, 10 MegΩ
Decibels. -10 +62 db
Accuracy: DC ±3%, AC ±4% (of full scale)
Batteries. Two 1.5 V dry cells. Size AA, "Eveready" 915
● Overload-protected by dual silicon diodes. ● Mirror scale.
● Double-jewelled ±2% meter. ● ±1% temperature-stabilized film resistors.

Just arrived. New stocks of the latest model Crystal Radios. Price \$3.95 plus postage 35c. Complete with earphone, aerial clip and attractive plastic case.

RADIO HOUSE PTY. LTD.

306-308 PITT STREET: 6 ROYAL ARCADE & 760 GEORGE STREET, SYDNEY

ANSWERS - continued

ALL-WAVE RECEIVERS: Have you published any simple transistorised short-wave and long-wave receivers, and any electronic games other than the "Parlour Game" in the December, 1968, issue, which proved amusing? Is there any way of receiving VHF on a SW receiver? Is there such a wave as "microwave" and is it associated with medium wave? (J.S., Toowoomba, Qld.)

● We published a simple two-transistor receiver with plug-in coils to cover the short-wave band as part of the Basic Radio Course. Copies of the relevant chapter may be obtained through the Information Service (File No. 4/TR2/3). Although we have not described a receiver for the long-wave band, we did describe a low frequency converter in the March, 1969, issue—copies of this article are also available through the Information Service (File No. 2/CV/21.) The "Parlour Game" was published in our "Reader Built It" section. Although we may have published similar items in this section in the past we do not keep an index of these projects and cannot advise on when any were published. In our August, 1969, issue, however, we did publish a more elaborate version of this game which may be of interest to you. It is possible to receive VHF on a short-wave receiver by means of a suitable converter. We published a universal converter in September, 1961, which may meet your requirements. Copies of this article (File No. 2/CV/16) are available. The articles mentioned as being available through the Information Service cost 20c each. Microwave is a general term applied to radio waves in the upper UHF and higher bands (say above 1,000MHz.) Medium waves, on the other hand, are of the order 500 to 1,500KHz.

SOMETHING IN BETWEEN: I have been a subscriber to E.A. for eight months and have a copy of "Basic Electronics," but now seem to be at a dead end. "Basic Electronics" is too elementary and "Electronics Australia" is a bit too hard. Would it be possible to print something each month that would bridge the gap or produce an in-between book? Congratulations on a fine magazine. (N.S., Rainbow, Vic.)

● We do our best to include material in each issue which is readable by someone in your position. However, we suspect that you might be trying to grow on a constant diet of circuits which happen to exactly match your experience. If you have built all the circuits in the "Basic

Radio Course" and have exhausted the simple circuits that have appeared in E.A. over the past eight or nine months, maybe you should be spending less time with circuits and more time with theory to expand your basic comprehension. If you have really mastered all that is in the "Basic Radio Course" to the point where it is "too elementary," there shouldn't be a gap between your present knowledge and the lower level articles in this magazine. There will be a long jump to the top level articles, but that is inevitable.

BOOTSTRAP AMPLIFIER: Could you explain briefly the operation of a bootstrap amplifier, as used for example in the "RC Bridge" of May, 1966? I cannot find an explanation of bootstrap action in any of my textbooks. Also, could you explain how a half-wave voltage doubling rectifier works when it is connected to a transistor collector. I cannot see how the circuit can work, as the voltage at the collector does not reverse in polarity. (M.H.S., Woy Woy, N.S.W.)

● Basically, M.H.S., "bootstrapping" is a circuit trick to effectively increase the impedance of a resistor or other circuit element, as this is seen by the circuitry connected to one of its ends. It consists of applying to the "other end" of the element a voltage which is in phase, and usually a substantial fraction of, the voltage at the "input" end. The effect of this voltage is to effectively reduce the voltage across the element, so that it draws less current than it would do due to the "input" voltage alone. As far as the "input" is concerned, then, the element draws a considerably lower current than it would do without the "bootstrapping," and thus the element appears to have a much higher impedance. Your problem with the half-wave doubler circuit seems to stem from confusion regarding the actual input voltage to the rectifier. The input signal is not the direct component of voltage present at the transistor collector, but the alternating component—which effectively swings both positive and negative with respect to the direct component. Actually the direct component of collector voltage does not enter into the operation of the circuit, because it simply produces a fixed charge "bias" on the input capacitor to the rectifier. As far as the rest of the circuit is concerned, the capacitor charge varies in both directions from this steady "bias" value, and the rectifier effectively adds both of these excursions together to produce its "doubled" output.

"The Impossible Dream"

FAULT FINDING: Would it not be possible to publish an article or a series of articles on fault-finding in valve and transistor receivers? Many relative newcomers to radio start on old salvaged sets and home-built units but have little knowledge of the techniques of fault finding in these sets. I have read your article on this topic in "Basic Radio Course" but feel that something in more detail is required. A series of articles would be ideal and would probably be appreciated by the more advanced amateurs, as well. (B.R., Armidale, N.S.W.)

● We assume that you have in mind a series of articles which, after study by a relative newcomer, would enable them to locate faults with reasonable confidence. If only one or two pieces of equipment were involved, there might be a reasonable hope of achieving something like this. A number of statistically common faults could be described and the appropriate correction procedures specified in terms of "replace this resistor," etc. But, when the discussion has to apply to any kind of radio, old or new, valve or transistor, the number and variety of fault conditions can be almost endless, each one of them attributable to a variety of possible causes and involving a wide variety of possible corrective measures. This involves so much interpretation of cause and effect, and so much ability at circuit tracing and analysis that it is tantamount to saying that anyone able to service a variety of receivers must understand a lot about circuit operation and layout. In other words, he must have a good knowledge of fundamentals; if he doesn't, he simply won't be able to relate cause, effect and cure on a broad basis. In short, we feel that the idea of a modest series of articles or a modest book, capable of bridging the gap between little knowledge and effective fault finding is largely an illusion.

ELECTRONIC DESPATCH

P.O. BOX 149, AUBURN 2144
9-1 DAILY AND SAT.

16 SHERIDEN ST., GRANVILLE,

MAIL ORDERS WELCOME

Add Postage Please

BASIC COMPONENTS

½W resistors 10-470K 6c
½W resistors 10-10M 6c
1W resistors 10-10M 7c
All in 5 p.c. tolerance except ½W above 1M which are 10 p.c.
Full range of Elna miniature polyester "GreenCap" capacitors. See September Electronics for range of prices.
Large range of Elna electrolytic capacitors. See September Electronics for values and prices.

TRANSISTORS

BC 108 60c 2N3055 . . \$2.50
BC 107 70c
BC 109 75c AD161/162
BC 148 55s matched pair
OCP71 . . . \$3.50 \$3.60
BF 115 70c UJT D13T1 \$1.20
FET 2N5459 (MPF 105) . . . \$1.20
Photo resistor (LDR)
ORP 12 60c
Voltage dependent resistors
150V 10c 125V 10c
Reed Relay Hamlin DRG2 1A . 80c
The above items are always in stock.
STR. BTY79 400R 6.4 amps, 400V \$3.75
BC178 PNP Sc. 65c
BF179 200V Video amp. . . . \$1.50

SPECIAL COMPUTER BOARDS

10c per transistor, 2½c per diode. All other components are free and include resistors, capacitors and chokes.

VERNIER DIALS No. 11 SET

These are new 50c

240V MAINS STABILISERS

192V to 264V input giving 240V 5± p.c. output at 10A
Few left at \$25
Same but 5A 2 left at \$20
Bell wire 1 x .036 PVC fortisan lapped and lacquered.
Single 1½c per yd.
Twin 3c per yard
Coil of 880 yards, single . . . \$10
Coil of 440 yards, double . . . \$10
Fibreglass PVC covered sleeving 0.5 MM 0.75MM and 1MM.
10c per yard.
1K WW pots.
30ohm WW pots,
with very short shafts 40c
1/3 HP 3-phase motors 220/380V will run on 240/415V.
Brand new \$10
Large range of silver mic capacitors.
20% tol 10c
10% tol 15c

Telite

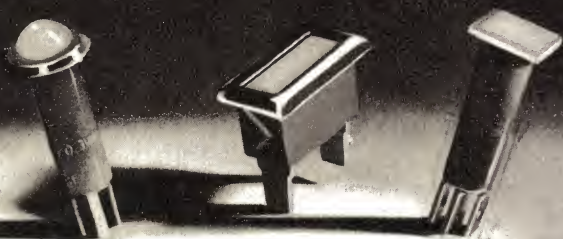

The Light Fantast^{ic}

TELITE NEON INDICATORS ARE TRULY A "FANTASTIC" LIGHT

- NO FILAMENT TO BURN OUT!
- UNAFFECTED BY VIBRATION!
- NOR BY POWER SURGES!
- NOR BY FREQUENT SWITCHING!

TELITE NEON INDICATORS are available in voltages from 60V. A/C to 415V. A/C and in a variety of attractively styled mouldings in materials to suit your purpose—for example, Nylon, for high temperature operation — or indelibly impressed with letters or figures in permanent colours. Your new project is worthy of these advantages — ask for technical literature.

IRH
COMPONENTS
PTY. LIMITED

A Subsidiary of IRH Industries Limited

THE CRESCENT,
KINGSGROVE,
N.S.W. 2208.
TEL. 50 0111

INTERSTATE AGENTS & REPRESENTATIVES

MELBOURNE I R H Components Pty. Ltd. Phone 489-1088	LAUNCESTON W.P. Martin Pty. Ltd., Phone 22-844	PERTH Simon Holman & Co. Phone 8-2271
BRISBANE K.H. Dore & Sons Phone 2-1391	HOBART W.P. Martin Pty. Ltd., Phone 34-2811	ADELAIDE Collett & Cant Pty. Ltd. Phone 23-1971

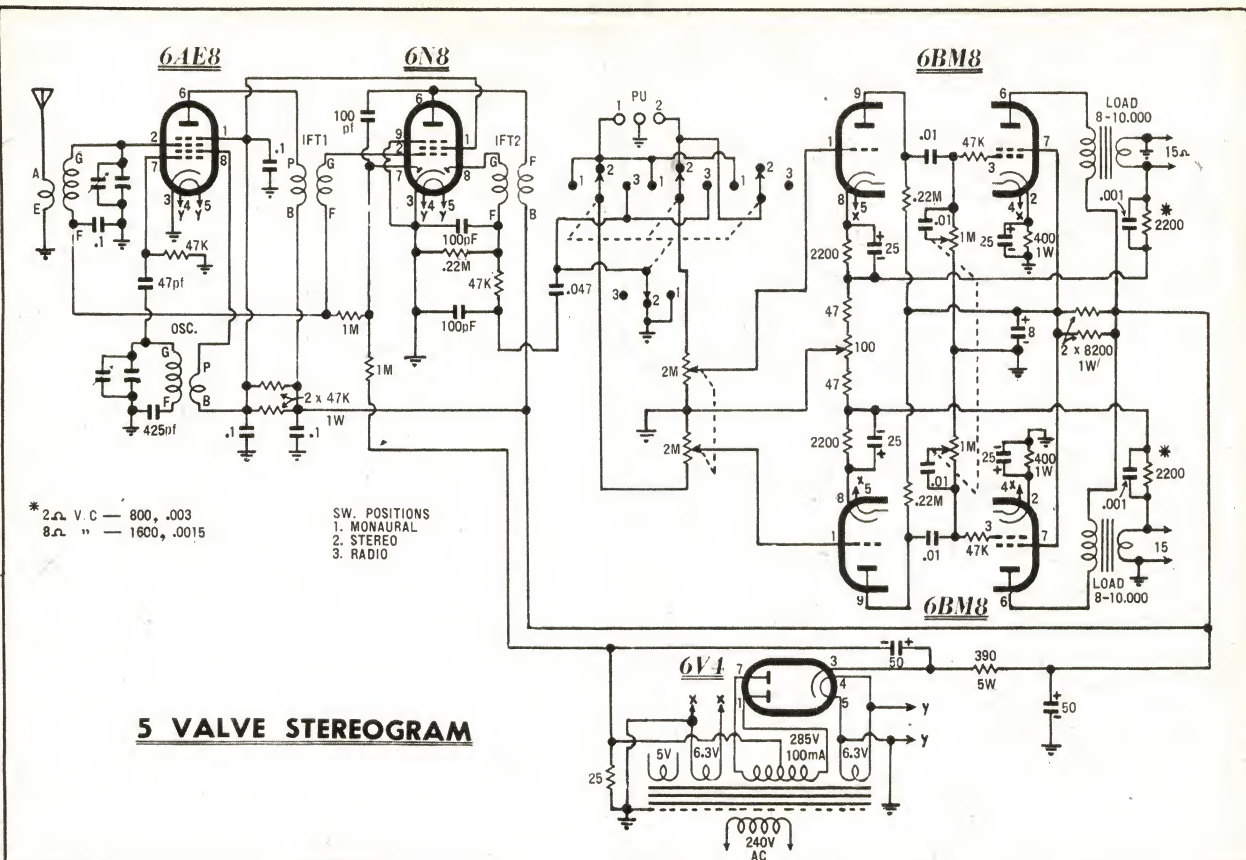

LOUDSPEAKER IMPEDANCE: Is there any way of finding out the impedance of the output of a receiver so that a suitable loudspeaker can be fitted? I have an old mains operated receiver from which the loudspeaker is missing and I want to know what the impedance of the loudspeaker should be so that I could fix it up again. (J.J., Loxton, S.A.)

• With the information you have given us we can be of only limited assistance. You do not say whether the output transformer is still in the set, or whether it is missing with the loudspeaker. Some years ago it was customary to find the output transformer mounted on the back of the loudspeaker frame. In any case, it would be fairly safe to assume a primary impedance of about 7K. If the output transformer is on the chassis, the loudspeaker impedance would almost certainly be 2 to 3 ohms. However, if the set is really old, it may have used an electrodynamic loudspeaker, in which the electromagnetic winding was also doubling as filter choke. In this case, the chances of obtaining a suitable loudspeaker would be virtually nil. While it would still be possible to make the set work by substituting a filter choke and using a permag speaker, we doubt whether the effort and cost involved would be worthwhile.

PLAYMASTER 115 COMPONENTS: I am building the Playmaster 115. Can you tell me who are the suppliers of the printed wiring boards 67/a3 and 67/p3? Are there any additions to the circuit as published in April, 1967? Can you tell me the price of the complete kit set? (B.H., Auchinflower, Qld.)

• Printed wiring boards for this project, as well as other components for Playmaster designs, are available from various suppliers who advertise parts for projects in the magazine. A glance through the advertisements in any issue will give you this information. Notes on the Playmaster 115 were published in the

Here is a circuit which should interest readers who may have collected parts from aging valve receivers and who may have ideas of reassembling them as a low-cost stereogram. The circuit was designed by the late John Moyle and described in the April, 1959, issue. Copies of the article are still available. Address your letter to the Technical Editor, "Electronics Australia," Box 2728, G.P.O., Sydney, 2001. Enclose 20c and quote file number 5/ACRS/45. The original receiver used a 6AE8 frequency changer but a 6AN7 or other similar type could be substituted. An aerial coil, oscillator coil and two IF transformers are required, intended for a normal 455KHz IF channel. The original receiver used good quality output transformers, both to preserve good efficiency in the output stages and to permit the use of about 14dB of feedback around the amplifier. Cheap output transformers should be avoided. As with all amplifier circuits of this type, connections to the output transformer must be so phased as to produce negative feedback. If the gain tends to rise when the feedback is connected or the amplifier breaks into active oscillation, the connections to either the primary or the secondary of the particular output transformer should be reversed. The gain of the two audio systems would be only modest by modern standards and necessitate the use of a crystal cartridge to ensure adequate drive from all records. If necessary, gain could be increased by increasing the value of the feedback resistors above the values specified for the various voice coil impedances.

May, 1967, July, 1967, and November, 1967, issues. We also draw your attention to the article "Parameter Spreads and FET Preamplifiers" published in July, 1968, mainly to assist constructors who encountered difficulties with this problem in the Playmaster 115 design. Prices for components parts should be sought from components suppliers. We do not provide a pricing service for our projects.

SATELLITE COMMUNICATIONS: Thank you for the article on Apollo 11 communications. Would it be possible to make a converter of some kind for these frequencies? Also thanks a lot for the annual list of frequencies. It is very much appreciated. (E.W., Christchurch, N.Z.)

• We are glad to know that you find the station list useful and that the Apollo 11 article fitted your interest. Unless the VHF transmissions happened to line up on earth, there would be little chance of hearing them in any circumstances. The microwave transmissions pose a double problem: (1) the frequencies are outside the range of equipment and techniques

readily available to the home constructor and (2) the signals are so weak that their reception involves large steerable antennas and very sophisticated receiver front-ends.

DISTANCE TO MARS: In the July issue you featured an article on a possible Mars landing in 1973. In this it was stated that the distance from Mars to the earth was 150 million miles. My mate and I had an argument about this and we finally rang up the observatory. They gave the mean distance as nearer 50 million miles. Who is right? (W.G.P., Jannall, N.S.W.)

• No question about it, W.G.P., the observatory is right and the article is wrong. We are sorry about that, but feel bound to say that we took the article from a reliable overseas source and assumed that the author had checked his facts. When we came to check the story as a result of your letter, we found a possible explanation for this error. The figures he quotes, both for distance and light time, are very close to those between Mars and the sun. Presumably, this is where he slipped up.

SOUND PROJECTORS

Cinevox Prefect and Harcourt and Heath 16mm in good working order. 240v operated, complete with speaker and amplifier. **from \$90.00**

CIRCULAR SLIDE RULE

3 3/4 in diameter. Will do the same work as the conventional slide rule. Instruction book included.

\$1.25 each
Post 10 cents.

REFLECTOR GUNSIGHT

Contains these lenses:

- 1 Lens 1 1/2 in Focus, 1 1/2 in diam.
 - 1 Lens 1 1/16 in Focus, 1 1/4 in diameter.
 - 1 Air-spaced Lens, 1 1/4 in diam.
 - 1 Filter Lens, 1 Graticule.
 - 1 Lampholder. **\$1.85**
- Post.: N.S.W. 30c; Interstate: 40c.

P.M.G. TYPE TELEPHONES

Standard desk type with magneto bell calling device. Range 30 miles. Uses standard batteries at each phone. Any number can be connected together on single line. **\$23.00**

(2 TELEPHONE SETS)

30c cartage to rail. Freight payable at nearest attended railway station.

Please note we are now able to include 1/2 mile of telephone cable **FREE** with each set of Phones.

BATTERY CHARGERS

240 volt A.C. Input.

Each battery charger will charge either 6 or 12 volt batteries. 2 amp. without meter, **\$13.75**
2 amp. with meter, **\$15.75**
Post N.S.W. 70c; Interstate 95c.

MINIATURE ELECTRIC MOTORS

1 1/2 to 3 volts D.C. Ideal for model boats, cars, planes, etc. Strong torque. Only **65 cents** each or **10 for \$4.00**. (Post 7c).

TRANSCEIVER

(2-way radio) R.C.A. America RT 68, 24 volt, operated 10 watt output 38-54 megacycles F.M. crystal locked. Transmitter and receiver using frequency synthesiser in 100 K/c/s: step 10 channel per meg/cycle with power supply. Leads, mike and headphones \$45, 60c cartage to rail. Freight payable at nearest attended railway station.

TRANSCEIVER

(2-way radio) 62 set ideal small ships, Hams, etc. 1.6 to 10 mcs. Crystal locked or V.F.O. controlled 5 watt output. Complete with antenna, headphones and mike \$60. 60c cartage to rail. Freight payable at nearest attended Railway Station.

HEAD PHONES

Low impedance moving coil fitted with rubber muffler to reduce external noise, fitted with press to talk, dynamic hand microphones. Ideal for use with all types of transceivers, \$3.50 pair. Same with black felt muffler, \$4.50 pair. Post N.S.W. 25c; Interstate 30c.

12 VOLT D.C.

DESYNN INDICATOR AND TRANSMITTER UNIT. Suitable for aerial rotation indicator, etc. 0-360 deg., weatherproof mountings. **\$5.00 per set.**
Postage: N.S.W., 95c; Interstate \$1.67.

16" WHIP AERIALS

6-Piece, brand new, \$5.75. 60c cartage to rail. Freight payable at nearest attended railway station.

AVO MULTI METER

Type CT 38
\$75.00

A.W.A. AUSTRALPHONE

Transceivers 12 V. New Complete Station. 1.6 to 10 mcs on transmit. 0.54 to 16 mcs on receive. **\$150.00**

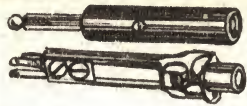

P.M.G. Phone Jack and plugs, 25c each, 45c the pair. Post 7c.

NIFE CELLS

1.2 Volt fully charged, 4in x 3in x 1in 4 AH. \$1.00 each
Post. N.S.W., 25c; Interstate 35c.

WALKIE TALKIE TWO-WAY RADIOS

P.M.G. Approved Citizen Band. 9 Transistor. \$79.00 per set of 2. Post. N.S.W. 50c; Interstate, 60c.

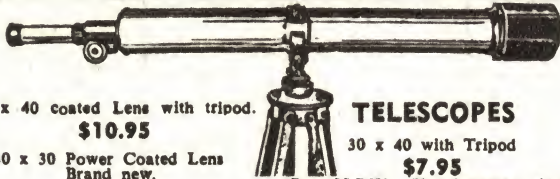

P.M.G. TYPE KEY SWITCHES. 45c each. Post, 15c.

BC 221 Frequency Motres \$55.00**TELESCOPES**

45 x 40 coated Lens with tripod. **\$10.95**
30 x 30 Power Coated Lens Brand new. **\$3.75**
60 magnification with a 60mm coated objective lens. With tripod. **\$23.00**
As illustrated. Postage, 95c; Interstate \$1.20.

30 x 40 with Tripod **\$7.95**
Post N.S.W., 70c; Interstate \$1.20

INSULATION TESTER

Type C.T. 91
Will test up to 15,000 V. Complete with all leads connectors, Top grade power supp. with E.H.T. low and high power complete with indicator unit and 45 KV and 250 mu meters. **\$150.00**

HIGH STABILITY RESISTORS

I.R.C. brand new, usually 80c ea. 50 assorted values for only **\$3.75**
Post 15c.

RECEIVER 8C A.W.A.

With ABC and D Coils. Complete, with all spares. **\$90.00**

522 TRANSCEIVERS

100 to 150 m/cs. **\$35.00**

TYPE S POWER SUPPLY

(240 Vac supply for AT 5-ARB) suit most types of Disposal transmitters and receivers outputs 250 volt, 10ma 550 volt 200ma, 300 volt 100ma, **\$30.00**

TELEPHONE WIRE

21 gauge copper, plastic covered. Ideal telephone or bell wire. 1,320ft coil of twin (equal 1/2 mile) \$7 per coil.
Post. N.S.W. 70c; Interstate \$1.20.

SCOOP PURCHASE

Gramo Motors. New. Made in U.S.A. 4-speed 240 volt A.C. 50 cyc. Only \$2.75 each. Post. N.S.W. 30c; Interstate, 40c.

CO-AXIAL SWITCH

70 ohms 4 positions, can be motor driven completely waterproof 70 ohms type connectors. Housed in metal case 9in x 8in x 8in \$5.00 each. Post N.S.W. 70c. Interstate \$1.20.

ASTRONOMICAL TELESCOPE

3 1/4 in reflector 126 X magnification. Complete with 4 X finder and equatorial mount. **\$59.00**
Post \$1.50.

VALVES BRAND NEW IN CARTONS

Special discount for quantity

807	75c	X61M	\$2.20
65N7GT	95c	CV850	\$1.50
8989	\$1.00	1H6G	30c
5U4G	95c	832	\$5.00
77	\$1.00	6AK5	\$1.50
EF50	35c	6X4	\$1.00
6U7	75c	12SK7	90c
5Y3	\$1.75	VR65	25c
6C4	80c	VT4C	75c
2 x 2	75c	AU5	\$1.00
6AG5	80c	80	\$1.25
12AU7	\$1.00	6AK5W	\$1.50

CATHODE RAY TUBES

3FP7	\$2.95	5BP1	\$3.50
3JP1	\$2.95		
V1669 4/1	\$2.95	CY2184	\$2.95

PLEASE ADD POSTAGE ON ALL ARTICLES

MINE DETECTORS

Ex A.M.F with Instruction Book. Complete in wooden case. Ideal for plumbers, counsellors for locating buried pipes, etc. Freight payable at nearest attended railway station. **\$39.00**

4 DIGIT RELAY COUNTERS

50-volt D.C., suit slot car. Lap counters, etc. **\$1.25 each.** Post 13c.

ALTEC STUDIO MICROPHONES

639B Western Electric, top grade, original cost \$250, ideal Broadcast Studio, music recording, Church and play recording, etc. Fraction of original cost. Price on Application.

240 VOLT**522 POWER SUPPLY**

Supplies all necessary voltages to operate 522 transceiver from 240 V.A.C. Complete and ready to plug in **\$30.00**.

SPECIAL lucky dip valve offer, 15 new valves in cartons for only **\$2.00**. We haven't got time to sort them, so you reap the benefit. Post 60c.

SOLENOIDS

Plunger Type 12V 300M.A. Suit electric camera control, miniature trains, radio, etc. **\$1.25.** Post, 10c.
200 Mill. amp., 24 volt, 1/8 in push movement. **\$1.25.** Post 10c.

LENSES

TOP GRADE ACHROMATIC 2in DIAMETER. 20in FL ideal as telephoto lens, telescope objectives. \$13.
Postage 46c.

CONDENSER LENS

2 1/2 in DIAM. 2in FL. \$1.80 each or \$2.50 per pair. Post 21c.

CONDENSER LENS

1 1/2 in diam. 1 1/2 FL. 50c each. Postage, 17c.

FOUR CHANNEL BRANCHING AMPLIFIER

With 4in Vu, meter G.LORAD. Complete with Portable Power Converter, 600 ohm balanced input and output. Ideal for outside broadcasting, etc. **\$39.50**

MONITOR SPEAKER UNIT

Ex-A.B.C., consisting of low resistance 8in speaker in Acoustic Labyrinth Baffle Box, complete with 10-watt amplifier, 600 ohms plus 8dbm input, 240 volt A.C. operated. **\$37.50**

TEN CHANNELS VHF TRANSCEIVER

Types TR1934 100-125 meg/cyc. and TR1935 125-150 meg/cycles. 28 volt DC operated AM single crystal locks both TX and RX on same channel complete with generator. **\$33.00**

RECORDING TAPE

EX-GOVERNMENT SURPLUS STOCK. Topgrade. 600ft on 3in spool, \$1.45, post 13c. 150ft on 3in spool, 65c, post 9c.

TELEPRINTER PAPER TAPE

8 1/4 in x 6 5/8 in
Full Page
\$1.50 per roll.

WHEATSTONE BRIDGE

Top grade
In Multiples up to 1000
\$65.00

Deitch Bros.

70 OXFORD STREET, SYDNEY, 2010

SORRY, NO C.O.D.

ANSWERS - continued

HIGHER FREQUENCIES: Congratulations on an excellent magazine. During the Apollo missions, I have become very interested in the frequencies above VHF. Have you ever published any theory or constructional articles on the subject? What is Faraday rotation? How do helical antennas work? Why are they wound in different directions? I have two different types of antenna, the trough-like one and a dish. How do they differ and how are they fed? What are the considerations for designing and building one? I am 16 years of age. (G.M., Maroubra, N.S.W.)

● We have referred to the general subject at various times but would almost certainly not have published the kind of information you are seeking. We hope that the questions you ask are rhetorical, intended to indicate the kind of things you want to know. Answering questions of this nature and of this extent is quite outside the scope of the Answers to Correspondents service. As far as textbook is concerned, our suggestion is that you pay a visit sometime to one of the larger technical bookshops in the city and see what they have on the shelves. We rather expect that you will find theory texts — at a price — but not too much in the way of do-it-yourself level material at least not for these frequencies. At 16 years of age, you seem to have generated an ambitious interest very early. Best of luck.

CAPACITOR RATINGS: I have been reading your magazine for about four years and have constructed a lot of projects with complete success. One annoying habit of E.A. is in regard to capacitors of different voltage rating. One has to make a stab at where they go. While this sounds like a moan, I would like to say that I enjoy reading E.A. and the high standard of workmanship evident in your projects. What about an up-dated radio control transmitter? (G.P., Blackburn South, Vic.)

● You have a point about the capacitor voltage ratings and it is something we will have to cope with in due course. There is a hidden problem in that arguments do arise at purchaser level over figures which we quote. If we quote actual working voltage required at points in the circuit, purchasers tend to demand capacitors with those ratings. If we quote an adequate overall figure — say 200VW — to correspond with what is currently available, difficulties arise when a new line of capacitors turns up at, say, 175VW. They may be quite adequate but purchaser won't accept them. This is one of

Letters to clubs?

CORRESPONDENCE: I feel sure that some high school and other radio clubs would be thrilled if someone on the editorial staff of E.A. could write them a personal letter. The particular club I have in mind is the Tardona High School Radio Club, 17 Wells Pde., Blackmans Bay, 7152. As for myself "our" magazine brings a sick DX'er and his nephews and nieces many hours of really educational enjoyment. Keep up the good work. (N., Bellerive, Tas.)

● Thanks for the good wishes and suggestion. Our staff is so involved with mail which flows inevitably from the production of a journal like E.A. that we couldn't possibly wish on to them a further activity. Our contribution is to produce a magazine which is as interesting, educational and personal as we can make it. But maybe we could encourage correspondence between clubs. We don't mind publishing requests along this line, provided they are free of commercial involvement.

the reasons why the matter has rested in the "too hard" basket. We are currently doing some work with a radio control receiver and transmitter but it is unlikely that we will get too involved with mechanisms and control systems as such. This gets so involved in the techniques of building and controlling models that it moves into a quite different area of activity better served by modellers' magazines.

VARACTORS: Superhet receivers have one fault as far as solid-state is concerned — the tuning gang at the front end is mechanical. Why not then a tuner using varactors? Are they available and what kind of receivers can they be applied to? I believe they are characterised by stability. This is not necessary for the broadcast band but it would be welcome in a communications receiver. Most likely the voltage will be controlled by a potentiometer. Because voltage may drift, a calibrated voltmeter may be necessary. Both

the aerial and the oscillator varactor could be controlled by a common line to ensure tracking. If the tracking law is not identical, another varactor could be used for trimming. Another possibility is to use a varactor to trim the BFO coil. (R.H., Doncaster, Vic.)

● It would seem from your letter that your prime objective is to use solid-state devices just because they are solid-state. By contrast good design practice would be to use solid-state devices to replace other components where there was an overall advantage in so doing — a consideration involving cost, reliability, performance, size, availability and so on. A mechanical tuning capacitor is not an unstable device and it may well be better, overall, than an arrangement involving (of necessity) a tuning dial, a potentiometer, multiple varactors and means to secure the desired tracking law. For a remote tuning system it would be fine, of course, but that would be a special case. Undoubtedly we will one day use varactors for tuning but only when a consideration of all relevant factors indicates an overall advantage in so doing.

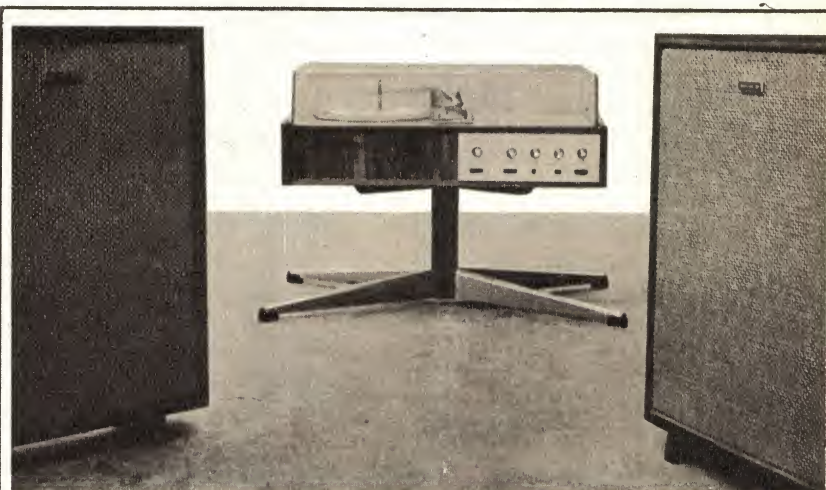

FOUR TOP VALUE COMPLETE ENCEL STEREO SYSTEMS

1. Sound Model SAQ-203 solid state stereo amplifier (12 watts R.M.S. output), B.S.R. Model MA70 turntable, Micro Model 2100 magnetic stereo cartridge with diamond stylus, two Sonics Model AS-61 multiple speaker systems. Each enclosure houses five speakers. (Cabinets as illustrated above.) Total Encel price inc sales tax **\$275**
2. The well known Cosmos Model SW-30C stereo amplifier with 16 watts R.M.S. output, a belt driven Compax III turntable, the Lustre ST-510 tone arm, your choice of the Micro 2100/3 or Shure 44-7 stereo magnetic cartridge, a matched pair of Sonics Model AS-60 speaker systems, base for the turntable. This unit is wired and ready to switch on. Inc sales tax \$229 With a perspex dustproof cover for the turntable **\$215**
3. The powerful Sound Model SAQ-305X solid state stereo amplifier (50 watts RMS output). Compax belt-driven turntable, Lustre ST-SIOD tone arm with lift, Micro 3100/E magnetic stereo cartridge with elliptical diamond stylus, two matched Sonics Model AS-303 multiple speaker systems, base for the turntable with a dustproof perspex lid. Completely assembled Inc. sales tax **\$365**
4. The Lux SQ-1220 solid state stereo amplifier (100 watts RMS output), a Goldring Model G99 transcription turntable, the Grace Model G545 tone arm, the Grace Model F-8L stereo magnetic cartridge with an elliptical diamond stylus, two Celestion "Ditton" 15in speaker systems, a base for the turntable with a perspex dustproof lid. Fully assembled, ready to switch on. Inc. sales tax **\$679**

Encel
ELECTRONICS
(STEREO) PTY. LTD.

Head Office:
431 Bridge Rd., Richmond, Victoria 3121.
Tel. 42 3762.

Sydney Store: Ground Floor 25M Building
257 Clarence Street, Sydney, N.S.W. 2000.
Tel. 29 4563, 29 4564.

Wholesalers Trade ins accepted
Australia's Greatest Hi-Fi Centre

HAM

RADIO SUPPLIERS

Mail Order Specialists

323 ELIZABETH STREET,
(2 Doors from Little Lonsdale Street)
MELBOURNE, VIC. 3000
TELEPHONES: 677329, 674286

1B3GT (DY30)	\$1.45
1C7	.50
1D4	.75
1F5	\$1.00
1KS	.75
1K5	.50
1K7	.50
1L4	.50
1L5	5 for \$2.00
1LN5	.50
1M5	.50
1OS	.50
1R5	\$1.80
1S2(DL86)	\$1.45
1S4	\$1.00
1S5	\$1.70
1T4	\$1.00
1X2 A/B	\$1.90
2D21	\$1.20
354	\$1.00
3V4	\$1.70
SAR4 GZ34	\$2.45
SAS4	\$1.30
SR4GY	\$2.00
5T4	\$1.75
5U4GB	\$1.30
5V4(GZ32)	\$1.50
5Y3GT	\$1.20
5Z3	\$1.50
6A8G	\$2.00
6A8T	\$1.00
6AC7	ea. .50
6A8 or 5 for	\$2.00
6AD8	\$1.35
6AE8 (X79)	\$3.50
6AG5	.75
6AG7	or 12 for \$2.00
6AJ5	.75
6AK5(EF95)	\$2.55
6AL3	\$1.00
6AL5	.75
6AM5	.75
6AM6	or 3 for \$2.00
6AN7/A	3 for \$2.00
6AQ5	\$1.30
6AR7GT	\$1.80
6AU4GT/A	\$1.50
6AU6	\$1.30
6AV6	\$1.30
6AX4	\$1.50
6B6	\$2.00
6B8	\$3.00
6BA6	\$1.40
6BE6	\$1.40
6BH5	\$1.35
6BK8 (EF86)	\$2.00
6BL8	\$1.50
6BM8	\$1.60
6BQ5 (EL84)	\$1.50
6BQ6GTB/	
6CU6	\$2.50
6BQ7A	\$1.50
6BV7	\$1.35
6BX6	\$1.35
6BY7	\$1.95
6C4	.50
6C8	or 5 for \$2.00
6CA4	\$1.00
6CA7/EL34	\$3.00
6CB6	\$1.40
6CD6G/A	\$4.50
6CG7	\$1.50
6CH6	\$2.40
6CK6	\$2.00
6CK6	\$2.40
6CM5	\$2.20
6CQ6	\$2.20
6CO8	\$1.40
6CS6	\$1.30
6CW4	
(NUVISTA)	\$2.75
6DC6	\$2.40
6DC8	\$1.90
6DQ6A	\$2.20
6DQ6B	\$2.65
6DS8	\$1.80
6DT6	\$1.40
6DX8	\$1.65
6EA8	\$1.55
6ES6	\$1.80
6ES8	\$1.80
6F6G	\$1.25
6G6G	\$2.25
6GV8	\$2.70
6GW8	\$1.70
6HG6T	.20
6HG6	or 12 for \$2.00
6HS5	\$1.50
6J5GT	\$1.00
6J6	.75
6J7G	or 3 for \$2.00
6J8G	or 5 for \$2.00
6K6	\$3.00
6K7	.50
6K8GT	\$1.25
6K8 Metal	\$2.00
6KV8	\$1.75
6L6G	\$2.30
6L7	.50
6M5	\$1.35
6N3	\$1.20
6N7	\$1.20
6N8	or 10 for \$2.00
6Q7G	\$2.50
6R3	\$1.55
6S2	\$1.85
6SA7GT	\$2.20
6SC7	.75

6SF5	.75
6SF7	.75
6SH7	.50
6SJ7	or 5 for \$2.00
6SL7GT	\$1.25
6SN7GT	\$1.00
6SQ7GT	\$2.10
6S7	.75
6U4GT	\$2.00
6U7G	.75
6UB/A	or 3 for \$2.00
6V4	\$1.35
6V6GT	\$1.05
6X2	\$1.75
6X4	\$1.95
6X5GT	\$1.00
6Y5	\$1.90
7A8	.35 or \$2
7C5	.50
7E6	.50 or \$2
7H7	5 for \$2
7W7	.50 or \$2
9A8	\$1.90
9U8	.75
12A6	.50 or \$2
12A7	5 for \$2
12A7	.50 or \$2
12A8	5 for \$2
12AU6	\$1.50
12AU7	\$1.45
12AV6	.75
12AX7/ECL83	\$1.60
12BE6	.75
12BY7/A	\$1.75
12C8	.50
12D5	.50
12SA7GT	\$1.00
12SC7	.50
12SH7	.50
12SK7	.50
12SN7GT	\$1.00
12SR7	5 for \$2
16A8	\$2.00
35L6	\$1.00
19	.50
42	\$2.50
47	.50
57	.50
58	.50
70	\$1.00
80	\$1.00
100TH	\$3.00
717A	\$1.25
807	\$1.00
808	\$1.00
832A	\$7.00
866A	\$1.00
954	50c or \$2
955	5 for \$2
956	.50
958A	50c or \$2
1625	5 for \$2
1629	50c or \$2
5636	.75
9006	25c or \$2
BA50	10 for \$2
12 for \$1	10c or \$2
ECC35	\$2.00
ECH35	\$2.80
EF86/6BK8	\$2.00
EL34 (6CA7)	\$3.00
EM84	\$1.50
EY91	.50
KT61	\$3.90
KT66	\$4.75
KT88	\$5.30
RL18	75c or \$2
UL41	3 for \$2
VR150	\$1.00
2D21	1.25
2E26	Reg. \$1.20
2X2/ø79	\$4.60
6CW4	.75
NUVISTA	\$2.75
6DQ5	\$4.75
75C1	Reg. \$2.25
100TH	\$3.00
90C1	Reg. \$2.50
108C1/OB2	\$2.50
150C4/OA2	Reg. \$1.65
832A	\$7.00
866/A	Reg. \$1.00
807	\$1.20
884	\$6.25
885	\$2.85
2051	.50
5763	\$2.55
6146A	\$5.95
6146B	\$6.25
OA2/150C4	\$2.55
OB2/108C1	\$2.50
QEO3/10	\$2.55
QEO3/12	\$2.65
QEO3/20	\$2.65
QEO6/14	\$1.70
QVO4/7	\$1.50 or 3 for \$3.75

ALSO OTHER TYPES AVAILABLE, P.O.A.



MODEL OL-64D MULTIMETER, 20,000/OPV, DC Volts: 0-0.25/1/10/50/250/500/1000V at 20K/OPV, 5000 volts at 10K/OPV, AC Volts: 0-10/50/250/1000V at 8K/OPV, DC/A; 50uA/1mA/50mA/500mA/10 amps. RESISTANCE: 0-4K/400K/4M/40Megohms, DB Scale: —20 to plus 36db. Capacitance: 250pF to .02uF, Induct. 0-5000H, size: 5 3/4 x 4 1/8 x 1 3/4 in.

PRICE: \$19.50 post 30c.



MODEL 200H MULTIMETER, 20,000 opv, DC Volts: 0-5/25/50/250/500/2500V (20,000 opv) AC Volts: 0-15/50/100/500/1000V (10,000 opv) DC/Amps: 50uA/2.5mA/250mA, Resistance: 0-60K/6M ohm (scale centre 300 ohm—30K ohm. Capacitance: 10uF to .001uF/.001uF—1uF, D3 scale 20 db to plus 22 db. Size 4 3/4 x 3 3/4 x 1 1/8.

PRICE: \$11.25 post 30c.



NEW MODEL US-100, Overload protection, Shockproof Movement, polarity switch DC volts: 0.25/1/25/10/50/250/1000V (20K/OPV) AC Volts: 0-2.5, 10/50/250/1000V (5K/OPV), DC/Amps: 1mA/25mA/500mA and 10A. AC/Amps 10A. RESISTANCE: 0-50M/ohms (centre scale 50) R X 1/10/100/1K/10K, db scale —20 to plus 10 plus 22/plus 35/plus 50db.

PRICE: \$28.75 post 40c. Mirror Scale



MODEL C-1000 POCKET MULTIMETER, 1000 ohms per Volt, AC Volts: 0-10/50/250/1000 (1000 opv) DC Current: 0-100mA, Resistance: 0-150K ohms (3K centre), 2 colour scale, Range Selector Switch, Dimens.: 3 1/2 x 2 1/4 x 1 in.

PRICE: \$6.50 post free



MODEL CT500 MULTIMETER, 20,000/OPV, DC Volts: 0-2.5/10/50/250/500 5000V (20K/OPV) AC Volts: 0-10/50/250/1000V (10K/OPV) DC/Amps: 5uA/5mA/50mA/500mA. RESISTANCE: 0-12K/120K/1.2Meg/12Megohms, (scale centre: 60/600/6K/60K, DB scale: —20db to plus 62db (5 ranges). Size: 5 1/2 x 3 5/8 x 1 3/4 in.

PRICE: \$14.95 post 30c.



MODEL CT330 MULTIMETER, 20,000/OPV, DC Volts: 0-6/6/30/120/600/1.2K/3K/6K Volts, AC Volts: 0/6/30/120/600/1.2K Volts (10K/OPV), DC/Amps: (0-0.06/6mA/60mA/600mA. RESISTANCE: 0-6K/600K/6M/60M/600Megohm. (30/3K/30K/300Kohms) centre scale: Capacitance: 50 uf to .001 uf. Decibels: —20 to plus 63db size approx: 5 1/2 x 3 5/8 x 1 3/4.

PRICE: \$16.75 post 30c.



NEW LAFAYETTE SOLID STATE HA600 RECEIVER

5 BAND AM/CW/SSB AMATEUR AND SHORT WAVE, 150 Kc/s—400 Kc/s and 550 Kc/s—30 Mc/s. F.E.T. front end • 2 mechanical filters • Huge dial • Product detector • Crystal calibrator • Variable BFO • Noise limiter • S Meter • 24in Bandspread • 230V A.C./12V D.C. neg. earth operation • RF gain control. Size 15in x 9 3/4in. 8 1/4in. Wt. 18lb. S.A.E. for full details.

PRICE \$199.50



"KEW" KYORITSU NO 65 METERS, NEW

Size: 3 1/4 inch, mounting hole 2 1/2 inch, 1 1/2 inch deep.
All plus Postage 20c.
1 mA, 5 mA, 10 mA, 25 mA, 50 mA, 100 mA, 150 mA, 250 mA, 500 mA.

\$4.50

1 amp DC	\$4.50
5 amp DC	\$4.50
10 amp DC	\$4.50
30-0-30 amp DC	\$5.25
15v DC, 30v DC, 300v DC	\$4.50
300 volts AC	\$5.50



STEREO HEADPHONES

Large rubber earpiece, full audible frequency, 100-15,000 cycles.

\$9.00 inc. Tax.



P25 2 1/4 inch square, clear plastic face, 2 1/8 inch mounting hole, 3/4 inch deep.
50 uA . . . \$5.75 15 volts d.c. \$5.50
100 uA . . . \$5.75 25 volts d.c. \$5.50
500 uA . . . \$5.25 500 volts a.c. \$5.50
1, 5, 10, 20, 50 "S" Meter . . \$5.75
250 and 500 mA . . . \$5.00 "VU" Meter \$6.50

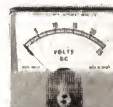

MR3P 3 3/8 inch square, clear plastic face, 2 3/4 inch round mounting hole, 1 1/2 inch deep.
50 uA . . . \$7.00 50-0-50 uA . . \$5.75
100 uA . . . \$6.75 15 volts d.c. . \$5.75
500 uA . . . \$6.50 25 volts d.c. . \$5.75
1, 5, 10, 25, 50 30 volts a.c. . \$5.75
100, 250 and 500 mA . . . \$5.75 "VU" Meter \$8.25

S.W.R. METERS, MODEL KSW-10

Specifications.—Standing Wave Ratio: 1:1 to 1:10. Accuracies: Plus or minus 3 per cent, scale length, Impedance: 52 ohms and 75 ohms. Meter: 0-100 DC microamperes.

Price \$19 inc. tax.

ANSWERS - continued

JET SOUND: I have come across a circuit which is supposed to create jet sound. I have not built it, but it may be of some interest. (P.H., McKinnon, Vic.)

● Since you wrote your letter, you would doubtless have read the "Forum" discussion in the July issue, which illustrates the methods normally adopted to obtain the desired effect. It also indicates fairly definitely that purely electronic systems cannot provide the necessary signal delay. Whatever effect the circuit may have on the signal, it would almost certainly not produce jet sound, in the accepted sense of the term.

LOUDSPEAKER LOADING: I am thoroughly confused by the effect of enclosures in loading loudspeakers — the increase in power handling capacity, the effect on efficiency, etc. If sealed enclosures are so good, why not simply build all loudspeakers with solid backs? (N.R., Pitt Street, Sydney.)

● From your letter, which we have merely summarised, you certainly are confused. But we couldn't possibly attempt to answer your questions in these columns. We have put your letter aside with the idea that we may be able, within the next few months, come up with some discussion in "Audio Topics."

CIRCUIT CHANGES: In the July, 1969, issue of "Electronics Australia" is a circuit for a simple transistor and crystal set. I made some slight changes to the values of the capacitors and improved the volume and tone. I also used a type AF117 transistor in place of the AC126. I am 14 years of age. (A.S., Nth. Balwyn, Vic.)

● We would not have expected the changes to make any significant difference to the performance. Changing the values would have slight effect on the higher audio frequency response and the end result may have suited your earphones better. It is important that you not assume that changes like this will always be justified or beneficial. But perhaps the main thing is that the set worked and allowed you to add to your experience.

RECORDING TV SOUND: Now that there are thousands of tape recorder owners, electronic equipment manufacturers must be missing out by not putting on the market a device to pick up the high-fidelity music that is broadcast by the television networks. A small transistor circuit powered by dry cells is all that is necessary. The tape recordist is then independent of a TV set and can please himself what he records without interfering with the family use of the TV set. Many tape recordists do not own TV sets, anyway. I am sure that if "Electronics Australia"

Leduc

LEDUC CURRENT: I refer to the paragraph on page 73 of the September issue, in which the Editor says that the term Leduc current is unknown to either your staff or your technical dictionary. It is actually an interrupted direct current, each pulse of which is approximately of the same strength and duration. It is used in electro-therapeutics. (L.D., Toowoomba, Qld.)

● Thanks for filling this lamentable gap in our information. Apparently we haven't been mixing in wide enough circles, or we didn't start soon enough! Vibrators, multivibrators, choppers, dividers and a variety of other devices all presumably manufacture current of the Leduc variety. But somehow solid-state pulse circuits and Leduc don't seem to belong together!

published a circuit for an FM tuner as previously mentioned in the correspondence columns they would earn the gratitude of many tape recorder users. (J.R.P., Carlton, Victoria.)

● The problem is by no means as simple as you appear to think. There are two approaches, each of which has its special drawbacks. Firstly, one can construct what is virtually the whole front end and IF section of a TV receiver, followed by sound IF and FM detector. This has the advantage of stability, but suffers from the risk of "frame buzz" such as one experiences with most TV receivers. Alternatively, one can construct a conventional type FM tuner and feed this directly into the tape recorder input, but this has the inherent tendency to drift in frequency, and can result in unsatisfactory recordings. A tuner of this type was described in the "Reader Built It" section of our June, 1966, issue. ■

LINE FILTER

(Continued from page 81)

2000V should be regarded as desirable and 1000V as a minimum and then only for capacitors of known merit. Alternatively capacitors may be used which are intended for AC applications and rated for not less than 250VAC continuous working.

As far as the value is concerned, the capacitors should be as large as possible, consistent with available space, cost and—at least two other important considerations.

One is that unduly large bypass capacitors may cause problems in situations sensitive to current through the earthing circuit.

Another is the safety aspect in the event of an earth wiring failure; this would leave the equipment floating in respect to earth by a potential deter-

mined by the ratio of the respective capacitances to the active side of the mains and to neutral/earth.

The figures suggested on the circuit were appropriate for the original situation but probably represented as well as advisable maximum for total capacitance value between each leg of the mains and frame.

The optimum distribution of capacitance in a line filter is likely to vary with the application and situation and it is entirely possible that experiment may establish that better results are obtained with the capacitors reversed in position, or even with one pair of capacitors disconnected from the appliance or the mains end. In the original situation, the filter coped well with the interference in the form shown.

The fuses are a rather unusual feature in the line filter but were included as a precaution against failure of a component within the filter. The idea was that operation could be restored, with a minimum of delay, by simply taking the filter out of circuit and plugging the appliance straight into the power point.

The filter as pictured was constructed

(Continued on page 191)



**CONVERTERS
FOR AIRCRAFT,
MARINE, FIRE,
AMATEUR BANDS**

RF FET CONVERTER
CRYSTAL CONTROLLED—1MHz BAND-
WIDTH INTERNAL OR EXTERNAL
BATTERY. CONVERT YOUR CAR
RADIO OR HOME RADIO INTO
SENSITIVE VHF RECEIVER.
\$24.75 incl. tax, crystal extra.
Crystals — State Exact listening Frequency
S. E. WILLIS TRADING CO.,
38 RIVERSDALE ROAD,
CAMBERWELL JUNCTION.
Phone 82-5787. Please include freight.
SORRY — NO C.O.D.

EXPLORATION UNLIMITED



**ELECTRONIC WEATHER
EQUIPMENT**

- Electric wind speed generator.
- Instant wind direction indicator.
- Barometer
- Hygrometer
- Thermometer

- Telescopes
- Microscopes
- Binoculars
- Astronomical books, charts, atlases
- Build-it-yourself kits
- Celestial globes
- Scientific weather equipment

**SEEK OUR EXPERT ADVICE
ENJOY OUR FRIENDLY SERVICE AND
BIG PRICE SAVINGS**



Become
a
weather
expert



**WRITE OR
CALL FOR
OUR
FREE
CATALOGUE
NOW**

AMATEUR ASTRONOMERS SUPPLY CO.
Dept. E 11A-B Clarke St., Crows Nest,
Sydney 2065 Phone 43-4360

MARKET PLACE

Send your ads for this page on the form from page 192

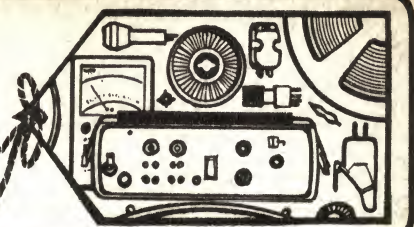

FOR SALE

HEWLETT-PACKARD vacuum tube volt-meter 110-240 AC mirror scale 001 to 300V RMS — 60dB to plus 50dB unused, cost price \$396. Sacrifice \$200. Range Collins parts, Adcoia Irons, TV trans., tuners, valves, etc. Sydney 51-5276, 40 Victory St., Fairfield, N.S.W.

COMMUNICATION receiver, A.M.R.300. Many new parts. 35 Waratah St., Mayfield, Newcastle. 68-2544.

PLAYMASTER 1.3 speaker system complete \$38 ea. complete kit \$30. Cabinets \$19.80 ea., kit \$12.50 ea. Maple or walnut veneer teak extra. Packing \$1. Freight extra. Robert N. Smallwood, 205 Brisbane Rd., Boovala, Qld. Ph. 82-1550 anytime.

RECORDING TAPE. New guar. 3 x 600 1:1.0; 5 x 1800 \$2.70; 7 x 1800 \$2.50. All brands and sizes. New lists free, many reduced. BASF down 10 p.c. Imported cassettes C60 \$1.65; C90 \$2.55; C120 \$3.35. empty cases 30c. Recorders, players, radio accessories, etc. at wholesale prices, quotes free. Fully guaranteed. A 1 Mail Orders, Box 15, Footscray, Vic. 3011.

INTEGRATED radio circuit TAD100 \$5.86; integrated output amplifier circuit TAA300 \$4.95; post/pack any order 10c; send SAE for electronic catalogue. Hobipak, P.O. Box 224, Carlton South, Vic. 2053.

THORENS turntable TD124, almost new. \$145. Stewarts, 78-4194, Indooroopilly, Brisbane.

FERROGRAPH stereo tape recorder model 424. Four years old, little use, mint condition. Original cost \$500, sell for \$250 o.n.o. D. Frupp 98 Priam St., Chester Hill, N.S.W. 2162, 644-1887 (Sydney).

FUZZ BOX E/A. with treble boost \$15. 3 plus 3 stereo amplifier \$49. 10 plus 10 stereo amplifier \$69. All new. 58-6612 Melbourne.

**TRANSISTORIZED TRANSMITTERS
RECEIVER DESIGN, INSTRUMENTATION,
MODULATED LIGHT COMMUNICATION
THE SUPER WORMTURNER
REAL BOOK REVIEWS
PITHY COMMENTS ON EVERYTHING**

All this and more, in the EEB

Send for sample copy.
THE AUSTRALIAN EEB
P.O. BOX 177, SANDY BAY,
TASMANIA 7005, AUSTRALIA

ATTENTION

Wholesalers & Manufacturers

- HI-WATT BATTERIES.
- RADIATORS.
- ELECTROLYTIC CAPACITORS.
- POLYESTER CAPS.
- POTENTIOMETERS.

**DIETRON IMPORTING CO.
PTY. LTD.**

**4-6 TAYLOR ST., DARLINGHURST
31-5430 31-6786**

FOR SALE

BARGAINS. 2N3055 \$1.80, matched pr. \$3.90. 2N3033 \$1.20, BC108-109 50c, BC107 65c. AD161/162 \$2.70. AC187/188 \$1.80. AC127/128 \$1.40. BF115 65c. OA91 25c. OC71-72-44-45-171 all 50c ea., MPF105 \$1.10, sil diodes studs 6A 400V 60c, min types 1A 800V 60c, 1A 400V 40c, ganged stereo pots 470K + 470K log or lin. 47K +47K log \$2 ea., 470K lin. single 65c. Post 5c any order. Sorry no C.O.D. T. & M. Electronics, Box 57 P.O., Haberfield, N.S.W. 2045.

DISCOUNT Hi-Fi. We can't beat everyone on everything all the time, but we're working on it. Ask about—Sony, Kenwood, Wharfedale, Tandberg, Thorens, Labcraft, J. H., A.D.C., Quad, Peerless, etc., etc. Also Lux, Sound, Mail order, Duratone, P.O. Box 125, Curtin A.C.T., Canberra. Ph. 81-2549.

STEREO Supplies, Brisbane, stock Compact Lux, Sound, Grace, Lustra, Celestion, Shure, Dual, Peak and all brands pre-cut speaker enclosures, accessories. 100 Turbot Street, Phone 21-3623.

CHANNEL Master "Telstar" transistorised aerial booster amplifiers, ideal for fringe or low signal areas \$25 ea. Channel Master automatic antenna rotators, ideal where a number of channels are received from different directions. Excellent for the ham rig. \$40 ea. J. Yalden, 21 Oxford St., Glen Innes, N.S.W. 2370.

Hi! Wasn't our September classified ad a beauty! That first line—intriguing, mystifying—was a printing boo-boo. Just so you'd know we're not completely crazy, ES & I Electronics, 81 Prospect Rd., Summer Hill, N.S.W., 2130. Look out for our ad this issue.

POLYESTER CAPACITORS: top-grade 10pc. 100V types .001uF, .0022, .0033, .0047, .0068, .01, all 7c ea.; .022, 8c; .033, 9c; .047, 10c; .068, 11c; .08, 11c; .1, 12c; .12, 16c; .33, 20c; .47, 25c. 10c pack-post any order. Return mail service. Kit-Sets Aust., Box 176, P.O., Dee Why N.S.W., 2099.

PRESTO disc recorder type MRC165 \$30, or offer, phone Sydney 747-5149.

Classified Advertisers

For the December issue your advertisement must reach our office by October 31st, 1969.

Address your advertisement to the Advertising Manager, "ELECTRONICS Australia," Box 2728, G.P.O., Sydney, N.S.W. 2001.

BC108, 5 for \$2, AC128, 5 for \$2. OC71, 5 for \$2, OC72, 5 for \$2. All new, tested and guaranteed. 10c pack-post any order. Kit-Sets Aust., Box 176, P.O., Dee Why, N.S.W. 2099.

NEW OC71, 2N3638, 5 for \$2 or 50c ea. OC44, 45 BC108, 109 2N3638A AC128 4 for \$2 or 60c ea. 2N3642, 3643 OC171, 2N370, 371, AF116N, 117N, 70c ea. OC72, 84, 6 for \$3 or 60c ea. BF115, 2N3694, AC127, 60c ea. Power types 2N176, 51 ea. 2N301, \$1.20 ea. OC28, 29, 35, 36, \$1.50 ea. 2N3055, 8DY20 40250, \$1.80 ea. OA210, EM404, 50c ea. OA211, BY100, EM410, 70c ea. UJT 2N2160, FET 2N4360, \$1.20 ea. MPF105 2N6549, 90c ea. BA100 30c ea. OA81, 85, 91, 95, 10 for \$2 or 25c ea. No S.A. sales. Post and pack 15c Custom Electronics, Box 1452, G.P.O., Adelaide, 5001.

PRINTED circuits, new easy method. No chemicals, kit \$3, p. and p. 40c. Mail order service for valves and components. Catalogue 25c refunded with order. S.A.E. with enquiries please. Robbins, Box 129, Carlingford, N.S.W. 2118

MODEL BEAM ENGINE, blueprints \$6.12 set. Castings from \$60 set. Bolton, 72 King Street, Sydney. Catalogue \$1.50.

ADC 10E MkII, Shure, M75E, etc. Special prices also speakers, speaker kits, and all audio equipment. Quotations. Sudana Products, P.O. Box 44, Turramurra, N.S.W. 2074.

TRANSISTORS silicon planar, new tested 200-300MHz HFE 0.2-200 similar 2N708 BSY95A etc. 30c ea., 10 \$2.50 100 \$20. PNP also available. Semiconductor Electronics, Box 83, St. Agnes, S.A. 5097.

EDDYSTONE \$680 all band communications receiver. \$100, new condition, Presland, 32 River Terrace, Bundaberg, Qld.

CRYSTALS: New, 500KHz \$3.85. Waltham Dan, 96 Oxford St., Sydney, 31-3360.

TAPEDECK 3-speed 3-head 4-track, Collaro \$40 R. Young, Box 1331, Boroko, Papua New Guinea.

FOR SALE

SELL cheap or exchange video amplifiers, field strength meters, amplifiers, modern walkie-talkies, various battery chargers. Eizer, P.O. Kalliga, 4030.

AMPEX PR-10-1 studio tape recorder. Full track 7 1/2 and 15ips. Push-button relay operated. Portable, but complete with 4-ft console cabinet, inc. monitor unit. \$600. Vista Recording Studios, 78 Robert St., Wickham, N.S.W. 61-4908.

RELAYS—high speed computer type. 1000-ohm coil 4 pole change-over. Suitable 12 to 50V 75c each post free. Larger quantities less. Call or write 628 Sandgate Road, Clayfield, Qld 4011.

UNIVERSITY TS22 valve and circuit tester, as new with data cards. Phillips mod. osc. CM2883 400KHz to 30MHz. Both for \$60. Beverard, 75 Fitzroy St. Tumut, N.S.W. Ph. 162

TEST equipment for TV and radio—AWA and Heath VTVM, Odance and Palco RF oscilloscope and pattern generator. 98 Riversdale Road, Camberwell, Vic. 82-5787.

BURGLAR ALARMS, 12V, 150uA. Transistor Control units, \$12, plus 15 p.c. s.t. Unit on 4 x 2 plate and case, \$16, plus s.t. 4 1/2v rotary sirens, \$10.50. All above plus 60c p. and post. Foil tape terminals, mats, key switches, bells, reed switches, infra-red ray unit. Complete quote and installation service to insure requirements. EDORE ENTERPRISES, 802 Doncaster Rd, Doncaster, Vic. 848-1386

TRANSISTOR ignition system capacitor discharge type. \$32.00, 12V systems only. State whether positive or negative side of battery connected to car body. Two Way Radio Service, 31 Rotherham Street, Kangaroo Point, Brisbane, Queensland.

SCOOP for battery chargers. Zero-5A. DC meters 1 1/2in scale \$1.50. Westinghouse selenium rectifiers f/wave bridge 2-6-12V DC 4.2A \$1.00. New brand, English make, post 15c. Peak Electric, 732 Victoria Rd, Ermington, N.S.W. 2115.

SCOOP For motor speed control. Set of 1 STC stud mount thyristor 400PIV 3A plus 2 AWV diodes 400PIV 1A (all brand new) for only \$2.50 plus 15c post. Peak Electronics, 732 Victoria Rd, Ermington, N.S.W. 2115.

LOCATE (radio, audio faults quickly! Square wave (signal) generators, complete probes (simple instructions novices). Ideal for servicemen. \$10 each. Sole manufacturer, Plantation Services, Corio, Vic. Ph. 78142.

MAIL ORDERS: Transistors, FET, kits, meters PVC capacitors, resistors, transformers, radio sets, etc. Very low prices. Free catalogue on request. IEC, P.O. Box K1829, Hong Kong

SELL all back issues "ELECTRONICS Australia" in stock at all times, 1939-63 50c; 64 to date 60c. Post free. T. Weir, 56 O'Connor St, Haberfield, Sydney, N.S.W., 2045. Phon 798-7569. Wanted to buy copies also.

BYER "100" SERIES Professional tape recorder, Triple-head assembly, 12-track stereo, Speeds 7 1/2 and 15 ips. Independent record and playback facilities. Input/output 600 ohms balanced. Contact Mr. Binion at W and G. Record Processing Co, 136 Batman St, West Melbourne. Phone 329-7255.

WANTED

COLLARO studio tape deck. Condition as new. Particulars to J. Blythman, Box 6, Daw Park S.A. 5041.

Q METER Marconi or similar, please ring Sydney 31-3273.

WANTED—Recording studio equipment: Filter microphones, mixers, amplifiers, tapedeck, reverb, etc. Mr. Lawson, Box 2340, G.P.O. Sydney, Phone 649-7106.

SURPLUS TV valves, Cash, Last, 847 Ne Canterbury Road, Hurstville Park, N.S.W. 55-7151.

READER SERVICE

MAGNETIC tape cassettes, talking letters, ve wide range of famous German brand—high quality and very competitively priced. Write for catalogue and details of introductory offer Wholesale and retail. Permaston Austral, Box 1691, G.P.O., Adelaide 5001.

PRECISION printed circuitry to your instructions and all other work in the photograph and associated fields by P. & D. Herfor Photographic Productions, 13 Clarence R, Wantirna Vic. 3152. Telephone 231-2058 hours.

TOP quality discs from your tapes. At quality, all sizes and speeds. We guarantee our work to comply with R.I.A.A. and A.B.C.S. standards. Enquiries welcome. Write for details A.A.V.R., 87a Mullens Balmain, 2041, Phone 82-5158, Sydney.

READER SERVICE

TV PICTURE TUBES. Sure Brite Pty. Ltd., now at 542 King St., Newtown, N.S.W. Now the largest factory of its kind in N.S.W. Daily delivery Sydney, suburbs and to railway station. Lowest prices in Sydney to the trade. Duds bought. Send all duds to Sydenham station freight paid. Customer sales rear of building. Phones, 519-3403, 51-5928. Brisbane area: 1120 Oxley Rd., Oxley, 79-6828.

PRE-RECORDED TAPE hired to members of Australian Tape Recording Society, B1. Monthly release. "The Microphone" news-papers, round robins, sales service, tape-sponding. Send 5c, 9in x 4in SAE to ATRS, Box 9, P.O., Crows Nest, N.S.W., 2065, or phone (2) 43-6681, after hours.

MOBILE recording studio. Professional and private recordings. Weddings — shows — concerts — tape and discs — editing, copying, mastering for commercial discs. Large catalogue popular and classical organ discs. Concert Recording, Sydney. 631-6189, 635-7026.

DUPLICATING. James E. Smith Duplicating Service for photostats, photo copies, electronic stencils, addressing service, extensive duplicating coverage. Customers wanted. P.O. Box 48, Albion, Qld., 4010. Phone 67-6612.

FREE stereo pre-recorded tape, cartridge or cassette, when you join the Rondo Reef Pre-recorded Tape Service. Est. 5 yrs. Save 20 to 25 labels on pre-recorded tape, etc. over 25 labels to choose from interstate, N.G. and Fiji inquiries welcome. Regular new releases posted to all members. Details Rondo Reef, Box 162, Rockdale, N.S.W., 2216, Aust.

RADIO TV Tape service, all spares available, trade discounts on parts. Amplifiers, microphones. Nicholas Radio, 91 Wellington Street, Launceston, Tas.

REPAIRS to receivers, transmitters, construction, testing: TV alignments; Xtal conv., specialised electronic equip. Eccleston Electronics, 146a Cotham Rd, Kew, Vic., 30-3777.

ELECTRONIC ORGANS. Do not build yourself an organ without first finding out about the superb Schober (U.S.A.) Assemble-It-Yourself Kits. Inquiries to Schober Organs (Australia) 124 Livingstone Ave., Pymble, N.S.W., 2073. (Mail only, please.)

TAPE to disc service. Take advantage of W. and G. Records' professional experience when next needing tape to disc service. W. and G. Record Processing Co., 185 A Beckett Street, Melbourne. Tel. 329-7255.

TRANSFORMERS wound. Output or mains and specials to orders. Reply with S.A.E. Paris Electronics, 7a Burton St, Darlingshurst, N.S.W. 31-3273.

MODEL RAILWAYS. Rivarossi, Tri-ang, Peco. Prompt rail order service. Write for free price lists. Free packing and postage on all orders. P.J.P. Productions, 15 Hamilton St., Gisborne, Victoria, 3437.

AUSTRALIAN Tape Recordists Assoc.: Tapespond with members everywhere. Meetings in 3 States. Manual of tape recordings now available to non-members, \$1.00. Box 970H, G.P.O., Adelaide, 5001.

POSITIONS VACANT

SUPPLY DEPARTMENT VICTORIA.
DEFENCE STANDARDS LABORATORIES
TECHNICAL SECTION
MARBURN ROAD
DRAFTSMAN GRADE 1
SALARY: \$3553-\$4553.
DUTIES: Position No. 161—Undertake independent design based on established principles and prepare layouts and detailed drawings on electro-mechanical and electronic laboratory equipment.
QUALIFICATIONS: An approved Certificate from a technical college or institute of technology or its equivalent, or such other qualifications as the Board considers appropriate, together with appropriate experience.
Applications will, however, be accepted from people who do not possess acceptable qualifications provided they have a minimum of six years' relevant experience including at least three years' experience on drafting. If the selected applicant does not possess acceptable qualifications he will be required to pass a test of knowledge and competence to establish his eligibility for nomination for the position.
APPLICATION TO: The Chief Superintendent, Defence Standards Laboratories, Box 50 P.O., Ascot Vale, Vic. 3032.

COMMONWEALTH OF AUSTRALIA
DEPARTMENT OF SUPPLY
WEAPONS RESEARCH ESTABLISHMENT,
WOOMERA.
VACANCIES FOR TECHNICAL STAFF
The Weapons Research Establishment is desirous of recruiting staff for a number of technical vacancies at the Woomera Rocket Range. Interested persons possessing the necessary qualifications are invited to apply for the following vacancies.
Technical Assistant Grade 2 (A number of positions).
SALARY: \$3428/3928 (Actual) per annum.
DUTIES: Assist with the installation, operation and maintenance of intercommunications, optical, electronic, telemetry and computing systems equipment at the Woomera Range.
QUALIFICATIONS: Basic training in electronics with several year's experience in the field of line or radio communications systems. Operation or maintenance of computing equipment and its peripherals.
NOTE:

- (1) A special allowance of \$280 per annum is payable to a married man maintaining a family, others receive \$160 per annum.
 - (2) An amount of \$90 plus 1/12 of the claim for dependants is allowable for taxation purposes provided at least six months of the financial year are spent residing at Woomera.
 - (3) Married accommodation will be made available within a reasonable period after taking up duty.
 - (4) Fares and removal expenses for the successful applicants and their families (wives and children) will be met by the Department.
 - (5) Successful applicants may be required to fly in fixed or rotary wing aircraft and to drive a Commonwealth vehicle whilst on duty.
 - (6) Payment is made in lieu of excess travelling time.
- APPLICATIONS: On forms available from the Regional Director's Office, Department of Supply, in each capital city should be lodged with—

The Director,
Weapons Research Establishment,
Box 1424H, G.P.O.,
ADELAIDE, S.A., 5001.
By: 15th October 1969.

* AEGIS

*Reg. Trade Mark

MAINS FILTERS

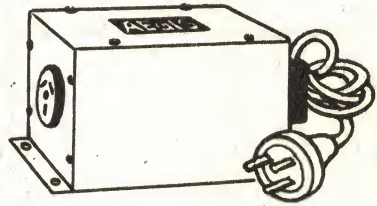

Aegis range of mains filters consists of:—
MF2A 240V 0.5 amps
LF1 240V 2.0 amps
MF8 240V 5.0 amps
These filters are useful in reducing noise and hash carried through the mains. Available from any good radio parts distributor.

Write direct for technical details and prices.

AEGIS PTY. LTD.

347 DAREBIN RD., THORNBURY, VIC.,
3071, P.O. BOX 49, THORNBURY, VIC.,
3071. PHONE 49-1017, 49-6792.

SERVICE

BILL TURNBULL offers you service on Hi Fidelity equipment tape Recorders, Communication Receivers and Electronic Test Equipment.

25 years experience
All work guaranteed

BILL TURNBULL

11 ELLALONG ROAD,
CREMORNE, N.S.W. 90 4825

COMPUTER BOARDS

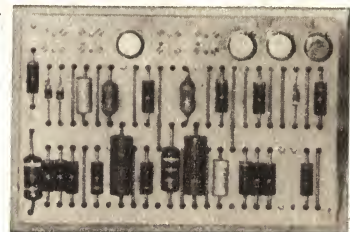

TRANSISTORS 15c Each.

Resistors, Diodes, Capacitors Free.

8 BOARDS WITH A MINIMUM OF 50 TRANSISTORS \$4.00

25 BOARDS WITH A MINIMUM OF 100 TRANS. \$12.00

Technical information supplied with goods. Minimum order \$1.50. Please add Postage.

COLSTOK ELECTRONICS

Box 178, KELLERBERRIN. 6410

MARS ENVIRONMENT

(From page 25)

ture and from deep space (the latter represents a zero reference point).

Light reflected from the surface of Mars, which includes thermal radiation, was filtered by optical elements in the instrument on to the two detectors producing a voltage proportional to surface temperature. This analog voltage was converted to two pulses whose separation in time was proportional to the analog voltage. This information was encoded into binary form for transmission to Earth. Data from this experiment was stored in the digital recorder and transmitted in real-time.

The detectors were Antimony-Bismuth 5-junction thermopile detectors. The receptor surface was made of gold and was 0.25 millimetre on a side. Channel 1 covered the 8-12 micron wavelength range and channel 2, 18-25 micron. Filters determined the wavelength reaching the detectors.

FILTER — continued

ed in a stout metal box bent up from flat galvanised steel, and measuring overall 3 inches wide, 2½ inches deep and 9 inches long. All corners were rounded and a central partition installed dividing the box into two. The base, with rubber feet, was held on by eight self-tapping screws.

Care must be taken with the mounting and insulation of all components carrying the mains voltage but the vital lead to watch is the earth connection. Make sure that the incoming cord is firmly anchored and that, in the event of stressing on the cord, the earth lead will be the last to break.

FOOTNOTE: For some time, one of our staff members has had to put up with a heavy plop from an electronic organ amplifier each time the cutout operated on the refrigerator. Tried in the refrigerator power lead, the filter unit described here reduced the noise to a much more tolerable level — this without any further experiment. The experience would suggest that a filter along these lines might offer relief to audio enthusiasts plagued with refrigerator noise in high fidelity equipment.

ADVERTISING INDEX

A. & R. Transformers Pty. Ltd.	160
A.C.E. Radio	170, 171, 172
Adcola Products Pty. Ltd.	109
Aegis Pty. Ltd.	131
Akai Electric Co. Ltd.	130
Amalg'd Wireless (A'sia) Ltd	60, 111, 112
Amateur Astronomers Supply Co.	22
Amplion (A'sia) Pty. Ltd.	183
Arrow Electronics Pty. Ltd.	117
Atram Pty. Ltd.	78
Audio Engineers Pty. Ltd.	145
Aurisma (A'sia) Pty. Ltd.	123
Australian EEB	190
Aust. Radio and TV College Pty. Ltd.	155, Outside Back Cover
Brashts Hi-Fi Centre	82
Bright Star Radio	167
British Institute of Careers	52
Broadway Electronics Pty. Ltd.	64, 65
Broadway Electronics (Sales) Pty. Ltd.	4, 5
Celotex Industries Pty. Ltd.	160
Chapman, Maurice & Co. Pty. Ltd.	166
Charmac Pty. Ltd.	66
Classic Radio Service	104
Classic Tape Recorders	137
Colstock Electronics	131
Convoy International Pty. Ltd.	131
Cunningham R. H. Pty. Ltd.	121, 169
Deltch Bros.	186
Delttron Electronics	148
Delttron Electronics Service Div.	195
Delttron Importing Co.	195
Douglas Trading Pty. Ltd.	94
E. D. & E. (Sales) Pty. Ltd.	114, 115
Electronic Despatch	183
Elmeasco Instruments Pty. Ltd.	63, 106, 113
E.M.I. (Austra) Ltd	156
Encl. Electronics (Stereo) Pty. Ltd.	19, 51, 90, 93, 106, 133, 134, 145, 187
E.R.I. Pty. Ltd.	103
E S & I Electronics	113
Ferris Bros. Pty. Ltd.	156
Foot, Richard (Aust.) Pty. Ltd.	151
General Accessories Ltd.	44, 154, 164
Goldring Eng. (A'sia) Pty. Ltd.	6, 7, 122, 123
Goodmans Loudspeakers Ltd	132
Gray, Simon Pty. Ltd.	28, 48, 136, Inside Back Cover
G.R.D. Instruments Pty. Ltd.	100
Green Corporation Ltd.	128
Haco Distributing Agencies Pty. Ltd.	Inside Front Cover
Haldex Pty. Ltd.	102
Ham Radio Suppliers	188
H.B. Radio Sales	63, 127
Heating Systems Pty. Ltd.	150
Homecrafts Pty. Ltd.	150
International Correspondence Schools	157
IRH Components Pty. Ltd.	20, 42, 72, 184
Jacoby, Mitchell and Co. Pty. Ltd.	14, 84, 142, 180
J.H. Reproducers Co.	46
Kitsets Australia	65
Lafayette Electronics	162
Leak, H. J. (Aust.) Pty. Ltd.	124
Leroya Industries Pty. Ltd.	80
Magnetic Sound Industries	110
Magrath, J. H. & Co. Pty. Ltd.	152
Manufacturers Spec. Prod. Pty. Ltd.	95, 168
Marconi School of Wireless	190
Market Place	190
Mastersound Sales Pty. Ltd.	128
McMurdo (Australia) Pty. Ltd.	38
Miniwatt Electronics Division	34
Mullard-Australia Pty. Ltd.	34
National Radio Supplies	178, 179
Noyes Bros. Pty. Ltd.	78
O'Rourke Enterprises (Reg.)	122
Photronic	119
Plessey Ducon Pty. Ltd.	118
Plessey Rola Pty. Ltd.	144
Pre-Pak Electronics	144
Racal Electronics Pty. Ltd.	30
Radio Despatch Service	85
Radio House Pty. Ltd.	45, 102, 182
R.C.S. Radio Pty. Ltd.	148
Rhodes, K.L.	81
Rutherford Electronics Pty. Ltd.	74
Sansul Electric Co. Ltd.	8, 9
Sato Parts Co. Ltd.	164
Shalley, Peter Electronics Pty. Ltd.	154
Standard Telephones & Cables Pty. Ltd.	26
Stereo Music Systems	62
Stott's Tech. Correspondence College	155
Tasmanex Pty. Ltd.	101
Technical Training Int. Pty. Ltd.	138, 139
Tecnico Electronics Division	50
Tel-Leigh-Tubes Pty. Ltd.	177
Trio Electronics Inc.	96, 97
Truscott Electronics	191
Turnbull, Bill	191
Union Carbide Australia Ltd.	32, 66
United Radio Distributors Pty. Ltd.	35
United Trade Sales Pty. Ltd.	143
University Graham Inst. Pty. Ltd.	88
Wagner, R. H. & Sons Pty. Ltd.	150
Warburton Frankl Ltd.	56, 175
Wedderspoon, W. C. Pty. Ltd.	120
Weston Electronics Pty. Ltd.	168
Willis, S. E. Trading Co.	47, 147, 189
Wireless Institute of Aust. (N.S.W.)	163
Wonder Wool Pty. Ltd.	134
Zephyr Products Pty. Ltd.	38, 174

CLASSIFIED ADVERTISERS

USE THIS FORM FOR YOUR NEXT ADVERTISEMENT IN THE
ELECTRONICS Australia MARKET PLACE



MARKET PLACE

FOR SALE
 WANTED
 READER SERVICE
 POSITION VACANT

To the Advertising Manager,
ELECTRONICS Australia,
Box 2728 G.P.O.
Sydney, 2001

Endorsement
Residential Address
State

• Please insert the following advertisement in the issue
• I enclose P. Note/Cheque for \$..... being full payment for lines at \$0.72 per line. (Min. 2 lines)

ELECTRONICS Australia

SPECIAL ORDER FORM

Guarantee yourself a complete set of issues for your library with no copies missing.

SUBSCRIPTION RATES

Australia, New Guinea, Fiji, New Zealand	PER YEAR \$5.00
Elsewhere	\$7.00

POST THIS COUPON TO:

The Circulation Manager, **ELECTRONICS Australia,**
Box 2728, G.P.O., Sydney, 2001, Australia.

Name

Address

Enclosed is \$..... for years. Start with

(Please use cheque, money order, etc. Do not enclose cash)

Please write in block letters with ink or ball-point pen. Number of insertions



Which is the most popular imported speaker?

The Wharfedale Super 8.

More Wharfedale Super 8 high-fidelity speakers are sold in Australia than any other imported single speaker unit — because the Super 8 *sounds* like a much larger wide-range loudspeaker.

Frequency response is from 20 Hz. to 20,000 Hz. when used in a suitable enclosure, the massive magnet structure provides extremely high sensitivity and the audio quality is unequalled when comparisons are made with similarly sized speaker chassis. In addition to these attributes the transient performance of the Super 8 is quite remarkable.

It's easy for the handyman/music lover to

build a matching enclosure for his new Super 8 from detailed specifications which are included in the box containing your purchase. Where space is a problem enclosures for the Super 8 can be as small as 1 cubic foot!

Addition of the Super 8 makes a world of difference to your hi-fi system, radio, TV set or your tape recorder . . . and many Super 8's have been successfully added to car radios. Whatever the application, the Wharfedale Super 8 will add a new dimension of Wharfedale superior sound. The comprehensive Wharfedale range is available at all good audio stores.



WS8-1

Australian National Distributors:

Simon Gray Pty. Ltd.

Head Office: 28 Elizabeth St., Melbourne, Vic. Tel. 63 8101*

Sydney Office: 22 Ridge St., North Sydney, N.S.W. Tel. 929 6816

Canberra Office: 31-33 London Circuit, Canberra City, A.C.T. Tel. 49 6050

INTERSTATE REPRESENTATIVES:

N.T.: Pfitzner's Music House, Smith Street, Darwin. Tel. 3801

Q'land: Sydney G. Hughes, 154-158 Arthur St., New Farm, Brisbane. Tel. 58 1422

S.A.: Eilco Sales Pty. Ltd., 7-9 Osmond Terrace, Norwood, S.A. Tel. 63 4844

Tas.: K. W. McCulloch Pty. Ltd., 57 George Street, Launceston. Tel. 2 5322

W.A.: Athol M. Hill, 613-615 Wellington Street, Perth. Tel. 21 7861



YOU CAN EARN BIG MONEY IN RADIO- TELEVISION

ASK YOURSELF THESE 3 QUESTIONS!

1. Am I in a dead-end job? 2. Could I earn more by learning more? 3. Could I use my spare time to get ahead?

If the answer is yes, there is room for you in radio/television/electronics.

NOW IS THE TIME TO TRAIN!

Does your job offer good prospects — real security? Does it hold your interest? If not, now is the time to do something about it. Television is expanding daily. It's the most exciting subject you can study. The sky's the limit for the **trained man** . . . but **only** the trained man. Radio and television technicians are in huge demand. Train for success now, in Australia's fastest-growing industry! **Join the ranks of skilled men** . . . the Australian Radio and Television College can train you for a bright future with unlimited prospects. Send for the free booklet "Careers in Radio, TV & Electronics" and find out how A.R.T.C. can bring you success—in your own business or as well-paid technical staff!

A.R.T.C. CAN TRAIN YOU AS IT HAS THOUSANDS OF OTHERS

For nearly 40 years A.R.T.C. has successfully trained thousands of progressive Australians who realised how much the training could mean to

them. Now they're making big money in radio and television. Training can bring you success, too.

FOR A FEW PENCE PER DAY YOU CAN STUDY THE A.R.T.C. WAY

. . . in your spare time, you can equip yourself for a rewarding career in radio/television. The future belongs to the trained.

The A.R.T.C. "Service Engineering Course" teaches you from the ground up . . . step by step . . . at your own pace. Remember, opportunity is always knocking for the trained man!

PRACTICAL UP-TO-DATE LESSONS

At the work benches and lecture halls of A.R.T.C. — or in your own home by correspondence — you can learn every necessary aspect of radio and television, every application of fundamental principles. The Course gives you both basic and advanced instruction.

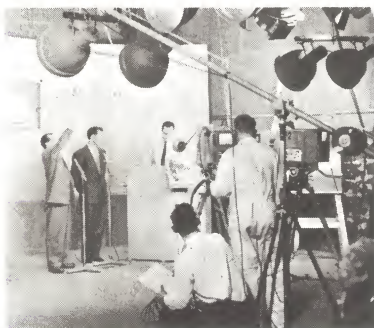

No previous experience or high educational standard required . . . only enthusiasm and normal intelligence. A.R.T.C. will give you

all the instruction you need. Each lesson is made easy to understand by numerous illustrations and diagrams. The Course adapts itself to your requirements, your speed. It's up to you! Instruction is individual and intensely practical.

THOUSANDS OF SUCCESSFUL STUDENTS HAVE PROVED THIS

Make your spare time earn money for you while training at home.

Many students make extra money after only a few weeks' tuition. Train at the modern A.R.T.C. workshops, if more convenient.

GET INTO ONE OF THESE PROFITABLE CAREERS IN RADIO/TELEVISION

There is a career for you in one of the many phases of radio/television, including manufacture, servicing, research, sales, executive positions, armed forces, audio, etc., etc.

A.R.T.C. can help you gain one of these sought-after careers. Remember it's the trained man who wins, every time!

MAIL COUPON NOW!

Safeguard your future! You are invited to send in the coupon below. A.R.T.C. will mail you by return their big free and post-free booklet "Careers in Radio, TV and Electronics." This exciting book shows you definite steps you can take towards a big future—how you can succeed in life and find satisfaction in doing a worthwhile job well.

AUSTRALIAN RADIO AND TELEVISION COLLEGE

PTY. LTD.

E. S. & A. BANK BUILDING,

Cnr. Broadway and City Road, Sydney.
(Opp. Grace Bros.) Phone 211-4244 (3 lines.)

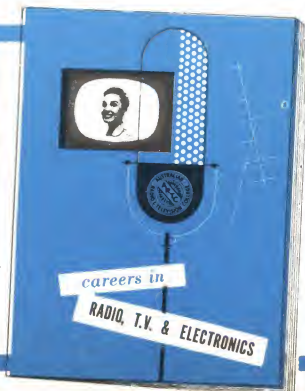

AUSTRALIAN RADIO & TELEVISION COLLEGE PTY. LTD.

206 Broadway, Sydney, N.S.W.

Dear Sir,
Please send me, without obligation, your free booklet "Careers in Radio TV and Electronics."

NAME

ADDRESS

.....