

ELECTRONICS

Australia

September, 1969



40¢

Ionospheric station, Norfolk Island (See page 10)

MACHINES THAT LISTEN
CERAMIC FILTER TESTS



1MHz to 1Hz CALIBRATOR
MUSICAL FREQUENCY LIST

Be your own switched on Bach In 30 minutes



(feel what it's like to be master of National's great 30-watt electronic cathedral-shaker.)

We want you to try our new organ. The dazzling SX2100. With our unique 'colour chord' system you can learn to play inside 30 minutes. If you play piano, you're on your way to the most tingling musical thrill you'll ever experience. The SX2100 is al-

most a living thing. It sings with incredible depth and feeling. It gives you a near limitless range of tones and expression. And the sound is rich and clear. Try it and see what we mean. Walk right into your nearest National Electronic organ dealer and sit

yourself down at the SX2100. We don't mind how long you play. A few minutes. An hour. All day. If you can't drag yourself away at 5.30, remember the man in the store has something that'll let you keep playing as long as you like. An order book.

NATIONAL

electronic organs



To Haco Distributing Agencies Pty. Limited,
57-69 Anzac Parade, Kensington, N.S.W. 2033.

Please tell me more about the National SX2100
electronic organ, and where I can try it.

NAME.....

ADDRESS.....

..... POSTCODE.....

U697

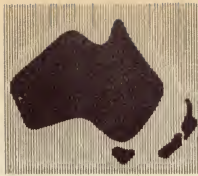

ELECTRONICS Australia

incorporating RADIO, TELEVISION & HOBBIES

ABC certified circulation in excess of 47,000

volume 31, number 6

CONTENTS — SEPTEMBER, 1969

IONOSPHERIC PREDICTION: *Ionospheric Prediction Service stations are currently being re-equipped with sounding units designed and built by I.P.S. engineers. (Page 10.)*

CRYSTAL FREQUENCY CALIBRATOR: *Although designed primarily as an adjunct to digital instruments, this versatile unit should also prove to be extremely useful to those interested in the construction of a crystal-controlled clock. (Page 52.)*

TEMPERED MUSICAL SCALE: *We believe this to be a world first — a computer print out to 11 significant figures of the tempered musical scale, octaves based on A—448Hz to A—425Hz. (Page 95.)*

CONTROL TONES ON MAINS: *Professor R. M. Huey, current president of the I.R.E.E., enters the lists in the controversy concerning control tones on mains electricity supplies, and their effect on electronic equipment. (Forum, page 72.)*

features

- 3 Editorial
- 10 Charting the ionosphere
- 17 Arthur Cushen's world tour
- 20 Machines that listen and obey
- 24 Superconductive power

technical digest

- 27 Are fuel cells on the way out?
- 29 Flat television screen displayed
- 31 Automatic TV gun assembler

technical articles

- 40 Powered loudspeaker for portable recorders
- 47 FET preamp for ceramic pickups
- 52 Solid-state crystal frequency calibrator
- 59 Ceramic resonators, part 1
- 67 Transistor damage
- 77 Fundamentals of solid state, chapter 5
- 87 Reliability and M.T.B.F.
- 95 The tempered musical scale
- 99 A filter tuner one-valve receiver (historical)

regular features

- 33 Scientific and industrial news
- 72 Forum
- 89 Serviceman
- 105 Reader built it
- 113 Audio topics—scratch filters
- 116 Record reviews—classical
- 121 Record reviews—documentary
- 125 Record reviews—devotional, popular, jazz
- 140 Trade reviews and releases
- 153 Technical books and publications
- 161 Amateur band news and notes
- 173 Listening around the world
- 181 Answers to correspondents
- 190 Market place
- 192 Index to advertisers
- 87 Notes and errata

Editorial Office:

12th Floor, 235-243 Jones Street,
Broadway, Sydney, Australia.
Phone 2-0944.

Postal Address:

Box 2728, G.P.O., Sydney, 2001, Australia.

Advertising:

Manager, Selwyn Sayers.
Sydney Representative, Bill Summons.
Office: 8th Floor, 235-243 Jones Street,
Broadway, Sydney, Phone 2-0944.
Melbourne Representative, Clarrie Levy.
Office: 392 Little Collins Street,
Melbourne, 3000. Phone 67-8131.

Circulation:

Alan Parker, Manager.
Office: 9th Floor, 235-243 Jones Street,
Broadway, Sydney, Phone 2-0944.

Subscription Rates: See back page.

Representation:

Melbourne—John Fairfax and Sons Ltd., 392 Little Collins Street, 3000. Phone 67-8131.
Brisbane—Sungrature Pty. Ltd., 78 Elizabeth Street, 4000. Phone 2-6688.
Adelaide—John Fairfax and Sons Ltd., 104 Currie Street, 5000. Phone 51-3502.
Perth—Sungrature Pty. Ltd., 454 Murray Street, 6000. Phone 21-8217.
Newcastle, N.S.W.—Associated Newspapers Ltd., 22 Bolton Street, 2300. Phone 2-3696.
London—John Fairfax and Sons (Aust.) Ltd., Reuter Building, 85 Fleet Street.
New York—The Sydney Morning Herald Ltd., 1501 Broadway, New York, N.Y., 10036.

Distribution:

Distributed in N.S.W. by Sungrature Pty. Ltd., Jones Street, Broadway, Sydney, N.S.W.; in Victoria by Sungrature Pty. Ltd., 392 Little Collins Street, Melbourne; in South Australia by Sungrature Pty. Ltd., 104 Currie Street, Adelaide; in Western Australia by Western Press; in Queensland by Gordon and Gotch (A'sia) Ltd.; in New Zealand by Truth (N.Z.) Ltd.; in Tasmania by Davies Bros. Ltd., "Mercury," Hobart.

Copyright. All rights reserved.
Devices or arrangements shown or described herein may embody patents. Information is furnished without responsibility for its use and without prejudice to patent rights.

a new approach to
low cost, high
performance power
control for domestic
electrical equipment

Although widely used in professional and industrial equipment to provide reliable, efficient and silent control of power, cost considerations have prevented the general use of thyristors for domestic applications.

Now as the result of a breakthrough in thyristor design the Miniwatt BT100A with its outstanding performance and reliability makes 240

volt mains control for household and light industrial appliances a practical and economic proposition. The BT100A is sturdily constructed, easily mounted and is designed for a hard life in such applications as:

- motor speed controls
- light level controls
- temperature controls
- voltage conversion
- alarm systems

Quick Reference Data

Repetitive peak reverse voltage	max. 500 V.
Average forward current	max. 2 A.
Storage temperature	-40 . . . + 100°C
Voltage: to trigger all devices	> 2 V
Current: to trigger all devices	> 10 mA

new low cost Thyristor BT100A

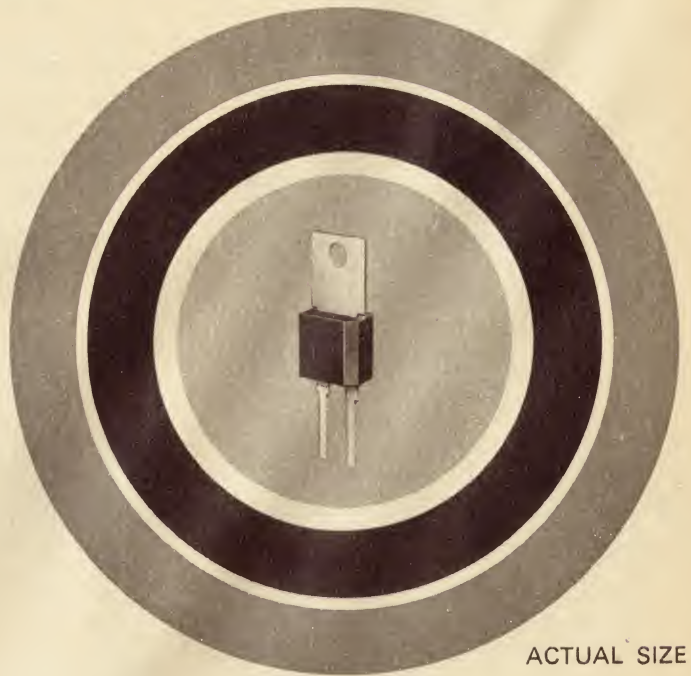

ACTUAL SIZE

*For detailed data and Application
Information contact*

"Miniwatt"

ELECTRONICS DIVISION OF PHILIPS
ELECTRICAL PTY. LIMITED

Sydney • Melbourne • Adelaide
• Perth • Canberra • Brisbane.



EDITORIAL VIEWPOINT

by Neville Williams

Colour TV tests . . .

During the past couple of months, television stations in Sydney and Melbourne have radiated colour material during the small hours of the morning, using pictures and sound deliberately unrelated. Carried out in collaboration with the Australian Broadcasting Control Board and equipment manufacturers, the tests were intended to give the Australian authorities and engineers first-hand experience with the PAL colour system, and to help them determine some of the finer details in standards and specifications appropriate to the Australian situation.

EDITOR

Neville Williams
M.I.R.E.E. (Aust.)
(VK2XV)

ASSISTANT EDITOR

Philip Watson
A.M.I.R.E.E. (Aust.)
(VK2ZPW)

TECHNICAL EDITOR

Jamieson Rowe
B.A. (Syd.),
B.Sc. (Tech., N.S.W.)
M.I.R.E.E. (Aust.)

TECHNICAL STAFF

Ian Pogson (VK2AZN)

Harry Tyrer (VK2ZHH)

Anthony Leo (VK2ZHK)

John Horsfield

Robert Flynn

Leo Simpson

One of the important aspects which needed to be verified was that of compatibility between colour transmissions and existing Australian monochrome receivers — a matter which formed the subject of our editorial last month. Indications are that, with a suitable and entirely practical ratio between picture carrier power and sound carrier power, no significant compatibility problem exists. In the wide selection of receivers installed in the homes of engineers and technicians—old receivers, new receivers and middle-aged ones — the presence of the colour sub-carrier did not disturb operation of the basic circuitry and visual beat patterns were not obvious at ordinary viewing distances.

This seems to demonstrate the validity of our closing quip, last month, "Compatible — By courtesy of the A.B.C.B."

Tests of this nature were necessary — and will continue to be so from time to time — to prove standards, specifications and equipment, as Australia gradually gears for colour television. It is important to realise, however, that the tests indicate only that the authorities are moving towards the time when they can announce the phasing in of colour— not less than eighteen months from that date. We have tipped that the announcement will come before the end of the current year but we could be wrong. Even then it means that the first official colour programs will not be put to air until mid 1971.

It is natural, in such a situation, for viewers to be highly curious and to want to glimpse colour television, even if pictures of "Skippy" run with the soundtrack of "New Faces." But, it will be time enough to reach for the cheque book when the major manufacturers have come to light with receivers which they are prepared to guarantee in a manner commensurate with the anticipated price.

In the meantime, I have a suspicion that right now is a pretty good time to buy an extra monochrome receiver, if you need one. Colour does not supersede monochrome, any more than a luxury stereogram in the lounge room supersedes more humble receivers on the beach and in the car. There's not going to be a clearance of "obsolete" black and white sets below current prices. On the contrary, my tip is that, faced with the need to reorganise for colour production, manufacturers may have to curtail production for a while, bringing to an end the present buyer's bonanza.

Come to think of it, I could do with a new set myself!

On the cover

The Ionospheric Prediction Service's sounding station at Norfolk Island is one of nine operating in Australia and its territories. These stations gather data on which are based prediction charts of usable frequencies over various signal paths for the months ahead. These enable telecommunications and broadcasting authorities concerned with long-range transmissions to select suitable frequencies for any time of the day or night. This station has sounding equipment designed and built by I.P.S. engineers. (Story, page 10.)

ON SALE
THE
FIRST MONDAY
OF EACH MONTH

INSTROL HI-FI...

AMPLIFIERS



10 WATTS R.M.S. PER CHANNEL, ONLY \$86.50

Choose from the following solid-state stereo amplifiers, all competitively priced from just \$86.50.

- Instrol 20-20 Mk. II, 10 watts R.M.S. per channel
- Kenwood TK150U, 13 watts R.M.S. per channel
- Sansui AU 222, 16 watts R.M.S. per channel
- Kenwood TK 250U, 20 watts R.M.S. per channel
- Sansui AU 555, 20 watts R.M.S. per channel

Or perhaps you prefer something more elaborate such as the Kenwood KA 6000, Sansui AU 777, Quad 33/303, Leak Stereo 70 or Sony TA 1120. Whatever you desire in amplifiers, Broadway Electronics caters for you. Ask for our free Hi-Fi Catalogue, which contains details of all the above amplifiers; or call at our modern Showroom and hear for yourself the brilliant performance of these amplifiers.

PLAYERS

The new **DUAL Models 1210 and 1212** changers are now on display, and are being demonstrated at our modern showrooms.

The model **1209 Dual Changer** will be available towards the end of this month.

Ask for our special mail order price-list and catalogue, containing full details of the new Dual range, together with all other brands of players and changers.

Our showroom also has on display a full range of Garrard, Elac, Labcraft, B.S.R., Goldring, Thorens and other well-known brands of players.

New Range of **DUAL** . . .
NOW
AVAILABLE!



The new **Dual 1210 turntable** now has many outstanding features, including: Tone up balance adjustment; direct dial stylus force adjustment; Auto/Manual cue control; Pitch control; as well as the high precision German workmanship for which the Dual name is renowned.

PLAYER STANDS

The Instrol range includes a wide variety of player stands and combination amplifier-player cabinets. High quality perspex covers (clear and tinted) are also available, some hinged, others separate.

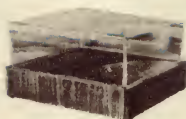

PRICE DETAILS:

Player Stands, from \$8.00

Perspex Covers, from \$8.00

Amplifier/Player Cabinets (with perspex cover), from \$24.50.

HI-FI equipment & cabinets

SPEAKER SYSTEMS

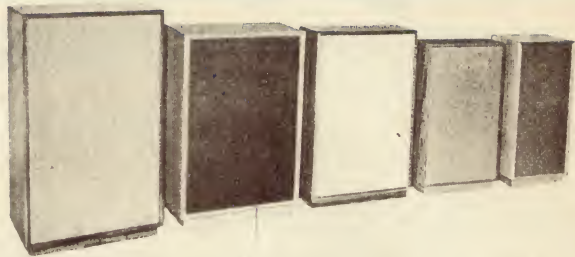

A wide range of speaker systems, with attractive Instrol Speaker Enclosures, are on display at our modern showroom.

Outlined below is a mere sample of the many systems available:

- Goodmans Sherwood 3-way system with Instrol teak enclosure **\$250.00**
- Magnavox new 2,000 cu. in. "twin 8," 3-way speaker system, featuring approved Magnavox enclosures. Only **\$67.50**
- Magnavox 10WR 2-way speaker system with approved Magnavox enclosures **\$59.00**
- Wharfedale unit 3-speaker system kit of parts with the new Wharfedale teak enclosure kit. Complete **\$50.50**
- New Playmaster "One Point Three" speaker system in either kit form or built and tested. Priced from (in teak) **\$34.50**
- Instrol-Playmaster bookshelf system, available in built and polished enclosures or as kits of parts. From **\$30.00**
- Instrol-Playmaster "Point Four" speaker system, attractively priced, as built unit or kit. From only **\$31.50**
- Instrol Mini Speaker system in teak, either in kit form or built and tested. From **\$23.50**

Ask for our free Hi-Fi Catalogue which contains details of all the many speaker systems which are available.

"The Flamenco" Mediterranean Setting

This magnificent new Instrol 3 Cabinet setting which provides for amplifier, player, tape deck plus generous record and tape storage, is also available as a pre-cut kit to assemble yourself.



MAKE YOUR OWN FOR HALF THE COST

A few hours of your time gives you the terrific fun of assembling this magnificent Mediterranean setting, which will finish up 100% professional in appearance and function. All timber panels are precision cut and fit together perfectly. Absolutely all assembly materials are included, plus complete instruction book. When assembled, you can stain, polish or antique colour it to suit your own colour scheme. Price for the 3 cabinet setting kit, only \$179, half the cost of a ready-made unit. If you prefer terms, \$37 deposit and small monthly repayments.

Packed with quality features:

- Drop down front for amplifier compartment.
- Dignified period-style handles.
- Magnetic door catches.
- Spacious equipment and storage compartment.
- 2½ cu. ft. enclosures to suit quality speaker systems.
- Equipment or speaker cabinets available separately if required. Free descriptive leaflet available.



INSTROL CABINET and HI-FI CATALOGUES

BROADWAY ELECTRONICS (SALES) PTY. LTD.

32 GLEBE PT. ROAD, GLEBE, N.S.W.

Telephone 660-1171. Only 100 yards from Broadway.

OPEN SATURDAY MORNINGS.

Send Coupon for FREE CATALOGUE. (Please enclose postage stamp.)

NAME

ADDRESS

.....

.....

Instrol Hi-Fi Instrol Cabinets

poly-planar

ULTRA-THIN, WAFER-TYPE, WIDE-RANGE, ELECTRO-DYNAMIC SPEAKERS

Replace Cone Speakers in Any Application.

The Poly-Planar speakers employ a lightweight acoustic panel supported by a frame of compatible plastic material to reproduce a wide range of frequencies. There is also a minimum of piston motion resulting in low distortion and high electromagnetic efficiency. The unique construction of these electromagnetic loudspeakers provides a combination of characteristics not available from conventional cone speakers or equivalent designs.

ADVANTAGES OF THE POLY-PLANAR

- Wafer-thin construction permits new design and installation ideas.
- Wide-range performance—low distortion.
- Rugged—meets extremes of shock and vibration.
- Wide temperature operating range: -20° to $+170^{\circ}$ F.
- Completely waterproof—more than just moisture-proof.
- Easily incorporated into present equipment.
- Priced competitively with conventional loudspeakers.
- Bi-directional polar pattern
- High-power capability.
- Lightweight.
- Ideal for consumer, industrial or military applications.
- Completely replaces the conventional cone speaker.

20 WATT MODEL



SPECIFICATIONS

Model designation:
P-20 Poly-Planar

Power capability:
20 watts peak

Frequency range:
40 cps—20 KC/S

Sensitivity: 85 DB/M
for 1 watt electrical input
Input impedance: 8 ohms

Size (WxDxL): 1-7/16"
x 11-3/4" x 14-11/16"

Weight: 19 ounces

5 WATT MODEL



SPECIFICATIONS

Model designation:
P-5 Poly-Planar

Power capability:
5 watts peak

Frequency range:
60 cps—20 KC/S

Sensitivity: 80 DB/M
for 1 watt electrical input
Input impedance: 8 ohms

Size (WxDxL): 13/16"
x 4-1/2" x 8-1/2"

Weight: 10 ounces



Trade enquiries: **GOLDRING ENGINEERING (A/ASIA) PTY. LTD.**
443 Kent Street, Sydney. 29 1275

Distributed throughout Australia by **AURIEMA (A/ASIA) PTY. LTD.**
443 Kent Street, Sydney. 29 6485

Now BSR McDonald Total Turntable



BSR McDonald 600

Every BSR McDonald automatic turntable is precision made in Great Britain to the most exacting specifications. Upon their arrival in Australia, every model is unpacked and re-tested under actual playing conditions. That's why BSR service calls are the lowest in the industry—and perhaps that also explains why BSR sells more turntables than anyone else in the world.

The BSR McDonald 600 encompasses every fine feature one could desire in an automatic turntable.

- Heavy cast, specially balanced turntable.
- Dynamic anti-skate control applies continuously corrected compensation at all groove diameters.
- Cueing and pause control lever allows for exact positioning of stylus on record and permits you to interrupt listening and reposition to same groove.
- Micrometer stylus pressure adjustment permits $\frac{1}{3}$ gram settings from 0 to 6 grams.
- Automatic lock on tone arm after last record is played.
- Dynamically balanced 4-pole induction motor has high torque, constant speed design—assuring minimum rumble and wow.
- Low mass tubular aluminum tone arm perfectly counter-balanced both horizontally and vertically.
- Resiliently mounted, coarse and fine vernier adjustable counter-weight.
- Tone arm is jam-proof even if it is held during the cycling operation.
- Clip-in cartridge holder, provides universal mounting and quick change. (Optional)

BSR McDonald 600—\$114 (with C1/ST4 cartridge).



BSR (A'Asia) Pty. Ltd.,

Southern Section Industrial Estate,
St. Marys, N.S.W.

Phones: 623-0375, 623-0376

Wholesale Distributors

Goldring Engineering (A'Asia) Pty. Ltd.

N.S.W.: 443 Kent St., Sydney, 29-1275

Vic.: 368 Little Bourke St., Melbourne, 67-1197

Qld.: 235 Edward St., Brisbane, 2-7010

W.A.: 91 Hay St., Subiaco, Perth, 8-4988

S.A.: 77 Wright St., Adelaide, 51-5117

Three great ways to start a stereo system.



5000A

4000

AU-555

Sansui 5000A A powerful 180 watt AM/FM Multiplex Stereo Tuner Amplifier with IC and FET circuitry. Wide 15 to 30,000Hz power bandwidth with less than 0.8% distortion. Functional black window styling with linear scale FM tuning band.

Sansui 4000 Top-performing 160 watt AM/FM Multiplex Stereo Tuner Amplifier capable of powering up to three sets of speaker systems. IC and FET circuitry. Power Bandwidth: 20 to 30,000Hz. Less than 0.8% in distortion. Double tuning meters.

Sansui AU-555 Professional Stereo Control Amplifier. 60 watts. Wide 20 to 30,000Hz bandwidth. Less than 0.5% harmonic distortion. Four outputs and seven inputs, plus independent pre- and main amplifier sections.

And three great ways to complete it.

SP-200



SR-3030BC

SS-2

For a thoroughly professional separate stereo system, match these components with any one of the amplifiers on the left.

SP-200 Rich sounding 3-way 5-speaker system with 40 watts handling ability. 35 to 20,000Hz in frequency response. Oiled-walnut

enclosure with exclusive *Kumiko* fretwork grille.

SR-3030BC Precision 2-speed manual turntable. Direct belt drive system. Tubular tonearm with unique Inside Force Canceler. Wow and flutter less than 0.09%.

SS-2 Comfortable wearing stereo headphone set. 20 to 18,000Hz frequency response. Less than 1% distortion.

sansui

CHARTING THE EVER-CHANGING

By L. I. McGarry and S. M. Campbell *

The importance of the ionosphere in long distance radio communication, and some of the effects of its continually changing state, were dealt with in the article "Sunspots, the Ionosphere and DX" which appeared in our March, 1968, issue. This article describes equipment used in preparing predictions issued by Australia's Ionospheric Prediction Service. The information obtained is published monthly, principally for the use of professional organisations concerned with long distance radio communication — such as the telecommunications and broadcasting authorities — but is available to publications associated with amateur activities.

* This article is based on a report entitled "The Type IIID Ionosonde" and is published by permission of the Ionospheric Prediction Service Division of the Bureau of Meteorology of the Department of the Interior.

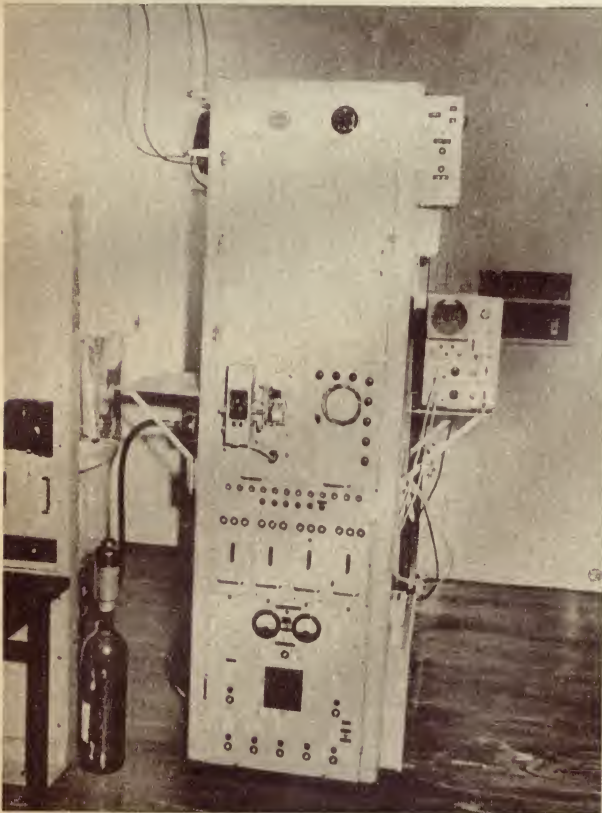

Figure 1. The Type IIID Ionosonde used by the Ionospheric Prediction Service.

Radio signals may be propagated from place to place by several methods. Ionospheric predictions are concerned with the propagation of radio signals by reflections from the ionised layers of the upper atmosphere. This method of propagation is generally used for communication over long distances. The frequencies of the signals transmitted by ionospheric reflection usually lie in what is known as the high frequency (HF) band, but, under certain conditions, medium frequency (MF) signals can be transmitted in this way and, under other special conditions, frequencies in the lower part of the very high frequency (VHF) band can also be propagated by ionospheric reflection.

Ionospheric predictions give the expected monthly median conditions. Calendar months are used. There is a normal day-to-day variation about the medians but at present no attempt is made to predict the daily values. It has been observed that for the F2 layer on most days the value of the characteristics are within fifteen per cent of the median value. For the other layers this day-to-day variation is found to be much smaller.

The propagation of radio signals via the ionosphere may involve one or more reflections from the ionosphere. Single reflection propagation is referred to as single-hop propagation, or the 1F or 1E mode depending upon the layer (F or E) from which the signal is reflected. There is a limit to the length of a single-hop, set by the height of the reflecting layer. When the distance to be covered is greater than the maximum possible length of one hop, the signal is reflected between the ionosphere and the ground in a succession of hops and this is generally referred to as multi-hop propagation, although the more precise description 2F, 3F or 4F mode may be used at times. (The numeral in each expression referring, of course, to the number of hops.)

In order that signals transmitted from one place should be received at another it is necessary for the frequency of the signal used to be below the maximum usable frequency (MUF) for that path. The MUF depends upon the state of the ionosphere at the point of reflection and the angle at which the signal strikes the layer. This angle depends upon the height of the layer and the length of the hop. The characteristics of the ionosphere change and so also will the MUF, hence the need for predictions.

The Ionospheric Prediction Service Division operates nine ionospheric sounding stations in Australia and its territories; two in Antarctica, and one each in New Guinea, Townsville, Brisbane, Canberra, Hobart, Cocos Island, and Norfolk Island. These stations are equipped with vertical incidence ionospheric sounders, which are called ionosondes. Four of the stations use type IIID ionosondes which were designed and built by the I.P.S.D. The remaining stations are equipped with older types of ionosondes, which are gradually being replaced.

The ionosondes produce ionograms on 35mm film. These ionograms are scaled and the data obtained are used for prediction and research purposes. The intention of this article is to describe briefly the type IIID ionosonde. A photograph of this equipment is reproduced in figure 1.

The equipment is used to sound the ionosphere regularly at vertical incidence, by the pulse echo technique, over a range of radio frequencies. This provides a relationship between the transmitted frequencies and the virtual heights above the ground of the reflection points of the pulse echoes from the ionosphere. From this relationship the heights of the various layers and the critical frequencies (and hence the density of ionisation) of the layers can be obtained which, together with other specialised information, provide valuable data for both prediction and research purposes.

A pulsed transmitter is operated into a vertically

IONOSPHERE

directed antenna over a varying frequency range, 1-20MHz. The resulting echoes from the ionosphere are received at a similarly located antenna by equipment automatically synchronised to the same frequency as the transmitter. The echoes received are applied to a trace on a cathode ray tube which is calibrated so that the time taken for the transmitted pulse to be reflected back to the receiver may be measured as a function of virtual height (h') versus frequency (f). Suitable height and frequency markers are superimposed on the image, which is photographed, producing a recorded graph called an ionogram of the ionosphere (figure 2).

The ionosonde consists of the following main sections:

- (a) a variable frequency pulse transmitter
- (b) a variable frequency receiver
- (c) a photographic recording system
- (d) pulse and timebase generators
- (e) an automatic programming system
- (f) power supplies
- (g) auxiliary equipment.

The block diagram of the ionosonde (figure 3) indicates how the various sections are associated with the final filming of the results. A brief description of each section follows.

The basic frequency control circuit is the variable frequency oscillator (VFO) which operates between the frequencies of 31 and 50MHz. This VFO drives a pair of broadband amplifiers, one of which is coupled to the transmitter mixer and the other to the first mixer stage of the receiver. For the transmitter this variable 31-50MHz



ABOVE: The Ionospheric Prediction Service sounding station at Norfolk Island, one of nine such stations in Australia and its territories.

BELOW: Figure 3. Block schematic of the ionosonde used at the ionosphere sounding stations.

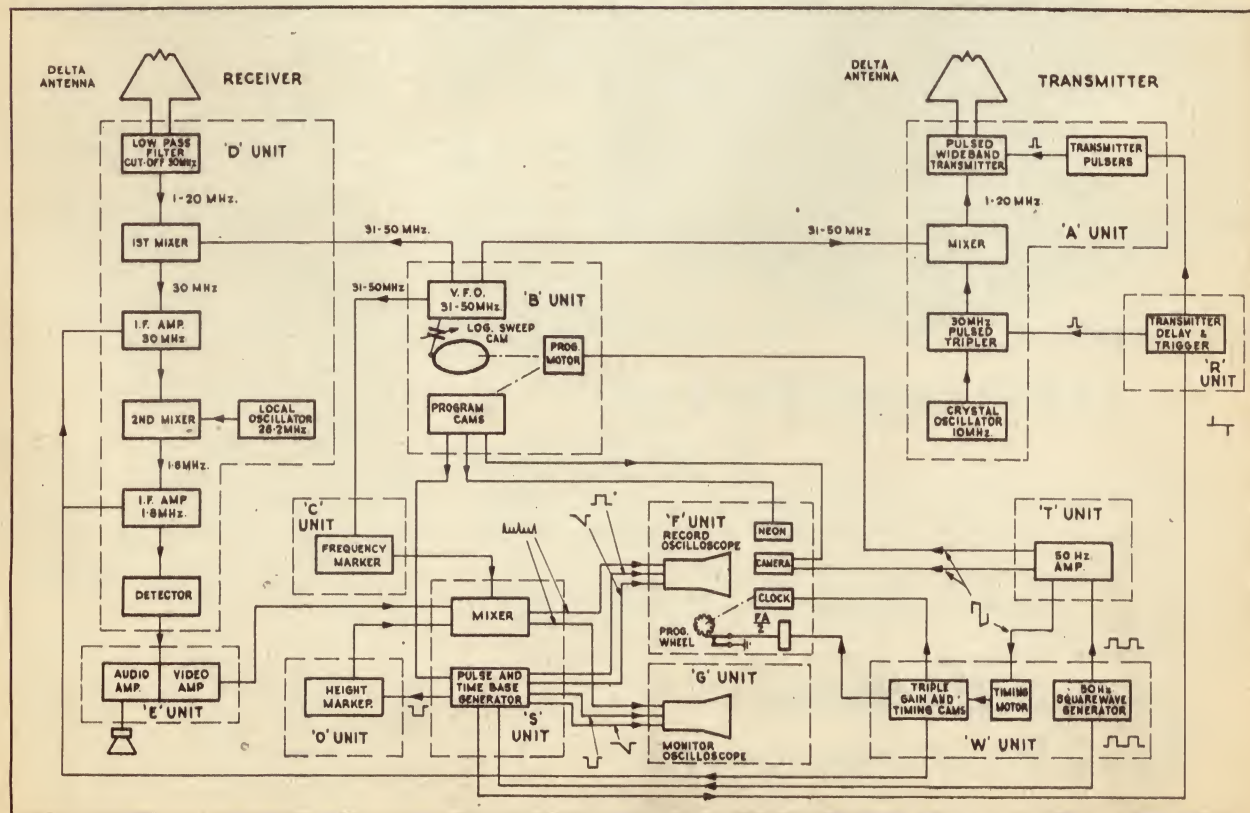

SOUNDWOOD

Apollo speaker system



price breakthrough
\$36.50 each.

SPEAKERS

6½" Bass Unit featuring high compliance suspension, consisting of large diameter spider and synthetic rubber pneumatic rim, allows large excursions without non-linearity.

Specially treated cone to provide sharp cut-off at the crossover frequency. Aluminium voice coil former provides long term stability and increased power handling capacity.

Soundwood 5" Dual Cone Treble Unit.

SOUNDWOOD

Apollo speaker system

MANUFACTURED BY Soundwood Products Pty. Ltd. P.O. Box 14, Frenchs Forest. N.S.W. 2086.

signal is heterodyned with a signal from a pulsed fixed-frequency oscillator (FFO) at 30MHz.

The heterodyne difference between the VFO and pulsed FFO is obtained from the mixer thus providing a 1-20-MHz pulsed signal. The frequency sweep from 1-20MHz takes 30 seconds and, for constant percentage accuracy of measurement and for ionogram production techniques, a logarithmic frequency sweep is used. The signal is then amplified by several simultaneously pulsed broadband amplifiers before being applied to a separately pulsed push-pull output stage.

A transmitter pulse width of 100 microseconds has been found to be the optimum width for best resolution, but the width may be varied from 60 to 260 microseconds for special purposes.

As shown in the block diagram of the receiver, the antenna signals are applied to the mixer stage via a low pass filter having a cut-off frequency of 30MHz. The mixer derives its conversion voltage from the same VFO that supplies the transmitter. The first intermediate frequency stage operates at 30MHz which is always the difference frequency of the 1-20MHz transmitted signal and the 31-50MHz VFO frequency. This arrangement ensures that the receiver is automatically tuned to the transmitted frequency.

The 30MHz signal is converted to a second IF of 1.8MHz, after which it is detected and passed to the video amplifier. The video signal is combined with the height and frequency markers, and is applied to the cathodes of the display tubes in the record and monitor units.

The receiver may be switched to allow manual gain control or to make, automatically, triple gain runs on the hour as described later.

Two cathode ray tubes are used, one is used with a 35mm camera for making photographic records, and the other is a long persistence type, for monitoring purposes.

Figure 2 shows a typical daytime height versus frequency plot, recorded by the 35mm camera, which shows the heights of the various layers, the critical frequency and other specific information. The oscilloscope display for this method of recording is shown in figure 4. It is a horizontal trace which is photographed on film moving continuously in a vertical direction. The horizontal trace is intensity modulated by video, height markers and frequency markers using the following methods:

(a) **Video.** Signals from the receiver, including echo pulses, cause dark gaps in the trace.

(b) **Height Markers.** The time taken for a pulse of radio energy to travel 50KM and return is 333 microseconds. Every 333 microseconds a height marker is generated which causes a narrow gap in the trace, and the vertical motion of the film extends these gaps into the horizontal lines shown in figure 2.

(c) **Frequency Markers.** A sample VFO output is connected to the frequency marker unit and mixed with the harmonics of a 1MHz oscillator, producing zero beats at each MHz. These beats are used to blank the complete oscilloscope display for about 100 milliseconds and thus produce a line on the film.

(d) **Ground Pulse.** The direct pulse from the transmitter to the receiver (ground pulse) also causes a dark gap in the trace. There is provision to delay the transmitter pulse with respect to the time base so the ground pulse and a height marker pulse occur simultaneously. This ensures that the first height mark represents a height of 50KM.

By moving the film vertically past the horizontal trace at a speed of 4 inches per minute, as shown in figure 5, a two-dimensional record is obtained on the film.

The CRT is an electrostatically deflected type selected for its high light output and definition of trace. The date-time information is recorded on the film by momentarily flashing a set of small lights which illuminate a modified IBM date-time printer unit.

The monitor display employs a similar tube having long persistence. An actual ionogram is "painted" on the screen during the sweep. To achieve this, the scan shown in figure 4 is presented vertically and a slow time base is used to move the trace across the screen in the sweep time. By using positive intensity modulation, the long persistence of the screen leaves an ionogram which can be examined immediately. A movie can be made by photographing a series of sweeps, using a 16mm camera, although this is not a regular feature. A panoramic scan is illustrated in figure 6.

Provision is also made for switching the monitor unit on to "A" scan mode shown in figure 7. This feature is often useful in examining echo and signal characteristics.

The pulse and timebase generator unit generates the waveforms required to synchronise the operations of the transmitter, sweep generator, brightening pulse generator, and height maker units. A pulse repetition rate of 50 pulses per second is used, and the timing may be derived from the mains supply, or from an internal crystal-controlled source. This latter source is normally used for ionosonde soundings.

The principle of operation of the automatic programming system is illustrated in figure 8. The square wave output from a 50Hz amplifier drives a timing motor and a program motor. The timing motor controls a time clock and the receiver triple gain switching, and the program motor drives the logarithmic sweep cam and the program cams.

The time clock is mechanically coupled to a program wheel and a date-time drum. The required times of soundings are arranged by removing appropriate teeth from the program wheel. The wheel is normally arranged so that the 30 second sweep occurs on the hour, and at 1, 15, 30, 45 and 59 minutes past the hour.

The receiver gain switching system causes the quarter hour programs to occur on medium gain, and a triple

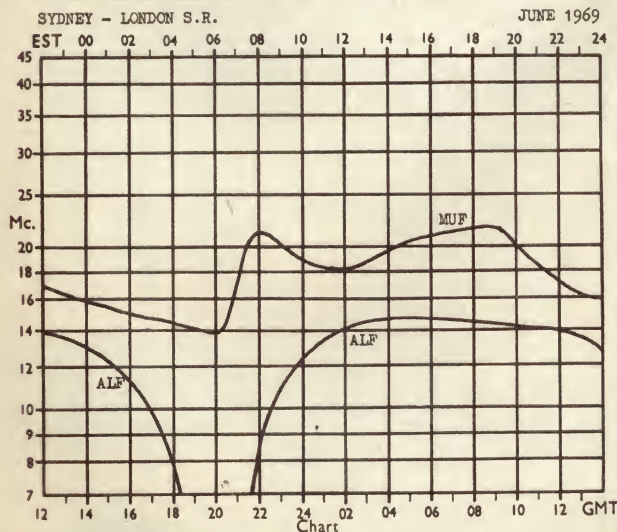

Information relating to maximum usable frequency (MUF) and absorption limiting frequency (ALF) for the months ahead is supplied to many authorities in the form of a series of charts, such as that reproduced above. Each chart relates to a particular signal path, and shows the predicted variations in MUF and ALF over each 24-hour period for the month in question.

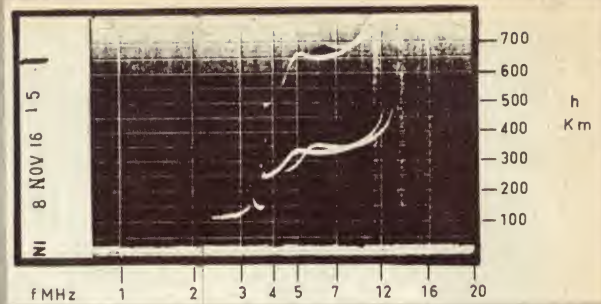

Figure 2. An "ionogram" of the ionosphere, produced by photographing from the face of a cathode ray tube. Note that the axes correspond to frequency (X axis) and height (Y axis).

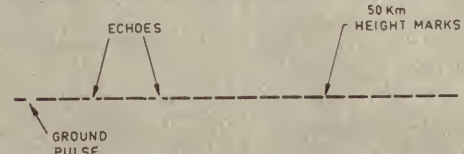

Figure 4. Example of the horizontal oscilloscope trace from which the "ionograms" are obtained by moving the film past the oscilloscope screen continuously in a vertical direction. The trace is intensity modulated by video, height markers, and frequency markers, as explained in the article.

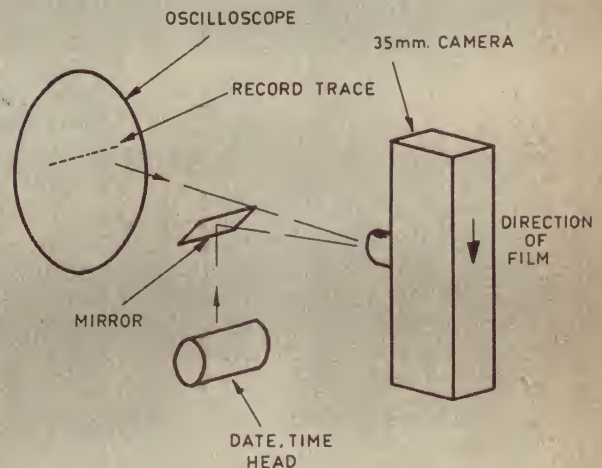

Figure 5. Diagram showing the arrangement of recording the "ionograms." The film in the recording camera moves in a vertical direction at a speed of 4in per minute. Note that date and time information is added simultaneously by means of the date-time head and mirror.

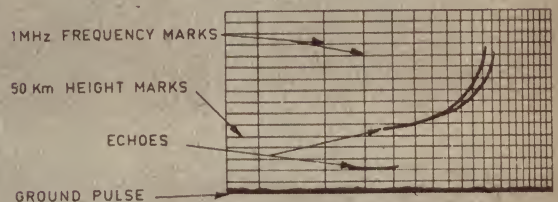

Figure 6. A panoramic scan contained by the method described above.

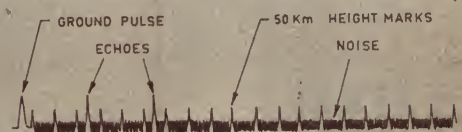
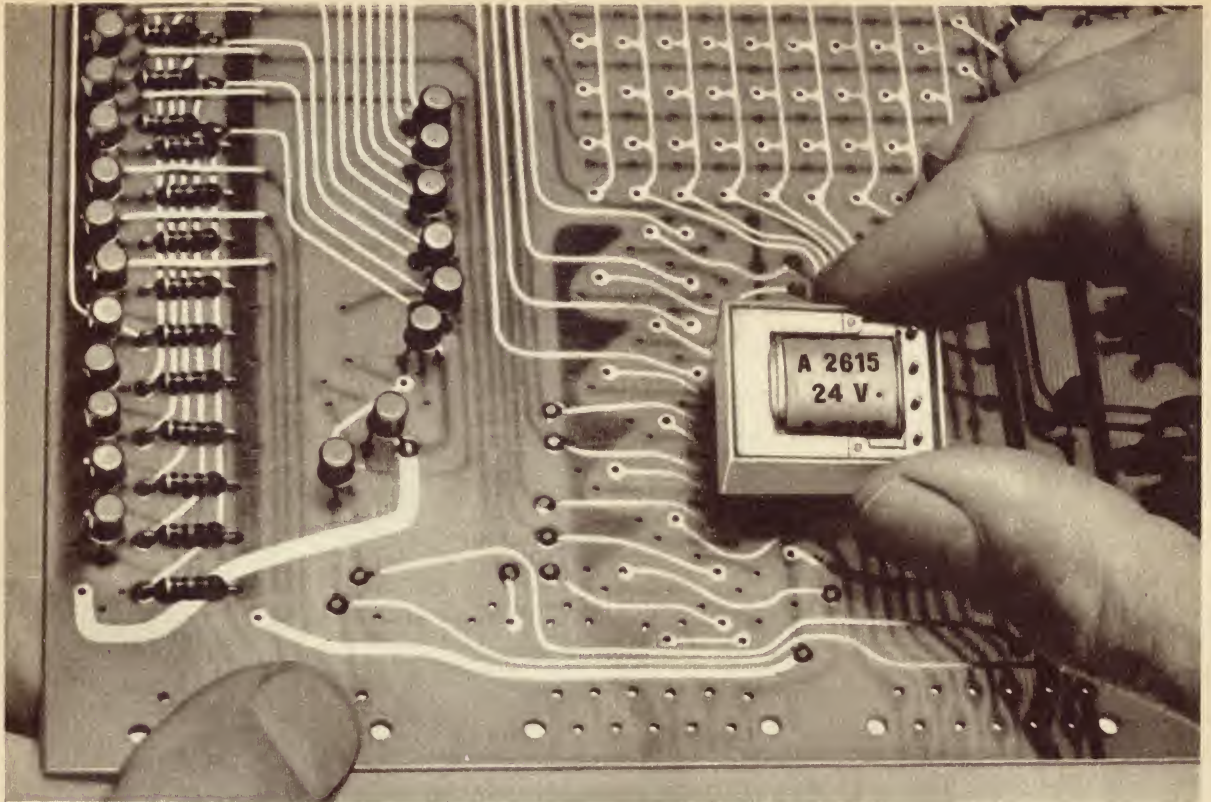

Figure 7. Another method of displaying echo and signal characteristics, using the technique known as "A" scan.



STC PZ Miniature Relays have a giant advantage

You can direct-mount them.

With STC PZ miniature relays the need for a separate socket has been eliminated. They can be directly mounted onto printed circuit boards for simpler assembly and more compact layout.

This makes for efficiency and savings all the way round.

STC PZ miniature relays are available with four (PZ4) or six (PZ6) changeover twin contacts rated at .2A AC/DC, 100v DC, 6 to

48v DC coil, operating at .5w minimum. You'll like the immediate delivery and they come at a price that matches their size. Only \$2.36 for PZ4 and \$3.14 for PZ6 (100 up OEM).

For further details contact **Standard Telephones and Cables Pty. Ltd.**, Electronic Components Division, Moorebank Avenue, Liverpool, N.S.W. Phone 602 0333. Melbourne 480 1255. Canberra 49 8667. Brisbane 47 4311. Adelaide 51 3731. Perth 21 6461. Launceston 31 2511.

AN
ITT
ASSOCIATE

worldwide telecommunications and electronics



gain run to occur on the hour. The triple gain run is low gain at one minute to the hour, medium gain on the hour, and high gain at one minute past the hour. This triple gain run enables more information to be extracted at times when ionospheric conditions mask detail on the ionograms.

The logarithmic sweep cam varies the frequency of the VFO from 31 to 50MHz during the sweep period. The program cams switch the pulse and timebase generator, the camera, and the date-time lights on and off at the appropriate times.

Provision is also made for continuous monitoring and sweeping without the camera running. When the recorder is switched to continuous operation, medium gain runs will occur at all times except programmed times, when the normal triple gain switching takes control. All sweeps are programmed to commence at the beginning of each minute thereby ensuring that correct time is always imprinted on the film.

The crystal-controlled clock is necessary because ionospheric data are exchanged throughout the world and all results must be accurate with respect to time for correct comparisons to be made. At some remote locations where ionospheric sounders are operated, the mains supply varies considerably from the nominal 50Hz, and mains driven synchronous motors would not be satisfactory. In the event of a mains failure the timing unit is automatically switched over to battery operation so that the clock and timing system will run continuously.

The major requirements of the aerial system are as follows:

- The impedance of the system must be relatively uniform over the frequency range, and as nearly equal to the output impedance of the transmitter (of the order of 800 ohms) as possible;
- The radiation must be substantially in the vertical direction;
- The aerial must be as efficient a radiator as possible.

The aerial used is a variation of the "vee" antenna, and a crossed version with a separate delta section for receiving and transmitting is now in common use. It is called a vertical delta and is shown in figure 9.

The type IID ionosonde has been in use for five years. During this time it has been modified to make it more reliable and to obtain better records. One recent modification was the inclusion of the 50Hz amplifier to provide crystal-controlled voltage to drive the timing, program and camera motors. The ionosonde contains approximately 80 valves and 130 semiconductor devices. The electronic circuits have been very reliable. Many of the more troublesome faults have been associated with the electro-mechanical devices in the ionosonde, such as cam-microswitch arrangements and the timing clock. Future development work will include replacing all electro-mechanical devices, and most valves circuits, with solid state circuits. Some special problems are involved when designing solid state circuits to operate in the same cabinet as a 10KW pulsed transmitter.

Current development projects include an integrated circuit system of automatically programming the ionosonde. One project for future consideration is the provision of logarithmic tuning from 1 to 20MHz for the transmitter and receiver using all solid state devices in place of the mechanical tuning cam.

Another project under consideration is to digitise the output of the ionosonde so that results will be in a more suitable form for analysis by a computer.

The information acquired by the techniques described above is used as the basis for the prediction charts which are supplied each month to the interested organisations. The sample chart on page 13 indicates the form in which the predictions are presented. Charts are presented for point-to-point long-distance circuits (for example, Sydney to London) and for shorter point-to-point circuits in and around Australia. Separate charts are prepared for a number of circuits of interest to New Zealand and New Guinea users.

It will be noted that both maximum usable frequency (MUF) and absorption limiting frequency (ALF) are given for a 24-hour period. The frequencies which can be used at any time are those which fall between the two traces. In some cases, the MUF and ALF lines cross, indicating that there is a communications blackout predicted at those times.

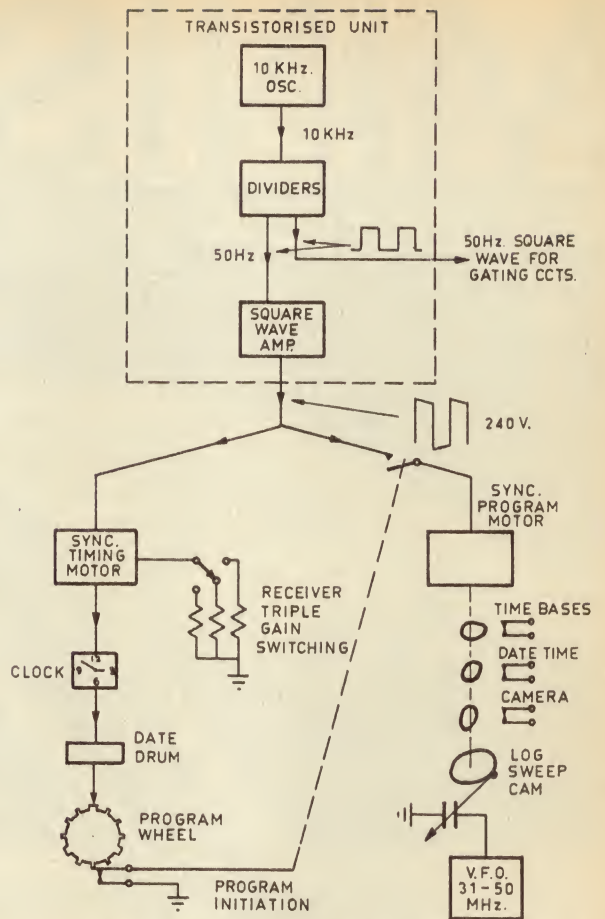

Figure 8. Simplified schematic illustrating the principle of operation of the automatic programming system used at the ionosphere sounding stations. This causes sweeps to be made over a range of frequencies at 15, 30 and 45 minutes past the hour, and a triple gain series of three sweeps at one minute before the hour, on the hour, and one minute after the hour.

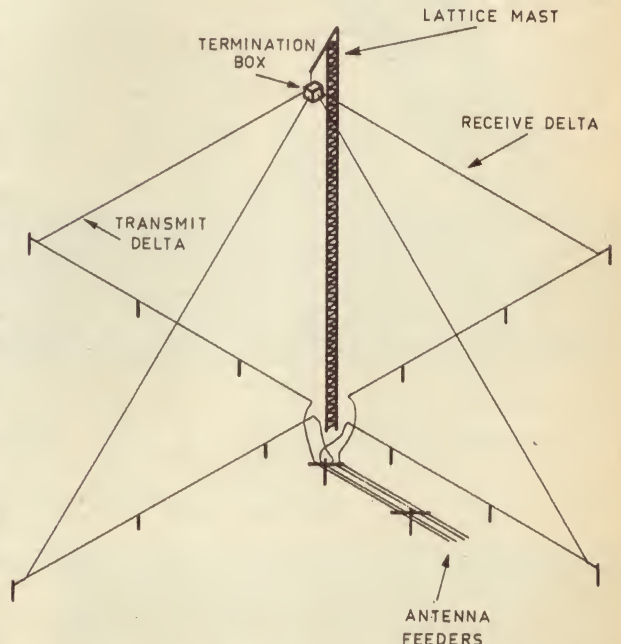

Figure 9. The basic configuration of the vertical delta aerial used at the ionosphere sounding stations. A variation of the V aerial, it uses separate sections for receiving and transmitting.

MINISCOPE

THE ONLY IRON OF ITS TYPE — IN THE WORLD



This unique soldering iron has a big heart for hard work. Small but sturdy, it performs all the work usually requiring a conventional iron of up to 75 watts. Check these features before you buy just any soldering iron.

SPEED Only 5 seconds initial heating up time from cold, then practically instantaneous.

CONTROL Temperature control at your finger tips. Heat only where, when, and as much as needed.

VERSATILITY Copes with all soldering jobs — from miniature components to large solder lugs. Can even be operated from a 6 volt car battery.

MINI WEIGHT Only 1¾ oz. complete, and its comfortably designed handle reduces operators fatigue, on the longest jobs.

ECONOMY Consumes current only whilst in use. Performs all the functions of other irons up to 75W.

GUARANTEED Time tested dependability, backed by full guarantee.

LESS MAINTENANCE Longer tip life. NO expensive heating element to replace. Spare tips and carbon elements readily available from your Scope distributor.

LABOUR SAVING Fast warm-up—always ready, cuts wiping, re-tinning and filing of tips to a MINIMUM.

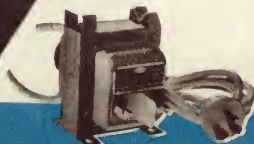

TRANSFORMER by NATRONICS
A Miniscope operates on voltages from 2.5V to 6.3V A.C. or D.C. or from 240V A.C. mains through a "Natronic" Scope Transformer fitted with 6 ft. 3-core flex and 3 pins mains plug. \$7.65.

MINISCOPE, beautifully presented in a handy re-usable plastic pouch-pack, ideal for neat storage and easy portability. MINISCOPE \$5.28

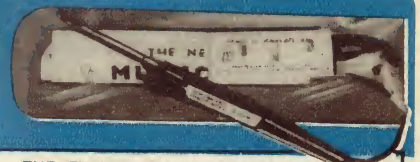

AVAILABLE FROM ALL MAJOR ELECTRICAL WHOLESALEERS AND HARDWARE STORES — THE FULL GUARANTEE APPLIES ONLY WHEN THE IRON IS USED WITH THE APPROVED 'SCOPE' TRANSFORMER. MANUFACTURED BY NATRONICS PTY. LTD.

AUSTRALIAN & OVERSEAS AGENTS:

IRH COMPONENTS PTY. LIMITED

A Subsidiary of IRH Industries Limited

THE CRESCENT, KINGSGROVE, 2208, N.S.W. 50 0111

VICTORIAN OFFICE:
143 Christmas Street, Fairfield.

TASMANIA: W. P. MARTIN PTY. LTD.
202 Argyle Street, HOBART.

S. AUSTRALIA: COLLETT & CANT PTY. LTD.
103 Halifax Street, ADELAIDE.

N.Z.: H. W. CLARKE (N.Z.) LIMITED
42-46 Cable Street, WELLINGTON, C.3

N.Z.: H. W. CLARKE (N.Z.) LIMITED
10 Teed St., New Market, AUCKLAND, S.E.1



W. AUSTRALIA: I. W. HOLMAN & CO.
854 Beaufort St., Inglewood. PERTH

QUEENSLAND: K. H. DORE & SONS
505-507 Boundary Street, BRISBANE

ALSO TOWNSVILLE AND ROCKHAMPTON

VOTED FIRST BY A HOST
OF SATISFIED USERS.

Please post — free illustrated literature and specifications

My Name _____

My Address _____

City _____ Postcode _____

AROUND THE WORLD IN 80 DAYS

Arthur Cushen reports on his world tour

At the conclusion of his world tour, which began in April and finished in July, our short wave correspondent Arthur Cushen has many experiences to relate. During his tour, Arthur visited numerous broadcasting bodies in all quarters of the globe, spoke to hundreds of broadcasters and engineers, consulted with many well known DX personalities in other countries, and attended the recent International DX Parliament in Sweden.

On our arrival in Los Angeles, on the start of this world tour, we were met by representatives of The Voice of America who interviewed us for V.O.A. From then on the hospitality and kindness shown by broadcasters in all continents we visited reached, at times, the point of embarrassment, so keen were they to show me their organisation. One also became aware of the prestige which I, as a listener, have overseas. From heads of departments downward everyone was keen to meet a listener from New Zealand, and in Europe, as their most distant listener, technical questions on reception in New Zealand of programs were of paramount interest to the stations visited. During the period away every opportunity was taken to sample listening conditions and throughout the period some 50 medium wave stations were reported, stations which would not be possible to be heard in New Zealand. The climax of the visit to the International DX Parliament at Halmstad, Sweden, was the presentation of an award to me, the highest ever given to a radio listener.

UNITED STATES: During our stay in Los Angeles, we were met by representatives of The Voice of America, which operates a studio in that city, and were interviewed for their world wide programming. Medium wave station KABC requested me to appear on their all-night program, but this was deferred, and I spoke to the station audience by telephone.

Outside Sacramento is the high transmitting site known as the Dixon relay, and here we were shown the facilities which V.O.A. use to service the South Pacific. Three new 260KW transmitters are being installed and the programs are now being carried by satellite across the Pacific to the Philippines. At Denver, Colorado, we visited the frequency and time station WWV at Fort Collins, which provides world-wide reception on 5, 10 and 15MHz. Plans are underway to introduce English announcements, giving ionosphere information. These would replace the present CW transmissions of this material. While in Denver, a meeting was held with the International Radio Club of America at the home of president, Larry Godwin. A visit was paid to KDEN, Denver, a station which broadcasts three programs.

These are (1) a medium wave program which is fully automatic, all music being on tape, jingles, commer-

cial and news being on tape cassettes (2) an FM station which operates 24 hours a day with live programming (3) a program of uninterrupted music, carried to stores and hotels and received at these points on a special receiver which the station rents to the businesses.

At Detroit, we visited CBE Windsor, across the river, and met Ronald D. Scott, well known for his "country style" programs on Radio Canada. We also spent a day visiting other broadcasting organisations.

CANADA: At Toronto Airport, we were met by Gray Scrimgeour, executive secretary of the North American Association of Radio Clubs, who presented me with the "Man of the Year" award for outstanding services to short wave radio, which had been formerly announced at a recent NAARC Convention. At the Montreal Airport we were met by some of the staff of Radio Canada, who had planned a full schedule of engagements while in their city, and this was to be repeated many times by other broadcasting organisations. Interviews were made for Radio Canada Short-Wave Club in English and also for three other language programs, while Earle Fisher had me behind the microphone for his "Listeners' Corner" program. Earle also took us to Ottawa to visit the CBC monitoring station at Britainia Heights, which relays to the home program many items for the B.B.C. and also

checks the signals of several international broadcasters. Here we were to see the first of the Racal receivers now widely used for monitoring.

The C.B.S. studios are located in an old hotel, and the Radio Canada Short-wave Club is in the I.B.M. Building further along the street, but plans are under way for a new Broadcasting House of 23 floors, while at Sackville, several 250KW transmitters are scheduled to come into operation in 1971.

UNITED KINGDOM: On Monday, May 19, we arrived in London and shortly after reported in at Bush House and met Henry Hatch, who is my contact in the B.B.C. engineering section. The next two weeks were full of interesting projects, interviews for B.B.C. World Radio Club, visiting the B.B.C. Tatsfield monitoring station; meeting heads of departments; and seeing the analysis of the weekly reports which I have been sending since 1942, and which since May are processed on computers.

We also visited Broadcasting House, the home of the domestic B.B.C. Radio, where I was interviewed for "In Touch" on Radio 4. Also, some time was spent nearby at the extensive B.B.C. publicity section, which provides a world-wide photo service for newspapers.

HOLLAND: As I have been a regular broadcaster over Radio Netherlands at Hilversum, the Dutch hospitality was extended to us in full from the moment my wife and I arrived at Amsterdam airport. We were met by Harry van Gelder, head of the English section, and taken to Hilversum. At their modern broadcasting studios (a view of which appears in the photograph overleaf) we were interviewed for several programs, and met the famous Edward Startz of the "Happy Station." We enjoyed our "Nice Cup of Tea" with Eddy, who had recently celebrated 40 years of his Happy Station program. A visit was paid to Lopik, the site of Radio Nederlands' transmitters, laid out with typical Dutch neatness. Studios and aerial systems at this site provide a good service world-wide. The station recently opened a relay at Bonaire in the Netherlands Antilles, and is now building a second relay on Madagascar, due to commence in 1971. After this



In London, Arthur Cushen (right) was interviewed by Henry Hatch, of the B.B.C.'s World Radio Club.

date, it is planned to modernise the transmitters at Lopik.

SWEDEN: The highlight of the visit was indeed Sweden, for not only did we stay with Arne Skoog, the DX Editor of Radio Sweden, but we also flew down to Halmstad on the south-west coast for the International DX Parliament and meeting of the European DX Council. While in Stockholm, we were the guests of Radio Sweden for two days at their studios in the finest broadcasting building we visited on our tour. Interviews for "Sweden Calling DXers" and for other programs were made, and some time was spent in monitoring both at Radio Sweden and at Arne Skoog's home. In Sweden, the technical side of broadcasting is handled by a Government department. Plans for three new 500KW transmitters for the short-wave service have been announced.

At the Halmstad meeting, the first day was devoted to the European DX Council, and this included revision of the Constitution to allow club representation instead of country representation as at present. A new country list, which will regulate counting of radio countries, was also discussed, while a Report Form Committee presented a survey conducted with 50 international broadcasters, which

DENMARK: As guests of Radio Denmark at lunch in their open-air restaurant on top of the Radio House of Copenhagen, we started off a busy time in Copenhagen. Lunching with the director and chief engineer of Radio Denmark, we found that, like Radio New Zealand, they have been using their transmitter for 21 years. Recent modifications have given it a better signal for its 50KW output. Interviews, photographs and the like were again the usual procedure, and one full day was spent with the former editor of the World Radio TV Handbook, O. Lund Johannsen, and later with the new editor, J. Frost. In the evening, the handbook was discussed over dinner at the "7 Small Homes" restaurant.

WALES: The first ever British convention of a DX club was held at Neath, when the World DX Club was host to its members in Britain and overseas. This convention enabled us to spend two days listening to tapes, discussing DX problems, and enjoying the company of some of Britain's top DXers. As guests of the president, Allan Thompson, we were able to examine verifications received in Europe. Allan Roth, from the U.S.A., Maarten van Delft, Holland, and some of the prominent British listeners such

grams are transmitted by FM link to the transmitting site some 18 miles away. In Rome proper we visited the program section of Vatican Radio, where programs in over 30 languages are prepared. We then drove by car to Santa Maria de Galeria, the site of the Vatican transmitters, some 18 miles from Rome. At present the SW transmitters consist of five 100KW units. A new 250KW transmitter is being installed to operate on medium wave, 1529KHz. After lunch, at a cafe overlooking one of the Italian lakes, we were taken to Rome Radio and met the director of R.A.I. Through his interpreter we had a long discussion on the reception of Rome Radio in the Pacific, the lack of English programming for this area and the improvement in program content. The director accompanied us part of the way to the airport and after saying farewell we went the rest of the journey in his car.

SOUTH AFRICA: The warmth of the South African winter in Johannesburg was matched by the hospitality of the Radio South Africa staff, who in three days took us over 400 miles of the Johannesburg area in an S.A.B.C. car. Interviews and photographs at Broadcasting House and a meeting with the director were included in a busy day, also a visit to Radio Bantu. Radio Bantu provides a seven-language program on FM. One program in Zulu is on the air 18 hours a day with commercials, and recordings made at S.A.B.C. by native musicians brings in a mail of 80,000 letters a month. The entire station is staffed by native people except for the director and the controller of each program who, besides speaking English or Afrikaans, must have the knowledge of the language being broadcast.

A morning was spent at Panorama, some 18 miles north of the city, the site of the S.A.B.C. monitoring service and R.S.A. technical operations. The monitoring service checks signals from some 25 international broadcasters each day, while in the nearby technical section the reports from observers throughout the world are studied and the work of frequency assignment is carried out. Head of this department is Leo van der Walt, known as DX Editor of Radio South Africa. A visit was also paid to the transmitting site at H. R. Verwoerd, some 40 miles south-east of the city. Here the chief engineer, Colin Taylor, is justly proud of his wonderful station, which he designed and put into operation. The aerial system, located on a 1,300-acre site, must be the most impressive in the world. Some 38 towers rise to a height of between 300 to 640 feet, the highest one carrying the seven arrays beamed on New Zealand. The towers were constructed by the manufacturer in long lengths, but cut and erected on the site, using native labour under the guidance of Mr Taylor.

Radio South Africa is at present broadcasting in 10 languages. After the erection of a new aerial to serve the Far East and, on the reverse side South America, the station will serve all parts of the world. The transmitting hall with four 250KW transmitters and switching arrangements are the most modern we saw.



The magnificent modern building housing the studios of Hilversum Radio, in Holland.

showed the type of material the stations require for verification of reports. In Sweden, the community looks on the DX hobby as a valuable source of youth activity, and so it was not surprising that the foreign visitors were the guests of the city on sight-seeing tours, and at a banquet. The DX Parliament included an international panel which discussed reception reports and received questions from over 200 present at the convention hall from 17 different countries. The panel consisted of the DX editors and broadcasters from Sweden, Holland, Finland, Austria, Denmark, and HCJB (Ecuador), and myself from Radio New Zealand. The Governor of the Province of Hlland was the guest at the dinner and made some special awards to the overseas visitors. HCJB received the award for the best DX program in Swedish, and I received a special award for verifying over 200 countries under the new European DX Council country list.

as Noel R. Green (shortwave) and Charles Malloy (medium wave) added much to the discussion.

SWITZERLAND: The Swiss "Merry-Go-Round" team of Bob and Dave at the S.B.C. Broadcasting House, in Berne, were there to greet us and during the day interviews were recorded for their program. The S.B.C. studios are located in a modern building which has a magnificent mosaic mural depicting earth, sun and moon, which is made up from over five-million small pieces of stone. From this building is originated, in addition to the shortwave services, a wired six-language service which is carried by landlines to homes throughout Switzerland, to those areas where reception of the medium wave and VHF/FM services is poor.

ITALY: Vatican Radio has its studios at the top of a hill in Vatican City, which commands a view of the entire city of Rome. From here pro-

(Continued on Page 177)

Some electronics engineers say Willi Studer is a genius.



The new REVOX A77 is certainly a fine tribute to his rare talents.

Since its recent release the Revox A77 stereo tape deck has been acclaimed by professionals and tape enthusiasts all over the world. Read this excerpt from a recent review in "Hi-Fi Sound" . . .

"This recorder is a masterpiece of electronic and mechanical engineering . . ." "The electronic function and motor control system certainly sets a new standard in deck design and performance which, coupled with the really high fidelity electronic performance, puts this new range of REVOX recorders in the connoisseur class."

What will your New Revox A77 do for you?

You will make and replay tapes to professional standards—many REVOX recorders are used for precisely this purpose. Every desirable facility is there — sound-on-sound, multi-play, echo, on-off tape monitoring, playback to both European and American equalisation standards. Add to these features calibrated VU meters, electronic speed change for the two tape speeds of $7\frac{1}{2}$ and $3\frac{3}{4}$ i.p.s., 3 motor tape transport system, use of silicon planar transistors . . . and you get a frequency response of 30-20,000

Hz. +2, -3 dB at $7\frac{1}{2}$ i.p.s., a signal-to-noise figure of better than 58 dB. and a wow and flutter figure of a maximum 0.08% at $7\frac{1}{2}$ i.p.s. Space does not permit detailing of the complete specifications of the REVOX A77. Unabridged data is available now. The REVOX A77 stereo tape deck is on continuous demonstration!

Ask for a trade-in valuation on your old equipment, or, if you cannot come to town, ask for your personal EMQ*. You'll save more *and more* at Encel Electronics! Call or write now!

*Encel Mail Quote.

ENCEL
ELECTRONICS (STEREO)
PTY. LTD.

Head Office:
431 Bridge Rd., Richmond, Victoria 3121. Tel. 42 3762.

Australia's Greatest Hi-Fi Centre *Wholesalers *Trade-ins accepted

VOICE RECOGNITION: machines

Progress in the design of machines that can recognise human speech and then act on commands has been gathering momentum in recent years, and this dream of science fiction writers may become a reality sooner than we realise.

In the near future, an American astronaut will literally be able to talk his way throughout space. Free from the confines of his capsule, he will be able to manoeuvre himself simply by speaking commands such as "up," "down," "yaw right," and "roll left" into a microphone enclosed in his space helmet. A voice-controlled device would respond to the order by activating a switch that would move the spaceman in the desired direction. Both of his hands would be left free for making repairs, taking photos, transferring cargo, or, perhaps, rescuing a stranded fellow astronaut.

This is one of the more dramatic examples of the potential of voice and sound in the control of operations and communications systems. For more than three decades, scientific and industrial organisations—especially electronics companies—in the United States and elsewhere have been experimenting in the field of voice recognition. The ultimate goal of these researchers is to build a machine that would be able to hear, understand, and act in response to the continuous spoken word. This would solve two major problems.

First, such a device would enormously simplify man's communication with machine, a process that has become increasingly cumbersome as technology has advanced. Instead of preparing an elaborate set of programmed instructions or actuating a myriad of dials, keys, switches, and levers, a man could direct a machine to perform a set

of operations just by speaking to it. If he wants to dial a telephone, he could simply voice his own code number and a central computer system would instantly retrieve his speech profile. Then, he would speak the desired phone number and the machine would recognise the digits and automatically complete the call. Scientists at Bell Laboratories have been attempting to design such a system. In another case, a man who desires information could merely phrase a question to a computer, which would then retrieve the data and print out a reply or respond with synthesised speech constructed from some 200 to 500 prerecorded basic sounds.

Equally important, the voice-recognition device could end the pressing problem of the overcrowding of the frequency band width—vital to almost all areas of communication, from radio to telephone. For example, a police officer in a patrol car could respond to a call from headquarters by speaking into the recognition device. There, his speech would be reduced to a digital code and reconstructed at the other end of the communications system into synthesised speech. By transmitting the code, rather than human speech, the band width requirement is reduced by a ratio of 1,000 to one.

A machine that could produce an accurate printed or oral record of continuous speech is still quite far on the research horizon. However, scientists have successfully built several electronic systems that recognise limited vocabularies. One system developed by RCA that reacts to a spoken postal sorting code, and may soon be put in operation by the U.S. Post Office Department, is discussed in detail later in this article.

All speech-recognition machines—regardless of complexity—are based on identification of acoustical clues. Speech is broken down into its smallest possible component,

This schematic drawing illustrates the similar manner in which human beings and machines listen and react to an oral command—in this instance, the operation of a typewriter.

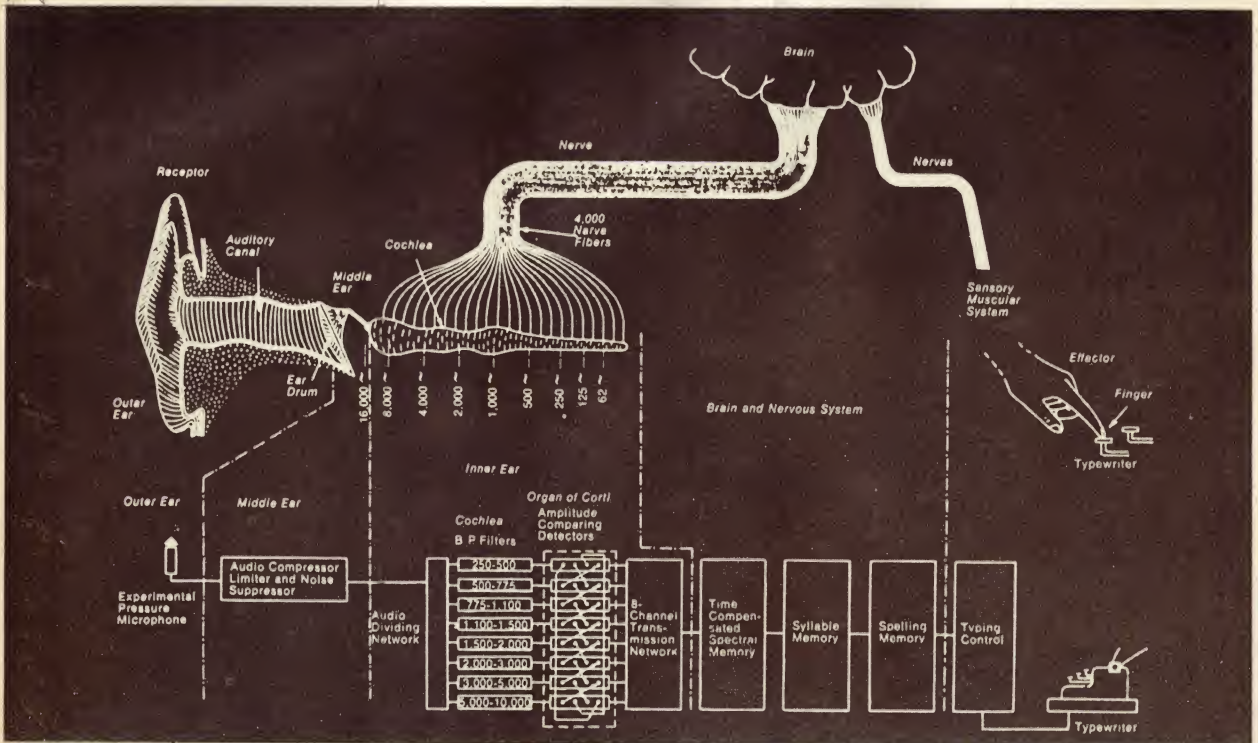

that listen and obey

by Robert L. Moora
and Norman H. Solon*

which—depending on the sound and the sophistication of the machine—could be a syllable, syblet (phonetic syllables that are usually determined by the vocal transition from a hard to soft or soft to hard sound), or phoneme (smallest distinguishable word component). To comprehend or express ideas adequately in a language, a vocabulary of some 10,000 words is required. This can be reduced to a more wieldy 1,500 syllables, 800 syblets, or 41 phonemes. The energies of these components are electronically analysed in three dimensions: time (duration of the sound); frequency; and amplitude (loudness). An electronic pattern of these components is thus established, and recognition consists of matching the pattern with the acoustical input.

However, recognition of continuous speech is much more complex than the simple comparison of two patterns. The individual components of speech, when strung together in words and sentences, greatly change in their acoustical values. And no two persons speak exactly alike. The optimum voice-recognition machine would have to allow for such variables as accents, speech defects—and even the physical and emotional state of the speaker. Thus, most of the research being conducted today is aimed at determining the information-bearing features and characteristics of sound within the three fundamental parameters of amplitude, frequency, and time. In other words, scientists are attempting to learn the common denominators of particular sounds that will lead to their identification no matter how they are pronounced. This is lengthy trial-and-error work, consisting of analysing and reanalysing sound, mostly by computer and other speech-recognition hardware.

The actual dynamics of listening and reacting to speech are amazingly similar in man and machine. The human ear canal and middle ear transmit sound and also promote clarity by de-emphasising extraneous low frequencies and compressing sound levels. These functions are duplicated in a machine by the microphone, audio amplifier, and audio compressor and limiter. (Sound levels are compressed—normalised in amplitude—to minimise the effects on the speech analysis process of the speaker's distance from the microphone and the variations of loudness in talking.)

In man, the inner ear is, in effect, a sound analyser able to distinguish as many as 1,500 frequencies, to measure amplitude, and to feed its finding to the brain via 4,000 nerve-end fibres. In greatly simplified terms, the brain then processes the data, makes a decision, and, for example, directs a finger to type.

Although the brain is infinitely more complex than even the most sophisticated voice-recognition machine, their control processes are comparable. The frequency analyser of the machine breaks down speech into frequency bands, and an amplitude sensor compares their levels. The information is then coded and passed through a time-compensated spectral memory device where it is further subdivided in terms of time. The quantised information, in numerical form, is then funnelled into the speech element memory of the unit. There, the recognition of the correct syllable, syblet, or phoneme from the numerical code is simply a sorting-out process. When the word element is determined, a spelling or word-memory relay, associated with that element or group of elements, is activated. In the case of a phonetic (voice-operated) typewriter, this relay would be wired up to sequencing and letter-code buses in a typing control unit, which in turn operates the electric typewriter.

The one drawback to all voice-recognition units is

* This article is reproduced from "Electronic Age" by arrangement with RCA.

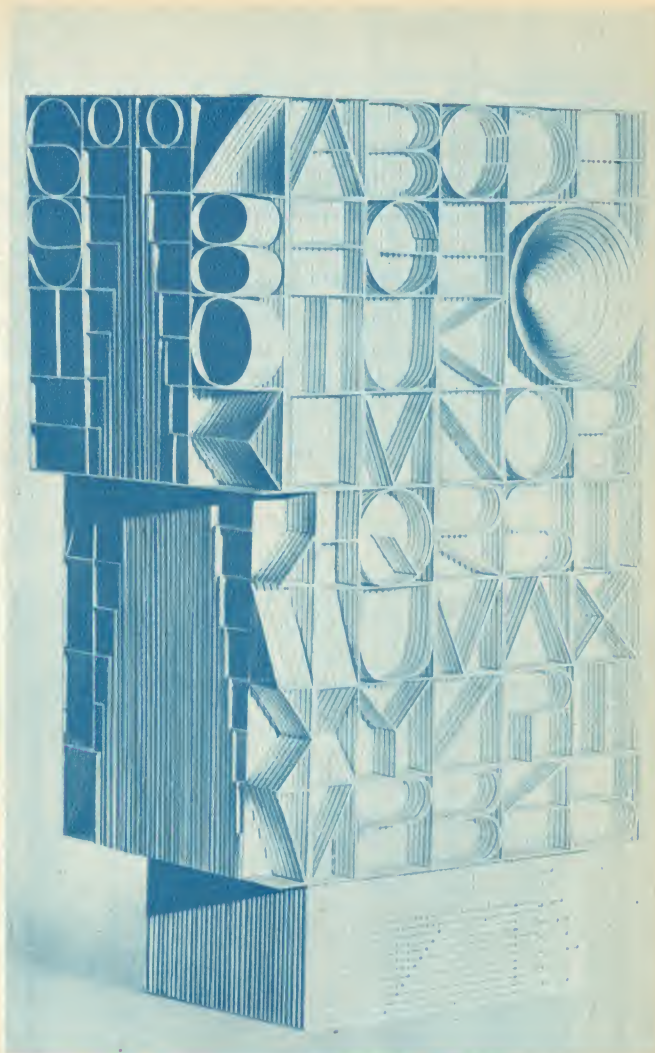

that, unlike a brain, they cannot think and cannot be programmed with unlimited knowledge. Thus, all words have to be typed in a predetermined spelling form, based on phonetics rather than rules of English. A closer approach to conventional spelling would require a much more sophisticated memory unit—large enough to include sentence structure and grammar.

The use of sound to control inanimate objects is hardly new. Nearly a half-century ago, the toy industry put on the market a kennel with a metal dog inside. When the dog's young master commanded "Here, Fido," in a sharp tone, the door would fly open and the pup would obediently pop out. More recently, safety devices have been produced that can stop a tractor by the sound of a loud voice. The farmer could yell "stop" or give a hog call, it makes no difference. Both of these applications are based simply on the physical reaction to sound vibrations, and bear no more relation to sophisticated voice-recognition devices than a kite does to a jet liner.

Research in voice analysis and recognition dates back to the late 1930s, when a team headed by Dr Homer Dudley of Bell Laboratories developed the Vocoder, a device that broke down speech into a frequency code for transmission and reconstructed it at the other end. This early attempt to prevent the present bandwidth population explosion was only partially successful, because of comparatively small bandwidth reduction, and the complexity and expense of the hardware.

In 1956, a team headed by Dr Harry Olson of the RCA Laboratories in Princeton, N.J., achieved the first major breakthrough in voice recognition by building the first phonetic typewriter, with a memory unit of only seven syllables. The most advanced experimental unit at Princeton today can recognise 200 speech elements, enough to handle about one-half of the words in the average person's vocabulary.

A portable solid state oscilloscope with a band width of 20 MHz at a maximum sensitivity of 10mV/cm. The use of solid state circuitry enables this oscilloscope to be fully operational within 15 seconds of switching on. Supply rails are stabilised against AC supply variations by a VOLSTAT constant voltage transformer.

Plug-in time bases and Y amplifiers ensure maximum versatility. There is a choice of single and dual trace, and high gain differential amplifiers, and standard or delayed time base plug-ins. All plug-ins have a unique quick action release mechanism.

A rectangular tube with a bright trace and a 10cm x 6cm display area, together with 200 nanoseconds of signal delay, ensure that the leading edge of any suitable waveform is clearly visible.

Solid State Oscilloscope OS2000

• 20 MHz • 200nS • Portable



BRIEF SPECIFICATION

MAIN FRAME OS2000 MF: 5 in. rectangular Cathode ray tube with helical PDA.

SINGLE TRACE UNIT OS2001 Y: *Bandwidth* DC to 20 MHz (— 3dB). *Rise time* 17nS. *Sensitivity* 50 mV/cm. *Input impedance* 1MΩ/approx. 35p F.

DUAL TRACE UNIT OS2002 Y: *Bandwidth/Sensitivity* (1) DC to 20 MHz (— 3dB) at 10 mV/cm. *Rise time* 17 nS. (2) *Input impedance* 1MΩ/approx. 35 pF.

STANDARD TIME BASE OS2003 X: *Sweep speeds* from 200 mS/cm to 0.2 uS/cm. *Trigger level* (1) Manual. (2) Auto (40 Hz to 20 MHz). *X Gain* Switched X5.

HIGH GAIN DIFFERENTIAL UNIT OS2004 Y: Under Development:

Bandwidth DC to 200 kHz (— 3dB). *Sensitivity* 100μV/cm. *Input impedance* 1MΩ shunted by approx. 47 pF each side to earth. *Common mode rejection* 80dB, DC to 5 kHz up to 100 mV range.

SWEEP DELAY UNIT OS2005 X: *Sweep speeds* 19 ranges from 200 mS/cm to 0.2 μS/cm for both A and B time bases.

Trigger level. Time base A. (1) Manual. (2) Auto 40 Hz—20MHz. Time base B. Manual only.

Delay. Continuously variable 0.2 μS to 2 secs. *Single shot.* Available in all operating modes. *X Gain.* Switched X5.

WEIGHT: 35 lbs.

ADVANCE INSTRUMENTS

Distributed by:

JACOBY, MITCHELL & CO. PTY. LTD.

469-475 Kent Street, Sydney. 26-2651



MELBOURNE
30-2491/2

ADELAIDE
53-6117

BRISBANE
2-6467

PERTH
28-1102

LAUNCESTON
2-5322

JM17-68

However, only recently has voice-recognition research advanced into practical applications. The Astronauts Manoeuvring Unit (AMU), developed by the Advanced Technology Laboratories of RCA, is one of the latest examples. The AMU voice controller, which can comprehend and obey 14 commands, can be "trained" to recognise any of the voices of the three-man Apollo spacecraft crew and that of a ground-control speaker. Thus, it can be operated by the astronauts, or by remote control from the spacecraft, or by launch command. An inexpensive set of voice-pattern cards could be prepared in advance for each probable astronaut on a projected mission, to compensate for last-minute changes in the crew. The AMU, which initially will supplement the present manually controlled unit, will not create a weight or space problem. Ultimately, it will weigh less than five pounds and fit into a package no bigger than a cigar box.

Another system currently under development may allow the Air Force to transmit voice conversations from spacecraft to ground stations with a small fraction of the power now needed. A prototype model has already been delivered to Wright-Patterson Air Force Base at Dayton, Ohio. It was purposely built large — six equipment racks, each 6ft high — to provide accessibility for experimentation. But with the use of micro-sized integrated circuitry, it could easily be reduced to one-third the size of one of these racks. RCA engineers, who call it the most accurate voice-recognition device yet developed for electronic commands, see it as a pioneering approach to such developments as voice control of computer programming.

Voice recognition, however, is more than a space age tool. RCA scientists are applying concerted effort to one project that promises to help efficiency in the post office. It is a system to enable postal workers to distribute packages much more quickly into the proper sorting bins or sacks, and speed them through many of the nation's larger post offices which are equipped with mail-sorting machines.

In the larger post offices — such as Washington, Miami, and Philadelphia — the process of routing packages is now performed by a number of two-man teams. One man separates and directs the package onto a conveyor belt, and the second man reads the ZIP code (the U.S. post code) and key-punches it on a device resembling an adding machine. The key-punch activates a parcel-sorting system that, as the package travels down a conveyor belt, kicks the parcel into the proper chute or bin to send it toward its proper destination.

With electronic speech recognition, this work can be accomplished far more efficiently. A clerk, wearing a head microphone that leaves both hands free, can speak a memorised sorting code number and place the package on the conveyor. An indication of the spoken number is instantly flashed on a monitor in front of the operator as an accuracy check. The conveyor then proceeds to feed the sorting machine automatically.

RCA Colour TV Demonstrations

RCA's new three-tube colour television camera was demonstrated for the first time in Australia at the Institute of Radio and Electronics Engineers Convention in May. During the Convention, RCA gave a series of very impressive demonstrations of colour television under indoor studio conditions, but the question most often asked was "Does it perform as well outdoors?" To prove that it does, RCA subsequently gave demonstrations with the camera under live outside broadcast conditions in Victoria, at the Yarra Glen races, and during an Association Australian Rules football match.

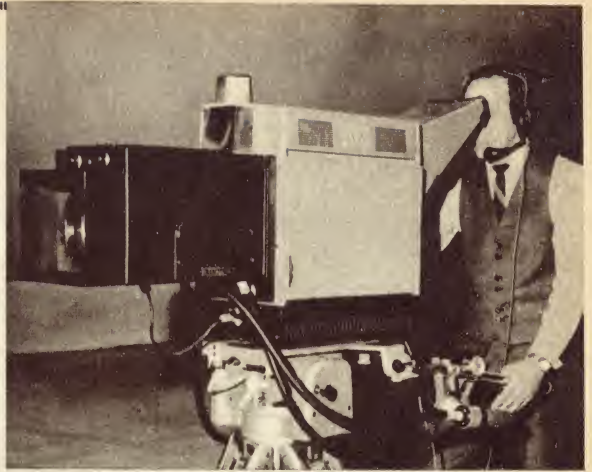

RCA say the camera passed all tests "with flying colours" (apparently no pun was intended!). Colour television pictures of high quality were produced, although the signals passed through two standard RCA TVM-1C radio links.

For example, if the operator speaks code number "34" after reading the address on the package, the bag will be deposited in the bin for New York State. If he speaks "35," the package will be dumped into the bin for California.

As in all speech-recognition projects, the engineers have encountered problems in implementing the sorting code recognition system. For one thing, although the sorting code requires recognition of only 11 words — "one" through "nine," "zero," and "oh" — the pronunciation of these digits, with no pauses between, introduces problems in determining when a digit begins and ends.

For another, the problem of background noise — which might automatically trigger the system with sounds that resemble the intended ones — is a formidable one, since a busy post-office is an extremely noisy place. However, the noise problem probably can be solved through use of a close-up noise-cancelling type microphone that hugs the speaker's cheek and cancels out irrelevant sounds.

Third, there are many differences in the accents peculiar to various sections of the country. These differences must be taken into account in the design of the digit-recognition system and are creating one of the biggest headaches for engineers working on speech-recognition, or voice-controlled, electronic systems. But the problem is not insurmountable, says Marvin B. Herscher, who heads pattern-recognition research for RCA's advanced technology programs. Again, it is simply a matter of isolating information-bearing features common to all speech.

Finally, any computer (and the speech-recognition system is essentially a computer) is a simple-minded creature that can "think" only in terms of absolutes, such as yes and no. Since speech is mostly "grey," methods are

being found to make the system respond only to the sounds essential to form the required digit or word.

There are many other voice-recognition projects at the drawing-board stage. For example, scientists are attempting to develop a translator that, in correct sentence form, will instantly convert foreign speech into continuous English. In essence, the foreign and English word memories would be compared, the translation made, and the correct sentence structure formed by a word-sequence device. The synthesised voice output would then be created from prerecorded speech elements. This system is still years away from development, but word-for-word translating machines have already been built.

Music, as well as speech, can be analysed and synthesised. In fact, it is easier to control music electronically since all tones can be completely described in terms of the frequency, intensity, portamento (passage from one tone to another in a continuous glide), timbre — and duration of growth, steady state, and decay of each note. All of these properties can be coded and converted into music on the experimental Electronic Music Synthesiser (E.M.S.) developed by the RCA Laboratories in Princeton, N.J. The E.M.S. could be a step in the development of a commercial "computer music" phonograph. According to one prominent scientist, a coded disc the size of a conventional 12-inch record could produce as many as 200 hours of music on this type of phonograph.

Although voice-recognition and synthesising systems are just beginning to emerge from the laboratory stage, their effect on business, industry, pure science, and the military is more than a promise. As Dr Olson puts it, "There is no doubt that these systems will become a reality since developments have advanced beyond the questioning stage."

Cool thoughts on superconductive

Although bright prospects have been predicted for low temperature and superconductive power transmission, no practical cables have yet been built. The atmosphere at a recent international conference in London was one of cautious optimism.

Superconductivity — the total loss of electrical resistance in some metals at temperatures approaching that of liquid helium — was discovered nearly 60 years ago. Yet no commercial use for it has ever been developed, although in recent years it has been the means of constructing magnets for various types of physics research with field strengths immeasurably greater than anything possible with conventional equipment.

Now it looks as if the stage is being set for the emergence of superconductivity in a major engineering role. This is not likely to happen for a number of years yet for complex, simultaneous equations of metallurgy, thermodynamics, electrotechnics and economics remain to be solved. They probably can be, but the question worrying some engineers is, "Are they worth solving — or is this just another Moon shot?" On balance, the answers seem to be "Yes — but don't let's be stampeded into a crash program." This, at least, was a general impression gained at a recent international conference in London, where physicists and engineers met to see how this venerable phenomenon could be put to wider use.

The idea of low-temperature power transmission had a mixed reception, and a British engineer who managed to deliver a long paper on the present electricity transmission in Britain and its probable development, without once mentioning superconductivity or giving any indication of possible future shortcomings in the present type of system, may have voiced the opinions of many. Yet a lot of relatively high-

powered work is already going into superconductivity around the world — and nowhere more so than in Britain, including studies at the Central Electricity Generating Board's (C.E.G.B.) own research laboratories at Leatherhead. In short, there are the hawks (the enthusiasts) and the doves, and this is probably no bad thing, for the whole subject is still clouded by uncertainties. It is rather like the state of nuclear energy during 1945-50: lots of bright ideas but very little actually happening.

Superconductivity in power engineering could be applied to generators and motors, cables, transformers and rectifiers. There has been much theorising about all these, but virtually the only work to have reached the practical hardware stage anywhere in the world is the 3250hp superconducting motor now in the final assembly stage at International Research and Development at Newcastle upon Tyne. As an experiment, this is to be installed at the C.E.G.B.'s Fawley power station for driving a water pump, and trials are expected to begin later this year. This remarkable machine uses special niobium field windings supercooled in liquid helium, with its rotor virtually just a segmented disc with brushes at the inner and outer peripheries for the direct current on which it runs. (See "Electronics Australia," November, 1968, page 14).

But such is the pace of development that the Newcastle motor is already obsolescent. Designed afresh today, it could be built to a quarter of its present size. Although reported to be competitive in cost with large slow-speed conventional motors, the main advantage of the superconducting

motor is its size — 30 tons or so compared with hundreds for a motor in the 10,000hp class. Applications foreseen for the I.R.D. motor include rolling mills, ship propulsion, and mine winding. Furthermore, the idea can be applied to generators, and prospects for these are seen in industries requiring very heavy direct currents at low voltages — aluminium reduction and chlorine production, for example.

Direct current, however, is not of very much interest to the public supply engineer, unless it is at very high voltages. He is mainly concerned with AC power, and prospects for superconducting machines seem a good deal less bright. This is because although superconductors have no resistance they still have dielectric and eddy current losses. The situation is further complicated by the fact that with AC, the current flows only in a very thin layer on the surface of the conductor. I.R.D., however, appears confident that better superconductor materials will eventually lead to practical AC machines.

The superconducting power cable also seems bogged down in difficulties, yet it is an attractive idea which would enable huge currents to be transmitted without the complication of high voltage. But apart from short laboratory lengths in Britain and France (and possibly Russia), no one has yet built such a cable. Paradoxically, a major problem is that a superconducting cable would have so much capability that to make economic sense a circuit of this type would have to be much more powerful than anything needed at present: just how much is still a matter for argument. Experimenting with untried systems on

This article is reproduced from "New Scientist" of 10/4/69, by arrangement.

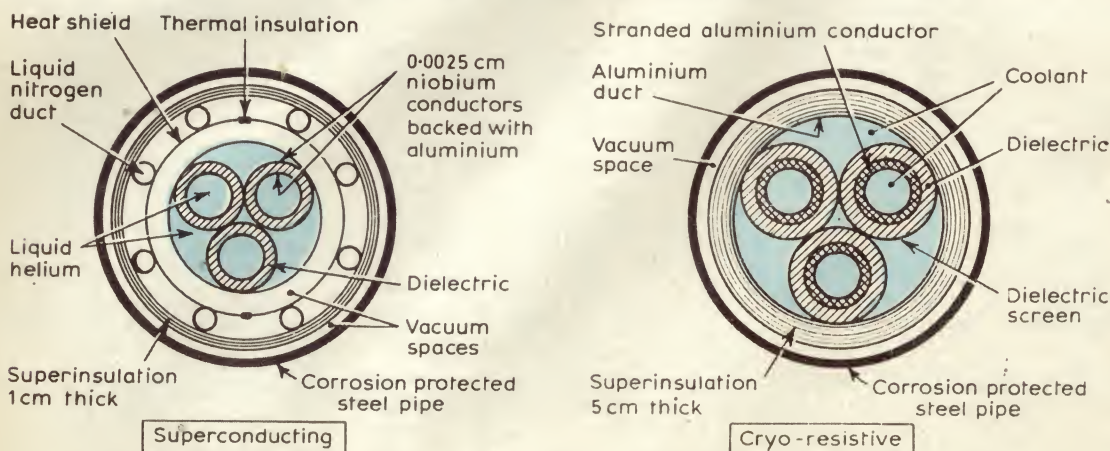

Cross sections of proposed British cryo-resistive and superconducting cables.

power

by William C. Davidson

such important power links is properly viewed with misgivings. Yet a low-power cable would prove little.

However, as power stations continually get larger and are driven away from industrial load centres in their ceaseless search for cooling water supplies, the need for such power links will grow. Furthermore, there is a mounting need, particularly in the U.S.A. and in Europe, for the interconnection of complete power systems. Overhead lines are virtually the only way of doing this at present, but in some cases amenity considerations will demand underground transmission and it is doubtful if the conventional cable can be developed much further.

On cable design there is no consensus — not even on whether they should be AC or DC. Furthermore, there is a school of thought that favours cryo-resistive cables — that is, cables of ultra-pure copper or aluminium (99.999 per cent) working in liquid nitrogen (77 deg. K) or liquid hydrogen (20 deg. K) and making use of their very low, but not zero, resistance. These gases are much more readily available than helium, and the refrigeration systems — a very important cost element — would be simpler, it is argued. The Americans are strong advocates of the cryocable, but British studies seem to show that there is no substitute for the out-and-out superconductor.

A superconducting cable would really be a pipe-line, fitted with frequent expansion (or rather contraction) joints and connected to refrigeration stations perhaps every six miles or so. The phase conductors might be con-

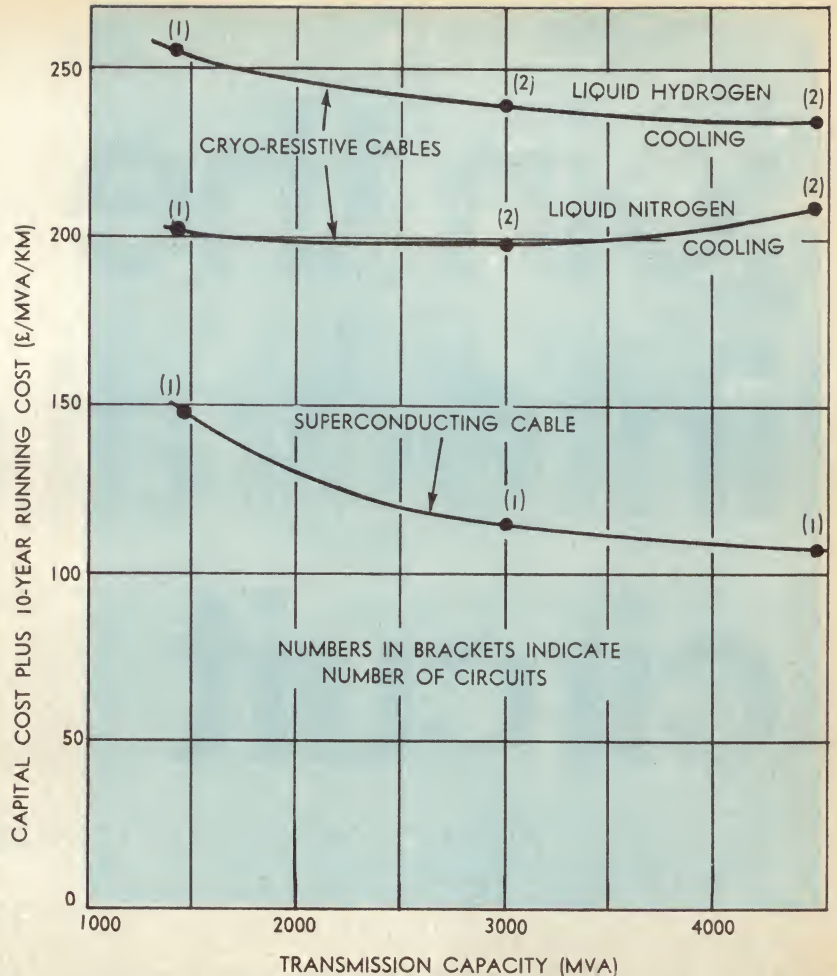

centric or separate tubes of the superconducting material — invariably niobium in some form. The helium might flow back and forth, through and between the tubes, or it might have its own return pipe. Part of the assembly would have to carry pressure, and other parts might contain vacuum for electrical and thermal insulation. Considerable thickness of superinsulation would probably be required to stop heat influx from the soil, and a strong outer sheath would be needed. The electrical part only of such a cable, as described by the British team, would be upward of 200mm in diameter, but it would carry 750MVA at 33KV in one envelope.

Another superconductivity idea is the all-magnetic hovertrain, floating on a

Graph comparing the comparative costs of cryo-resistive and superconducting cables.

sort of magnetic cushion and propelled by a linear induction motor. A U.S. team claims that, using this so-called Maglev system, six quite small superconducting magnets could levitate a 22-ton 100-seater car, and that power to do this and drive it at 300mph would be about 5500hp. The main advantage over other forms of rapid transport would be its complete silence, apart from the aerodynamic noise. How the current would be collected from the track at this speed was not made clear, however.

Perhaps the most imaginative concept of all is the French scheme for vast superconductive storage devices. These would consist of huge coils of superconductor in various forms of toroid. One to store 10^{13} joules or 2800MWH, would be a plain circular toroid of 68M mean radius and 17M in diameter. Alternating current from the system would be rectified and fed into the toroid as DC. When required to meet a peak demand it would be taken out and inverted back to AC.

One of the problems not yet overcome, and which would need to be solved before a superconducting transmission system could become a practical reality, is the need for reliable semiconductor devices capable of rectifying the voltages and currents involved in systems of this type, and converting again to AC for reticulation. (See "New High Power Rectifiers," in the April, 1969, issue, page 27.)

Diagram of the proposed French superconducting power storage ring.

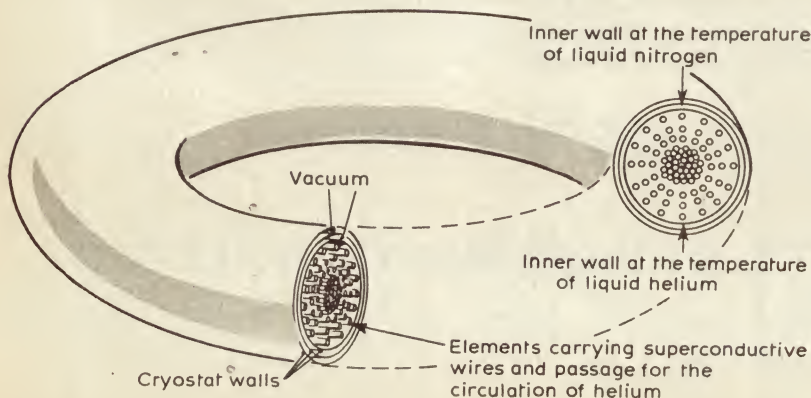

join the integrated circuit

(the people who use **Mullard** IC's)

Medium speed DTLs—FC range

These are monolithic circuits available in two temperature ranges for industrial and military applications. There is a wide choice of circuits, a high complexity of gates and modern encapsulations. Notable features include a propagation delay time of typically 20nS; high noise margins; high fan-outs; and operation from a single 6 V D.C. power supply.

Versatile high speed TTLs—FJ range

This is our general range and circuits cover almost all digital applications. These are monolithic and offer advantages over DTL in speed (propagation times are in the 13nS region) and a reduction in power consumption per gate (to approximately 10mW). Encapsulation is dual-in-line. Hermetic sealed types available.

Sophisticated, ultra-fast circuits—FK range

This is a specialised range for high speed computer central processors. It is a Mullard first—a new concept combining speed and low dissipation. Propagation delays are down to 2nS and power consumption is low (only 60mW for a standard gate with 0.7 V logic swing).

Compatible, versatile linears—TA range

These are specialised devices for various applications. They include low-level amplifiers, a high impedance audio amplifier, a 1-watt amplifier, operational amplifiers, a ring modulator, and receiver IF amplifiers, for telecommunications, instrumentation and control systems. All devices are of monolithic construction.

Send for full technical data to Central Technical Services Depts. at the addresses below—



Mullard

Mullard-Australia Pty. Ltd.

35-43 CLARENCE STREET, SYDNEY, N.S.W. 2000. PHONE: 29 2006
123 VICTORIA PARADE, COLLINGWOOD, VIC. 3066. PHONE: 41 6644
ST. PAUL'S TCE. AND LIGHT ST., BOWEN HILLS, QLD. 4066. PHONE: 51 5151

Associated with MULLARD LIMITED, LONDON

M 219



TECHNICAL DIGEST

Fuel cells — are they on the way out?

Although many American companies have invested heavily in fuel cell development, their present disinterest induced a spirit of pessimism at the recent Third International Congress on Fuel Cells, in Brussels. Once hailed as the answer to a multitude of portable power problems, fuel cells now seem to have a shaky future. The thought uppermost in the minds of delegates appeared to be, "Just how much future if there for fuel cells in commercial applications?" The following is an extract from a report which appeared in "New Scientist," issue of June 26, 1969.

Although they have spent more money and man-years on the development of fuel cells than the rest of the world put together, there is now only one major U.S. company left with any significant stake of its own in the field, though a few others are carrying on under military contracts. On the roll of the "drop-outs" are General Electric, American Standard, Tyco Inc., Texas Instruments, Leeson Moos, Pioneer Aerospace, none of whom has more than a nominal effort. Among the petroleum companies, Phillips and Esso, the situation is much the same. Allis Chalmers and Union Carbide have military support for most of their work, while American Cyanamid is not in fuel cells but is, more shrewdly, in the electrode business. Pratt and Whitney alone, the prime Apollo fuel cell contractors, remain in the field with a sizable stake of their own.

It may be too early to write "finis," but American companies, at least, seem to have decided that the fuel cell's once brightly painted future is fading. It remains for the rest of us to weigh up the facts and decide if our own considerable research efforts are justified.

The fuel cell promised the direct conversion of chemical into electrical energy, without using moving parts and without the limiting efficiency of the Carnot cycle. Unfortunately, none of these promised benefits has turned out to be as great as was supposed, and the cost of the cells remains prohibitive for all but a very few specialised uses such as the Apollo program. (The Bacon cells certainly

did contribute to the success of that project.)

It was realised early on in fuel cell research that there were more ways than one of producing current from an oxidation reaction, and "system engineering" was introduced to find the best combination of fuel, operating temperature, electrolyte, etc. Hydrogen and hydrazine presented no electrochemical problems as fuels, but the inconvenience of using hydrogen, and the high cost of both materials, continues to rule them out for any mass application of the cells. There is still little sign of a cheap route to hydrazine. Hydrocarbons offered an alternative fuel, but were not found practicable to use directly. Several research groups then came up with the idea of reforming a hydrocarbon fuel such as methane to hydrogen and carbon dioxide, removing the carbon dioxide, and burning the hydrogen in a hydrogen fuel cell. The drawback here proved to be the extra weight and cost of the reformer/scrubber system and the loss of overall efficiency due to this step.

Most research groups around the world settled for one or two systems and their efforts at optimisation seem to have produced remarkably similar results. American companies working in the field eventually took a long hard look at the progress and came to the following conclusions: Unless the fuel cell system could meet a big market, it was not worth pursuing. On both cost and power/weight bases, the prospects for a fuel cell automobile seemed very remote. Moreover, hydro-

carbon fuel cells were no solution to the problem of CO₂ pollution.

The prospects of nuclear power were good, and demonstrably so. This fact, it was felt, eroded prospects for stationary fuel cells. Developments in mobile power sources included the Wankel engine, the steam engine, and high-density electric storage batteries, all of which showed more promise than the fuel cell. Thus while the fuel cell slowly improved, its actual prospects deteriorated. Hydrocarbon fuel cells as known today, require some \$1,000 of precious metals per installed KW.

As far as this last point was concerned it was long argued that this cost could be largely recovered and that a non-precious metal catalyst would sooner or later be found. However—and here came the blow—costings showed that even if either of the above developments came about, this would still not rescue the situation. The only hope would be a catalyst of non-precious metal, whose performance was some 10 times better than that of the precious metals.

Nothing startling emerged from the Brussels conference which might alter this picture. France and Germany alone are stepping up their efforts, and German firms have made some progress towards cheaper catalysts. Learning from the mechanism of the human body, they have used organo-metallic compounds such as iron-phthalocyanin to reduce oxygen. They could probably produce the cheapest fuel cell yet, using Siemen's impressive hydrocarbon reformer, AEG's tungsten carbide anode, and the phthalocyanin cathode of the Robert Bosch Co. The salient fact is that if all these components lived up to their inventors' wildest dreams, the fuel cell would still not be anything like economic.

Where does this leave the fuel cell? There are still the so-called "special applications" such as signal buoys, remote radio repeater stations, cathodic protection of distant pipelines, and more recently, body-implanted cells to drive heart pace-makers. All of these markets are so small and specialised, or so hard-pressed by developments in such things as isotope power sources, that some fierce in-fighting seems certain as companies try to recoup their research outlays. ■

subminiature toggle and pushbutton switches

now available from Plessey

Manufactured in U.S.A. by C. & K. Components Inc.

Designed to meet the highest standards of quality and reliability these C. & K. subminiature toggle switches combine maximum performance with minimum weight and size. All switches feature rugged construction, simple mounting, excellent appearance and long, trouble-free operation. These switches adapt to virtually any manual switching requirement in a very wide range of aerospace/ground/undersea application where space is at a premium.

GENERAL SPECIFICATIONS
Contact Rating 5 Amps. resistive load @ 115 VAC—28 VDC
Insulation Resistance 1000 megohms minimum
Dielectrical Strength 1000 volts r.m.s. at sea level
Electric Life 100,000 make and break cycles minimum on all models ending in 01 only; all other models 40,000 cycles 115 VAC—28 VDC resistive load.
Initial Contact Resistance 10 milliohms

maximum at 2-4 VDC, 1 amp.
Contacts Working contacts are Coin Silver.
Operating Lever Bright chrome plated brass bat handle toggle is standard; plastic colour caps supplied on request.
Case Material General purpose phenolic.
 For further information please contact Professional Components Department, Villawood, N.S.W., or Ducon Interstate Offices.

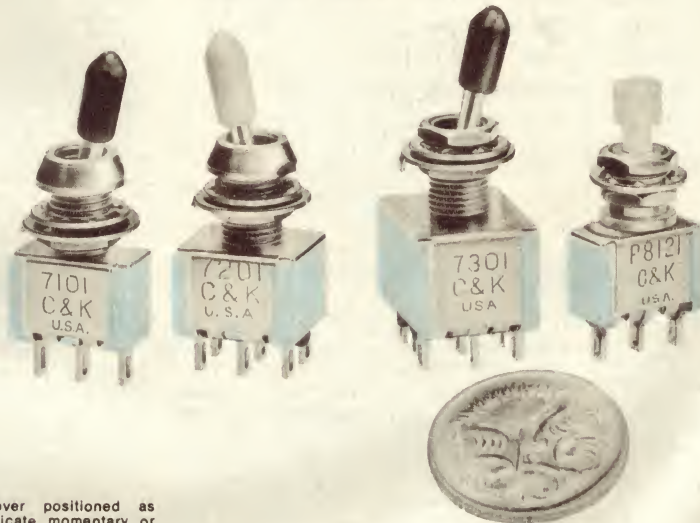

Circuitry with toggle lever positioned as shown. (.) Parenthesis indicate momentary or non-locking position.

Model No.			
SPDT			
7101	ON	NONE	ON
7103	ON	OFF	ON
7105	(ON)	OFF	(ON)
7107	ON	OFF	(ON)
7109	NONE	ON	(ON)
7101 RPC	ON	NONE	ON
7103 RPC	ON	OFF	ON
7105 RPC	(ON)	OFF	(ON)
7107 RPC	ON	OFF	(ON)
7109 RPC	NONE	ON	(ON)

Model No.			
DPDT			
7201	ON	NONE	ON
7203	ON	OFF	ON
7205	(ON)	OFF	(ON)
7207	ON	OFF	(ON)
7209	NONE	ON	(ON)
7211	ON	ON	(ON)
7213	ON	ON	(ON)
7215	(ON)	ON	(ON)
3PDT			
7301	ON	NONE	ON
7303	ON	OFF	ON
7305	(ON)	OFF	(ON)
7307	ON	OFF	(ON)
7309	NONE	ON	(ON)

Model No.			
4PDT			
7401	ON	NONE	ON
7403	ON	OFF	ON
7405	(ON)	OFF	(ON)
7407	ON	OFF	(ON)
7409	NONE	ON	(ON)
7411	ON	ON	ON
7413	ON	ON	(ON)
7415	(ON)	ON	(ON)
PUSH BUTTON			
8121	SPDT	} Momentary	
8221	DPDT		
8321	3PDT		
8421	4PDT		

PLESSEY
Components



Ducon Division
 Plessey Components
 Box 2 PO Villawood NSW 2163
 Telephone 72 0133

Melbourne 42 3921
 Brisbane 2 3287
 Adelaide 76 3434
 Perth 21 4821/21 7867

AD1/R

Flat screen television display demonstrated in Japan

The present-day bulky conical TV tube, with its trappings of yoke coils and EHT components, may be replaced by a flat screen display, if an experimental electroluminescent panel display being investigated in Japan by the Matsushita company can be further developed for production.

Designed to operate at the 525-line standard, the all-solid state panel can display a picture with a viewable diagonal measurement of 13 inches. Although the display system, including its companion receiver, employs a total of 8,600 discrete components, its power dissipation is only 100 watts.

An important feature of the flat display is that since there's no electron beam to contend with, there's no need for deflection coils or a high-voltage power supply.

The panel is made on a glass substrate and has a layer of zinc sulphide phosphor sandwiched between the vertical and horizontal electrodes that form the picture elements at their crosspoints.

There is still an obstacle to be overcome in this design, though. Because the zinc sulphide phosphor does not yield a particularly bright light, the display can't be viewed comfortably in a well-lighted room. It's hoped that both brightness and picture contrast can be improved by replacing the zinc sulphide phosphor with zincsulphoselenide, Zn(S, Se).

Although the system is being developed to handle standard TV pictures, it could, with slight modifications, be applied to alphanumeric or graphic displays. Until now, the only electroluminescent displays capable of reproducing high-density TV picture elements have been converters or intensifiers using an optical input. One such system has already been developed by the Matsushita Research Institute of Tokyo.

In any TV system, about 10 per cent of the lines occur when the beam is returning from the bottom to the top of the picture, and hence cannot display picture information. Also, a number of other lines are hidden under the top and bottom of the picture-tube mask. The maximum number of lines that make up a 525 line picture, therefore, is about 470. The horizontal resolution is about 80 lines for each megahertz of bandwidth at the broadcast scan rates.

The experimental display has 230 vertical and 230 horizontal electrodes for a total of 52,900 picture elements, each measuring 1 by 0.75 millimetre. Unlike interlaced scanning systems, both fields—odd and even—are displayed successively on the same horizontal lines. And although the image reproduced isn't yet comparable to the average TV picture, it shows as much detail as some of the inexpensive helical-scan video tape recorders on the market today.

In addition, the experimental system isn't subject to the main shortcomings

of previously developed flatscreen displays. The earlier designs have proved increasingly difficult to manufacture as picture elements are added. Furthermore, interaction between elements would start to set in as the number of elements increased, and this so-called cross-effect diminished picture contrast. The Matsushita display has its problems, but not these.

The number of reproducible picture elements largely depends on the number of vertical and horizontal elec-

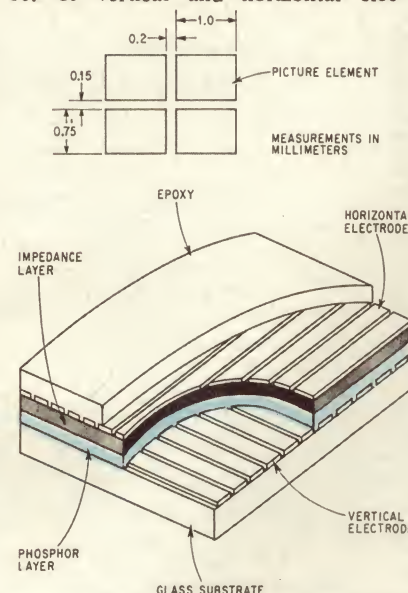

trodes on the panel. The vertical electrodes face the front of the display, and are made transparent so as not to obstruct illumination of the phosphor screen.

If an alternating voltage is applied between two electrodes on the matrix, the brightness of the picture element at the intersection will be proportional—within certain voltage limits—to an exponent of the applied voltage, and will be directly proportional to the voltage frequency. And if the alternating voltage is replaced with a pulse, the brightness will then be proportional to an exponent of the pulse amplitude. If the light output from the element is monitored, the observed waveform will appear somewhat differentiated. The leading edge of the pulse will cause the light waveform to rise abruptly to maximum and then decay in an exponential manner. The trailing edge of the pulse has the same result.

With a narrow pulse, total light output during rise and fall times will be just a little more than that during rise time alone. However, as the pulse width is increased—assuming that the separation between pulses is equal or greater than the pulse width—light output also increases. Regardless of the pulse width, though, the output can never exceed twice the amount of light provided by the short-duration pulses. Hence, techniques that lengthen the pulse's "on" time cannot be used to increase picture brightness appreciably.

An electroluminescent panel can be made to almost any size, and it lends itself to batch production. Since the basic picture element has a width-to-height ratio of 4 to 3, picture aspect ratio is maintained, even though the matrix consists of the same number of vertical and horizontal electrodes. ("Electronics," 17/3/69.)

Electro-luminescent displays at I.E.E.E.

The following extract from a report which appeared in the June, 1969, issue of "Radio-Electronics" gives further information about the results achieved with electroluminescent panels. It is a first-hand account, following a demonstration of a panel at this year's I.E.E.E. exhibition in New York.

Resolution is fair, but the phosphor has a distinct green hue and contrast and brightness are low.

Here is how a single horizontal line of the 230 x 230 matrix is scanned. The horizontal electrode receives a negative selecting pulse, while blanking pulses dim the lines not being scanned. Simultaneously, a sampled video signal for the entire line is applied to all the vertical electrodes. This is accomplished with a 50.6usec lumped delay line, which holds the video for the scan line until it can be displayed simultaneously when the horizontal pulse is applied.

The brightness of each element is a function of the video pulse amplitude on the vertical strips, varying exponentially, within limits, with the pulse width. An input transistor to each vertical strip serves as a variable resistor, its collector resis-

tance modulated by the sampled video from the delay line. Then, after one line has been scanned, a counter, triggered by the horizontal sync. signal, steps the horizontal pulse distributor to the next line. A second horizontal pulse generator simultaneously delivers blanking pulses to all the other lines.

The prototype model demonstrated at the show was equipped with provisions for video tape recorders and closed circuit cameras in addition to VHF reception. With circuit modifications, the display system could be adapted for graphic and alphanumeric readouts.

ICs are used in the counter circuits, and could simplify the brightness circuits. Some 8,600 components are used in the set, comparable to the number in a desktop electronic calculator. Power consumption is about 100W.

DESPITE the initial reservations felt by many people, particularly with reference to servicing, the printed circuit is now firmly established in most types of electronic equipment, ranging from the incredibly cheap pocket radios that have flooded the country in recent years, to some of the most sophisticated professional equipment available. Its origins lie in weaponry — a heritage unfortunately common to many good "electronic" ideas, but printed circuitry is, and indeed has been for some time, an attractive system for the amateur who constructs his own equipment, for it solves the mechanical problems of component mounting and eliminates the chores of wiring — as well as facilitating a neat and workmanlike job. For the amateur who has so far shied away from etching his own boards, a new system is now available, which is both economical and easy to use, yet with care, is capable of excellent results. Known as **Cir-kit**, the system utilises bakelite boards, similar to those used commercially, in conjunction with self-adhesive copper strip. This is 1/16in or 1/8in wide — easily cut with scissors or a model knife — and attaches to the boards rather like a piece of Sellotape. The adhesive is very efficient, although the bond is not quite as good as that on pre-laminated boards — which means that care is needed when soldering not to overheat the copper. However, anyone who is competent to solder a transistor or capacitor without causing damage should have no trouble, and the adhesive improves with aging, so that long-term stability is satisfactory. Layouts can normally be planned using the theoretical circuit diagram as a guide, and boards may be pre-punched or drilled according to requirements. With the pre-punched board, the strip can either be laid over the holes, and then punched through with a small drill or a watchmaker's screwdriver, or it can be laid alongside the holes and component leads are inserted through the board, folded over and soldered (see photo). The former method permits a more compact layout.

A few tips on planning layouts. Always be sure that the component spaces you allocate are adequate — it is preferable to purchase the bits before embarking on this task, although capacitors are available in literally dozens of shapes for board mounting and resistors are more or less of standard size, dependent on ratings. Avoid siting adjacently on to your layout components which are in different stages — as this can lead to instability. If instability does occur, of course, **Cir-kit** does permit alterations to be made, although it is as well to investigate the problem before redesigning sections of the board for it may not prove necessary.

The excellence of the system, however, lies in its versatility, for it enables the home constructor to produce a wiring board on a one-off basis for most of the circuits described in this and other journals, and while it will no doubt encourage many to "try their hand," it will also enable many who already build their own equipment to achieve neater, more reliable results with a minimum of fuss.

**AVAILABLE ALL LEADING
RADIO HOUSES.**

(SOLE AGENT)



ZEPHYR PRODUCTS PTY. LTD.

70 BATESFORD ROAD, CHADSTONE, VICTORIA—PHONE 56-7231

MANUFACTURERS OF RADIO & ELECTRICAL EQUIPMENT & COMPONENTS

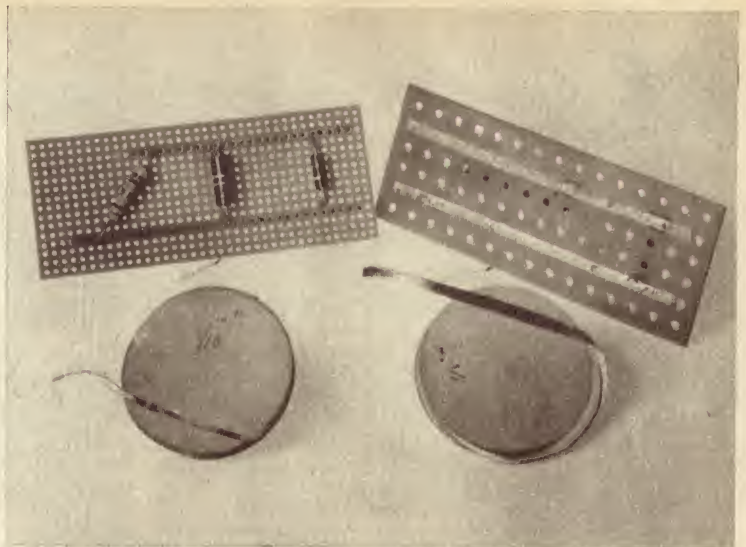

INSTANT CIRCUITS

**A new method of making component boards
using self-adhesive copper strip.**

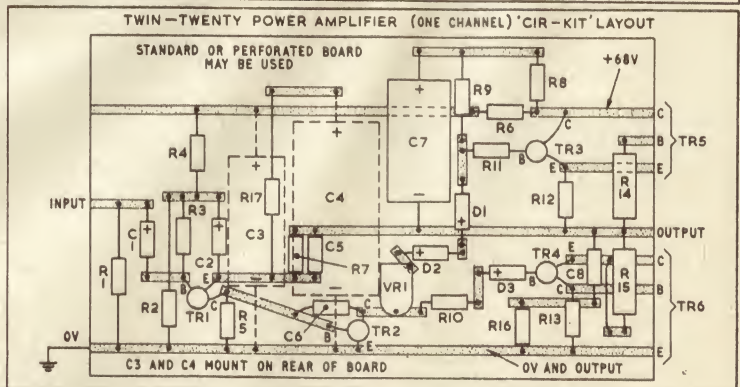
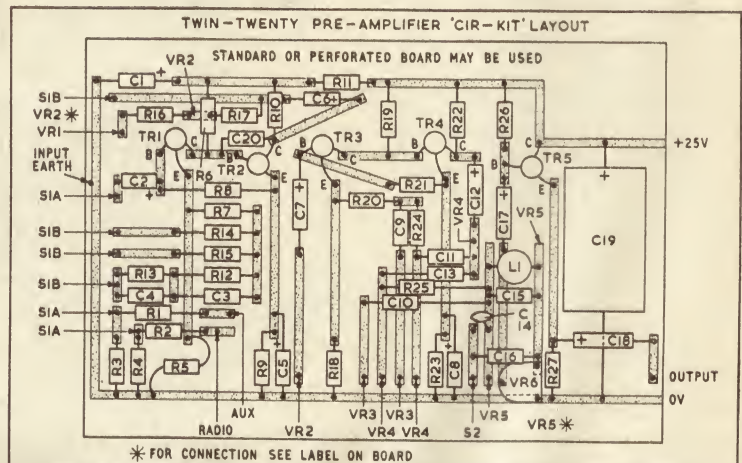

Automatic TV gun assembler — university aids U.K. industry

A machine which automatically assembles TV tube gun assemblies has been developed in the U.K. by the Department of Production Engineering and Production Management of the University of Nottingham in co-operation with Mullard Ltd. This development is the outcome of a scheme under which the Department is sponsored by industry in research projects.

The idea of persuading industries to support projects of this kind at Nottingham University is largely that of Professor W. B. Heginbotham and his colleagues in the Department of Production Engineering and Production Management.

In 1966 Professor Heginbotham outlined to a number of firms some ideas his department had about automatic assembly methods. Wide interest was aroused and in August, 1967, a consortium was formed between five firms, each with a particular interest in advanced automatic assembly methods. Each firm contributed £500 for which they got a basic pick-and-place automatic assembly machine.

The long-term hope was that the firms would ask the department to develop the basic prototype into a machine more suited to their particular needs. For this, firms would contribute the necessary financial assistance.

"To date the idea is working splendidly," said Professor Heginbotham. However, the first to come to fruition will be an advanced machine for electron gun assembly at the Mullard Simonstone plant. Delivery is expected to take place before Christmas.

"Academically the spin-off from this activity is of enormous value to us here in Nottingham. By helping to solve some of these complex assembly problems we not only keep ourselves up-to-date but are also able to get over to students some of the very real problems they will meet when they leave here and enter industry."

E. Gaskell, chief engineer at Mullard Simonstone, describes the project as "highly successful and a very good example of the way in which industry can benefit by this kind of co-operation with universities."

The electron gun of a TV picture tube is a precision sub-assembly comprising a large number of small components requiring the use of highly skilled female labour. The machine developed for Simonstone automatically assembles three of these components and makes a total of eight welds to produce a sub-assembly (grid 3) for a TV tube electron gun.

The three components are:

- A flat washer, 8mm diameter by 0.1mm thick with a central hole 1.5mm diameter.
- A 12mm "top hat" with a 3mm high, 4.5mm diameter central cylindrical section.
- An 8mm diameter by 7mm deep "body" with a 10mm diameter top flange and three 1mm diameter

by 5mm long pins welded radially to the body.

The parts are assembled by welding together parts 1 and 2 with four spot welds, then welding this sub-assembly to part 3 to produce the assembly shown in diagram A.

In the assembly machine, the component parts are fed by vibratory feeders to three pick-and-place units which pick up the components and place them on mandrels at welding stations.

These pick-and-place units are built as modular assemblies with a variety of

red to mandrel A. Part 2 is also transferred to this mandrel by pick-and-place unit No. 2. The previous sub-assembly of parts 1 and 2 is transferred from mandrel A to mandrel B. While this is taking place the component No. 3 is transferred from the feeder and also placed on mandrel B. A completed assembly is removed from mandrel B and placed into a tote bin.

Stage 2—At both welding stations A and B a double-headed welding unit makes two spot welds, then the mandrel is rotated and another two welds made.

State 3—All three pick-and-place units return to the start position and a new cycle can commence.

Because the location for parts 1 and 2 has to be on their inside diameters, part No. 1 has to be assembled on top of part No. 2.

For welding to part No. 3 it has to

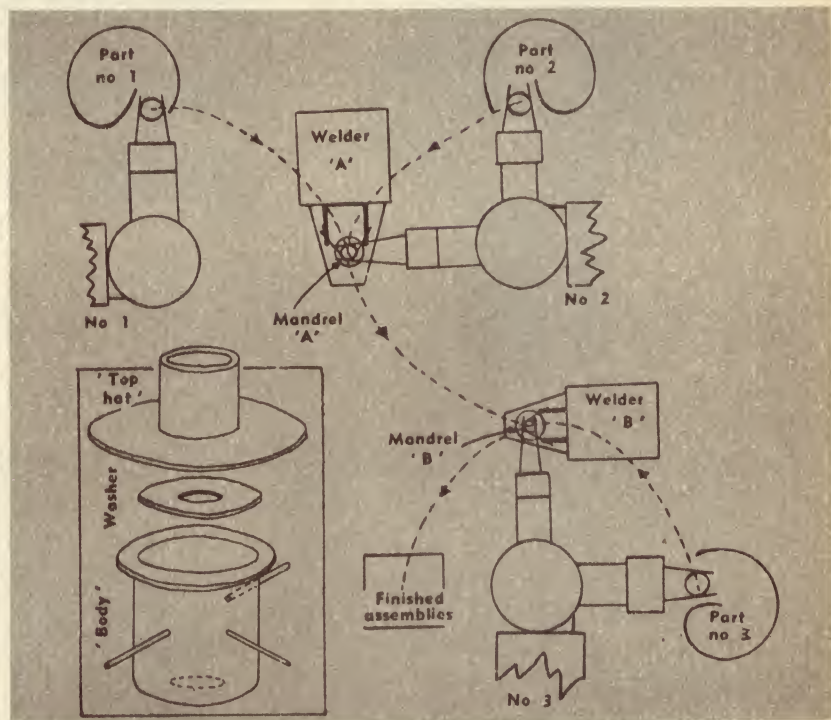

pick-up heads — gripping fingers or vacuum pick-ups — so that machines for different tasks can be built up. The units are pneumatically actuated and the sequence of operations is electronically controlled.

Three basic operations are involved: —component pick-up or release; raise or lower; rotary or linear motion to transfer components from one station to another. In the Mullard machine the transfer motion is rotary.

The basic layout of the assembly machine is shown in the diagram, with the mechanism in the start position. All three pick-and-place machines operate simultaneously.

Stage 1—Part 1 is picked up by pick-and-place unit No. 1 and transfer-

be turned the other way up. To accomplish this, the first arm of pick-and-place unit No. 2 rotates through 180 degrees about its own axis while transferring between mandrels A and B. This sequence of events is repeated continuously to produce the completed assemblies at a rate of up to 1,000 per hour.

Interlocks and part-detecting devices are built into the machine to ensure correct operation.

Because of its modular construction, it is hoped that the machine might also form the basis of others for the automatic assembly of many of the intricate parts of electronic devices and other engineering assemblies. ("Electronics Weekly," 27/11/68).

**di/dt capability 10 times industry's best
EVEN WITH LOW POWER GATE DRIVE**

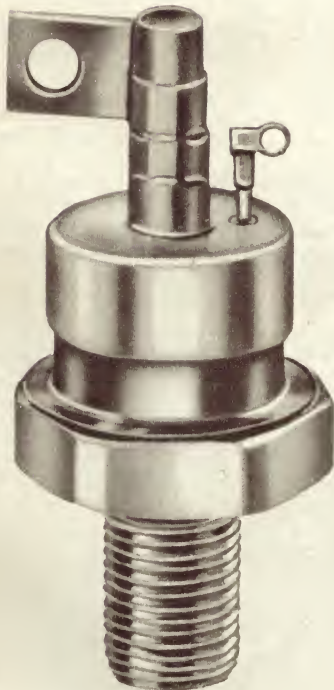

varian-national invents the regenerative gate* S.C.R.

* (Patent pending)

The Varian-National regenerative gate SCR is the only SCR that will give 600 A/usec when tested according to JEDEC SUGGESTED STANDARD No. 7 Section 5.1.2.4. This is a di/dt rating at 3 times the peak on-state current and half the switching loss of any SCR presently available. No sacrifice is required in gate drive, turn-on time, turn-off time or any other characteristic. 55A and 110A SCRs are currently available.

Varian-National SCRs are manufactured with ratings from 16A to 470A.



varian PTY LTD

electron tube and device group

38 oxley street/crows nest/nsw 2065 tel: 43 0673

springvale road/north springvale/vic 3170 tel: 5607133

Distributors:

Perth, Western Australia: Henderson Instrument Co. Pty. Ltd., Subiaco.

New Zealand: Geo. W. Wilton & Co. Ltd., Wellington and Auckland.

ETD3368

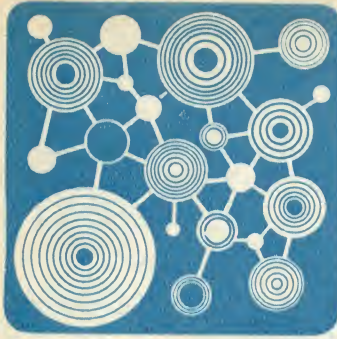

SCIENTIFIC AND INDUSTRIAL NEWS

Airline needs no passengers

Air Apparent has on its books seven aircraft types on 180 routes between 125 cities, issues passenger documents and tickets, and is expanding rapidly. However, this airline is not found at any of the world's airports. It exists entirely in the imagination of commercial research experts and a computer of Lockheed Aircraft Corporation in the U.S.A. The purpose of this exercise is to assess future needs of actual airlines under all possible route conditions.

One advantage of the simulated airline is that aircraft still on the drawing board can be included in the fleet. Lockheed has included its own TriStar due to go into real airline service in 1971. On each simulated flight various factors are worked out by the computer. These include aircraft performance characteristics, costs, changing passenger loads, baggage, cargo and ground handling. Every aircraft is flown over each route and the earnings per passenger are computed. The aircraft with the greatest earnings becomes the main aircraft assigned to that route. Eventually, by elimination, the best aircraft for particular routes and purposes are listed.

Two-colour images on CRTs

Mirrors and optical filters are being used by 20th Century Electronics in the U.K. to display data on cathode ray tubes in more than one colour. It was considered that colour would aid discrimination in many forms of CRT displays. Shadowmask tubes are too expensive, and multi-coated phosphor tubes produce insufficient brightness for many applications. 20th Century therefore initiated research into ways to use an optical system.

Initially two CRTs were placed at right angles, one tube producing a red trace and the other a green, the two images being coupled with a semi-transparent mirror. A further step was taken with a third CRT to give a blue component. However, this system was found to be too bulky and complex to be practical. In further research, two tubes were placed side by side with three mirrors and one semi-transparent mirror to couple the images. The next step was to substitute a double-beam tube for the two CRTs, using half for each colour. Results from this single tube are said to be very good particularly when comparing two similar wave forms.

Video switching unit

A completely solid-state, modular, video signal switching system has been developed by K.G.M. Vidiaids Ltd., Isleworth, Mddx., England. The system is said to offer greatly improved speed, reliability, flexibility, and quality standards in all video signal switching applications, including colour television transmission. Current methods use two-stage electro-mechanical and electronic systems for selecting and switching transmission from camera to camera or studio to studio. To preserve picture quality without flashing and distortion at the receiver, selection

is first made electro-mechanically. The selected change is then switched electronically but is limited to the alternatives of only two pictures at any one time.

The K.G.M. Vidiaids VSS 620 system provides for immediate push-button selection and direct electronic switching with no mechanical operations. In addition to immediate picture change without quality loss, the VSS 620 system increases the flexibility of selection to as many as ten alternative pictures by means of the TTL unit VSS 627 designed specifically for this purpose. If required, it can produce ten different pictures simultaneously in different sections of the receiver screen. When more than 10 inputs are required to be selected, selection must be carried out in two stages of switching. Large systems (up to 100 inputs and 50 outputs) may be constructed, but buffer input distribution amplifiers must be provided.

More power for Dominica

A new BC station with increased power is due to be on the air in October as part of the general development plans drawn up by the Government of Dominica. To be equipped by The Marconi Company, the station will be located near Roseau, the island's capital. The contract includes a 10KW MF broadcast transmitter, type B6029, together with studio facilities. The new station will cover not only Dominica, but also many of the surrounding islands. It will broadcast a varied program and, when necessary, will give advance warning of hurricanes and other bad weather conditions.

Advanced computer course

A high-level course on "The Design and Analysis of Communications-based Systems" was held recently at the IBM Centre, Sydney, under the direction of four lecturers from the U.S. Systems Research Institute in New York. Those attending the course were all professionals with at least five years experience of computer-based information processing systems and an understanding of control programs, multi-programming and direct access devices. The aim of the course was to give IBM customers the opportunity of significantly increasing their knowledge of communications-based systems.

Headed by Thomas D. Lutz, the group of lecturers also included Miss Phoebe C. LeSesne (the first Negro woman in the U.S. to become a senior systems engineer), Harold M. Krouse, and Leon W. Ellsworth. The topics discussed included: queueing

Computer for N.S.W. TAB

An operator is pictured using a branch input device which is typical of the equipment to be installed in the N.S.W. Totalisator Agency Board (TAB) branches under a \$3-million contract awarded to Amalgamated Wireless (Australia) Ltd. The contract covers TAB branch input devices, telephone betting machines, and P.M.G. line interfaces. The telephone betting machines are an adaptation of the branch input devices for standardisation of components. At each window in a TAB agency, there will be a compact equipment which will record details of each bet, transmit it to a central computer, and then print a betting ticket for the customer, all in six seconds.





General Electric, the originator of the triac, has developed two new and improved *plastic* power pac triacs that feature a sharp cost reduction. Both 6A (SC141) and 10A (SC146) are rated up to 400 volts. *Glass passivation* of the silicon pellet adds reliability by improving device hermeticity.

The cost advantage was obtained by the development of the new molded silicone plastic package that gives the triac added durability even under rugged use. Mounting is virtually foolproof because there is no maximum torque limit on the mounting screw.

Round leads greatly simplify your assembly. The leads can be conveniently formed to various configurations for easy mounting. Dimensionally compatible with the hermetic TO-66 package, both new triacs are designed for either printed circuit board or chassis mounting.

Applications for *plastic* power pac triacs include consumer and industrial fields. It can be used extensively in such major appliances as washing machines, refrigerators, and electric ranges, in houseware items — electric frying pans, blenders, hair dryers, and portable tools.

GE's new *plastic* device is also suited for industrial usage in electric furnace controls, machine tools, business machines, copying machines and light dimmers. **For switching and control applications requiring "metal cans" . . . GE's full-line of triacs up to 25 amps.**

GE's line of triacs is also available in press-fit or stud mounted metal packages as well as special mounting variations for printing board work.

The new addition of GE's triac line is a 25 amp device rated up to 500 volts.

Other industry-proved models are available in 3A, 6A, 10A, and 15A RMS ratings, and peak forward blocking voltages up to 500 volts.

Applications vary from lamp dimming, temperature control and phase control to infinite heat control, static switching, and induction-motor drives. For more information write on your company letterhead to **Australian General Electric Pty. Ltd.**

**Dept 40-24/QQ,
103 York Street,
Sydney, N.S.W., 2000
Telephone 29 8711;
or 552 Lonsdale Street,
Melbourne, Victoria, 3000
Telephone 67 8221.**

General Electric plastic triacs!

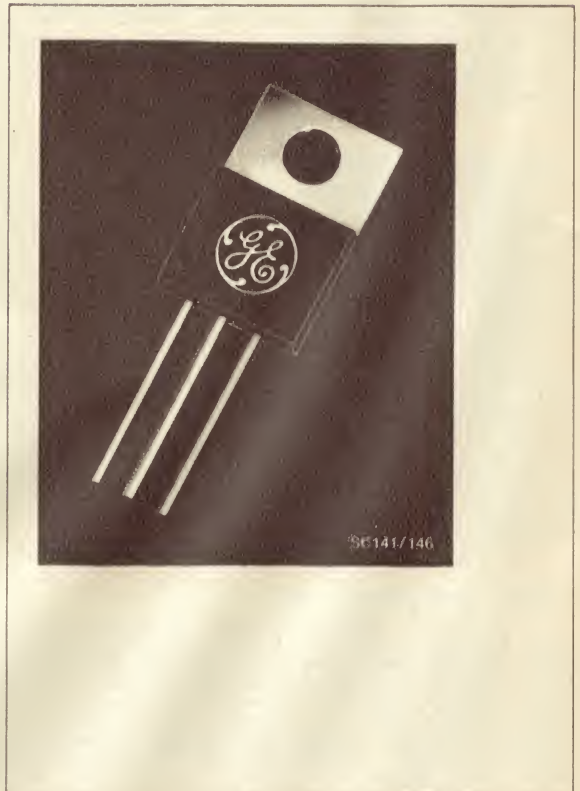

GENERAL ELECTRIC
U.S.A.
Reg. Trademark

theory applied to computer systems having waiting lines; simulation or the construction of mathematical models of systems for study and analysis by computer techniques; programming for communications-based systems which call for timesharing, multi-programming and multi-processing; general systems development process with practical experience in a case study on the design and analysis phase of the systems development process.

Canadian satellite

Earlier this year Canada successfully launched its third ionospheric study satellite, ISIS-1. Totally Canadian-made, it is designed to carry out 10 experiments for Canada's Defence Research Telecommunications Establishment, the National Research Council of Canada, and the University of Western Ontario. The vehicle is powered by 11,000 solar cells in 16 panels on its surface, which convert the sun's energy into electric power.

The \$25lb spacecraft has an on-board tape recorder to accept and store data over areas of the world where no ground receiving facilities are available. First replay from the recorder gave project engineers half an hour of engineering data collected during the launch, ascent and initial orbit — information never obtained before. Data is relayed directly to earth as it is collected. Four telemetry antennae, projecting from the base of the craft, transmit to some 20 ground stations around the world. Extensible antennae, up to 240ft long, combine remote and near measurements of the ionosphere for the first time. Canada's first satellite, Alouette I, was launched in 1962 into a circular orbit to make measurements. It was a resounding success, and is still relaying data for at least one hour each day.

Computerised water project

A battery of 37 Hewlett-Packard computers will help to control water flow through the aqueduct system link between the Sacramento River Delta and Buena Vista pumping plant near Bakersfield in California's \$2,800 million State Water Project. Contractor for the control system is F. and M. Systems Co., a division of Fischbach and Moore Inc. Each of two area control centres will completely scan, in less than a minute, every operational function at as many as 19 separate water control gate sites and four pumping plant sites. Human judgment is applied to control the water, using constantly updated information furnished by the system on every site's condition.

The system, however, is entirely capable of unattended automatic operation for extended periods. Local gate sites, each with its own processor, can function adequately during normal periods between flow changes without direction, should communications be interrupted. An alarm system draws human

Girls build computer



These schoolgirls at the Sion-Manning Secondary School in Kensington, London, England, are studying mathematics by building their own computer under the supervision of maths master Paul Malhorta. With 100,000 components to be soldered into position, the girls have been giving up their lunch hours and taking bits home to assemble. Their homemade computer is seen here at its halfway stage of construction. The girls, aged between 12 and 17, belong to the school's Computer Society, which needs a computer for studying and practising programming.

attention to unusual events, from minor losses of information to major breakdowns. A standby power source at each control centre and site is used in case of a primary power failure at that location. During a power failure there is no loss of stored data, and an orderly restart of computer operation is initiated automatically when power is stabilised or restored.

CCTV for London Stock Exchange



A computer-based, share-price closed-circuit television display system has been supplied to stockbrokers and jobbers at the London Stock Exchange. (See "Electronics Australia," July, 1969, page 31.) A typical office arrangement, as illustrated, has a push-button remote control unit on the desk to allow immediate selection of any of 16 stock-price channels, two feature channels, or two news channels, on the screen.

British postcoding

Postcoding in Britain is to be extended to cover all of the country's 20 million addresses instead of only 75 main centres. The wider program will fit in better with G.P.O. plans to speed up the handling of letters with electronic sorting machines and to meet a growing demand for a uniform system. Original plans were for codes to be given only to London head district offices and the largest of the provincial offices. Now another 40 or so smaller centres will be brought into the planning to complete a nation-wide network. The expanded program will be nearly finished by the end of 1972.

British postcodes have two parts, for example DE1 8ZL. The first part represents the town or village to which the letter is to be sent (in this case Derby), and the second the street or (in many cases) the actual building to which the letter is addressed. An operator at a keyboard converts the postcode to a series of phosphor dots on the envelope which can be read by an electronic sorting machine. The code systems in use in other countries are less effective than the British code as they enable mail to be sorted only to the town of destination. The British code will route a letter to the delivering postman.

Plated memory

The Automation Division of Plessey Electronics in the U.K. has developed what it claims to be Europe's fastest computer memory. Known as the Plessey Mark 1 S250, this memory system has a 290nS cycle time. The system operates in the destructive read-out mode using plated wire storage elements. The elements are formed at the crosspoints of beryllium copper wires, which are continuously plated with nickel iron and the word strip lines with are printed on flexible sheets. The stack design uses normal production techniques and avoids the high labour costs associated with core memories.

The system electronics is based on high-speed TTL integrated circuits. Full self-test facilities are designed into the system so that performance monitoring can be carried out independently from the main processor. The format of the system is 1,024 words of 100 bits, giving a very high interface data transfer rate. The specifications include 290nS cycle time, 175nS access time, and better than 10 per cent margins on currents and voltages on all standard memory tests over the temperature range 0 to 45 degrees C with simultaneous variation of the sense strobe timing. The Plessey Mark 2 S250 memory, to be available later this year, will have 250nS cycle time and a capacity of 16,384 words of 50 bits.



The best
buy at any
price!

PROFESSIONAL TAPE AT WHOLESALE PRICES

"BRAND 5"—unconditionally guaranteed and manufactured to highest U.S.A. professional standards and sensationally priced at half that of comparable tapes.

"BRAND 5" has high remanence iron oxide

emulsion coated to highest grade Acetate or Mylar base material.

"BRAND 5" ensures unmatched results in high fidelity mono and stereo recordings, with certain protection against head wear, squeal and gumming of heads.

FINEST QUALITY! HALF THE PRICE!

LENGTH	TYPE No.	DESCRIPTION & MIL. THICKNESS	NORMAL PRICE	OUR PRICE	LENGTH	TYPE No.	DESCRIPTION & MIL. THICKNESS	NORMAL PRICE	OUR PRICE
7" REELS					CORRESPONDENCE TAPES				
1200'	15D7	1.5 ACETATE	6.60	3.00					
1800'	10D7	1.0 ACETATE	7.25	3.25					
1800'	10D7M	1.0 MYLAR	9.15	3.99					
2400'	5D7M	.5 MYLAR	10.40	4.75					
2400'	5D7MT	.5 TENSIL MYLAR	11.90	5.25					
3600'	5D7MS	.33 MYLAR	13.20	6.75					
5½" REELS					3½" REELS				
1200'	10D57	1.0 ACETATE	5.50	2.55	900'	3D32MS	.33 MYLAR	3.90	1.95
1200'	10D57M	1.0 MYLAR	6.00	2.95					
1800'	5D57M	.5 MYLAR	8.90	3.75					
5" REELS					3" REELS				
600'	15D5	1.5 ACETATE	3.40	1.80	150'	15D3	1.5 ACETATE	.95	.50
900'	10D5	1.0 ACETATE	4.15	1.98	225'	10D3	1.0 ACETATE	1.20	.65
900'	10D5M	1.0 MYLAR	5.32	2.25	225'	10D3M	1.0 MYLAR	1.65	.70
1200'	5D5M	.5 MYLAR	6.95	2.50	300'	5D3M	.5 MYLAR	1.95	.85
1200'	5D5MT	.5 TENSIL MYLAR	8.70	2.75	600'	3D3MS	.33 MYLAR	3.30	1.60
1800'	5D5MS	.33 MYLAR	9.60	3.75					
					CASSETTES				
					C30 3.10 1.55				
					C60 3.50 1.65				
					C90 4.75 2.65				
					C120 6.50 3.30				

* AVAILABLE AT ALL GOOD RADIO,
TAPE AND RECORD STORES

GREEN CORPORATION LTD. 88 KING STREET
SYDNEY. TEL.: 25-1989



GREEN CORPORATION LTD. EA669

88 KING STREET, SYDNEY, N.S.W. 2000

Please send me FREE discount price list and specifications

NAME.....

ADDRESS.....

Recorder for Mars



Designed specifically for data gathering in the U.S.A.'s space probes, this prototype tape recorder measuring only 6in x 6in x 9in, packs nearly 3,500 bits per inch on each of its eight tracks. Designed and built by the Lockheed Electronics Co., it will be used to store 180 million bits of television and scientific data on a single reel aboard a Mariner spacecraft orbiting Mars. Scheduled for launch early in 1971, the probe will orbit the planet for a period of 90 days.

Lasers drill jewels

Yttrium aluminium garnet lasers from the Raytheon Company are to be used in automated feed and control equipment to drill ruby and other jewel bearings in the Swiss watch industry. The equipment conveys the jewels into position and indexes them to receive the rapid pulses from the laser head. The lasers enable several bearings to be drilled each second. The process is much faster than the conventional method of using rods and fine diamond dust for small holes, and ceramic bonded rods for larger ones.

Communication tests

The systems design group of Amalgamated Wireless (Asia) Ltd., is engaged in experimental satellite communication tests. NASA has agreed to make its Applications Technology Satellite ATS-1 available for experimental purposes. It is located in a "stationary" orbit over mid

Pacific. One of the co-operating ground stations, at Cooby Creek, Qld., is operated by A.W.A. technical staff for the Department of Supply.

The proposed equipment comprises four television-type Yagi antennae, supported on a simple frame, and a VHF base station type BST-50A/6. The A.W.A. test station is located in the grounds of its North Ryde (Sydney) works. Signals from a 50W transmitter have been received at the Cooby Creek station via the ATS-1 satellite. Tests have resulted in acceptable voice and teleprinter signals, and also facsimile prints of weather maps for meteorological purposes. Further technical tests are to continue.

Thai network

A complete telephone and telegraph network linking Bangkok, Thailand's capital, with the north-eastern and south-eastern parts of the country has been supplied and installed by Philips Telecommunications of Hilversum, Holland. The network, destined primarily for communications with provincial administrative centres, is used by the Thai Ministry of Interior, and is operated by the Thai police communications division. The network, which went officially into service on April 4, 1969, consists of automatic telephone and telegraph exchanges, multi-channel carrier telephone equipment, microwave installations, and equipment for remote signalling and control and for telesupervision.

TV production company

Operation began in July for a new commercial television production company, Video-Tape Corporation Pty. Ltd., East Roseville, N.S.W. The general manager, Winston Frecker, said that the 14,500 sq. ft facility includes two full-colour studios with complete high-band colour videotape and film capability. A mobile unit is also planned. Included in the equipment are three Ampex VR-2000B broadcast high-band videotape recorders with electronic editing capability, and a Marconi Mk VII colour camera designed to operate on the proposed Australian standard of 625-line PAL colour. The company anticipates the purchase of additional equipment within the next year to give on-location high-band taping and full animation capability.

Ferromagnetic chromium

A new chromium compound was recently found to be ferromagnetic in a study at the NBS Institute for Materials Research in the U.S. While investigating ferromagnetism, superconductivity, and diamagnetism in beryllium and some of its compounds, N. M. Wolcott and R. L.

Falge, of the Institute's Metallurgy Division, discovered that CrBe₁₂ is ferromagnetic below 50 degrees K. This discovery was unexpected for two reasons. First, chromium compounds are usually antiferromagnetic; for example, in chromium iron compounds the chromium decreases the magnetic moment of the iron. Secondly, the only beryllium compounds known to be ferromagnetic are the beryllium iron compounds, FeBe₂ and FeBe₅.

While studying CrBe₁₂, Wolcott and Falge found that this compound has a Curie point of about 50 degrees K. Above that temperature the material is paramagnetic. Below 50 degrees K, the material exhibits a weak ferromagnetic moment with hysteresis. Remanence was observed in the temperature range below the Curie point.

Audio-visual aid



This teaching aid can be used by children who cannot read, and can also be used for the teaching of reading. It presents visual material from a program "book" with audio instruction synchronised to it in much the same way as a tutorial conversation. Called the Talking Page, it can repeat, back track, or pass over material to suit the learning ability of the child through its random access system under the pupil's control. Manufactured by Rank R.E.C. Ltd., of London, England, the machine is battery operated and completely portable.

The audio material is recorded on a special disc which is slipped into the back of the machine, and the visual material is placed in position on top. Each page is marked at the edge to indicate the various audio access points. By operating a simple lever on the side of the machine opposite the appropriate mark on the book page, the user will hear the recorded information matching the visual material.

Detecting clear air turbulence

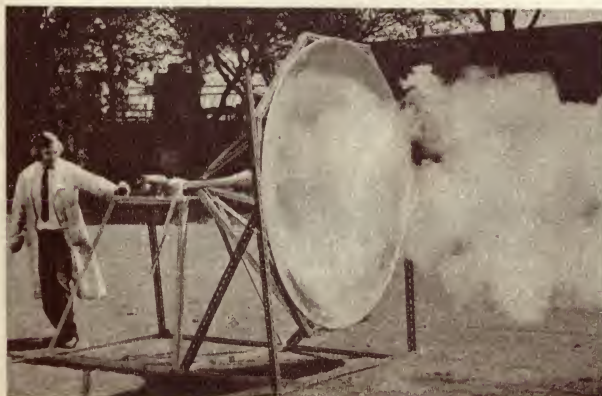

A 10 bore yachting cannon fitted with a six-foot diameter exponential horn is being used in experiments being conducted jointly by Britain's Royal Radar Establishment and Birmingham University into methods of detecting clear air turbulence (CAT) with radar. CAT is thought to have been responsible for several otherwise inexplicable crashes over the years. It is non-reflective, and for this reason has so far defied radar detection. The shock fronts created by the cannon are detectable, however, and are affected by air turbulence. Using a monostatic radar (one using a common aerial for transmitting and receiving) and the shock wave as a marker, scientists have already succeeded in tracking air movement up to 1,800ft, their findings later being confirmed by established meteorological methods.

The feasibility of the detection method has been proved, and further work may result in equipment to locate air turbulence, wind gradients, and the vortex effects caused by aircraft wings near airfields—all hazards when landing aircraft. With further development, the method may possibly be adopted for airborne detectors that will warn pilots of dangers ahead from CAT, though this will be limited to subsonic flight.

Radiography certifies tiny electronic parts on Telstar

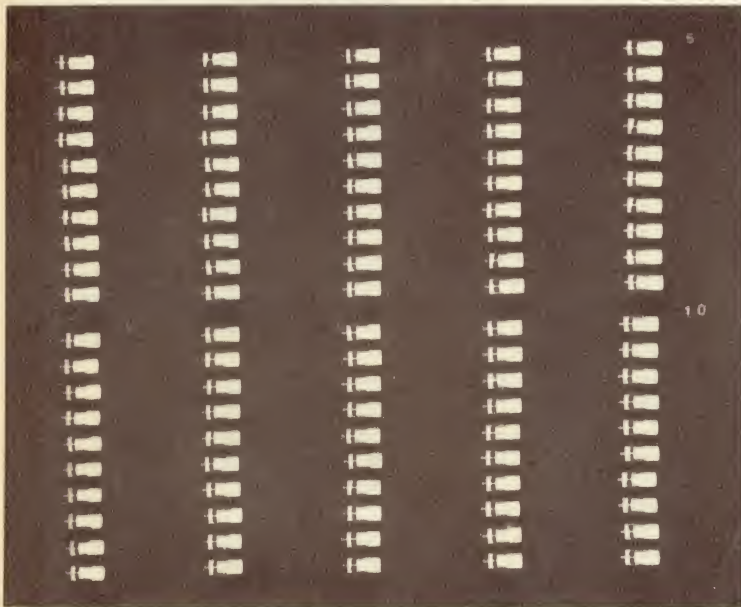

The thousands of parts in Telstar must perform perfectly, including solid tantalum capacitors shown in the radiograph reproduced here. These capacitors were radiographed on Kodak film to show whether their anodes were positioned and plotted properly, and to search for stray solder globules.

The uses of radiography in industry are practically endless. Castings and welds can be inspected for soundness. Even sealed internal assemblies can be inspected. For quality control of the smallest capacitor or largest transformer radiography can save you time and money and help you build a reputation for quality.

Kodak's outstanding range of industrial x-ray films includes general-purpose films; fine-grain films for highest quality production radiography, as well as for extra critical radiography; also single-coated films for maximum detail under high magnification.

Ask your Kodak technical sales representative for further information or write to:

Kodak Radiography Markets Division,
KODAK (Australasia) PTY. LTD.
Branches in all States.

K-1996

Zinc die wins competition

First prize of \$1,500 in an international competition for zinc die castings has been won by two Australian companies at the 6th International Pressure Die Casting Conference, held in Paris recently. The die caster, Wilmot Breedon (Aust.) Pty. Ltd. of Preston, Vic., and their customer, W. E. Cash Pty. Ltd., of Coburg, Vic., won their prize in a competition for an outstanding new application for a zinc die casting.

The prize-winning casting is the "Cash-angle" gutter corner which allows fast, easy erection of roof gutters without soldering, riveting or adhesive bonding. The system comprises a thin-walled zinc die casting designed to match the profile of an existing galvanised steel gutter. The casting is shaped to receive two pieces of guttering mitred at an angle of 90 degrees to each other.

Radar contract

The Marconi Company of England has received an order from the Malaysian Government for the supply of two transportable defence radar systems. The equipment to be supplied will come from the recently introduced Marconi S600 range of radars, and is expected to play a vital part in Malaysia's defence capability for the future. The contract includes extensive training of Royal Malaysian Air Force personnel at Marconi College, Chelmsford, Essex. The S600 series has been developed as a range of compatible radar units and auxiliary modules from which systems can be built up to meet all types of defence requirements.

Aluminium cables

The British G.P.O. is now using aluminium instead of copper in cables linking telephones with local exchanges. This is expected to save about \$1m a year. Although aluminium has been used experimentally, Britain is believed to be the first country to lay it for telephone lines in

everyday use. The G.P.O. began experiments in the 1950s and ran into difficulties with jointing and corrosion. The jointing problem has been solved by a crimping tool to compress the wire ends inside an insulated connector without stripping off the plastic insulation. A new method was developed to prevent corrosion in underground cables by packing them with petroleum jelly. Trials are now being carried out with aluminium wires thinner than previously thought possible; this may lead to a further reduction of costs.

Geophysical spacecraft

NASA recently launched the 1,393lb orbiting geophysical observatory satellite OGO-6 into orbit from the Western test range in California. The launch rocket was a Thorad-Agena D which injected the OGO-6 into a low altitude nearly polar orbit around the earth. OGO-6 is the last in a series of spacecraft designed to study the nature of earth/sun relationship from near-polar and highly elliptical orbits.

Underwater camera

An underwater photographic system has been developed by Lockheed Missiles and Space Co., Sunnyvale, California, U.S.A. Designed for the investigation of marine life on the continental shelf, the system consists of underwater cameras and the lighting needed for both time-lapse and motion - picture photography. The time-lapse camera is capable of 16,000 successive pictures; in a 24-hour period a picture is taken every 5.4 seconds. The motion-picture camera operates for 30 seconds out of each hour for a 24-hour period. Initial filming includes time-lapse studies of abalone movements at Morro Bay, California, in co-operation with the State Department of Fish and Game. Periodic motion-picture studies of hourly changes in the fish population of Monterey Bay reefs will also be made.

Simulating the movement of the sea



A research worker checks the instrument panel of electronic equipment which controls tidal and current reproduction in a large-scale tidal model of Morecambe Bay, the north-west England holiday resort. It is part of a \$1 million study commissioned by the British Water Resources Board to determine the feasibility of constructing a freshwater storage barrage across the bay. The model will be used to investigate the likely effects that this bar-

rage would have on tides, currents and siltation in areas to seaward of the proposed alignments. When constructed, the barrage would be about 12 miles long, crossing the drying sands in the landward reaches of the bay. It would store freshwater from the rivers Kent and Leven, which have catchment areas of high rainfall intensity. The reservoir created would permit some 70 million cubic feet of water to be used each day.

HI-FI

A budget-priced system for those who want to enter the wonderful world of High-Fidelity sound . . .

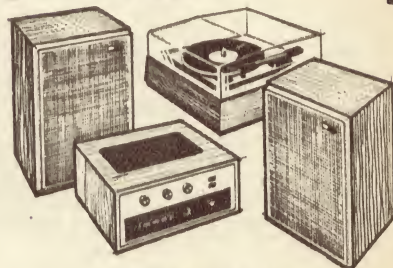

It is impossible for us to know what you personally look for in a Hi-Fi system, but we can guarantee that we have just the set-up you are looking for.

For example, this system, comprising a Rogers Cadet Amplifier with 2 Goodmans Ten/Ten loudspeakers and Garrard Record Player. At \$398, it is one of the best buys in Hi-Fi; terms available. Come in and let our experts help you with your choice.

URD

UNITED RADIO
DISTRIBUTORS PTY. LTD.

SHOP 32, ASH STREET,
ANGEL ARCADE, SYDNEY

Telephone 28-3718 28-3926

Please forward details of
High Fidelity Systems, including
Rogers Cadet/Goodmans Ten-Ten.

Name

Address

.....

State

Powered Loudspeaker For Portable Recorders

By LEO SIMPSON

This article discusses several ideas for those who wish to improve the sound quality from cassette recorders or portable radios. It describes the use of a larger speaker enclosure in place of the internal speaker, the construction of a power amplifier to provide still more boost, and a mains power supply to save battery costs.

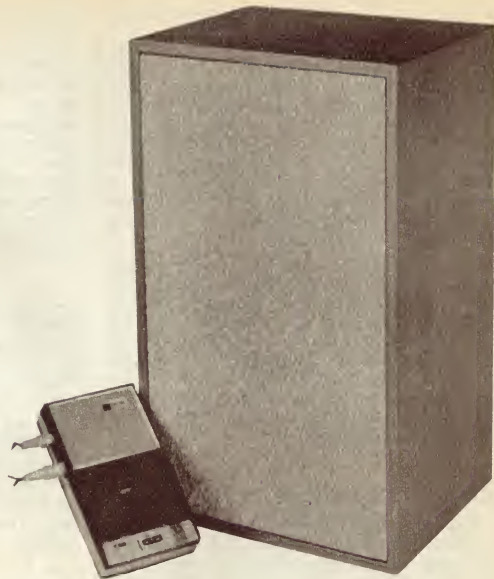

Practically everyone who owns a portable radio or miniature tape recorder has wished, at some time or other, to connect an external loudspeaker to improve the quality of the reproduction. After all, one cannot expect wide range sound from a small loudspeaker with little or no baffling. An external speaker of even average quality will improve the sound from just about any small set, provided the amplifier is not so badly designed that the internal loudspeaker is actually masking a lot of inherent distortion. The external loudspeaker, by virtue of its greater cone area, larger magnet, and improved baffling, will usually be far more efficient than the set's internal speaker and will allow the amplifier to operate at a lower, more distortion-free level.

Besides using the set with an external loudspeaker it is usually desirable to have a mains supply to conserve the batteries. The quality of reproduction from any amplifier depends to a large extent on the regulation of the power supply. While new batteries provide a portable power supply with good voltage regulation, this tends to deteriorate long before they have reached the end of their service life. This deterioration is caused by the gradual depletion of the chemical components of the battery. Poor regulation and reduced voltage causes an increase in the level of distortion, a decrease in the sensitivity of portable radios, and a general fall-off in power capability of the amplifier.

Since this kind of deterioration would largely offset the advantage of a more efficient speaker system, with or without its own amplifier, a power supply becomes almost essential if lengthy periods of operation are envisaged. There is also the straight-out economic aspect to be considered, as it is surprising just how expensive battery power becomes when batteries have to be replaced every few weeks.

The need for a separate power amplifier to drive the speaker is dictated by the limitations of most portable units. Their power output is usually limited to a few hundred milliwatts and, while even this will sound a whole lot better when applied to a large efficient speaker system, it

is not really sufficient in many applications.

What is desired then, is a loudspeaker-cum-amplifier with a power of, say, 3 watts, with the mains supply for the amplifier arranged to do double duty by supplying the power requirements of the cassette player or portable radio. As further icing on the cake, the amplifier would be suitable for direct connection to a ceramic cartridge: an arrangement which could perform sterling service at parties and so on.

The speaker system used should be one of the more efficient types—a bass reflex type would be ideal—to obtain the best performance with the proposed amplifier. The small bookshelf enclosures are seldom efficient enough to be driven to an adequate level with a 3-watt amplifier.

For our prototype unit we used the Playmaster One-Point-Three loudspeaker as described in July, 1969. The amplifier is based on the 3-plus-3 Stereo Amplifier described in August, 1968. The sensitivity has been increased to 150mV for full output, partly as a result of dispensing with the balance and tone controls, and partly at the expense of lower input impedance, which is now of the order of 500K. A ceramic cartridge such as the BSR C1 will drive the amplifier into clipping, even on lightly recorded discs. The volume control at the input enables the amplifier to handle a wide range of signals without being overloaded.

A value of 500K is somewhat less than ideal as a load for a ceramic cartridge, and will result in some loss of bass response. However, it is not as serious in practice as might be imagined, particularly in the kind of casual listening application for which this equipment is intended. If it should transpire that the particular cartridge has output to spare, then it would be advantageous to add as much resistance as possible in series with it; i.e., at the "top" of the volume control. This will reduce its output but improve the bass response.

The power supply for the amplifier consists of a small power transformer with a multi-tapped secondary winding, the 12.5V tap feeding a bridge rectifier. The D.C. output from the

rectifier is filtered by 4,000uF of capacitance. Part of the DC output is fed to a zener diode network which supplies the DC requirements of the signal source; tape recorder, radio, etc. A 6, 7.5, or 9-volt zener diode may be used, depending on the voltage required. For simplicity we have only shown a 7.5 volt zener on the circuit diagram. If a 6-volt zener diode is used the series resistor may be increased from 39-ohms to 47 ohms to avoid unnecessary current drain.

With the 7.5 volt zener in circuit the standing current is around 250mA which is the main reason for the large amount of filter capacitance. Some signal sources, such as a record changer, will not require low voltage DC and to avoid unnecessary power wastage when the DC is not required we have arranged for the zener diode network to be disconnected from the circuit when not in use. We have used a four-pin plug and socket for the DC output. The plug is wired with a link, as shown on the circuit diagram, and this serves the purpose of a switch. When the plug is removed no power is supplied to the zener diode network.

The maximum power available from the amplifier will depend on whether the zener diode network is in circuit or not. With it out the power output into an 8-ohm load will be 3 watts continuous, dropping to 2 watts continuous with the zener network in circuit. A similar order of power output can be obtained with a 15-ohm loudspeaker if the 15-volt secondary winding of the transformer is used. The 15-volt winding must not be used if the amplifier is intended for use with an 8-ohm speaker, to avoid running the output transistors in excess of their ratings.

Connection from the four-pin DC output socket to the cassette, portable radio etc., is by means of a "patch cord" terminated with a connector appropriate to the particular device. Usually, the act of inserting this connector will automatically disconnect the internal batteries. If no such provision exists it may be possible to provide a change-over jack and socket, and modify the player or radio for use with an external supply.

Most cassette players and portable radios have a socket allowing an ex-

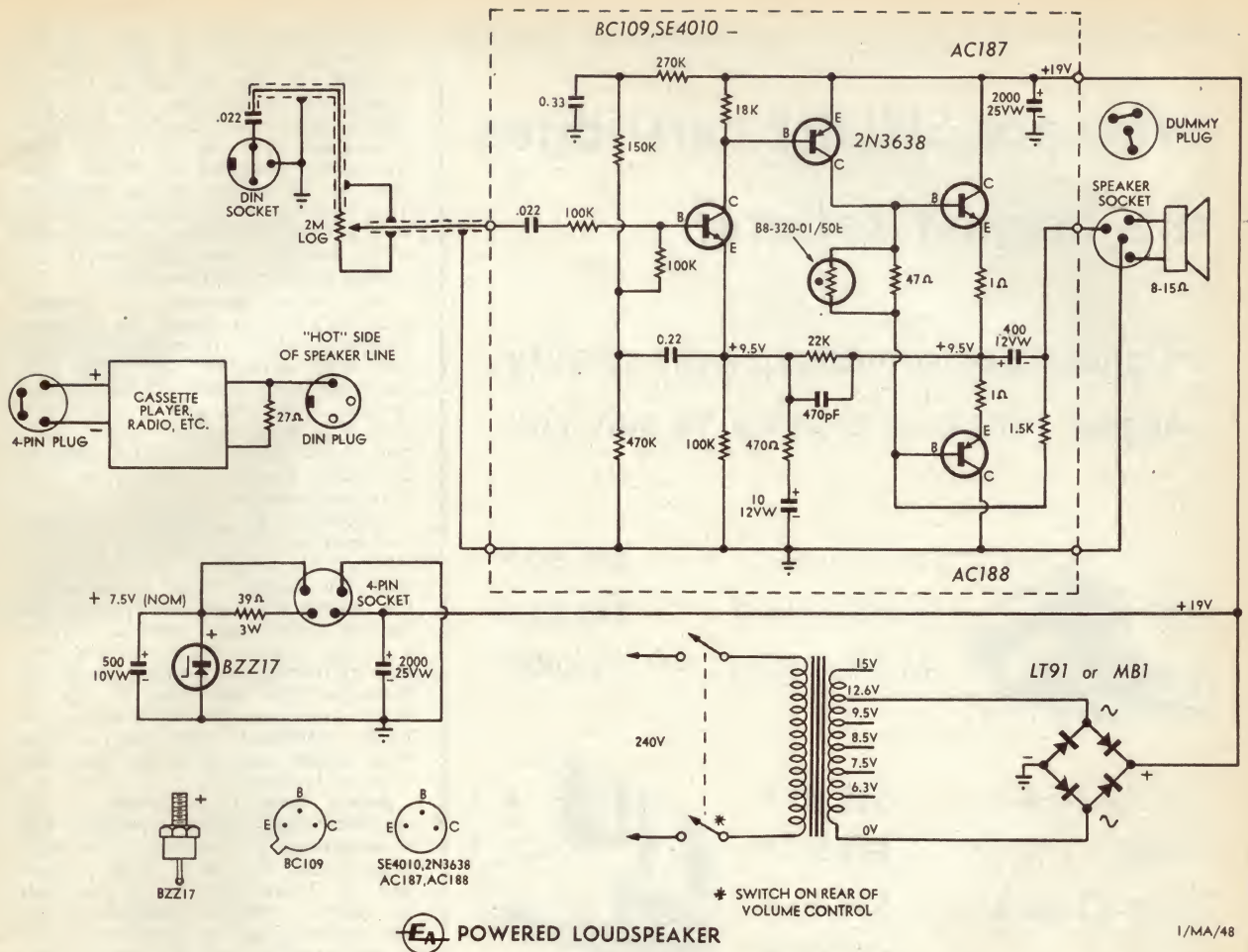

POWERED LOUDSPEAKER

1/MA/48

tension speaker to be fitted and we elected to take the signal for the external amplifier from this point. Ideally, the signal should be taken from across the volume control so that distortion caused by the internal amplifier of the set is not added to the signal. However, to do this would require modifications to most sets and these would be difficult because of lack of accessibility and space to run shielded cable and install an output socket. One could modify the external speaker socket so that it carried the signal from the volume control instead, but we feel that most people would rather not tamper with their sets.

The power supply, as shown, is suitable for use with either NPN (negative chassis, positive supply rail) or PNP (positive chassis, negative supply rail) systems, simply by connecting its positive and negative terminals to the corresponding input terminals of the device. The fact that one side of the power supply, the negative side, is "earthy" as far as the external amplifier is concerned is of no consequence while ever this is the only connection to the device.

However, as soon as we consider the situation where the speaker terminals of the device are to be connected to the input of the external amplifier, we face the possibility of conflicting polarities. Where the device has a negative chassis and positive supply rail, as for the external amplifier, there is no real problem. The chassis of the device can connect to the chassis of the external amplifier without complications.

On the other hand, a device with a positive chassis and a negative supply rail presents the problem that the two chassis must not be connected to-

gether, at least in the DC sense. For this reason, only one lead, the "hot" lead, is provided to convey the audio signal from the speaker circuit of the

Parts List

1 case and lid, inside dimensions, 7 x 4 x 4 inches.

1 loudspeaker system (see text).

1 printed board, 68/a8 (see text).

1 2M (log) potentiometer with power switch.

1 3-pin DIN plug and socket.

2 4-pin plug and socket (different pin patterns).

1 power transformer, with secondary tapped at 6.3, 7.5, 8.5, 9.5, 12.6 and 15 volts AC at 1 amp DC (A & R 2155 or equivalent).

SEMICONDUCTORS

1 AC188/187 complementary germanium pair (with flag heat-sinks).

1 BC109, SE4010 or similar, high-gain, silicon NPN transistor.

1 2N3638 or similar, high-gain, silicon PNP transistor.

1 LT91 selenium bridge rectifier or MB1 silicon bridge rectifier.

1 B8-320-01/50E thermistor.

1 BZZ15 or BZZ17 or BZZ19 zener diode for 6, 7.5 or 9 volt supply, respectively.

RESISTORS

($\frac{1}{4}$ or $\frac{1}{2}$ watt unless specified)

1 x 470K, 1 x 270K, 1 x 150K, 3 x 100K, 1 x 22K, 1 x 18K, 1 x 1.5K, 1 x 470 ohms, 1 x 47 ohms/ $\frac{1}{2}$ W, 1 x 39 ohms/3W, 1 x 27 ohms/ $\frac{1}{2}$ W.

CAPACITORS

(Higher voltage ratings may be used.)

2 x 2000uF/25VW electrolytic.
1 x 500uF/10VW electrolytic.
1 x 400uF/12VW electrolytic.
1 x 10uF/12VW electrolytic.
1 x 0.33uF/25VW ceramic or metallised polyester.
1 x 0.22uF/25VW ceramic or metallised polyester.
2 x 0.022uF ceramic or polyester.
1 x 470pF polystyrene or ceramic.

SUNDRIES

1 knob, spacers, screws, nuts, mains cord and plug, mains cord clamp, 2 grommets, shielded cable, 1 8-terminal tagstrip, spaghetti sleeving, hook-up wire, solder.

Why are SHURE cartridges the largest sellers?

Highest performance, best quality, largest range at a price to suit you.



VI5 Type 11 \$87.50 *

M75E Type 2 \$45.00 *

M75EJ Type 2 \$38.00 *

M75G Type 2 \$35.00 *

M55E \$32.50 *

M75-6 Type 2 \$29.50 *

M44E \$28.50 *

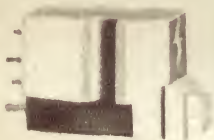
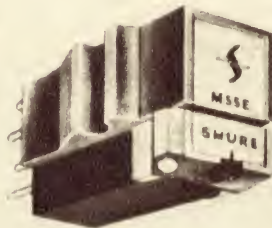

M31E-EP \$25.00 *

M32E-EP \$25.00 *

M 44-5 \$20.00 *

M 44-G \$19.50 *

M 44-7 \$19.50 *

M 44-C \$18.00 *



Contact your local representative for detailed literature on SHURE quality products.

N.S.W.: Audio Engineers Pty. Ltd., 342 Kent Street, Sydney.

W.A.: Athol M. Hill Pty. Ltd., 613-15 Wellington St., Perth.

QLD.: Ron Jones Pty. Ltd., 7-9 Merton Rd., Woolloongabba, Brisbane.

VIC.: Audio Engineers (Vic.), 2A Hill Street, Thornbury. Phone 44-3295.

* Recommended Resale Price.

device to the input of the amplifier. The return circuit for the signal is provided, in the case of a negative chassis device, via the negative DC supply lead. In the case of a positive chassis device it will be via the positive supply lead and the 500uF capacitor to the chassis of the amplifier. Thus the system is suitable for use with a device of either polarity, simply by ensuring that DC power terminals are connected correctly.

For correct operation the internal amplifier's output should be correctly loaded. In this application the load can, with advantage, be higher than the impedance value of the internal speaker. This will give a lower current drain and, usually, a slight reduction in distortion. We used a value of 27 ohms, and this appears to be a good compromise.

Originally, we thought to connect this resistor across the input socket of the external amplifier, but we realised that this would create a permanent low impedance input and prevent the use of other signal sources, such as a ceramic pickup. We solved the problem by wiring the resistor inside the three-pin DIN input plug for the external amplifier. The other end of the cable attached to this plug is fitted with a plug appropriate to the player or radio involved.

Motor noise superimposed on the amplifier signal can be a problem with some cassette players. The 500uF capacitor across the zener diode reduces this to a level that is not noticeable on normal program material. It can also be minimised by operating the external amplifier with its volume control set at a low level while the volume control on the cassette player is set at a fairly high level, but well short of overload.

The prototype amplifier was constructed in a small metal box measuring 7 x 4 x 4 inches and fitted with a biscuit tin lid. The box has a volume of 112 cubic inches, and this means it can be installed in speaker enclosures of more than about three quarters of a cubic foot with little effect on the performance of the speaker. The box could be installed in smaller enclosures without the biscuit tin lid fitted so that it occupied less volume in the enclosure. The use of the metal box is a much better way of accommodating the circuit components than mounting them on the rear panel, inside the enclosure.

The layout is such that the volume control, the four-pin DC output socket, the three-pin DIN input socket, and the grommited hole for the power cable are all fitted to holes in the bottom of the box. A cut-out is provided in the back of the speaker enclosure measuring approximately 5 1/4 in x 3 in and the bottom of the box is mounted against this from the inside. The box is secured by four wood screws, one in each corner, and an airtight seal provided by means of a thin felt gasket.

The only other fitting on the speaker box is a miniature four-pin speaker socket mounted directly on the wooden back. The purpose of this socket is to provide a convenient means of connecting the speaker to either the amplifier inside the speaker box, or an external amplifier, such as part of the domestic stereo system. A dummy plug

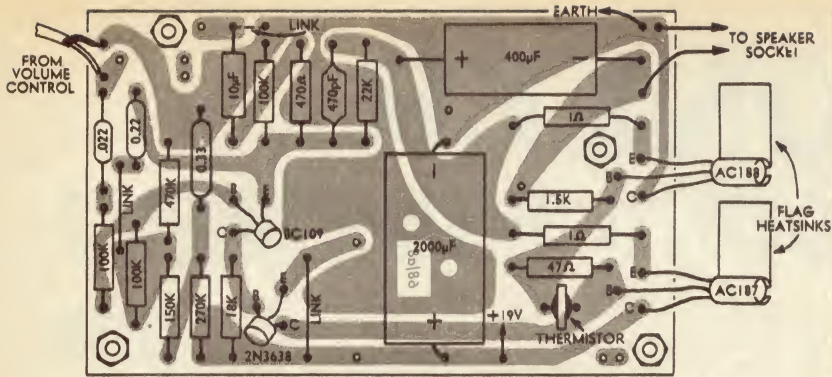

Above is the component layout on the printed board with the grey overprint showing the copper pattern on the reverse side.

is used to connect the speaker to its own internal amplifier, while external signals may be fed directly into the socket. Note that this four-pin socket has a different pin configuration to that used for the DC output socket, for obvious reasons.

The presence of these various sockets in the back of the cabinet will inevitably result in some air leakage in the enclosure, mainly via the holes in the four-pin sockets, the DIN socket being essentially airtight. While this is theoretically undesirable, it must be realised that the amount of leakage is quite small; nothing like the kind of leakage which can occur when an ill fitting back can leave a gap along one complete side. As far as any application involving tape players, portable radios

etc., are concerned, the effect on performance would be negligible.

Where higher quality signal sources are concerned, such as a stereo channel, some users may feel that even this is undesirable. Most of the leakage, such as it is, will be prevented if there is a plug in the socket and it would be worthwhile fitting a dummy plug in any otherwise unused socket. The alternative is to use a completely different system of connections, possibly based on terminals mounted directly on the wooden back of the box.

Use good quality components for the amplifier. The resistors should be carbon film types for best results, rather than carbon composition types. The latter tend to increase their value

At right is a view inside the case. Of the two sockets, the one on the right is the DIN input socket and the other is the DC output. A .022µF capacitor is wired between the DIN socket and the two-way tagstrip. Note the flag heatsinks which are screwed to the lower left side of the case. The grommetted hole for the speaker leads is obscured by the heatsinks. The bridge rectifier is mounted behind the 8-terminal tagstrip, next to the transformer.

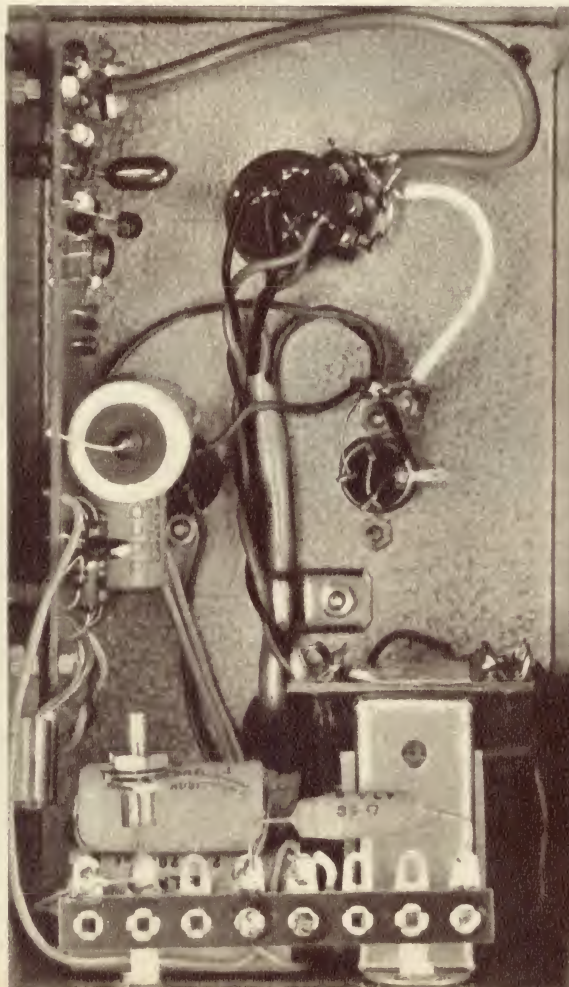

Regulated Power Supply BATTERY ELIMINATOR

SPECIALLY FOR LARGER BATTERY
OPERATED TAPE RECORDERS

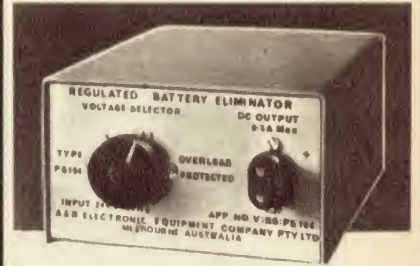

TYPE PS104

Designed primarily for Tape Recorders where a regulated voltage supply is necessary to prevent speed variation with load changes. A versatile power supply with a range of output voltages making it ideal for design, testing and repair of Transistor Radios, Amplifiers, Record Players, Test Equipment, etc. It is also eminently suitable for use in Schools, Universities, Government Departments and Industry.

SPECIFICATIONS

Input Voltage	240 Volts, 50 Hz
Output Voltage	4.5V 6V 7.5V 9V or 12V DC by Selector plus Max Current 0.5A
Protection	Electronic Overload Protection
Regulation	Approx. 10% on 12V Range Approx. 5% on all other Ranges
Ripple	Less than 100 µV R.M.S. under all conditions
Circuitry	All silicon solid state
Size	4 ins. wide by 2 1/2 ins. high x 5 1/2 ins. deep
Weight	2 lbs. 7 ozs.
Approval	Approved by Electric Supply Authorities

Manufactured by
**A. & R. ELECTRONIC
EQUIPMENT**

COMPANY PTY. LTD.,
42-46 LEXTON ROAD,
BOX HILL, VIC., 3128.

Phones 89-0238, 89-0239.

AGENTS IN ALL STATES

N.S.W. SOANAR ELECTRONICS PTY. LTD.
82 Carlton Cres., Summer Hill. Ph. 798-6999.
QLD. R. A. VENN PTY. LTD.
71-73 Doggett St., Valley, Bris. Ph. 51-5421.
S.A. SCOTT THOMPSON PTY. LTD.
93 Gilles St., Adelaide. Phone 23-2261.
W.A. EVERETT AGENCY PTY. LTD.
17 Northwood St., W. Leederville. Ph. 8-4137.

PIONEER

SOUND EQUIPMENT

has
NO BOUNDARY
at...



General Accessories

Come and see this exciting range of Pioneer sound equipment for a no obligation free inspection at General Accessories new stereo showroom.

at- 153 Sturt Street, South Melbourne.

LATEST



MODEL SX 440

The newly developed stereo receiver designed with meticulous attention to looks as well as to sound quality. It uses an FET in the FM front end to provide excellent selectivity and sensitivity as high as 2.5 mV (IHF). The AM tuner section is equipped for ideal reception with a ferrite loop antenna. The audio-frequency at a dynamic 40 watts (IHF/4 ohms).
Dimensions: 15-15/16" (W) x 5-7/16" (H) x 15" (D).



MODEL PL 11

The perfect addition to quality stereo systems, with 2-speed, 4-pole synchronous motor, 12" aluminium die-cast turntable. It is an idler driven system and has a static balance type pipe arm.
Dimensions: 16-9/16" (W) x 13" (D) x 6-5/16" (H).

RELEASES



MODEL SA 500

An efficient medium-range pre/main amplifier built to very high specifications for size of unit. It has a set of controls, inputs and outputs for versatile operation of speakers and tape recorders. Main amplifier total power is 44 watts (at 4 ohms). All solid state circuitry includes low-noise silicon transistors.
Dimensions: 13" (W) x 4-5/8" (H) x 12-5/16" (D)

GENERAL ACCESSORIES

SERVING THE RADIO AND ELECTRICAL INDUSTRY THROUGHOUT AUSTRALIA;

Division of Electronic Industries Ltd.

N.S.W. 443 Concord Road, Concord West. Phone: 73 0211.
S.A. 46 Milligan Street, Perth. Phone: 21 2501.
TAS. 199 Collins Street Hobart. Phone: 2 2711.

QLD. 50 Little Edward Street, Brisbane. Phone: 2 3093.
S.A. 81 Flinders Street, Adelaide. Phone: 23 4022.
VIC. 153 Sturt Street, South Melbourne. Phone: 69 0300.

after a period of service and this can play havoc with the amplifier's performance. The author recently had real cause for regret when he had to trace a fault in a high-power direct coupled amplifier. The fault was caused by three carbon resistors which had gone high. All the other resistors were carbon film types!

All the components within the dotted line on the circuit diagram are mounted on a printed circuit board. This board is actually one half of that for the 3-plus-3 Stereo Amplifier referred to above. The board is coded and is available from most kitset suppliers. Mounting the components on the board is straightforward and requires little comment except for a caution to avoid overheating the components when soldering.

The need to provide half a standard printed board warrants some comment. It is not clear at the time of writing whether any of the supply houses will be able to supply half boards, or whether, if they do, that the saving will be worthwhile. We suggest that the constructor should be prepared to buy a complete board and divide it himself. It may be possible for two constructors to share such an arrangement.

The most satisfactory way of dividing the board appears to be by scoring and breaking. An ideal scoring tool is a Laminex knife, available from most hardware stores. Score the board neatly down the centre, then clamp one half firmly between two pieces of board with their edges flush with the score mark. The board should then break cleanly.

The board is mounted by means of $\frac{1}{4}$ -inch long $\frac{1}{4}$ -inch Whitworth screws and nuts or shorter screws and spacers.

The output transistors, which have a TO-1 metal case, are wired directly into the amplifier board, leaving a lead length of about 1 inch. The leads should be insulated with spaghetti sleeving to minimise the risk of short circuits. The transistors are fitted with flag heatsinks (Miniwatt part No. 56200) which are normally supplied with each complementary pair. These metal flags are firmly secured to the case, as shown in the photograph, by means of $\frac{1}{4}$ -inch screws and nuts. The flags should be secured individually to the case to ensure the best heat transfer. — not two flags by one screw. If the box has been painted, the area to which the flag heatsinks are attached should be stripped to the bare metal to ensure efficient heat transfer. This is not to say that the transistors are dissipating a lot of power but it is desirable to keep the temperature as low as possible.

The speaker leads are brought out through a grommeted hole in the side of the case and run down to the four-pin speaker socket. The filter capacitors and the zener diode network can be seen in the photograph. The zener diode is soldered directly to a tag strip and requires no auxiliary heat-sink.

The mains cord should be anchored by a clamp as shown in the photograph. When terminating the mains cord the earth lead should be left longer than the active leads so that if the cord is strained to the limit the earth lead will be the last to break.

The bridge rectifier we used was a selenium type, Westinghouse LT91,

which sells at a very economical price. As an alternative, an encapsulated silicon bridge rectifier, type MB1, is marketed by STC: it is more compact than the LT91, but there is a price difference of almost one dollar.

Assembly will be made easier if a suitable order is followed. First mount the power transformer and bridge rectifier. Then mount the tagstrip, input and output sockets and volume control. Wire the components into the tagstrip and connect the wires to the DC output socket. Wire the mains cord to the switch on the rear of the volume

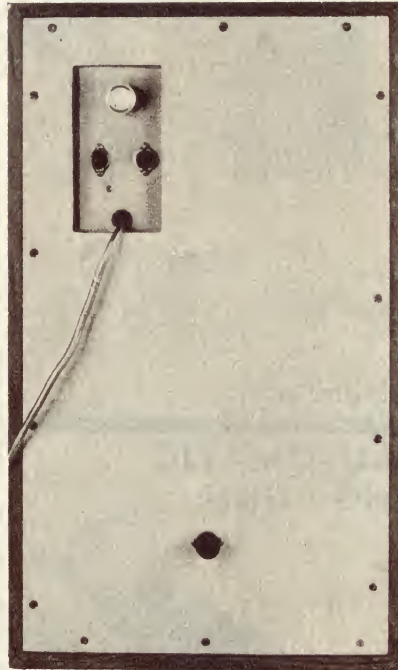

Above is the rear view of the enclosure. The case is mounted behind a cut-out in the rear panel and a felt gasket is used to ensure an airtight seal. The dummy plug at the base of the enclosure is inserted when the amplifier is in use, and is replaced by another when the loudspeaker is used with an external stereo system.

control, and connect the shielded cable from the volume control to the small tagstrip which accommodates the .022uF capacitor and chassis terminations. Lastly, the board is mounted and connected into circuit.

At no signal the amplifier should have a current drain of 8 to 10mA. If this is not the case, the quiescent current should be adjusted by varying the 47-ohm resistor. Increasing the resistor will increase the current and vice versa. For maximum power output at the point of clipping, the DC voltage at the positive connection of the 400uF output capacitor should be slightly less than half the supply voltage. Normally there should be no need to adjust this but it can be set by varying the bias resistors for the input stage.

The final step is to put the lid on the case, reinstall the back panel of the enclosure and connect up your cassette recorder, or other program source.

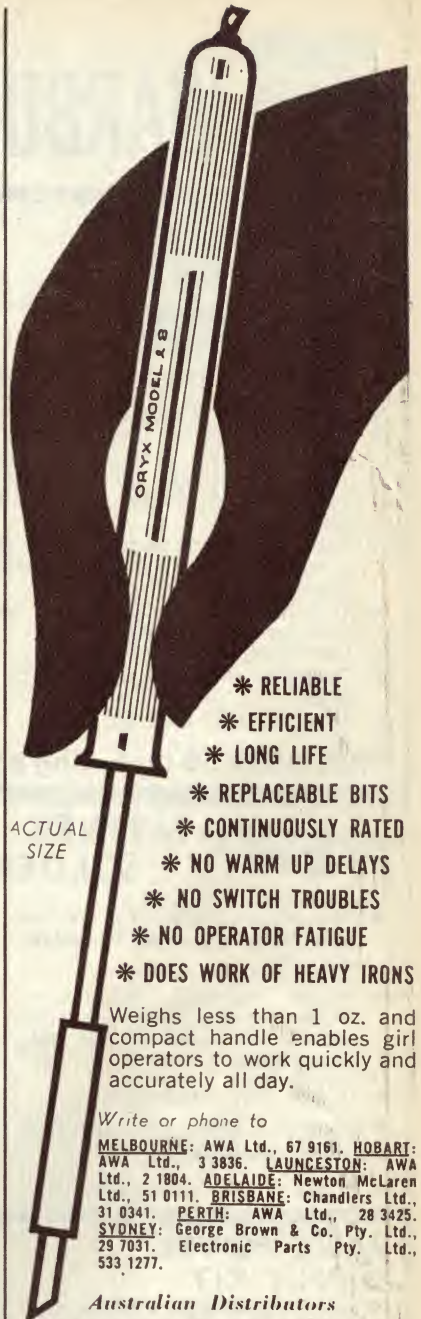

ACTUAL SIZE

- * RELIABLE
- * EFFICIENT
- * LONG LIFE
- * REPLACEABLE BITS
- * CONTINUOUSLY RATED
- * NO WARM UP DELAYS
- * NO SWITCH TROUBLES
- * NO OPERATOR FATIGUE
- * DOES WORK OF HEAVY IRONS

Weighs less than 1 oz. and compact handle enables girl operators to work quickly and accurately all day.

Write or phone to

MELBOURNE: AWA Ltd., 67 9161. HOBART: AWA Ltd., 3 3836. LAUNCESTON: AWA Ltd., 2 1804. ADELAIDE: Newton McLaren Ltd., 51 0111. BRISBANE: Chandlers Ltd., 31 0341. PERTH: AWA Ltd., 28 3425. SYDNEY: George Brown & Co. Pty. Ltd., 29 7031. Electronic Parts Pty. Ltd., 533 1277.

Australian Distributors
MANUFACTURERS SPECIAL
PRODUCTS PTY. LTD.

47 York Street, Sydney. 2 0233, Ext. 284

WANTED

BY ALL
PRODUCTION ENGINEERS

ORYX

miniature
soldering instruments



WARBURTON FRANKI

AUTOGUARD ANTI-THEFT ALARM Photoelectronic Beam

- A customer warning device; or
- Add an infra-red filter (supplied) flick the switch on the control and the unit becomes an INVISIBLE burglar alarm capable of protecting 30 feet.
- Light Source can be installed in any position with the unique flexible coupling.
- Transistorised "Solid State" unit with no moving parts.
- Low running costs.
- Complete with wire, cable tacks, buzzer and easy to follow instructions.
- Measures only 6" x 2½" x 2".



(Model 101)

PRICE \$39.50 including pack and post

NEW! METREX AUTOMATIC SOLDERING GUN

- The Metrex Automatic contains everything you need — solder, flux, heat.
- Simple one-hand operation — trigger action feeds the right amount of solder at the right temperature.
- Weighs only one pound.
- Magazine holds 10ft of solder (refills available).
- Works directly from 240v mains.



\$9.95

Plus 25c pack, and post.

BASIC POWER SUPPLY KIT

Includes Transformer, Contact cooled bridge rectifier and one filter condenser 16/350. This kit will supply 250 Volts D.C. at 60 m.a. and 6.3 volts A.C at 2 amps.

\$5.85

including pack. and post.

BASIC POWER SUPPLY KIT

Includes Transformer, Contact cooled bridge rectifier and one filter condenser, 1000 mfd. 15 V.W. This kit will supply 9 or 12 volts D.C. at ½ amp. Wiring diagram supplied.

\$3.85

including pack and post.

NEW — CLEANLEC ELECTRICAL CLEANER

- Non-toxic
- Non-inflammable
- Non-corrosive

for cleaning aircraft and automotive components such as—hydraulic and fuel systems, electric motors, generators, relays, etc. Also electronic components, such as printed circuits and other devices.

12oz. Pressure Pak Can

\$2.25

including pack. and post.

"CADET" SPEED CONTROLLER FOR ELECTRIC HAND TOOLS

Varies speed from stop to full speed with no loss of torque. Rated capacity 2 amps. Complete with flex and plug.

\$11.50

FREIGHT FREE.

SPECIAL CONDENSER POLYPAC No. 20

Contains 25 assorted condensers, including ceramic, electrolytic, metal pack, mica, paper tubular.

\$1 plus postage, 10c
(or five for \$5, post free.)

ELECTROLYTIC CONDENSER POLYPAC No. 22

12 assorted miniature electrolytic condensers—\$1 plus 10c pack and post (or five for \$5 post free.)

RESISTOR POLYPAC No. 24

20 Hi-stability 1-watt ± 1% resistors

\$3.50

plus 10c pack and post.
Values may be specified, but if not in stock nearest will be supplied.

TRANSFORMERS

Let us quote for the supply of special power or stepdown transformers. Quick delivery. Lowest prices.



WARBURTON FRANKI

220 PARK ST., STH. MELB., VIC. Ph. 69-0151 (30 lines)



FET Preamplifier For Ceramic Pickups

Here is an economical preamplifier for use with low-output ceramic cartridges. The following article discusses the principal of operation and the various ways in which the preamplifier can be used.

by Leo Simpson

Many readers have asked for an article describing a simple, add-on preamplifier. This would enable lower-output ceramic cartridges to be used with amplifiers which previously were suitable for use with crystal cartridges only. This is a common situation where people have one of the earlier stereo amplifiers, designed before ceramic cartridges became available.

A preamplifier is also often desirable when modifying a mono record player to suit stereo records. Instead of merely substituting a high output crystal stereo cartridge with the two channels paralleled, it is better to add a preamplifier and use a better-quality ceramic cartridge.

As well as requiring a greater amplifier sensitivity, the substitution of a ceramic cartridge requires a higher input impedance than does a crystal type. Typically, most ceramic cartridges require a load of 2 megohms and in the case of the Decca Deram, a sensitivity of around 60mV RMS for full power from the amplifier.

There are several possible approaches to providing the necessary gain and high input impedance using a single transistor (one for each channel). One would be to use a high beta, low-noise bipolar transistor in a bootstrapped common emitter amplifier. (Beta is a measure of the direct current gain of a transistor and is approximately equal to the ratio of collector current to base current.) Bootstrapping refers to the technique of applying positive feedback—with less than unity gain—from the emitter to increase the effective input resistance provided by the biasing resistor network.

While a bootstrapped input stage could be arranged to give the required high input impedance the gain may not be sufficient, while the noise generated in the biasing resistors can be a real problem. The use of high-quality carbon film resistors will not always alleviate the problem as the noise generated in the resistors is regenerated by the positive feedback.

Another approach is to use one of the very high beta transistors now available, without bootstrapping, and rely on biasing resistors with values up to 10 megohms to obtain the high input impedance. Noise may still be a problem, though to a much lesser extent, such that the use of high quality carbon film resistors will keep it within acceptable limits. Unfortunately, this

type of resistor is not always readily available over the counter, particularly in the high values required. Another problem is that transistors with a minimum guaranteed beta of say, 500, tend to be expensive and often in short supply.

The approach we have taken is to use a field effect transistor, an N-channel device made by Motorola, the 2N5459 which supersedes the MPF106. This FET is available economically and its parameters are more closely controlled than the first economy FETs. A major advantage of using a FET circuit is that the input impedance required is obtained simply by "plugging-in" the desired value of resistor. Noise generated in the input resistor is not a problem since no gate current flows (under small signal conditions).

Reference to the circuit diagram will show that the configuration is very similar to that used in triode amplifier circuits which employ "cathode-bias." Indeed, the principal of operation is very similar. We will explain it for the benefit of our novice readers.

The gate bias voltage—the voltage between gate and source—is used to set the correct operating conditions for the FET, such as to provide the most linear amplification for the supply voltage used.

For N-channel FETs, the gate is required to have a negative voltage with respect to the source. This voltage is generated by the current flowing through a resistor connected between source and the negative supply rail, making the source positive with respect to the negative supply rail. The 2.2M resistor for the gate carries no current and thus the gate is at the same potential as the negative supply rail. This means that the gate is negative with respect to the source. Bias developed in this manner is known as "source bias" which is analogous to "cathode bias" in valve circuits.

Source bias for P-channel FETs is obtained by the same method as described above except that the gate voltage is positive with respect to the source.

As with valve circuits, the source resistor must be "bypassed" with a suitable value of capacitor in order that the maximum voltage gain can be realised. "Bypassing" refers to the practice of providing a low impedance path for AC signals, so that they do not develop an AC voltage across a resistor which is used for deriving a DC voltage. If the source resistor was not bypassed, the audio signal fed to the gate of the FET would reappear across the source resistor, reversed in phase. Thus the mechanism by which

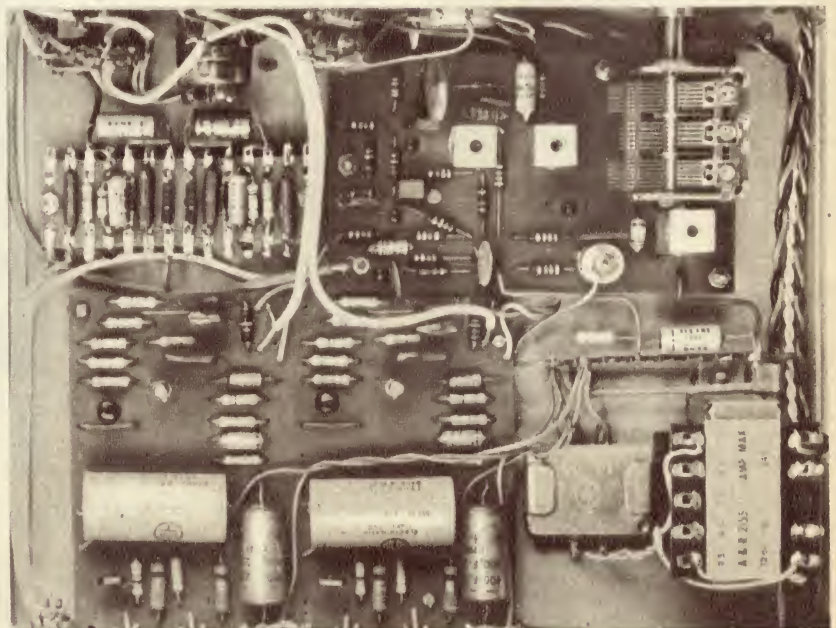

The FET preamplifier was installed in the Playmaster 124 Stereo as shown above. It could also be conveniently installed in a small metal box together with an 18-volt battery to make it self-contained.

The New Tandberg 1241X



The High Fidelity Stereo Tape Recorder With Every Desirable Feature

The versatile Tandberg 1241X is the successor to the proven and popular "Series 12", which enjoyed an international sales volume of well over 40,000 units. This recorder is not a "face lift" — it is completely new . . . and the new Tandberg bias head has made frequency response figures possible which, up till now, have been an audio engineer's dream. For example, frequency range even at 3¼ i.p.s. is 40-14,000 Hz. ± 2 dB.; signal to noise figures are considerably improved at all speeds.

When you step up to Tandberg you are investing in the Tandberg tradition of "Sound reproduction indistinguishable from the original". When you buy Tandberg you automatically purchase reliability and performance — and advanced features only available to Tandberg users. Listen to the Tandberg 1241X at selected dealers in all States.

Features of the 1241X include:

- Twin 10 watt amplifiers with double volume controls for both inputs and outputs •
- Three speeds, 7½ - 3¾ - 1½ i.p.s. • Twin internal loudspeakers
- Bass and treble controls continuously variable ± 12 dB.
- Inputs for radio tuner, microphone or magnetic pickup — no other amplifier required
- Frequency response at 7½ i.p.s. 20-25,000 Hz. • Signal to noise at 7½ i.p.s. (4 track versions) — 58 dB. • New twin VU meters • Ideal for language study.

And the new Tandberg Cross Field Bias Head!

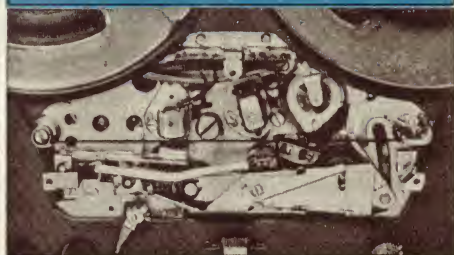

Tandberg



Australian National Distributors:

Simon Gray Pty. Ltd.

Head Office: 28 Elizabeth St., Melbourne, Vic. Tel. 63 8101*
 Sydney Office: 22 Ridge St., North Sydney, N.S.W. Tel. 929 6816
 Canberra Office: 31-33 London Circuit, Canberra City, A.C.T.
 Tel. 49 6050

INTERSTATE REPRESENTATIVES:

SG1241/1

N.T.: Pfitzner's Music House, Smith Street, Darwin. Tel. 3801

Q'land: Sydney G. Hughes. 154-158 Arthur St.,

New Farm, Brisbane. Tel. 58 1422

S.A.: Eilco Sales Pty. Ltd., 7-9 Osmond Terrace, Norwood, S.A. Tel. 63 4844

Tas.: K. W. McCulloch Pty. Ltd., 57 George Street, Launceston. Tel. 2 5322

W.A.: Athol M. Hill, 613-615 Wellington Street, Perth. Tel. 21 7861

the source bias is developed would apply the signal in reverse phase between the gate and source (negative feedback) and the gain would be reduced. The value of bypass capacitor selected must be such that its impedance is low for the lowest frequency to be handled.

The preamplifier uses a supply rail of the order of 18 to 21 volts and can be run directly from an 18-volt battery. The 18-volt supply is necessary to ensure minimum variation in gain over

plifier. This has a sensitivity of 420mV RMS for full power and, as such, is suited to the higher output cartridges. The addition of the pre-amplifier enables a Decca Deram to drive the amplifier to full power on the loud passages of most records.

The circuit diagram shows a zener diode network to derive the preamplifier supply from the main supply rail (HT1) of valve amplifiers. The zener diode is necessary to protect the FET from the higher-than-usual voltages

used, the decoupling components can be dispensed with and the unit could be installed in a small metal box underneath the turntable. If this is done, care should be taken in the positioning of the box so that it does not pick up hum from the turntable motor or associated wiring.

The preamplifier was constructed on a 14-lug tagboard. If the zener diode and 39K resistor are required an extra two lugs will be needed. If only one channel is required the current drain of the zener diode network can be reduced by increasing the resistor to 82K. The layout we have used is not mandatory but it has been arranged so that the inputs are at either end of the tagboard to keep cross-talk between channels as low as possible.

Shielded cable should be used for the inputs, with the shields connected as shown on the wiring diagram. If the unit is installed in a separate metal box as mentioned above, shielded cable should also be used for the outputs. The figure-8 stereo shielded cable is the most convenient for this purpose. In the Playmaster 124, the output of each preamplifier is connected to the appropriate terminals on the selector switch for "Disc" input. □

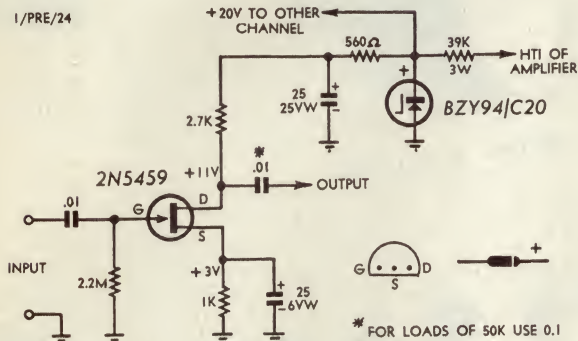

At left is the circuit diagram of the preamplifier. If only one channel is built, the 39K resistor can be increased to 82K to reduce current drain of the zener diode network. If used with a transistor amplifier the zener network can be omitted.

At right is a suggested layout, using tagboard. This should be compared with the photograph on page 47. The inputs are placed at either end of the board to keep the crosstalk between channels to a minimum. If the preamplifier is built to suit a valve amplifier, a longer piece of tagboard will be needed to accommodate the zener diode network.

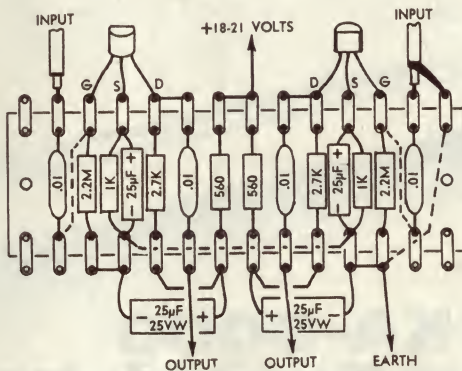

the likely range of parameters of this FET and to give a high margin of overload with the expected range of input signals. The gain of the preamplifier will be between 5 and 6 times, which makes it ideal for augmenting the gain of amplifiers previously suitable for use with crystal cartridges only. The preamplifier will overload with an input signal of approximately 700mV RMS, although this will vary with the gain and the supply voltage.

The above order of overload capability is highly desirable as today's heavily recorded discs can result in the cartridge delivering a much higher output than its nominal output voltage would suggest. The preamplifier is suitable for ceramic cartridges with a nominal output voltage up to about 200mV or so. The BSR C1 and equivalent cartridges in the Sonotone range are eminently suitable, as are the lower output ceramic cartridges such as the Decca Deram and Connoisseur. For the latter cartridges, the preamplifier may not have sufficient gain to drive some amplifiers to full power, although in most cases it should be adequate.

The prototype preamplifier was actually built into the Playmaster 124 Stereogram, published in the May, 1969 issue of "Electronics Australia." This uses the same amplifier as that published in the August, 1968 issue under the title of 3-plus-3 Stereo Am-

plifier occurring in valve equipment just after switch-on before the valves begin to draw current. This characteristic is particularly noticeable in valve amplifiers which have semiconductor rectifiers. The zener diode also has the advantage of rendering the decoupling network compatible with a wide range of likely HT supplies.

In the prototype the supply was derived from that of the amplifier via

PARTS LIST

- 1 BZY94/C20 zener diode.
- 2 2N5459 n-channel FETs.
- 1 14-tag panel.

RESISTORS

- ($\frac{1}{2}$ or $\frac{1}{4}$ watt unless specified)
- 2 x 2.2M, 1 x 39K/3W, 2 x 2.7K,
- 2 x 1K, 2 x 560 ohms.

CAPACITORS

- 2 x 25uF/25VW electrolytic.
- 2 x 25uF/6VW electrolytic.
- 4 x .01uF polyester (low voltage rating).

the 560-ohm resistor and 25uF capacitor shown on the circuit diagram. Here, the decoupling network is used to filter hum appearing on the amplifier's supply rail, and to eliminate the possibility of instability due to the increased overall gain of the amplifier plus preamp. If an 18-volt battery is

BUY RECORDING TAPE WHOLESALE

WILCOX BROS. & BARCLAY are now offering their line of recording tape direct to the public at wholesale prices. This is a leading American manufacturer's first-grade line especially packed for us in a plain box. We are not allowed to reveal the maker's name.

TYPE	CODE	YOUR Wholesale PRICE
5" 900ft Acetate	5R9	\$1.80
5" 1200ft Polyester	5P12	\$2.95
7" 1800ft Acetate	7R18	\$3.35
7" 2400ft Polyester	7P24	\$5.50

Wholesale prices allow for 3 1/3 per cent trade discount and cash settlement discount and include sales-tax. Freight free throughout Australia.

MONEY BACK GUARANTEE

WILCOX BROS. & BARCLAY tape is guaranteed to be first-grade splice-free recording tape made in the U.S.A. Your money will be refunded in full on return of goods within fourteen (14) days if you are not fully satisfied with your purchase.

ORDER FORM

FROM: _____

NAME: _____

STREET & NO.: _____

CITY OR SUBURB: _____

POSTCODE: _____

PLEASE SHIP:

..... rolls 5R9 at \$1.80

Total \$

..... rolls 5P12 at \$2.95

Total \$

..... rolls 7R18 at \$3.35

Total \$

..... rolls 7P24 at \$5.50

Total \$

I enclose cheque/postal order/ Money Order for

Total \$

RETURN THIS ORDER TO:

Wilcox Bros. & Barclay
WHOLESALE MERCHANTS
Mail Order Office Rm. 7, 3rd. Fl.
323 Bourke St., Melb.

W
B & B

180 WATT SOLID STATE STEREO AMPLIFIER

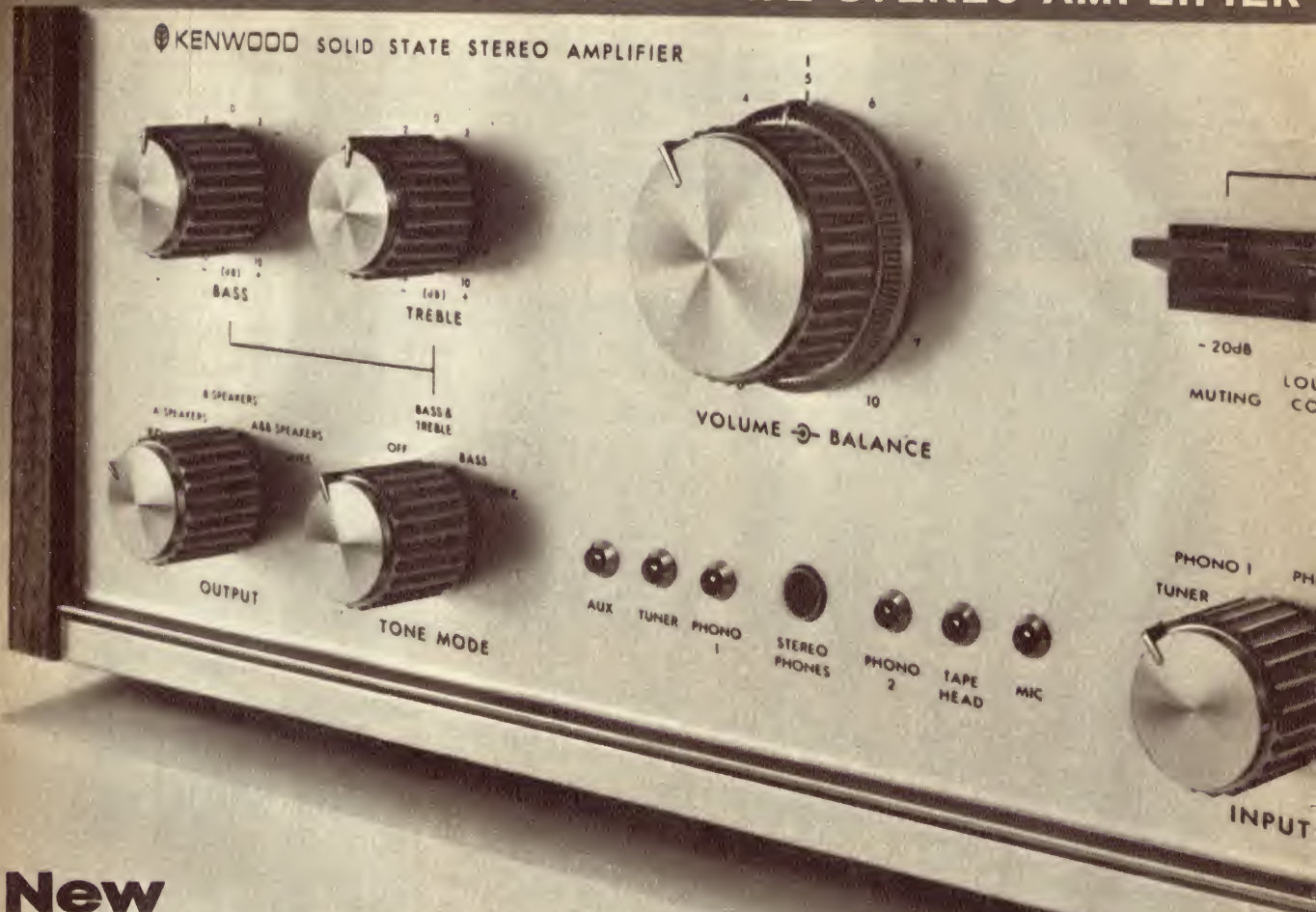

New KENWOOD's KA-6000 The Musical Powerhouse For Maximum Perfection

You don't have to look elsewhere—KENWOOD's KA-6000 180-watt solid state stereo amplifier has all the power you need for maximum perfection.

It has more than enough power to drive even Hi-Fi speakers of low efficiency.

With its wide power bandwidth of 10Hz to 50,000Hz there is low-low IM distortion.

The KENWOOD exclusive low level phono inputs for low level output phono cartridges of 2mV, 0.5mV or 0.05mV.

There are many other outstanding features in the KA-6000—all the results of high quality engineering—but the final test is in performance. Stop in at your KENWOOD dealer for a KA-6000 demonstration.

Remember, KENWOOD also has other amplifiers with less power.

There's a KENWOOD for every stereo need.

SOLE AGENT: Jacoby, Mitchell & Co., Pty., Ltd.: Head office; 489-475 Kent Street, Sydney Tel: 26-2651 Melbourne; 16 Abbotsford Street Tel: 30-2491 Brisbane; 58 Edward Street Tel: 2-8487 Adelaide; 652 South Road, Glandore Tel: 53-8117 Perth; United Australia Co., Pty., Ltd., 435 Hay Street, Subiaco Tel: 8-4865 Tasmania; K. W. McCulloch Pty., Ltd., 57 George Street, Loughceston Tel: 25-322 Newcastle; Edmunds Moir & Co. Pty., Ltd., 18 Wood Street Tel: 81-4991



BOOKSHELF TYPE 4-WAY 5 SPEAKER SYSTEM KL-660

- Mounted speakers: 12-inch, free-edge woofer × 1 (Bass)
- 6 1/2 inch cone squawker × 1 (lower midrange)
- 4 inch cone squawker × 1 (higher midrange)
- Horn-type tweeter × 2 (Treble)
- Dimensions: 15" (W), 25 1/2" (H), 11 1/2" (D)



40 WATT SOLID STATE STEREO AMPLIFIER TK-150U

- 5 pairs of input terminals for MAG, AUX 1, AUX 2, TAPE REC and TAPE PLAY.
- Damping factor: 40 (at 16 ohms), 20 (at 8 ohms)
- Dimensions: 10 1/2" (W), 4 1/2" (H), 9 3/4" (D).



60 WATT SOLID STATE STEREO AMPLIFIER TK-250U

- 2 sets of stereo speaker terminal and front panel speaker selector switch.
- Dimensions: 13" (W), 4 1/2" (H), 9 3/4" (D).

KA-6000

MODEL KA-6000

NORMAL

BUSINESS TOUR

40Hz 80Hz
LOW FILTER

8KHz
HIGH FILTER

MODE

TAPE

NO 2
TAPE HD

STEREO
REV
MIX

STEREO
LEFT
RIGHT
MIX

MODE / TAPE MONITOR

the sound approach to quality



KENWOOD

TRIO ELECTRONICS, INC.

6-5, 1-CHOME, SHIBUYA, SHIBUYA-KU, TOKYO, JAPAN



**30 WATT
FET SOLID STATE AM/FM
STEREO RECEIVER TK-20U**

* F.E.T. (Field Effect Transistor) 3 Gang Tuning Condenser front end for superior sensitivity, image rejection and cross modulation ratio.
* Dimensions: 14 1/2" (W), 4 1/2" (H), 11 1/2" (D)

Ask for a catalogue or demonstration by your nearest dealer.

To: Jacoby Mitchell & Co., Pty., Ltd. EA
469-475 Kent St., Sydney.

Send me information on KENWOOD RECEIVER, AMPLIFIERS, SPEAKERS & name of nearest KENWOOD retailer,

NAME: _____ AGE: _____

ADDRESS: _____

A Solid State, Crystal Frequency Calibrator

A compact instrument which may be used to deliver any of thirteen accurately controlled and stable test frequency signals, all derived from a quartz crystal oscillator and having a fast-transition rectangular waveform of high harmonic content. It should be found invaluable for calibration of receivers and instruments, and would also be useful as an audio oscillator, square-wave generator, digital circuit tester or as the heart of a crystal-controlled chronometer.

By Jamieson Rowe

A source of accurately controlled and stable test frequency signals vastly simplifies and facilitates the frequency calibration of short-wave receivers, signal generators and other equipment, both during initial calibration following construction, and for "spot check" purposes during critical operation. Such a source can also serve as a marker generator for sweep-frequency alignment, and as a time-period reference for such applications as the calibration of an oscilloscope timebase.

The instrument to be described in this article delivers any one of thirteen quartz-crystal derived fundamental test frequencies, each of which is accompanied by a series of its harmonics extending well up into the VHF spectrum. It is therefore well suited for the above applications, as well as for more general use as an audio-video squarewave generator and as a digital "clock" generator. It might also form the basis of a quartz-crystal chronometer, or the timebase system of a digital counter.

Although functionally very flexible, the instrument is basically quite straightforward in design. It is also very compact, and will involve but a modest outlay. When built up in its complete form, for example, it should cost no more than about \$50. However, if the full range of output frequencies is not required, this figure may be significantly reduced.

The key to the attractive high flexibility/low complexity ratio offered by the instrument lies in its use of integrated digital microcircuits to perform all the active functions. In fact, apart from the single quartz crystal and the power supply components, the instrument consists of nothing more than a handful of microcircuits and a few bypass capacitors.

The microcircuits used are all of the low-cost "RTL" (resistor-transistor logic) variety. Only two device types are used, both from the MC700P range manufactured by Motorola Semiconductors. One type MC799P dual buffer device is used in the crystal oscillator, while up to thirteen type MC790P dual J-K flip-flop devices are used in the cascaded divider chain used to derive the various output frequencies. All devices are in the 14-pin "DIL" (dual in-line) package. They are distributed in Australia by Cannon Electric (Aust.) Pty. Ltd.

All of the active circuitry of the instrument is mounted on a small single-sided printed wiring board, making assembly of the unit a simple and straightforward operation. The board measures only 3½ in x 5½ in, but provides adequate space for the quartz crystal and all fourteen microcircuits, together with minor components and wiring.

Heart of the instrument is the crystal oscillator, shown in figure 1. This uses an MC799P dual-buffer device connected basically as an astable multivibrator, with the quartz crystal in one feedback link. A capacitor/trimmer combination connected in series with the crystal allows vernier adjustment of the frequency of oscillation, and permits standardisation of the instrument against a reference such as the NBS standard transmissions of WWV or WWVH.

The crystal used in the oscillator is a "D-type" unit, having a nominal

frequency of 2MHz (2,000KHz). This frequency was chosen in contrast with the more usual figures of 1MHz and 100KHz because it would appear that, where modern crystals are concerned, 2MHz represents a considerably more attractive performance/cost compromise.

Typically a modern 2MHz crystal costs slightly less than half that of a 1MHz crystal of comparable tolerance and frequency stability, and less than one third the cost of a comparable 100KHz crystal. Naturally, the use of a 2MHz crystal involves additional frequency division, and this tends to reduce the cost advantage. However, with the use of low cost microcircuits in the divider chain the additional division is provided very economically, so that the advantage of employing a 2MHz crystal is still quite significant.

The crystal used in the prototype instrument is a .003 per cent adjustment tolerance AT-cut type, specified for operation at ambient temperatures. It was kindly supplied by Pye Pty. Ltd., who advise that similar units can be supplied to readers on order, either direct or via normal parts suppliers. The Pye designation of the unit in terms of tolerance and stability is class "FEF," with the holder code "Q12A" and the nominal intended shunt capacitance 30pF.

Similar crystals of different manufacture may be used, and even a disposals crystal may be tried if available. The oscillator circuit is not critical, and will operate with a wide

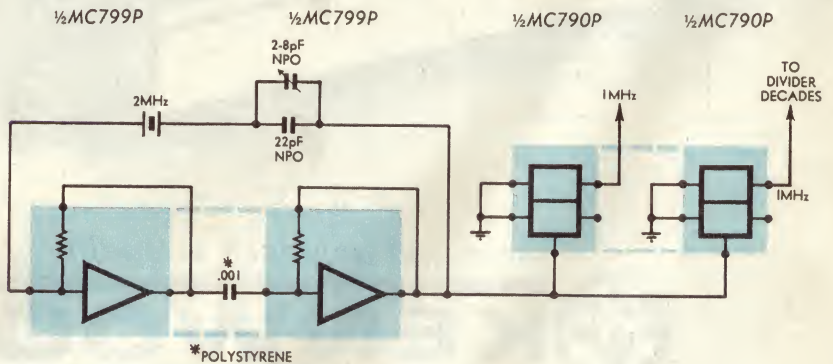

Figure 1 CRystal Oscillator/Buffer Divider

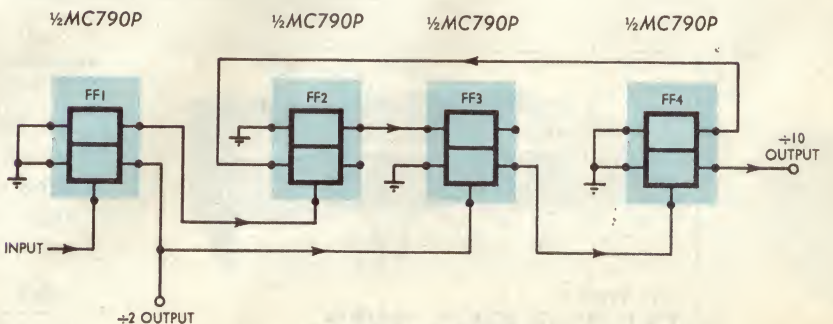

Figure 2 DIVIDER DECADE

variety of crystals. However, it should be borne in mind that the ultimate frequency stability of the instrument depends almost completely upon the crystal, so that a low-grade unit may seriously prejudice usefulness.

It may be noted that the capacitor and trimmer connected in series with the crystal are both NPO ceramic components, to ensure that the temperature stability of the oscillator is not significantly less than that of the crystal itself. It is for the same reason that the .001 μ F coupling capacitor is specified as a polystyrene type.

The 2MHz output from the crystal oscillator could be used directly as the highest fundamental output frequency of the instrument, although this would require the use of a third buffer element to ensure that output loading would not degrade the frequency stability. In the final design of the instrument we have not followed this course, but instead have settled upon 1MHz as the highest fundamental output frequency.

This has allowed the use of an MC790P dual J-K flip-flop both as an oscillator buffer and as the initial 2:1 divider. Both flip-flops of the device are connected in toggling mode and operated from the 2MHz oscillator output, as may be seen in figure 1, one effectively providing a buffered 1MHz output and the other providing an independent 1MHz signal for the following divider chain.

The divider chain of the instrument consists of a series of 10:1 divider decades, each using the configuration shown in figure 2. The configuration divides in what may be called a "quinary" or (5 x 2) fashion, with the first element FF1 dividing the input by two, and the remaining three elements dividing by five.

The actual configuration used is particularly attractive from the point of view of economy, for as may be seen it requires no separate gating elements to perform the required decade division. Only four J-K flip-flop elements are required, all gating being performed by the elements themselves. (The four elements used are provided by two MC790P dual flip-flop devices.)

Quite apart from its economical use of elements, the configuration has a further attraction. From the output of element FF1 may be taken a useful auxiliary output signal, representing a 2:1 division of the input signal. Thus in terms of frequency multiples, each decade of the divider can provide both a "X1" signal (FF4 output) and a "X5" signal (FF1 output).

Space is provided on the printed wiring board for up to six divider decades, in addition to the crystal oscillator and the initial buffer divider. Whether or not all of these decades are wired will depend solely upon the needs of the constructor concerning the available range of output frequencies.

If all decades are wired, the range of frequencies available extends from 1MHz down to 1Hz in a 10-5-1 sequence. However the sequence may be terminated at any desired point simply by omitting the redundant microcircuits. If both devices of any redundant decades are omitted, the lowest available frequency will be a multiple of 1 (or 10); however, it is entirely permissible to wire in only one

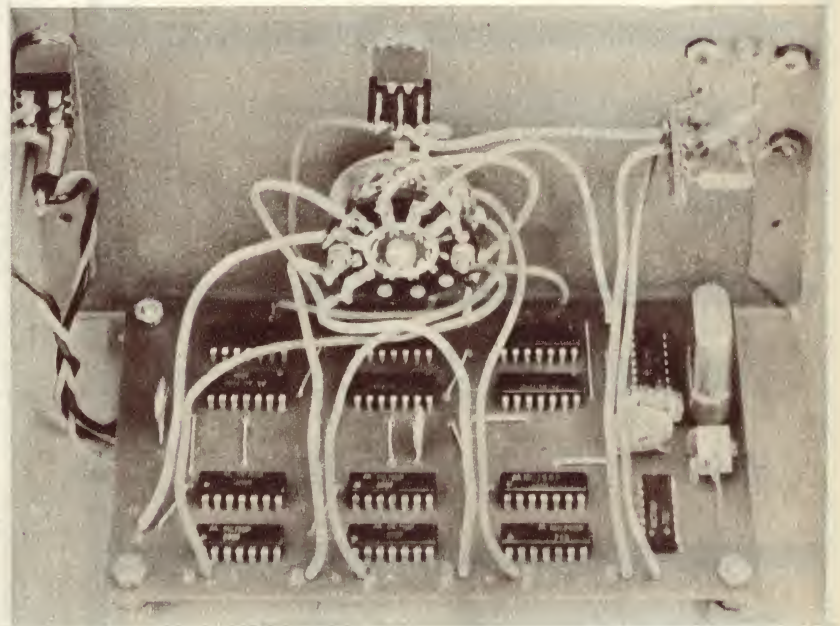

At top is a view of the completed calibrator, which will deliver any one of thirteen crystal-locked frequencies. Above is a view of the rear of the panel when inverted for inspection, showing the printed wiring board and its microcircuits.

device of the lowest decade involved, in order to provide the appropriate "X5" signal.

Hence if the constructor desires to provide only those frequencies extending down to 10KHz, he would wire in only the first two decades following the crystal oscillator and buffer divider. This would involve a total of only six microcircuits, and result in a considerable saving.

Another of the many possible variations would be where those frequencies down to 50Hz are required, but not those lower. This would require four full decades, together with the first device only from the fifth decade. In this case a total of eleven microcircuits would be involved.

Output voltage for all signals is approximately 2V peak to peak.

The design of the printed wiring board and circuitry is such that any or all of any decades or part-decades omitted when the instrument is first made could easily be added at a later time if the need arose for the provision of lower frequencies. It would also be feasible to add additional decades to the six allowed for on the board, in order to obtain still lower frequencies than 1Hz. However if this is contemplated it should be borne in mind that the power supply may have to be re-designed to cope with the additional current demands.

As may be seen from the main circuit diagram, the oscillator/divider board forms the heart of the instrument. The remainder of the circuitry consists of a simple regulated power supply delivering a nominal 3.6V DC

ADCOLA

"M" SERIES

AUSTRALIA'S LEADER IN MODERN PRECISION SOLDERING TOOLS

SELECTED AS

Good Design

FOR
AUSTRALIAN
DESIGN INDEX

INDUSTRIAL
DESIGN COUNCIL
OF AUSTRALIA



M70 Tip Shaft Dia: 1/8" Application: Transistor, miniature
Rating: 19 watts and micro-miniature electronics
Weight: 3 ozs. and instrument work.



M64 Tip Shaft Dia: 3/16" Application: Standard tool for
Rating: 23 watts radio and television assembly
Weight: 3 1/2 ozs. and servicing.



M107 Tip Shaft Dia: 1/4" Application: Servicing in tele-
Rating: 27 watts communication centres and
Weight: 4 ozs. similar heavier tagging.

*Weight of tool only, without cord set.



M150 Tip Shaft Dia: 5/16" Application: General Purpose
Rating: 45 watts Solder Tool, sheet metal, earthing
Weight: 6 ozs. strips and other heavy duty work.
Tip incorporates unique anti-seizing ferrule

LONG LIFE TOOLS, TESTED AND PROVED IN WORLD-WIDE SERVICE.

Adcole "M" Series soldering tools are long-life precision-made tools, the result of 20 years' development to meet the particular needs of the Communications and Electronics industries throughout the world. They are standard equipment in all Australian Armed Services, Space Tracking establishments, P.M.G.'s Department; major computer firms and numerous other organisations with the resources to carry out stringent comparative pre-selection tests on soldering equipment.

GREATER THERMAL EFFICIENCY

The advanced design reduces heat losses to a minimum and provides a work capacity in each model normally associated with conventionally designed tools of twice the rated power. Initial heat-up time (60 seconds for M70, 100 seconds for M64) and heat recovery are extremely rapid. Elements are calibrated to provide optimum tip temperatures for swift and sound soldering of terminations in each type of circuit.

DESIGNED FOR ACCURATE SOLDERING

The lightness and balance of the "M" Series tool; the flared handle, ribbed for a positive precision finger grip; the slim heater unit allowing the best possible visibility and penetration; the combination of these design features allows easy, precise manipulation and therefore better soldering.

INSTANT CONTROLLED HEAT

A constant heat tool operating at the correct soldering temperature ensures the swiftest and most efficient soldering. Poor quality soldered joints caused by too high or too low a soldering temperature are avoided. Fitted with a hook for suspension while idling, Adcole soldering tools will operate continuously without risk of overheating or loss of tip tinning. Heat sinks, idling or cut-off switches are NOT required.

EASY REMOVAL OF TIP

The tip is held firmly by a stainless steel collet, and is easily removed for cleaning and replacement and to allow quick fitting of special-purpose tips.

SAFETY FIRST

Safety was a primary consideration in the design of the "M" Series, which embodies a fully insulated element and a double-earthed helical wire outer casing to the heater unit. Every heater unit must pass an insulation test of 2,000 volts before release from the factory.

NO TRANSFORMER REQUIRED

Adcole tools conform to S.A.A. approval and test specifications and are approved in all States for mains voltage operation.

All models are available for 230-250V, 200-220V, 100-120V, 50-55V, 32V, 24V, 12V and 6V.

ADCOLA PRODUCTS PTY. LIMITED

22 FIRTH STREET, DONCASTER,
VICTORIA 3108. Telephone: 848-3777

N.S.W.: ADCOLA PRODUCTS PTY. LTD., 17 BURWOOD ROAD, BURWOOD, N.S.W. 747-1606.

S.A.: F. R. MAYFIELD PTY. LTD., 11 HALIFAX STREET, ADELAIDE, TEL: 8-4131.

QLD.: T. H. MARTIN PTY. LTD., 56-74 EDWARD STREET, BRISBANE, TEL: 2-0555.

W.A.: EVERETT AGENCY PTY. LTD., 17 NORTHWOOD STREET, WEST LEEDERVILLE, 6007, TEL: 8-4137.

N.S.W.: H. ROWE & CO. PTY. LTD., 512 PUNCHBOWL ROAD, LAKEMBA, 750-0333. GEORGE BROWN & CO. PTY. LTD., 29-3877; BROADWAY ELECTRONICS PTY. LTD., 211-4224; ELECTRONICS PARTS PTY. LTD., 533-1277; GENERAL ACCESSORIES PTY. LTD., 73-0211; GEORGE KENT (AUSTRALIA) PTY. LTD., 525-2811; MARTIN DE LAUNAY PTY. LTD., 29-5834; NEWCASTLE, 84741; WAGGA, 4644; WOLLONGONG, 86020; LAWRENCE & HANSON ELECTRICAL PTY. LTD., 69-4041; NEWCASTLE, 61-5573; WAGGA, 4224; PAUL'S (MERCHANTS) PTY. LTD., 61-6392; RADIO DESPATCH SERVICE, 211-0191; REG ROSE & CO. PTY. LTD., 29-1851; W. G. WATSON & CO. PTY. LTD., 29-5631; NEWCASTLE, 61-4961. VIC.: A.E.I. PTY. LTD., 34-0471; ELECTRONICS DEVELOPMENTS PTY. LTD., 63-3596; GENERAL ACCESSORIES PTY. LTD., 69-0300; HOMECRAFTS PTY. LTD., 32-3711; J. H. MAGRATH CO., 32-3731; RADIO PARTS PTY. LTD., 30-1251, 211-5921; WARBURTON FRANKI (MELB.) PTY. LTD., 69-0151. QLD.: BATTEN'S ELECTRICAL PTY. LTD., 8-3936; SOUTHPORT,

2-1685; CHANDLERS PTY. LTD., 31-0341; JAMES CROKER & SONS MACKAY, A. E. HARROLD PTY. LTD., 31-3081; LAW-CAIRNS, 3739; TOOWOOMBA, T'VILLE; GENERAL ACCESSORIES PTY. LTD., 2-3098; B. MARTIN PTY. LTD., CAIRNS, INNISFAIR; C.A. PEARCE & CO. PTY. LTD., 2-3201; TRACKSON BROTHERS PTY. LTD., 2-2804; WYPER BROTHERS LTD., 5-3219, BUNDA-BERG; WARBURTON FRANKI (BRISBANE) PTY. LTD., 51-5121. S.A.: GENERAL ACCESSORIES PTY. LTD., 23-4022; GERARD & GOODMAN PTY. LTD., 23-2222; HEALING (SALES) PTY. LTD., 8-0171. TAS.: CHARLES DAVIS (WHOLESALE) PTY. LTD., HOBART, 3-3121; W. & G. GENDERS PTY. LTD., LAUN., 2-2231; HOMECRAFTS PTY. LTD., HOBART, 2-2711; LAWRENCE & HANSON ELECTRIC PTY. LTD., HOBART, 2-7464; LAUN., 2-2683. W.A.: ATKINS (W.A.) LTD., 21-0101; GENERAL ACCESSORIES PTY. LTD., 21-2501; CARLYLE & CO. (1959) PTY. LTD., 21-9331. N.T.: LAWRENCE & HANSON ELECTRICAL (N.T.) PTY. LTD., DARWIN, 3732.

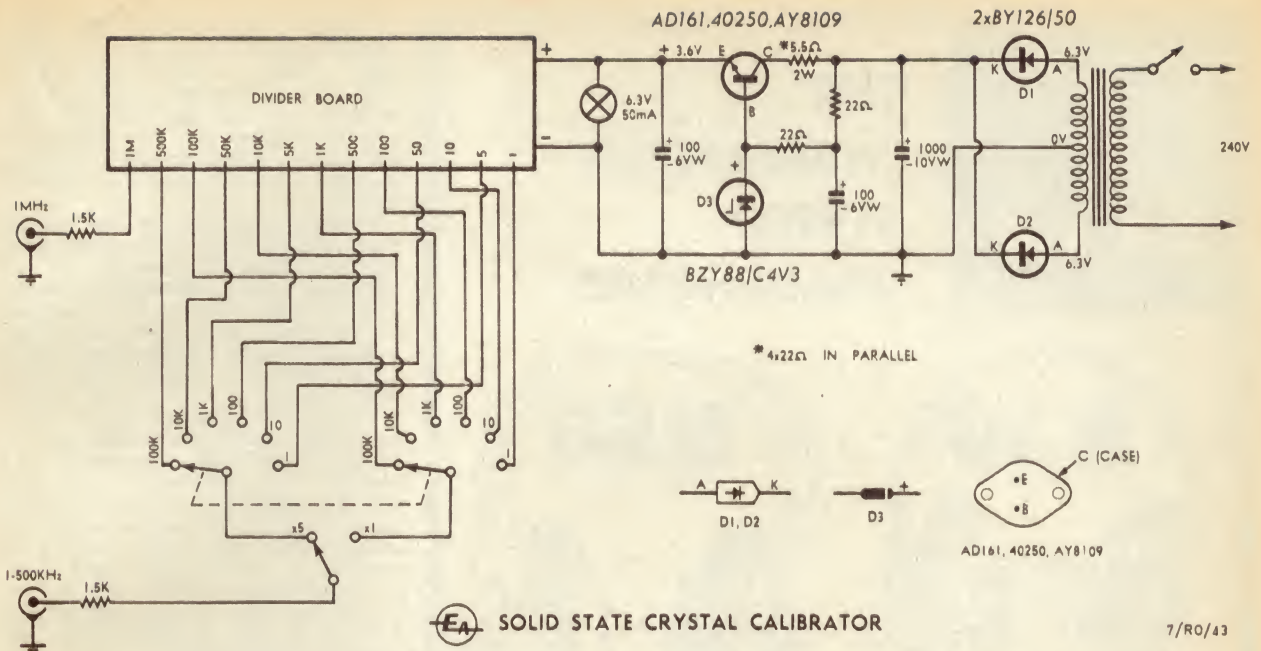

for the microcircuits, and a straight-forward switching system to permit selection of the desired output signal.

The printed board pattern will be supplied to interested board manufacturers, so that boards should be available in the near future. The pattern is coded 69/c9.

The power supply consists of a conventional full-wave rectifier followed by a simple series-pass regulator using an NPN power transistor. Reference voltage for the transistor is obtained using a 4.3V zener diode. The transistor base supply is filtered to ensure that the transistor also acts as a dynamic filter.

As the current drain of the oscillator/divider board is approximately 500mA when all divider decades are wired, the quiescent power dissipated by the series-pass transistor can exceed one watt. In view of this it is desirable to employ in this position a device with a rated dissipation of 3W or more at 40 degrees C., to allow adequate safety margin.

The TO-66 type power devices specified on the circuit have adequate ratings for this purpose, and are thus quite suitable. However, a device with higher ratings could be used if on hand. Alternatively it would be possible to use medium-power silicon TO-5 devices such as the 40408 or AY8116, providing they were fitted with the appropriate clip-on heat radiator to limit case temperature.

The output signal selection circuitry has been arranged for simplicity and operating convenience. The 1MHz output signal has been taken directly to one output connector, both because it is in a sense "thirteenth man" and because this permits the instrument to be calibrated to greatest accuracy using this signal, even when one of the other signals is being used simultaneously for another purpose.

The selection of the remaining twelve output signals is performed by a two-pole six-position switch and a two-position toggle switch, the latter connecting to a second output connector. Isolating resistors (1.5K) are fitted in series with each of the output connect-

The circuit of the calibrator, showing its essential simplicity. The number of microcircuits used on the divider board and the number of switch positions wired will depend upon the output frequencies required; the circuit shows the system as fully wired.

List of Components

- 1 Case, 7½in x 5in x 4in, with wrap-around front panel, board brackets.
- 1 Printed wiring board, 69/c9.
- 1 Stepdown transformer, 240V to 12.6V CT, at 1A.
- 1 2.000MHz quartz crystal (see text).
- 1 Two-pole six-position rotary switch.
- 2 SPDT miniature toggle switches.
- 1 Miniature pilot lamp, bezel, 6V at 50mA.
- 2 Co-axial connectors.
- 1 2-8pF NPO ceramic trimmer (see text).
- 1 22pF NPO ceramic.
- 1 .001uF polystyrene, 400V or lower if available.
- 3 .047uF 25VW ceramic.
- 2 100uF 6VW electrolytic.
- 1 1000uF 10VW electrolytic.

SEMICONDUCTORS

- 2 BY126/50 diodes or similar.
- 1 BZY88/C4V3 or similar 4.3V zener diode.
- 1 AD161, 40250, AY8109 or similar NPN power transistor.
- 1 MC799P dual buffer microcircuit.
- 13 MC790P dual J-K flip-flop microcircuits (see text).

RESISTORS

- 6 22 ohms ½watt.
- 2 1.5K ½watt.

MISCELLANEOUS

Mains cord and plug; grommet and cord clamp; 8-lug section of miniature resistor panel; 3-lug miniature tagstrip; case handle, rubber feet; screws, nuts, connecting wire, solder, etc.

NOTE: Motorola Semiconductor devices such as the MC700P microcircuit series are available in Australia from Cannon Electric (Aust.) Pty. Ltd., whose addresses for mail order are 58 Cluden Street, East Brighton, Vic. 3187; P.O. Box 25, Mascot, N.S.W., 2020; and Commonwealth Aerodrome, Parafield, S.A. 5106.

ors to prevent damage or malfunction due to severe loading or short-circuits.

The instrument is housed in a small rectangular instrument case similar to that used for many of our recent designs, and measuring 7½in x 5in x 4in. The front panel controls consist of the frequency selection switches, the output connectors and the mains switch and pilot bezel.

Inside the case, the printed wiring board is supported by two right-triangular brackets which are in turn clamped to the front panel by the input connector screws at one end, and the mains switch and bezel at the other. A hole in the bracket adjacent to the

crystal end of the board and a similar hole in the appropriate end of the case permit the crystal oscillator trimmer to be adjusted for calibration once the instrument is fully assembled.

The two miniature toggle switches and miniature pilot bezel used in the instrument are available from I.R.H. Components Pty. Ltd. The switches are N.K.K. type S-2012, while the bezel is a Rodan 6V 50mA type. Both components may be ordered via the usual parts suppliers.

Using the wiring diagram provided, assembly of the components on the printed wiring board should be simple and straightforward. The main point



THE "HUMANIZED" STEREO HEADPHONES



Thriftiest "humanised" stereo headphones — ideal for the young music lover.



Deluxe stereo model, the exclusive professional "humanised" type, the peak of engineering design.

SME the only tone arm for which the highly acclaimed SHURE cartridge was designed.

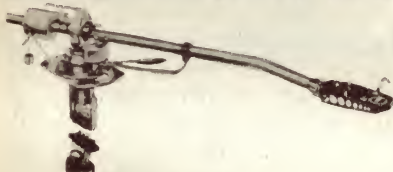

SME Series II 3009 and 3012 tone arms complete with 4' lead, ultra-lightweight shell. Fine engineering. English know-how at its best

SHURE V15 MK II Stereo pick-up cartridges. The computer designed perfect mate for the SME arm.



This is the way you can get high-quality sound, economically — the WHARFEDALE UNIT 3 Speaker Kit.

Complete your sense of achievement, your magnificent sound reproduction, with cabinetry — finished or in kit form (with all instructions), from Mastersound at low cost.

MASTERSOUND SALES PTY. LIMITED
400 KENT STREET,
SYDNEY. 29-1527

to watch is that a small, well tinned iron should be used, and the joints made rapidly in order to avoid overheating either the printed board conductors, or the microcircuits. Care should be taken that the solder does not form bridges between conductors in places where the spacing is relatively narrow.

Note that all wire links and bypass capacitors mounted on the board must be fitted, regardless of whether or not all of the divider decades are wired. The links are essential for continuity of the supply line, while the bypass capacitors ensure that operation of the microcircuits is not disturbed by supply line transients.

The NPO ceramic trimmer which forms the calibration adjustment for the crystal oscillator is a special type designed for printed-board mounting and side adjustment. The unit employed in the prototype and for which the printed board has been designed is marketed in Australia by the Imported Components Division of Plessey Ducon Pty. Ltd., and may be ordered via normal parts suppliers. The type number is DV11-PR8A.

The power supply section of the instrument is mounted in the lower rear of the case, with the power transformer mounted toward the case end opposite to that of the quartz crystal, in order to reduce thermal drift effects. The mains cord terminations are mounted on one side of the transformer, while the rectifier and regulator components are mounted on the other side on an 8-lug section of miniature resistor panel.

The regulator series-pass transistor is mounted centrally on the rear of the case, being insulated electrically by means of the usual mica washer and plastic bushes. In this way the case itself acts as the heat radiator for the device.

The power supply wiring is not critical, and the constructor may deviate from the layout of the prototype if desired. However, care should be taken to ensure that the power cord is clamped securely upon entry via the usual grommetted hole, to prevent strain on the connections. The cord earth conductors should be taken to a solder lug clamped under the adjacent transformer counting screw.

When the power supply section is completed, it would be wise to apply power and check its output voltage before the oscillator/divider board is connected. This will ensure that if an error has occurred, it can be rectified before damage could be caused to the relatively costly microcircuit array.

Without the microcircuits connected, the voltage delivered by the power supply should be between 3.8 and 4.5V DC; if it lies within this range, everything is probably in order and the microcircuits may be safely connected. However if the voltage is markedly higher than 4.5V with no load, switch off and look for a wiring or component fault.

As virtually all the functional wiring is provided by the printed wiring board, connection of the 3.6V supply to the completed board should result in full and correct operation. The only aspect of construction which will remain at this stage is calibration of the crystal oscillator against a known reference.

As explained earlier, this operation

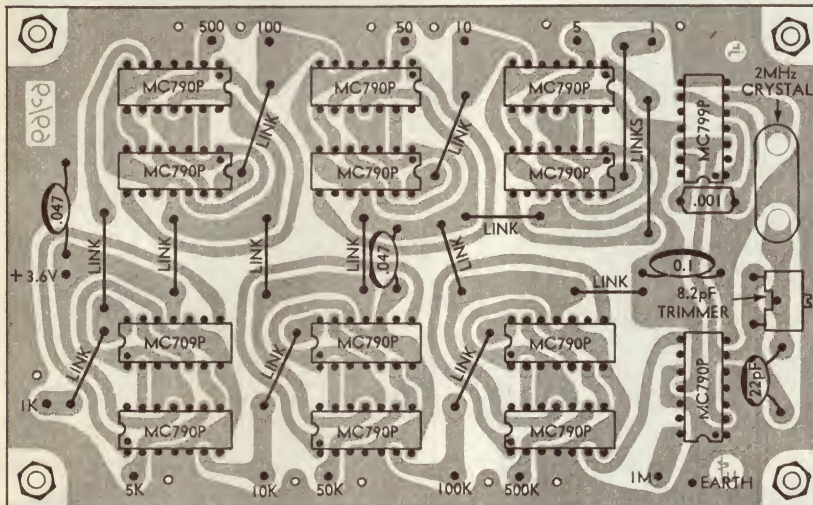
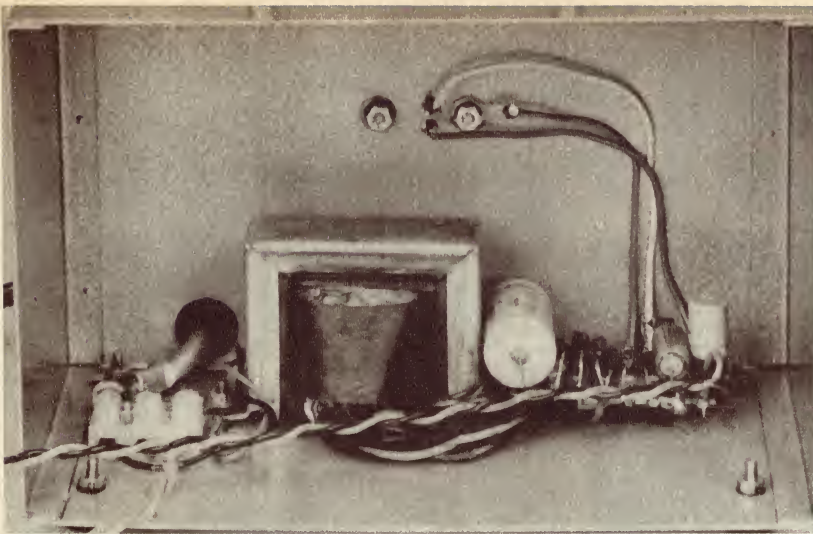

At top is a view inside the rear of the calibrator case, showing the power supply circuitry. Above is a diagram of the printed wiring board, viewed from the component side. Actual size of the board is 5½in x 3½in.

is performed when the unit is completed and assembled, using the small ceramic trimmer. Adjustment of the trimmer is carried out using a small insulated alignment tool, introduced through the holes provided in the end of the case and the board support bracket.

Two methods of calibration may be used. One simply involves measurement of the 1MHz output of the instrument using a high-accuracy digital frequency meter. This is a very efficient technique, and will no doubt appeal to those with the appropriate facilities. However, it should be noted that the frequency meter used should be one having a timebase system whose accuracy and stability are at least within 1 part per million, otherwise the exercise will have little validity. The reason for this is that the calibrator itself is likely to have a performance approaching 10 parts per million, when set up.

The electrical setup for the alternative method of calibration is almost as simple, and may be more convenient. It involves only a conventional shortwave or communications receiver capable of receiving a standard frequency transmission such as those radiated by station WWV on 2.5, 5.0,

10.0, 15.0, 20.0 and 25.0MHz, or by station WWVH on 5.0, 10.0 and 15.0MHz. The 1MHz signal from the calibrator is simply fed into a rudimentary aerial near the receiver, and the calibrator trimmer adjusted for zero beat.

The procedure is to switch both the calibrator and the receiver on and let them run for about 15 minutes to allow the case temperatures to stabilise. At this stage no connection should be made to the output connectors of the calibrator, in order that radiation

should be minimal. Then tune the receiver carefully to whichever of the standard frequency signals is currently available at a level adequate for convenient and reliable reception.

A foot or two of hookup wire may then be inserted into the 1MHz output connector, whereupon a beat note should become audible in the receiver output. It may in some cases be necessary to place the wire close to the receiver aerial lead-in, or perhaps even twist the two together, in order to obtain sufficient coupling.

Adjustment of the calibrator trimmer should allow the beat note to be reduced in frequency below audibility, although continued turning of the trimmer in the same direction should result in the note re-appearing and rising in pitch once again. The zero-beat condition lies in the centre of the inaudible-beat segment of adjustment, and with many receivers it may have to be estimated by interpolation. However, if the receiver is fitted with an "S" meter it should be possible to observe the beats on the meter when they are near zero, and a more accurate setting may be achieved.

Once set up in this fashion the calibrator should retain its calibration for a considerable period. The oscillator circuit is relatively insensitive to temperature, and is also free from many of the aging effects which are found with other circuits. However, before critical measurements are to be made using the instrument, it would be wise to re-check its calibration using the above techniques.

PIGTAIL ELECTROLYTIC CONDENSERS TOP BRAND

FULLY GUARANTEED

25 Volt Working		500 Volt Working	
10 MFD	17 cents	4 MFD	30 cents
25 "	18 cents	8 "	33 cents
50 "	21 cents	16 "	47 cents
100 "	25 cents	24 "	60 cents
250 "	30 cents	32 "	81 cents
500 "	45 cents		
1000 "	65 cents		
2000 "	\$1.19 cents		

Packed and Posted Free
Anywhere in Australia

Mixed 100 lot quantities only acceptable.

IMPORTED COMPONENTS

P.O. BOX 108 FITZROY
VICTORIA. 3065.

For Reliable Connections

OTL RESIN CORE SOLDERS

O. T. LEMPRIERE & CO. LIMITED

Head Office: 27-41 Bowden St., Alexandria, N.S.W., and
at Melbourne—Brisbane—Adelaide—Perth—Newcastle.



OTL/73

peak

STEREO HEADPHONES



Illustrated Model DH-04S \$13.50



DH-02S \$6.75



DH-03S \$9.50

Why miss half the fun and pleasure of your Stereo system? □ For bold dramatic sound use any of the Peak Stereophone models. □ Completely personalized listening with no disturbance to others and they do not disturb you. □ Full stereo response from all models. Light weight, adjustable and flexible headbands, soft foam earpads all contribute to your comfortable enjoyment. □ Frequency response (Deluxe DH-04S model — with independent tweeter and woofer) 20-20,000 Hz; Standard DH-03S model 20-18,000 Hz; Popular DH-02S model 20-12,000 Hz; □ Increase your enjoyment today. At all reputable dealers.

H. ROWE
& CO. PTY. LTD.

SOLE
AUSTRALIAN
AGENTS:

ADELAIDE BRISBANE
HOBART MELBOURNE
PERTH SYDNEY

CERAMIC RESONATORS

as IF filters and oscillators 1

This discussion on the characteristics of ceramic filters on a nominal frequency of 455KHz, shows that they have a very wide potential for applications in receivers and transmitters, etc., and opens up a new field which has interesting and exciting possibilities.

By Ian Pogson



Here is a group of the resonators about which we are writing. The case measures about 5/16in x 9/32in x 7/32in.

Concurrently, with the rapid development of solid-state devices, there has been a parallel development of ceramic products. These include ceramic capacitors of various types, and exploitation of the piezoelectric properties of certain ceramics. It is the latter in which we are currently interested.

Although the piezoelectric properties of ceramic materials have been known for some time, the earlier ceramics were not a practical proposition, due to lack of stability in terms of time, and an unsatisfactory temperature characteristic. Recently, lead-zirconate-titanate ceramics have been brought to a state of development where aging and temperature characteristics have been stabilised satisfactorily.

This has resulted in a number of components being brought on the market, generally in the form of small units for use as filters in IF applications, particularly at 455KHz. The manufacture of ceramic filters is not as widespread as many other components, but we have seen samples from the United States, England and Japan. It is the latter source with which we are mainly concerned at present.

From Japan, two makers have come to our notice, Murata and National. Of the two, Murata appear to make the wider range and, from our experience, the Murata units seem to offer the greater scope for investigation. Another important point is the fact that the Australian distributors for Murata filters, I.R.H. Components Pty. Ltd., are active in the field and keep good stocks on hand.

The writer has already made use of ceramic filters, both Murata and National, in tuners for the broadcast band, described in May, August and October, 1968. Such filters are attractive in that they are small in size, they do not need to be aligned and the ones most likely to be used in simple applications, are cheaper than IF transformers. On the other hand, there are some multiple ladder types offered, which have excellent characteristics, particularly skirt selectivity, and which are quite expensive.

Regarding the more expensive devices, Murata and we understand, others, have produced units which rival and often can take the place of crystal lattice and mechanical filters, so often used for SSB applications. In fact,

Murata catalogues two grades of such filters, differing in the skirt shape and thus the adjacent channel rejection. The higher grade lists no less than 10 items, ranging from a nominal bandwidth of $\pm 17.5\text{KHz}$ to $\pm 1.5\text{KHz}$; the other grade lists eight items, ranging from $\pm 17.5\text{KHz}$ to $\pm 3\text{KHz}$. It was one of the latter group that we used in the Wide Band Tuner, with a nominal pass band of $\pm 9\text{KHz}$ at the 3dB points.

From the experience thus gained, limited though it was at this stage, the idea naturally followed of using such filters in solid-state communications receivers. In such a receiver, we would otherwise use conventional IF transformers, backed up by either a mechanical or a crystal lattice filter, for the reception of SSB signals.

But each time we considered using the ceramic filters, obstacles seemed to appear. In the case of the expensive ceramic filter to take the place of the mechanical or crystal lattice filter, the unfortunate fact emerged that the narrowest unit offering was $\pm 1.5\text{KHz}$ minimum, at the 6dB points. In fact,

one of these units which became available, turned out to be a little over $\pm 2\text{KHz}$ or more than 4KHz wide between the 6dB points. As a figure of 2KHz to 2.5KHz is the widely preferred choice for SSB, it is obvious that the narrowest ceramic filter would not be adequate.

When we turned our attention to the low-cost versions of the ceramic filters, for applications where they would be cascaded in an IF strip, the problem arose of tolerances on the centre frequency. The quoted tolerance is $\pm 2\text{KHz}$ on the nominal centre frequency of 455KHz. This means that, in the extreme case and where we wished to use say four units in an IF strip, the centre frequencies of the individual units could be separated by as much as 4KHz. Where we are likely

The SFD-455B resonator consists of two "ring-dot" elements connected as shown right. The capacitor size determines the band-width.

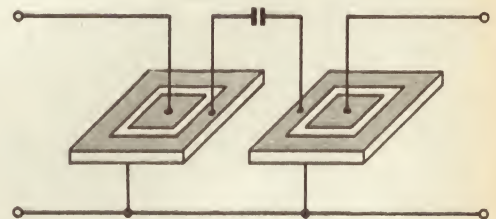

Figure 1

TABLE 1

Results of tests on an SFD-455B ceramic filter unit. Top coupling, 47pF. Centre frequency initially, 454.75KHz.

10K,	pin 1 to E:	fc = 454.30KHz	Approximately 10dB loss
10K,	pin 2 to E:	fc = 454.55KHz	Approximately 3dB loss
4.7K,	pin 1 to E:	fc = 454.15KHz	Approximately 20dB loss
4.7K,	pin 2 to E:	fc = 454.51KHz	Approximately 5dB loss
27pF,	pin 1 to E:	fc = 453.76KHz	Practically no loss
27pF,	pin 2 to E:	fc = 454.86KHz	Practically no loss
82pF,	pin 1 to E:	fc = 452.63KHz	Practically no loss
82pF,	pin 2 to E:	fc = 454.87KHz	Practically no loss

TELEQUIPMENT

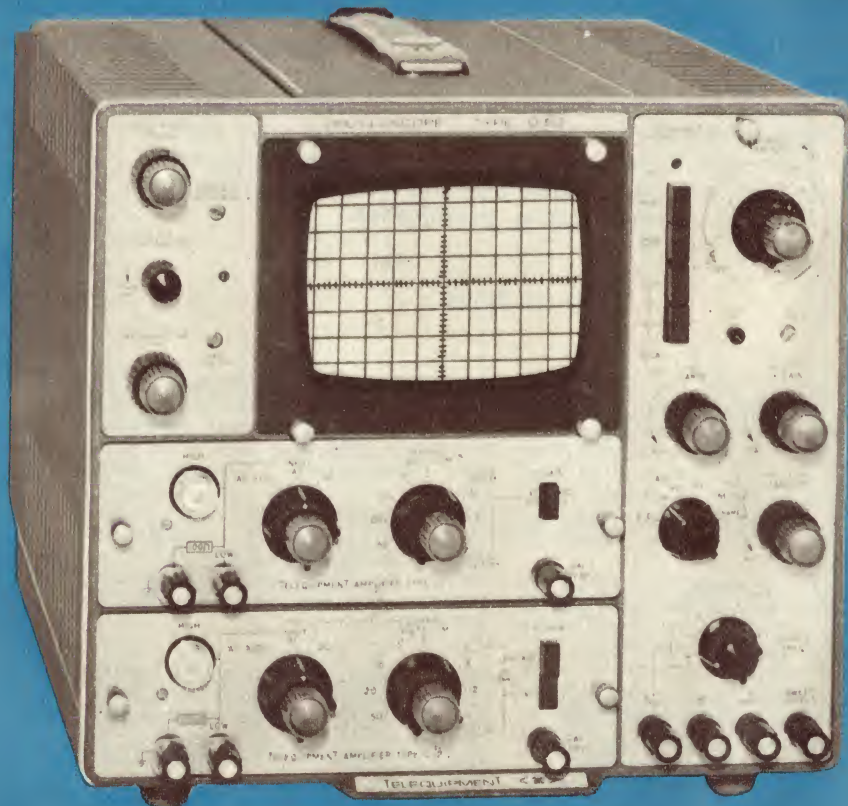

performance plus versatility with D53

5" rectangular double beam mesh tube. Signal and sweep delay. Choice of differential, ultra high gain, or wide band plug-in Y amplifiers.

Telequipment D53 is a sophisticated laboratory oscilloscope at a down-to-earth price. It offers all the extra facilities likely to be required in a general-purpose oscilloscope for some time to come. Send for full details—NOW.

TEKTRONIX



Distributed by Tektronix Australia Pty. Limited
N.S.W. 80 Waterloo Road, North Ryde 2113. 88 7066
VIC. Suite 20, 67 Queens Road, Melbourne 3004. 51 1592
S.A. 128 Gilles Street, Adelaide 5000. 23 2811

to be looking for a band width of 4 or 5KHz, or even less, it is obvious that such tolerances would be unacceptable.

Still looking for an answer to the filter problem for SSB reception, we investigated the availability of mechanical filters and suitable crystals (FT-241, etc.). We found that mechanical filters were not as readily available as we had hoped. Also, while FT241 crystals are still available in the United States, they are not readily available here. So we turned our thoughts to the low-cost ceramic filters again. Would it be possible to make use of them, in spite of the spread in tolerances?

With nothing to lose, and the possibility of something to gain, we decided to concentrate our efforts on the Murata type SFD-455B, a 5-terminal device. Its bandwidth can be adjusted by different values of top capacitive coupling, between the two elements which go to make up the complete unit.

Figure 1 illustrates the "works" of an SFD-455B assembly. It consists of two elements, each a ceramic slab about 3/16in square and about .015in thick. The slab is silver-plated on opposite faces. On one side, the plating covers the full surface. On the other side, the plating is such that two separate areas are formed, as shown. When two of these matched elements are placed back-to-back, we have the five terminal device, type SFD-455B. In the actual package, the two elements are held in small clips, making the appropriate contacts and brought out as small flat flexible leads.

To study the behaviour of the ceramic resonators under various conditions, we set up a sweep generator on 455KHz, actually the one described in December, 1963. A standard signal generator was used as a marker, monitored by an Advance frequency meter.

The sweep generator was fed into the test circuit as shown in figure 2; the output of the test circuit fed into a detector probe which in turn, connected to the vertical input of the CRO.

Our first test was to determine the centre frequency of each of a number of randomly selected SFD-455B units. Of five units checked, the centre frequencies turned out to be, 456.15KHz, 455.08KHz, 455.63KHz, 456.00KHz and 456.63KHz. The units all come

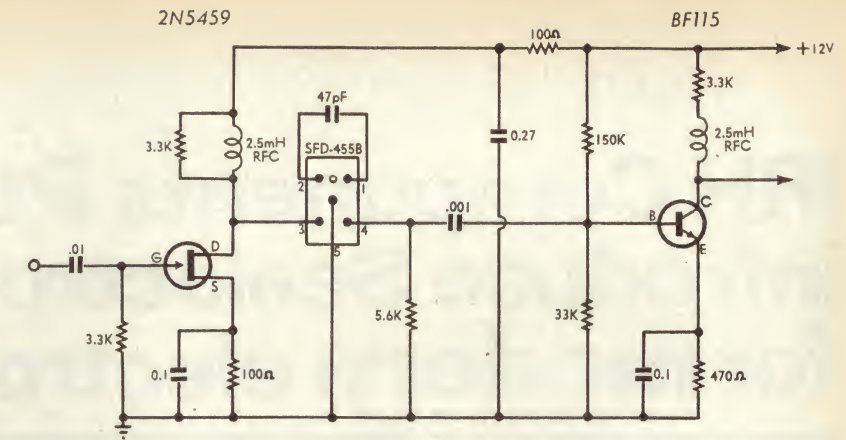

Figure 2

This is the circuit which we used to make tests on individual resonators. The circuit is straightforward and representative of current practice.

well within the maker's tolerance of ± 2 KHz. The greatest separation is represented by one on 455.08KHz and another on 456.63KHz; this amounts to 1.55KHz and looks promising, but we must face the fact that other samples could be much wider apart than these tested.

Our next test was a check on the band width at the 3dB points, of the same units and with the coupling of 47pF as shown in figure 2. The band widths turned out to be, 1.95KHz, 2.17KHz, 2.23KHz, 2.37KHz and 2.34KHz. Although there are notable differences, they are well within the maker's tolerances.

At this point, the vital question arose. Could we do something to bring all units to the same centre frequency, or otherwise control them so that a number of them could be used in cascade? If we could do this, then the selectivity characteristics of each unit in the setup would be additive, possibly resulting in a good shape factor. Also, could the band width be controlled?

Our next test consisted of placing a

random selection of SFD-455B units in the same test circuit, figure 1, as before. Arbitrary tests were carried out by connecting resistors and capacitors of various values across different terminals of the device. The results of this test are shown in Table 1.

A perusal of Table 1 can be very enlightening and indeed, very promising. It will be noted that a resistor or a capacitor across certain terminals changes the centre frequency quite appreciably. The frequency shift is to the low side in most cases, except where a capacitor is connected from pin 2 to earth, which results in a small shift in the high direction. It will also be noted that while resistors shift the frequency, they introduce a considerable insertion loss, whereas a capacitor introduces no significant loss.

It would seem from the above that resistors should be avoided and only capacitors used to modify characteristics, but this has turned out to be a premature assumption. In cases where elements in a complete system vary to a significant extent in Q, a suitable value of resistor can be used to advan-

An extension of the one above, this circuit was set up to test a full set of resonators, as they may be expected to be used under IF conditions of a short-wave or communications receiver. The switching would be more elaborate on an actual strip, compared with the token switching shown.

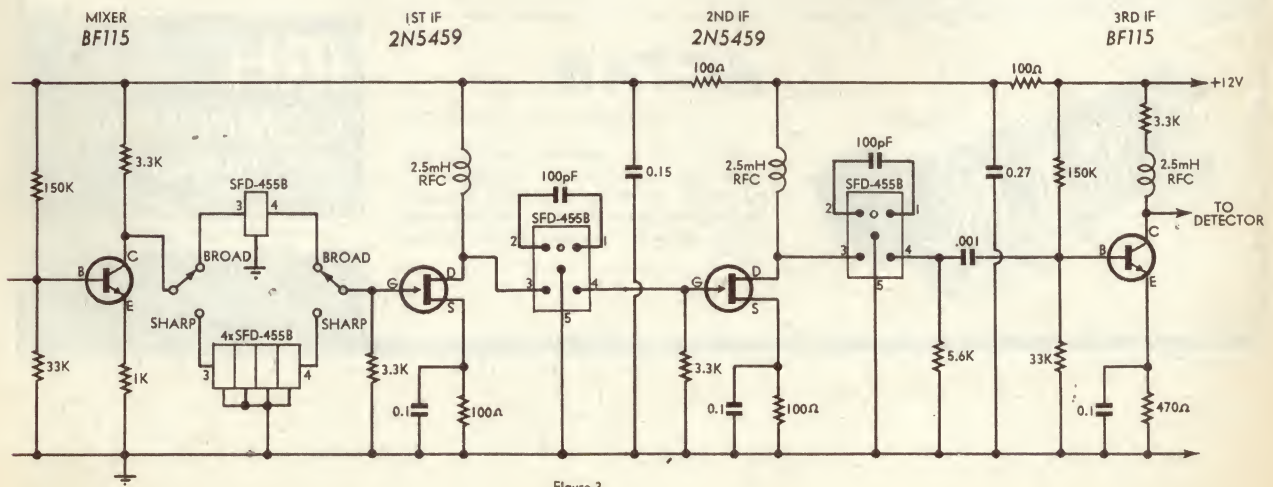

Figure 3

IRH Components Pty. Limited introduce Sealectro products for modern electronics.



Sealectro card, stub or badge readers

The Sealectro Static Punched Card or Stub Readers (80 x 12 or 51 x 12 cards) are suited to a wide and growing range of programming and matrix switching applications wherein immediate programme change and low volume programme store are requisite. Some samples are: Low-cost automation, machine tool control, automated testing, process control, function simulation. The Badge Reader (10 x 10 card) is designed for Personnel identification, Credit status, Data collection and transmission.

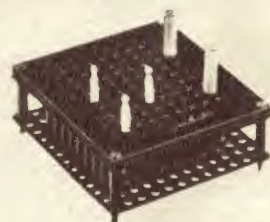

SEALECTOBOARD programme boards

The most flexible and reliable programming system, cord or cordless styles, single or multi-pole switching, programming by shorting pins or component interposition e.g. Diodes for back-feed elimination. Applications include: Analogue Computers, Naval Communications Channelling, Data Logging, Function Simulation, Pattern Generation, Factory Automation, Nuclear Power Control.

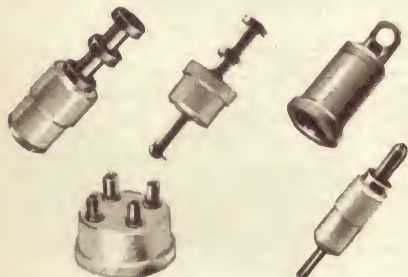

PRESS-FIT

teflon terminals

The PRESS-FIT terminal range includes a broad line of types and sizes of Stand-offs, Feed-throughs, Receptacles, Test Point Jacks, Probes and Plugs, Transistor Sockets, Transistor Holders, Bushings, Taper-pin Receptacles and special types for welded or wire-wrap connections. PRESS-FIT terminals are available in the ten E.I.A. colours - white, black, brown, grey, blue, violet, green, yellow, red and orange.

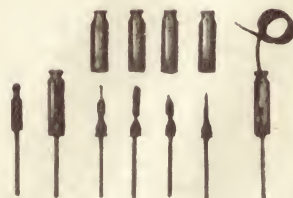

sub-miniature R.F. connectors

The widest range of Sub-miniature Coaxial Connectors, in screw-on, snap-on and slide-on styles. Conform to MIL-C-22557/A 50 ohm patterns available for RG-196/U or RG-188/U cables, and also for the equivalent semi-rigid cables. Hermetically sealed bulk-head mounting connectors suitable for pressurised equipment. A full range of BNC, TNC and C type adapters is also included in the ConheX range.

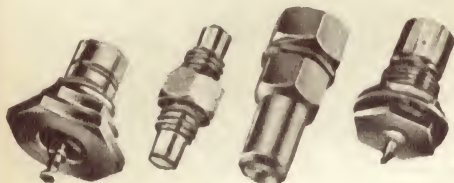

ACTAN

programming switches

Drum type programming switches permanent or field adjustable. Manual or timing motor or stepping solenoid actuated. Extreme versatility of contact arrangements enable up to 60 discrete programmes per switch.

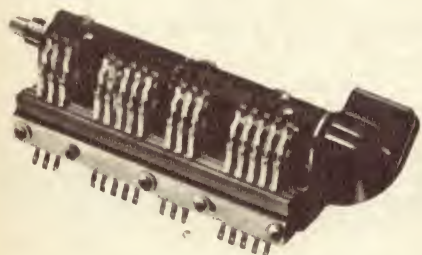

IRH COMPONENTS PTY. LIMITED

A Subsidiary of IRH Industries Limited

THE CRESCENT, KINGSGROVE, N.S.W. 2208. PHONE 50 0111

INTERSTATE TELEPHONES

MELB. VIC. 489 1088 BRIS. QLD. 76 2141
HOR. TAS. 34 2811 PERTH W.A. 8 2271
LAUN. TAS. 22 844 ADEL. S.A. 23 1921

tage to correct this. More will be said about this later on.

Further study of Table 1 shows up other points of interest. The higher the value of capacitor used, the greater is the frequency change. Alternately, the lower the value of resistor used, the greater the frequency change. Also, the amount of frequency change, all other things being equal, is different when different terminal connections are used.

A further point worth mentioning, and which is not shown in Table 1, is the fact that frequency changes can be achieved by connecting external components between terminals 3 and 4, and earth but the changes are not so great. Also, it is possible to effect changes by connecting between terminals 2 and 3, or 1 and 4. Again, the changes are not so marked.

The next series of tests were more ambitious, having been prompted by the results given in Table 1. Another test circuit was set up, so that a series of tests could be made which simulated actual application in an IF strip. The circuit is shown in figure 3.

This circuit consists of a BF115 transistor in the first stage, which could be the mixer in an actual application of the full system. Following this stage is provision for checks to be made on one or more SFD-455B filters. Then follows an amplifier stage in which we are using a 2N5459 field effect transistor. Between this and the next and similar stage is an SFD-455B filter as the coupling medium. Another SFD-455B is used to couple from the second FET, to the third IF amplifier stage, using a BF115 transistor.

Field effect transistors were selected for the first two amplifiers, as they could be controlled by an easily generated AGC voltage. The final stage uses a BF115, because it will not be controlled and it gives somewhat more gain than the FETs.

It will be noticed that the two FETs have a 2.5mH RF choke as the drain load, instead of the more conventional 3.3K resistor, which is associated with ceramic filters. The reason for this is that FETs take a much higher current than bipolar transistors, something between 5 and 10 milliamps. This would mean excessive voltage drop through a 3.3K resistor and, with a supply voltage of 12, the proposition would not be practical. The use of an RF choke solves the voltage drop problem and at the same time presents about the right source impedance for the filter.

An important point which should be mentioned in this circuit is the top capacitive coupling used for the two SFD-455B filters, already installed. The coupling capacitor used is 100pF. This results in some overcoupling, with a slight double hump. The thinking behind this approach is that, if we make these circuits somewhat wider than the widest pass band required, most of the selectivity can be determined in the first stage, with the other two acting only in a supplementary capacity.

With figure 3 ready to go, we connected one SFD-455B unit between the first BF115 and the following FET. The top coupling capacitor used on this occasion was 47pF, the pattern on the CRO appearing substantially as shown in figure 4A. Although not

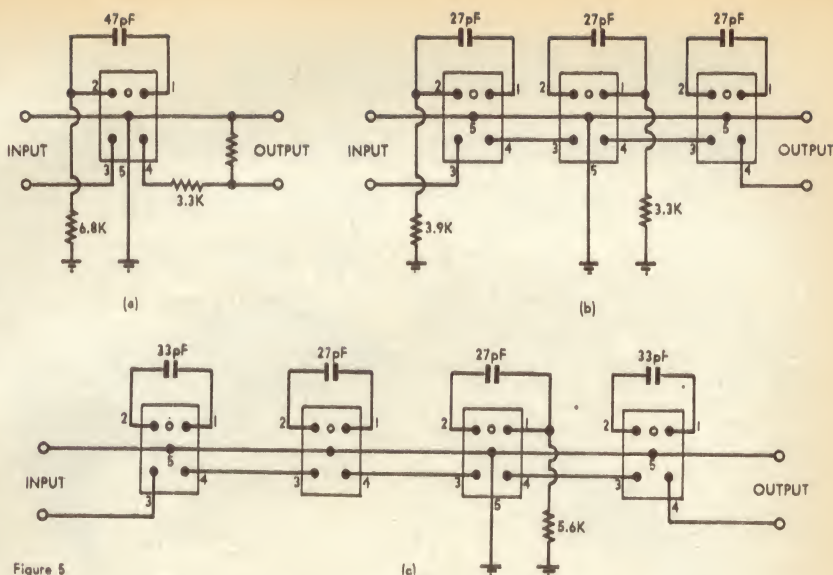

Figure 5

Circuits (a), (b) and (c) are those which produced the wide, medium and sharp curves. The compensating resistors would be different for other cases.

The curves A, B and C at right, were derived from filters (a), (b) and (c) above, when used in figure 3.

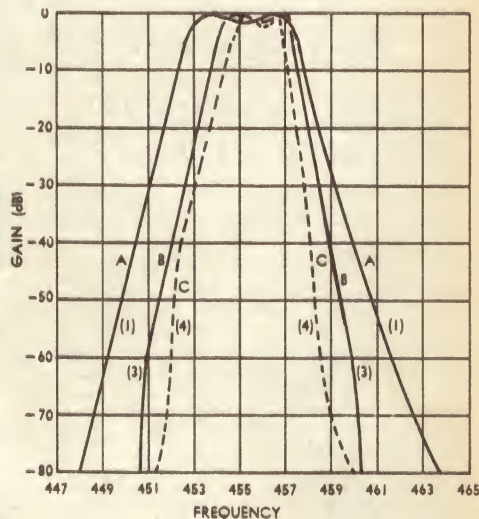

Figure 6

by any means perfect, it could be more or less acceptable. By connecting a 6.8K resistor from terminal 2 to earth, the pass band shape as shown in figure 4B was obtained.

The single SFD-455B was then removed to make way for a more ambitious test. It was considered that we may be able to connect a number of these units in cascade, to improve the overall pass band. Normally, terminals 3 and 5 are the input, with terminals 4 and 5 for the output. As the units are symmetrical, i.e., the input and output impedances are equal, it should be possible simply to connect a number of units in series, pin 4 to 3, etc., and all pins 5 to earth.

On this assumption, we connected three units together in this way. The 27pF capacitors were chosen for the top coupling for each unit and the whole assembly was then connected into the same position as previously. A reasonable shape was obtained, but attempts were then made to improve it. In this case, by connecting a 3.9K resistor from the first pin 2 to earth and a 3.3K resistor from the second pin 1 to earth, we obtained a very satisfactory shape.

Pursuing this approach a little further, we connected together another group of four and put them into the

test circuit. Once again, our experience was much the same. By connecting a 5.6K resistor from the third pin 1 to earth, an excellent shape was again obtained.

The connections for the three tests just given are summarised in figures 5A, 5B and 5C respectively. At this point, quite a number of important observations can be made. Firstly, it would appear that the investigations are reasonably successful so far. The next question is, just how successful? This can be answered at least in part by referring to the three photographs from the screen of the CRO and in somewhat more detail from the curves shown in figure 6.

The photographs look encouraging, but they only tell part of the story. Just how good is the skirt selectivity? The answer to this is given in curves of figure 6. Curve "A" is 5KHz wide at -6dB and 12.3KHz at -60dB. This gives a shape factor of 2.46. Curve "B" is 3.3KHz wide at -6dB and 9KHz wide at -60dB, a shape factor of 2.73. Curve "C" is 2.2 and 6.5 at the -6 and -60dB points, giving a shape factor of 2.96.

These figures for the shape factors could be considered as very satisfactory. It may be possible to improve upon these figures further by taking

CONVOY TECHNOCENTRE TOPICS

Specifications, Systems, Service, Friendly Advice

First Release! NEW REVOX AMPLIFIER

80 watts R.M.S.

Swiss craftsmanship is now giving a new value in quality for Stereo Amplifiers. This exclusive unit, the REVOX 80 watt R.M.S. Amplifier, is a fitting companion to the REVOX Tape Recorders and Decks from the famous Willi Studer Sound laboratories of Zurich. For the first time in Australia hear this superb system with top-quality Speakers. Typical of exclusive features is the balanced input for all channels, it is adjustable for constant volume on every mode. The price is also a value breakthrough.



REVOX TAPE RECORDER AT OLD PRICES!
Hurry while they last, a CONVOY SPECIAL!

READ WHAT GEOFRY HORN
AUDIO RECORD REVIEW SAYS—

"It must be put on record that the model 77 handles like a thoroughbred (which it is) and used in conjunction with an extremely good amplifier and a pair of electrostatic loudspeakers it was able to fool the best ears. Even at 3 1/2 i.p.s., given a good tape and a little care in setting up the levels, one can operate the tape monitoring switch several times in rapid succession and then challenge any listener to tell one whether the switch was left in the 'TAPE' or 'DIRECT' condition — a most severe test."

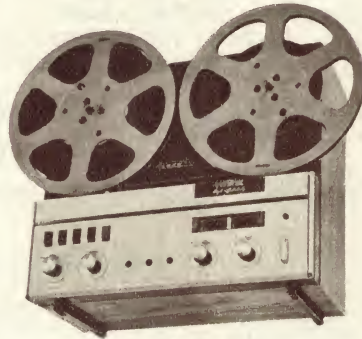

Famous Revox 77A.

HEAR NOW
FAMOUS

TANNOY

"MONITOR GOLD"
ONE SPEAKER
SYSTEMS—15" or 12"



Tannoy, known as a world leader in speaker manufacture, now offers, through Convoy, superb Monitor Gold, dual concentric speaker systems with entirely new crossover network for solid state amplifiers. Constant impedance characteristics; nominal impedance never falls lower than 5 ohms—others 1 ohm. Nothing better.

NEW PEERLESS 3 WAY
SPEAKER SYSTEMS.
DON'T ACCEPT LESS!

Peerless 15", 12" and 10" 3 way systems with factory crossover module bring new quality values at the price one would expect for twin cone systems.

You can now own this superb Danish system used by broadcast monitors throughout Europe. It has special tonal quality at low levels yet has full brilliance at high wattages.

Before choosing anything else than a 3 way system hear Peerless and a wide range of other speaker systems on line for comparison. Wharfedale, Leak, Poly Planar flat speakers, etc.

MAKE YOUR PURCHASE DECISIONS AT THE ONLY TECHNOCENTRE—
All leading makes of Hi-Fi Equipment on line or available, with data.
PROFESSIONAL HI-FI SERVICE AND MODS A SPECIALITY.

Convoy
FOR SOUND SATISFACTION

TECHNOCENTRE
Hi-Fi Centre of Australia
449 Kent St., Sydney. 29-6475

a little more care in adjustment, or by adding an extra unit or two, to those already existing. At this stage, we have not tried to improve upon these figures.

It will be noticed that we have taken the curves down to the -80dB points. While we can vouch for the accuracy of the curves, within reasonably small limits, down to -60dB, there may be some greater errors at the higher attenuation. Suffice to say, that the overall adjacent channel attenuation is little short of excellent.

In cases where more than one degree of selectivity is required, blocks of filters with selected characteristics would be fitted between the mixer and the first IF amplifier, with facilities to switch from one position to the other. As the insertion loss of these filters increases with additional units added in cascade, it may be necessary to introduce some attenuation to the filter with the lower insertion loss, so that there will be no change in signal level, when switching from one position to the other. This is the reason for the voltage divider shown at the output of the filter in figure 5A.

By now, readers will be asking how the band-width of these assemblies can be controlled to give the wanted characteristics. Fortunately, the answer is simple. The overall band-width is controlled simply by changing the value of the top coupling capacitance for each unit. This, of course, has to be determined for the particular assembly, together with any corrective measures such as the use of shunt capacitors or resistors, as mentioned previously. It is doubtful if the band-width could be changed, of a particular assembly, after it has been finally adjusted, simply by altering the top coupling capacitors.

To sum up on the question of obtaining a certain band width, it is kept to a minimum by using a small coupling capacitance, such as 27pF. Progressively wider pass bands are achieved, within reasonable limits, by increasing the top coupling to something of the order of 100pF.

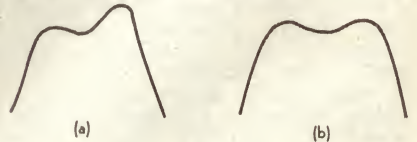
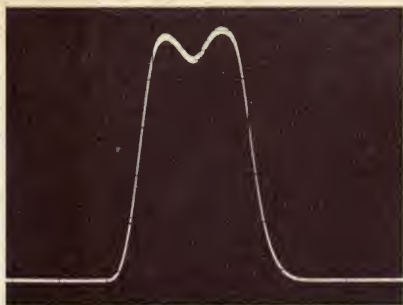

Figure 4

These curves are typical of "before" and "after" corrective measures are taken.

So far, the whole idea looks very promising. However, in spite of all the investigations up to this point, the question of maker's tolerances on centre frequency has not been fully resolved. As a further check, we picked at random another four new SFD-455B units and connected them up in a similar manner to those of figure 5C without any corrective measures.

A check on the sweep equipment showed that although the pass band shape was anything but correct, it would be reasonably satisfactory if nothing more was done about it. However, as it did leave quite a bit to be desired, we set about taking corrective measures. It transpired, after a few minutes' investigation, that a 3.3K resistor from the first pin 1 to



This photograph from the CRO, corresponds with the curve of figure 6C.

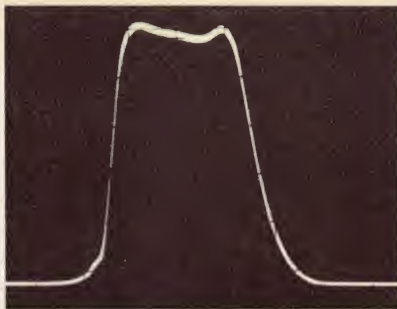

This photograph of the 3-unit filter corresponds to the curve of figure 6B.

earth, was sufficient to give a good shape. In short, and considering the foregoing, it would seem that there is no reason why these results could not be closely and satisfactorily approximated.

Clearly, a case has been established for the application of type SFD-455B ceramic resonator units in IF circuits where a high performance filter is required. It now becomes of interest to compare this potential, with the more firmly established mechanical filter and crystal lattice filter.

Although it is not easy to be too specific in a short space, we can at least make some general observations. The ceramic filters just described, compare favourably with either the more commonly used mechanical or crystal lattice filters in available bandwidths and shape factor. In size, the ceramic units would normally be smaller than equivalent mechanical or crystal filters. Perhaps one of the greatest advantages offered by the ceramic filters is that of cost. For a given performance, we suggest that a ceramic filter could be installed for about 20 per cent of the cost of a mechanical filter. It would also be much less than a crystal filter, depending on the source of the crystals.

We have already referred to the apparent reduction in supplies of mechanical filters and suitable crystals in this country, whereas stocks of SFD-455B ceramic resonators are readily available at a modest price.

So much for the advantages which ceramic filters have to offer. The question may be asked as to whether there are any disadvantages or, what is the catch? There are indeed, a couple of minor disadvantages but these can be readily overcome in most cases. We refer to the problem of alignment, where a builder has only limited test equipment in one instance and the insertion loss where several units are used for high performance.

The problem of insertion loss can be immediately overcome simply by adding an extra stage to the IF strip. The answer to the alignment problem with limited equipment, is not quite so easy. It may be possible to use an ordinary signal generator and a vacuum tube voltmeter, with a detector probe. However, we have not looked too closely into this one but we hope to have more to say about it later on, in a subsequent article.

Although we have spent some time on this investigation and we have come up with enough information to answer a lot of questions and to give much food for further thought, we feel that there is so much to be learned about

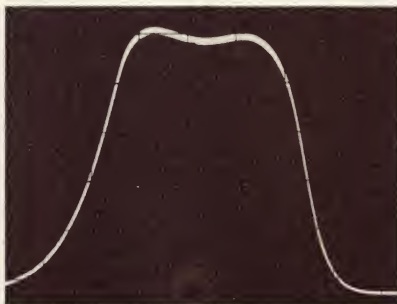

A broad curve, with one unit and suitable for AM, corresponds to the curve of figure 6A.

these devices and the surface has only been scratched. Suffice to say that the findings so far are most exciting and the application potential could be far-reaching. (To be continued).

SARABAND RECORD PLAYER



- Synchronous motor, belt drive.
- Heavy non-metal 12" platen.
- 14" arm with anti-skating and viscous bearing damping.
- Magnetic head with patented anti-distortion construction.
- Output 20 watts R.M.S. per channel; auxiliary ins and outs.

SEND TODAY FOR YOUR
"SARABAND" BOOKLET

M.B.H. AUDIO SALES,
33 MARLBOROUGH ROAD,
HOMEBUSH, N.S.W. 2140

PHOTOMULTIPLIER TUBES HAMAMATSU TV CO. LTD. HIGH PERFORMANCE — LOW COST

PM TUBE		RESPONSE
HTV-R106	1,600 to 6,500°A	Critical Applications
HTV-R136	1,600 to 8,000°A	Wide range spectral response
HTV-R166	1,600 to 3,200°A	U.V. Range
HTV-R196	4,000 to 12,000°A	Vis. and infrared range
HTV-R213	1,850 to 8,000°A	U.V. to near IR Range

OTHER TUBES AVAILABLE R212, 913A, IP21, IP22, IP28
9 Stage, side-on types, 11 pin base

FOR FULL DETAILS PLEASE CONTACT

Sole Australian Agents

VARIAN TECHTRON PTY. LTD.

Springvale Road, North Springvale, Victoria

Phone: 560 7133

THE MAGNIFICENT WORLD



Model X-2000

THREE MOTORS AUTO. REVERSE CUSTOM DECK ——— X-2000

*4 track stereo/monaural recording and playback *CROSS-FIELD HEAD *3 motors, 3 speeds *Solid state pre-amplifier with two integrated circuits *Sensing tape continuous reverse (Auto. reverse) *Manual reverse *Magnificent oil-finished wooden cabinet *For increased stereo enjoyment, use the matching amplifier AA-6000, 120 watt solid state amplifier and the matching speaker SW-160, AKAI 4 way, 6 speaker system with high and midrange level controls.

Prove it by the sound!
..... prove it with

AKAI[®]
CROSS-FIELD HEAD

AKAI AUSTRALIA PTY. LTD.: 276 Castlereagh St., Sydney, N.S.W./146 Burwood Rd., Hawthorn, VICTORIA/399 Montague Rd., West End, Brisbane, QUEENSLAND/8 Arthur St., Unley, S.A./579 Murray St., Perth, W.A. HOMECRAFTS: Patric St., Canberra, A.C.T. J.B. YOUNG: Giles St., Kingston, A.C.T.

TRANSISTOR DAMAGE . . .

the hidden menace of stray voltage on the soldering iron

Most of our readers will already be aware of the potential danger to transistors of excess heat from soldering irons, and the need to take precautions to ensure that overheating does not occur. However, there is another possible source of transistor damage that is not nearly so widely known — the presence of relatively high voltages with respect to earth on the tip of low voltage soldering irons.

This voltage can reach surprising levels, and when the soldering iron is applied to the leads of a semiconductor may cause a damaging amount of current flow through the transistor if a circuit path is established. It has been found that when such an iron is used for soldering a diode matrix, for example, diodes are often found to be defective in subsequent testing. In such cases, the quality of the components have sometimes been called into question, quite unjustly.

The real culprit, the soldering iron, is often not suspected. Perhaps this is not surprising, since it requires some thought to understand how the situation arises where voltage on the tip of the iron can reach destructive levels. Let us firstly consider the construction of such irons, in conjunction with figure 1. The transformer has a 240V primary and, say, 6V secondary. The heat is connected across the secondary, to operate on a nominal 6V. The bit is commonly connected to one side of the secondary, as shown. The real villain of the piece is the voltage coupled from primary to secondary by stray capacitance. The user of this type of iron will probably be very surprised to learn that a stray capacitance of 50pF can result in a voltage of 50V P-P with respect to earth at the soldering iron tip. The purpose of this article is to alert readers to the potential problems which can exist in this context, and to suggest ways of safeguarding against transistor damage.

Soldering transformer with static screen. A transformer without a static screen between the primary and secondary windings has a relatively high capacitance between the two windings, and this leads to the relatively high voltages on the tip already referred to. In figure 1, C represents the stray capacitance between primary and secondary, and R the resistance of the soldering tip to earth, consisting of the insulation resistance of the iron, the cable and the transformer with respect to earth. The potential of this tip with respect to earth is measured across this resistance by means of a voltmeter with a very high input impedance R_i .

The voltage (V) depends on the

value of C. If the capacitance between primary and secondary windings is 40pF, and the insulation resistance is 10M, the voltage on the tip will be 40V. Voltages of this order applied to semiconductors are, at the least, a potential source of damage.

It should be noted that we are referring, not to RMS values, but peak-to-peak voltages, which are more significant in this connection. Since this voltage is capable of destroying a sensitive semiconductor if the soldering iron tip comes into contact with it (assuming the existence of a return path, through common earthing ar-

rangements, through common contact, or even through the body of the user) we have to consider ways by which this voltage can be reduced to a safe level, or eliminated entirely.

Earthing the tip. This measure can certainly keep the tip of the iron entirely free from unwanted voltage. The drawback of this simple cure, however, is that the iron cannot then be used for soldering in circuits that are carrying voltages with respect to earth. Moreover, damage can still be caused to semiconductors if the circuit still carries static charges, which would be the case in a circuit with

Figure 4. Suggested set up for measurements using a meter with 5-10M input impedance.

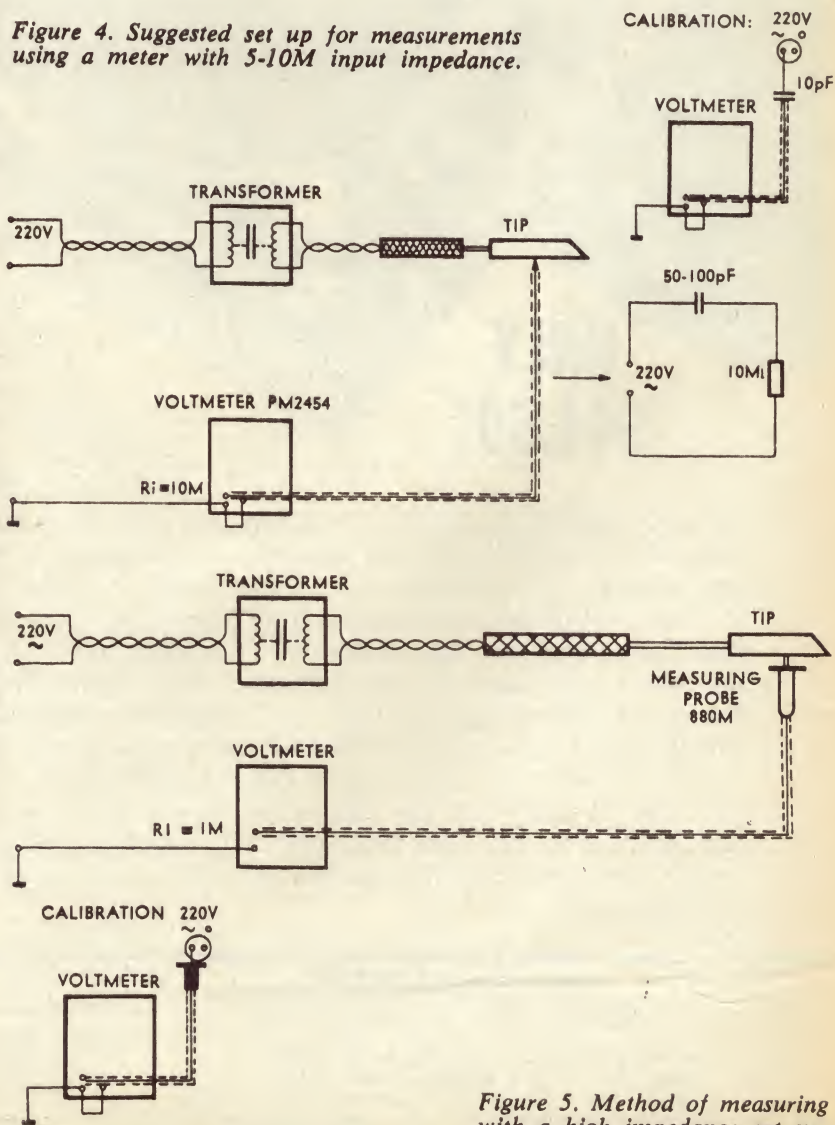

Figure 5. Method of measuring with a high impedance set up.

This is a condensed version of an article by A. E. Elzinga, of Philips Telecommunicatie, MAD, Holland, which originally appeared in "Philips Electronic Measuring and Microwave Notes," 1968/4. For reasons of style, and because of some differences in Australian and European conventions, some sections have been rewritten.

Simon Gray
 proudly presents
 the "SILCRON" . . .
 an all-new
 precision built Australian turntable



**ONLY
 \$44.50!**

With a wow and flutter specification of less than 0.04% the new SILCRON two-speed turntable combines precision engineering with the proven design principle . . . BELT DRIVE.

The most sophisticated stereo cartridges and tone arms may be used with this high-performance turntable. Speed accuracy is absolute as a substantial 12-pole sealed synchronous motor provides the motive power. A unique speed change mechanism of robust design permits changes from 33 $\frac{1}{3}$ to 45 r.p.m. in less than one second. Cast from aluminium, the 12" diameter turntable itself is machined to fine tolerances and dynamically balanced. An anti-static rubber mat is fitted as standard equipment. The actual drive belt is pure latex and drives the turntable around its perimeter where a deep groove is machined into the turntable edge. Depth required below the motor board is only $\frac{3}{4}$ " and height above can be as little as 2". No other turntable on the Australian market offers as much value and as much performance as the new SILCRON . . . which is backed by the national sales/service network of Simon Gray Pty. Ltd. Ask your favourite hi-fi dealer for a SILCRON demonstration!



Australian National Distributors:
Simon Gray Pty. Ltd.
 Head Office: 28 Elizabeth St., Melbourne, Vic. Tel. 63 8101*
 Sydney Office: 22 Ridge St., North Sydney, N.S.W. 929 6816
 Canberra Office: 31-33 London Circuit, Canberra City, A.C.T. Tel. 49 6050

INTERSTATE REPRESENTATIVES:

N.T.: Pfitzner's Music House, Smith Street, Darwin. Tel. 3801
 Q'land: Sydney G. Hughes, 154-158 Arthur St., New Farm, Brisbane. 58 1422
 S.A.: Eilco Sales Pty. Ltd., 7-9 Osmond Terrace, Norwood, S.A. Tel. 63 4844
 Tas.: K. W. McCulloch Pty. Ltd., 57 George Street, Launceston. Tel. 2 5322
 W.A.: Athol M. Hill, 613-615 Wellington Street, Perth. Tel. 21 7861

capacitors, directly after switching off. If the iron is applied to such a circuit, there is the risk of discharging capacitors through the semiconductors with sufficient current flow to cause damage.

Static screen. The use of a transformer with normal layer windings and a static screen gives reasonable results. In tests carried out, using this type of transformer, the amplitude of the unwanted voltage was kept smaller than 4V, which is regarded as safe for use in production and laboratory departments where ultra sensitive devices such as MOSFETS are not involved.

Separated windings on a C core. Separation between the windings is in itself sufficient to keep the stray capacitance between primary and secondary to a low value. If, in addition, the windings are provided with a static screen, the stray capacitance can be reduced to as little as a few tenths of a pF. The arrangement is illustrated in figure 3. The drawback is that it involves the manufacture of special transformers which could be rather expensive.

At this point, it is well to consider a special case, where the static screen cannot be effective. The case arises where a soldering iron is equipped with a thermostatic type of control which will switch the heater on and off, to maintain the tip at constant temperature. It should be noted that when the power is switched off, the

collapse of the field around the transformer windings will give rise to a pulse of voltage of fairly high amplitude. Should a switch-off occur when the iron tip is being applied to a transistor connection, damage to the transistor is almost inevitable.

In cases where it is desirable to prevent overheating of the iron, an acceptable solution has proved to be a combination of a screened transformer and a soldering iron support with a cooling plate to dissipate excess heat.

Tests carried out with screened transformers on C-cores with separated windings showed encouraging results. With the screens not connected to earth, the amplitude of the unwanted voltage was found to lie between 2V and 4V. With the screens connected to earth, the voltage was measured at between 0.3V to 1.5V. In contrast, the normal type of transformer had voltages measured to as high as 50V.

Measuring method. Before deciding that available transformers are not suitable, and need replacing, unwanted voltage at the tip should be measured. It should be realised from the start that any meter with a low input resistance will give a misleading result. Let us assume that the stray capacitance between the primary and secondary is between 50-100pF and represents an impedance at 50Hz of about 30-60M. If the meter has an input impedance of only 1M, the voltage division between the meter and the soldering iron circuit is from 30x to 60x. This means that whereas only 2V might be measured on the iron tip, there can be a potential of up to 120V with the meter not connected. Since such a measurement is virtually valueless, we put forward two alternative methods of measurement.

First method. Taking as a starting point the fact that few semiconductor circuits have an impedance greater than 5M to 10M with respect to earth, we use an electronic voltmeter with an input impedance of 10M, for example, the Philips type PM 2454. The measuring cable to the soldering tip must be screened, and should not exceed about 20in, if possible. (Figure 4, page 67.)

Calibration of the measuring installation:—

Measure the mains voltage with the electronic voltmeter. Connect a capacitor of 10pF to the active side of the mains and measure the mains voltage across this capacitor. If the R_i of the voltmeter is exactly 10M, then the indication will be about 7V for the mains voltage of 220V. If the meter only indicates 5V, then the reading must be multiplied by 7/5 in order to obtain a better approximation of the parasitic voltage on the soldering tip.

This measurement is not absolutely correct, as the multiplications factor changes at capacitance values other than 10pF.

Second method. If a meter with a very high input impedance is available, measurements of much greater accuracy can be made. (Figure 5.) If a probe is used with a series resistance of around 880M (for example, the high voltage probe of a diode voltmeter) the real RMS voltage can be

found after calibration. In these circumstances, an electronic voltmeter with an input impedance of only 1M will be satisfactory.

Calibration: After checking the actual value of the mains supply, connect the probe directly to the active side of the mains. If the mains voltage is 220V and the meter reads 0.6V, this indicates an attenuation factor between the probe and the meter of $220/0.6 = 360x$. If we now measure the voltage on the tip, the value measured must be multiplied by 360 to obtain the real RMS value of the parasitic voltage. ■

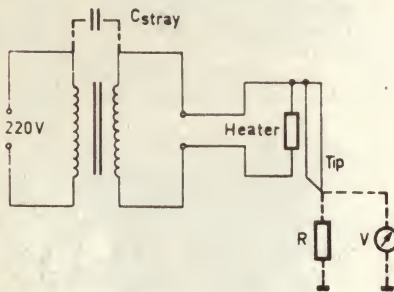

Figure 1. Showing how voltage is capacitively coupled to the soldering iron tip.

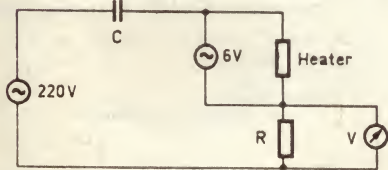

Figure 2. Equivalent circuit of figure 1.

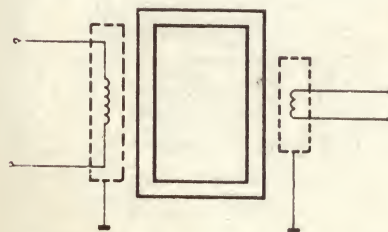

Figure 3. Separated windings on a C-core.

ELECTRO-PAK QUALITY RADIO COMPONENTS

DUCON Electrolytic Capacitors mF/V

2/12	26c	25/25	30c
6.4/12	26c	50/25	34c
10/12	26c	100/25	40c
50/12	28c	500/16	61c
100/12	32c	1000/25	\$1.20
200/12	40c	2000/25	\$1.46
2.5/25	28c	2000/40	\$2.20
6.4/25	28c	Plus 25% Tax.	

ARCO POLYESTER CAPACITORS

160V 10%			
1000pf	7c	.01mF	7c .1mF 14c
1500pf	7c	.015mF	8c .15mF 14c
2200pf	7c	.022mF	8c .22mF 16c
3300pf	7c	.033mF	10c .33mF 20c
4700pf	7c	.047mF	12c .47mF 24c
6800pf	7c	.068mF	12c
8200pf	7c	.082mF	12c
Plus 25% Tax			

STYROFLEX CAPACITORS 400V 10%
56pf, 68pf, 82pf, 100pf, 150pf, 220pf,
330pf, 470pf, 560pf, 680pf, 820pf, 5c each.
Plus 25% Tax.

MINIATURE TANTALUM CAPACITORS mF/V

.1/35	2/25	20/6	20/3
.2/35	5/25	15/6	10/3
.5/35	10/15	3/6	5/3
1/35	15/10	50/3	34c plus 25% Tax.

TRANSISTORS AND DIODES

AC126	65c	AF116N	62c	EM401	38c
AC127	72c	AF117N	62c	EM402	40c
AC128	70c	BC107	75c	EM404	42c
AC187	98c	BC108	62c	OA91	24c
AC188	88c	BC109	76c	AY8116	
AD161	\$1.65	BC178	65c	AY8109	
AD162	\$1.50	BF115	65c		\$1.50
AD149	\$1.76	BF167	77c		\$2.10
2N301	\$1.78	BF185	62c		40406 \$1.50
2N4241		BF200	98c		40407 \$1.50
AF114N	68c	BA100	35c	All plus 25 p.c. sales-tax	
AF115N	68c	QA102	85c		

CERAMIC TRANSFILTERS

BF455A	.32c	SF455B	.54c	SF455D	.85c
Plus 25% Sales Tax					

COILS FOR ELECTRONICS AUST. TUNERS

ST45C	\$1.40	S.201	\$1.40
S.203	\$2.18	S.195/196pr	\$4.10

R.F. CHOKES

10uH,	22uH,	47uH,	100uH,	330uH,
560uH . 38c each.				
1mH	. 42c	2.5 mH	. 48c	

Coils and Chokes, plus 25 p.c. Tax.

Clients please note: We sell only first quality components, no unmarked types, surplus or "similar." You can buy with confidence from:

**ELECTRO-PAK
COMPONENT SUPPLIES**

C/O P.O. Box 731,
Canberra City, A.C.T. 2601
Post & Pack 15c each order

EVERYTHING FOR THE HOBBYIST and

40 Watt & 60 Watt Instrol-Playmaster GUITAR AMPLIFIERS

All parts now available

Like all Instrol-Playmaster kits, the 116 and 117 Guitar Amplifier Kits are complete in every detail, down to the last nut and bolt, and precisely to "Electronics Australia" specifications. Chassis is ready drilled, cadmium plated and finally passivated to avoid fingermarking. The front label is beautifully finished with black lettering on silver-white background. Kits for both the 116 and 117 include extras such as 3 inputs (circuit included), vibrato and extra treble pull switches, and foot switch complete with chrome housing.

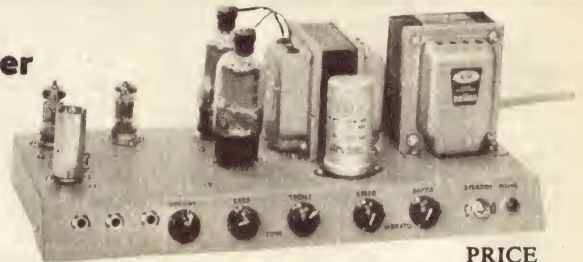

	PRICE
40 Watt complete kit of parts	\$84.36
40 Watt built and tested	\$91.49
60 Watt complete kit of parts	\$92.31
60 Watt built and tested	\$98.83
(Freight extra)	

All parts available separately if required.
 Chassis only **\$4.70** (plus 85c postage)
 Front Label **\$2.80** (plus 20c postage)
 Fuzz Box Kit **\$12.95** (plus 75c postage).



KEYLESS ORGAN
 (Electronics Aust. January 1969)

A useful novelty instrument which can be used successfully by a single entertainer or in conjunction with a group. Includes sharps and flats, built-in vibrato and has a high level of acoustic output.

Kit of Parts, \$35.10. Postage additional



INSTROL-PLAYMASTER 124 STEREOGRAM ("ELECTRONICS AUST." MAY 1969)

A Solid State Broadcast Tuner, combined with the successful 3-PLUS-3 Stereo Amplifier. All major stations for six States engraved on an attractive label.

KIT OF PARTS . . . \$67.70
 Postage Additional.



The new **INSTROL-PLAYMASTER 115 SOLID STATE STEREO AMPLIFIER** ("Electronics Aust.," April-May, 1967).

A fully transistorised 10 Watt Stereo Amplifier using the latest F.E.T. high-efficiency transistors.

Crystal/Ceramic Kit **\$96.80**
 Magnetic kit extra **\$10.50**

Postage additional

INSTROL-PLAYMASTER 123 PROGRAM SOURCE



("ELECTRONICS AUSTRALIA" Oct., 68)

A high quality wide band solid state unit, fitted in free-standing metal case, featuring meter tuning and large illuminated dial.

Kit of Parts — with Ceramic Filter **\$91.20**

Kit of Parts—without Ceramic Filter **\$77.50**

Postage additional



THE 10-PLUS-10 STEREO AMPLIFIER

("Electronics Australia," November, 1968)

A high quality solid-state 10 watt amplifier. Suitable for crystal or ceramic cartridges.

KIT OF PARTS \$62.74
 Postage additional



THE 3-PLUS-3-STEREO AMPLIFIER,

("Electronics Australia," August, 1968).

A small, modern, 3-watt solid-state audio amplifier.

Kit of parts **\$43.50**
 Postage additional

Tick catalogue required, and please include stamps for postage.

- | | |
|--|--|
| <input type="checkbox"/> Playmaster | <input type="checkbox"/> Test Equip Kits |
| <input type="checkbox"/> Toolkit | <input type="checkbox"/> Metalwork |
| <input type="checkbox"/> Cannon Connectors | <input type="checkbox"/> Transformers |

Name
 Address

Post Coupon for Free Catalogue.



Also Available,



EW2
 1 1/2" x 1/2"
 EW5
 1 1/2" x 1/2"

These robust and attractive meters are available in the following sizes:

- VP4A 1 1/2" x 1 1/2"
- VP3A 2 1/4" x 2"
- VP2A 3" x 2 1/4"
- VP45 2" x 2"

meters with scales to suit the following projects.

- Transistor Tester, Aug., 1968.
- Audio Generator, Sept., 1968.
- Power Supply, Sept., 1968.
- F.E.T. Voltmeter, Dec., 1968.

VP4A 0-500 microamps	\$4.81
VP4A 0-1 milliamp	\$4.81
VP3A 0-500 microamp	\$5.27
VP3A 0-1 milliamp	\$5.16
VP2A 0-50 microamp	\$7.11
VP2A 0-500 microamp	\$5.96
VP2A 0-1 milliamp	\$5.86
VP45 0-500uA V.U. scale	\$4.81
EW5 0-200 microamp V.U.	\$3.43
EW5 0-200 microamp	\$3.43
EW2 0-150 microamp	\$2.51

(Including Sales Tax and Postage)

BROADWAY ELECTRONICS

TECHNICIAN...

INSTROL EDUCATIONAL ELECTRONIC KIT

In this Electronic Age, every person should have some knowledge, however elementary, of "how it works." The new Instrol 20 in 1 electronic kit will enable you to understand in an absorbing, simple manner the basic principles underlying computers, satellite communications, industrial electronic devices, etc., etc. You make 20 different experimental circuits, including 10 working radio transistor operated radio circuits. Audio Amplifier circuits, home intercom, testing circuits including Audio Frequency Oscillator and Signal Tracer, Morse Code practice set and telegraph transmitter, etc. You use and learn about the amazing SOLAR CELL.



NO TOOLS OR SOLDERING IRON REQUIRED

All components pre-wired, ready for clip-on assembly. 50 page Instruction Manual supplied.

ONLY . . . **\$16.90**

(Plus 85c for Registered Post)



To allow others to hear the results you achieve, why not obtain the Instrol SPI Speaker box. Completely assembled, includes transistorised audio frequency amplifier, dynamic speaker and leads, housed in an attractive plastic box, and ready to plug-in at any appropriate stage of your experiments with the Instrol 20 in 1 Electronic Kit.

INSTROL SPEAKER BOX. PRICE \$6 plus 10 cents Postage.



ELECTRONIC TOOL KIT

For Hobbyists Students and Servicemen

An inexpensive, yet most comprehensive, pocket-sized tool kit. Ideal for the Student, Hobbyist and Practising Service Technician. The Soldering Iron is an Australian made high efficiency 30 Watt 240 Volt type. All the other hand tools are imported, high grade steel. The complete kit fits snugly into a strong attractive zip-fastening carrying satchet.

COMPONENTS

- 1—Soldering Iron with 3-pin plug 30 Watts 240V
- 1—Set 3 Spanners.
- 1—Coil Resin Cored Solder
- 1—Pair Pliers standard
- 1—Pair Long Nose Pliers
- 1—Pair Side Cutters
- 1—Pair Tweezers
- 1—Screwdriver Set complete with handle and chuck, comprising
- 2—Screwdriver bits
- 1—Philips driver bit
- 1—Pointed awl
- 1—Spintite for tin nuts

PRICE \$12.50. Plus Read. Postage \$1.00



SOLID STATE V.O.M. (Dec., '68)

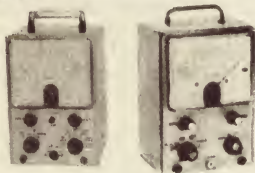

V.T.V.M. (Feb., '66)



LAB. QUALITY POWER SUPPLY (September, 1968)



TRANSISTORISED AUDIO OSCILLATOR (Dec., '67)



TRANSISTOR TEST SET (August, 1968)



R.C. BRIDGE (MAY, '66)

TEST EQUIPMENT KITS

	PRICE
Solid State V.O.M. . . . Dec. 68	\$57.00
V.T.V.M. Feb., 66	\$57.51
Transistor Test Set . . . Aug. 68	\$59.47
Audio Oscillator, Dec. 67)	\$57.05
Lab Quality Power Supply, Sept 68	\$67.32
R.C. Bridge May, 66	\$40.99
Postage additional on all kits.	

PTY. LTD.

E. S. & A. BANK BUILDING
CNR. BROADWAY & CITY ROAD, SYDNEY (opp. Grace Bros.)
 P.O. Box 43 Broadway 2007 Phone: 211-4244.



FORUM

Control tones on the power mains

Some months ago, we protested against the growing practice by supply authorities of imposing control tones on the power lines of frequency and amplitude such that they produced audible and annoying whistles from equipment involving audio amplifiers.

Conducted by the Editor

Following the protest, we received quite a spate of comment from readers, not all of whom had realised where the mysterious whistles came from.

We had reports of people who had authorised costly but abortive service calls on their television receivers and radiograms, under the impression that they had been sold a faulty piece of equipment.

And we had reports from others in more technical situations who had been plagued by spurious operation of sensing systems controlling charging circuits, emergency supplies and such-like.

Following a further mention in the June issue, we received a letter from Professor R. M. Huey, of the University of N.S.W. Reproduced opposite, the letter points out that the problem of control tones in audio equipment is part of the total problem of electrical and electronic environment and one which has been subject to a good deal of discussion at academic level.

However, having said as much, and having set out ways in which unwanted tones can penetrate audio and other equipment, Professor Huey agrees that the subject has not received anything like enough scrutiny at the practical level.

In plain terms this reduces to the amplitude and the frequency of the control tones which may reasonably be imposed on the mains, without causing embarrassment to the supply authorities' customers.

Undoubtedly, supply authority engineers would like to reverse the obligation and state a figure for attenuation of spurious tones which equipment designers should meet. However, the fact that audio systems came first might suggest that the problem of compatibility belongs mainly in the authorities' court.

Another reader who modestly failed to reveal his identity, sent through the post a photostat copy of page 190 of our June issue with the sentence marked which read:

"But did they look into the implica-

tions for hundreds of thousands of audio systems connected to their mains, ranging from domestic radiograms and TV sets to large-scale organs and public address systems?"

The copy was endorsed: "Yes, they did. See attached paper."

Unfortunately, for our present purpose, the whole paper is in German and even the title is enough to discourage any enthusiasm for the content by someone whose only knowledge of German is limited to words like Luftwaffe. Laboriously I quote:

"Über Beeinflussungsmöglichkeiten von Deraten und Anlagen der Informationstechnik durch Tonfrequenzrundsteueranlagen."

The author and reference respectively are:

Alfred Dennhardt, Hanover, Elektrizitätswirtschaft, lg. 67 (1968), Heft 21.

The page numbers I could understand: 644-648.

While a member of our staff is familiar with ordinary German conversation and prose, the time could not be spared which would have been necessary to derive a translation for a lengthy technical paper and coping, in the process, with problems of technical phraseology.

In broad terms, however, the paper does indicate that a survey was made in Europe of the effect of superimposing control tones on the power mains and that, presumably, problems do not arise provided that the amplitude of the tones does not exceed certain levels, depending on the frequency involved.

If I interpret it correctly, a diagram suggests a limit of about 20 volts for control tones between 150 and 500Hz. Above the latter figure, the limit falls progressively to 10V at 1000Hz and 5V at 2000Hz.

This would appear to support the point made in Professor Huey's letter that the problem is intimately related to frequency.

It would also appear that some, if not all, the observations in the above-

mentioned paper were based on the use of lower frequency control tones. The reduced tendency of such tones to couple into signal circuits, plus their lower audibility, could make a very big difference to the result as observed.

So, while I must thank the anonymous contributor for his interest it does not markedly affect what has been said in relation to the local scene.

People in Australia using audio equipment are being plagued by control tones on the mains. Some of the equipment involved is not of peculiarly Australian design but is imported from a variety of overseas countries.

It would be interesting to know how the amplitude of 1000Hz control tones actually imposed on the mains by local supply authorities compares with the 10V figure suggested by Herr Professor Alfred Dennhardt.

Yes, most interesting.

In the meantime, here is a brief extract from a letter which further illustrates the problem as it exists in private homes:

"Dear Sir,

"In the past few months, I have been driven up the wall by control tones superimposed on the 240V AC mains in my area.

"I have been trying hard to record conversational French for private study from records which are available to me for overnight borrowing.

"As it takes about 40 minutes to set up and make a recording, it is inevitable that the tones appear on my copies, sometimes so disturbingly that I have to knock off and start the recording all over again.

"There doesn't seem to be a tone-free period between 5 p.m. and 11 p.m. Or if there is, I haven't discovered it yet.

"I have tried many ways of suppressing these tones but to no avail. They are cutting right across both the pleasure and the utility of expensive equipment."

(R. M., Merewether, N.S.W.)

NOVICE LICENCES: On another subject, we have received a lot of correspondence from individual lads and from school clubs supporting the idea of amateur operator licences at Novice level. In many cases, the letters contain copies of correspondence directed to the Radio Branch of the Postmaster-General's Department and are countersigned by all the members of the individual clubs.

Please understand if we don't reproduce all this correspondence, but we have devoted a good deal of space to novice licences in the past and have helped to keep the discussion moving.

To allow the subject to dominate another "episode" of "Forum" would be to invite the wrath of the many readers who have other interests.

HOW TO LOSE WEIGHT: And what more typically human interest can there be in a prosperous community than the subject of losing weight?

One of our readers, a professional engineer, sends in a clipping from a newspaper circulating in Sydney's western suburbs. It describes a wonderful new electrical machine installed in a clinic which apparently specialises in coping with over-generous figures.

The machine takes all the chore out of exercise. The client simply lies on a comfortable bed in a cubicle and has a number of electrically conductive pads placed in contact with the body in areas where the embarrassment is greatest. The machine attached to the pads does all the work in this new form of "passive exercise," so called. The article goes on to say:

"After the first five minutes of orientation, many ladies starting out with determinedly gritted teeth have been known to slip quietly and blissfully off to sleep."

Why didn't somebody invent this kind of exercise before?

Our engineer-reader expressed himself as willing enough to expose his wife to the benefits of this "passive exercise" but before opening his cheque book, he felt that he should understand, at least in broad terms, what the machine was supposed to do.

This was the paragraph that worried him:

"The currents, a mixture of galvanic, faradic, leduc, high frequency and sinusoidal, are tolerable because the harsher jumpy elements of each current have been removed."

Now that must look very impressive to the layman—or laywoman!

The only trouble was that it didn't mean a thing to our engineer-correspondent and his cheque account is still intact.

The same goes for your Editor.

With the help of a technical dictionary, we had a look at the terms:

GALVANIC ELECTRICITY: An obsolete term for electric current, as opposed to static electricity.

FARADIC CURRENTS: Currents obtained from an induction coil and used for curative purposes.

LEDUC: Unknown to our technical dictionary or to any members of our technical staff.

HIGH FREQUENCY: A familiar term but one whose meaning depends on the context.

SINUSOIDAL: Pertaining to a sine wave.

Towards the end of the article is the statement that:

"One thing required by the clinic if you want to lose excess fat . . . is strict willpower in undertaking their high protein diet for as long as you visit the clinic."

This seems to add a rather contradictory extra dimension to the paragraph which opens the article:

"Ladies can now slim simply by lying quietly on a comfortable bed while harmless electric currents are directed to specific areas of their body."

I can't help but wonder how the clients would fare if they simply obeyed the strict dietary rules without getting involved with the bed, the pads and the currents.

CONTROL TONES . . . one sector of a problem area

Dear Sir:

I was interested to see the comments in Forum ("Electronics Australia," June 1969 issue) concerning the increase of interference by injected control signals in Australian AC mains. I believe you are quite correct in saying that particular problems of this sort have rarely been analysed or "quantised." Nevertheless, the question of audio frequency undesired couplings has received quite a deal of theoretical treatment by professional engineers. This can be seen by reference to the Transactions on Electromagnetic Compatibility of the Institute of Electronic and Electrical Engineers (N.Y.). Their professional group on EMC, as the name is commonly abbreviated, has about 1500 members in the U.S. In Australia, too, one finds more and more professional and technical people encountering what are basically EMC problems. One writer has defined EMC as the art of arranging that dense populations of electrical and electronic apparatus can live together in harmony.

For some time now I have been interested in the technical aspects of EMC, and delivered the guest paper at the I.R.E.E. Exposition held in Brisbane during August, 1968. This I entitled "Electromagnetic Compatibility: or A Fool's Paradise in Australia?." In this I endeavoured to stress the need for appropriate Federal legislation in Australia to preserve a "clean" electromagnetic environment in which might function not only communications and navigational equipment, but also all sorts of other electronics equipment including industrial sensors and controllers, computers, scientific instruments etc. and, last but not necessarily least, the audio equipment to which your own comments referred.

In looking at the electromagnetic spectrum it is not hard to see why the technical problems have not all been solved at audio frequencies. Injection of undesired signals may occur in several ways, among which one may list the following major modes:

- (1) By conduction e.g. by the impedance of common earth paths.
- (2) By capacitive coupling. Such capacitances are usually very small, so the action is to inject a small current into the victim circuit, of a value proportional to frequency, assuming a constant voltage at the offending source. This medium for injecting interference is readily reduced by quite simple arrangements of metallic shielding, at either source or victim equipment.
- (3) By magnetic inductive coupling. In the case of a power supply transformer whose primary carries not only 50Hz but also audio frequency control currents, the leakage magnetic field may couple into inductive components in the victim equipment, or even into single wiring loops. This coupling may be analysed by estimating the mutual inductance between the source and the victim circuits. Assuming a constant current at the source, the voltage generated in the victim circuit would then be proportional to frequency. Unfortunately such stray leakage fields are not at all so readily shielded against as the electrostatic fields mentioned above. It is not hard to see why coupling by mutual inductance which transfers negligible voltages at 50Hz into the victim circuit, may cause some trouble at higher frequencies — typically an increase of 20dB in transmission between 50Hz and 500Hz, or an increase of 30dB between 50Hz and 1600 Hz.
- (4) By the transmission of energy as an electromagnetic wave between the source and the victim. If this problem could be evaluated, this would be a much more satisfactory means for "quantising" the problem at audio frequencies. The readily available techniques for calculating the amount of attenuation when an EM wave passes through a metallic structure (i.e. shielding) are limited to calculations for the passage of a plane wave through an infinitely extensive thin metal sheet, and to approximate calculations for such penetration through an idealised shield in a coaxial cable. In some audio frequency cases with "practical" shielded cables the measured attenuation may be only a few dB.

It can be seen therefore that the technical situation as regards EMC does actually present many unresolved difficulties. I note in your remarks that you describe these problems as having been relegated to the "too hard" basket, and I rather agree with you that this has undoubtedly happened and will continue to happen all too frequently. I would be interested to learn more about the complaints of audio tone interference. Although I regret I could not undertake the large task of individually commenting on each complaint. I would try from time to time to comment on groups of complaints having common features.

R.M. HUEY

Associate Professor of Electrical Engineering,
The University of New South Wales.

TRUSCOTT'S

AUSTRALIA'S GREATEST MAIL ORDER TAPE RECORDER & HI-FI CENTRE

STOCKISTS OFF ALL LEADING
BRANDS OF TAPE RECORDERS
HI-FI EQUIPMENT, COMPONENT
PARTS AND ACCESSORIES

NEAT MAN—THAT'S THE WAY TO ENJOY HI-FI MUSIC

Truscott Electronics are the sole Australian agents for Neat Hi-Fi equipment. Available from your local HI-FI store or direct from agents. Listed below are just two of the Neat range of products.

Neat G30 Professional Static Balance Tone Arm. New release now fitted with lifting/lowering device. A precision built unit, outstanding in appearance and simple to mount and use in any installation. The results obtained are far beyond those usually expected at such an extremely moderate price. It will accommodate all standard cartridges and the tracking weight is easily adjusted to the particular one in use.

Neat V70 Moving Magnet Cartridge. The V70 is a top performance, high quality magnetic cartridge that out-performs many more expensive cartridges. When used with the Neat G30 tone arm, an excellent low priced combination can be obtained. Send now for reviews and test reports by the Gramophone, Hi-Fi Sound and Electronics Australia on both the G30, V70 and all other Neat tone arms and cartridges.

Fast Mail Order Service

When ordering, please give your full address printed in BLOCK LETTERS. All Truscott equipment is brand new and fully guaranteed. Sales tax is included in all quoted prices. All orders are despatched promptly. All prices quoted are Nett. Postage and freight extra.
NOTE: T.M.Q.—Truscott Mail Order Quote.

ACCESSORIES

Microphones and Stands — Tapes and Spools — Splicing Kits — Record Care Accessories — Speaker Enclosure — Acoustic Cloth and Inner Baffling — Headphones — Pre-packed Leads — Plugs and Connectors — Head Cleaning Kits — Pillow Phones — Bases and Covers, and Many Others.

COMPONENT PARTS AND ACCESSORIES

Truscott's are stockists of all General Electronic components, including resistors, capacitors, plugs and sockets, solder, Scope Irons and spares, hook-up cables, valves, terminals, tag strips, matrix board, cambric spaghetti, fuses, chassis, grommets, solder lugs, alligator clips, valve sockets, D.I.N. connectors, TV connectors, battery savers, and also a large range of semi conductors for all Japanese makes.

AMPLIFIERS



KENWOOD
TK 20U

Akal — Sound —
Monarch — Lux —
Compax — Kenwood —
— Trio — Sony —
Trio — Sony —
Tempo — Sansul —
Leak — Grundig —
Cosmos.

TURNTABLES

DUAL
1009F

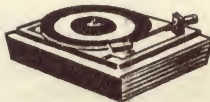

Dual — JH — Neat — BSR — PE —
Compax — Labcraft — Goldring.

TONE ARMS AND CARTRIDGES



NEAT G30 TONE ARM

NEAT V70 CARTRIDGE

Neat — ADC — Ortofon — All Balance —
— Goldring — Decca — Audio Technica —
— Dual — Shure — Micro.

SPEAKERS

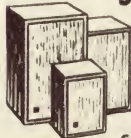

Soundmaster —
Wharfedale — Tesla —
— Philips — Kenwood —
— Sansul — Akai —
Leak.

SOUNDMASTER
SPEAKER SYSTEMS

SONY TC 200B TAPE RECORDER



Vertical or Horizontal Operation. HI-FI Stereo Tape Recorder. Features Complete 4 track stereo and mono tape recording and playback system. Sound on sound recording. Two complete full range satellite speaker systems. Individual VU meter and volume controls for each channel. Light weight (only 27lb). Two Sony high quality dynamic microphones. Compact carry case, beautifully styled in black and ivory decor. Truscott's price only \$190.

HI-FI TRANSCRIPTION TURNTABLE COMBINATION

Consists of the one and only JH Synchronous Turntable, the new Neat G30 Tone Arm with lifting/lowering device, Neat V70 magnetic cartridge, and hand-finished oiled TEAK wooden base. Retail \$96.00. Truscott's price only \$77.50. If assembly required — add \$6.00.

TAPE RECORDER BELTS

Belts available to suit most models of Telefunken, Uher, Philips, Coscor, Stella, Grundig, BSR, Ferguson, Walter and Korting Recorders. When ordering, it is most essential to state the correct make and model of recorder.

TAPE RECORDER AND HI-FI SERVICE CENTRE

For service on all leading brand tape recorders and HI-FI equipment — come to the experts. Truscott's modern service centre uses only the finest servicing tools backed up by fully trained professional technicians.

SPEAKER ENCLOSURE PADDING

Truscott's are the leading South Australian stockists of Innerbond and Bonded Courtelle. Ensure dust-free padding for your speaker enclosure. Send for a T.M.Q.

STEREO HEADPHONES



ELEGA
DR-65C

Truscott's carry all the leading brand top quality stereo headphones, including Elega, Akai, Sony, Sennheiser, Sansul, Astidavox, Foster, etc. Send for details and a T.M.Q.

SENNHEISER DYNAMIC MICROPHONES



SENNHEISER
MD421

This attractively styled Dynamic Microphone Model MD421 has been designed to meet the requirements of professional installations, which require low-priced directional studio microphones. A full range of famous Sennheiser studio microphones for amateur or professional use is available at Truscott's. Send now for specifications and a T.M.Q.

220S MULTIMETERS

D.C. Volts 5, 25, 125, 500, 2500.
A.C. Volts 10, 50, 250, 1000.
Current: 0-250 μ A, 0.250 mA.
Resistance: 0-10K, 0.1 MEG.
Truscott's price only \$7.95.

SAVE YOUR RECORDS... USE THE UNIVERSAL LUSTRE TONE ARM LIFT



LUSTRE SA-202

This beautifully finished and functional universal tone arm lift will fit all tone arms — the lowering action is pneumatically damped and extremely smooth — risk of record damage may now be eliminated — Truscott's price only \$8.50.

TAPE RECORDERS & DECKS



Tesla — Akai —
— Sony — National —
— Thorn Atlas —
Julliercord — BSR —
— Toshiba —
— Sanyo — AIWA —
Philips — Grundig —
TESLA Tandberg —
B45 Gelosco.

CAR RADIO SPECIAL "SOUNDMASTER 8"



The new super sensitive push-button all transistor car radio, featuring 8 trans. — 3W output — push-button tuning — built-in noise suppression — high quality speaker — suit any model car — Truscott's price only \$55.00. If aerial required add \$4.00.

ACOUSTIC SPEAKER GRILLE CLOTH

Truscott's now carry over 50 top grade cloths to select from. Send now for samples and a T.M.Q.

P.E. TURNTABLES

Model P.E. 34. Limited stocks available of this very popular German HI-FI transcription turntable. Send now for details, and a very attractive T.M.Q. All other model P.E. turntables stocked.

PHILIPS 82 DICTATION MACHINES

Limited stocks available of this very efficient dictation machine — complete with all accessories. Send now for details and a T.M.Q.

AKAI TAPE RECORDERS

All latest models in stock — XV, 1710, M9, 1800, X360, 4000D, X150D. Prices slashed to an all-time low. Send now for a T.M.Q.

TRUSCOTT'S HI-FI COMBINATIONS

Select your HI-FI equipment from our vast range and send for a Truscott combination price — the lowest in Australia.



TRUSCOTT ELECTRONICS

AUSTRALIA'S GREATEST TAPE RECORDER & HI-FI CENTRE

62-64 HINDMARSH SQ. ADELAIDE, 5000 Phone: 233024 233278

Still, I'm one of those hard-to-convince people, particularly where money might be involved!

BUZZPHRASES: Having just pointed the finger at a paragraph which, to say the least, contains a curious collection of terms, one must admit that whoever wrote it is a mere beginner when it comes to compiling technical sounding jargon. You will know what I mean when you read a quote from "Electronics Weekly," in a section entitled "Talkback" ascribed to one who uses the pseudonym "Janus."

"Many of my readers will be familiar with the Honeywell Buzzword Generator, an ingenious card which enables anyone to construct highly technical - sounding phrases without having any idea what they are talking about.

"Now the company have come with a second - generation model — the Honeywell Computers Buzzphrase Generator.

"Master this, and you can construct whole sentences and paragraphs. In fact, with a certain amount of patience you could probably write a complete thesis, and perhaps even get a Ph.D for it.

"It works on much the same principle as the Buzzword Generator, but with four columns of phrases rather than words. These can be put together in a great number of permutations to create statements of seemingly high intelligence.

"Using the kit, say Honeywell, anyone who can count to 10 can write up to 40,000 discrete, well-balanced grammatically correct sentences packed with state of the art terminology.

"For example, the top line of the four columns makes the sentence: 'In particular, a large portion of the interface co-ordination communication must utilise and be functionally interwoven with the sophistication hardware.' Try it backwards, as well.

"With 40,000 combinations to choose from, I will resist the temptation to give more examples. But I leave you with this thought:

"Any discrete configuration made presents extremely interesting challenges to the independent functional principle in respect to specific goals."

HERTZ: I had thought that the skirmishing about Hertz and cycles per second had finished but one valiant soul is still keen to join battle:

"Sir,
"While listening to a Voice of America moon-shot broadcast, I was pleased to hear them announce their various transmission frequencies IN KILOCYCLES PER SECOND. This

CIRCUIT THEORY COLLOQUIUM

A Circuit Theory Colloquium on Filter and Integrated Circuit Design will be held at the School of Electrical Engineering, the University of N.S.W. on Thursday, September 25, 1969.

Sponsored jointly by the University, the Institution of Engineers, Australia, and the Institution of Radio and Electronics Engineers, Australia, the colloquium is intended to provide a means whereby contact between universities and Industry can be strengthened, education can be supplemented and whereby non-specialists can gain an appreciation of the broad problems encountered in the area under discussion.

It is anticipated that 10-12 papers will be presented by invited authors.

Further information may be obtained from Mr K. G. Knight, General Secretary I.R.E.E. Aust., Box 3120 G.P.O., Sydney, 2001.

demonstrates conclusively that the trade has not accepted the foolish and unnecessary change to KHz. I suggest that 'Electronics Australia' might well abandon its futile effort to promote this unwanted change and revert to the well established cps. Without doubt, radio men still THINK in cps for, no matter what abbreviation is used, this is the unit they are interested in, and the time and mental effort necessary to convert every KHz to the wanted unit is both frustrating and distracting.

"The intrusion of the unwanted KHz has destroyed much of the pleasure of reading technical articles, and I frequently find myself so distracted as to abandon an article out of sheer disgust. Whatever excuses may be made for introducing the change it has certainly done a disservice to the industry, is illogical, out of line with the concept, and rightly rejected by those on whom it is being inflicted.

"If for no other reason, Electronics Australia' might well lead the world in a change back to cps and receive the unstinted approbation of its readers."
(L.S., Auckland, N.Z.)

Rather than argue at a superficial level, I can do no better than refer L.S. to the excellent article written by his compatriot L. S. Spackman, and reproduced on page 84 of our December 1968 issue.

It would be funny, you know, if the NASA boys were technically wrong!

ALWAYS RELY ON R.D.S.

SPECIALS

**R
D
S**

Matched prs., AC127/
128 trans., \$1.20 nett.

200V pl diodes at
500MA, 25c each nett

EMG 1065 conds. 1000
mfd at 50V, 80c each
nett.

PVD 103. 100MA V.D.
transformers. \$10.00
each nett.

PF1229 trans. 340/340 1500MA
\$5.00 each nett.

Pkts. mixed resistors and pots.
Great value. \$1.00 nett.

Compax transcription turntable,
\$39.50 nett.

The Independent Wholesaler

RADIO DESPATCH SERVICE

Radio and Electrical Distributors

869 GEORGE STREET,
SYDNEY.

Corner George and Harris Streets
Telephone 211-0816, 211-0191

Open Saturday mornings

SERVICE

BILL TURNBULL offers you service on Hi Fidelity equipment tape Recorders, Communication Receivers and Electronic Test Equipment.

25 years experience
All work guaranteed

BILL TURNBULL

11 ELLALONG ROAD,
CREMORNE, N.S.W. 90 4825

SO YOU WANT TO . . .

ORGAN-ise some lights?
Install a HUE-fi system?
Set up a PSYCHO-delicatessen?
Greet Christmas with jingle-BULBS?

BUT SERIOUSLY . . .

The new **ELECTRONICS** Australia "Musicolour" unit should meet the many requests for devices which have so often been mis-called colour organs. It splits an audio signal into three frequency bands and uses the signals to control up to 1,000 watts of coloured lighting per band. It can be added as a gimmick to a hi-fi system or organ, developed as a stage feature by pop groups, or used to create the most novel Christmas decorations in your district.

FULL DESCRIPTION IN NEXT MONTH'S ISSUE.

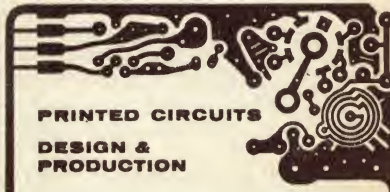

**PRINTED CIRCUITS
DESIGN &
PRODUCTION**

WE MANUFACTURE P.C. TO MEET THE HIGHEST STANDARDS OF QUALITY. SPECIALIZE IN LAYOUT, ARTWORK, ALL TYPES OF PRINTED CIRCUITS, COBING AND SPECIAL FINISHES.

PHOTRONIC Tel. 937664

515 PITTSWATER ROAD, P.O. BOX 195, BROOKVALE, N.S.W. 2100

These RCA Triacs will turn you on

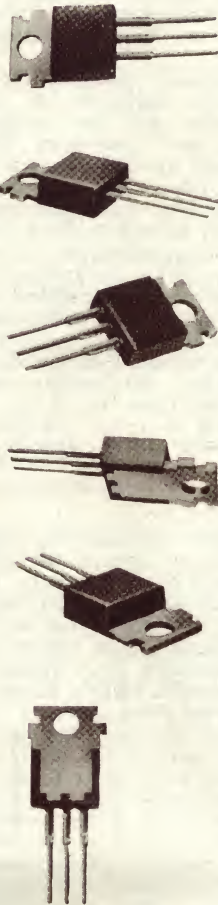

Choose New RCA 8 Amp Triacs for On-Off or Variable Phase Control of Power Into Resistive or Inductive Loads

Now's the time to think in terms of more than electro-mechanical controls and turn on with Triacs! Not just any triac — but the new RCA-40668 and RCA-40669. Both feature the unique RCA hermetic chip in the popular, easy-to-mount RCA "plastic TO-66" package.

Use the RCA-40668 for 120 V per 1-kW capability, the RCA-40669 for 240 V per 2 kW. With either, look what you get:

- Commutating dv/dt capability of 10 V per μs (typ.) permits opera-

tion into inductive loads.

- Critical rate of rise of off-state voltage — 300 V per μs (typ.) for 40668 and 250 V per μs (typ.) for 40669 — minimizes false triggering caused by line transients.

- 85 A single-cycle in-rush current capability handles start-up surge loads readily.

- 8 A (RMS) capability at a case temperature of 80°C.

- 4 modes of gate control allow design flexibility and simplicity with either positive or negative DC logic.

For relay replacement, relay protection, motor speed controls and the like — in switching or phase control applications — for use in such devices as comfort control systems, vending machines, appliances — turn to and turn on with RCA Triacs.

For technical details on these and all RCA Triacs write to Amalgamated Wireless Valve Co. Pty. Ltd., Private Mail Bag, P.O. Ermington 2115 or Interstate Offices and Distributors.



AMALGAMATED WIRELESS VALVE CO PTY LTD

Fundamentals of SOLID STATE



Chapter 5

by Jamieson Rowe

Diodes and semiconductor materials — reverse bias current — temperature effects — forward bias characteristics — high temperature operation — power rating — surge current rating — reverse breakdown — peak inverse voltage rating — switching speed — package capacitance — junction capacitance — charge storage — diode applications.

The basic P-N junction, whose behaviour was described in the preceding chapter, effectively forms the functional "heart" of almost every type of semiconductor diode. However, as the reader may already be aware, practical semiconductor diodes are encountered with widely differing electrical ratings. They are also found in circuits performing a variety of rather different tasks, and seen in an almost bewildering array of different physical forms.

In order to provide the reader with a satisfying explanation of these wide divergences between practical semiconductor diodes, it is necessary to expand the concepts of basic P-N junction operation already developed, and this will be attempted in the present chapter and in that which follows it. The present chapter will deal with what may be called "orthodox" diodes — that is, those devices which are designed to take advantage mainly of the unidirectional conduction properties of the P-N junction. Such diodes include those commonly encountered in circuits performing rectification, signal detection, mixing, switching, gating and clipping.

Chapter six will deal in turn with those diode devices which are designed to take advantage of aspects of P-N junction behaviour other than that of unidirectional conduction. Examples of this type of device are diodes used as voltage regulators and coupling elements, variable capacitors, oscillators and amplifiers, light detectors and energy converters.

Perhaps the first thing to be noted regarding practical semiconductor diodes is that, as one might perhaps expect, they are made from a number of different semiconductors. A very large majority of diodes in use at the present time are made from either germanium or silicon; the latter having been used to a lesser extent in the early days of semiconductor technology because of manufacturing difficulties, but now used very extensively and possibly to a greater extent than germanium. Other semiconductor materials which are becoming used for diodes include gallium arsenide, gallium phosphide and gallium antimonide.

The electrical behaviour and the ratings of a diode are both influenced significantly by the semiconductor material from which it is made. As we shall see, the semiconductor concerned plays a significant part, along with the doping level, in determining the voltage-current characteristics of a diode for both forward and reverse bias. It also determines the extent to which this behaviour varies with temperature, and the power which the

0.72eV (electron-volts), while silicon has a somewhat larger gap width of 1.11eV. The compound semiconductor gallium arsenide has a gap width which is even larger again at 1.39eV.

The width of the forbidden energy gap was shown earlier to control the conductivity of intrinsic semiconductor material, by determining the excitation energy required for electrons to be transferred to the conduction band. From this, and knowing that the generation of minority carriers in an impurity semiconductor material takes place by the same "intrinsic" mechanism, it should be fairly clear that the gap width also determines the number of minority carriers generated in an impurity semiconductor at any given excitation and doping level.

However, it is also true that the width of the energy gap controls, in a minor, but inverse manner, the rela-

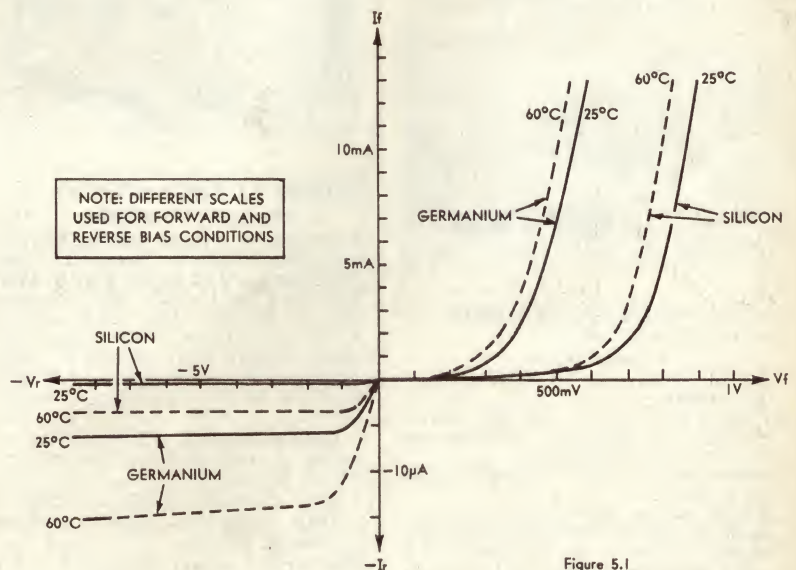

Figure 5.1

device is capable of dissipating before this behaviour is permanently altered.

As we saw in chapter 2, all crystalline semiconductors are alike in the sense that, in the ground state, they behave as electrical insulators. The valence electron energy band is completely filled, while the empty conduction band is isolated from it by the "forbidden energy" gap. From an electrical viewpoint the essential differences between the various semiconductors arise mainly because this forbidden energy gap has a different width in each case.

Germanium, it may be remembered, has a forbidden energy gap width of

relationship between minority carrier level and excitation level. Thus, although material with a wide energy gap tends initially to have a smaller number of minority carriers than material with a narrower gap, for the same excitation, its minority carrier population tends to multiply slightly more rapidly with increasing excitation.

Hence, while silicon impurity semiconductor material tends to have a considerably smaller minority carrier population than germanium material, at room temperatures, it also exhibits a slightly increased tendency for this population to grow as the temperature is increased. Despite this the minority carrier population of typical silicon

Sinclair products for the electronic constructor—

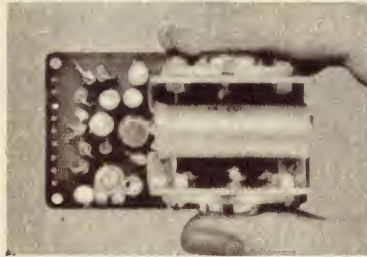

Z.12 INTEGRATED 12-WATT HIGH FIDELITY AMPLIFIER

Technical specification

Output: Class B, ultra-linear, with generous negative feed-back.
 Output Power: 12 watts R.M.S. continuous sine wave (24 watts peak); 15 watts R.M.S. music power (30 watts peak).
 Frequency Response: 15 to 50,000 c/s, ± 1 dB.
 Input Sensitivity: 2 mV K Ω .
 Signal to Noise Ratio: Better than 60dB.
 Output Impedance: Suitable for 3, 7.5 and 15 ohm loudspeakers. Two 3 ohm speakers may be used in parallel.
 Power Requirements: 6 to 20 volts D.C. or Sinclair PZ.4 Mains Power Supply Unit.
 Quiescent Current Consumption: 15mA.
 Size: 3in x 1½in x 1½in (7.6 x 4.45 x 3.2cm).
 Weight: 3oz (85gm).
 Ready Built and Tested with Manual, \$13.60, plus sales tax.
Z12 Power Supply, Ready Built, \$13.60, plus sales tax.

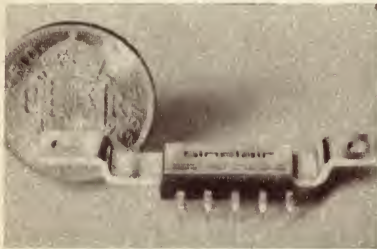

IC.10 INTEGRATED CIRCUIT 10-WATT AMPLIFIER

Specifications

Output: Class AB. 10 watts peak, 5 watts RMS.
 Frequency response: 5Hz to 100kHz ± 1 dB. Total harmonic distortion less than 1% at full output.
 Power gain: 110dB (100,000,000,000 times) total.
 Supply voltage: 8-18 volts.
 Sensitivity: 5mV. Input impedance adjustable externally up to 2.5m Ω for above sensitivity. Size: 1in x 0.4in x 0.2in.
 Circuitry: 3 transistors in pre-amp; 10 (including two power output) in power amplifier. Both sections are d.c. coupled, and a high level of negative feedback is applied over all. With a transistor cut-off greater than 500mHz, the pre-amp can be used as an RF or IF transformer and the whole IC.10 used as a radio receiver without the need to add further transistors.
 Price, including application manual, \$9, plus sales tax.

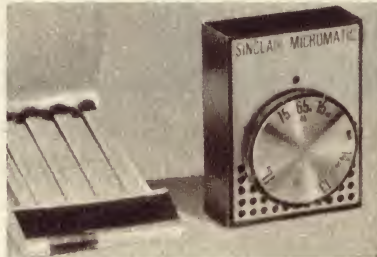

MICROMATIC WORLD'S SMALLEST RADIO

Technical specification

Size: 1 13-16in x 1 7-16in x ½in (46 x 33 x 13mm).
 Weight including batteries: 1oz (28.35 gms) approx.
 Transistors: High gain silicon types.
 Circuit: Five stage reflex.
 Aerial: Self-contained ferrite rod.
 Earpiece: High-fidelity magnetic type for best possible quality.
 Battery requirements: Two Mallory Mercury Cells, type RM 675, giving extra long working life.
 Complete Kit with Instructions. \$7 plus sales tax.



STEREO 25 PRE-AMPLIFIER

Technical specification

Performance figures obtained from using the Sinclair Stereo 25, two Z.12's and a Z12 Power Supply Unit.
 Sensitivity for 10 watts into 1.5 ohms load per channel. Mic.: 2mV into 50 K ohms. Pick up: 3 mV into 50 K ohms. Radio: 20 mV into 10 K ohms.
 Frequency Response (Mic. and Radio): 25 c/s to 30 kc/s ± 1 dB extending to 100 kc/s ± 3 dB.
 Equalisation for P.U.: Correct to within ± 1 dB on RIAA curve from 50 c/s to 20 kc/s.
 Tone Controls: Treble + 12dB to -10dB at 10 kc/s. Bass +15dB to -12dB at 100 c/s.
 Size: 6½in x 2½in x 2½in (14.5 x 6.3 x 6.3cm) overall, plus knobs.
 Finish: Front panel in brushed and polished solid aluminium with solid aluminium knobs. Black figuring on front panel.
 Ready Built and Tested with Manual, \$29.80, plus sales tax.

STOP PRESS

IC10 STOCKS DUE IN SEPTEMBER

Sole Australian Agents:

CENTRAL IMPORTS PTY. LTD.
 196 ADELAIDE TERRACE, PERTH, W.A.
 PHONE 23-5103

Victorian Agents:
 Charmac Pty. Ltd.,
 P.O. Box 95,
 Eltham
 Victoria. 3095.
 Phone 439-9415

N.S.W. Agent:
 Allan Electronics Pty. Ltd.,
 Suite 28,
 280 Pitt St.,
 Sydney, N.S.W. 2000.
 Phone 61-7562



Q.14 HIGH FIDELITY LOUDSPEAKER

New Design Principles New Materials

Construction: The seamless sound, or pressure chamber and mounting baffle are of special high-density ultra-low resonance materials made possible by modern bonding and processing techniques to ensure freedom from spurious coloration.

Loading: The Sinclair Q.14 has in input impedance of 8 ohms and will comfortably accept loading in excess of 14 watts, far greater than that required for average listening requirements.

Frequency response: As the independently made test curve shows, remarkably smooth response is maintained between 60 and 15,000 Hz.

Driver unit: This is a specially designed unit having exceptionally high compliance due to the method of cone suspension employed. It has a massive ceramic magnet of 11,000 gauss and aluminium speech coil, with the cone treated to ensure a brilliant transient response.

Contoured pressure chamber: The shape of the sealed chamber has been determined mathematically to ensure forward sounding presence and freedom from directional effect. Connections at rear are marked for correct phasing.

Size and styling: The Sinclair Q.14 measures 9½in square on its front face by 4½in deep from front to back. A separate base for free standing position is provided as well as a template for wall or flush mounting. A neat solid aluminium bar inset is used to embellish the front.

Price \$29.80, plus sales tax.

R.T.C. Recording Tapes

High quality British product. Send for price list. All reel sizes available. In single, long, double and triple play.

OTHER SINCLAIR PRODUCTS

Z20 P.W.M. 20 watt amplifier and pre-amp Built and Tested, \$20.00, plus sales tax.

Z20 Power Supply 32 or 36 volt 1.5 amp, \$12.60, plus sales tax.

material does not even approach that of germanium until very high temperatures are reached, both because germanium has a larger initial population, and because this population itself increases significantly with temperature.

What effect do these differences have on the behaviour of practical P-N diodes? They have a significant effect upon the reverse-bias saturation currents, because it may be recalled that these currents are directly proportional to the minority carrier populations on either side of the junction.

In short, diodes made from a semiconductor material having a relatively

bias currents of something like 100 times this figure, i.e., a few tens of μA (microamps). Because of the influence of excitation upon minority carrier generation these figures both increase as the temperature is raised, the silicon device current increasing slightly more rapidly.

Typically the reverse bias current of a germanium diode approximately doubles for every 8°C rise in temperature, while that of a silicon diode approximately doubles for every 5°C rise.

An illustration of the reverse-bias aspect of diode performance is pro-

junction made from the material will be relatively large under equilibrium conditions, compared with that across a junction made from a semiconductor having a relatively narrow energy gap. In turn this will mean that a relatively high external forward bias will be required before the internal barrier is surmounted.

Hence, because of the wider energy gap of silicon, a diode made from this material tends to require a higher applied forward bias than a comparable germanium diode for the same total forward conduction current. This is illustrated by the right-hand portion

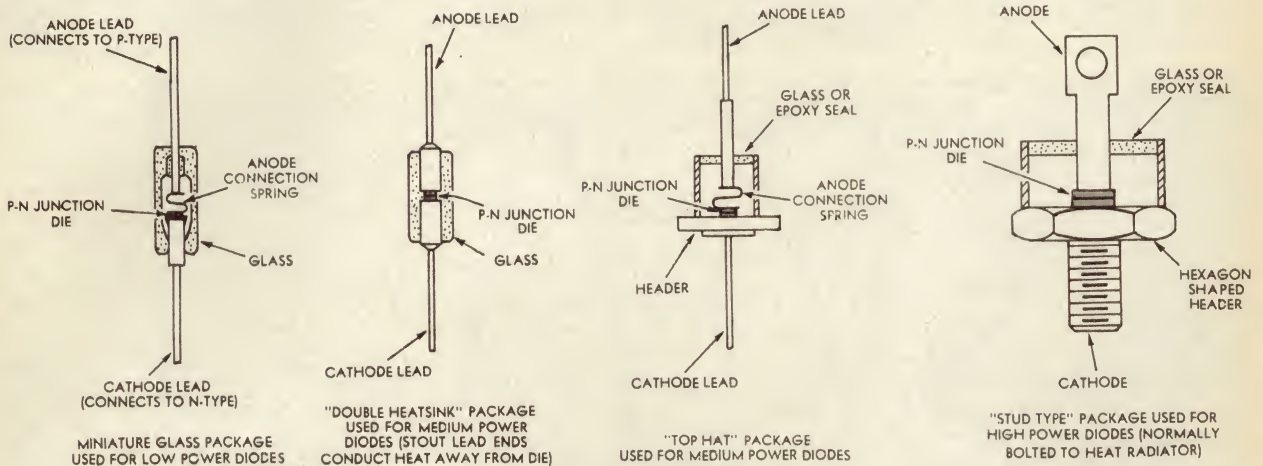

Figure 5.2

wide forbidden energy gap, such as silicon or gallium arsenide, tend to have a very low reverse bias saturation current at normal temperatures. In comparison diodes made from a semiconductor material such as germanium, which has a relatively narrow energy gap, tend to have a somewhat larger saturation current at the same temperature. This despite the fact that in the former case the saturation current will tend to increase slightly more rapidly with temperature.

It is true that the total reverse bias current drawn by a practical semiconductor diode is not composed of the minority carrier saturation currents alone. It is very difficult, during the manufacture of practical diodes, to ensure that the surface of the semiconductor crystal element or "die" does not become contaminated in some way, and such contamination tends to result in additional reverse bias currents, which are commonly referred to as leakage currents.

Early in the history of semiconductor device development, these leakage currents were typically of the same order of magnitude as the saturation currents. However, in recent years, manufacturing techniques have been considerably improved, and leakage currents can typically be held to a very small fraction of the saturation currents. Hence, with modern semiconductor diodes and other devices, the reverse bias current drawn by an independent P-N junction is almost entirely composed of the minority carrier saturation currents.

In quantitative terms, the total reverse bias current of a typical modern silicon diode is of the order of a few hundred nA (nanoamps), at room temperature. Comparable germanium diodes typically have reverse

biased by the left-hand portion of figure 5.1, which shows the reverse-bias currents of typical silicon and germanium diodes compared at room temperature (25°C) and at 60°C. It may be seen that at both temperatures the silicon diode has a considerably lower saturation current, even though the proportional increase may be larger over the temperature range concerned.

From the foregoing one might be tempted to infer that, because silicon diodes have lower reverse bias currents than germanium diodes under similar conditions, they would consequently be preferable for any application requiring a device whose performance should approach that of an "ideal" unidirectional conducting element. However, while this is true where reverse bias is concerned, unfortunately the reverse is the case under forward bias conditions. Here it is found that germanium diodes are somewhat closer to the ideal.

The reason for this is that, in addition to its influence upon minority carrier generation, and consequently upon saturation currents, the forbidden energy gap width of a semiconductor also plays an important part in determining the magnitude of the "inbuilt" drift field and potential barrier set up across a P-N junction in equilibrium. As a result the gap width also has a controlling influence upon the forward bias characteristic of such a junction, because it may be remembered that the forward bias current consists of excess majority carrier diffusion currents, which develop as the inbuilt potential barrier is surmounted.

For a semiconductor with a relatively wide forbidden energy gap, there will be a large energy difference between the Fermi levels of P-type and N-type material. Because of this, the potential barrier set up across a P-N

of figure 5.1, which shows the forward conduction characteristics of typical silicon and germanium diodes compared as before at 25°C and 60°C. It may be seen that the silicon diode is "harder to turn on" than the germanium device, and also that it has a higher voltage drop when in forward conduction.

It should be noted that both types of device "turn on" at a lower voltage, and have a lower conducting voltage drop, at the elevated temperature. The reason for this should become clear if it is recalled that the Fermi level of an impurity semiconductor moves toward the forbidden energy gap midpoint with increasing excitation, due to the increase in minority carriers. This means that the energy difference between the Fermi levels of the P-type and N-type materials becomes less as the temperature is raised, and accordingly the junction barrier potential also decreases. Forward conduction thus takes place at a lower applied voltage.

At this stage it should be fairly clear that when both forward and reverse characteristics are considered, neither silicon nor germanium diodes have a clear advantage. The silicon diode tends to have a somewhat lower reverse bias current, and therefore, more closely approximates the "ideal" diode in the reverse bias condition, but the germanium diode has a lower forward bias voltage requirement and thus represents the closer approximation to the ideal in the forward bias condition.

In terms of characteristics, then, the choice of the semiconductor material from which a diode is made depends largely upon the ultimate application and its requirements. If the application is one in which low reverse bias current is necessary or desirable, then a diode

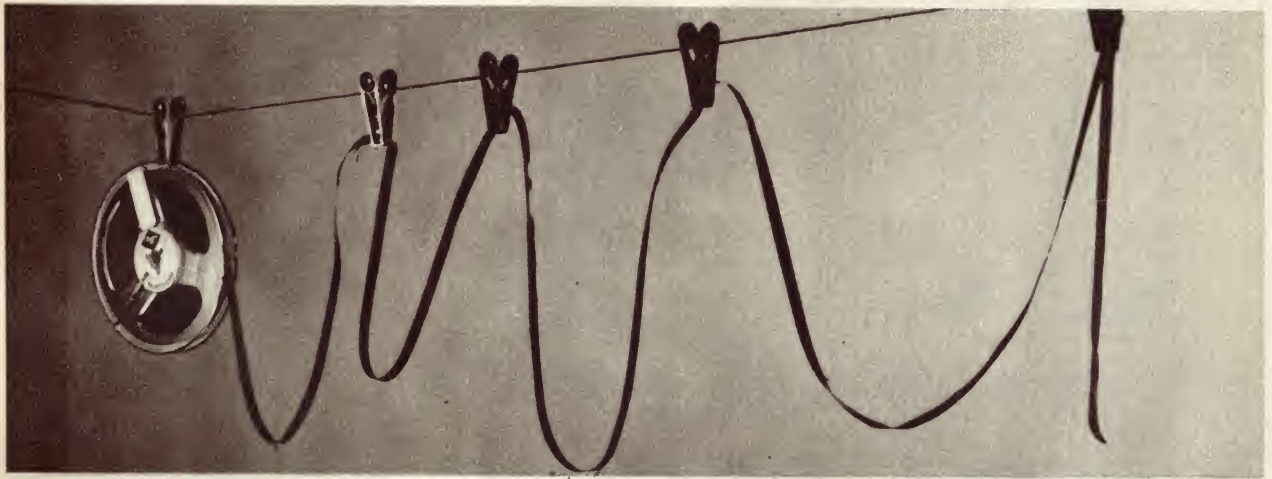

COOK IT! COOL IT! HANG IT OUT TO DRY!

Agfa PE tapes came through unharmed! These torture tests show that Agfa PE (Polyester) tapes last longer, wear better!

AGFA PE TAPES HAVE BEEN PRE-STRESSED TWICE!
Stretched until there's no stretch left . . . both ways; length and breadth.
AGFA PE TAPES have distortion free recording and playback. No surface hiss when recording is played back, even at full volume.
All these features add up to the toughest, most perfect magnetic recording tape.

Write for the free leaflet on Agfa recording tapes and accessories.
To
AGFA-GEVAERT LIMITED
P.O. Box 48, Nunawading, Victoria. 3131

NAME

ADDRESS

STATE POSTCODE



the toughest



PE RECORDING TAPE

AGFA-GEVAERT LIMITED
MELBOURNE • SYDNEY • BRISBANE • ADELAIDE • PERTH

*Registered trademark AGFA-GEVAERT Antwerp/Leverkusen.

made from a wide energy-gap material such as silicon or gallium arsenide would be most appropriate.

Conversely if the prime requirement of the application concerned is for turn-on at a low voltage and minimum forward voltage drop in conduction, then the choice would favour a diode made from a narrow energy-gap semiconductor such as germanium. It is true that if either both forward and reverse bias behaviour were critical, or both were not unduly critical, the choice would be less straightforward. In such cases the decision might well be made on the basis of other factors, one of which would probably be operating temperature capability.

Generally a diode made from a semiconductor having a wide energy gap is more suitable for high temperature operation than a diode made from a semiconductor having a narrow energy gap. This is partly because of the somewhat lower reverse bias current at higher temperatures. However, a further reason is that the energy gap of a semiconductor plays a part in determining both the temperature at which the electrical structure of the device begins to alter permanently, due to thermal diffusion of the actual impurity atoms and ions, and also the crystal melting point. The wider the energy gap, the higher these temperatures tend to occur.

In practice the manufacturer of a semiconductor diode or other device usually rates his product in terms of the maximum allowable junction temperature. This is done in order to take into account the fact that both the ambient temperature and the power dissipated by the device contribute to its internal operating temperature.

Typically, germanium devices are given a maximum junction temperature rating of around 80-90°C, while silicon devices are usually given a somewhat higher rating of between 150-180°C. A silicon device would, therefore, be the logical choice for most applications involving high temperatures and/or very high power dissipation.

In order to allow the user to ensure that a device is operated within its maximum junction temperature rating at all ambient temperatures, the manufacturer must also normally provide information regarding the typical temperature rise of the device junction(s) with power dissipation. This information is usually given in terms of the thermal resistance of the device, expressed in units of (degrees C/watt dissipation).

Naturally the thermal resistance of a particular device depends upon both the size of the semiconductor crystal die itself, and the physical "package" in which it is mounted. Hence a device intended for very low power applications may have a very small die and be mounted in a small glass or plastic package having a fairly high thermal resistance, while a device for high power use will normally have a relatively large die and will be mounted in a large metal package of low thermal resistance.

In addition to thermal resistance, a crystal die and its package also possess thermal "capacitance" or inertia. Because of this, heating and cooling of the device involve definite thermal time-constants. Hence the heating of the

die tends to be proportional not to the instantaneous power dissipation, but to the average dissipation taken over a short time interval — the interval length depending upon the crystal die itself, and on the package and its thermal time-constant.

As a result of this averaging effect, a diode is typically able to withstand short bursts or "surges" of power dissipation which may be considerably higher than its continuous or "steady-state" dissipation rating. This short-term capability is often expressed in terms of the forward conduction surge current rating of the device, which may be given a number of values for different time periods.

Depending upon the device itself and also upon the time period for which a surge rating is given, it may represent

con type are made available are further subdivided into many individual device types differing from one another mainly in terms of two other important parameters. These are the reverse breakdown characteristic, and the switching speed, each of which will now be briefly discussed.

It may be remembered that if the reverse bias voltage applied to a P-N junction is increased, a point is eventually reached where the junction current rises rapidly from its low saturation value, and the junction is then said to have entered "breakdown." One of two main mechanisms is usually responsible for this behaviour, one being called field emission or Zener breakdown, and the other avalanche breakdown.

As was explained in the preceding

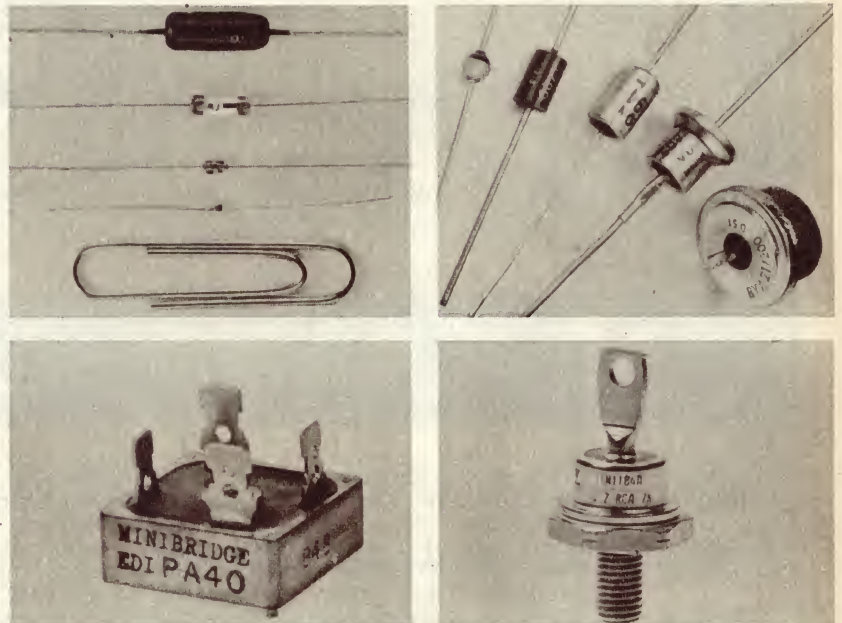

Figure 5.3. Typical semiconductor diodes. At upper left are various low-power or "signal" diodes, compared in size with a common paper clip. At upper right are four medium-power diodes as used in many receiver and amplifier power supplies, together with a power diode used in the rectifier within an automotive alternator. At lower left is an assembly containing four high-power silicon diodes, connected for bridge rectification. At lower right is a single stud-mounting high power silicon diode capable of handling an average current of 40 amps. All devices are shown approximately normal size.

from about five times to more than 50 times the forward current corresponding to the continuous power rating of the device. The shorter the time involved, naturally enough, the higher tends to be the figure; however devices may be produced with the ability to withstand quite long surges of high amplitude, by appropriate thermal design.

Further discussion of thermal considerations will be given in a later chapter. However, from the foregoing it should be apparent that power dissipation requirements provide at least a partial explanation for the variety of packages in which semiconductor devices are found. Figures 5.2 and 5.3 show the basic construction of some of the diode packages in common use.

In general each of the various sizes and packages in which "orthodox" diodes of both the germanium and sili-

chapter, the phenomenon of junction reverse breakdown does not involve inherent damage. However, it does constitute a potentially high-dissipation mode of operation, because under breakdown conditions a junction tends to maintain a relatively large voltage drop while at the same time being capable of heavy conduction.

It is also true that with practical P-N junctions, in diodes and other semiconductor devices, breakdown tends to occur unevenly and in a localised manner at some specific point on the crystal die. As a result, the increased current which flows is concentrated in a small area, and localised overheating and damage can occur with great rapidity at power levels considerably lower than the forward conduction continuous power rating of the device.

By exercising extreme control over

the birth of an AR^{INC.} speaker

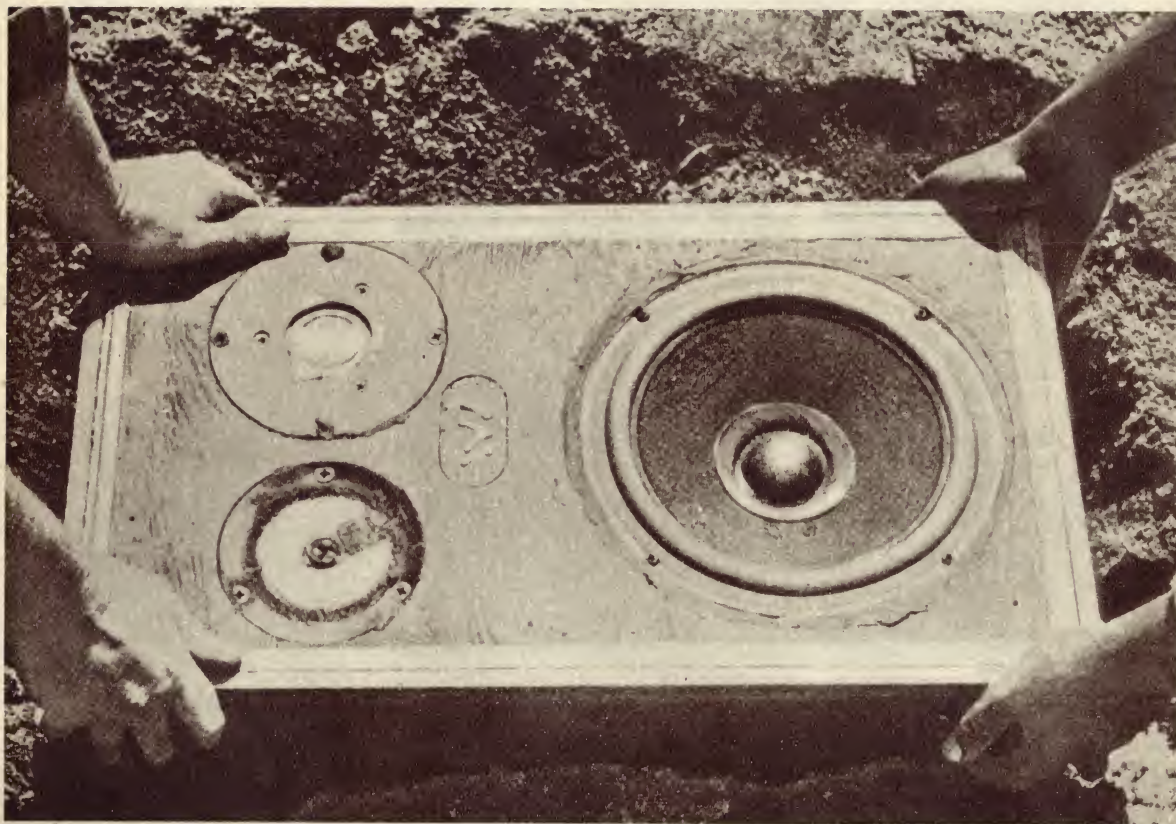

This is a photograph taken immediately after the final testing of the prototype of an AR Speaker. The system is measured buried face upward in a flat, open field, a technique more accurate than indoor tests, where precision is adversely affected by the limited size of an anechoic chamber. The criterion of accuracy when measuring the AR prototype is the sound of live music, that is, absolute accuracy of reproduction. And every AR Speaker matches the accuracy of the prototype to the closest tolerances. Many times the AR Speakers are tested by independent bodies and most favourably reviewed, but even more comprehensive tests are carried out by AR themselves on every Speaker that will go into a listener's home. Only in this way can they be certain of what they have made, and consumers certain of what they are being offered.

Because of their confidence in the quality of their equipment, AR offer a unique guarantee of five years' free service, parts, two-way freight and packaging on every AR Speaker sold.

American-developed AR Speakers are now available in Australia. We are the first and only distributors and are proud to uphold the AR guarantee, and to place the facilities of our fully equipped service department at your disposal. Come in and hear at one of the dealers listed below the results of exhaustive AR testing—hear the true high fidelity reproduction of our range of AR Speakers.

First and only Australian distributors:

W.C.Wedderspoon Pty.Ltd.

Now also available from:

N.S.W.:
Stereo Music System,
193 Clarence Street, Sydney.
Edels Pty. Ltd.,
88 King Street, Sydney.

Kent Hi-Fi,
432 Kent Street, Sydney.
Glen-dor Camera Centre,
43 The Corso, Manly.

QLD.:
Tel-Air Sales Pty. Ltd.,
19 Adelaide Street, Brisbane.

Retail distributors wanted Perth, Adelaide and Melbourne.

cleanliness and such factors as doping uniformity during the various fabrication processes, device manufacturers have recently been able to effect a considerable reduction in this tendency for localised breakdown. However, the "transient protected" devices which have resulted from this effort are necessarily more costly than devices fabricated under less stringent conditions; and, of course, such devices still enter breakdown eventually, albeit in a uniform and evenly distributed manner.

Junction breakdown thus represents a condition which at the very least involves potential device damage. It should also be evident that quite apart from this, the rise in reverse current, which tends to occur at breakdown, represents in itself a significant departure from the ideal diode characteristic.

For a practical diode, therefore, the reverse breakdown characteristic is of considerable importance. It must be considered not only with relevance to the protection of the device itself, but also because of its possible conse-

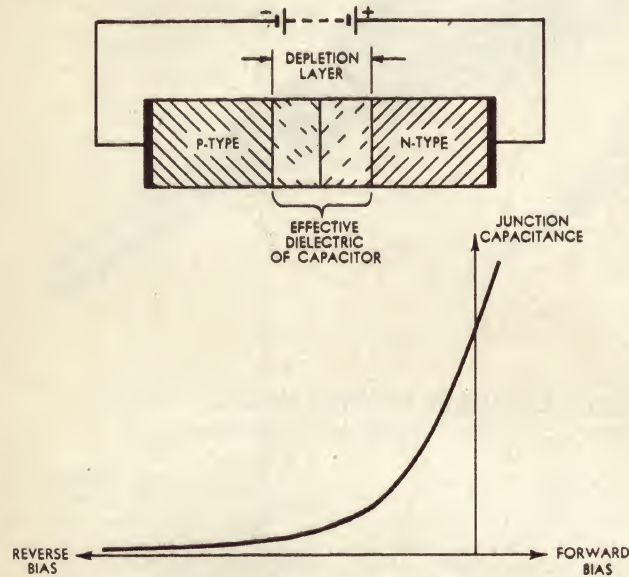

Figure 5.4

quences in the circuitry into which the device is connected.

Usually the reverse breakdown characteristic of a semiconductor diode is specified in terms of a peak inverse voltage or "PIV" rating, which in effect represents a specific value of reverse bias voltage at or below which no device of the type concerned should enter breakdown. Some types of device may be given a number of different PIV ratings, to cover both steady-state and various reverse transient conditions. The "transient protected" diodes mentioned earlier are examples of devices normally given such multiple ratings.

Both silicon and germanium diodes may be manufactured to exhibit a wide range of breakdown voltages. However, devices required to have a very high breakdown voltage rating are usually made from silicon or some other semiconductor having a similarly wide energy gap. This is because the relatively high reverse saturation current of a narrow-gap semiconductor such as germanium tends to make it very difficult to delay the onset of avalanche breakdown.

Germanium diodes are typically available with PIV ratings ranging from less than a volt to about 150V. Silicon diodes are available with PIV ratings ranging from about 3V to more than 1500V. Still higher PIV ratings can be produced by connecting a number of individual silicon dice in series; devices with PIV ratings in excess of 50KV have been produced using this technique.

As noted earlier, a further important general parameter of practical semiconductor diode behaviour is switching speed. This basically describes the ability, or otherwise, of a device to rapidly follow any changes in external circuit conditions. As diodes are often found in circuits involving rapid reversal of the bias voltages applied to the device,

ponent of the total shunt capacitance is provided by the inherent capacitance of the diode P-N junction itself. This capacitance is known as the "depletion layer capacitance," "barrier capacitance," "space charge capacitance," "junction capacitance," or "transition capacitance."

Although it may seem surprising at first that the P-N junction itself acts as a capacitor, the reason for this should become evident after a moment's consideration. Essentially, a capacitor consists of two conductors separated by a dielectric, and in the P-N junction we have, after all, two quite high conductivity semiconductor regions separated by a low conductivity depletion layer region. The latter is largely devoid of carriers, yet provided with the facil-

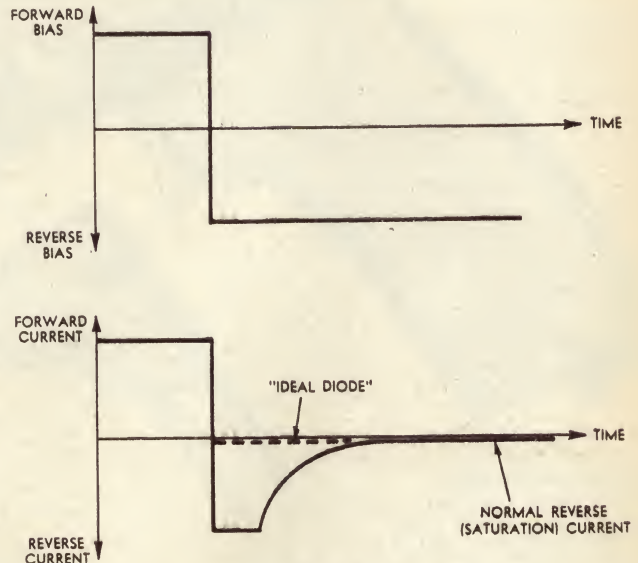

Figure 5.5

ity for charge storage in the form of ionised impurity atoms; small wonder, therefore, that it acts as a very effective dielectric.

Of course the width of the depletion layer varies with applied voltage, as we have seen. Under equilibrium conditions, with zero applied bias, it has a width determined by the semiconductor concerned and by the doping levels. If reverse bias is applied, the depletion layer widens to uncover more impurity ions, and conversely if forward bias is applied it narrows to reduce the number of uncovered ions.

Because of this width variation, the junction capacitance is not static but also varies with applied voltage. This is illustrated in figure 5.4, where it may be seen that the junction capacitance of a typical diode varies inversely with reverse bias voltage, and directly with forward bias voltage.

The junction capacitance of a device may be minimised by using the smallest crystal die capable of handling the required power, and by using low doping levels to result in a relatively wide depletion layer. Naturally the latter technique involves a compromise, as low doping levels also increase the resistivity of the material and hence tend to increase the forward voltage drop and consequently lower efficiency.

As will be discussed in the next chapter, some semiconductor diodes are expressly designed to exhibit a very high junction capacitance. Such diodes are intended not for use as unidirectional

this parameter can be of considerable importance.

One of the main factors determining the switching speed of a diode is its shunt capacitance, which is simply the total effective capacitance present between the two device electrodes. Because it is effectively in parallel with the actual diode element, this capacitance can have a considerable influence upon the overall high-speed performance. For example, it tends to draw a current component which is purely proportional to the rate of change of applied voltage, regardless of polarity; behaviour which fairly obviously represents a significant departure from that of an ideal diode.

Naturally enough the diode package alone will contribute to the total shunt capacitance, as some finite package capacitance is unavoidable with practical devices. However, by careful design manufacturers have been able to produce packages with very low shunt capacitance, and these are normally employed for those devices intended for extremely high speed operation.

Quite apart from the package capacitance, however, an important com-



Wire-Wrap

AIR, ELECTRIC, BATTERY or HAND-POWER
**TOOLS for SOLDERLESS
 WRAPPED CONNECTIONS**



BATTERY-POWERED "WIRE-WRAP" TOOL

No power outlets needed. This battery-powered tool brings new convenience to the production line—new freedom to the serviceman. Battery works through a full day's schedule —recharges overnight.

HAND-SQUEEZE "WIRE-WRAP" TOOL

For convenient servicing or making occasional connections with all the advantages of connections made with powered "Wire-Wrap" tools. Other manual wrapping and unwrapping tools also available.

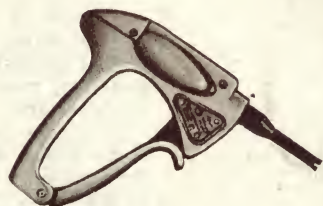

GARDNER-DENVER "WIRE-WRAP" TOOLS MAKE CONNECTIONS IN A HURRY

"Wire-Wrap" tools wrap connections in only three seconds (actual wrapping time .3 second). That's speed that means dollar savings to you—in production, assembly, in the wiring of communications equipment, computers or electrical or electronic assemblies where dependability is equally as important as economy. Because, with "Wire-Wrap" tools, when the connection's made, the connection stays.

WRITE FOR FULL INFORMATION

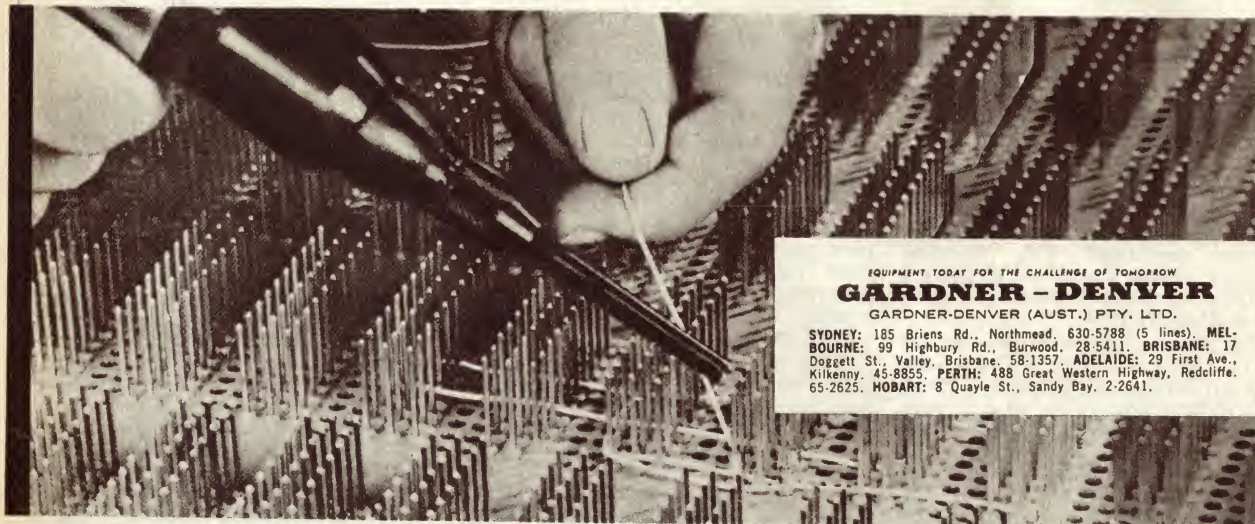

EQUIPMENT TODAY FOR THE CHALLENGE OF TOMORROW

GARDNER - DENVER

GARDNER-DENVER (AUST.) PTY. LTD.

SYDNEY: 185 Briens Rd., Northmead, 630-5788 (5 lines). MEL-
 BOURNE: 99 Highbury Rd., Burwood, 28-5411. BRISBANE: 17
 Doggett St., Valley, Brisbane, 58-1357. ADELAIDE: 29 First Ave.,
 Kilkenny, 45-8855. PERTH: 488 Great Western Highway, Redcliffe,
 65-2625. HOBART: 8 Quayle St., Sandy Bay, 2-2641.

circuit elements, but rather as voltage-controlled variable capacitors.

Yet another important factor which influences the switching speed of a semiconductor diode is the phenomenon known as **charge storage** or **minority carrier storage**. This is particularly relevant where a diode is required to switch rapidly between the forward conducting or "on" state and the reverse-biased "off" state.

When a P-N junction is conducting due to forward bias, it may be remembered, excess majority carrier diffusion currents are flowing in both directions across the junction. At the same time the depletion layer has a width somewhat less than that for equilibrium conditions, and the potential barrier a somewhat lower value.

If the voltage applied to the device is changed, these conditions must also change to achieve a new dynamic balance. Thus if the forward bias is increased, additional carriers must be swept across the junction to set up higher diffusion current levels, while at the same time some of the previously ionised impurity atoms must be neutralised to reduce the depletion layer width and reduce the potential barrier.

Conversely, if the bias is reduced or reversed in polarity, the number of carriers crossing the junction must fall, while additional impurity atoms must be ionised to widen the depletion layer and increase the potential barrier.

In both cases, significant time must elapse before the new conditions stabilise. The depletion layer changes involve movement of carriers through a finite volume of material, and this necessarily takes time. Hence there is an inevitable delay involved before the new balance conditions are reached, and during the delay period the behaviour of the device may differ considerably from that of an ideal diode.

For example, figure 5.5 shows what tends to happen if the polarity of the applied voltage is suddenly switched from a forward bias value to a reverse bias value. Ideally when this occurs the diode current would drop immediately to its very low reverse saturation current value; however, it can be seen that what in fact happens is that the current swings rapidly to a high reverse value, and only subsequently falls back exponentially to its saturation value.

The reason for this is that at the instant of bias reversal, a considerable number of carriers of both types are stored or "trapped," in the depletion layer region and also in the adjacent P-type and N-type material as injected minority carriers. Before normal reverse-bias operation can be achieved, these carriers must all be removed, generally by being swept back across the junction in both directions. It is the removal of these stored carriers which results in the temporary high reverse current.

The charge-storage mechanism can be controlled to a considerable extent by special techniques involving non-uniform doping and careful choice of impurities. The rather specialised diodes produced by such techniques include those called "step-recovery diodes," "snap-off diodes," "avalanche switching diodes" and "PIN diodes."

To conclude this discussion of "orthodox" semiconductor diodes, brief descriptions will be given of a

small, but representative selection of the great many applications of these devices.

Probably the most familiar application of semiconductor diodes is in circuits used for the rectification of alternating current into unidirectional current. In fact they are particularly well suited for this task, because, despite the limitations discussed in this chapter, they still represent the closest available approximation to an ideal diode element.

There are numerous different rectifier circuit configurations, each of which has certain distinct advantages in specific situations. Two of the most common configurations are illustrated in figure 5.6 (a) and (b).

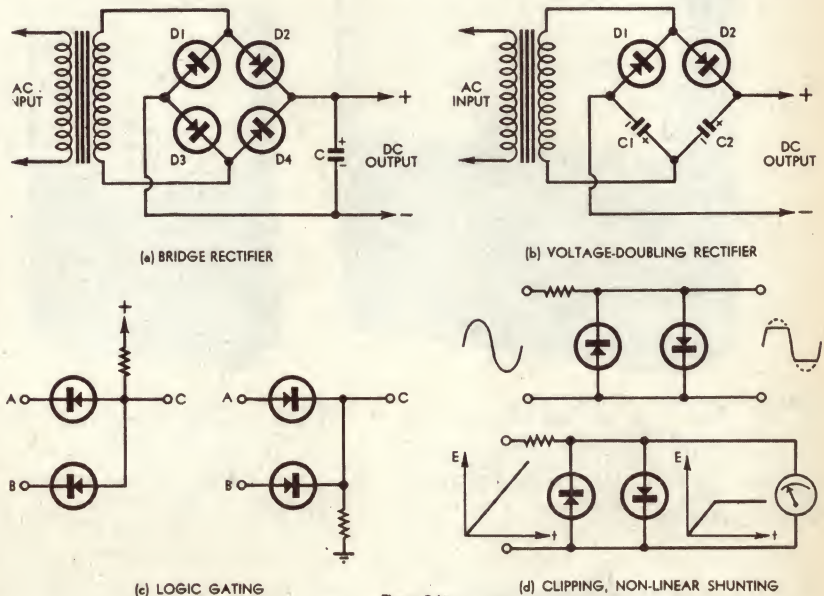

Figure 5.6

The first of these is the so-called "bridge" circuit, which employs four diode elements as a commutating switch which effectively reverses the output connections to the AC source on alternate half-cycles. The second configuration is the so-called "full-wave voltage doubler" circuit, which during alternate half-cycles charges two storage or reservoir capacitors which are effectively connected in additive series with respect to the DC output circuit.

In both of these circuits (but not necessarily in other rectifiers) the diodes used should normally have a dissipation rating sufficient to allow them to carry the full load current for 50% of the time. This is because each element conducts on alternate half-cycles only, but can under some circumstances conduct for the full half-cycle.

In the voltage-doubling circuit, and in the bridge circuit if a reservoir capacitor is used (shown dashed), the diodes must also be capable of handling the surge currents which will flow when the capacitor(s) are fully discharged. The amplitude of such surges is limited primarily by the effective secondary impedance of the transformer, but can be reduced if necessary to suit particular diode devices, by the addition of a low-value high-dissipation resistor in series with the transformer secondary.

The PIV rating of the diodes used

in a bridge rectifier must be greater than the peak value of the transformer secondary voltage, as each diode when non-conducting is effectively connected directly across the winding. In contrast, the PIV rating of the diodes used in a voltage-doubler circuit must be greater than the peak-to-peak value of the transformer secondary voltage, because when non-conducting each diode is effectively connected across both the winding and a charged reservoir capacitor in series.

It should be noted that in both cases the minimum diode PIV rating corresponds to the no-load DC output voltage. This relationship is not universal among rectifier circuits; in fact it is relatively uncommon. Many rectifier

circuits require the use of diodes having a PIV rating of more than double the no-load DC output.

Many "rectifier" circuit configurations are in basic form suitable not only for power rectification, but also for detection—the process of extracting modulation information from a high frequency carrier signal. Hence signal detection circuits form another important application of semiconductor diodes, and account for many of the diodes found in radio and television receivers and test equipment. Few detector circuits are based upon the bridge or voltage-doubling circuits of figure 5.6, however, most being based upon either the "full-wave" or "half-wave" configurations.

A rapidly growing application for semiconductor diodes is in circuitry involved in logic gating and signal switching. Here the unidirectional properties of the device are used to effectively connect or disconnect circuit points in response to their relative voltage polarities.

Simple circuit configurations of this type are shown in figure 5.6(c). In the left-hand circuit, it may be seen that point "C" will assume a significant positive potential if, and only if, both points "A" and "B" are raised to a positive potential. If either "A" or "B" is connected to earth (reference potential), "C" will also be held at approximately earth potential by the corresponding diode.

Rapar Rapar Rapar Rapar Rapar Rapar

HIGH QUALITY MULTIMETERS



MODEL: SK100 — 100K O.P.V.
 D.C. V.: 0.6, 3, 12, 60, 300, 600, 1200.
 A.C. V.: 6, 30, 120, 300, 1200.
 D.C. mA.: 0.012, 0.3, 6, 60, 600, 12A.
 OHMS: 1 Ω to 20 Meg. in four ranges.
 SIZE: 7" x 5 $\frac{1}{2}$ " x 2 $\frac{1}{4}$ ".
 PRICE: \$45.00.

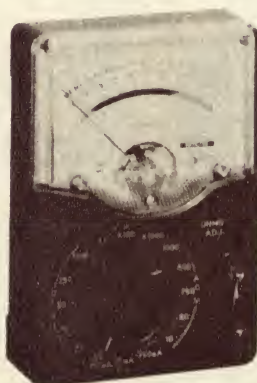

SK33 — 10K O.P.V.
 0.5, 2.5, 10, 50, 250, 1000.
 10, 50, 250, 500, 1000.
 0.1, 25, 250.
 1 Ω to 3 Meg. in three ranges.
 5" x 3 $\frac{1}{4}$ " x 1 $\frac{1}{4}$ ".
 \$15.00.



YT68A — 1K O.P.V.
 10, 50, 250, 1000.
 10, 250, 500.
 250.
 100 Ω to 100K, one range.
 2 $\frac{1}{2}$ " x 3 $\frac{1}{4}$ " x 1 $\frac{1}{4}$ ".
 \$9.00.

All Prices include Sales Tax and Freight.



MODEL: SK120 — 20K O.P.V.
 D.C. V.: 0.6, 3, 12, 60, 300, 1200.
 A.C. V.: 6, 30, 120, 300, 1200.
 D.C. mA.: 0.06, 6, 60, 600.
 OHMS: 2 Ω to 8 Meg. in four ranges.
 SIZE: 5 $\frac{1}{2}$ " x 3 $\frac{1}{4}$ " x 2".
 PRICE: \$17.50.



SK7 — 4K O.P.V.
 10, 50, 250, 1000.
 10, 50, 250, 500, 1000.
 0.25, 10, 250.
 10 Ω to 2 Meg. in two ranges.
 4 $\frac{1}{2}$ " x 3 $\frac{1}{4}$ " x 1 $\frac{1}{4}$ ".
 \$12.50.



M303 — 30K O.P.V.
 0.6, 3, 12, 60, 300, 1200.
 6, 30, 120, 300, 1200.
 0.06, 6, 60, 600.
 2 Ω to 8 Meg. in four ranges.
 5 $\frac{1}{2}$ " x 3 $\frac{1}{4}$ " x 2".
 \$19.50.

SK100, M303, SK120 and SK33 have diode protected movements.

RADIO PARTS PTY. LTD.

MELBOURNE'S WHOLESALE HOUSE
 562 Spencer Street, Melbourne, Vic.
 Phone: 329-7888.
 Orders: 30-2224.

CITY DEPOT: 157 Elizabeth Street, ...
 Melbourne, Vic. Phone: 67-2699.
 SOUTHERN DEPOT: 1103 Dandenong
 Rd., East Malvern, Vic. Phone: 211-6921.

To: RADIO PARTS PTY. LTD.
 P.O. Box 124, North Melbourne,
 Vic. 3051.

Please send me further details of:

- Other Multimeters
 Other Equipment

In logical terms the circuit thus performs the "AND" operation, because it can be said that if point "C" is positive, then both points "A" and "B" must also be positive.

In contrast with this behaviour is that of the right-hand circuit of figure 5.6(c). Here, because of the changed diode connections, the point "C" will go positive if either point "A" or "B" is taken positive. In this case the circuit can be said to perform the logical "OR" operation, because if point "C" is positive, then either point "A" or point "B" (or both) must be positive also.

Another important class of applications for semiconductor diodes includes circuits which take advantage of the fact that the forward characteristic of such devices is non-linear, representing a high initial resistance and subsequently a low resistance when the device reaches full conduction. Figure 5.6(d) illustrates two of the many types of circuit which exploit this behaviour.

In the left-hand circuit, it may be seen that two diodes are connected in inverse parallel across a source of sine wave signals, a resistor being used to limit diode current. During each half-cycle of the signal, one of the two diodes conducts; however because of the non-linearity of the forward bias characteristic, this conduction is effectively confined to that part of the half-cycle during which the signal amplitude exceeds the turn-on "knee." Hence the effect of the diodes is to effectively "clip" the signal to a known peak-to-peak amplitude.

The second circuit of figure 5.6(d) shows how a similar diode configuration may be used to protect a delicate meter movement from damage due to overload. Here the non-linearity of the diodes effectively prevents the voltage applied to the movement from rising above the turn-on knee voltage, in either direction. Silicon diodes are normally used in this type of application, because their higher turn-on voltage and lower saturation current both ensure that normal meter operation is not disturbed.

While the foregoing discussion of semiconductor applications has been necessarily very brief, it is hoped that it will serve to give the reader some insight into the vast number of applications to which these devices are being applied.

FURTHER READING

BRAZEE, J. G., *Semiconductor and Tube Electronics*, 1968, Holt, Rinehart and Winston, Inc., New York.

MORANT, M. -J., *Introduction to Semiconductor Devices*, 1964, George G. Harrap and Company, London.

PHILLIPS, A. B., *Transistor Engineering*, 1962, McGraw-Hill Book Company, Inc., New York.

SMITH, R. A., *Semiconductors*, 1950, Cambridge University Press.

SURINA, T., and HERRICK, C., *Semiconductor Electronics*, 1964, Holt, Rinehart and Winston, Inc., New York.

Also "Solid-State Diodes," a special section in *Electronics World*, V.82, No. 1, July, 1969.

RELIABILITY IN TERMS OF M.T.B.F.

How long should any piece of electronic equipment operate before it is likely to give trouble? It seems a bit like the classic question "How long is a piece of string?" but in fact reliability engineers have methods of reducing the complex question of equipment reliability to simple statistics.

After you build a project, do you have any idea of how long it will operate before it needs repair? Do you have any idea how long your kitchen radio will play before it starts giving trouble? Or your TV set? Have you ever wondered why transistor radios seem to work forever (unless you drop them or start fiddling with the insides) while valve sets seem to go on the blink regularly?

It all has to do, of course, with what we call reliability — and what reliability engineers call "mean time between failure" or M.T.B.F. A numerical value, in hours for M.T.B.F. can be calculated for any given piece of equipment by using a simple mathematical expression. Although the value thus determined is not infallible since there are too many variables (temperature, voltage variations, humidity, shock and vibration, etc.), experience has shown that a reasonable amount of faith can be placed on M.T.B.F. calculations.

A fundamental assumption used in M.T.B.F. calculations is that failure of one part causes failure of the entire system — otherwise why have that particular part at all? Thus, to determine the M.T.B.F. of an electronic system, we first need to know the failure rate of each of the parts that make up the system.

Failure rates for the most important electronic components in use today are shown in the table. These values were arrived at through extensive testing by various component and system manufacturers.

The use of the table in calculating M.T.B.F. can best be shown through an example. Assume we have a transistor radio containing 10 transistors, 11 resistors, 1 potentiometer, 6 inductors (including chokes and transformers), 12 paper capacitors, 6 ceramic capacitors, and 5 electrolytic capacitors.

First find the failure rate for each type of component from the table. Multiply the failure rate by the number of components of that type and add all of the resulting figures. Thus:

Transistors: 10 x 0.04 = 0.400
Resistors: 11 x 0.001 = 0.011

TYPICAL COMPONENT FAILURE RATES

COMPONENT	FAILURE RATE (% per 1000 hrs.)
Resistor, composition	0.001
Resistor, film	0.002
Capacitor, paper	0.01
Capacitor, moulded mica	0.003
Capacitor, ceramic	0.001
Capacitor, electrolytic	0.03
Choke	0.2
Transformer	0.2
Potentiometer, composition	0.2
Transistor	0.04
Semiconductor diode	0.02
Valve	5.0

Potentiometers: 1 x 0.2 = 0.200
Inductors: 6 x 0.2 = 1.200
Paper capacitors: 12 x 0.01 = 0.120
Cer. capacitors: 6 x 0.001 = 0.006
Elec. capacitors: 5 x 0.03 = 0.150

2.087

So the total failure rate is 2.087 per cent per 1000 hours. To find the M.T.B.F., divide the total failure rate into 100,000.

M.T.B.F. = 100,000/2.087

= 48,000 hours (approx.)

Once this is known, establish how many hours a day the device will be used, and you can then calculate how many days, weeks, months, or years, the system will probably operate.

If we were to determine the M.T.B.F. for the same radio with five valves instead of the 10 transistors, we would come out with about 3700 hours. Now you know why transistor radios last longer.

How can you improve the reliability of a piece of electronic equipment? You can start by derating the components you use. If physical size is not too big a problem, use resistors with a higher wattage rating or capacitors with higher voltage ratings. The use of premium valves, high-quality components, heat sinks for valves and transistors, and cooling fans can also improve reliability. A good rule of thumb is to derate all components by 50 per cent and use them in a cool environment. (Reproduced from "Popular Electronics," August, 1969, by arrangement.)

Notes and Errata

IMPROVED VERSION OF PARLOUR GAME, Reader Built It, August, 1969, page 109. On Bank No. 2, the contact representing "one counter remaining" (No. 6 counting anti-clockwise) should be joined to the three adjacent contacts, Nos. 7, 8 and 9. On Bank No. 3, the connection from the battery positive line to the centre contact of S1b should connect, instead, to the right-hand contact.

CRYSTAL DRIVE CLOCK UNIT, Part Two, July, 1969, page 40. We have been advised by the Postmaster-General's Department that a new schedule of VNG time signals came into operation recently.

MHz (DSB)	Transmission Times E.A.S.T.
4.500	1945 - 0730
7.500	0845 - 0830
12.000	0745 - 1930

Also, the power of all transmissions has increased from 1KW to 10KW.

thoroughbreds



Sandwich MK 11
Loudspeaker System
\$139.00 each Size 26" x 15" x 12"



Mini-Sandwich
Loudspeaker System
\$99.00 each Size 18½" x 11" x 7"

From the House of Leak, two speakers with a fine pedigree ... the combination of talented designers and the finest technical minds in the business.

These two beauties are capable of reproducing any sound fed into them ... faithfully and to perfection. The secret is the light and rigid cones, constructed from two skins of aluminium separated by expanded polystyrene.

These rigid piston-action cones give a smooth response over the entire audio frequency range and are totally free from mechanical breakup and associated distortion.

The award winning enclosure for the Leak Sandwich employs the most sophisticated techniques, providing optimum acoustic conditions.

The cabinets are designed to blend harmoniously into any room setting, and are available in teak, walnut or mahogany.

For those with limited space Leak have developed the Mini-Sandwich Loudspeaker, which is manufactured to the same exacting standards as its big brother.

The Stereo 30 Amplifier: All transistor, with an output of up to 15 watts per channel, and is without question the best proven amplifier on the market today.

To: H. J. Leak (Aust.) Pty. Limited, P.O. Box 14, French's Forest, N.S.W. 2086. Telephone 94 4902.

Please send me comprehensive details of the Leak Stereo Hi-Fi products.

Name.....

Address.....

LEAK HI-FI



"An explosion in the TV set . . ."

I suppose most servicemen have a secret fear that, sooner or later, they will be involved in an accident caused by an imploding picture tube. Granted these incidents are rare, but there is always a first time, and I thought it had happened to me on a recent occasion.

The story started out as a phone call from a hysterical dear old lady who, between gasps for breath and other obvious expressions of fear, managed to blurt out a story about ". . . an explosion in the TV set" and ". . . glass all over the lounge-room." My first reaction was to enquire whether the D.O.L. herself was unhurt and, on eventually being reassured that this was so, I decided that the job could wait until I was in that part of town later in the day. In the meantime I was able to reassure the D.O.L. that there was no risk of any further explosion.

Thus it was that, several hours later, I knocked on the door of the D.O.L.'s residence and was admitted to the lounge-room. Imagine my reaction when I glanced at the TV set and realised that the face of the picture tube appeared to be completely intact. Closer examination showed that, in fact, the whole of the picture tube was intact and the set in perfect working order. What had "exploded" was the safety glass; which seems to suggest that perhaps we should have a safety glass in front of the safety glass — or something.

Or, looking at it another way, it seemed pertinent to ask why a device which is supposed to provide protection had itself failed in the same manner.

By this time the D.O.L. had calmed down somewhat and I was able to piece together a more coherent story. It seemed that the TV set had been running for an about an hour before the accident, but had been shut down just prior to it. The D.O.L. had been sitting quietly reading alongside the set when the glass went off ". . . with an awful bang." I'm afraid my imagination painted a rather vivid picture of the scene and, unkind though it might have been, I could see only the funny side. It took quite a deal of self-control to keep my face straight.

As to the cause, one factor which may have been significant was that this happened on a day during last summer when the temperature reached a record high. (This story has not been printed earlier for the apparently simple reason that its length has never been compatible with the space left

over after the main stories have been allocated.)

The glass itself was a contoured type separate from picture tube, but having approximately the same shape. It was of the same type as used for car windscreens, that is, it disintegrated into small and relatively harmless cubes of glass which, in spite of preliminary efforts to clean them up, could still be found on the lounge-room floor. (If my own experience with a car windscreen is anything to go by, they will still be turning up in odd places 12 months from now.)

Closer examination showed that the safety glass was mounted in a diecast frame with a thin layer of rubber between the glass and the metal. Although the rubber was thin, I imagine it would have been perfectly adequate, except for one factor—the excessive zeal of some factory operator who had apparently tightened the whole assembly with the same vigour as one tightens the wheel nuts on a car. As a result, some portions of the rubber had been so compressed that they would have ceased to function as rubber for all practical purposes. This was clearly obvious in parts of the rubber where minor imperfections in the metal frame were permanently indented.

The set was about five years old and, while the rubber had not actually



"My Dad's radio'll go farther'n your Dad's!" (Radio-TV Experimenter).

hardened, it had probably lost some of its original resilience. Apparently all these factors added up to a situation where the glass could no longer stand the strain.

Repairs consisted of obtaining a new glass from the manufacturer, plus a new rubber gasket, and reassembling everything as before. However, I took considerable care to ensure that the relevant screws were tightened by no more than was necessary to keep everything firmly in place, but with plenty of come and go to cope with expansion, distortion, and similar variables.

My next story is a continuation of one that I told last month. Remember the imported portable set which suffered from inherent distortion, and which I could only cure by adopting drastic measures? The last I saw of the set the owner was going happily on his way to present it to his son as a birthday present and, although we both knew that its gain had been significantly reduced, we were both equally confident that its performance was still at least equal to the usual run of sets used by teenagers. In any of the typical situations — on the beaches, in the trains, or even well out in the country — it should still make more noise than was necessary.

All of which was undoubtedly true and everyone would probably have been quite happy with the performance except for one thing. Within a few days of the birthday celebration, and contrary to the assurance from the owner that it was unlikely to be used anywhere but on the local beaches, the family took off for a remote fishing spot a couple of hundred miles down the coast and about as far away from any broadcasting station as one is likely to get these days.

This was a tough enough situation on its own but was made worse by the presence of another family holidaying in the area, the teenage offspring of which also had a portable set—and one featuring one less transistor than our hero's. Thus, when the two kids became involved in a "My set's better'n yours" argument, and made direct comparisons to prove it, the smaller set "licked the pants off" the bigger set, to quote my customer. Which was why he was back in the shop about a week later wanting to know whether I couldn't "turn it up just a little more."

Strangely enough, I was rather more confident about being able to accede to his request now than I would have been when, working under a certain amount of pressure, I was striving to get the thing into some kind of working order in time for the formal presentation. Now I could at least take my time and think about the problem.

Not that I felt a great deal differently about the original fault. As far as I was concerned it was a result of poor design, and I felt no more like redesigning the thing than I did when I first realised what was wrong with it. But I was considering the possibility that the "cure" I had devised could be modified, or optimised, so that the gain was reduced by no more than was absolutely necessary to prevent overload.

There appeared to be two relatively simple ways in which this could be done. One was to replace the original

A SPECIAL OFFER

FROM TWO OF EUROPE'S LEADING MANUFACTURERS
OF SOUND EQUIPMENT

TESLA

TAPE RECORDERS



MODEL B43A. A four-track, fully transistorised, stereophonic tape recorder. Synchronous recording, multiple synchronous recording and simultaneous play-back of two tracks. Three speeds. Housed in an elegant timber or teak case. **\$196.**

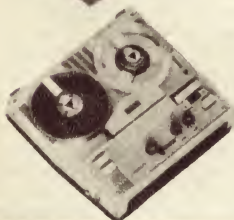

MODEL B46. Records stereo or mono with remote-control facilities. Records at 3¾ i.p.s. and plays back through your own stereo system. 2-tone plastic case. Fully transistorised. Complete with microphone, tape, spare fuses, plugs, lead and built-in speaker. **\$124.**

INCIS

TAPEDECK



MODEL V34. Mechanism only, with two heads, 4 track, 3-speed, automatic stop and pause control. Takes up to 7" reels. Operates upright or flat. **\$68.**

LOUD SPEAKER UNITS

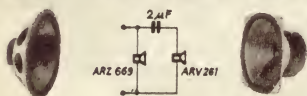

MODEL ARZ 668. 8" rolled-edge cone woofer. Impedance 4 or 8 ohms. Resonant frequency 28 cps. Price **\$6.**
4" tweeter. Impedance 4 ohms. Range within 6-17 KC/S. **\$5.50.**



MODEL ARS 720. 2 speakers in each cabinet. 10-watt rating with crossover network. Cabinet dimensions: 19" x 13" x 4½". **\$36 each.**

CASSETTE PLAYERS



MINI STAR. Battery or mains operation. Takes standard cassettes. Ideal for the teenager. In a range of bright colours. **\$49.**



CAR PLAYER. Simple operation. Takes standard cassettes, **\$49.** Voltage-reduction cable, **\$4.93.** Car bracket, **\$4.93.**

AMPLIFIER

Supraphon Studio 1 stereo amplifier. 10 watts per channel R.M.S. **\$161.**



TURNTABLE

All-balance arm. Stroboscopic speed indicator. Hydraulic arm lift. Fine speed adjustment. Price without cartridge. **\$108.**



RADIO AERIALS

Lockdown, top-cowl and motorized models from **\$2.20.**

CHARMAC PTY. LTD.

Representatives for Tesla Czechoslovakia.
33 Bridge Road, Eltham 3095. 439 9517.

- ALL PRICES INCLUDE TAX
- ALL UNITS AVAILABLE IMMEDIATELY
- MAIL ORDERS ACCEPTED

CH891

AUDIO-LEC OF AUSTRALIA PTY. LTD.

Representatives for Incis of Milan, Italy.
33 Bridge Road, Eltham 3095. 439 9517.

Please send details on

NAME

ADDRESS

.....POSTCODE

RADIO: Unofficial history

At a Sydney radio factory at which I worked during the war years, one of the testers was a character named Charlie. Charlie was an average kind of bloke who liked to spend a few hours of his Saturday afternoon at the local pub drinking and yarning with his mates and listening to the races.

On this particular occasion, Charlie over-indulged. Whatever the celebration was, it must have been a dilly, because Charlie awoke on the Sunday morning with a grand-daddy of a hang-over. And, from past experience, Charlie knew that there was only one thing that would give him relief; he needed a hair of the dog that bit him!

So, as soon as he could bear to put his feet to the ground and make himself presentable, he headed back to the pub. His intention was strictly illegal but that didn't worry Charlie. He presented himself at the correct door, knocked the correct number of times, was recognised and admitted.

In fact, he was only one of many seeking comfort that morning, and the bar was moderately crowded. He ordered a drink, retired to a quiet corner, and drank it slowly. After a while he felt a good deal better and, by the time he had finished the drink, he felt almost human again. He decided to have one more, "to make sure" then go home.

But hardly had the foaming tankard been handed to him than trouble struck. Someone poked his head through the bar door and yelled, "The cops." Pandemonium followed. Everyone rushed for the nearest door or window in the hope that it might provide

an escape route. It was a futile effort there seemed to be blue uniforms everywhere.

Charlie looked around for a way of escape also, but not via the doors and windows. He was looking for something else; the mantel radio set used for the Saturday afternoon race broadcasts. He found it on a shelf above the bar and lifted it down. Then he whipped out a pocket screwdriver and in a few moments had the knobs off, the chassis screws undone and the chassis upturned on the bar in front of him.

The police were in the bar by now, posing the routine question to each occupant as to why they were there. And, in the absence of a satisfactory reply, each one was "lumbered" on the score of being on licensed premises after hours without lawful excuse.

Finally one of them reached Charlie. "What are you doing here?"

Charlie prodded the works of the set with his screwdriver, producing a series of crackles and squawks from the speaker, and calmly replied, "Fixin' the man's radio."

The cop was beaten — and he knew it. No matter how suspicious he might have been, he knew very well that he had no evidence to present in court. What was more, once Charlie had a legitimate excuse for being on the premises, there was nothing to stop the publican from extending "hospitality" to him in any form he chose.

So Charlie looked the cop straight in the eye, took a long enjoyable swig from his tankard, licked his lips — and went on "fixin' the man's radio."

(Readers are invited to submit contributions to "RADIO: Unofficial History" and a publication fee will be paid for those used. Stories must be humorous and they must be true. Letters must be signed and the locale of the story indicated as a mark of good faith. The Editor reserves the right to re-phrase contributions as necessary to preserve uniformity of style.

emitter bypass capacitor with a smaller value, determined experimentally, which would permit the IF stage to operate with just the right order of gain. The other was to achieve the same result by retaining the original capacitor but with a suitable value of resistance, again determined experimentally, connected in series with it.

The second idea seemed to have several points in its favour. The first one — and the one which, I confess, first prompted me to consider it — was that it was a good deal more convenient in the physical sense. The terminations for this particular capacitor were not particularly easy to get at, one in particular being very awkward. Since it would obviously be necessary to try a number of capacitor values in this position before the optimum one was found, it could involve a lot of soldering in an awkward spot. And this, where a printed wiring board is involved, is to be avoided if at all possible.

On the other hand, use of a series resistor would mean that the awkward termination of the capacitor need be made only once, the experimentation then taking the form of various values of resistance fitted between the free end of the capacitor and the more

accessible point on the board. Which brings me to another advantage; I had a greater range of resistors available than capacitors, at least in physical sizes that could be conveniently accommodated.

Electronically, there are some advantages to this approach also, although I confess that I am not fully conversant with all the finer points behind them. Suffice it to say that, according to an engineer friend, some of the older germanium transistors, as these appeared to be, could be rather critical in regard to the value of emitter bypass when operating close to the limit of their frequency. Certain critical values could bring about phase shift conditions whereby the stage might become unstable.

Which all added up to a good case for the series resistor arrangement. I started out with a 220 ohm resistor, but this had little apparent effect on the gain and none on the overload condition, so I progressively reduced the value until, at 47 ohms, there was noticeable overload. I went back to 56 ohms, which I had already tried once, and realised that, once alerted, I could still detect slight signs of overload. I finally settled for the next highest value, 68 ohms, on the basis

MICRO

LOW PRICED CERAMIC CARTRIDGE FOR BUDGET CONSCIOUS MUSIC LOVERS!

The popular Micro SC-301 cartridge has now been superseded by the new, improved Model SC303D. Only the price remains the same! Frequency response is 20-15,000 Hz. and tracking angle is 15 degrees. With diamond stylus \$6.90 inc sales tax

ECONOMICAL MICRO MOVING MAGNET STEREO CARTRIDGE—THE MODEL 2100/5 ONLY \$14.50.

With an input sensitivity of 5 mV, the new Model 2100/5 stereo cartridge has a frequency response of 10-28,000 Hz plus minus 3 dB and a tracking angle of 15 deg. Tracking pressure recommended is 1-3 grams; channel separation is 30 dB at 1kHz. Listening to this Micro cartridge can be quite deceptive—some music lovers thought they were hearing a cartridge three times as expensive! A conical diamond stylus is standard equipment .. incl. sales-tax \$14.50

NEW MICRO VF-3100 SERIES STEREO CARTRIDGES PROVE MOST POPULAR EVER!

With a frequency response of 20-28,000 Hz. and channel separation of 28 dB, the Micro VF-3100 series cartridges have already established new performance standards for lower priced magnetic cartridges. Two models are available, the VF-3100/E with elliptical diamond stylus and the VF-3100/S with a conical diamond stylus. Stylus both cartridges are replaceable; both track effectively at 1 1/2 grams.

EXTRACTS FROM REVIEW

In "Electronics Australia," Page 119, February 1969. Speaking of the Micro VF-3100/E cartridge the following comments were made — "frequency response checked out at plus or minus 2dB from 30 Hz. to 20 KHz ... very good performance indeed."

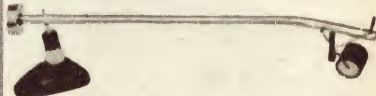

MICRO DUST PICKUPS—\$3.50

An effective automatic record cleaner which removes dust as the record plays. An ideal gift. \$3.50 inc. sales tax.

Encel

ELECTRONICS
(STEREO)PTY. LTD.

Head Office:

431 Bridge Rd., Richmond, Victoria 3121.
Tel. 42 3762.

Sydney Store: Ground Floor 2SM Building
257 Clarence Street, Sydney, N.S.W. 2000.
Tel. 29 4563, 29 4564.

*Wholesalers *Trade-ins accepted

Australia's Greatest Hi Fi Centre

CALLING ALL PROSPECTIVE AMATEURS

The Wireless Institute of Australia was established in 1910 to further the interest of Amateur Radio. With over 45 years experience, who could be more experienced in the teaching of this subject?

We are a non-profit making Organisation. Correspondence Courses are available at any time. Personal Classes commence in February of each year.

For further information write to:

THE COURSE SUPERVISOR, W.I.A.,
14 Atchison Street,
CROWS NEST, N.S.W.

LUX AMPLIFIERS ARE UNEQUALLED FOR VALUE, QUALITY AND PERFORMANCE



THE NEW LUX SQ-1220 SOLID STEREO AMPLIFIER OVER 100 WATTS R.M.S. TOTAL OUTPUT!

The new and outstanding Lux SQ-1220 is rated at over 50 watts R.M.S. into an 8 ohm speaker load. Distortion is so minute it is difficult to measure even at high outputs. 40 transistors and diodes. Frequency response is 10-50,000 Hz. ± 1 dB. Provision is made for separate bass and treble controls in each channel, low and high filters, frequency selectors and tape monitoring. Ask for complete and unabridged specifications for this sophisticated Lux amplifier. Performance can only be described as superlative. Encel price (including Sales Tax) **\$350**

LUX MODEL SQ-505 SOLID STATE STEREO AMPLIFIER

Rated at 30 watts R.M.S. per channel, the all new Lux Model 505 is a silicon transistor unit. Power transistors are designed to withstand temporary short circuits and overloading — overall frequency response is 10-50,000 Hz. plus or minus 1dB in the power amplifier and 20-50,000 Hz. plus or minus 2dB in the pre-amplifier. Controls and features include volume, balance, mode selector, treble/bass controls, filters, tape monitor, headphone jack, exclusive A/B speaker systems selector, etc. All in all the Lux SQ-505 is a very fine amplifier. **\$259**



LUX MODEL SQ-606 SOLID STATE STEREO AMPLIFIER

Rated at over 30 watts R.M.S. per channel, the handsome new Lux Model SQ-606 is an all-silicon unit with 27 silicon transistors. Power transistors are designed to withstand temporary short circuits and overloading. Overall frequency response is 10-50,000 Hz. ± 1 dB. Acoustic performance is quite outstanding. Controls and features include volume, balance, mode selector, treble/bass controls, filters, tape monitor, headphone jack, etc. All in all the SQ-606 is a very fine amplifier, attractively priced. **\$219** Inc. sales tax

LUX SOLID STATE STEREO AMPLIFIER — THE MODEL SQ-77TW — \$169

Using silicon power transistors the SQ-77TW is rated at 30 watts R.M.S. in each channel with a 4-6 ohm speaker load. Frequency response is 10-50,000 Hz. plus 0, minus 3dB. Input sensitivity is 1.8mV for magnetic pickup or tape head, aux. inputs being rated at 200 mV and 800 mV. Controls include stereo volume, stereo balance, mode switch, treble and bass (separate controls for each channel), input selector, head-phone jack and switch, tape monitor switch, rumble and scratch filter switches, etc. (including Sales Tax) **\$169**



NEW LUX MOVING MAGNET STEREO CARTRIDGE

The Lux T-15-M has been acclaimed as a brilliant performer by discriminating audio enthusiasts — frequency response is conservatively quoted at 20-20,000 Hz. and stylus pressure is from 1 to 2½ grams. Tracking angle is 15°, output is 5 mV. at 1 kHz. Stylus sizes available are 0.7 mil. conical diamond and the new elliptical diamond (T-15-ME). T-15-ME: **\$29.50**. T-15-M7B (conical diamond stylus) Inc. **\$24.50** Sales Tax

EXTRACTS FROM REVIEW OF LUX SQ1220 INTEGRATED AMPLIFIER APPEARING IN "HI FI NEWS" JANUARY, 1969.

"Here, then, is an amplifier of Japanese origin which conforms very closely (on some counts, better!) to the published specifications" . . . "The amplifier was run for several weeks under domestic conditions with a wide range of programme sources, pickup cartridges and speakers and at all times it performed perfectly and without flaw." . . . "Nice to look at, nice to use and very well made and designed, I vote the Lux SQ1220 a top-of-the-class amplifier which, I am sure, will hold its own with the best of the other Class-B designs now available."

EXTRACTS FROM REVIEW OF LUX SQ77 AMPLIFIER APPEARING IN "HI FI SOUND" FEBRUARY, 1969.

"Both design and construction reach very high standards of electronic engineering. Some idea of the excellence of the design of the amplifier can be gleaned from the illustrations. It is also note-worthy that the components employed are of good quality and reasonably rated, especially the mains transformer, so normal servicing should not cost much from one year to the next." . . . "After running the amplifier for several weeks in a typical domestic environment with all sorts of signals and sources, and not encountering any troubles or even mere shortcomings on my ordinary dynamic speaker systems of various kinds, I have no hesitation at all in voting this one of the most worthy of amplifiers I have had the pleasure of testing for a long time. For the power that it delivers and the way it is made it is well worth its price."

ENCCEL

ELECTRONICS (STEREO) PTY. LTD.

Head Office:
431 Bridge Rd., Richmond, Victoria 3121. Tel. 42 3762.
Sydney Store: Ground Floor, 2SM Building,
257 Clarence Street, Sydney, N.S.W. 2000. Tel. 29 4563, 29 4564.
Australia's Greatest Hi-Fi Centre *Wholesalers *Trade-ins accepted

that it would provide a small margin of safety.

As for the gain, well this had been pushed to the limit. It was noticeably better, but whether it was now equal to, or better than, the "Little Beaut Transistor 7", or whatever it was that licked it before, I had no way of knowing. Nor was it really important. I had done my best with what was available, and I doubt whether anyone else could have done better, short of completely re-hashing the whole AGC system. Unless the owner was prepared to spend more than he paid for the set, and take the risk of it not turning out as planned, he would have to be content with what he had.

Perhaps he will shop a little more carefully next time he goes overseas!

My next story is yet another example of how a breakdown in communications between customer and serviceman can cause unnecessary inconvenience and expense for both. The reason for the lack of communication is also worth noting, since it is not an uncommon one.

The story as the owner presented it to me was simply that the set was suffering from lack of horizontal hold, and I treated it on this basis. What I did not learn until later was that the set had already been treated by another serviceman, who had made two unsuccessful attempts to fix it. This was all the more surprising, incidentally, because he was one of those servicemen who specialise in, and service, only one make of set — this one.

After these two attempts, the customer apparently decided to call in some one else — yours truly — but, for some perverse reason which I cannot explain, did what a lot of other people seem to do in similar situations: deliberately refrain from mentioning anything about the previous serviceman or his problems. If only they realised the extra trouble and expense this silly habit can cause, they wouldn't do it.

As it was, I treated the job as a routine case of loss of horizontal hold which, in this particular set, is usually caused by failure of the horizontal oscillator valve. I replaced the valve and reset the horizontal hold control, and this appeared to cure the fault. The only point about which I wasn't absolutely sure was the locking range of the horizontal control, which seemed more restricted than I had expected. However, it was some time since I had noted the performance of this particular make of set in this respect, and I couldn't be sure. In the absence of any other symptoms I assumed that I had found and fixed the fault.

Unfortunately, the cure lasted less than one evening, and the customer was on the phone first thing next morning complaining that the set was as bad as ever. In the interest of diplomacy, I made this my first call for the morning.

This time, as I removed the back of the cabinet, I noticed a small sticker carrying the name of another serviceman. The sticker looked fairly new, so I tackled the customer's wife and asked her straight out whether there had been any recent service on the set for a fault similar to the present one.

Then the whole story came out. The other serviceman had been called in a couple of weeks previously when the trouble first appeared. He had replaced

a valve (presumably the horizontal oscillator valve) and this seemed to cure the trouble at the time. However, it wasn't long before the trouble was back again, and the serviceman was called a second time. This time he explained that he had changed the wrong valve the first time, and changed another valve. This had me puzzled at first, but more careful questioning revealed that, as well as loss of horizontal hold, the vertical hold also failed on odd occasions; something I had neither been told about or been able to observe.

It was all plain now. The fault was really a sync. fault and the second valve the other serviceman had replaced had undoubtedly been in the sync. system. Fully alert now, I checked the performance of the vertical hold and found that it was quite touchy. Then I replaced both the sync. separator and sync. amplifier valves, and checked again. Both vertical and horizontal systems behaved exactly as before, so I reasoned that the trouble must be more deep seated. Out came the chassis and I attacked the sync. separator.

A preliminary check showed nothing wrong there, but a quick once over of the sync. amplifier stage revealed that the plate load of the sync. amplifier, normally 1M, was nearer 10M. With that replaced everything came good and, I imagine, will stay that way.

However, the story is a classic example of how circumstances — including a momentary slackening of one's own alertness — can lead to wrong diagnosis, waste of time, and customer dissatisfaction. But, by the same token, had the customer been completely frank about his previous troubles, we would both have been saved a lot of trouble.

To change the subject to more routine matters, have you ever noticed how some faults have seasonal peaks. For example, humid weather usually finds the weaknesses in crystal pickups and transformer windings, particularly TV vertical and horizontal windings.

A more subtle one, which I did not appreciate myself for some time, is the high incidence of TV tuner troubles during the winter months, and invariably involving dirty contacts. And

even when I realised that this seemed to be a fact, I couldn't work out what connection there was between these two apparently unrelated facts. All I could be sure of was that it was definite contamination, this being obvious from an examination of any of the tuners involved.

Then one night I called at a customer's home to deal with such a problem and, as I moved towards the TV set the customer moved in ahead of me to shift a kerosene room heater that was sitting in front of the set. Suddenly the penny dropped. I thought back over several similar jobs I had done recently and realised that in all cases the lounge-room had been heated by a kerosene room heater.

That was about three winters ago and, thus alerted, I took careful note from then on. As a result, the point has been proved long since as far as I am concerned. Fumes from the kerosene heater, slight though they may be by all other standards, are more than can be tolerated by TV tuner contacts and the exacting task they have to do. I wonder if anyone else has noticed this connection?

Fortunately, the cure is relatively simple. An aerosol of moisture inhibiting fluid is my main weapon. Sometimes it is necessary to remove a cover from the tuner to do a proper job, in others there are sufficient openings available to make even this simple step unnecessary.

Another winter season trouble is failure of the local oscillator on the high frequency channels. It is only seasonal because the added load created by radiators during the peak evening viewing period will find any weak points in the supply authorities power distribution systems. The resultant drop in voltage will, in turn, find any converter valves which are approaching the end of their life.

One of the annoying aspects of this kind of fault is that it seldom occurs in the daytime. In the early days of TV, before I woke up, I made many fruitless daytime calls in search of such faults. Eventually, I treated myself to a Variac type transformer; an investment which proved a real money saver at the time and which I still use to good advantage when I suspect voltage sensitive faults. ■

ACOS

REPLACEMENT LONG LIFE CARTRIDGES

Acos 90 Series — a family of pick-up cartridges covering all the main types needed today, each fitted with Diamond Stylus at no extra cost.

GP91-1 MONO CRYSTAL Stereo Compatible ..	\$5.95
GP91-2 HIGH OUTPUT MONO CRYSTAL Stereo Compatible ..	\$5.95
GP92 MONO CERAMIC Stereo Compatible ..	\$6.55
GP93 STEREO CRYSTAL ..	\$7.55
GP94-1 STEREO CERAMIC ..	\$7.95
GP94-5 STEREO CERAMIC FOR TRANSISTOR AMPLIFIERS ..	\$8.95



fitted with
DIAMOND
Stylus at no extra cost.

TECHNICAL DATA SHEETS SENT FREE ON REQUEST

Sole Australian Agents:

AMPLION (A'SIA) PTY. LTD.

29 Majors Bay Rd., Concord,
Sydney, N.S.W. Phone 73 1227

can you afford to buy anything less than SANSUI?



Illustrated this month: Sansui Model AU 777 Amplifier, 70 watts music power.

Twelve months from now you will have forgotten precisely how much you paid for your Sansui Amplifier. Price will have become irrelevant. The only important factor in your mind will be how satisfied you are — how glad you paid that little bit more for the first class workmanship that has been put into your Sansui.

On the other hand, if you bought something that was a "bargain" and maybe only bought it because it was cheap, you will most likely regret it for ages. Measure it this way: Over a ten year period of enjoyment and complete satisfaction with your amplifier, is it worth jeopardizing all this to save a few dollars?

12 models to choose from



... and appearance wise they look what they are . . . top performance combined with smart styling.

SANSUI

Imported direct from Japan and distributed by Magnecord Sales and Service, 276 Castlereagh St., Sydney 2000. Phone 61 9881.

MC632

THE TEMPERED MUSICAL SCALE

Computer print-out to eleven significant figures of octaves based on A—448Hz to A—425Hz.

The figures set out below are probably the most detailed and accurate of the type ever published. They relate to the octave above middle C and are for the tempered scale, where the semitone intervals have a relationship based on the twelfth root of 2.

The frequencies throughout the octave are shown for each value of A and, alongside them the reciprocals, which may be the preferred reading figure when using a digital frequency meter with a large number of available display digits. Quantitatively, the reciprocal represents the duration of 1 cycle of the indicated frequency in seconds to the power -3 (shown by the expression E-03); in other words, it is the duration of one cycle of the indicated frequency in milliseconds.

The print-out was made available to "Electronics Australia" by Mr Eric Mirovitch, who is currently doing development work on a tuning instrument based on a logic type divider fed from a master oscillator and switched to produce the required semitone intervals.

The program was run at the Sydney branch of the Division of Computer Research, C.S.I.R.O., by courtesy of Mr C. H. Gray, officer in charge, and Miss Joan Hayhurst.

To avoid risk of error, the figures were not re-set for reproduction but were photographed directly from the original computer print-out and re-touched by hand where necessary. The slight misalignment and the variations in line thickness are therefore largely a heritage of the original high-speed print-out — but they are also an indication of authenticity.

In terms of frequency, the ultimate accuracy represented by the figures is far in excess of normal musical requirements which seldom exceed 0.1 per cent. The print-out can be used, however, to put in order earlier tables which may contain errors or which may have been rendered ambiguous by "rounding off." More particularly, the figures will be of use to those fortunate enough to have access to a digital frequency meter for tuning. They may also assist in designing tuning instruments relying on beats, synthesis or division from a common source.

In an idealised situation, the only octave of interest would be that based on A—440Hz. Using these figures and a digital frequency meter, it would be a simple matter to tune an electronic organ to standard pitch.

A pipe organ, however, presents a quite different problem because of the complexity of the tuning procedure, the nature of the adjustments involved, and the day-to-day effect of temperature and humidity variations. These all provide a strong incentive to tune such an instrument to itself and minimise the number and the extent of adjustments to the pipes on any single occasion. If observation suggests that this will be most easily achieved by tuning on the basis of A—438Hz, then this is what most likely will be done.

The figures should cover the pitch settings which might conceivably be encountered in practical — though sometimes venerable — instruments. Rarely, if ever, should anyone be involved in a pitch above A-448 or below A-425.

(An article on tuning was presented in the June, 1965 issue of "Electronics Australia." Written by the Editor, Neville Williams, it was entitled: "Musical Scales and Tuning — in matter-of-fact electronic terms.")

A = 448

532.76478748	C	1.8770009271E-03
502.86299762	B	1.9886132102E-03
474.63946626	A+	2.1068623051E-03
* 448.00000000	A	2.2321428572E-03
422.85569209	G+	2.3648729784E-03
399.12262575	G	2.5054956434E-03
376.72159406	F+	2.6544801673E-03
355.57783568	F	2.8123237718E-03
335.62078527	E	2.9795532455E-03
316.78383802	D+	3.1567267012E-03
299.00412739	D	3.3444354387E-03
282.22231524	C+	3.5433059188E-03
266.38239382	C	3.7540018529E-03

A = 447

531.57558037	C	1.8812000342E-03
501.74053557	B	1.9930620094E-03
473.58000317	A+	2.1115756436E-03
* 447.00000000	A	2.2371364653E-03
421.91181777	G+	2.3701635220E-03
398.23172703	G	2.5111007791E-03
375.88069765	F+	2.6604186016E-03
354.78413516	F	2.8186153237E-03
334.87163173	E	2.9862189127E-03
316.07673123	D+	3.1637887297E-03
298.33670747	D	3.3519173972E-03
281.59235471	C+	3.5512327777E-03
265.78779026	C	3.7624000674E-03

A = 446

530.38637325	C	1.8854179715E-03
500.61807352	B	1.9975307583E-03
472.52054007	A+	2.1163101182E-03
* 446.00000000	A	2.2421524663E-03
420.96794346	G+	2.3754777900E-03
397.34082831	G	2.5167310499E-03
375.03980123	F+	2.6663836658E-03
353.99043463	F	2.8249350891E-03
334.12247819	E	2.9929144708E-03
315.36962446	D+	3.1708824263E-03
297.66928753	D	3.3594329071E-03
280.96239419	C+	3.5591951830E-03
265.19318671	C	3.7708359419E-03

A = 445

529.19716614	C	1.8896548659E-03
499.49561147	B	2.0020195914E-03
471.46107698	A+	2.1210658712E-03
* 445.00000000	A	2.2471910112E-03
420.02406915	G+	2.3808159423E-03
396.44992959	G	2.5223866254E-03
374.19890481	F+	2.6723755391E-03
353.19673410	F	2.8312832579E-03
333.37332465	E	2.9996401212E-03
314.66251767	D+	3.1780080048E-03
297.00186761	D	3.3669821947E-03
280.33243366	C+	3.5671933744E-03
264.59858315	C	3.7793097307E-03

A = 444

528.00795902	C	1.8939108453E-03
498.37314942	B	2.0065286446E-03
470.40161388	A+	2.1258430466E-03
* 444.00000000	A	2.2522522523E-03
419.08019484	G+	2.3861781404E-03
395.55903087	G	2.5280676762E-03
373.35800839	F+	2.6783944030E-03
352.40303358	F	2.8376600220E-03
332.62417112	E	3.0063960675E-03
313.95541090	D+	3.1851656805E-03
296.33444768	D	3.3745654878E-03
279.70247313	C+	3.5752275938E-03
264.00397959	C	3.7878216896E-03

The tempered musical scale—continued.

A= 443

526.81875192	C	1.8981860391E-03
497.25068738	B	2.0110580546E-03
469.34215079	A+	2.1306417894E-03
* 443.00000000	A	2.2573363431E-03
418.13632052	G+	2.3915645471E-03
394.66813216	G	2.5337743753E-03
372.51711198	F+	2.6844404400E-03
351.60933305	F	2.8440655750E-03
331.87501758	E	3.0131825146E-03
313.24830411	D+	3.1923556707E-03
295.66702776	D	3.3821830171E-03
279.07251261	C+	3.5832980849E-03
263.40937603	C	3.7963720770E-03

A= 439

522.06192344	C	1.9154815839E-03
492.76083919	B	2.0293820460E-03
465.10429841	A+	2.1500553820E-03
* 439.00000000	A	2.2779043280E-03
414.36082327	G+	2.4133555680E-03
391.10453728	G	2.5568611578E-03
369.15352632	F+	2.7089000340E-03
348.43453094	F	2.8699796122E-03
328.87840343	E	3.0406374806E-03
310.41987699	D+	3.2214431940E-03
292.99734805	D	3.4130001744E-03
276.55267051	C+	3.6159477258E-03
261.03096180	C	3.8309631665E-03

A= 442

525.62954479	C	1.9024805776E-03
496.12822533	B	2.0156079597E-03
468.28268769	A+	2.1354622459E-03
* 442.00000000	A	2.2624434389E-03
417.19244621	G+	2.3969753266E-03
393.77723344	G	2.5395068965E-03
371.67621557	F+	2.6905138346E-03
350.81563252	F	2.8505001125E-03
331.12586404	E	3.0199996696E-03
312.54119733	D+	3.1995781949E-03
294.99960782	D	3.3898350149E-03
278.44255209	C+	3.5914050941E-03
262.81477247	C	3.8049611542E-03

A= 438

520.87271634	C	1.9198548295E-03
491.63837714	B	2.0340153383E-03
464.04483532	A+	2.1549641842E-03
* 438.00000000	A	2.2831050229E-03
413.41694896	G+	2.4188655122E-03
390.21363856	G	2.5626987403E-03
368.31262990	F+	2.7150847373E-03
347.64083042	F	2.8765320770E-03
328.12924989	E	3.0475795753E-03
309.71277021	D+	3.2287980870E-03
292.32992812	D	3.4207924124E-03
275.92270999	C+	3.6242033142E-03
260.43635824	C	3.8397096578E-03

A= 441

524.44033767	C	1.9067945926E-03
495.00576328	B	2.0201784993E-03
467.22322460	A+	2.1403045640E-03
* 441.00000000	A	2.2675736962E-03
416.24857190	G+	2.4024106448E-03
392.88633472	G	2.5452654155E-03
370.83531915	F+	2.6966147731E-03
350.02193200	F	2.8569638316E-03
330.37671050	E	3.0268477415E-03
311.83409055	D+	3.2068334742E-03
294.33218790	D	3.3975217157E-03
277.81259156	C+	3.5995488699E-03
262.22016892	C	3.8135891839E-03

A= 437

519.68350922	C	1.9242480900E-03
490.51591509	B	2.0386698357E-03
462.98537222	A+	2.1598954524E-03
* 437.00000000	A	2.2883295194E-03
412.47307464	G+	2.4244006736E-03
389.32273985	G	2.5685630395E-03
367.47173349	F+	2.7212977458E-03
346.84712990	F	2.8831145304E-03
327.38009635	E	3.0545534416E-03
309.00566342	D+	3.2361866412E-03
291.66250819	D	3.4286203126E-03
275.29274946	C+	3.6324966856E-03
259.84175469	C	3.8484961787E-03

STANDARD PITCH A=440Hz

A= 440

523.25113057	C	1.9111282166E-03
493.88330123	B	2.0247698140E-03
466.16376151	A+	2.1451688925E-03
* 440.00000000	A	2.2727272727E-03
415.30469759	G+	2.4078706689E-03
391.99543600	G	2.5510501097E-03
369.99442273	F+	2.7027434430E-03
349.22823147	F	2.8634569312E-03
329.62755696	E	3.0337269409E-03
311.12698377	D+	3.2141217322E-03
293.66476797	D	3.4052433559E-03
277.18263104	C+	3.6077296627E-03
261.62556536	C	3.8222564321E-03

A= 436

518.49430211	C	1.9286615030E-03
489.39345304	B	2.0433456839E-03
461.92590913	A+	2.1648493410E-03
* 436.00000000	A	2.2935779817E-03
411.52920034	G+	2.4299612255E-03
388.43184113	G	2.5744542390E-03
366.63083708	F+	2.7275392544E-03
346.05342937	F	2.8897271783E-03
326.63094281	E	3.0615592981E-03
308.29855664	D+	3.2436090876E-03
290.99508826	D	3.4364841206E-03
274.66278894	C+	3.6408281000E-03
259.24715113	C	3.8573230049E-03

A= 435

517.30509499	C	1.9330952076E-03
488.27099099	B	2.0480430303E-03
460.86644604	A+	2.1698260062E-03
* 435.00000000	A	2.2988505747E-03
410.58532602	G+	2.4355473433E-03
387.54094241	G	2.5803725247E-03
365.78994066	F+	2.7338094597E-03
345.25972884	F	2.8963702294E-03
325.88178927	E	3.0685973655E-03
307.59144986	D+	3.2510656601E-03
290.32766834	D	3.4443840841E-03
274.03282841	C+	3.6491978198E-03
258.65254757	C	3.8661904142E-03

A=448H₃ to A=425H₃

A= 434

516.11588788
487.14852894
459.80698294
* 434.00000000
409.64145171
386.65004369
364.94904424
344.46602832
325.13263573
306.88434308
289.66024841
273.40286788
258.05794401

C 1.9375493440E-03
B 2.0527620235E-03
A+ 2.1748256053E-03
A 2.3041474654E-03
G+ 2.4411592035E-03
G 2.5863180836E-03
F+ 2.7401085597E-03
F 2.9030438934E-03
E 3.0756678663E-03
D+ 3.2585565949E-03
D 3.4523204530E-03
C+ 3.6576061097E-03
C 3.8750986869E-03

A= 429

510.16985230
481.53621870
454.50966747
* 429.00000000
404.92208014
382.19555010
360.74456216
340.49752568
321.38686804
303.34880918
286.32314877
270.25306526
255.08492623

C 1.9601315042E-03
B 2.0766869887E-03
A+ 2.2001732230E-03
A 2.3310023310E-03
G+ 2.4696109425E-03
G 2.6164616510E-03
F+ 2.7720445569E-03
F 2.9368789038E-03
E 3.115148111E-03
D+ 3.2965351099E-03
D 3.4925572881E-03
C+ 3.700235516E-03
C 3.9202630073E-03

A= 433

514.92668076
486.02606689
458.74751985
* 433.00000000
408.69757739
385.75914497
364.10814783
343.67232779
324.38348219
306.17723630
288.99282848
272.77290736
257.46334045

C 1.9420240539E-03
B 2.0575028134E-03
A+ 2.1798482972E-03
A 2.3094688221E-03
G+ 2.4467969846E-03
G 2.5922911045E-03
F+ 2.7464367549E-03
F 2.9097483827E-03
E 3.0827710254E-03
D+ 3.2660821296E-03
D 3.4602934794E-03
C+ 3.6660532370E-03
C 3.8840481066E-03

A= 428

508.98064519
480.41375665
453.45020438
* 428.00000000
403.97820584
381.30465138
359.90366575
339.70382516
320.63771450
302.64170239
285.65572885
269.62310474
254.49032267

C 1.9647112507E-03
B 2.0815390612E-03
A+ 2.2053138147E-03
A 2.3364485981E-03
G+ 2.4753810615E-03
G 2.6225748791E-03
F+ 2.7785212966E-03
F 2.9437407704E-03
E 3.1187847056E-03
D+ 3.3042372948E-03
D 3.5007174687E-03
C+ 3.7088809617E-03
C 3.9294225003E-03

A= 432

513.73747365
484.90360484
457.68805675
* 432.00000000
407.75370309
384.86824625
363.26725141
342.87862726
323.63432866
305.47012952
288.32540856
272.14294684
256.86873690

C 1.9465194799E-03
B 2.0622655514E-03
A+ 2.1848942423E-03
A 2.3148148148E-03
G+ 2.4524608665E-03
G 2.5982917784E-03
F+ 2.7527942476E-03
F 2.9164839115E-03
E 3.0899070693E-03
D+ 3.2736425050E-03
D 3.4683034180E-03
C+ 3.6745394713E-03
C 3.8930389586E-03

A= 427

507.79143807
479.29129460
452.39074128
* 427.00000000
403.03433152
380.41375266
359.06276934
338.91012464
319.88856096
301.93459561
284.98830892
268.99314421
253.89571911

C 1.9693124480E-03
B 2.0864138599E-03
A+ 2.2104784840E-03
A 2.3419203747E-03
G+ 2.4811782069E-03
G 2.6287167406E-03
F+ 2.7850283721E-03
F 2.9506347768E-03
E 3.1260886510E-03
D+ 3.311975554E-03
D 3.5089158702E-03
C+ 3.7175668657E-03
C 3.9386248949E-03

A= 431

512.54826653
483.78114279
456.62859366
* 431.00000000
406.80982877
383.97734754
362.42635500
342.08492674
322.88517512
304.76302274
287.65798863
271.51298631
256.27413334

C 1.9510357664E-03
B 2.0670503902E-03
A+ 2.1899636026E-03
A 2.3201856148E-03
G+ 2.4581510309E-03
G 2.6043202975E-03
F+ 2.7591812411E-03
F 2.9232506955E-03
E 3.0970762272E-03
D+ 3.2812379633E-03
D 3.4763505257E-03
C+ 3.6830650850E-03
C 3.9020715316E-03

A= 426

506.60223096
478.16883256
451.33127819
* 426.00000000
402.09045721
379.52285394
358.22187292
338.11642411
319.13940742
301.22748883
284.32088899
268.36318368
253.30111555

C 1.9739352472E-03
B 2.0913115451E-03
A+ 2.2156674007E-03
A 2.3474178404E-03
G+ 2.4870025689E-03
G 2.6348874372E-03
F+ 2.7915659975E-03
F 2.9575611497E-03
E 3.1334268873E-03
D+ 3.3197501459E-03
D 3.5171527620E-03
C+ 3.7262935485E-03
C 3.9478704932E-03

A= 430

511.35905942
482.65868075
455.56913056
* 430.00000000
405.86595446
383.08644882
361.58545858
341.29122622
322.13602158
304.05591596
286.99056870
270.88302579
255.67952978

C 1.9555730589E-03
B 2.0718574841E-03
A+ 2.1950565412E-03
A 2.3255813954E-03
G+ 2.4638676613E-03
G 2.6103768564E-03
F+ 2.7655979417E-03
F 2.9300489528E-03
E 3.1042787302E-03
D+ 3.2888687492E-03
D 3.4844350618E-03
C+ 3.6916303526E-03
C 3.9111461166E-03

A= 425

505.41302384
477.04637051
450.27181509
* 425.00000000
401.14658289
378.63195523
357.38097651
337.32272358
318.39025389
300.52038205
283.65346906
267.73322316
252.70651199

C 1.9785798007E-03
B 2.0962322780E-03
A+ 2.2208807358E-03
A 2.3529411764E-03
G+ 2.4928543397E-03
G 2.6410871724E-03
F+ 2.7981343881E-03
F 2.9645201171E-03
E 3.1407996564E-03
D+ 3.3275613227E-03
D 3.5254284155E-03
C+ 3.7350612979E-03
C 3.9571596003E-03

MAGRATH'S

VEROBOARD FULLY PIERCED copper clad

Part No.	Between Holes	No. of Strips	Size	Pin Size	Price
2/7003	.1"	16 way	17.9" x 3.4"	.052"	\$1.64 each
4/1001	.1"	21 way	18" x 4.8"	.052"	\$2.00 each
6/7006	.1"	24 way	17.9" x 5"	.052"	\$2.25 each
41/1501	.1"	16 way	17" x 2.55	.052"	\$1.16 each
44/1505	.1"	24 way	17" x 3.75"	.052"	\$1.60 each
101/231	.106"	27 way	17" x 4.371"	.052"	\$2.00 each
122	.075"	34 way	17.9" x 3.75"	.040"	\$1.86 each

VEROBOARD PLUG-IN copper clad

Part No.	Between Holes	No. of Strips	Size	Pin Size	Price
202/7011	.1"	16 way	5.1" x 3.4"	.052"	\$1.04 each
241/2502	.1"	16 way	5" x 3.55"	.052"	\$0.93 each
243/2504	.1"	24 way	8" x 3.75"	.052"	\$1.60 each
245/2506	.1"	24 way	3.75" x 3.75"	.052"	\$1.16 each
281/271	.106"	23 way	3.7" x 3.591"	.052"	\$1.13 each
304	.075"	22 way	3.7" x 2.5"	.040"	\$1.04 each

VEROBOARD Copper strips each side

Part No.	Between Holes	No. of Strips	Size	Pin Size	Price
1311	.1"	39 way	8.1" x 8.4"	.052"	\$3.51 each

VERO-EDGE Connectors

To suit Board(s)	Price
304	\$1.88
41/1501	\$3.30
44/1505	\$2.44
281/271	\$3.96
2/7003	\$2.84
6/7006	\$4.20

TERMINAL PINS



2140/3073
To fit a 0.052" (1.32 mm) diam. hole 85c per 100

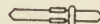

2142
To fit a 0.0375 (0.94 mm) diam. hole 45c per 100.



2141
To fit a 0.052" (1.32 mm) diam. hole 85c per 100.

VEROBOARD PLAIN

Part No.	Between Holes	No. of Strips	Size	Pin Size	Price
402/7022	.2"	16 way	17.9" x 3.4"	.052"	\$1.16 each
403/4001	.2"	21 way	18.0" x 4.8"	.052"	\$1.34 each
441/4501	.15"	16 way	17" x 2.5"	.052"	\$0.78 each
442/4505	.15"	24 way	17" x 3.75"	.052"	\$1.00 each
522	.1"	34 way	17.9" x 3.75"	.040"	\$1.16 each

PIN INSERTION TOOL

Tool No. 2150 is for use with terminal pin 2140/3073, and Tool No. 2151 with terminal pin 2142. \$1.55 each, exempt Sales Tax.

POST FREE 15% Sales Tax Extra

BATTERY SAVERS

A. & R. BATTERY SAVER A/C ADAPTOR

- 6 or 9 Volt (Nominal Voltage) selected by external switch.
- Double insulated for absolute safety.
- Handsome cabinet complete with 3-pin power point plug, and radio lead with lug.
- Measures a compact 3 1/2" x 2 1/2" x 2 1/2".
- Suitable for any 6 or 9 Volt Battery Operated Transistor Equipment.

PS 64 Specially for tape recorders \$14.00
PS 82 Specially for transistor radios \$9.00

RADAR REGULATED BATTERY ADAPTORS

Input 11-15 Volts D.C. Model 912. Output 9 Volts plus-minus 5 per cent D.C. Model 712. Output 7.5 Volts plus-minus 5 per cent D.C. Ideal for Cassette Tape Recorders. Model 612. Output 6 Volts plus-minus 5 per cent D.C. Save your batteries while motoring. Size 2 3/4" x 1 1/2" x 7/8". \$8.75.

Radar Solid State INVERTER

Ideally suitable for use in your car, boat or caravan. With it you can use your Electric Shaver, Tape Recorder, Record Player, Radio, Small P.A. System, Personal Fan or any other A.C. powered unit up to 10watts consumption. Simply connect the Unit to any 12V car battery. The inverter will draw 4 amps, a full load equivalent to the consumption of one headlamp. With a fully charged battery the unit can operate for many hours without danger of battery drainage. \$26.

RADAR 05X POWER SUPPLY UNIT

Designed to operate the majority of ELECTRONIC APPLIANCES — Transistorised Tape Recorders, radios, record-players, small amplifiers, Radiograms, Battery Shavers, and all Battery-operated units of 6 volts, 9 volts and 12 volts at a maximum current of 0.5 amps. The only unit available incorporating these three-power outputs. This unit features full wave bridge rectification with capacitor and choke filtering. Select your voltage by adjusting the Selector switch then plug into any power point. 220 to 250 Volt A.C. Costs 1c per 100 hours — Saves dollars on Battery purchases. Can be used also for car batteries as a trickle charger. \$15.

'STENTORIAN' SPEAKERS

H.F. 1016 STENTORIAN MAJOR SPEAKER

Designed to achieve full range response when mounted in a "compact" cabinet. Cone diam. 10in. Pole diam. 1in. Flux density 15,000 gauss. Total flux 64,000 Maxwells. Impedance coil at 15 ohms. Frequency response 50 c.p.s. to 16,000 c.p.s. in suggested cabinet. 30 c.p.s. to 16,000 c.p.s. in larger cabinet. Capacity 10 watts \$28.50 (including Sales Tax).

Model H.F. 1016 STENTORIAN SPEAKER

10in P.M. Unit and 16,000 gauss magnet. Universal impedance speech coil at 3, 7.5 and 15 ohms. Capacity 10 watts. Frequency response 30 c.p.s. to 15,000 c.p.s. Bass resonance 35 c.p.s. \$21 (including Sales Tax).

Model H.F. 1012 STENTORIAN SPEAKER

10in Unit 12,000 gauss magnet. Universal impedance speech coil at 3, 7.5 and 15 ohms. Capacity 10 watts. Frequency response 30 c.p.s. to 14,000 c.p.s. Bass resonance 35 c.p.s. \$14.00 (including Sales Tax).

Model T.10 STENTORIAN TWEETER

Speech Coil is aluminum wire wound on an aluminum former rigidly fixed to an aluminum diaphragm, giving high standard of reproduction when used with Stentorian H.F. 1016 speakers. Speech coil impedance 15 ohms. Response: 200/15,000 c.p.s. flux density 14,000 gauss. Capacity: 5 watts. \$16.00 (including Sales Tax).

CX 3000 CROSSOVER NETWORK

W./B. Crossover is of the filter type and is fitted to all the Duplex Loudspeakers. It is available for use separately, the 3,000 c.s. type is half section series connected having an attenuation of 12dB per octave. C.X. 3000. \$6.50 (including Sales Tax).

T359 TWEETER

3,000-15,000 c.p.s. Size overall 3 1/2" diam. x 2 1/2" deep Voice coil impedance 15 ohms. \$5.50 (including Sales Tax).
POST FREE ANYWHERE IN AUST.

SCOPE DELUXE

Complete with pouch pack. Stainless barrel. Only 6 seconds INITIAL heat-up time from cold. Exclusive "switch-rings" — no metal to metal contact to burn out.

\$5.95

SCOPE STANDARD

6 second INITIAL warm-up from cold. Performs work of lions requiring up to 150 watts.

\$5.50

MINISCOPE

Light, only 1 1/2ozs. FIVE seconds heat-up time from cold. Ideal for reaching inaccessible spots

\$5.28

Matching "Scope" 3.3V transformer designed for these "Scope" products

\$7.65

VIBROSCOPE

Protects your property by etching on any metal, ferrous or non-ferrous or annealed, dull or polished. Produces deep penetration — lasting results

\$3.50

• All Post free anywhere in Australia.

VOLTAC Variable Autotransformers

FREIGHT and 15% SALES TAX EXTRA ALSO 3 PHASE COMBINATION P.O.A.

TYPE	In V	Out V	Current	CAP. VA	Price Sales Tax Extra
P1 Panel Mounting	230	0.260	0.5 Amps	100	\$ 9.75
BP3 "	"	"	1.5 Amps	300	\$ 14.60
BP5 "	"	"	2.5 Amps	500	\$ 17.55
SB5 Bench Mounting	"	"	5.0 Amps	1000	\$ 24.95
SB10 "	"	"	10.0 Amps	2000	\$ 47.15
B15 "	"	"	15.0 Amps	3000	\$ 61.45
B25 "	"	"	25.0 Amps	5000	\$108.90

J. H. MAGRATH & CO. PTY. LTD.

208 LT. LONSDALE STREET, MELBOURNE, VICTORIA, PHONE 663 3731

A FILTER TUNER ONE VALVE RECEIVER

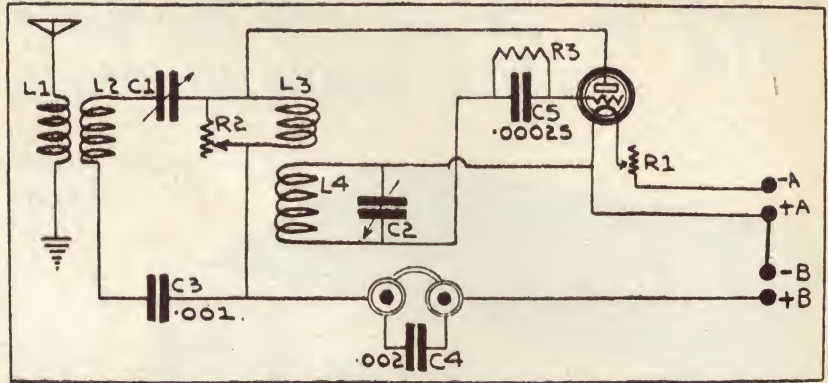

Of all wireless sets, from crystal sets to multivalve sets, there is a strong fascination for a single valve receiver. Close to a high power broadcasting station reasonably good loudspeaker results may be expected from a one-valve set. But the owner must be within two miles of this station. The other day the writer listened to a loudspeaker operated by a crystal set, but it was situated right under 2BL's mast. This, of course, is the exception rather than the rule.

When speaking of one-valve sets, the first question asked by the uninitiated is generally, "Will it work a loudspeaker?" Now this question is hard to answer with any degree of authority. It is realised that situation plays a most important part. If the operator lives under the shadow of a big broadcasting station it is possible to have a loudspeaker coupled to a single-valve receiver with quite good results. But again, if one is between 10 and 50 miles away, earphone strength only is available.

Phone strength again is most satisfactory. And if the owner wishes loudspeaker strength the addition of one or two stages of audio amplification will produce wonderful loudspeaker results. Still reverting back to the one-valve loudspeaker results here is an interesting experience which befell the writer, and is worth while relating.

During the cyclonic disturbance which happened during the Easter holidays, the writer's aerial, situated right on the top of a hill in an exposed position, crashed—through the roof by the way. The aerial itself, lying over clothes lines and on the sodden lawn, was to all intents and purposes, rendered useless. Forgetting this fact

altogether, on Easter Sunday, the Cock-a-day One Valver recently described, was connected up and by dint of careful tuning and hard effort, 4QG was tuned in. This again proved an exception rather than a rule, but it goes to show that even with a poor aerial reception is still available.

Nevertheless, when the fallen aerial was re-erected temporarily, the volume from 4QG was increased in an astounding measure, which indicates that a good aerial plays a most important part. So remember when building this or any other set, that much better results will accrue from a good aerial than from an inferior one and volume counts to a marked degree.

The time once was when a one-valve receiver had associated with it numerous controls and projecting coils, which had to be movable in relation to one another. This action called for a certain amount of juggling which took quite some time to understand. The trend of radio development today is such that simplicity is the keynote aimed at. Combined with sim-

plicity should be the all important factors, sensitivity and selectivity. These are included in the receiver of this week.

The parts required are published elsewhere in this article, and while no brands are given, the constructor is adjured to use only good parts. The condensers, for example, make a big difference in reception, particularly in

- 1—Dilecto or Radion Panel, 12in. x 7in. x 1/8in. or 3/16in.
- 1—6in. Length of 3in. Diameter Dilecto or Radion Tubing.
- 1—4in. Ditto.
- 1—.0005 Variable Condenser with Dial.
- 1—.00025 Variable Condenser with Dial.
- 1—Bradleyohm 10.
- 1—Bradleystat.
- 1—.00025 Fixed Condenser.
- 1—.001 Fixed Condenser.
- 1—.002 Fixed Condenser.
- 1—Valve Socket.
- 1—30 ohms. Rheostat.
- 1—Terminal Board with Eight Terminals.
- 1—Baseboard, 11in. x 9in. x 1/4in. Sundry screws, busbar, etc.
- 1lb No. 20 D.C.C. Wire.

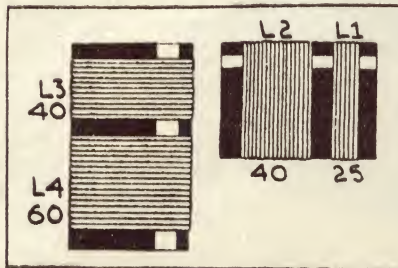

Details of the coils and formers referred to in the article.

This article is reprinted from "Wireless Weekly," April 29, 1927. We have tried to follow the original presentation — heading, layout, diagrams, etc. — as closely as possible, "warts and all." It should appeal to newcomers and old-timers alike. It will give newcomers a good indication of what radio was like more than 40 years ago, as well as providing material for what could be a very interesting project; the reconstruction of a piece of historical equipment.

For old-timers it will provide nostalgic memories: of the emphasis on interstate reception, without which no receiver description was complete; of the elusive one valve loudspeaker receiver, a much sought-after goal which few achieved; of the uncomplicated valve type situation whereby the author of this article did not see fit to even quote a type number, but simply write "any of the well-known makes . . . will do." Ah yes, those were the days!

relation to selectivity, and to this end we recommend such brands as Heath, Advance, Pilot or Igranic. These are very reliable and can be trusted to do good work as well as last for years. There is nothing more annoying than poor condensers, which have their plates touching at different places, so obviate this by purchasing good quality lines at the beginning — it is cheaper in the long run.

The variable resistance is a very necessary article. We have specified a Bradleyohm 10, but if a good variable resistance of from 10,000 to 100,000 ohms. is on hand, use it by all means.

Let us look at the circuit for a moment and analyse its properties. In L1 we have an untuned aerial coil and L4 is the secondary coil tuned by the .00025 variable condenser. The two intermediate coils, L3 and L4, are filter coils. Now the signal from the aerial passes through the untuned primary coil and is filtered from other signals



PIONEER

the first family of stereo



PIONEER MODEL SA900 200 WATT SILICON SOLID STATE PRE-MAIN STEREO AMPLIFIER

One of Pioneer's most advanced amplifiers. Professional features neatly compacted into an all solid state set. Presenting a Powerful, flexible 200 watt integrated amplifier. Finest, most expensive materials have been used, from the low noise silicon transistors to the special Brazilian rosewood front panel. The control amplifier has FET and advanced 3-stage E-S (Emitter.Source) feedback circuitry. The pre and main amplifiers can be used independently.

PIONEER MODEL SA500 44 WATT SOLID STATE STEREO INTERGRATED AMPLIFIER

This is an efficient medium-range pre/main amplifier built to very high specifications for this size of unit. It has a set of controls, inputs and outputs for versatile operation of speakers and tape recorders. Main amplifier total power is strong at 44 watts (at 4 ohms). Circuitry is all solid state and includes low-noise silicon transistors. For those who want to enjoy full stereophonic realism the SA500 is the set.



PIONEER MODEL SA700 120 WATT INTEGRATED AMPLIFIER SOLID STATE

Designed to more than meet all demands of modern stereo. First, there's power, a full 120 watts of non-clip music power (at 4 ohms). Secondly, Pioneer uses the finest, most expensive material, such as selected low noise transistors and FET in the control amplifier section. Third, the most advanced circuitry, a 3 stage E-S (emitter-source) feedback circuit control amplifier is typical.



ALL PIONEER AMPLIFIERS ARE TAILORED TO SUIT A RANGE OF MATCHING SPEAKERS OF ALL SIZES FOR MAXIMUM STEREO PERFORMANCE.



PIONEER

THE QUALITY NAME IN HI-FI MUSIC EQUIPMENT

WRITE FOR THE NAME OF YOUR NEAREST PIONEER DEALER.

SOLE AUSTRALIAN REPRESENTATIVES —

ASTRONICS AUSTRALASIA PTY. LTD. (ALL STATES)
DIVISION OF ELECTRONIC INDUSTRIES LIMITED.

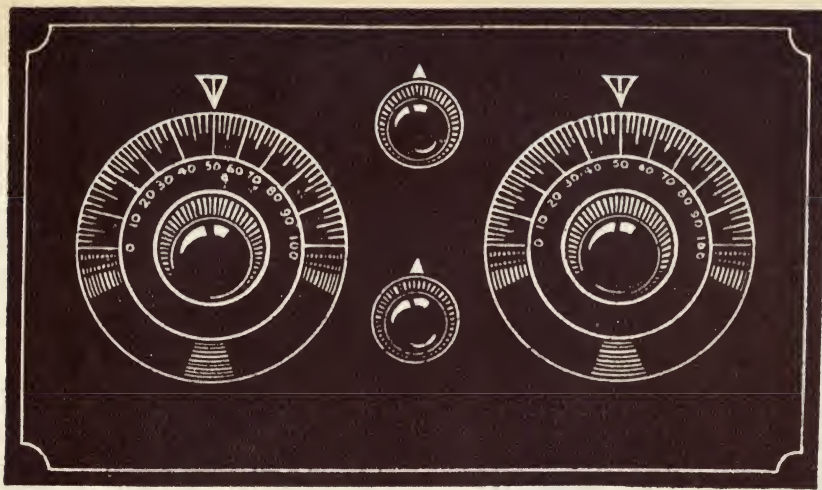

The front panel view.

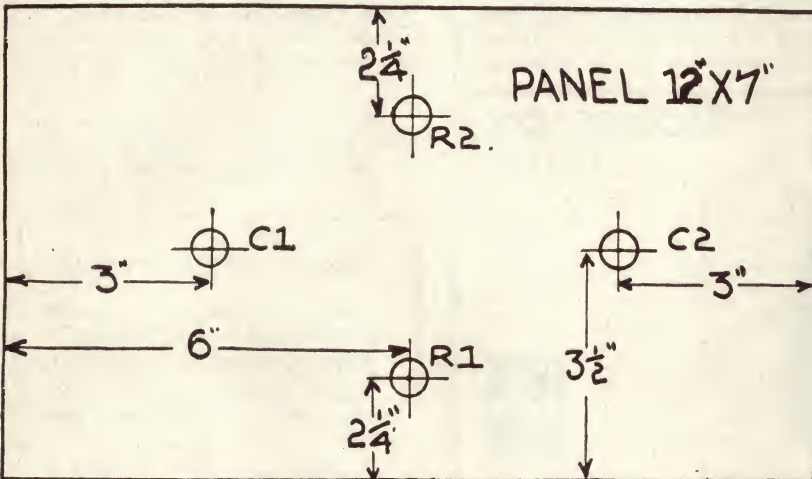

The panel drilling template

by two intermediate or linking coils (L2 and L3) before it reaches the secondary coil (L4). Two features of the filter tuner, giving it a unique place in radio, are the arrangements for reducing the resistance of the linking circuit and for controlling the current used for the purpose. Increased selectivity without loss of volume is accomplished by including one of the linking coils in the plate circuit. Think of the selective qualities of the Marnikay and the Extraordinary One Valver. These are on a par.

The variable resistance controls the strength of the magnetic field produced by the second filter coil L3, which, in turn affects the entire filter circuit. This controls regeneration and volume.

The construction of this receiver may be tackled by the veriest novice. Only the usual household tools are necessary and provided the parts are on hand and provided again the instructions are followed with reasonable intelligence, no difficulty should be met with in building a really efficient receiver.

The panel should first of all be marked out and drilled. A centre punch or a nail is pressed into service to make the small indentations on the panel in exact accordance with the panel drilling diagram accompanying this article. The panel being laid on a flat surface,

such as a table, should be drilled with a high speed and a slow pressure. It will be noticed that on the panel there is provision for two condensers and the rheostat or Bradleystat and the variable resistance or Bradleyohm — all the terminals, including aerial and earth, and phone terminals, are at the back of the set.

Mount this apparatus on the panel and leave on the one side until the

coils are wound. For this purpose the Dilecto tubing is required. Wind the six inch former first with coils L3 and L4. At a distance of three-eighths of an inch from one end drill two small holes $\frac{1}{4}$ an inch apart and thread the beginning of the No. 20 D.C.C. wire through each hole, to hold it securely. Now wind on 40 turns, each turn close to the other, and finish off by securing through two more holes. One quarter of an inch away begin winding L4, which consists of sixty turns of the same gauge wire. On the 4 inch former wind 25 turns for L1 and a quarter of an inch away start L2, which boasts of 40 turns. Small terminals or contact studs are very useful for connections, and they may be fixed on the tube in each instance, 8 altogether being required.

Prepare the baseboard by sandpapering the surface and treating it to a coat of shellac or some other quick-drying varnish. Lay out on the baseboard the valve socket and the coils. A small grid leak clip may be improvised as a bracket to secure the 6in former to the baseboard and two pillars about $1\frac{1}{2}$ or 2in long are handy to raise the 4in former off the baseboard. Long wood screws will fix this unit to the board through the pillars, which may consist of short lengths of $\frac{3}{8}$ in diameter fibre tube. Raise this 4in former off the baseboard with L2 running opposite to L3, and at right angles thereto. This will be found the best position. The back of panel view is slightly out of alignment to show the position of the variable condenser (.0005 mfd.), but otherwise the layout is quite correct. Follow this out correctly and then begin the wiring.

The wiring is quite simple and easy. Fix the panel to the baseboard and gather together the pliers, soldering outfit and busbar. Study carefully the back of panel wiring diagram, the circuit diagram and reconcile with the wiring instructions appearing elsewhere. Solder neatly and carefully, crossing out on the diagram each wire as it is installed. If using busbar, make neat right angled bends and keep all wiring as low as is possible. Complete the wiring and check over carefully, then test out.

Insert a valve in the socket. Any

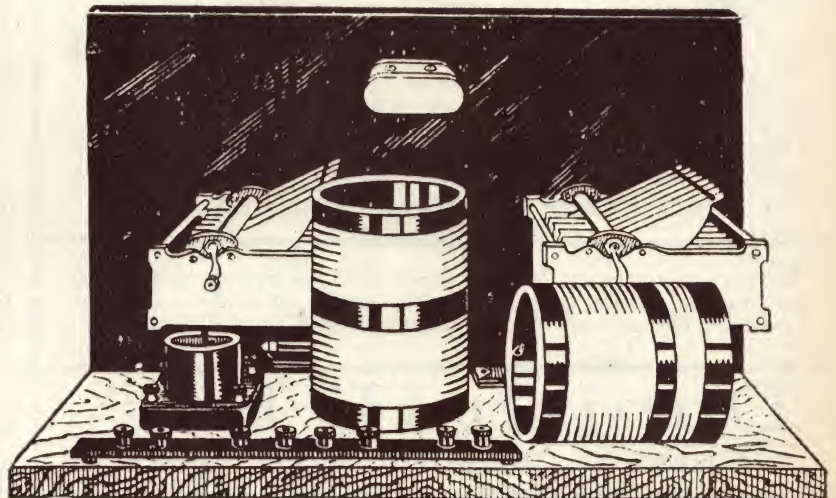

Layout of the apparatus.

DISTINCTION IN DESIGN AND QUALITY



BEOGRAM 1500



A compact stereo unit consisting of a 3-speed belt driven turntable with cover, ST/L low mass arm, built-in anti-skate and SP 7 or SP 9 magnetic cartridge, hydraulic arm lift and solid state 2 x 8 watts R M S amplifier, tape and radio connections. The reproduction is excellent, particularly with Beovox speakers.



BEOCORD 2000
DE LUXE



The finest taperecorder you can buy: All solid state circuitry with professional specification. Built-in 4-channel mixer section with twin faders, 4 heads, 3 speeds multiplayback, synchroplayback, echo. Professional swing arms take up tape slack, ensure absolutely smooth running. Built-in transformerless output amplifier with 2 x 8 watts R M S and electronic overload protection.



DYNACO STEREO
AMPLIFIER SCA-35



A high quality stereo amplifier from the U.S.A. - 35 watts continuous, 45 watts IHF music power. Frequency range 20 Hz - 20 kHz within 1 db of 17.5 watts (each channel). Unmeasurable distortion at normal listening levels. Inputs for ceramic and magnetic cartridges. Available in kit form or assembled.

AN EXTENSIVE RANGE OF STEREO SYSTEMS IS AVAILABLE AT:

Australia's largest range of High Grade Danish stereo equipment now on display in our showroom, including the most outstanding amplifier and speaker system ever produced for domestic use:- Beolab 5000 amplifier and Beovox 5000 speakers.

Danish Hi-Fi Pty. Ltd.

941 BURKE RD., CAMBERWELL 3124. TEL: 82 4839

of the well-known makes of valves will do, a Mullard, Osram, Radiotron, or De Forest, all being worth while. To the A. battery terminals linkup the A. battery required for the valve used. The B. battery may be between 22 volts and 67 volts, according to the valve used.

Hook on aerial and earth and connect the phones to their respective terminals. Turn up the rheostat and turn the two dials slowly. Keep the .0005 condenser a little in advance of the .00025 or secondary condenser, and a station will soon be located. Tuning is very critical, remember, and when the station is received it may be very mushy. Clear this up by slowly and fractionally (spare the word) turning back the left hand condenser (.0005), when good reception will result.

Carefully adjust the variable resistance until a point is reached where all broadcast signals may be heard without further adjustment. Don't forget that this variable resistance controls the volume as well as the regeneration—you won't be likely to forget it after the first hour or so.

After a while the operator will develop a system of tuning of his own, but the foregoing remarks regarding

WIRING INSTRUCTIONS

Aerial terminal to outside (beginning) of L1 (25 turns).

Earth terminal to end of L1.

Joint beginning of L2 to moving plates of .0005 mfd condenser.

Connect the fixed plates of .0005 mfd condenser to top of L3 thence to plate of valve socket, thence to one side of variable resistance.

Link bottom of L2 to one side of .001 mfd fixed condenser, the other side of which goes to one side of phones and thence to remaining side of the variable resistance, and to bottom of L3.

Join top of L4 to moving plates of .00025 mfd variable condenser, thence to F positive terminal of valve socket, thence to A positive terminal or terminal board which terminal is joined to B-terminal adjacent.

Connect bottom of L4 to fixed plates of .00025 variable condenser, thence to one side of grid condenser (.00025 fixed), the other side of which joins to the grid terminal of valve socket.

Connect remaining F terminal of valve socket to one side of the rheostat, the other side of the rheostat being connected to the A minus terminal of terminal board.

Connect B positive terminal of terminal board to the remaining phone terminal.

Link the .002 mfd fixed condenser across the phone terminals and the wiring is completed.

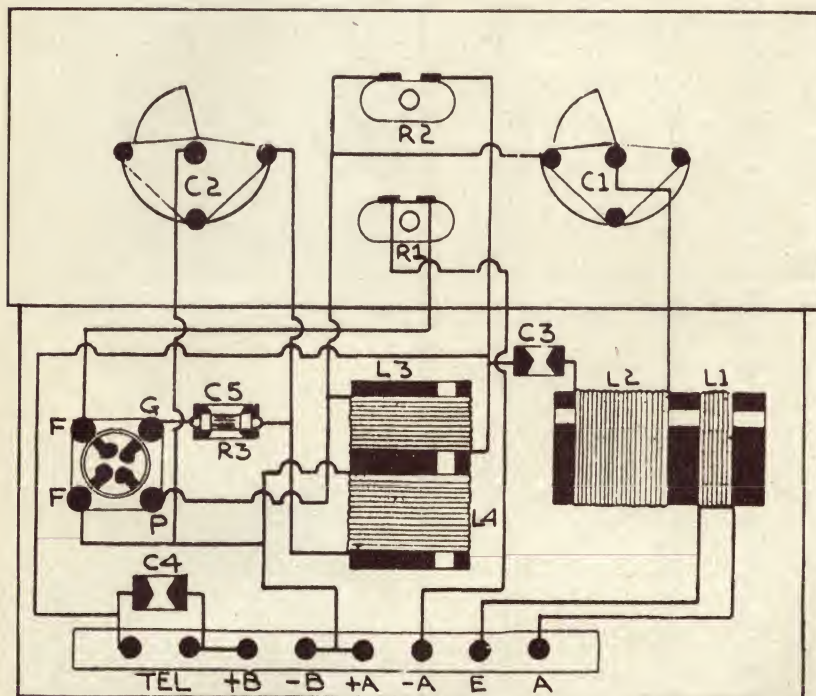
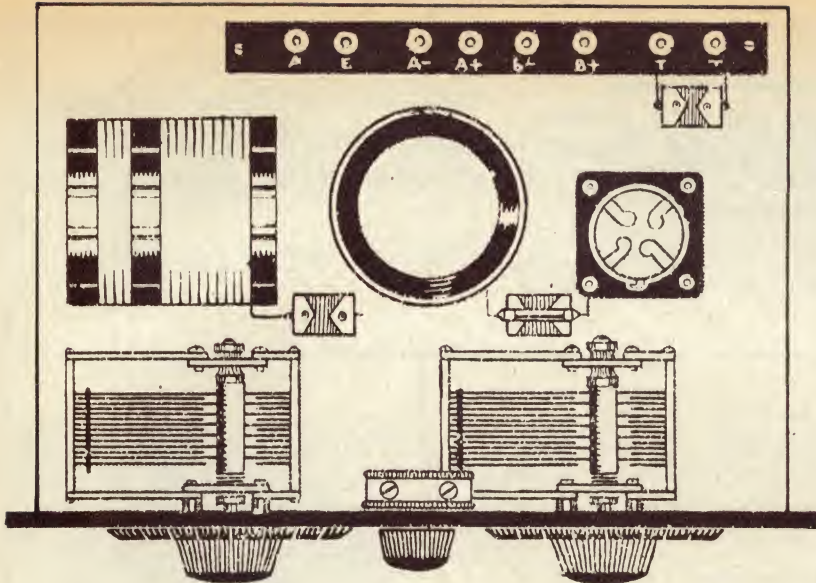

tuning will prove of great assistance. A long aerial may be used with advantage, as none of the interfering problems common to other one valve sets are encountered.

This was proved at Marrickville on test, as 3LO, 4QG, and 5CL were nicely heard on the phones. The filter circuit requires careful tuning. This is a really good set, and is to be recommended.

EDITOR'S NOTE: The circuit for this set is a rather unusual one, even by the standards of 1927. It appears to be a rather cunning arrangement whereby the function of a preselector stage, main tuning stage, and regeneration were all achieved with only four windings and a minimum of other components. Assuming that everything worked out as intended — and we have no reason to doubt that it did, at least as far as the original model was concerned — then it should have provided quite a high order of performance.

If attempting to duplicate the original construction it may be difficult to obtain all the parts of this vintage, and some compromise may be necessary. On the other hand, it is surprising just how many old parts one can unearth when one starts looking in earnest. And, in any case, there is no "exact" version of the set since, even at the time it was described, no two constructors would have produced identical models.

The absence of a specific valve type number would have been less of a problem in those days than it is now, since there were relatively few types available and roughly, two broad classifications; detector or "general purpose" valves, and power valves. Typical detector valves advertised at the time were: Radiotron UX200A, UX201A, UX199; Philips A609, and "Philips Supreme Detector valve" (no type number); Mullard PM3 and PM5; de Forest DL5; and the Q.R.S. Super Detector (no type number).

up to ten times longer life



MAXELL Alkaline Dry Cell — this unique new design concept features high capacity and durability that surpasses the performance of the world's top dry cell batteries. The construction of the Maxell Alkaline Dry Cell differs greatly from conventional types of carbon ZINC cells. However, the Maxell Alkaline cells can be used where you normally use a carbon ZINC cell. MAXELL ALKALINE CELLS are especially suitable where there is a demand for increased current, combined with durability and little voltage drop. Even near the end of the cell life the discharge capacity is large and stabilized.

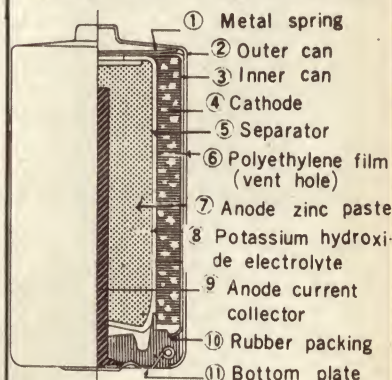

Exclusive new construction minimises leakage. Double cans are used and rubber sealing with the unique spring safety device. (see diagram)

Interior drying is prevented by hermetic sealing, therefore long storage periods are possible (over two years). Even then Maxell Alkaline cells are in the same condition as when they left the production line. These cells will withstand severe temperature changes. Rigid tests have shown extremely stabilized capacities from the low temperature of -4F to the high temperature of 150F at which temperatures dry cells would fail to operate satisfactorily.

Prices:
AM1 75c
AM2 50c
AM3 40c

Grade enquiries to
TASMANEX PTY. LTD.
376 Pittwater Road, Harbord 2096



**PROUDLY PRESENTS THEIR
NEW RANGE OF APPROVED
STEPDOWN TRANSFORMERS**

All transformers in this range are suitable for connecting to a 240 volts, 50 Cycles, Single phase supply and, where applicable, comply with Australian Standard C126 - 1950 under approved Number N158.

SECONDARY VOLTS	TYPE NO.	RATING DIMENSIONS					WEIGHT LBS.
		V.A.	AMPS	H.	W.	L.	
FUSEMASTER RANGE - Enclosed in Steel Cases							
6	TS6/60B	60	10	5	3 $\frac{1}{2}$	7	6 $\frac{1}{2}$ lb.
12	TS12/12B	12	1	2 $\frac{1}{4}$	2 $\frac{1}{2}$	5 $\frac{1}{2}$	2 $\frac{1}{2}$ lb.
12	TS12/30B	30	2.5	4 $\frac{1}{2}$	3	6	4 lb.
12	TS12/60B	60	5	5	3 $\frac{1}{2}$	7	6 $\frac{1}{2}$ lb.
12	TS12/125B	125	10.42	5 $\frac{1}{4}$	4 $\frac{1}{4}$	9	11 $\frac{1}{4}$ lb.
24	TS24/30B	30	1.25	4 $\frac{1}{2}$	3	6	4 lb.
24	TS24/60B	60	2.5	5	3 $\frac{1}{2}$	7	6 $\frac{1}{2}$ lb.
24	TS24/125B	125	5.2	5 $\frac{1}{4}$	4 $\frac{1}{4}$	9	11 $\frac{1}{4}$ lb.
24	TS24/200B	200	8.33	5 $\frac{1}{4}$	4 $\frac{1}{4}$	9	14 $\frac{1}{2}$ lb.
32	TS32/30B	30	.94	4 $\frac{1}{2}$	3	6	4 lb.
32	TS32/60B	60	1.88	5	3 $\frac{1}{2}$	7	6 $\frac{1}{2}$ lb.
32	TS32/125B	125	3.9	5 $\frac{1}{4}$	4 $\frac{1}{4}$	9	11 $\frac{1}{4}$ lb.
32	TS32/200B	200	6.25	5 $\frac{1}{4}$	4 $\frac{1}{4}$	9	14 $\frac{1}{2}$ lb.
32	TS32/300B	300	9.4	5 $\frac{1}{4}$	4 $\frac{1}{4}$	9	18 lb.
32	TS32/500A	500	15.6	6 $\frac{1}{4}$	5 $\frac{1}{2}$	6 $\frac{1}{2}$	26 lb.
32	TS32/750A	750	23.44	8 $\frac{1}{4}$	6 $\frac{1}{4}$	6 $\frac{1}{4}$	38 lb.
32	TS32/1000A	1000	31.35	8 $\frac{1}{4}$	6 $\frac{1}{4}$	8 $\frac{1}{4}$	51 $\frac{1}{2}$ lb.
115	TS115/30B	30	.26	4 $\frac{1}{2}$	3	6	4 lb.
115	TS115/60B	60	.52	5	3 $\frac{1}{2}$	7	6 $\frac{1}{2}$ lb.
115	TS115/125B	125	1.09	5 $\frac{1}{4}$	4 $\frac{1}{4}$	9	11 $\frac{1}{4}$ lb.
115	TS115/200B	200	1.74	5 $\frac{1}{4}$	4 $\frac{1}{4}$	9	14 $\frac{1}{2}$ lb.
115	TS115/300B	300	2.61	5 $\frac{1}{4}$	4 $\frac{1}{4}$	9	18 lb.
115	TS115/500A	500	4.35	6 $\frac{1}{4}$	5 $\frac{1}{2}$	6 $\frac{1}{2}$	26 lb.
115	TS115/750A	750	6.53	8 $\frac{1}{4}$	6 $\frac{1}{4}$	6 $\frac{1}{4}$	38 lb.
115	TS115/1000A	1000	8.7	8 $\frac{1}{4}$	6 $\frac{1}{4}$	8 $\frac{1}{4}$	51 $\frac{1}{2}$ lb.
115	TS115/2000A	2000	17.4	10 $\frac{1}{2}$	8 $\frac{1}{4}$	8 $\frac{1}{4}$	79 lb.

SOLDERING IRON TRANSFORMERS - Enclosed in pressed steel cover - suitable for Mico or Oryx Soldering Irons.

5, 6, 7,	TS7/20	20	2.85	3 $\frac{1}{4}$	2 $\frac{1}{2}$	2 $\frac{1}{4}$	2 $\frac{1}{2}$
10, 11, 12,	TS12/40	40	3.33	3 $\frac{1}{4}$	2 $\frac{1}{2}$	3 $\frac{1}{4}$	3 $\frac{1}{2}$

FERGUSON TRANSFORMERS PTY. LTD.

331 HIGH STREET, CHATSWOOD, N.S.W., 42-0261.

Agents in all States.

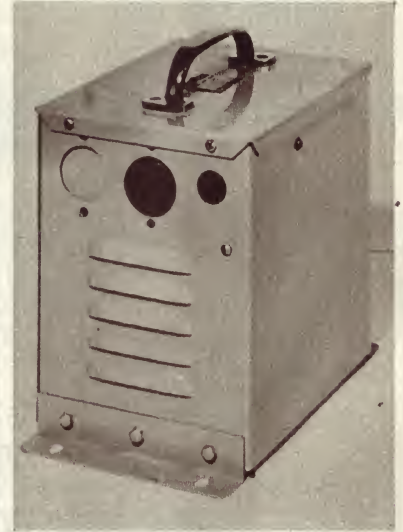

"A" TYPE TRANSFORMER



"B" TYPE TRANSFORMER

FERGUSON TRANSFORMERS PTY. LTD.

331 HIGH STREET, CHATSWOOD, N.S.W. • POST OFFICE BOX 301, CHATSWOOD. TELEPHONE: 40-0261 (8 LINES).

AGENTS

TASMANIA: Associated Agencies Pty. Ltd., 25 Barrack Street, Hobart, 7000. 'Phone: 2-1843.	A.C.T.: Errol Nazer Pty. Ltd., 84 Barrier Street, Fyshwick, 2600. 'Phone: 9-0325.	QUEENSLAND: Keith Percy & Co. Pty. Ltd. Waterloo Street, Newstead, 4006. 'Phone: 51-5461.	WESTERN AUSTRALIA: Athol M. Hill, 613 Wellington Street, Perth, 6000, 'Phone: 21-7861.	SOUTH AUSTRALIA: Wm. M. Mathew Pty. Ltd., 12 French Street, Adelaide, 5000. 'Phone: 23-6202.	VICTORIA: Ferguson Transformers Pty. Ltd. 181-183 Hawke Street, West Melbourne. Phone: 329-7437, 329-6415
--	--	--	---	---	--



A READER BUILT IT

A capacitor-discharge transistor ignition system

In view of the healthy interest evident in transistor ignition revealed in recent correspondence, this contribution from a reader for a capacitor-discharge system is timely.

After investigating the economics and performance of the various transistor ignition systems, I have concluded that the only worthwhile set-up is the so-called "capacitor-discharge" system. This costs a little more to construct than the standard transistor ignition but the saving in not having to purchase a special coil largely compensates for this. As far as efficiency is concerned, it wins hands down every time, and must therefore be the logical choice for anyone who is dissatisfied with the standard ignition on his car.

The system to be described is reasonably inexpensive to construct and is reliable in operation. It is absolutely conventional in all respects, simple to put together and easy to get working if the layout and instruction are followed reasonably closely.

The heart of any capacitor-discharge system is the converter circuit whose function is to step up the 12V DC from the battery to 250-300V DC ready for application to the coil primary. The circuit shown here is a push-pull transformer-coupled converter utilising square-loop material for the transformer core. (3E grade ferrite is used, as it is cheap and although it does not have a strictly "square" hysteresis loop, its saturation level is well defined and it is quite satisfactory for this application). A description of the operation of the converter can be found in almost any book on transistor theory so will not be repeated here.

The transformer must be carefully hand-wound on a ferrite toroid of dimensions shown (figure 1) and of 3E grade ferrite. A suitable core is supplied by Mullard and is obtainable for about 60c. Wind the primary on first. This consists of two coils, bifilar wound, of 20 turns each of 22SWG copper wire. Wrap it up with plastic tape to hold it in place. Then wind a base-drive winding of six turns of the same wire at each end of the primary. Make sure all the ends are identified in some way, a bit of coloured sleeving is ideal for this, and tape the whole thing so far. The secondary may now be wound to fill the rest of the available space. That is several layers adding up to 450 turns of 29SWG. Having completed this the whole thing may be taped up to hold it all together, and some robust

lengths of wire soldered to the ends of the secondary to prevent the fine wire being broken in an awkward place. The transformer may then be mounted on a piece of Veroboard as shown in figure 6. Assemble the rest of the converter components on the Veroboard including the diodes and the 330K resistor, fit the transistors to the case-cum heat sink and wire them up to the board with long leads.

Check all the wiring so far and, if O.K., connect a 12-volt battery to the circuit (observing the correct polarity).

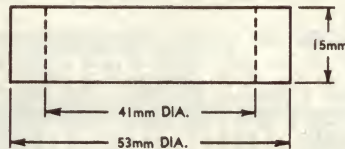
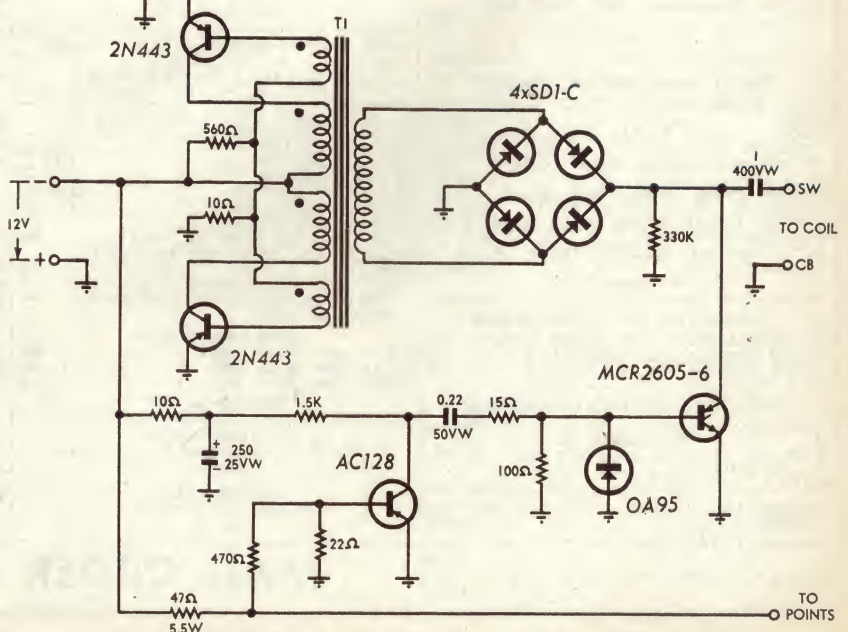

Figure 1

ABOVE: Figure 1. The ferrite toroid, with dimensions.

BELOW: Figure 2. The circuit diagram for use with a positive earth system.



Parts List

- Converter transformer
Core — Mullard. (See Editor's note overleaf.)
Primary 40T CT, 22SWG bifilar wound
Base drive — 6T 22SWG (2 windings)
Secondary — 450T 29SWG.
- Semiconductors
2 x 2N443 Transistors
1 x AC128 Transistor
4 x SD-1C Diodes (any 500mA 400PIV type)
1 x SCR — Motorola type MCR-2605-6 (any 400V 6A type will do)
1 x Diode, OA95, OA85, or similar.

- Resistors
1 x 330K, 1 x 1.5K, 1 x 560, 1 x 470, 1 x 100, 1 x 47 (5.5 watt), 1 x 22, 1 x 15, 2 x 10 (values in ohms, all ½ watt unless otherwise stated.)

- Capacitors
1 1uF/400V polycarbonate
1 0.22uF/50V polycarbonate
1 250uF/25V electrolytic

- Sundries
Veroboard, screws, etc.
Aluminium case measuring 5½" x 4" x 1½".

UHER

TAPERECORDERS

Made in Western Germany

"The World's Most Reliable Name for Precision Taperecorders"

NOW every Amateur and Enthusiast can benefit from this experience because

ATRAM PTY. LTD.

presents to you

ACTION and SOUND

with the NEW BREED styled Uher Taperecorders available to you without restrictions!

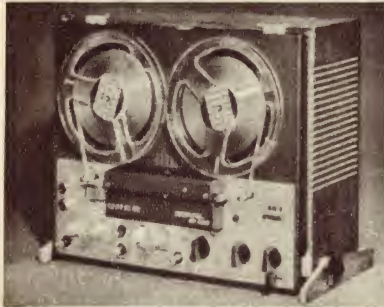

All New Uher Royal Deluxe Stereo

Stereo Home Studio of the ultimate hi-fi class 20 watts rms push/pull output by separate amplifier—fully transistorised—4 or 2 track operation (stereo)—4 speeds—4 heads—A & B monitoring—4 amplifiers—VOR—11 exclusive recording functions, operated by one control—all new tape comparator—dia pilot-echo sound mixing—frequency response 20-20,000 cps at 7½ ips. Teakwood cabinet, can be hung on wall.

ATRAM PTY. LTD.

Sole Australian Importer and General Agent.
5 McLaren Street, North Sydney, Tele.: 92-4177.

N.S.W.: John Border Photographics Pty. Ltd.,
175 Liverpool Street, Sydney.
Tel.: 26-1106.
N.S.W.: Milversons Sound Centre,
791 Pacific Highway, Chatswood.
Tel.: 41-4365.
N.S.W.: Glen Dor Camera Centre,
43 The Corso, Manly.
Tel.: 92-2709.
A.C.T.: Canberra Sound & Recording Service.

109 Malura Avenue, Dickson,
Vic.: 45980.
VIC.: Atram Pty. Ltd.,
1 Corr Street, Moorabbin.
Tel.: 95-5633.
VIC.: Klapp Electronics Pty. Ltd.,
224 Chapel Street, Prahran.
Tel.: 51-4653.
S.A.: Kallin Distributors (W./S.) Pty. Ltd.,
140 Gawler Place, Adelaide.

Tel.: 8-7171 (11 lines).
W.A.: Alberts TV and Hi-Fi Centre Pty. Ltd.,
282 Hay Street, Perth.
Tel.: 21-5004.
QLD.: A. E. Harrold Pty. Ltd.,
123-125 Charlotte Street, Brisbane.
Tel.: 31-3081.
N.T.: N.T. Musical & Electrical W./S. Pty.,
Ltd., 54 Cavanagh Street, Darwin.
Tel.: 3072.

Homecrafts FOR RADIO PARTS

289 Elizabeth St. Melbourne. Phone 60 1442

PIEZO PICK-UP AND CARTRIDGES

PU-86 Pickup LP/78 T/O Crystal
cartridge. Length 240mm Ea. \$2.99
Y700 Ceramic Cartridge, Mon. LP/78 . \$3.00
PU-86 Pickup Ster-LP/78. T/O Cartridge,
Length 204mm Ea. \$4.00
Y200 Ceramic Cartridge. ST LP/78 . \$4.00
Y400 Crystal Cartridge. LP/45 . \$2.00
Y130 Crystal Cartridge. T/O Type Ster/
LP Ea. \$2.70
Sapphire Replacement Styl. Each Ster/
LP Plus postage 15c.

PIEZO MICROPHONE INSERTS

MC-3 Crystal, 50-7K, 35 x 25 x 8mm. -57
DB \$1.00 ea.
MC-7 Crystal, 100-7K. 39mm Round x 11
mm. -56 DB \$1.00 ea.
MC-8 Crystal, 50-8K. 48mm Round x 17mm.
-50 DB \$1.20 ea.
MC-9 Crystal, 50-8K, 25mm Round x 9mm.
-68 DB \$1.80 ea.
MC-33 Crystal, 50-10K, 33mm Round x 9m
-60 DB \$1.60 ea.
MD-5 Dynamic, 100-15K. 33mm Round x
14mm. -55 DB \$2.00 ea.
Plus postage 20c.

TRANSISTOR SET ACCESSORIES

Magnetic Earpiece with 3.5mm Plug . . 75c
Crystal Earpiece with 2.5mm Plug . . . 75c
Crystal Earpiece with 3.5mm Plug . . . 75c

LAFEL TYPE CRYSTAL MICROPHONE

With 3.5mm Plug 75c ea.
Fuses for Japanese equipment 1A, 3A, 5A
5c pkt of 5 Plus postage 10c.

Michigan/Collard—Twin	Track	Rec./Play
Heads		\$8.50
Michigan/Collard—Twin	Track	Erase
Heads		\$3.00
Michigan/Collard—Four	Track	Erase
Heads		\$8.50

12-Pin Wafer Sockets. 20c ea.
12-Pin Plugs . 25 ea.
Plus postage 10c.

OCTAL PLUG AND CORD

Ext. Socket.
45c pr. Plus postage 10c.

ALL TYPES AMPHENOL PLUGS AND SOCKETS

Carried in stock.
Plugs 27c ea. Sockets 30c ea. Meall Covers for
same 27c ea.
Plus postage 10c.

HALF-INCH MINIATURE PLUGS AND SOCKETS

2, 3, 4 and 5-Pin Plugs 10c ea.
Sockets 10c ea. Plus postage 10c.

ELECTROLYTIC CAPACITORS IN METAL CANS

16 + 16 450 VW 95c ea.
32 + 32 450 VW \$1.30 ea.
50 + 50 450 VW \$1.85 ea.
50 + 50 + 50 350 VW \$1.90 ea.
100 MFD P.V.C. Cover \$1.15 ea.
Jacks, 2.5 and 3.5mm 20c
3.5mm Plug and Cord Ext. Jack Pair . . 50c
Metal Co-axial Plugs and Line Sockets
Pr. 65c
"Din" and "Hirschmann" 2, 3, 4 and
5-pin Plugs, Chassis and Line Sockets,
carried ex stock.

Prices on application.

P.M.G. type Plugs from 50c
P.M.G. type Jacks from 35c
P.M.G. Line Jacks from 55c
Plus postage 15c.

5 CORE CABLE

7/0076, P.V.C. insulated, P.V.C. covered.
25c yd.

6 CORE CABLE

same spec. as above
30c yd.

Capacitor Substitution Box, 1,000 VW . \$5.00
Resistor Substitution Box, 1 Watt.
Plus Post, 20c. \$4.50

TRANSISTOR AERIALS

5in extends to 39in \$1.40
6in extends to 46in \$1.70
6in extends to 32in \$1.00
6in extends to 28in \$1.00
7in extends to 39in \$1.20
9in extends to 39in 95c
5in extends to 4ft 6in \$1.80
7in extends to 5ft 8in \$3.00
Plus Post 15c.

CRYSTAL SET BUILDERS

Coils 80c Tuning Conds. . \$2.00
Diodes 35c Terms Ea. 12c
Headphones . . . \$2.90 Plus Postage.

TAPE RECORDER ACCESSORIES

2½in Spools . . . 30c	3in x 600ft
3in Spools . . . 35c	Tape \$2.35
5in Spools . . . 40c	5¾in x 1,200ft
5¾in Spools . . . 70c	Tape \$3.10
7in Spools . . . 50c	7in x 1,800ft
2½in x 100ft	Tape \$5.10
Tape 60c	5in Plastic Tape,
2½in x 300ft	boxes 60c
Tape \$1.40	7in Plastic Tape,
Plus postage 20c.	boxes 90c

See us for Tape Recorder Patch Cords,
Adaptors, etc.

STEREO PLUGS AND JACKS

Metal Plugs . . . 95c Bakelite ext.
Bakelite 70c sockets 70c
Chassis Jacks . 65c
Plus postage 10c.

MAIL ORDER SPECIALISTS

A whistle at about 8KHz should be heard. This indicates the converter is functioning. If no whistle is heard, disconnect the power immediately and reverse the connections to one of the base-drive windings. The converter should now function and a voltmeter placed across the 330K resistor should show about 270V DC. Having got the converter working, the SCR circuit may be wired up on the board, along with the trigger circuit. This is straightforward and should be easy enough referring to the photograph of the layout and the circuit diagram.

The lay-out should be followed reasonably closely, or false triggering of the SCR may result. At one stage in the development the SCR was picking up hash from the converter and triggering continuously. Obviously a defect of this type would not improve the performance of any motor car engine. Incidentally a trigger circuit using a unijunction transistor was tried originally and although it worked 100 per cent it was discarded in favour of the circuit shown, on the grounds of cost.

When the wiring has been completed and thoroughly checked, the unit may be tested, before hooking it up to a car, by connecting a coil to the appropriate terminals with a spark gap of about $\frac{1}{4}$ in connected to the secondary. (This is important as the coil insulation may be broken down if it is omitted.) Apply power and ground the "breaker points" terminal. Upon breaking this ground connection a thin blue spark should snap across the spark gap. With a standard 100:1 coil the output voltage will be about 27KV, more than adequate for ignition purposes.

The shape of this 27KV pulse is important too. With this system a very short rise time is possible, i.e. a "sharp" pulse is generated, and this is more effective at ionising the gas at the plug points than a pulse of slower rise time, such as is produced by a conventional transistor ignition system. Note that a 250:1 or 300:1 low inductance primary transistor ignition coil will work just as well as the standard coil, but will produce an

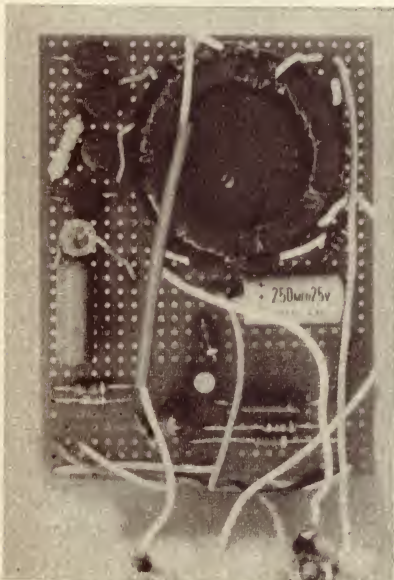

Figure 6. The layout of components here should be closely followed.

Modifications to the basic circuit

NEGATIVE EARTH. The negative earth version is somewhat simpler, as the pulses from the breaker points are already of the correct polarity to trigger the SCR into conduction directly. (The positive earth circuit uses a transistor to invert trigger pulse polarity.)

The only requirements, therefore, are that the trigger circuit provides a pulse of the correct amplitude and duration from a sufficiently low impedance source. These factors are taken care of by the circuit in figure 3.

It should be noted that at extremely high rpm, contact bounce can cause erratic firing. It is possible to prevent this by ensuring that the SCR gate is isolated from the breaker points for a short period after each firing pulse. This can be accomplished by including a diode and discharge network as shown in figure 4.

The voltage on the capacitors reverse biases the diode immediately after firing. The voltage bleeds off in about 0.6 milliseconds and the SCR cannot be fired during this period. (At 8000 rpm, a six cylinder engine fires approximately every 2.5 milliseconds, so this delay does not impose a rpm limit.) D1 is any 150mA 50PIV (or more) silicon diode. Capacitor C (shown dotted) may be added to reduce RF interference, if this is a problem. Its value should be about 0.2 μ F.

CATHODE INJECTION. It may be noted in passing that it is possible to trigger an SCR with negative pulses by injecting them at the cathode.

even higher output which may cause trouble if the HT leads and distributor cap on the car are not in new condition.

The prototype has been fitted to a Mk. 3 Ford Zephyr for about 3,000 miles and has proved completely reliable. Improvements in performance that have been noted are:

1. Easier starting on cold mornings and smoother running when cold.
2. Gas mileage up from 22.6mpg to 24.4mpg (measured over 1,000 miles of everyday driving, in both cases).
3. Slightly better pulling power on hills.
4. Top speed in 3rd gear (4-speed transmission) increased from 60mph to over 70mph.

A few words on mounting the unit might not go amiss. It should be screwed to the fire wall or inside guard under the bonnet but not in such a place as to receive a blast of hot air from the radiator. The transistors do not run all that hot mounted on the case as shown but a cool airstream is desirable. Also care should be taken to ensure that mud and water cannot splash all over the unit. It should not be mounted inside the passenger compartment as the high pitched whistle emitted may be very irritating. Leads should not be run much over three feet, especially the lead to the coil SW terminal (caution — this carries 260 volts). It is not necessary to remove the condenser fitted across the car's points. Note also that a negative ground version is available if anyone is interested. (See above.)

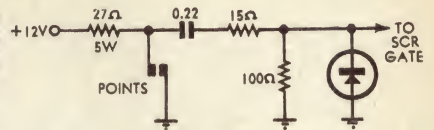

Figure 3

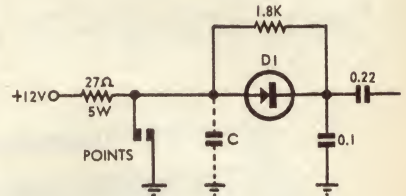

Figure 4

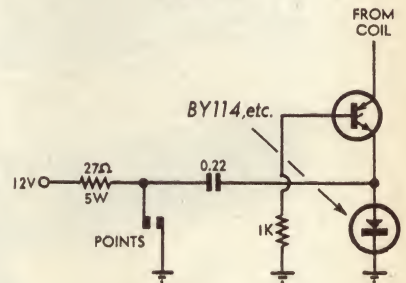

Figure 5

This has not been tried by the writer but may provide a cheaper and simpler circuit for the positive earth version. The circuit, figure 5, is suggested as a basis for experimentation.

EDITOR'S NOTE: We are advised by Mullard-Australia Pty. Ltd. that they do not use the term "3E grade" in Australia, and they recommend that home constructors making this project should use the Ferroxcube Toroid No. FA1079, of A3 material. A limited supply of these is available at present from Mullard distributors, but should demand exceed the supply, steps will be taken to obtain replacement stocks quickly.

TRANSISTOR SERVICE

All Japanese and local sets repaired

including . . .

Aristone	Aurora	Belair
Berlin	Crown	Fujiya
General	Hitachi	Kenco
Mariner	Mitsubishi	Nanaola
National	Nivico	Sanyo
Sony	Spica	Standard
Sharp	Toshiba	Yashica

We do not sell spare parts

PETER G. BROUGHTON

211 George Street, Sydney.
Tel. 27-5831 (3 lines)

Sony replaced IFT in this
4-band transistor radio

with the new Murata
ceramic filter SFD-455B.



BFB-455A L SFD-455B

muRata



ACTUAL SIZE

SFD-455B

Throughout the world electronic design engineers have begun to realise the many benefits offered by Murata Ceramic Filters. These include high gain, low spurious response, negligible ageing characteristics (0.4% over 10 years) and, since no alignment is necessary, considerable cost saving in production. Sony engineers have taken advantage of these benefits and have incorporated two Murata Ceramic Filters

SFD-455B and BFB-455A in the quality model TR-1000 4-band transistor radio.

Combining excellent overall response and selectivity characteristics with space saving and production economy, the Murata Ceramic Filters are proving superior to conventional IF transformers.

Include Murata Ceramic Filters in **your** next design.



MODEL BFB-455A improves the selectivity of transistor radios when used as an emitter by-pass in transistor IF Stages.



MODEL SFD-455B is a resonance type filter of 455 KHz. It replaces the transistor radio's IFT or can be used in combination with IFT's.



LADDER TYPE Ceramic Filters CFS-455 and CFP-455 (Popular Type) are ideal for IF stages of high quality communication receivers.

IRH COMPONENTS PTY. LIMITED

A Subsidiary of IRH Industries Limited

THE CRESCENT, KINGSGROVE, N.S.W. 2208. TEL. 50 0111

muRata

MAKES THE MOST OF CERAMICS

IRH M2

Time switch from old alarm clock

Using a clock to perform various functions at nominated times is not a new idea, but it does not seem to have been exploited much beyond the simple alarm clock concept. Here are some suggestions on how to make and use a versatile time clock.

I like to listen to my portable radio at night, but the trouble is that I fall asleep and the batteries are flat by morning. Batteries being dear enough, I decided to make a time switch. The finished product proved very successful and, with the mains relay, could switch on almost any electric appliance — radio, frypan, lamp, TV receiver, etc. — at any set time, and off again 30 minutes to three hours later. It would be especially suitable for switching on an electric blanket.

I had an old clock and some contacts salvaged from an old tape recorder. The clock was a cheap type that has the alarm dial separate, i.e. the alarm pointer spindle is not concentric with those of the main hands.

mount them, drilling a hole in the frame if needed.

Solder a heavy gauge wire from one of the contacts and bend the wire so that it rests on the gear without fouling anything. It is a good idea to insulate

At right is a diagram of a typical clock gear mechanism with contacts fitted. Below is the additional circuitry needed for mains switching.

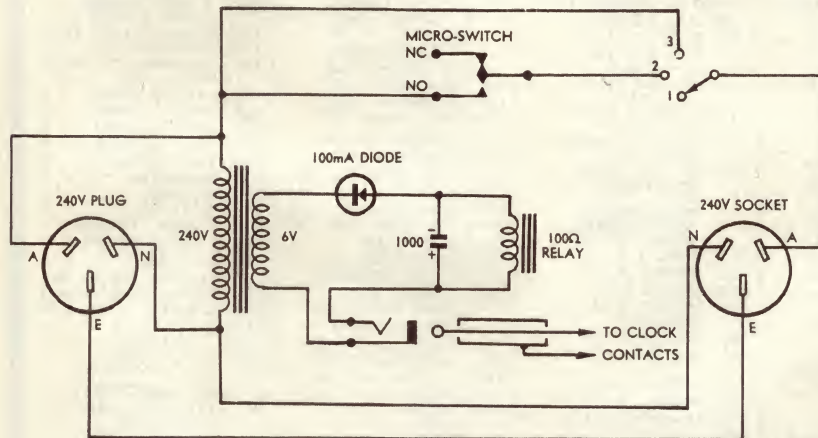
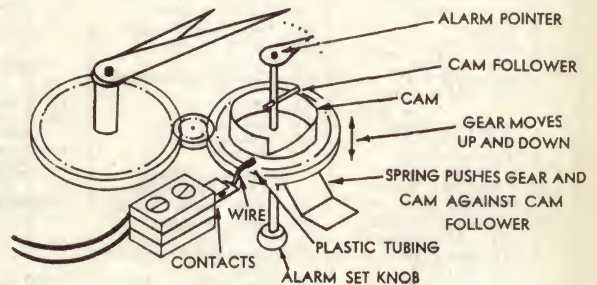

51 POSITIONS:-
1: OVERRIDE CLOCK, SWITCH OFF
2: CLOCK CONTROLLED
3: OVERRIDE CLOCK, SWITCH ON

The contacts could be almost any type from a record-player or tape recorder.

The glass was removed from the clock by easing the rim off with a screwdriver. The hands were then pulled off (it is not necessary to note the time) and the face was pulled off.

(Editorial Note: In some types of clocks it is easier to gain access to the mechanism by removing the keys from the rear spindles, removing the back and, finally, the entire mechanism.)

On the alarm spindle there should be a gear with a cam attached. By turning the alarm set knob this gear should move backward or forward. If all this checks out, see if there is room behind the face to mount the contacts so they are near this gear. If there is, arrange the contacts suitably and this wire from the clock with some plastic tubing glued over it.

Wire up the contacts in series with a light and battery. Turn the alarm set knob and note through how many degrees of rotation the bulb stays alight. Bend the soldered wire or the contact until a suitable time is found (90 degrees would equal three hours in the "on" state). I found one hour suitable (30 degrees). When satisfied, check that the clock is functioning correctly and wire up the contacts, passing the two wires through a hole in the case.

Put back the face and place the alarm hand on (in any position) and turn the alarm knob to a certain time, say 3.00. Then turn the hands knob till a click is heard when the alarm goes off, and put on the hands to the time wires were then passed out to the clock.

This set-up is quite safe for low voltages, but to switch mains voltages

shown by the alarm hand, 3.00. Check this by turning the alarm hand to a different time and then turn the hands till the alarm goes off. Compare the times shown on the alarm dial and the hands dial. The difference should not be greater than 10 minutes. Turn the hands to 12 and align the hour and the minute hand. Replace the glass.

To use the clock to operate my portable radio, I connected wires to two pieces of thin brass separated by a piece of plastic and fitted this between one battery end and its holder. The

it is necessary to build up the extra circuit shown.

This circuit is basically a relay with its own power supply. A small transformer is adequate; secondary current will not exceed 100mA. A relay with a micro-switch is needed.

The capacitor not only smooths out the pulsating DC, but also minimises relay chatter as the contact is opened. The contacts open very slowly and the relay may open and close several times as resistance between the contacts varies. The capacitor holds the relay in until the switch-off is definite. Any diode capable of passing 60mA at least, would do for the rectifier. The switch is a single pole double throw type.

(Submitted by: Mr P. Francis, 65 Parer Road, Niddrie, Victoria, 3042.)

(Editor's Footnote: "Reader Built It" projects are published for the general interest of experimenters and as a source of ideas. Based on readers' contributions, they have not been tested in our laboratory and we cannot accept responsibility for them.)

RESISTORS

1/2w 4c each or \$3.00 per 100

POLYESTER CAPACITORS

.01mf — .01mf 7c each
all values available

ELECTROLYTIC CAPACITORS

all values — 5mf — 12c
Send for list.

S. E. WILLIS TRADING CO.
38 RIVERSDALE RD.,
CAMBERWELL JUNCTION 3124.

**K
I
T
S**

**AMPLIFIERS — PREAMPLIFIERS — TUNERS — CONTROL UNITS —
GUITAR UNITS — INSTRUMENTS — INVERTERS — CONVERTERS —
RECEIVERS — TRANSMITTERS — REGULATED POWER SUPPLY —
TRANSISTOR AND VALVE TYPES.**

**K
I
T
S**

**1967
ALL WAVE
3-4-5-6-7**



**ANY PART FROM A
SINGLE RESISTOR
TO THE FULL KIT**

POPULAR KITS - TOP QUALITY - LOWEST PRICES

- | | | | | |
|--|---|--|--|--|
| <p>INSTRUMENTS C.R.O.</p> <ol style="list-style-type: none"> 1. 5in wide range. 2. 1963. 3in cal. 3. Audio. 4. 1966. 3in. 5. 1968—Audio. 6. Electronic SW. 7. W/band Preamp. <p>MULTIMETERS and V.T.V.M.'s</p> <ol style="list-style-type: none"> 8. 20K ohm/Volt protected M/M. 9. Probe for above. 10. Protected D.C. M/M. 11. Meterless V/meter. 12. A.C. Millivoltmeter. 13. A.C. Solid State Millivoltmeter. 14. Solid State A.F. Millivoltmeter. 15. Noise Distortion Millivoltmeter. 16. Standard V.T.V.M. 17. 1966—V.T.V.M. 18. 1968—V.T.V.M. <p>BRIDGES</p> <ol style="list-style-type: none"> 19. Standard R/C. 20. 1966. R/C. 21. 1968 R/C and Signal Injector. <p>TV INST.'s</p> <ol style="list-style-type: none"> 22. Sweep and marker Generator. 23. Dual sweep Gen. 24. Silicon diode sweep Gen. 25. Silicon diode noise Gen. 26. Pattern Gen. 27. Trans. pattern Gen. 28. Wide range pulse gen <p>AUDIO INST.'S</p> <ol style="list-style-type: none"> 29. 1960 Audio Osc. 30. 1962 High perf. audio Gen. 31. Crystal locked std. 32. Electronic tuning standard. 33. 1965. Solid State audio osc. 34. Direct reading A.F. meter. 35. Sq. wave Gen. 36. 1967 transistor audio Gen. 37. Additive frequency meter. 38. A.F. tone burst gen. 38A. 1968. Solid state A.F. Generator. <p>R.F. INST.'s</p> <ol style="list-style-type: none"> 39. 6-band service oscillator. 39A. Trans. wave meter. 40. "Q" meter. | <ol style="list-style-type: none"> 41. G.D.O. wide range. 42. G.D.O. adaptor. 43. Trans. service osc. 44. Simple signal injector. 45. Transistorised signal tracer. 46. Transistorised osc. 47. Basic test osc. 48. Transistor test oscillator. <p>MISCELLANEOUS INST., ETC., KITS</p> <ol style="list-style-type: none"> 49. 1960 Trans. Tester. 50. 1968 Transistor test set. 51. Valve and Transistor tester. 52. Electronic Stethoscope. 53. Moisture alarm. 54. Electronic Pistol range. 55. Transistor Geiger Counter. 56. Light beam alarm. 57. Burglar alarm. 58. Flasher unit. 59. Transistor alarm. 60. Electronic switch. 61. Photo Timer. 62. Direct reading impedance meter. 63. Electronic anemometer. 64. S.W.R. indicator. 65. Simple proximity alarm unit. 66. Pipe and wiring locator. 67. Electronic metronome. 68. Monophonic organ. 68A. Keyless organ. 68B. Theremin. 68C. Laser unit. <p>BATTERY CHARGERS</p> <ol style="list-style-type: none"> 69. Universal unit. 70. 1 amp unit. <p>REGULATED POWER SUPPLIES</p> <ol style="list-style-type: none"> 71. Transistor. 9v. 72. Transistor, fully protected supply. 73. 1966 H.T. unit. 74. 1968 lab. type. D-30v. supply 74A Simple Pwr. supply. <p>VOLTAGE CURRENT CONTROL UNITS</p> <ol style="list-style-type: none"> 75. Vari-watt unit. 76. Vari-tach. motor speed control. 77. 2KW auto-light dimmer. 78. 4KW auto. llight dimmer. 79. Model train control unit. | <ol style="list-style-type: none"> 80. Model train control unit with simulated inertia. 81. Above-hi-power. 82. No. 81 with simulated Inertia. <p>TACHOMETER UNITS</p> <ol style="list-style-type: none"> 83. 6 or 12v Std. 84. 6 or 12v Mullard. 85. 6 or 12v with dwell angle. 86. Tachometer and dwell angle unit for service stations. <p>TRANSISTOR IGNITION</p> <ol style="list-style-type: none"> 87. Ro-Fo. 6 or 12v. 88. Hi-Fire 6 or 12v. (transformer). <p>POWER CONVERTERS</p> <ol style="list-style-type: none"> 89. D.C.-D.C. 60w. 90. D.C.-D.C. 40w. 91. D.C.-D.C. 40w. 12v—input. 92. D.C.-D.C. 70w 12v—input. 93. D.C.-D.C. 100w 12v—input. 94. D.C.-D.C. 140w. 24v—input. 95. D.C.-D.C. 225w. 24v—input. <p>HIGH FIDELITY AMPLIFIERS MONO UNITS</p> <ol style="list-style-type: none"> 96. Hi-Fi 3. 97. Mullard 3.3. 98. Mullard 5-10. 99. Mullard 5-10 transistor. 100. Transistor 20w. 101. Transistor 60w. <p>STEREO UNITS</p> <ol style="list-style-type: none"> 102. Mullard 2-2. 103. Mullard (v) 3-3. 104. Mullard (t) 5-5. 105. Mullard (t) 5-5. 106. Mullard (v) 10-10. 107. Mullard (t) 10-10. 108. Philips Twin 10. 109. S.T.C. 10-10. 110. Wireless world transistor 20-20. 111. Hi-Fi 60-60. 112. Playmaster 2-2. 113. Playmaster 3 plus 3. 114. Playmaster unit 3. 115. Playmaster unit 4. 116. Playmaster 10 plus 10 117. Playmaster 101. 118. Playmaster (t) 105. 119. Playmaster (t) 113. 120. Playmaster (t) 115. 121. Playmaster (v) 118. <p>P.A. UNITS</p> <ol style="list-style-type: none"> 122. 10 watt std. | <ol style="list-style-type: none"> 123. 25 watt std. 124. 35 watt std. 125. 30 watt (t). 126. 100 watt std. 127. stereo P.A. <p>GUITAR UNITS</p> <ol style="list-style-type: none"> 128. 10 watt std. 129. 25 watt std. 130. 35 watt std. 131. 50 watt std. 132. 70 watt (t). 133. Playmaster 102. 134. Playmaster 103. 135. Playmaster 40w. 116. 136. Playmaster 60w 117. 137. Guitar fuzz box. 138. Guitar Waa-Waa. 139. Reverb unit. 140. Guitar preamp. 140A. Guitar 50w. Solid State P/M 125. <p>STEREOGRAMS</p> <ol style="list-style-type: none"> 141. Playmaster 105. 142. Playmaster 106. 143. Playmaster 107. 143A Playmaster 124. <p>CONTROL UNITS</p> <ol style="list-style-type: none"> 144. Playmaster No. 9. 145. Playmaster No. 10. 146. Playmaster No. 104. 147. Playmaster No. 112. 148. Playmaster No. 120. 149. Mullard 3v. 150. Mullard 3v. 151. Philips Miniwatt. 152. Wireless world stereo system unit. <p>PREAMP UNITS</p> <ol style="list-style-type: none"> 153. Transistor—Mono. 154. Transistor—Stereo. 155. Transistor—Silicon mono. 156. Transistor F.E.T. mono. 157. Transistor dyn. mic. mono. 158. Above-Stereo. 159. Playmaster 115 F.E.T. Stereo. 160. Playmaster 118 map. 161. Sound projector. <p>MIXER UNITS</p> <ol style="list-style-type: none"> 162. Trans. 4 ch. (1966). 163. Trans—4 ch. (1967). 164. Valve—4 ch. <p>TUNER UNITS</p> <ol style="list-style-type: none"> 165. Playmaster u/style. 166. Playmaster No. 11. 167. Playmaster No. 114. 168. Playmaster No. 122. 169. Playmaster No. 123. 170. Philips Miniwatt. 180. Trans.—Long range. | <p>TAPE UNITS</p> <ol style="list-style-type: none"> 181. Trans. Preamp. 182. Playmaster 110 (M). 182. Playmaster 110 (S). 183. Power Unit 110. 184. Adaptor 110. 185. Playmaster 119 Adaptor. 186. Transistor V.O.X. 187. Tape Actuated relay. 188. Mullard Trans Tape Amp. <p>RECEIVERS</p> <ol style="list-style-type: none"> 189. Fremodyne 4. 190. Fremodyne 4 R.F. Sock only. 191. Synchrodyne. 192. Communications RX. 193. Deitahet RX. 194. 3 Band Double Change S/het RX. 195. Explorer VHF Transistor RX. 196. Interceptor 5 Semi-Comm. RX. 197. 1967 All-Wave 2 198. 1967 All-Wave 3 199. 1967 All-Wave 5 200. 1967 All-Wave 6 201. 1967 All-Wave 7 202. Transporta 7 203. Transistor 8 204. 3 Band 2V RX. 205. 3 Band 3V RX. 206. Interstate 5 207. Versatile Mantel Set. 208. All-Wave Transistor 3 209. A.B.C. 3 210. 1968 F.E.T. 3 210a. I/C TRF Rx. 210b. R.F. Preamp. 210c. "Q" Multiplier. <p>TRANSMITTERS</p> <ol style="list-style-type: none"> 211. 144 MHz 50W. Linear Final. 212. 144 MHz 20W. 213. 144 MHz 75W. 214. 144 MHz 18W. 215. 144 MHz S.S.B. 216. 3 Band A.M. 217. Basic 3 Band. 218. 5 Band S.S.B. 219. 1967 S.S.B. <p>CONVERTERS</p> <ol style="list-style-type: none"> 220. 50 MHz. 221. 144. MHz. 222. 50 and 144 MHz Crystal Locked. 223. 1965 S/W. 224. 1965 S/W 2 Band. 225. 1966 3 Band. 226. Basic S/W. <p>V.F.O. UNITS</p> <ol style="list-style-type: none"> 227. Remote Unit. 228. 7, 8 and 9 H.F. and V.H.F. 229. All transistor. |
|--|---|--|--|--|

Phone 63-3596

E. D. & E. (SALES) PTY. LTD.

Phone 63-3596

232 FLINDERS LANE, MELBOURNE, VICTORIA 3000

Public Address Units — Geiger Counters — Metal Locators — Decade Boxes — Mixers — Battery Chargers — Oscillators — Bridges — Parts Supplied for Projects in Electronics (Aust.), Wireless World, Practical Wireless, Electronics World, Electronics Illustrated, Practical Electronics, etc.



1968 Solid State. V.T.V.M. ELECTRONICS (Aust.), Dec., 1968.

BATTERY CHARGER 1A
ELECTRONICS (Aust.), Feb., 1966

PLAYMASTER 116 and 117 and 125 GUITAR AMP.

Electronics Australia
June 1967 — 40 watt
July — 1967 60 watt
July 1969 — 50 watt



3-BAND SHORT-WAVE CONVERTER
ELECTRONICS (Aust.), May, 1966.

LAB QUALITY

Regulated Power Supply (0-30v)
ELECTRONICS (Aust.), Sep-
tember, 1968.

1966 R/C Bridge
May, 1966.



Excellent frequency response. Low distortion figure. High input sensitivity. All controls self-contained. 10 watts per channel.

PLAYMASTER STEREO 10 PLUS 10
COMPLETE KIT \$86.85



PUBLIC ADDRESS and GUITAR AMPLIFIERS

10, 25, 50 and 100 watt units



3-BAND DOUBLE-CHANGE RECEIVER
ELECTRONICS (Aust.), April, 1966.

1966 3m CRO
ELECTRONICS (Aust.), May, 1966.

Playmaster 122
Program Source.
Electronics (Aust.),
August, 1968.



FOUR-CHANNEL AUDIO MIXER
ELECTRONICS (Aust.) Feb., 1966 & 1967

3-BAND 3-RECEIVER
ELECTRONICS (Aust.), Nov., 1966.

TRANSISTOR MILLIVOLT METER

Electronics (Aust.),
May, 1968.

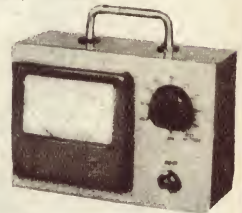

Enjoy your leisure time and build

PLAYMASTER STEREO 3 PLUS 3
COMPLETE KIT \$54.25

MAJOR STOCKISTS OF ALL GENERAL RADIO & ELECTRONIC COMPONENT PARTS -- YOU NAME IT -- WE WILL QUOTE

VALVES — TRANSISTORS — ZENER & POWER DIODES — SEMI-CONDUCTORS — DIACS — TRIACS — S.C.R.'S. — I/C'S. SPEAKERS — MICROPHONES — COILS — IFT'S. TRANSFORMERS — INST CASES — METALWORK. PLAYERS & CHANGERS — METERS — RELAYS — CONDENSERS — RESISTORS — BEZELS — STYL II — CARTRIDGES — RECORDING TAPE — PROBES — INSTRUMENTS — POTENTIOMETERS — CRYSTALS — FERRITE BEADS — CORES — BALUNS — TERMINALS — CO-AXIAL PLUGS & SOCKETS — MULTI CONNECTORS — PRINTED CIRCUIT BOARDS — COPPER WINDING WIRE — ETC. — ETC. —

Phone 63-3596

E. D. & E. (SALES) PTY. LTD.

Phone 63-3596

232 FLINDERS LANE, MELBOURNE, VICTORIA 3000

TELEFUNKEN

FROM MELBOURNE'S LEADING

TAPE RECORDER SPECIALIST

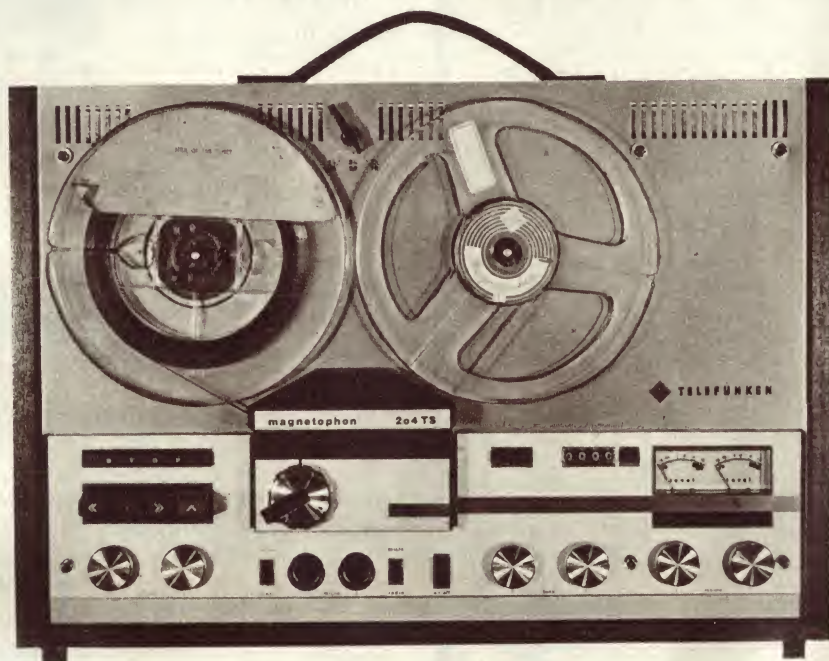

TELEFUNKEN . . .

NEW 1970 MODEL . . 204 TS

- 3 Speed • 4 Track • Stereo/Mono • Piano Key Operation • Twin VU Meters • 4 Digital Counter • Separate Record/Play Volume Controls • Din Standards Throughout • 12 Watts Music Power • 40-1800 CPS at $7\frac{1}{2}$ IPS.

Exclusive Victorian Distribution on this model brings you Continental Perfection at an amazingly low price.

DOUGLAS TRADING P/L

Inc. City Hi Fi — Tape Recorders (Vic.) — BJD Electronics
191 BOURKE STREET, MELBOURNE 3000—PHONE 63-9321

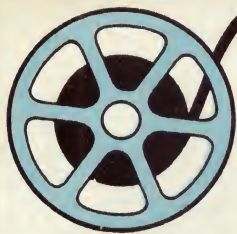

AUDIO TOPICS



SCRATCH FILTERS: A MYTH THAT LINGERS ON

"Would you please supply me with a circuit for a scratch filter to suit my record player?" Every letter of this kind which arrives in our mail is evidence that a myth lives on. Let's make one more attempt to despatch it.

by Neville Williams

Most readers with a long enough memory will recall the circumstances which nurtured the myth, when it was much younger — circumstances involving 78rpm shellac records and early vintage magnetic pickups.

In those days, record "scratch," as it was most commonly called, was a very real problem. Behind the sound reproduced from every standard disc was a continuous frying noise or crackle. Listeners, perforce, had to put up with it and accept it as philosophically as they could, as a characteristic of reproduction from mass-produced discs. They listened rather enviously to the almost silent acetate transcription discs used by broadcast stations, and to sound-on-film reproduction, which might hiss but at least it didn't crackle!

The noise from the old 78rpm discs — frying, crackling, scratching — resulted primarily from the granular nature of the material from which they were pressed. Writing in "Wireless World" in November, 1939, well-known engineer and author M. G. Scroggie had this to say:

"What is heard is due mainly to the material of which the record is composed. At one time abrasive material was intentionally included in the mixture with the object of quickly grinding the playing needle to the contour of the groove.

"The choice of materials now is determined chiefly by a balance between economy and physical properties such as hardness, durability, uniformity and so forth."

The reference to hardness may sound rather strange to modern ears but it must be remembered that, up to that time, the idea of lightweight pickups, in the real sense of the term, had not emerged.

Pickup design proceeded from the assumption that a standard interchangeable needle had to be used. This involved a needle chuck with a set screw to hold the needle in place; attached to the chuck, there had to be

the internal mechanism of the pickup, which generated the actual audio signal.

It added up to quite a large mass, which needed to be wiggled by the groove, and the playing weight on the needle point had to be quite high to make sure that it stayed in the groove during heavily modulated passages. Playing weight on the needle point ranged from 3 to 7 or more ounces compared with modern standard lightweight pickups, which have a playing weight of as many grams — or less! (There are approximately 28 grams to one ounce.)

ation of the problem led to speculation as to whether the scratch tended to concentrate in a particular frequency region. If such turned out to be the case, it was reasonable to assume that a filter, tuned to this region, would markedly reduce the intensity of the scratch, without affecting too much the overall sound reproduction.

As early as 1931, Buchmann and Meyer (E.N.T., May, 1931) published curves which are reproduced herewith. They indicate the relative intensity of total record surface noise plotted on a decibel scale against frequency. It is seen to distribute across the whole audio spectrum from 60Hz to 7KHz, which probably represented the limits of measurement then possible. The effect of lineal groove speed is apparent, in that the high frequency components are emphasised in the outer grooves — something that could logically be expected.

Buchmann and Meyer's findings were lost, however, on a great many record enthusiasts. They observed that scratch

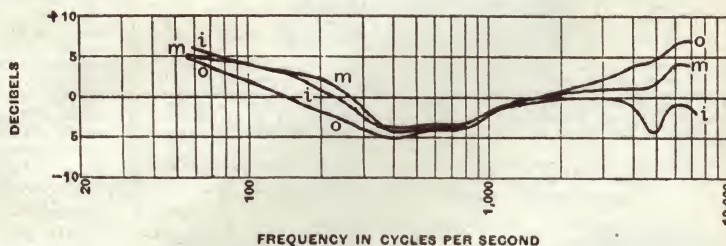

Buchmann and Meyer's frequency-analysis of record surface noise. Tests made on outer, middle and inner grooves are distinguished by o, m and i respectively. The decibel zero is arbitrary.

A typical formulation for shellac records was given as:

Slate dust	56 p.c.
Orange lac	22 p.c.
T.N. shellac	16 p.c.
Rosin	4 p.c.
Lamp black	1.5 p.c.
Cotton flock	0.5 p.c.

It is apparent that slate dust made up more than half of such a mixture and, however finely it was ground, the dust constituted hard, discrete particles protruding from the surface of the bonding material. These discrete particles, striking the tip of the playing needle, were responsible for the scratch.

Not surprisingly, perhaps, consider-

could often be reduced markedly by connecting a filter to the output of the pickup tuned to attenuate frequencies in the region of 3.5KHz.

It was a case of believing ears rather than curves and a whole generation of experimenters fiddled with resonant circuits in series or in parallel with the pickup output leads, seeking to tune out the troublesome scratch.

In fact, neither curves nor ears were wrong, only the assumption of what was going on.

Surface noise did, in fact, appear to concentrate in the 3.5KHz region but not because of any characteristic of the surface itself. It was simply due to the fact that, by reason of their construction, most of the pickups of

WHY DOESN'T YOUR TURNTABLE LOOK LIKE THIS?

- The ERA arm outperforms even the most recent cartridge; it can track at 1/10th of a gram.
- By principle its pivot eliminates all friction. The pivot is in fact the intersection of four counter-balanced spring blades. They form two X's which do not touch each other.
- The tracking weight is applied directly to the pivot by changing the angle of the blades. In this way the inertia of the arm is not increased with the tracking force as in all other arms. The pickups sound better.
- The arm itself is made of a light alloy H beam which eliminates the resonant frequencies of tubes.



UNIT 1: Armstrong Model 426 amplifier, power output, continuous sine wave 25 watts per channel, 8 ohms, frequency response from 20 to 20,000 Hz plus minus 1 db, 2 Jordan Watts loudspeakers, Dual 1015 turntable with Empire Model 888 cartridge, frequency response from 10 to 24,000 cycles.

Total Price \$535.

With Armstrong Model 521 amplifier, technical specifications as above. Less \$80. The same with Armstrong Model 226 amplifier, power output 10 watts push-pull, frequency response from 30 to 20,000 cycles plus minus 1dB.

Less \$100.



UNIT 4: Empire 999VE cartridge, frequency response from 6-35,000 cycles, ERA Mk3 turntable, 2 Empire 8200 loudspeakers frequency response from 30-200,000 cycles, power handling capacity: music power 100 watts, NordMende Model 8001/ST stereo receiver 2 x 30 watt sine wave continuous output frequency channel. (25 watt with non-linear distortion factor less than 1 p.c. in the frequency range specified in DIN 45 500).

Total Price \$1,515

UNIT 2: ERA Mk3 turntable (illustrated above), Empire Model 888TE cartridge, frequency response from 6 to 32,000 cycles, Armstrong 521 amplifier, 25 watt RMS per channel (as illustrated), 2 Tannoy 10in Dual Concentric loudspeakers.

Total Price \$620



UNIT 3: 2 Empire Model 2000 loudspeakers, frequency response from 30 to 18,000 Hz, components: 10-inch high-compliance woofer with 2in voice coil. Mid-range/tweeter direct radiator, Ampex Model 2163 tape recorder, automatic threading, automatic reverse and bi-directional recording plus outstanding reliability.

Total Price \$1,000

With Schaub-Lorenz Model 4000 tuner/amplifier, 25 watt per channel, broadcast, short wave, long wave ultra short wave, FM magnetic input.

Add \$300

The same with NordMende 8001/T tape recorder, quarter track, 7in reels speeds 1-7/8in./s, and 7 1/2in./s with multiplex (complete mixing) facility.

Less \$100

UNIT 5: Harman Kardon Model 210 tuner/amplifier, power output 50 watts IHF frequency response plus minus 1 db: 8 to 25,000 Hz at 1 watt (Normal listening level), 10 to 23,000 Hz at full rated power, 2 Harman Kardon Model HK40 loudspeakers, Dual 1019 turntable, Empire 888TE cartridge.

Total Price \$1,250

UNIT 6: Kenwood TK 250U amplifier, Dual 1015 turntable, Empire 808 cartridge, frequency response from 10-20,000 cycles.

2 Wharfedale Super 8in RSDD loudspeakers.

Total Price \$310



UNIT 7: P.E. 34 belt driven turntable, hydraulic controlled lowering device, Empire 888E cartridge, frequency response from 10 to 30,000 cycles, Monarch SA-500 amplifier, 2 Wharfedale 8in Bronze RSDD loudspeakers.

Total Price \$235

UNIT 8: Armstrong 127 tuner/amplifier integrated with AM/FM tape recording and playback facilities, Dual Model 410 turntable complete with cartridge, 2 Goodmans 10in Twinaxlette loudspeakers.

Total Price \$250

SCHAUB-LORENZ STEREO 4000 TUNER/AMPLIFIER

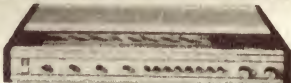

A completely new stereo tuner/amplifier, fully transistorised with impressive performance, remarkable versatility and new distinctive styling. Four wavebands (VHF/FM, SW, MW, LW), 31 transistors, 17 semi-conductor diodes, 2 rectifiers, transformerless push-pull output, 18-watt output per channel, music power; 2 x 25 watt, dimensions — 54.4 x 8 x 28 cm weight approximately 7 kilograms.

ARMSTRONG MODEL 521 AMPLIFIER



Technical Specifications:

Power Output, continuous sine wave: 25 watts per channel, 8 ohms.
Power bandwidth: 20-25,000 Hz
Frequency response: 20-20,000 Hz plus/minus 1dB.
Harmonic distortion: less than 0.5 % at 1 kHz, measured at 25 watts output, plus/minus 1dB
Cross talk: better than 40 dB.

HORMAN KARDON MODEL 210 AMPLIFIER



TECHNICAL SPECIFICATIONS:

Power output: 50 watts IHF ● Frequency response plus/minus 1 db: 8 to 25,000 Hz at 1 watt (normal listening level); 10 to 23,000 Hz at full rated power ● Harmonic distortion: Less than 1% ● Hum and noise suppression: 90 db ● Damping factor: 25:1 from 20 to 20,000 Hz ● Square-wave rise time: 4 usec ● Usable FM sensitivity: 2.7 Uv IHF ● Image rejection: Better than 45 db ● Spurious-response rejection: Better than 70db ● FM IF rejection: Better than 75db ● Multiplex separation: 30 db ● (AM specifications for Two Ten) AM sensitivity: 50 uv/meter ● AM selectivity: 10,000 Hz bandwidth at 6 db points ● AM IF rejection: 55 db ● Dimensions: 14 3/4 in wide, 4 1/2 in high 13 1/4 in deep ● Shipping weight: 20lb. ● Optional walnut enclosure.

EMPIRE MODEL 2000 SPEAKERS

For Homemakers who want the finest in sound but are short on space. Less than one foot square and 16 1/2 inches high, Frequency response: 30 to 18,000 cycles. Components: 10-inch high-compliance woofer with 2in voice coil. Mid-range/tweeter direct radiator. Minimum Power Requirements: 20 watts. Maximum Power Requirements: 60 watts, undistorted. Impedance: 8 ohms. Controls: 3-position treble response switch.



EMPIRE MODEL 888VE CARTRIDGE.

Deluxe stereo cartridge with patented "Magnetic Cone Stylus," for high performance turntables. Frequency response: 6-32,000 cycles. Output voltage: 8.0 mv. per channel. Channel separation: more than 30 db. Terminal impedance: 47,000 ohms. Compliance: 30 x 10-6 cm/dyne. Tracking force: 1/2 to 2 grams. Stylus: .2 x .7 mil bi-radial elliptical handpolished diamond.

Price in U.S.A. \$59.95.

Price in Australia \$60.

EMPIRE MODEL 8200 IMPERIAL GRENADIER SPEAKER

Frequency response: 30-20,000 cycles.

Power Handling Capacity:

Music Power: 100 watts.

Sine Wave Power:

25-450 cycles 60 watts

450-5000 cycles 40 watts

5000-20-000 cycles 20 watts

12in woofer, Mid Range-Direct Radiator.

1 tweeter-Ultra Sonic Domed Tweeter.

Satin Walnut finish. Overall dimension 24 3/4 in W x 14 in H x 12 1/8 in D.



RECORDED MUSIC SALON

C. PINCZEWSKI

TRUE FIDELITY

23 COLLINS STREET,
MELBOURNE 3000.

Telephone 63-6257

the day had a marked resonance in this region. So also did many loudspeakers. The noise itself was distributed over the whole spectrum but it seemed loudest in the region where the system gain was highest.

What the experimenters of the day were doing was to provide not scratch filters, but pickup filters. In fiddling with the attenuation characteristic, they were fitting it not to the record, but to the pickup.

In the article referred to earlier, M. G. Scroggie related how he quite independently verified the findings of Buchmann and Meyer, using silent grooves on shellac pressings and a G.R. wave analyser, an instrument capable of measuring selectively signal components anywhere in the audio band.

With a wide-range professional Telefunken pickup, the surface noise was found to distribute over the whole audio spectrum. With a typical needle-holder type pickup, a sharp peak was evident at 4KHz, some 5dB above the adjacent plateau area. This latter pickup would have been an obvious candidate for an attenuation filter tuned to this frequency.

Relative to 1969, the matter can be re-stated thus:

(1) Record scratch never did peak at a particular frequency and the time-honoured concept of a scratch filter is erroneous.

(2) Modern vinyl records contain no particle-type fillers and do not suffer from "in-built" scratch.

(3) Even if the facts of (1) and (2) were otherwise, the filters devised for old-style magnetic cartridges would be quite inappropriate for modern crystal and ceramic cartridges.

Compared with the surface noise of the old style 78 rpm shellac pressings, that produced by modern L.P.s is very small indeed — or at least it should be.

Modern records do have the characteristic, however, that the plastic materials from which they are pressed can acquire a surface electrostatic charge, which will attract particles of dust and lint. Interposed in the path of the tiny, jewelled stylus, such particles can produce noticeable clicks and pops.

Some records contain an inhibiting dopant (e.g. "Catenac" supplied by Dow Chemical) which renders the disc less prone to picking up dust and lint.

It is also possible to buy anti-static fluids which are supposed to achieve a similar effect, although not everyone agrees with the idea of a surface film on a disc, no matter how thin the film may be.

But dopants or fluids notwithstanding, the golden rule for modern discs is to expose them as little as possible to dust and lint.

Before each playing session clean off the turntable platter with a brush, a lint-free duster or a damp rag.

Transfer the discs direct from their sleeves to the platter and back again, handling them only by the edge and the label area.

Never lay them flat on a table, a lounge or anywhere else, while you look for the jacket.

These are very simple precautions which involve no effort, only care by all those handling your records.

It is possible, of course, to go to greater lengths, as by the use of a "Dust-Bug" or other such device. Go the "extra mile" if you wish but care is the major part of the battle.

Not suprisingly, the observations made earlier in the article about old-fashioned scratch apply in general to the odd crackle and pop which may be heard from a modern record system. The audio spectrum of such noises will tend to peak where the gain of the system is highest, notably on a response peak of the cartridge or loudspeaker.

Whereas old-fashioned pickups used to peak at about 3 to 4KHz, modern cartridges tend to peak at about double this frequency, or beyond. If the peak is a prominent one and the loud-



And now we would like to play a little number that has been climbing up the charts for the last 200 years. ("TV Times").

speaker also has a strong response in this region, clicks will tend to be exaggerated. The simplest cure in such a case is to turn down the treble tone control until surface clicks are attenuated without — one would hope — too great a loss in the high frequency content of the program material.

Fortunately, with a response peak at 7KHz or above, a good deal of rolling off is possible before the balance is compromised below ordinary medium fidelity standards.

Some amplifiers intended for the hi-fi market have a control to attenuate high frequency components, variously marked "High Filter," "Noise," "Scratch," or some other such term. In some cases, it merely provides extra treble cut and is little more than a gimmick. In other cases it gives a sharp roll-off above some selected frequency and is a useful facility for records with a particularly noisy surface.

In this connection, it should be noted that the severity of surface noises can be aggravated by excessive bass boost and any tendency to low frequency feedback. Over-emphasised bass can easily turn a "click" into a "bong."

The best approach, undoubtedly, is to select a cartridge and a loudspeaker system which is as free as possible of peaks within the audible range. Used with records which are properly cared for, such a system will suffer so little from surface clicks and pops, that it will disturb no one but a zealot.

TRADE ENQUIRIES ONLY

- ★ COMPAX 111 TURNTABLES
- ★ LUSTRE TONE ARMS
- ★ MICRO CARTRIDGES

See review on Page 119 of February, 1969 Issue, "Electronics Australia."

- ★ COMPAX AMPLIFIERS
- ★ LUX AMPLIFIERS
- ★ PML MICROPHONES
- ★ LONDON MICROPHONES
- ★ GRACE TONE ARMS AND CARTRIDGES
- ★ CELESTION GUITAR SPEAKERS
- ★ PRL TANGENTIAL FANS
- ★ MICRO DUST PICKUPS
- ★ PLANET P.A. AMPLIFIERS
- ★ SOUND AMPLIFIERS
- ★ COMPAX TUNERS
- ★ PIEZO MICROPHONES
- ★ SONICS SPEAKER SYSTEMS

Trade supplies only available from:

INTERNATIONAL DYNAMICS (AGENCIES) PTY. LTD.

4 Duke St., Abbotsford, Victoria. 3067. Tel. 42 4403

INTERSTATE DISTRIBUTORS.

Queensland:

STEREO SUPPLIES

100 Turbot St., Brisbane, Qld. 4000.

Tel.: 21-3623.

South Australia:

CHALLENGE RECORDING CO.

65 Henley Beach Rd., Henley Beach Sth., S.A. 5022. Tel. 56-2585.

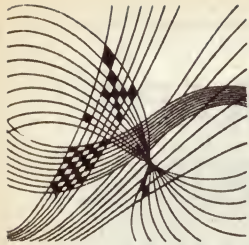

CLASSICAL RECORDINGS

Reviewed by Paul Frolich

GABRIELI, Antiphonal Brass Music. Philadelphia Brass Ensemble, Cleveland Brass Ensemble, Chicago Brass Ensemble. C.B.S. Stereo SBR 235309.

Although the blurb introducing this disc seems, at the outset, a little distasteful it certainly was a major achievement to bring together America's leading nineteen brass virtuosi, members of three orchestras, for a united recording session. Whatever the complications of the logistics, this effort was entirely worthwhile as it made a major musical achievement possible. The participants, heard in various combinations, play six trumpets, three French horns, five trombones, three tubas and two euphoniums and the sounds produced by them border on the improbable.

There are 13 pieces on the disc, taken from two published collections of Gabrieli's works: the "Sacrae Symphoniae" of 1597 and "Canzoni oer Sonare" of 1608. They are very rich-sounding works, varied in modality and full of utterly brilliant colour. This really is magnificent music superbly played in every last detail and the sound is stunning—a disc that will severely test even the most superior stereo outfits!

★ ★ ★

RAYMOND HANSON: Trumpet Concerto in B flat; WILLIAM LOVELOCK: Trumpet Concerto in C. John Robertson, trumpet; Sydney Symphony Orchestra; conductor Joseph Post. RCA Stereo SL 16371.

John Robertson's virtuosity as one of the world's great orchestral trumpeters has been widely recognised for many years, but record buyers have, until now, known him only in light music items. On this record which, I am assured, will receive overseas release also, Mr Robertson plays two concerti which were written for him and he does them fullest justice.

Musically, listeners should be interested in Mr Hanson's concerto, at least. It was first performed in 1952, when Sir Eugene Goossens conducted it and it was recognised as a very fine piece at the time; yet it has lain neglected all these years, pointing to the sad indifference with which we have generally treated Mr Hanson's compositions. The concerto is in one long, flowing movement, with the haunting suggestion of some epic rituals; it has been criticised for a certain lack of forward motion in it, due to the absence of fast passage, but it is fine music all the same. Even without fast sections, the concerto proves an excellent vehicle for Mr Robertson and I

believe it will be affectionately remembered by any who listen to it, both for the excellence of the trumpet playing and for its content of good music, well scored.

The Lovelock concerto is in a more minor league, but it is a true virtuoso piece, with all of its three movements designed to give every possible opportunity to the trumpet to shine and astound. Mr Robertson threads his way through the very difficult score with confident ease and plays this as he does the Hanson work — as an unchallenged master.

The Sydney Symphony Orchestra, firmly directed by Mr Post, proves highly competent in both works and the recorded sound is very good although my preference would have been for a balance less favouring the solo instrument. Local recordings of a high standard are still rare events and RCA of Australia deserve our thanks and congratulations for venturing in this field.

★ ★ ★

MENDELSSOHN, Symphonies No. 3, in A minor, op. 56 ("Scottish") and No. 4 in A major, op. 90 ("Italian"). London Symphony Orchestra; conductor Claudio Abbado. Decca Stereo SX L6363.

This disc is the only one I know to couple these two popular symphonies, and in quite excellent performances too. Abbado is one of the current crop of brilliant young conductors and he

Julius Katchen's last recording

BEETHOVEN: Piano Sonata No. 32 in C minor, op. 111; Six Bagatelles, op. 126; Polonaise in C, op. 89. Julius Katchen, piano. Decca Stereo SXL 6373.

It is both symbolic and fitting that Beethoven's final piano sonata should have been one of the last things to be recorded by Katchen before his sudden death. Although forewarned by a colleague, I had not been quite prepared for the wistfulness, even sadness, Katchen brought to this great work, deepening all the way right to that final pianissimo, one of Beethoven's most sublime moments and one I've rarely heard played with greater poignancy.

There are, of course, other fine versions of this sonata, including an earlier one by Katchen himself; in particular, there is Backhaus' wonderful account of this piece—and Backhaus too is gone now. Whatever other inter-

has been making quite a name for himself with Europe's leading orchestras. Important is that he is young, young enough really to get the utmost fun from these two Mendelssohn scores.

Mr Abbado's "Scottish," though very fine in its way, is decidedly less exciting than Peter Maag's version and, because of its being crammed on to one side of the disc, suffers some slight distortion on the inside grooves. His "Italian" is distinguished by impeccable good taste, not such a common characteristic of young conductors, and Abbado manages to gloss over the composer's dreadful lapses into sentimentality with considerable gracefulness. At the very least, these are thoroughly interesting interpretations, very well played; and, apart from the slight inner-groove distortion, the recorded sound is very good indeed.

★ ★ ★

MAHLER: Symphony No. 3. Helen Watts, contralto; Ambrosian Chorus; Boys from Wandsworth School; London Symphony Orchestra; conductor Georg Solti. Decca Stereo SET 385-6 (2 discs, boxed, with illustrated booklet).

I am beginning to suspect that wholly satisfactory performances of Mahler's gigantic third symphony are impossible. The fault is presumably the composer's, who tried to cram so much into it that conductors all too often fail to discover coherent sense in its towering structure. The principal problem remains the enormous first movement; I am certain that Mahler had a genuine design for this, but in most performances I've heard recently it sounds disjointed and tends to disintegrate into meaningless pieces. This criticism certainly applies to Mr Bernstein's slightly superficial version and even Kubelik, who did pretty well on the whole, failed to make this music entirely convincing.

Mr Solti, alas, does even worse here than Bernstein and he tears this movement apart with some most peculiar punctuation, finishing up with a series of episodes bereft of meaning. After this initial disappointment, the two middle movements, in addition to be-

pretation you might be used to, Katchen's reading of the work cannot fail to impress and awe with its insight and the artist's utter conviction in restating Beethoven's illuminating thoughts.

If the sonata is a fateful portent of tragedy, the Bagatelles might be expected to bring some emotional relief. It would be true to say, I think, that never have they sounded less than "trifles." No pianist has ever regarded these pieces as minor ones, but I cannot recall that any one of them, in recent years, has played them with greater conviction or sympathy. The same can be said for the little known Polonaise, presented by Beethoven to the Russian Empress during the Congress of Vienna. Katchen's sensitive playing and fine touch apart, the recording is distinguished by an exceptionally fine piano tone, first-class even by the highest of Decca's standards. This is really a disc to remember!

ing graced by beautifully eloquent singing from Helen Watts, come off better here than in any other recent version known to me. The last movement is, again, something of a failure. The tempo is much too brisk for the mystic content of the music to become apparent, there are some instances of extremely ill-considered balance and there is much that sounds merely vulgar and must displease all lovers of Mahler's music.

This symphony, in terms of recordings, remains a big problem. In terms of Mahler's music, I cannot recommend this interpretation as superior to Kubelik's and only about on a level with Bernstein's; looking at it as a recording, I must prefer it because of the quality of the disc. If you look for fine orchestral playing, lovely singing and superb sound, this set will meet your demands; if you are a Mahler fan, your joy will be tempered by irritation. Solti has proved, on other occasions, a certain flair for Mahler; we know he can do it on some occasions, but he has failed this time.

★ ★ ★

MOZART: Concerto No. 9 in E Flat, K. 271 ("Jeunehomme").

HAYDN: Concerto in D Major, op. 21. Igor Kipnis, harpsichord; The London Strings, conductor Neville Marriner. C.B.S. Stereo, SBR 235316.

As a solo performer, the American harpsichordist, Igor Kipnis, has been more than favourably known for some time past, but this is the first time, harpsichordist Igor Kipnis has been heard as soloist with an orchestra, and an English one at that; the players, generally, are those of the Academy of St. Martin-in-the-Fields, known to us chiefly from Argo recordings. Kipnis' playing is, once again, splendid both in style and in execution; he is a very musicianly performer and seems to obtain greater expressiveness from the harpsichord than anyone else currently recording.

The Mozart concerto is perhaps too familiar to us as played on a modern piano and it is difficult to persuade oneself that it should be played on the harpsichord at all, despite historical evidence that Mozart himself played it indiscriminately on both instruments—and Mozart's "forte piano" was certainly a far cry from a twentieth-century concert grand! The work is, of course, lovely in any version. It is named after Mademoiselle Jeunehomme, a French clavichordist who commissioned it while on a visit to Salzburg in 1776; therein lies, no doubt, the strongest argument in favour of the harpsichord for playing it. My own preference is for a piano version (merely from force of habit?), and particularly the Ashkenazy one, issued by Decca two years back.

The Haydn concerto is a very different matter. I have heard it on the harpsichord before (Westminster Collector No. 9707) played by Veyron-Lacroix and it was obvious, even on this elderly recording, that this work sounds better this way than when a piano is used. The concerto is usually regarded as rather a lightweight affair and is unlikely to have been meant for the piano in any event. The proof is in the fact that it undoubtedly

LITTLE SHORT OF REVOLUTIONARY

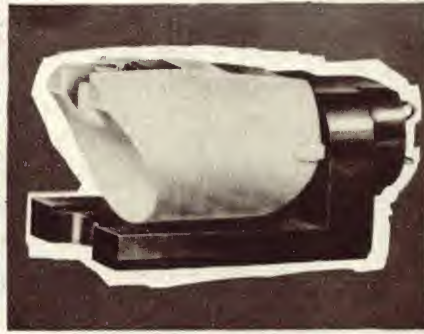

DECCA Deram

MICROGROOVE "CERAMIC" CARTRIDGE
fitted with diamond stylus
for stereo or mono microgroove records

Micrographs of a groove recorded with a 10 KHz signal taken from three copies of a Decca stereo frequency test record SXL 2057.

UNPLAYED MICROGROOVE

AFTER ONLY 1 PLAYING
with a good, average-priced
cartridge. Arrows show damage

NO DAMAGE AFTER 250
PLAYINGS with Decca Deram.

THE DECCA DERAM DOES LESS DAMAGE AFTER 250 PLAYINGS THAN THE AVERAGE CARTRIDGE DOES AFTER ONLY ONE

The Decca Deram has a tip mass of 0.6 milligramme; its compliance is 9×10^{-6} cms/dyne (lateral) and 5×10^{-6} cms/dyne (vertical); tracking weight 2.5 gms.; frequency response ± 3 dBs 18Hz to 18KHz. Output 50MV/CM/Sec.

Retail Price
\$12.60

Sole Australian Agent:

BRITISH MERCHANDISING PTY. LTD.

Shaw House 49-51 York St., Sydney, N.S.W. Telephones 29.1571 (3 lines)

NOW...ANOTHER COPY!

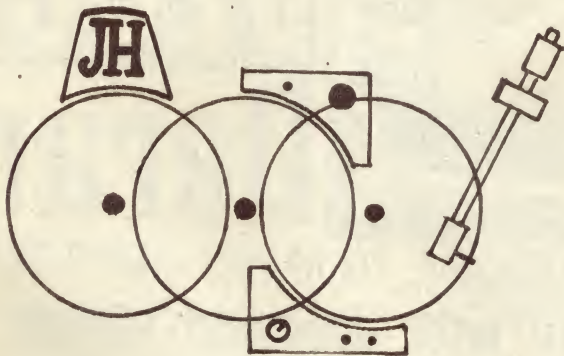

OF THE POPULAR J.H. TURNTABLE

—but the original design remains unmatched, for these important reasons:—

- the basic concept was to approach the idea of spinning a record on air — then the J.H. principle was born of coupling a delicate and accurate 12 pole “SYNCHRON” motor to a featherweight platter.
- the J.H. turntable carefully avoids the use of a heavy cast platter because the increased inertial mass imposes an undesirable load on the delicate motor and fine latex drive belt.
- because we have perfected the art of spinning the lightweight platter to a finely balanced degree of accuracy (we are yet to see this workmanship equalled) we have not had occasion to resort to machined castings which we regard as totally incompatible with the fundamental design principle.
- our turntable reaches speed in less than half a turn and rumble and wow and flutter are components which are not measurable by any known instrument.
- anti-static properties are not required with our mat as it touches the disc only at the outer perimeter and makes no contact with recorded areas. Radial supports are avoided as these can do irreparable damage to delicate styli in the event of accident when the turntable is revolving.
- the price of our turntable is the lowest on the Australian market, notwithstanding its high performance characteristics.

ONLY
\$36.00

**AT ALL
REPUTABLE
DEALERS**

WE ALSO SELL GOLD PLATED TURNTABLES—THE FAMOUS TRANSCRIPTOR UNITS

J. H. REPRODUCERS CO.

293 HUNTINGDALE ROAD, CHADSTONE, VICTORIA. 3148

TELEPHONE: 277-3066

Exclusive Australian Agents for — ADC Cartridges and Amplifiers, Kef speakers, J. H./G. H. Unipoise Pickup Arms, Pritchard Arms, TRANSCRIPTOR TURNTABLES and the popular J.H. Synchronous Turntable.

sounds a great deal more interesting from the harpsichord and that piano versions almost seem to be lacking in something.

On this occasion, the playing of both soloist and orchestra is exceptionally fine and I would certainly prefer this to any piano version I have yet heard. Both recordings are further enhanced by the use of a second harpsichord in the continuo part and quite excellent recorded sound. The disc is a sure winner.

★ ★ ★

ROSSINI: Semiramide (Highlights). Joan Sutherland, Marilyn Horne, Joseph Rouleau, John Serge, Spiro Malas; Ambrosian Opera Chorus; London Symphony Orchestra; conductor Richard Bonyngne. Decca Stereo SET 391.

This rarely heard Rossini opera, so full of fine music and cursed with a most peculiar libretto, was issued unabridged on a three-record set more than two years ago; as I missed it then, I am doubly glad to hear these excerpts which, to many, may prove an adequate introduction to the work. As far as I can tell, all the best musical material in this score has in fact been included on this record, which is accompanied by an illustrated booklet, giving the texts of the sections heard as well as connecting commentary.

Whatever one may feel about Rossini's score (I vote in favour, anyhow), the disc is a spectacular demonstration piece. It includes one of Miss Sutherland's greatest performances, convincing dramatically as well as superbly sung and quite splendid work from all others involved, particularly from Miss Horne and that great bass Malas. I am, once again, impressed by the fact that the hard-driving Mr Bonyngne (a conductor not exactly beloved by many artists) does achieve outstanding results from his thoroughness. In this case, the orchestral playing and chorus work are of as high a standard as is the singing of the principals and I am equally satisfied with the recorded sound produced by Decca's engineers.

★ ★ ★

SCRIABIN: The Poem of Ecstasy.

SCHOENBERG: Transfigured Night. Los Angeles Philharmonic Orchestra, conductor Zubin Mehta. World Record Club Stereo 4529.

Twelve years have passed since I last heard this work of Scriabin's or, for that matter, any other of his compositions and I was surprised to discover how well this piece stands up beside its rather similar and so much better known companion piece, with which it is coupled here. Scriabin's pseudo-religious and no more than half-digested ideas have found no philosophical echo in our day, but his music, for all that, seems to deserve more attention than it usually receives from performers.

The "Poeme," with its typically French chromaticism, is luxuriantly scored and seems to be music after Mehta's heart. The orchestral playing is of the highest standard and the recorded sound of rare brilliance. However, the interpretation, for all Mehta's enthusiasm, somehow lacks conviction. The orchestral playing in the Schoen-

berg is every bit as good, so is the recorded sound—perhaps even better. Although the performance of this piece is very good indeed, I still prefer the recent version conducted by Barenboim who, it would seem, is even more romantically extroverted than his friend, Zubin Mehta. Nevertheless, this is an excellent disc and one collectors should take a close look at.

★ ★ ★

SIBELIUS: Symphonies No. 3 in C major, op. 52 and No. 6 in D minor, op. 104. Vienna Philharmonic Orchestra; conductor Lorin Maazel. Decca SXL 6364.

Breaking through the present tradition by which Sibelius is now largely ignored and unknown in Central Europe, Mr Maazel set out to record the whole of his symphonic output with the Vienna Philharmonic. This is, I think, the fourth disc in the series; the only one I'd heard before was the first one, featuring the 5th and 7th symphonies, released late in 1966. On that occasion, I was less than satisfied with both interpretation and recording.

Mr Maazel is a conductor who inspires respect rather than enthusiastic admiration and while I must acclaim this issue as a remarkably fine one, I retain a hankering after Beecham's way with these scores. Personal leanings aside, however, there is not a single thing in Maazel's reading of the third symphony that I could single out for being less than perfect and I feel certain that it must be the best version of this work currently available on disc.

The sixth is just a little less convincing and I feel that intending purchasers might do well to consider, on their respective merits, both this reading and that of von Karajan. There may be others who, brought to Sibelius by Sir Thomas, will continue to want the Beecham sound. It is only fair to point out, therefore, that Beecham certainly did not have such a wonderful orchestra at his disposal. Moreover, the recorded sound here is so marvellous that one really need look no further for fine performances of these great symphonies.

★ ★ ★

STRAUSS: "Also Sprach Zarathustra." Los Angeles Philharmonic Orchestra, conductor Zubin Mehta. Solo violin: David Frisina. Decca Stereo SXL 6379.

Although this symphonic poem is wonderfully effective "conductors' music," it has not, surprisingly, been recorded as often as others of Strauss' tone poems written in 1896. This piece remains one of the composer's most spectacular works and it is a remarkable example of his great skill in manipulating large orchestral forces. The last satisfactory recording of the work I've heard is von Karajan's and he, as might be expected, did it superbly well. Several other versions of the work have been recorded on less than two full sides, but one really needs no filler when, as in Karajan's or Mehta's case, one gets a truly stunning performance.

It becomes quickly obvious that, since Mehta's arrival, the Los Angeles Philharmonic has developed from one

of many good orchestras into one of the world's best. The sound produced by them, and brilliantly recorded by British Decca's engineers who specially went to California from England, is really something worth hearing, even if you don't much care for the music. In fact, I think that performances such as this one may well gain Strauss new adherents among younger listeners. The music is, admittedly, a little dated and, taking the long view, I doubt that it is of major importance; I doubt that it will be much heard of in future decades.

Zubin Mehta, once again proving himself one of the most exciting of living conductors, comes pretty close to making one believe in the work's musical importance. Needless to say, this is a disc for audio fans, with its magnificent percussion effects and the absolutely first-rate brass and winds; the Los Angeles strings are not yet quite up with the world's best, but if Mehta continues to train them it won't be long.

★ ★ ★

SOLER: Six Double Concertos for Two Organs, E. Power Biggs and Daniel Pinkham. C.B.S. Stereo SBR 235311.

These concerti for a duo of organs are about the most charming and delightful music I've heard this year. Forget all ideas of organs as church-sounding, pompous elephants. The instruments used here, both of them built in the Netherlands — one in the eighteenth century, the other a modern

EKCO-STYLUS DIAMOND AND SAPPHIRE RADIOGRAM NEEDLES

- EKCO-STYLUS — THE ROLLS ROYCE OF NEEDLES!
(Easier said than done!)
- EXAMINED at all critical stages of manufacture, under 200 mag. microscopes!
- USE our needle clinic for FREE inspection of your STYLUS. Sold by all good music houses.

Enquiries:

ERNEST KUENZLI

PTY. LTD.

60 Hunter Street, Sydney,
N.S.W. 2000.

Telephone 221-2899

Stereo Music Systems Centre of the World's Finest HI-FI and STEREO equipment

monarch

Amplifier Model SA500



Australia's largest-selling budget-priced amplifier. Check these features: * 17.5 Watts/channel r.m.s. * Inputs for magnetic crystal cartridge tuner tape * Low filter * High filter * Loudness.

Check our price in the system of your choice.

Acoustic Research Speakers

AR

From the inventors of the acoustic suspension bass driver. The natural sound — The tightest bass — The smoothest and best dispersed Highs. These famous American speakers are for the connoisseur, the lover of true high-fidelity.

Don't buy a quality speaker without hearing A.R.



BOSE 901



What is revolutionary about a speaker system with 18-4" full range speakers — five sides and a direct/reflecting principle? Why not come and hear them! Especially if you have a mighty good speaker system now. You'll have a lot of questions to ask. We can answer them for you. Then —

Go back to your own system — if you can.

We are now also demonstrating the new Stanton range of cartridges and invite you to hear, particularly the 681EE. Hi-Fi Stereo Review said, "The tracking was distinctly better than any other cartridge we have tested. The frequency response was the flattest of the cartridges tested".

For all Hi-Fi requirements plus our unique demonstration facilities and extended guarantee.



Sales and Service
193 Clarence Street. 29 6681
(Between King and Market)

"true-classic" one — are gay and flighty affairs, which at times sound like old-fashioned barrel organs remembered from childhood. The music is every bit as bright and gay as the instruments, superbly played throughout. Antonio Soler's scores bubble over with folksy Spanish dances, enlivened by syncopation and tantalising variations on cheeky little ditties.

The recording, though very good, will be found to be very resonant and a little brighter than I care for, but the acoustics are appropriate to those common in the composer's own day. These concerti were written for the monastery of El Escorial, where there were eight organs available simultaneously. I am rather glad Soler used a bare two at a time — after all, I've only got two channels in my stereo outfit!

★ ★ ★

SHOSTAKOVICH: Violin Concerto No. 2 in C sharp minor, op. 129; Symphony No. 6 in B minor, op. 54. David Oistrakh, violin; Moscow Philharmonic Orchestra, conductor Kiril Kondrashin. Melodiya-H.M.V. Stereo ASD 2447.

This is another in the recent set of issues by E.M.I. of Russian recordings, reprocessed in England; once again, the sound is beautiful and completely unlike that usually heard on Russian pressings. We have heard so much of Shostakovich's music conducted by American and Continental musicians, that the opportunity of hearing a Russian interpretation must be welcomed, whatever the merit of the music. As it happens, the second violin concerto, written in 1967, is a great deal more interesting than was the first; this might have been better described as a solo piece for Oistrakh with orchestral obbligati. The new work, particularly in the lovely and melodious Adagio, gives the orchestra a much bigger part to play and the overall impression left by the work gains much from this.

The concerto is, not unreasonably, a rather conventional work, expertly put together, amply scored and providing Oistrakh with ample scope for his virtuoso displays. Although the piece says nothing new, it says it well; it is music specifically written for a virtuoso fiddler, who plays it superbly and at the same time, taken as music, it is never less than attractive and, in many places, genuinely interesting.

The 6th symphony, in a key dear to Russian composers, was written in 1939. When I last heard it some six years ago, I shrugged it off as a wholly conventional piece without anything special to commend it. Kondrashin persuades me that there is rather more to this work than I thought, even though, when compared with Shostakovich's best music, it remains a mediocre effort. At the least, there is a quite interesting Allegro, shot through with fires of savagery and bordering on the bizarre. I assume that it is the final movement, a thoroughly good-humoured Presto, which accounts for the symphony's relative popularity in Russia. Whatever one's reservations, this music makes agreeable listening, played (as is the concerto) extremely well and given simply first-rate direction by Kondrashin, the type of conductor any composer would be happy with. □

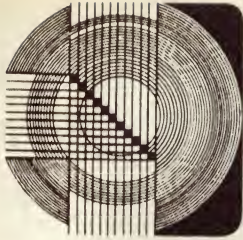

DOCUMENTARY RECORDINGS

Reviewed by Glen Menzies

THE ENGLISH POETS: EARLY VICTORIAN POETRY. Read by Jill Balcon, Freda Dowie, Ian Holm and Gary Watson. Directed by George Rylands. Argo RG 580.

This is a very valuable addition to the Argo English Poetry series which would most certainly lead one to take a fresh look at a group of poets who are today largely out of fashion.

Side 1 begins with several poems by John Clare, a born nature poet, son of a farm labourer, who spent his last years tragically insane. His lines evoke the countryside with an unpretentious freshness, but not every poem here is in that mood. There are several that show a heightened awareness of the darker moments as in "An Invite to Eternity," written, I should imagine, in one of the poet's more lucid moments during those years in Northampton County Asylum.

Then we have a sampling of the poetry of the Bronte sisters, that strange doomed family of the wild Yorkshire moors, all of whom died young. The poems chosen to represent Emily, Charlotte and Anne are well contrasted, and yet have about them an inward, withdrawn quality, with Charlotte emerging as the stronger character. She, after all, was the one who managed to escape for a short while from the father-dominated house on the moors.

Elizabeth Barrett Browning impresses in quite another way, with excerpts from "The Cry of the Children," a poem of social protest, an eloquent plea on behalf of the children against the evils of child labour prevalent in Victoria's time.

Nearly all of side 2 is given over to a selection of sonnets from George Meredith's "Modern Love." For the Victorian age the title was an ironic one; the poems are indeed concerned with love in a way quite foreign to the prudish attitudes of the time. In quoting from G. M. Trevelyan's "The Poetry and Philosophy of George Meredith," the cover note says . . . "The merit of 'Modern Love' lies in no small degree in its variety. Psychology, comedy, tragedy, irony, philosophy and beauty follow upon each other's heels in such quick succession, that scarcely, except by a certain greater master, has a single tune been played upon so many stops."

These excerpts from "Modern Love" are given a quite exceptional reading by Ian Holm which, as well as giving each individual sonnet its full value, picks up the thematic thread which ties all the poems together.

Several verses from Meredith's

"Love in the Valley" follow but these are of a lighter, less philosophical character. However, I would commend Gary Watson's reading of them and also give him full praise for his sensitive handling of the poems of John Clare.

Jill Balcon and Freda Dowie share the reading of the Bronte and Browning poems and help in sustaining a mood which makes this album the fine listening experience that it is.

★ ★ ★

SIR ADRIAN BOULT INTRODUCES THE INSTRUMENTS OF THE ORCHESTRA. Featuring members of The London Philharmonic Orchestra. Music for Pleasure. Stereo/Mono LP MFP-A 9002.

We have long needed a really comprehensive introduction to the instruments of the orchestra and here at last we have an exceptional one and in excellent high-fidelity as well.

A few weeks ago I heard Sir Adrian Boult speaking in an interview and was struck by his extremely youthful voice in spite of his eighty or so years. Who better than Sir Adrian, with a lifetime of music making behind him, to take us on a really intelligent conducted-tour among the instruments.

The album, which plays for upwards of an hour, makes the traditional division of instruments into the four families: strings, brass, woodwind and percussion. Each section is conveniently banded on the disc. On the back of the cover the instruments are illustrated and listed in numerical order and, even more helpful, the musical excerpts are named for future reference. I am quite sure that after hearing some of the sections from the great masterworks that are used as illustrations many listeners will want to hear more of them.

As an example of the completeness of the approach I list the sub-headings under violin; the four strings, the compass, pizzicata, mutings, long notes, double stopping.

The members of the London Philharmonic Orchestra excel themselves in putting the individual instruments through their paces, materially helped by excellent microphone placement in a hall with a suitably reverberent acoustic. All the while, Sid Adrian helps to put the listener in the picture about the particular instruments. He does this without any trace of archness and the way he speaks is an object lesson in pleasant unaffected speech, enabling us to share with him his obvious enjoyment of the task in hand.

Credit must also be given to John Boyden for his excellent script and production. This is a compatible stereo record, and it does replay with a genuine stereophonic sound. The sound quality is something of a demonstration disc.

At the price this record is a bargain and it is also an extremely useful album to add to school collections for musical appreciation courses.

★ ★ ★

TINTOOKIES SOUNDTRACK: From Peter Scriven's Original Musical Play for Marionettes. Book and Lyrics by Hal Saunders. Music by Kurt Herweg. Calendar Mono LP R66-594. Released through Festival Records.

When first released on the full-price label, the sound on this album, as I remember it, sounded disappointingly dim, particularly in the orchestral and singing parts. I would have liked to have been able to report that it had improved in this cheap label reissue. The fault, I think, lies with the original tape. I can remember attending a performance in the theatre and noticing the same faults in the tape used to accompany the action of Mr Scriven's remarkable puppets on stage.

I have singled out the sound more with regret than anything else because Hal Saunders (book and lyrics) and Kurt Herweg (music) between them turned in a highly professional job. Mr Herweg's score has many sparkling moments which deserve an equally sparkling recording.

Anyone who especially wants the Tintookies Soundtrack as a memento of Mr Scriven's beautifully presented show will find here plenty of the dialogue.

QUEENSLAND HI-FI ENTHUSIASTS

Get the best deal on Stereophonic

- Custom-built Systems or Equipment
- Pre-cut speaker enclosures

All brands available including Compax, Lux, Grace, Micro, Celestion, Shure, Dual, Sound, Sonics, Peak,

Sansui, Wharfedale, Rola, Garrard, Etc.
100 Turbot Street, Brisbane.

Ph
21 3625

stereo supplies
Write, phone or call for details.

A/H
55 3643.

With a BSR X3M
 'compatible' cartridge,
 almost any mono
 record playing
 equipment can take
 stereo records
 (without damaging
 them)

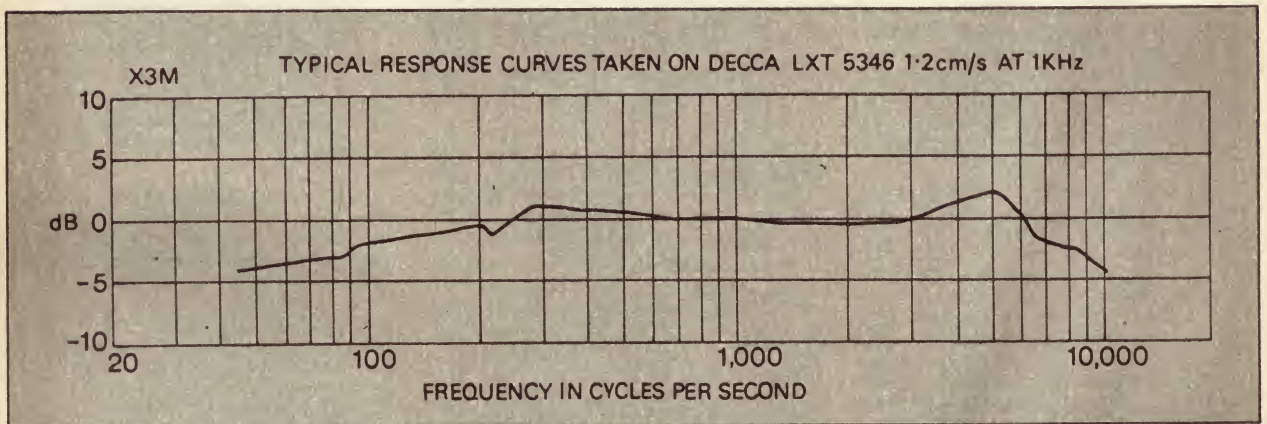
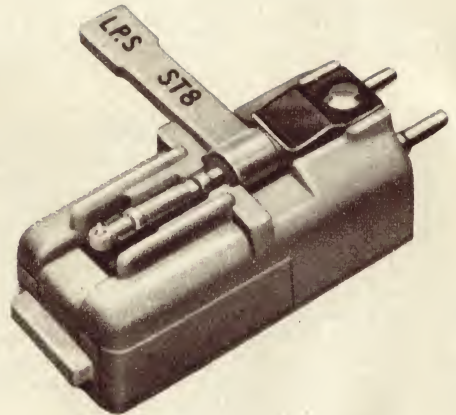

Why compatible cartridges?

An increasing number of record companies are now making stereo LP records only.

Until now these records could not be played on a mono player without distortion and damage to the records.

When playing stereo records the stylus tip moves vertically and horizontally following groove contours. Mono records have grooves which only move the stylus horizontally so old mono cartridges will not allow vertical movement of the stylus. Playing stereo records with old mono cartridges will damage the vertical component of the groove irrevocably.

The X3M 'compatible' cartridge, designed and perfected by BSR, is the answer to this problem. For a small outlay it allows you to play both stereo and mono records without harming either. Retail price, \$6.00.

TECHNICAL DATA X3M

Output: 350 mV \pm 2 dB

1 KHz test record Decca
 LXT 5346 at 1.2 cm/s

Frequency Response: See typical curves above

Dynamic Compliance:

Horizontal 3.0×10^{-6} cm/dyne ($\pm 20\%$)

Vertical 1.0×10^{-6} cm/dyne ($\pm 20\%$)

Equivalent Capacity: 800 pF

Nominal

Recommended Loading: 2 M. ohm 100 pF

Stylus Pressure: 4-6 grammes
 depending on pick-up arm

Measuring Temperature: 20° C 68° F

Colour: Beige



BSR (A/ASIA) PTY. LTD.
 SOUTHERN SECTION INDUSTRIAL ESTATE
 ST. MARY'S, N.S.W.
 PHONE: 623-0375, 623-0376



DISTRIBUTORS:
 GOLDRING ENGINEERING (A/ASIA) PTY. LTD.
 443 KENT STREET, SYDNEY, N.S.W.
 OFFICES IN ALL CAPITAL CITIES.

BSR:P100

There's an AIWA microphone to solve your recording problem.

AIWA DM.57 DYNAMIC MICROPHONE—Impedance: 60 and 50K. Frequency Response: 100-13,000 cps. Sensitivity: 75 db's. Dimensions: 7½" x 1½". Weight: 14 ozs. **\$18.50**

AIWA DM.17 OMNI-DIRECTIONAL DYNAMIC BOOM MICROPHONE—Impedance: 50K or 50Ω. Frequency Response: 70-14,000 cps. Sensitivity: 75 db's. Dimensions: 5½" x 1½". Weight: 10½ ozs. **\$18.50**

AIWA DM.51 DYNAMIC MICROPHONE. Impedance: 50Ω or 50KΩ. Frequency Response: 50-15,000 cps. Sensitivity: 55 db's. Dimensions: 10" x 1½". Weight: 29 ozs. **\$27.00**

AIWA DYNAMIC NON-DIRECTIONAL MICROPHONE DM.13—Impedance: 50K or 50Ω. Frequency Response: 60 c's-14,000 cps. Sensitivity: 55 db's. Dimensions: Length 10½". Weight: 18½ ozs. **\$29.00**

AIWA UNI-DIRECTIONAL DYNAMIC MICROPHONE DM.47—Impedance: 50Ω or 50K. Frequency Response: 40-18,000 cps. Sensitivity: 75 db's. Dimensions: 5½" x 1½". Weight: 18 ozs. with cord. **\$36.00**

AIWA DM.10 DYNAMIC DESK MICROPHONE—Impedance: 50KΩ or 50Ω. Frequency Response: 60-13 Kc's. Sensitivity: 75 db's. Dimensions: 7½" x 1½". Weight: 11 ozs. without stand. **\$16.80**

AIWA DM.14 DYNAMIC MICROPHONE—Impedance: 50Ω or 50K. Frequency Response: 90 c's-14,000 cps. Sensitivity: 75 db's. Dimensions: 3½" x 1½". Weight: 10 ozs. **\$12.50**

AIWA DM.67 CARDIOD DYNAMIC MICROPHONE — Impedance 50Ω or 50 KΩ. Frequency response 100> 12000 CPS with 15 dB. Front to rear separation. Sensitivity: 74 dB. Dimensions: 5½" x 2" max. Weight: 8 ozs. **\$33.00**



DM 57



DM 17



DM 51



DM 13

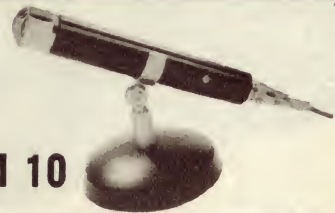

DM 10



DM 47



DM 67



DM 14



Distributed by:
GOLDRING
ENGINEERING (A'ASIA) PTY. LTD.

N.S.W.: 443 Kent St., Sydney. 2000. 29-1275.
VIC.: 162 Pelham St., Carlton, Vic. 3053. 67-1197.
QLD.: 415 Adelaide St., Brisbane, Qld. 4000. 23247.
W.A.: 32 Northwood St., Perth, W.A. 6007. 84988.
S.A.: 77 Wright St., Adelaide. 5000. 51-5117.

GE:P345

Dual

NEW RELEASE

1210 and 1212



Model 1210 illustrated

FRED A. FALK (SALES) PTY. LTD.

28 KING STREET, ROCKDALE, N.S.W. — PHONE 59 4783—59 7731

Distributors:

N.S.W.—All leading Electrical Houses.

VIC.—Radio Parts & Electrical Houses.

QLD.—Ron Jones P/L, 7-9 Merton Rd., Sth. Brisbane.

S.A.—Truscott Electronics & all leading Electrical Houses

W.A.—Athol M. Hill, 613 Wellington St., Perth.

TAS.—All leading Electrical Houses.



VARIETY FAIR

By HARRY TYRER, FORBES CAMERON, NEVILLE WILLIAMS

Devotional recordings

STEEL AWAY. Pete Drake. Stereo, Canaan CAS-9640-LP. (From Sacred Productions Aust., 181 Clarence Street, Sydney, and in other capitals.)

Interest: "Talking" guitar.

Performance: Certainly novel.

Quality: Normal.

Stereo: Normal.

Pete Drake, son of a minister, had to struggle the hard way to his present role as a top-line accompanist on the Nashville scene. A specialist on the steel guitar, he has developed a technique for making the guitar seem to pronounce words. There is no hint on the label as to how it is done but I suspect that it involves feeding the sound into the mouth or applying it to the throat, the player then mouth-ing the words into a microphone.

The trick is heard to best advantage in "Steal Away," the item from which the album takes its gimmick title. Played as an occasional track it will inject interest into a listening session but I doubt that many people would want to sit out the 10 tracks in a row.

The titles: Steal Away—Happy Tracks — In The Garden — What A Friend—When They Ring Those Golden Bells—The Eyes Of Jesus—Beyond The Sunset—How Green Thou Art—Stairway To Heaven—Whispering Hope.

Novel, interesting—but in small doses! (W.N.W.)

★ ★ ★

PATHWAY TO SONG. With Y.F.C. Compatible stereo, Crest CRT-12-SLP-019. (Distributed by Sound and Film Enterprises of Australia Pty. Ltd., 291 Toonga Road, Tooronga, Vic. 3146.)

Interest: Youth artists.

Performance: Gifted but not professional.

Quality: Good.

Stereo: Normal.

Y.F.C. stands for Youth For Christ, an organisations spread over fifty countries, which encourages youth to train and crusade for youth. Represented on this album are youth artists from Y.F.C. Victoria, who, among other activities, conduct regular rallies in the Melbourne Town Hall and the Melbourne Assembly Hall.

Two distinct standards of judgment have to be applied in commenting on

an album like this. Within the circle of those involved in Y.F.C. and similar activities, and who know the artists or their counterparts in other cities, the album will hold considerable interest. And it should be said that, by and large, the performances are good by amateur standards.

On the other hand, to listen to the album as a non-involved party and to judge it by commercial standards, one must inevitably take note of significant details: here and there faulty balance, apparent nervousness, misshapen vowel sounds — details that set talented amateurs apart from talented professionals.

But don't let's be unrealistic. For what it is and for the audience to which it is aimed, the record stands up well against anything similar that I have had opportunity to review.

Lack of space prevents us listing the titles and artists but it is typical youth rally material: vocals from formal to a yodeller, instrumental from piano, organ and guitars to xylophone and sax. By youth for youth. (W.N.W.)

★ ★ ★

HYMNS FOR OUR DAY. Music for the contemporary church. Composed by Jim Minchin. Stereo, World Record Club, W.R.C. S/4514.

Interest: Rock hymns, protest.

Performance: A great deal of merit.

Quality: Good.

Stereo: Plenty of separation.

To the rising generation, conditioned to guitars, the big beat and elemental emotions, traditional church music is reckoned to be square, routine, dull. Not surprisingly, a lot of people have tried to re-express religious convictions in other musical styles — jazz, rock, folk, C. and W. or pure schmaltz. Much of it has been pretty commonplace but, equally, some of it has reflected a great deal of sincerity coupled with perception and talent.

This recording, made in Melbourne and carrying an endorsement by the Anglican Bishop of Melbourne, must be included in the latter class. It features a talented group of musicians under the title The Most Men, also The Martindale Four, two soloists and a vocal support group. All the names are listed in the jacket notes.

The notes also mention that most of

the music has been published in the "Jazz in the Church" series.

Of the seventeen tracks—too many to list separately—more than half use words from what might be described as "great" hymns—"The Church Is One Foundation," "My Song Is Love Unknown," "The King of Love" and such like. The tunes, however, relate entirely to the present.

The remaining tracks are songs of comment and protest, including one which begins with a sound montage of well-known and immediately recognisable off-air and off-TV advertisements. Are these products really a panacea for "Feeling Sad And Lonely."

In another track, a soloist comments on complacent attitudes in the church while a formal congregation agrees, without the slightest conviction, that "Systems Come And Systems Go."

And a coloured Christ tries in vain to attract the attention of a white congregation in a warm, dry church, while he remains "Standing In The Rain."

This is not an album for those who have been brought up in the tradition of the church hymnal. Nor will it have much to say to those who have a preference for the schmaltzy and sentimental kind of Gospel song. But it certainly will appeal to those who share the convictions of composer Jim Minchin. (W.N.W.)

★ ★ ★

SONGS WE LOVE. Rudolf Schock (tenor). The Choir of St. Hedwig's Cathedral, Berlin. Berlin Symphony Orchestra. World Record Club Stereo S/4533.

Interest: Concert devotionals.

Performance: Sure to please.

Quality: Slightly dated.

Stereo: Normal.

One would expect to hear most of the items presented here in the concert hall and the recital room, rather than in church. (In fact, two of them have no devotional connotations.) Nevertheless, the contents should have their greatest appeal to buyers of devotional type records, and is included in this section for this reason. The solo tenor, Rudolf Schock, has been featured in several WRC discs, in which he has performed very competently. However, here he reveals himself to be something more, a fine singer with a voice that is extremely steady and sure of pitch, and with a particularly fine floating quality in the high register. I have nothing to complain about in the performance of the choir or orchestra either. All told, this is a most pleasing disc, which I recommend with confidence.

The selection comprises: Ave Maria (Gounod) — The Heavens are Telling (Beethoven) — Caro Mio Ben (Giordani) — Ave Maria (Schubert) — Ave Verum Corpus (Mozart) — Thus Never, Then, My Hands (Silcher) — Thanks to Thee, O Lord (Handel) — Halleluja Chorus (Handel) — Suffering Virgin (Stradella) — The Virgin's Cradlesong (Reger) — In Silent Night (Brahms)—Largo from "Xerxes" (Handel). It should be noted that the works are all sung in either German, Latin or Italian, so if you can only listen to English language versions, this is not for you. (H.A.T.)

NEW EQUIPMENT CABINETS



MODEL 192. Record storage or equipment cabinet. 36in wide, 21in high, 15½in deep, plus 9in legs. Record bins: 14in high, 8½in wide. Horizontal shelf 5½in high. Features: Sliding doors, mitred corners, semi-square legs. Price complete maple, teak, etc. \$57.60. Kit of parts (maple) \$31.50; teak \$6 extra. Packing \$1.00.

New Player Platform model 175 is 16in x 14in x 3½in. Price \$7.50 for maple or walnut. Kit of parts \$4.00. Teak, 50c extra. Perspex cover, 3½in or 5½in high, \$8.20 and \$1.50 extra if required hinged. Please specify cut out required.



MODEL 186

New Player Cabinet model 186 is 9½in high, 16in wide, 16½in deep and 5½in above shelf. Finished with tinted perspex top. Price: \$22.00 for maple or walnut or teak.

Kit of Parts \$13.50.

Teak: \$1.00 extra (kits only)

Height of this model can be increased to take various amplifiers. Tailored cut out. Ask for quotation. F.O.R. Packing \$1.

Write for Catalogue and Player Guide

H. B. RADIO SALES

103-105 CATHERINE STREET,
LEICHHARDT, SYDNEY.
TELEPHONE 56-5580

NEON TESTER AC-DC



Stuart brand AC-DC voltage tester. This handy continuity tester, has flexible leads with prods and pocket clip. Glows on contact with AC or DC from 100v to 500v. Insulated alligator clips can be supplied to fit the prods for remote testing.

PRICE: NEON TESTER 65 CENTS. Alligator clips, if required, 10 cents each extra.

Available from

RADIO PARTS PTY. LTD.
562 SPENCER STREET,
MELBOURNE, VICTORIA

Instrumental, Vocal and Humour . . .

PEER GYNT SUITES and SYMPHONIC DANCES. (Grieg). The Philharmonia Orchestra conducted by Walter Susskind. Concert Classics Series (E.M.I.) Stereo SOXLP 30105.

Interest: Light classics.

Performance: Pleasing.

Quality: Dated but good.

Stereo: Restricted.

The performance of the "Peer Gynt" suites dates from the early days of stereo, circa 1959, and was re-issued by World Record Club, in 1961. Originally, the two suites ran over on to the second side, and the fill was three Norwegian Dances. Now the suites have been accommodated on a single side, and the fill is much more generous, four fairly lengthy Symphonic Dances. This is certainly a popular and attractive program, and the performance of the Peer Gynt music has been a favourite version of mine for many years. In fact, I would go so far as to say that I have yet to hear a version I prefer (although this is not to say that there are not versions equally as good or better available). Issued now at the new low price of the E.M.I. Concert Classics series (\$2.50) this disc represents remarkable value. The performance of the Symphonic Dances equals the high standard of the suites, and despite the age of the recording, the sound quality is entirely satisfactory. (H.A.T.)

★ ★ ★

MUSIC FROM MILLION DOLLAR SHOWS, The Boston Pops Orchestra conducted by Arthur Fiedler. Stereo, RCA Dynagroove LSC-2965.

Interest: "Symphonic" show music.

Performance: Full bodied.

Quality: Excellent.

Stereo: Plenty of spread.

The Boston Pops Orchestra is of symphonic proportions and its conductor, Arthur Fiedler, is no stranger to classical concerts in association with leading orchestras throughout the world. But his expressed belief, according to the jacket notes, is that the patrons of classical concerts will respond warmly to any music, provided it is good music of its kind, well presented.

"Oliver" — a bargain at \$2.50

OLIVER. Lyrics and music by Lionel Bart. With Stanley Holloway, Alma Cogan, Violet Carson, and the Williams Singers. Tony Osborne and his orchestra. Stereo, EMI Columbia SOEX-9485.

Interest: Successful musical.

Performance: Top line.

Quality: Virtually flawless.

Stereo: Used to advantage.

Having seen and enjoyed the film version of Oliver a few months ago, I wasn't ready to settle for a routine studio performance of the music. But I needn't have worried — this is no routine performance.

Obviously enough, he rates the music presented here as such, the music from four shows: On A Clear Day You Can See Forever (Lerner-Lane); My Fair Lady (Lerner-Loewe); Camelot (Lerner-Loewe); The Sound Of Music (Rogers-Hammerstein II).

The arrangements for the first two, by Richard Hayman, use a wider sound canvas than for the remaining two by Robert Russell Bennett, but all make good listening.

The tunes, presented in medley style, are too numerous to list but they are the ones you'd expect to hear. A good disc, although those who like to pile on the bass boost may notice a trace of low frequency rumble behind the quietest passages. You'll enjoy it nevertheless. (W.N.W.)

★ ★ ★

HIGHLIGHTS FROM PAGANINI. (Lehar.) World Record Club Stereo S/4526.

HIGHLIGHTS FROM GIUDITTA (Lehar.) World Record Club Stereo S/4527.

Interest: Popular operettas.

Performance: High standard.

Quality: Clean.

Stereo: Normal.

Most of the performers in these two discs of Lehar's later operettas will already be well known to W.R.C. members, since they have been featured in several operetta sets issued in the last three years: Dorothea Chryst, soprano; Ferry Gruber, tenor; Rudolf Schock, tenor; Margit Schamm, soprano (in "Paganini" only); The Berlin Symphony Orchestra, conducted by Robert Stolz ("Paganini" only). The choir in both discs is the Gunther Arndt Choir. For the demanding role of Giuditta, Sylvia Getzy has been brought in — a wise move, as she has a beautiful voice, entirely suited to the part. The conductor in this work is Werner Schmidt-Boelcke, who is unknown to me.

With such an excellent caste of first rate artists, I confidently sat back to enjoy the performances, and was not in the east disappointed. The singing is of a consistently high standard, with Sylvia Getzy particularly good, and the wealth of fine melody to be found in both work sustains the enjoyment all through. I get the impression that these recordings date from several years ago.

The characterisation is excellent — Mr Bumble, Oliver, Nancy, Fagan, Bill Sykes, the lot. One gains the impression that the cast have been thoroughly involved in the motions of Lionel Bart's very successful re-creation of the famous Dickens' story.

And the recording itself is a beauty. Diction is superb and the solo voices are projected from the orchestral backdrop, with not a hint of the mechanics involved.

If you haven't seen the show, this album will whet your appetite. If you have seen it, you'll enjoy it all over again. At the advertised price of \$2.50 it's a bargain. (W.N.W.)

and the brilliance of the latest recordings is missing. However, the sound is perfectly clean, and the surfaces of the review discs were quiet and free from flaws. (H.A.T.)

★ ★ ★

PROMISES, PROMISES. Original Broadway Cast Recording of the musical, United Artists (Festival) Stereo SUA1-933,198. Available in Mono.

Interest: See above.

Performance: Presumably definitive.

Quality: Very good.

Stereo: Normal.

I must confess that most discs of this sort make little impression on me unless I have seen the show in question. In this case, I have not, so that the absence of any synopsis of the plot in the sleeve note left me in the dark as to what it is all about. Quite apart from this, I could find little to enthuse about in the quality of either the tunes or the lyrics, and coming to it cold the way I did, the impression was one of complete mediocrity. Nevertheless, if you are familiar with the show and its music, this one has the undoubted advantage of being an original Broadway cast recording, which should give it a head start over any competitors. The technical side of the disc is quite up to standard. (H.A.T.)

★ ★ ★

MEXICAN PEARLS. Billy Vaughn, sax, with orchestra. Calendar (Festival) Stereo SR66-9,591. Available in Mono.

Interest: Swinging sax.

Performance: Smooth as silk.

Quality: Very good.

Stereo: Normal.

The gently swinging, smooth sax playing of Billy Vaughn has never failed to please me, and this re-issue on the economy Calendar label is as good as any I have heard of Billy and his excellent orchestra. From the title, one might have expected a disc devoted to Latin American numbers, but in fact this is something of a mixed bag, with the following quite diverse numbers included in the 12 tracks: Mexican Pearls—Blue Orchid—Heart and Soul—Just One More Chance—The Nearness of You—Stella by Starlight. Tunes of this kind provide plenty of opportunities for Billy to demonstrate his lyrical qualities and if there is a sax player who can make them sound better, I have yet to hear him. Excellent value at \$2.95. (H.A.T.)

★ ★ ★

TANGO DYNAMICS. Nobuo Hara and his Sharps and Flats. Calendar (Festival) Stereo SR66-9,601. Available in Mono.

Interest: Popular tangos.

Performance: High standard.

Quality: Excellent.

Stereo: Well spread.

First issued a couple of years ago, this disc has now been released by Festival on its economy price Calendar label. It features that versatile Japanese musician Nobuo Hara, who has given us several very enjoyable discs on the King Records label. This particular one stands comparison with

RECORD MAINTENANCE TAKES ANOTHER BIG STEP FORWARD!

With these latest advanced products . . . from Cecil E. Watts
New Hi-Fi Parastat (Reg'd Pat. App. 58216/67).

GRAMOPHONE RECORD MAINTENANCE AND STYLUS CLEANING KIT



Designed for use on NEW records or records in new condition which are to be played with pick-ups requiring very low tracking pressures. The 30,000 finely pointed tips of the Hi-Fi Parastat Brush positively explore every detail in the record groove to provide the high degree of record cleanliness necessary when using ultra lightweight pick-ups tracking at 2 grams or less. The cover pad in the lid of the case is provided for the purpose of cleaning and activating the brush which when enclosed within the case is kept at the correct level of humidity required to control all static at the working surface. Perfectly clean records must be played with a perfectly clean stylus and an integral part of the kit is the new Watts Stylus Cleaner which provides a safe and efficient method of cleaning the stylus. Supplied complete with instructions, 1oz New Formula dispenser, Distilled Water dispenser, spare pad cover and ribbons. Price \$9.75.

NEW STYLUS CLEANER

Available separately complete with instructions. Price \$1.20.



"PARASTATIK" Regd. DISC PREENER (Patent No. 982599)

Keeps new records like new. Expressly designed for use with records which have not had previous antistatic treatment. Complete with instructions. Price \$2.10.



The original "DUST BUG" regd. (Patent No. 817598)

Automatic Record Cleaner, easily fitted to any transcription type turntable. Provides a simple and effective method of removing static and dust while the record is being played. Surface noise and record and stylus wear is reduced, resulting in cleaner reproduction. Complete with 1/2oz New Formula Dispenser and instructions. Price \$5.60.



AE ARROW ELECTRONICS

342 KENT STREET, SYDNEY, 2000, N.S.W. 29-6731.

Please send post-free:

..... Disc Preeners at \$2.10. Hi-Fi Parastats at \$9.75.
..... Dust Bugs at \$5.60. Stylus Cleaners at \$1.20.

I enclose cheque/P.N., value \$.....
(Do not send postage stamps)

Name

Address

here is the one for the

BIG SOUND

New Rola
12U50 speaker
with
**50 watts
RMS
power!**

Now you can let them hear it — all of it. No need to keep it down — new Rola 12U50 is built for the big sound. It was developed specifically for the high power handling requirements of electric bass guitars. The 12U50 is a 12" speaker with all the power handling capacity you need — it is as tough as they come — and it bears the Rola label . . . your guarantee of quality and fidelity to the highest standards. It has been fully field tested under the most rigorous conditions.



Features

- 50 watts R.M.S. power handling over full range.
- Long, heavy gauge aluminium voice coil former for high thermal conductivity.
- Epoxycoated voice coil winding insulates coil against high temperatures generated at high power levels.
- Heavy duty voice coil connecting braids to prevent flexing fracture.
- Fully felted cone, with special rlm treatment to provide large linear excursions without break up at high levels.

A leaflet detailing recommended Rola enclosures for 50 or 100 Watt systems is available on request. Complete Rola enclosures are also available.

PLESSEY
Rola



Plessey Rola Pty Limited
The Boulevard Richmond Victoria 3121
Telephone 42 3921 Telex 30383
NSW PO Box 2 Villawood 2163
Telephone 72 0133

AR19

any disc of Latin American music from any source. The musicianship of the band is of a high standard, and the selection of tunes will, I am sure, include the favourite tangos of most people: La Cumparsita — Blue Heaven—Orchids in the Moonlight—Blue Tango—Il Pleut sur la Route—El Choclo—Isle of Capri—Ole Guapo—Tango della Rosa—La Paloma—Pearl Fishers—Adios Muchachos. The technical side of the disc is of a high order, with no noticeable distortion and excellent stereo spread. (H.A.T.)



*Off to your mother's again?
Why can't you spend an evening
at home occasionally?
"TV Times."*

UNDER THE BRIDGES OF PARIS.
The Magic Accordions of
Adriano, Studio 2 Stereo (E.M.I.)
TWO 223.

Interest: Popular French tunes.
Performance: Lacks sparkle.
Quality: High standard.
Stereo: Good spread.

This presentation of well-known French numbers by an English accordion band is pleasant enough, and should make excellent background music, but to my mind it lacks a little in excitement in both performance and arrangements. The disc is saved to a great extent by the pleasant tunes but I feel a little more attention to dynamics and more skilful arrangements would have made it a much better proposition. In addition to the title number, the 12 tracks include: Petite Fleur—Milord—Irma la Douce—Live for Life—Soul Coaxing—That's Paris. (H.A.T.)

★ ★ ★
THE NASHVILLE SOUND. The
Nashville Brass. RCA Victor
Stereo LSP-4059.

Interest: C. and W. and brass.
Performance: Bright and lively.
Quality: High standard.
Stereo: Well spread.

A setting of country and western standard for trumpet, flugelhorn, trombone and orchestra is something of a novelty, but it is not to be despised as a gimmick on that account. The horns are played by Danny Davis and Bill McElhiney, which gives the personnel a good start, but in addition they are backed by some impressive talent: Floyd Cramer on piano; Johnny Hart-

ford, banjo; Bobby Moore, bass; and The Jordanaires provide the vocal line. The presentation is lively and entertaining, and in all respects the disc earns good marks, but I feel moved to protest against the short playing time of 14½ minutes on side one and an even worse 12 minutes on side two — poor value indeed for a top-price disc. On the credit side, the sound quality and stereo spread are both excellent. The well-known numbers include: Mule Skinners Blues—Let It Be Me—I Fall to Pieces — Mountain Dew — Jambalay. (H.A.T.)

★ ★ ★
THE ROYAL MARINES PLAY SOUSA. The Band of the Royal Marines, conductor Lieut.-Col. F. Vivian Dunn, Studio 2 Stereo (E.M.I.) TWO 235.

Interest: Military band.
Performance: Rather tame.
Quality: Excellent.
Stereo: Normal.

The Band of the Royal Marines play very competently, but they seem to be lacking a little in the vitality (even perhaps pomposity) which these Sousa marches require. They rather give the impression of lacking a bit in enthusiasm, as though this performance is really only part of the day's work for a military band, and let's get it over with and call it a day. The big American bands seem to get much more pleasure out of these grand marches, and since there are so many alternatives available, it is difficult to find any grounds for recommending this particular disc. However, if you are a collector of band music, this one should certainly not be written off entirely, since the selection will certainly appeal, and the recorded sound is excellent: The playing time is generous (14 tracks in all) and the program includes: El Capitan — The Belle of Chicago—Sound Off—The Gladiator—The Thunderer—Kansas Wildcats—King Cotton. (H.A.T.)

★ ★ ★
DANCE TO THE MOST BEAUTIFUL VIENNESE WALTZES.
Frank Pourcel and his Orchestra.
Columbia (E.M.I.) Stereo SOEX
9515.

Interest: Waltzes for dancing.
Performance: Attractive and fresh.
Quality: Excellent.
Stereo: Wide and even.

The high standard of performance we have come to expect from Frank Pourcel and his orchestra is maintained in this \$2.50 reissue, featuring some of the most popular of the Viennese waltzes: Vienna Blood — Treasure Waltz — Voices of Spring—Wine, Women and Song—Gold and Silver—Tales from the Vienna Woods—Artist's Life—Danube Waves —Emperor Waltz. On a purely personal basis, I have a distinct preference for these waltzes to be played complete, with all the preludes and postludes—in other words, the complete concert versions. This particular performance is obviously intended mainly for the ballroom, and all the waltzes are presented in shortened form. These are played in sparkling fashion, and as usual, Pourcel's arrangements are attractive and imaginative. Sound quality and stereo spread are excellent throughout. (H.A.T.)

FOUR HIGH QUALITY MICROPHONES FOR USE WITH YOUR TAPE RECORDER

LONDON LM-100
An omni-directional dynamic dual impedance microphone with a response of 50-15,000 Hz. An ideal general-purpose unit—robust and designed to withstand studio or field use. Ask for complete specifications. EnceI price inc. sales-tax.

\$9.75



LONDON MODEL LM-200

A dynamic cardioid dual impedance microphone with balanced output and a frequency response of 50-15,000 Hz. Discrimination at 180 deg. eliminates unwanted background noise. Natural recordings are possible even under unfavourable acoustic conditions. Weight is only 4½oz including the cable. Ask for complete specifications. EnceI price inc. sales-tax.

\$16.85

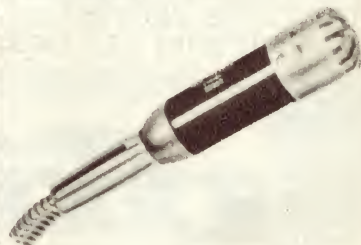

SWEDISH PML MICROPHONES MODEL RD-36.

Probably the most popular of the PML range is the Model RD-36, a dynamic cardioid dual impedance microphone with a frequency response of 30-20,000 Hz. This slender microphone is recommended for high quality sound recording; even under the most unfavourable conditions it solves problems arising from feedback and background noise. Ask for complete details. EnceI price inc. sales-tax.

\$47.00

NEW PML CONDENSER MICROPHONE MODEL EC-71 — ONLY \$102.

A new solid state miniature cardioid condenser microphone with a frequency response of 40-16,000 Hz. Weight is only 1½oz and size only 2 11-16in x 11-16". The PML EC-71 is used by many professionals, and is ideal for use with the Revox A77 tape deck. EnceI price includes the power supply.

\$102.00

Encel ELECTRONICS (STEREO)PTY. LTD.

Head Office:
431 Bridge Rd., Richmond, Victoria 3121.
Tel. 42 3762.

Sydney Store: Ground Floor, 2SM Building,
257 Clarence Street, Sydney, N.S.W. 2000.
Tel. 29 4563, 29 4564.

*Wholesalers *Trade-ins accepted

Australia's Greatest Hi-Fi Centre

NEW ALL TRANSISTOR STEREO AMPLIFIER ULTIMATE IN DESIGN-LONG DEPENDABILITY USING ALL SILICON TRANSISTORS 40 WATTS – RMS

SPECIFICATIONS:

POWER OUTPUT: 20 watts per channel

R.M.S. Total output 40 watts R.M.S.

FREQUENCY RESPONSE: From 20 cycles to 20,000 \pm 1db.

HARMONIC DISTORTION: Less than 1% at rated output.

HUM & NOISE: Aux. 70db, Mag. 50db.

INPUT SENSITIVITY. Mag. 3mv. Aux. and tuner 150 mv.

SPEAKER IMPEDENCE. 8 ohms.

EQUALIZED: Mag. RIAA.

TONE CONTROLS: Bass 50 c/s \pm 12db.

Treble 10 kc/s \pm 12db.

LOUDNESS CONTROL: 50 c/s 10db.

SCRATCH FILTER: (High filter) at 10 kc/s 9db.

RUMBLE FILTER: (Low filter) at 50 c/s 5db.

PROVISION FOR TAPE RECORDER. RECORD OR PLAY-BACK WITH DIN PLUG CONNECTION.

PROVISION FOR HEADPHONES WITH HEADPHONE/SPEAKER SWITCH ON FRONT PANEL.

THE CIRCUIT INCORPORATES REGULATED POWER SUPPLY WITH TRANSISTOR SWITCHING PROTECTION FOR OUTPUT TRANSISTORS. 26 SILICON TRANSISTORS PLUS 5 DIODES ARE USED.



MODEL C300/20

\$119.00 FREIGHT EXTRA

DIMENSIONS: 16 $\frac{1}{2}$ in x 5 $\frac{1}{2}$ in x 11 in deep
MOUNTED IN OILED WALNUT OR TEAK
VENEERED CABINET WITH METAL
TRIM AND MATCHING KNOBS.



MODEL C300/20/T

**ABOVE AMPLIFIER
WITH INBUILT A.M.
TUNER**

\$144.00 FREIGHT
EXTRA

12 WATT RMS PER CHANNEL VERSION OF ABOVE AMPLIFIERS AS PREVIOUSLY
ADVERTISED ALSO AVAILABLE.



**MODEL C200V. BASED ON THE
PLAYMASTER 118 WITH TUNER**

Dimensions 16 $\frac{1}{2}$ in x 5 $\frac{1}{2}$ in x 11in.

CABINET IN OILED WALNUT OR TEAK WITH
METAL TRIM.

\$118.00 FREIGHT EXTRA

This amplifier is based on the Playmaster 118 circuit as featured in "Electronics Australia" to which has been added the following features.

- Inbuilt high gain A.M. tuner with a coverage of 530 to 1,600 K.C.
- Loudness control giving bass boost at low volume.
- Provision for tape, record and play-back, with din connector.
- Calibrated dial available for all States.
- EM84 tuning indicator giving accurate tuning with ease.

POWER OUTPUT: 9 watts per channel R.M.S. **FREQUENCY RESPONSE:** 20 to 20,000 cycles incorporating Ferguson O.P.412 grain oriented output transformers. **VALVES USED:** 4-6GW8, 12AX7 or 12AU7, 6AN7, 6N8, EM84 and 2 silicon diodes.

CLASSIC RADIO

245 PARRAMATTA ROAD, HABERFIELD, N.S.W. PHONE 798-7145

MEMORIES. Lawrence Welk and his orchestra. Ranwood (Festival) Stereo SFL-933,160. Available in Mono.

Interest: Evergreens of yesteryear.
Performance: Appropriately easy paced.
Quality: Very good.
Stereo: Normal.

The popularity of Lawrence Welk's light and sparkling "champagne music" is too well established to warrant anything in the way of comment. Here, Welk has collected 12 of the songs which were popular in the thirties, hence the disc title, "Memories." This, for once, is a very apt title, since this collection of evergreens will surely evoke memories for millions of folk who lived through the decade of the thirties: Going Home—Melody of Love—Paradise—Silver Moon—Cinco Robles—When I Grow too Old to Dream—Three O'Clock in the Morning—I'll See You Again—Fascination—Poeme—Anniversary Song—Memories. Pleasingly played in very relayed style, this disc will surely find many takers among those in the forty-plus age group. (H.A.T.)

★ ★ ★

HAMMOND IN STEREO. Hubert Teichmann. Compatible Stereo. CBS, SBP-233661.

Interest: Hammond, club style.
Performance: Very adept.
Quality: Normal.
Stereo: Normal.

Hubert Teichmann is presumably the featured organist at the Hotel Frankfurter Hof, Frankfurt on Main. In my book he must also qualify as an outstanding exponent of the percussive techniques possible on the organ, with a strong sense of rhythm to match. Much of his performance proceeds with accentuated attack but, by

"Great Organ . . ." most satisfying

GREAT CATHEDRAL ORGAN SERIES, No. 15, Westminster Cathedral. His Master's Voice (E.M.I.) Stereo OCS D 3648.

Interest: Massive organ.
Performance: Masterly.
Quality: Well recorded.
Stereo: Adds presence.

This fifteenth disc in the series features the massive instrument of London's Westminster Cathedral (the Catholic cathedral, by the way, and not to be confused with Westminster Abbey). This outstanding instrument was finished as recently as 1932, and is really two organs in one. It comprises a four manual organ with its own attached console, and an earlier two-manual organ with a detached console which controls both organs singly or together.

The four-manual 16ft great organ covers CC to C, 61 notes, and consists of a 19 stop great organ, a swell organ with 15 stops and tremulant, a choir organ with 12 stops and tremulant, a solo organ with 14 stops and tremulant. The 18 stop pedal organ covers the wide range CCC to G, 32 notes, and is equipped with wooden 32ft double open bass. The smaller organ has a seven stop great organ with three

contrast, he occasionally exploits the rounder tones of the instrument.

Played at high volume, these differences are most apparent but, interestingly enough, at low "background" level the immediate awareness of attack give place to a sense of brightness and an awareness of changes in voicing. Presumably this is how the performance would be heard in the hotel.

A generous program includes thirteen tracks: Walk On The Wild Side — Dixieland Medley — Spanish Eyes — Musette Medley — Yesterday Man — Strangers In The Night — Woolly Bully — Somewhere My Love — Evergreen Medley — Die Schlittschuhläufer — Gershwin Medley — Amorada — Slow Waltz Medley.

Not everybody goes for Hammond organ records but, in its class, this must be rated as a very successful album. (W.N.W.)

★ ★ ★

SPOTLIGHT. Earl Grant. Festival Stereo SDL 933008 (also in Mono).

Interest: Largely vocals.
Performance: One of Grant's best.
Quality: A bit flat.
Stereo: Normal separation.

Earl Grant's natural habitat is first and foremost the nightclub, where his dynamic personality comes through to full effect. He does not record nearly as well and the majority of his albums have failed to do him justice.

But this studio recording is certainly one of his better L.P.s. On six of the twelve tracks, he is accompanied by a somewhat subdued Gerald Wilson Big Band while, on the remainder, he has with him his regular small backing group.

He sings on all but two tracks, a delicate and sensitive version of "All The Things You Are" and "Drown in My Own Tears." He shows his best form, however, on "Love Letters,"

couplers, swell organ with five stops and three couplers and a 32 note pedal organ with three stops and three couplers, equipped with 32ft sub bass. A detailed listing of all stops and couplings is given on the sleeve.

To demonstrate the huge resources at his command, organist Nicolas Kynaston has chosen the following works: Chorale No. 3 in A minor and Pastorale (Franck) — Combat de la Mort et de la Vie (Messiaen) — Carillon de Westminster from "Suite No. 3" (Vierne). While he may be accused of showing little imagination in his choice of works, these pieces do have the merit of allowing the performer to utilise the resources at his disposal, and this he proceeds to do in no uncertain fashion. The recording is characterised by wide dynamic range, and will be a severe test of your equipment. If it can handle the roaring of the 32ft pipes without distress, you can be pretty sure it will be able to handle anything you are likely to throw at it. Altogether, a most satisfactory disc, featuring a wonderful instrument, playing of a very high order and excellent sound which, despite the difficulties which must have accompanied this recording assignment, shows negligible distortion. (H.A.T.)

If you want STEREO EQUIPMENT

You'll deal better with
H. B. RADIO SALES

SEPTEMBER SPECIALS

KENWOOD TK250 AMPLIFIER/
2 Wharfedale unit 3 speaker systems. Dual 1019 player on platform, Shure magnetic \$398.00
KENWOOD 150 AMP, 2 Magnavox 10in speaker systems in Teak. Garrard AT60 on platform, with Shure M44G \$275.00
SANSUI 555 2 Wharfedale super 10 dual speakers in R3 teak cabinets, dual 1019 player, Shure M44G, platform and cover \$460.00
MAGNAVOX or ROLA design slimline cabinets with 8 W.R. (V.C. 15, 8 or 3 ohms) or 8 CMX speaker fitted \$30.00
Cabinet Kit only \$11.00
MAGNAVOX 10 W.R. and 3 C.F. Tweeter with Crossover in 2 C.F. cabinet, 4in material \$43.00
12 W.R. in 3 cubic ft.
cabinets \$44.00
GOODMANS design 3 CF Cabinet and Twin-axiom 10 speaker, 4in material \$57.50
Cabinet Kit and Speaker . . \$45.00
WHARFEDALE design, 3 CF cabinet (R3) 4in material and Golden 10 speaker \$63.00
Cabinet Kit and Golden 10 Speaker \$50.80

Special quotes for other Wharfedale or Goodmans speakers. Available in Maple, Walnut or Rosewood colours. Teak veneer \$1 extra for Slimline and Bookshelf models. \$2.00 extra for others.

BOOKSHELF SPEAKER UNITS
PLAYMASTER, complete . . . \$31.00
CABINET Kit and Parts . . . \$23.40
POINT 4, complete \$35.00
CABINET Kit and Parts . . . \$25.00
PLAYMASTER SUPER \$42.00
CABINET Kit and Parts . . . \$32.50
Wharfedale Unit 3 (large) \$54.00
CABINET Kit and Parts . . . \$43.50
Wharfedale Unit 3 (small) \$49.00
CABINET Kit and Parts . . . \$39.50

Packing charge \$1 per order.
Freight payable on delivery.

Send for Stereo Catalogue

H. B. RADIO SALES

Manufacturers of Quality Radio and Radio Furniture for 37 years.

103-105 Catherine Street,
LEICHAARDT, SYDNEY
Telephone 56-5580

ELECTRONICS FOR EXPERIMENTERS

Constructional projects, common-sense theory, News, views and comments. Send for sample copy.
THE AUSTRALIAN EEB
P.O. BOX 177, SANDY BAY,
TASMANIA 7035, AUSTRALIA

Goodmans

The Greatest Range-

The Greatest Name

Goodmans High Fidelity loudspeakers meet your every requirement, and Goodmans name is your guarantee of excellence.

From Goodmans range, you can select your own personalised system – to suit your amplifier output, room size, pocket and ear. Choose, too, the cabinet style you prefer from the range of recommended designs.

Our range of single unit full range High Fidelity speakers is illustrated here – each, when correctly housed, a complete High Fidelity system. Find out all about them. And Goodmans 'Stage-built' and Multiple Speaker systems, using the world-famous Audiom Bass speakers with mid- and high frequency units. And the special Audioms for Public Address work and Musical Instrument amplification.

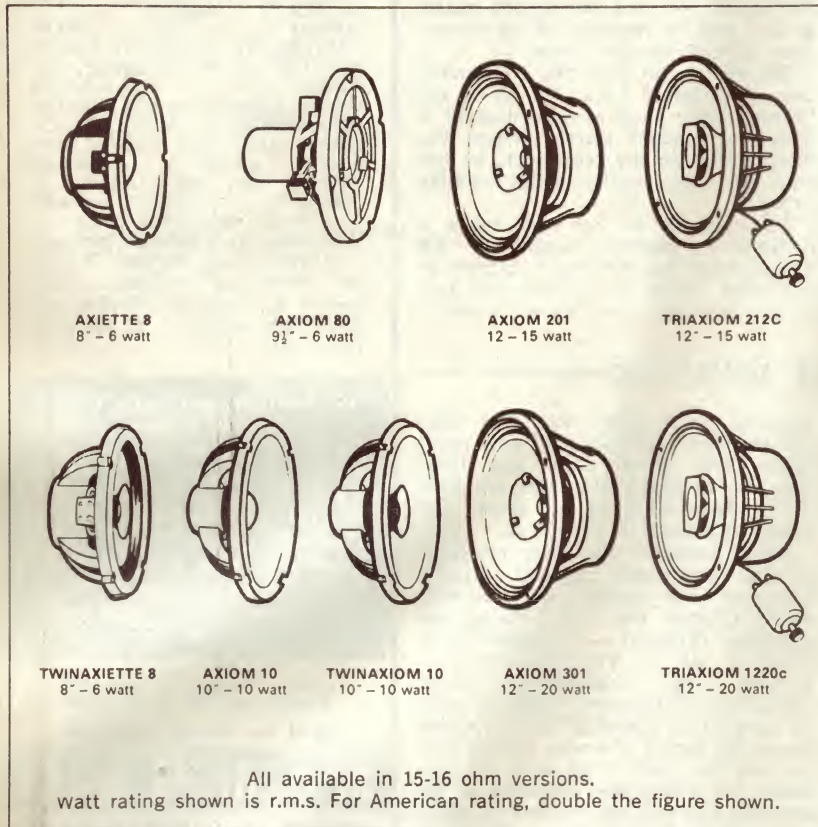

Goodmans for High Fidelity

For full particulars, write to the Sole Australian Agent:

British Merchandising Pty Limited

Shaw House, 49-51 York Street, Sydney.

Telephone: 29 1571 (3 lines)

"This Little Girl of Mine," "I Left My Heart in San Francisco" and "Work Song."

If, like me, you have been a little disappointed with Earl Grant's recent recordings, you may find that the 36 minutes of music on this L.P. will restore your faith in this talented artist. (T.F.C.)

★ ★ ★

I'VE GOTTA BE ME. Peter Nero, piano, with orchestra and chorus. CBS Stereo SBP 233667.

Interest: Piano artistry.

Performance: Highly sophisticated.

Quality: Excellent.

Stereo: Normal.

I am sure that there will always be a wide audience for Peter Nero's highly sophisticated style of music making, but personally, I do not get the same amount of pleasure from his latest discs that I did from his early efforts. I think this is because a few years ago, everything Peter did had a touch of originality, whereas now he seems to have settled into a stereotyped rut, playing current hits with a fair amount of ornamentation and possibly improvisation too. There is no denying his keyboard artistry, and if you like this kind of musical histrionics, using flashing runs, arpeggios and ornamentation around the melodic line, you will find plenty to enjoy in this performance. The tracks are: For Once in My Life — Wichita Linesman — Soulful Strut — Scarborough Fair (Canticle) — Rain in my Heart — I Love How You Love Me — I've Gotta be Me — Variations on Ob-La-Di-Ob-La-Da — Hey Jude — All I Need is Time — I'm Gonna Make You Love Me. Orchestral and choral backing are excellent. (H.A.T.).

★ ★ ★

NOTHING BUT ACES. Caterina Valente and Edmundo Ross (vocals) with the Edmundo Ross Orchestra conducted by Edmundo Ross. Decca Phase 4 Stereo (E.M.I.) PFS 4157.

Interest: Latin American songs.

Performance: Disappointing.

Quality: Excellent.

Stereo: Good spread.

As an ardent admirer of Caterina Valente, I was disappointed by her performance on this disc. The cause of complaint is not hard to find. In half of the tracks, bandleader Edmundo Ross gets in on the vocals, and severely cramps Valente's style. Ross is an outstanding bandleader, and a pretty fair vocalist too, but here he simply gets in Valente's way. In total, the pair sound like a pair of amateurs having a happy time hamming it up at a late night party. Even when singing alone Valente does not seem to settle down to her usual sparkling form, Valente fans who doubt whether this great performer really sounds as bad as I make out should at least try to sample this disc before buying.

The songs, all sung in Spanish or Portuguese, are: La Bamba — Azulao — The Fool on the Hill — La Pergrinacion — Sabor a Mi — Sueno Que Estoy Junto a Ti — Be In — Samba de Verao — O Meu Violao — Maria Elena — La Rosita — Canto de Ossanha. The Decca Phase 4 sound is, as always, excellent. (H.A.T.)

"SUNSET": Festival's new label

Festival Records has established a new budget-price record label, called Sunset, which will feature top ranking artists and sell at the price of \$2.95. The material all appears to be from the Liberty label, which Festival has handled for some years. The first Sunset releases reached us recently and proved to be in line with the company's claim of big names and technical excellence. Each disc has 10 tracks with the relatively short playing time of 15 minutes a side. From the first release, we have selected three for review.

★ ★ ★

THE INCOMPARABLE PIANO STYLINGS OF FERRANTI AND TEICHER. Stereo SLS-96,002. Available in Mono.

This features the slick piano duo in a typical flowing performance of popular tunes, backed as usual by a large orchestra of accomplished musicians. The arrangements are also of the typical high standard for these artists. The music is possibly a little less than exciting, but as mood music, or for relaxation, I cannot suggest anything better. The tracks are: Moon River — Jessica — Spring Song — Three Coins in the Fountain — June in January — Laura — Springtime — Love is a Many Splendoured Thing — To Spring — Ebb Tide. A good varied program which should contain something for everybody's tastes.

★ ★ ★

THAT'S ALL. Vikki Carr. Stereo SLS-96,001. Available in Mono.

The very accomplished and versatile Vikki Carr presents a wide ranging program with a variety of moods which should please her fans enormously. These tracks are vintage Carr, which I

judge to be from the period just after she reached the peak of her popularity. The material ranges from the emotional "That's All" and the sadness of "None but the Lonely Heart" to the bright and lively rendering of "Accent-Tchu-Ate the Positive" and "Hey Look Me Over." Shades of protest appear in "One More Mountain." The remaining tracks are: "I've Got Your Number—Everything I've Got—I've Grown Accustomed to Her Face—Sunshine—How Does the Wine Taste. The last-named is a very good track, typical of the wistful, questioning song that Vikki can project so well. Orchestral backing is excellent and the arrangements are outstanding.

★ ★ ★

THE FANTASTIC PIANO STYLINGS OF THE REMARKABLE PETER NIELSEN. Stereo SLS-96,005. Available in Mono.

Peter Nielsen is one of the most skilful exponents of the style known as "cocktail piano." For those who appreciate this style, this disc will prove a very enjoyable experience. The piano playing is virtually faultless, sensitively phrased and smoothly delivered. Backing is by bass and drums, the latter not surprisingly being mainly subdued brush work. The bass has been very prominently recorded, and I found it necessary to cut my bass control back from its normal level. The material in eight of the 10 tracks is concerned with arrangements and medleys from "My Fair Lady" and "Porgy and Bess." The other two are "Tea for Two Cha Cha" and "Danzero." A very pleasing disc.

CONCLUSION. If the first release is typical of what is to follow, this should be a very popular series. (H.A.T.)

FRANCOISE HARDY. Disque Vogues (Festival) Stereo SVL 933199. Available in Mono.

Interest: French singing star.
Performance: Has wide appeal.
Quality: High standard.
Stereo: Well spread.

Festival Records has recently taken over the distributorship of the French label Disque Vogues, and this is the first release featuring the popular Francoise Hardy. This enchanting young French singer has that special quality which appeals to people in all age groups, and I am pleased to hear from Festival that this disc is only the first of several they have lined up for early release. She is an outstanding artist, who not only sings delightfully, but also composes her own songs and accompanies herself on guitar.

In this particular disc, she sings entirely in French, which some people may find a handicap to full enjoyment, but her message is simple and direct, and if you do not get this message, there is something wrong with your hormones. The selection includes her first big hit, "All the Boys and All the Girls." Also included are: It Flopped — The Girl With You — Oh, Oh Darling — The Love Time — He is Everything to Me — We Please Each

Other — Your Best Friend — I've Thrown My Heart Away — He Left Some Day — I Agree — It's Love I'm Thinking Of. The technical quality of this French recording is the equal of the best available today. (H.A.T.)

★ ★ ★

BOTH SIDES NOW. Robert Goulet. Stereo, CBS SBP-233664.

Interest: Popular male vocalist.
Performance: Enjoyable.
Quality: Virtually flawless.
Stereo: Normal.

I can listen with a good deal of pleasure to Robert Goulet — a man's-man vocalist of the old school, who needs neither gimmicks nor even a microphone to create a fine performance. Teamed here with a good orchestra and with some excellent arrangements, he presents a thoroughly enjoyable program.

Both Sides Now — For Once In My Life — Thirty Days Hath September — Wait For Me — Those Were The Days — How Small We Are — How Little We Know — Cycles — Here In My Heart — Les Bicyclettes De Belize — Bon Soir Dame — I'll Catch The Sun. A very enjoyable record, well recorded. (W.N.W.)

COMPLETE HI-FI RADIOGRAM-TAPE RECORDER ALL IN ONE

MODEL TR9



AS AN AMPLIFIER . . .

- Frequency response, 20-20000 cps.
- 7 Watts RMS. output per channel.
- Distortion less than .25%
- Separate treble and bass controls.

AS A RADIO . . .

- Being fully transistorised, can be switched on all day at full output without heat problems. Program can be recorded on tape without any external connections.

AS A TAPE RECORDER . . .

- Freq. response 30-18000 cps.
- 3 speeds. Meter level indicator.
- Push button operation.
- Superimposing.

PRICES:

- 2 track mono, \$159.00
- 4 track mono, \$169.00
- 4 track stereo, \$230.00

RADIO TUNER CAN BE FITTED TO ANY OF THE ABOVE MODELS FOR \$28 EXTRA.

TAPE DECKS

for the home constructor. COLLARO (Magnavox) tape decks complete with record/play and speed change switch wafers fitted . . .

2 tracks, \$48. 4 tracks, \$55. SPECIAL LOW IMPEDANCE HEADS for transistorised tape amplifier circuits (Mullard) available).

CLASSIC TAPE RECORDERS

93B LIVERPOOL ROAD,
SUMMER HILL, N.S.W.
Telephone 79-2618



SAVE YOUR RECORDS . . . USE THE UNIVERSAL LUSTRE TONE ARM LIFT!
This beautifully finished and functional universal tone arm lift will fit all tone arms . . . the lowering action is pneumatically damped and extremely smooth. Risk of record damage may now be eliminated. Including Sales-Tax

\$8.50

COMPAX SOLID STATE TUNERS

A high quality wide band AM tuner, the Compax represents outstanding value. Output suits all amplifiers and tape recorders. The external teak finish case is optional. Price with case is \$46.50 inc. sales tax. Encel price without case

\$43.60

DEMAGNETISE YOUR TAPE HEADS AND IMPROVE TAPE PERFORMANCE!

Simply plug the tape head demagnetiser into any AC power point and pass over the heads. Takes only five seconds and can make a world of difference. Two models—single and double probe. Both (inc. Sales tax)

\$4.50



NOW . . . SPEAKER WITH UNIQUE PERFORMANCE AND SIX POWERFUL MAGNETS . . . ONLY \$34.50!

Can any 8in speaker be worth \$34.50? Easily . . . when you see and hear the remarkable CX-20D. Here at last is a total-performance 8in co-axial speaker with six magnets, a horn type tweeter, an electrical crossover, high compliance and unusually robust ribbed construction. Total weight is almost 8lbs and frequency response is 35-20,000 Hz. The response curve is substantially flat. From an engineering viewpoint the CX-20D is superb in design and construction. The matching enclosure is easy to make and any handyman can make it from readily available materials. We want you to hear the CX-20D and make your own appraisal. It's tremendous value for money! Inc. sales tax.

\$34.50

SPECIAL SLASHED PRICES ON SHURE CARTRIDGES

If you're waiting to buy a new Shure cartridge be sure to get Encel's bargain basement price before you make your purchase. We are not at liberty to advertise our new low prices.

CASSETTE RECORDERS

If you're looking for a cassette tape recorder, write or call at your nearest Encel Stereo Centre for an EMQ. We are not permitted to reveal the current cash prices for popular cassette recorders through advertising.



POWERFUL PUBLIC ADDRESS AMPLIFIER OFFERS AN OUTPUT OF 35 WATTS R.M.S.—\$73.50

Once more stocks of the Planet MG-300 public address amplifier have arrived. Parallel push-pull 6BQ5s are used in the output stages . . . frequency response is 30-15,000 Hz, plus or minus 2 dB. Inputs suit two crystal/dynamic microphones at 5 mV, and an auxiliary input with 300 mV sensitivity suits tuners, tape recorders, etc. Output impedances include 8, 16 and 250 ohms as well as a 70V line. Inc. sales tax

\$73.50

CELESTION CO-AXIAL HIGH FIDELITY LOUDSPEAKERS

Limited supplies of both 12in Celestion speakers—the CX 2012 at \$64.50 and the CX1512 at \$44.50 — are available from time to time. Demand from world markets and limited specialised production have restricted supplies to Australia. If you've been waiting for one of these fine co-axial units, order from Encel's now! Both prices include sales-tax and orders will be filled in strict sequence.

"DITTON 10's" AND "DITTON 15's" ARE ONCE MORE IN LIMITED SUPPLY
The Celestion Ditton 15 measures only 21in x 9 1/2in x 9 1/2in and incorporates the HF 1300 Mark II tweeter, a new type of bass drive unit and the revolutionary auxiliary bass radiator. Many favourable reviews have been published — ask for your copies! "Hi-Fi Sound" — "it was difficult sometimes to realise that so small a loudspeaker was really producing such well-defined low frequency sounds. It goes without saying that the treble performance was fully up to standard of the HF 1300." "The Gramophone" — "the listening tests made an excellent impression. Treble was bright and forward; the bass was clean and powerful enough to produce a good balance." "Hi-Fi News" — "the quality of bass sound was above average; plenty of bass, but always clean and clear." "A very wide range of programme material was enjoyed and nothing caught it out or gave cause for reservation."

The Celestion Ditton 10 measures 12in x 6 3/4in x 8 1/4in and features a specially designed bass unit and the well known Celestion tweeter. Both 3 and 15 ohm impedances are available. One review of the Ditton 10 in "Records And Recording" says, "On a wide range of music it proved to be a clean-sounding speaker with the sort of characteristics which would make it one of the most popular in its class."

Prices: "Ditton 15in" (inc. Sales Tax) **\$89**

"Ditton 10in" (inc. Sales Tax) **\$64.50**

CELESTION GUITAR SPEAKERS

Write or call now for full details and prices of Celestion 15in and 18in woofer speakers — designed for guitar applications. These fine units feature massive magnet structures to provide high flux density and extended bass response. Power handling capacity is up to 100 watts R.M.S. with 18in models.

LOOKING FOR AN ADC CARTRIDGE? SEE ENCEL ELECTRONICS WITHOUT DELAY!

A full range of renowned ADC cartridges is now available and Encel prices cannot be advertised. However you can overcome this tragedy by writing for a personalised quote or a trade-in valuation. You'll save more at Encel Electronics!

SEE A COMPLETE AUDIO RANGE AT ENCEL STEREO CENTRES!

Apart from the many exclusive Encel lines you'll find a vast range of high quality equipment at Encel stores in both Sydney and Melbourne. They are a few of the manufacturers represented: Eric Kenwood, K.F. Sony, ADC, Wharfedale, Ortofon, National, Toshiba, Shure, Akai, Sansui, Philips, Nivico, BSR, Garrard, and many, many more. Be sure to set an Encel EMQ (Encel Mail Quote) — you'll save much more at Encel Electronics!

TRADE-IN AND TRADE-UP!

When purchasing equipment from Encel Electronics, be sure to ask for a trade-in valuation on your old equipment. If your old equipment is in good working order, the cost of your current purchase can be reduced considerably. Bring in your amplifier, tape recorder, tone arm, etc. and save more than ever at Encel Stereo Centres!

SAVE MORE ON ALL LEADING MAKES OF TAPE RECORDER

Encel Stereo Centres stock all the best makes: Akai, National, Toshiba, Philips, Revox, Tandberg, Nivico and many more. You'll be wise to secure an Encel price before you commit yourself elsewhere. Save at Encel's!

KENWOOD AMPLIFIERS NOW AVAILABLE!

Save more at Encel's . . . write or call for your Kenwood price. Ask for a trade-in valuation on your old equipment; often the allowances made for working units will reduce your outlay considerably. All Kenwood models available.

CANBERRA ENQUIRIES FOR ENCEL EQUIPMENT

If you live in Canberra and you want further information on Encel equipment, please phone. Canberra 81-1667.

TAPE SPLICERS . . . ONLY \$2.50!

We've just made a special purchase of tape splicers . . . and while the stock lasts this easy-to-use unit is priced at only \$2.50. Save time and fidgeting—and frayed nerves! order now!



THE NEW LUSTRE MODEL ST-510 TONE ARM . . . TRACKS AT LESS THAN 3/4 GRAM . . . AND COSTS ONLY \$19!

Orders for the new Lustré Model ST-510 tone arm can now be filled immediately. Miniature ball races are used throughout. The head shell accepts all standard 1/2in mounting cartridges, finish is satin chrome and anodised aluminium. An outrigger bias adjustment is fitted and stylus pressure is adjusted with the counter balance weight. The Model ST-510D is fitted with a lifting/lowering device and costs \$24.50. The Model ST-510 (without lift), inc. sales-tax is priced at \$19.

CONNOISSEUR STEREO CARTRIDGE — ONLY \$12.50.

Designed to effectively load any amplifier or tape recorder, the Connoisseur Model SCU-1 ceramic stereo cartridge has an extremely wide frequency response and is fitted with a diamond stylus. Ask for copies of reviews.

\$12.50

PE TURNTABLES MODELS PE2020 AND PE2010.

Perpetuum-Ebner turntables are probably the most popular in their price categories . . . and the low Encel price adds further value to these fine German products. Write for Encel prices (EMQs) or call for your PE proposition. Stocks are limited although more are on the water. Contact Encel's now!

SAVE ON SANSUI AMPS AND SPEAKERS

All popular Sansui models are in stock . . . amplifiers and speaker systems. Write for your EMQ or call at your nearest Encel Stereo Centre.

DUAL 1019 TURNTABLES ON SPECIAL OFFER!

Write or call now for a very special Encel proposition—we're not at liberty to advertise the low Encel price.



NEW COMPAX TURNTABLE FEATURES BELT DRIVE—ONLY \$39.50

Belt driven around the perimeter of its 12in non-ferrous platter, the wow and flutter figure of the new Compax III turntable is an amazing .04%. The 12-pole synchronous motor is completely sealed—a unique speed selection mechanism (pat. applied for) permits choice of 33-1/3 or 45 r.p.m. speeds. The rubber mat on the turntable is of anti-static material. Encel price inc. sales tax . . . **\$39.50**

SEE THE NEW GRUNDIG STENORETTE AT ENCEL'S!

If you need a dictating system, be sure to see the Grundig Stenorette Model L at Encel Stereo Centres in Melbourne or Sydney. This fine tape cassette machine features a remote control microphone so you can control recording, playback, forward and backspace facilities without moving from your chair. Ask for the complete details and for your special Encel price. Your new Stenorette will cost you far less than you thought possible!

GRUNDIG PORTABLE/OFFICE DICTATING SYSTEMS

Away from your office you use the Grundig EN3 electronic notebook and record your reports, notes, memos and instructions on an instant loading 44 minute cassette. It is a completely transistorised battery operated dictating machine which fits in your pocket. In the office the AC operated Grundig EWS transcriber offers every desirable facility for speedy typing of recorded matter. Foot or keyboard control, fast erasure for security, internal speaker price . . . they're all there. Ask for a special price on both units at Encel Electronics stores in Melbourne or Sydney. You'll save more and be left with spending money!

ENCEL ELECTRONICS (STEREO) PTY. LTD.

Head Office: 431 Bridge Rd., Richmond, Victoria 3121. Tel. 42 3762.
Sydney Store: Ground Floor, 25M Building, 257 Clarence Street, Sydney, N.S.W. 2000. Tel. 29 4563, 29 4564.
Australia's Greatest Hi-Fi Centre *Wholesalers *Trade-ins accepted

GREATEST HITS OF ROD MCKUEN. Rod McKuen, with orchestra conducted by Arthur Greenslade. Warner Bros. (Australian Record Co.). Stereo WS-1772.

Interest: Leading folk singer.
Performance: Unassuming but interesting.
Quality: Up to standard.
Stereo: Normal.

Rod McKuen, now internationally famous through his film scores, has written innumerable songs which have become smash hits when sung by other artists. Here, he sings 14 of his songs which have become favourites via this route. Despite limited vocal technique, Rod is reasonably pleasant to listen to, with his quietly husky, intimate style, and he receives worthy support in both the arranging and conducting departments from Arthur Greenslade. The songs are: Kaleidoscope — The World I Used To Know—Blessings In Shades Of Green — Stanyan Street —The Ivy That Clings To The Wall — The Lovers — Ally, Ally Oxen Free — The Marvellous Clouds — I'll Catch the Sun — Lonesome Cities — One By One — If You Go Away — Doesn't Anybody Know My Name — Seasons In the Sun. As I mentioned in a previous review, McKuen's lyrics can be a rewarding experience for those interested in contemporary poetry, but are possibly a little high flown for the average record buyer. (H.A.T.).

Popular Jazz

THE SWINGER FROM RIO—Sergio Mendes. Atlantic Records (Festival) Stereo SAL933144. (Also in Mono.)

Interest: Bossa nova instrumentals.
Performance: Delightful album.
Quality: Excessive surface noise.
Stereo: My review copy was mono.

The Brazilian pianist, Sergio Mendes, is internationally known as the leader of the highly successful Brasil '66 group. But on this instrumental album, he and his regular rhythm section are, on all but three tracks, joined by the composer and musician, Antonio Carlos Jobim, who on this occasion plays only guitar. Three well-known American jazz musicians, Art Farmer (flugelhorn), Phil Woods (alto) and Herbert Laws (flute) share the front-line honours, but they do not play together on any tracks.

The very successful results illustrate vividly the compatibility between modern Brazilian and American music, the essence of bossa nova.

Farmer plays on three tracks, Herbert Laws on four and Phil Woods on three. Farmer seems to me to be a little ill at ease but Laws and Woods play sympathetically and convincingly. Mendes' piano solos are also first-class with melodic and graceful improvisations and a sensitive touch.

All the material is Brazilian with Jobim contributing six attractive compositions, including his famous "Girl From Ipanema." The possibility of monotony over two sides of an L.P. is overcome by sensible production and programming.

For readers who enjoy the delicacy

PARIS AT MIDNIGHT. Duke Ellington. CBS Harmony, Stereo HAS 173.

Interest: 1962 Ellington Orchestra.
Performance: Forgettable.
Quality: Well recorded.
Stereo: Normal spread.

The latest in the series of Duke Ellington albums on the \$2.50 Harmony label is very disappointing. Indeed, it is one of the very few Ellington albums which can safely be regarded as of little importance.

The main handicap is the material. Ellington and Strayhorn composed only three of the thirteen songs and even they are decidedly sub-standard. The rest of the material is trite and completely unsuitable for the Ellington Orchestra. On tracks like "Comme Ci, Comme Ca," "Speak to me of Love," "The River Seine" and "The Petite Waltz," the band sounds almost commonplace and anonymous.

The only moments of real consequence are the odd solos by Paul Gonsalves, Lawrence Brown, Ray Nance, Johnny Hodges and Harry Carney but, in the main, the musicians give the impression of complete disinterest.

The recording dates, which are not given on the sleeve, were five sessions between 30 January and 26 June, 1962 and the playing-time is 43 minutes. (T.F.C.).

of bossa nova, the 40 minutes of music on this album are essential listening. (T.F.C.)

★ ★ ★

HOW ABOUT THIS — Kay Starr and the Count Basie Band. Paramount Records (Festival) Stereo SMPML933,190 (also in Mono). Interest: Mainly bluesy material. Performance: Successful pairing. Quality: Bright recording. Stereo: Excellent balance.

The combination of Kay Starr and Count Basie (65 years old in August), is a bit less surprising than younger readers might imagine. The 47-year-old Miss Starr sang in the late 1930s and early 1940s with jazz bands like Bob Crosby and Joe Venuti. Before she went on to national success as a solo artist in 1945, she consolidated her jazz reputation with three years in the Charlie Barnet Orchestra.

Since then, she has aimed largely at the popular market but her singing has retained much of its jazz and blues quality. She sounds very much at home with the Basie Band on jazz standards like "If I Could Be With You," "God Bless The Child," "Baby, Won't You Please Come Home" and "Hallelujah I Love Him So."

On an album which contains 11 tracks and plays for only 32½ minutes, it is not surprising that the soloists in the Basie Band get little opportunity to stretch out. But their backings, which were arranged by Dick Hyman, are, as usual, punchy and swinging.

Older readers with a nostalgia for the big band era should find this album an attractive proposition. (T.F.C.)

"INNERBOND"

(Regd.)

BONDED ACETATE FIBRES

FOR PACKING IN

SPEAKER ENCLOSURES

A new resilient Bonded Wadding made from ultra fine Cellulose Acetate Fibres that gives high efficiency for Sound Absorption.

"INNERBOND" is light, clean, dust-free and easy to handle. Because all the fibres are bonded "INNERBOND" will hang as a "curtain" and will not fracture or break down due to vibration.

"INNERBOND" is odourless, highly resistant to attack by bacteria or fungus and is vermin repellent; "INNERBOND" at 16oz sq. yd. has a normal thickness of 1" and at this density is recommended as a packing in Speaker Enclosures for Sound Absorption.

STOCKISTS:

SYDNEY: Arrow Electronics Pty. Ltd., 342 Kent St.; Broadway Electronics (Sales) Pty. Ltd., 32 Glebe Point Rd.; GLEBE: Convoy International Pty. Ltd., 449 Kent St.; Ence Electronics Pty. Ltd., 257 Clarence St.; Kent H.F.I., 432 Kent St.; Mastersound Sales Pty. Ltd., 400 Kent St.; Radio Despatch Service, 869 George St.; Stereo Music Systems, 193 Clarence St.; Circuit Components (A/ist) Pty. Ltd., 460 Bexley Rd.; BEXLEY: Classic Radio, 245 Parramatta Rd.; HABERFIELD: Dyna Stereo Pty. Ltd., 331 Prince's Hwy., ST. PETERS: Albert Wright Radio Service, 795 New Canterbury Road HURLSTONE PARK; H. B. Radio Products, 103-105 Catherine St., LEICHHARDT.

NEWCASTLE: Martin de Launay Pty. Ltd., King and Darby Streets; Dynamic Sound, 587 Hunter Street.

WOLLONGONG: Electron Parts Pty. Ltd., 82 Keira Street; Martin de Launay Pty. Ltd., 270 Keira Street.

MELBOURNE: J. H. Magrath and Co. Pty. Ltd., 208 Little Lonsdale Street.

BRISBANE: A. E. Harrold Pty. Ltd., 123 Charlotte Street; Brisbane Agencies, 78 Wickham Street, Fortitude Valley.

IPSWICH: Robert N. Smallwood, 205 Brisbane Road, Booval.

NORTH QUEENSLAND: Alvin Communications and Electronics, 38 Pennair St., Finnic, Townsville.

ADELAIDE: Duncan Agencies, 57 Woodville Road, Woodville; General Accessories, 81 Flinders Street; Trustcott Electronics, 62-64 Hindmarsh Square.

PERTH: Atkins (W.A.) Ltd., 894 Hay Street; Carlyle and Co. Pty. Ltd., 1 Milligan Street; General Accessories, 46 Milligan Street.

HOBART: Homecrafts-Tasmania, 199 Collins Street.

If unobtainable

For 1 sq. yd. as above send \$2.00
For 2 sq. yds. as above send \$3.75
For 4 sq. yds. as above send \$6.50

Postage paid in Australia and Territories to the manufacturers.

**WONDER WOOL
PTY. LTD.**

87 JAMES STREET, LEICHHARDT.
N.S.W., 2040.

Box 548 — G.P.O., Sydney. 2001.
Phone: 56-2780.

I'm alright, Jack.



I've happily settled for
SANSUI

All over Australia discriminating music lovers are settling for nothing less than Sansui. Sansui is Japan's top quality brand . . . and costs a little more than lesser makes. And with Sansui you get what you're paying for — the priceless ingredient that is *quality*. Two new solid state stereo amplifiers have now been

released in Australia — both offer *real* value for money. The new Model AU555 costs \$217 and the Model AU222 is priced at \$180. Examine the specifications; then see your nearest Sansui supplier and *listen* to these fine amplifiers. We know you'll agree with us, and *invest* in Sansui.

IMPORTANT: Ask for complete unabridged specifications. Then you can see how much more you get when you buy Sansui. See your local Sansui agent!



MODEL AU555 PRICE: \$217 inc. sales tax

OUTPUT: 60 watts music power at 4 ohms
FREQUENCY RESPONSE 20-80,000 Hz. + 1 dB. **IMPEDANCE:** 4-16 ohms
SENSITIVITY: Mag. p.u. 2mV.
 Tape head 1.5mV. Aux. 1 200mV.
 Mic. 3.8mV. Plus other inputs.



MODEL AU222 PRICE: \$180 inc. sales tax

OUTPUT: 46 watts music power at 4 ohms
FREQUENCY RESPONSE 20-30,000 Hz. + 1 dB. **IMPEDANCE:** 4-16 ohms
SENSITIVITY: Mag. p.u. 2mV.
 Tape head 1.5mV. Aux. 1 150mV.
 Aux. 2 150mV. Plus other inputs.

Australian National Distributors:

Simon Gray Pty. Ltd.

Head Office: 28 Elizabeth St., Melbourne, Vic. Tel. 63 8101*
 Sydney Office: 22 Ridge St., North Sydney, N.S.W. Tel. 929 6816
 Canberra Office: 31-33 London Circuit, Canberra City, A.C.T.
 Tel. 49 6050

INTERSTATE REPRESENTATIVES:

N.T.: Pfitzner's Music House, Smith Street, Darwin. Tel. 3801
 Q'land: Sydney G. Hughes, 154-158 Arthur St., New Farm, Brisbane. Tel. 58 1422
 S.A.: Eilco Sales Pty. Ltd., 7-9 Osmond Terrace, Norwood, S.A. Tel. 63 4844
 Tas.: K. W. McCulloch Pty. Ltd., 57 George Street, Launceston. Tel. 2 5322
 W.A.: Athol M. Hill, 613-615 Wellington Street, Perth. Tel. 21 7861

S.G. S11/68

JAZZ PARTY. Duke Ellington and his Orchestra. Harmony (CBS) Stereo HAS 146.

Interest: Ellington plus guests.

Performance: Mixed.

Quality: Adequate recording sound.

Stereo: Poor balance.

The late 1950s were not particularly good years for Duke Ellington. His orchestra was well above standard, but the recordings of that period somehow lacked the Ellington personality, the distinctive stamp of greatness.

The tracks on this album were recorded before a large studio audience at two sessions in February, 1959. For the occasion, Ellington added a number of guests including Dizzy Gillespie, Jimmy Rushing, Jimmy Jones and a nine-piece percussion section.

The two features for the latter were Ellington/Strayhorn compositions called "Malletoba Spank" and "Tymper-turbably Blue." Neither of these tracks seems to me to be of any lasting importance.

Much better was his four-part extended composition called "Toot Suite," which comprised "Red Garter," "Red Shoes," "Red Carpet" and "Ready Go." This suite is not one of his major works but it does contain good solos by Britt Woodman, Shorty Baker, Jimmy Hamilton, Russell Procope, Quentin Jackson and, on "Ready Go," a very exciting up-tempo tenor feature by Paul Gonsalves.

The other three tracks on the album are "Upper Manhattan Medical Group" with good Gillespie; "All of Me," a showcase for the velvet alto of Johnny Hodges; and "Hello Little Girl" with a typically roaring vocal by Jimmy Rushing.

Despite my reservations, this album will probably interest Ellington collectors, particularly in view of the 45 minutes playing-time and the bargain price of \$2.50. (T.F.C.)

★ ★ ★

THE BEST OF BENNY GOODMAN.

RCA Victor Stereo LSP4005.

Interest: Goodman 1935-1939.

Performance: Mainly excellent.

Quality: Well re-mastered.

Stereo: Electronically reprocessed.

This album contains 11 very familiar tracks by the Goodman trio, quartet and orchestra, recorded between July, 1935 and February, 1939.

It could hardly be argued that relatively insignificant tracks like "Goodnight My Love" (with a vocal by Ella Fitzgerald), "Loch Lomond" (featuring Martha Tilton) or the 1935 "Goodbye" constitute "the best of Benny Goodman."

But the remaining eight tracks are absolutely first-rate. These years saw the Goodman organisation at the height of its abilities and popularity. Tracks like Edgar Sampson's "Don't Be That Way" and Count Basie's arrangements of "One O'Clock Jump," both of which were recorded just after the Carnegie Hall concert, are superb by any standards. Established favourites like "The Angels Sing" (1939) and "Sing Sing Sing" (1937) are included in this collection together with "Stompin' At the Savoy" (1936) and Fletcher Henderson's 1935 arrangement of "King Porter Stomp."

The trio version of "After You've Gone" and the quartet's "Avalon" complete this useful Goodman re-issue.

Despite the acceptable playing-time of 40 minutes, I would suggest that this album should have been re-issued on the \$3.95 Vintage series. The recording dates in the sleeve-note, incidentally, are accurate but no personnel details are provided. (T.F.C.)

★ ★ ★

WALKING THROUGH NEW ORLEANS — Pete Fountain. Coral Records (Festival) Stereo SCL-933130 (also in mono).

Interest: Mainly clarinet.

Performance: Enjoyable.

Quality: Good, bright recording.

Stereo: Well balanced.

Pete Fountain is far from being a convincing and creative jazz soloist. But his clarinet playing is technically superb and his albums are usually easy listening and enjoyable. With much the same appeal as Acker Bilk's L.P.s with strings, his considerable popularity is not hard to understand.

This album is closer to the jazz idiom than some of his previous recording sessions with standards like "South," "Careless Love" and "Clarinet Marmalade." Three of his own compositions are also included but they are neither particularly distinguished nor original.

Fountain, himself, plays with his usual facility despite Bud Dant's rather ordinary arrangements for the various backing groups. Some of the supporting musicians include Stan Wrightsman (piano), the late Paul Barbarin (drums) on two tracks, Jack Sperling (drums), Morty Corb (bass) and Eddie Miller, whose warm tenor playing provides some of the best moments on the album.

Pete Fountain enthusiasts will certainly enjoy this album, but they should perhaps be warned that the playing time is thin at 31 minutes. (T.F.C.)

★ ★ ★

SUMMERTIME—Paul Desmond. A. and M. Records (Festival) Stereo SAML 933234 (also in mono).

Interest: His first L.P. after Brubeck.

Performance: Excellent.

Quality: Disappointing for Van Gelder.

Stereo: Normal spread.

This album, which was recorded at six sessions between October and December, 1968, was Paul Desmond's first solo outing since the break-up of the Dave Brubeck Quartet at the end of 1967.

Desmond is an elegant improviser, a creator of beautiful melodies and the tracks on this L.P. show him at something close to his best. His soft, liquid tone, gentle but never flabby, is superbly offset by Don Sebesky's arrangements for brass and a rhythm section which includes Herbie Hancock on piano and Ron Carter on bass.

Some of the highlights of the album include a jaunty romp through the Beatles' "Ob-La-Di," Johnny Mandel's beautiful ballad "Emily," a 5/4 version of "Summertime" and "Where is Love," certainly the finest song in the "Oliver" score.

This is a most attractive and thoroughly recommended album. Desmond's alto solos and the piano work of Herbie Hancock more than sustained my interest but the music is also easy and relaxing. The playing-time is 40½ minutes. (T.F.C.)

2

POPULAR SOLID STATE STEREO AMPLIFIERS FROM THE SOUND/ENCEL STABLE!

With specifications that demand attention and most effective quality control in manufacture, it's not surprising that Sound stereo amplifiers command a high proportion of the markets in their respective price ranges. In Australia Encel prices make Sound amplifiers better value than ever. Ask for a trade-in valuation when you write or call!



SOUND MODEL SAQ-203 SOLID STATE STEREO AMPLIFIER

Frequency response is 30-20,000 Hz. and input sensitivity suits magnetic cartridges at 3 mV. Output is 12 watts R.M.S. or 30 watts E.I.A. peak power. 18 low noise transistors. Headphone jack, all necessary controls, attractive front control panel. Speaker matching for 4, 8 and 16 ohm speakers or speaker systems. An ideal compact amplifier for use with tape recorders or for building into cabinets and bookshelves. Inc. sales tax **\$74.50**



SOUND MODEL SAQ-505X SOLID STATE STEREO AMPLIFIER

With an output of 25 watts R.M.S. into 8 ohm speaker systems, the 505X represents outstanding value for money. Frequency response is 20-20,000 Hz. ± 1dB. and extends well beyond this range. Sensitivity is 3 mV. for magnetic cartridges and all desirable control facilities are incorporated. This powerful amplifier is bargain priced by Encel Electronics at only **\$119.50**

ENCEL TEST REPORT ON THE SOUND SAQ-505 AMPLIFIER

Our laboratory test report indicates that the actual power output of the unit is 24½ watts R.M.S. per channel. Frequency response is substantially flat, being down 2 dB. at 20kHz. and down 1 dB. at 20 kHz. Square wave tests at 1 kHz. and 10 kHz. are excellent and show little variation in the audible ranges.

Encel
ELECTRONICS
(STEREO) PTY. LTD.

Head Office:

431 Bridge Rd., Richmond, Victoria 3121.

Tel. 42 3762.

Sydney Store: Ground Floor, 25M Building

257 Clarence Street, Sydney, N.S.W. 2000.

Tel. 29 4563, 29 4564.

*Wholesalers *Trade-ins accepted

Australia's Greatest Hi-Fi Centre

Electronic Technicians Earn Big Money!

Why not YOU?

With training through T.T.I., you could qualify for a start in the Electronics Industry as a:

- Radio-television technician • Telecommunications technician • Instrumentation technician • Business machine technician • Automatic control technician • Industrial electronic technician—and many other skilled positions.

WILL YOU FILL THE BILL WHEN THE TIME COMES?

The "good job" you hold down today may offer less and less opportunity for advancement as Electronics increase their impact on all branches of industry.

TECHNICAL TRAINING INTERNATIONAL, a world-wide company with 30 years' experience in the field of specialised technical training, offers the latest Electronics training programmes available in Australia.

GAIN FULL PRACTICAL EXPERIENCE BY BUILDING YOUR OWN LABORATORY AT HOME. With T.T.I. training you build over 100 circuit-proving projects. In addition, you actually construct the professional test equipment illustrated here.

IF YOU ARE BETWEEN 18 AND 45 YEARS, AND EARNING LESS THAN \$80 PER WEEK . . . IF YOU ARE SERIOUSLY INTERESTED IN TRAINING FOR A CAREER IN ELECTRONICS, FILL IN THIS COUPON FOR FURTHER INFORMATION, WITHOUT OBLIGATION.



To: Technical Training International Pty. Ltd.
P.O. Box 328 Chatswood, N.S.W. 2067.

Please tell me more about T.T.I. Electronics Training, without obligation to me.

Name _____

Address _____

Age _____ Present occupation _____

T.T.I.—The Industry-approved Technical Training Organisation

EA/K



TECHNIPAL

IS COMING!

TRADE REVIEWS AND RELEASES

JBL LANCER 77 . . . superlative sound

In the March 1969 issue of "Electronics Australia" we reviewed the JBL SA600 stereo amplifier and found it to have very high performance. Here we review one of the same company's loudspeaker systems and find that it has the same order of performance.

The JBL Lancer 77 loudspeaker system is unusual, if not unique, on the Australian market in that it uses a passive radiator to augment the low audio frequencies. This modifies the bass-reflex principle to obtain a system which has the advantages of bass-reflex operation without — in this case — the boomy bass normally associated with the system. For the major part of the audio spectrum, the Lancer 77 operates as a normal system with a high quality 10-inch low resonance woofer, a 2-inch tweeter and a cross-over frequency in the region of 2KHz.

The woofer loudspeaker is the JBL LE10A, a low-resonance, high-compliance unit with a massive, cast aluminium frame. The large magnet structure weighs six pounds and the cone is driven by a three-inch voice coil which is edge-wound with copper ribbon. As can be seen from the illustration, the cone is made in two sections, the outer part being plasticised. The cone is supported at the periphery by a very flexible synthetic rubber roll surround which allows very long excursions. The free-air resonance of the loudspeaker is of the order of 15Hz.

The enclosure measures 23½ x 14 x 11½ inches and is finished on four sides so that it can be used horizontally or vertically. The front grille is removable,

allowing access to the loudspeakers, and when these are removed, to the cross-over network.

The system used for the Lancer unit is not new and there has been frequent mention in technical literature of the idea of mounting a "drone cone," a "passive radiator" or an "auxiliary bass radiator" in the vent of what would otherwise look like an ordinary reflex enclosure. Because it modifies radiation from the vent, the auxiliary cone becomes an essential part of the design, and any available cone is no more likely to be optimum than any available hole, port or acoustic resistance!

The basic design objective is to ensure that the auxiliary cone will move in phase with the driven cone — and reinforce radiation from the driven cone — over a range of frequencies low down in the spectrum, where the response would otherwise tend to fall away.

This bass-end reinforcement is due to the normal phase reversal which occurs in any reflex enclosure over a certain range of frequencies. However, while the air in the vent of such an enclosure may move in phase with the driven cone, the movement is not necessarily uniform at all points across the vent. The passive radiator tends to obviate this possibility over its operating range.

It would appear also that use of an

auxiliary cone makes it possible to have an effective vent area much larger than would otherwise be possible in a compact enclosure. This gets away from the problem of distortion due to excessive air velocity through under-sized vents or ports.

These factors, added to the control exercised over the main cone in resonance region can add up to clean, distortion-free bass.

There is more to a passive radiator, however, than just another ordinary loudspeaker cone.

The passive radiator must have a linear and very compliant suspension to enable it to make large excursions, since it does not have any electromagnetic damping via the usual voice coil and magnet. The JBL PR10 passive radiator consists of the chassis and cone assembly of the LE10A woofer with magnet and voice coil omitted. Most of the spider assembly is cut away to increase the compliance of the suspension. The mass of the cone assembly is varied, to tune it to different enclosure sizes, by adding or removing fibre discs which are mounted on the voice coil former.

In other respects, the JBL Lancer 77 enclosure is like any other. It is airtight and is lined with a 1-inch layer of fibre-glass damping material.

What is not expected is the impedance curve of the woofer speaker, which is very similar, at first glance, to that of a low resonance speaker in a completely sealed enclosure, having a single substantial peak at 70Hz. However, closer investigation reveals that the passive radiator is modifying the normal bass-reflex system impedance curve.

When the passive radiator is blocked off with a piece of board the impedance peak moves to 60Hz which represents the impedance peak of the LE10A woofer speaker in a completely sealed enclosure. A bass-reflex enclosure is normally tuned so that it has an impedance peak either side of the natural system resonance. The 70Hz peak is undoubtedly the upper peak of this "quasi-reflex" system, but the lower impedance peak is undetectable. This is not surprising because, in the lower region, the passive radiator is moving in phase with the driven cone and thus would be applying substantial damping to the driven cone; this would tend to reduce or even eliminate the lower impedance peak.

All our listening tests were done with a twin 40-watt amplifier and this, coupled with a high quality magnetic cartridge, produced some delightfully satisfying sounds. Most listeners preferred the system with tone controls set "flat."

The outstanding feature of the Lancer 77 is the solid, well-controlled bass. Percussion instruments sound completely natural, even at high power levels. The definition on complex organ passages where many speakers tend to sound "muddy" was a revelation.

Above 2KHz, where the tweeter takes over, the response is smooth and distortion free. Treble dispersion is very wide due to the point source effect of the small-diameter tweeter. Violins and other string instruments sound very "sweet" and natural. The cross-over network incorporates a three-position attenuator, but we found the best position to be that which gave the least attenuation.

One small feature we did not like was the way in which the two decorative aluminium strips were fastened to the front grille with panel pins. These tended to come loose and it would be easy to scratch the enclosure if the grille was removed carelessly.

Unfortunately, first cost plus import duty places this system out of reach of all but the most "well-heeled" enthusiast. The retail price is \$259 each and the units are available from selected dealers in Sydney and the metropolitan area. Trade inquiries should be directed to the Australian distributors for JBL equipment, Auriema (Australasia) Pty. Ltd., 443 Kent Street, Sydney. (L.D.S.)

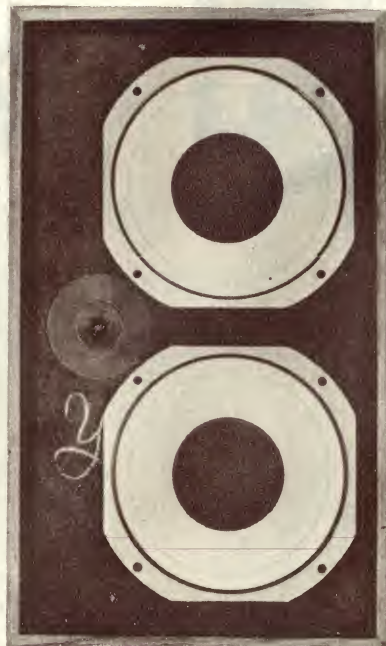

The complete JBL Lancer 77 loudspeaker system and, at right, a view of the unit with the fret removed. From the front, the driven unit (top) looks identical with the passive radiator. The tweeter is at centre left.

Multimeter Features

10uA Movement

The SK-100 Volt-Ohm-Milliammeter is a recent addition to the range of instruments offered by Nucleonics Electronics and Telecommunications Pty. Ltd. (N.E.T.) Manufactured by Kaize Electric Works Ltd. of Japan, this low-cost meter offers higher sensitivity and a lower DC current range than the usual VOM.

In their SK-100 multimeter, Kaize has used a basic movement with the very small FSD current of only 9.5uA. This gives the multimeter a sensitivity of 100K per volt on DC and 10K per volt on AC—very high for this type of instrument. It has a resistance range with a highest reading of 20M, again an unusually high figure for such an instrument.

A 4½in rectangular type, the meter is mirror-backed for convenient and accurate reading. Protected against overload by two silicon diodes, it is a double-jewelled type with a fundamental accuracy of plus or minus 2 per cent. The instrument uses 1 per cent temperature-stabilised film resistors throughout.



The SK-100 measures approximately 5in x 7in x 2½in deep, and has a carrying handle which doubles as a prop to hold the meter at an angle for bench use. The meter uses two 1.5V dry cells, size AA, which are easily replaced by removing the back of the instrument. However, the polarity markings in the meter are not quite as clear as might be desirable.

The instrument covers a wide range of readings from 12uA and 0.6V to 12A and 1200V on DC with ranges as multiples of 3, 6 or 12. Against the meter must be set the fact that the rated accuracy is only plus or minus 3 per cent of full scale on DC and 4 per cent on AC.

Ranges on the SK-100 are as follows: DC volts — 0.6, 3, 12, 60, 300, 600 and 1200V; AC volts — 6, 30, 120, 300 and 1200V; DC current — 12uA, 300uA, 6mA, 60mA, 600mA and 12A; AC current — 12A; resistance — 20K, 200K, 2M and 20M.

There are also a series of decibel ranges which can be used for comparison of voltage levels or, if terminated across

(Continued next column)

NEW SOLDERING GUN FROM SUN ELECTRIC PTY. LTD.

Recently available in Australia, the "Hi-Way Wen" soldering gun shown in the accompanying photograph is being distributed by the Sun Electric Company Pty. Ltd., of Melbourne, Sydney, Brisbane and Adelaide. Available in two models, the gun offers features which are unique in the range of quick-heating soldering irons currently available.

Soldering guns have enjoyed considerable popularity in America and are used extensively in the United Kingdom. As yet, they have been used relatively infrequently in Australia, as evidenced by the fact that no member of the staff of "Electronics Australia" owns or has ever used one.

However, an obvious advantage of this style of soldering tool is that the step-down transformer, necessary with a quick-heating soldering iron, is built in. This avoids the restraint associated with transformer type irons where the lead between transformer and iron has to be kept short to minimise power losses.

Inevitably, one's initial impression of the soldering gun is that it is much heavier because of its built-in transformer. But it is obvious that considerable care has been taken to ensure that the gun balances to best advantage when held in the hand. Even so, some fatigue may result from prolonged use of the gun at the bench.

For servicing work, automotive work, and the casual soldering job, however, the soldering gun is eminently suitable as a mains-operated soldering tool, providing virtually instant heat at the squeeze of a trigger. Quite a useful job-illuminating light is provided just above the trigger allowing the gun to be used in very poorly illuminated areas. The small trigger-activated lensed-type lamp is angled so that a bright beam of light intersects with the end of the soldering tip.

Incorporating a double-insulated transformer, the gun is completely safe and is fully approved by the Australian electricity authorities. And, with a casing moulded from a phenolic resin having high impact resistance the gun should prove to be quite durable and well able to withstand the rugged use encountered in the normal service situation.

600 ohms, for readings in dBm which are actual power values. The zero reference for this scale is 1mW or 0.775V across 600 ohms. The basic range covers -20 to +17dB with additives of +14, +26, +34, and +42 for the other ranges.

A function switch on the front panel of the instrument permits the selection of AC or either polarity DC. The meter has separate input terminal sockets for the 1200V and 12A ranges for both AC and DC, in addition to the usual positive and common negative terminals.

The sample SK-100, illustrated, was tested in our laboratory and found to be easy to operate and well within the accuracy quoted by the manufacturer.

The instrument should be of particular value for experimenters and servicemen whether working with transistor circuits (where the low value ranges and high sensitivity should be of particular value), valve circuits, or for domestic power measurements.

The sample instrument was supplied by the sole Australian distributors for Kaize, Nucleonics Electronics and Telecommunications Pty. Ltd. (N.E.T.), 6-8 Clarke Street, Crows Nest, N.S.W. 2065. The price is quoted as \$29.95 plus 15 per cent sales tax where applicable. (J.H.)



The manufacturers claim that the "Hi-Way Wen" soldering guns have "Automatic Thermal Regulation" in the heating element which uses a specially developed high-temperature wire. When we bench-tested the Model 450 submitted for review, there was certainly evidence of some form of heat regulation; the soldering tip did not get so hot as to make the solder "boil" and become ineffective, as is the case with other types of quick-heating irons, if used carelessly.

A further effect of thermal inertia with the soldering tip was noticed when using the gun. While the heating time of the tip was around 15 seconds it seemed to retain sufficient heat for soldering for some considerable time after the trigger was released. And for continuous soldering only occasional squeezes on the trigger were necessary to maintain an adequate temperature for light-duty work.

Provided with alternative fine or medium soldering tips, the smaller Model 222 is intended for light-duty applications, whereas the submitted Model 450 takes a range of three tips for fine, medium and heavy-duty work. The soldering tips are easily replaced by releasing two small screws which are accessible through holes provided in the top of the moulded housing.

The retail price for models 222 and 450 are \$15.95 and \$17.95 respectively. The latter model is rated at 85 watts and both operate from 240 volts at 50Hz.

The "Hi-Way Wen" soldering guns are manufactured in Auckland, New Zealand, by Highway Industries Ltd. under licence from the American Wen company. However, trade inquiries should be directed to the Sun Electric Company who are the sole Australian distributors. (A.J.L.)

ELECTROLYTIC CAPACITORS

Miniature Type		Top Grade	
Type	Price	Type	Price
25VW	1-9 10-99	10VW	1-9 10-99
5mf	16c 13c	5mf	12c 11c
10mf	18c 14c	10mf	13c 11c
25mf	20c 16c	25mf	14c 12c
50mf	21c 18c	30mf	15c 13c
100mf	25c 21c	50mf	17c 14c
200mf	29c 23c	100mf	19c 15c
500mf	40c 35c	200mf	25c 21c
1000mf	60c 53c	500mf	33c 27c
2000mf	95c 85c	1000mf	49c 42c

100 off prices on application. For resistor prices see classified section. Prompt service. Pack and post 10c any order.

KITSETS AUST.
Box 176, P.O., Dee Why, 2099, N.S.W.

R.C.S. SPECIALS



**NEW IMPROVED
30 WATT**
NOMINAL
34w MAX.

**12v All Transistor
P. A. AMPLIFIER**

WIRED READY TO OPERATE
15 ohm output. No. 591D ... \$62
125, 250, 500 ohm, 592D ... \$62
Dimensions: 6 1/2 in. w. x 3 1/2 in. h x
8 1/2 in. d. For 240V. ex. \$33 extra.

10 WATT P.A.
Inputs 5 MV and 100 MV 10w R.M.S.
at 1%. Frequency 40cy.—30Kc. For use
with 1 4 ohm, 2 8 ohm or 4 16 ohm
speakers in parallel. Same cabinet and
dimensions as 30w above, complete with
240v power supply.

Wired and tested. No. 485 ... \$40
Freight extra in both cases.



**R.C.S. COMPLETE
DO-IT-YOURSELF
KITS**

Peak reception,
low price. No ex-
pensive test equip-
ment. Everything
fits. 1964 R.F.
Transports 7.
Complete kit — No. 640 ... \$43.50
Portable car radio, identical to 640
above plus extra switch and car coil,
etc. No. 642 ... \$48.00
(Write for brochure on 640 and 642.)
Postage \$1.

NEW TRANSISTOR PREAMP KIT
SIZE 3 x 2 x 1 1/2 in. 2 req. for Stereo.
LOW IMP. Input 2 trans. 672C \$6.50
Wired ready for use. 672D ... \$9.00
HIGH IMP. 2 trans. 680C ... \$6.50
Wired ready for use. 680D ... \$8.00
HIGH IMP silicon 3 trans. 682C \$9.50
Wired ready for use. 682D ... \$9.50
Postage 10c each. Write for data.

HI-FI BROADCAST TUNER UNIT 4 TRANSISTORS — HI SENSITIVITY.



R.F. mixer, I.F., pwr. dectr. stages, adjustable aerial
coupling. Complete as illust., wired and tested with 461
dial, knobs and switch pot No. 474D, \$31. Postage \$1.
WHISTLE FILTER for above set for 8Kc band width (can
be altered to 9, 10 or 11Kc). No. 128, \$4, Post 10c.

PRINTED CIRCUITS

For all R. and H., E.A., Mullard, Philips and other designs.
Clearly coded, White letters and numbers, easy assembly
and service, polished and resined for easy soldering. With
blueprint parts list.
SPECIALS: To your drawing — write for particulars and
drafting aids.

Number	Recent Designs
722	Mullard pre-amp. \$3.00
725	Protected supply \$2.50
734	EA 69 01 gold-p organ ... \$5.00
709	Pre-amp. 67-PS \$2.50
684	Pre-amp. 65-P10 \$2.50
737	AWA 10/25W amp \$2.50
740	Crystal clock 68-10CL \$5.00
741	Guitar amp 69 PS \$3.00

726 3 x 3 or 10 x 10 w stereo 68/AB ... \$2.00
736 B/C tuner EA 69/TS ... \$2.50
727 E and A wide band, tuner 68/8T ... \$3.20
728 Audio osc., EA 68-09 ... \$3.20
718 Mullard main amp. ... \$2.50

Immediate dispatch. Postage 10c.



10W STEREO

**MULLARD 10 x 10
watts R.M.S.**

With output transistor **PROTECTION**. Frequency response
40cy. to 30Kc. Distortion 0.5%. Treble, bass, boost 20DB
Complete kit of parts No. 480C ... \$74.00
Wired and tested No. 480D ... \$79.00
With hi-fi tuner and whistle filter. \$35 extra. Freight extra.
Write for brochure. For special stat. demo. ring 59-6550.

MAGNETIC STEREO PRE-AMP

In 5Mv out 250Mv. Bass and
treble 20DB. No. 724C \$29
Wired ready for use ... \$31
Postage 30c each.
For crystal ceramic
No. 722D ... \$27

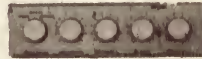

TRANSFORMER

Tap 4.6v. and 9v D.C. at
100 millamps.

Filter, condensers, rectifier, resistor,
case, etc. \$6.50, Post 10c.

PERSONAL PORTABLES 2 TRANSISTORS

Range 30 miles,
200 with short
aerial and earth.
Earpiece only, no
speaker.
Do-it-yourself kit
No. 686C \$9.00
Postage 20c.



1 TRANSISTOR — 1 DIODE
593C Do-it-yourself kit. \$8, Post 10c.

DIAL KITS SCALE GOLD WITH WHITE LETTERS.

• No. 459 to match 300 pf gang.
Price ... \$4.50
• No. 461 to match 200 pf gang.
Price ... \$4.50
Post 20c.

NEW AUDIO AMPLIFIER

4 transistors.
1/2 or 1 watt.
Small size, cabi-
net 3in x 2in x
1 1/2 in plastic.
Suitable crystal
P./up. Inter-
com., micro-
phone, radio,
etc. (9 volt.)
**DO-IT-YOURSELF KIT 662, \$10 (Post
10c). Wired ready for use 665D \$11.50.**

COILS & IF's 455 Kc

Aer. R.F., OSC. and IF's ... \$1.80 ea.
Ferrite Aer. ... \$2
No. 255 Universal tape OSC. Coil \$6
Postage 10c. Write for details and price.

R.C.S. RADIO PTY. LTD., 651 FOREST ROAD, BEXLEY, N.S.W., 587-3491, 587-5385

PETER SHALLEY Electronics Pty. Ltd.

New 5-WATT Base Station

JUST RELEASED

FEATURES:

- Delivers a full 5-Watt Input Power to the Final Amplifier
- Operates on any of the 6 Citizen's Band Channels.
- Tone Call System for more effective communication
- Stable Crystal-controlled Receiver with RF Stage.
- For short distance communication, Battery Saver slide installed.
- Variable Squelch and full series of Jacks for PA, Mic, External Speaker, External Antenna and External Power connecting.
- All Die-cast Cabinet and Leather Case.

Also PT51 - New Release

- 11 Transistors
- Sep. Spkr. and Mic.
- All metal
- Ear piece
- Leather case
- Squelch

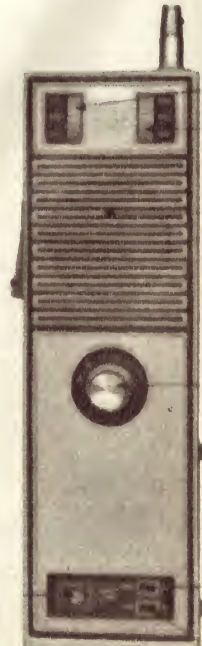

from **\$49.75**

127 YORK STREET (just near Town Hall) 29-7021 29-3767

AKG HIGH FIDELITY HEADPHONES

We recently received for review two sets of stereo headphones made by AKG, GmbH, of Vienna, Austria. These units, comprising a low-cost headset and a fairly highly priced one, were submitted by the Engineering Products Division, Amalgamated Wireless (A'sia) Ltd., Lane Cove, N.S.W.

The AKG company is mainly known for its range of high quality dynamic microphones, many of which are used in broadcast studios throughout the world. They are also the makers of the K50 stereo headphone set which has established a reputation for extreme wide range reproduction, although a relatively low-priced unit.

The original AKG headset, the K50, was first reviewed in this magazine in 1960, at which time their wide frequency range made them unique in their price scale. The fact that these phones are still selling well in 1969 is a tribute to the soundness of their design. The only significant disadvantage of this headset has been the lack of ear cushions, which made it slightly uncomfortable to wear, as well as contributing to low frequency loss through ineffective coupling to the ears.



AKG has now produced the K20 headset, selling at the low price of \$13.62; and the relatively expensive K60 headset, priced at \$30.62. Both these units appear to use a similar type of transducer to that used in the earlier K50s, which has tiny plastic diaphragms, instead of the miniature loudspeakers used in most other designs of headsets. The makers say that it is this lightweight construction which is responsible for the wide frequency response, given in the specification sheet as 20 to 20,000Hz for the K20s, and 16 to 20,000Hz for the K60s.

The K20s appear to have been brought on the market to compete with the many low-cost headsets selling in the price range \$10 to \$15. In this context, they are certainly worth considering, since they provide a very acceptable order of performance, well sustained at the high frequency end, but slightly lacking in bass response, presumably because of inefficient coupling of the transducers to the ears. The K20s are fitted with simple moulded plastic shells which do not make a very close fit around the ears, and it is certain that some of the pressure generated by the transducers at the low frequency end is lost, unless the headshells are pressed firmly against the head. While the ear shells are possibly not ideal in terms of comfort, they should remain reasonably cool in hot weather, when the rather more solid ear muffs fitted to many head-



Above, the AKG K60 headphones and, at left, the less expensive K20 phones.

sets can become quite uncomfortable and sticky.

In designing these headphones to a price, AKG appear to have elected to make such economies as were necessary in the overall finish. The headband is a simple metal bow covered with a plastic sleeve and as noted above, the ear shells are simple plastic mouldings. Nevertheless, those who want high fidelity at low cost should find this compromise very acceptable.

Comparing specifications, the higher priced K60s do not seem to offer much in the way of advantages, on paper at least. However, in actual use, the advantages are obvious enough. For one thing, they sound better, and this can be put down to more extended response at the high end and very smooth response over the entire audible range. The bass response is noticeably better, and this is certainly aided by the foam plastic ear muffs which fit snugly over the ears. These ear muffs are soft and pliable, and this feature, coupled with the light weight of the unit as a whole, makes the K60s possibly the most comfortable headphones we have tested. Finally, the K60 headset is much better finished than the cheaper model and has a double head band pivoted at both extremes so that it will automatically adjust to the shape of the user's head.

A feature found on both these sets (which was absent from the K50s) is that the earpieces are colour coded to identify the right and left channels, red for the right channel, yellow for the left channel. Earpieces are adjustable along the headband. No plug is fitted, and the type required would have to be obtained separately to obviate the frustration of having the phones without the means of connecting them to the amplifier. Both sets are available with 75 ohm impedance or 600 ohm impedance per channel. (H.A.T.)

SONICS

LOW COST, HIGH PERFORMANCE
SPEAKER SYSTEMS FROM
ENCEL ELECTRONICS!

Separate speaker systems are essential if you wish to exploit the full potential of your amplifier, tape recorder or radio. Sonics speaker systems are beautifully finished in selected walnut/teak veneers, are styled to blend with period or modern decor and are extremely effective from an audio point of view. The following models are the most popular.

MODEL AS-60E: Although only 18 3/8in x 12 3/8in x 5 1/2in the AS-60E is fitted with a bass/mid-range speaker, and a separate high frequency reproducer. An excellent speaker system which has proved very popular with audio enthusiasts. Hand finished teak/walnut cabinet. Inc. **\$27.50** Sales Tax.

MODEL AS-61: A true "Slimline" enclosure with four bass/mid-range speakers and a high frequency reproducer. Measures only 4 3/8in depth; height is 21 3/8in and width is 17 1/2in. Finish is teak/walnut and the legs are detachable. Probably the most popular multiple speaker system ever offered at this price in **\$38.50** Australia, Inc. Sales Tax.

MODEL AS-202: A 3-speaker, 3-way system which measures 20 1/8in x 11 5/8in x 11 5/8in, the AS-202 is a recent addition to the Encel Sonics range. An 8in woofer and a 6 1/2in mid-range speaker are incorporated — and a high frequency reproducer completes the speaker complement. Will handle 10 watts R.M.S. with ease. Beautiful hand finished teak/walnut cabinet. Inc. Sales **\$46.50** Tax.

MODEL AS-220: A most effective 3 way speaker system with an 8" bass reproducer, a 6 1/2" mid-range speaker and a high frequency reproducer. Cabinet size is 20 1/8" x 11 5/8" x 11 5/8" and the front grille features a timber fret which matches the teak-walnut veneer cabinet. Handles 10 watts R.M.S. easily. Inc. sales tax **\$56.50**

MODEL AS-303: A magnificent hand finished teak/walnut speaker system with three speakers and a 3-way crossover network. A 12in woofer with a long throw voice coil provides excellent bass response, a 6 1/2in mid-range speaker covers the middle ranges and a horn type tweeter comes in at 5kHz. Power handling capacity is over 15 watts R.M.S. Extremely wide frequency response free of coloration. Size 25in x 14 1/2in x 11in. Inc. **\$68.00** Sales Tax.

MODEL AS-251: This is a new deluxe 3-way speaker system with a 10in bass reproducer, a 6 1/2in mid-range speaker and an exponential horn tweeter. A 3-way crossover network assures smooth response over the total range of 40-20,000 Hz. Dimensions are 13in x 22 1/2in x 11 1/2in and finish is in oiled teak/walnut veneer. Inc. **\$78.00** Encel price including Sales Tax.

MODEL AS-330: The deluxe system of the Sonics range. It is a 3-way system with five speakers including a 12in bass reproducer, a pair of mid-range speakers and two exponential horn type tweeters. The attractive cabinet is hand finished in teak/walnut figured veneer has a most attractive timber fret grille and measures 15 3/8in x 26in x 13 3/8in. Overall frequency response is 30-20,000 Hz. Carefully selected crossover frequencies provide a smooth and musical performance over the frequencies specified. Encel price inc. sales **\$98.50** tax is

IMPORTANT! All "Sonics" enclosures are 8 ohms impedance.

SONICS STEREO HEADPHONES FROM \$9.50.

The popular Model HS-304 offers fatigue free listening on a personal basis . . . the headset is very comfortable even over lengthy periods. Price! Only \$12.50. The Models HS-303 and HS-303H (High Impedance) are also available. Frequency response is 20-15,000 Hz. and the price only \$9.50. All models have foam rubber earpads. From

\$9.50

Encel ELECTRONICS (STEREO) PTY. LTD.

Head Office:
431 Bridge Rd., Richmond, Victoria 3121.
Tel. 42 3762.

Sydney Store: Ground Floor, 25M Building
257 Clarence Street, Sydney, N.S.W. 2000.
Tel. 29 4563, 29 4564.

*Wholesalers *Trade-ins accepted

Australia's Greatest Hi-Fi Centre



ALLIED CAPACITORS

specialised facilities and years of experience
enable Allied to design and manufacture for your specific needs



- Ceramics
- Plastic Film
- Electrolytics
- Silvered Mica
- Potentiometers
- Paper Capacitors
- Connectors
- Switches
- Trimmers
- Centralab Packaged Electronics



ALLIED CAPACITORS PTY. LIMITED



A Member of the Australian Telecommunications
Development Association

Distributed by
Ferris Bros. Pty. Limited, 752 Pittwater Rd.
Brookvale, N.S.W. 2100. Ph. 93-0221 (10 lines)

Write for catalogue and service information to
Allied Capacitors Pty. Limited,
752 Pittwater Rd., Brookvale, N.S.W. 2100.

NAME.....PHONE.....

ADDRESS.....

.....

EA.....POSTCODE.....

FB4211/69

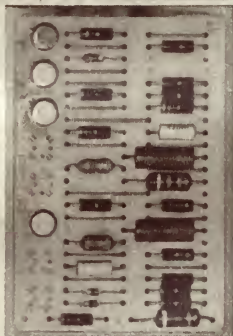

actual size 2½" x 4"

COMPUTER BOARDS

CONTAINING

**TRANSISTORS at less
than 15 cents each**

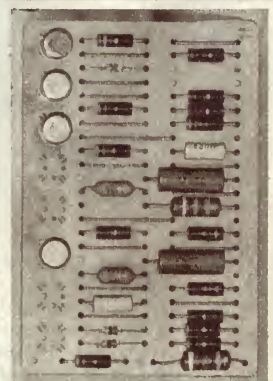

These boards contain a variety of PNP & NPN Germanium Transistors both TO5 and TO18 types suitable for:—

Audio, RF, Multivibrator and High Speed Switching Applic.

All other components on these boards are free. They are all high quality resistors, capacitors, diodes, and inductors. Technical info. supplied with order.

8 boards with a minimum of 30 transistors \$4.00 P&P 25c.

25 boards with a minimum of 100 trans. \$12.00 P&P 70c.

Minimum order 10 transistors \$1.50 P&P 20c.

New Zealand orders add 30c to above postage rates

AMPLE STOCKS NOW AVAILABLE

COLSTOK ELECTRONICS

**BOX 178,
KELLERBERRIN, W.A. 6410.**

INSTRUMENT CASES AND RACKS

A wide range of standard instrument cases, racks, consoles, chassis and accessories are available from Celotek Industries Pty. Ltd., who submitted two samples for our inspection.

The Celotek range is manufactured by an associate company, M.A.J. Products. Any standard Celotek equipment can be modified to meet requirements or, if the requirements fall outside the Celotek range, M.A.J. will manufacture to customer's specifications.

High quality bright mild steel is used for all racks and cases. Rack panels are made from high quality 10SWG mild steel plate. All anodised trims and handles, and all chromium plated screws and accessories, have a high standard of finish. All painted steel parts are pre-treated by degreasing and phosphating, then bake-enamelled with primer and finishing coats. Standard finishes available are blue, silver, and dark grey hammertone for all cases, with front panels in either light grey or dark grey high-gloss enamel. Special finishes, including two-tone colour schemes, are available to order on all cases. Front panels and, if required, the cases themselves can be supplied in under-coat only.

The standard range of Celotek racks and cases includes the following items.

The Celorak series: A comprehensive and flexible system of modular rack construction developed to provide housing at a reasonable cost. Two different styles are available, a square-form rack and a tube-frame rack, each capable of being equipped with a standard range of doors, panels, chassis, slides, runners, etc. Standard panel mountings are provided to

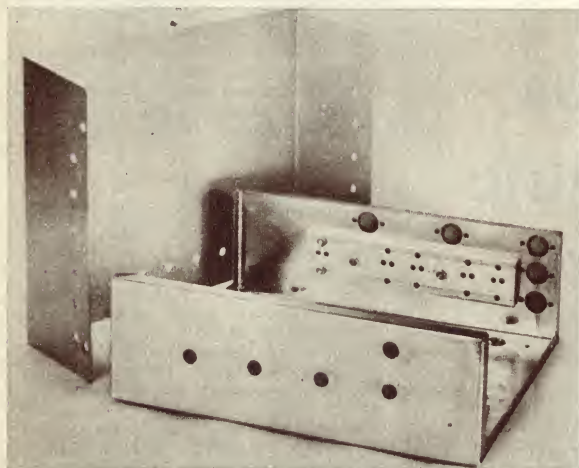

The Celotek chassis and cover, similar to that of the 10-Plus-10, showing the aluminium channel for mounting the output transistors.

allow front panels to be fixed directly to the vertical members, which are punched at international centres to take captive screws.

Alternative mountings are available which allow the front panels to be recessed to any depth. These mountings also permit fitting other standard equipment such as runners, slides, etc. Also available is the Celotek type E. C. Electrical Cubicle to satisfy the particular requirements of the electrical industry. It is constructed in the same styling as the square-form rack.

The Celotek range of standard panels: These are press formed from 16 gauge steel in the international standard 19in panel width. Alternative panels in 14 gauge steel can be supplied for specialised applications. The panels are available in 11 heights, based on 1½in units. They are punched to take chrome-plated mushroom-head fixing screws across centres of 18½in. Double width panels are available in 10SWG steel to suit the standard Celotek Electrical Cubicle. Supplied with fixing

A 700 series case showing the timber veneer finish which makes this suitable for a furniture-style case.

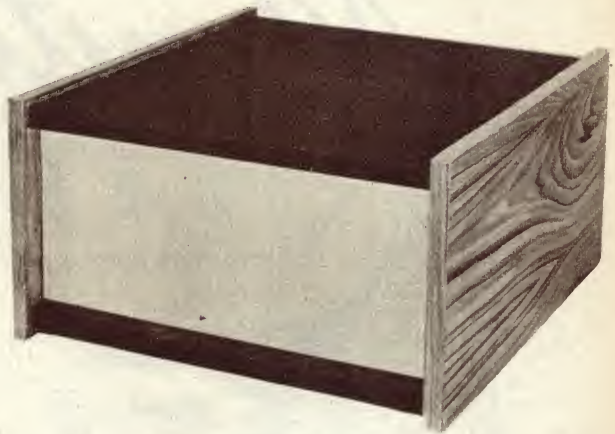

holes already drilled, they are available in four heights and two widths.

Standard panels punched with square ventilation holes are available in two sizes, 5½in and 7in high, to suit the standard 19in panel widths. These panels are constructed in the same manner as the standard panels being press formed from 16 gauge steel.

The Celotek range of standard chassis: These include 11 sizes and shapes of steel chassis and eight of aluminium. The steel chassis are supplied zinc-plated and

available for this case, and a louvred rear panel can be supplied if desired. The size of this case is 12-15/16in wide x 14in deep x 7-1/16in high, with a front panel size of 11-13/16in x 5½in. Price is quoted as \$15 each for small quantities.

The 600 Series sloping front cases: Used mainly where meters and dials are to be mounted on a case. The front panel is

mounted on the formed section of the other panels, and is slightly recessed. The case is supplied zinc dichromate plated and painted; a two-tone colour arrangement is available at no extra cost.

The 500 Series rectangular cases: Simple cases to fulfil laboratory needs but keep development costs down. They range in size from 6-13/16in wide x 6-9/32in deep x 9½in high to 19-13/16in wide x 9-17/32in deep x 13½in high. Both the 600 and 500 Series cases can be supplied with louvred rear panels.

The 400 Series Visor Front Cases: Said to be the most popular of the Celotek range, these are well ventilated for use with high heat generating equipment. A wide range of sizes is available with front panel sizes from 11in to 19in wide and 3½in to 10½in high. The steel or aluminium chassis is supplied blank, but can be punched to requirements at extra cost. The chassis and front panel are easily removed from the enclosure, and in the case of the larger sizes may be fitted with slides. There are louvres in the rear panels for adequate ventilation, but additional louvres in the side panels can be supplied.

The smallest of the 400 Series of cases, the 400A, with a size of 11-1/8in wide x 9in deep x 3-9/16in high is priced at \$9.20 with an aluminium chassis (small quantities).

The 300 Series cases: Designed for economy with robustness. Each case consists of two parts of 18SWG steel held together by four self-tapping screws. The bottom part is used as a chassis, and the top when fitted gives a visor effect to the front panel. There is provision for a power cord inlet at the rear of the case. Standard finish for the chassis is zinc dichromate plating. The cover comes in a red or black "crinkle" finish.

The 200 Series Venticases: Economical cases constructed from 18SWG steel. They consist of a zinc dichromate treated chassis section and a cover of painted perforated steel to provide ventilation. They are suitable for housing small heat generating power supply units. The cover fits into four formed slots at the top of the chassis and is held in place by four self-tapping screws at the base of the chassis.

The 100 Series Minicases: Available in either 18SWG zinc dichromate steel or 18SWG half-hard aluminium, they comprise two parts secured by self-tapping screws. They range from 3in wide x 1-5/8in deep x 2-1/8in high to 17in wide x 4in deep by 5in high.

One of the samples submitted was a chassis with cover, similar to that used for the 10-Plus-10 Stereo Amplifier pu-

THE

TANNOY

Monitor

GOLD



Full range world famous dual concentric loudspeakers

The Monitor Gold is a further refinement in the almost legendary range of Tannoy Dual Concentric Loudspeakers. An entirely new crossover network not only provides facilities for adjusting treble energy to suit prevailing acoustic conditions, and treble roll-off to accommodate variations in programme material, but also gives a smoother frequency response in the middle treble register together with a more constant impedance characteristic; thus ensuring the highest performance from modern transistor amplifiers. The impedance is nominally 8 ohms but never falls below 5 ohms.



Distributed through the Consumer Products Division of
AMALGAMATED WIRELESS (AUSTRALASIA) LIMITED
554 PARRAMATTA ROAD, ASHFIELD. 71 0791

167 Queen Street, Melbourne. 67 9161 • 70 Merivale Street, Brisbane. 4 1631
• Cnr. Darby and King Streets, Newcastle. 2 5166 • 231-233 Bulwer Street,
Perth. 28 6400 • 48 King William Road, Goodwood, Adelaide. 72 2366 • 42
Frederick Street, Launceston. 2 1804 • 123 Murray Street, Hobart. 3 3836-7



Said to be the smallest and lightest electronic calculator to come from Japan, the Toshiba BC-1211S weighs only 6lb and features a 12-digit display with 16-digit product capacity. The 10-key layout of the keyboard makes the unit simple enough for use in retail stores and offices. The height is only 4in and the base only slightly larger than quarto paper. The BC-1211S is priced at \$465 and available through the sole Australian distributors, Hanimex Pty. Ltd., Old Pittwater Road, Brookvale, N.S.W.

published in "Electronics Australia" in November, 1968 and April, 1969. However, it differs in that it uses a length of aluminium channel for mounting the power transistors which is not as specified in the original articles. Based on the Celotek 300 series, it is larger than the standard cases in that series, and is in a grey "crackle" finish. It is one of a batch produced for, and available from, Deitron Electronics.

The wide range of Celotek cases, etc. should be of value to home experimenters and development laboratories without the necessary facilities to produce their own.

A comprehensive catalogue describing the complete Celotek range of equipments is available on request to the company at 800-810 Parramatta Road, Lewisham, N.S.W. 2049. (J.H.).

TRADE RELEASES—in brief

E.S.N. ELECTRONICS, 53 Paterson Street, Campbelltown, N.S.W., 2560. **American Standard P.G.S. Humidity Meter**. An accurate instrument suitable for sensing and control of humidity in a wide range of industrial and laboratory applications. A special permeable glass sensing element covers the range of 1pc to 100pc relative humidity, and will operate over the temperature range of 0 to 500 degrees F. The sensor will resist attack by organic solvents, corrosive gases, and common contaminants, and is unaffected by temporary water condensation on its surface. In addition to front panel meter indication, there is an output at the rear of the instrument for use with recording units. For standard units, temperature correction curves are available from 40 to 180 degrees F. The basic accuracy of the instrument is plus or minus 2 per cent at the meter and 1 per cent at the rear panel output.

Reinforced Computer Tapes. A range of Mylar reinforced, splice free, continuous rolls of perforator tapes is available featuring capacities of 95 to 100 per cent, and tensile strengths of 40 to 60lbs/in. Designed for high-speed photoelectric and electro-mechanical readers, they can be read indefinitely after perforation. Changes in relative humidity will not affect the tapes. Special features of these tapes make them suitable for use with numerical control tools, as computer test tapes, for the storage of information required to be continuously read, or where tape wear and breakage cannot be tolerated.

RONALD J. T. PAYNE PTY. LTD., 385-387 Bridge Road, Richmond, Vic. 3121. Agents for Computer Instrumentation Ltd., U.K. **Incremental Plotters**. Models 141, 142, 341, and 342. Features: speeds up to 300 increments per second; increment size either .005in or .01in; rapidograph or ball point pen; black or choice of colours; simple controls; input from punched paper tape or off-line magnetic tape. Model 6011 to 6014. Features: on-line operation with most digital computers, or off-line with punched paper or magnetic tape input; two-pen option for colour work or varying thickness; basic increment size 0.05in, .01in optional; speed, up to 600 increments per second; switchable dual speed, dual step size. **Magnetic Tape Input System, 5000 series**. Features: No redundant bytes of information at 800bpi; two bytes execute any plotting movement in the X, Y, or XY directions of movement; high quality computer-type tape transport with vacuum columns and solid state reel servos; dual speed — plotting speed and high-speed search; high-speed rewind — full 2,400ft reel rewind in 3 minutes; lateral parity checks; solid state control circuits. **Remote Terminal Plotting Systems**. Features: pen-on-paper remote terminal computer output drawings, etc.; high-speed plotting over telephone lines; plotting systems can include teleprinters; choice of 14in or 30in incremental plotters; can be incorporated into existing time-sharing terminals.

TECNICO ELECTRONICS, division of Pye Industries Ltd., 53 Carrington Rd., Marrickville, N.S.W. 2204. Agents for Princeton Applied Research Corp., U.S.A. **Operational Amplifier, model 215**. Frequency response adjustable over a wide range by the use of front panel switches. One selects a desired series or parallel RC feedback network. A second switch selects a separate input network. Features include: open loop gain of 10^4 ; flat frequency response beyond 10MHz at unity gain; input offset voltage and current temperature coefficients of typically 0.1uV and 0.1uA per degree C; minimum slewing rate 50V/uS; maximum output plus or minus 15V into 1K; output impedance 50 ohms in parallel with 25uH.

Radio Control Unit



A range of contemporary-styled control units has been released by Philips Telecommunications of Australia Ltd. for its VHF radio-telephone base stations. The solid-state consoles have a wood-grained finish, and are designed especially for modern offices. Apart from providing a means of controlling remotely sited base stations, the units also give the facility of an inbuilt 10-line internal telephone system which enables any extension user to talk over the radio system. Control of the system can be switched to an extension for after-hours operation.

100W AF POWER AMPLIFIER

RCA Ltd., 11 Khartoum Road, North Ryde, N.S.W., 2113. **100W Power Amplifier, type PA-100**. Designed and manufactured in Australia for AF power applications with auditoriums, high-quality, high-power public address systems, and audio reinforcement generally. Silicon semi-conductors are used throughout. It is a self-contained unit with a built-in power supply operating directly from AC mains, and is said to be an extremely stable and reliable unit.

Comprehensive protection circuits are incorporated which operate on input signal overload as well as output irregularities. Operation into no load or short-circuit load will not harm the unit. The



standard load impedance is 50 ohms unbalanced. The total harmonic distortion is less than 2 per cent in the power bandwidth with 100W RMS at 1KHz as the reference. Power bandwidth is 40Hz to 15KHz (plus or minus 3dB). The PA-100 develops its full output power with a 0.77V input when the gain control is at maximum. The standard unit has an unbalanced input impedance of 10K. Price is \$270, plus sales tax, if applicable.

DISTRIBUTORS CORPORATION PTY. LTD., 24 Johnson Street, Fitzroy, Vic. 3065. Australian distributors for Microdyne Instruments Inc., U.S.A. **Integrated Circuit Testers, series 700**. A complete range of low cost IC testers, offering a high degree of flexibility and capable of testing both digital and linear circuits. The instruments range from the simplest manually operated model 701 to the fully automatic models 720 and 721. They are suitable for incoming inspection, small run production, and laboratory and failure analysis of ICs. The tests which can be performed include such digital checks as measurement of input load current drain, and clocking flip-flop and counter circuits.

Linear checks include voltage gain, input voltage offset, bandwidth, input differential current, and output voltage under full load. All units are of the constant voltage type and can produce a bi-polar output voltage. Each unit is capable of sourcing or sinking current regardless of output polarity. Each unit has a limit alarm indicator lamp to display any overload condition. All power supplies are short circuit protected. Resistor, capacitor, or resistor-capacitor loads may be selected by front panel rotary switches. The resistor-load and the capacitor-load switches each select two identical loads simultaneously to meet flip-flop requirements.

Coilmaster NEW DELUXE

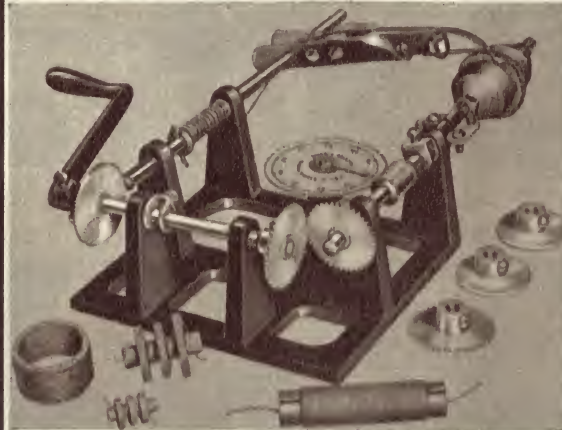

**ACCURATE
COIL
WINDER
\$15.95**

Post Paid

This new, Easy-to-Use machine winds honeycomb, spiderweb and solenoid coils of various widths and diameters—equal in appearance to a factory job. Also suitable for winding chokes, transformers and filter inductors. Indicator counts number of turns on coil. The COILMASTER is suitable for both experimental and practical work. Supplied with accessories including wood spools, metal pegholders and extension for making long solenoid coils. Instructions included, but less coil forms and pegs.

SEND REMITTANCE WITH ORDER FOR IMMEDIATE DELIVERY ANYWHERE TO THE SOLE AUSTRALIAN AGENTS.

**Electron Tube
Distributors Pty. Ltd.**

**VICTORIAN SALES CENTRE AND
HEAD OFFICE 94 HIGH STREET,
ST. KILDA, 3182, VICTORIA.
TELEPHONE 94-6036.**

A vast range of SATO Parts

- For manufacturers
- For TV
- For radio
- For instruments
- For amplifiers
- For kitset builders
- For sound equipment
- For industry
- For stereo equipment
- For educational purposes
- For electronics
- For tape recorders

Distributed by

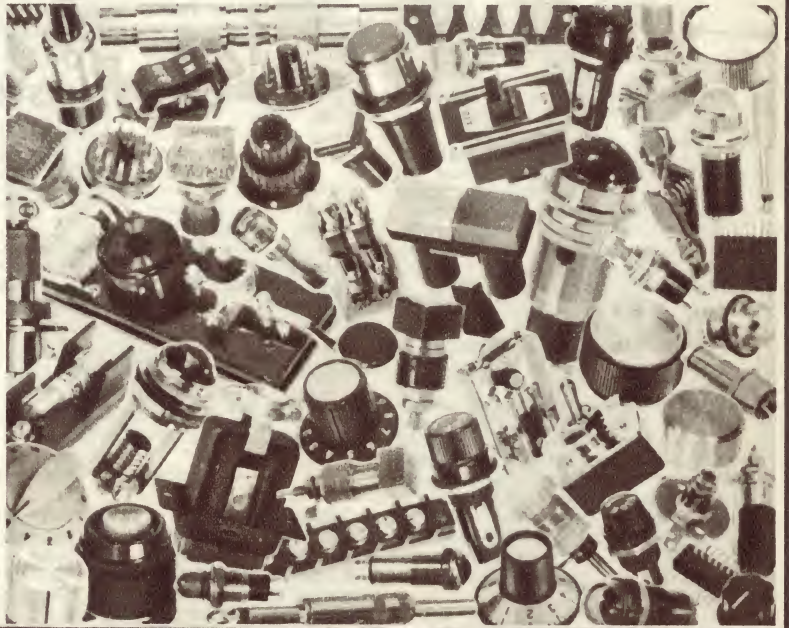

GENERAL ACCESSORIES

(A DIVISION OF ELECTRONICS INDUSTRIES)

116-118 CLARENCE STREET, SYDNEY 443 CONCORD ROAD, RHODES — 73-0211
BOTH STORES OPEN SATURDAY MORNING

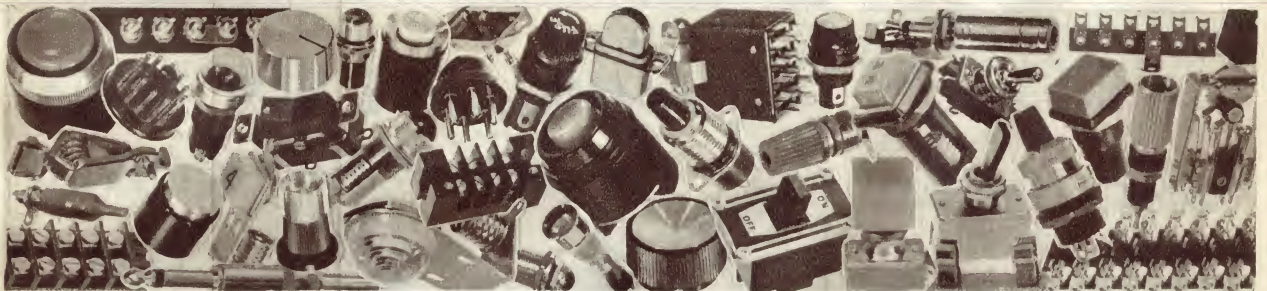

Like being proud of their Kangaroo, Sato's large variety of electrical parts is the favorite choice by Australians. Your inquiries are welcome.

SATO PARTS

SATO PARTS CO., LTD.

HEAD OFFICE: EBISU, SHIBUYA-KU, TOKYO, JAPAN TEL: (442) 8506~8
BANK ACCOUNT: MITSUBISHI BANK

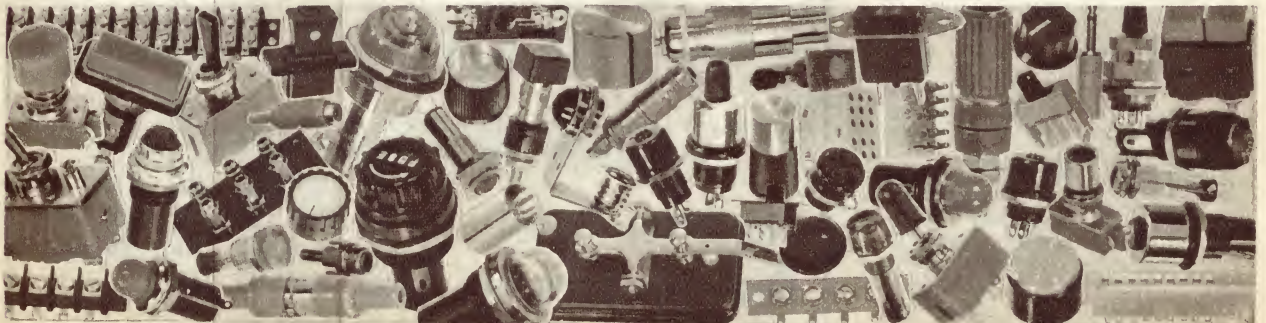

TRANSISTOR NOISE ANALYSER

HEWLETT PACKARD AUSTRALIA PTY. LTD., 22-26 Weir Street, Glen Iris, Vic. 3146. **Transistor Noise Analyser, model 4470A.** Measures all three bipolar transistor noise characteristics: noise figure, noise current, and noise voltage. Also measures the noise figure and noise voltage of FETs. Noise figure measurement range for both bipolar and FETs is from 0 to 40dB with source resistance selectable from 10 ohms to 10M. Noise voltage is measured in full-scale ranges from 3 to 3000nV per root Hz with essentially short circuit transistor input impedance (about 3 ohms). Bipolar

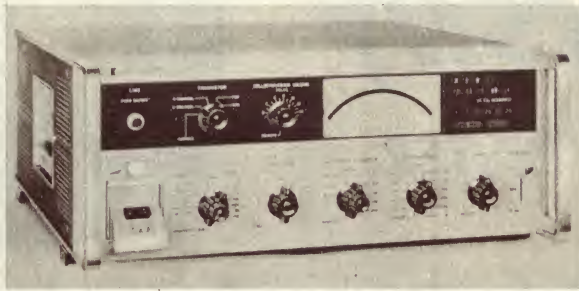

noise current is measured with practically infinite input impedance with full-scale ranges from 0.1 to 3000pA per root Hz. Accuracy is plus or minus 1dB over the entire 10Hz to 1MHz frequency range.

L. SHANK AND CO. PTY. LTD., 68 Sophia Street, Sydney, N.S.W. 2010. Australian and New Zealand agents for Minthorne International Co. Inc. of the U.S.A. **Tymeter Digital Clock Movements.** Models 130-12H (12-hour readout) and 130-24H (24-hour readout), digits resettable individually, 5/8in digits on 12-hour clock and 5/16in digits on 24-hour clock, time registered on three drums — minute, 10 minute, and hours, price \$40.50 retail plus \$1 packing and post. Models STD-12 hour and STD-24 hour, self-starting electric, synchronous motor with rotor speed of 450rpm, digits and drums as for 130 models, price \$24.30 and \$2,550 retail respectively plus \$1 for packing and postage.

A wide range of Tymeter digital clock movements is available, including elapsed time indicators and a calendar clock which indicates the month, date and hour at a glance.

DATAMATIC PTY. LTD., 90 Alexander Street, Crow's Nest, N.S.W. 2065. Agents for Potter Instruments Co., U.S.A. **Key Data Recorder System.** A medium for transferring data from a keyboard directly to magnetic tape in computer compatible format. Features: simplified job set-up for operator; fast duplication, skip and release functions; easy correction through access to individual characters; memory display without destruction of data; built-in end of tape sensing; left zero field — right justification of numeric fields.

VARIAN PTY. LTD., 38 Oxley Street, Crow's Nest, N.S.W. 2065. **Mini Vacuum Hardware.** A line of miniature vacuum hardware mounted on 1.33in o.d. Mini Conflat flanges with demountable copper-gasket seals. Available are: fittings (nipple, elbow, tee, cross, and flexible couplings); adapters from a stainless steel Mini-Conflat flange to a tubulation of 7052 glass, Pyrex, or OFHC copper; flexible stainless steel hose; right angle valves sealed with Viton or Polyimide; electrical feedthroughs (12KV/150A or 12KV/10A); a



Varian mini vacuum hardware.

coaxial instrumentation feedthrough; and a sapphire window. This hardware is scaled for such applications as vacuum-jacketed cryogenic lines, compact gas-sampling, gas-inlet systems, and miniature vacuum systems. It can be used for reducing weight and bulk in aerospace equipment, and for replacing screw-type fittings to gain greater strength, temperature range and leak-free reliability.

3M COMPANY, 950 Pacific Highway, Pymble, N.S.W. 2073. **Scotch brand E-Z Seal no. 2200.** An electrical insulating pad of inert, oil-free, insulating compound laminated to an all-weather electrical-grade vinyl plastic. It is a one-step method to insulate, moisture-seal and pad all 1100V phase-to-phase (nominal 660V phase-to-ground) connections on bus bars, service drops, terminal spades, transformers, and similar equipment. Designed to adapt easily to the most difficult horizontal or vertical splice configurations, it is installed in seconds by wrapping the pad around the connector and kneading the putty to conform to the splice. The compound fuses together with the vinyl backing, to give additional protection according to 3M.

RACAL ELECTRONICS PTY. LTD., 47 Talavera Road, North Ryde, N.S.W. 2113. **Airmec VLF and LF Signal Generator type 422.** A solid-state crystal-monitored digital-display instrument with a continuously variable frequency range from .005-Hz to 50KHz. The digital presentation of frequency prevents parallax errors and resetting ambiguities. Least significant digit in the readout indicates uHz on lowest frequency range. "Zig-zag" ranging of the coarse tuning control gives continuity of tuning by reversing the direction of rotation for frequency increase for successive half-ranges of the frequency decade switch. Accuracy is up to plus or minus 2 parts in 10⁵ with stability of 1 in 10⁴ over 30 minutes. Outputs: 10V square or sinewave via a matched 600 ohms 80dB attenuator; unattenuated triangular wave at 5V peak to peak about earth.

RUTHERFORD ELECTRONICS PTY. LTD., has moved to 62 Jackson Court, Doncaster, Vic., 3108. The postal address remains unchanged as P.O. Box 30, North Balwyn, Vic., 3104, and the telephone number is still 848-3033.

IRH COMPONENTS PTY. LTD., The Crescent, Kingsgrove, N.S.W. 2208. Agents for Emerson and Cuming Inc., U.S.A. **Collimating Microwave Lenses.** This is not a standard line of lenses, but rather a design and manufacturing capability. Each lens is designed and built to meet the requirements of a specific application. The primary purpose of such

UNITED TRADE SALES

PTY. LTD.

NU-METAL SHIELDS

To suit 5BP1 and other 5in CRTs mfd. by Magnetic Shields Ltd. Brand-new, \$5 ea. plus 30c pack. and post.

TAPE HEADS

Cassette Recorder Type Relay Heads. 2-track Mono Current Manuf.

New \$1.50 ea.

PLUS 10c pack, and post.

CAPACITORS

80 for \$2 in Poly Packed Bags. Mixed values only.

VALVES

6J6 30c each. 815 70c ea. 807 70c each. 6AC7 20c ea. or 12 for \$2. 6C4 50c ea. 8020 35c ea. QS150/15 50c ea. 6H6 Metal 20c ea. QB2/250(813) New in sealed cartons, \$6 ea.

TRANSISTORS

2SC73, 2SD65, 2T76, OC66, 2T65 25c ea. or in 100 lots 20c ea.

LSG11 SIGNAL GENERATOR

120KHZ to 260 MHZ New in sealed carton \$35, postage \$1.

MILLER TRANSISTORISED IF STRIPS

455 Kc Selectivity 5 Kc at 6db down. Power 6 Volts 2mA gain 50db. Price: \$9.70.

TRIO TR2E

2-METRE TRANSCEIVER

- Triple conversion receiver with crystal locked second and third oscillators for maximum selectivity and sensitivity.
- Separate VFO tuning for both receiver and transmitter.
- Nuvistor RF amplifier.
- Provision for crystal locking of the transmitter.
- 12 volts DC (internal transistor power supply) and 230-240 volts AC operation.
- Noise limiter and squelch.
- 17 tubes, 4 transistors and 7 diodes.
- 1 microvolt sensitivity for 10 db. S/N ratio at 14 6Mc.
- "S" meter, RF output meter and "netting" control.

Price: \$282.

3,000 TYPE RELAYS.

Large range. Only 50c each.

COMPLETE RANGE OF METERS.

P25's 24sq.	
100uA .. \$6.95	1mA \$4.50
500uA .. \$5.25	50mA ... \$4.50
10mA .. \$4.50	S'meter .. \$5.25

MULTIMETERS, 200H, 20K ohms per volt, \$11.25, inc. tax. CT 500 20K ohms per volt, \$15 inc. tax. CT 330 20,000 ohms per volt, \$17.25.

RESISTORS. Mixed Values only in Bags; \$2 per 100, or 50 for \$1. 3,000 Type Relays. New stocks, 50c each. Plus postage.

TRANSISTOR V.H.F. CONVERTER Tunable 108-136 Mhz Aircraft Band 1F-600Kc to 1,000Kc. No connecting wires needed, 9V Battery, self-contained, just place alongside broadcast radio. Price only \$14.40 plus 45c postage.

WANTED BUY:

RECEIVERS, TRANSMITTERS, TEST EQUIPMENT. All prices subject to alteration without notice. All items PLUS POSTAGE.

280 LONSDALE STREET, Melbourne. Phone 663-3815
Opposite Myers

University

T.V.T. VALVE TESTER



Due to the demand for the model T.V.T. Valve Tester, "University" have re-introduced the unit and it is now available from University Graham Instruments Pty. Ltd., or representatives in all States.

This fine instrument can be used as a portable or counter type Valve Tester. It is designed to operate from 240 volts A.C. and has provision for testing radio valves as well as T.V. valves.

An important feature of the model T.V.T. is that all the elements in a valve are brought out to individual lever switches. This allows for great flexibility and also provides for valves which may have unusual connections or unusual sockets. It makes it possible to apply filament voltage to any base pin.

The model T.V.T. incorporates the University model W4 all polystyrene meter with multi-coloured scale. The scale is marked "Good"—"Bad" so that quick and rapid indication of the condition of the valve under test is given.

The case is fitted with a carrying handle which lies flat when not in use, and a comprehensive instruction booklet listing valve test settings is provided.

The outside dimensions of the unit are 14" x 11" x 6".

Valve Tester Price . . . \$88.00 each, plus 15 per cent Sales Tax

Also available is a Picture Tube Adaptor model T.V.2. This allows for testing television picture tubes without the necessity of removing the tube from the television receiver.

Picture Tube Adaptor Price \$4.00 each, plus 15 % Sales Tax.

University Graham Instruments Pty. Ltd.

106 Belmore Road, Riverwood, N.S.W., 2210.
Telephones: 53-8758, 53-0644 (5 lines).
Telegrams and Cables, Requip, Sydney.

Victoria: Eastern Instrument and Electronic Service Pty. Ltd.
3 Carroll Cres., Glen Iris, Melb., Vic. 3164.
Phone: 20-6953.

REPRESENTATIVES:

W.A.: Atkins (W.A.) Ltd.,
894 Hay Street, 21-0101.
PERTH, W.A. 6000.
TAS.: W. P. Martin and Company,
202 Argyle Street, 34-2811.
HOBART, Tas. 7000.

And 150 Wellington St.,
LAUNCESTON, Tas. 7250, 22-844
S.A.: Compar Distributors Pty.
Ltd.,
33 Market Street,

ADELAIDE, S.A. 5000, 51-6263.
QLD.: Keith Percy & Co. Pty. Ltd.,
Waterloo Street,
NEWSTEAD, Bris. Qld. 4006.
51-5461.

NEWCASTLE DIS.:
Hunter Engineering Sales Pty. Ltd.,
Cnr. Gordon Avenue and
Perry Street, Hamilton,
NEWCASTLE, N.S.W. 2303.
Phone 61-4321.



A NEW, PRECISION MADE TONE ARM—THE GRACE MODEL G-545

Although they've been available only a few months, Grace tone arms are already prized by the audio enthusiast. This new model, the G545, is a winner . . . it will track down to $\frac{1}{2}$ gram with suitable cartridges and features a gimbal type gyrosopic bearing system. An ultra light weight head shell is supplied . . . and the new arm shape reduces tracking error to the point where this factor may be disregarded.

The main counter balance weight is divided into two for easier, more precise balancing. Sub-weight adjustment sets stylus pressures from 0 to 3 grams. The arm accepts all Ortofon/SME type headshells without modification and all "New Generation" cartridges. Tracking ability of this fine tone arm is best demonstrated with stylus pressures below one gram. Ask for an EMQ or call at Encel Stereo Centres in Melbourne or Sydney for a demonstration.



TOP PERFORMING GRACE MODEL F-8M STEREO CARTRIDGE

With an output of 7 mV. and a frequency response of 5-35,000 Hz., the Grace F-8M stereo cartridge tracks down to $\frac{1}{2}$ gram — recommended stylus pressure being $\frac{1}{2}$ gram. An elliptical diamond stylus 0.2 x 0.8 mil. is standard equipment, tip mass is 0.75 m/grams, and total cartridge weight is only 61 grams. Cross talk is less than -30 dB. at 1 kHz. Musical performance rivals many stereo cartridges selling at twice the Encel price. Write for complete specifications and for prices . . . better still, call and compare when you listen to several top quality cartridges.

ENCCEL

**ELECTRONICS (STEREO)
PTY. LTD.**

Head Office:

431 Bridge Rd., Richmond, Victoria 3121. Tel. 42 3762.

Sydney Store: Ground Floor, 25M Building

257 Clarence Street, Sydney, N.S.W. 2000. Tel. 29 4563, 29 4564.

Australia's Greatest Hi-Fi Centre *Wholesalers *Trade-ins accepted

a lens is to achieve far-field performance in an antenna or back-scatter test range when the length of the range, wavelength, and aperture or target size do not meet the necessary criteria. The dielectric constant and shape of the lens are so chosen as to minimise reflections from the lens surface, while at the same time producing the desired energy focusing to produce an excellent approximation to a plane wave immediately in front of the output aperture. Uniformity of dielectric constant is stressed in the manufacturing method to minimise aberrations.



A typical collimating lens, 44in o.d., 18in long, made in one piece.

RCA LTD., 11 Khartoum Road, North Ryde, N.S.W. 2113. **Colour Video Distribution Amplifier, type TA-100C.** Designed for distribution, isolation, and level recovery applications associated with composite or non-composite signals in monochrome or colour television systems. Particularly suitable for colour systems, this high-quality feed-back stabilised wide-band amplifier has an inbuilt power supply regulator to operate from a wide range of AC voltages. Using silicon transistors throughout, this extremely stable and reliable unit provides five isolated source terminated outputs from a single bridging loop input. Price \$230.



The RCA colour video distribution amplifier, type TA-100C.

PLESSEY PACIFIC PTY. LTD. has appointed Dr F. P. Levi as technical manager of the components division at Villawood, N.S.W. He will be responsible for co-ordinating technical activities at the Plessey Rola and Plessey Ducon plants. Before his appointment Dr Levi was the technical manager of Plessey Rola in Melbourne.

Solid state machine controller

DIGITAL EQUIPMENT AUSTRALIA PTY. LTD., 75 Alexander Street, Crows Nest, N.S.W. 2065. **PDP-14 Machine Controller.** A general purpose, solid-state machine controller to replace electrical relay systems used in such industries as steel, automotive, textile, and chemical. It comprises a central processing unit and an interface which accepts inputs from contacts and drives outputs up to 1000VA. The interfacing is expandable to accommodate up to 256 inputs, such as limit switches and push buttons, and 255 outputs such as motor starters, solenoids, and indicators. Included in the central processor is a read-only memory. This is an interchangeable, hard-wired memory constructed specifically to perform series of user defined tasks.

The solid-state design is said to give a longer mean-time between failures and longer life expectancy than electrical relay networks. Modular construction and the non-destructive read-only memory also contribute to the PDP-14s economy. When

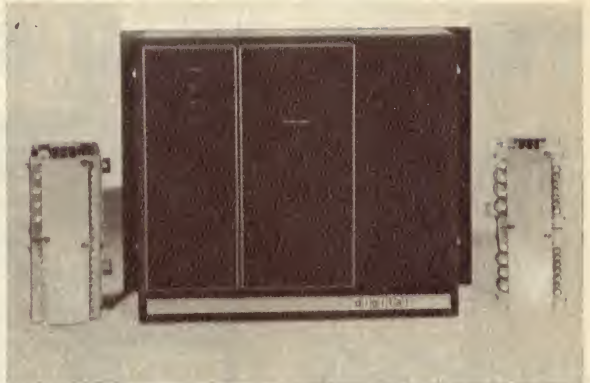

extensive production changes are necessary, the PDP-14 user defines his new production parameters, and installs a new memory at minimal cost and in a matter of minutes. For minor changes, the existing memory can be altered. Digital claims that one of the most useful applications of the PDP-14 is its integration with small or large computers to develop large process plant monitoring and control systems. This frees the main computer for more complex tasks, while providing complete supervision through the PDP-14.

ELECTRONIC INDUSTRIES LTD. has acquired a 51 per cent interest in Associated Telecommunications Australia Ltd. (A.T.A.) with the approval of the respective Government authorities. Of the remaining 49 per cent, Philips Industries Ltd., of Sydney, holds 27 per cent and Pye Ltd., of the U.K., 22 per cent. A.T.A. has acquired all the shares in Philips Telecommunications of Australia Ltd., Pye Pty. Ltd. (a wholly owned subsidiary of Pye Ltd.), and Telephone Manufacturing Co. (Asia) Pty. Ltd. A.T.A. is now one of the major telecommunications groups in Australia with assets exceeding \$9 million.

FAIRCHILD AUSTRALIA PTY. LTD., 420 Mount Dandenong Road, Croydon, Vic. 3136, has appointed Mr Bruce Cliff as engineering representative in Victoria. Prior to this appointment, he was employed for three years as an engineer in the Fairchild applications laboratory.

FERRIS INDUSTRIES LTD., 752 Pittwater Road, Brookvale, N.S.W. 2100, is now a subsidiary of Hawker de Havilland Australia Pty. Ltd.; following the acquisition of more than 90 per cent of the ordinary capital of Ferris.

RACAL ELECTRONICS PTY. LTD., 47 Talavera Road, North Ryde, N.S.W. 2113, is now responsible for sales and service of Airmec products in Australia, following a recent merger of Airmec Instruments and Racal Electronics in the U.K. Products manufactured by the Airmec division of Racal include HF and VHF signal generators, wave analysers, modulation meters and analog voltmeters. Racal has announced the appointment of Mr Harold Norrie as instrumentation sales manager. Mr Norrie was previously associated with Airmec.

UNITED DATA CENTRES LTD., A.D.C. House, 189 Kent Street, Sydney, 2000, is a computer service bureau formed recently by the amalgamation of Grazcos Computer Services Pty. Ltd. and Tutt Bryant's Rydalmore Computing Services. The following appointments have been announced: General manager, Mr W. David Sherington (formerly general manager of Grazcos Computer Services); assistant general manager, Mr H. Barrie Fitz-Henry (former manager of Rydalmore Computing

Services); marketing manager, Mr Wallace Regan (formerly data processing manager with Grazcos); city centre manager, Mr J. S. Burke, responsible for data processing facilities at A.D.C. House; suburban centre manager, Mr H. J. Roberts, similar responsibilities at 8 South Street, Rydalmore.

DATAMATIC PTY. LTD., 90 Alexander Street, Crows Nest, N.S.W. 2065, has appointed Dr Michael White as technical director in succession to Mr Michael Marks, who has returned to England. Before joining Datamatic, Dr White was with the Weapons Research Establishment in South Australia.

*AEGIS AF-1 NOISE REDUCING AERIAL KIT



This AF-1 aerial system is for use in noisy locations for clearer reception. It is designed to cover both M/W and S/W broadcast bands (from 500 to 1500 KHZ and 2 to 15 MHz, approximately). Available in all States. Write for our illustrated leaflet.

AEGIS PTY. LTD.
347 Darebin Road, Thornbury, Vic. 3071. Phone: 49-1017.



Let The World University Of Postal Education TRAIN YOU FOR A KEY JOB



BRANCHES THROUGHOUT THE WORLD

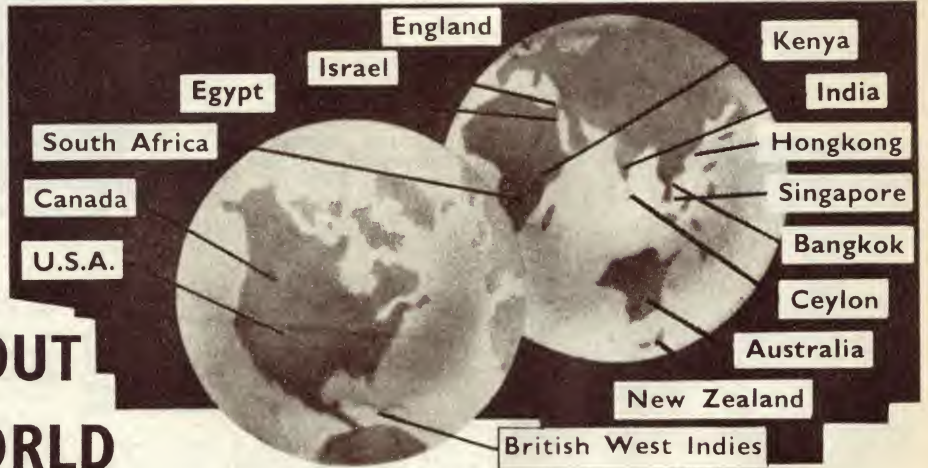

TODAY there are wonderful Opportunities for the forward-looking man and woman. However, the best jobs go to those who have the foresight to prepare themselves by proper Training. British Institutes have already trained some 300,000

men and women who have reached the top of the ladder. Therefore, it is up to **YOU** to make something of yourself. Don't delay, act **NOW**. Remember that an enquiry places you under no obligation but could be the turning point in **YOUR** career.

OVER 500 COURSES

Courses offered by British Institutes include:—

TECHNICAL

Aero Engines
Aeronautical Eng.
Air Conditioning
Arch. Drwg. & Design
Automation
Auto Elec. Equipment
Automobile Eng.
Automobile Repairs
Building (General)
Carpentry & Joinery
Chemical Engineering
Civil Engineering
Computers
Die & Press Tools
Diesel Engines

Draughtsmanship
Electrical Engineering
Elec. Installations
Elec. Measurements
Electrical Power
Electricity Supply
Electronics
Foundry Practice
Garage Management
Gas Turbines
Geology
Hydraulics
Illuminating Eng.
Industrial Chemistry
Jig & Tool Design
Mach. Drwg. & Design
Maintenance Eng.

Management
Marine Engineering
Mechanical Eng.
Metallurgy
Municipal Engineering
Naval Architecture
Painting & Decorating
Patternmaking
Petroleum Technology
Plastics
Production Eng.
Radar Technology
Radio Engineering
Radio Servicing
Refrigeration
Reinforced Concrete
Road Engineering

Rubber Technology
Sanitary Engineering
Structural Eng.
Surveying
Telecommunications
Television
Television Servicing
Timber Technology
Tracing
Welding Technology

Business M'gement
Commercial Art
Commercial Law
Company Law
Costing
Economics
Fiction Writing
Journalism
Secretaryship
Selling

COMMERCIAL

Accounting
Advertising
Auditing
Book-keeping

GENERAL

English
European Languages
Mathematics
Shorthand
Typewriting

And many other Subjects.

Details of Engineering and Commercial Exams., Certs. of Competency, Matriculation, etc.

CHECK THESE FEATURES:

- Modern streamlined methods . . . you learn the fast way and make rapid progress.
- Courses based on STANDARD TEXT-BOOKS . . . Lessons and Model Answers written and planned by experts.
- We provide all necessary text-books which remain your own property.
- Moderate fees payable by small monthly sums. Written guarantee.
- Courses can be "tailored" to individual requirements.

SECURE ONE OF THESE BOOKS



POST COUPON NOW!

BRITISH INSTITUTE OF CAREERS

College House, 113 Pacific Highway, North Sydney, 2060

I am interested in
Please send me the appropriate Career-Book.

NAME (PLEASE PRINT)

ADDRESS

E.L.-W-9

Occupation Age



BRITISH INSTITUTE OF CAREERS

In association with
British Institute of
Engineering Technology

THE B.I.C. GROUP LEADS THE WORLD IN POSTAL TRAINING

TECHNICAL BOOKS AND PUBLICATIONS

VHF-VHF manual

VHF-UHF MANUAL, by G. R. Jessop, C. Eng., M.I.E.R.E., G6JP. Published by the Radio Society of Great Britain, London, 1969. Soft covers 9½in x 6½in, 244 pp., many circuits and diagrams. Price in U.K. 21/-.

This is the latest addition to the ever growing and already impressive list of R.S.G.B. publications. Even a preliminary glance through this book indicates that it is of a high standard. The author is well known for his work in earlier publications and needs no introduction here.

To give an idea of the coverage, here is a list of the chapter headings. 1 Introduction; 2 Propagation; 3 Tuned Circuits; 4 Filters; 5 Receivers; 6 Transmitters; 7 Mobile; 8 Single Sideband; 9 Aerials; 10 Aerial Test Gear and Accessories.

The first chapter is a brief resume of the amateur VHF and UHF bands, including their peculiar characteristics. This text has a particular U.K. slant, in that they do not have access to the 52MHz band but have a band on 70MHz instead. Also, there is an agreed frequency allocation plan for the U.K. which is listed in detail. Following is an interesting discussion on the somewhat elusive subject of VHF propagation. Such influences as the weather patterns where such are significant, auroral propagation, solar wind, the earth's magnetic field, etc., are dealt with in an informative manner.

Transistor principles

PRINCIPLES OF TRANSISTOR CIRCUITS, by S. W. Amos. Fourth Edition, 1969. Published by Iliffe Books Ltd., London. Hard covers, 5½in x 8-5/8in, 310 pp., many circuits and diagrams. Price in U.K. 37/6.

The fourth edition of a book which has become well known and highly respected since it was first published in 1959. The new edition contains a considerable amount of new and updated material, and thus continues the tradition of practicality and relevance set by the previous editions.

For those hitherto unaware of the book, S. W. Amos is Head of the Technical Publications section of the Engineering Training Department of the B.B.C. He is the author of many articles on receiver and amplifier design, and also co-author with D. C. Birkinshaw of the book "Television Engineering." His aim in writing "Principles of Transistor Circuits" was to provide a compact but comprehensive treatment of the basic principles of transistor circuitry, intended both for students and for "thermionic" technicians and engineers. The degree to which he achieved this aim may be judged from the number of editions since initial publication, and also by the fact that the book has become widely used as a text and reference in technical colleges.

The fourth edition follows the same general plan as before: after a brief discussion of semiconductor physics, the

Following are discussions on tuned circuits and filters, particularly where they differ from conventional HF practice. The chapter on receivers goes into the finer points of crystal locked converters, followed by design considerations for a suitable tunable IF and other points of a complete receiver. Crystal oscillators, RF amplifiers and noise are dealt with at length. A good selection of constructional projects is also included. Of particular interest, is the treatment of tunnel diode amplifiers. Similar comments could be made on the chapter on transmitters. Suffice to say that any VHF or UHF enthusiast will find much interesting and informative reading on the subject.

There is also a nice sprinkling of details of various aspects of mobile operation. Sufficient subject matter to enable present AM operators to change over to the SSB mode is given in the following chapter. Finally, there is an excellent treatment of aerials and aerial test equipment.

This book goes rather more deeply into the subjects covered than most other contemporary counterparts. As such, it is a most useful publication, for the less experienced and advanced amateurs alike. Indeed, it would be an excellent reference work for all who have a serious interest in VHF and UHF techniques.

Our review copy came direct from the publishers. No details are available as to the local price or availability but similar publications in the past have generally been available from the larger Australian bookshops. This one should be available by the time this review appears. (I.L.P.)

reader is led progressively through the design aspects of bipolar transistors themselves, amplifiers, oscillators, detectors, mixers, switching circuits, pulse and sawtooth generators, and miscellaneous circuits. An expanded section then deals with field-effect transistors (FETs), uni-junctions (UJTs) and thyristors. The book concludes with appendices covering transistor fabrication, transistor parameter systems, stability of tuned amplifiers, and the binary number system, and an index.

As with the previous editions the text of the book is written in a concise and readable style, and is well illustrated with circuit examples and diagrams. It should accordingly be found of considerable interest and value by all seeking an up-to-date, clear and essentially practical introduction to semiconductor circuit operation and design.

The review copy came direct from the publisher, and no information was supplied regarding local price and availability. However it is likely that supplies will be available in local bookstores by the time this review appears. (J.R.)

Tape recorder

ADVICE ON BUYING A TAPE RECORDER, by J. F. Ling. Published by Tape Recording Magazine, Prestige House, 14-18 Holborn, London E.C.1. Card covers, 35 pages, size 7½ x 5in. No illustrations. Price in Australia 75c post free.

Intended to assist the potential tape recordist about to purchase his first tape

recorder, this book attempts to explain the features he should look for, including those which are desirable and those which are not. Reference is also made to the points which have to be considered when the recorder may be required to operate with existing equipment, and the circumstances in which it will be used, such as mainly outdoors or mainly indoors. In general, these points are reasonably well covered, if rather sketchily, and I do not doubt that a complete beginner would obtain some useful advice from a perusal of the book. However, in detail, the text leaves much to be desired.

The technical qualifications Mr Ling brings to his task are not stated, but judging from this text they may not be very extensive. Some of the statements are likely to confuse the beginner, some are misleading, and some are downright errors. The following examples have been selected at random: On the relative advantages and disadvantages of tape and disc: "Tape is not liable to wear" and "Tape can be used over and over again." This is only partly true, since deterioration will eventually result in inferior recordings.

On matching of exterior equipment to the recorder: "It is necessary to know the sensitivity of the OUTPUT of your equipment and the sensitivity of the input of the recorder." Apparently, to Mr Ling's mind, signal levels and sensitivity are one and the same thing.

RADIO ENTHUSIASTS

Learn amateur radio in your spare time.

Whatever your interests are in amateur radio, there's a Stott Radio course for you. Easy to follow.

Practical. Modern. Guidance all the way by top-flight radio engineers.

Radio for amateurs

Learn the exciting skills of building modern radio receivers. Learn about the latest advances in electronics, design, construction and operation.

Let Stott's show you how.

Amateur Operator's Certificate Course:

Broadcasting is fascinating. Stott's offer an entirely new course that enables you to sit for the Amateur Operator's Certificate of Proficiency Examinations with complete confidence.

Get full details now on Stott's Radio Courses.

POST THIS COUPON TODAY

Stotts 

TECHNICAL CORRESPONDENCE COLLEGE

159 Flinders La, Melbourne. 383 George St, Sydney
290 Adelaide St, Brisbane. 45 Gilles St, Adelaide.
1130 Hay St, Perth.

Please send me, free and without obligation, full particulars of your courses in Radio for Amateurs.

Mr Mrs Miss.....

Address.....

..... Age.....

No sales representative will call

EA369

NEW RH (Radio House) RANGE OF MULTIMETERS

Model RH-80 \$18.00 Postage 50c



20,000 Ohms per Volt DC
10,000 Ohms per Volt AC

Specifications:
DC Volts. 0.5, 2.5, 10, 50, 250, 500, 1000 V
AC Volts. 10, 50, 250, 500, 1000 V
DC Current: 50uA, 5mA, 50 mA, 500 mA
Resistance. 5 kΩ, 50kΩ, 500kΩ, 5 MegΩ
Decibels. -10 + 62 lb
Accuracy. DC ±3%, AC ±4% (of full scale)
Batteries. Two 1.5V dry cells. Size AA, "Eveready" 915
● Overload-protected by dual silicon diodes. ● Mirror scale. ● Double-jewelled ±2% meter. ● ±1% temperature-stabilized film resistors.

Model RH-50 \$31.00 Postage \$1.00



Modern Design. 33 Micro-Amp Meter.
300,000 Ohms per Volt D.C.
13,000 Ohms per Volt A.C.

SPECIFICATIONS

DC VOLTAGES 0-0.25-1-2.5-10-25-100-250-500-1,000 at 30,000 ohms per volt.
AC VOLTAGES: 0-2.5-10-25-100 - 250 - 500 - 1,000V at 15,000 ohms per volt.
DC CURRENTS: 0-0.5-5-50-500 mA, 0-12 A.
Resistance: 0-60K - 6M - 60M (350, 35K, 350K at mid-scale).
Decibels: Minus 20 to plus 56dB (0 dB equals 1mW 600 ohms).
Audio Out: Capacitor in series with AC Volt ranges.
Short Test: Internal buzzer.
With leather case \$38.00.
Accessory: 1 pr. heavy test leads.



\$19.95

BOOK TYPE

MINI-TORCH

With fob keyring, attractive gold finish case. Simply squeeze. Illuminates car and house locks. \$4 posted anywhere.

The latest model portable Tape-recorder. 4 transistor, 3in reels, 2 trays. Instruction manual. Size 10½in x 7in x 1½in. Just open the book and record. Supplied complete with tape, microphone and batteries. Special discount price, \$19.95 posted anywhere.

Model RH-20 \$15.00 Postage 50c



20,000 Ohms per Volt DC
10,000 Ohms per Volt AC

Specifications:
DC Volts: 0.25, 2.5, 10, 50, 250, 1000 (20,000/V)
AC Volts: 10, 50, 250, 500, 1000 (10,000/V)
DC Current. 50 uA, 25mA, 250mA
Resistance. 7kΩ, 700kΩ, 7MΩ
Decibels. -10 +22 (at AC/10V) +20 +36 (at AC/50V). Upper frequency limit 7kc.
Accuracy. DC ±3%, AC ±4% (of full scale)
Batteries: Two 1.5V dry cells. Size AA, "Eveready" 915
● Overload-protected by dual silicon diodes.
● Double - jewelled ±2% meter. ● ±1% temperature-stabilized film resistors.

Model RH-55 \$20.00 Postage 50c



30,000 Ohms per Volt DC
14,000 Ohms per Volt AC

SPECIFICATIONS:
*DC Volts: 0.6, 3V, 12V, 60V, 300V, 1200V (30,000 ohms/V).
*AC Volts: 12V, 60V, 300V, 1200V (14,000 ohms/V).
*DC Current: 60 A, 12mA, 300mA.
*Resistance: 10K ohm, 1Meg ohm, 10Meg ohm.
*Decibels: -10 db +23 db.
*Meter Sensitivity: 23 A.
● Overload-protected by dual silicon diodes. ● Mirror scale. ● Double-jewelled ±2% meter. ● ±1% temperature-stabilized film resistors.

Model RH-60 \$25.00 Postage 50c



50,000 Ohms per Volt DC
10,000 Ohms per Volt AC

Specifications:
DC Volts: 0.25, 2.5, 10, 50, 250, 500, 1000 V
AC Volts. 10, 50, 250, 500, 1000 V
DC Current. 25 uA, 5 mA, 50 mA, 500 mA
Resistance: 10 kΩ, 100 kΩ, 1 MegΩ, 10 MegΩ
Decibels. -10 +62 db
Accuracy: DC ±3%, AC ±4% (of full scale)
Batteries. Two 1.5 V dry cells. Size AA, "Eveready" 915
● Overload-protected by dual silicon diodes. ● Mirror scale. ● Double-jewelled ±2% meter. ● ±1% temperature-stabilized film resistors.

NOTICE

Our branch shop at No. 6 Royal Arcade will be closed down during rebuilding as from 30th December, 1969.
Enquiries at head office 306-308 Pitt St. 26-2817.

RADIO HOUSE PTY. LTD.

306-308 PITT STREET: 6 ROYAL ARCADE & 760 GEORGE STREET, SYDNEY

REFERENCE DATA FOR RADIO ENGINEERS

. . . highly recommended

REFERENCE DATA FOR RADIO ENGINEERS, Fifth Edition. Published by Howard W. Sams and Co. Inc., New York. High quality binding, a volume two inches thick. Pages not sequentially numbered, 9½ x 6½ inches, tightly packed with text, tables, curves diagrams. Australian price \$25.

In scientific, engineering, tutorial and editorial situations, there is a recurring need to refer often to an ever-growing mass of data. Most people so involved are familiar with the situation where a certain piece of information is required urgently; the individual can remember having seen it somewhere —but where in that array of possible reference texts?

If any book is likely to provide a ready way out of this familiar dilemma, I'd say it would be this one.

Back in 1942, W. L. McPherson, of Standard Telephones and Cables Limited, put together a 60-page brochure containing data most frequently needed by radio engineers of the day. Such was its acceptance that it was reprinted in the U.S.A. by the parent company, the International Telephone and Telegraph Corporation. Further editions followed in 1946, 1949 and 1950, each larger than the one before. This fifth edition, published by the Howard Sams organisation, an I.T.T. subsidiary, is 50 per cent larger again than volume 4.

Since the pages are not numbered sequentially, it would involve a long arithmetical sum to determine the total number of pages. Its size is indicated by the thickness, however, and by the fact that it contains 46 sections involving from 15 to 50 pages each.

To list all the sections fully, would involve a great deal of space and the patience to read them. Broadly, however, they cover frequency, time and telecommunication data; units, constants and properties of materials; filters, networks, attenuators; amplifiers and feedback; valves, transistors and their circuitry; waveguides, antennas, propagation; radar, computers, nav aids; space, electroacoustics, nucleonics, quantum electronics; information theory, probability, reliability; Fourier, Maxwell's equations, tables; an extensive index.

By way of example, a closer look at the sections on frequency and time revealed a complete breakdown of the total frequency spectrum, the terms allotted to certain portions of the spectrum, identification of the radar bands, and allocation of frequencies within the U.S. Detailed information followed on time signals and time standards throughout the world. In the telecommunication section there is a wealth of data on call signs, abbreviations, conventions, etc.

A further and closer look at the section on recording revealed electrical and dimensional data on discs, tapes and sound films, more specific and more detailed than in most audio texts. Included are figures on such things as wow and flutter for both recording and playback. In this same general area are data on broadcasting, AM, FM and television, including videotaping standards.

So it goes on from section to section, a mass of reference data, logically grouped, clearly presented and ready of access by reason of a section index in the front and a word index at the rear. No wonder the publisher excuses his inability to credit all the authors, or all those inside and outside the I.T.T. organisation that contributed to the finished work.

This is one of the largest and possibly one of the most expensive books we have reviewed in these pages to date but, all things considered, it is probably the most useful. My tip is that it will become the book most frequently referred to in the "Electronics Australia" library.

For all situations requiring convenient access to data pertinent to radio — sorry electronics — engineering, this book is highly recommended. Our review copy came from Grenville Publishing Co. Pty. Ltd., 401 Pitt St, Sydney, 2000. (W.N.W.)

On decibels: "The decibel expresses the relationship between the intensity of one sound and that of another at the same frequency." Anybody taking Mr Ling's definition seriously would find it very hard to understand a frequency response curve covering the full audio range

Statements like this limit the usefulness of the text and although, as previously stated, the complete beginner will benefit from some of the advice given, I would recommend paying a little more for something more comprehensive and accurate, such as "The Tape Recorder" available in the Philips Paperbacks series.

Our review copy was supplied by B. T. Lovett, 5 Glover Street, Willoughby, N.S.W. 2068. (H.A.T.)

Tape recording

INTRODUCTION TO THE TAPE RECORDER, by Charles Langton, A.M.Brit.I.R.E. Published by Tape Recording Magazine, London. Paper cover, 24 pages, size 7½ x 5in. Illustrated with line drawings and circuit diagrams. Price in Australia 75c post free.

This modest little book is uniform with the "Advice on Buying" book reviewed elsewhere in this issue, and is similar in intention, being intended for the complete beginner. It must, therefore, be regarded in this light, and although in another context some of the statements could poss-

PLAN YOUR FUTURE

CHOOSE a career in the field of ELECTRONICS* — the Nation's most progressive and fastest expanding industry.



Advancement in this modern science demands technical ability, a sound knowledge of basic principles and applications.

YOU can master the subject by training at the MARCONI SCHOOL and be ready to grasp the opportunities that occur in the three fundamental branches of Radio-technology.

KNOW WHERE YOU'RE GOING

A = APPLIED SERVICING

Comprehensive training in the maintenance and repair of radio and television receivers offers substantial rewards to competent technicians. Marconi School training covers all aspects of radio and television receiver circuit applications, practical exercises in fault finding and alignment procedures.

B = BROADCASTING

A thorough and practical grounding is available to students in broadcasting transmitter performance standards and maintenance techniques, with individual instruction in station operation and studio control and testing.

C = COMMUNICATIONS

Combines all the foregoing, together with radio aids to navigation, mobile telephony, marine service application and international wireless telegraph regulations, qualifying the successful student for the Commonwealth Government Certificate of Proficiency and the Marconi School Diploma in Radiotechnology.

Classes are conducted at 21 Pier Street, Sydney (at the foot of Goulburn Street).

Daily: 9.30 a.m. to 4.30 p.m.

Evenings: 6 p.m. to 8.30 p.m.

or by Home-Study Courses (except practical instruction on equipment).

STUDY NOW

Send for training syllabus. There is no obligation.

NAME.....
ADDRESS.....

the MARCONI SCHOOL of
wireless

G.P.O. Box 2516, Sydney

A Service of Amalgamated Wireless (Australia) Ltd.

INDUSTRY IS CLAMOURING FOR ELECTRONICS ENGINEERS

Train now to go straight to the top

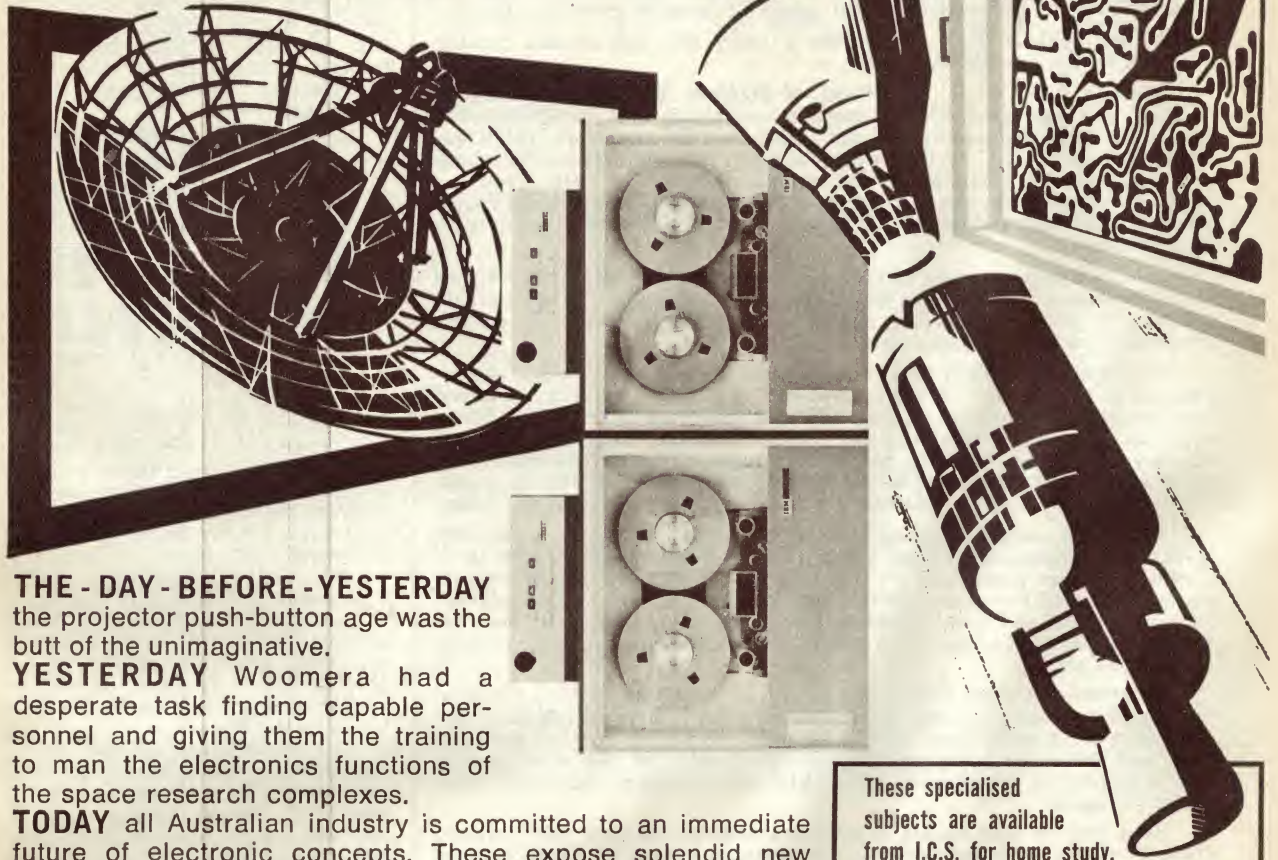

THE - DAY - BEFORE - YESTERDAY the projector push-button age was the butt of the unimaginative.

YESTERDAY Woomera had a desperate task finding capable personnel and giving them the training to man the electronics functions of the space research complexes.

TODAY all Australian industry is committed to an immediate future of electronic concepts. These expose splendid new frontiers of production, of work output in commerce, of living standards. The lack of skilled personnel alone could retard this progression into a totally new world. Eventually the lack will and *must* be overcome. Meantime, Australia will search desperately about the world for the people with electronic skills. Already there is a dearth of them in Australia, *and overseas!* Trained Australians can choose their workplace from the whole world. If you train now with I.C.S., you will be rewarded well. You will reach the top of your profession while many thousands are just beginning to train.

Make your decision for success now!

These specialised subjects are available from I.C.S. for home study.

- | | |
|--|---|
| <input type="checkbox"/> Audio: Hi-Fi, Stereo | <input type="checkbox"/> Monochrome and Colour TV |
| <input type="checkbox"/> Automation Electronics | <input type="checkbox"/> Electronic Drafting |
| <input type="checkbox"/> Automatic Controls | <input type="checkbox"/> Printed Circuits, Conventional |
| <input type="checkbox"/> Industrial Applications | <input type="checkbox"/> Printed Circuits, Micro Integrated |
| <input type="checkbox"/> Nuclear Instrumentation | <input type="checkbox"/> Fringe Equipment |
| <input type="checkbox"/> Digital Techniques | Also Computer Programming for Commerce, Research, Industry. |
| <input type="checkbox"/> Transistors & Semi-Conductors | |
| <input type="checkbox"/> Communications | |

Read the **FREE I.C.S. Illustrated Prospectus**

Send Coupon today!

International Correspondence Schools,
Dpt. 527, Division of Electronics,
400 Pacific Highway, Crows Nest, N.S.W. 2065.
Branches in all States and New Zealand.



Please send me **FREE** Prospectus about.....

Name..... Age.....
(Please print)

Address.....

State.....

Postcode..... Phone..... Dpt. 527

ibly be better expressed, this is undoubtedly brought about by the desire of the author to simplify the explanations to the greatest possible degree.

Within the limited space at his disposal, the author has covered the ground reasonably well. There are eight chapters, entitled:

1 General Principles; 2 Amplifiers; 3 Record/Playback Heads; 4 Erasing; 5 Microphones; 6 Loudspeakers; 7 Ancillary Equipment; 8 Choosing the Tape.

Some of the material is inclined to be too technical for the beginner, but the foreword says that the book is also intended to assist technicians and radio service apprentices. However, service personnel will probably find the material too superficial to be of any great value. In any case, the circuits shown are all valve types, whereas solid state circuits are now the rule rather than the exception in tape recorders.

In summary, then, a book which the beginner will find informative and helpful, even if in the process he may gain a few wrong impressions through oversimplification. Those who subsequently adopt tape recording as a serious hobby will in any case be following up the subject in more comprehensive books where the material will be explained at a higher level.

Our review copy came from B. T. Lovett, 5 Glover Street, Willoughby, N.S.W., 2068. (H.A.T)

Servicing with a CRO

TROUBLE SHOOTING WITH THE OSCILLOSCOPE. By Robert L. Goodman. Published by TAB Books, Blue Ridge Summit Pa. 17214, U.S.A. Paper covers. 250 pages, 8½ x 5½, illustrated by circuits, photographs, block diagrams, C.R.O. patterns. Australian price \$6.15 paper cover, \$9.95 hard covers.

The author of this book is obviously a dedicated believer in the CRO as a service instrument. In particular, he believes that the triggered CRO and the dual beam CRO represent the ultimate forms of this instrument at the present time, and that these two forms overcome most of the limitations which have discouraged service technicians from making full use of the CRO as a service instrument in the past. To a large extent, therefore, this book is based on the use of the instrument in one or both of these forms.

There are 11 chapters in all. Chapter 1 poses, and answers, the question, Why Use a Triggered Scope? In doing so it explains what a triggered scope is and does.

Chapter 2 discusses DC coupled deflection systems and dual beam instruments, describes the circuitry, the special CRO tubes involved, and talks about the advantages of these systems over the older and more conventional arrangements.

Chapter 3 is headed, Oscilloscope Control Adjustments. It might equally have been headed, How To Drive Your CRO, for this is really what it amounts to. It is illustrated with front panel diagrams of typical commercial instruments, such as Hewlett-Packard, Tektronix, and Heathkit. It takes each of the features of such instruments and discusses them in detail as well as dealing with such broader subjects as, time/cm to frequency correlation, various types of probes and how to use them.

Chapter 4 is headed Looking Behind the Front Panel. It deals with the circuitry and functioning of CRO and ranges from time base circuits, CRT phosphors, to practical gratitudes.

Chapter 5. Interpreting Waveform Displays. This heading is almost self-explanatory. The author deals with frequency response, transient response, rise time, bandwidth, voltage measurement, and square-wave interpretation, to name some of the subjects.

Chapter 6 moves from what might be termed the theory to the practical. It is

titled Stereo Amplifier and Multiplex FM Trouble-shooting. Fairly obviously, the multiplex FM will be of only academic interest to Australian readers, but the section on stereo amplifiers will be more to the point. Unfortunately, this section is small, but it is valuable in that it concentrated on the "complimentary symmetry" configuration so frequently used in solid state amplifiers.

Most of the remaining chapters are devoted to TV and colour TV servicing. They are titled as follows: Chapter 7; Making Solid State TV Servicing Easier. Chapter 8; Solid State Pulse Testing Techniques. Chapter 9; Alignment and TV Remote Control. Chapter 10; Trouble-shooting the Colour Receiver. Chapter 11; Scoping the Electronic Power Supply. This is followed by a useful glossary of electronic terms.

As with many overseas books, this one suffers from the disadvantage that most of the "typical" circuits are related to equipment on the local market; in this case the U.S.A. This leaves the Australian reader with the problem of deciding how typical these circuits are relative to the local scene.

However, having said this, one can only commend the book in all other respects. Granted, the references to colour TV are not appropriate at the moment, and may not assume their full value until the reader has a colour TV chassis in front of him, but it would not be too early for TV servicemen to at least make a preliminary survey of what is likely to be involved.

Later, when practical exercises are feasible, the full meaning and value of the texts will become apparent.

The book appears to be well written and the author has a cheerful style which, at the same time, is not "smart" in the objectionable sense.

In summary: Well worth considering. Our copy from Grenville Publishing Co. Pty. Ltd., Australian agents for TAB Books, who advise that there are good stocks on hand and that copies should be readily available from all major book-stalls. (P.G.W.).

LITERATURE—in brief

NEW TECHNOLOGY, No. 30, July, 1969. Published by the British Ministry of Technology and Central Office of Information. Obtainable free on application to the Central Office of Information, Hercules Road, Westminster Bridge Road, London, SE1, England. Contents: The Superconductivity Project; Harwell's Post-Grad Education Centre; FR5 and Peppers Work Together for Cheaper, Lighter Explosion-Proofing; Explosion-Proofing with Flame Arresters; News; Statistical Indicators. Also with this issue is a 4-page metrication supplement, contents: The Functions of the Metrication Board; Metrication Board Members and Terms of Reference; Implementation in Industry; Metric Units in Industry; Government Departments; Some Information Aids.

BERNARDS FAMOUS RADIO AND TELEVISION BOOKS

HI-FI, TUBES, RADIO VALVES, TRANSISTORS, ELECTRONICS

No.	TITLE	PRICE	No.	TITLE	PRICE
56	Radio Aerial Handbook	.45	174	Practical Subminiature Receivers	.85
57	Ultra-Shortwave Handbook	.45	175	Transistor Test Equipment and Servicing Manual	.80
58	Radio Hints Manual	.45	176	Manual of Transistor Audio Amplifiers	1.00
64	Sound Equipment Manual	.45	177	Modern Transistor Circuits for Beginners	1.30
68	Freq. Modulation Receivers Manual	.45	178	Comprehensive Radio Valve No. 5	1.00
83	Radio Instruments and Construction	.45	179	Transistor Circuits Manual No. 5	.85
96	Crystal Set Construction	.20	180	British Semiconductor Survey	2.50
100	Comprehensive Radio Valve No. 1	.85	181	22 Tested Circuits Using MAT's	.85
103	Master Colour Code Index	.25	183	How to Receive Foreign TV Programmes by Simple Modifications	.85
104	Three Valve Receivers	.25	184	Tested Transistor Circuits Handbook Using Professional Printed Circuit Modules	.60
121	Comprehensive Radio Valve No. 2	.85	185	Tested Shortwave Receiver Circuits Using M.A. Transistors	.85
123	Beginners' Push-Pull Amplifier	.25	186	Tested Superhet Circuits for Shortwave and Communication Receivers using MAT's	1.00
126	The Boys' Book of Crystal Sets and Simple Circuits	.55	187	The TSL Mark-4 Valved F.M. Tuner and its Construction	.60
129	Universal Gram-motor Speed Ind.	.20	188	Construction of the B.H. Hi-Fi 14-Watt Audio Amplifier	.25
135	All Dry Battery Portable Constn.	.45	190	How To Build the World's Smallest Hi-Fi Amplifier (4 Transistors)	.25
138	How to Make F.M. and TV Aerials Bands 1, 2 and 3	.50	191	Practical Car Radio Handbook	1.00
141	Radio Servicing for Amateurs	.60	192	How to Build the Sinclair X-10	.25
143	Comprehensive Radio Valve No. 3	.85	193	'At a Glance' Radio Valve and TV Tube Equivalents and Substitution Manual	1.00
146	Hi-Fi Loud Speaker Enclosures	.85	194	How to Build 11 Tested Circuits using specially designed TSL Relays and Light Cells, practical working wonder gadgets for use in Car, Home, Nursery, Kitchen and Workshop. Burglar Alarms, Rain Detectors, Life Savers, Car and Engine Alarm, etc., etc.	.25
147	Practical Tape-Recording Handbook	.85	501	ABC's of Magnetism	.25
148	Practical Transistor Receivers	.85	502	ABC's of Missile Guidance	.85
149	Practical Stereo Handbook	.60	503	ABC's of Ultrasonics	.85
150	Practical Radio Inside Out	.80		Resistor Colour Code Calculators	.25
151	Transistor Test Receivers	.85		Engineer's Reference Tables	.25
156	Transistor Circuits Manual No. 1	1.30			
157	Comprehensive Radio Valve No. 4	.85			
158	Radio, TV, Industrial Tubes, Semi-Conductors and Diodes Equivalent Handbook	1.80			
160	Coil Design and Constn. Manual	.85			
161	Radio, TV and Electronics Data Book	.60			
162	Hi-Fi Stereo Gramophone for Home Constructor	.85			
163	Transistor Circuits Manual No. 2	.45			
165	Radio Tuners—Hartley on Hi-Fi	.85			
168	Transistor Circuits Manual No. 4	.45			
170	Transistor Circuits for Radio-Controlled Models	.45			
171	Super-Sensitive Trans. Pocket Radio	1.30			
172	International Radio Stations List	.45			
173	Practical Transistor Audio Amplifiers	.60			

ADDITIONAL BOOKS RECOMMENDED FOR BEGINNERS, STUDENTS AND HOBBYISTS.

BASIC ELECTRONICS by van Valkenburgh, Nooger & Neville, Inc. Expanded Course.. Volumes 1 through 6, bound in one large volume. Published by Rider. Price \$17.00.
INTERNATIONAL TUBE & TRANSISTOR HANDBOOK by De Mulderkring (10 Languages). Volume 1 Valves & Tubes, \$5.50; Volume 2 Semi-Conductors, \$4.00.
 An authoritative and most outstanding work. 2 volumes bound in plastic covers.
GLENN'S AUTO REPAIR MANUAL, 1964 Edition, 1,232 pages.
 Exploded diagrams on practically every page. Normal selling price \$17.00. now offered for \$9.50.

YOUNG PEOPLE'S SCIENCE ENCYCLOPEDIA, 20 volumes with two complementary volumes entitled Science Dictionary and New Frontiers in Science, 22 volumes for only \$49.50. This outstanding work is strongly recommended by leading Educational authorities, and has been approved for subsidy to State schools and is an inspiring work for young students and adults.

POSTAGE TO BE ADDED TO ABOVE PRICES. TERMS AVAILABLE BY NEGOTIATION. SPECIAL DISCOUNTS TO BOOKSELLERS AND INSTITUTIONS.

DESCRIPTIVE CATALOGUE AVAILABLE UPON REQUEST.
 Sole Australian Distributors
BERNARDS RADIO BOOKS AND SUPPLIES
 3 Kerferd Street, East Malvern, Vic, 3145. Telephone 50-5225
 Also Branch Office: 51 Station Street, Malvern, Vic. (opp. Malvern Station)

SONY-O-MATIC TC-210

Take Everywhere!



Tape Everywhere!

SONY-O-MATIC TC-210 FEATURES

This new take everywhere . . . tape everywhere model is a dual track, dual speed, solid-state tape recorder for quality recording and reproduction. Refined styling with an elegant two-tone panel of black and silver make it a pleasure to use for home, business, on-the-spot recording, etc.

The SONY-O-MATIC system automatically adjusts the incoming signal to optimum recording level without any manual control . . . may be used by the 'inexperienced' with assured results.

This take everywhere . . . tape everywhere recorder is a ready-to-go portable—battery operated, lightweight, built-in carrying handle, full 5-inch tape reel capacity with lid closed, SONY-O-MATIC TC-210 will expand your enjoyment in tape recording.

Take everywhere . . . tape everywhere operates also on A.C. house current without external adaptor unit.

Remote control operation is provided by a convenient start/stop switch on the cardioid dynamic microphone. Take everywhere . . . tape everywhere . . . with the new, easy-to-operate SONY-O-MATIC TC-210.

SPECIFICATIONS

Recording System: 2-track monaural. Power Requirements: D.C.: 6 V. A.C.: 110, 120, 220 & 240 V., 50/60 Hz. Reels: 5" or smaller. Tape Speeds: 3 $\frac{3}{4}$ i.p.s., 1 $\frac{1}{2}$ i.p.s. Recording Time: 1.5 hours in total at 3 $\frac{3}{4}$ i.p.s. (with 900' tape, 3 hours in total at 1 $\frac{1}{2}$ i.p.s.). Frequency Response: 100-7,500 Hz. at 3 $\frac{3}{4}$ i.p.s. Bias Frequency: Approx. 32 kHz. Power Output: 1 watt. Inputs: Microphone (1) Sensitivity: 0.195 mV. Impedance: 400 ohms. Line (1) Sensitivity: 0.0615 V. impedance Approx. 150 kohms. Outputs: Monitor (1) Standard output level 0.775 V. (load impedance 100 kohms). Motor: D-006G. Speaker: 3 $\frac{1}{2}$ " x 6 $\frac{1}{2}$ " PM dynamic. Transistors: 7. Diodes: 5. Power Consumption: A.C. 5.4 W. Battery Life: 10 hours in continuous recording (with supplied batteries). Dimensions: 11 $\frac{1}{2}$ " (W) x 4 $\frac{3}{4}$ " (H) x 11 $\frac{1}{2}$ " (D). Weight: 8 lbs. 13 oz. without batteries. Standard Accessories: Microphone (F-25S), 5" demonstration tape, 5" empty reel, head cleaning ribbon, super batteries, power supply cord (DK-16). Optional Accessories: Battery pack (BP-8), telephone pick-up (TP-4S), earphone (ME-20 or CE-3), microphone mixer (MX-600M), foot switch (FS-5), microphone extension cord (EC-5R), carrying case (LC-2).

Also available
SONY-O-MATIC
TC-505

TAKE EVERYWHERE



TAPE EVERYWHERE

FEATURES

- **Auto tape reverse**
- Accurate servo-controlled tape speed
- Automatic record level
- A.C./D.C. operation
- Simple and convenient take everywhere . . . tape everywhere operation.

SONY®

Distributed by:

Jacoby, Mitchell & Co. Pty. Ltd.

469-475 Kent Street, Sydney. 26 2651

Melbourne
30 2491/2

Adelaide
53 6117

Brisbane
2 6467

To: Jacoby, Mitchell & Co. Pty. Ltd., 469-475 Kent Street, Sydney, 2000.

Please send me information on Sony Tape Recorders and nearest Sony retailer.

NAME

ADDRESS

JMS/3-69/EA969

MOBARK INSTRUMENTS CORP., 1273 Terra Bella Avenue, Mountain View, Calif. 94040, U.S.A. A 4-page brochure describes the company's new low-cost digital incremental magnetic tape recorders which accept parallel or serial data, and achieve a high uniform packing density by means of a patented optical synchronisation system. Available in a number of configurations for data logging and terminals, billing, and inventory controls, the instrument uses commercially available 1/8in tape cassettes, each containing 280 feet of tape.

TECHNICAL NEWS BULLETIN, Vol. 53, No. 5; May 1969. Published by the U.S. National Bureau of Standards. Inquiries to Superintendent of Documents, U.S. Government Printing Office, Washington, D.C. 20402, U.S.A. Contents: Improved dental splinting material; Magnetic dipole transitions in cyanide radical; Ultrasonic determination of liquid equation of state; Compensation technique measures noise generator power; Data obtained on electron energy losses; Outdoor performance of plastics; Reference program on paper testing; Ultrapure aluminium produced; Standards and calibration; International standard reference zero for audiometers; NSRDS news; Standard reference materials; FIPS notes; Conference and publication briefs; Publications of the NBS.

TELECOMMUNICATION JOURNAL, Vol. 36, No. 7, July, 1969. Published by the Publications Service, International Telecommunication Union (ITU), Place de Nations, 1211 Geneva 20, Switzerland. Contents include: "Economic factors influencing the break-even relations between satellite and terrestrial point-to-point communication" by S. G. Lutz; "The development of fully filled cables for the telephone distribution network" by N. S. Dean; "Reflections on the plan for development of telecommunication networks in Latin America on the eve of the fourth Latin America Plan meeting," by M. Malek-Asghar.

Enclosed in this issue is a 36-page illustrated brochure "The Eighth Report by the ITU on Telecommunication and the peaceful Uses of Outer Space" which contains information on progress made in space radiocommunications by the permanent organs of the Union and 33 of its member countries. In the feature "Union Activities" reports are given of the last session of the Administrative Council and recent C.C.I.T.T. meetings. There is some information on World Telecommunication Day and ITU participation in the 28th Paris Air Show. Under "Ideas and Achievements" information is given on: 50 years of co-operation between the Nordic countries in the field of telecommunications (1917-67); Improved television reception — antenna measurement by helicopter; The Tunisian telecommunication program for 1969.

RECORDING DIGITAL MEASUREMENTS, WITH THE HP 2547A COUPLER, Hewlett-Packard Application Note 113, 24 pages. Inquiries on company letterhead to Hewlett-Packard Australia Pty. Ltd., 22-26 Weir Street, Glen Iris, Vic. 3146. The note describes techniques for recording measurements from digital voltmeters, counters, nuclear scalars, etc. on computer compatible input media. Also described are techniques for easy entry of data through local time-sharing terminals that employ the BASIC language. The note presents 15 applications of the 2547A Coupler with single instruments, multiple instruments, and data acquisition systems.

INSTRUMENTATION TECHNIQUES SA 10A. Published by the Singer Co. of the U.S.A. A background to communications and communication systems is given in the introduction. The brochure contains comprehensive information on the applications of high resolution spectrum analyser systems. General informa-

tion is given on the cause and effect of signal distortion, human engineering factors (describing the desirability of reducing operator control to a minimum), and analyser requirements for communications applications. The specifications of two analysers by the Singer Co., models SSB-50-1 and SSB-50, are described in full with their respective capacities and performance qualities.

NATO AND SERVICES REFERENCE NUMBERS RELATING TO BELLING-LEE PRODUCTS. Available from Belling & Lee (Australia) Pty. Ltd., Canterbury Road, Kilsyth, Vic. 3137. Contains two tables relating the Belling-Lee catalogue numbers and service reference numbers with descriptions. The first table lists the items in alphabetical order by description, while the second lists them by NATO catalogue order.

GELOSO S.P.A., Milan, Italy, has published two catalogues. Inquiries to the Australian distributors, R. H. Cunningham Pty. Ltd., 608 Collins Street, Melbourne. 3000.

Geloso Microphones. A 16-page catalogue describing the company's range of dynamic and crystal microphones, wireless microphones, accessories and dynamic headsets.

Professional Sets and Accessories. Describes the range of Geloso sound equipment for professional users. Include: complete amplification systems; amplifiers; sound control centres; megaphones; intercoms; turntables; loudspeakers; sound lamps; sound columns; reflex trumpets; microphones; mixers; tape recorders, etc.

ACOUSTICS HANDBOOK, Hewlett-Packard Application Note 100, 120 pages. Available only to engineers and scientists concerned with electro-acoustics. Applications on company or departmental letterhead to Hewlett-Packard Australia Pty. Ltd., 22-26 Weir Street, Glen Iris, Vic. 3146. Almost half of this handbook is devoted to the nature of sound, the character of human response to sound, and modern theories about measuring it. The remainder is concerned with instrumentation, from microphones and automatic data collection to data processing with computerised instrument systems.

THE ELECTRIC INDUSTRIAL TRUCK, 1969 edition (completely revised and expanded), 52 pages. Inquiries on company letterhead to Australian Lead Development Association, 95 Collins Street, Melbourne. 3000. All the features of earlier editions are included and updated with provision for calculation of operating costs for various types of industrial trucks in a given plant. Comparative cost analyses for fork lift trucks over eight years are now provided, and discounted cash flows for typical examples over eight years are also given. Useful sections on calculations of required battery capacity for an electric lift truck to perform a given duty and maintenance of lead traction batteries are included. Every basic type of electric industrial truck is described and their capabilities are detailed. 57 photographs and 23 tables and diagrams are included.

SINGER INSTRUMENTATION REVIEW. Published by the Singer Co. of the U.S.A. Available from Distributors Corporation Pty. Ltd., 24 Johnston Street, Fitzroy, Vic. 3065. Describes the performance limitations found in microwave and high-resolution spectrum analysers, discusses the reasons why erroneous responses occur, and then suggests the causes behind them. Analysis and graph charts relevant to the data on the various pages are included. A two-page feature discusses the growing importance of frequency test and measurement instrumentation. The Review outlines the specifications of a new wideband interference-free microwave spectrum analyser recently developed by the company.

★ PRACTICAL NIGHT CLASS TRAINING for Careers in Radio, T.V. & Electronics

Trained technicians are wanted urgently. It's in your hands to train NOW for a successful future. A.R.T.C. Practical Night Classes (established nearly 40 years) provide individual practical workshop training.

- Commence at any time.
- No previous knowledge required.
- Proceed at your own pace.
- Modern technical electronic training.
- New Australians welcome, the COURSE is specially simplified.
- Low in cost and you pay for the COURSE not the time taken.

College open for enquiries Monday-Friday 9 a.m. to 5 p.m. and until 7 p.m. on Monday and Thursday nights.



POST COUPON FOR FREE BOOK

Careers in Radio, T.V. & Electronics

Name

Address

AUSTRALIAN RADIO & TELEVISION COLLEGE Pty Ltd
E.S. & A. Bank Building, cnr.
Broadway & City Rd.,
BROADWAY (opp. Grace Bros.)
Phone: 211-4224

TELECON, MOST POWERFUL, VERSATILE

5 watt C.B. Transceiver

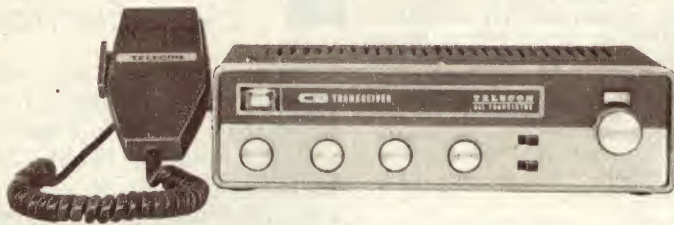

\$168.55
INC. TAX
Telecon TMC-703A

P.M.G. approved

Features: 12 and 240 volt operation, tuneable or crystal locked receiver, 19 transistors and 10 diodes, .5 micro volt sensitivity, 3.5 watts r.f. output, public address and external speaker facility, 3 transistor voltage regulator, 6 month warranty.

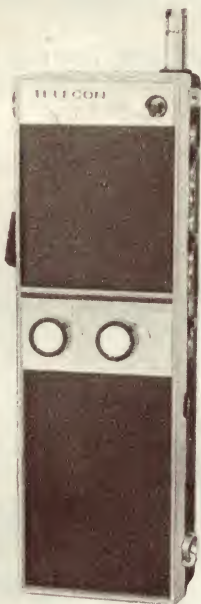

TELECON
1 watt, 214 A
\$99.95
inc. tax

- Battery Meter
- Squelch, noise limiter
- Rugged metal case
- Sold to 50 Govt. Depts.
- Ext. Power, antenna, speaker, mike jacks

P.M.G. approved

TELECON
.1 watt, 204 A
\$49.95
inc. tax

- Battery meter
- Leather case
- 12 ozs. with battery
- Pocket size
- 1 microvolt sensitivity



P.M.G. approved

ALSO: Base and mobile antennae from \$5, SWR bridges \$12.45, multimeters, bench power supplies, microphones, crystals, spare parts, co-axial cable, fittings.

Australasian Agents:

Strato Communications Pty. Ltd.,
25 WENTWORTH ST., PARRAMATTA, N.S.W. 2150
Telephone 635-9856, 635-5569.

TEDCO PTY. LTD.,
579 Murray St.,
Perth, W.A.

HOME CRAFTS-TAS.,
199 Collins St.,
Hobart, TAS.

FRED HOE & SONS
Block 23, Industries Road,
Salisbury North, Brisbane.
QLD.

RADIO PAGING Pty. Ltd.
20 Collins Street,
Melbourne, VIC.



AMATEUR BAND NEWS AND NOTES

Wireless Institute's Bi-Centenary Award

The Wireless Institute of Australia is planning to commemorate jointly the arrival of Captain Cook in Australia and its own Diamond Jubilee, both anniversaries occurring in 1970.

by Pierce Healy, VK2APQ

To mark the occasion of the 200th anniversary of the discovery of the eastern coast of Australia by Captain James Cook in the year 1770, the Wireless Institute of Australia is issuing a special award to be known as the "Cook Bi-Centenary Award."

This award will be available free to any licensed radio amateur throughout the world who during 1970 makes two-way radio contact with the required number of Australian amateur stations under the rules governing the award.

The year 1970 is also the sixtieth anniversary of the founding of the Wireless Institute of Australia, the oldest amateur radio society in the world. As such it has served the interests of Australian radio amateur operators since 1910.

Special Call Sign

Because of the special significance of the year 1970, the Postmaster-General's Department has given permission for the use of a new prefix by all Australian amateur radio stations from January 1st, 1970 until December 31st, 1970.

At the option of the station operator during this period the "VK" prefix to the call sign may be replaced by the special "AX" prefix.

The use of the prefix is not compulsory, but may be used at the option of the licensee concerned. There are no formalities necessary to enable licensees to use this privilege. Individual licensees will not be notified personally of this privilege.

Special QSL Cards

The Australian Tourist Commission has provided the Wireless Institute of Australia with 100,000 special QSL cards for use by Australian amateur radio operators during the 1970 celebrations.

There are four designs, each a colour photograph of a typical Australian scene. The scenes depicted are: Sydney Harbour, Ayers Rock, the Whitsunday Passage in Queensland, and an action shot of a surf boat.

These cards will be distributed through the divisional councils of the W.I.A. to amateurs in each State for use in acknowledging overseas contacts during 1970. Individual amateurs will be able to have their own call sign printed in the space provided.

Award Rules

Operation: Only Australian amateur stations using the special "AX" prefix

News and notes of Divisional and Club activities submitted for inclusion in these columns should be forwarded direct to Pierce Healy, 69 Taylor St., Bankstown, N.S.W. 2200.

may be worked for the purposes of this award.

Contacts: These may be made on any band or mode available to Australian amateur service. Crossband operation will not be permitted.

No contacts made with ship or aircraft stations in Australian Territories will be eligible, but land mobile or portable stations may be contacted provided the location of the station worked, at the time of the contact, is clearly indicated.

Operators at all times must operate within the terms of their licence.

All contacts must be made during the period January 1st, 1970 to December 31st, 1970, inclusive.

Contestants may work each station once only during this period for the purposes of this award.

Requirements

Overseas applicants: Stations outside Australian territory must contact 50 different Australian amateur stations using the "AX" prefix during the period of the contest.

"AX" applicants: Stations within Australia must contact 100 different Australian amateur stations using the "AX" prefix, working the required number of stations in each call area, as shown, during the period of the contest.

AX1	(VK1)	3 stations
AX2	(VK2)	30 "
AX3	(VK3)	30 "
AX4	(VK4)	11 "
AX5	(VK5)	11 "
AX6	(VK6)	6 "
AX7	(VK7)	4 "
AX8	(VK8)	1 "
AX9	(VK9)	3 "
AX0	(VK0)	1 "

Applications: Stations applying for the Award are NOT to forward QSL cards, but instead should submit a list of stations worked, in order of call signs by call areas, plus the following details of each contact: date, time GMT, band, mode, report.

This list, certified by two other licensed amateurs plus a statement to the effect that they have sighted the log entries of the applicant, should be sent to: Awards Manager, W.I.A., P.O. Box 67, East Melbourne, Vic. 3002, Australia.

Applications should be clearly marked "Cook Award" on the back of the envelope containing the check list, plus the full postal address to which the award is to be sent.

All applications are to be received at the above address no later than December 31, 1971.

No further entries will be accepted after this date.

Certificates will be forwarded free of charge by surface mail. However if air-

mail return is required, eight International Reply Coupons (IRCs) must be included to cover the extra postage costs.

S.N.P. Award

The Students' Radio Club, OK3KFV, has the pleasure to announce the issue of the S.N.P. Award certificate on the occasion of the 25th anniversary of the Slovenske Narodne Povstanie (Slovak National Rise in Arms.)

This certificate is available to all licensed radio amateurs in the world.

Conditions:

1. This certificate requires valid QSOs with radio amateurs in 13 districts of middle-slovak country during the period from July 15 to September 15, 1969.

During QSOs "OK" stations will give their district.

2. The districts are: Banska, Bystrica, Cadea, Dolny Kubin, Liptovsky Mikulas, Lucenec, Martin, Povazska Bystrica, Prievidza, Rimavska Sobota, Velky Krtis, Zvolen, Ziar nad Hronon, Zilina.

3. Points for QSOs with stations in the above districts are:—

Bands	European Stations:	DX Stations:
1.8MHz	3	4
3.5MHz	2	3
7MHz	2	3
14MHz	1	2
21MHz	1	2
28MHz	1	3
VHF	3	10

4. Every radio amateur who obtains 12 points for contacts with radio amateurs of middle-slovak country will be eligible for the S.N.P. Award certificate.

List of amateur radio stations of middle-slovak country — OK3- CU, DT, EO, FQ, HO, IR, IS, IT, JL, JV, KV, KT, LC, LF, MU, OB, PB, RC, RO, SH, SU, SY, UN, WB, WO, YE, YS, AZC, ALA, CAL, CAN, CAO, CBJ, CBU, CCB, CCC, CCG, CCI, CCJ, CCX, CCY, CDA, CDM, CDO, CDP, CDZ, CEH, CEN, CEP, CEV, CEX, CFD, CFF, CFI, CFM, CDV, CFW, CFX, CGA, CGB, CGH, CGN, CGO, CGV, CHW, CHX, CHY, CHZ, CIB, CID, CIE, CIH, CII, CIL, CIN, CIU, CIX, CJA, CJD, CJH, CJJ, CJK, CJL, CJP.

All OK3Y.

All OL9 on 1.8MHz and 144MHz only.

5. Each station may be worked only once per band on CW or phone.

6. Any mode of transmission and any band may be used. No cross band contacts allowed. Minimum signal reports accepted CW-RST 338, phone-RS 33.

Application Rules:

A signed and dated application for the S.N.P. Award must contain a list of the most important data of the QSOs and QSL cards to the amateur radio stations worked in the middle-slovak country, as well as 7 International Reply Coupons (IRCs). No stamps will be accepted.

The S.N.P. Award is not available to short wave listeners.

All applications must be postmarked not later than February 1, 1970, and should be sent to: Students' Radio Club, OK3KFV, P.O. Box 29, Martin 1, Czechoslovakia.

Note: In the period August 1 to August 31, 1969, an expedition was organised to operate with a special prefix—OH5SNP.

FED UP!

with the high cost of electronic projects ???

FED UP!

with poor service and slow deliveries ???

SO WERE WE!!

Until we formed our Electronic Experimenters' Club. We reckon the title — "Electronic Experimenters' Club" is a bit involved, so we've shortened it and called ourselves



WHAT IS ELTRAN?

Simply an organisation whose aim is to provide a new deal for the electronics hobbyist.

HERE'S WHY ELTRAN CAN OFFER YOU A BETTER DEAL—

ELTRAN — For the first time in Australia offers a UNIQUE service. We keep you right up to date on the latest projects, current prices and component availability with our monthly "ELTRAN Newsletter."

ELTRAN — supplies EVERYTHING for the hobbyist. You save on freight costs by obtaining all your parts from the ONE supplier.

ELTRAN — specialises in supplying the hobbyist. We have been in the Electronics game for years and are ready to help in getting your project under way with the minimum of delay and expense.

ELTRAN — supplies individual parts or the complete kit.

ELTRAN — offers helpful advice to the beginner. Our free booklet — "Getting started in Electronics" — gives you all the information you need to get going in this fascinating hobby.

ELTRAN — deals exclusively by mail order thus enabling us to slash overheads to a minimum. YOU reap the benefit of lower prices.

YOU can avail yourself of these services and a whole lot more, simply by becoming a member of ELTRAN. Membership is completely free and places you under no obligation. Fill out the form below and mail direct to:



P.O. BOX 35,
BALACLAVA, VIC. 3183.

To ELTRAN—P.O. Box 35, BALACLAVA, Vic. 3183.

Please enrol me as a member of ELTRAN, and rush me my free copy(ies) of:

- Guide to Electronics Purchasing.
 Getting started in Electronics.

Check square(s) applicable.

I understand that membership is completely free and places me under no obligation of any kind.

NAME (BLOCK LETTERS)

ADDRESS

Postcode.

N.D.A.R.C. Field Day

The Nepean District Amateur Radio Club will hold its annual field day on Sunday, September 21, 1969.

Location:— Penrith Civil Defence Headquarters, St. Marys Industrial Estate, St. Marys, N.S.W.

Directions:— Turn-off Great Western Highway at Glassip Street, St. Marys, and follow the directing signs. The N.D.A.R.C. station VH2BND will be operating on the 146MHz net frequency to talk mobile stations into the location.

Registration:— 9 to 10 a.m.

Program:— 10 a.m.—7MHz hidden transmitter hunt. 144MHz hidden transmitter hunt for pedestrians.

11 a.m.—7MHz and 144MHz rally, an event with a difference.

12 Noon — All Band Scramble any mode. "One Rule."

1.30 p.m.—Lunch.

2 p.m.—144MHz pedestrian event.

3 p.m.—7MHz, 144MHz and 146MHz cryptic clue event.

4 p.m.—Prize giving.

The location is ideal, providing plenty of playing area for children and parking space for cars.

Building is available for all-weather conditions.

Bring your own lunch, hot water supplied.

Morning and afternoon tea provided.

Novelty events for the ladies and children.

Disposal tables and lucky dip will be operating.

Registration fees are:— Youth Radio Club Scheme members 50c. Licensed amateurs \$1.50 (including family).

Good prizes can be won and a pleasant day in ideal surroundings can be had by attending.

Remember—September 21, N.D.A.R.C. Field Day.

For further information contact the Secretary, Mrs H. Drew, telephone 625-8742 (Sydney).

All Asian DX Contest

The results of the ninth All Asian DX Contest released by the organisers of the contest, the Japan Amateur Radio League, are:—

Continental winners—multi-band:

Call sign	Points	Location
CR7IZ	594	Mozambique
UA1KBA	13725	European Russia
KH6GNE	3485	Hawaii
JA1CWZ	53874	Japan
WA6IVN	12183	U.S.A.
CX3BH	5376	Uruguay

Continental leaders—single band:

Band	Call sign	Points	Location
28MHz	JA1PAG	105	Japan
	VK3AXK	70	Australia
	JH1AYT	20118	Japan
21MHz	YU1BCD	4650	Yugoslavia
	W6MSM	1290	U.S.A.
	VK3APJ	978	Australia
	OA4PF	207	Peru
	JA2HLX	21500	Japan
14MHz	UB5EM	4680	Ukraine
	WA6AFI	3405	U.S.A.
	VK2APK	1793	Australia
	PY1PK	132	Brazil
	JA1OHV	1386	Japan
7MHz	UP2KPI	207	Lithuania
	W5EQT	270	U.S.A.
	VK4SS	102	Australia
3.5MHz	JA1YEF	75	Japan
	HA3GA	36	Hungary

For the purpose of the contest Australia is, along with New Zealand and Hawaii, classified as Oceania.

The scores of Australian and New Zealand stations participating in the ninth contest were:

Australia:	Points
VK2GW	1590
VK3AXK	28MHz 70
VK3RJ	28MHz 10
VK3QV	28MHz 9
VK3APJ	21MHz 978
VK4CK	21MHz 524
VK3KS	21MHz 485
VK2APK	14MHz 1793
VK4SS	7MHz 102

New Zealand:

ZL2CD Multi-band 1524
ZL1IL 21MHz 44

Logs for the tenth All Asian DX Contest, which took place over the last weekend in August, must be mailed to arrive not later than November 30, 1969, at: J.A.R.L. Contest Committee, P.O. Box 377, Tokyo Central, Japan.

Jamboree-on-the-Air

The 1969 Boy Scouts Jamboree-on-the-Air will be held over the weekend October 18 and 19, the 12th to be held. The main object of this event is to give the boys an introduction to amateur radio and the opportunity for them to speak to fellow Scouts in other areas or countries. It could also encourage latent interest which may lead to an eventual career in electronics.

All Australian amateur operators are urged to support the event and assist their local Scouting groups to participate in this world-wide event.

In next month's notes, a full report on last year's Jamboree-on-the-Air will be given, together with details of the arrangements for this year. This report has been supplied by the Australian organiser, Commissioner Noel Lynch.

New Zealand

Emphasis is placed this year on the importance of the VK-ZL-Oceania DX Contest set down for the first and second weekends in October. (See Rules on page 169). To celebrate the arrival of Captain James Cook in New Zealand in 1769, the New Zealand Association of Radio Transmitters has introduced changes to encourage greater participation.

Contacts between Australian and New Zealand stations will be permitted on the 80-metre band. Also, many special awards will be presented to winners of various sections of the contest. All amateurs are invited to participate in the contest, thereby taking an active part in the New Zealand Bi-Centenary Celebrations.

The Wireless Institute of Australia's magazine, "Amateur Radio," will be available in New Zealand through the N.Z.A.R.T. Those wishing to obtain copies should contact the Secretary, N.Z.A.R.T., Box 1459, Christchurch, N.Z.

The official news broadcast from the N.Z.A.R.T. can be heard from ZL2IY at 10 p.m. E.S.T. on the last Sunday of each month on the frequency 3900KHz.

torical Museum and beautiful Albury Botanical Gardens for the ladies and children.

Evening — Dinner Dance. A three course dinner will be served and a dance band will entertain. Soft drinks will be available.

Sunday 5th: 9.30 a.m. — Assemble in Mates Car Park, Albury. 9.45 a.m.—Proceed to Mungaabreena Reserve.

10.30 a.m. — Pedestrian 144MHz transmitter hunt.

11.00 a.m. — VK2WI Broadcast.

11.30 a.m. — All band scramble.

12.30 a.m. — Lunch.

1.30 p.m. — 144MHz hidden transmitter hunt.

2.30 p.m. — 7MHz hidden transmitter hunt.

3.30 p.m. — 146MHz hidden transmitter hunt.

4.30 p.m. — Prize giving.

Throughout the day, raffles and technical competitions will be conducted. Boat excursions are being arranged on the Murray River.

Monday 6th: For those who are able to remain, there will be a fishing and scenic trip to the beautiful Hume Weir.

Registration: The registration fee is \$2 per adult male, to be paid at the registration booth on Saturday. Maps of the area and local information will be available at the booth.

Convention Dinner: The fee will be \$1.50 per head and should be forwarded as soon as possible so that catering arrangements can be finalised two weeks prior to the event.

Auction Sale: Bring along any radio equipment that you wish to dispose of. Some good buys are promised.

Accommodation: The organisers have made 30 reservations at a guest house. Reservations will also be made to suit individual tastes at motels or hotels. Send reservation deposit stating first and second preferences. Book early to avoid disappointment. Accommodation will be at a premium on this long weekend.

REGISTRATION FORM

Name
Call sign I require accommodation for adults and children at or From to Enclosed is my cheque/ money order for \$.....
Saturday dinner: Please reserve seats at the dinner for which my cheque/ money is enclosed.
I will/will not be bringing equipment for auction. I will be participating in name events
Registration forms should be set out as shown in the accompanying panel and

WIRELESS INSTITUTE ACTIVITIES

Arrangements have been completed for the N.Z.A.R.T. publication "Break-In" to be available to Australian amateurs through the publications department of W.I.A. Federal Executive. This magazine contains many articles for the home constructor, as Custom duties and tariffs tend to influence New Zealand amateurs towards home constructed equipment. Subscription details may be obtained from Publications Manager, Federal Executive, P.O. Box 67, East Melbourne, Vic. 3002.

NEW SOUTH WALES

P.M.G. Regulations

In Sydney during July, Mr H. Young, the New South Wales Superintendent of Radio, drew the attention of officers of the New South Wales Division, W.I.A., to the fact that the call sign of the division's station VK2BWI was being used in a manner that contravened P.M.G. Regulations.

A check made at the time the transmissions were reported showed that no divisional station was being manned and, therefore, in addition to the transgressions against operating procedure, the station call-sign was being used illegally on 53.866MHz.

Mr Young went on to express concern at the increasing tendency among operators transmitting on the VHF amateur bands to disregard the regulations relating

to operating procedures and discreet conduct.

He also said that it was now considered necessary to make arrangements for the continuous monitoring of these bands and for the official station, VK2AA, to come on the air if flagrant breaches of the regulations were observed by the monitoring stations.

The matter has been brought to the attention of members over the divisional news broadcasts and all operators were urged to observe the regulations so as not to bring discredit to the amateur service and, in particular, leave themselves open to disciplinary action by the Radio Branch.

South West Area Convention

This year the annual South West Area Convention of the New South Wales Division W.I.A. will be a joint VK2-VK3 event when members of the Victorian North Eastern Zone will join in the activities.

The venue for the convention will be Albury, and it will be held over the holiday weekend October 4, 5 and 6, 1969.

The program commences Saturday 4th. Morning—Registrations at the Masonic Hall, Keiwa Street, Albury.

Introductions. Preparing equipment for auction. Morning tea provided.

Afternoon — Giant Auction.

A tour to the famous Jinderra His-

Registered Trade Mark
ELECTROLUBE 2A-X

IMPROVES ELECTRICAL CONTACTS
INCREASES RELIABILITY AND
LOWERS MAINTENANCE COSTS

SAFE ON POLYSTYRENE, P.V.C. MAKROLON, PAINTS, NATURAL AND SYNTHETIC RUBBER NON-HAZARDOUS VAPOUR

Write for free Products Summary on the range of electrical and mechanical oils and greases

RFA RICHARD FOOT (Australia) PTY. LTD.
63 Hume St., Crows Nest, N.S.W. Tel. 43-0326.

Available from leading electrical wholesalers.

STOP RUST OUTDOORS 2 YEARS -- OR MORE!

Lubricates Penetrates Stops Rust

DRY YOUR ELECTRICAL SYSTEMS
with LPS — the NON-GREASY ONE

**STOPS
Squeaks!**



LPS is NOT a paint, lacquer or a varnish, and will NOT damage paint, rubber, fabrics, plastics, or finishes.

Displaces Moisture Fast!

TECHNICAL INFORMATION

Physical Properties:

LPS I

Less than .0001 inch non-greasy molecular film with capillary action that spreads evenly and easily to seal out moisture at very low cost.

Rust Inhibitor: Protects all metals from rust and corrosion.

Water Displacing Compound: Dries out mechanical and electrical systems fast.

Lubricant: Lubricates even the most delicate mechanisms; non-gummy, non-sticky; does not pick up dust or dirt.

Penetrant: Penetrates to loosen frozen parts in seconds.

Volume Resistivity per ASTM D-257; Room temperature, $\Omega\text{m/cm}$: 1.04×10^{12}

Dielectric Constant per ASTM-877:

Dielectric Constant 2.11 Dissipation Factor: 0.02

Dielectric Strength per ASTM D-150:

Breakdown Voltage 0.1 inch gap: 32,000 volts

Dielectric Strength volts/inch: 320,000 volts

Flash Point (Dried Film)

Fire Point (Dried Film) 900 degrees F

TESTS AND RESULTS: 950 degrees F

Lawrence Hydrogen Embrittlement Test for Safety on High Tensile Strength Steels: Passed. Certified safe within limits of Douglas Service Bulletin 13-1 and Boeing D6 17487.

Mil Spec. C-16173D-Grade 3

Passed

Mil Spec. C-23411

Passed

Swiss Federal Government Testing Authority for Industry: Passed 7 Day Rust Test for acid and salt water. Passed Weiland Machine Test for Lubricity as being superior to mineral oil plus additives.

LPS PRODUCTS CONFORM TO
FEDERAL MIL SPECS
C-23411 and/or C-16173D



LPS RESEARCH LABORATORIES, INC.
2050 COTNER AVE • LOS ANGELES, CALIF. 90023

HOW LPS SAVES YOU TIME AND MONEY

1. LPS PROTECTS all metals from Rust & Corrosion.
2. LPS PENETRATES existing rust — stops it from spreading.
3. LPS DISPLACES moisture on metal—forms fine protective film
4. LPS LUBRICATES even the most delicate mechanisms at extreme temperatures.
5. LPS PENETRATES to free rust frozen parts, nuts, bolts, etc.
6. LPS PREVENTS equipment failures due to moisture (drives it out).
7. LPS LENGTHENS LIFE of electrical & electronic equipment—improves performance.
8. LPS RESTORES equipment damaged by water contamination & corrosion.
9. LPS PENETRATES AND PROTECTS plated and painted metal surfaces.
10. LPS PROTECTS metals from salt atmosphere, acid & caustic vapours.
11. LPS LOOSENS dirt, scale, minor rust spots & cleans metal surfaces.
12. LPS ELIMINATES squeaks where most everything else fails,

(SOLE AGENT)



ZEPHYR PRODUCTS PTY. LTD.

70 BATESFORD ROAD, CHADSTONE, VICTORIA—PHONE 56-7231

MANUFACTURERS OF RADIO & ELECTRICAL EQUIPMENT & COMPONENTS

A Pioneer Passes

On July 23, 1969, Joe Reed, VK2JR, a pioneer of radio in Australia, passed away.

Joe was a Life Member of the New South Wales Division of the Wireless Institute of Australia, and will be remembered for the numerous lectures he gave at Divisional meetings. The era of Joe's association with radio extended from the days long before any broadcasting service existed in Australia to the reception of the first television pictures from the moon.

However, not so well known to the present generation was the contribution Joe Reed made towards the introduction and growth of radio in Australia. So, in his memory, here are a few facets of the work of this pioneer.

He was known affectionately among his associates as the professor; a nickname conferred on him by his school mates at the Newcastle High School during 1910, when he wrote an article on wireless for the Teachers' Journal. The title stuck so well that a visiting science master from another school called at his home and asked in all seriousness to see Professor Reed. He was completely dumbfounded to be confronted by a schoolboy.

During the early part of 1914, he conducted experiments with the naval depot at Newcastle and subsequently joined the Navy as an electrical artificer. It was during his service with the Royal Australian Navy that the first wireless valves were introduced. The Navy commandeered the whole consignment and he was able to study and experiment with these important pieces of equipment, which were to have a far-reaching effect on the development of radio.

In association with Basil Cook in July, 1919, he carried out elementary experiments with sound broadcasting and they were successful in transmitting music over a short distance. This was later extended to over 100 miles; probably the first time speech and music had been transmitted for this distance in Australia.

While in Melbourne he carried out experiments with Sydney experimenters Charles MacLurcan and Jack Pike, using very low power transmitters, and achieved some spectacular results over a distance of 600 miles. Joe also designed and built a transmitter used by Charles Mac-

lurcan for Sunday night broadcasts in 1923.

After leaving the Navy about 1919, Joe joined the P.M.G.'s Department as a junior engineer and, while stationed in Sydney, he designed an audio oscillator for testing and locating faults in the Sydney-Melbourne telephone trunk line. Later in 1920 he joined the Chief Radio Inspector's office in Melbourne under the then Chief Radio Inspector J. Malone. This was long before broadcasting was introduced in Australia. Leaving the P.M.G.'s Department, he joined A.W.A. and became associated with the radio industry both in executive and advisory capacities.

While technical superintendent at Amalgamated Wireless Australia, he was responsible for the design and building of the 2FC transmitter, to be operated by Farmer and Company. This was opened in November, 1923, and operated on a wavelength of 1100 metres (272KHz). This channel was chosen to act as a type of trade embargo for Australia's infant radio industry, as most of the imported receivers were designed for a maximum wavelength of 600 metres (500KHz) and would be totally unsuited for receiving 2FC.

Following the establishment of 2FC, he designed 3LO Melbourne, on 1720 metres, 4QG Brisbane on 350 metres, 5CL Adelaide on 370 metres, and finally 6WF Perth on 1250 metres.

When the Federal Government decided to build Australia's first national shortwave station at Shepparton, Victoria, with an output of 100KW, Joe Reed, in association with S.T.C. engineers, was responsible for the design of the station.

Over the years Joe Reed's name was associated with many radio installations in New Zealand, New Guinea, and Pacific Islands. He wrote technical articles for many Australian and overseas journals, and was always willing to give information to anyone. Even shortly before his death he was heard on the air from his station VK2JR at Northbridge, Sydney, discussing various subjects with fellow amateurs.

A cheery voice on the air and a colourful personality, Joe Reed will be missed by his many friends among those to whom radio was a hobby or a profession.

To his wife and family is extended the deepest sympathy from those who were associated with him through amateur radio.

sent as soon as possible to: Don Haberecht, VK2RS, 605 Abercorn St., South Albany, N.S.W. 2640, or Jim Linden, VK3AXB, 135 Hume St., Wodonga, Vic. 3690.

Illawarra Branch

The Illawarra Branch of the N.S.W. Division hold their General Meeting on the first Monday of the month in the Wollongong Town Hall committee room at 7.30 p.m. The branch publishes a monthly newsletter for members, which gives details of coming activities as well as technical hints and list of publications available from the branch library.

The following advice appeared in a recent issue, in a section devoted to safety precautions:

"Power supplies under the bench are not a bad idea, but your big toe might not like the feel of 2000V as much as the anode of the 813, so why not enclose it? Open type transmitters and receivers are terrific for test models but, once testing is finished, the job is only finished when the cabinet is done.

"One well-known member of our club tested his transmitter by putting his finger in the final's tank coil. If you have heard of RF cooking, you might guess what happened; looked like a sausage for a fortnight! Rather painful, so give some thought to safety; you'll enjoy your hobby much longer that way!"

Details of the club's activities and membership can be obtained from the secre-

tary: H. Laauw, VK2BHL, 433 William Beach Road, Kannhooka Point, Dapto, N.S.W. 2530 (phone Wollongong 61-2279).

Wagga District Radio Club

The Wagga District Radio Club was inaugurated at a general meeting of local amateurs in June, 1968, and is an affiliated member of the Wireless Institute of Australia. Part of the club activity is to provide the local Civil Defence Organisation with a communications section and the club meetings are conducted in permanent quarters of the Civil Defence Organisation. A large proportion of club members are also active in the C.D.O.

The radio communication equipment provided by the club consists of a 50W 146MHz FM base station, eight 10W 146MHz mobile stations, and a 7MHz base station. Base stations are operated by members on a roster basis.

Future developments are expected to include the acquisition of a second 50ft tower for antennas, C.D.P. single-sideband transceivers, and a 146MHz FM repeater station. A very good coverage of the locality will be given by the repeater, which is expected to be operational by December.

Another aspect of the club's activity is the fostering of the W.I.A. Youth Radio Club Scheme. Rev. Bro. Jeffrey, VK2HI, at the Christian Brothers' College, is in charge of this aspect and progress is such that other Y.R.S. stations will be in opera-

ON TELEX



from



Cunninghams

Call . . .
Melbourne:
31447
Sydney:
21707

FOR SERVICE.

Bob Cunningham

We have installed full TELEX facilities for customer service. This is your means of obtaining rapid answers and deliveries from our extensive range of components and equipment.

WHAT'S NEW?

EXTENSION LOUDSPEAKERS

Whatever your requirements may be GELOSO has the speaker and equipment to suit the occasion. We know also how to tailor a system to meet the occasion or we can sell to professional installers if required.

LOUDSPEAKERS IN ENCLOSURES FOR LOW LEVEL SOUND

No. 3093



No. 3093
Moulded plastic enclosure with 8" speaker.

MOBILE SPEAKER SYSTEMS

No. 2537



Instant Quick-Mount installation. No drilling of holes required. Weather-proof high impact construction. Uniform sound dispersion.

MOUNTING CEILING BAFFLES



No. 3081

Moulded plastic recessed mounting ceiling baffle with inverse magnet 8" speaker. Grey polished finish. Uniform controlled 360 deg. sound dispersion. Output power: 6 watts.

STREAMLINED BAFFLE WITH SPEAKERS



No. 3092

Two tone grey-white moulded plastic enclosure with two 3" x 5" elliptical speakers. Can be mounted horizontally or vertically. An excellent and well illustrated catalogue of all GELOSO audio products is available upon request from any of our offices.

R.H. Cunningham
PTY. LTD.

VIC.: 608 Collins St., Melbourne.
N.S.W.: 64 Alfred St., Milsons Point.
W.A.: 34 Wolya Way, Balga.
QLD.: 95 Central Ave., Sherwood.
L. E. Boughen and Co.

Deitron

ELECTRONICS

4-6 TAYLOR ST., TAYLOR SQUARE, DARLINGHURST. N.S.W., 2010

FERRITE RODS

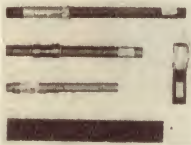

Round Type	Flat Type
\$	4 x 15 x 140mm
100 x 8mm 90	\$1.25
120 x 8mm 1.00	4 x 12 x 140mm
120 x 10mm 1.00	\$1.00
140 x 10mm 1.15	5 x 13 x 55mm
160 x 10mm 1.25	90c
180 x 10mm 1.40	5-13 x 60mm 90c
200 x 10mm 1.60	5-14 x 50mm 90c

All Ferrites come with BC coil windings.

SPEAKERS



Round Magnet	Square Magnet	Special
2" 8 ohm 2.00	2 1/2" 8 ohm 1.40	
2 1/2" 8 ohm 2.00	2 1/2" 8 ohm 1.50	
2 1/2" 8 ohm 2.25		
2 1/2" 8 ohm 2.50		
3" 8 ohm 3.00		
3 1/2" 8 ohm 3.25		
4" 8 ohm 3.30		

CASSETTE TAPES



C-60 (2 x 30 mins)	\$1.75
C-90 (2 x 45 mins)	\$2.75
C-120 (2 x 60 mins)	\$3.00

CAR ANTENNAS



Telescopic Lock Down 5 Section, 3' 4"	\$4.50
Telescopic Lock Down 5 Section, 4' 10"	\$6.00
Telescopic-Cowl Mount 3 Section	\$4.00

PLASTIC CABINETS



Drawers Size L5 1/2" x W2 1/2" x D1 1/2".
 STM12A 12 Drawers, 12 1/2" x 5 1/2" x 6" **\$5.90**
 STM16A 16 Drawers, 12 1/2" x 7 1/2" x 6" **\$7.10**
 STM24A 24 Drawers, 12 1/2" x 10 1/2" x 6" **\$9.50**

STEREO HEADPHONES



8 ohm. 100-15000Hz.
\$9.00

SPEAKER BOX



10 ohm pot in series with speaker
 6 1/2" 8 ohm 2 watt speaker walnut finish 11 1/2" x 5" x 8".
\$9.85

DYNAMIC MICROPHONE UNIDIRECTIONAL



UDm 105 dual hi/low impedance with on/off switch 80-10,000Hz.
\$16.80
 UDM 104 As above only high impedance **\$14.30**

STEREO AMPLIFIER

ELECTRONICS Australia 10-10 stereo with overload protection circuit, complete kit of parts to last nut and bolt. Beautiful cabinet **\$62.50**
 Assembled and completed tested, **\$72.50**
 Chassis and cabinet and front panel only for above, **\$12.00.**

RADICATORS (other scales available)



Model DE-RAD-30D



Model DE-RAD-40-UV



Model DE-RAD-11D

Manufacturers enquiries on above should be directed to Deitron Importing Co. Pty. Ltd., of above address and phone number.
 MODEL DE-RAD-30D. FSD: 200UV. SIZE: 1 1/2" x 1 1/2" approx. PRICE: **\$2.80.**
 MODEL DE-RAD-11D. FSD: 200VA. SIZE: 1 1/2" x 1 1/2" approx. PRICE: **\$2.40.**
 MODEL DE-RAD-40UV. FSD: 200VA. SIZE: 1 1/2" x 2 1/2". PRICE: **\$4.00.**
 Includes int. rectifier.

BEREC CAR LIGHT



Battery Operated Fluorescent Light.

6 volt 1.25A 6 watt	\$16.00
12 volt .6A 6 watt . . .	\$16.50
12 volt 1 A 8 watt . . .	\$16.80
12 volt 1.25A 13 watt	\$18.00



VALVES

6 BQ5 . . . \$1.30	6EM5 . . . \$1.30
6BM8 . . . \$1.50	6V4 . . . \$1.00
66W8 . . . \$1.50	12AX7 . \$1.40
6EA8 . . . \$1.40	

DIODES

	Min. qty.	10
1N4001 100 PIV 1A		25c
EM404 400 PIV 1A		30c
EM408 800 PIV 1A		55c
MB101 100 PIV 2A Bridge		\$1.50
OA 91 Germanium		18c
OA202 Silicone		45c
1N 914 Miniature silicone		20c

TRANSISTOR PARTS

10mm IF transformers . .	\$1.00
7mm IF transformers . . .	\$1.00
Standard 20mm PVC gang .	\$2.00
Standard 5K switch pot . .	30c

TRANSISTORS

2N2160 unijunction	\$1.40
2N3646 NPN silicone	50c
2N3638 PNP silicone	60c
2N3638A PNP silicone	70c
BC 108 NPN silicone	50c
BC 109 NPN silicone	55c
AC128 PNP Germanium	50c
AD161-AD162 pair	\$2.85
C106 F1 thyristor	\$1.25

ALL POSTAGE FREE THIS MONTH ONLY



SERVICE TRADE and RETAIL

To all brands of transistor radio, tape recorder, record player, TV and specialising in Hi-Fi Stereo equipment. (Trade pick-up and delivery available.)

DEITRON ELECTRONICS SERVICE DIVISION 31-5430 31 6786

VHF-UHF-ATV Contest Result

The results of the New South Wales VHF and TV Group's Mid-winter VHF — UHF contest held over the Queens Birthday holiday weekend, June 14-16, 1969, give some interesting figures about what proved to be a most successful event.

From the seventeen entries received it was found that 114 different stations participated and 124 call signs were mentioned. The difference in numbers being those who operated in the field under multi-operator stations. Participants were located in Australian Capital Territory, VK1; New South Wales, VK2; Victoria, VK3; and Queensland, VK4, call areas.

Special merit award to contestant licensed less than 12 months went to VK2ZPY with 138 points and 41 QSOs.

Note: VK2ZPC was the highest scorer in the Portable six hour 144MHz section with 3243 points but, having won the portable total section was not eligible to also win the six hour division. VK2BPJ was the highest scorer in the

portable six hour 432MHz section with 2099 points but, having won the portable total section was not eligible to also win the six hour division.

Both VK2ZPC and VK2BPJ were multi-operator stations in the field at Mount Bindo and Kanangra Walls respectively, located in the Blue Mountains west of Sydney.

Entries received, listed in order of overall score:—

Station	Score
VK2ZPC	14287
VK2BPJ	12656
VK2ZBU	2505
VK2ZTQ	2242
VK4ZT	1963
VK2ZCF	1852
VK2ZXC/Mobile	1306
VK2ATO/Portable	1306
VK2HZ	846
VK2BAU	784
VK4NO	715

VK2APQ	714
VK2ZGB	328
VK2ZPY	238
VK2ZMM	check log
VK2ZWQ	check log
VK2ZAH/ATV	check log

Note: VK2ZXC operated aeronautical mobile from Sydney to Cowra and return.

VK2ZAH amateur television transmission was copied by VK2ZPC at Mount Bindo a distance of 63 miles.

Longest distance contact was between VK2ZPC and VK3NN at Yanac in north-western Victoria, 550 miles.

Statistics taken from the entries give some interesting facts. Of the 124 call signs appearing in the entries, 58 were full calls and 66 limited licensees.

During the contest some participants took the opportunity to operate their stations in one or more classes; i.e. home, portable, or mobile. Others operated on standard net frequencies and on frequencies that could be covered by the use of a tunable receiver.

There were 102 stations operated from home locations made up as follows:

Band	No. Stations	Net Frequency	Tunable
52MHz	23	18	5
144MHz	71	18	53
432MHz	6	-	6
432MHz (ATV)	1	1	-
1296MHz	1	-	1

40 stations operated mobile as follows:

52MHz	12	12	-
144MHz	28	26	2

24 stations operated portable as follows:

52MHz	5	5	-
144MHz	12	4	8
432MHz	4	-	4
432MHz (ATV)	1	1	-
1296MHz	1	-	1
10GHz	1	-	1

Placings in the various sections were:—

Class	Division	Band	Call sign	Points	QSOs
Home	Total period	52MHz	VK2HZ	864	24
Home	Total period	144MHz	VK2ZTQ	2164	76
Home	Total period	432MHz	VK4NO	715	10
Home	Six hours	52MHz	VK2BAU	336	61
Home	Six hours	144MHz	VK2ZCF	943	30
Mobile	Six hours	52MHz	VK2ZGB	328	26
Mobile	Six hours	144MHz	VK2ZXC	1306	91
Portable	Total period	52MHz	VK3ZBU	616	90
Portable	Total period	144MHz	VK2ZPC	12269	265
Portable	Total period	432MHz	VK2BPJ	3728	30
Portable	Six hours	52MHz	VK2BAU	448	60
Portable	Six hours	144MHz	VK2BPJ	2664	72
Portable	Six hours	432MHz	VK2ZPC	1458	11
Portable	Six hours	1296MHz	VK2ZCF	207	2

Highest overall score VK2ZPC/P 14287points 299 QSOs.

tion during the coming year.

A very active program has been followed during the year, centring around instruction for the P.M.G. Amateur Operator's Certificate of Proficiency examinations, and five members have gained their licences.

Further activities for members are planned, including participation in all major Australian contests, Jamboree-on-the-Air, VHF hidden transmitter hunts, field days, inter-club visits and contests, club sponsored construction projects, and the continuation of the A.O.C.P. classes.

Club members feel that these activities are furthering the interests of amateur radio in the Wagga Wagga area and providing a valuable public service through the links with Civil Defence Organisation.

Inquiries regarding the club should be made to: Hon. Secretary, Wagga District Radio Club, 106 Ashmont Avenue, Wagga Wagga, N.S.W. 2650.

Khancoban Radio Club

The annual meeting of the Khancoban Radio Club was held on June 30th. The membership of the club has been depleted due to transfer of members to other Snowy Mountains Authority projects. Among those transferred were the president Jim Winckel and secretary Dennis Johnston.

The officers elected were — President, John O'Brien; Secretary - Treasurer, David Harrison.

VICTORIA

A fatal light-aircraft crash occurred near Ararat in Victoria on July 17. Next morning, a searching aircraft reported sighting wreckage on a nearby mountain. Two members of the staff of the local television station, Harvey Lelliott, VK3ZG, and David Miles, VK2ADS, went to the mountain to try to locate the scene of the accident. Before leaving the TV station, they alerted a third member of the staff, Neville Maddern, VK3AAQ, who had been on duty the night before, to stand by for traffic.

BRIGHT STAR CRYSTALS

PREFERRED BY LEADING MANUFACTURERS
THROUGHOUT THE COUNTRY FOR —

ACCURACY - STABILITY - ACTIVITY - OUTPUT



All types of Crystals Available
Such as DC11, FT 243 HC6U CRA
B7G, HC18U, ETC.
TOLERANCES: .0015%, .002%,
.003%, .005% ETC.

Consult us for Crystals for any Mobile Radio.
Prices depend on tolerance and frequency
required.

DISCOUNT FOR QUANTITY ORDERS

Established 36 Years



AMATEUR AIRCRAFT and ULTRASONIC CRYSTALS also AVAILABLE

Our new Factory employing the most modern equipment
allows us to offer you PROMPT DELIVERY for all your
CRYSTAL requirements.

DEVOTED EXCLUSIVELY TO THE MANUFACTURE OF

PIEZO ELECTRIC CRYSTALS

Contractors to Federal and State Government Departments

REPRESENTATIVES AUSTRALIA AND NEW ZEALAND: Messrs. CARREL & CARREL
BOX 2102, AUCKLAND.

MESSRS ATKINS (W.A.) LTD.,

894 Hay Street, PERTH.

MESSRS. A. E. HAROLD PTY. LTD.,
123-125 Charlotte Street, BRISBANE.

MESSRS LAWRENCE & HANSEN

ELECTRICAL (VIC.) PTY. LTD.,

34 Brisbane Street, HOBART,
and 29 St. John Street,
LAUNCESTON, TASMANIA.

BRIGHT STAR RADIO

546-5076

LOT 6 EILEEN ROAD, CLAYTON, VICTORIA

546-5076

LEADER TEST INSTRUMENTS

NEW 5" OSCILLOSCOPE

Wide Range, High Sensitivity At A Budget Price.

FEATURES

Wide Bandwidth with high sensitivity, DC-10MHz at 10mVp-p/cm.
DC amplifiers for vertical and horizontal inputs.
Highly linear wide sweep range with automatic synchronization.
Vector pattern display for color TV circuits.



MODEL LBO-52B

SPECIFICATIONS

Vertical Axis	Deflection sensitivity Bandwidth, at -3dB	10mVp-p/em or better. DC: DC to 10MHz. AC: 2Hz to 10MHz.
Horizontal Axis	Deflection sensitivity Bandwidth, at -3dB	300mVp-p/em or better. DC: DC to 500kHz. AC: 2Hz to 500kHz.
Sweep Circuit	Frequency Synchronization	1Hz to 200kHz in six steps: H-TV at 15.75kHz/2. INT + & -, EXT and LINE.
Size and Weight		10½" x 8" x 16½"; 24 lbs.

3" PRIMA - SCOPE

The PRIMA-SCOPE is a compact oscilloscope designed for all-around service. Its small and handy size will appeal to experimenters, servicemen and plant technicians who desire maximum performance with minimum space requirements.



MODEL LBO-31M

Maximum Performance With
Minimum Space Requirements.

Vertical Channel	Sensitivity: 80mVp-p/em, at 1kHz. Response: -3dB, 3Hz to 1MHz.
Horizontal Channel	Sensitivity: 2.5Vp-p/em. Response: -3dB, 3Hz to 400kHz. (at max GAIN)
Size and Weight	Sweep Frequency: 10Hz to 100kHz in 4 steps. 7" x 4" x 12"; 11 lbs.

FROM ALL GOOD TRADE HOUSES
WHOLESALE ENQUIRIES ONLY TO
SOLE AUSTRALIAN REPRESENTATIVES:
ASTRONICS AUSTRALASIA PTY. LTD.,
ALL STATES.

During their second search on the mountain, they sighted wreckage of the aircraft and found parts of the aircraft and two bodies. This information was radioed back to Neville in Ararat, who passed the message to the local police. Harvey and David marked out the track and stood by to direct the police to the actual scene of the tragedy. Their initiative shown in this emergency and assistance given received the praise of the police and civil aviation authorities.

Eastern Zone News

Members of the Eastern Zone of the Victorian Division, W.I.A. held their annual convention at Mirboo North during the weekend, April 19 and 20. There was a good attendance and the event attracted a number of visitors from Melbourne.

The zone president elected for the coming year was David Godfrey, VK3AZM, (ex-VK3ZOZ). David conducts the Traralgon Technical School Youth Radio Scheme class. Other officers elected were: vice - president, Rodney Champness, VK3UG (ex-VK0CR); secretary, Lee De Vries, VK3AXM (ex-VK3ZSS); publicity officer, George Francis, VK3ASV (ex-VK3ZCG).

Members of the zone are active on the DX band, and 40 are operating mobile on 146MHz Channel B FM net frequency. The zone project is the construction and testing of a Channel 4 repeater to be put into service in the Traralgon area to serve the Melbourne to Lakes Entrance area. Interest is also being shown in the 432MHz band.

George Francis, VK3ASV, wishes to express his appreciation to all the VK1 and VK2 operators on the 52MHz and 146MHz net frequencies with whom he had contact during his motoring holiday through New South Wales. Contacts were made with 11 VK1 and 54 VK2 stations.

QUEENSLAND

A very active program is being prepared by the Queensland Division Intruder Watch co-ordinator. This activity is designed to bring to the notice of the relevant authorities the illegal use of purely amateur frequency allocations by commercial stations. Reports on such activities are correlated by the Federal Executive of the W.I.A.

To encourage members to participate, it is proposed to form a Triangle Club. Three stations at least 40 miles apart, with facilities to determine the direction from which signals are emanating, will work together. A special membership badge will be issued to members of groups who submit a minimum of three reports per year.

Full details may be obtained from the Secretary, W.I.A., Queensland Division, Box 638, G.P.O., Brisbane, 4001.

SOUTH AUSTRALIA

Council of the South Australian Division, acting on an agreement reached at a general meeting, has arranged to establish a Divisional library. A local radio firm in Adelaide has agreed to make space available free of charge.

Briefly the arrangements envisaged are: to be open from noon to 2 p.m. daily, and 9 a.m. to 11.30 a.m. Saturday; to be staffed by retired members of the division on a roster basis; to have two sections—reference and lending; text books and magazines to be available.

All that awaits finalisation is the number of assistants considered as being adequate to staff the venture.

WESTERN AUSTRALIA

In the editorial of the July issue of the Bulletin of the West Australian Division, members were strongly urged to bring along to meetings pieces of home-constructed equipment. To quote a portion of the editorial:

"Many of us may feel that our efforts may appear uninteresting to others, but surely the most minor piece of originality is worthy of a group having amateur

(Continued on page 172)

AUSTRALIA — NEW ZEALAND — OCEANIA DX CONTEST

The national amateur radio associations of New Zealand and Australia—New Zealand Association of Radio Transmitters and Wireless Institute of Australia—invite world-wide participation in the 1969 VK-ZL-Oceania DX Contest.

This year the contest rules have been changed. A large number of awards are available both for VK, ZL, and overseas stations.

The Contest is one function of the New Zealand Bi-Centennial Celebrations.

Objects:

For the world to contact VK-ZL-Oceania stations and vice-versa.

Dates:

Phone Section: 24 hours from 1000-GMT Saturday, October 4, 1969, to 1000-GMT Sunday, October 5, 1969.

CW Section: 24 hours from 100GMT Saturday, October 11, 1969, to 1000-GMT Sunday, October 12, 1969.

Contest Rules

1. There shall be three main sections to the contest:

- Transmitting phone.
- Transmitting CW.
- Receiving — phone and CW combined.

2. The contest is open to all licensed transmitting stations in any part of the world. No prior entry need be made. Mobile marine and other non-land-based stations are permitted to enter. Their "country status" will be determined by the country which issued the call sign used in the contest.

3. All amateur frequency bands may be used but no cross band operation is permitted. NOTE: VK and ZL stations, irrespective of their location, do NOT contact each other for contest purposes, except on 80 metres. On this band contacts between VK and ZL stations are encouraged.

4. Phone will be used during the first weekend, and CW during the second weekend. Stations entering both sections must submit separate logs.

5. Only one contact on CW and one contact on phone per band is permitted with any one station for scoring purposes.

6. Only one licensed amateur is permitted to operate any one station under the owner's call sign. Should two or more operate any particular station, each will be considered a competitor and must submit a separate log under his own call sign. This is not applicable to overseas competitors operating club stations.

7. Entrants must operate within the terms of their licence.

8. Ciphers: Before points can be claimed for a contact, serial numbers must be exchanged and acknowledged. The serial number of five or six figures will be made up of the RS (phone) or RST (CW) report plus three figures which may begin with any number between 001 and 100 for the first contact, and will increase in value by one for each successive contact. Example: If the number chosen for the first contact is 021, then the second must be 022 followed by 023, 024, etc. After reaching 999 restart from 001.

9. Scoring:

a. For Oceania stations other than VK/ZL: 2 points for each contact on a specific band with VK/ZL stations; and 1 point for each contact on a specific band with the rest of the world.

b. For the rest of the world other than VK/ZL: 2 points for each contact on a specific band with VK/ZL stations; and 1 point for each contact on a specific band with Oceania stations other than VK/ZL.

c. For VK/ZL stations: 5 points for each contact on a specific band and, in addition, for each new country worked

on that band bonus points on the following scale will be added:

- 1st contact, 50 points.
- 2nd contact, 40 points.
- 3rd contact, 30 points.
- 4th contact, 20 points.
- 5th contact, 10 points.

Note: The A.R.R.L. countries list will be used except that each call area of "W/K," "JA," "UA" will count as "countries" for scoring purposes as indicated above.

For 80 metre contacts between VK and ZL stations, each VK and ZL call area will be considered a "scoring area" with contact points and bonus points to be counted as for DX contacts.

NOTE: Contacts between VK and ZL on 80 metres only.

10. Logs:

A. Overseas stations—
a. Logs to show in this order; date, time in GMT, call sign of station contacted, band, serial number sent, serial number received, points claimed. Underline each new VK/ZL call area contacted. Separate log must be submitted for each band used.

b. Summary sheet: To show call sign, name and address in BLOCK LETTERS, details of station, and for each band: QSO points for that band, VK/ZL call areas worked on that band. "All Band" score will be total QSO points multiplied by sum of VK/ZL call areas on all bands, while "single band" scores will be that band QSO points multiplied by VK/ZL call areas worked on that band.

B. VK/ZL Stations—
a. Logs must show in this order: date, time in GMT, call sign of station worked, band, serial number sent, serial number received, contact points, bonus points. Use separate log for each band.

b. Summary sheet: To show name and address in BLOCK LETTERS, call sign, score for each band by adding contact and bonus points for that band, and "all band" score by adding the band scores together; details of station and power used; declaration that all rules and regulations have been observed.

11. The right is reserved to disqualify any entrant who, during the contest, has not strictly observed regulations or who has consistently departed from the accepted code of operating ethics.

12. The ruling of the Executive Council of the N.Z.A.R.T. will be final.

13. Awards:

World-wide except VK/ZL —
a. Attractive multi-coloured certificates to the top scorers in each country (call areas in "W," "JA," "UA"). Separate awards for phone and CW.

b. Similar certificates to all participants with a minimum operating time.

c. Silver Shield and N.Z.A.R.T. badge—mounted on polished wooden base awarded in the following categories:

1. Top scorer in each continent with separate awards for phone and CW.

2. Top world score on each band: 40, 20, 15, 10 metres. Separate awards for phone and CW.

3. Top "club" entry from North America and from Europe to consist of a phone log and a CW from members of that club— e.g., Ohio Valley DX Club, West Gulf DX Club, Long Island DX Association, etc.

4. Multi operator "club" stations in the U.S.S.R. using CW only.

Note: Stations entering for the "club" award must clearly indicate name of club and also entry for this section of the contest.

d. SWL: attractive multi-colour certificates as for transmitting section in (a) above.

e. Copper medallions specially struck for New Zealand's Bi-Centenary awarded to the following:

- Each winner in category (c) above.
- Runner-up in each section of category (c).

VK-ZL Awards:

a. Attractive multi-colour certificates to the following:

1. To the top three scorers in each call area of VK and of ZL.

2. To the top three scorers on individual bands (80, 40, 20, 15, 10 metres) in VK and in ZL. Separate awards for phone and for CW.

b. Similar certificates to participants with a "minimum" operating time.

c. Large silver mounted plaque to the top scorer in both VK and ZL with separate awards for phone and CW.

d. Silver mounted shield to runner-up in section (c) above.

e. Silver mounted shield to top VK and top ZL scorer using 80 metres only. Separate awards for phone and for CW.

f. Silver mounted shield to top scoring ZL on 40, 20, 15, 10 metres with separate awards for phone and for CW.

g. Copper Medallions specially struck for New Zealand's Bi-Centenary awarded to the following:

1. Each winner in sections c, d and e above.

2. Top scorer in each call area of VK and ZL, both on phone and on CW.

3. Top scorer on each individual band for VK and for ZL. Separate medallions for phone and for CW. Except: that duplicate medallions will not be awarded where one entrant is the top scorer in more than one section.

h. One year's subscription to N.Z.A.R.T. publication "Break-In" to top scoring VK station on phone and on CW.

i. SWL: multi-colour certificates to the top scoring SWL in each VK-ZL call area with medallion to the top scorer for VK and ZL.

14. Entries from VK-ZL should be posted direct to: N.Z.A.R.T. Contest Manager, ZL2GX, 152 Lytton Road, Gisborne, N.Z., to arrive not later than December 31, 1969. Overseas stations, to the above address or N.Z.A.R.T., P.O. Box 489, Wellington, N.Z., to arrive not later than January 23, 1970.

SWL Section

1. The rules are the same as for the transmitting section but is open to all members of any SWL Society in the world. No transmitting station is permitted to enter the contest.

2. The contest times and loggings of stations on each band per weekend are as for the transmitting section except that the same station may be logged twice on any one band— once on phone and once on CW.

3. To count for points, the station heard must be in QSO exchanging ciphers in the VK-ZL-Oceania DX Contest and the following details noted: date, time in GMT, call of the station he is working, RS(T) of the station heard, serial number sent by the station heard, band points claimed.

4. Scoring is on the same basis as for transmitting section, and a summary sheet should be similarly set out.

5. Overseas stations may log only VK-ZL stations, but VK stations may log overseas stations and ZL stations, while ZL receiving stations may log overseas stations and VK stations.

6. Awards will be made as listed in the section under "Awards."

NEW RANGE OF RESISTORS, CONDENSERS AND POTENTIOMETERS

We have just purchased the complete stock of Resistors, Condensers and Pots. of a large manufacturer and can offer same at less than 25 per cent of list price. The resistors are mainly I.R.C. and Morganite and are in 1/4, 1 and 2-watt, also included are I.R.C. 3-watt wire wound 2,200 ohm, 3,300 ohm, 4,700 ohm, etc. List price \$9.00 per 100, our price, \$2.00 per 100, post. The condensers are in most popular makes and include standard values, including 4mfd, 8mfd, 16mfd, 300V, List price \$11.00 per 100, our price, \$2.00 per 100, post. The potentiometers are all current types and include switch, tab pots, etc. List price, \$12.00 per dozen, our price, \$2.50 per dozen, post. and packing 50c extra.

FREE With each lot of resistors, condensers or pots, IT4, 6K7G. Resistors, condensers and pots are in individuals lists of values or types. we will supply free one new valve-type 6U7G, 6X5GT, packs of 100 or 12 and we regret we cannot supply to



LEADER SIGNAL GENERATOR LSG11
240V A.C. operated, 6-band 120KC to 390 Megs. Provision for crystal. **\$32**
Post N.S.W., 75c; Interstate, \$1.25.

USED HIGH-SPEED 240V. AC/DC MOTORS

These 240V A.C. or D.C. motors are 1/8 H.P. with a speed of 7,000 r.p.m. and are ideal for small drills, grinders, etc. Dimensions: 5 1/2 in x 3 1/2 in, with 5/16 in spindle **\$3.75**

Postage N.S.W., 50c; Interstate, 85c.

NEW TRANSISTOR 8 KIT SET

SPECIAL PURCHASE ENABLES US TO OFFER THIS KIT SET AT **\$24.00**



DIMENSIONS
9" x 5" x 3" deep

- Complete kit of parts with circuit and full instructions.
 - Eight transistors.
 - Magnavox 5X3 speaker gives excellent fidelity.
 - High sensitivity, suitable for city or country use.
 - Heavy duty battery for economical operation.
 - Modern design, plastic cabinet with gold trim.
 - Dial calibrated for all States.
 - Available in colours of off-white, red, black
- Postage N.S.W., \$1.25; Interstate, \$1.75.



NEW 25 AND 35 WATT P. A. AMPLIFIERS

These amplifiers are suitable for installation in clubs, schools, restaurants, factories, etc. Wherever the amplification of speech or music is required.

25 W \$61 SPECIFICATIONS 35W \$71.

- Nominal power 25 or 35 watts.
- Inputs two microphone and pick-up radio with separate controls and mixing facilities.
- Tone control.
- Microphone sensitivity 6MV, pick-up or radio 150MV.
- Frequency response 30 to 18,000 CPS.
- Output impedance Line output (100, 166, 250, 500 ohms) or can be supplied with V.C. output (2, 3, 7, 8, 15 ohms).
- Dimensions 11in x 6in x 8in. Weight 25W 23lb, 35W 26lb. Freight extra.

New Electrolytic Condensers

These condensers are miniature pigtail type insulated new stock in packets of 12, each packet containing: 3 16mfd 300 V.W., 2 32 mfd. 300 V.W., 1 25 mfd. 450 V.W. and 6 low voltage electrolytics. **\$2.50.**

Post and packing 20c extra.

NEW IMPORTED 4" P.M. SPEAKERS

Available with a 4 or 16 ohm voice coil. **\$2.00.**
Post and packing 30c extra.



NEW MINIATURE MOTORS

Ideal for models, toys, etc. 1 1/2 to 3 volts, 6,000 r.p.m. 39c each or \$3.50 per doz. Post 10c.

NEW ENGLISH and AMERICAN TRANSISTORS AT 1/4 LIST PRICE

PACKET OF 12 FOR \$3.00

Ideal for the experimenter or service man.
Each package of 12 contains 3 each of the following types

Mazda XA101.
Texas 2N1108.
Texas 2N1111.
Texas 2N1110.

Equivalent:
"
"
"

OC45 RF Transistor.
OC44 OSC. Transistor.
OC75 General purpose.
OC45 R.F. Transistor.

THESE TRANSISTORS CAN BE SUBSTITUTED FOR MANY OTHER TYPES.
Post and Packaging 20c extra.

NEW 240V ELECTRIC MOTORS

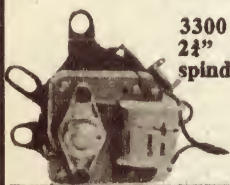

3300 R.P.M. Size 3 1/2" x 2 1/2" x 3 1/2", including spindle.

\$2.75

plus 60c postage.



NEW MIDGET POWER TRANS. \$3.75

40mA prim., 240v. Sec 225 x 225 with 6.3v Fil. Winding. 30mA 240v. Prim. Fil. Winding.

Postage: N.S.W., 25c; Interstate, 45c.

150 x 150v. Sec. with 6.3v.

Postage: N.S.W., 35c; Interstate, 60c. **\$3.75**

NEW AMERICAN TWIN TELESCOPE TV AERIAL. Extends to 36in, each section can be used singly for car or portable .. **\$1.50.** Post 20c
SINGLE TELESCOPIC Aerial, 12in extends to 33in. **60 cents.** Post 10c

A PREAMP FOR MAGNETIC PICK-UP OR TAPE HEADS

SUITABLE FOR USE WITH THE COLLARO OR B.S.R. TAPE DECKS

Using 3 silicon transistors as featured in October Electronics Australia complete with kit of parts including transistors mono **\$7.50,** stereo **\$13.00,** 240 power supply for above **\$7.00.**
Please specify if required for pick-up or tape heads.



NATIONAL RADIO SUPPLIES

332 PARRAMATTA ROAD, STANMORE, N.S.W. PHONE 56-7398

Something You've Been Waiting For . . .

A SOLID STATE GUITAR AMPLIFIER

Here is a fully solid state guitar amplifier rated at a nominal 50 watts continuous power. Featuring two totally independent tone control channels and a fully transistorised Tremolo facility, the amplifier offers unique flexibility of application in a light and compact unit.

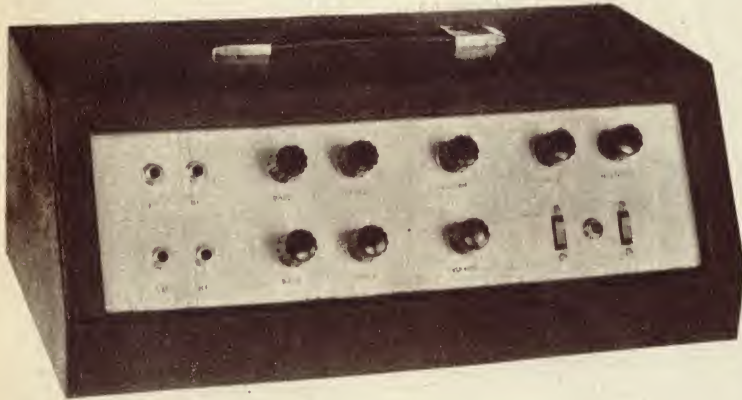

As featured in Electronics Aust, July-August issues. Complete kit of parts to Electronics Aust. specifications supplied with foot control switch and lead for remote tremolo. Cabinet finished in heavy duty black vinyl and control panel in black and silver with matching knobs.

\$98.00

COMPLETE KIT OF PARTS

\$114.00

WIRED AND TESTED

NEW TRANSISTOR CAR RADIO

New transistor six car radios with R.F. stage, of Aust. manufacture using A.W.A. components and transistors. Available in manual models with dial calibrated for all Australian States.

Supplied with speaker (5", 6", 5" x 7" OR 6" x 9") and lockdown aerial.

MANUAL MODEL ----- **\$43.00**

Post and Packing N.S.W. \$1.50, Interstate \$2.50



Suitable for 6 or 12 volts for positive or negative earth. Please state type required.

NEW TRANSISTOR STEREO RECORD PLAYER

This Stereo Record Player is fitted in a durable and attractive vinyl covered case with silver trim and incorporates an 8-transistor Stereo amplifier with two Magnavox 5in x 3in speakers and B.S.R. record player (4-speed) with crystal pick-up. For 240 volt A.C. operation only. DIMENSIONS — 21" x 10" x 3½". Weight, 12lb.

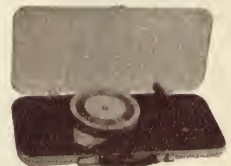

\$38.00

Post and Packing extra N.S.W. . . . \$1.50. Interstate . . . \$2.50

NEW VALVES AT BARGAIN PRICES

7193 25c	IT4 45c	6H6G 35c	6SS7 equiv.	JA7GT 75c
807 \$1.75	3Q4 75c	6K7G 45c	6SK7 85c	IL5G 95c
IC7G 30c	3S4 \$1.00	6K8G 68c	6U7G 45c	12SK7 50c
ID8GT 95c	5V4G \$1.00	6SA7GT 95c	6X5GT 75c	12A6 50c
IK5G E 40c	6C8G 50c	6SJ7 95c	7C7 35c	12K8 50c
IK7G 49c			12AT7 \$1.00	12SH7 50c
IM5G 40c				866 \$1.50
IP5G 25c				954 25c
IQ5G 25c				955 25c
				EK32 68c

Please add postage on all valves.

NATIONAL RADIO SUPPLIES

332 PARRAMATTA ROAD, STANMORE, N.S.W. PHONE 56-7398

the right time



at a glance



solari



Solari Cifra 3 — an exceptionally compact digital clock, attractively styled for the modern office or home.

Gives the correct time, minute by minute, in an unmistakable way — there are no hands to misread.

Silent, synchronous electric motor; direct-read time legible from at least 33 ft; extremely simple time resetting; unbreakable lightweight plastic case.

Only 7" long, 3¾" diameter, 1½ lbs weight. Available in red, green, beige or light grey; with 12 or 24 hour direct-read flaps. Only \$32.00 including tax.

PLESSEY

Communication Systems



Plessey Communication Systems Pty Limited
87-105 Racecourse Road North Melbourne Victoria 3051
Telephone 329 6333 Cables INTERPHONES Melbourne

Sydney 642 0311 Canberra 95 1596 Townsville 79 5066 Perth 31 1588 Launceston 27 3520
Newcastle 61 1092 Brisbane 2 3287 Adelaide 76 2022 Hobart 34 2828 Devonport 24 1000

AS7

(Continued from page 168)

radio as a hobby. No matter in what particular aspect one may be interested, a series of seemingly trivial details presented on other topics can quite often act as a catalyst for one's ideas.

"In the event of others present having different views on the way the problem may have been solved, the ensuing discussion must surely stimulate the interest of all present."

This seems to have a lot of merit and could create a lot of interest among members.

For information on membership and monthly meetings write to the Hon. Secretary, Box N1002, G.P.O., Perth, 6001.

VHF Propagation

Further information has come to hand, this time from George Francis, VK3ASV (ex-VK3ZCG), regarding the VHF band opening in April and reported in the June and July issues of these notes. At 1730-EST on April 24, Bill, VK3AJX, at Bendigo, heard signals from the north on 145.854MHz FM. Later Bill worked a station at Numurkah 62 miles to the north of Bendigo and, on identifying a call sign of a mobile station in Sydney, realised that he was hearing the experimental repeater station at Mount Canobolas, near Orange, N.S.W.

At the same time, signals from the repeater station were being copied in Geelong as previously reported by Darrold St. John, VK3AQR. At that time, the Geelong Radio Club was making a preliminary survey for a translator installation with an experimental station on a hilltop six miles out from Geelong. This repeater was set up to receive on 145.854-MHz and to relay on 146.44MHz, the local simplex frequency. The result was that signals from the Orange repeater were relayed all around the Geelong district.

The only reported contact made through the Orange repeater was Bob Knaggs, VK3AJN, at Wangaratta, who made contact with John Thornthwaite, VK2ATO, in Sydney. On April 25, signals from Orange were not quite as strong as on the previous night but Bill, VK3AJX, was able to make a tape recording of the transmission as received.

YOUTH RADIO SCHEME

NEW SOUTH WALES

Maitland Radio Club

Members of the Maitland Radio Club have spent a lot of time during the past two months installing drains and painting the building. A covered front patio and more shrubs and gardens are among the projects planned. Inside the building a library has been started and painting is to begin soon. A canteen is included in plans for the future.

An elaborate amplifier and monitor system has been wired and tested. The system, which connects all rooms, can be used for monitoring radio contacts, for lectures, as an intercom system, or for making tape or disc recordings.

The first communication equipment that will be permanently installed will be a FM unit on 52.525MHz, to be used as a net frequency for licensed club members. This will facilitate communication between the club and members.

In July, Phillip Orchard, VK3APO, radio operator of the M.V. Baralgah, visited the club while in port at Newcastle. Phillip displayed for club members an amateur transceiver using integrated circuits.

The students studying for the Y.R.S. Elementary, Junior and Intermediate examinations are progressing well. All sections are constructing projects as group efforts.

At the request of Alderman N. Unicomb,

(Continued on page 191)



LISTENING AROUND THE WORLD

South Africa Plans European Relay Base

Radio South Africa, which is finding the European listener the hardest to reach on short-wave, is planning a relay base in Portugal to ensure good reception in Europe, and has plans to introduce services to the Far East and South America shortly.

by Arthur Cushen

The four huge 250KW transmitters of Radio South Africa, and the array of 38 towers and aerials, are now being used to great effect to service North America and Africa with excellent signals. Their service to Australia and New Zealand has at times been below normal signal level, but transmission time changes and some frequency alterations should rectify this to some degree. Europe still presents the difficult area to service, due to the congestion of the bands. Plans have been announced to feed the programs from Johannesburg by landline to Portugal and from this country or a base nearby, re-transmit the service to achieve greater signal level in Europe.

A service for the Far East and another for South America is the next step in the plans of Radio South Africa to service the world. When approval has been granted, a new aerial system will be erected to carry the signals to the Far East, and, reversed, to South America.

Radio South Africa will then have a daily service for all continents.

PARADYS CLOSES

The transmitting site at Paradys, the location of the short-wave service of the S.A.B.C. for reception in South Africa, is being closed. The equipment is being moved to Blumendal, the site of the high-powered Radio South Africa transmitters, 40 miles south-east of Johannesburg. On this 1,300-acre site a new station is now being built to house seven 100KW transmitters to carry programs in the 90, 60, 49 and 41 metre bands to South-West Africa. The old 20KW transmitters are being retained to be used for a short-wave service in the 120-metre band. When completed, the transmitting site will house 17 transmitters, with world-wide and internal services serving overseas listeners in 10 languages and internal listeners with 17 programs.

ENGLISH FROM LATIN AMERICA

English broadcasts are now being received more frequently from stations in South America. For years past the most consistent signal has been HCJB, Quito, Ecuador. Other stations have recently been heard with English broadcasts.

BOLIVIA: Radio Progreso, La Paz, using 6005KHz has been heard closing its daily transmission at 0430GMT with an announcement in English.

Notes from readers should be sent to Arthur Cushen, 212 Earn Street, Invercargill, N.Z. All times are GMT. Add 8 hours for Perth, 10 hours for Sydney and 12 hours for Wellington.

ARGENTINA: Buenos Aires station LRY1, with the programs of Radio Argentina Exterior, has been observed in New Zealand on 6090KHz, at fair level. The program in English is on this frequency 0300 to 0400GMT.

PERU: Radio Pacifico, Lima, is a new station with gospel programs using the frequency of 9675KHz. The station has been heard with a news bulletin in English at 0205GMT.

SERVICES FROM MALDIVES

The Maldiv Islands Broadcasting Service has issued its first program sheet with details of broadcasts from Male.

GMT	KHz
0100-0230	7225
0300-0430	6150
0500-0630	1507
0700-0830	9538
0900-1030	7225
1100-1230	6150
1300-1430	3331
1515-1730	5740
1500-1730	1507

The best reception is on 4740KHz, and English is heard on this frequency from 1530-1730GMT. This includes the Voice of Prophecy at 1600 and the World Tomorrow at 1630GMT.

WIRED RADIO

Due to its mountainous terrain, Switzerland not only uses medium and short-wave, but frequency modulation to cover the country. Even this is not sufficient, and so a service is fed through telephone lines to some subscribers.

This service offers a choice of six programs, with transmissions in German, French, Italian, Spanish, Portuguese and English. The English programs include some of the normal short-wave output and B.B.C. news from London. We noted in hotels that this type of programming was the most popular, and even in mountain huts the wired service is mostly used. The cost involved is only 30c a month.

LISTENING AT WILKES

Interesting signals on the broadcast band have been received at the Wilkes Base in Antarctica, reports Winston Nickols of Burnie, Tasmania. Many Australian stations are received during darkness. One of the best signals was that of Lourenco Marques Radio, in Mozambique, on 917KHz. This station carries programs in English and Afrikaans for reception in South Africa. Another signal heard was DZRV, in Manila, heard on 860KHz at 1200GMT. This is a 50KW station, and the programs are mainly of a gospel nature.

ENGLISH FROM WARSAW

Radio Warsaw has programs in English to Europe, which also can be received in New Zealand particularly at 0700GMT. This service is in effect until October, 1969.

GMT	KHz
0700-0730	7125, 6010
1100-1125	9675, 7145
1600-1625	11800, 7125
1830-1900	7145, 6135
1930-1957	7125, 6010
2030-2055	7125, 6010

RECEPTION ANALYSIS

An examination of reports from listeners in various parts of the world on a regular basis enables much to be learnt of short-wave transmission paths. Nowhere are such reports more thoroughly studied than in the External Transmission Section of the B.B.C., London. Near to Bush House, the offices of this section receive regular reports from nearly 200 reception points throughout the world each week. Now, with the use of computers, these provide a picture of the performance of each frequency, and other data necessary to modern short-wave broadcasting on an international scale.

In the Australasian section four major reports are received of reception conditions in our areas.

These are submitted by the Australian Broadcasting Commission, the New Zealand Broadcasting Corporation, James N. Paris, of Prospect, South Australia, and myself from Invercargill, N.Z.

The material of these reports, in the form of weekly reception logs and cable reception information, is fed into the computers. An estimated two million checks on world-wide reception of B.B.C. frequencies are made by the team. From this, information is available on overall reception of any given frequency, interference on frequencies, and the general pattern of reception and disturbances which have occurred over each weekly period.

Other modern electronic devices enable reports, which are sent in the form of lines showing reception, to be read electronically and also analysed. The work of providing the overall picture on reception of B.B.C. signals is no hit or miss venture. It is very exacting work and is a continuous process the year round.

ARNE SKOOG

On of the world's leading DX editors is undoubtedly Arne Skoog of Radio Sweden, one of the few in the world employed full time as the editor of a DX session. His program "Sweden Calling DXers" is now celebrating its 21st year on Radio Sweden.

Arne Skoog became interested in radio at 15. He served in a radio college, then at sea, and later at a telecommunications station handling ship to shore traffic. In 1939, at the outbreak of World War II, the Swedish Foreign Office asked him to establish a monitoring service, and with a staff of three he built up an important monitoring service, which specialised in listening to German broadcasts.

After the war he continued in this role, and also worked as a free lance journalist. In 1948 he founded the DX session on Radio Sweden, and in 1958 he was employed full time by Radio Sweden. The

Forget kid gloves!

This SANWA Multimeter can take it and give you legibility and accuracy plus!

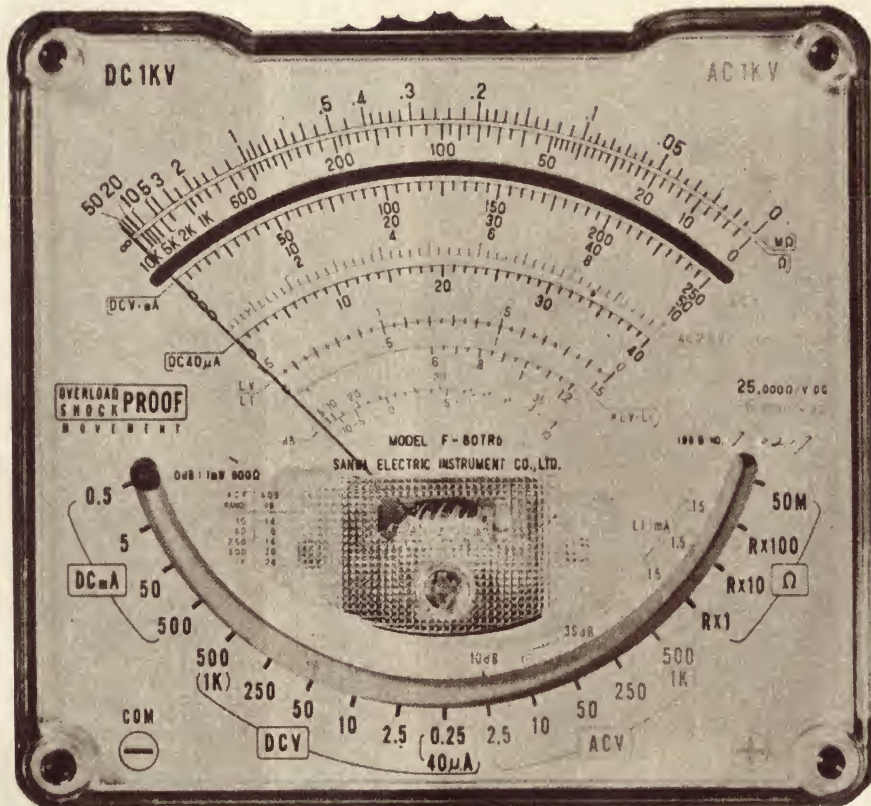

The Sanwa TR Series F80-TRD
(shown here actual size)

This unique multi-tester from Sanwa concentrates many measuring functions in a small panel area. It combines legibility and accuracy with rugged performance . . . ideal for the daily demands of "toolbox" use.

The Sanwa multi-tester has a sensitive taut band 34.5 microamp movement which is silicon diode protected against mechanical and electrical abuse. Range indication is

both novel and practical. A red ball appears against the range selected by the thumbwheel switch which may be easily operated single handed.

MEASUREMENT RANGES

DC Voltage: 0.25v-2.5v-10v-50v-250v-500v-1000v
(25k Ω /v)

AC Voltage: 2.5v-10v-50v-250v-500v-1000v (5k Ω /v)

DC Current: 40 μ a-0.5ma-5ma-50ma-500ma

Resistance: From 100 ohms to 250k ohms midscale in 4 ranges

Load Current: L1-15ma-1.5ma-150 μ a

Load Voltage: LV-1.5v

Volume Level: -10~+10db-+5~+36db

AVAILABLE EX STOCK FROM WARBURTON FRANKI



WARBURTON FRANKI

ADELAIDE: 23-3233. BRISBANE: 51-5121. CANBERRA: 4-7755.
HOBART: 2-1841. LAUNCESTON: 2-1218. MELBOURNE: 69-0151.
MOUNT GAMBIER: 2-3841. NEWCASTLE WEST: 61-4077. PERTH:
8-4131. SYDNEY: 29-1111. WOLLONGONG: 2-5444.

weekly DX session goes out in six languages, on short-wave and is also carried on medium-wave for late-night listening in Europe. Since the session began it has been increasingly used by DXers all over the world, and at one time often had some 150 contributors each week with DX news. This correspondence had to be severely edited for a ten-minute session, as so much interesting news was received. Due to a budget cut earlier this year the session, on its 1000th broadcast, had to discontinue free mailings to contributors, but it continues in its radio form. This has meant a drop in contributions to an average of about 40 each week. From this variety of information Arne Skoog chooses the items of greatest interest to his audience.

THE CHANGING DX HOBBY

In a recent issue of the Radio South Africa program magazine, their DX editor Leo Van Der Walt gave his opinion on DXing at the moment. I quote:

"Quite often people ask me, 'What is a DXer?' Now, a few years ago this could be quite a simple question to answer, I could merely say, 'He's a fellow that twiddles a receiver knob in his spare time, looking for new stations so as to accumulate as many QSL cards as possible.' To answer the question now, however, is not quite so easy, for there have been some radical changes in DXing as a hobby.

"Although accumulating QSL cards is still quite an important part of DXing, it has entered a new phase—that of paying more interest to the program content. This, I think, is an important step forward, and has resulted in a rise in status of the hobby.

"At one stage, most stations would just take a fleeting glance at a DXer's report, send a QSL card and then throw the report into the wastepaper basket. But since DXers have begun to take more interest in definite aspects of broadcasting, it would be an unwise broadcasting organisation that did not take heed of what the DXer had to say in his report. For it has become quite clear that, on the average, DXers' reports are not just hurried notes. They show that the listener has made almost an investigation of the technical and program quality of a transmission.

"DXing is on the right track. By paying more attention to program content DXers have become program critics. They can now write an authoritative report not only about the material but also about how it is presented. DXers may not be opinion-makers when it comes to politics, but when it comes to international broadcasting they are slowly but surely winning respect as opinion-makers of radio programs."

VERIFICATION FROM BELIZE

Bob Padula, of Melbourne, advises receiving a QSL from the station at Belize, British Honduras, for his reception of 3300KHz. The station confirmed with a large card, showing a map of the country, via airmail, for reception early in June, when transmissions were on an extended schedule. Since this reception, the station has reverted to its 1200GMT sign-on, a time which precludes reception in Australia, being too late for satisfactory propagation on this low frequency.

INDONESIA ON 120 METRES

ARDXC members report good signals of various Indonesian regional stations operating in the 120-metre band. These include: Djakarta, now using 2450KHz to replace 2460KHz heard at around 2015GMT on Saturdays; Kotoradja, now known as Banda Atejeh on 2380KHz, replacing 2390KHz, and heard at 1230GMT; Surakarta using 2437KHz, monitored at 1240GMT, and heard as late as 1800GMT on Saturdays when on an extended schedule.

KADUNA VERIFIES

Robert Shepherd, of Glen Iris, Victoria, has received verification for his reception

NEW SCHEDULES OPERATING

ENGLISH FROM MOSCOW

The present schedule of English programs for Australia and New Zealand from Radio Moscow is as follows:

GMT	KHz
1100-1130	17820, 12060, 9750, 620
1130-1200	12060, 9750, 1470, 620
1230-1300	15130, 11690, 12060, 9750, 1470, 620
1300-1400	17820, 12060, 9750, 1470, 620

ENGLISH FROM BUDAPEST

The present schedule of Radio Budapest, Hungary, valid until 1-11-69, is as follows:

GMT	KHz	Area
1930-2000	6234, 7100, 9833, 11910	Europe
2130-2200	6234, 7100, 9833, 11910	Europe
0100-0130	6234, 9833, 11910, 15160	North America
0300-0330	6234, 9833, 11910, 15160	North America
0400-0430	6234, 9833, 11910, 15160	North America
0800-0815	11910, 15160, 17795, 17890, 21665	Far East
1015-1030	11910, 15160, 17795, 17890, 21665	Far East

BROADCASTS FROM PRAGUE

Radio Prague, Czechoslovakia, in a schedule effective until 3-11-69, is operating in English as follows:

GMT	KHz	Area
0100-0155	5930, 7345, 9540, 9630, 11990, 15365, 17840	United States and Canada
0300-0355	5930, 7345, 9540, 9630, 11990, 15365	United States and Canada
0700-0755	9575, 11800, 15310, 21485, 21700, 6055, 9505	Australia and New Zealand

of Radio Television Kaduna, on 9570KHz. The verification was in the form of a letter from the chief engineer, and full QSL details were given. The station also advised that a new channel in the 25-metre band would be taken into use in the near future, this being 11965KHz. With the QSL was sent a program schedule and literature about the country.

GOOD RECEPTION OF MOGADISHU

Sam Dellit, Brisbane, Keith Barton, Adelaide, and John Eig, Toowoomba, all advise good reception of the "Voice of the Somali Republic" using 6097KHz. English news was presented at 1730GMT, and many identification announcements were noted until 1800GMT. The station verified via airmail in 3 weeks, the QSL card showing a view of three transmitting towers. Mint stamps were sent with the report.

INTERESTING QSL FROM COLOMBIA

Stephen Morgan, Bendigo, Victoria, advises receiving a QSL letter in Spanish from Emisora Nueva Granada, Bogota, on 6160KHz, for his report which was in the same language. Mint stamps were sent with the report. The station also sent a pennant, via airmail. The station is currently audible at around 1100GMT until fade-out at 1230GMT on this 49 metre band outlet.

THE VOICE OF NIGERIA

The Nigerian Broadcasting Corporation was created as an independent corporation in 1956, and commenced to function from April 1, 1957. The N.B.C. is not only concerned with the function of providing radio services for the whole of Nigeria, but is also involved with short-wave transmissions, and is providing services similar to its home service to countries outside Nigeria.

The Nigerian Broadcasting Corporation was unique in 1957, being the first Corporation of its kind to be set up in the British Empire. Its organisation was based on that of the B.B.C., being both a national organisation and having regional stations throughout the country.

The expansion of the transmitter services in Nigeria resulted in 12 transmitters being established in provincial centres by 1960.

By 1961, the transmitter power on short-wave had increased to 70KW and on medium wave to 40KW. In the first 10 years of the N.B.C., great progress has been made in Nigerian radio. At present the position is:

Station	MW	SW
Lagos	2 x 20KW	3 x 130KW
Lagos		5 x 410KW
(Ext. Service)		
Kaduna	1 x 1KW	3 x 37KW
Enugu	1 x 10KW	2 x 12KW
Ibadan	1 x 10KW	2 x 11KW
Benin	1 x 5KW	1 x 10KW

In all, some 44 transmitters are in operation in Nigeria. Most of these have been put into service by the N.B.C. in the past 10 years.

RADIO NIGERIA STATIONS

The home program of the Nigerian Broadcasting Corporation is carried in medium and short-wave from Lagos and the various regional areas. According to a recent issue of the N.B.C. program magazine, the stations are operating as follows:

GMT	KHz	Station
0430-2230	1088	Lagos
0430-2230	1416	Kaduna
0430-2230	1376, 1397	Kano
0430-2230	1358	Ibadan
0430-2230	638	Benin
0530-0830	4990	Lagos
0845-1730	4990	Lagos
0530-1915	7255	Lagos
0530-0715	3986	Lagos
1900-2400	3986	Lagos
0530-0803	3326	Kaduna
1730-2330	3326	Kaduna
0530-2330	6175	Kaduna
0800-1915	9655	Kaduna
0530-0900	3396	Kaduna
0600-2000	3980	Enugu
0600-2000	6035	Enugu
0530-0830	3204	Ibadan
1600-2330	3204	Ibadan
0830-1700	7285	Ibadan
1500-2330	4932	Benin

FLASHES FROM EVERYWHERE

EUROPE

FRANCE: O.R.T.F. in Paris is now using a new frequency for the news in French at 0500GMT. The new channel is 7255KHz. This channel also has a news bulletin in English at 0515GMT.

LUXEMBOURG: Radio Luxembourg this year will replace its 6KW transmitter on 15350KHz with a new one of 100KW. This transmitter carries the Radio Luxembourg French service, 0500 to 0300GMT.

WELL BELOW COST

BATTERY CHARGERS

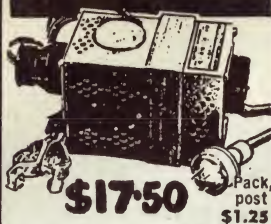

\$17.50 Pack, post \$1.25
 • Charges 6V and 12V Batteries overnight • High 4-amp. charge rate • 12 months written GUARANTEE.

Top quality! Top performance! A fantastic direct deal from top manufacturer. They are usually sold at \$30.00. Finest quality components; steel case. Charges 6v. and 12v. batteries from 240v. A.C. mains. Complete with fuse, ammeter, long lead with alligator clips for battery terminals and long flex with 3-pin plug. Units are brand new in carton and have passed strict electrical authorities test.

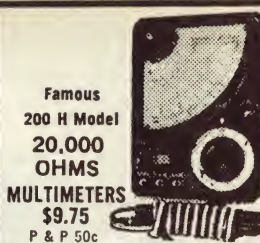

Famous 200 H Model **20,000 OHMS MULTIMETERS \$9.75** P & P 50c
 Extremely sensitive 20,000 ohms complete with full instructions and probes with overload protection
RANGES:— D.C. VOLTAGE: 5-25-50-250-500-2.5K (20,000 ohms per volt). A.C. VOLTAGE: 10-50-100-500-1000 volts (10,000 ohms per volt). D.C. CURRENT: 0-50 uA, 0-2.5 MA, 0-250 MA. RESISTANCE: 0-6K, 0-6mg. (300 ohm and 30K at centre scale). CAPACITANCE: 10 uF to .001 uF, .001 uF to 1uF DECIBELS: -20 to +22DB

ANTENNAE RODS — 69c post 10c. 6 Section telescopic, chromed brass, fits most transistor radios, extends from 5 1/2" to 27", female threaded base.



BELOW \$ PRICE! \$73 SAVE \$104
SEA HAWK BRAND NEW 2.5 h.p. OUTBOARD MOTOR Freight \$2.50
 12 months warranty

SPECIAL FIRST RELEASE 'TAS' SEA HAWK MK. II
 The new 1969 version of the original Sea Hawk outboard. Powerful enough to drive a 12ft. boat at 10 m.p.h. 35lb. static thrust equal to 3 h.p. model of well known make. Uses only 1 pint fuel per hour. Weighs only 23lb. Spares will always be available. Write for full information.



240v. Electric Pumps BRAND NEW \$8.75
 No. 102 direct English purchase from a famous manufacturer. We purchased their entire stock of these ABSOLUTELY BRAND NEW in carton 240-volt electric motorised pump unit. Usually sell for \$25.00. Full 3 MONTH GUARANTEE. Special Neoprene impeller pump will handle corrosive fluids, fuel and water. Pumps 300 400 g.p.h. To be gravity fed and will lift to 8'. Ideal for fuel or water transfer, fountains, fish ponds, etc. Pump entirely non-corrosive. Rush your order now as stocks will not last at this price. Pack, post 75c.

Write for our free list of Hydraulic equipment in stock — brand new by famous manufacturers, all with three months full guarantee. Rams, pumps, solenoid and manual valves, all fittings available. Also available a two-page "All About Hydraulics" information sheet with diagrams, etc. ... only 10c.

DIRECT DISPOSALS Mail Order Specials

Mail orders to **DIRECT DISPOSALS 36 HELEN ST, VALLEY, BRISBANE, 4006** • 3 shops Brisbane • Phone 5 4833

ELECTRICAL BARGAINS

HALF-PRICE SPECIAL HI-FI RECORDING TAPE

Fantastic purchase of "Mylar" professional recording, computer tape (the best money can buy). Famous 3-name brand (one we can't mention due to huge price reduction). Silicone lubrication. Suits all tape recorders, hi-fi and stereo. Selling well under half price. Post 10c each.
3" 225' 65c
5" 600' \$1.50
7" 1200' \$2.50
 Also long play 5 1/4" 900ft.—\$2.25. 7" 1800ft.—\$3.25.



CRYSTAL MICROPHONES \$1.40
 CM21 for desk or hand, high sensitivity load resistance 500K-1M ohms with 5' lead and plug, \$1.40 P & P 10c. Crystal mike smaller size lapel clip. CM62 response 100-9000 Kc's, 3' lead and plug, 69c, P & P 10c.

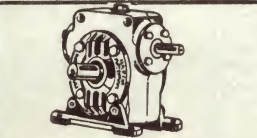

GEARBOXES \$17.50
 2 ratios available 10.5 to 1 and 14.5 to 1, made by David Brown "Radicon" England. Very robust construction, has two driving shafts at right angles and oil filler plug. Unit is drilled for 4-bolt fixing, size 4 1/2" x 4 1/2" x 3 1/2", 7/16" and 3/8" dia. x 1 1/2" long shafts (cost over \$100 to make). Bargain 100 only. (Pack and Post \$1.)



HAND GENERATORS \$2.45
 Brand new in cartons, gives 100v AC, ideal for line testing (megger). P & P 50c.



Tremendous SAVINGS
 Brand new Army "L" **FIELD TELEPHONES \$15.50** (2 for \$29)
 Made by L. M. Ericsson 6 MONTHS' GUARANTEE. Pack freight \$1 extra per phone housed in completely rust proof metal case. Has long distance ringing generator complete with bell. As used by P.M.G. linemen and the Army. Ideal for property to property, house to house or shed, line testing, fire fighting communications, etc. Range over 20 miles; use fencing wire (just insulate on posts). Absolutely brand new in original wax sealed cartons. Govt. cost over \$100. Size 10" x 5 1/2" x 5". Battery set 80c extra per phone.

INDUCTION MICROPHONES
 Will pick up sound waves from a distance. Has suction cap, long cord and plug for tape recorder, etc. Sticks to wall or case of telephone for recording speech. \$1.25.

"Cutler Hammer" TOGGLE SWITCHES
 Post pack 10c. 4-Pole, 3-way (3 position) panel switches (centre off). Handles 10 amps. at 12 or 24/32 volts D.C. Ideal for panels, control boards, 75c.



Fantastic New Item!
PEN TELESCOPE \$1.95
 10-Power pocket telescopes, 4 1/2" closed; 8" long extended. Very clear image. Has clip for pocket. Closed, can also be used as a 50-Power microscope. Post free. Use also for inspecting record stylus needles.

Micro switches 10 amp. 125v AC 5 amp. 240v AC, 95c. P & P 10c.

Now 4 AMP 3-18 volt SELENIUM RECTIFIERS
 Current English make. Brand new. Converts A.C. to D.C. \$1.00, post 25c. 2 1/2 AMP. 65c (Post 15c).

COMPUTER BOARDS
 Enormous purchase from famous computer manufacturer. Each board comprises at minimum 4 transistors and up to 6 transistors, plus host of resistors, diodes, capacitors, etc. 4 Boards with minimum of 16 transistors \$2 (post 20c); 8 Boards with minimum of 32 transistors \$3.50 (post 25c). Special price for quantity.

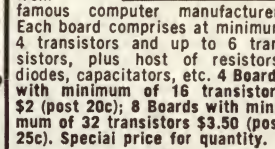

\$1.65 MODEL MOTOR & GEAR TRAIN
 \$1.65, P & P 25c. Powerful permanent magnet model motor in steel chassis, with all metal English reduction gear train, produces considerable torque, operating voltage 1 1/2 to 4 1/2 volts DC (torch batteries), final drive speed approx. 100 r.p.m. at 1 1/2 volts. Size 4" x 2 1/2" x 1 1/2" high, brand new, originally designed for Mecano products.

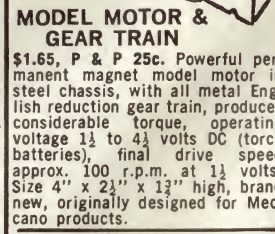

\$12.50 5,200 G.P.H. CENTRIFUGAL PUMP Freight \$1
 6 MONTHS' GUARANTEE
 A top quality 1 1/2" inlet, 1" outlet (O.D.) corrosion proof (salt water proof), all metal centrifugal pumps. Capacity up to 5 200 g.p.h. pressure up to 60 P.S.I. Heavy duty bearings gives pump smoother running and long life. Handles heaviest loads and highest speeds — designed to pass solids such as sand, silt dirt, etc. without damage. Heads to 120ft., suction lift to 25ft. Spare parts always available. Ball type port valve for 1 1/2" hose, will seal completely at only 2ft. head, \$2.75. Post 25c (if separate). 3" pulley to suit \$1.50.

STEREO HEADSETS \$8.95 post 25c
 Beautifully made and top quality, complete with jack plug. frequency range 50 to 40,000 cps, sensitivity 118 DB. Usually sells at \$17. Fantastic realism of pure stereo sound.

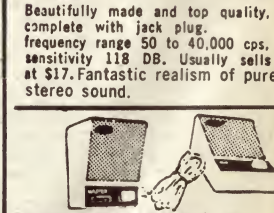

Famous Make and Brand New INTERCOMS \$9.50 Post 50c.
 Two station intercommunication system comprising master and sub-station. A faultless unit with volume control and connecting wire. Fully transistorised. Has press-button buzzer on each station. Operates up to 1/2-mile. Battery operated. Neatly packed in cartons.

NIFE BATTERIES—95c (Pack, despatch and post 10c ea.)
 Brand new! Nickel iron, spill-proof, leak-proof cells—Lasts forever, 4 A.H., 1.2 volts. Sizes 3 1/2" x 2 1/2" x 1". Couple together for any voltage—superb for spotlights, lamps, bells, flash equipment, etc. Set of 10 gives 12 volts 4 A.H. \$7.95 (Pack post \$1); Set of 5 for 6 volts. 3.95 (Pack post 50c).

English 240v flasher fits into ordinary light socket, for 25 watt bulb, 75c; for 40 watt bulb, 85c. Post 10c. Great for displays.

A.C. FAN \$2.75
 Post 30c. Small but very powerful 240v. mains motor by "VARLEY" England. With 4" 3 blade fan, ideal for cooling equipment or as extractor fan. Self-aligning bearings, silent but very efficient. Mounts from back or front. Brand new. Motor separate \$2.45. Post 30c.

Money cheerfully refunded if not completely satisfied.

BELGIUM: Radio Belgium, Brussels, has two programs in English, which have both been received at fair level. They are from 2205 to 2215GMT on 9550, 9615, 11715KHz, and 0050-0100GMT using 6125, 9615 and 11715KHz, to North America.

FINLAND: Radio Finland in Helsinki has transmissions in English as follows:

To Europe 1800-1830GMT 15185, 11805, 9550KHz.

To North America 2300-2330GMT 15185KHz

GERMANY (WEST): Radio Free Europe is received now with popular music programs and announcements in English. A recent issue of "Contact," published in Britain, gives reception as 1410 to 1500, and 1510 to 1600GMT on 5985, 7115, 9595, 11815, 15170 and 17770KHz.

AFRICA

RHODESIA: The Rhodesian Broadcasting Corporation has replaced 4828 and 5012KHz with 3306 and 3396KHz. The station has been heard in New Zealand at 1745GMT on 3396KHz. A new station at Manica is on the air 1500-1600GMT, on the medium-wave frequency of 980KHz.

SEYCHELLES: The first British-built missionary radio is now testing from Seychelles. The new station is used by Far East Broadcasting Association Ltd., and has programs beamed to India, Pakistan and Ceylon. The transmitter power is 3000W, and is using 15165, 17755 and 21475KHz. A 38-foot periodic antenna is to be used.

BURUNDI: La Voix de la Revolution,

Art Cushen's Tour

(Continued from page 18)

Nearby, another transmitting site is being constructed to serve South-West Africa, and also to carry the S.A.B.C. programs for internal reception. Seven new 100KW transmitters are being installed, and the existing 20KW transmitters from Paradys are to be shifted to this site. The old Paradys station will then close. The S.A.B.C. operations are now carrying 17 different programs on medium wave and VHF/FM as well as the external service.

This summary of our fascinating tour must of necessity be brief and incomplete, but it would be a major omission not to mention some of the personalities met in various countries. In Los Angeles we spent some time with August Balbi, who, at 78, is one of the world's most active listeners. In Detroit, Bill Matthews came up from Huston, Pennsylvania, to spend a day with us. In Holland we attended two meetings, one at Maarten van Delft's home and the other at the canteen of Radio Nederlands with the Benelux Club. In Sweden we met many DX organisations, in Denmark we had a meeting with the Danish Short-wave Club at the home of Anker Petersen, and in Switzerland we met some listeners. While on our return journey via Perth, we stayed with Dallas McKenzie, and had a meeting with the West Australian branch of the Australian Radio DX Club.

The knowledge gained and the contacts made will enable me to provide even more detailed and comprehensive information in the "Listening Around the World" pages in the future, as the stations have a better understanding of the help that the shortwave listener can be in improving their service for reception in the Pacific area.

Bujumbura, has been received in New Zealand at 0420GMT. Reception by Tony Marr of Auckland has been during a broadcast in French. Reports from Europe state the signal can also be heard from 1900 to 2100GMT when they sign off, the frequency 6140KHz now being clear of the interference formerly noted from Madrid. The station has news in French at 2050GMT and uses French and local languages in its transmission.

SUDAN: Reception of the Omdurman transmitter has been observed in England for the entire broadcast period 0400-2200GMT, using the new frequency of 15270KHz. The signal on 4995KHz is still received at 0500GMT and again at 1800GMT with programs in Arabic.

GHANA: Radio Ghana at Accra is reported from Switzerland as being received on the new 6130KHz channel, using 100KW. Best reception is 1900 to 2200GMT, and the service at this time is beamed to West Africa.

ASIA

CHINA: Radio Peking is using the frequency of 9585KHz at 2130GMT, with a service in the Russian language. The station suffers from interference from Paris, France, which also is using the same frequency for its Arabic service. Peking has also been heard in Russian, opening a service at 1100GMT and using 11775KHz.

PHILIPPINES: The Philippine Broadcasting Company, Manila, using 3286KHz, has been received at better level, with best reception at 1100GMT. News in English is heard at this time, and also on the parallel channel of 6170KHz. Bob Padula, of Melbourne, reports FEBC Manila has made a frequency change and is now heard on 7245KHz at 1040GMT when the broadcast is in Chinese. The same program has also been noted on 11855KHz.

NORTH KOREA: Radio Pyongyang is using 4770KHz, and has been observed with the home program in Korean at 1030GMT. The English program from Pyongyang is 1100-1200, 1400-1500GMT, on 11765, 9615KHz. French is 1500-1600 and 0800-0900GMT, on 15520, 6540KHz.







SOUTH KOREA: The Republic of Korean Army Station, Voice of Hope, is still received 1200-1300GMT on 6190KHz with Korean programs, and no English is now observed in the transmission. Seoul, with the Voice of Free Korea program has been noted in Perth by Dallas McKenzie as opening at 2100GMT in English on 9640KHz. Other times of English in the General Service are 0500 and 1100GMT.

INDIA: All India Radio in Delhi has changed the times of the French programs to Europe and Near East. The new schedule is 1845-1930GMT using 9912 and 11805KHz.

(Continued on page 180)



BARGAIN PACKS!

<p>SEMI-CONDUCTOR PACKS. BRAND NEW AND TESTED SILICON AND GERMANIUM</p> <p>10—RF Type Similar AT325, BF115, AY1101 . . . \$2.95</p> <p>10—Audio Type Similar AT326, BC108 . . . \$2.95</p> <p>10—Audio Output. Matched Pairs . . . \$3.25</p> <p>1—NPN Output. 2N3055 / BDY20 . . . \$2.00</p> <p>5—Pair Complementary Output . . . \$3.25</p> <p>1—PNP RF 1F Type SIM AF116, AF117 each60 or 10 for . . . \$5.00</p> <p>1—PNP Power Output SIM 2N301 and 2N2148 . . . \$1.30</p> <p>1—PNP Audio Similar OC7050</p> <p>FET'S</p> <p>MPF 102 . . . \$1.10</p> <p>MPF 105—2N5459 . . . \$1.10</p> <p>MPF 106—2N5458 . . . \$1.30</p> <p>2N3819 . . . \$1.10</p> <p>SILICON RECTIFIERS</p> <p>50V. 100V. 200V. 400V. at 36c ea. 600V. 55c. 800V. 60c. 1,000V. 95c.</p> <p>DIODES</p> <p>OA90 Type, 27c ea. or 10 for . . . \$2.50</p> <p>OA91 Type, 27c ea. or 10 for . . . \$2.50</p> <p>Similar BA100, 21c ea. or 10 for . . . \$1.90</p> <p>BA100, ea27c</p>	<p>SOLDER SPECIAL!! RESIN CORED "SUPER FAST" 2 1/2lb Reels ONLY . . \$2.75</p>  <p>Peak 7W Stereo Amplifier, 50-20,000 Hz. In oiled timber cabinet. \$34.50 complete.</p> <p>STEREO HEADPHONE SPECIAL</p>  <p>BRAND NAME — 8 Ohm Wide Range. \$6.00.</p> <p>PIONEER Speakers, 15in. Guitar-type, 60-watt. \$30 each.</p> <p>RECORDING TAPE, POPULAR MAKE AT WHOLESALE PRICES</p> <table border="0" style="width: 100%;"> <tr><td>3in 150 ft</td><td>.50</td></tr> <tr><td>3in 225 ft</td><td>.70</td></tr> <tr><td>3in 300 ft</td><td>.85</td></tr> <tr><td>5in 600 ft</td><td>\$1.80</td></tr> <tr><td>5in 900 ft</td><td>\$1.98</td></tr> <tr><td>5in 1200 ft</td><td>\$2.50</td></tr> <tr><td>7 1/2" 1200 ft</td><td>\$2.55</td></tr> <tr><td>7in 1200 ft</td><td>\$3.00</td></tr> <tr><td>7in 1800 ft</td><td>\$3.25</td></tr> <tr><td>7in 2400 ft</td><td>\$4.75</td></tr> <tr><td>7in 3600 ft</td><td>\$6.75</td></tr> </table> <p>PHILIPS TYPE CASSETTES</p> <table border="0" style="width: 100%;"> <tr><td>C60 60 Min</td><td>\$1.65</td></tr> <tr><td>C90 90 Min</td><td>\$2.65</td></tr> <tr><td>C120 120 Min</td><td>\$3.30</td></tr> </table> <p>MURATA CERAMIC FILTERS</p> <table border="0" style="width: 100%;"> <tr><td>BF 455A ea.</td><td>.32</td></tr> <tr><td>SF 455D ea.</td><td>.75</td></tr> </table> <p>ALL COMPONENTS, TRANSISTORS AND DIODES AT SPECIAL PRICES. SEND S.A.E. FOR DETAILS.</p>	3in 150 ft50	3in 225 ft70	3in 300 ft85	5in 600 ft	\$1.80	5in 900 ft	\$1.98	5in 1200 ft	\$2.50	7 1/2" 1200 ft	\$2.55	7in 1200 ft	\$3.00	7in 1800 ft	\$3.25	7in 2400 ft	\$4.75	7in 3600 ft	\$6.75	C60 60 Min	\$1.65	C90 90 Min	\$2.65	C120 120 Min	\$3.30	BF 455A ea.32	SF 455D ea.75	<p>SPECIAL!!!! 1st RELEASE! 8 TRANSISTOR RADIO KIT! USES SILICON TRANSISTORS AND DIODES. COMPLETE WITH INSTRUCTIONS. Carrying Case and earphone \$16.50. Wired Tested \$18.50. Post & pack, 75c.</p>  <p>ELECTRONIC PROJECT BROADCAST TRANSISTOR RADIO KIT with Speaker. \$11.25.</p> <p>NEW 1969 TRANSISTOR RADIO KIT</p>  <p>6 Silicon Transistors and complete with instruction book, carrying case and earphone. Special Price . . . \$11.25</p> <p>Wired . . . \$13.50</p> <p>Post and Pack 75c.</p>  <p>BOYS' CRYSTAL SET KIT Complete with Plastic Cabinet, earphone and instructions . . . \$2.50</p>  <p>TRANSISTOR MODULES 10 Watt RMS, 25W RMS. 65W Hi Fi Amplifiers. Pre-amp Tone Control Stage, etc. REDUCED PRICES. SEND FOR NEW PRICE LIST.</p>
3in 150 ft50																																	
3in 225 ft70																																	
3in 300 ft85																																	
5in 600 ft	\$1.80																																	
5in 900 ft	\$1.98																																	
5in 1200 ft	\$2.50																																	
7 1/2" 1200 ft	\$2.55																																	
7in 1200 ft	\$3.00																																	
7in 1800 ft	\$3.25																																	
7in 2400 ft	\$4.75																																	
7in 3600 ft	\$6.75																																	
C60 60 Min	\$1.65																																	
C90 90 Min	\$2.65																																	
C120 120 Min	\$3.30																																	
BF 455A ea.32																																	
SF 455D ea.75																																	

INTEGRATED CIRCUITS

FAIRCHILD—Flip Flop, etc. PHILIPS—Pre-amp and Tape

MOTOROLA.

G.E. 1 Watt RMS.

G.E. 2 Watts RMS.

G.E. 5 Watts RMS.

B.H.A. SPECIAL 15W RMS.

Prices on application. State requirement.

UNIT 10—With RF Stage and Power Supply 8KHz band-width — \$31. Plus tax.

TRANSISTORISED TUNERS NEW WIDE BAND TNER Based on Playmaster Design. Ceramic Filters, Tuning Meter, Whistle Filter, etc. \$62 plus tax. Teak Cabinet \$6 extra.

S. E. WILLIS TRADING CO.

38 Riversdale Road, Camberwell Junction, Vic., 3124.
Phone 82-5787, Please Include Freight Sorry No C.O.D.



WEEKENDS & AFTER HOURS 98-5956.

136 VICTORIA ROAD MARRICKVILLE - 51-3845

K 20
CT330



K 20
CT500

C.T. 330 20K OPV
D.C. Volts, 6, 6, 30, 120, 600, 1,200, 3,000, 6,000. A.C. Volts 6, 30, 120, 600, 1,200. D.C. Current .06-6, 60, 600mA. Resistance, 6K, 600K, 6meg., 60meg. D.B. minus 20 to plus 62. 5 Ranges. Specially suitable for transistor use.
\$16.45

C.T.500 20K.OPV
D.C. Volts, 2.5, 10, 50, 250, 500, 1,000. A.C. Volts, 10, 50, 250, 500, 1,000. D.C. Current, .05, 5.50, 500mA. Resistance, 12K, 120K, 1.2meg., 12meg. D.B. minus 20 to plus 62.
\$13.25

KAMODEN-100B
100,000 O.P.V.
D.C. Volts, .5, 2.5, 10.50, 2.50, 500, 1,000.
A.C. Volts, .25, 10.50, 250, 500, 1,000.
Mills., .01, .25, 2.5, 25, 250, 10A. Res., 20K, 200K, 2M, 20M:OHM. D.B. minus to 20 plus 62. 5 Ranges.
\$29.75 post \$1.00

P.T.34 1000.OPV
D.C. Volts., 0, 10, 50, 250, 500, 1,000.
A.C. Volts, 0, 10, 50, 250, 500, 1,000.
M.A. 1-100-500 RESISTANCE.
\$5.50 Post 50c

200H 20K.OPV
D.C. Volts, 5, 25, 50, 250, 500, 2,500. A.C. Volts, 10, 50, 100, 500, 1,000. D.C. Current, 50uA, 2.5, 250mA. Resistance, 6K, 600K. Capacitance, 2 D.B. Ranges.
\$10.95 Post 50c
Full range of Kalse-S.K. brand at Special Prices.
Send for details.
ALL PRICES NET, INC. S-TAX

PANEL METERS



EDGE METERS: 1mA, Scaled V. U.S. Tuning Stereo Bal. \$2.50. A FULL RANGE OF UNITS. 85 Types, 1 1/4in to 3 1/4in. FROM \$3.25. Send for full list.

HI-FIDELITY TWIN CONE SPEAKERS
Aust. made, 8 to 16 ohms.
6in .. \$9.00 12in .. \$11.75
8in .. \$7.50 Postage:
8in .. \$9.00 N.S.W., 50c.
10in .. \$10.75 Interstate 80c.

AMPLIFIERS
Public Address Range
240V-AC



MINIATURE P.A. AMPLIFIER 15 WATTS OUTPUT
Multi Match Ferguson O.P. transformer input for crystal mike and pick-up with electronic mixing P.P. EL-84 output ... **\$42.50**
30 Watt. As above, EL-34 P.P. ... **\$57.50**
40 Watt. As above, EL-34 P.P. ... **\$85.50**
60 Watt. As above, 6DQ6 P.P. ... **\$105.50**

LINE OR VOICE COIL

SOLID STATE 240V A.C.
20 Watt ... **\$49.50**
50 Watt ... **\$69.50**
50 Watt 240 A.C. plus 12V. D.C. Plus Self Battery Charging. **\$95.00.**

All have inputs for 2 microphones or 2 Magnetic or Crystal P.U. With Mixing.

P.A. SPEAKERS
8 WATT.
8in Units in Waterproof Projection Horns. 15 Ohm Voice Coils.
\$15.25
In Double-ended Flares. Duolateral Coverage.
\$17.25

Line Output Transformers to suit. **\$1.75 extra.**

DYNAMIC MICROPHONES



Model UDM-105 CARDIOID (Uni-directional)
Impedance: High 50K ohms—Low 600 ohms. Sensitivity: -60db/1,000 cps. Frequency Response: 150-10,000 cps.
\$16.95



Model DM-108 (Uni-directional)
Impedance: 50K ohms. Sensitivity: 57db/1,000 cps. Frequency Response: 100-10,000 cps.
\$11.95

KEYLESS ORGAN
Complete Kit Set, \$42.50. Wired, Tested, Tuned, \$49.50. Post \$1.00.

4 CHANNEL TRANSISTORISED MICROPHONE MIXER

Specs. High imp. input. Gain. Approx 3DB. Max. input sig. 1 volt max. output sig. 1-3-volt noise ratio 60dB, 9-volt operation.
\$9.95

REVERBERATION UNITS

Latest design to suit organs, stereo, guitar, any hi-fi equipment.
\$5.75
Post 35c.

50 WATT SOLID STATE GUITAR AMPLIFIER

E.A. July & August Issue. Kitset, including Cabinet.
\$98.00
Wired and Tested, **\$114.00**
Speaker Enclosures to suit **\$104.00**
4 MS.P. Speakers, **\$94.00**
2 Pioneer 15in Speakers.

MICROPHONE GOOSE NECKS. SATIN

9in ..	\$2.75	MIC. STAND,
12in ..	\$3.50	Floor Model,
18in ..	\$4.35	\$11.75,
24in ..	\$5.00	Table mod \$3.65

STEREO RECORD CHANGERS

Latest Model, 4-speed.
\$28.75
De Luxe Model. Fully machined and balanced. Heavyweight turntable. Ceramic Cartridge.
\$34.00
Post: N.S.W. \$1.25. Interstate \$1.75.
De Luxe Model with mechanical cueing device. Calibrated stylus. Pressure control. Adjustable counter balance. Two spindles.
\$46.50

ELAC 190 4-Speed Changers. Ceramic pick-up.
\$27.50

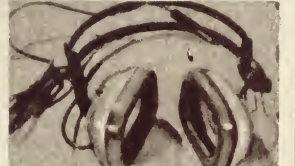

HI-FI STEREO HEADPHONES
8 OHMS. Range 25c to 17 Kc.
\$9.75
Post 35c.

240V VARIABLE POWER
Units,
0 to 20V. 1 Amp. Fully Transistorised. **\$21.50.**

TAPE CASSETTES
TENSILISED MYLAR

C 60	\$1.65
C 90	\$2.45
C120	\$3.25
Head Cleaners	\$1.75
Post. 10c per unit.										

CO-AXIAL SPEAKER

12in 2 ohms, 20 watts, Cross over, 3,000 cycle. Frequency range 40 to 20,000 cycles.
\$27.75

V.T.V.M. MODEL TE-40 MILLIVOLTER
Spec. A.C.V. Inv.—300 Vrms, 10 ranges. Accuracy 5 cps-1 2 mc, plus-minus 2db, 10 cps-1 mc, plus-minus 1db, 20 cps-250 KC, plus-minus 0.2db.
dB. Scale: 40-30-20-10-0, 10-20, 30-40, 50 dBm, 240 V.A.C.
\$48.75

MODEL TE-65 V.T.V.M.
DC, V. 0-1, 5-5.15-50-150-500-1,500 V. Rms. A.C.V. 0-1.5-5-15-50-150-500-1,500. V. Rms. 0-1-4-14-40-140-400-1,400-4,000 V. P.P. Resistance: RX10, 100, 1K, 10K, 100K, 1M, 10M, Decibel—100db, minus-plus 65dB.
240 V.A.C.
\$43.75
TECH. P.V. 58, \$40.50.

ORGAN KEYBOARDS

49-Note. Complete with Switching System.
\$72.00
13-Note. Pedal Claviers, Complete with Switches.
\$39.95
SPECIAL: Semi-finished Stromberg Organ Cabinets to suit above.
\$19.50
Organ Stools ... **\$14.50**

NEW SPEAKER SPECIALS

2in	..	\$2.75	8 to 15 ohms.	4 x 2in	..	\$3.30
2 1/4in	..	\$2.75		5in x 3in	..	\$3.30
2 3/4in	..	\$2.85		6in x 4in	..	\$3.50
3 1/4in	..	\$2.85		7in x 4in	..	\$4.25
3 1/2in	..	\$2.95		9in x 6in	..	\$5.95
5 1/4in	..	\$3.20		N.S.W. 25c,		
6in	..	\$4.00		Interstate 40c.		

NEW RECORDING TAPE

Most Popular Brand

3in Correspondence	..	50c
3in Mylar L.P. 300ft	..	\$1.05
3 1/4in Mylar D.P. 600ft	..	\$1.25
5in Mylar L.P. 900ft	..	\$2.50
5in Mylar D.P. 1200ft	..	\$3.15
5 1/4in Mylar L.P. 1200ft	..	\$3.15
5 3/4in Mylar D.P. 1800ft	..	\$4.70
7in Mylar L.P. 1800ft	..	\$4.70
7in Mylar D.P. 2400ft	..	6.25
7in Mylar T.P. 3600ft	..	\$7.00
7in P.V.C. 1200ft	..	\$2.50
Postage: N.S.W. 15c. Interstate 25c.		



GUITAR AMPLIFIERS

10-Watt, Two-Channel, with Twin Cone Speaker . . . \$53.55
14-Watt, 4 Inputs, Bass and Treble Boost, 2 Twin-cone Speakers, \$63
17-Watt, 4-Channel, Bass and Treble Boost. Two Twin-cone Speakers . . . \$76.25

35 WATT

4-Channel, Bass and Treble Boost, 4 Twin-cone Speakers . \$109.05
Vibrato with foot control and 2 preset controls for frequency and intensity. \$10.50 extra on above models.

ELECTRIC GUITAR

Pickup Units . . . \$8.75
Accordion Pickup Units . . . \$8.75
Harmonica Pickup Units . . . \$1.95
Post: N.S.W. 40c, Interstate 75c.

FUZZ BOX

FUZZ BOX, E. AND A. AUG. WIRED AND TESTED. \$15.
Post 75c.

REVERB UNIT

COMPLETE WITH AMPLIFIER. E.A. October Issue. Kitset \$39.95. Wired and tested, \$41.95.



MULLARD MAGNAVOX

BOOKSHELF ENCLOSURE

Maple, Teak or Walnut Complete \$24.75
SUPER BOOKSHELF \$36.75.

Post: N.S.W. 50c, Interstate \$1.00.

CABINETS ONLY. R.H. BOOKSHELVES, \$11.50. MULLARD, \$10.95.

BOOKSHELF UNITS

6in 8in 10in 12in
\$27.75 \$33.50 \$35.50 \$36.50

PLAYMASTER 106 AND 107



Feb. and March Elect Aust. 106

WIRED AND TESTED \$94.75

107

WIRED AND TESTED \$83.75

SOLID STATE VTVM

E.A., Dec. Wired, Tested. \$49.50

PIGGY BACK GUITAR AMPLIFIER

Excluding Speakers

30 Watt . . . \$79.75
45 Watt . . . \$89.75
60 Watt . . . \$119.75
4 Inputs, Bass and Treble Boost Vibrato if required, \$10.50 extra.

PIGGY BACK GUITAR AMPLIFIER

Complete with Speakers & Cabinet
30 Watt Lead . . . \$138.75
30 Watt Bass . . . \$146.75
45 Watt Lead . . . \$158.75
45 Watt Bass . . . \$166.75
50 Watt Lead . . . \$218.00
60 Watt Bass . . . \$234.00
Vibrato if required extra \$10.50

14 pus 14 WATT

With Reverberation. May be used as 28-watt or as 14-watt plus 14-watt Reverb. Two 9 x 6 Woofer Speakers, Two 9 x 6 Twin-cone Speakers, 4 Channels, Bass and Treble Boost. Foot Vibrato control included.

\$163.50

UA 41A - 20-20

SOLID STATE STEREO
20 watts per channel. Inputs for tape, magnetic and ceramic P.U. Tuner and aux. Teak cabinet.

\$88.00



119 STEREO TAPE ADAPTER

Suits all Playmaster Stereo amplifiers and others that accept crystal P.U.

Kitset . . . \$79.00
Wired and tested . . . \$96.00

TAPE DECKS B.S.R.

2 Tracks, 3 1/4 i.p.s. \$25.50

4 Track, 3 Spd Stereo. \$41.50



240v A.C. POWERED SOLID STATE STEREO

T.S.138

18 Transistor, 15-watt per channel. Inputs for Tape, Mag. P.U., Ger. P.U., Radio Aux., Freq. Range 30c to 20KC. Max. Sensitivity 3 MV. Speaker matching 4 to 15 ohms.

\$78.00

SONATA

SOLID STATE STEREO AMPLIFIER

20 WATT R.M.S. PER CHANNEL
Inputs for mics, Magnetic & Ceramic Pick-ups, Tuner & Tape Heads. Outputs to 8V Speakers & S.H. Phone Controls, Bass, Treble Balance, Volume Loudness, Top and Low Filter.

\$89.50

11 1/2" FULLY BALANCED PICK UP ARM

COMPLETE WITH MAGNETIC Stereo Cartridge . . . \$19.50
Arm less Cartridge . . . \$11.50
Mag. Cartridge only . . . \$9.50

WIDE BAND OSCILLOSCOPES

SPECIFICATIONS

VERTICAL AXIS

Deflection Sensitivity (at 1 kc) 0.1 V p-p/cm.
Frequency Characteristics, 1.5 cps—1.5 MC.
Input Impedance, 2 M ohms 25pF.
Calibration Voltage IV p-p/cm.

HORIZONTAL AXIS

Deflection Sensitivity 0.9V p-p/cm.
Frequency Characteristics 1.5 cps—800 KC.
Input Impedance 2 M ohms 20 pF.
Sweet Oscillator (5 Range) 10 cps—300 KC.
Synchronisation Devices Internal (Positive and Negative, External).
Power 240v AC 50/60 cps.
Cathode Ray Tube 3KF1F.



5 Meg Bandwidth Push-Pull vertical and Horizontal Amplifiers, 8 positions, high sensitivity, vertical Amplifier Frequency Compensated on all positions. Calibrated .02 to 600 volts. Hard time base, 20 cycles to 75K. Latest American R.C.A. circuitry. Complete with probe.

3-inch \$102.75;

5-inch \$118.75

PLAYMASTER 115

The new Solid State Stereo-Amplifier. April Issue.
Wired and tested . . . \$104.00
Kit Set . . . \$90.00
Pre-amp to suit magnetic Cartridge . . . \$12.00



10 PLUS 10 STEREO AMPLIFIER

E.A. November.

Kit Set . . . \$59.75
Wired and tested . . . \$69.75



T.O. 2" OSCILLOSCOPE

IDEAL TV AID

240V-AC, 2 BPI CRO Tube
Vert Sen. 10V P-P/CM. 50V P-P/CM.
Vert Input Imp. 2 Meg. 25pf
Vert Freq. 2 cps/1 Meg. 3DB.
Sweep Freq. 2 ranges, 60 cps—75 KC.
\$64.50.

SIGNAL GENERATOR

De Luxe Model TE20D.
Freq. Range 120 KC—500 Mcs. 7 Bands. Accuracy 2 per cent. Output 8V. Provision for Xtal Suitable for self-calibration Marker generator. Printed circuit. 240 T.E.20. \$25.50. \$28.50
V.A.C.

15-INCH HI-POWER SPEAKER

Imported 30 Watts R.M.S. \$30.00
Local 50 Watts R.M.S. . . \$50.00

L.S.G. 11 SIGNAL GENERATOR

FREQ. RANGE IN 6 BANDS
120KC—130MCS.
Calibrated Harmonics.
120MCS—390MCS.
R.F. Output over 100,000UV.
120KC—38MC.
Mod. Freq. 400 and 1000CPS.
Crystal Osc. 1.15MCS.
A.F. Output, 3 to 4 Volts.
A.F. Input, 4V approx.
240 V. A.C. Operation.
\$31.75. Post 75c.

T.E. 46 RESISTANCE-CAPACITANCE

Bridge and Analyser.
Capacity 20pf to 2000mf.
Resistance 2 ohms to 200 megs.
Also tests power factor, leakage, impedance, transformer ratio, insulation resistance to 200 megs. at 600V.
Indications by eye and meter.

\$49.75

VOLT. A.C.

VARIABLE TRANSFORMER.
0-260V, 10 amp. . . \$49.50
0-260V, 5 amp. . . \$37.50
0-260V, 2 1/2 amp. . . \$25.50

AUDIO GENERATOR

De Luxe Model TE—22D.
Freq. range, Sine 20 cps—200 KC. SQ. 20 cps—25KC. Output voltage—Sine 7V. SQ. TV P-P. Output Impedance 1000 ohms. Acc. 5 per cent. Distortion less than 2 per cent. 4-range attenuation. 1/1, 1/10, 1/100, 1/1K. Printed circuit. 240V A.C.
\$42.95

SIGNAL INJECTOR

Transistorised. Fountain pen-sized Unit for Signal Tracer in Radio, TV and Amplifier Service.
\$5.75. Post 25c.

TRANSISTOR AND DIODE TESTER

E.A. August, '68.
Wired and Tested.

\$57.00

KIT SET \$48.00

G.D.O. UNITS

Post: N.S.W. 50c, Interstate 75c.
T.E. 15 Transistorised, 7 Band, 360 Kc to 270 Mega.

\$35.75

TV BOOSTER

240VAL. Especially designed for fringe area reception. Also up to 3 TV sets can be operated off common aerial for improved signal strength.
\$15.95 Post Free.

NEW GRAMMO MOTORS

240V. A.C.
3 Speeds, \$2.75.
Post: 40c.

INTER. COM. UNITS

2 Station Transistorised. \$11.95
4 Station, including Master. \$20.95

REALISTIC PERFORMANCE REALISTIC PRICE



REALISTIC DX 150

ALL SOLID STATE - 4 BAND

COMMUNICATIONS RECEIVER

A big professional looking set that makes exciting news for amateurs . . . the DX150 gives realistic reception on SW/CW/SSB/AM-Broadcast bands; obsoletes tube receivers with their warm-up delay; banishes dependence on AC main power . . . the DX150 will run on dry cells if current fails or is not available; will operate from a car's cigarette lighter or any 12V DC service. 240V AC power supply is built-in, of course.

Over 30 semi-conductors—Product detector for SSB/CW, plus fast and slow AVC—variable pitch BFO—illuminated electrical bandspread fully calibrated for amateur bands—Cascade R.F. Stage—ANL for RF and AF—Zener stabilised—OTL audio—illuminated "S" meter—Built-in monitor speaker plus front panel jack for external (optional) matching speaker.

Attractive silver extruded front panel, solid metal knobs, grey metal cabinet, size 14 1/2" x 9 1/4" x 6 1/2". . . a truly Realistic performer at a realistic price.

\$229.50

Brings in the
whole wide world of
SW/CW/SSB/AM-
Broadcast

240V AC or 12V DC
operation.

CONSULT YOUR LOCAL RADIO DEALER, OR

MAIL THIS COUPON *today*

Please forward free illustrated literature and specifications on Realistic.

Name

Address



(A unit of Jacoby Mitchell Holdings Ltd.)

376 EASTERN VALLEY WAY, ROSEVILLE, N.S.W.
Cables and Telegraphic Address: 'WESTELEC,'
Sydney, Phone: 40 1212

THE AMERICAS

ECUADOR: HCJB, Quito, is on the air to North America 0200-0500GMT, with 11795KHz instead of 11765KHz. The service on 11915KHz has been moved to 15255KHz, while 15115KHz is now replaced by 15325KHz. News in English is on the air 2330GMT when on 11765KHz. To the Pacific, HCJB is using 11765KHz at 0700 to 1000GMT as an additional frequency to the present 6050, 9754, 11915 and 15325KHz channels.

NICARAGUA: Radio Nacional at Managua, using the channel of 11875KHz, is reported by Phillip Boulton of Wellington, N.Z., at 0400GMT. This new government station is also using 5935KHz and medium wave 620KHz, as well as an FM outlet.

COSTA RICA: Signals from TIRICA on 9615KHz, broadcasting from San Jose, have been received at good level with English at 0400GMT. Tony Marr of Auckland N.Z. reports good signal at this time of reception.

BROADCAST BAND NEWS

COOK ISLANDS: The power of ZK1ZC, Raratonga, using 600KHz, has recently been increased to 10KW. The station is now providing a good signal in the South Pacific area, and best reception is at sign-on at 1630GMT. Sign-on is later on Sunday. The increase in power has resulted in the deletion of the former transmission on 820KHz on ZK1ZA.

NEW ZEALAND: The newly constituted New Zealand Broadcasting Authority has called for applications for new radio stations in Auckland, Hamilton and Dunedin to be operated by private organisations. Two private commercial radio stations for Auckland will have the power of 5KW, while one station for Hamilton and one for Dunedin will use 2KW. Six applications for the Auckland licences, two for Hamilton, and four for Dunedin, have been received and hearings are pending on the processing of the applications.

AUSTRALIA: One of the Australian Broadcasting Commission stations in Western Australia recently made a frequency change. This is 6CA Carnarvon, which has moved from 720 to 850KHz. Signals in New Zealand have been observed at 1600GMT sign off.

HAWAII: It is hoped to have KHAI back in operation on 1090KHz shortly, broadcasting from Honolulu as it did in the past. The station, which has been silent for some weeks due to delinquent taxes, was sold by the State. The new station will have the power of 10KW. Another new station is KBAY, using 1570KHz with the low power of 12W. This station is located on an American air station, 10 miles from downtown Honolulu. Sign-on is at 1600GMT, the only time reception would be possible in the South Pacific.

NORFOLK ISLAND: Radio VL2NI, Norfolk Island Broadcasting Service, has now discontinued its evening broadcasts reports the "New Zealand DX Times." The station plans to increase power to 50 watts later this year. Present hours of transmission are Sunday and Tuesday 2130-0030, Monday, Wednesday, Thursday 2130-2215GMT.

MISARAH ISLAND: The two new BBC relay transmitters, both with the power of 750KW, have been received and subsequently verified by A. Mervyn Branks of Invercargill, N.Z. His reception was around 1700 to 1800GMT. The signals on 701KHz were received with Arabic programs. The World Service was on 1412KHz, but this was mixed with the program of 2KO Newcastle, N.S.W., on the adjacent channel of 1410KHz. ■



ANSWERS TO CORRESPONDENTS

NICKEL-CADMIUM CELLS: I read in a recent copy of "Electronics Australia" of the characteristics of nickel-cadmium cells. I was interested in this because I own a shaver operating from these cells and fitted with a built-in charger. The shaver is only about eight months old but it suddenly gave up the ghost and would operate only weakly. I tested the cells with a voltmeter and one showed about 1.2 volts, which I believe is normal, and the other showed only a slight deflection and of reverse polarity. From what I had read I decided to try an experiment. I have a six volt, four amp charger and I connected the negative terminal of this to the negative side of the cell and the positive side of the charger to the positive battery terminal with a six volt, 0.15A dial lamp in series. I charged the cell with this set-up for 15 minutes, after which it worked OK and has done so ever since. I now leave the unit connected to the mains for much longer periods. I heard of another case similar to this, except that the person concerned bought a new set of cells. (C.F., West Heidelberg, Vic.)

● Thank you for your letter C.F. and we are publishing the essential portion for the benefit of other readers who may have a similar problem. It is not possible for us to say precisely what caused this situation, but we imagine that it was a simple case of too much work and too little charging, plus the fact that one cell needed a few cycles to bring it to full capacity. It is possible that the same result could have been obtained from the shaver's own charger, but would have taken a good deal longer. In any case, apparent premature failure of these cells is well worth reporting to the (cell) manufacturer. In most cases it will be shown that the cell can be revived. If not, and the cell is really defective, it will most likely be replaced.

TRANSISTOR EQUIVALENT: When I examine the output waveform, either square-wave or higher frequency sine wave, from my Transistor Audio Generator (December 1967-January 1968) on my 3-inch Oscilloscope (May 1966), there is pronounced overshoot. Could you advise whether this is likely to be in the generator or in the oscilloscope. With reference to the former, when constructing the unit I could not obtain the 2N3569 transistor but have used the type AY1118 which I was advised was a near equivalent; could this be having some effect? Incidentally, I too am looking forward to your describing a higher power transistorised stereo amplifier — say one capable of delivering about 20 watts per channel. Keep up the good work, though, and rest assured that your magazine has at least one enthusiastic regular subscriber over here. (L.P.G., Upper Hutt, New Zealand.)

● It seems very unlikely that the overshoot is originating in the audio generator or square-wave converter, L.P.G.; we think it much more likely that the input attenuator of your oscilloscope is a little overcompensated. If you have no other source of overshoot-free square waves or pulses for reference, we would suggest that your best plan would be to

regard the generator-converter output as correct, and adjust the frequency compensation capacitors of the oscilloscope attenuator to display the waveforms as such. As far as we are aware the AY1118 transistors which you have used in place of the 2N3569 devices specified for the generator, are quite suitable, and should not affect operation. We note your support for a 20W-per-channel transistor stereo amplifier. However while we have plans for the development of such a project in the near future, at the moment it is too early to predict when we will be able to publish details. Thanks for your compliments regarding the magazine.

TRADE LITERATURE: You mention in "Basic Electronics" in Chapter 20 that there is a great deal of literature available from valve companies at little or no cost. One example you give is the RCA publication "Receiving Tube Manual." Could you please tell me how I can obtain this and similar publications? Also, can you tell me where I can obtain a copy of the book "Amateur Radio Handbook" published by the Radio Society of Great Britain. (B.H., Bairnsdale, Vic.)

● Other than publishing a complete list of Australian valve and transistor manufacturers and of representatives of overseas companies, we can only suggest that you examine advertisements to discover the addresses of these companies. The books we have specifically mentioned in Chapter 20 should all be available through any technical bookseller. However, in the event of difficulty, the "RCA Receiving Tube Manual" is available from Amalgamated Wireless Valve Co. Pty. Ltd., Private Mail Bag, P.O. Ermington, N.S.W.

2115. The "Miniwatt Technical Data" is published by Miniwatt Division, Philips Electrical Pty Ltd., 20 Herbert Street, Artarmon, N.S.W. 2064. If you are interested in the "De Muiderkring Tube Handbook," this was reviewed in our October, 1968 edition of "Electronics Australia" with our review copy being supplied by H.W.C. Blyth and Co., 3 Kerferd Street, East Malvern, Vic. 3145. No doubt they will be pleased to help you.

AUDIO POWER MEASUREMENT. In your article "Measuring Audio Power Output" (April, 1969 issue) the final paragraph says "The final stipulation made by the British Specification is that all amplifiers should be in use for at least one hour before measurements are recorded, and that solid state amplifiers should be in use for at least two hours before measurements, to ensure that conditions in the amplifier have stabilised." I should have thought that solid state amplifiers needed a shorter time to stabilise. (J.C.R., Wallsend, N.S.W.)

● The reasons why conditions of this kind are specified in Standards documents are not usually explained. However, the main factors for the two hour settling down period could be (1) the lower heat dissipation of solid state equipment would necessitate a longer period for all components to reach uniform temperature, compared with valve type equipment, and (2) to ascertain that heat sink arrangements are adequate, and that the amplifier does not become unstable through overheating of transistors. One hour's operation is presumably not regarded as sufficient time for the second provision.

"ELECTRONICS Australia" Information Service

As a service to readers "ELECTRONICS Australia" is able to offer: (1) Photographs, dye-line prints and other filed material to do with constructional projects and (2) A strictly limited degree of personal assistance by mail or by reply through the columns of the magazine. Details are set out below:

PROJECT REPRINTS: For a 20c fee, we will supply data, as available from our files. The amount of data available varies but in no case does it include material additional to that already published in the magazine. For complicated projects involving material extracted from more than one issue, an extra fee may be requested. As a rule, requests for project data will be answered more speedily if the projects are positively identified and the request is not complicated by questions requiring the attention of technical personnel. Where articles are not on file, we can usually provide a photostat copy at 20c PER PAGE.

PHOTOGRAPHS, DYE-LINE PRINTS: Original photographs are available for most of our projects, from 50c plus 8c postage for a 6in x 8in glossy print. In addition, metalwork dye-line prints are available for most projects for 50c each; these show dimensions and the positions of holes and cut-outs but give no details of wiring.

BACK NUMBERS: A fairly good selection is available. On issues up to six months old the cost is the face value, plus 5c surcharge. From seven to 12 months, 10c surcharge; over 12 months, 20c surcharge. Package and postage is 10c extra per issue. Please indicate whether a PROJECT REPRINT may be substituted if the complete issue is not available.

REPLIES BY POST: This provision is made primarily to assist readers in matters relating directly to articles and projects published in "ELECTRONICS Australia" within the last 12 months. Note, however, that we cannot provide lengthy answers, undertake special research or modifications to basic designs. A 20c query fee must be enclosed with letters to which a postal reply is required; the inclusion of an extra fee does not entitle correspondents to special consideration.

OTHER QUERIES: Technical queries which fall outside the scope of "Replies by Post" may be submitted without fee and may be answered through the columns of the magazine at the discretion of the Editor. Technical queries will not be answered by interview or telephone.

COMMERCIAL EQUIPMENT: "ELECTRONICS Australia" does not maintain a directory of commercial equipment, or circuit files of commercial or ex-disposal receivers, amplifiers, etc. We are therefore not in a position to comment on proposed adaptation of such equipment, or on its general design. "ELECTRONICS Australia" does not deal in electronic components. Prices, specifications or other assistance must be sought from the appropriate advertiser or agent.

REMITTANCES: These must be in a form negotiable in Australia. Where the charge may be in doubt, an open cheque, endorsed with a limitation, is recommended.

ADDRESS: All requests for data and information, as set out above, should be directed to The Assistant Editor, "ELECTRONICS Australia," Box 2728 G.P.O., Sydney, N.S.W. 2001.

5/69

MULTIDRAWER

A TRANSPARENT MULTI-COMPARTMENT DRAWER
AND OUTER CASE MADE OF STRONG CLEAR PLASTIC

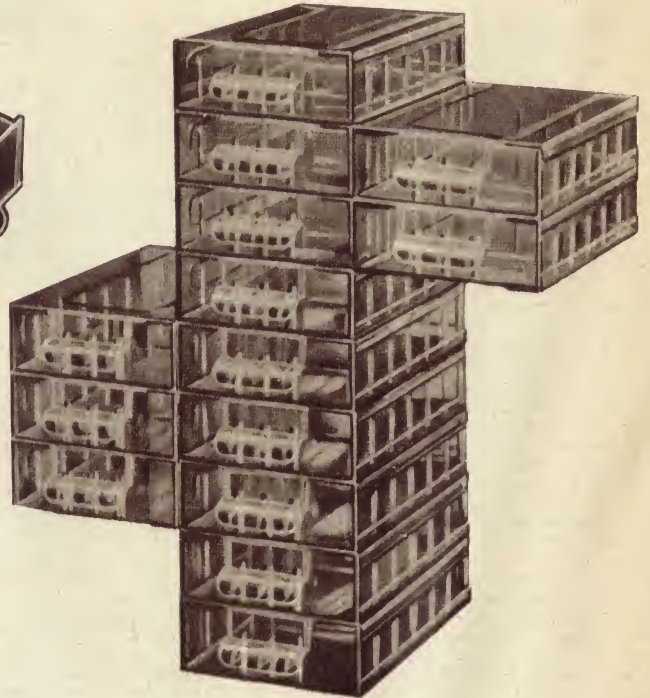
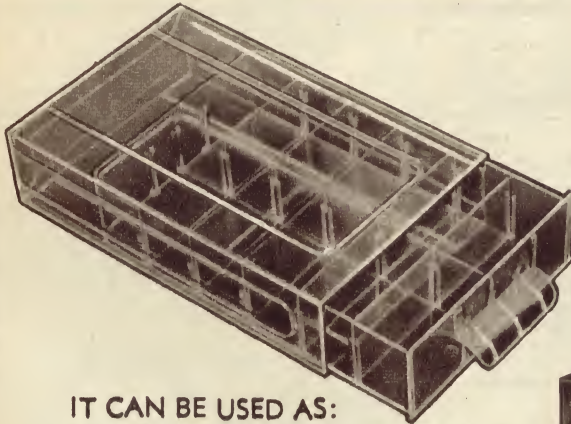

IT CAN BE USED AS:

- a self contained STORAGE BOX UNIT
 - or a MULTIDRAWER CABINET by joining the individual units
- IMMEDIATE ASSEMBLY
by sliding action
NO GLUE — NO TOOLS
NECESSARY!

Each drawer can be partitioned into 12 varieties of compartment arrangements by removable dividers.

The Multidrawer consists of a drawer sliding into an outer case. Both parts are made of strong clear plastic to ensure immediate visual location of stored articles (opaque outer case also available). The outer case has built-in integral dovetails and grooves for vertical and horizontal assembly by means of sliding the corresponding sides. This assembly is achieved instantaneously without using any tools or cement.

The drawer has built-in grooved side ribs, which allow its partitioning into 13 possible combinations of compartments by simply dropping into the grooves standard dividers, available in 4 lengths. The longest of the dividers is provided with the same ribs as the drawer in corresponding positions, to firmly hold the smaller dividers.

The dividers can be left as removable for any future rearrangement, or could be cemented in by using TRICHLORETHYLENE.

The assembled cabinet will firmly stand on any flat surface and will not require additional reinforcement.

AT HOME: as a box for sewing, jewellery, haberdashery, hair accessories, cosmetics, medicaments, fishing accessories, writing utensils, small hardware, cigarettes and cigars, photographs, colour slides and many others,

AND IN: SHOPS, OFFICES, WORKSHOPS, LABORATORIES, STORES and FACTORIES.
for visible storage of small parts and also as production assembly aid.

THE MULTIDRAWER — THE STORAGE BOX OF 101 USES

SPECIFICATIONS: Drawer — transparent. Outer case — opaque (steel grey). Dimensions—Identical for both models are: Outer Case: Length: 9 5/16", width: 6 7/16", Height: 2 3/8". Drawer: Length, 9 3/8", Width: 6", Depth: 2". Protrusions of the handle — 3/4". Weight of the unit — 12 ozs.

Also available from General Accessories Interstate Branches.

Trade Enquiries Invited

Write to General Accessories for further information and Price List.

GENERAL ACCESSORIES

(A DIVISION OF ELECTRONICS INDUSTRIES)

116-118 CLARENCE STREET, SYDNEY 443 CONCORD ROAD, RHODES — 73-0211



OUR FAMILY TREE: I refer to the query from H.P., Murwillumbah, N.S.W., on page 173 of "Electronics Australia" for July 1969. The following information may be of interest:

"Wireless Weekly," April 29, 1927: Editorial mentioned that five years had elapsed since the first issue of "Wireless Weekly" had been published and mentioned that "Radio" would appear shortly in a reorganised form.

"Wireless Weekly," July 1, 1927, continued a subscription form for "Radio in Australia and New Zealand." The Editor's address was given as 51 Castlereagh Street, Sydney, which was the same address as the Editor of "Wireless Weekly."

"Wireless Weekly," December 21, 1928: Editorial reads, inter alia: "Our Christmas greetings will take a very definite form in the next issue . . . the first of a new series . . . "Radio in Australia and New Zealand" will be incorporated in

the New "Wireless Weekly." The next issue of W.W., Dec. 28, 1928, has a cover reading "Wireless Weekly incorporating Radio in Australia and New Zealand." (E. C., Homebush, N.S.W.)

● What a memory you must have, or what files, to be able to come up with this information. We checked it against our own rather battered files and it is just as you say. Checking in old copies on file indicates that "Sea, Land and Air," the pre-1927 "Radio," and "Radio in Australia and N.Z." are all part of our family tree, along with "Wireless Weekly." If time were at less of a premium, we could probably undertake research at an historical library, but, in the meantime, what you have pointed out is interesting indeed. If we come across other copies of these journals, we will feel free to reprint from them. It also appears to answer the question raised by H.P. on page 173 of our July issue under the heading "Longest-standing subscriber." Incidentally, we can add one more piece of information: the April, 1921, copy of "Sea, Land and Air" carries the endorsement that it's the official journal of the Australian Aero Club, The Wireless Institutes of Australia and New Zealand, and the Mercantile Marine War Service Association of Australasia.

TOXIC DEGREASING AGENTS: I refer to the article "Factory Finishes for Labels and Panels" by Leo Simpson in the June, 1969 issue. In this article there is a suggestion that carbon tetrachloride should be used as a degreasing agent. While you do include a warning that it is toxic, it is dangerous even to suggest its use. I know from experience how difficult it is to stop the average workshop technician from using this material and the mind boggles at the idea of people using it in domestic situations. For some idea of the toxicity of the solvent I refer you to "Laboratory Handbook of Toxic Agents" (Royal Institute of Chemistry, London, 1961) p. 61 and to an article in "Choice," April, 1966. (D.L., University of Sydney, N.S.W.)

● Thank you for your observations on the matter. We were aware of its toxic effects—hence the warning. There is no doubt that significant exposure to carbon tetrachloride fumes can cause nausea and, in worse cases, unconsciousness and organic damage. We have never known ill-effects to occur from isolated use in a well-ventilated area but we may be taking too much for granted.

CIRCUIT VARIATION: May I first congratulate the "Electronics Australia" staff on an excellent magazine, which is easily the best in the world by comparison. I have just assembled the AF Signal Generator described in the September, 1968, issue and am very pleased with an excellent piece of equipment. However, at one place the circuit and the printed wiring board do not agree. Can you tell me if the metering circuit should be connected as shown on the circuit, or as shown on the printed wiring board. (K. J. O'Br., Frankston, Victoria.)

● The instrument will work equally well with either configuration, since the two capacitors involved are connected in series. The effect of the rearrangement is only to reverse their relative positions. The rearrangement was found to make a more convenient layout for the components on the printed wiring board.

SOLID STATE BOOK: Would you please let me know if the "Fundamentals of Solid State" course will become available in book form, similar to your "Basic Electronics"? (B.D.J.V., Sth. Granville, N.S.W.)

● It's a little early to say definitely whether we will be able to publish the series as a book, B.D.J.V., as this depends both upon the series progressing

to the appropriate point, and the degree of reader interest. Suffice to say that at the moment we hope to be able to publish the material as a book, and should be able to do so if all goes well. But, first, the series has to be completed.

THREE-VALVE RECEIVER: Have you published an article giving the constructional details of a radio using about three valves and, if possible, using odd parts? (H.S., Kewdale, Vic.)

● We published the design for a receiver which should meet your requirements February, 1966. This was the "ABC Three" (File No. 5/ACR3/25) and was followed the following month (March, 1966) by the "ABC Four." (File No. 5/ACR4/44.) Copies of the articles describing these receivers are available through the Information Service for 20c each.

SIMPLE SW RECEIVER: I am a 14-year-old schoolboy and I have built the two-transistor shortwave receiver featured in the June, 1960, issue. I would like to build a better low cost receiver covering 2-31MHz, but have been unable to find a suitable circuit. Have you a circuit you can send me? Also, do you know of a good aerial for my receiver, as I am dissatisfied with the 60ft length of wire I now use? (T.S., West Moonah, Tasmania.)

● A circuit for a simple SW receiver covering 2-20MHz is included in our "Basic Electronics" book, available from this office for \$2.20 post included. Alternatively, we can supply you with reprints of Chapter 22 of the original "Basic Radio Course," containing details of the same receiver, for 20c, through the Information Service (quote File No. 4/TR3/2). A useful aerial is the Twin Doublet, described in our November, 1963, issue (File No. 2/AE/13). Details of this can also be obtained through the Information Service for 20c.

STROBOSCOPE: Can you tell me where I can get a circuit diagram or any information to build a stroboscope? (D. Stewart, 72 Etna Street, Gosford, N.S.W. 2290.)

● We published a circuit describing an "ignition timing light" in February, 1961 (ref. 3/MS/3) which used the stroboscopic principle for adjusting the timing of a car engine. We have published your name and address, as requested, so that other readers who may know of a more suitable circuit can get in touch with you directly.

"OXFORD"



RADIO CHASSIS



INSTRUMENT CASES



MINI BOXES "ALUMINIUM"



All printed and engraved panels for "Electronics Aust.," Mullard "Outlook," Philips "Digest."



Any special metalwork and panel engraving to specification.



All stock cases and chassis from our distributors in Brisbane, Melbourne, Adelaide.

HEATING SYSTEMS PTY. LTD.

24 O'Riordan St.,
ALEXANDRIA, N.S.W.
2015.

69-3764 - 69-7616

It's a *Now* world!

Remember when you could only have one type of wire wound resistor?

Now you have the choice of *FIVE* styles



1. Vitreous coated Wire wound 1.5 to 14 watts.

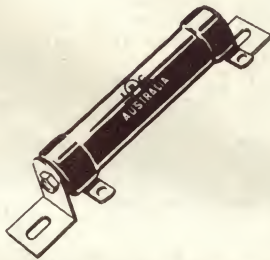

2. Tubular, fixed and adjustable Wire wound 3 to 200 watts with "Pyrosil" coating.

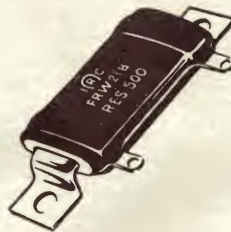

3. Flat Wire wound with "Pyrosil" coating 20 to 75 watts.



4. Ceramic case Wire wound Fireproof inorganic construction 5 to 15 watts.

Now another IRC first, **NEW ASW SERIES**

Axial weldable leads

Low T.C. close tolerance winding

Pyrosil coating

Welded Termination

ASW Series
2w - 5w - 7w and 10w

Supersedes the old fashioned AA/AB "Radio" type wire wound resistors.



**IRH
COMPONENTS
PTY. LIMITED**

A Subsidiary of IRH Industries Limited

THE CRESCENT, KINGSGROVE, N.S.W. 2208. PHONE 50 0111

INTERSTATE TELEPHONES

MELB. VIC.	489.1088	BRIS. QLD.	70.2141
HOB. TAS.	34.2811	PERTH W.A.	8.2271
LAUN. TAS.	22.844	ADEL. S.A.	23.1971

Check your literature file is up to date on the complete IRC Resistors range.

ANSWERS – continued

Imported intercom. units are now available readily and cheaply but we nevertheless get an occasional inquiry from readers who want to construct their own or want a system that is more complex than usual. For such readers, an article in the June, 1968, issue should give valuable guidance, particularly in respect to switching and cabling, which requires a good deal more thought than might at first appear. This information will be valid, irrespective of whether the now rather dated amplifier is modernised or replaced altogether by another configuration. Copies of the article are available for 20c each from the Assistant Editor, "Electronics Australia," Box 2728, G.P.O., Sydney, 2001. (Quote File No. 1/IA/7, Transistor Intercom. Amplifier.) One small point: In the original article, the symbol for the lower output transistor was wrongly drawn. This has been corrected in the circuit reproduced herewith.

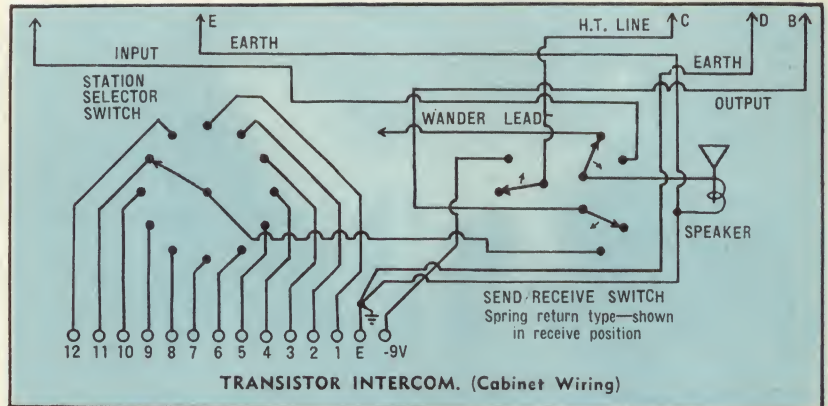
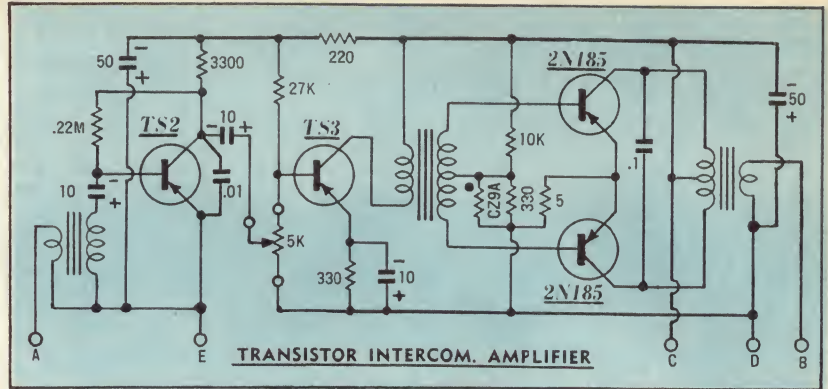

QUALITY OF PRESSINGS: Some record labels sell for \$1.99 and \$2.50. Is the quality of the records comparable with the original and dearer pressings? Could you discuss in your columns the relative merits of the various labels, clubs, etc.? I would like to endorse the many requests for an audio book. In the meantime, I hope you keep up the good work with "Electronics Australia." It is a well-balanced magazine that serves the non-technical person interested in electronics in industry and the home but not really keen to build his own equipment. (K.M., Burnie, Tas.)

● It is not possible to make flat statements about the cheaper pressings, simply in terms of brands. Some of the cheaper pressings are, in fact, the actual original pressings in original sleeves which were over-stocked in the first place. In nearly all other cases, they are produced from the same stampers, from the same materials on the same presses, the reduced price simply being an attempt by the manufacturers to get more "mileage" from the original outlay, which had to cover manufacturing rights, copyright, marketing cost, block cost for the sleeve and so on. At the same time, we have heard a few quite poor re-releases, mainly of very old material which might just have "got by" when it was first released but which certainly can't do so now. The only safe course is to be guided by reviews, recommendations or actual listening. In addition, if a particular album was well spoken of in its original form, it will most likely be a good buy on the economy label. Thanks for your observations about the audio book. We can assure you that it is not a lack of inclination but simply of the number of hours in the week and the number of hands to do the work. As regards the quality and coverage of "Electronics Australia," if it doesn't continue to please, it certainly won't be for want of trying on our part.

BULK ERASURE METHOD: After writing to you seeking a design for a bulk eraser for magnetic tape, and learning that you were unable to supply such a design, it was suggested by a friend that I try experimenting with an armature tester or "growler" as used by garages. This I have

done, and you may find the results of interest. By passing the tape spool over the top of the growler in a few circular passes, and then repeating in reverse, slowly removing the spool at the same time, I have found that I can erase the tape very effectively. When played on a machine immediately after the process, the residual on the tape is almost as low as virgin tape. Perhaps you might like to pass this tip on to other readers. (V. K., Charters Towers, Qld.)

● Many thanks for the details, V.K., and we imagine that it will certainly be of interest to tape recording enthusiasts.

LETHAL ELECTRICITY: Could you please explain to me what is the lethal aspect of electricity: voltage, current,

power, etc.? Thank you for your new semiconductor course. How about printing an article on the "short-wave" effect used in pop recordings. Also an explanation of the special visual effects television stations use to accompany sound. (P. J., Hightett, Vic.)

● By coincidence, we were preparing for publication an article on this subject when your letter arrived, and this has since appeared in our August issue. No doubt you have already read it. We are glad to note that you like the semiconductor course. The pop effect you mention is probably the same thing as "jet sound," which was discussed at some length in "Forum" for July. We shall keep in mind your request for an article on TV visual tricks.

CENTAUR CAPACITIVE DISCHARGE ELECTRONIC IGNITION

- Plug life of more than 50,000 miles.
- Point life of more than 100,000 miles.
- Low temperature starting (full voltage at zero rpm's).
- Better idle and acceleration; improved fuel economy.
- Fast installation—no changes in existing engine adjustments or components.
- Easy to change from one vehicle to another.



GROUP ELECTRONICS PTY. LIMITED
47 SOUTHERN ROAD, MENTONE, VICTORIA, 3194, AUSTRALIA
TELEPHONE 550-1085. TELEGRAMS, CABLES: "GROUP," MELBOURNE

ANSWERS – continued

ELECTRONIC TARGET TIMER. Have you thought of publishing an article on an electronic timing device for operating rapid fire targets on pistol ranges. Times required would be 2, 4 and 6 seconds. (G.J.W., Parattah, Tasmania.)

● We have no plans for publishing as a project details for a timer designed specifically for pistol ranges. However, the dark-room timer described in our issues of July and August, 1964, could possibly be adapted to your requirements. The article (reference 2/PT/2-3) can be supplied by post for 40c the two. Incidentally, the "Electronic Pistol Range" described in our issues of June, 1962, may interest you, although it has no connection with your problem outlined above. A copy of the article (reference 3/MS/7) is available through the Information Service for 20c.

OLD TV SETS: There is a flood of second-hand TV sets in clearance houses for less than \$20. Are you planning to describe a TV set made from such parts at any time in the near future? Would it be possible to adapt the tuner and IF system out of an old set, worth say \$5 to another which might have the power supply, EHT circuitry and tube intact? I feel certain that a set could be built for less than \$40. (M.N., Balwyn, Vic.)

● If all TV sets used the same parts and circuitry, it might be possible to describe something along these lines. In fact, there is an enormous variation in parts, circuitry and mechanical construction and, while we could undoubtedly put something together from what we happened to pick up, it would differ from the combination of parts available to individual readers. They would still be left to solve the problems of integrating the components that they personally happened to pick up; the end result would be an article which would be of very limited value to those who needed it most.

BUDDING AMATEUR: I have a receiver which covers from 550KHz to 22MHz. As I intend to become an amateur when I am old enough, I would like to know if I can replace the "magic eye" with an "S" meter. Would it be possible to add a bandspread control for the 160, 80, 40, 20 and 15 metre amateur bands? Could an RF gain control be added to the RF stage? What is the difference between FM and AM and is it possible to receive FM satisfactorily on an AM receiver? (P.J., East Geelong, Vic.)

● We are pleased to know that you intend become an amateur. You have certainly asked a lot of questions in one short letter but we will do our best to answer them for you. Details for adding S Meters to Receivers, were given in an article in September, 1965, and copies are available through the Information Service, for 20c each. Technically, it should be possible to add band-spread facilities to your receiver. However, it can be quite an involved process and we would not particularly recommend that you attempt this. The problem of extra space would also be one which may not be able to be worked out. An RF gain control could be added. A 10K potentiometer could be added in series with the earthy end of the RF amplifier cathode resistor. A suitable place would have to be found for the control on the front panel. The explanation of the differences between FM and AM are beyond the scope of this service but suffice to say that with the type of receiver you have in mind, narrow-band FM could be resolved satisfactorily by the "slope" method, which means that you tune slightly to one side of the centre frequency.

SUITABLE FOR GUITARS? I want to make the 30W P.A. amplifier described in the May, 1968, issue, but for use with guitars. Is this practicable, or would I have to use a more elaborate design? I intend to duplicate the two input circuits to accommodate four instruments. (G.C., Earlwood, N.S.W.)

● The 30W P.A. amplifier you propose using has sufficient sensitivity for your pur-

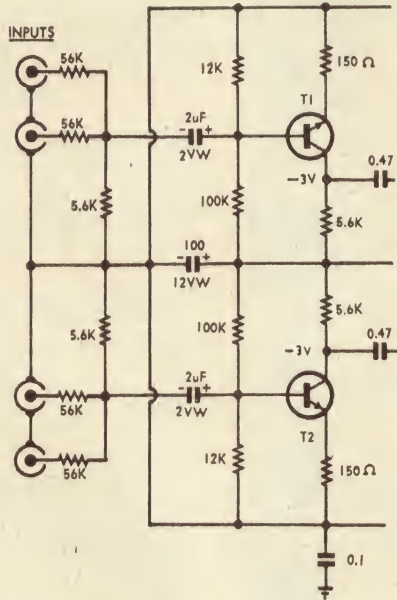

pose, and can be quite easily adapted for four inputs by including the isolation network shown in the accompanying diagram. However, we have reservations about your proposed scheme. The resulting system will not provide features normally regarded as pre-requisites for a guitar amplifier, namely vibrato and full tone control facilities. We fear that you and your three fellow

guitarists may be disappointed with an amplifier lacking these features. We suggest that one of the guitar amplifiers described in our magazine in recent years would be a better proposition. These include the 40W (June, 1967, File No. 7/GA/8), 60W (July, 1967, File No. 1/GA/9) and the just published 50W solid state amplifier (July, 1969, File No. 1/GA/16).

FM PROGRAMS: I would like to obtain a Hi Fi tuner, but before I do I would like to know when and on what frequency FM radio programs could be expected in Australia. Would it be possible to receive a Sydney FM station 350 miles away? Also, could you please explain the difference between FM and FM Multiplex? (K.J.E., Kamarah, N.S.W.)

● In answer to your first question, K.E., your guess is as good as ours. It is virtually impossible to say what the future holds for FM in Australia. As far as frequencies are concerned, we can say that transmissions will be on UHF due to the non-availability of space in the VHF bands. Hence, as most overseas FM tuners are designed for VHF bands they would be of little use in this country. On either VHF or UHF reliable reception at 350 miles from Sydney would be virtually impossible. FM Multiplex is a system used for transmitting stereo program material instead of mono. An ordinary mono FM tuner would receive a mono signal. A special type of tuner can resolve the stereo content.

ANONYMOUS FAN: I would like to congratulate you on the centre colour pages of the July issue. I will continue to buy the magazine because of its good organisation, record reviews, technical reviews, etc. But the main point of interest remains the projects, which are sometimes basic, sometimes complex but always interesting. (Unsigned, Chelsea, Vic.)

● Thank you for the letter and the observations. The only trouble was that you forgot to sign it. How frustrating it must be to receive a red rose from a secret admirer!

EXPLORATION UNLIMITED

- Telescopes
- Microscopes
- Binoculars
- Astronomical books, charts, atlases
- Build-it-yourself kits
- Celestial globes
- Scientific weather equipment

**SEEK OUR EXPERT ADVICE
ENJOY OUR FRIENDLY SERVICE AND
BIG PRICE SAVINGS**

ELECTRONIC WEATHER EQUIPMENT

- Electric wind speed generator.
- Instant wind direction indicator.
- Barometer
- Hygrometer
- Thermometer

Prompt mail order service
All goods fully guaranteed.

WRITE OR CALL FOR OUR FREE CATALOGUE NOW

AMATEUR ASTRONOMERS SUPPLY CO.
Dept. E 11A-B Clarke St., Crows Nest,
Sydney 2065 Phone 43-4360

ANSWERS - continued

RECEIVER AND OTHER PROJECTS:

I am a 15-year-old reader who enjoys reading the magazine and I would like to make some suggestions regarding projects. You have not described or developed a transistor communications receiver for six years, the last being the Three Band Transistor Eight. I suggest a receiver using an IC, and being capable of simplification, yet having all the optional features such as S meter, BFO, noise limiter, AGC, etc. What about transmitters and converters for the VHF bands? Something simple, like three stages for the transmitter, possibly using an IC and FETs. What about a simple two or three stage AM or CW transistor transmitter, which could be used with the receiver suggested earlier? You have not described a general purpose audio amplifier. Something giving about 200mW output and operating from a torch cell and which could be used with a microphone, pickup, crystal set, etc. (J.Y., Hunters Hill, N.S.W.)

● Thank you, J.Y., for your comments and suggestions. We are also pleased to know that you enjoy reading the magazine. However, we wonder if you realise that your suggested projects could keep one member of our staff working for a year or two to complete all the items? With the staff and time available, we have to give the widest spread of projects which are of interest to most readers. We agree that there has not been a description of an all-wave or communications receiver, which uses all transistors. However, it would be wrong to suggest that we are not doing anything along these lines. Indeed, we are doing quite a lot at present. This should result in some high-grade receivers being described in the foreseeable future. Although there are some plans afoot for VHF converters, we are unable to plan a transmitter at present. It may be worth noting that we have some good converters and transmitters for VHF use, which are valve operated.

We have recently developed an audio amplifier, which would go a long way towards meeting your need for a general purpose amplifier. However, such a unit is not so easy to produce as may at first be imagined. Such important points as input levels must be taken into account, with the possibility of adding a pre-amplifier when needed. The unit developed will be described when space permits. Meanwhile, it should be remembered that there are many audio amplifiers already in our files which may suit your need.

ENLARGING METER: I have been a reader of your magazine since the days of Wireless Weekly and have enjoyed reading them. I particularly enjoy reading the Serviceman. How about some articles on photographic equipment such as a transistorised photographic timer, an enlarging exposure meter, and anything else that would be useful. (C.A. Blaxland, N.S.W.)

● Many thanks for your letter, C.A., and we are glad to learn that you are still an interested reader after all these years. Thanks also for the suggestions, which we will keep in mind. However, for the moment, we cannot visualise a photographic timer which would be a significant improvement on the one we described in July and August, 1964 (File No. 2/PT/2-3). The mere substitution of solid state devices for valves will not necessarily improve its performance, or make it easier to build. The idea of an enlarging exposure meter is one which crops up regularly, but is also one about which we remain unconvinced. More specifically, we are not convinced that such a device is as easy to make as many people believe or that, even if all the technical problems could be overcome, it would provide a complete answer to the photographer's problems. We dis-

cussed this in considerable detail in the "Let's Buy an Argument" section of the magazine for March, 1963. As far as we are concerned, what we said then is just as valid today or, if anything, more so by reason of what we have been able to observe in the meantime.

REVIEWS: I have been reading your magazine for four years and, although I find most of the practical articles interesting and the scientific features of a high quality, I feel that I must spring to the defence of P.B. (Bendigo, Vic.) who wants to see "pop" reviews. You are being biased in your refusals because your "Variety Fare" section is mostly just "antiquated pop." I think you should concentrate on the underground scene which you should have been backing all along, as it is deeply involved in both electronic and classical music, yet it is better than both. Would you please consider publishing the circuit for a colour organ. It might also double as drill speed controller, with the drill replacing the light and by using a variable input rather than a variable output. (W.B., Blaxland, N.S.W.)

● Let us assure you that there is no need to spring to the defence of P.B., or anyone else advocating the inclusion of pop reviews. Their requests are perfectly legitimate and they are in no danger of being scorned or attacked. The simple fact is that we have built up a solid body of interest in the range of material currently reviewed, be it called "antiquated pop" or "evergreen." We could not afford to prune this further and there simply isn't space to include a complete additional review section at present. If pressures and/or space considerations change, we may one day be able to oblige, but not at present. We have had a number of requests for colour organs, though few of the correspondents appreciate that units, which turn on a display of any magnitude can be quite complex and costly. The idea of a colour organ circuitry doubling for a drill speed controller is novel, to say the least!

LF AND RF TRANSISTORS: I am a 14-year-old reader and I enjoy the magazine very much. My father gave me a radio engineer kit last Christmas and I would now like to make radio either my hobby or career. I am also reading your course in semiconductors, although I find it somewhat over my head at present. Could RF type transistors be used in place of LF ones? It seems to me that RF transistors first amplify the RF, then rectify it, finally amplifying it as LF. Also, I wound a few turns of wire on the ferrite rod of my receiver and connected the ends to an aerial and earth system. I could then pick up an amateur on 1825KHz. Why is this so?

● We are pleased to know that you are so interested in radio and that you enjoy reading the magazine. Transistors designed for RF use have certain vital parameters (characteristics) closely controlled from an RF point of view, whereas LF transistors have parameters of more interest to audio frequencies closely controlled. It does not mean that an RF transistor, as such, does the various functions which you mention, as this is actually a function of circuit design. Quite often, RF transistors can be used successfully in audio circuits. Indeed, there are times when LF transistors can be used in some of the lower RF applications. By adding the extra winding to the ferrite rod, you are picking up much more signal. The amateur may be coming in now simply because the receiver tunes to this frequency, which is a little higher than the broadcast band. On the other hand, the amateur may be quite close to you and his signals spuriously penetrating the front end of your receiver, by virtue of the extra aerial added.

(Continued on page 191)

ELECTRONIC DESPATCH

P.O. BOX 149, AUBURN 2144

9 - 1 DAILY AND SAT.

16 SHERIDEN ST., GRANVILLE,

MAIL ORDER SPECIALISTS.

Please Add Postage

BASIC COMPONENTS

RESISTORS

* Cracked Carbon * High Stability
* 5% Tolerance.

1/4 Watt 10 ohm to 1/2 Meg. . . . 6c
1/2 Watt 1 Ohm to 10 Meg. . . . 6c
1 Watt 1 Ohm to 10 Meg. . . . 7c

These are professional grade made to mill spec. R-11-C and to ensure the full range being available we buy from two major European manufacturers. Resistors are the most used component in your projects—and the least expensive. Further, resistor failure has been the most likely cause of disappointment. Cheaper moulded encapsulated resistors cannot meet high stability requirements and the little you could save is false economy at its worst. Work out what you might save on an entire project. 12c? 25c? Your peace of mind is worth more than that.

CAPACITORS

To cover the range 1pf-1000pf we can offer ceramic, miniature polyester or polystyrene. 1 pf-1000pf. All 10c each.

Full Range

"ELNA" GREEN CAPS

These famous brand miniature polyesters go up to 1m. 200WV. Ideal for transistor work and mount vertically on P.C. board by two parallel leads.

.001F 100VW	.0056 100VW
.0022 100VW	.0068 100VW
.0033 100VW	.0082 100VW
.0039 100VW	.01 100VW
.0047 100VW	.022 100VW

ALL 10c EACH

.033 100VW	.056 100VW
.039 100VW	.068 100VW
.047 100VW	.082 100VW

ALL 14c EACH

.1 100VW 14c	.33 200VW 24c
.22 100VW 18c	.49 200VW 24c
.27 100VW 22c	.37 200VW 26c

1uF 200VW 42c

"ELNA" ELECTROLYTICS

These are the largest selling imported in Australia. Over 2 million in use by leading set builders, Govt. Depts. etc. Price for quality they are unsurpassed.

LOW VOLTAGE RANGE

2mf/12V . . . 19c	250/25 . . . 38c
2/25 . . . 20c	250/50 . . . 56c
2/50 . . . 20c	500/6 . . . 30c
5/3 . . . 10c	500/15 . . . 48c
5/12 . . . 19c	500/25 . . . 58c
5/25 . . . 20c	500/50 . . . 96c
10/3 . . . 12c	1000/15 . . . 56c
10/6 . . . 13c	1000/25 . . . 82c
10/12 . . . 19c	30/3 . . . 14c
10/15 . . . 15c	30/12 . . . 20c
10/25 . . . 24c	50/12 . . . 24c
10/50 . . . 24c	50/50 . . . 34c
25/25 . . . 24c	100/6 . . . 24c
25/50 . . . 28c	1000/50 . . . \$1.30
100/12 . . . 24c	2000/15 . . . \$1.10
100/25 . . . 31c	2000/50 . . . \$1.40
100/50 . . . 40c	2000/50 . . . \$2.75
125/16 . . . 30c	5000/20 . . . \$1.80
250/12 . . . 28c	

Mostly single-ended parallel leads for P.C. board. Larger values pigtail each end.

HIGH VOLTAGE RANGE

1mf/350V . . . 24c	16/500 . . . 72c
8/350 . . . 30c	20/350 . . . 90c
10/150 . . . 18c	50/350 . . . 90c
10/525 . . . 50c	200/350 . . . \$1.80
8/500 . . . 50c	

COMPUTER BOARDS

We have large new stocks of this popular item.
10c per transistor plus 21c diodes.
Min. 50c plus 10c P.P.

NEW STOCKS UJTs FETs, etc.

Programmable UJT D13T1 . . .	\$1.20
FET 2N5459 (MPF105) . . .	\$1.20
Photocell (Phillips LDRs) . . .	60c
Red Switch Hamlin DRG2 1A . . .	80c

READER SERVICE

RADIO TV TAPE service, all spares available, trade discounts on parts, Amplifiers, microphones. Nichol Radio, 91 Wellington Street, Launceston, Tas.

TV PICTURE TUBES, Sure Brite Pty. Ltd., now at 542 King St., Newtown, N.S.W. Now the largest factory of its kind in N.S.W. Daily delivery Sydney suburbs and to railway station. Lowest prices in Sydney in the trade. Duds bought. Send all duds to Sydneyham station freight paid. Customer sales rear of building. Phones, 519-3403, 51-5928, Brisbane area: 1120 Oxley Rd., Oxley, 79-6826.

FREE stereo pre-recorded tape, cartridge or cassette, when you join the Rondo Reef Pre-recorded Tape Service. Est. 5 yrs. Save 20 p.c. on all your pre-recorded tape, etc., over 25 labels to choose from. Interstate, N.G. and Fiji inquiries welcome. Regular new releases posted to all members. Details Rondo Reef, Box 162, Rockdale, N.S.W., 2216, Aust.

DUPLICATING: James E. Smith Duplicating Service for photostats, photo copies, electronic stencils, addressing service, extensive duplicating coverage. Customers wanted. P.O. Box 48, Albion, Qld., 4010. Phone 67-6612.

TRANSFORMERS wound. Output or mains and specials to orders. Paris Electronics, 7a Burton St., Darlinghurst, N.S.W. 31-3273.

COILS, CHOKES, R.F.s, I.F.s, etc., wound to your own specifications or on contract basis. Repiv with S.A.E. Paris Radio Electronics, 7a Burton St., Darlinghurst, N.S.W. 31-3273.

TOP-QUALITY discs from your tapes. Any quantity, all sizes and speeds. We guarantee our work because we take every precaution to ensure satisfaction. Write for details. A.A.V.R., 87a Mullens St., Balmain, 2041, Sydney. Phone 82-5158.

PRE-RECORDED TAPE hired to members of Australian Tape Recording Society. Bi-monthly release "The Microphone," newspapers, round robins, sales, etc. Tape-sponding. Send 5c, 9in x 4in SAE to ATRS, Box 9, P.O., Crow's Nest, N.S.W., 2065, or phone (2) 43-6681, after hours.

REPAIRS to receivers, transmitters, construction, testing; TV alignments; Xtal conv. specialised electronic equip. Eccleston Electrics, 146a Cotham Rd., Kew, Vic. 80-3777.

ELECTRONIC ORGANS. Do not build yourself an organ without first finding out about the superb Schober (U.S.A.) Assemble-It-Yourself Kits. Inquiries to Schober Organs (Australia), 124 Livingstone Ave., Pymble, N.S.W., 2073. (Mail only, please.)

TAPE to disc service. Take advantage of W. and G. Records' professional experience when next needing a tape to disc service. W. and G. Record Processing Co., 185 A'Beckett Street, Melbourne. Tel. 329-7255.

POSITIONS VACANT

SUPPLY DEPARTMENT

VICTORIA
DEFENCE STANDARDS LABORATORIES
TECHNICAL SECTION
MARIBYRNONG
DRAFTSMAN GRADE 1

SALARY: \$2553-\$4553.

DUTIES: Position No. 162—Prepare design and detail drawings of electro-mechanical and electronic laboratory equipment.

QUALIFICATIONS: An approved Certificate from a Technical College or Institute of Technology or its equivalent or such other qualifications as the Board considers appropriate, together with appropriate experience. Applications will, however, be accepted from people who do not possess acceptable qualifications providing they have a minimum of six years' relevant experience including three years of experience on drafting. If the selected applicant does not possess acceptable qualifications he will be required to pass a test of knowledge and competence to establish his eligibility for nomination for the position.

APPLICATIONS TO:

Chief Superintendent,
Defence Standards Laboratories,
Box 50, P.O.,
ASCOT VALE, VIC. 3032.

BROADCAST TECHNICIAN

Radio 2UE requires a Broadcast Technician holding a B.O.C.P. or similar qualifications. Applicants should be familiar with maintenance procedures for solid state equipment and have experience in studio maintenance.

This is an opportunity to work under good conditions on modern equipment. Salary commensurate with qualifications. Reply by mail giving full details of qualifications and experience to:

The Manager,
Radio 2UE Sydney Pty. Limited,
P.O. Box 950,
North Sydney, 2060.

WANTED

SURPLUS TV valves. Cash. Last, 847 New Canterbury Road, Hurstville Park, N.S.W. 55-7151.

RADAR head type 1 Ident 10D/18501 preferably complete. Also control unit type 913. Forward detail to "Radar," C.S.I.R.O., Station Street, Ascendale, Vic. 3195.

TAPE RECORDERS. E.M.I., B.T.R. 1, and B.T.R. 2. Lawson, Box 2340, G.P.O., Sydney. Phone 649-7106.

AERIAL 122, preferably with tops. R. Haskard, Kimba, S.A. 5641.

LEAK TL/10 feedback amplifier and point one preamplifier. Newcastle 82-4117.

ANSWERS . . . continued

CRYSTAL CLOCK DRIVE: After reading part one of the article on Crystal Clocks and considering the electronic drive unit in the Revox tape recorder, I came up with the following idea. Why not an electronic drive unit for record turntables as well? The only changes necessary to the Crystal Clock Drive Unit would be in the final divider circuitry. The turntable speeds of 78, 45 and 33-1/3rpm could be achieved by a two-speed motor, one speed being half the other, achieved by pole switching in the motor. This would give speeds of 78 and 39rpm. To obtain a speed of approximately 33-1/3rpm the frequency would be approximately 40Hz, and for 45rpm the frequency would be approximately 60Hz. This could be done in the last divider, by dividing by 16 for 45rpm or 24 for 33-1/3rpm. A vernier control could be used for precise speed adjustment, using a strobe disc on the turntable. (G.R., Bowen Hills, Qld.)

● "Approximately" is the operative word here, as we have taken a quick look at the calculations and they are indeed approximate. It would appear that this approximation could be corrected by some vernier control. Unfortunately, the only vernier control would be by a slight change in the crystal frequency, which would be quite insignificant. Our calculations show that we would have to divide by 23.4 for 42.7Hz, and by 17.33 for 57.7Hz, for 33-1/3rpm and 45rpm, respectively. We could divide by, say, 23 or 24 in one instance and 17 or 18 in the other case. This, at best, would be a compromise and may or may not be acceptable to all individuals. It seems rather a hard way to us, of doing what could perhaps be more easily done with a Wien Bridge audio oscillator. ■

Y.R.S. NOTES

(Continued from page 172)

the club will be participating in the Captain Cook Bi-centenary celebrations to be held in Maitland next year. The form that the display will take is yet to be decided.

Further information about the club's activities can be obtained from the secretary, Box 54, P.O., East Maitland.

Westlakes Radio Club

Another member of the Westlakes Radio Club has received high praise for his pass in the Elementary Y.R.S. certificate examination. Steven Pettet, of Speers Point, received 95 per cent pass, and Mr D. Williamson, the examiner, commended Steven on his achievement.

At the Schools' Science Exhibition held in Sydney in 1968, Steven won a prize with his "Light Beam Communicator."

Details of the club's activities may be obtained by writing to the Secretary, Bruce Morley, VK2ZNB, P.O. Box 1, Teralba, 2284, or by phone, Newcastle 59-1667.

VICTORIA

Camberwell Grammar School

One of the activities members of the club are pursuing is the creation of "Electronic Music." Currently, they are working on a "symphony" based on the constant repetition of the sounds of a milking machine, with many other audio effects superimposed.

The latest project by some club members is the building of 10 automatic light dimmers, as per "Electronics Australia" design in the December, 1966, issue. All are mounted in one control panel and are to be used for school play productions.

Some problems have been encountered, but the club is confident that Robert Wills and Greg Day will iron them out.

Recording sound tracks for films made by the school's film unit is another aspect of the work being done by the boys.

All candidates who sat for the recent Y.R.S. certificate examinations are confident they will receive good passes. ■

SIMPLIFY INTRICATE WORK with



'1000' RANGE
SPECIAL PURPOSE
PLIERS

Designed specifically for instrument and electronic technicians to handle fine, precision work, the Elliott-Lucas 4½" size '1000' series is available in Box Joint or Single Joint Tools. All bright finish, in individual Display Packs or in Plastic Tool Roll sets of three or six.

DIAGONAL CUTTING NIPPERS

SNIPE NOSE PLIERS

SNIPE NOSE SIDE CUTTING PLIERS

FLAT NOSE PLIERS

ROUND NOSE PLIERS

END CUTTING NIPPERS

Australian Representatives:

THOMAS C. BROWN

& CO. PTY. LTD.

Sydney • Melbourne • Adelaide
Brisbane • Perth

rcb/sz

ADVERTISING INDEX

A & R Transformers Pty. Ltd. 43
 A.C.E. Radio 178, 179
 Adcola Products Pty. Ltd. 174
 Agsig Pty. Ltd. 151
 Agfa-Gevaert Ltd. 80
 Akai Electric Co. Ltd. 66
 Allied Capacitors Pty. Ltd. 144
 Amalgated Wireless (A'sia) Ltd. 146
 Amalg'd. Wireless Valve Co. Pty. Ltd. 76
 Amateur Astronomers Supply Co. 187
 Ampilon (A'sia) Pty. Ltd. 93
 Arrow Electronics Pty. Ltd. 127
 Astronics Australasia Pty. Ltd. 100, 168
 Atram Pty. Ltd. 136
 Audio Engineers Pty. Ltd. 42
 Australian EEB. 131
 Australian General Electric Pty. Ltd. 34
 Aust. Radio and TV College Pty. Ltd.
 159; outside Back Cover
 Bernards Radio Books and Supplies 157
 Bright Star Radio 167
 British Institute of Careers 152
 Broadway Electronics Pty. Ltd. 70, 71
 Broadway Electronics (Sales) Pty. Ltd. 4, 5
 Broughton, Peter G. 107
 Brown, Thomas C. and Co. Pty. Ltd. 191
 Central Imports Pty. Ltd. 78
 Chapman, Maurice and Co. Pty. Ltd. 94
 Charmac Pty. Ltd. 90
 Classic Radio Service 132
 Classic Tape Recorders 133
 Colstok Electronics 144
 Convoy International Pty. Ltd. 64
 Cunningham R. H. Pty. Ltd. 165
 Danish HI-FI Pty. Ltd. 102
 Decca 117
 Deitch Bros. 186
 Dietron Electronics 166
 Direct Disposals Trading Co. 112
 Douglas Trading Pty. Ltd. 112
 E. D. and E. (Sales) Pty. Ltd. 110, 111
 Electronic Despatch 169
 Electro-Pak Components Supplies Co. 69
 Eltran 162
 Encel Electronics (Stereo) Pty. Ltd.
 19, 91, 92, 129, 134, 137, 145, 150
 E S & I Electronics 190
 Falk, Fred A. (Sales) Pty. Ltd. 124
 Ferguson Transformers Pty. Ltd. 104
 Foot, Richard (Aust.) Pty. Ltd. 163
 Gardner-Denver (Aust.) Pty. Ltd. 84
 General Accessories Ltd. 44, 148, 182
 Goldring Eng. (A'sia) Pty. Ltd. 6, 7, 122, 123
 Goodmans Loudspeakers Ltd. 132
 Gray, Simon Pty. Ltd.
 48, 68, 136, Inside Back Cover
 Green Corporation Ltd. 36
 Group Electronics Pty. Ltd. 185
 Haco Distributing Agencies Pty. Ltd.
 Inside Front Cover
 Ham Radio Suppliers 188
 H.B. Radio Sales 126, 131
 Heating Systems Pty. Ltd. 183
 Homecrafts Pty. Ltd. 106
 Imported Components 57
 International Correspondence Schools 156
 International Dynamics (Ag.) Pty. Ltd. 115
 IRH Components Pty. Ltd. 16, 62, 108, 184
 Jacoby, Mitchell and Co. Pty. Ltd. 22, 158
 J. H. Reproducers Co. 118
 Kitsets Australia 141
 Kodak (Australasia) Pty. Ltd. 38
 Kuenzli, Ernest Pty. Ltd. 119
 Lafayette Electronics 147
 Leak, H. J. (Aust.) Pty. Ltd. 12, 88
 Lembriere, O. T. and Co. Ltd. 57
 Magrath, J. H. and Co. Pty. Ltd. 98
 Manufacturers Spec. Prod. Pty. Ltd. 45
 Marconi School of Wireless 155
 Market Place 190
 Mastersound Sales Pty. Ltd. 56
 M.B.H. Audio Sales 65
 Miniwatt Electronics Division 2
 Mullard-Australia Pty. Ltd. 26
 National Radio Supplies 170, 171
 Photronic 75
 Plassey Comms. Systems Pty. Ltd. 172
 Plassey Ducon Pty. Ltd. 128
 Plassey Rola Pty. Ltd. 128
 Radio Despatch Service 75
 Radio House Pty. Ltd. 154
 Radio Parts Pty. Ltd. 86, 126
 R.C.S. Radio Pty. Ltd. 142
 Recorded Music Salon 114
 Rowe, H. and Co. Pty. Ltd. 58
 Sansul Electric Co. Ltd. 8, 9
 Sato Parts Co. Ltd. 148
 Shalley, Peter Electronics Pty. Ltd. 142
 Standard Telephones and Cables Pty. Ltd. 14
 Stereo Music Systems 82
 Stereo Supplies 12
 Stott's Tech. Correspondence College 153
 Strato Communications Pty. Ltd. 160
 Tasmanex Pty. Ltd. 103
 Technical Training Int. Pty. Ltd. 138, 139
 Tektronix Australia Pty. Ltd. 60
 Trio Electronics Inc. 50, 51
 Truscott Electronics 74
 Turnbull, Bill 75
 United Radio Distributors Pty. Ltd. 39
 United Trade Sales Pty. Ltd. 149
 University Graham Inst. Pty. Ltd. 150
 Varian Pty. Ltd. 32
 Varian Techtron Pty. Ltd. 65
 Warburton Frankl Ltd. 46, 174
 Wedderspoon, W. C. Pty. Ltd. 120
 Weston Electronics Pty. Ltd. 180
 Wilcox Bros. and Barclay 49
 Willis, S. E. Trading Co. 109, 177, 190
 Wireless Institute of Australia (N.S.W.) 91
 Wonder Wool Pty. Ltd. 135
 Zephyr Products Pty. Ltd. 30, 164

CLASSIFIED ADVERTISERS ELECTRONICS Australia MARKET PLACE

USE THIS FORM FOR YOUR NEXT ADVERTISEMENT IN THE
ELECTRONICS Australia MARKET PLACE

To the Advertising Manager,
 ELECTRONICS Australia,
 Box 2728 G.P.O.
 Sydney, 2001

Endorsement
 Residential Address
 State

• Please insert the following advertisement in the issue

• I enclose P. Note/Cheque for \$ being full payment for lines at \$0.72 per line. (Min. 2 lines)

<input type="checkbox"/>	FOR SALE																		
<input type="checkbox"/>	WANTED																		
<input type="checkbox"/>	READER SERVICE POSITION VACANT																		

Please write in block letters with ink or ball-point pen. Number of insertions

ELECTRONICS Australia SPECIAL ORDER FORM

Guarantee yourself a complete set of issues for your library with no copies missing.

SUBSCRIPTION RATES

Australia, New Guinea, Fiji, New Zealand
 Elsewhere

PER YEAR
 \$5.00
 \$7.00

POST THIS COUPON TO:
 The Circulation Manager, ELECTRONICS Australia,
 Box 2728, G.P.O., Sydney, 2001, Australia.

Name
 Address
 Enclosed is \$ for years. Start with
 (Please use cheque, money order, etc. Do not enclose cash).

proven wharfedale high fidelity sound from two low priced compact speaker systems!

Several years of intensive research have resulted in the release of two new compact speaker systems by Rank Wharfedale Ltd. The problems associated with small speaker enclosures have finally been solved; until now these limiting factors have been restricted frequency response and lack of musical quality.

The "Denton" measures only 9¾" x 15" x 9" . . . the "Super Linton" is 19" x 10" x 10". Both systems feature a new type of bass/mid-range 8" drive unit with an exclusive Wharfedale Flexiprene surround, an extra-long throw voice coil and a new-type ceramic magnet. A specially designed paper cone is employed as laboratory tests reveal that a well-designed paper cone is far more sensitive to musical sound than those made from plastics or man-made fibres. Lower registers are reproduced without restraint or collapse.

Treble response is smooth, clean and satisfying; a new H.F. pressure unit incorporated in both enclosures features an "Acoustiprene" dome — the lightest material ever used in speaker manufacture.

the new Wharfedale Denton



\$69.50

ea. inc.
sales tax.

Frequency response of the "Denton" is conservatively quoted at 65-17,000 Hz. Response of the "Super Linton" is 40-17,000 Hz. Impedance is 4-8 ohms.

Cabinets are finished in selected oiled teak or polished walnut veneers and have been designed to match both modern and period decor. Both "Dentons" and "Super Lintons" are supplied in acoustically matched pairs for optimum stereo-phonetic performance.

When first you listen to these compact Wharfedale multiple speaker systems you will find it hard to believe; after several weeks you will still wonder how Wharfedale succeeded in putting high fidelity Wharfedale sound into extremely compact enclosures.

the new Wharfedale Super Linton

\$89

ea. inc.
sales tax.



Australian National Distributors:

Simon Gray Pty. Ltd.

Head Office: 28 Elizabeth St., Melbourne, Vic. Tel. 63 8101*

Sydney Office: 22 Ridge St., North Sydney, N.S.W. Tel. 929 6816

Canberra Office: 31-33 London Circuit, Canberra City, A.C.T.
Tel. 49 6050

INTERSTATE REPRESENTATIVES:

N.T.: Pfitzner's Music House, Smith Street, Darwin. Tel. 3801

Q'land: Sydney G. Hughes, 154-158 Arthur St., New Farm, Brisbane. Tel. 58 1422

S.A.: Eilco Sales Pty. Ltd., 7-9 Osmond Terrace, Norwood, S.A. Tel. 63 4844

Tas.: K. W. McCulloch Pty. Ltd., 57 George Street, Launceston. Tel. 2 5322

W.A.: Athol M. Hill, 613-615 Wellington Street, Perth. Tel. 21 7861

SGW7/68

This A.R.T.C. Success Story Can Be Yours!

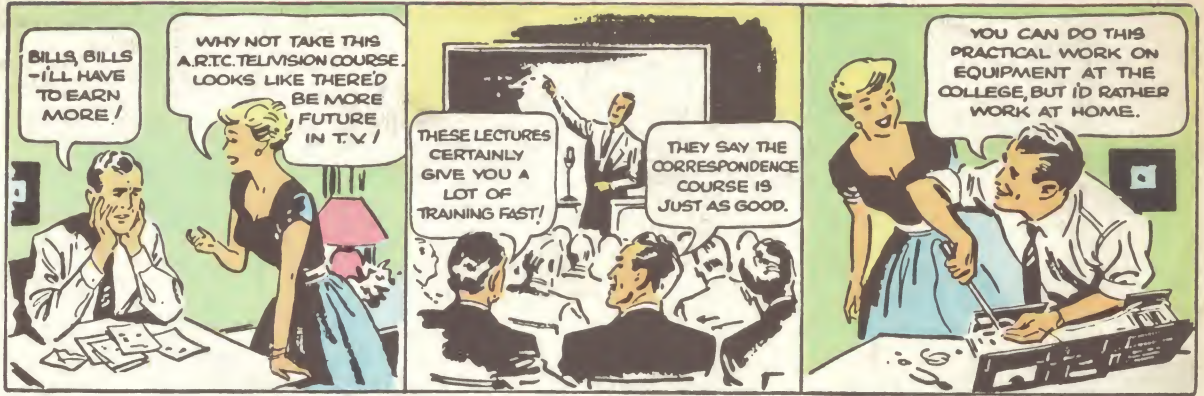

GET INTO ONE OF THESE PROFITABLE CAREERS IN RADIO AND TELEVISION

There is a profitable career for you in the many phases of radio television including manufacturing, radio servicing, television servicing, research, sales broadcasting and television executive, armed forces. A.R.T.C. can help you gain one of these much sought-after positions. But remember, it is only the trained man who succeeds and A.R.T.C. can give you the complete training which is necessary.

TRAIN AT HOME OR AT THE COLLEGE

With A.R.T.C. you can obtain the training you need. At the benches and in the lecture halls of Australian Radio and TV college or in your own home by correspondence . . . you can be taught every important aspect of radio, television, details of every application of the fundamental principles. The course is intensely practical and individual.

MAKE SPARE-TIME MONEY

If you wish you can make your spare time earn money for you. Many students make extra money at spare time work after only the first few weeks. Think of all those things extra money can bring you, home of your own, car, time for relaxation, etc. Safeguard your future . . . mail the coupon today.

MAIL COUPON NOW

You are invited to mail the coupon below which can be your first step towards securing a job or business of your own with good prospects, security and big money. A.R.T.C. will mail to you by return, at no obligation to you the big free booklet: "Careers in Radio and Television." This booklet will show you definite steps you can take for a better job, how you can succeed in life. Post the coupon, phone or call NOW.

AUSTRALIAN RADIO AND TELEVISION COLLEGE

PTY. LTD.
E. S. & A. BANK BUILDING,
Cnr. Broadway and City Road, Sydney.
(Opp. Grace Bros.) Phone 211-4244 (3 lines.)



AUSTRALIAN RADIO & TELEVISION COLLEGE PTY. LTD.,

206 Broadway, Sydney, N.S.W.

Dear Sir,

Please send me, without obligation, your free booklet, "Careers in Radio, TV and Electronics."

NAME

ADDRESS