

ELECTRONICS

Australia

August, 1969



40¢

AWA, Marconi colour television equipment

LASER FOR CLASSES & CLUBS
HOW STEREO SHOULD SOUND

● RADIO ON APOLLO
● NEW RECORDS REVIEWED



NATIONAL RF-5000 RADIO



**If it's on the AIR (anywhere)
this portable radio will pick it up**

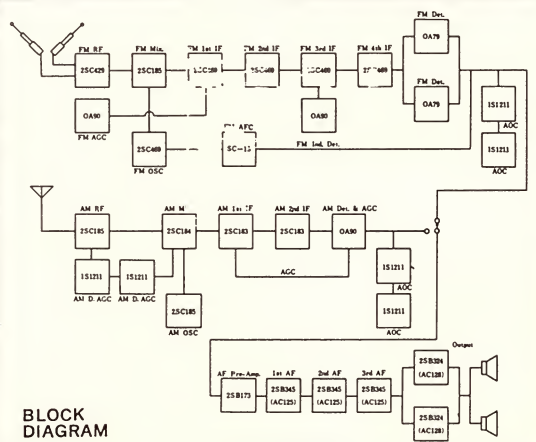
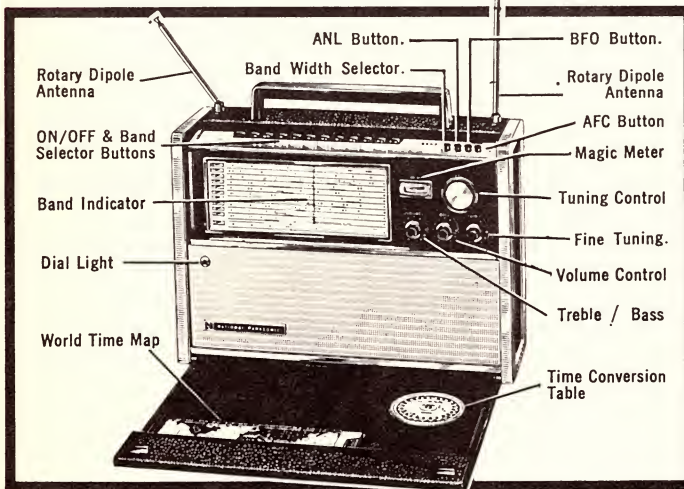

You can tune into the world with National's RF-5000. It has no less than 11 bands, including FM, AM, Short Wave, and amateur bands, plus 30 transistors and diodes. Five highly efficient antennae match every frequency. Two hi-fi speakers provide superior sound. Ultra linear transistors give an output of 2,000 mW—five times the normal wattage of portables!

Without any doubt, it is the best portable radio in the world — made for those who want the very best. Price: \$495.

DESCRIPTIVE LITERATURE FREE!



To HACO DISTRIBUTING AGENCIES PTY. LIMITED
57/69 Anzac Parade, Kensington, N.S.W.

Please send me further information on the RF-5000.

Name.....

Address.....



ELECTRONICS Australia

incorporating RADIO, TELEVISION & HOBBIES

ABC certified circulation in excess of 47,000

volume 31, number 5

APOLLO COMMUNICATIONS: *A detailed account of the channels used to provide voice, telemetry, and colour TV circuits between Apollo 11 vehicles and earth. Page 10.*

LASER: *Constructional details of an experimental gas laser suitable for science classes, radio clubs, etc. Page 40.*

NOISE SILENCER: *Our own version of the Lamb type noise silencer for use against pulse type electrical interference in SW receivers. Page 63.*

GUITAR LOUDSPEAKERS: *Part Two of our 50W Solid State Guitar Amplifier deals with loudspeaker systems for use with this and similar guitars. Page 52.*

Editorial Office:
12th Floor, 235-243 Jones Street,
Broadway, Sydney, Australia.
Phone 2-0944.

Postal Address:
Box 2728, G.P.O., Sydney, 2001, Australia.

Advertising:
Manager, Selwyn Sayers,
Sydney Representative, Bill Summons.
Office: 8th Floor, 235-243 Jones Street,
Broadway, Sydney, Phone 2-0944.
Melbourne Representative, Clarrie Levy.
Office: 392 Little Collins Street,
Melbourne, 3000. Phone 67-8131.

Circulation:
Alan Parker, Manager.
Office: 9th Floor, 235-243 Jones Street,
Broadway, Sydney, Phone 2-0944.

Subscription Rates: See back page.

Representation:
Melbourne—John Fairfax and Sons Ltd., 392 Little Collins Street, 3000. Phone 67-8131.
Brisbane—Sungravure Pty. Ltd., 78 Elizabeth Street, 4000. Phone 2-6688.
Adelaide—John Fairfax and Sons Ltd., 104 Currie Street, 5000. Phone 51-3502.
Perth—Sungravure Pty. Ltd., 454 Murray Street, 6000. Phone 21-8217.
Newcastle, N.S.W.—Associated Newspapers Ltd., 22 Bolton Street, 2300. Phone 2-3696.
London—John Fairfax and Sons (Aust.) Ltd., Reuter Building, 85 Fleet Street.
New York—The Sydney Morning Herald Ltd., 1501 Broadway, New York, N.Y., 10036.

Distribution:
Distributed in N.S.W. by Sungravure Pty. Ltd., Jones Street, Broadway, Sydney, N.S.W.; in Victoria by Sungravure Pty. Ltd., 392 Little Collins Street, Melbourne; in South Australia by Sungravure Pty. Ltd., 104 Currie Street, Adelaide; in Western Australia by Western Press; in Queensland by Gordon and Gotch (Asia) Ltd.; in New Zealand by Truth (N.Z.) Ltd.; in Tasmania by Davies Bros. Ltd., "Mercury," Hobart.

CONTENTS — AUGUST, 1969

features

- 3 Editorial
- 10 Apollo mission communications
- 16 Secrets of Mars (historical)
- 18 Creating a noise-free environment
- 20 Computers and Australia's oil future
- 23 Radar with a memory

technical digest

- 27 Solid-state devices in flexible sheets
- 29 Simple infra-red image converter
- 31 Preparing enriched uranium

technical articles

- 40 Experimental helium-neon gas laser
- 52 Solid-state guitar amplifier, part 2
- 63 Lamb type noise silencer
- 71 Power supply for solid-state receivers
- 77 Fundamentals of solid state, chapter 4
- 105 What is a fatal current?

regular features

- 33 Scientific and industrial news
- 90 Forum
- 101 Serviceman
- 107 Reader built it
- 112 Audio topics—stereo spread or separation
- 120 Record reviews — classical
- 125 Record reviews — documentary
- 129 Record reviews — devotional, popular, jazz
- 144 Trade reviews and releases
- 157 Technical books and publications
- 161 Amateur band news and notes
- 173 Listening around the world
- 181 Answers to correspondents
- 190 Market place
- 192 Index to advertisers
- 189 Notes and errata

60 NORBIT

SERIES

LOW PRICED STATIC SWITCHES

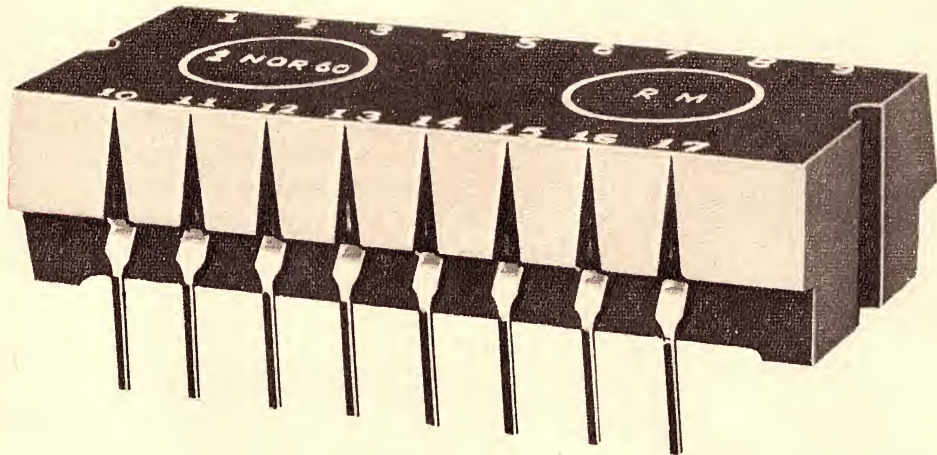

- | | |
|------------------------------------|---|
| Single supply rail: | 24 volts |
| 25% voltage tolerance: | 18 to 30 volts |
| Temperature range: | -10° C to +70° C ambient |
| Immunity to noise: | Totally unresponsive to d.c. noise of
up to 1 volts on 'o' state.
up to 2 volts on '1' state.
even greater immunity to noise above 100 kHz |
| Choice in interconnections: | miniwrap or solder-tag |
| Full range: | compatible input and output transducers
inexpensive mounting aids and accessories. |

Where relays would have been the natural choice, NORBIT static switches cut system costs in: Alarm systems; lift systems; automatic batching; transfer line control; production machine control; electro-plating installations; power system control and all other systems (large and small) which call for

a variety of sequence logic and combination logic. For further details refer to Miniwatt Digest "Special Norbit Issue" Vol. 7, No. 6, September/October, 1968. Application information and assistance in design is available from the Miniwatt Applications Laboratory.

"Miniwatt"

ELECTRONICS DIVISION OF PHILIPS
ELECTRICAL PTY. LIMITED

Sydney, Melbourne, Brisbane, Adelaide,
Perth, Hobart, Newcastle, Canberra.



EDITORIAL VIEWPOINT

by Neville Williams

Wheels within wheels . . .

There is good reason to believe that, within a couple of years, new family sedans in Australia will have five load-bearing wheels. Some months ago, the Australian Roadcasting Control Board invited experts to serve on steering and other committees to examine in detail technical aspects of the proposal. In due course, the A.R.C.B. will advise the Government what regulations and standards should be gazetted to govern use of the new vehicles.

While the technical advisers are pursuing their task with interest and application, sales executives of their own organisations are becoming apprehensive about the possible effect that talk of five-wheel vehicles may have on sales of the present four-wheel type. Some have suggested a joint campaign to point out to the buying public that the introduction of a new style vehicle will in no way reduce the practicability of those currently in use, or currently displayed in car showrooms. The majority, however, seem to have adopted the attitude of saying as little as they can for as long as they can.

Reacting to this situation, the manufacturer of Castor vehicles recently embarked on a large-scale advertising campaign keyed to the word "Compatible." For the protection of customers, says the company, all Castor vehicles will carry an emblem formed by the letter C intertwined with a 4 and a 5. The emblem will confirm that their vehicles have four wheels and that they will remain upright and functional on the road alongside the proposed five-wheel type.

Rival manufacturers have expressed dismay at the campaign. Some complain that it takes unfair advantage of a gullible public. Others suspect that it is designed, as much as anything, to bring the whole subject out into the open. One thing is certain: Like it or not, they will have to start talking about the new vehicles; they will have to stress to the public that virtually all family sedans have four wheels and that their roadworthiness will not be affected by the introduction of another type.

A silly story?

Yes it is! But no sillier than the situation that has arisen during the month in the television receiver field, where one manufacturer has mounted a big campaign based on the fact that his particular brand of TV receiver is fully compatible with the proposed colour service. The advertisement concedes that other existing receivers "may" also receive the colour transmissions in monochrome. How utterly magnanimous!

If I have done my homework correctly, from the day that the whips began cracking in the RCA Laboratories, the whole basis of electronic colour has been that it must be compatible with existing monochrome standards. Through all the stages which have followed, through to N.T.S.C., PAL and SECAM, compatibility has been studied and safeguarded. For certain, the Australian Broadcasting Control Board is insisting on the same requirement.

Maybe the other manufacturers should get together and issue a little sticker, to be affixed to all existing monochrome receivers:

COMPATIBLE—By courtesy of the A.B.C.B.

On the cover

In conjunction with The Marconi Company Ltd., of England, Amalgamated Wireless (A'sia) Ltd. recently demonstrated a comprehensive range of Australian and United Kingdom-made studio colour TV equipment. More than 600 people engaged in the Australian TV industry accepted the company's invitation to view the demonstrations at its North Ryde (N.S.W.) works. An A.W.A. colour transmitter, the first to be designed and built in Australia, was used in the demonstrations. Pictured are sync. generators, camera control units, colour coders, colour bar generators, picture and waveform monitors.

EDITOR

Neville Williams
M.I.R.E.E. (Aust.)
(VK2XV)

ASSISTANT EDITOR

Philip Watson
A.M.I.R.E.E. (Aust.)
(VK2ZPW)

TECHNICAL EDITOR

Jamieson Rowe
B.A. (Syd.),
B.Sc. (Tech., N.S.W.)
A.M.I.R.E.E. (Aust.)

TECHNICAL STAFF

Ian Pogson (VK2AZN)
Harry Tyrer (VK2ZHH)
Anthony Leo (VK2ZHK)
John Horsfield
Robert Flynn
Leo Simpson

ON SALE
THE
FIRST MONDAY
OF EACH MONTH

NOW hi-fi from only \$199

INSTROL HI-FI SYSTEMS

Fully assembled and tested

complete with all leads and fittings

SYSTEM No. 2 \$229.00

This very compact, shelf or table mounting system offers the additional advantage of a Teak cabinet to house both the Amplifier and Player. It features the BSR MA70 Changer with CI cartridge; the Instrol 20-20 Amplifier; 2 Instrol Mullard Mini Speaker Systems; and the Instrol Model 75 Amplifier/Player Cabinet (Teak) which features hinged perspex top.

SYSTEM No. 4 from \$374.00

This well balanced suggestion features the Kenwood TK150U Amplifier, together with the Garrard AP75 Player (with Shure M44G Magnetic Cartridge); the speakers used are 2 Wharfedale Super 8RS DD Speakers fitted to 2 Instrol Vented Speaker Enclosures; the System is made complete with an Instrol No. 75 Amplifier/Player Case with Perspex cover.

SYSTEM No. 6 \$686.00

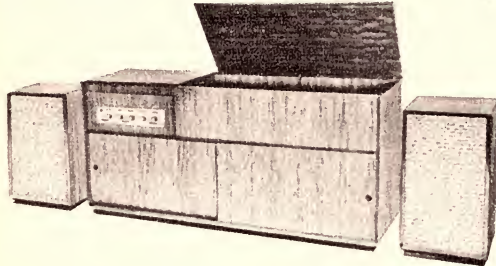

Here is the ideal system for the enthusiast who wishes to include a tape deck in his selection. It features the Kenwood TK150U Amplifier; the Garrard AP75 Player (with Shure M44G magnetic cartridge); the Sony TC255 Tape Deck; and the 2 Wharfedale Super 10 Speakers fitted into Instrol Vented Enclosures. The Instrol Model 375RS cabinet, which features record storage space, adds the finishing touches to this system. All cabinet work would be in Teak. The system would cost only \$663.00 if either Maple or Walnut finish was desired.

INSTROL AMPLIFIER

**NEW MODEL 20-20
Mark 11**

SOLID STATE STEREO AMPLIFIER

Featuring new improved output transistors, Increased bass boost, attractive teak cabinet, plus all the features of the previous Model 20-20 amplifier.

PRICE: \$86-50

Incl. Teak Case.

Yes, we carry a large range of imported loudspeakers, players, amplifiers and tape recorders, as well as Australian equipment. Please state your requirements and we will gladly quote. All well known brands are stocked, including the following:

A.D.C., Akai, B.S.R., Decca, Dual, Elac, Fisher, Garrard, Goodmans, Instrol, Kenwood, Labcraft, Leak, Magnavox, Quad, Sansui, Shure, Sony, Tandberg and Wharfedale.

SYSTEM No. 1

\$199.00

This exceptional system offers quality high fidelity at very low cost. It features a Garrard 3500 changer with Sonotone 9TA in Teak Stand; an Instrol 20-20 Amplifier in Teak Case; 2 Mullard Mini Speakers with 2 Teak Speaker Enclosures. Alternatively, the BSR MA70 Changer with CI cartridge might be preferred. Yet all this still costs no more than \$199.00.

SYSTEM No. 3

\$269.00

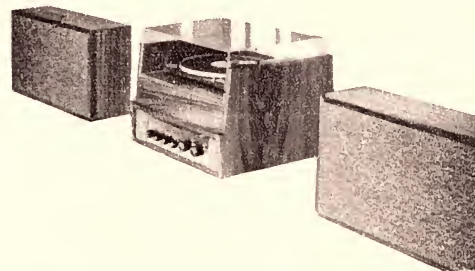

Once again a compact shelf or table mounting system, but featuring the popular Instrol-Playmaster Bookshelf Speaker System. It features the Instrol 20-20 Solid State Amplifier; the Garrard AT60 Mark II Changer with Decca Deram Cartridge; 2 Instrol-Playmaster Bookshelf Speaker Systems (All Teak); plus the Instrol No. 50 Amplifier/Player Cabinet with perspex cover.

SYSTEM No. 5

from \$467.00

This splendid selection features an attractive cabinet which includes record storage space. Take the Instrol model 250RS Cabinet, with 2 Wharfedale Super 10 Speakers fitted into Instrol Vented Enclosures. The cabinet work may be Queensland Maple, Teak or Walnut. The Amplifier used is the Kenwood TK150U, and also included is the Garrard AP75 Player (with Shure M44G Magnetic Cartridge).

SYSTEM No. 7

\$715.00

This prestige system is based on the magnificent new Instrol Cabinets "Series One Thousand." We suggest the Kenwood TK250 Amplifier and Dual 1019 Player (with Shure M75G magnetic cartridge), plus 2 Wharfedale Super 12RS DD Speakers all fitted in Instrol Teak Cabinets; 1 model 1002, and 2 Speaker Enclosures model 1001. This fine combination can be built and tested for only \$715.00.

INSTROL WIDE BAND TUNER Solid State Model T-101

A high quality hi-fi tuner designed to operate with all makes of valve and solid state amplifiers.

- Wide band 530 to 1600KHz.
- Tuning Meter.
- Efficient Noise Filter.
- R.F. Stage.
- Built-in A.C. Power Supply.
- Major Stations, all States clearly marked on large illuminated scale.

Housed in smart metal box. Available as Amp/Tuner in combination with the Instrol 20-20 Amplifier, in attractive Teak cabinet (as illustrated) or less cabinet for panel mounting.



PRICE DETAILS:

T101 TUNER (in metal case) \$72.00
T101 TUNER (without case) \$69.00
Combined 20-20 T101 in Teak case. \$158.50



ASK FOR OUR FREE HI-FI BROCHURES AND CATALOGUE.

Send in the coupon on the opposite page, ticking the square marked Instrol Hi-Fi.

INSTROL cabinet kits . . .

and now INSTROL
**MEDITERRANEAN and
 PERIOD STYLE**
Hi-fi furniture . . .

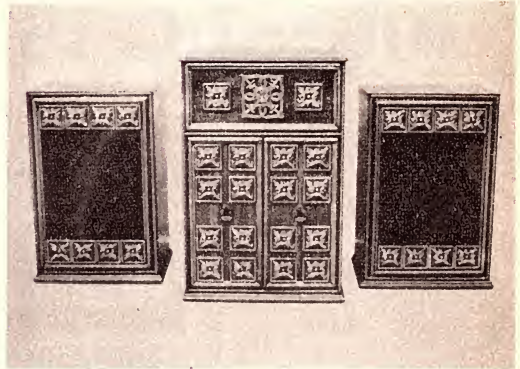

We are in the process of adding Period and Mediterranean styling to some of the models from our standard range of Instrol hi-fi furniture. The photographs show Model 600 equipment cabinet with Wharfedale speaker enclosures rendered in Mediterranean and Queen Anne period styling. These stylings are equally attractive for other models from the Instrol range.

PRE-CUT KITS OR BUILT AND FINISHED

All Period and Mediterranean Styles are available as pre-cut kits to assemble yourself or as built and finished furniture. By assembling yours from an Instrol pre-cut kit, you can make your own antique style furniture for little more than half cost. Ideal for finishing to an almost exact replica of cedar, mahogany, rosewood, etc., and really magnificent when finished in any of the new Estapol Antique colours. Each kit is complete, with all necessary pre-cut timber parts, legs, antique handles, moulding, carvings, nails, screws, etc., plus fully illustrated easy to follow instruction manual.

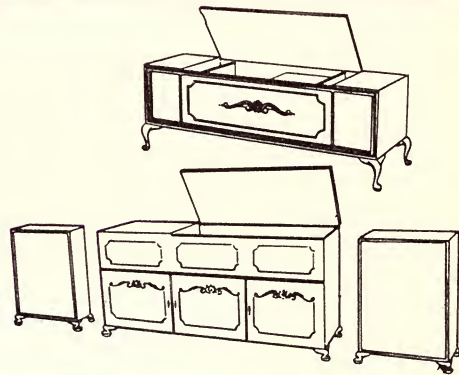

EQUIPMENT CABINETS

There are more than sixteen Instrol equipment cabinet designs, all available built and polished or as kits of parts to assemble yourself. They range from massive floor units to compact table models, and include cabinets for record storage and wall shelf units.

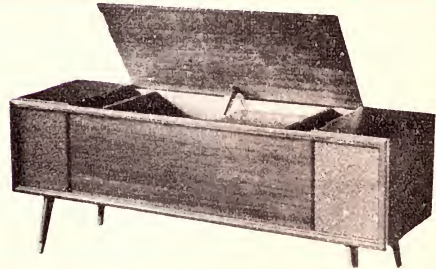

SPEAKER ENCLOSURES AND SYSTEMS

Name your speaker and Instrol can supply an enclosure to suit. If it's not in the standard range we can quickly produce enclosures to suit speaker manufacturers' specifications. Enclosures only or complete speaker systems are all available built and polished or as kits.

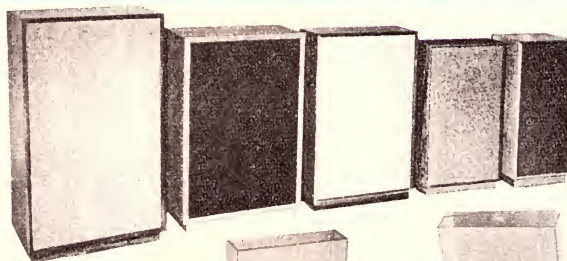

Post coupon, call, or phone for free fully illustrated Instrol hi-fi cabinet brochure. It includes full specifications and down to earth price details of all Instrol cabinet designs. (If writing please include postage stamp.)

PLAYER STANDS

The Instrol range includes a wide variety of player stands and combination amplifier-player cabinets. High quality perspex covers (clear and tinted) are also available, some hinged, others separate.



FREE

**INSTROL
 CABINET and
 HI-FI
 CATALOGUES**

**BROADWAY ELECTRONICS (SALES)
 PTY. LTD.**

32 GLEBE PT. ROAD, GLEBE, N.S.W.

Telephone 660-1171. Only 100 yards from Broadway.

OPEN SATURDAY MORNINGS.

Send Coupon for **FREE CATALOGUE.**
 (Please enclose postage stamp.)

NAME

ADDRESS

.....

.....

Instrol Hi-Fi Instrol Cabinets

Fantastic is the word for the

The new GRUNDIG TR6000 is no set for just everyone. Its technical brilliance, extraordinary ease of operation and its sturdy, fascinating looks will satisfy the most meticulous radio enthusiast.

See and hear it at:

Goldring Sales & Service (N.S.W.) Pty. Ltd.
443 Kent St., Sydney

or at leading retailers in all States

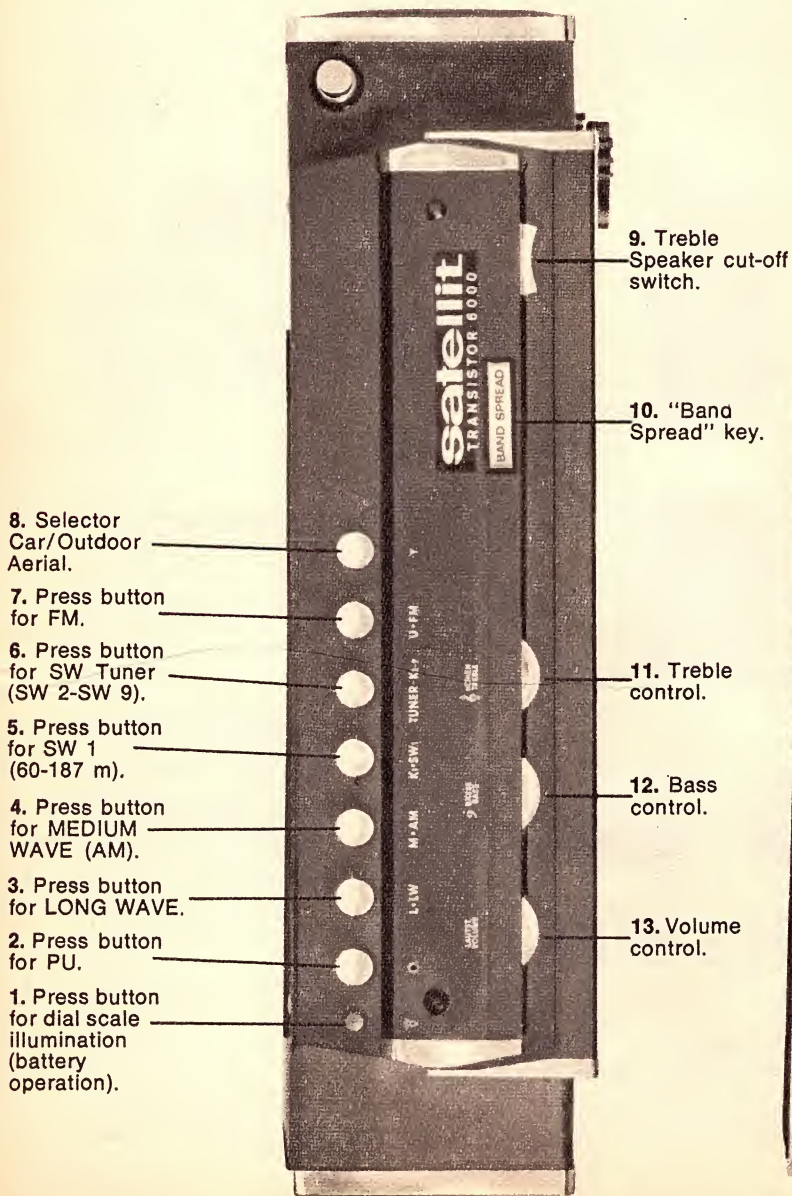

GRUNDIG

Transistor 6000

Technical Specifications:

20 tuning ranges: FM, 17 x SW (SW 1: 60-187 m, SW 2: 42-60 m and 49 m band, SW 3: 36-50 m and 41 m band, SW 4: 26,5-37 m and 31 m band, SW 5: 21,5-30 m and 25 m band, SW 6: 16,5-24 m and 19 m band, SW 7: 14-20 m and 16 m band, SW 8: 12-16,7 m and 13 m band, SW 9: 10-14 m and 11 m band), Medium Wave (AM) and Long Wave • circuits: FM 14 (3 can be tuned), AM (without SW Tuner) 9 (3 can be tuned); SW Tuner 14 (3 can be tuned) • 19 + 1 transistors (17 of these are silicon trans) • best possible cross modulation by field effect transistors • 14 + 2 diodes • tuned-in first stage on all ranges • double superimposition of SW Tuner with 4-circuit band filter • gain control: AM 3-stage, SW Tuner 3-stage with additional control, FM 1-stage • ferrite aerial for MW (AM) and LW; MULTI-MATCH telescopic aerial for FM and SW (switchable) • DUPLEX Single Selector tuning • separate SW rotating drum selector drive by means of a pull-and-push

tuning knob • colour marks for station tracing • SW fine tuning for SW 1 • "Band Spread" key • switchable AFC on FM • AM band width selector switch • tuning indicator (S-meter) • battery voltage indicator • 2 Superphone speakers (treble speaker can be switched off) • bass and treble control • 2 Watts push-pull output stage • battery operation by 6 x 1,5 V mono cells • built-in mains power pack TN 12 • dial scale illuminated • sockets for external power supply, earphone, external speaker, outdoor aerial, car aerial, outdoor dipole antenna, ground, record player/tape recorder • receptacles for SSB device with switch-over to manual control, sound filter, product demodulator • cabinet: wood, w/leatherette covering, in black and walnut.

Size approx. 44 x 26 x 12 cm
(= 18½" x 10¼" x 5")

Weight (incl. power pack), approx. 6.1 kg
(w/out batt.)

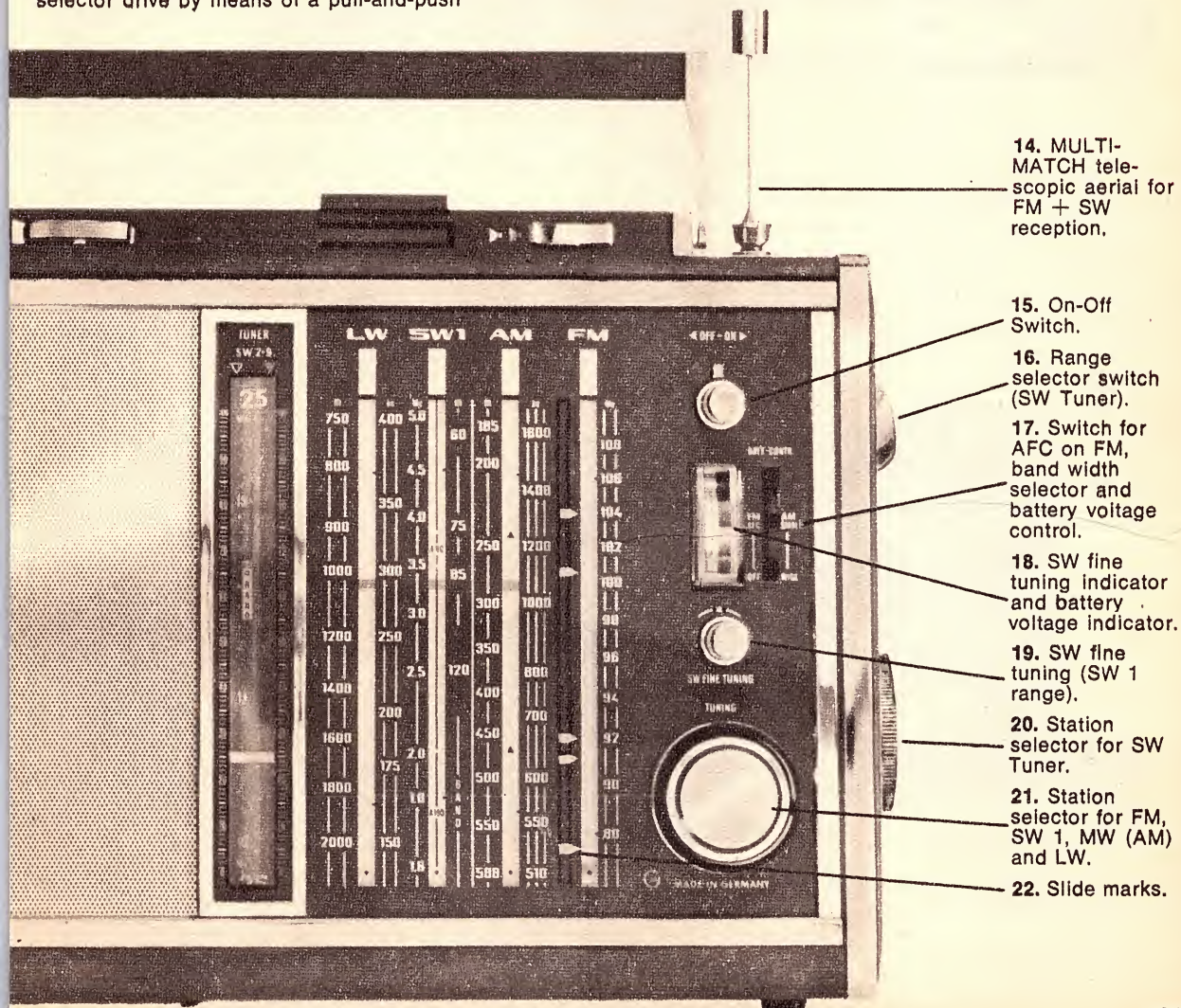

14. MULTI-MATCH telescopic aerial for FM + SW reception.

15. On-Off Switch.

16. Range selector switch (SW Tuner).

17. Switch for AFC on FM, band width selector and battery voltage control.

18. SW fine tuning indicator and battery voltage indicator.

19. SW fine tuning (SW 1 range).

20. Station selector for SW Tuner.

21. Station selector for FM, SW 1, MW (AM) and LW.

22. Slide marks.

Sansui's systematic way

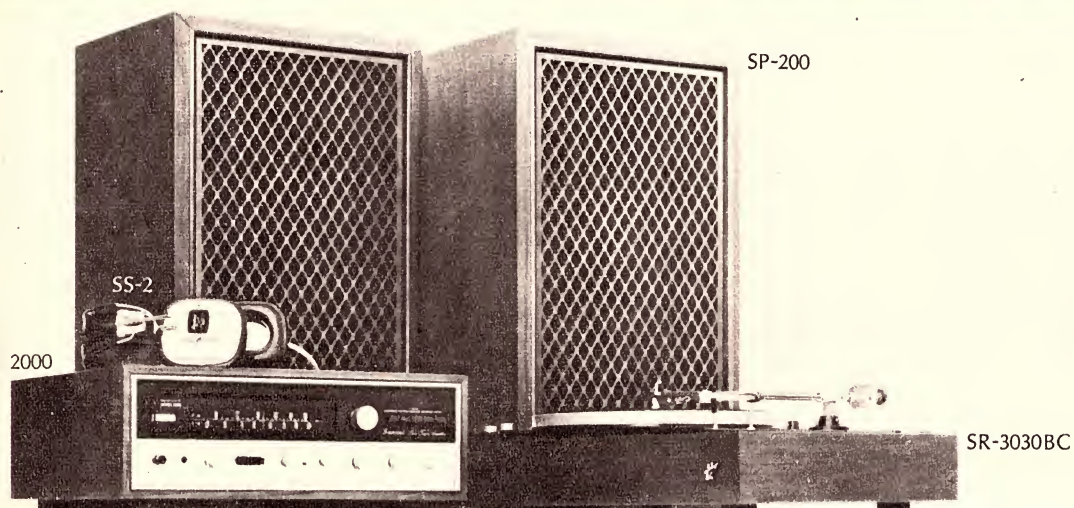

For a start, check into this attractive 100 watt system. The solid state 2000 AM/FM multiplex stereo tuner amplifier handles the other components like they were made for each other. And they were. Beginning with audio characteristics that include 100 watts in output power, wide power bandwidth from 20 to 40,000Hz and a distortion factor of less than 0.8%, the 2000 gets total performance from every component, including its own FM tuner section with FET circuitry.

The SP-200 is a 3-way 5-speaker high fidelity system with a 40 watt handling capacity and the latest tap-type level controls. The SR-3030BC is a 2-speed manual turntable incorporating a unique belt-drive system, heavy platter and tubular tonearm for flawless characteristics of wow and flutter. The SS-2 is a moving coil type headphone set that gives you "you are there" stereo faithfulness throughout a wide 20 to 18,000Hz frequency range.

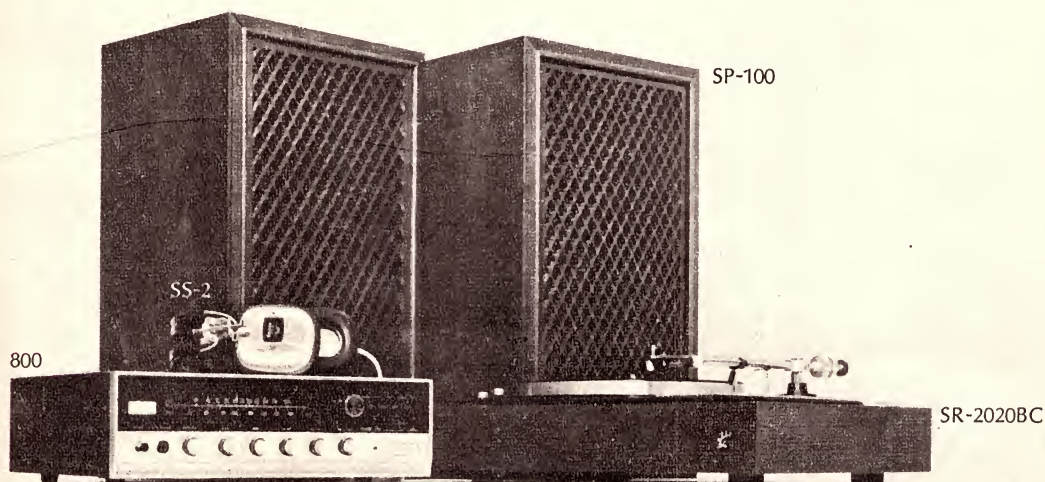

Or, check into this 70 watt system. It combines the Sansui 800 AM/FM multiplex stereo tuner amplifier with the SP-100 3-way 3-speaker high fidelity speaker system, SR-2020BC 2-speed manual turntable and SS-2 headphone set.

Like the larger 100 watt system, the components that make up this one feature compatibility in both design and performance. It brings larger system performance into the medium power and price range. Ask your nearest authorized dealer for spec sheets for either of these systems. What you see will surprise you and what you hear will surprise you even more if you haven't heard a Sansui system before.

to better sound.

If you're looking for something even more professional, ask your dealer to show you the Sansui AU series of professional stereo control amplifiers. They turn on at 70 watts (AU-777), 60 watts (AU-555) and 46 watts (AU-222), respectively.

And they turn on some of the finest engineering features ever offered to stereo enthusiasts anywhere. Wide dynamic ranges, low distortion factors, high S/N ratios and independent pre- and main-amplifier sections for the two larger models.

Sansui also makes matching AM/FM Multiplex Stereo Tuners for these models, which is something to keep in mind for the time when multiplex broadcasts become operational in Australia.

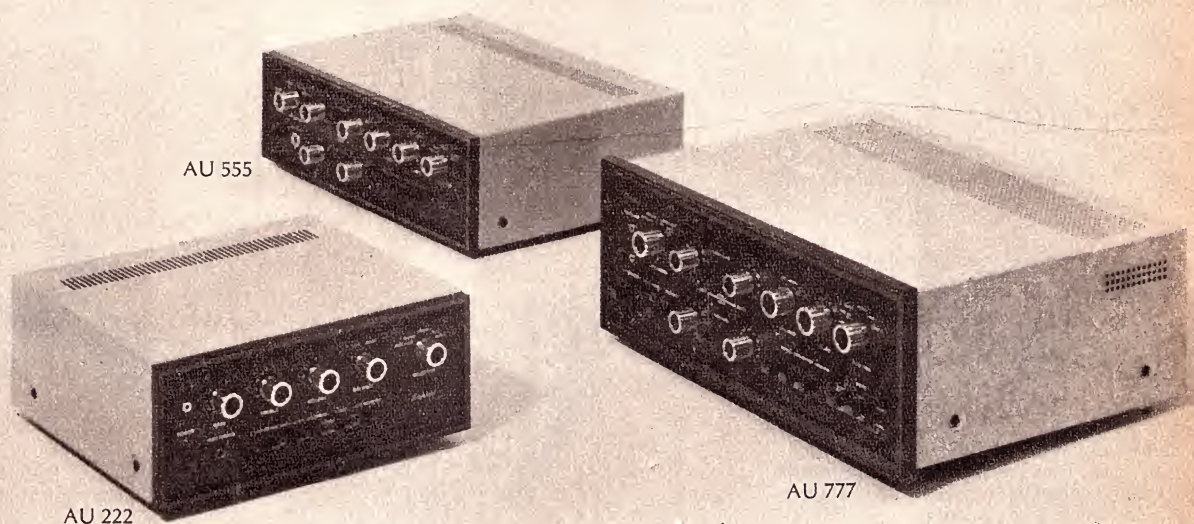

AU 555

AU 222

AU 777

Sansui[®]

SAID THE SPIDER IN

A spindly, ugly, clumsy-looking, insect-like contraption that only an astronaut could love may look out of place in this age of super-smooth and sleek flying machines, but the aerodynamic misfit inappropriately called "Eagle", the U.S.A.'s lunar module, will go down in history as the first manned machine to land on the moon.

By Howard W. Kelly, K4DSN

Reprinted by permission of "CQ" of the U.S.A.

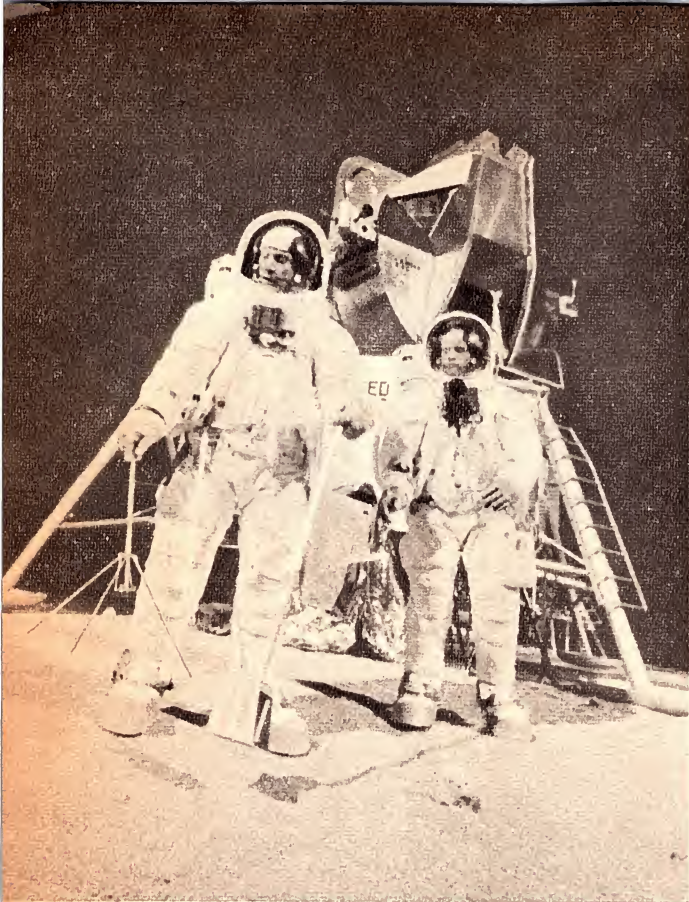

The final objective of the Apollo moon mission is due to be carried out aboard the spidery Lunar Module (LM) whose homeliness is offset by its beauty of advanced technology and practicality. Though its ability to space-fly is something of amazement about which pages could be written, this discussion is limited to the LM's communication ability.

The communications subsystem aboard the Lunar Module is capable of three two-way combinations of in-flight or lunar surface radio links: LM to the orbiting Command Module (CM), LM direct to earth, and LM to the astronauts who are roaming about the moon's terrain.

As in the Apollo, the LM places its communications responsibilities in Unified S-band (2101.8 and 2282.5 MHz) and VHF equipment.

In flight (Figure 1), when the LM is on the earth side of the moon and separated from the Command Module, communication with earth is handled on S-band, but between the LM and CM information is passed back and forth on VHF.

As in the Apollo S-band system a

A WORD OF EXPLANATION . . .

Because of our publication schedules, this article had to be made up, complete with illustrations, before the Apollo 11 mission left the launch pad. It had to be on the presses some hours before the astronauts were due to splash down in the Pacific. All indications are, however, that the communications network worked well during the mission and a great deal of the traffic was handled through Australian tracking stations. Television signals direct from lunar capsule were picked up by Australian radio telescope and tracking station antennas and fed into a world relay network.

multitude of information sources on the LM can be transmitted and received at the same time, on the same antenna and often on the same frequency. LM-to-earth S-band links contain voice, TV, digital uplink, ranging code signals, biomedical, and systems telemetry data (see Table III).

S-band voice is the primary means of communication between Mission Control and the two men aboard "Eagle" (the voice identifier for the Lunar Module). Backup voice from earth is possible using the digital uplink channel, but this is usually tied up keeping the LM's guidance computer up-to-date.

In response to ranging code signals sent to the LM, the S-band equipment supplies earth stations with a return ranging code signal that enables Mission Control to track and determine range of "Eagle."

Biomedical data pertinent to astro-

naut heartbeat is transmitted by the LM (so earthbound doctors can monitor and record the physical condition of the spacemen) as is telemetry and voice (using redundant S-band equipment). In case voice capability is lost, an emergency key is provided for CW communication to the Manned Space Flight Network.

Most of the same information can be exchanged between "Columbia" (voice identifier for the Command Module) and "Eagle," that can be sent directly to earth from the LM. However, these communications use VHF. Normal voice chatter goes out on 296.8MHz (Channel A) simplex. Backup is on 259.7MHz (channel B) simplex. VHF ranging, which is initiated by "Columbia" uses both VHF channels in a duplex system.

When the two orbiting spacecraft are behind the moon, contact with Mission Control is not possible. Sim-

IN FLIGHT COMMUNICATION

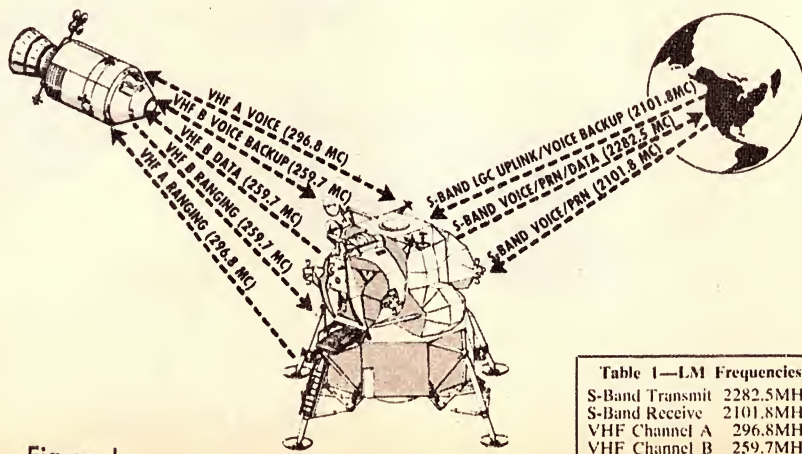

Figure 1

Table 1—LM Frequencies	
S-Band Transmit	2282.5MHz
S-Band Receive	2101.8MHz
VHF Channel A	296.8MHz
VHF Channel B	259.7MHz

THE SKY

plex voice is maintained over the 296.8MHz circuit between "Eagle" and "Columbia" at this time, while telemetry data is fed over channel B into tape recorders aboard the command ship to be stored and re-transmitted to earth at 32-times the original recording speed when radio conditions between earth and space permit.

When the 16-ton Grumman Aircraft "Eagle" has planted its legs into the moon's crust, the orbiting CM will use its S-band system to talk to earth and VHF to maintain communications with the astronauts who are on the lunar surface (figure 2). The Lunar Module then becomes the world's most expensive repeater. The LM takes the VHF voice, converts it to S-band and

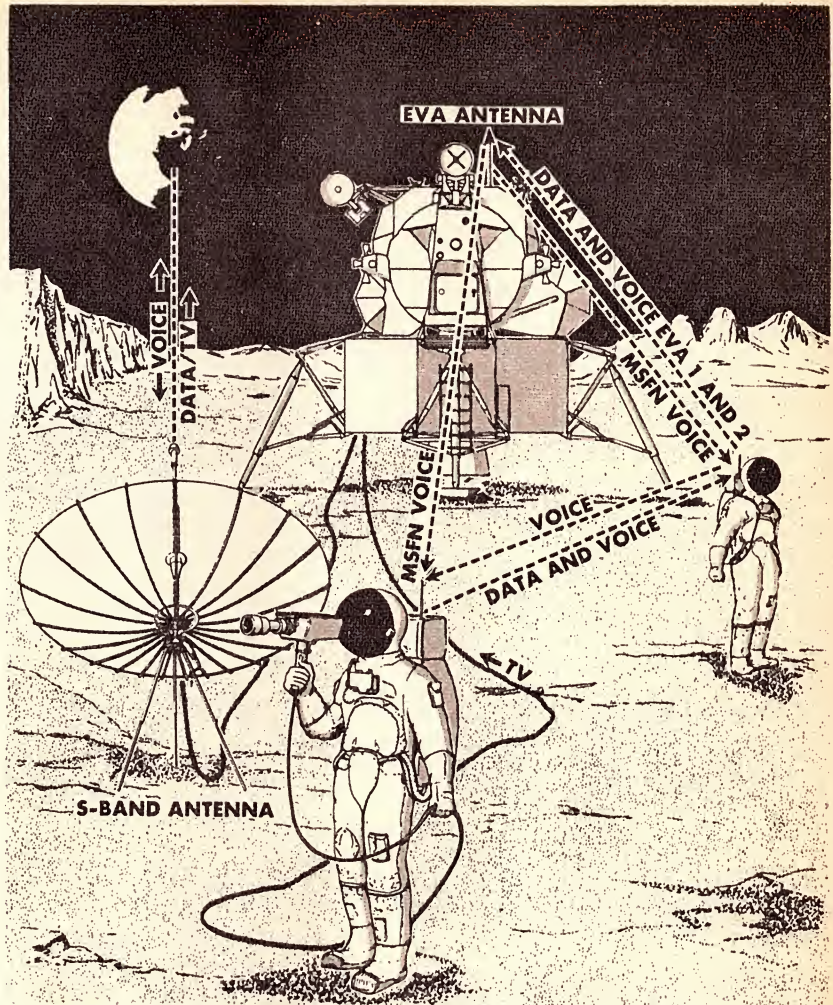

ABOVE RIGHT: Figure 2. Lunar surface communications. The voice communication link operates on 296.8MHz. The unattended Lunar Module acts as a repeater to relay to earth the VHF communications via 2282.5MHz (S-Band).

BOTTOM RIGHT: Figure 5. Simple schematic of the Lunar Module sub-system.

re-transmits it to the space network of earth receiving stations.

Should VHF between the moon-bound astronauts and the command ship not be satisfactory, earth stations may act as repeaters by re-transmitting S-band from the moon back into space to the CM.

LM-to-earth capabilities from the moon are the same as in-flight except that, in addition, TV may be directly transmitted to earth from the lunar surface. Originally, it was intended to use an erectable antenna (figure 2) but subsequently NASA indicated that the TV signals would be transmitted via the LM's steerable S-Band antenna.

The television system has a much more utilitarian use than just to show earthlings the spectacle of man's first step on a foreign planet. It will provide the closest, most exacting view thus far of the moon's topography for instant evaluation by scientists in Houston. These same scientists can advise the spacemen which rocks to pick up and bring back, which features are important, and which way to point the camera. There are also plans to set the camera on a tripod a distance away from the LM so that we on earth can see the actual blastoff from the moon when the job is done and "Eagle" returns to space for a rendezvous with the mothership. The television trans-

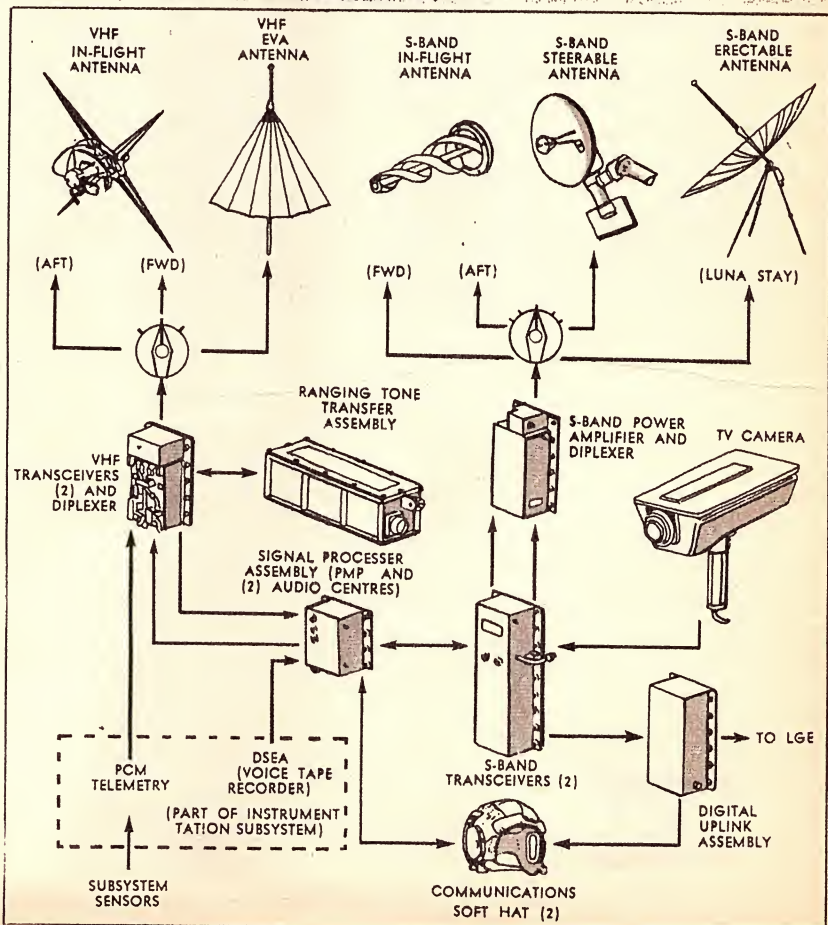

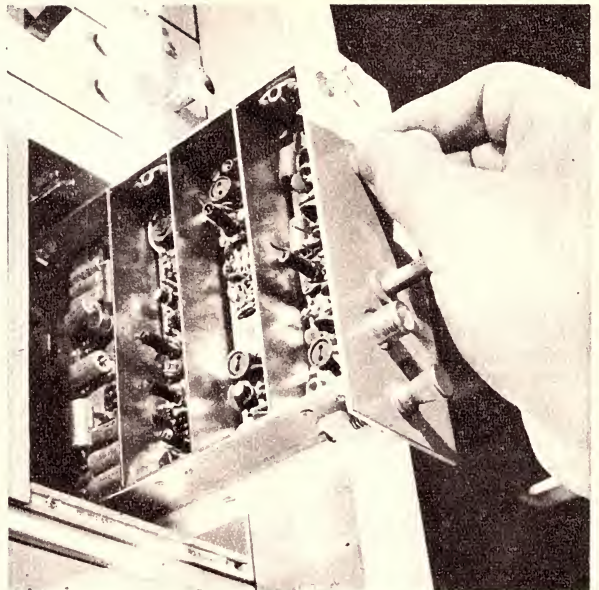
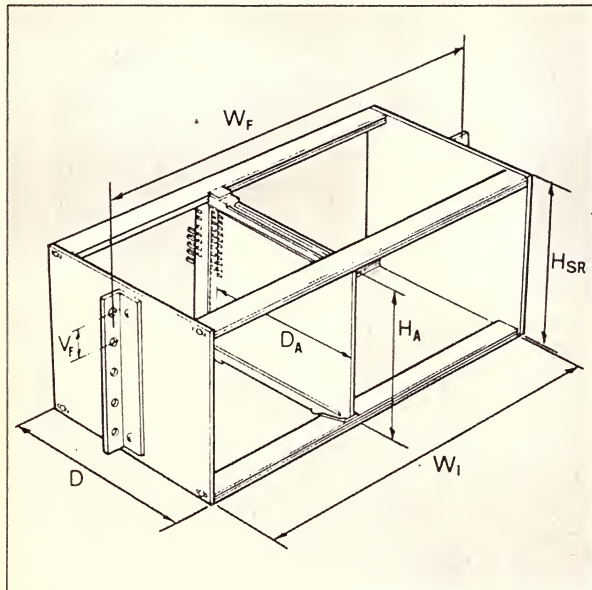

Modular Mounting and Connecting Rack Systems (ISEP) custom-built to your requirements.

Low-cost ISEP housing systems increase efficiency, speed assembly and servicing of electronic equipment.

Whether you are mass producing or building equipment to order, we can supply an ISEP modular housing system with a comprehensive range of racks, sub-racks, plugs, sockets and accessories to meet your exact needs.

Assembly is easy and fast. In design and electrical specifications, ISEP systems meet the highest professional standards. Plugs and sockets for example, are rated at 250v. r.m.s., 4A. per connector,

and have a contact resistance of less than 5m/ohms.

Why not have one of our ISEP specialists call and show you how much an ISEP housing system can save you? His service is free, of course. Or — write for our illustrated technical booklet all about ISEP. The booklet's free also. **Standard Telephones & Cables Pty. Limited**, Components Division, Moorebank Avenue, Liverpool, N.S.W. 2170. Telephone 602.0333. Melbourne 480.1255. Canberra 49.8667. Brisbane 47.4311. Perth 21.6461. Adelaide 51.3731. Launceston 31 2511. Newcastle 61.5172. Wollongong 2.7974.

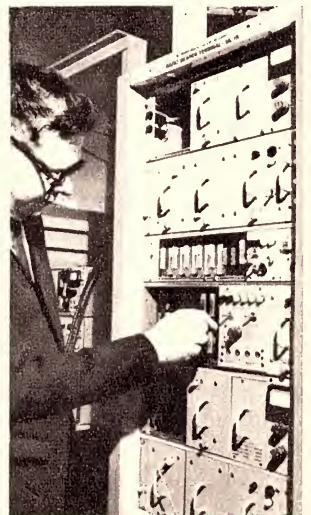

ISEP (International Standard Equipment Practice) is a simple and highly flexible modular mechanical mounting and connecting system developed by ITT.

AN

ITT
ASSOCIATE

world-wide telecommunications and electronics



Table 2 — Frequency Chart of Apollo/Lunar Module

MHz	Vehicle	Mode	Information
2287.500 secondary	CM	PM	Voice, tracking/ranging, data
2282.500 transmit	LM	PM/FM	Voice, TV, tracking/ranging, data
2272.500	CM	FM	TV, data
2106.400 primary	CM	PM	Voice, tracking/ranging, data
2101.800 receive	LM	PM	Voice, tracking/ranging, data
296.800 Ch. A	CM/LM	AM	Voice, CM to LM, EVA, data
259.700 Ch. B	CM/LM	AM	Voice, CM to LM, data
243.000	CM	AM	Recovery beacon
10.006	CM	SSB	Backup HF recovery link

CM—Command Module of Apollo. LM—Lunar Module. EVA—Extra Vehicular Activity.

Table 3 — Lunar Module S-Band Capabilities

Information	Freq. or Rate	RF Carrier Modulation	Subcarrier Modulation	Subcarrier Freq.
Receive: 2101.8 MHz				
Voice	300 to 3000 Hz	PM	FM	30 KHz
Voice Backup	300 to 3000 Hz	PM	FM	70 KHz
Ranging Code	990.6 kilobits/sec.	PM		70 KHz
Uplink Data	1.0 kilobits/sec.	PM		70 KHz
Transmit: 2282.5 MHz				
Voice	300 to 3000 Hz	PM or FM	FM	1.25 MHz
TV	10 Hz to 500 KHz	FM baseband		
Biomedical	14.5 KHz subcarrier	PM or FM	FM	1.25 MHz
Lunar Surface Unit	3.9, 5.4, 7.35, 10.5 KHz subcarriers	PM or FM	FM	1.25 MHz
Voice	300 to 3000 Hz	PM baseband		
Biomedical	14.5 KHz subcarrier	PM baseband		
Lunar Surface Unit	3.9, 5.4, 7.35, 10.5 KHz subcarriers	PM baseband		
Voice Backup	300 to 3000 Hz	PM baseband		
Ranging Code	990.6 kilobits/sec.	PM		
Emergency Code	Morse Code	PM	AM	512 KHz
Pulse-code-mod. non-return zero	High bit rate: 51.2 Low bit rate: 1.6	PM or FM	Phase Shift	1.024 MHz

mitter is located in the base section (descent stage) of the LM — the part that stays behind.

The small hand-held camera (figure 3) designed for the Apollo program, weighs only 4½lb. The TV system is a dual standard one, with a bandwidth of 10Hz to 500Hz. It scans at either 10 frames per second at 320 lines, or 5/8 frame per second at 1280 lines. The lin vidicon consumes about 7½ watts.

The well-dressed astronaut who strolls along Lunar Lane wears upon his back an all important unit known as the PLSS — Portable Life Support System (figure 4). The PLSS is a self-contained, self-powered rechargeable environmental control system. For four hours the back-pack supplies pressurized oxygen, cleans and cools the expired gas, circulates cooling liquids, and contains a transmitter for biomedical information and a dual VHF transceiver for communication.

The PLSS has a contoured fibreglass shell to fit the astronaut's back, and a thermal micrometeoroid protective cover. It has three control valves, and, on a separate remote control unit, two control switches, a volume control, and a five-position switch for the dual VHF transceiver. The remote control unit rests on the chest.

The astronaut has available to him primary and secondary duplex voice

communication, and physiological and environmental telemetry all of which must go through the LM to the CM on VHF, then from the CM to earth on S-band. The VHF antenna for the PLSS is permanently mounted on the oxygen purge system. Two side-tone generators override incoming audio in the headphones to notify of low pressures or low fuel reserve.

In several respects, RF equipment (figure 5) on the LM is much like that on its big brother Apollo. (Note: Unlike military ships, astronauts don't refer to their spacecrafts as "she," but

rather "he.") The S-band assembly consists of two identical phased-locked receivers, two phase modulated (PM) transmitters (0.75 watts output) with driver and multiplier chains, and a frequency modulator (FM). The receivers and phase modulators provide the ranging, voice, emergency CW, and telemetry transmit-receive functions. FM is primarily used for video transmission, but accommodates pulse-code-modulation telemetry, biomedical, and voice transmission. FM also provides limited backup for both PM units.

When more RF is required ampli-

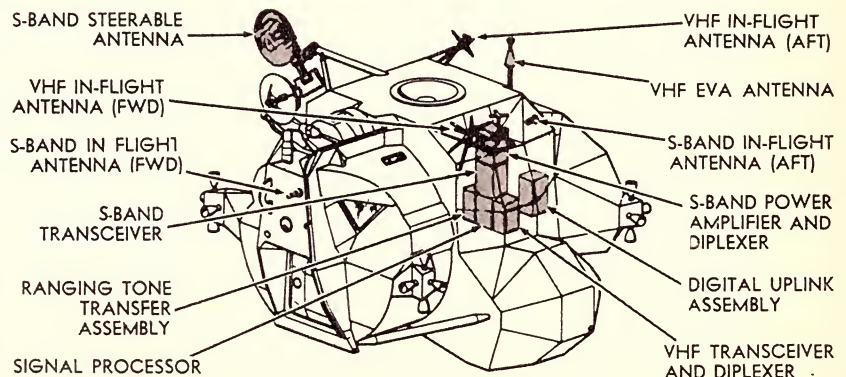

Figure 6. Major communications equipment locations on the LM.

Eveready re-chargeable Nickel Cadmium batteries can do hundreds of cycles.



'Eveready' Nickel-Cadmium cells have an incredibly long life: they can be stored charged or uncharged, they are completely sealed, they can be trickle charged, and their charge discharge cycle life extends into hundreds.

Cell sizes range from 20mah to 23ah in button, cylindrical and rectangular forms.

Contact your nearest Union Carbide Sales Office or write to Union Carbide Australia Limited, 167 Kent Street, Sydney, 2000. Please ask for technical literature.

EVEREADY BATTERIES Products of **UNION CARBIDE**
'Eveready' and 'Union Carbide' are registered trade marks.



ABOVE LEFT: The Apollo astronauts wearing the "integral thermal micrometeoroid garment," as their spacesuits are designated, during an exercise on earth.

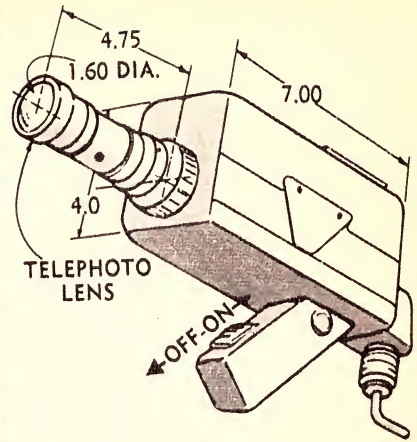

BOTTOM RIGHT: Figure 4. Keyed diagrams indicating the principal features of the spacesuits. Included inside the garment is a dual VHF AM transceiver for voice communications and capable of carrying constant physiological telemetry.

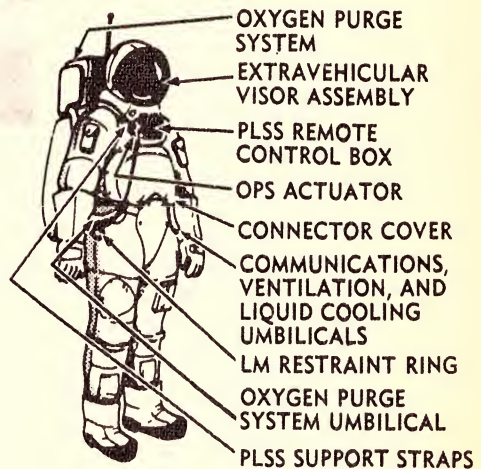

TOP RIGHT: Figure 3. The 1in vidicon television camera designed to transmit live pictures to earth from the moon of the activities of the astronauts during a lunar landing.

plers can be brought into circuit. This assembly consists of two amplifiers (primary; 18.6 watts output, secondary; 14.8 watts output), an input and output isolator (ferrite circulators), and two power supplies all mounted on a common chassis. The RF circuit is a series inter-connection of the isolators and amplifiers. The amplifiers themselves (which are saturated, rather than linear) are broadband and exhibit high efficiency, high peak and average output power, but relatively low gain. The isolators protect both amplifiers and both S-band transmitter driver and multiplier chains. The isolators exhibit minimum isolation of 20dB and a maximum insertion loss of 0.6dB. Only one amplifier can be activated at a time and when neither amp is selected, a feed-through path through the power amplifier exists with a maximum insertion loss of 3.2dB.

Although the Apollo relies heavily on its S-band capabilities, the Lunar Module is oriented toward VHF. This equipment consists of two solid-state superhet receivers and two 5-watt AM transmitters. One transmitter-receiver combination operates on 296.8MHz (Channel A), the other on 259.7MHz (Channel B), for simplex or duplex voice communications. Channel B may also be used to transmit pulse-code-modulation (PCM) data from the LM to the CM at a low bit rate and to receive biomedical and space suit data from the astronauts who are outside the ship on the moon.

The signal processor unit is the common acquisition and distribution point for most received and trans-

mitted information, except that low bit rate split-phase data are directly coupled to VHF Channel B and TV signals go directly to S-band FM. The signal processor assembly processes voice and medical information and provides the interface to the proper RF generator, tape recorder, modulator, or computer.

This signal processor includes an audio centre for each astronaut and a premodulation processor where information is switched, mixed, and modulated. It also has a repeater function so that VHF received signals can be re-transmitted on S-band.

The two identical audio centres provide individual selection, isolation and amplification of audio received or transmitted from the LM. Each centre includes a microphone preamp, headset amplifier, VOX circuit, diode switches, audio gain controls, and an intercom system.

The digital uplink assembly decodes 2101.8MHz commands from earth and routes the information to the LM guidance computer. It also provides a verification signal to the pilots that the equipment has in fact received all the needed information from earth. However, if for some reason the computer doesn't get all the information it wants or it suspects some of it is wrong, it will signal through the S-band transmitter "no-go" and ask for a repeat. The uplink commands addressed to the LM parallel those inputs available to the LM guidance computer via the display and keyboard accessible to the spacemen. The digital uplink assembly also provides another means of voice-backup if the received S-band audio

circuits in the premodulation processor fail.

The ranging tone transfer unit operates with VHF receiver B and VHF transmitter A to provide a transponder function between the command and the moon vehicle. The VHF ranging tone input is made up of two acquisition tone signals and one track tone signal. Accurate ranging is accomplished when the track tone signal from the CM is received and re-transmitted from the LM.

The S-band steerable antenna (figure 6) is a 26-inch diameter parabolic reflector with a point source feed that consists of a pair of cross-sleeved dipoles over a ground plane. Primarily this antenna provides deep-space voice and telemetry communications and deep-space tracking and ranging. This radiator functions over 174° azimuth and 330° elevation coverage and can be operated manually or automatically. Initial positioning is done manually to orient the steerable antenna within $\pm 12.5^\circ$ (capture angle) of the line-of-sight signal received from the earth. Once the antenna is positioned within the capture angle, it can operate in the automatic mode within the limits of its gimbal mount.

In flight, two omni-directional S-band antennas can be used; one forward, one aft on the LM. The radiators are right-hand polarised helicals that collectively cover 90 per cent of the sphere at -3dB or better. As mentioned earlier there is also an erectable 10-foot parabolic surface reflector that is unstowed from a side

(Continued on page 189)

SECRETS OF MARS

WHICH WILL BARE THEM—ROCKET, RADIO OR CAMERA?

SCIENTISTS COMBINE TO SOLVE THE PROBLEM

ROCKET, radio or camera — which will be first to lay bare the secrets of Mars?

Of course, it isn't at all certain that any one of the three will prove a successful Sherlock Holmes of the skies, but scientists, lured on by an age-old curiosity concerning our neighbouring planet, are pressing along all three paths.

The latest development to set the scientific world again agog over the old question of whether there was life on Mars was the announcement from Paris of B. McAfee, American scientist, and Professor David Todd, American astronomer, that they proposed to snapshot the planet by using an abandoned mine shaft in Chile as the barrel for a telescope.

Only a short time before Signor Marconi, of wireless fame, had put a kick of interest in the most fantastic of scientific inquiries by suggesting that a radio signal of 150,000 metres which he had picked up might have come from some Martian armed with a mammoth sending set.

But it was left to Professor Robert H. Goddard, of Clark College in Worcester, Mass., to suggest making an investigation of the moon by means of a multiple charge, high efficiency rocket, capable of carrying cameras or other recording apparatus needed to explore the unknown regions of the upper air. As the claim was made that a rocket could be constructed of unlimited cruising power, it has been suggested that it might be shot up to Mars instead of the moon, which many scientists affirm is uninhabited. One or two daring individuals even have volunteered to be shot up in place of a camera.

The possibility that some folk might be wandering up and down the valleys of Mars has excited the curiosity of astronomers and laymen throughout all the ages, for Mars is the nearest planet to the earth and the easiest to observe.

Imaginative writers took their readers on trips to the moon and laid the scenes of their stories in the surroundings of Mars, Saturn and other planets, but there was little scientific knowledge to furnish a basis for such fiction.

The perfecting of the high-powered telescope and the adaptation of photo-

graphy to the uses of the astronomers quickened their interest in the possibility of life on another world. Mars, which was seen to have large areas of a bluish green and other areas of an ochre red, with patches of white at the poles, was believed by many astronomers to be capable of supporting life in some form.

Schiaparelli, an Italian astronomer, announced in 1871 that he had found the surface of the planet scarred by many lines, which were perfectly straight, and seemed to have some system, like vast engineering works. He called the lines "canale" and said he believed they had been constructed, and were not simply cracks in the surface of the planet.

Professor Percival Lowell erected an observatory in Flagstaff, Arizona, many years ago, and commenced a systematic observation of Mars. More than 10 years ago he startled the world by expressing his belief that Mars was inhabited by intelligent organisms living in a civilisation much farther advanced than ours.

The canals, he said, were really big ditches bringing water from the poles to irrigate the rest of the planet. The ochre red areas on the surface of Mars, he asserted, were deserts or fallow fields which became bluish green as the water flowed along the canals in the seasons.

Later, he said that he had watched the bluish green area, denoting land springing to life with the coming of the water, spread down the northern hemispheres along the borders of the canals to beyond the equator of the planet, and then gradually turn reddish brown with the waning of the season. The water, he claimed, was from ice melting on the polar caps of the planet.

Other scientists took the opposite point of view. Some said the canals were only cracks in the surface of the planet filled with sand, impregnated with salts of various kinds, which became dark or light to the observer according to its moisture content. The temperature on Mars, they said, was too cold to support life of any kind.

Lowell retorted that his observations showed that the average temperature was 48 degrees Fahrenheit. The irregularity of the canals their even spacing,

the accuracy with which they made a great circle, such as navigators employ on a curved surface thousands of miles in extent, the manner in which some of the canals were paralleled at certain points and the regularity of the spots at the intersections of canals all testified, he asserted, to the artificial nature of the canals and justified a belief that they were made by sentient organisms of high intelligence.

More than five hundred canals and oases, as Lowell claimed the spots to be, have been mapped out, and their names are so well known that Harvard Observatory announced last April that snow had been observed falling at Isidis, in the district of Syrtis Major, Mars. It was held by some that the canals had been developed to signal the earth, which must appear to the Martians as of immense size, being nine times bigger than Mars.

With the development of wireless telegraphy several attempts have been made to get into communication with Mars with high-powered apparatus. Signor Marconi gave encouragement to that field of research recently, when he announced that in the course of experimenting he had picked up a signal with a wave length of 10,000 metres, about six times as long as any commercial apparatus in use today. Marconi said the letter V had been repeated several times in international code. He suggested that possibly the inhabitants of Mars were trying to get into communication with the earth.

Two engineers of Omaha devoted two weeks recently to listening for signals from Mars. They kept their apparatus tuned to catch such a message as Marconi described, but they heard nothing.

Controversy has run high over the bold proposal of Messrs B. McAfee and Todd. A mine shaft in the Chilean Andes, which will point directly at Mars in 1924, will provide the barrel of their telescope, they announced, and a big pan of mercury revolving at high speed at the bottom will provide the mirror. The two Americans calculate that the surface of Mars will be magnified at least twenty-five million times, bringing it within a few miles of their cameras.

The mine shaft will be widened to 50 feet in diameter and sheathed. The pool of mercury at the bottom will be revolved at such speed that it will assume a concave shape and become a mirror. The depth of the fortunately placed shaft is so great that there will be sufficient luminosity, the two scientists said, to enable them to take snapshots instead of time exposures.

The Goddard proposal for aerial investigation also includes the use of cameras. To summarise his principle, the determining factor of the efficiency of a rocket is the velocity of the

(Continued on page 25)

With the conditions of the Lunar landscape already revealed, and a soft landing on Mars with the prospect of television pictures transmitted back to Earth scheduled for 1973, this article, reprinted from the January, 1922, issue of "Sea, Land and Air," makes extremely interesting reading. Rocket, radio or camera? The author could not have foreseen that it will be a combination of all three, plus something not in existence at that time—television—which will give man his first clear image of conditions on Mars. Nevertheless, in many respects the predictions recorded here from nearly 50 years ago have proved to be remarkably accurate. However, the author's reference to the size of Mars is wide of the mark.



POPULAR COSMOS MODEL SW-30C AMPLIFIERS AGAIN AVAILABLE!

Since first introduced to the Australian market hundreds of Cosmos amplifiers have been sold. Many music lovers still prefer the sound of a well designed valve amplifier; this factor is doubtless responsible for the popularity of the Cosmos SW-30C. Output is 8 watts R.M.S. or 15 watts I.H.F.M. in each channel, all necessary control facilities are included and the price is only \$79.50. (IMPORTANT: the sensitivity of the Cosmos suits magnetic cartridges at 5 mV.) Provision is made for use of stereo headphones and a DIN socket permits connection of tape recorders. The pre-amplifier is fully transistorised. Speaker outputs allow for use of 4, 8 and 16 ohm speakers or speaker systems. The Cosmos is ideal for use with tape recorders and tape decks. When used with high quality stereo pick-ups and wide range speaker systems, results are very satisfying. Encel price, inc. sales tax. **\$79.50**

COMPAX SOLID STATE TUNERS

A high quality wide band AM tuner, the Compax represents outstanding value. Output suits all amplifiers and tape recorders. The external teak finish case is optional. Price with case is \$46.50 inc. sales tax. Encel price without case **\$43.60** is only

DEMAGNETISE YOUR TAPE HEADS AND IMPROVE TAPE PERFORMANCE!

Simply plug the tape head demagnetiser into any AC power point and pass over the heads. Takes only five seconds and can make a world of difference. Two models — single and double probe. Both (inc. Sales tax) **\$4.50**

SPECIAL SLASHED PRICES ON SHURE CARTRIDGES

If you're waiting to buy a new Shure cartridge be sure to get Encel's bargain basement price before you make your purchase. We are not at liberty to advertise our new low prices.

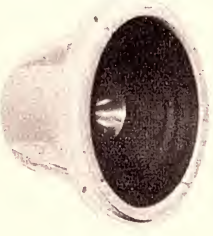

NOW . . . A NEW 8-INCH CO-AXIAL SPEAKER WITH UNIQUE PERFORMANCE AND SIX POWERFUL MAGNETS . . . ONLY \$34.50!

Can any 8in speaker be worth \$34.50? Easily when you see and hear the remarkable CX-20D. Here at last is a total-performance 8in co-axial speaker with six magnets, a horn type tweeter, an electrical crossover, high compliance and unusually robust ribbed construction. Total weight is almost 8lbs and frequency response is 35-20,000 Hz. The response curve is substantially flat; from an engineering viewpoint the CX-20D is superb in design and construction. The matching enclosure is easy to make and any handyman can make it from readily available materials. We want you to hear the CX-20D and make your own appraisal. It's tremendous value for money! **\$34.50** inc. sales tax.



"DITTON 10's" AND "DITTON 15's" ARE ONCE MORE IN LIMITED SUPPLY

The Celestion Ditton 15 measures only 2 1/2in x 9 1/2in x 9 1/2in and incorporates the HF 1300 Mark II tweeter, a new type of bass drive unit and the revolutionary auxiliary bass radiator. Many favourable reviews have been published. Ask for your copies! "Hi-Fi Sound" — "It was difficult sometimes to realise that so small a loudspeaker was really producing such well-defined low frequency sounds. It goes without saying that the treble performance was fully up to standard of the HF 1300." "The Gramophone" — "the listening tests made an excellent impression. Treble was bright and forward; the bass was clean and powerful enough to produce a good balance." "Hi-Fi News" — "the quality of bass sound was above average, plenty of bass, but always clean and clear . . . a very wide range of programme material was enjoyed and nothing caught it out or gave cause for reservation."

The Celestion Ditton 10 measures 12in x 6 1/2in x 8 1/2in and features a specially designed bass unit and the well known Celestion tweeter. Both 3 and 15 ohm impedances are available. One review of the Ditton 10 in "Records, And Recording" says, "On a wide range of music it proved to be a clean-sounding speaker with the sort of characteristics which would make it one of the most popular in its class."

Prices: "Ditton 15in" (inc. Sales Tax) **\$89**

"Ditton 10in" (inc. Sales Tax) **\$64.50**

CANBERRA ENQUIRIES FOR ENCEL EQUIPMENT

If you live in Canberra and you want further information on Encel equipment, please phone, Canberra 81-1667.

SAVE MORE ON ALL LEADING MAKES OF TAPE RECORDER

Encel Stereo Centres stock all the best makes . . . Akai, Sony, National, Toshiba, Philips, Revox, Tandberg, Nivico and many more. You'll be wise to secure an Encel price before you commit yourself elsewhere. Save at Encel's!

KENWOOD AMPLIFIERS NOW AVAILABLE!

Save more at Encel's . . . write or call for your Kenwood price. Ask for a trade-in valuation on your old equipment; often the allowances made for working units will reduce your outlay considerably. All Kenwood models available.

TRADE-IN AND TRADE-UP!

When purchasing equipment from Encel Electronics, be sure to ask for a trade-in valuation on your old equipment. If you old equipment is in good working order, the cost of your current purchase can be reduced considerably. Bring in your amplifier, tape recorder, tone arm, etc. . . and same more than ever at Encel Stereo Centre!

TAPE SPLICERS . . . ONLY \$2.50!

We've just made a special purchase of tape splicers . . . and while the stock lasts this easy-to-use unit is priced at only \$2.50. Save time and fidgeting—and frayed nerves; order now!

SEE A COMPLETE AUDIO RANGE AT ENCEL STEREO CENTRES!

Apart from the many exclusive Encel lines you'll find a vast range of high quality equipment at Encel stores in both Sydney and Melbourne. Here are a few of the manufacturers represented: Trio-Kenwood, KEF, Sony, ADC, Wharfedale, Ortofon, National, Toshiba, Shure, Akai, Sansui, Philips, Nivico, BSR, Garrard, and many, many more. Be sure to get an Encel EMQ (Encel Mail Quote) . . . you'll save much more at Encel Electronics!

CELESTION CO-AXIAL HIGH FIDELITY LOUDSPEAKERS

Limited supplies of both 12in Celestion speakers—the C2012 at \$64.50 and the CX1512 at \$44.50 — are available from time to time. Demand from world markets and limited specialised production have restricted supplies to Australia; if you've been waiting for one of these fine co-axial units, order from Encel's now! Both prices include sales-tax and orders will be filled in strict sequence.

CELESTION GUITAR SPEAKERS

Write or call now for full details and prices of Celestion 15in and 18in woofer speakers — designed for guitar applications. These fine units feature massive magnet structures to provide high flux density and extended bass response. Power handling capacity is up to 100 watts R.M.S. with 18in models.

PE TURNTABLES MODELS PE2020 AND PE2010.

Perpetuum-Ebner turntables are probably the most popular in their price categories — and the low Encel price adds further value to these fine German products. Write for Encel prices (EMQs) or call for your PE proposition. Stocks are limited, although more are on the water. Contact Encels now!

SAVE ON SANSUI AMPS AND SPEAKERS

All popular Sansui models are in stock . . . amplifiers and speaker systems. Write for your EMQ or call at your nearest Encel Stereo Centre.

CONNOISSEUR STEREO CARTRIDGE — ONLY \$12.50.

Designed to effectively load any amplifier or tape recorder, the Connoisseur Model SCU-1 ceramic stereo cartridge has an extremely wide frequency response and is fitted with a diamond stylus. Ask for copies of reviews. **\$12.50**

DUAL 1019 TURNTABLES ON SPECIAL OFFER!

Write or call now for a very special Encel proposition—we're not at liberty to advertise the low Encel price.

STENTORIAN SPEAKERS NOW IN FULL SUPPLY!

Although supplies have not been readily available for some months, Encel Electronics now has a stock of models 812, 816, 1012 and 1016. Ask for an EMQ or call at Encel Stereo Centre in Sydney and Melbourne. Save more on Stentorian!



THE NEW LUSTRE MODEL ST-510 TONE ARM . . . TRACKS AT LESS THAN 3/4 GRAM . . . AND COSTS ONLY \$19!

Orders for the new Lustre Model ST-510 tone arm can now be filled immediately. Miniature ball races are used throughout, the head shell accepts all standard 1 1/2in mounting cartridges, finish is satin chrome and anodised aluminium. An outrigger bias adjustment is fitted and stylus pressure is adjusted with the counter balance weight. The Model ST-510D is fitted with a lifting/lowering device and costs \$24.50. The Model ST-510 (without lift), inc. sales-tax is priced at \$19.



SAVE YOUR RECORDS . . . USE THE UNIVERSAL LUSTRE TONE ARM LIFT!

This beautifully finished and functional universal tone arm lift will fit all tone arms . . . the lowering action is pneumatically damped and extremely smooth. Risk of record damage may now be eliminated. Including Sales-Tax **\$8.50**

ENCEL ELECTRONICS (STEREO) PTY. LTD.

Head Office: 431 Bridge Rd., Richmond, Victoria 3121. Tel. 42 3762.
Sydney Store: Ground Floor, 2SM Building, 257 Clarence Street, Sydney, N.S.W. 2000. Tel. 29 4563, 29 4564.
Australia's Greatest Hi-Fi Centre *Wholesalers *Trade-ins accepted

CREATING A NOISE-FREE ENVIRONMENT

The National Bureau of Standards in the U.S.A. has built a sound laboratory specifically for basic research in the fields of ultrasonic, infrasonic, physical, architectural, and audio acoustics, also vibration. A single storey structure of unique, highly specialised construction and acoustical design, the laboratory is part of a new laboratory complex being built for the N.B.S. at Gaithersburg, Maryland.

Much of the work carried out in the building will be directed toward:

(1) The development and standardisation of calibration procedures for microphones, audiometers, earphones, vibration-measuring systems, bone-vibrators, artificial ears and hearing aids.

(2) The study of the properties and characteristics of reverberant sound fields.

(3) The determination of speech intelligibility and the loudness of, or human response to, noise.

(4) The study of the velocity of sound, thermodynamic behaviour and other properties of matter by using physical-acoustic, cavitation and ionising radiation techniques.

(5) The development of new or improved methods for the measurement of the acoustical power radiated by various types of noise sources and for measurements of the absorption and transmission of sound in building materials and structures.

(6) The development of methods for generating and measuring vibratory motion having amplitudes from 10^{-8} to 10^{-1} metre and frequencies up to 100KHz.

(7) The development of methods for generating, measuring and analysing motions suitable for calibrating shock-measuring pickups.

(8) The development of new and improved transfer standards to permit the calibration of vibration pickups at field installations.

These research programs will be conducted by staff members of both the Sound Section and the Vibration Measurements Section of the Mechanics Division National Bureau of Standards.

In addition to these programs, an expanded program in applied architectural acoustics, which will require modern though somewhat different laboratory and test facilities, is currently being developed by the Building Research Division of the N.B.S. Institute for Applied Technology.

The primary requisite of an ideal sound laboratory building is that it have a very low internal ambient noise level under normal operational conditions. This means that the intrusion of noise from outdoor sources must be negligible and that noise generated within the building, either by experimental or any other operational activity, must be controlled, reduced, or confined to prevent undue interference with research or experimental work being conducted in other areas of the building.

Such acoustical performance requirements have been attained, albeit with some difficulty, in the new N.B.S. sound laboratory building even though the experimental work conducted within will cover an extremely wide dynamic



LEFT: Setting up an experiment for measuring the sound absorption properties of a rug in the reverberation chamber.

BELOW: Exterior view of the sound laboratory building. On the right is the reverberation chamber.

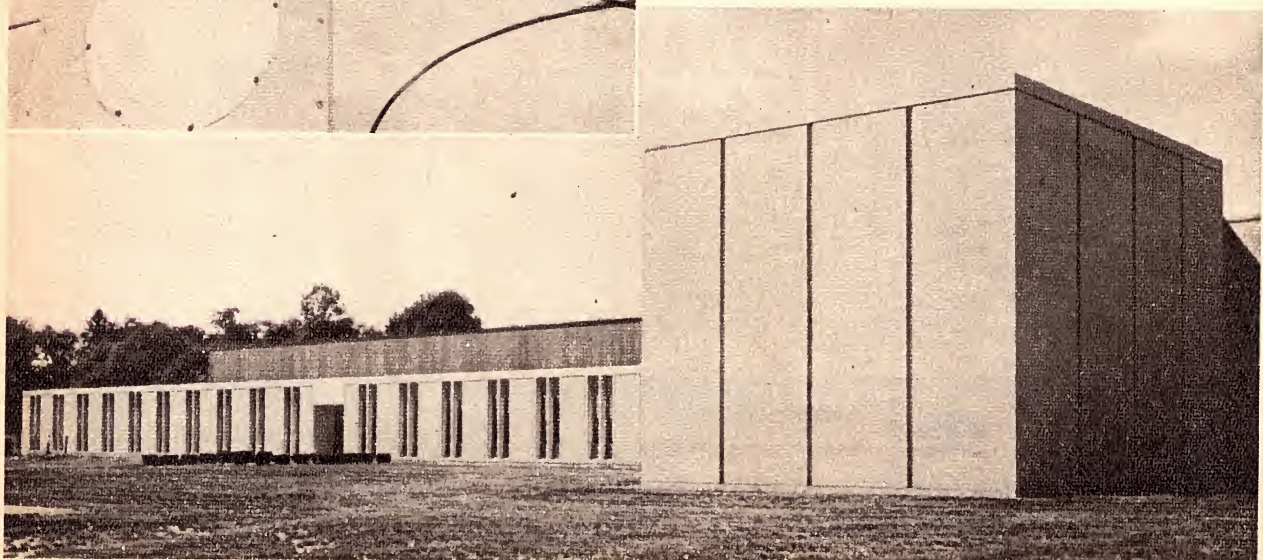

range of sound-pressure levels. In some laboratory spaces, for example, levels as high as 150dB, approaching those radiated by jet engines, may be generated. Other audiometric investigations will involve measurements of sound-pressure levels about 30dB below the threshold of hearing.

To accommodate experimental work covering this dynamic range, without interference from or with other laboratory activity, extremely effective sound-insulating, noise control, and vibration-isolating techniques were mandatory in the design and construction of the building.

First and foremost, the intrusion of outdoor noise was minimised by using 6-inch-thick, dense, solid-core concrete blocks faced with bricks, reinforced concrete slabs, and double-pane windows in the construction of the exterior faces of the building, along which the office modules are located. The laboratory modules, with noise-sensitive areas widely separated from intense-noise areas, are located in the central core of the building and surrounded by an acoustically treated corridor, which serves as an acoustical barrier or buffer zone. The installation of acoustical ceilings throughout the building further reduced the low ambient noise level within. In both laboratory and office areas, the interior partition walls were constructed of the same solid-core type of concrete blocks, and thick sound-insulating wooden doors were installed in these areas.

Some laboratory spaces requiring a higher degree of sound insulation have double walls of block construction that are separated by an airspace, and utilize floating floors, which are structurally isolated from the building structure.

Two of the main features of the sound laboratory building are the anechoic and the reverberation chambers. These are both huge, massive, shell-within-shell type structures, whose inner shells are floating on helical-coil steel springs. The walls of the exterior shells, which are 22in thick and constructed of reinforced high-density concrete and brick facing, enclose a three-foot airspace envelope surrounding the 18in-thick concrete inner shells.

The anechoic chamber, which is the larger of the two, has a bare inner-shell volume of approximately 52,000 cu. ft, but this will be reduced to about 16,000 cubic feet upon the full-coverage installation of 6ft-long fibre-glass wedges on all six interior chamber surfaces. The fibre glass installation will provide an "acoustically-dead" environment that will be at least 99 per cent sound absorbent in the audio frequency range above 50Hz.

In contrast, the reverberation chamber, which has a volume of approximately 15,000 cu. ft, will be about 95 per cent sound reflecting over most of the audio frequency range. The large volume of enclosed air possesses an appreciable amount of sound absorptivity that limits the reverberation response of the room at higher frequencies.

But low-frequency sound signals introduced into the chamber will echo and re-echo for periods as long as 25 to 30 seconds.

The airborne, impact, and structure-borne noise generated in the electromechanical room and various test chambers is confined in such areas, or its transmission is controlled and reduced to negligible levels to prevent it from reaching other parts of the building. In addition to the double-wall and floating-floor construction in these areas, flexible couplers, resilient hangers, vibration isolators, and dampers, as well as sound-insulated and acoustically treated enclosures, were used extensively in the installation of all heating, air-conditioning, plumbing, and electro-mechanical equipment, including the mounting of all duct-work, piping, conduits, or service lines emanating from such equipment or systems. For example, the heating, air-conditioning, and ventilation system was specially designed for non-turbulent, low-velocity, and low-pressure operation to eliminate generation of air-flow noise. The largest fans are enclosed in acoustically lined, vibration-damped calming chambers. All other fans, blowers, pumps, and motors are mounted on large concrete slabs that are supported on resilient springs or rubber mounts.

The duct system throughout the building was specially designed and constructed of double-wall, acoustically-treated construction for high sound-insulating and sound-absorbing efficiency. Resilient hangers support the entire system; and at points of penetration through walls, ceilings, and floors the ducts are encased in soft sponge-rubber gaskets to provide an air-tight seal and prevent the transmission of vibrational energy to the building structure.

The large power transformers and high-pressure steam valves, which usually are exceedingly noisy and troublesome devices, are housed in an underground concrete vault located about 100ft east of the building. All penetrations through the roof for ventilation purposes are acoustically protected against the intrusion of noise from aircraft, traffic, and other outdoor sources. The location of the building and its orientation on the site were carefully selected to minimise the intrusion of noise from these sources.

Thus, virtually every vibration-isolating technique and noise-control measure, within budgetary limits, was used in the construction of the building. In most cases, the acoustical performance specifications of the building were met. The successful performance was largely due to close supervision and monitoring during the building construction and to inspection of the building materials before use.

Reprinted from "Technical News Bulletin" Vol. 52, No. 12, by arrangement with National Bureau of Standards, U.S.A.

A small anechoic chamber set up for frequency response measurement of a loudspeaker.

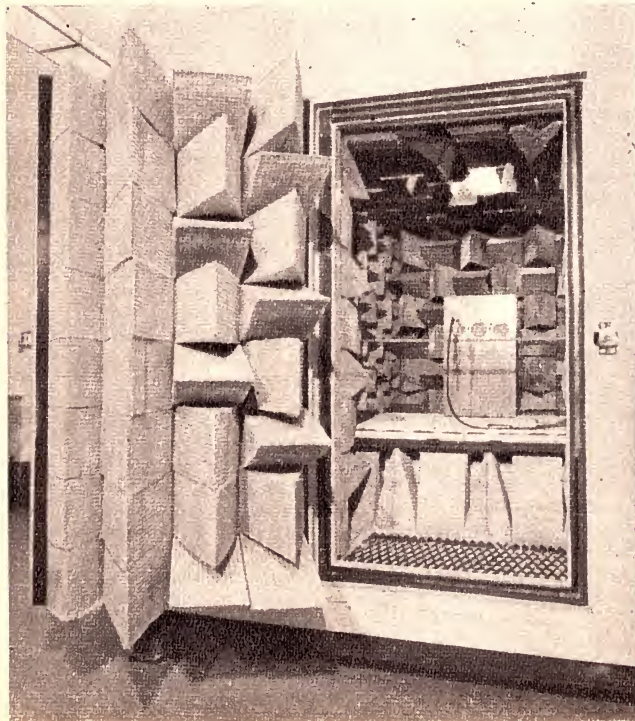

Calibrating an accelerometer with a transducer-speaker system developed by N.B.S.

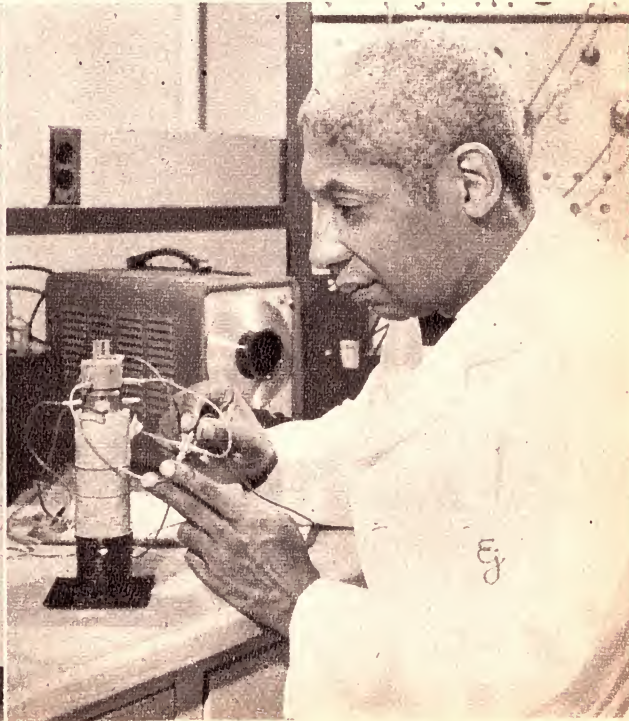

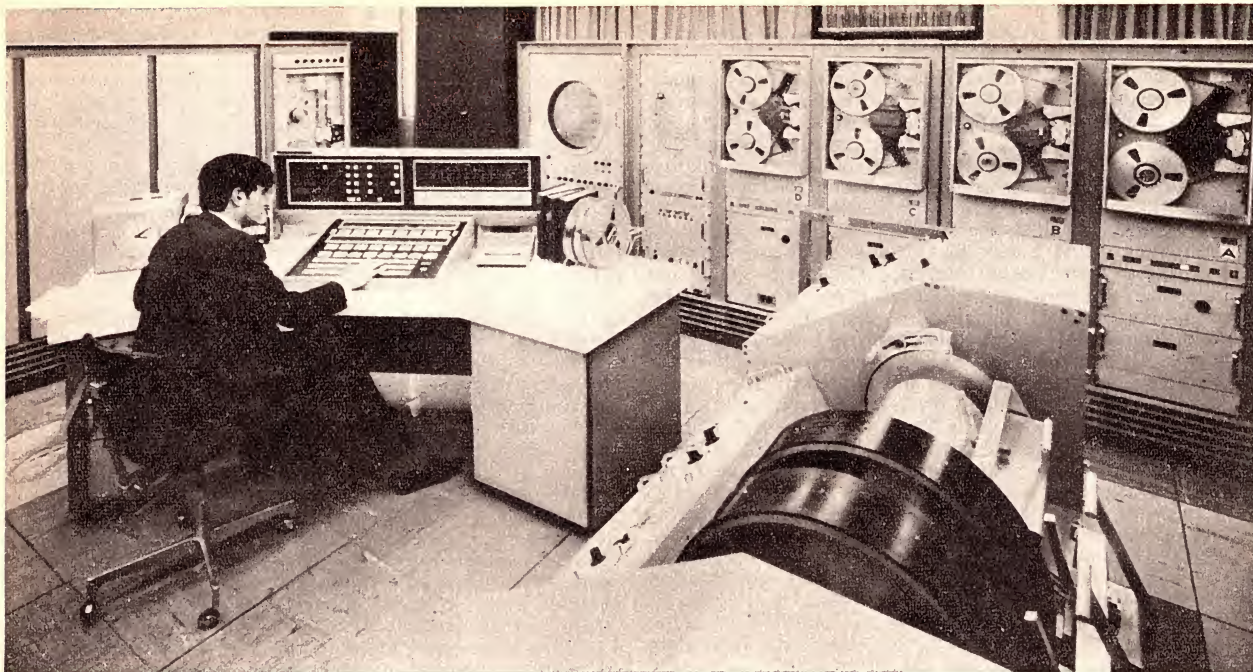

The computer at Geophysical Surveys International's centre for processing seismic data at St. Leonards, Sydney.

Computers shape Australia's oil future

A computer centre set up in Sydney last year for processing seismic data for the oil industry is expected to make a significant contribution to the discovery of commercially viable fields and their exploitation.

The role of computers in the accounts and statistical sections of various industries is well known, but in recent years computers have also become an invaluable aid in petroleum exploration, production, refining and product distribution. The combination of advances in mathematics and electronics in our time is producing results with long-term implications that stagger the imagination.

One of the most striking instances of the application of the computer for the processing of seismic data concerns the Idris field in Libya. Earlier methods had indicated the field to have little or no potential. A subsequent recorded seismic survey using modern digital techniques led to renewed interest in the field. Drilling on the strength of this report resulted in a major oil find. Not surprisingly, many oil companies are sending for digital processing their old analogue tapes from earlier seismic surveys.

The importance of accurate processing of geophysical data can hardly be over-emphasised. On this depends the decision whether to drill or not to drill, and also where to drill. Drilling is the most costly single operation in the search for oil. The deepest well ever drilled—25,304 feet or roughly five miles—in Texas, had to be aban-

doned because it turned out to be dry. On a world basis only one well out of 36 wildcats finds oil or natural gas in commercial quantities. As the search for oil continues to move to the offshore and the arctic regions of the world, drilling costs soar.

This is not to imply that digital processing techniques can by themselves conclusively establish the location of petroleum deposits and thus do away with costly exploratory drilling failures. Nonetheless, finding petroleum is now less like a game of blind man's buff in the sense that the modern petroleum geophysicist can at least say where it is most likely to be found. As a corollary, any improvements in geophysical techniques and data processing methods increase the chances of successful drilling.

The setting up in Sydney last year of a \$1 million seismic data-processing centre thus has great significance for petroleum exploration in this country. This centre, the first of its kind in Australia, was opened by Texas Instruments Inc. of U.S.A., and is being operated by a subsidiary, Geophysical Surveys International.

The centre is based on a specially designed computer equipped with 300 programs. It will process information at high speed, reject superfluous material in the initial data and prepare cross sections which indicate the structure of underground strata. These can be combined with information from surface outcrops to obtain a

three-dimensional geological picture of the area. Prior to this digital seismic data from onshore and offshore surveys had to be sent overseas for processing. Local processing not only ensures saving in time, but also better control of data.

Apart from the search for oil, computers are also helping in the drilling process itself. Modern electronic data gathering and analysis systems can monitor and record drilling conditions at the well site. This minute-to-minute recording device enables the operator to check drilling operations continuously while maintaining maximum penetration rates. Any defects such as mud losses, well-bore instability or dull bits can be quickly recorded for remedial action.

Many problems considered insurmountable only a few years ago are now being solved on routine basis using computers. These electronic wizards are being increasingly used to study oilfield production platform designs, reservoir behaviour extending even to individual wells, flow rates, and for evaluation and control of many operations such as the number of wells to be drilled in a particular field.

Fully automated production of crude oil dates back to 1960 when Standard Oil of California's Poso Creek field, U.S.A., came under computer controlled production. Only 300 barrels a day were then under computer production control in the U.S.A., but this figure

~~~~~  
This article is reprinted from "Petroleum Gazette," Vol. 15, No. 5, by arrangement.



had jumped to 300,000 barrels a day by early this year and is expected to double soon. Devices now in existence make it possible to scan the performance of 6,500 wells every five minutes.

In Australia, one of the most striking examples of the use of computers is to be found in the production facilities for the offshore gas and oil fields in Bass Strait, off the Victorian coast. Waves 45ft high and 100 m.p.h. winds rule out manning of production platforms on a continuous basis — even helicopter and boat services have to be suspended. Esso-B.H.P.'s supervisory control system has been designed for remote control operations to enable continuous gas and oil production from unattended platforms after the commissioning stage. This will be accomplished by the installation of a computerised master station onshore and remote control stations at each producing platform. Under normal operating conditions, platforms will not be manned on a continuous basis.

The system has been designed to permit full manual control in the event of computer failure. The transmission and receipt of data to and from the master station are performed by UHF radio. Each piece of equipment in this communications system is backed up by a standby unit which is automatically actuated in the event of failure or improper operation of the primary unit. In this event the operator on duty at the master station is alerted of an alarm condition.

The special purpose digital computer, equipped with storage capacity for 18,000 words, will record all required data, programs, alarms, etc., from the offshore stations. The computer will automatically store up-to-date data and will provide, at pre-selected times or on demand, reports of daily production as well as cumulative production, well-test reports, producing time for each well, and at the end of each month a complete monthly production report.

The master station housing the computer will be manned around the clock. The operator's job will be to observe the various indicators, re-adjust flow control set points when required and perform relevant control measures. Should an alarm condition occur, the operator will immediately take corrective measures and, in the event of an emergency, self-protective, failsafe and automatic shutdown devices on each platform will go into action.

The range of information immediately available to the operator even extends to the status of each compressor, pump, generator, valve and item of radio equipment, as well as weather conditions such as wind velocity, wave height and barometric pressure.

The initial program for the computer is entered on punched paper tape and, for normal operations, minor program additions and deletions can be manually entered. Should a major program modification be necessary, or if new remote installations are added to the system, a complete new program can be prepared and fed into the computer.

Control of offshore oil and gas production by computers with associated radio communications facilities is one

of the most significant advances in oil industry technology in recent times. As exploration and production extend into progressively deeper waters, and as the proportion of world oil production that comes from off-shore areas rises above the present figure of 16 per cent, computers will play an increasingly important role in maintaining world fuel supplies.

Substantial benefits are also being realised from the use of computers in refining operations.

There are many types of crude oil, and many ways in which each can be processed in a refinery. The formulation of a particular processing scheme, which will result in the production of as many as possible of the required products from a particular type of crude, is a complex undertaking.

It is worked out within the framework of "linear programming." All relevant data are fed into the computer. Thousands upon thousands of different solutions can be obtained, each with a detailed cost analysis.

The computer calculates the feasibility and cost of, say, "crude oil X"

refineries, tankers and pipelines is highly computerised. This is accomplished by one of the critical path network programs, such as PERT (Program Evaluation and Review Technique). These systems enable the co-ordination of thousands of inter-dependent tasks. The computer sorts out various jobs to be done, arranges them into the right sequence, works out skills required, and greatly aids the deployment of labour for maximum efficiency and economy.

It must be emphasised, however, that whatever computations are needed for a particular construction project or operational procedure, the human factor is still the most important. Despite the lightning speed with which a computer works, and the complex problems it can solve, it possesses no "thinking" capabilities.

A computer is nothing more than a highly complicated calculating machine in which information can be stored and retrieved at will. But it is a person who must prepare the data to be fed into the computer, and who must devise the all-important program to control the operation of the computer.

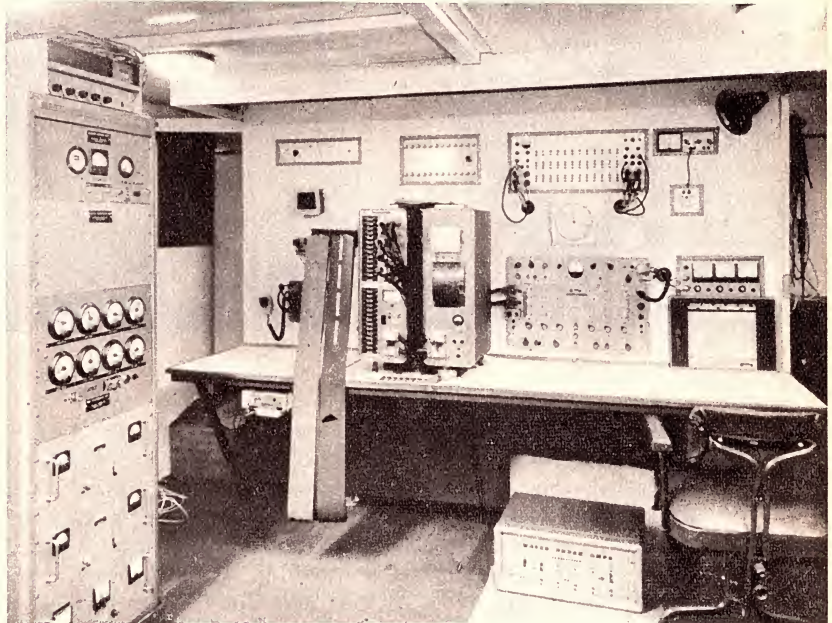

*The recording room of Merino, the vessel chartered by G.S.I. to make marine seismic surveys in Australian waters. The data obtained is processed by the St. Leonards computer installation.*

and "processing scheme Y," and compares this with solutions of alternate crudes and processing schemes. It keeps examining solutions and continues to work out better and better solutions until the "optimum" is reached.

Within the refinery, physical and chemical properties of crude oil as well as prices of petroleum products might be entered into a computer model of processing units. The computer manipulates the data on the basis of shifting process variables to determine the most economical way to produce the products required by the market. Advanced computer control techniques can minimise undesirable variations in process flow rates, temperatures and pressures.

Even the construction of modern

Both these tasks are highly skilled operations, particularly the writing of the programs, which requires a tremendous grasp of the subject concerned and a clear understanding of the problems to be solved. If either the input information or the program is faulty, the computer cannot possibly make corrections or give the right answers. What the computer does is extend man's problem-solving capabilities, by performing many arithmetical, logic, branching, and input/output instructions with lightning speed.

Since the oil industry happens to be one of the biggest users of computers, it is inevitable that the experience gained in various oil industry undertakings will be of immense value not only to the computer manufacturers but to other users of computers as well. ■



# Who is Peter Mothersole?

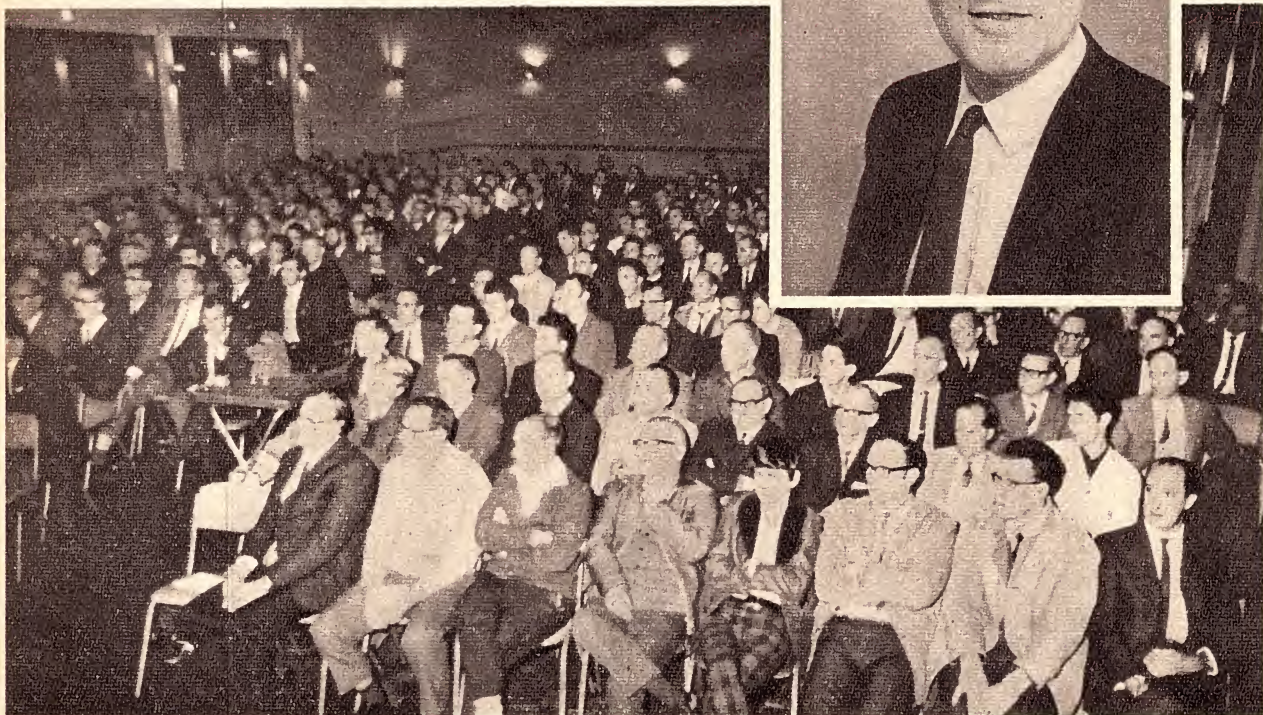

He is one of the world's leading TV receiver design engineers and head of the Consumer Products Division, Mullard Central Applications Laboratory, Mitcham, England. He recently visited Australia to present a paper entitled "Solid State Television Receivers — a Pattern of 2nd Generation Designs for Monochrome and Colour," at the 12th National Convention of the I.R.E.E. Australia in May.

He also addressed a meeting, shown above, of 500 service technicians on Wednesday, 4th June, at the Lane Cove Town Hall, Sydney on service aspects of solid state colour TV receivers, arranged by the executives of T.E.T.I.A. and attended by T.E.T.I.A. and T.E.S.A. members and their colleagues. We congratulate T.E.T.I.A. on its enterprise in arranging the function and the spontaneous and magnificent support that followed. In retrospect it was a pity that time did not permit a similar performance in other States.

We trust the Australian Service Industry is making the fullest advantage of the various facilities offered by Mullard in supporting the service engineer with publications, lectures, films and helpful advice. We feel the Industry is indeed doing this by the very tangible support given us in other ways, for which we are most grateful.



## **Mullard-Australia Pty. Ltd.**

35-43 Clarence Street, Sydney, N.S.W. 2000. Phone: 29 2006

Also VIC., QLD., S.A., W.A., TAS.

Associated with MULLARD LIMITED, LONDON



# RADAR WITH A MEMORY

## ... and it predicts future situations

A new marine radar with a unique memory, called the Marconi Predictor, has been demonstrated in the U.K. by The Marconi Company. The memory automatically stores radar information which can be used to provide automatically plotted tracks of all vessels within the range of the radar, in either true track or relative track modes, with the added facility of prediction of the effects of a contemplated change of course or speed.

In radar systems using PPI (Plan Position Indicator) display, it is extremely desirable that the information presented to the user should give an indication of the following: (1) whether targets are stationary or moving, (2) if moving, information from which the direction of motion and speed can be deduced. With present marine radars, this is possible to a limited degree, by virtue of the "tail" formed by successive traces and built up through the action of the long persistence phosphor of the display tube.

However, a major disadvantage of the marine radars has always been that the target blips do not have long enough tails in most cases to enable the required information to be determined with any degree of accuracy, because of the relatively slow speed of the ships and the correspondingly short distance they travel in the decay time of the phosphor.

The new Marconi Predictor radar attempts to overcome the disadvantage of the short tail by creating an artificial tail from which the information required, as detailed above, can be deduced with a satisfactory degree of accuracy. A track prediction facility is also made possible by utilising the same stored information.

In a paper presented to the Institute of Navigation in U.K., by J. Watt and B. C. Piercy, of the Marconi Company Ltd., in which the new radar was described, the authors first deal with some of the other problems associated with present-day radars.

Among the points covered are the following:

The true motion display, which shows a progressive shift corresponding to own ship's motion, applied to the PPI scan, suffers from the inherent disadvantage of limited brightness in long-term after-glow; and operation in this mode cannot be continuous, since it is necessary at intervals to reset the origin of the PPI, to prevent the ship from "sailing off the map." Further, although the systems can show either the relative motion or the true motion of target ships, switching from one mode to the other requires a lapse of several minutes before a useful display of the new form is available.

The paper then makes the following very telling point: "In the meantime, the remanent display of the previous form is getting progressively out of

date. This long delay and the hiatus make this method of acquiring information on relative and true motion extremely inefficient, frustrating to the observer, and dangerous to the point that it is very rarely used."

These limitations of the existing systems have resulted in the use of manual plotting, with the radar operating in the relative motion mode, and the true motions of other vessels being produced by triangle of velocity methods, which is slow and liable to human error.

The Predictor radar attempts to overcome the limitations of existing radars by providing a display showing the history of the movements of all vessels within range over the past six minutes, and containing provision to allow instantaneous switching from true motion to relative motion, with the additional unique facility of predicting the outcome of a proposed change of course and/or speed.

This facility has been achieved by using a loop of magnetic tape to provide an easily updated and readily available memory of complete radar pictures, covering a six-minute period. This is presented in four stages, covering the situations as they were six minutes, four minutes, and two minutes previously, followed by a picture of the "now" situation. As will be explained later, this information can be manipulated in various modes, designated the True Track Mode, the Relative Track Mode, and the Prediction Mode. The system can, of course, also be used for a normal radar display.

To record the radar signals on tape, it became necessary to use a bandwidth compression system, to reduce the 8MHz bandwidth of the radar system to a bandwidth within the capabilities of a fairly simple tape recording system. With bandwidth compression, the radar signals are compressed into a 150KHz bandwidth, allowing a tape recording speed of 30ips to be used.

Externally, there is nothing to distinguish the Predictor radar from other units. The scanner, comprising a conventional 8ft slotted waveguide aerial and its driving unit, and the transmitter-receiver unit are much the same as in other radar equipment.

The first unit of the display equipment is the bandwidth compressor, followed by the tape loop recorder and the 16in display circuit. Finally comes

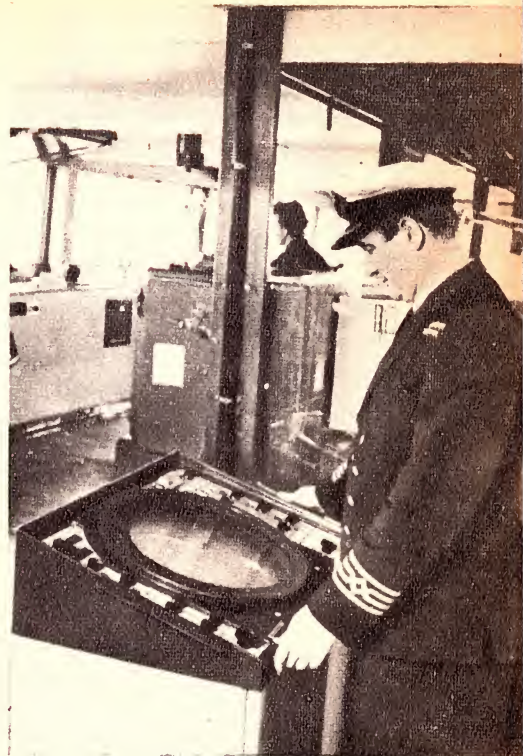

*The PPI console for the Marconi Predictor radar is conventional in appearance. All controls for setting the various operating modes are contained on the PPI panel.*

the shift generator and programmer, the latter being the unit which selects the pictures to be displayed, either direct from the radar or from the tape loop, and controls the operations of record and erase heads.

The tape loop used completes each cycle every two minutes. In this time, the aerial and PPI trace both make 48 revolutions.

Only one in four of the radar traces derived from a complete revolution of the aerial is recorded on the tape. Thus, a new radar picture is recorded every 10 seconds, and remains stored for four more revolutions of the tape, before being erased. The timing of the recordings is so arranged that during each revolution of the tape a new radar picture is recorded; the pictures from six minutes ago, four minutes ago, and two minutes ago are presented to the replay head sequentially; and the picture which would be eight minutes old if presented is erased and replaced by the new "now" picture. In this way, the tape is continually used; and a series of 36 radar pictures is built up and continually maintained, and updated every 10 seconds.

The effect of the four traces representing the positions of all vessels over the six minute period is to create what is virtually an artificial tail, showing the course being followed by target ships, and giving immediate indication of any change of course. Moreover, since the four blips are stepped out in chronological order, from the earliest to the "now" trace, there is no ambiguity as to which direction ships are going; the length of the artificial tail allows the speeds of target vessels to be determined with a fair degree of



# MINISCOPE

THE ONLY IRON OF ITS TYPE IN THE WORLD



This unique soldering iron has a big heart for hard work. Small but sturdy, it performs all the work usually requiring a conventional iron of up to 75 watts. Check these features before you buy just any soldering iron.

**SPEED** Only 5 seconds initial heating up time from cold, then practically instantaneous.

**CONTROL** Temperature control at your finger tips. Heat only where, when, and as much as needed.

**VERSATILITY** Copes with all soldering jobs — from miniature components to large solder lugs. Can even be operated from a 6 volt car battery.

**MINI WEIGHT** Only 1 3/4 oz. complete, and its comfortably designed handle reduces operators fatigue, on the longest jobs.

**ECONOMY** Consumes current only whilst in use. Performs all the functions of other irons up to 75W.

**GUARANTEED** Time tested dependability, backed by full guarantee.

**LESS MAINTENANCE** Longer tip life. NO expensive heating element to replace. Spare tips and carbon elements readily available from your Scope distributor.

**LABOUR SAVING** Fast warm-up—always ready, cuts wiping, re-tinning and filing of tips to a MINIMUM.

**TRANSFORMER by NATRONICS**

A Miniscope operates on voltages from 2.5V to 6.3V A.C. or D.C. or from 240V A.C. mains through a "Natronic" Scope Transformer fitted with 6 ft. 3-core flex and 3 pins mains plug. \$7.65.

MINISCOPE, beautifully presented in a handy re-usable plastic pouch-pack, ideal for neat storage and easy portability. MINISCOPE \$5.28



AVAILABLE FROM ALL MAJOR ELECTRICAL WHOLESALERS AND HARDWARE STORES — THE FULL GUARANTEE APPLIES ONLY WHEN THE IRON IS USED WITH THE APPROVED 'SCOPE' TRANSFORMER. MANUFACTURED BY NATRONICS PTY. LTD.

AUSTRALIAN & OVERSEAS AGENTS:

**IRH COMPONENTS PTY. LIMITED**

(a subsidiary of International Resistance Holdings Ltd.)

THE CRESCENT, KINGSGROVE, 2208. N.S.W. 50 0111

VICTORIAN OFFICE:  
143 Christmas Street, Fairfield.

TASMANIA: W. P. MARTIN PTY. LTD.  
202 Argyle Street, HOBART.

S. AUSTRALIA: COLLETT & CANT PTY. LTD.  
103 Halifax Street, ADELAIDE.

N.Z.: H. W. CLARKE (N.Z.) LIMITED  
42-46 Cable Street, WELLINGTON, C.3

N.Z.: H. W. CLARKE (N.Z.) LIMITED  
10 Teed St., New Market, AUCKLAND, S.E.1

W. AUSTRALIA: I. W. HOLMAN & CO.  
854 Beaufort St., Inglewood, PERTH

QUEENSLAND: K. H. DORE & SONS  
505-507 Boundary Street, BRISBANE

ALSO TOWNSVILLE AND ROCKHAMPTON

VOTED FIRST BY A HOST  
OF SATISFIED USERS.

Please post — free illustrated literature and specifications

My Name \_\_\_\_\_

My Address \_\_\_\_\_

City \_\_\_\_\_ Postcode \_\_\_\_\_



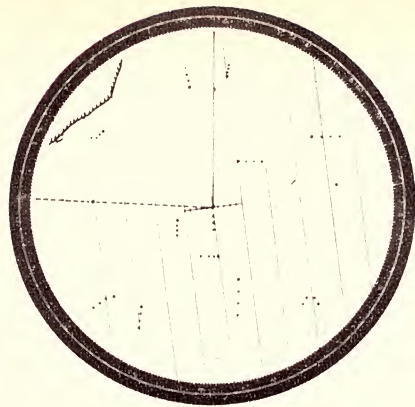

A. True Tracks Mode

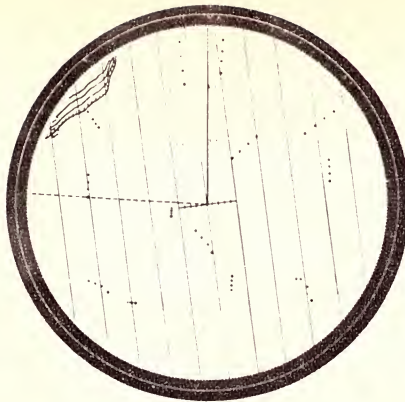

B. Relative Tracks Mode

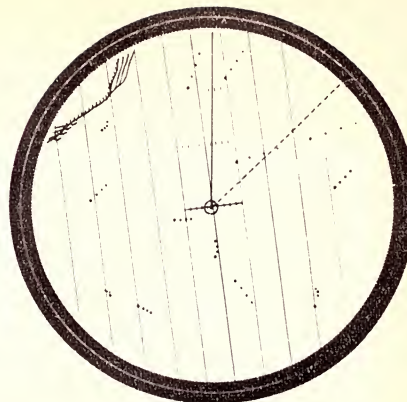

C. Predicted Relative Tracks Mode

These three diagrams show the same situation as presented on the radar display using the True Track Mode (left), the Relative Track Mode (centre) and the Predicted Relative Tracks Mode. Situation A gives the six-minute plot with the true position of every target six, four and two minutes ago, plus the "now" position. There appears to be some risk of collision with targets bearing 055 deg., 098 deg., 116 deg., 137 deg., and 163 deg. Situation B presents the same situation with relative tracks displayed. By using the parallel lines engraved on the mechanical bearing cursor, the closest point and immin-

ence of approach can be quickly estimated. Experience shows that a 45 deg. turn to starboard will avoid target bearing 163 deg., but this may raise a collision risk with the overtaking ship bearing 271 deg. or target bearing 116 deg. The situation can be checked by using the prediction facility. The Predictors' bearing "proposal" control is set to the new course, but the speed is maintained at 15 knots. After pressing the Predicted Relative Tracks button, Situation C appears on the display. The electronic bearing marker shows the proposed new heading, while

the heading marker is still displayed on the present course of 110 deg. The ring around "own ship" indicates the amount of overshoot, corresponding to the angle of turn, and represents a turning radius of three cables. A new triangle of velocities has been worked out for each target and are now displayed as the relative tracks as they will appear if the ship is actually set to the new course of 115 deg. All the seven targets considered as possible collision risks will obviously pass well clear, and a quick inspection shows that there is no risk from other ships.

accuracy; and the spacing between successive blips in the tail indicates whether a vessel has changed speed.

The Predictor is provided with two controls which are set before switching to the prediction mode. The first is calibrated in degrees, and serves to indicate the proposed new course, and at the same time sets an electronic bearing marker on the PPI display corresponding to the proposed course. The second is calibrated in knots, and is used to set any proposed change of speed.

The shift generator signals from "own ship's" gyro compass and log, and maintains six voltage analogues of the eastings and northings run by "own ship" during the immediately preceding six, four and two minutes. When a display of the true tracks of observed vessels is required, it is simply a matter, in effect, of closing a six-pole switch so that these voltage analogues of easterly and northerly components of motion are connected to apply westerly and southerly shifts to each display history phase corresponding to its age.

This means that when the six-minutes old radar scene is displayed, the centre of the P.P.I. scan is shifted astern by the amount travelled by "own ship" in the last six minutes. Correspondingly smaller astern shifts are applied to the four-minutes and two-minutes old radar scene, and the "now" radar scene has zero astern shift applied, so that "own ship's" present position remains permanently depicted at the centre of the screen, even though true tracks are now being displayed. The change from relative to true tracks is completed within ten seconds.

When the astern shifts are switched on, the displayed tracks of observed vessels are their true tracks, independ-

ent of the actual course and speed by which "own ship" reached its present position. They are, in fact, plotted out as what the relative tracks would be if "own ship" were stationary at its present position.

To display what the relative tracks of other ships would be if "own ship" had reached its present position on some other course or speed, different from actual course and speed, it is now only necessary to add additional shifts to the display of each of the history

scenes corresponding to the reciprocal of this other course and speed. Thus the effect on the relative tracks of other vessels, with their distances of closest approach and times to closest approach, can be visually predicted for a new course and/or speed contemplated for "own ship." This visual presentation of the predicted situation will be achieved within ten seconds of setting the proposed new course and speed on the controls and pressing the appropriate button. ■

## SECRETS OF MARS ... continued from page 16

ejection of gases due to the explosion of propelling material. By increasing this velocity, through increasing the proportion of the propelling material to weight of projectile, and through a greatly improved nozzle-shaped passage for the escape of gases, Professor Goddard claims to have raised the efficiency of the rocket to nearly 64 per cent.

Many investigators are convinced that life exists on Mars and expect to prove it with the novel telescope. What they will find on their photographic plates is the object of speculation by scientific men the world over.

Lowell has said that Mars is level and uninteresting, with no mountains and only a few dried-up beds of shallow seas to diversify its topography. More than one-half of it is desert land and the rest is only green when the canals are bringing water from the polar ice caps. Dust storms, which blot out hundreds of square miles of the planet's surface from the view of scientific observers, sweep over its equatorial section.

The physical conditions of Mars are

entirely different from those we know on earth. The force of gravity exerted by Mars is only three-eighths that of the earth, while the atmosphere pressure that is about 15 pounds to the square inch at sea level on our world is less than four pounds on Mars, according to scientists. The air is very thin and no known animal could live on it. These conditions, however, make it possible for great weights to be lifted with little effort.

Lowell computed that the Martians could do seven times more work than human beings could accomplish with the same amount of effort. A human observer on Mars, he said, would be impressed by the slowness and flatness of his surroundings.

An elephant could leap like a gazelle in such an atmosphere, he said; water would flow like a hesitant lazy current and a stone thrown into the air would sink with graceful moderation to the ground. He made no attempt to describe how the Martians themselves might appear to worldlings, but he said they would not resemble human beings. ■



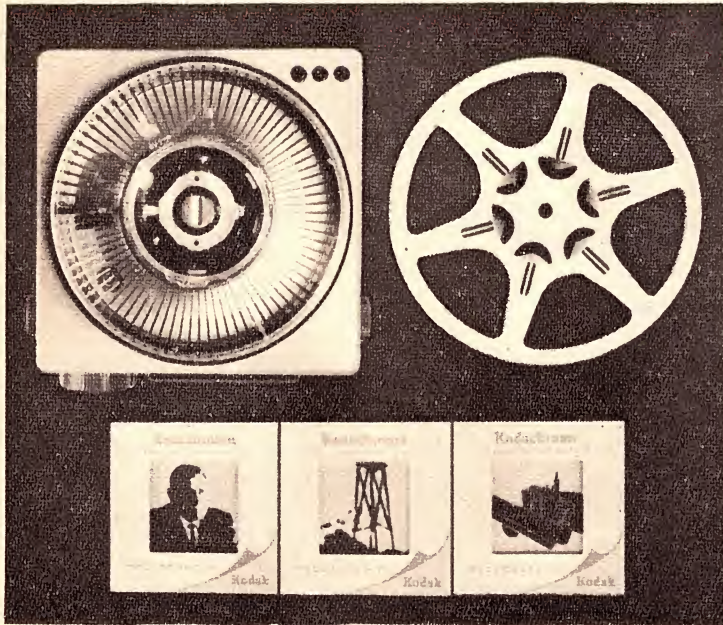

Liven up sales meetings, presentations, staff training, etc., with Kodak audio visual aids. One picture is worth a thousand words. Think of the breaths you'll save. Kodak have all the equipment and "know how" to help you make the most dynamic and memorable presentations ever—using pictures in color or black-and-white. Cameras for making color slides and movies. Slide and movie projectors (including slow-motion models) and screens. Plus the widest range of films, both color and black-and-white. There's a special camera kit for taking close-ups of small objects or printed material from books and maps. Everything you can think of to make it easier for you, and *much* more meaningful and interesting for your audience.

## Kodak

Contact the Kodak branch in your State for details.  
 Motion Picture & Educational  
 Markets Division KODAK  
 (Australasia) PTY. LTD.  
 Branches in all States.

# Say it in pictures.

K. 1961





# TECHNICAL DIGEST

## Solid-state devices in thin flexible sheet form

A new technology for manufacturing solid-state devices in the form of very thin flexible sheets has been developed by the Philips organisation in Holland.

At present the method is being used mainly for photoconductors and solar batteries, but it also offers prospects for the production of resistors, capacitors, diodes and other components.

The method, called "monograin," combines the advantages of the monocrystalline nature of planar devices with the greater freedom in choice of dimensions and electrical parameters of thin film techniques. Growing large single crystals of the type required for the planar technique is a costly business and not possible at all with some materials. The basic idea underlying the new system is that, instead of growing large crystals and then cutting them up into ultra thin wafers, a layer is made from material in powder form.

A powder may consist of small single crystals, and it is possible to prepare the powder in such a way that the crystals are individually physically perfect. In many cases, the chemical composition and the size of the powder grains can also be accurately controlled.

In the Philips "monograin" technique a collection of such grains, all of about the same size, is embedded in a sheet of plastic, e.g. polyurethane (a thermosetting resin). The grains are close to each other in the sheet, but not above each other; the layer is nowhere more than one grain thick. It is essential for the grains to be insulated from each other by the plastic and to protrude from one or both sides of the sheet.

These light and flexible film-like sheets can be made by a method which is basically very simple and therefore inexpensive. The principle is illustrated in figure 1. A thin layer of adhesive is applied to a rigid, flat substrate (a). The grains are then sprinkled over the substrate, and stick to it like flies on a flypaper (b). The surplus non-adhering grains are brushed off (c), and the substrate with powder is then dipped into a thermosetting resin which fills up the spaces between the grains (d). The tops of the grains can be exposed by etching away the top layer of the resin (e). After drying and hardening, the resultant sheet is stripped away from the

substrate (f), and when the remaining adhesive has been removed the grains are also exposed underneath (g). Finally, the grains can be connected together, for example by evaporating a conducting metal film on both sides (h). By applying masks during the evaporation process, groups of the particles can be connected together in any desired pattern in parallel and in series.

This new technology opens up new fields in many applications. A wide variety of circuit devices can be made on this principle, such as resistors, capacitors, diodes, photoconductors and solar batteries.

For making photoconducting sheets, cadmium-sulphide grains with a diameter of about 40  $\mu\text{m}$  are used, which are doped with copper and chlorine. A rubber-based adhesive is used and the resin is a polyurethane. After the sheet has been stripped from the substrate and the adhesive removed, an electrode in the form of a gold film

is deposited on the side of the sheet which will later be exposed to light; a thin gold film is chosen because it combines high conductivity with low light-absorption. The other side of the sheet is coated with a less expensive conductor such as cadmium.

Between the electrodes and the CdS grains an ohmic contact is required with the lowest possible contact resistance. This is achieved by giving the grains a strongly N-type surface before the electrodes are applied. The usual method of doing this, by the diffusion of indium, is not practicable in this case because it requires temperatures at which the polyurethane resin breaks down. Philips therefore use a gas discharge at room temperature in an argon-filled space, the sheet being given a negative potential so that it can be bombarded with positive argon ions. As a result of the ion bombardment, sulphur vacancies occur in the surface layer of the grains (sulphur being more volatile than cadmium, so that more of it evaporates) and this makes the surface strongly N-type.

A better idea of the characteristics of the resulting photoelectric cell, i.e. the sandwich cell with electrodes on both sides of the photoconducting

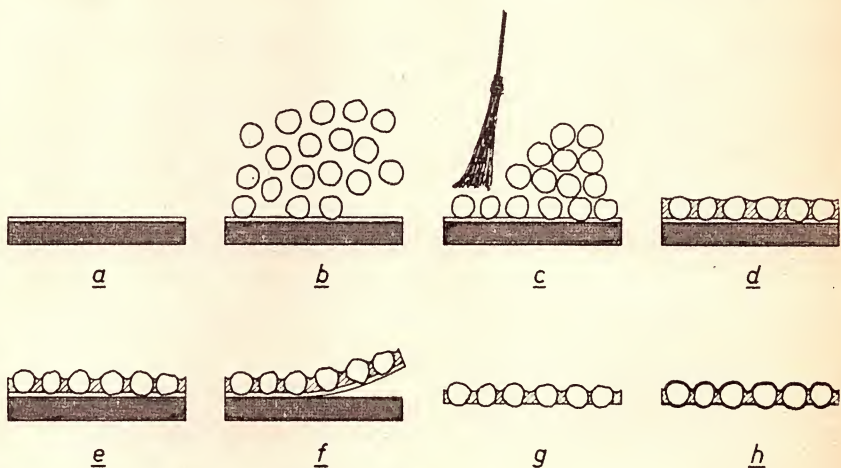
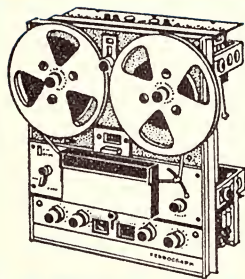

Figure 1. Diagram showing successive stages in the manufacture of sheets containing monograin layers. (a) An adhesive is applied to a substrate. (b) Powder is sprinkled on to it. (c) The loose, surplus grains are brushed off. (d) A thermosetting resin is applied. (e) The top layer is etched away. (f) The resin is hardened and the resultant sheet is stripped from the substrate. (g) The adhesive is dissolved, and (h) a thin metal film is deposited on both sides of the sheet.



# not a year old and already a classic

## FERROGRAPH



*Ideal  
for  
rack  
mounting*

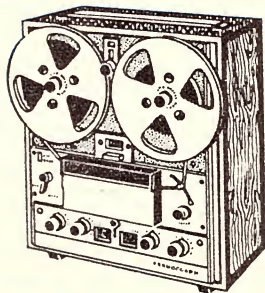

*Elegant  
hardwood  
case*

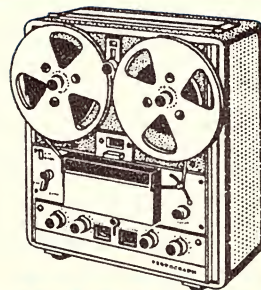

*Grey  
vinyl  
case*

Ferrograph Tape Recorders, Series 1 to 6, have been famous since 1949, and although Series 7 was introduced only a year ago it is already acknowledged as a classic. No other recorder today gives you quality like this, reliability like this, and offers so many desirable facilities.

It has the finest specification—and when Ferrograph gives you a figure, it is a conservative minimum. Ferrograph guarantees it. Every instrument is finally individually adjusted for optimum performance. With Ferrograph you know where you are—exactly.

Available in Mono, and in Stereo with and without end amplifiers; embodying a unique range of recording aids:

- All silicon solid-state electronics with FET input stages and wide input overload margins.
- Vertical or horizontal operation.
- Unit construction: The 3 individual units i.e. tape deck, power unit and amplifier complex are mounted on a single frame easily removable from cabinet for service or installation in other cabinet or racks.
- 3 motors (no belts).
- 3 tape speeds.
- Variable speed spooling control for easy indexing and editing.
- Electrical deck operation allowing pre-setting for time-switch starting without need for machine to be previously powered.
- Provision for instantaneous stop/start by electrical remote control.
- Immediate access head block for editing and cleaning.
- Independent press-to-record button for safety and to permit click-free recordings and insertions.
- Adjustable reel height control.

- Damped tension arms for slur-free starting.
- 8½" reel capacity.
- Endless loop cassette facility.
- Provision for signal operated switching units.
- Internal loud speakers (2)—1 each channel on stereo, 2 phased on mono.
- 2 inputs per channel with independent mixing (ability to mix 4 inputs into one channel on stereo machine).
- Signal level meter for each channel operative on playback as well as record.

- Tape/original switching through to output stages.
- Re-record facility on stereo models for multi-play, echo effects, etc., without external connections.
- Meters switchable to read 100 kHz bias and erase supply with accessible preset adjustment.
- Three outputs per channel i.e. (1) line out—level response. (2) line out—after tone controls. (3) power output—8-15 ohms.
- Power output 10W per channel.
- Independent tone controls giving full lift and cut to both bass and treble each channel.

SOLE AUSTRALIAN DISTRIBUTORS

**Leroya Industries PTY. LTD.**

266 HAY STREET, SUBIACO, WESTERN AUSTRALIA, 6008.



material, can be obtained by comparing it with the hitherto much more widely used gap cell, in which the electrodes are applied on one side of the photoconducting material, in the form of parallel strips or interlocking combs.

An important characteristic of a photoelectric cell is the radiation sensitivity, i.e., the ratio of its output photocurrent to the incident radiant flux. The radiation sensitivity of a photoelectric cell is inversely proportional to the square of the distance between the electrodes, and also depends on the voltage between the electrodes, the lifetime and mobility of the charge carriers, etc. Small electrode distances have hitherto been achieved with the least expense in photoelectric cells of the gap type. For example, in gap cells of pressed and sintered CdS the interelectrode spacing can be reduced to 200microns. Further reduction of the interelectrode spacing in this type of cell gives hardly any further increase in the radiation sensitivity, since the resistance of the electrodes themselves and their contact resistance become relatively too high. Because of the different electrode configuration, the resistance of the electrodes in the photoconducting CdS sheet is much smaller in comparable conditions. What is particularly important, however, is that their contact resistance has been made extremely small by using the special method of making the contacts. It has been found possible to make CdS sheets which have negligible contact resistance at an interelectrode distance of 40microns. This means that, compared with gap cells of the same material, with the same voltage between the electrodes and the same penetration depth for the radiation, etc., the sensitivity can be made 25 times higher.

CdS grains are monocrystalline, unlike the sintered cadmium sulphide of the gap-type photoconductor. Because of the monocrystalline nature of the CdS, the monograin sheets do not show the troublesome after-effects connected with the presence of grain boundaries.

Many laboratories throughout the world are working on solar batteries for the conversion of solar energy into electrical energy.

Monolithic solar batteries are heavier than is necessary for their actual function. This is a particular drawback for space-vehicle applications, certainly for developments such as the moon project, where very high powers are needed and any extra weight must be cut to an absolute minimum. One can therefore understand why efforts to make solar batteries from evaporated thin films are already under way. Some loss of efficiency due to the polycrystallinity of the evaporated material then has to be accepted. Monograin layers appear to offer an attractive alternative. With this method, light and flexible sheets of any required size can be produced, which can be rolled up before the space vehicle is launched and then unrolled in orbit.

Sheets of CdS grains have been made covered with an epitaxially grown layer of copper sulphide (in a particular form). The CdS was doped so as to make it a strong N-type conductor, and the copper sulphide formed the P region. The solar radiation is

## SIMPLE INFRA-RED IMAGE CONVERTER

A simple image converter that permits viewing and photographing of infra-red and ultraviolet radiation has been devised in the U.S.A. by scientists of the National Bureau of Standards.

Objects emitting heat, even though they are not ordinarily visible by their own radiation, can be made visible by the image converter as a colour pattern and can be photographed. Developed under sponsorship of the Department of Defence, the converter has been successfully used in the laboratory and offers promise of an imaging process that is both simple and economical.

Image converters that change infra-red into visible images have widespread applications. They are used, for example, in military night-vision devices and in the medical diagnosis of certain types of cancer. These converters, however, are generally expensive and quite complicated.

In the N.B.S. device, a concave mirror focuses an infrared image on a special plate. This energy changes the colour of the plate by changing humidity conditions at the surface of the plate, according to the intensity of the infrared radiation, thus making the image visible.

The special plate is, in fact, the converter: it is produced by first

putting a very fine-grained photographic emulsion in contact with mercury. The emulsion is then exposed, through the glass back on which it is deposited, to light from a helium-neon laser. The light reflected from the mercury combines with light that comes directly from the laser to produce standing waves of light in the emulsion.

When the photographic plate is developed, these standing waves become closely spaced layers of silver grains. The layers give the plate a colour that depends on the humidity, changing from red to blue and then to white as the humidity is increased. Absorption of moisture from the air expands the gelatin; this increases the distance between the layers of silver, and as a result produces the colour.

When an infra-red image is focused on the plate, a diffuse light shining on the plate reveals the infra-red image. At this point the image may be seen and can also be photographed. (N.B.S. "Technical News Bulletin," Vol. 52, No. 9, September, 1968.)

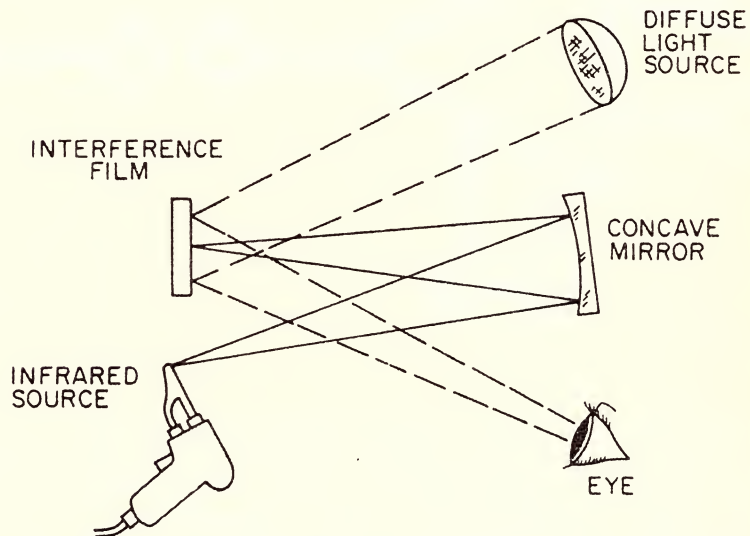

absorbed by the copper sulphide layer. Since this material has a particularly high coefficient of absorption, compared with silicon, the layer can be made very thin so that the sheet is extremely light. Work is now in progress with a view to producing these "solar sheets" in a practical form. If the direct conversion of solar energy into electrical energy also becomes a successful economic proposition for non-space applications, the prospects opened up will be considerable. Many desert regions remain barren because there is no cheap source of energy available for pumping existing underground water up to the surface. The abundance of solar energy for which these regions are noted makes this an obvious choice.

The economic conversion of this energy, however, is no simple matter, as illustrated by the following figures. The efficiency obtained from monolithic solar batteries of monocrystalline silicon at the present time is between 10 and 15 per cent. Taking this efficiency and the present-day cost of material, it can be shown that it would cost several hundred thousand dollars per KW to install such a "solar generator," i.e., about a hundred times the installation costs per KW of a diesel generator. Even at the experimental stage reached at present, costs can be reduced considerably by using sheets of monolithic batteries, instead. (Condensed from "Miniwatt Digest," Vol. 7, No. 9.)



# What's better than one great OP-AMP?

## 2 great OP-AMPS!

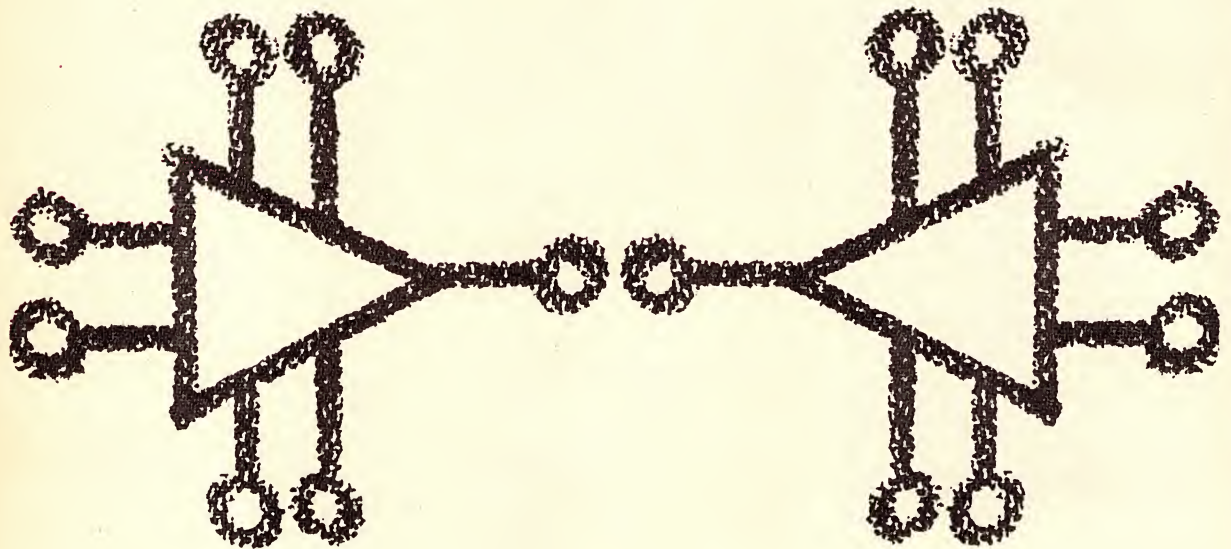

$\mu$ A739C consisting of two identical operational amplifiers is constructed on a single silicon chip, using the Fairchild Planar epitaxial process. These low noise, high gain amplifiers exhibit extremely stable operating characteristics over a wide range of supply voltage and temperatures.

The  $\mu$ A739C is intended for a variety of applications, its low cost and flexibility making it an ideal building block in home entertainment systems.

**FEATURES:** LOW NOISE FIGURE, 2.0 dB  HIGH GAIN, 20,000 V/V  OUTPUT SHORT CIRCUIT PROTECTED  NO LATCH UP  LARGE COMMON MODE RANGE  $\pm 11V$   EXCELLENT GAIN STABILITY VS. SUPPLY VOLTAGE  SINGLE OR DUAL SUPPLY OPERATION.

PART U6E7739393. TEMP. RANGE 0° to 70°C

Prices:— 1-24 \$4.85; 25-99 \$3.90; 100-999 \$3.25.

Limited supply available off the shelf.

**FAIRCHILD**

AUSTRALIA PTY. LTD.

420 Mt. Dandenong Rd., CROYDON, VIC., 3136. P.O. Box 151, Croydon. Cables: Fairchild Melbourne. Telephone: 723 4131, Fairchild Representatives: Phil Cohen, Melbourne, 723 4131.  David Finch, Sydney, 929 7511.  Peter J. Walker, Adelaide, 23 1356.  Ray Crutcher, AUCKLAND, N.Z. 57 9307. New Zealand Distributing Agents: John Gilbert and Co. Ltd., Tasman Buildings, Anzac Avenue, AUCKLAND, N.Z. Fairchild Devices Now Available in Distributor Quantities from: George Brown & Co., 267 Clarence Street, SYDNEY, N.S.W., 2000.  General Accessories, 81 Flinders Street, Adelaide, S.A., 5000.  J. H. Magrath & Co. Pty. Ltd., 208 Lit. Lonsdale Street, Melbourne, Vic., 3000.  Radio Parts Pty. Ltd., Spencer Street, Melbourne, Vic., 3000.  Purvisonic Sound and Distributing Co., 44 McCoy Street, Myaree, Perth, W.A., 6154.  Douglas Electronics, 7 Gralunga Street, Mansfield, Qld., 4122.



# ENRICHED URANIUM BY THE GAS CENTRIFUGE METHOD

A new method for "enriching" uranium being developed in Britain could result in a much more economical method of producing fuel for advanced nuclear reactors.

Over the past five years there has been a big swing toward nuclear-fueled generating stations as a potentially cheaper source of energy than burning fossil fuels. A number of countries — particularly in Europe and North America — have drawn up plans for large increases in electricity generating capacity, using atomic stations.

But this expansion will impose a heavy strain both on world supplies of cheap ore and the processing factories that now produce uranium fuel from the natural ore. Though it is not the most abundant mineral, new reserves of uranium have been located over the past two years and prospectors are confident that more reserves in accessible mining areas remain to be uncovered. Natural uranium contains less than 1.0 per cent of the fissile U-235 needed for fuel. Separation from the isotope U-238, which makes up most of the ore, is both difficult and expensive. To harness more of the potential of fission, requires more efficient nuclear furnaces operating at much higher temperatures. This involves going into fuel processing; enriching the uranium to raise the percentage of U-235 from about 0.7 per cent to between 2 and 5 per cent. This requires separation of the two components and the only successful process for doing this on a large scale is the gaseous diffusion method.

Gaseous diffusion depends on converting the raw material into uranium hexafluoride, a particularly corrosive and toxic substance. To separate out some of the U-238 which differs from the fissile portion of the feedstock by only three units of mass, the uranium hexafluoride is pumped through a very fine membrane which admits the lighter molecules of U-235 more readily than the heavier ones. In a process known as diffusion cascade, the gas is pumped through several thousand membranes to obtain the required degree of enrichment. Because of the repetition of the cascade method, enrichment factories need large buildings, perhaps a mile long, plus an electricity supply of 2500MW or so to drive the compressors which force uranium hexafluoride through the separation stages.

None of the five diffusion plants in operation were built to provide an economic supply of nuclear fuel for power generation, but were originally military installations. Since they were built there has been an extensive search for a better and cheaper route to enrichment. This is one reason why the Netherlands, West German and British Governments have agreed to

co-operate on a venture for exploiting the gas centrifuge.

In principle this is much the same as a spin drier or cream separator. A drum containing uranium hexafluoride gas is spun at extremely high speeds, 50,000 to 100,000rpm, so that the heavier molecules of uranium 238 are thrown preferentially toward the edge of the container. By passing the gas through a series of centrifuges — the cascade system again — an enriched compound is made.

The big attraction of the scheme is that it needs relatively small power — about one-fifth that diffusion takes. Capital costs should also be smaller because centrifuge factories can be tailored to almost any capacity. Though the total cost of a centrifuge and diffusion plant would be about the same for a given production volume, the diffusion plant can be operated only on a large scale. So a plant built today would have to include a surplus capacity for future demands. Centrifuge processing lines can be extended by quite small stages.

On the other hand the technical problems of centrifuge enrichment are both numerous and complex. Centrifuge rotors with diameters of about half a metre may be needed to withstand acceleration forces as high as one million g. As if this were not a big enough materials and engineering challenge, there are questions of structural strength of the outer wall of the rotor and the design of vacuum seals that allow uranium hexafluoride to be passed from one machine to the next.

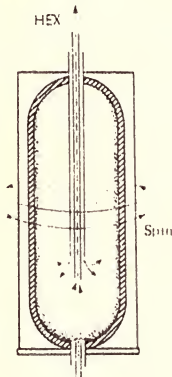

*Simplified diagram illustrating the operating principle of the gas centrifuge.*

The capital costs of entering the diffusion field have deterred several countries from going into the enrichment business — particularly when added to the technical risks. Very little information on diffusion is available, so an entrant to the business has no guarantee of success. ■

## Which system for Australia?

The gas diffusion method of enriching uranium may cause a change in Australian thinking concerning the relative merits of alternative systems of nuclear power generation. Tentative decision made by the Commonwealth Government so far favour the use of natural uranium, as outlined in the following report, extracted from an article in "The Sydney Morning Herald," 18/5/69.

Four basic systems using natural uranium are available. The longest established, the Magnox gas-cooled, graphite-moderated system, has generated more commercial nuclear power for Britain than has been produced by any other country. However, this system is too expensive for Australia, Britain itself has moved on to "advanced" gas-cooled reactors (AGRs), which burn slightly enriched fuel. The remaining three natural-uranium possibilities are all heavy-water moderated. [Heavy water is ordinary, or light, water containing hydrogen in the heavier deuterium form. Heavy water is naturally present in minute quantities.]

Since 1967 the Australian Atomic Energy Commission has favoured this method, but one major drawback is that, lacking the interest of the great Powers, the development of heavy-water reactors lags behind light-water concepts. The advantages of heavy-water moderated systems using natural uranium include: Fuel elements of simple design, efficient use of fuel, and significantly greater production of plutonium, which can be stored indefinitely and eventually reprocessed for "fast-breeders." Australia would have to import large quantities of heavy-water initially. But it should build quickly its own \$100m heavy-water plant.

Various kinds of coolants and moderators are balanced in different reactor designs, but the first decision for Australia to make was the choice of fuel—natural uranium or enriched uranium. The Commonwealth announced a few months ago that it would stick to natural uranium. The choice was made on the advice of the Australian Atomic Energy Commission, for several reasons.

For a start, Australia cannot afford to enrich its own uranium by any foreseeable method. Australia would have to buy enriched fuel from America, and the A.A.E.C. is worried that enriched prices may go up when private industry takes over American enrichment plants. In addition, if America did not want Australia to convert fuel to plutonium for bombs, it could cut-off the supply — on which Australia would be dependent if it had reactors using enriched fuel. But with the use of natural uranium, of which Australia is believed to have ample reserves, Australian power stations would be given two capabilities:

- (1) to generate power at the maximum rate of 10,000 MWD (megawatt-days) for each ton of fuel, and create at the same time a mixture of plutonium isotopes for fast-breeder reactors, or
- (2) to generate power at the rate of 600MWD for each ton of fuel to recover plutonium 239 for use in bombs.



# ONLY A FEW MAGNETIC STEREO CARTRIDGES EARN PLACES IN THE SUPERLATIVE BRACKET. **ORTOFON** HEADS THE LIST.

Most reviewers have several favorite cartridges — *in most cases, ORTOFON heads the list.* The explanation is a simple one. ORTOFON is the only organization in the world manufacturing professional disc cutting equipment and cartridges for playback. Many of your favorite recordings will be reproductions from ORTOFON cut masters! As reproduction is complementary to recording it naturally follows that ORTOFON should produce the finest arms and cartridges available in the world today.

The ORTOFON moving coil principle is the only recognised transducer system inherently free of non-linear distortion; tracing distortion caused by the differing shapes of cutting stylii and reproducing stylii has now been eliminated by ORTOFON thanks to the use of exclusive ORTOFON elliptical diamonds. All ORTOFON cartridges feature a 15° tracking angle.

*Technically and musically ORTOFON stereo cartridges are unique and quite superior.*

ORTOFON cartridges have won universal popularity with discerning music lovers and professional users; the low distortion moving coil principle is quite incomparable. Stereo cartridges developed by ORTOFON engineers have always been advanced in design and construction; the ORTOFON S15 series offers superior sound reproduction and will trace the most complex waveforms at 1.5 grams. The S15 is available with an optional built-in transformer and may also be purchased ready mounted in the lightweight metal "G" shell for use with the ORTOFON SMG-212 tone arm.

\*An exclusive protective device . . . "Protecto-Skate" . . . shields the stylus if the cartridge is accidentally subjected to excessive external lateral, or vertical pressure. This tube is highly polished to afford added protection for the record surface itself.



#### ORTOFON S15 SPECIFICATIONS:

|                                 | S15T                            | S15         |
|---------------------------------|---------------------------------|-------------|
| Weight of cartridge             | 18.5 grams.                     | 12.5 grams. |
| Output impedance                | 15 Kohm                         | 2 ohm       |
| Output in mV/cm/sec (loaded)    | 2                               | 0.04        |
| Equivalent mass at stylus point | 0.9 mg.                         | 0.9 mg.     |
| Recommended stylus pressure     | 1-2 gr.                         | 1-2 gr.     |
| Elliptical stylus radius        | 0.0007" x 0.0003" (both models) |             |
| Spherical diamond radius        | 0.0006" (both models)           |             |
| Tracking angle                  | 15°                             | 15°         |
| Static compliance               | 20 x 10 <sup>-6</sup> cm/dyne   |             |
| Frequency response              | 15-40,000 Hz.                   |             |
| Channel separation              | 20-30 dB.                       |             |

ORTOFON now introduce the new SL15 light-weight stereo cartridge — a moving coil unit with very high compliance and improved frequency response. This superb cartridge is designed for use in transcription tone arms of the highest possible calibre.

#### ORTOFON TRANSFORMER MODULE

A twin transformer module which may be fitted anywhere in the lead between the tone arm and the amplifier is now available, complete with plugs and cables.

Specifications: Input impedance — 2 ohms. Output impedance — 15 Kohm. Load impedance — 47 Kohm. Frequency response — 10-40,000 Hz.

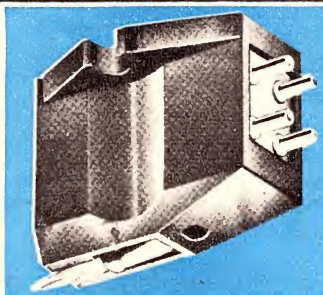

#### ORTOFON SL15 SPECIFICATIONS:

|                                       |                               |
|---------------------------------------|-------------------------------|
| Weight of cartridge:                  | 7 grams.                      |
| Output impedance:                     | 2 ohms.                       |
| Equivalent mass (at stylus point):    | 0.9 mg                        |
| Recommended stylus pressure:          | 0.75-1.5 grams.               |
| Output:                               | 0.025 mV/cm/sec.              |
| Stylus radius: Spherical diamond—SL15 | 0.0006".                      |
| Stylus radius: Elliptical diamond—    | 0.0007" x 0.0003".            |
| Tracking angle:                       | 15°.                          |
| Static compliance:                    | 25 x 10 <sup>-6</sup> cm/dyne |
| Channel separation:                   | 20-30 dB.                     |
| Frequency response:                   | 10-40,000 Hz.                 |

#### THE NEW ORTOFON TONE ARM MODEL RS-212

Full advantage of the outstanding characteristics of the SL15 series cartridge may be taken with the new ORTOFON RS-212 arm. A stylus pressure mechanism based on spring tension also incorporates an effective automatic anti-skating arrangement; stylus pressure and anti-skating force are correctly related when the stylus pressure is set. Although factory set for ORTOFON cartridges with elliptical stylii, a ratio adjustment screw permits use of any cartridge. The ORTOFON "Hi-Jack" lifting/lowering device is standard equipment with the RS-212 arm.

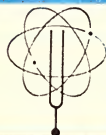
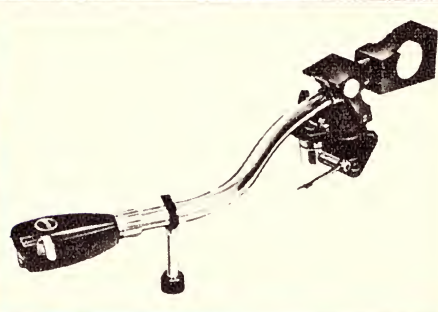

Australian National Distributors:

*Simon Gray Pty. Ltd.*

Head Office: 28 Elizabeth St., Melbourne Vic. Tel. 63 8101\*  
Sydney Office: 22 Ridge St., North Sydney, N.S.W. 929 6816  
Canberra Office: 31-33 London Circuit, Canberra City. A.C.T. Tel. 49 6050

INTERSTATE REPRESENTATIVES:

N.T.: Pflitzner's Music House, Smith Street, Darwin. Tel. 3801  
Q'land: Sydney G. Hughes, 154-158 Arthur St., New Farm, Brisbane. 58 1422  
S.A.: Elico Sales Pty. Ltd., 7-9 Osmond Terrace, Norwood, S.A. Tel. 63 4844  
Tas.: K. W. McCulloch Pty. Ltd., 57 George Street, Launceston. Tel. 25322  
W.A.: Athol M. Hill, 613-615 Wellington Street, Perth. Tel. 21 7861



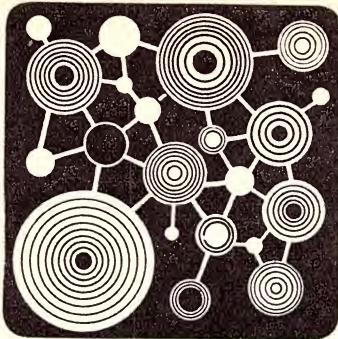

# SCIENTIFIC AND INDUSTRIAL NEWS

## Optical readers

IBM Australia has installed two IBM 1287 Optical Readers, said to be the first in Australia capable of reading hand-printed numbers from a variety of sources directly into a computer. Optical readers eliminate the need for punching data from source documents into cards or paper tape as an intermediate step before processing. The units are now operating in the Gas and Fuel Corporation's data processing centre, Melbourne, and in the IBM Data Centre, St. Kilda. In the Gas and Fuel Corporation's centre, the IBM 1287 is reading hand-written gas consumption figures from meter readers' sheets directly into a System 360 complex for processing and combining with a magnetic tape file of the customers' essential information.

## Symposium on logical systems

An international symposium on the "Design and Applications of Logical Systems," to be held at the University of Brussels, Belgium, from September 15 to 20, 1969, is being organised by the Societe Royale Belge des Electriciens. The organisers are endeavouring to create active co-operation between those concerned with the design of logical systems by systematic methods and their applications in research and industry. For further information, write to Dr J. Florine, International Symposium, Laboratoire d'Electronique Industrielle, Universite Libre de Bruxelles, 50 Avenue F.D. Roosevelt, Bruxelles 5, Belgium.

## Alternative ILS

An alternative to the use of radio guidance for Instrument Landing Systems (ILS) has been proposed by the Norwegian Defence Research Establishment. The basic principle involves the use of a series of separate sources of gamma rays — cobalt 60 was selected — housed in lead alloy containers in which accurate slits are formed to collimate the radiation into precisely formed beams of several thicknesses and orientations. The sources are located along an approach path in such a manner that an aircraft equipped with suitable detection equipment receives a sequence of coded pulses. The received pulse series and the time data they provide are processed by on-board computational equipment to yield azimuth and elevation guidance, height, ground speed, distance to touch-down, three-axis attitude information, and other signals such as runway identity, warnings, etc.

## Computerised telephone exchange

A computer-controlled telephone exchange system is being developed by the Plessey Telecommunications Group under a multi-million dollar program spread over the next few years. In the U.K., teams of engineers and scientists are already engaged in a development program and a basic systems model will be operating later this year. In Australia a team at Plessey Telecommunications Pty. Ltd., is developing facilities to enable operators handling "person-to-person" trunk calls to take advantage of the new techniques.

The Plessey approach differs from other computerised or Stored Program Control (S.P.C.) systems under development elsewhere. These are based on a large central processor which signals instructions to the switching equipment, and which must be duplicated to guard against breakdown. In the Plessey system, a number of smaller processors are used, each of which not only performs its own function but also takes over automatically the role of any other processor in the event of failure. Immediate advantages predicted for S.P.C. by Plessey are remote administration of telephone exchanges, increasing use of special data processing equipment by subscribers, and additional subscriber facilities such as data transmission, short code dialling, and call transfer.

An engineer (right) tests the scanner distribution surface of the Plessey computer-controlled telephone exchange system.

A number of source patterns and beam orientations have been evaluated in flight trials by the Norwegian team, which has given the system the designation Hermes. Processed guidance data in the aircraft is suitable for either an autopilot, or a cathode ray tube or head-up display for manual control.

## Portable house

A compact aluminium house of three rooms, kitchen, and bathroom, which can be erected in less than an hour on a prepared site, has been developed by Svenska Metallverken of Sweden. Called the Essem Telescopic House, it comes in three sizes and is equipped with all modern conveniences. The kitchen is complete with electric stove, fan, refrigerator, stainless steel sink, and cupboard space. The house can be folded into container form and moved to a new site. Floor sections, which during transportation serve as container walls, are set up on a 6in thick gravel foundation and a bed of impregnated sleepers. The outer sections of the house are then slid into place.

## Faster sputtering

A sputtering system which can handle two different materials, avoiding oxide formation between metal faces and loss of time through a second pumping, has been introduced by NCR-Europe, Welwyn Garden City, Herts., England. With the system, the NCR 3199, 48 silicon wafers of 50mm diameter can be treated in one operation. The water-cooled target on which the material to be sputtered is mounted can be rotated during the process. A high-voltage insulator allows both DC and RF sputtering, and shields are provided to prevent sputtering of target materials on to substrates which are not directly facing the target.

## Ground control of aircraft

An operational control centre, small enough to fit into a field car, for the forward control of strikes and reconnaissance aircraft has been developed by Elliott Space and Weapon Automation Ltd., Rochester, Kent, England. Called Retriever,

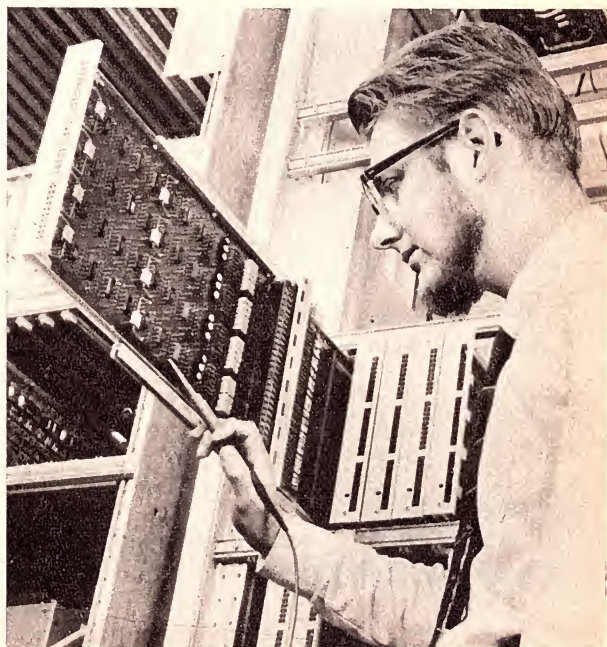



# Plessey Series 331 Connectors

- \*Intermateable and interchangeable with similar types of connectors
- \*Crimp contacts \*Monobloc insulators

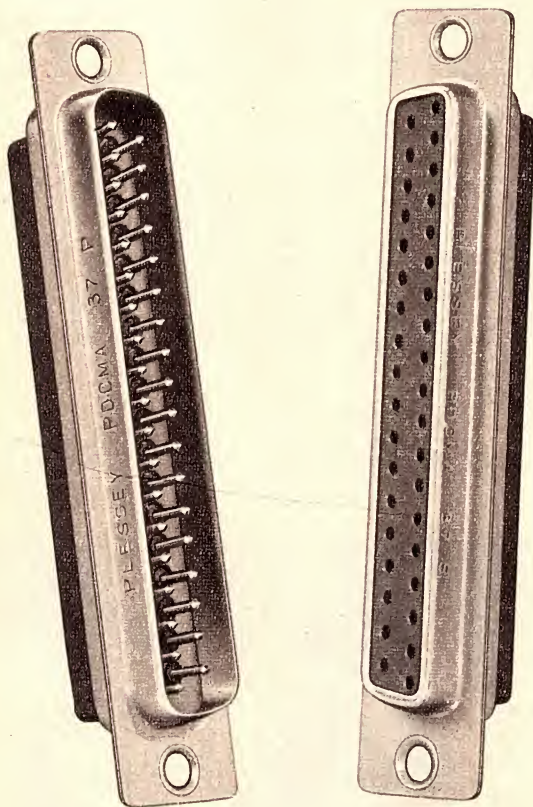

Plessey sub-miniature rectangular connectors provide maximum space utilisation on rack/panel chassis equipment and combine the important factors of weight-saving, strength and operation ruggedness. Five versions are available of 9, 15, 25, 37 and 50-way capacity each containing size 20 contacts for crimp connection. Contacts are rated at 5 amps continuous working and their finish is gold flash on silver. Plug pins are of brass and socket inserts are made of phosphor bronze. Monobloc insulators house contact-retaining clips which enable contacts to be inserted and extracted from the rear. The moulding material enables the connectors to operate within a temperature range of  $-55^{\circ}\text{C}$ . to  $+150^{\circ}\text{C}$ .

Styles can be supplied for either fixed or float mountings. Coupling is by friction and the keystone shell polarisation prevents mismatching, reducing the risk of contact damage.

The connectors in this range are intermateable and interchangeable with similar connectors meeting the dimensional requirements of DEF5325 and U.S. Specification SCL/6020. This type also meets or exceeds the applicable requirements of MIL-C-8384.

For further information on this or other types of connectors within the Plessey range, please contact Professional Components Department, Villawood, N.S.W., or Ducon Interstate Offices.

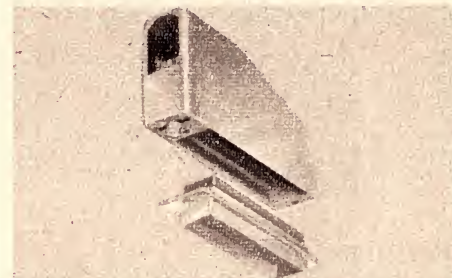

#### Cable Outlet Covers

Moulded, grey coloured nylon,  $90^{\circ}$  cable outlet covers available to suit each shell size. Covers adaptable to either plug or socket.

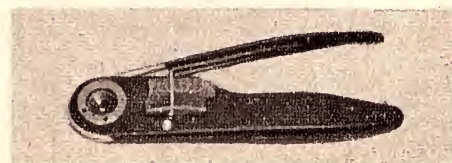

#### 4-Indent Service Crimping Tool

Approved to MIL-T-22520 (Class 1) and MS3191-4, this one-handed crimping tool contains a 7-position wire-size selector to cater for all contacts up to size 12.



#### Contact Removal Tool

Designed for the removal of plug pins and socket inserts.

**PLESSEY**  
**Components**



Ducon Division  
Plessey Components  
Box 2 PO Villawood NSW 2163  
Telephone 72 0133

Melbourne 42 3921  
Brisbane 2 3287  
Adelaide 76 3434  
Perth 21 4821/21 7867



the system allows the controller in the field to move rapidly to his required location, store in a computer all the local tactical information and the location and armament of his supporting aircraft, and to control support operations with the minimum of equipment and manpower. Using an electronic display, keyboard, and light pen, the controller can call up precisely the information he requires for a particular decision, insert new information by editing the display, make an assessment of the relative effectiveness of particular weapons against a target, and issue instructions to waiting pilots.

## Cassette data recorder



A low-priced digital magnetic tape recorder, using a newly patented optical system for uniform data packing, has been developed by Mobark Instruments Corporation, Mountain View, California, U.S.A. The incremental recorder couples stepping motors with an optical disc to strobe serial data on magnetic tape from a temporary shift register for precise positioning on the tape regardless of instantaneous irregularities in tape speed. The tapes produced are of fully IBM-compatible format. Designed for such applications as data terminals, data logging, central billing, and inventory control, the instrument will record 140,000 characters on a single low-cost 1/8in tape cassette at recording speeds up to 120 characters per second and playback rates to 300 characters per second. Other features include serial-by-bit recording, play-back either in serial or parallel, dual capstan closed-loop tape drive, and backspacing character correction.

## Viewing faint stars

A low-light image intensifier, manufactured by Marconi Instruments, has been fitted to the Isaac Newton telescope at the Royal Greenwich Observatory, England. Used to identify and centre extremely faint stars, it comprises a low-light camera, a television monitor, and associated apparatus. Attached to the main telescope is a finder telescope to locate the desired area. The low-light camera intensifies the very faint pictures and reproduces them clearly on the television monitor. The image on the monitor can be reversed (stars shown as black on white) for comparison with star charts. As well as detecting stars fainter than can be seen with a dark-adapted eye using the same telescope, the system allows observers to work in the light, avoiding the time for eyes to adapt to the dark.

## Symposium on contact phenomena

The 5th International Symposium on Electric Contact Phenomena will take place in Munich, West Germany, from May 4 to 8, 1970. Reports on the present state of contact research will be studied by several large working groups.

## POST OFFICE OPEN DAYS

The Post Office Research Laboratories in Melbourne plan to hold a series of open days from September 15 to 18, 1969. The main concern of the laboratories is to solve technical and research problems facing the Post Office. Its work includes basic research and development in telecommunications theory and practice under Australian conditions, the design and development of telecommunications or mail-handling plant most suitable for Australia, and an appraisal of world developments in telecommunications. The laboratories are at present carrying out more than 200 projects of varying magnitude, and a comprehensive exhibition of the work being done is planned for visitors.

The research laboratories are housed in several buildings at the eastern end of the city, and transport between buildings will be arranged by the Post Office. Inspection tours for visitors will begin at 59 Little Collins Street, Melbourne. For further information contact the Information Officer at the Research Laboratories. Phone Melbourne 630-7932.

Informative lectures will be given summarising the progress made since the last international symposium in Swansea, in 1968. These will be followed by individual papers on research and development in all aspects of contact behaviour as well as operating contacts. Testing methods, statistic problems, and questions of reliability will be included. Languages of the meeting are German, English and French. Further information may be obtained from the Organisationsburo ITK, 8 Munchen 19, Waisenhausstr. 4, West Germany.

## Recovering diamonds

An electronic separator, announced by Gunson's Sortex, London, uses X-rays to identify and recover diamonds from a gravel feed. When irradiated with X-rays, diamonds fluoresce to a high degree, emitting visible light. This emission is sensed by a photomultiplier in the device, the Sortex XR21. Whenever the light from a particle exceeds a predetermined level, the particle is deflected from the feed into a separate chamber. The unit is claimed to recover up to 99 per cent of diamonds present in a mineral mixture at a single pass through the machine.

## Purity measurement technique



Dr I. J. Lawrence, of the National Physical Laboratory at Teddington, Middlesex, England, inserts an organic specimen in a sealed container into a spectrometer to determine the purity of the contents. A new method, developed at the laboratory, uses the techniques of nuclear magnetic resonance spectroscopy and provides a quick and accurate measurement of the specimen without contaminating it in any way and without removing it from a sealed container. A digital read-out shows the liquid percentage present in the container from which the purity of the specimen can be calculated. The method is said to be suitable for routine purity control in the chemical industry as well as for laboratory use.



# INTRODUCING THE ARISTOCRAT OF STEREO SYSTEMS



  
**PIONEER**

# C-5600

A NEW MULTI-AMPLIFIER STEREO SYSTEM with TUNER/RECORD PLAYER/SPEAKERS. A magnificent new set with the very latest multi-amplifier speaker system for supreme clarity. To obtain the very finest audio delivery of radio and records in your home PIONEER has developed this high performance set with a special multi-amplifier speaker system.

The PIONEER C-5600 incorporates two separate amplifiers in each speaker enclosure, one for the high frequencies and one for the medium/low frequencies. This involves a total of four amplifiers. Total power output is a big 60 watts. The pre-amps use expen-

sive silicon transistors, providing a remarkably low distortion rating and an ideal signal to noise ratio. The multi-amplifier configuration, completely avoids intermodulation distortion, gives remarkable efficiency, and guarantees clear, sharp audio delivery.

ASK YOUR NEAREST PIONEER RETAILER FOR FULL DETAILS.

Sole Australian Representative  
ASTRONICS AUSTRALASIA PTY. LTD.  
Melbourne Sydney Brisbane Adelaide Perth  
Hobart Auckland



## Trunk-line radiotelephone



A VHF/UHF single-channel radiotelephone equipment, ordered by the P.M.G.'s Department for trunk telephone routes throughout Australia, has been developed by C. E. Electronics Pty. Ltd., a subsidiary of Philips Telecommunications of Australia Ltd. Called the Series SC9, the equipment is considerably smaller and said to be more reliable than the company's earlier models. Fully transistorised and based on robust modular plug-in construction, the equipment is available in several versions to cover frequencies from 78MHz to 500MHz. Mr O. Wilson, development manager, inspects a rack of six SC9 equipments prior to dispatch.

## Two-way reflector

The external surface of satellites built by the Lockheed Missiles and Space Co. of the U.S.A. is basically a second-surface mirror composed of silver vacuum-deposited on silica. Made in sheets, it is chipped into small pieces which are applied in mosaic fashion to the spacecraft. The resultant thermal surface acts as a barrier to heat, solar winds, ultra violet rays and other elements that could adversely affect the spacecraft. The mirror's two-way feature permits heat from the equipment operating in the spacecraft to be dissipated at the same time as isolation is provided against external elements. Tests in simulated envir-

## Isotope-powered cardiac pacemaker

An isotope battery to supply power to implanted cardiac pacemakers has been developed by the Atomic Energy Research Establishment at Harwell, England. The battery (shown here fitted in a pacemaker and immediately below the fingertips) converts the spontaneous heat generated by the radioactive isotope plutonium 238 into electricity by using a thermopile. The battery is matched to the pacemaker by a DC-to-DC converter which can be designed to suit any pacemaker circuit. The design life of the unit is said to be ten years, substantially greater than the life of conventional batteries, thus reducing

the frequency of replacement surgery. Care has been taken in the design and manufacture of the unit to ensure that no radiation hazard exists for the patient.

## Paint-on heating

A coating that will conduct electricity and which can be readily applied to existing wall surfaces to provide a heating element in buildings has been developed by the Paint Research Station, Teddington, Middlesex, England. The paint has a very low resistance and can be heated with a 40V AC supply, so reducing the hazards from shock when the coating is on accessible parts. The coating is dark, but a decorative paint can be used over the top without appreciably affecting the radiation of the conductive paint. The cost of installation is said to be competitive with conventional heating systems, the major factor being the cost of the step-down transformer.

In a test installation, an 80 sq. ft wall successfully produced 1½KW of heat maintaining a surface temperature of 42 degrees C. Aluminium electrodes were concealed at the top and bottom of the wall behind the picture rail and skirting.

## Air pollution control

An electrochemical process for salvaging the sulphur dioxide present in smoke from chimneys has been developed by the Lockheed Missiles and Space Company's research laboratory at Palo Alto, Calif., U.S.A. Although one of the most irritating and poisonous air pollutants, sulphur dioxide is also of value to various industries. In the Lockheed process, the chimney gases flow through a chemical bed that causes sulphur dioxide to unite with moisture and form droplets of sulphuric acid. Collected periodically, this acid could then be sold to cover the estimated costs of installing and operating the equipment, according to a company spokesman.

## Testing car engines

The Buick Division of General Motors, U.S.A., is using compressed air to test car engines when partly assembled, for better quality control. Fed into the cylinders through the spark-plug holes when the engine is about 75 per cent assembled, the air turns it over slowly enough for a visual inspection to be carried out. Buick says that early inspection allows faulty engines to be stripped before they are completed, thus saving labour. Previously engines were tested with petrol after completion, and dismantling was a longer job. Also, as the "hot test" had to be made at speed, no visual inspection was possible.

## Machining tungsten

Sintered tungsten impregnated with copper makes a material which can readily be machined and freed of the copper later, according to Sylvania



Metals and Chemicals, Towanda, Penn., U.S.A. Ordinary sintered tungsten is too hard to machine, but with the softer copper to support the particles it can be worked on machine tools with normal high-speed bits. Once shaped, the tungsten is heated in a vacuum to evaporate the copper. The resulting porous tungsten can be used as a filter, or it can be made to absorb some other material. Suggested additives are aluminium, to make an electron emitter; or silver, for rocket nozzles. (The evaporation of the silver cools the nozzle.)

Flux pen

## Flux pen

Using a flux pen with a nylon tip, assemblers can place a thin layer of flux on leads to be soldered to terminals or tabs. The pen, made by BLH Electronics, Waltham, Mass., U.S.A., is said to dispense flux like a fountain pen places ink. The flux is mixed with a special carrier to make it flow easier and to retard evaporation. The makers say that the pen contains enough flux for a year of normal use.

## Field ion microscope



At GEC-AEI Research Ltd., Wembley, Middlesex, England, liquid nitrogen is poured into the head of a field ion microscope to cool the vacuum chamber and the specimen to be studied. This form of microscope magnifies up to 10 million times, allowing the atomic structure of materials (including metals) to be seen. An intense electric field is applied to the specimen under study in a low pressure of helium or other gas removing a beam of ions from the specimen to produce an image on a phosphor screen. The method is still experimental, but is expected to become a commercial proposition in a few years when it should have applications in metallurgy, nuclear research, etc.

## Cooking on glass

A form of glass for such uses as top panels for electric and gas cookers transmits enough heat to cook food and makes it possible to clean the surface by merely wiping with a damp cloth. The glass can be made to expand with heat, to contract, or to remain unchanged by suitable treatment according to PPG Industries, Pittsburg, Penn., U.S.A. It is made in sheets up to 3/8in thick, and can be transparent, translucent, or opaque. Grids etched on the glass show the heat concentration from the burners or elements for optimum placing of pans.



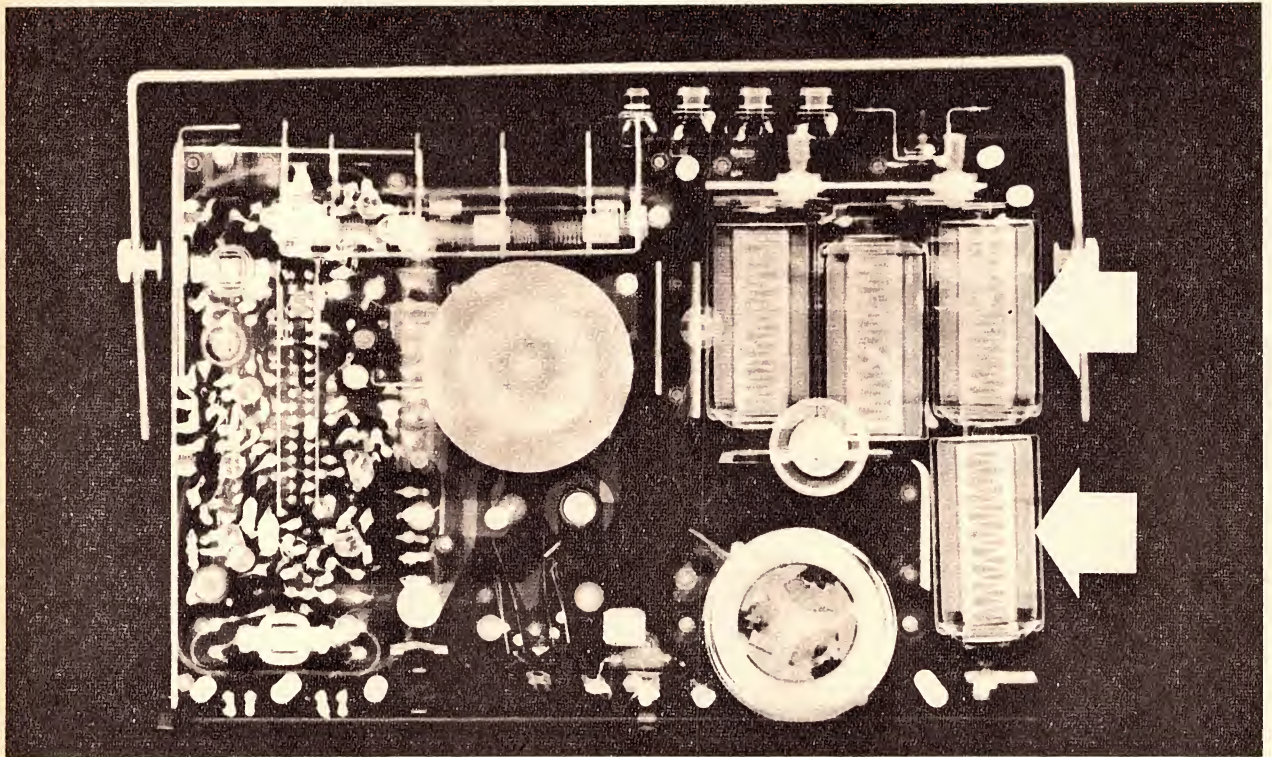

# The more they put into tape recorders

## the more you need Duracell®

They put in interlocks to give you sound-on-sound. Automatic shut-offs to save you tape. VU meters, reset counters, automatic level controls—all built-in. Today's portable tape recorders have everything. But it takes heavy-duty batteries to run them. Many manufacturers now recommend Duracell. Duracell, the long distance power cells, pack a maximum of power in a minimum of space.

Inside its steel-jacketed body are almost a dozen patented advances — power cores, special seals and electrolytes. And they all work to stand up to the heavy drains of tape-drive motors. Keep voltage levels high for precise amplifier operation. Hold their power for years. Ask for Duracell—the long distance power cells — wherever batteries are sold.

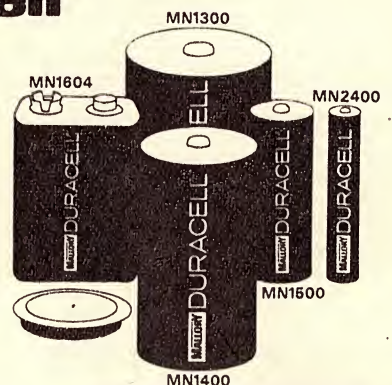

**DURACELL. THE LONG DISTANCE POWER CELL  
STILL GOING STRONG LONG AFTER ORDINARY BATTERIES ARE DEAD.**

Trade enquiries to Mallory Batteries (Australasia) Pty. Ltd., marketers of Duracell 439 2544



© Registered trademark of P. R. Mallory & Co. Inc.

MB2998/68



## 1MV electron microscope

An electron microscope which will work at one million volts (ten times the common voltage in use) has been developed by the National Physical Laboratory in the U.K. The voltage of an electron microscope governs the thickness of specimens which can be examined. By increasing the voltage to 1MV, the scientists expect to see through specimens six times as thick as they can handle at present. The first 1MV machine, to be made by GEC-AEI, will be delivered to the Laboratory this year.

## Automatic bank cashier

A machine called DACS, the De La Rue Automatic Cash System, developed in the U.K., cashes a cheque when the bank is closed. The cheques are special ones for a fixed amount — in Britain, £10. To use the machine, a personal code number is entered on a panel of numbered push-buttons. Only a genuine number allows the machine to accept the cheque for scrutiny, a process which takes 20 seconds. If the machine is satisfied, it delivers the money; if not, it signals "rejected" and returns the cheque. The special cheques can be cleared by the bank in the same way as ordinary ones. While intended to provide a service after banking hours, customers may find it more convenient to use the machine even when the bank is open rather than wait to be served over the counter.

## Industrial safety

The 13th N.S.W. Industrial Safety Convention is to be held at the Wollongong Town Hall from 13 to 16 October, 1969. More than 20 speakers will address delegates on various aspects ranging from safety in containerisation to safety in space travel. A safety exhibition to be held in conjunction with the convention will provide displays of personnel protective equipment, machine guards, fire protection, and electrical safeguards. Inquiries should be addressed to the Secretary, N.S.W. Industrial Safety Convention and Exhibition, P.O. Box 344, Wollongong East, N.S.W. 2500.

## Ion source

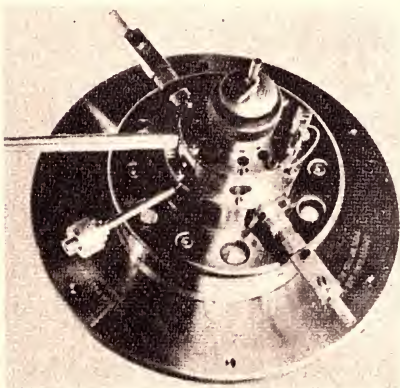

The Diode Ion Gun type 705 (announced by C & N Electrical Ltd., Gosport, Hants, England) provides a constant supply of gas or metal ions for ion implantation, for doping of semiconductor materials, or for the study of ion behaviour. The gun uses gas ions (generally argon) to bombard a negatively-charged electrode. Neutral sputtered atoms, which can be ionised in an arc, are produced from the electrode. The arc conditions can be controlled and made self-sustaining by the ions from the negative electrode without further recourse to the argon. The material from which ions are to be obtained is mounted on the cooled negative electrode. If the ion material is a gas, the ions are pro-

duced by injecting the gas into the arc at a controlled rate instead of by sputtering. The gun can be used with most accelerators, and the sputtered ions can be extracted and focused as a beam of ions.

## Fluidics simulator

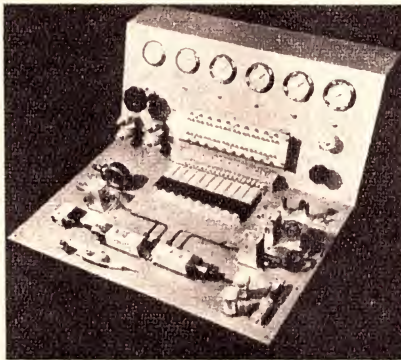

The Maxalog Systems Simulator, designed to teach users the techniques and potentialities of fluidics in general, is said to be capable of reproducing in bread-board form the majority of circuits and systems likely to be met in practice. The instructional unit, manufactured by Maxam Power Ltd. (Camborne, Cornwall, England), offers 20 axial and 20 planar turbulence amplifiers with associated manifolds and pipework.

Twin low pressure regulators and four low pressure gauges enable functions to be monitored at any point; two pneumatic cylinders allow control movements to be demonstrated; and quick-action connectors and a high pressure gauge and regulator make coupling fast and easy. Peripheral equipment includes air stream detectors, interruptible jets, step-up and step-down relays, limit switches, and air-to-electric and electric-to-air converters.

## Decca Navigator for W.A.

A contract worth \$1.5 million has been awarded for the construction of a Decca Navigator chain at Port Hedland in Western Australia. The chain, consisting of three transmitting stations, will be supplied to the Department of Shipping and Transport to guide large iron ore carriers safely through shoals 15 to 20 miles offshore, beyond the dredged channel. The project is expected to be completed within eight months, and to be fully operational and tested one year later. A further contract provides for Decca to operate the stations for a minimum period of three years. The Decca company and others are currently undertaking studies, at the request of the Australian Government, to establish whether advanced electronic aids are required elsewhere on the Australian coast.

## Canadian electronics

The latest electronic equipment manufactured in Canada is being displayed at the 5th International Trade Show in Melbourne from August 4 to 9. Some of Canada's top electronics executives and technicians will be on hand to explain the displays and to discuss problems and their solutions. The Canadian electronics industry embraces all branches of the subject, and counts the following amongst its achievements: a 17,000-mile integrated microwave system to link Canada's scattered population; 20,000 miles of microwave systems for 13 other countries; three electronic satellites and two ground stations; a giant radio telescope at Lake Traverse. A domestic satellite system has been proposed to provide coast-to-coast communications over the 4500-mile breadth of Canada.

# HI-FI

A budget-priced system for those who want to enter the wonderful world of High-Fidelity sound . . .

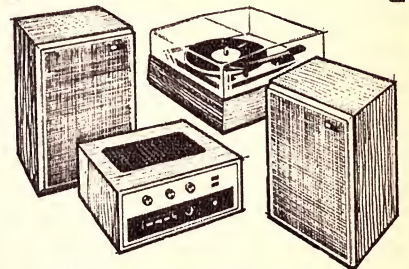

It is impossible for us to know what you personally look for in a Hi-Fi system, but we can guarantee that we have just the set-up you are looking for.

For example, this system, comprising a Rogers Cadet Amplifier with 2 Goodmans Ten/Ten loudspeakers and Garrard Record Player. At \$398, it is one of the best buys in Hi-Fi; terms available. Come in and let our experts help you with your choice.

# URD

UNITED RADIO  
DISTRIBUTORS PTY. LTD.

SHOP 32, ASH STREET,  
ANGEL ARCADE, SYDNEY  
Telephone 28-3718 28-3926  
Please forward details of  
High Fidelity Systems, in-  
cluding Rogers Cadet/Good-  
mans Ten-Ten.

Name .....

Address .....

State .....



# An Experimental Helium-Neon Gas Laser

There is good reason to believe that, in the near future, many intriguing and educational experiments will be performed in science classrooms using a small gas laser unit, such as the one described in this article. This article should therefore be of considerable interest, particularly to High schools, universities and technical colleges.

by Jamieson Rowe

Although the laser has only been present on the technological scene for just on nine years, it has already made considerable impact. Most non-technical laymen know of its existence, if only from hearsay or as a result of the somewhat imaginative representation such a device in the James Bond movie "Goldfinger."

Those with more technical background or inclination will no doubt have a somewhat more detailed and factual concept of such devices and their operation, particularly if they are regular readers of a journal such as "Electronics Australia." In the past few years there have been many articles and news stories describing both the operation of the various types of laser, and their ever-growing applications.

Understandably, most of the laser applications publicised have been rather esoteric. Examples are extreme bandwidth optical communications links, optical rangefinders and other navigation aids, precision micro-machining, rapid hole-drilling in diamonds, 3-D "photography" or holography, and the welding of detached retinas inside human eyeballs. Some of these applications require the use of lasers of very high power, and correspondingly high cost; however, others may be performed using relatively low power and low cost units.

It may not always be realised that, in addition to their more esoteric applications, lasers are also very suitable and are in fact widely used for a variety of somewhat more mundane tasks. These include surveying, precision measurement of length, flatness and motion, and the simple and quite dramatic demonstration of many of the basic laws of optics. The last-named of these applications promises to ensure an ultimate place for lasers in every High school, university and technical college physics laboratory.

The small helium-neon gas laser to be described in this article is particularly suitable for demonstrations and experiments in optics, and should be found of considerable interest as a result. It is also capable of being used for simple interferometry and holography experiments, and possibly may also serve as the heart of an optical communications system. Despite its flexibility the unit is of relatively low

cost in terms of laboratory equipment and construction is made very simple as a result of the use of a sealed and pre-aligned plasma tube.

The recent availability of the particular plasma tube used has in fact made the project possible. The tube used is the type EOA-9040, manufactured by Electro Optics Associates of Palo Alto, California, and imported to this country by their sole representatives, Laser Electronics Pty. Ltd., of Southport, Queensland.

Actual cost of the tube is \$148.88 plus sales tax where applicable. We understand that, although sales tax on this type of equipment is normally 15 per cent, exemptions may be obtained under Section 63 of the Sales Tax Act by bona fide students and by manufacturing companies with a legitimate use for a laser in research or to aid manufacture. In the case of students, an exemption may apparently be obtained upon presentation of a state-

or "co-axial" construction in which the outer envelope forms both the mechanical support for the pre-aligned resonator mirrors, and also provides the electrode chambers. The inner capillary tube provides the only plasma passage between the two electrode chambers, and therefore forms the actual oscillation cavity in which the "lasing" takes place.

Because of the integral construction employed, the tube has no need for the specially-angled low loss "Brewster windows" used on external mirror tubes; as a result the output beam from the unit is unpolarised (but can be externally polarised if this is required). The use of a so-called "confocal" combination of plane and spherical concave mirrors also ensures that the tube oscillates in its most basic transverse mode, producing an output beam whose intensity is substantially uniform in cross-section. The beam diameter on emerging from the output end of the tube is rated as 1.2mm.

Although of relatively short length, the output beam is quite highly collimated (formed into a parallel beam), having a rated maximum divergence of only 1.5 milliradians. This can be reduced by optics to a diffraction limited minimum of 0.15 milliradians.

Guaranteed minimum optical power output of the EOA-9040 tube is 0.5mW, with a quoted typical figure of

## WARNING

The optical output of the laser unit described in this article, while of low power, is concentrated into a narrow beam potentially capable of passing fully through the iris of a normal human eye. The intensity which would be produced at the eye retina if this occurred is regarded as sufficient to cause permanent sight impairment, so that intending constructors of the unit are strongly warned against allowing this situation to occur.

A very worthwhile rule is "never to look a laser in the eye", either directly or via a highly specular reflective surface such as a mirror or a polished metal or paint finish. Only allow such a beam to enter the eye when it has been widely diffused, as from a screen or white card.

ment from their school or college verifying that the unit is to be used in connection with their studies.

The EOA-9040 is a compact tube measuring a nominal 7½in long by 1in diameter. It is basically a hot-cathode discharge tube filled with a mixture of helium and neon gases at low pressures — approximately 0.4mM and 0.1mM of mercury, respectively. At these pressures the tube output is in the red region of the optical spectrum, with a wavelength of 6328 Angstroms (0.6328µM).

As may be seen from figure 2 the tube employs a novel doubly re-entrant

nearer 1mW. While this may seem a very modest figure it is in fact quite adequate for most experimental purposes, and is regarded as an attractive compromise between usefulness and operational safety.

Due to the concentrated nature of the output beam, the full optical power output of the tube could conceivably enter the eye, producing an intensity exceeding that produced by a direct glance at the sun or a high-intensity electric arc discharge—even with an output level of only 0.5mW. Readers and intending constructors are therefore advised to take careful note of



the safety precautions given in the warning panel.

The directly heated cathode of the EOA-9040 tube requires a conventional heater supply of 6.3V at a nominal 0.6 amps. Anode ignition voltage is approximately 3KV, maintaining voltage approximately 1100V. Current-controlled operation is necessary because of the negative-resistance characteristic exhibited by plasma discharges, and the rated maximum continuous anode current is 7mA. The optical output in the tube is claimed to be substantially a linear function of anode current between the rated maximum value and near-extinction at approximately 3mA.

The following explanation of the nature of the light produced by lasers, and the operation of the He-Ne gas laser in particular, may be found of value both by intending constructors and also perhaps by those reading this article for general interest and background.

It is fairly common knowledge that light is a variety of electromagnetic radiation, and as such is basically similar in nature to the type of energy radiated by radio and television transmitters, radar sets and X-ray tubes. The essential differences between these varieties of electro-magnetic energy are in terms of frequency—or its complement, wavelength.

Thus radio transmitters generally radiate electromagnetic waves whose frequency falls between 10 KiloHertz (KHz) and 100 Megahertz (MHz), television transmitters generally radiate waves somewhere between 40MHz and 800MHz, and so on. In comparison with these examples the frequencies of visible light radiation are very much higher, lying in a band between about 500 and 1,000 million Megahertz. The corresponding wavelengths are 0.7 and 0.4uM (micro-metres).

Although light and the other forms of electromagnetic radiation may seem to consist of continuous waves, their behaviour in many situations has been found to suggest strongly that this is not the case. Rather it has been found necessary to conceive such radiation as consisting of a stream of tiny "packets" or particles of energy. The name given to these particles is **photons**.

Probably the most common way in which photons of light are produced is when atoms of a material which have become "excited" by absorption of heat or other energy suddenly drop back either to a less excited state, or to their original unexcited "ground state." When an atom thus reverts to a less excited state, the energy is expelled and emitted as a photon of radiation.

The amount of energy which is expelled as a photon when an atom

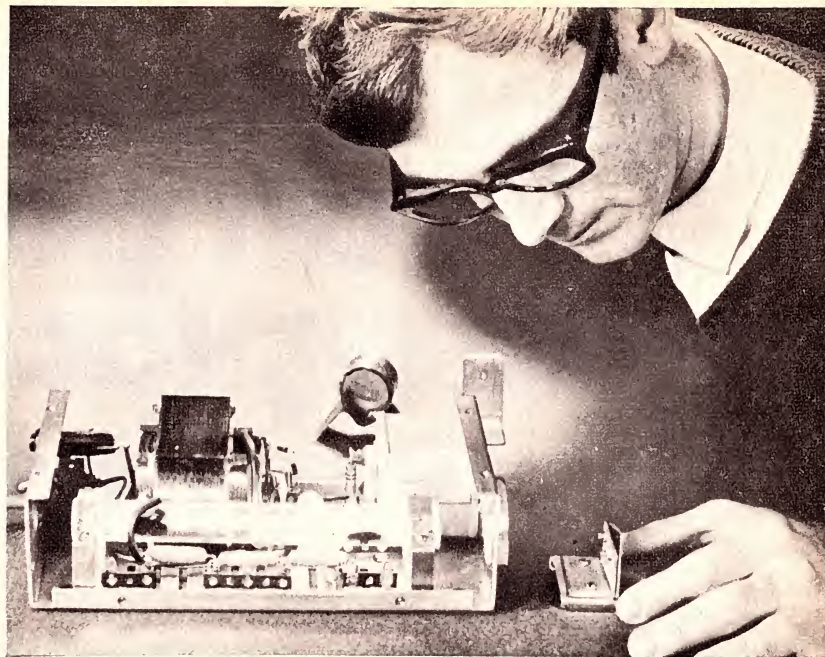

The author is seen above adjusting a simple diffraction slit placed in the output beam of the laser. The unit is shown here without its top cover, revealing the plasma tube and power supply components.

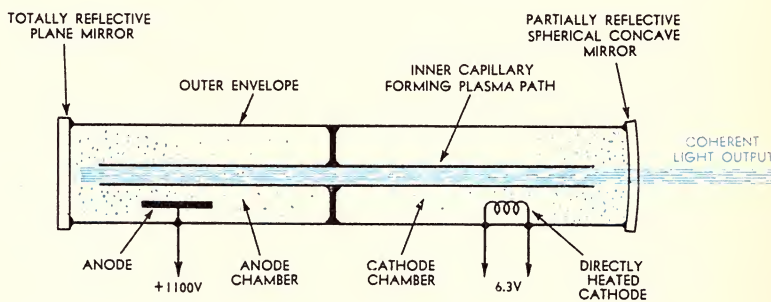

Figure 2 THE EOA-9040 He-Ne GAS LASER

"relaxes" depends naturally upon the degree to which it was excited prior to relaxing, and the degree, if any, to which it remains excited after the relaxation. The expelled energy is simply the difference between the two. And the amount of energy expelled has been found to determine the **frequency** of the photon emitted — not, as one might perhaps expect, its "size."

By their very nature, atoms can only absorb and expel energy in definite amounts or increments, called **quanta**. The size of the quanta also depends both upon the composition of the particular atom concerned, and also upon its degree of excitation at the instant concerned. Hence an atom of a particular element or substance, when it relaxes, can emit only those photons whose frequency correspond to the various possible transitions between the allowed energy levels of the atom concerned. This explains the characteristic "spectra" found by analysing the light radiated (or absorbed) by materials under suitable conditions.

In an ordinary flame, electric arc or incandescent lamp filament, many millions of atoms are constantly becoming excited to a greater or lesser extent, and similarly relaxing to a greater or lesser extent; the whole occurring in a completely random and haphazard fashion. The light which is produced by such sources therefore consists of

vast numbers of independent photons, differing from one another both in terms of frequency and in terms of phase.

As such, this type of radiation differs considerably from that emitted by radio and television transmitters, because the latter radiate (ignoring modulation, for simplicity) a steady stream of photons all of the same frequency and synchronised with one another in terms of phase, such that together they effectively constitute a continuous wave-train. The term "**coherent**" is used to describe radiation which is in this more organised form.

In short, virtually all "normal" sources of visible light radiation produce light which is incoherent — composed of many frequencies, and lacking any significant synchronisation even between those photons having the same frequency. As such, the light emitted by such sources generally cannot be used for many of the potential applications which have long been known to exist for radiation possessing both coherency and the high photon energy of visible radiation.

The development in 1960 of the ruby laser provided the first known source of truly coherent light radiation, and for the first time enabled the potential applications to be realised. Since then a number of other types of laser have been produced, all pos-



# Laser Electronics can go anyplace anytime

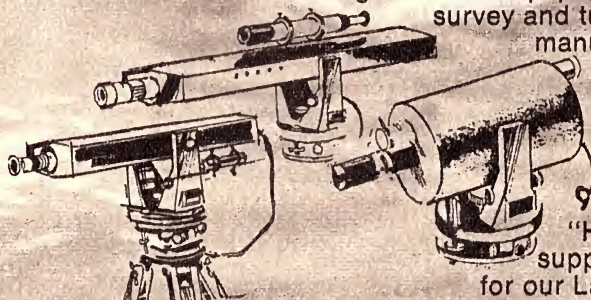

A range of Laser equipment for navigational, survey and tunnel applications is manufactured exclusively in Australia by Laser Electronics. The EOA9040 Laser tubes featured in the July

Electronics Australia article "How to build a Laser", were supplied by Laser Electronics. Write for our Laser catalogue on your Company letterhead.

**Laser Electronics Pty Ltd**

PO Box 359, Southport, Queensland 4215 Telephone Gold Coast 7 1977



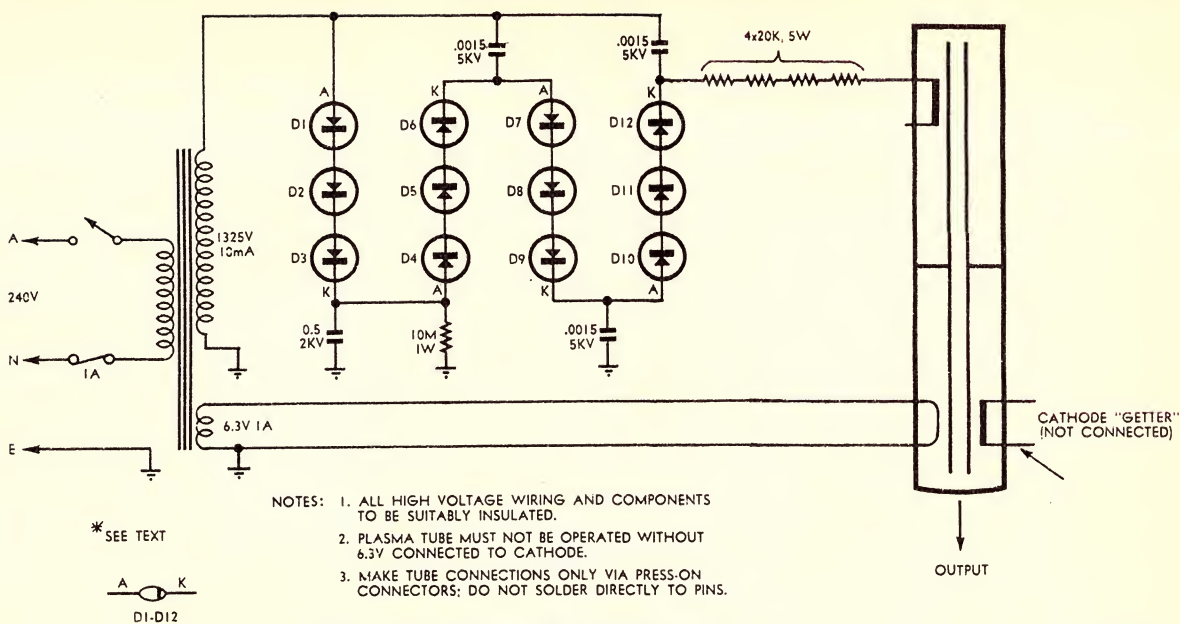

**LOW POWER He-Ne GAS LASER**

2/MS/18

The circuit diagram of the laser unit, which may be seen to consist essentially of a high-voltage power supply.

sessing the ability to generate coherent light radiation, and all contributing to the current development of ever-exciting applications of such radiation.

The name "laser" is itself a rather cryptic key to the way in which these devices operate. The name is really an acronym formed from the initial letters of the words Light Amplification by Stimulated Emission of Radiation.

As this suggests, the operation of lasers depends upon the effective amplification of light by a process known as "stimulated emission."

Basically, stimulated emission is not a difficult phenomenon to understand, although it may initially be found rather surprising. What it amounts to is this: if an atom is excited, and is therefore potentially able to relax by emitting a photon of a particular frequency, it can be stimulated into relaxing in this way by the occurrence of a collision with another photon of the same frequency. When this happens, the photon emitted by the relaxing atom is created in exact synchronism with the photon which triggered the event. At the same time the stimulating photon is not absorbed or otherwise disturbed, but is able to leave together with the second photon.

In other words, stimulated emission is the process whereby a photon of radiation collides with an excited atom, to trigger the emission of a second photon identical in frequency and synchronised in phase; the two photons then leave together.

It should be fairly clear that this mechanism is a potential means of achieving light amplification, because a continuing and cumulative series of stimulated emissions can effectively result in the production of two photons from one, then four from two, eight from four, and so on. And it should also be apparent that, because the stimulation mechanism in each case produces new photons which are identical in frequency and synchronised in phase with those triggering their production, the amplification process will result in coherent radiation.

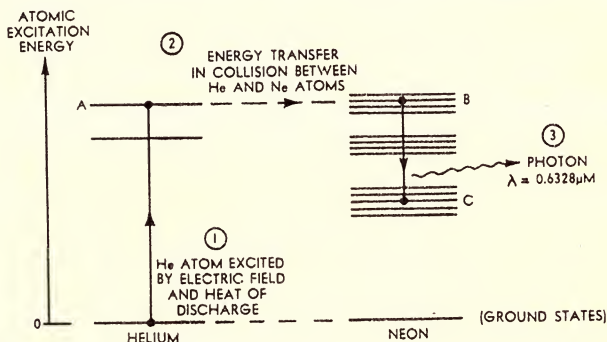

Figure 1

All lasers depend upon the mechanism of stimulated emission for their operation. The various varieties of laser differ mainly in terms of the material used to provide the excited/relaxing atoms, and the method used to "pump" or excite large numbers of the atoms into the excited state. Naturally enough, for cumulative light amplification or "lasing" to occur to any appreciable extent from stimulated emission, there must be a situation in which large numbers of atoms are in an excited state.

The helium-neon or "He-Ne" gas laser, of which the EOA-9040 is an example, is possibly the most common type of laser in use at the present time. In this type of laser it is actually the neon atoms which are associated with the stimulated emission mechanism; the helium atoms are used merely as an energy transfer medium for "pumping" the neon atoms to the appropriate level of excitation.

The pumping system employed may be understood by reference to the excitation energy diagram of figure 1. Here the solid horizontal lines represent the various allowed excitation energy levels or states for atoms of helium, on the left, and neon, on the right. The lowest lines in each case correspond to the ground states, and

these have been aligned to show more clearly the relationships existing between the two types of atom in terms of excitation increments.

In passing it should perhaps be noted that although the diagram of figure 1 is somewhat similar in appearance to the electron-energy diagrams used in analysing electrical conduction and the operation of semiconductor devices, it does not have the same significance. The levels here do not correspond to specific allowed electron energy levels, but rather correspond in a more general manner to the levels of excitation available to the atoms considered as complete systems.

In the He-Ne gas laser the electric field and high temperature existing in the discharge plasma causes helium atoms to be ionised and accelerated, thereby exciting them to energy levels above the ground state. One of the allowed excitation levels for helium, shown on the diagram as "A," corresponds almost exactly to one of a number of closely spaced excitation levels of the neon atom. This level is shown on the diagram as "B."

Because of this level equivalence between the two types of atom, a collision between an excited helium atom and an unexcited neon atom almost



# SONY TC-230 *Not just a tape recorder...*



*... a compact, portable stereo music control centre*

## SPECIFICATIONS

**Recording system:** 4-track stereo/mono recording and playback. **Power requirements:** 240V, 50, 60 Hz, AC 60W. **Tape speed:** 7½ ips, 3¾ ips, 1½ ips. **Frequency response:** 40-18,000 Hz at 7½ ips • 40-12,000 Hz at 3¾ ips • 40-6,000 Hz at 1½ ips. **Signal-to-noise ratio:** Better than 46 dB. **Flutter and wow:** less than 0.17% at 7½ ips • less than 0.3% at 3¾ ips • less than 0.4% at 1½ ips. **Harmonic distortion:** less than 3% at OdB line output. **Recording time** (1,800' tape): 4-track stereo 1.5 hrs. at 7½ ips • 3 hrs. at 3¾ ips • 6 hrs. at 1½ ips. **Power output:** 4Wx2. **Inputs:** Rec/PB connector—impedance approx. 10K ohms • Microphone inputs—sensitivity—75dB (0.14mV) impedance 600 ohms • Phono inputs—sensitivity—52.5dB (2mV) • Tuner (auxiliary) inputs—sensitivity—25dB (44mV) impedance approx. 100K ohms. **Outputs:** Line outputs—output level PB 3dB (1.1V) Rec. 1dB (0.87V) • Load impedance 10K ohms • External speaker outputs—11.3dB (2.83V) impedance 8 ohms • Headphone outputs—impedance 8 ohms or more • Rec/PB connector—impedance approx. 3.5K ohms.

## FEATURES

Call the TC-230 an integrated stereo amplifier with a built-in tape recorder, or a tape recorder with a built-in stereo amplifier—either way you have the most advanced, compact, solid state stereo tape and music system to ever come along. In addition to a complete 4-track stereo monophonic tape recording and playback system, this versatile TC-230 features the exclusive stereo control center consisting of a multiple input stereo preamplifier and 4Wx2 stereo power amplifier. Just connect your stereo tuner, stereo changer or turntable to the TC-230, and you are free to choose instantly, with just a flick of the selector switch on the front panel, either listening or recording source from any of the connected components. The TC-230 literally gives you convenience and versatility—designed also for travel use, its two high-compliance speakers are installed in the two split-lids which can be separated up to fifteen feet for optimum stereo effect. Features include • 3 speeds • 7" reel capacity • dual VU meters • automatic shut-off switch • digital tape counter • contemporary style, pale grey heavy-duty vinyl-finished case with aluminium trim • handsome front panel in gleaming chrome and black.

# SONY®

Distributed by:

## jacoby, mitchell & co. pty. ltd.

SYDNEY • MELBOURNE • BRISBANE • ADELAIDE

To: Jacoby, Mitchell & Co. Pty. Ltd., 469-475 Kent St., Sydney, 2000  
Please send me information on Sony Tape Recorders

Name.....

Address.....

..... JMS/4-69/EA869



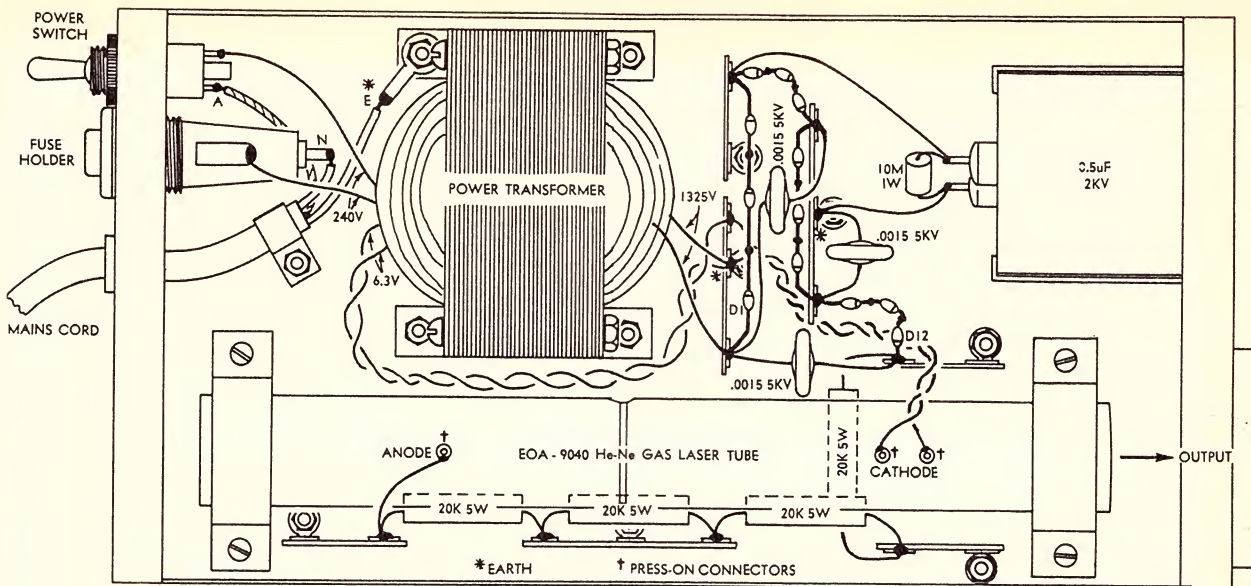

inevitably results in a total transfer of excitation energy between the two. After such a collision, the helium atom is almost always left in the ground state, while the neon atom is found to have acquired the excitation energy represented by level B.

In the He-Ne gas laser system there is a high probability that this type of collision will occur, because the particular level "A" of the helium atom is meta-stable: once having absorbed the appropriate amount of energy, the helium atom cannot spontaneously expel it to "relax." Hence there tends to be a high proportion of excited helium atoms in the discharge, and accordingly a high probability that collisions between excited helium atoms and neon atoms will occur frequently.

In effect, then, the helium atoms serve to "pump" large numbers of neon atoms to the level of excitation represented by the line "B." And it transpires that, if the pressure of the gases in the tube is adjusted to a suitable value, neon atoms which possess this excitation level exhibit a strong tendency to relax, either spontaneously or by stimulation, to a lower excitation level represented on the diagram by "C." From this level they may then drop to the ground state, at a later time.

The energy difference between levels "B" and "C" corresponds, as may be seen, to a photon of frequency equivalent to the wavelength 0.6328uM. Hence every neon atom which relaxes after colliding with an excited helium atom in the foregoing manner emits a photon of radiation of this wavelength. The excitation transition between levels "B" and "C" of the neon atom is thus that associated with the stimulated emission process in producing a coherent light output.

From the foregoing it may be seen that throughout the ionised gas mixture inside a He-Ne gas laser there will be excited neon atoms relaxing, either spontaneously or due to stimulation, and emitting photons of the appropriate frequency. Cumulative light amplification or "lasing" thus tends to occur everywhere inside the plasma tube, to a certain extent. However, in the case of a tube whose construction is similar to that of the EOA-9040, shown in figure 2, the

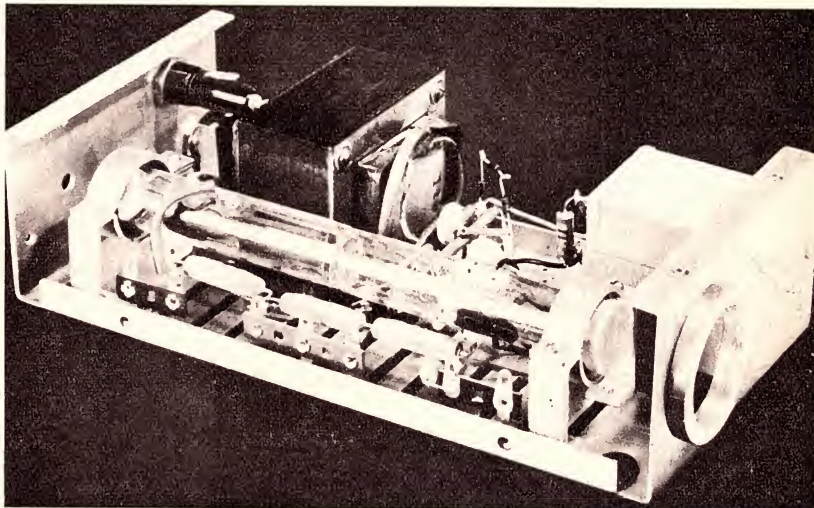

At top is a complete wiring diagram of the laser unit, while above is a close-up view showing the tube mounting brackets and current limiting resistors. Note the modified tagstrips used to support the latter, produced by removing lugs from standard strips.

lasing can only build up to significant magnitude and be maintained in a continuous manner in the narrow region extending through the central capillary tube and bounded at each end by the mirrors at the ends of the outer envelope.

One reason for this is that, in general, it is only inside the capillary tube that there are sufficient numbers of excited neon atoms to support the stimulated emission process in a continuous manner. Because the construction of the tube forces the discharge plasma to "squeeze" through the narrow capillary, it is naturally inside the latter that the greatest degree of gas ionisation and excitation is produced.

Apart from this there are more fundamental reasons for the confinement of continuous lasing of the tube within the narrow central region. For coherent radiation to grow to a significant magnitude, the synchronised photon "team" produced by the stimulated emission process must be able to accumulate a large "membership"; this implies a long optical path, as it is only over such a path that the stimulated emission process will be sufficiently

cumulative. From figure 2 it can be seen that the longest unimpeded optical path existing in the plasma of the tube is within the capillary tube and aligned with its axis.

In itself, a long optical path could not result in continuous lasing. For coherent radiation to be maintained continuously after having built up, there must be some sort of positive feedback mechanism available whereby the stimulated emission process may be self-perpetuating. In the gas laser this feedback is provided by the mirrors at each end of the active optical path.

In effect, the mirrors form a resonant optical cavity, such that coherent radiation produced within the active optical path can oscillate back and forth to maintain itself. The reflection at the mirror surfaces is not entirely lossless, but the reflection losses are compensated by the optical gain of the plasma path. In fact, one of the mirrors is intentionally designed to be only partially reflective, and this is the means used to extract coherent light output from the laser. As shown in figure 2, in the EOA-9040 tube it is the spherical concave mirror which is



## TEST EQUIPMENT BUDGET TIGHT THIS YEAR?



"805" series  
HEATH DIGITAL  
INSTRUMENT

# HERE'S A BUDGET BOOSTER

One economical instrument performs as many as 7 different functions ●  
Events Counter ● Frequency Meter 12.5 MHz ● Integrating Digital Voltmeter  
● Ratio Meter ● Time Interval Meter ● Period Meter ● Voltage Integrator.

The Heath/Malmstadt-Enke "805" Universal Digital Instrument (UDI) is the ideal multi-purpose instrument . . . it combines in one package a Universal Counter/Timer with a Digital Voltmeter and is capable of many high-accuracy standard measurements with the adaptability and versatility required of modern research instrumentation.

### FEATURES:

- Unique . . . modular design based on 16 plug-in circuit cards. This concept enables card addition of new functions to the Heath Universal Digital Instrument and protects it against obsolescence. All cards stay in place to perform the above 7 functions.
- High accuracy . . . the Heath UDI has an accuracy  $\pm 1$  count, plus time base error. In the Digital Voltmeter mode of operation the UDI is capable of 0.05% accuracy.
- TTL Integrated Circuits provide high performance, reliable "state-of-the-art" electronics.
- Stability . . . the short term time base stability of the UDI is better than 5 parts in  $10^9$ . The long term (one year) time base stability is better than one ppm (for temperature range 15° to 55° C) except in DVM Mode.
- Sensitivity of Input Comparators is 10 mV from

DC to MHz, 25 mV from 10 MHz to 12.5 MHz.

- Resolution of 10  $\mu$ V in DVM Mode.
- Complete range of trigger controls, including Automatic Mode.
- Available with or without DVM which may be easily added later.
- Lowest price of any on the market for comparable functions and performance.

### THE UDI's LOGICAL COMPANION

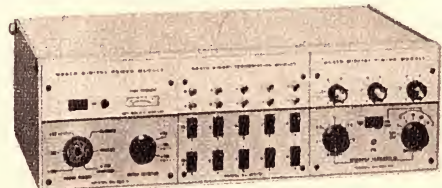

The Heath Analog-Digital Designer is a modular breadboarding instrument that allows you to "wire-patch" design almost any type of digital or analog circuitry. It consists of modules and plug-in cards that may be easily connected together without soldered joints. You just plug-in your design in the ADD . . . optimize it and use the solution directly.

FOR FULL DETAILS CONTACT THE INSTRUMENTATION SPECIALISTS



**WARBURTON FRANKI**

ADELAIDE: 56-7333; BRISBANE: 51-5121;  
HOBART: 2-1841; LAUNCESTON: 2-1318; MEL-  
BOURNE: 69-0151; MOUNT GAMBIER: 2-3841;  
NEWCASTLE WEST: 61-4077; PERTH: 8-4131;  
SYDNEY: 29-1111; WOLLONGONG: 2-5444.

W.F.2878



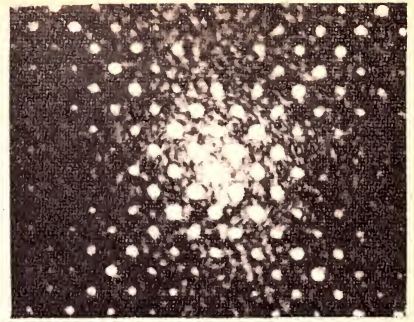
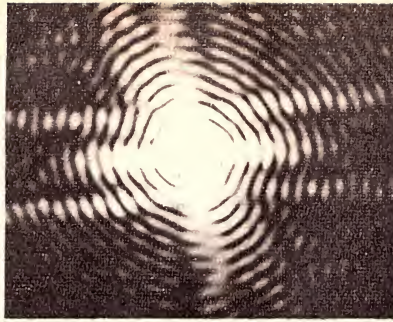
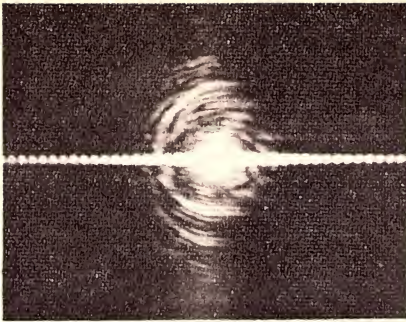

Three interference patterns produced with the prototype laser. The first, at left, was produced by placing in the beam a simple vertical slit formed by two safety razor blades mounted approximately 1/64in apart. The second, centre, was formed using a small pinhole—whose slightly irregular shape has been exaggerated by the fringes. The final pattern was produced using a small piece of optical screen, as used in half-tone printing.

partially reflective, and therefore this mirror which forms the "output" end of the tube.

As may be seen from the circuit diagram, the EOA-9040 plasma tube forms the heart of the experimental laser unit. The remaining components are employed in a fairly simple power supply designed to provide the tube with the appropriate operating voltages.

The power supply employs a mains transformer having two secondary windings. One secondary is a conventional heater winding which supplies 6.3V at approximately 600mA for the plasma tube heater. The other secondary winding is designed for use with the rectifier circuit shown, to produce the anode voltage for the plasma tube; rated secondary voltage is 1325V at a nominal average current of 10mA.

The apparent complexity of the rectifier circuit arises from the fact that plasma tubes must be supplied initially with a voltage somewhat higher than the maintaining voltage in order to achieve reliable ignition. In the case of the EOA-9040 the required initial voltage for reliable ignition is approximately 3,300V, while the maintaining voltage is approximately 1100V.

To satisfy the dual requirements concerning maintaining voltage and ignition voltage in an economical fashion, the power supply circuit combines a relatively well-regulated half-wave rectifier with a very poorly regulated voltage-multiplying rectifier. The half-wave section produces the plasma tube maintaining voltage, while the multiplier section produces the additional voltage necessary for reliable ignition.

The basic half-wave circuit consists of the three diodes D1, D2 and D3, together with the 0.5uF/2KV reservoir capacitor. The 10M/1W resistor across the reservoir capacitor is a bleeder to promote rapid discharging upon switch-off, for operator protection, while the four 20K/5W resistors connected in series with the plasma tube anode provide the necessary current limiting. Three diodes are connected in series to provide sufficient peak inverse voltage rating.

The remaining nine diodes and three .0015uF/5KW capacitors form the voltage multiplying rectifier, whose output effectively adds to that of the basic half-wave circuit prior to ignition of the plasma tube. However the low value reservoir capacitors used in this section provide very poor regulation,

with the result that immediately the plasma tube ignites and draws significant current, the total output voltage drops to the value determined by the half-wave circuit.

Three series-connected diodes are again used in each leg of the multiplier section, to provide sufficient peak inverse voltage rating.

The device type specified for all 12 diodes used in the power supply is the General Electric type A14P, a 1A/1000V peak inverse rating device which features transient overload protection. The special characteristics of this device permit the use of a simple series connection to achieve the required peak inverse rating, and also justify the use of only three diodes per leg, whereas four would be dictated from normal rectifier theory.

Although other types of silicon diode may be used in the circuit as it stands, and with possibly no ill effects, it would really be necessary to fit resistor-capacitor combinations across each device to ensure equalisation of both periodic and transient reverse voltages. Suitable values for most types of device would be a 470K resistor and .0047uF/2KV capacitor, connected in parallel across each device.

The 0.5uF/2KV main reservoir capacitor is a standard sealed paper type. In the prototype unit we used a Ducon unit, designated type 7S05, which should be available through most trade suppliers. The three .0015uF/5KV capacitors are standard high-voltage "button" ceramics, those used in the prototype again being from the Ducon range.



Cat. No. M207



**DE-SOLDERING/SOLDERING TOOL**

This unique tool allows fast removal of 90 per cent of the solder on soldering tags and printed circuit board component terminations.

Removal of components is greatly simplified and P.C.B. and component damage can be avoided.

A range of six tips for both de-soldering and soldering, allows this tool to be used for all applications from micro-miniature to standard radio and TV circuit work. All tips are specially plated and de-soldering tips are stainless steel lined.

Cat. No. M207 is **Approved** in all Australian States for mains voltage operation. Models are available for all voltage ranges.

See the range of Adcola "M" Series Solder Tools illustrated in "Electronics Australia," May, 1969, edition or write for illustrated brochure to —  
**ADCOLA PRODUCTS PTY. LIMITED, 22 FIRTH STREET, DONCASTER, VIC., 3108, Phone 848-3777.**  
 17 BURWOOD ROAD, BURWOOD, N.S.W., 2134, Phone 747-1606.  
 S.A. Distributor: F. R. Mayfield Pty. Ltd., 11 Halifax Street, Adelaide. 8-4131.  
 Qld. Agent: T. H. Martin Pty. Ltd., 56-74 Edward Street, Brisbane. 2-0555.  
 W.A. Agent: Everett Agency Pty. Ltd., 17 Northwood Street, West Leaderville, 6007. 8-4137.



STOP RUST OUTDOORS 2 YEARS - - OR MORE!

# Lubricates Penetrates Stops Rust

DRY YOUR ELECTRICAL SYSTEMS  
with LPS — the NON-GREASY ONE

**STOPS  
Squeaks!**



LPS is NOT a paint, lacquer or a varnish, and will NOT damage paint, rubber, fabrics, plastics, or finishes.

**Displaces Moisture Fast!**

## TECHNICAL INFORMATION

Physical Properties:

LPS I

Less than .0001 inch non-greasy molecular film with capillary action that spreads evenly and easily to seal out moisture at very low cost. **Rust Inhibitor:** Protects all metals from rust and corrosion.

**Water Displacing Compound:** Dries out mechanical and electrical systems fast.

**Lubricant:** Lubricates even the most delicate mechanisms; non-gummy, non-sticky; does not pick up dust or dirt.

**Penetrant:** Penetrates to loosen frozen parts in seconds.

**Volume Resistivity per ASTM D-257;** Room temperature, ohm/cm:  $1.04 \times 10^{12}$

**Dielectric Constant per ASTM-877:**

**Dielectric Constant 2.14 Dissipation Factor: 0.02**

**Dielectric Strength per ASTM D-150:**

**Breakdown Voltage 0.1 inch gap, 32,000 volts**

**Dielectric Strength volts/inch 320,000 volts**

**Flash Point (Dried Film)**

**Fire Point (Dried Film) 900 degrees F**

**TESTS AND RESULTS: 950 degrees F**

**Lawrence Hydrogen Embrittlement Test for Safety on High Tensile Strength Steels: Passed. Certified safe within limits of Douglas Service Bulletin 13-1 and Boeing D6 17487.**

**Mil Spec. C-16173D-Grade 3**

Passed

**Mil Spec. C-23411**

Passed

**Swiss Federal Government Testing Authority for Industry: Passed 7 Day Rust Test for acid and salt water. Passed Weiland Machine Test for Lubricity as being superior to mineral oil plus additives.**

LPS PRODUCTS CONFORM TO  
FEDERAL MIL SPECS  
C-23411 and/or C-16173D



LPS RESEARCH LABORATORIES, INC.  
2050 COTNER AVE. • LOS ANGELES, CALIF. 90025

## HOW LPS SAVES YOU TIME AND MONEY

1. LPS PROTECTS all metals from Rust & Corrosion.
2. LPS PENETRATES existing rust — stops it from spreading.
3. LPS DISPLACES moisture on metal—forms fine protective film
4. LPS LUBRICATES even the most delicate mechanisms at extreme temperatures.
5. LPS PENETRATES to free rust frozen parts, nuts, bolts, etc.
6. LPS PREVENTS equipment failures due to moisture (drives it out).
7. LPS LENGTHENS LIFE of electrical & electronic equipment—improves performance.
8. LPS RESTORES equipment damaged by water contamination & corrosion.
9. LPS PENETRATES AND PROTECTS plated and painted metal surfaces.
10. LPS PROTECTS metals from salt atmosphere, acid & caustic vapours.
11. LPS LOOSENS dirt, scale, minor rust spots & cleans metal surfaces.
12. LPS ELIMINATES squeaks where most everything else fails,

(SOLE AGENT)



**ZEPHYR PRODUCTS PTY. LTD.**

70 BATESFORD ROAD, CHADSTONE, VICTORIA—PHONE 56-7231

MANUFACTURERS OF RADIO & ELECTRICAL EQUIPMENT & COMPONENTS



The power transformer used in this project is a rather special type, and for this reason we have arranged for Ferguson Transformers Pty. Ltd. to be able to supply constructors with a suitable transformer to order. The type number which may be quoted when ordering is PF-3124.

As may be seen from the photographs, the physical construction of the demonstration gas laser is quite straightforward. The unit is housed in a small case measuring 10in x 5in x 2½in, the case consisting of two complementary "U" sections. One section, forming the base and ends of the case, mounts both the plasma tube and the power supply components; the other section forms the top and sides of the case, and constitutes a removable lid.

The plasma tube is mounted along

of the case, with the 10M bleeder resistor connected directly across its terminals. The four 20K/5W current limiting resistors are below and adjacent to the plasma tube itself, supported by a further group of three tagstrips.

The tagstrips used in the unit are basically standard (not miniature) types, but with some of the original tags removed to improve the break-down characteristics. In general every tag used to support a high voltage point of the circuit is isolated from the nearest earthed support tag by a blank hole corresponding to a removed tag from the original strip; this should be fairly evident from the illustrations. All components and wiring which are floating at high voltage are suitably protected by rylex or varnished

supplied with the tube, the connectors then being pushed by hand on to the tube pins when they have cooled.

Each connector should be held in a pair of pliers while the soldered joint is made, and the joint itself should be made quickly to avoid overheating the connector and reducing its "springiness." However care should nevertheless be taken to ensure that the joints are sound; this is particularly important with the two cathode connections, as accidental loss of the 6.3V heater supply during operation could ruin the plasma tube.

When mounting the plasma tube in

## LASER PARTS LIST

- 1 Plasma Tube, Electro Optics Associates EOA-9040.
- 1 Power transformer, 240V to 1325V at 10mA, 6.3V at 1A. (See text.)
- 1 Cartridge fuseholder, 1A fuse cartridge.
- 1 SPST toggle switch, 240V rating.
- 12 Silicon diodes, type A14P, or similar. (See text.)
- 4 20K 5 watt resistors.
- 1 10M 1 watt resistor.
- 3 .0015uF 5KV ceramic capacitors.
- 1 0.5uF 2KV sealed paper capacitor. (See text.)
- 1 Metal case, 10in x 5in x 2½in, with plasma tube clamps.
- 2 Neoprene "O" rings, 7/8in inside diameter, 1/8in thick.
- 7 Tagstrips (modified—see text).
- Nuts, bolts, connecting wire, mains cord and plug, insulating sleeving, etc.

**NOTE: The EOA-9040 plasma tube may be obtained from Laser Electronics Pty. Ltd., of P.O. Box 359, Southport, Queensland, 4215.**

one side of the base, fixed securely but without strain on the glass envelope, by means of neoprene "O" rings clamped lightly between two metal clamps. The neoprene rings are of a standard type measuring 7-8in inside diameter and 1-8in thick. The base and lid of the case are provided with ventilation slots which align above and below the axis of the plasma tube when the case is assembled, to ensure adequate convection cooling. The power supply components are mounted inside the case beside the tube.

A circular aperture approximately 1½in in diameter is provided in the end of the case adjacent to the "output" end of the plasma tube, to provide adequate clearance both for the output beam and for manual cleaning of the external surface of the plasma tube mirror. From the photographs it may be seen that the prototype unit is also fitted with an accessory mounting ring on the exterior of the aperture; however this is not really necessary except for serious research work.

The mains toggle switch and cartridge fuseholder are mounted on the "rear" end of the case, with the mains cord entry nearby. The mains cord is passed into the case through the usual rubber grommet, and is clamped securely upon entry to prevent strain on the terminations.

Immediately to the front of the switch and fuseholder is the power transformer, and in front of this again are four tagstrips mounting most of the minor power supply components. The large 0.5uF paper capacitor is mounted via the clamps supplied to the front

cambric sleeving, and spaced at least ¼in from the chassis and from other components.

In order to assist constructors in wiring the unit we have provided a complete wiring diagram, and this used in conjunction with the circuit diagram and photographs should render the task quite straightforward. However there are a few points which should be noted, particularly regarding the handling of the plasma tube.

Particular care should be taken when handling the tube, as it is by far the most costly single item in the project. Take care also never to touch the surface of the tube output mirror with the bare hands, or in fact with anything other than a "cotton bud" used for cleaning. The remainder of the tube envelope may be handled, with care, although in the interests of safety such handling should be kept to a minimum.

Probably the most wise procedure when assembling and wiring the unit is to assemble all the power supply components in the case, and complete virtually all the wiring, before the plasma tube is mounted in position. This will protect the tube from most of the likely sources of danger arising during these operations.

Under no circumstances should the connections to the tube itself be made by soldering directly to the tube pins, as the resultant heating of the pins would almost certainly fracture the glass and ruin the tube. Instead the leads should be soldered separately to the small spring disc connectors

## NEW EQUIPMENT CABINETS

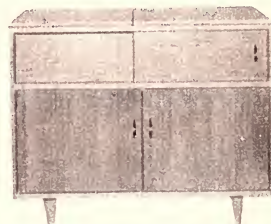

**MODEL 154**

With lift-up lid over player. Sliding door in front of amplifier compartment. Large storage space with four separators. Size 36in wide, 17½in deep, 31in high.

|                                           |         |
|-------------------------------------------|---------|
| Made and Polished (maple, walnut or teak) | Price   |
| Packing                                   | \$63.50 |
| Kit of Parts (maple)                      | \$2.20  |
| Teak extras (Kits only)                   | \$36.00 |
| Packing                                   | \$6.50  |
|                                           | \$1.40  |

New Player Platform model 175 is 16in x 14in x 3½in. Price \$7.50 for maple or walnut. Kit of parts \$4.00. Teak, 50c extra. Perspex cover, 3½in or 5½in high, \$8.20 and \$1.50 extra if required hinged. Please specify cut out required.



**MODEL 186**

New Player Cabinet model 186 is 9½in high, 16in wide, 16½in deep and 5½in above shelf. Finished with attractive hinged, tinted perspex top. Price: \$22.00 for maple or walnut or teak.

Kit of Parts \$13.50  
Teak: \$1.00 extra (kits only)  
Height of this model can be increased to take various amplifiers. Tailored cut out. Ask for quotation.

Free on rail.  
Packing charge \$1 per order.

Write for Catalogue and Player Guide

## H. B. RADIO SALES

Manufacturers of Quality Radio and Radio Furniture for 37 Years

103-105 CATHERINE STREET,  
LEICHHARDT, SYDNEY.  
TELEPHONE 56-5580.



# Telite



## The Light Fantastic

TELITE NEON INDICATORS ARE TRULY A "FANTASTIC" LIGHT

- NO FILAMENT TO BURN OUT!
- UNAFFECTED BY VIBRATION!
- NOR BY POWER SURGES!
- NOR BY FREQUENT SWITCHING!

TELITE NEON INDICATORS are available in voltages from 60V. A/C to 415V. A/C and in a variety of attractively styled mouldings in materials to suit your purpose — for example, Nylon, for high temperature operation — or indelibly impressed with letters or figures in permanent colours. Your new project is worthy of these advantages — ask for technical literature.

**IRH**  
**COMPONENTS**  
**PTY. LIMITED**

A Subsidiary of International Resistance Holdings Limited

THE CRESCENT,  
KINGSGROVE,  
N.S.W. 2208.  
TEL. 50 0111

### INTERSTATE AGENTS & REPRESENTATIVES

|                                                           |                                                      |                                                       |
|-----------------------------------------------------------|------------------------------------------------------|-------------------------------------------------------|
| MELBOURNE<br>I R H Components Pty. Ltd.<br>Phone 489-1088 | LAUNCESTON<br>W.P. Martin Pty. Ltd.,<br>Phone 22-844 | PERTH<br>Simon Holman & Co.<br>Phone 8-2271           |
| BRISBANE<br>K.H. Dore & Sons<br>Phone 2-1391              | HOBART<br>W.P. Martin Pty. Ltd.,<br>Phone 34-2811    | ADELAIDE<br>Collett & Cant Pty. Ltd.<br>Phone 23-1971 |



position take care that there is adequate clearance between the first 20K current limiting resistor and the pins of the electrically unused "getter" in the plasma tube cathode chamber. Unless there is at least 3/8in between these points arc-over may occur before the tube ignites properly, and both the tube and power supply components could be damaged as a result.

The manufacturers of the plasma tube recommend that, prior to the initial application of anode voltage to the tube, it is wise to make completely sure that the cathode heater is correctly and reliably connected to the appropriate 6.3. volts. Because simple disconnection of the tube anode lead could result in damage to the rectifier diodes and reservoir capacitor due to inadequate loading, the suggested procedure for this check is to omit connection of the "hot" end of the 1325V transformer secondary to the rectifier components. (Temporarily insulate the transformer lead with sleeving to prevent shorts.)

If everything is in order, switch-on will then simply result in the heating-up of the tube heater. If desired the voltage actually present across the heater pins may be measured with a suitable AC voltmeter, to ensure that the contact between the disc connectors and the tube pins is of low resistance. Then, having made sure that the tube heater is being correctly energised, the power may be turned off and the final connection made between the transformer and the rectifier circuit.

Once this connection is made, the tube should begin "lasing" whenever power is applied. No further adjustments will normally be required, as a result of the sealed and pre-aligned mirror system used in the EOA-9040 tube. If desired the tube current may be measured using a suitably insulated milliamp meter inserted in series with the anode lead, and should be no more than 7 milliamps. However, if the circuit is wired as shown and all component values are unchanged, this measurement should be unnecessary.

There are a wide variety of experiments which may be performed with the unit once it is operational, and for a full description of these the reader must be referred to one or more of the standard texts. However a few examples will be given, both for the interest of those reading this article mainly out of curiosity, and also to whet the appetite of those intending to build the project.

Because of its coherence, the output beam of the laser may be used to demonstrate quite dramatically the effects of optical diffraction and interference. Thus a narrow vertical slit placed in the beam will cause it to diverge horizontally due to diffraction, and will result in a characteristic "dashed line" interference pattern on a screen placed in the path of the beam. The pattern illustrated was produced using a slit formed by two safety-razor blades clamped in a small holder fashioned from scrap aluminium.

Another quite impressive interference pattern is produced if the beam is passed through a small pinhole. Here diffraction causes the beam to be spherically divergent upon exit from the hole, causing a pattern of concentric interference fringes to be pro-

duced on the screen. The pattern illustrated was produced using a small hole formed by passing a common dressmaking pin through a piece of blackened photographic film.

The third pattern illustrated is slightly more complex than the other two. It was formed by passing the beam through a very fine optical screen, of the type used in half-tone printing, and thus represents the effect of passing the beam in effect through a whole array of regularly spaced pinholes. A similar effect might be produced by a hand-made screen produced by scratching a series of closely spaced fine lines in a grid pattern on a sheet of blackened photographic negative.

A novel experiment may be performed by using a small lens to diffuse the output beam of the laser and project a suitably sized spot of light upon a screen or white card. If one allows the eyes to relax, it will be found that the spot of light appears to be composed of a large number of "grains." The interesting thing about the "grains" is that they appear to move if one moves about, and in a direction which depends upon the basic focal characteristics of the eye.

Hence if one is basically short- or near-sighted, the "grains" will appear to move in the opposite direction to any head movement. Yet those with normal or far-sighted eyes will find that the "grains" will appear to move in the same direction as the head. The experiment thus gives a simple test for the condition of one's eyes, although the results will fairly obviously be of little diagnostic value.

There are many more experiments which may be performed with the laser unit, but those briefly described above may serve to illustrate its potential applications. Perhaps it would be worthwhile stressing that, in seeking to discover the fascinating behaviour of the device, the experimenter should always remember the possible injury which could result from direct entry of the full laser beam into the eye. In general, the rule should be "never look a laser in the eye," and the rule relaxed only with caution when the beam from the device has been well diffused.

A final note. The external surface of the output mirror of the plasma tube may from time to time collect sufficient dust to reduce the available output intensity. When this occurs, the surface may be cleaned carefully using a "cotton bud" dampened with medicinal quality acetone. Use a different part of the bud surface for each wipe of the mirror, to prevent scratching, and take care not to use an excessive amount of acetone because the mirror mounting cement is very slightly soluble and may be weakened.

#### FOR FURTHER READING:

- BROWN, R., *Lasers*, 1968. Aldus Books Ltd., London.
- LAISK, E., "Holography—3D Break-through," in *Electronics Australia*, V.28, No. 5, August, 1966.
- PATEK, K., *Lasers*, 1967. Iliffe Books Ltd., London.
- WALTERS, C., "Laser—Light Generator Extraordinary," in *Electronics Australia*, V.27, Nos. 1 and 2, April-May, 1965.

# PLAN YOUR FUTURE

CHOOSE a career in the field of ELECTRONICS\* — the Nation's most progressive and fastest expanding industry.



Advancement in this modern science demands technical ability, a sound knowledge of basic principles and applications.

YOU can master the subject by training at the MARCONI SCHOOL and be ready to grasp the opportunities that occur in the three fundamental branches of Radio-technology.

# KNOW WHERE YOU'RE GOING

#### A = APPLIED SERVICING

Comprehensive training in the maintenance and repair of radio and television receivers offers substantial rewards to competent technicians. Marconi School training covers all aspects of radio and television receiver circuit applications, practical exercises in fault finding and alignment procedures.

#### B = BROADCASTING

A thorough and practical grounding is available to students in broadcasting transmitter performance standards and maintenance techniques, with individual instruction in station operation and studio control and testing.

#### C = COMMUNICATIONS

Combines all the foregoing, together with radio aids to navigation, mobile telephony, marine service application and international wireless telegraph regulations, qualifying the successful student for the Commonwealth Government Certificate of Proficiency and the Marconi School Diploma in Radiotechnology.

Classes are conducted at 21 Pier Street, Sydney (at the foot of Goulburn Street).

Daily: 9.30 a.m. to 4.30 p.m.

Evenings: 6 p.m. to 8.30 p.m.

or by Home-Study Courses (except practical instruction on equipment).

# STUDY NOW

Send for training syllabus. There is no obligation.

NAME.....  
ADDRESS.....

the MARCONI SCHOOL of wireless

G.P.O. Box 2516, Sydney

A Service of Amalgamated Wireless (Australasia) Ltd



# A SOLID STATE GUITAR AMPLIFIER

## PART TWO

This is the second and concluding article describing the construction of a high power transistorised guitar amplifier. It completes the constructional details for the amplifier, describes a suitable amplifier cabinet, and discusses a number of possible loudspeaker enclosure systems.

By Anthony Leo

In the July issue we presented a 50 watt solid state guitar amplifier, the Playmaster 125. In that article we described the amplifier's circuitry and operation but, due to the space required, we were able to give only sufficient constructional detail to complete the power supply and power amplifier wiring. However, constructors were told how to check for correct operation of the power amplifier.

A diagram of the printed wiring component layout has been included in this article together with a diagram

ponents on the wiring board are in the correct position. An error in a wiring board assembly can be particularly difficult to trace.

After wiring the smaller components, the potentiometers should be fitted with short (approximately 3in) lengths of hook-up wire. But, first cut the shafts as short as is necessary to allow the knobs to fit flush against the front panel. We used Elma collet knobs (supplied by Associated Controls Pty. Ltd.) which are recessed to allow them to fit over potentiometer nuts.

The input jack sockets should also be wired before the wiring board mounting bracket is fitted to the front panel. It is advisable to use twin core shielded wire for the input connections simply as a precaution against stray pickup.

The two rocker switches (supplied by IRH Components Pty. Ltd.), one as a power switch and the other for the "bright" switch, can also be fitted to the front panel. When wiring the power switch it would be wise to fit some sleeving over the three lugs on the switch to prevent accidental contact with the mains when the amplifier is in operation on the bench.

The front panel can now be fitted as a completed assembly to the chassis and the various wiring and interconnections completed. A twin core shielded lead should be used to connect pre-amplifier outputs to power amplifier input. Also, a piece of single core shielded cable is used to connect the tremolo intensity potentiometer to the remote foot-switch jack socket.

After connecting the preamplifier board to power supply the completed amplifier can be switched on and the preamplifier voltages checked against those on the circuit diagram. Having established correct operation of preamplifier controls the amplifier is ready for use.

Note that there were two minor errors in the circuit diagram published last month. A two-amp fuse should be shown and the speaker load should be from eight to sixteen ohms.

A remote tremolo foot switch is pictured and consists of a robust "button" switch mounted in a small plastic box. The actual switch may be either of two types, a push-on and push-off type or a push-on type with a self-returning spring action. The switch is connected to the amplifier by a length of single-core shielded cable and a standard jack plug.

Our switch container was made from a small plastic box measuring  $4\frac{3}{4} \times 2\text{-}5/8 \times 1\text{-}5/8$ in. The rear edges were tapered to obtain the wedge shape and two holes drilled, one on top toward the "high" end to mount the switch and the other through the "high" end itself, through which the cable passes.

A rubber grommet should be placed in the hole to protect the cable which should be, in turn, securely anchored to prevent mechanical strain on the soldered switch connections. A large knot in the cable should prevent it being torn away.

If a more robust foot switch is required, an auto headlamp dip switch could be mounted in a metal box

*In terms of frontal dimensions, this design suggested by MSP engineers is about as small as it can be to house four 12-inch loudspeakers. It is intended to tilt back, supported by a rear, swing leg, to secure better projection off-stage of middle and high frequencies and to expose a vent port on the underside. For practical guitar use, the enclosure would need to be fitted with protective corners and carrying handles.*

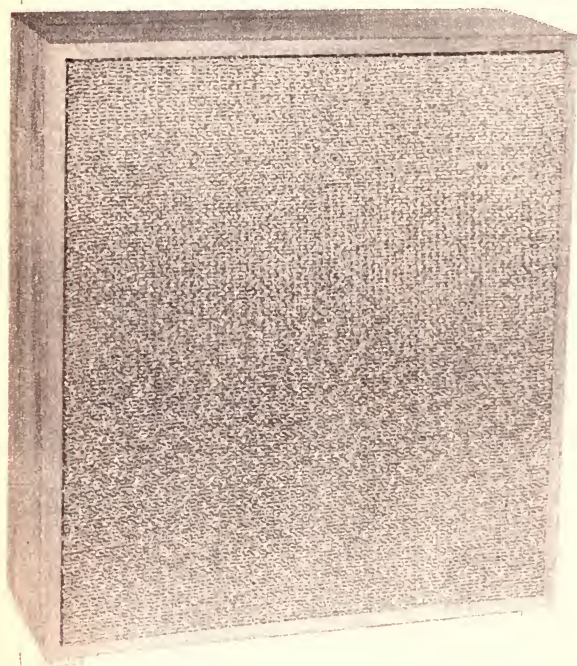

of the copper pattern on the board. These will assist in the construction of the control board.

Normal procedures for printed wiring board assembly apply, with particular care being necessary when wiring transistors. Be careful not to heat transistors excessively and if necessary use a pair of long nose pliers to hold their leads separately as each one is soldered — this will remove excess heat.

Other passive components—resistors, capacitors, etc., are not as critical to heating, but care should still be taken when soldering these components. Also, the leads of resistors and capacitors should not be bent acutely near the component.

Take particular care that the com-

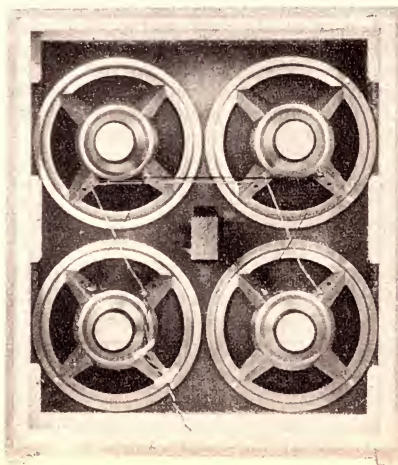



folded from heavy gauge sheet aluminum. A suitable alternative arrangement might be a wedge shaped wooden block suitably hollowed out to accommodate the "dip" switch.

With the amplifier completed and tested it can be installed in a suitable cabinet. We expect that kit suppliers will make available suitable cabinets the design of which is a matter for the manufacturers, largely according to their production requirements and facilities. However, for those who may wish to fabricate their own cabinet we have included details and dimensions of the one we made for the prototype amplifier.

It was made from 3/8in flake board and covered with black vinyl-covered fabric. In essence, the cabinet consists of five pieces of board cut to the appropriate size and shape, which are tacked and glued together. Extensive use is made of cleats to provide the necessary strength.

The included diagram gives all details of cabinet dimensions and the use of cleating. Note that the dimensions given on the diagram are for the inside of the cabinet, allowing adequate clearance for the chassis and front panel.

That part of the cabinet-front which fits around the front panel may require a bit of fiddling because of the angles involved. However, with a plane and some patience quite a neat finish is possible.

Care and patience are also necessary when applying the vinyl covering, particularly over corners and in the frontal area. The type of glue you use will

determine, largely, the ease with which the vinyl can be applied.

Both water soluble woodworking glue and contact adhesive are suitable solely as sticking agents. However, we found that the woodworking glue was best for covering large areas because it allowed air bubbles to be removed from under the vinyl, since it does not hold the vinyl until dry. For the small strips around the cabinet front we found that contact adhesive was useful, as it held the vinyl over corners and in difficult positions immediately on contact.

The cabinet was finished with four rubber feet and a plastic carrying handle. The handle, which sits flush with the cabinet-top when not in use, should be positioned such that the cabinet balances when carried.

After presenting a high power guitar amplifier the question of suitable loudspeakers and enclosures is a natural and consequent one. Although by no means complete we will, in the following paragraphs, attempt to provide satisfactory answers to the problems encountered in the selection of suitable loudspeakers and enclosures. Much of the material now presented is repeated from an article published in the September, 1967, issue.

The requirements of a guitar loudspeaker system are unique and differ in many ways from those of a high fidelity amplifier or organ loudspeaker system.

In a high-fidelity application considerable emphasis is placed upon a satisfying, although not necessarily smooth, bass and an extended treble response

with minimal harmonic and intermodulation distortion. In general, speakers of reasonable size meet these requirements and perform well in such systems because they are only moderately stressed.

Loudspeaker systems for organs have to satisfy a quite different set of requirements. Invariably they must have a bass response which is not just "satisfying" but is actually smooth, particularly over the range of pedal notes. It is most disturbing to an organist and audience alike if certain notes in the pedal octave (s) stand out prominently above others.

As far as treble response is concerned, the requirements for an organ loudspeaker are relatively modest. In fact, a loudspeaker which rolls off smoothly beyond 6- or 7KHz may be preferred for its "rounder," "more organ-like" tone and its reduced sensitivity to unwanted hiss and key-clicks.

The power handling capacity required of an organ loudspeaker system varies with the situation but organ amplifiers typically deliver from about 20 to 60 watts (continuous power). Remembering that organ installations are more usually permanent rather than portable, the tendency is to use large and/or multiple loudspeakers, generously baffled to obtain the requisite bass characteristics, and not too heavily stressed.

A basic reason for using organ loudspeakers well within their power handling capacity is to ensure a minimum of intermodulation distortion. This can become very evident in the sustained and complex chords which are pos-

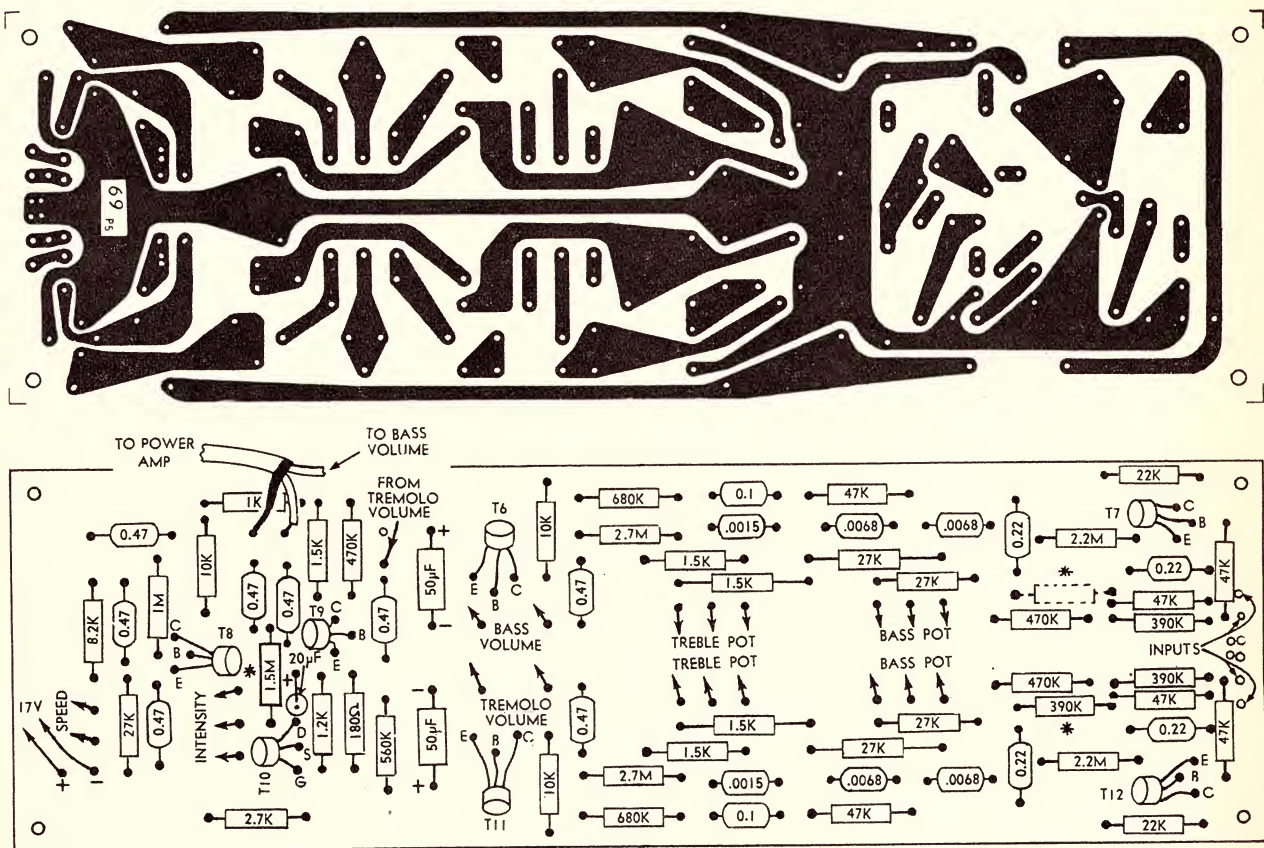

The copper pattern (top) and the component layout for it. Hold the copper pattern board up, orientated as shown, then transpose it left to right. It will now match the component layout diagram and the components may be mounted as shown.



# CONVOY TECHNOCENTRE TOPICS

## Buy wisely . . . .

At the Convoy Technocentre you may purchase any type of system, but you will have available at no extra cost the plus value of systems which have been selected by our professional experts. They match dollars against frequency response and long term resale value—your real cost. This is FREE INSURANCE that you will obtain "sound satisfaction" from Convoy

## Peerless

of Denmark

### NEW 3-WAY SYSTEMS HERE.

New High Flux-Gap Speakers. Danish Peerless is the Heart of good Sound. Let your head go on Speakers. Even the modest system

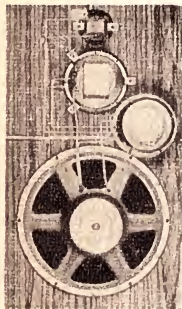

comes over big with a Peerless Danish 3-way System. You cannot afford to miss it — from only \$61.00 for a kit of 12" Base, 5" Mid-range, and a famous Peerless aluminium voice-coil former HFC225 Tweeter, together with the Peerless factory-sealed crossover unit. Full instructions are supplied for cabinets and hookup or we supply in enclosures to your exact requirements. Also 10" 3-way systems.

Compare Peerless with other famous makes of speakers in our Technocentre auditorium — your ear is the final judge.

### RICHARD ALLEN 15 INCH MODULAR SYSTEM FOR CONNOISSEURS.

This is a sound experience at Convoy that is worth a visit. These famous English speakers represent extraordinary quality for value — Hear them at Convoy. Also, Wharfedale, Goodmans, Poly-Planar (flat speakers) and many others.

### NOW A SWISS QUALITY AMPLIFIER FROM REVOX

2 x 70 watts music power (2 x 40W. RMS) 20 Hz-20,000 KHZ ± 1p.c. Power Band Width 10 Hz-40KHz. Base and treble controls 40db steps ± 12db. Full range of inputs including Mike and Tape Monitor, Loudness and filters, Superb quality electronics in teak cabinet.

Also, Kenwood Pioneer, Quad, Sangui and many others working.

### FULL RANGE OF TAPE DECKS, TURNTABLES, ALL LEADING MAKES. CARTRIDGES, ARMS ETC.

### REVOX LOSES WEIGHT BUT GAINS QUALITY

Famous Revox 77A Tape Deck or Recorder is setting new levels of quality with a new standard in price values too. The Revox G36 was regarded as a top standard in recorders. Now, the all-new solid-state 77A sheds 11lbs of weight, but due to the revolutionary electronic capstan speed-control system, performance figures are up in the Studio class (thousand dollars plus, machines). Here is a comparison:

|                                 | New 77A             | Revox G36                                          |
|---------------------------------|---------------------|----------------------------------------------------|
| Wow and Flutter—Max.            | .08%                | .1%                                                |
| Tape Slip less than             | .2%                 | .3%                                                |
| Harmonic Distortion (Full Mod.) | .2%                 | .3%                                                |
| Frequency Response via Tape     | 30 c/s—20 Kc/s      | 40 c/s—18 Kc/s                                     |
| Output Weight                   | 8 watts RMS<br>34lb | 3.3/4 lbs<br>40 c/s—12 Kd/s<br>6 watts RMS<br>45lb |

The most surprising new feature is our special low price.

## ★ STOCKTAKING SPECIALS ★

### MANY OUTSTANDING BARGAINS

Including 15 watt amplifier, 12" two-way speakers in special Teak Enclosures, floor type cabinet. Dual Player, with perspex lid. Normal \$500. Special \$320.

LET THE TECHNOCENTRE SERVICE TAKE CARE OF YOUR REPAIRS AND MAINTENANCE FOR HI-FI EQUIPMENT.

WE ARE SPECIALISTS.

# Convoy

FOR SOUND SATISFACTION

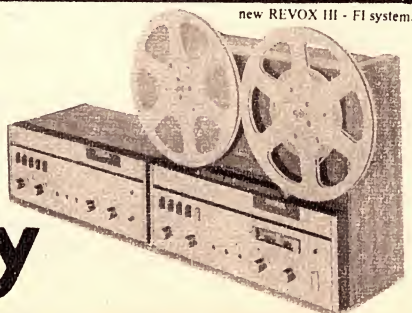

sible on a modern electronic instrument and to audiences which, for the most part, are quiet and attentive.

Loudspeaker systems for electric guitars have to satisfy yet another set of requirements, the two most pressing ones probably being (1) Ability to produce a very high level of sound and (2) To be no more cumbersome than strictly necessary. In general, this means that the baffle systems for guitar loudspeakers are very much a compromise and that loudspeakers themselves are heavily stressed, with the result that bass response, distortion level and loudspeaker life expectancy fall somewhat short of what is expected in either high fidelity, or organ service.

In recent years, guitarists' ideas of what constitutes a practical loudspeaker system have undergone considerable change and some of the systems in current use involve enclosures of one type or another, which are more easily carried by two men than one!

A proportion of these are open-backed or fitted with variously vented or slotted backs which actually impose very little air loading on the cones at low frequencies. Their users like them because the open back allows sound from the rear of the cone to bounce around the stage area, broadening the apparent source. They are successful only if the loudspeaker's "unloaded cone" rating is high enough to cope with the power involved and/or if the player keeps away from damagingly heavy bass chords. For the most part, guitar manufacturers are wary about selling such enclosures because of the potential abuse of the loudspeakers.

They much prefer to standardise on completely sealed or, at most, cautiously vented designs which do load the rear of the cones with a cushion of

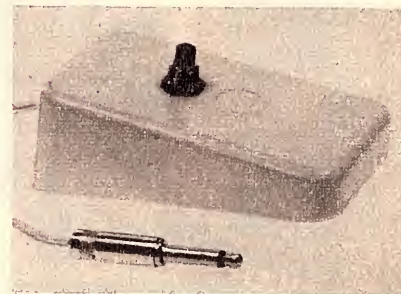

A simple footswitch constructed from a plastic box. Heavier duty types could be constructed from metal.

air. The problem is that, for all their size, such enclosures are usually quite limited in internal volume, relative to the total area of the cone(s) involved.

From the viewpoint of the loudspeaker manufacturer, this practical limitation in enclosure volume is something of a bonus, in that it leads fairly naturally to the use of fully sealed boxes, with a sufficiently small volume of air trapped behind the cone(s) to cushion them against the excesses of over-enthusiastic guitarists.

Most loudspeakers used by guitarists in conjunction with higher-powered amplifiers are of the heavy-duty 12-inch type, with fairly substantial cone, surround, and supporting spider and a

TECHNOCENTRE 449 KENT ST., SYDNEY. 296475



natural low-frequency resonance in the vicinity of 50Hz. When placed in a sealed enclosure with dimensions as typically recommended, the resonance rises to the region of 80Hz. Above this figure, the response is relatively flat; below it, the response falls at an effective rate of between 6 and 12dB per octave. These figures are strongly reminiscent of sealed "bookshelf" type enclosures but with the difference that many such guitar loudspeaker systems employ a minimum of internal damping. One consideration is that the amount of damping material required would be quite substantial but, more

the general thinking runs a close parallel to "bookshelf" techniques where output at the lowest frequencies is deliberately augmented by the use of bass boost. Naturally, this technique increases the stress on the loudspeakers and bass guitarists often have to "go easy" or put up with reduced loudspeaker life or discover, the hard way, those makes and models which will stand up to the punishment better than others.

Not surprisingly, this situation has focused considerable attention on the use of larger loudspeakers for bass service—15in and upwards—or loud-

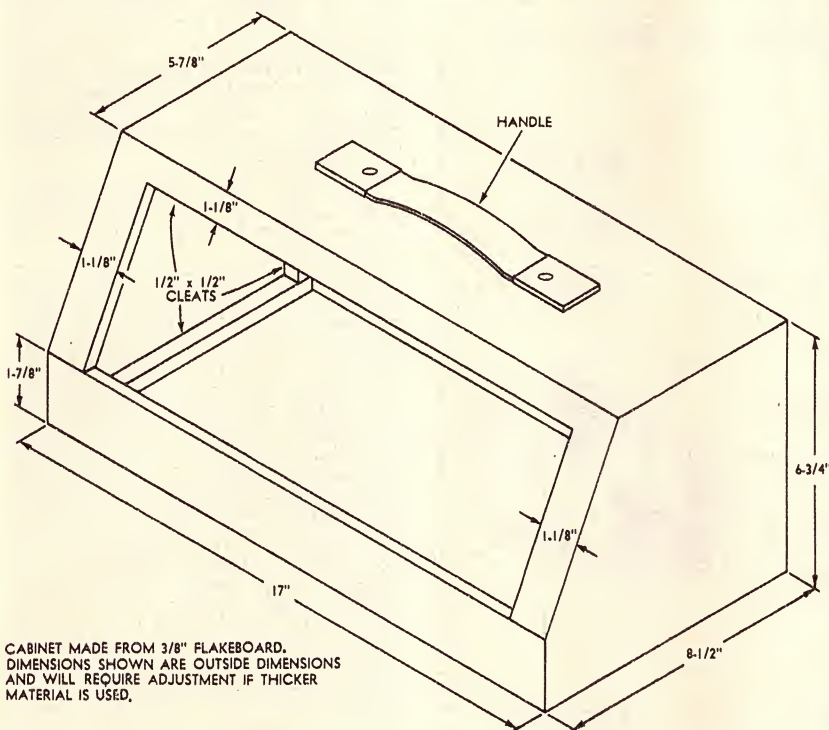

CABINET MADE FROM 3/8" FLAKEBOARD. DIMENSIONS SHOWN ARE OUTSIDE DIMENSIONS AND WILL REQUIRE ADJUSTMENT IF THICKER MATERIAL IS USED.

A diagram of the prototype cabinet is shown above, complete with carrying handle. Note that the dimensions shown are outside and the thickness of the flakeboard is 3/8in. Finish is vinyl covering.

to the point, guitarists do not appear to be averse to a somewhat less damped bass characteristic and to colouration from "bounce" at other frequencies being audible through the paper cone.

In fact, for lead and rhythm guitars, in particular, this kind of bass curve is quite practical. The lowest open string on the instrument produces a frequency of about 70Hz, which is not all that far from the nominal bass roll-off point. Furthermore, unlike an organist, a guitar player can control the amplitude of each individual note by the way he plucks the relevant string. In fact, he may even relish a bit of boom over the lower frets!

Bass guitars pose an additional problem in that they have an extra octave extending to about 35Hz and involve proportionately greater cone excursion for a suitably high level of sound. However, for practical reasons, bass guitarists often have to be satisfied with the same general class of loudspeaker system as other players and with developing high acoustic output by heavily driving loudspeakers in sealed enclosures at frequencies below the natural system resonance. Here again,

speakers with moulded plastic cones, very large and/or vented enclosures and so on. Such techniques can pay dividends in terms of louder and more trouble-free bass but they may also involve much higher initial expense and enclosures which are even less conveniently transportable than the more usual variety.

It would be a monumental task to list and test all the loudspeakers which might conceivably be considered for guitar service and to relate their likely performance and limitations in the kind of enclosures which are typically in use. Instead, we have chosen to make particular mention of four typical loudspeaker systems, with the idea that these can serve as a guide to the form which such systems can take.

The Rola Company has just announced the development of a 12-inch high power loudspeaker, the 12U50, specifically for the rigorous conditions found in guitar applications. According to the manufacturers the speaker will handle 50 watts over the range 35Hz to 6.5KHz.

With the Playmaster 125 amplifier one 8-ohm 12U50 can be used for an

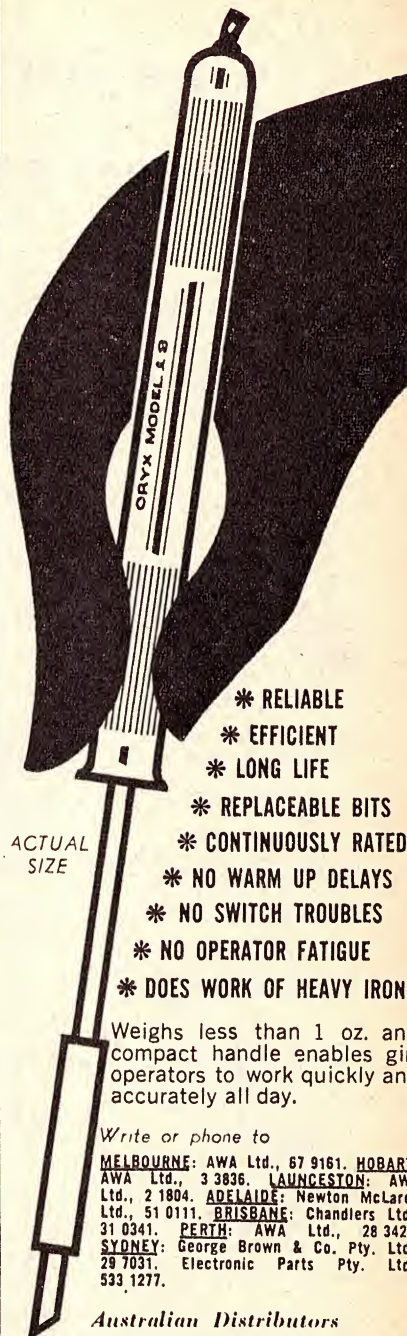

ACTUAL SIZE

- \* RELIABLE
- \* EFFICIENT
- \* LONG LIFE
- \* REPLACEABLE BITS
- \* CONTINUOUSLY RATED
- \* NO WARM UP DELAYS
- \* NO SWITCH TROUBLES
- \* NO OPERATOR FATIGUE
- \* DOES WORK OF HEAVY IRONS

Weighs less than 1 oz. and compact handle enables girl operators to work quickly and accurately all day.

Write or phone to

MELBOURNE: AWA Ltd., 67 9161. HOBART: AWA Ltd., 3 3836. LAUNCESTON: AWA Ltd., 2 1804. ADELAIDE: Newton McLaren Ltd., 51 0111. BRISBANE: Chandlers Ltd., 31 0341. PERTH: AWA Ltd., 28 3425. SYDNEY: George Brown & Co. Pty. Ltd., 29 7031. Electronic Parts Pty. Ltd., 533 1277.

Australian Distributors  
MANUFACTURERS SPECIAL  
PRODUCTS PTY. LTD.

47 York Street, Sydney. 2 0233, Ext. 284

# WANTED

BY ALL  
PRODUCTION ENGINEERS  
**ORYX**  
miniature  
soldering instruments



# Why are SHURE cartridges the largest sellers?

Highest performance, best quality, largest range at a price to suit you.

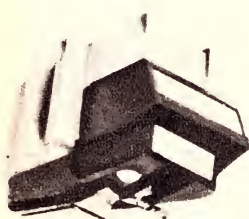

- VI5 Type 11 . . . . . \$87.50 \*
- M75E Type 2 . . . . . \$45.00 \*
- M75EJ Type 2 . . . . . \$38.00 \*

- M75G Type 2 . . . . . \$35.00 \*
- M55E . . . . . \$32.50 \*
- M75-6 Type 2 . . . . . \$29.50 \*
- M44E . . . . . \$28.50 \*

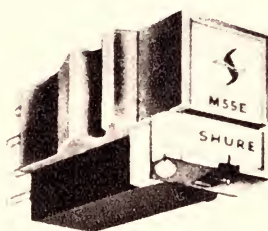

- M31E-EP . . . . . \$25.00 \*
- M32E-EP . . . . . \$25.00 \*

- M 44-5 . . . . . \$20.00 \*
- M 44-G . . . . . \$19.50 \*
- M 44-7 . . . . . \$19.50 \*
- M 44-C . . . . . \$18.00 \*



Contact your local representative for detailed literature on SHURE quality products.

N.S.W.: Audio Engineers Pty. Ltd., 342 Kent Street, Sydney.

W.A.: Athol M. Hill Pty. Ltd., 613-15 Wellington St., Perth.

QLD.: Ron Jones Pty. Ltd., 7-9 Merton Rd., Woolloongabba, Brisbane.

VIC.: Audio Engineers (Vic.), 2A Hill Street, Thornbury.  
Phone 44-3295.

\* Recommended Resale Price.

output of 50 watts. However, the speaker is also available in a 15-ohm version.

For application in a 50-watt speaker system for both lead and bass guitars, the Rola company recommends one 12U50 in a totally sealed enclosure of dimensions 16 x 16 x 10 inches, with the suggestion that the box be internally damped with Insulwool, carpet underfelt or other similar material. Presumably this would include commercial damping materials such as Innerbond and Tontine 75.

On Rola recommendations the system can be scaled up to handle 100 watts of continuous power by using two 12U50s in an enclosure of dimensions 30 x 20 x 10 inches. Again the requirements of a totally sealed box with internal damping apply. An information leaflet on enclosure recommendations is available direct from Rola on request.

As with all multiple speaker systems, care must be taken to see that the speakers operate in phase with one another.

For their AD-5200 series loudspeaker, the Philips organisation suggests that it should be used in a completely sealed and airtight enclosure on the basis of not more than 40 litres of enclosure volume per 12-inch speaker (i.e. 2,440 cubic inches or 1.4 cubic feet). They further recommend that airspace in the enclosure be substantially occupied with a light filling (Innerbond, Tontine 75, etc.). Provided the box is rigidly constructed and absolutely airtight, they will rate the AD-5200 series loudspeaker to operate at 25 watts, which is substantially above the power rating under other conditions of baffling.

Figure 1 shows the photograph of a single - loudspeaker enclosure constructed to these basic requirements. External dimensions are 20 x 16 x 8 inches and, allowing for half-inch

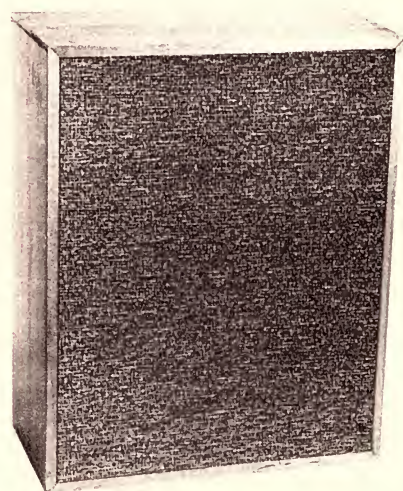

Figure 1: Sealed and filled in the manner of a "bookshelf" unit, this enclosure suggested by the Philips Miniwatt laboratory houses a single AD-5200 loudspeaker and is rated to handle up to 25 watts. Enclosure volume must not exceed 1.4 cubic feet for one speaker, 2.8 cubic feet for two, and so on.



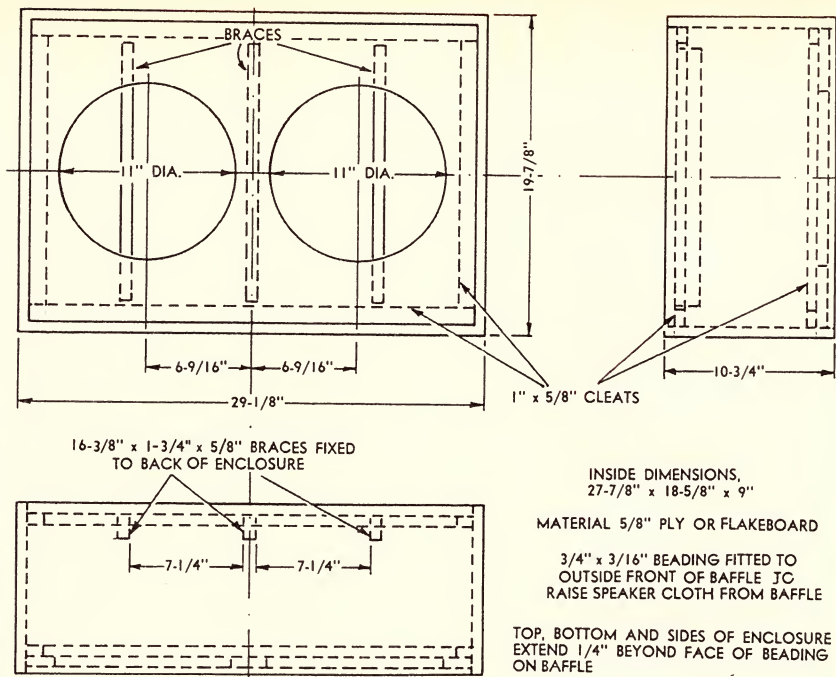
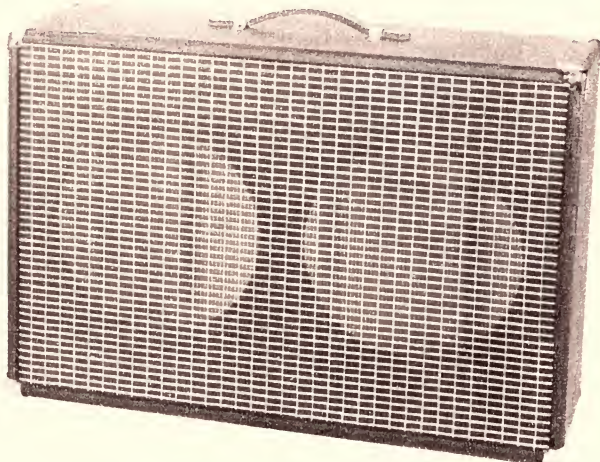

Figure 2: At right is a two-loudspeaker portable enclosure marketed by R. Moody & Co. Pty. Ltd. The carrying handle normally rests against the case top, allowing a "piggy-back" amplifier to sit on top of it, without fouling. For home carpenters, the essential dimensions are shown above in figure 3.



timber, the nominal internal dimensions of 19 x 15 x 7 give an enclosure volume of 1995 cubic inches or 1.15 cubic feet. This is well under the maximum figure just quoted and gives a system resonance of 95Hz, as compared with 45Hz for the speaker in free air. The Miniwatt division of Philips Electrical Industries have tested the speaker under these conditions and consider it to be an entirely practical design for lead and rhythm guitars in particular.

However, as a single loudspeaker unit, it will handle only 25 watts and would need to be scaled up to handle more power. But if 25 watts is sufficient, as it would be in many situations, a single 15 ohm loudspeaker can be used with the Playmaster 125 whereupon its output will be automatically limited to 25 watts.

Note, however, that the amplifier can deliver maximum rated output power into the 7.5 ohm load provided by two AD-5200 loudspeakers operating in parallel in an 80-litre (2.8 cu. ft.) sealed enclosure which should cope with 50 watts. An important point is that larger enclosures will need to be constructed from thicker material (normally 1-inch) to maintain the

requisite rigidity, and the larger panels may need to be internally braced.

It should be stressed that the performance figures quoted in connection with figure 1 are based primarily on the Philips AD-5200 loudspeaker and, while we would expect other comparable heavy-duty loudspeakers to behave in a similar manner, they may or may not have a comparable power rating. This would be up to their manufacturers to say.

Figure 2 is a photograph of a two-loudspeaker system currently being marketed by R. Moody and Co. Pty. Ltd., of 126 Bombay Street, Lidcombe, N.S.W., 2141. It is constructed of flake board 5/8in thick, covered with good-quality plastic cloth and fitted with chrome-plated corners, rubber feet and tilt-back legs. It is available from the manufacturer with or without internal padding and with or without loudspeakers.

Fitted with MSP or Rola loudspeakers, the enclosure is sold as a nominal 40-watt system. With lead or rhythm guitars as recommended, it would be adequate with the Playmaster 125. However, its internal volume of 2.6 cubic feet would qualify it to take two Philips AD-5200 loudspeakers and

**ON TELEX**



from  
**Cunninghams**  
Call . . .  
Melbourne: 31447  
Sydney: 21707  
**FOR SERVICE.**

Bob Cunningham

## Automatic Aerial Rotator

NEW . . . UNRIVALLED AERIAL ROTATING SYSTEM!

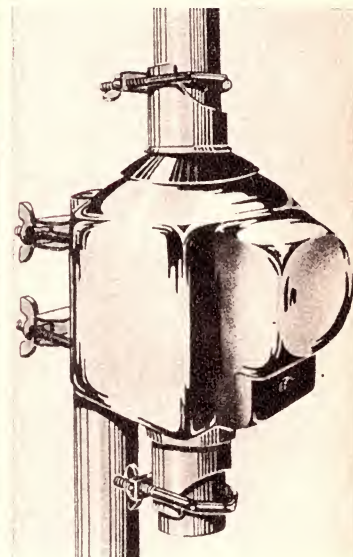

### STOLLE Automatic Aerial Rotor

Complete with direction control unit — fully synchronised balanced bridge circuit.

- Rugged—water tight.
- Hollow shaft, 1½" diam.
- Loading: 112 lbs. (max.)
- Rotation angle: 360 deg.
- Permanently lubricated.
- Speed: 1 r.p.m.
- Magnetic disc brake.
- 240v. AC (60w.) drive 42v.

**R.H. Cunningham**  
PTY. LTD.

VIC.: 608 Collins St., Melbourne.  
N.S.W.: 64 Alfred St., Milsons Pt.  
W.A.: 34 Wolya Way, Baysa.  
QLD.: L. E. Boughen & Co., 95 Central Ave., Sherwood.



# These RCA Triacs will turn you on



## Choose New RCA 8 Amp Triacs for On-Off or Variable Phase Control of Power Into Resistive or Inductive Loads

Now's the time to think in terms of more than electro-mechanical controls and turn on with Triacs! Not just any triac — but the new RCA-40668 and RCA-40669. Both feature the unique RCA hermetic chip in the popular, easy-to-mount RCA "plastic TO-66" package.

Use the RCA-40668 for 120 V per 1-kW capability, the RCA-40669 for 240 V per 2 kW. With either, look what you get:

■ Commutating  $dv/dt$  capability of 10 V per  $\mu s$  (typ.) permits opera-

tion into inductive loads.

■ Critical rate of rise of off-state voltage — 300 V per  $\mu s$  (typ.) for 40668 and 250 V per  $\mu s$  (typ.) for 40669 — minimizes false triggering caused by line transients.

■ 85 A single-cycle in-rush current capability handles start-up surge loads readily.

■ 8 A (RMS) capability at a case temperature of 80°C.

■ 4 modes of gate control allow design flexibility and simplicity with either positive or negative DC logic.

For relay replacement, relay protection, motor speed controls and the like — in switching or phase control applications — for use in such devices as comfort control systems, vending machines, appliances — turn to and turn on with RCA Triacs.

For technical details on these and all RCA Triacs write to Amalgamated Wireless Valve Co. Pty. Ltd., Private Mail Bag, P.O. Ermington 2115 or Interstate Offices and Distributors.



AMALGAMATED WIRELESS VALVE CO PTY LTD



would presumably gain the blessing of the Philips organisation as a 50-watt unit. And, fitted with the new Rola speakers, even higher power ratings can be obtained.

For those who may wish to build their own enclosure along these general lines, figure 3 gives the essential dimensions. Note that it should be constructed from material not less than 5/8in thick and that all joints should be accurately finished, then glued and screwed as necessary. The rear lid must also make a virtually airtight fit and be fastened in place with at least four screws along each of the longer edges and three screws at the ends. The original design provides for the fret cloth to be supported in front of the actual face of the baffle to minimise the risk of it flapping under the influence of large low-frequency cone excursion.

Pictured in figures 4 and 5 is an enclosure developed by Manufacturers Special Products to mount four 12-inch loudspeakers. As shown, it contains four 12UA15 units and is rated to handle 60 watts, more than adequate for lead and rhythm work with the Playmaster 125 amplifier. However, for bass work and heavier duty service, the company suggests a particular version of the MSP type 12PQ (part no. 50226) rated at 20 watts per loudspeaker.

Of particular interest is the fact that the MSP enclosure design provides for a small vent in one surface which

would normally be placed so that it is at the bottom, and exposed by tilting the enclosure backwards. The idea behind this is that tilting the enclosure will get the middle and upper frequencies out over the audience and away from people, furnishings and carpets. Having a vent feeding into a V-slot formed by the bottom of the cabinet and the floor is presumably intended to improve bass efficiency somewhat, as compared with a conventionally vented or a non-vented enclosure of the same general size.

The design provides for an internal volume of about 3.5 cubic feet, which is considerably short of the figures quoted earlier as being adequate for a sealed enclosure. It would therefore appear that MSP engineers have tried to come up with the smallest practical enclosure which would house four 12-inch loudspeakers, resorting to a vent in an effort to offset the very limited internal volume. While the presence of the vent will remove some of the protection from the cones at very low frequencies, they should not be unduly distressed, provided the 60-watt rating is observed. One would expect other comparable loudspeakers to perform in a similar manner to the 12UA15 units and this would include the Philips AD-2000 series; Philips have emphasised that the 25-watt rating per unit, mentioned earlier, applies ONLY with sealed enclosures not exceeding the stated maximum volume. Figure 6 gives the main dimensions

of the MSP enclosure. Note that material not less than 3/4-inch thick should be used, with a centre pillar to stiffen the front and back panels.

For those who may be disturbed by the rather high resonance of these four loudspeaker systems, a possible alternative would be to install three loudspeakers only, eliminating any vent and filling the enclosure with Innerbond or Tontine 75, to further broaden and lower the resonance.

Alternatively, if four loudspeakers must be used, for their higher power-handling capacity, consideration could be given to increasing the internal dimensions to about 5 cubic feet (with 5.6 as a maximum) again without the use of a vent but with internal padding.

For the 50-watt amplifier, four Rola 12PEG loudspeakers could be used in a suitable enclosure, or four 12PX loudspeakers if the player is seeking additional brightness which can be contributed by a tweeter cone. For higher power amplifiers, and particularly for bass work, four 12UEG loudspeakers are recommended, giving a nominal power handling capacity of 80 watts. Again, where brighter sound may be sought, four 12UX speakers could be substituted.

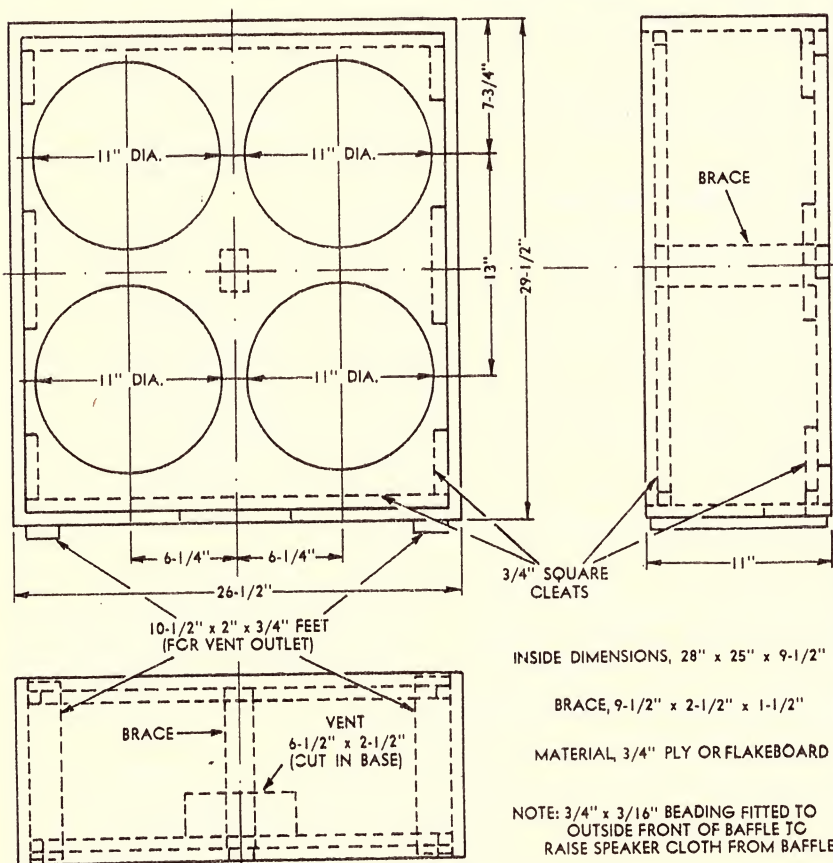

Dimensions of the MSP enclosure, as shown on page 52. The cabinet would be a tight fit for loudspeakers of larger diameter than 12 inches and all dimensions should be regarded as minimum. Our own reaction is that the enclosure performance would be bettered by increasing the internal volume, though this would obviously increase weight and reduce portability.

## RADIO ENTHUSIASTS

Learn amateur radio in your spare time.

Whatever your interests are in amateur radio, there's a Stott Radio course for you. Easy to follow. Practical. Modern. Guidance all the way by top-flight radio engineers.

### Radio for amateurs

Learn the exciting skills of building modern radio receivers. Learn about the latest advances in electronics, design, construction and operation. Let Stott's show you how.

**Amateur Operator's Certificate Course:** Broadcasting is fascinating. Stott's offer an entirely new course that enables you to sit for the Amateur Operator's Certificate of Proficiency Examinations with complete confidence.

Get full details now on Stott's Radio Courses.

POST THIS COUPON TODAY

**Stotts** 

TECHNICAL CORRESPONDENCE COLLEGE

159 Flinders La, Melbourne. 383 George St, Sydney  
290 Adelaide St, Brisbane. 45 Gilles St, Adelaide.  
1130 Hay St, Perth.

Please send me, free and without obligation, full particulars of your courses in Radio for Amateurs.

Mr Mrs Miss .....

Address .....

Age .....

No sales representative will call

EA869



# Electronic Technicians Earn Big Money!

## Why not YOU?

With training through T.T.I., you could qualify for a start in the Electronics Industry as a:

- Radio-television technician • Telecommunications technician • Instrumentation technician • Business machine technician • Automatic control technician • Industrial electronic technician—and many other skilled positions.

### WILL YOU FILL THE BILL WHEN THE TIME COMES?

The "good job" you hold down today may offer less and less opportunity for advancement as Electronics increase their impact on all branches of industry.

**TECHNICAL TRAINING INTERNATIONAL**, a world-wide company with 30 years' experience in the field of specialised technical training, offers the latest Electronics training programmes available in Australia.

**GAIN FULL PRACTICAL EXPERIENCE BY BUILDING YOUR OWN LABORATORY AT HOME.** With T.T.I. training you build over 100 circuit-proving projects. In addition, you actually construct the professional test equipment illustrated here.

IF YOU ARE BETWEEN 18 AND 45 YEARS, AND EARNING LESS THAN \$80 PER WEEK . . . IF YOU ARE SERIOUSLY INTERESTED IN TRAINING FOR A CAREER IN ELECTRONICS, FILL IN THIS COUPON FOR FURTHER INFORMATION, WITHOUT OBLIGATION.



To: Technical Training International Pty. Ltd.  
P.O. Box 328 Chatswood, N.S.W. 2067.

Please tell me more about T.T.I. Electronics Training, without obligation to me.

Name \_\_\_\_\_

Address \_\_\_\_\_

Age \_\_\_\_\_ Present occupation \_\_\_\_\_

T.T.I.—The industry-approved Technical Training Organisation EA/K

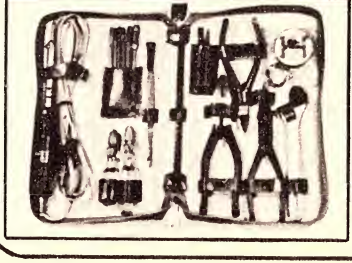
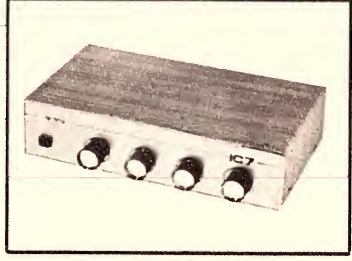
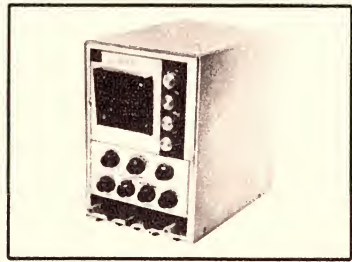
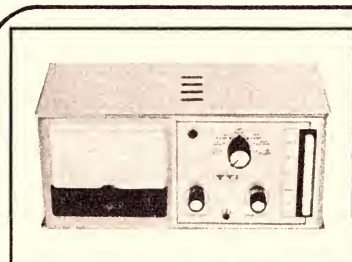



**TECHNIPAC**

**IS COMING!**



# MULTIDRAWER

**A TRANSPARENT MULTI-COMPARTMENT DRAWER  
AND OUTER CASE MADE OF STRONG CLEAR PLASTIC**

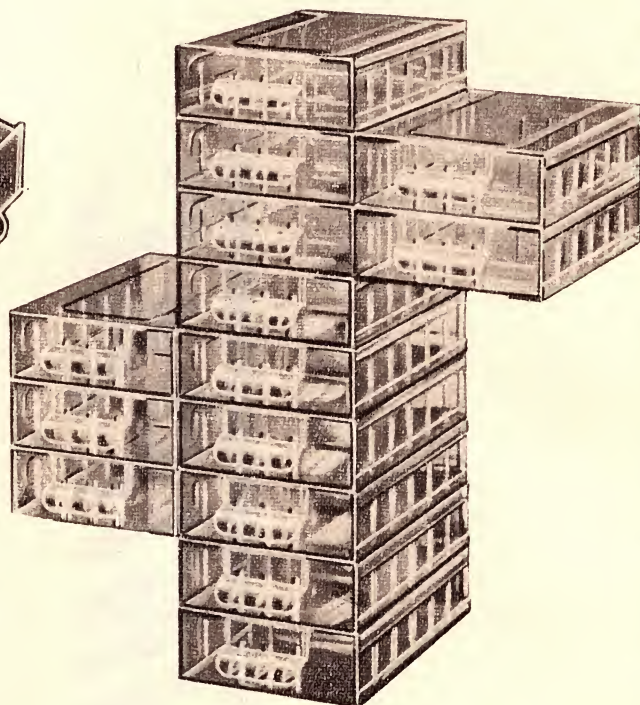
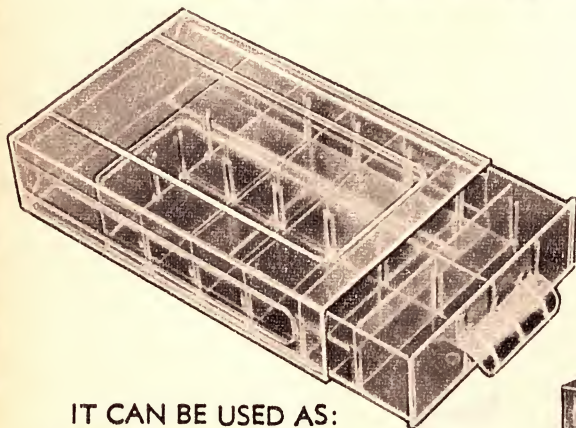

IT CAN BE USED AS:

- a self contained STORAGE BOX UNIT
- or a MULTIDRAWER CABINET by joining the individual units IMMEDIATE ASSEMBLY by sliding action  
**NO GLUE — NO TOOLS NECESSARY!**

Each drawer can be partitioned into 12 varieties of compartment arrangements by removable dividers.

The Multidrawer consists of a drawer sliding into an outer case. Both parts are made of strong clear plastic to ensure immediate visual location of stored articles (opaque outer case also available). The outer case has built-in integral dovetails and grooves for vertical and horizontal assembly by means of sliding the corresponding sides. This assembly is achieved instantaneously without using any tools or cement.

The drawer has built-in grooved side ribs, which allow its partitioning into 13 possible combinations of compartments by simply dropping into the grooves standard dividers, available in 4 lengths. The longest of the dividers is provided with the same ribs as the drawer in corresponding positions, to firmly hold the smaller dividers.

The dividers can be left as removable for any future rearrangement, or could be cemented in by using TRICHTHLORETHYLENE.

The assembled cabinet will firmly stand on any flat surface and will not require additional reinforcement.

**AT HOME:** as a box for sewing, jewellery, haberdashery, hair accessories, cosmetics, medicaments, fishing accessories, writing utensils, small hardware, cigarettes and cigars, photographs, colour slides and many others,

**AND IN:** SHOPS, OFFICES, WORKSHOPS, LABORATORIES, STORES and FACTORIES.  
for visible storage of small parts and also as production assembly aid.

## THE MULTIDRAWER — THE STORAGE BOX OF 101 USES

**SPECIFICATIONS:** Drawer — transparent. Outer case — opaque (steel grey). Dimensions—Identical for both models are: Outer Case: Length: 9 5/16", width: 6 7/16", Height: 2 3/8". Drawer: Length, 9 3/8", Width: 6", Depth: 2". Protrusions of the handle — 3/4". Weight of the unit — 12 ozs.

Also available from General Accessories Interstate Branches.

Trade Enquiries Invited

Write to General Accessories for further information and Price List.

# GENERAL ACCESSORIES

(A DIVISION OF ELECTRONICS INDUSTRIES)

116-118 CLARENCE STREET, SYDNEY 443 CONCORD ROAD, RHODES — 73-0211



# A Lamb Type Noise Silencer

Noise! A phenomenon which brings shudders to most users of receivers, particularly for communications purposes. Over the years, various means have been devised to combat this menace to short-wave communication. This article discusses the broad principle of noise silencing and describes a practical unit capable of extremely good results.

by Ian Pogson

The way in which the problem of noise, and its possible reduction, is approached is dictated by a number of considerations. It is difficult to present these considerations in any strict order of priority, as many of them are interdependent. Broadly speaking, the two main technical aspects are the type of noise to be dealt with and the type of modulation of the received signal. Another point which must be considered, in many circumstances, is that of economics.

The noise we are considering is that received by the aerial system, rather than any generated within the receiver or which may find its way into the receiver via the power mains.

The noise which arrives via the aerial can again be divided into three broad types. These are referred to as "man-made," atmospheric, and galactic or cosmic. Man-made noise comes from neon signs, arc welders, switches, domestic appliances, high-tension power-line leakage, car ignition, etc. Atmospheric noise results from lightning discharges, often referred to as "static." Galactic or cosmic noise emanates from outer space.

Carrying our divisions one step further, there are two further groups. These are "hash" or "hiss" in one instance and "impulse" in the other. The hiss more or less describes itself, being random pulses which are continuously overlapping. Impulse noise is entirely different in character, being normally of very short duration and often very high amplitude. As we will see later, the latter type is much easier to deal with than the former.

There are various causes of these two types of noise, but any attempt to list them may not be entirely accurate, since there is sometimes an overlap in characteristics.

Generally, hiss can be traced to commutator motors, atmospheric discharges, galactic noise, etc. Impulse noise originates particularly from auto ignition systems, as well as from switches, neon signs, HT power-line leakage, rain static, etc.

One of the most successful systems for combating received noise was developed by J. J. Lamb, as far back as 1936. For the degree of complexity, even to this day, it is doubtful if there is another system which will equal it, much less one which gives superior results. We would emphasise, however, that the degree of success one attains with this system depends upon the trouble taken with any individual unit.

The principle of the system is shown in the block diagram. Between the mixer and the first IF amplifier and ahead of any highly selective circuits, there is a "gating" circuit. From the output of the mixer are taken the signal and noise, which are passed through a "noise amplifier." Following this amplifier is a detector or rectifier circuit. The noise amplifier and detector circuits are biased by a gain control. The bias is so adjusted that the two circuits combine to separate the signal component from the noise pulses, by reason of the greater amplitude of the latter. Thus, pulses only, caused by the noise, emerge from the detector. This can be seen in more detail in the circuit diagram.

The pulses are then passed through the "pulse amplifier" and from this

blanketed by noise, are now completely readable.

Apart from the effect of noise on readability, noise pulses have the additional effect of actuating the AGC system and desensitising the receiver accordingly. In extreme cases, this can reduce the receiver sensitivity to a point where the signal is inaudible for this reason alone.

The Lamb noise silencer is most effective in the fight against impulse-type noise. Although not so successful in combating other types of noise, it can often be used to at least reduce the nuisance. And, as the silencing occurs early in the IF stages, noise which would otherwise desensitise the receiver through the AGC system is stopped or reduced.

The silencer is located at the begin-

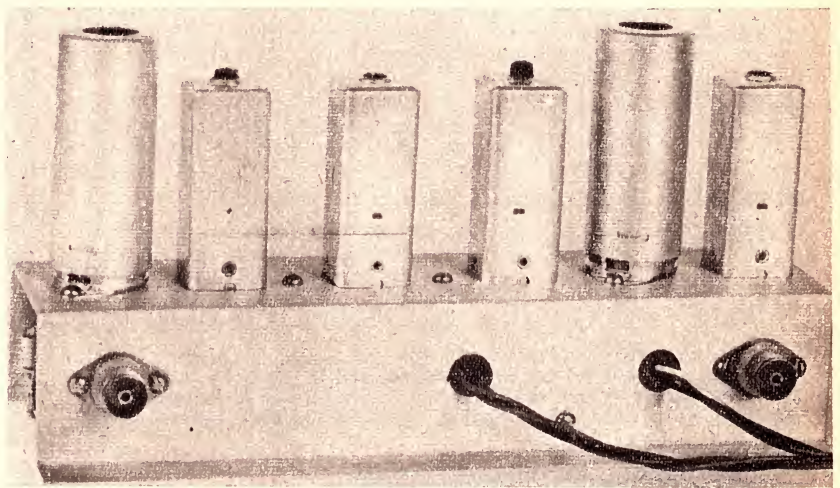

From right to left are T1, V1, T2, T3, T4 and V2. Input and output sockets are at right and left, respectively. The gain control is on a lead running out of the picture.

amplifier are fed into the gating circuit. The pulses are of such polarity as to close the gate for the duration of the pulse.

As the ratio of the duration of a noise pulse, to the time between pulses, is generally quite high, the signal through the gate is cut off for only a very small percentage of the total time. This means that, rather than a series of narrow but high amplitude pulses superimposed on the wanted signal, we have the wanted signal, with short, silent periods corresponding to the time of the pulse. This gives a far more satisfactory result and, quite often, signals which were completely

ring of the IF strip for a very good reason. It is an unfortunate fact that a pulse which originates as a very narrow spike is made considerably wider when it is passed through highly selective circuits, such as an IF amplifier. This is due to both amplifier overload and ringing in the tuned circuits. It causes a pulse which was simply objectionable to become intolerable.

By putting the silencer in this position, we avoid most, but not all, of these ill effects. Indeed, it would be better to put such a system right at the input to the receiver, where no selective circuits are involved, and so



# FED UP!

with the high cost of electronic projects ???

# FED UP!

with poor service and slow deliveries ???

## SO ARE WE!!

That's why we've formed our Electronic Experimenters' Club. We reckon the title—"Electronic Experimenters' Club" is a bit involved, so we've shortened it and called ourselves



### WHAT IS ELTRAN?

Simply an organisation whose aim is to provide a new deal for the electronics hobbyist.

#### HERE'S WHY ELTRAN CAN OFFER YOU A BETTER DEAL—

- ELTRAN** — For the first time in Australia offers a UNIQUE service. We keep you right up to date on the latest projects, current prices and component availability with our monthly "ELTRAN Newsletter."
- ELTRAN** — supplies EVERYTHING for the hobbyist. You save on freight costs by obtaining all your parts from the ONE supplier.
- ELTRAN** — specialises in supplying the hobbyist. We have been in the Electronics game for years and are ready to help in getting your project under way with the minimum of delay and expense.
- ELTRAN** — supplies individual parts or the complete kit.
- ELTRAN** — offers helpful advice to the beginner. Our free booklet—"Getting started in Electronics"—gives you all the information you need to get going in this fascinating hobby.
- ELTRAN** — deals exclusively by mail order thus enabling us to slash overheads to a minimum. YOU reap the benefit of lower prices.

YOU can avail yourself of these services and a whole lot more, simply by becoming a member of ELTRAN. Membership is completely free and places you under no obligation. Fill out the form below and mail direct to:



P.O. BOX 35,  
BALACLAVA, VIC. 3183.

To ELTRAN—P.O. Box 35, BALACLAVA, Vic. 3183.

Please enrol me as a member of ELTRAN, and rush me my free copy(ies) of:

- Guide to Electronics Purchasing.
- Getting started in Electronics.

Check square(s) applicable.

I understand that membership is completely free and places me under no obligation of any kind.

NAME ..... (BLOCK LETTERS)

ADDRESS .....

Postcode.

deal with the pulse in its pristine form. Unfortunately, although this approach is practicable, it makes for a more complicated device. The IF system, having no variable tuned circuits, simplifies the circuitry and is a good compromise position.

Our unit is based on a design by Herbert Hoover, jun., whose article originally appeared in QST for January, 1963. We make no apologies for this approach, as we feel that the design is a very good one, consistent with a minimum of complexity. We have, in fact, made several changes where we considered this to be an advantage, or to adapt the design for components which are available in this country. Most of the changes are centred around the IF transformers, and more will be said about these later on.

At this point, let us look at the circuit diagram. Consider that the plate lead between the primary of the first IF transformer and the mixer valve is cut, and the complete silencer placed in series with this lead. This means that the input to the silencer comes straight from the mixer plate. The output goes directly to the primary of the first IF transformer of the receiver.

At the silencer input, the signal is split. Part is directed via an IF transformer to a cathode follower. (V1a). From the cathode follower, the signal passes to transformer T3; a much modified IF transformer, with very tight coupling and a centre-tapped secondary. Neither winding is tuned.

The output of T3 feeds into a balanced gate, consisting of two normally forward biased germanium diodes. The two diodes look into a balanced load and a further modified IF transformer (T4). This transformer also is tightly coupled and not tuned. In the original version a potentiometer and a trimmer were provided to balance the system. We found this to be unnecessary, possibly because we bifilar wound the secondary of T3. To make up for circuit losses, an amplifier (V2a) follows T4.

Returning to the input, the other split of the signal is fed into a noise amplifier (V1b). This is a departure from the original, in that the feed for the noise amplifier is taken from the primary rather than the secondary of the IF transformer. Our experience suggests that slightly better results are obtained by making this change. In the plate circuit of the noise amplifier is another modified IF transformer, T2. Again, the primary and secondary are tightly coupled. In this case, the primary is tuned but the secondary is not.

Once again we have departed from the original. The original provided full wave rectification by means of a centre-tapped secondary winding. As a tapped winding is not easy to come by, we used a bridge rectifier.

In order to separate the noise pulses from the modulated signal, a potentiometer varies the cathode bias voltage of the noise amplifier. At the same time, this voltage is fed to the rectifier to reverse bias the diodes. With both stages biased to the correct level for the signal being received, only those noise pulses above the signal level are allowed to pass. By virtue of the rectifier, all pulses are made positive-going at the output of the rectifier, regardless of their direction previously.







# LEADER TEST INSTRUMENTS

## SINE-WAVE / SQUARE WAVE AND COMPLEX

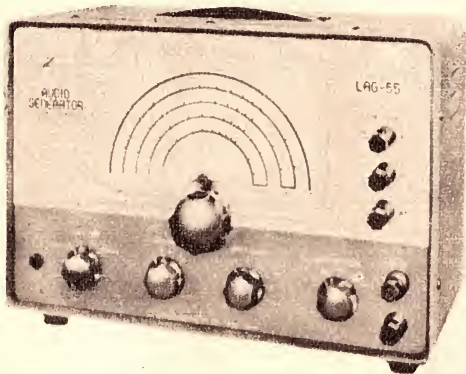

### LAG - 55

Budget priced unit indispensable for any serious audio measurements.

#### Specifications:

|                      |                                                                                                  |
|----------------------|--------------------------------------------------------------------------------------------------|
| Frequency Range      | 20-200,000Hz in four 10 : 1 bands                                                                |
| Calibration Accuracy | Within $\pm 2\% + 2\text{Hz}$                                                                    |
| Sine Wave Output     | 20-200,000Hz; level constant within $\pm 0.5\text{dB}$ below 100kHz; Output 5 V rms below 100kHz |
| Square Wave Output   | 20-20,000Hz; Output 10 Vp-p                                                                      |
| Complex Wave Output  | Above 5,000Hz combined with line frequency                                                       |
|                      | Amplitude ratio 4 : 1 (low to high); Output 10Vp-p                                               |

## AUDIO SIGNAL GENERATOR WITH METERED OUTPUT AND FREQUENCY METER

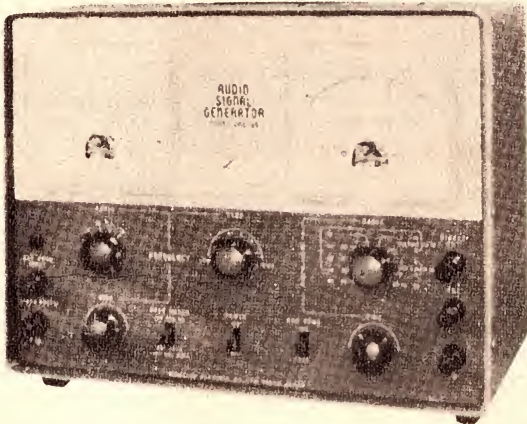

### LAG - 66

Top quality Leader Unit.

#### Specifications:

|                  |                                                                                                                                       |                        |                                                                                                           |
|------------------|---------------------------------------------------------------------------------------------------------------------------------------|------------------------|-----------------------------------------------------------------------------------------------------------|
| <b>Generator</b> |                                                                                                                                       | <b>Frequency Meter</b> |                                                                                                           |
| Frequency Range  | 11 to 110,000Hz<br>in 4 bands<br>600 Ohms: 0-1V<br>in 6 ranges<br>10k Ohms: 0-10V<br>in 2 ranges<br>Less than 0.3%,<br>20 to 20,000Hz | Range                  | 10 to 110,000Hz<br>in 4 ranges<br>200,000 Ohms,<br>approx.<br>$\pm 1.5\%$ , full scale;<br>10 to 11,000Hz |
| Output Voltage   |                                                                                                                                       | Input Impedance        |                                                                                                           |
| Distortion       |                                                                                                                                       | Accuracy               |                                                                                                           |

### FROM ALL GOOD TRADE HOUSES

WHOLESALE ENQUIRIES ONLY TO  
SOLE AUSTRALIAN REPRESENTATIVES:  
ASTRONICS AUSTRALASIA PTY. LTD.,  
ALL STATES.

unsolder the leads to the terminals. As the wire is normally multi-strand Litz, take care not to let one or more of the strands be lost from the tinned end of the lead.

The two windings have to be brought together as closely as is practicable. To do this, we used a hacksaw blade and carefully sawed off the top winding from the rest of the assembly. (If the coil former you are using happens to be of cardboard rather than plastic, we suggest using a sharp knife or razor blade rather than the hacksaw.) Make the cut about 1/32in from the winding but, in no circumstances, should the teeth be allowed to touch the winding. Make a cut right around the former, without necessarily cutting through it. Having done this, try breaking the former at the cut. If necessary, deepen the cut.

This operation leaves a piece of former protruding beyond the primary (lower) winding. Cut this piece off in the same way as before. Try not to damage it and do not throw it away. The rough edges adjacent to the two windings should be carefully cleaned up with a file.

The slug in the primary (lower) winding is now wound forward so that it protrudes beyond the primary winding by about half its length. This allows the secondary winding to be screwed on and brought close to the primary. The space left between the windings will be between 1/32 and 1/16 inch. When screwing the windings together, do not tighten them, as the slug will have to be shifted later on.

As we need only half the turns on the secondary winding, remove 145 turns. The finish of the winding will normally be fixed by a blob of wax. Salvage as much as possible and put aside for later use. Wind off the turns and re-seal with the wax, heated with a soldering iron. The excess wire is cut off and the end tinned. The insulation can be cleaned off with a sharp knife, again taking care not to cut or otherwise lose one of the tiny strands. The two ends of the winding are then re-terminated.

To make a permanent job of the junction between the windings run some cellulose glue between the windings and over the former. Try to prevent the glue from entering the junction and reaching the slug as far as possible, although our experience suggests that it does not adhere to the slug particularly well.

Since we have removed a portion of the former it will now be too short to fit in the can correctly. We can restore the length by using the small piece cut from between the windings. Unscrew the slug from inside the secondary (upper) winding so that it protrudes from above the former, leaving only about 3/32in still engaged in the former. Screw the small piece of former over the slug leaving about 1/16in gap between the two pieces of former. This gap must be adjusted so that original overall length of the former is restored. Run some glue over the joint to secure it. Since the slug performs no magnetic function, it will not have to be moved.

T4 is a modified type 178 (or similar) transformer. Remove the centre



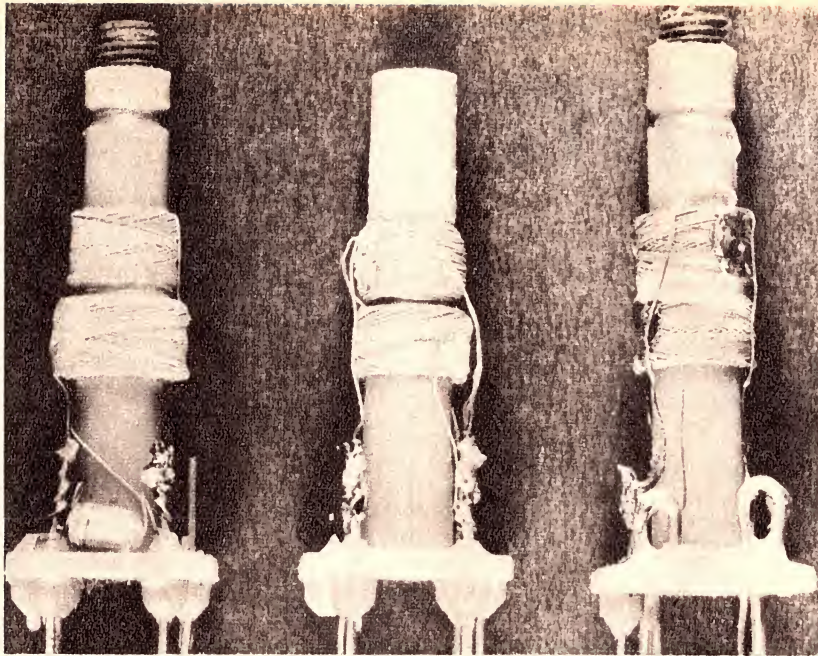

This picture shows the modified IF transformers. From left to right are, T2, T3 and T4. See text for further details.

section of the former between the windings, as for T2. Screw the two parts together again, as for T2, but fairly tightly, as the slug is fixed and used as a coupling device between the windings. Add the piece of former from between the windings to the end of the former, in the same way as for T2. Glue both joints together as before.

T3 is also a modified type 178 transformer. The former does not have to be cut but we need a centre-tapped coil for a secondary, closely coupled to the existing primary winding. Remove the 330pF capacitor from across each winding. These will not be needed again. Scrape the fixing wax from the finish of the secondary (top) winding and carefully remove all the wire. There will be about 180 turns, tapped at 34 turns. Break the wire at the tap and keep the longer piece.

The salvaged wire will become the new secondary winding. This is bifilar

wound. Find the centre of the wire and fold it back on itself. The new winding is wound by hand, making it about the same width as the primary winding and spaced about 1/32in from primary winding. Wind the wire as evenly as possible and seal the finish with wax. There should be about 150 (2 x 75) turns on the new secondary.

This winding, has four ends, two starts and two finishes. Carefully clean and tin all four ends. To establish a centre tap we must connect together the start of one winding and the finish of the other. Check a start and a finish with an ohm meter and connect together any two which do not give a reading. The remaining start and finish become the outer ends of the secondary.

Remove the slug from the top of the former and screw up the other slug so that it is centred about the primary and secondary. This slug is used as a coupling device, similar to that in T4.

The three modified transformers are shown in the photograph as T2, T3 and T4 in that order. The top slugs in T2 and T4 can be clearly seen and will normally be left in this protruding position. The modified windings are fitted into their cans and are ready for use.

The complete noise silencer is built on a "U" shaped channel chassis. It measures 8in x 2in x 1½in, with mounting flanges protruding both sides by ½in. We used aluminium mainly because of its ease of working but plated steel could be used. This chassis shape was chosen as being the most likely one to fit into some convenient spot in the cabinet of the existing receiver.

As shown in the photograph, the lineup proceeds from right to left, with T1, V1, T2, T3, T4 and V2, in that order. This allows about as logical a layout as is possible with this shape of chassis. The input at the right and the output at the left are via coaxial sockets. We did this simply for convenience; there is no reason why the coaxial cable should not be brought out through grommets holes. The other leads coming from the two grommets holes, are for the 6.3 volt heater supply, 240 volts DC, and the 5K switching and control potentiometer.

Mounting the IF transformers, which are provided with only two small solder lugs, can present a problem with an aluminium chassis. With steel, the lugs are simply soldered to the chassis. We filed two slots, one each side of the square hole, passed the lugs through the slots, and bent them over. We ran two pieces of 16-gauge, tinned, copper wire along the row of IF transformers, soldering them to each lug. This results in a firm support.

The general layout can be seen from the underneath picture. There is not a lot of space, but it is sufficient. Tag strips and solder lugs have been used liberally and, where necessary, lead lengths have been kept to a minimum. There are a couple of exceptions to the short lead concept. The one from pin 8 of V1a, to T3 is quite long, but is of low impedance and presents no problems. The lead from the diode in the plate circuit of V2b, to T3, is also fairly long. Again, this presents no problems.

Make sure that earth leads are as short as possible, particularly around V1. Solder lugs should be fitted under socket-holding screws and the centre shield of the sockets connected to chassis. The sockets should be orientated as indicated on the underchassis photograph.

We used two 2-tag strips, one under each screw of the input coaxial socket, and a 5-tag strip on the side of the chassis, between T2 and T3 and nearer the latter. The same thing is done between T3 and T4. Finally, there is a 5-tag strip under one screw of the output coaxial socket.

We used ceramics for the .01uF capacitors, the 0.1uF units are polyester and the rest are polystyrene, or Styroseal. In the case of the 0.1uF polyester capacitors, due regard is given to voltage ratings, where this is significant.

Having built the silencer, testing and alignment will complete the project. When satisfied that there are no short

## PARTS LIST

|                                               |        |           |
|-----------------------------------------------|--------|-----------|
| 1 Chassis, 8in x 2in x 1½in                   | 1 3.3K | 2 3.9K    |
| 2 9-pin valve sockets with shields            | 1 4.7K | 2 22K     |
| 2 6BL8 valves                                 | 1 33K  | 1 47K     |
| 8 OA91 diodes                                 | 4 100K | 1 100K 1W |
| 2 455KHz IF transformers, type 119 or similar | 1 150K | 1 470K    |
| 2 455KHz IF transformers, type 178 or similar | 1 1M   | 1 8.2M    |
| 1 5K linear potentiometer with switch         |        |           |
| 2 Coaxial sockets                             |        |           |
| 2 Coaxial plugs                               |        |           |
| 2 2-tag strips                                |        |           |
| 4 5-tag strips                                |        |           |

### CAPACITORS

|                                                                     |  |
|---------------------------------------------------------------------|--|
| 2 100pF 600V Styroseal                                              |  |
| 1 390pF 600V Styroseal                                              |  |
| 1 470pF 600V Styroseal                                              |  |
| 1 .001uF 150V plastic                                               |  |
| 1 .01uF 100V plastic                                                |  |
| 8 .01uF 400V ceramic                                                |  |
| 3 0.1uF 100V plastic                                                |  |
| 1 0.1uF 400V plastic                                                |  |
| 1 100uF 10VW electrolytic                                           |  |
| Coaxial cable, hookup wire, solder lugs, solder, screws, nuts, etc. |  |

### RESISTORS

|                                  |            |
|----------------------------------|------------|
| (½ watt unless stated otherwise) |            |
| 1 47ohms                         | 1 220 ohms |
| 1 470 ohms                       | 4 2.2K     |



# "HIGH FIDELITY?"

## LET'S FACE IT!

When you really think about it, the reason most people buy high fidelity equipment is to obtain first class reproduction of music. We at Arrow believe that you don't have to master audio jargon and technicalities before you can enjoy its fruits in your own home.

Our aim is to help you achieve and maintain the most satisfying and rewarding reproduction of fine music. We want to help you choose a system that gives you **musical satisfaction**. Shown in the illustration below is one of our most popular combinations of record player, cartridge and amplifier, one of the many available.



SHURE MAGNETIC  
CARTRIDGE



DUAL 1019  
PLAYER



KENWOOD TK250  
AMPLIFIER

This combination, used with any of the quality speakers listed below will reproduce music to a high degree of fidelity. However, each speaker has its own characteristic sound and the final choice is yours.

|                           |                         |
|---------------------------|-------------------------|
| LEAK SANDWICH Mk II       | WHARFEDALE SUPER LINTON |
| WHARFEDALE DOVEDALE III   | WHARFEDALE SUPER 10     |
| WHARFEDALE MELTON         | CRITERION 100A          |
| WHARFEDALE SUPER 12 RS/DD | CRITERION 200A          |

We can only make suggestions. You make the decisions when it comes to the final choosing of equipment that suits your ear and your pocket.

**Let Arrow help you to really enjoy the sounds of music.**

circuits on the high-voltage line and that there are no wiring errors or omissions, the unit may be connected into the receiver.

Normally, it should be possible to get a 6.3 volt heater supply, with one side earthed, directly from the receiver. Also, suitable well filtered DC should be readily available. Due consideration should be given to the extra load which will be placed on the receiver power supply; about 20mA HT current and 900mA heater current for the two valves.

Cut the mixer plate lead, run the plate to the silencer input, and the IF transformer to the silencer output. These leads should be low capacitance coaxial cable and kept to minimum length. Our leads are 10in long and this did not introduce any more capacitance than could be accommodated by slug adjustment in the respective IF transformers.

Having connected the silencer into the receiver, the power can be switched on and voltages checked to see that all is well in this respect. Even without any alignment, signals should be heard through the receiver, more or less as normally.

The first steps in alignment are carried out with the silencer switched off at the control potentiometer. Feed a steady signal into the receiver, preferably from a signal generator or other suitable source. Adjust the primary slug in the receiver IF transformer which previously connected to the mixer. Then adjust the two slugs in T1 on the silencer.

If the signal source is modulated with a continuous tone, connect a high sensitivity AC voltmeter, or a VTVM, from test point "A," to chassis. Set the meter to one of the lower ranges and adjust the silencer control, together

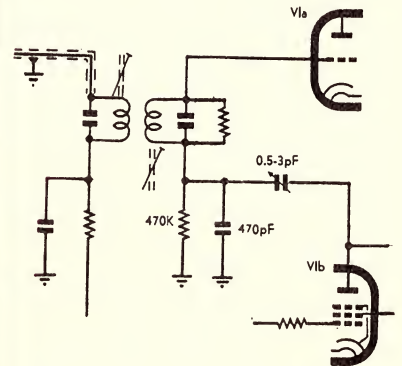

*If instability should be experienced this neutralising circuit should help control it.*

with the generator input to the receiver, so that a suitable reading is obtained on the meter. Adjust the slug in the primary of T2 for maximum response. If the signal source is not modulated, connect the meter, set to the 10 volt DC range, across the .001uF capacitor at the junction of two diodes and the 100K resistor. The meter will read a DC voltage, corresponding to the reverse bias from the control potentiometer and this will vary with the setting of the control. Adjust the slug in the primary of T2 as before.

If a CRO is available it can be

# AE

**ARROW ELECTRONICS**

**NOW AT**

**342 Kent St. SYDNEY 29-6731**

**Opposite 2UW between KING & MARKET Sts.**



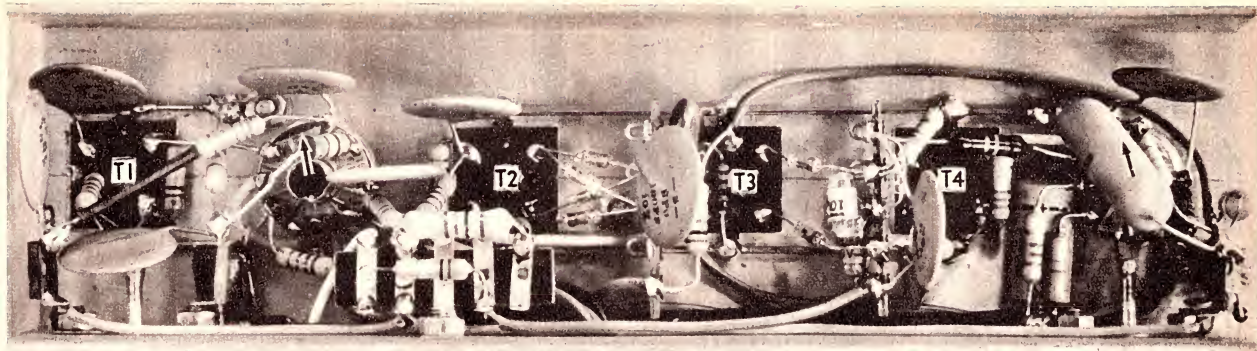

*This underchassis picture shows the general layout and placement of the major components. Note the orientation of the valve sockets.*

used with advantage in place of the meter. It can also be used to check the gating pulses at test point "B." With the signal generator disconnected and the aerial connected, the silencer gain control turned up, and assuming that noise pulses of sufficient amplitude are present, corresponding gating pulses will appear at point "B." These will vary in width, according to the original pulse, and the amplitude could reach 90V peak.

This completes the adjustments, except for the possible need to reduce any IF gain provided by the silencer. Should an increase in gain be noted and it is desired to reduce it a convenient method is to reduce the value of the 2.2K $\Omega$  resistor shunting the secondary of T4.

Should there be trouble with the noise amplifier, V1b, breaking into oscillation, it may be necessary to neutralise it. A suggested circuit is given on these pages. However, before going this far, try to stabilise the stage by changing earthing, by-passing, etc.

With the silencer set up as described, it should be possible to tune in a signal and, with noise present, advance the silencer control until the noise is considerably reduced or virtually vanishes, depending mainly on the nature of the noise. A little practice will be necessary to get the best results. Best results will not necessarily be obtained with the control fully advanced. In point of fact, with AM signals, advancing the control too far will clip the tops of the modulation peaks and may result in distortion. Maximum silencing is available before this occurs.

Our experience shows that in the presence of relatively weak noise, such that it is largely over-ridden by the signal, it is better to switch off the silencer. Otherwise noise pulses are fed to the gate and holes punched in the signal. These may be more noticeable than the noise.

To give some idea as to what may be expected of this silencer, we have made some measurements and observations, which may be of interest. To make these checks, we have used a Pulse Generator, which was described in December, 1967. Although this is intended mainly for audio use, it has strong harmonics well into the high frequency range, at least to 10MHz. These were fed into the aerial terminal, along with the wanted signal from an aerial or signal generator. The other instrument was a double beam CRO. On one beam, we set up the pulses at test point "B," and on the other beam the audio output.

With this setup, it is possible to control the ratio of signal to interfering noise. In addition, the repetition rate of the noise pulses can be varied over a wide range. It should be noted, however, that although the pulse width is variable on the generator, it is automatically differentiated at the input to the receiver and so only narrow pulses are available.

Here are some tests which we carried out. Signal frequency, 7MHz

in all cases. First test on AM, with a 20uV signal modulated 100 per cent. Without noise, this signal produced a good clean audio pattern on the CRO. The amount of noise then introduced completely obliterated to signal, both in the speaker and on the CRO. The AGC was actuated to such a point that the "S" meter was reading well up scale; the main reason why the signal disappeared. When the silencer was

(Continued on page 189)

## Be Paid What You are REALLY WORTH!



Develop your aptitudes at your own pace, for recognition that brings HIGHER PAY. Begin YOUR Progress Today! Select the course you want and which will benefit you most. ICS will send YOU promptly—a FREE illustrated BOOK, giving FULL DETAILS.

### GENERAL

Journalism—Short Stories  
Writing for Radio & TV  
Interior Decorating  
Etiquette & Entertaining  
Textiles  
Photography  
Mathematics  
General Education  
Dressmaking

### DRAUGHTSMANSHIP

Architectural  
Builders' Plan Drawing  
Mechanical Structural  
Surveying & Mapping

### ILLUSTRATING

Still Life—Landscape  
Caricature & Cartoons  
Oil & Water Colour.  
Fashion Drawing  
Showcards & Tickets  
Signwriting

### COMMERCIAL

Accountancy  
Cost Accountancy  
General Bookkeeping  
Salesmanship  
Shorthand Typing

Retail Management  
Commercial Management  
Small Business Owners  
Hotel-Motel Management  
Club Administration  
Window Dressing  
Business Letters

### BUILDING

Architecture  
Building Contracting  
Carpentry, Joinery  
Structural Engineering  
Concrete Engineering  
Estimate & Quantities  
Roofing, Steel Square  
Timber Home Building

### INDUSTRIAL

All Mechanical Eng.  
Fitting & Turning  
Soft Drink Manufacture  
Air Conditioning  
Gas or Elect. Welding  
Chemistry, Plastics  
Electronics  
Electrical Mechanics  
Radio Eng. or Service  
Television  
Refrigeration  
Diesel Engines

Auto Mechanics  
Civil Engineer  
Production Management  
Industrial Management  
Executive Training  
Modern Supervision

### SPECIAL EXAMINATION

### COACHING COURSES

Account'cy: All Exams  
Institute of Secretaries  
Inst. Cost Accountants  
Inst. Sales & Marketing  
Metric. or Lev. Cert.  
Intermediate Certificate  
Senior or Junior Public  
C'wealth Clerical Exams  
Police Entrance Exam  
Nurses' Entrance Exam  
Steam Certificate  
Refrigeration Certificate  
Radio Examinations  
Inst. Auto. Mech. Engrs.  
Inst. Diesel Engineers  
Shire Overseers' Exam  
Engineers' Institutions.

### ADVERTISING

Copywriting  
Commercial Art  
Advertis'g Inst. Aust.

## TO INTERNATIONAL CORRESPONDENCE Dept. 526 SCHOOLS.

**SYDNEY:** 400 Pacific H'way, Crow's Nest. Tele.: 43-2121.

**MELBOURNE:** 234 Collins Street. Tele.: 63-7327.

**BRISBANE:** Heindorff House, 171 Queen St., Brisbane. Tele.: 2-6125.

**ADELAIDE:** T. & G. Building, King William St. Tele.: W-4148.

**PERTH:** C'wealth Bank Building, 55 William St. Tele.: 21-7268.

**NEW ZEALAND:** Wellington, 182 Wakefield St. Tele.: 53-109.

Please send Free Book on .....

NAME (Mr, Mrs, Miss) ..... AGE .....

ADDRESS .....

.....STATE .....Dept. 526

OCCUPATION .....PHONE .....

EA 8 69



# TEST WITH THE BEST

New from Sanwa  
**A-303TR<sub>D</sub>**—a medium-size  
 circuit tester with a 44-micro-  
 ampere meter movement.

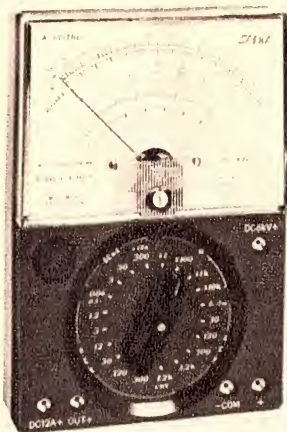

- Zener effect via silicon diode automatically safeguards the moving coil from burn-out. Also functions against pulse voltage in television circuit checking.
- Solid-state diode rectifier obtains stability measurement extending frequency coverage up to 100kHz for lower ranges.
- High voltage probe is available extra to align television circuits.
- As a Sanwa TR Series multimeter, the specific LI and LV scales provided serve to check characteristics of semiconductors by reading current and voltage applied simultaneously with resistance.
- For better insulation and ruggedness, the front panel and rear case are moulded from plastics.

#### Measurement Ranges

DC voltage : 0.3V 1.2V 3V 12V 30V 120V 300V 1.2kV 6kV (20kΩ/V) 25kV (with probe)  
 AC voltage : 6V 30V 120V 300V 1.2kV (8kΩ/V)  
 DC current : 60μA 3mA 30mA 300mA 12A (300mV)  
 Resistance : Range · ×1 ×100 ×1K ×10K  
 Midscale · 25Ω 2.5kΩ 25kΩ 250kΩ  
 Maximum · 5kΩ 500kΩ 5MΩ 50MΩ  
 Load current (LI) : 60mA 500μA 60μA  
 Load voltage (LV) : 1.5V 1.5V 1.5V  
 Volume level : -10~+17~+63dB  
**Accuracy.** Within ±2.5% for DC range up to 1.2kV.  
 Within ±4% for DC 6kV range.  
 Within ±3% for AC ranges.  
 Within ±2.5% for ohm ranges.  
**Batteries.** 1.5V×1 and 22.5V×1  
**Size.** 170×116×59mm

## 430-ES Multitester



- Meter movement of 10 microamperes, doubly protected by silicon diode circuit and spring-backed jewel bearings.
- Common terminals for DC and AC current measurements. Two AC current ranges read on single scale because of equalized characteristics.
- Solid-state germanium diode rectifier.
- Flat frequency response up to 100kHz.

#### Measurement Range.

DC voltage : 0.3V 3V 12V 30V 120V 300V (100kΩ/V)  
 1.2kV 6kV 30kV (with probe) · (16.6kΩ/V)  
 DC current : 12μA 0.3mA 3mA 30mA 300mA 1.2A 12A (300mV)  
 AC voltage : 3V 12V 30V 120V 300V 1.2kV · 5kΩ/V  
 AC current : 1.2A 12A  
 Resistance : Range · X1 X10 X100 X10K  
 Midscale · 40Ω 400Ω 4kΩ 400kΩ  
 Maximum · 5kΩ 50kΩ 500kΩ 50MΩ  
 Volume level : -17~+63dB  
**Accuracy.** Within ±2% (10% for 6kV and above) fsd for DC voltage.  
 Within ±2% fsd for DC current.  
 Within ±3% fsd for AC voltage.  
 Within ±2% of scale length for resistance.  
**Frequency coverage.**  
 50Hz-100kHz for AC 30V and below (±3%)  
 10kHz for other AC voltage ranges.  
**Batteries.** Four 1.5V (UM-3) and one 1.5V (UM-2) dry cells.  
**Size & weight.** 179×133×85mm & 1400 gr

## SH-63TR<sub>D</sub> Multitester



- Protected by silicon diode circuit.
- Stabilized AC voltage reading by solid-state rectifier and frequency coverage extended up to 100kHz.
- Current loss minimized by high input impedance (20k ohms/volt for DC and 8k ohms/volt for AC).
- Standard HV probe of sealed-in 480-megohm resistor

#### Measurement ranges.

DC voltage : 0.25V 1V 2.5V 10V 50V 250V 1000V (20kΩ/V)  
 AC voltage : 1.5V 10V 50V 250V 1000V (8kΩ/V)  
 DC current : 1.5V 10V 50V 250V 1000V (8kΩ/V)  
 DC current : 50μA 2.5mA 25mA 250mA (250mV)  
 Resistance : Range · X1 X10 X100 X1000 X10000  
 Midscale · 25Ω 2.5kΩ 25kΩ 250kΩ  
 Maximum · 3kΩ 300kΩ 3MΩ 30MΩ  
 Minimum · 0.5Ω 50Ω 500Ω 5kΩ  
 Load voltage : 1.5V 1.5V 1.5V ·  
 Load current : 60mA 600μA 60μA ·  
 Volume level : -15~+5dB for AC 1.5V range  
 0~+22dB for AC 10 volt range and up to +62dB  
**Accuracy.** ±3% fsd for DC voltage & current  
 ±4% fsd for AC voltage (±6% for 1.5V range)  
 ±3% of scale length for resistance  
**Batteries.** One each 1.5V (UM-3) and 22.5V (BL-015) dry cells.  
**Size & weight.** 160×103×64 mm & 730 gr approx.

## U-50<sub>D</sub> Multitester



- Meter movement of 35 microamperes safeguarded by a protection circuit.
- Reading error eliminated by battery sheaths.
- Shunt adapter separately available.

#### Measurement Ranges:

DC voltage : 0.1V 0.5V 5V 50V 250V 1000V (20kΩ/V)  
 AC voltage : 2.5V 10V 50V 250V 1000V (8kΩ/V)  
 DC current : 50μA 0.5mA 5mA 50mA 250mA  
 Resistance : Range · X1 X10 X100 X1K  
 Midscale · 50Ω 500Ω 5kΩ 50kΩ  
 Maximum · 5kΩ 50kΩ 500kΩ 5MΩ  
 Volume level : -20~+62dB  
**Accuracy.** ±3% for DC and ohm ranges  
 ±4% for AC ranges  
**Batteries.** Two 1.5V dry cells (UM-3 or equivalent)  
**Size & weight.** 131×89×41mm & 445 gr  
**Accessories available.**  
 Shunt adapter High voltage probe  
 Clip adapter Carrying case

For full details contact the Exclusive Sanwa Specialists...



**WARBURTON FRANKI**



**SANWA ELECTRIC  
 INSTRUMENT CO., LTD.**

Dempa Bldg., 2-chome, Sotokanda, Chiyoda-ku, Tokyo, Japan. Cable: "SANWAMETER TOKYO"



# A POWER SUPPLY FOR SOLID-STATE RECEIVERS

This little power supply is capable of supplying a 3-watt class B audio amplifier from a 17.5-volt line, RF and IF amplifiers from a 12-volt regulated line and 9 volts regulated for all oscillators, for a full-size communications or short wave receiver.

By Ian Pogson

During some recent work on the design of communications receivers, the need naturally arose for a power unit to meet specific power supply requirements. Although the design of the complete project is not past the drawing board in some areas, the power supply has been designed and built and has been found to meet the need satisfactorily and at moderate cost. At this stage, we thought that other readers may have need for a similar supply and we present it in the hope that it will meet some of those needs.

Firstly, 17 to 19 volts DC was needed to supply a class B audio amplifier system. This supply need not be regulated but, as the current demand would swing over very wide limits, from say 20 to 250 milliamps, the output voltage would vary accordingly.

As a supply to the audio system, this arrangement would be entirely satisfactory. However, for the rest of a receiver the voltage would be somewhat higher than necessary, while a more stable voltage would be most desirable. And so the next requirement seemed to centre around a regulated supply of 12 volts and a current of 50 milliamps or so.

This would meet almost all the needs of a high grade receiver, except that it was felt that the regulation may be improved for a supply to the oscillators, in the interests of maximum frequency stability. By taking a line from

windings connected in parallel and the latter the windings connected in series. In each case, we end up with a supply of 12.6 volts at 1 amp. These are ideal for our purpose.

Rectification can be achieved efficiently, with four silicon diodes in a bridge arrangement. As the inverse voltage is quite low, diodes with a rating of as low as 50 volts or so can be used. We used diodes rated at 100 volts and they have a forward current rating of 1 amp.

Filtering immediately after the rectifiers, is by one 2000µF 25VW electrolytic capacitor, the voltage at this point being about 17.5. This is sufficient filtering for this position, as it normally

The regular type of zener diode which we are accustomed to using, has a maximum dissipation rating of, say, 340 milliwatts. This will not meet the situation and so we must use a larger zener diode, or resort to another method of regulation.

A satisfactory method is to use the zener diode as a reference for a power transistor, in either a series or shunt regulator arrangement. With the series arrangement, which is often used, the danger lies in overloading the output and a possibility of damaging the transistor, unless precautions are taken. On the other hand, if we use the shunt circuit there is no possibility of damaging the transistor. This is the method which we have adopted.

In designing such a regulator, the limiting factors are maximum emitter current of the transistor and its maximum power dissipation. We have decided on an AC128 transistor. It has a maximum permissible emitter current of 1000 milliamps and a maximum dissipation of 1.0 watt, with the proper heat sink fitted. Obviously, the emitter current rating is so far

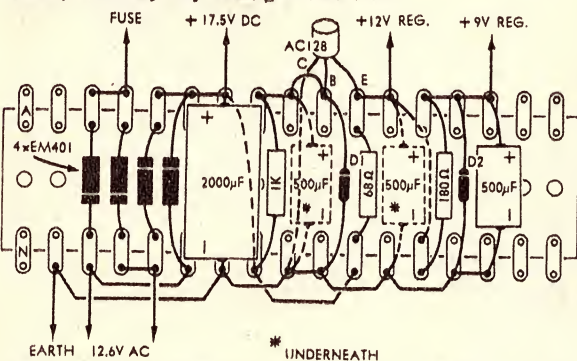

the 12 volts regulated supply and further regulating it at 9 volts, an excellent source would then be available for the oscillators.

At first sight, this may seem to be rather involved but a very satisfactory design can be arrived at without difficulty. Let us take a look at the circuit of the finished article.

Starting with the transformer, there are several suitable types available. As examples, we can cite two types, one with two windings rated at 12.6 volts at 0.5 amp and the other with two windings rated at 6.3 volts at 1 amp. The former can have the two

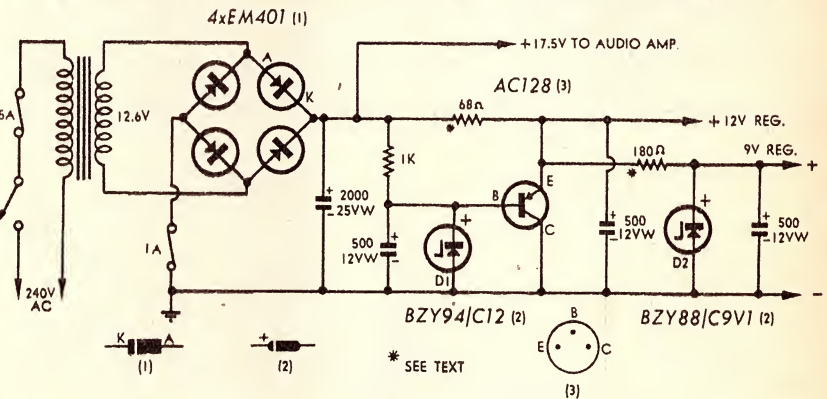

Above is the circuit of the power supply, which gives about 17.5 volts unregulated, 12 volts regulated. At left is a diagram showing how we fitted the components on a piece of miniature tag board.

feeds a high level output stage, and earlier stages in the amplifier have extra filtering as required.

The next part of this exercise is to obtain 12 volts, regulated, and with a current capability of 50 milliamps or so. It may be possible to do this by simply using a suitable series dropping resistor and a 12 volt zener diode. This would mean that under conditions when the load is removed, the zener diode must be capable of passing the total load current, plus say a minimum of another 5 milliamps. This amounts to a dissipation of 12 x 55, which is equal to 660 milliwatts.

above that which we are likely to need, that we can concentrate on the dissipation rating only.

With 12 volts between collector and emitter and with a maximum collector dissipation of 1 watt, the maximum collector current would be 83 milliamps. Assuming also that there is no load on this part of the supply, then the lowest value of series resistor would be 66 ohms, say 68 ohms. This means that with a suitable heat sink for the transistor, the 12 volt line could be left unloaded. A maximum of about 70 milliamps or so could be taken from this point.

The manner in which regulation is achieved by the shunt transistor method is, briefly, as follows: The base voltage of the AC128 transistor is virtually pegged at 12 volts with the zener diode. Should the output voltage increase, the bias on the AC128 will also increase. This, in turn, causes an increase in emitter current and causes an increase in the voltage developed across the 68 ohms resistor, thereby tending to restore the output voltage to its original value. The opposite process would apply if the output voltage tended to drop, and so the output voltage is kept substantially constant.



# A Bass Guitar Enclosure specially designed for ELECTRIC GUITARS

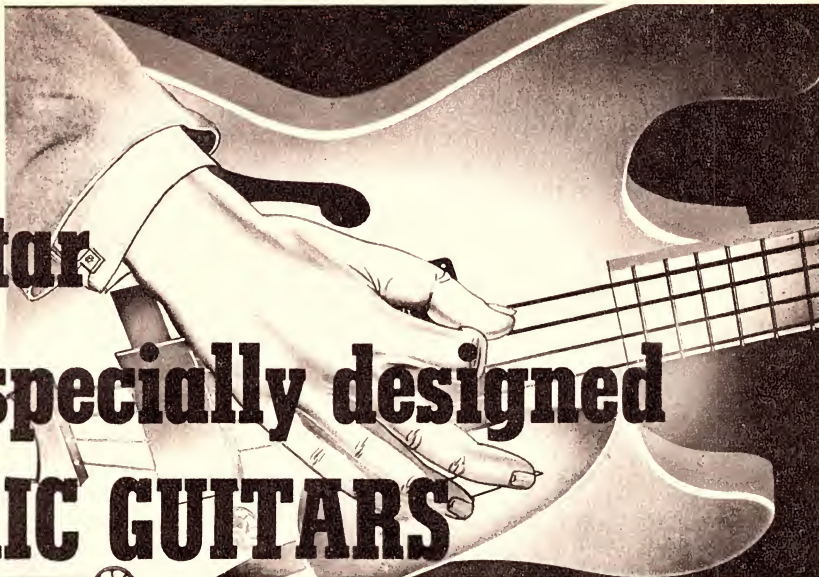

Built to handle the severe stresses imposed by the sounds from a bass guitar, this highly reliable unit has been designed to satisfy the rugged requirements of 60 watts of deep, rich sound. The enclosure contains four 12" Hi-Flux speakers, type 12PQ with Alnico ring magnetic systems for maximum sensitivity and durability. Low resonance and controlled excursion make for the utmost in bass response.

## SPECIFICATION

| TYPE NUMBER            | 50226/12PQ/15<br>PRESTIGE FINISH | 21622/12PQ/15<br>MANUFACTURERS TYPE | 53416/12PQ/8<br>MANUFACTURERS TYPE |
|------------------------|----------------------------------|-------------------------------------|------------------------------------|
| Impedance              | 15 ohms                          | 15 ohms                             | 8 ohms                             |
| Frequency Range        | 35-6000 Hzs                      | 35-6000 Hzs                         | 35-6000 Hzs                        |
| Resonance              | 40 Hz                            | 40 Hz                               | 40 Hz                              |
| Maximum Power Handling | 15 W                             | 15 W                                | 15 W                               |
| Magnet Material        | Alnico V                         | Alnico V                            | Alnico V                           |
| Flux Density           | 10500 gauss                      | 10500 gauss                         | 10500 gauss                        |
| Total Flux             | 82000 lines                      | 82000 lines                         | 82000 lines                        |
| V.C. Diameter          | 13 1/4"                          | 13 1/4"                             | 13 1/4"                            |
| Mounting Hole Centres  | 11 3/4" P.C.D.                   | 11 3/4" P.C.D.                      | 11 3/4" P.C.D.                     |
| Maximum Depth          | 6 3/4"                           | 6 1/4"                              | 6 1/4"                             |

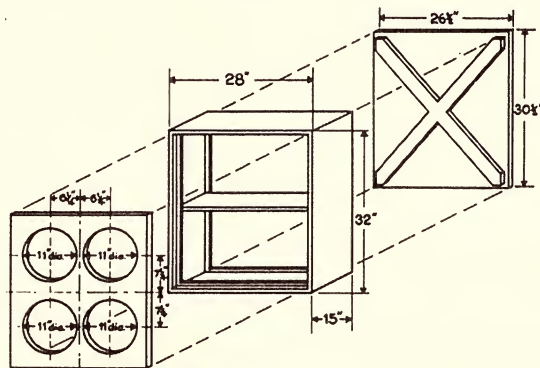

MANUFACTURERS SPECIAL PRODUCTS PTY. LTD.  
47 York Street, Sydney. 2 0233



**Hi-Flux** SPEAKERS

DISTRIBUTED BY:  
**ADELAIDE:** Newton McLaren Ltd. 51 0111.  
**BRISBANE:** Chandlers Ltd. 31 0341.  
**HOBART:** Amalgamated Wireless (Australasia) Ltd. 3 3836.  
**LAUNCESTON:** Amalgamated Wireless (Australasia) Ltd. 2 1804.  
**MELBOURNE:** Amalgamated Wireless (Australasia) Ltd. 67 9161.  
**Radio Parts Pty. Ltd.** 30 1251. **J. H. Magrath & Co. Pty. Ltd.** 32 3731.  
**PERTH:** Amalgamated Wireless (Australasia) Ltd. 28 3425.  
**Atkins (W.A.) Ltd.** 21 0101. **Carlyle & Co. (1959) Pty. Ltd.** 21 9331.  
**SYDNEY:** Electronic Parts Pty. Ltd. 533 1277.  
**George Brown & Co. Pty. Ltd.** 29 7031.



This is true for load currents from zero up to almost the full value of the emitter current.

Moving along to the 9-volt zener regulated line, the series dropping resistor has to be calculated. Disregarding other factors for the moment,

which gives us 65 ohms. We can make this one 68 ohms.

The above figures are given as an illustration and, if your needs are somewhat different from those quoted, it is an easy matter to make the calculations and change the resistors

accordingly. Make sure, however, that dissipation ratings of the transistor, zener diode and resistors are not exceeded.

Apart from the power transformer, we built the unit on a piece of tag board, with a total of 17 pairs, some of which were not used. The layout of the components is shown in the diagram, which may also be related to the photographs. Apart from the usual need to take care with soldering, making good joints and not overheating components in the process, there is not much more need be said along these lines.

You will notice in the photograph that the 9-volt zener diode is clamped with a heat sink. This is one of the old type of the OAZ series and we found this a convenient way to mount this item. The AC128 transistor is also mounted in the same way. The complete assembly is provided with two 1/2 in long spacers, to allow its being mounted to a chassis. The two heat sinks are thereby clamped to the chassis, affording ample metal for dissipation.

So there is our power supply which could have many applications and we hope that it will do the job which you have for such a device. ■

At right is an underneath view of the assembly. The heat sink on the zener diode will not be needed for the BZY88/C9V1.

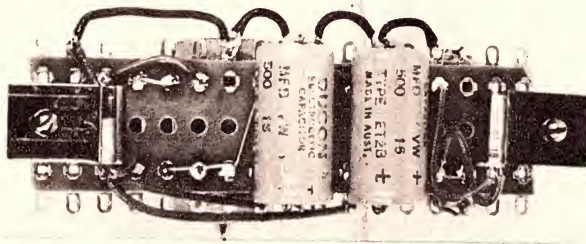

At left is a top view of the assembly, which can be related to the drawing on the previous page.

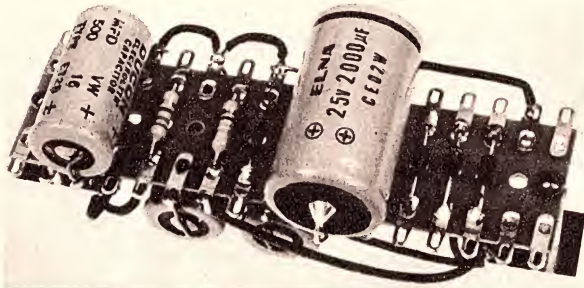

the maximum dissipation permissible for the zener diode is 340 milliwatts. At nine volts, this means that the maximum permissible current is 37 milliamps. To drop the voltage from 12 volts to 9 volts, the series resistor will be 81, say 82 ohms. Under these conditions, the 9-volt regulated output can just safely be left unloaded. Up to about 30 milliamps could be taken from this point.

In an attempt to simplify the calculation of the value of each of the two series dropping resistors, we have left out some factors which need to be taken into consideration. The logical place to start is with the 9-volt regulated output. First of all, we must determine the load current. Let us suppose that this amounts to 10 milliamps. Added to this is the current through the zener diode. We can allow 5 milliamps for this. The total current flowing through the dropping resistor will therefore be 15 milliamps. With the voltage to be dropped from 12 volts, the resistor will be 3/.015, which gives a value of 200 ohms. This could safely be made 180 ohms.

Now in order to calculate the value of the dropping resistor for the transistor regulator, we must take into consideration three current components. Firstly, there is the 15 milliamps for the 9-volt supply. Secondly, we must determine the external load current and we will assume that this is 50 milliamps. Thirdly, we must allow a residual of collector current of say, 20 milliamps. This totals 85 milliamps. To drop the 17.5 volts nominal, to 12 volts, the resistor will be 5.5/.085,





## LOTS OF EXTRA MONEY

How you can get it, part or full-time, whether man or woman, between 18 and 58, in city or country. For guaranteed Real Money Making Information, plus a Special FREE PREMIUM, send stamp TODAY. No obligation, no strings attached.

DEPT. RH.47  
BOX 5070, G.P.O., SYDNEY, 2001.



# BARGAIN PACKS!

|                                                                                                                                                                                                                                                                                                                                                                                                                                                                                                                                                                                                                                                                                                                                                                                                                                                                                                                                                                                                                                                                               |                                                                                                                                                                                                                                                                                                                                                                                                                                                                                                                                                                                                                           |                                                                                                                                                                                                                                                                                                                                                                                                                                                                                                                                                                                                                                                                                                                                                                                                                                                                                                                                                                                                                                                                                                                                                                                                       |                   |                   |                   |                      |                      |                       |                         |                       |                       |                       |                       |                      |                      |                        |
|-------------------------------------------------------------------------------------------------------------------------------------------------------------------------------------------------------------------------------------------------------------------------------------------------------------------------------------------------------------------------------------------------------------------------------------------------------------------------------------------------------------------------------------------------------------------------------------------------------------------------------------------------------------------------------------------------------------------------------------------------------------------------------------------------------------------------------------------------------------------------------------------------------------------------------------------------------------------------------------------------------------------------------------------------------------------------------|---------------------------------------------------------------------------------------------------------------------------------------------------------------------------------------------------------------------------------------------------------------------------------------------------------------------------------------------------------------------------------------------------------------------------------------------------------------------------------------------------------------------------------------------------------------------------------------------------------------------------|-------------------------------------------------------------------------------------------------------------------------------------------------------------------------------------------------------------------------------------------------------------------------------------------------------------------------------------------------------------------------------------------------------------------------------------------------------------------------------------------------------------------------------------------------------------------------------------------------------------------------------------------------------------------------------------------------------------------------------------------------------------------------------------------------------------------------------------------------------------------------------------------------------------------------------------------------------------------------------------------------------------------------------------------------------------------------------------------------------------------------------------------------------------------------------------------------------|-------------------|-------------------|-------------------|----------------------|----------------------|-----------------------|-------------------------|-----------------------|-----------------------|-----------------------|-----------------------|----------------------|----------------------|------------------------|
| <p><b>SEMI-CONDUCTOR PACKS.</b><br/>BRAND NEW AND TESTED<br/>SILICON AND GERMANIUM</p> <p style="text-align: center;">TYPES</p> <p>10—RF Type Similar<br/>AT325 BF115 .. \$2.95<br/>AY1101 .. \$2.95</p> <p>10—Audio Type Similar<br/>AT326, BC108 .. \$2.95</p> <p>10—Audio Output<br/>Matched Pairs .. \$3.25</p> <p>1—NPN HI-Power<br/>Output, 2N3055 .. \$2.00</p> <p>5—Pair Complementary<br/>Output Type .. \$3.25</p> <p>1—PNP RF IF Type<br/>SIM AF116, AF117<br/>each .. .60<br/>or 10 for .. \$5.00</p> <p>1—PNP Power Output<br/>SIM 2N301 .. \$1.30</p> <p>1—2N148 .. \$1.30</p> <p>1—PNP Audio Similar<br/>OC70 .. .50</p> <p><b>FET'S</b></p> <p>MPP 102 .. \$1.10</p> <p>MPP 105—2N5459 .. \$1.10</p> <p>MPP 106—2N5485 .. \$1.30</p> <p>2N3819 .. \$1.10</p> <p><b>SILICON RECTIFIERS</b><br/>50V, 100V, 200V, 400V, at<br/>36c ea.; 600V, 55c; 800V,<br/>60c; 1,000V, 95c.</p> <p><b>DIODES</b></p> <p>OA90 Type, 27c ea.<br/>or 10 for .. \$2.50</p> <p>OA91 Type, 27c ea.<br/>or 10 for .. \$2.50</p> <p>AN1102, BA100 27c ea.<br/>or 10 for .. \$2.50</p> | <p><b>SOLDER SPECIAL!!</b><br/>RESIN CORED "SUPER FAST"<br/>2 1/2 lb Reels ONLY .. \$2.75</p> <div style="text-align: center;">  <p>Peak 7W Stereo Amplifier, 50-<br/>20,000 Hz. In oiled timber<br/>cabinet.<br/>\$34.50 complete.</p> </div> <div style="text-align: center;">  <p>PALACE 10-watt solid-state<br/>amplifier, 50—19,000 Hz,<br/>\$33.50.</p> </div> <p><b>PIONEER Speakers, 15in.</b><br/>Guitar-type, 60-watt.<br/>\$30 each.</p> | <p><b>SPECIAL!!!! 1st RELEASE!</b><br/>8 TRANSISTOR RADIO KIT!<br/>USES SILICON TRANSISTORS<br/>AND DIODES COMPLETE with<br/>Instructions, Carrying Case<br/>and earphone \$16.50. Wired<br/>tested \$18.50.</p> <p><b>NEW 1969 TRANSISTOR<br/>RADIO KIT</b></p> <div style="text-align: center;">  </div> <p>6 Silicon Transistors and<br/>complete with instruction book,<br/>carrying case and earphone.<br/>Special Price .. \$11.25<br/>Wired .. \$13.50<br/>Post and Pack 75c.</p> <div style="text-align: center;">  <p><b>BOYS' CRYSTAL SET KIT</b><br/>Complete with Plastic Cab-<br/>inet, earphone and Instru-<br/>ctions .. \$2.50</p> </div> <p><b>TRANSISTOR MODULES</b></p> <p>Unit 1. 25W RMS Amplifier.<br/>Unit 2. 10W Amplifier.<br/>Unit 3. 10W RMS Amplifier.<br/>Unit 4. Pre-amp tone control<br/>stage.</p> <p>Unit 11. 65W HI-FI Amplifier.</p> <p><b>TRANSISTORS AND DIODES<br/>AT SPECIAL PRICES. ALSO<br/>ALL COMPONENTS, TAPE,<br/>FILM, ETC.</b><br/>SEND S.A.E. FOR DETAILS<br/>AND LIST.</p> |                   |                   |                   |                      |                      |                       |                         |                       |                       |                       |                       |                      |                      |                        |
| <h2 style="margin: 0;">INTEGRATED<br/>CIRCUITS</h2> <p><b>FAIRCHILD—Flip Flop, etc.</b><br/><b>PHILIPS—Pre-amp and Tape</b></p> <p style="text-align: center;"><b>MOTOROLA.</b></p> <p>G.E. 1 Watt RMS.<br/>G.E. 2 Watts RMS.<br/>G.E. 5 Watts RMS.<br/>B.H.A. SPECIAL 15W. RMS.<br/>Prices on application.<br/>State requirement.</p> <p><b>UNIT 10—With RF Stage and<br/>Power Supply, 8KHz band-<br/>width — \$31. Plus tax.</b></p> <p><b>TRANSISTORISED TUNERS<br/>NEW WIDE BAND TUNER</b><br/>Based on Playmaster Design.<br/>Ceramic Filters, Tuning Meter,<br/>Whistle Filter, etc. \$62 plus<br/>tax. Teak Cabinet \$6 extra.</p>                                                                                                                                                                                                                                                                                                                                                                                                                                    |                                                                                                                                                                                                                                                                                                                                                                                                                                                                                                                                                                                                                           |                                                                                                                                                                                                                                                                                                                                                                                                                                                                                                                                                                                                                                                                                                                                                                                                                                                                                                                                                                                                                                                                                                                                                                                                       |                   |                   |                   |                      |                      |                       |                         |                       |                       |                       |                       |                      |                      |                        |
| <p><b>RECORDING TAPE, POPULAR<br/>MAKE AT WHOLESALE</b></p> <p style="text-align: center;">PRICES</p> <table border="0" style="margin: auto;"> <tr><td>3in 150 ft .. .50</td></tr> <tr><td>3in 225 ft .. .70</td></tr> <tr><td>3in 300 ft .. .85</td></tr> <tr><td>5in 600 ft .. \$1.80</td></tr> <tr><td>5in 900 ft .. \$1.98</td></tr> <tr><td>5in 1200 ft .. \$2.50</td></tr> <tr><td>5 1/4 1200 ft .. \$2.55</td></tr> <tr><td>7in 1200 ft .. \$3.00</td></tr> <tr><td>7in 1800 ft .. \$3.25</td></tr> <tr><td>7in 2400 ft .. \$4.75</td></tr> <tr><td>7in 3600 ft .. \$6.75</td></tr> </table> <p><b>PHILIPS TYPE CASSETTES</b></p> <table border="0" style="margin: auto;"> <tr><td>C60 60 Min .. \$1.65</td></tr> <tr><td>C90 90 Min .. \$2.65</td></tr> <tr><td>C120 120 Min .. \$3.30</td></tr> </table> <p><b>SIGNAL INJECTOR<br/>RF/AF SLIMLINE .. \$6.75</b></p>                                                                                                                                                                                                  |                                                                                                                                                                                                                                                                                                                                                                                                                                                                                                                                                                                                                           |                                                                                                                                                                                                                                                                                                                                                                                                                                                                                                                                                                                                                                                                                                                                                                                                                                                                                                                                                                                                                                                                                                                                                                                                       | 3in 150 ft .. .50 | 3in 225 ft .. .70 | 3in 300 ft .. .85 | 5in 600 ft .. \$1.80 | 5in 900 ft .. \$1.98 | 5in 1200 ft .. \$2.50 | 5 1/4 1200 ft .. \$2.55 | 7in 1200 ft .. \$3.00 | 7in 1800 ft .. \$3.25 | 7in 2400 ft .. \$4.75 | 7in 3600 ft .. \$6.75 | C60 60 Min .. \$1.65 | C90 90 Min .. \$2.65 | C120 120 Min .. \$3.30 |
| 3in 150 ft .. .50                                                                                                                                                                                                                                                                                                                                                                                                                                                                                                                                                                                                                                                                                                                                                                                                                                                                                                                                                                                                                                                             |                                                                                                                                                                                                                                                                                                                                                                                                                                                                                                                                                                                                                           |                                                                                                                                                                                                                                                                                                                                                                                                                                                                                                                                                                                                                                                                                                                                                                                                                                                                                                                                                                                                                                                                                                                                                                                                       |                   |                   |                   |                      |                      |                       |                         |                       |                       |                       |                       |                      |                      |                        |
| 3in 225 ft .. .70                                                                                                                                                                                                                                                                                                                                                                                                                                                                                                                                                                                                                                                                                                                                                                                                                                                                                                                                                                                                                                                             |                                                                                                                                                                                                                                                                                                                                                                                                                                                                                                                                                                                                                           |                                                                                                                                                                                                                                                                                                                                                                                                                                                                                                                                                                                                                                                                                                                                                                                                                                                                                                                                                                                                                                                                                                                                                                                                       |                   |                   |                   |                      |                      |                       |                         |                       |                       |                       |                       |                      |                      |                        |
| 3in 300 ft .. .85                                                                                                                                                                                                                                                                                                                                                                                                                                                                                                                                                                                                                                                                                                                                                                                                                                                                                                                                                                                                                                                             |                                                                                                                                                                                                                                                                                                                                                                                                                                                                                                                                                                                                                           |                                                                                                                                                                                                                                                                                                                                                                                                                                                                                                                                                                                                                                                                                                                                                                                                                                                                                                                                                                                                                                                                                                                                                                                                       |                   |                   |                   |                      |                      |                       |                         |                       |                       |                       |                       |                      |                      |                        |
| 5in 600 ft .. \$1.80                                                                                                                                                                                                                                                                                                                                                                                                                                                                                                                                                                                                                                                                                                                                                                                                                                                                                                                                                                                                                                                          |                                                                                                                                                                                                                                                                                                                                                                                                                                                                                                                                                                                                                           |                                                                                                                                                                                                                                                                                                                                                                                                                                                                                                                                                                                                                                                                                                                                                                                                                                                                                                                                                                                                                                                                                                                                                                                                       |                   |                   |                   |                      |                      |                       |                         |                       |                       |                       |                       |                      |                      |                        |
| 5in 900 ft .. \$1.98                                                                                                                                                                                                                                                                                                                                                                                                                                                                                                                                                                                                                                                                                                                                                                                                                                                                                                                                                                                                                                                          |                                                                                                                                                                                                                                                                                                                                                                                                                                                                                                                                                                                                                           |                                                                                                                                                                                                                                                                                                                                                                                                                                                                                                                                                                                                                                                                                                                                                                                                                                                                                                                                                                                                                                                                                                                                                                                                       |                   |                   |                   |                      |                      |                       |                         |                       |                       |                       |                       |                      |                      |                        |
| 5in 1200 ft .. \$2.50                                                                                                                                                                                                                                                                                                                                                                                                                                                                                                                                                                                                                                                                                                                                                                                                                                                                                                                                                                                                                                                         |                                                                                                                                                                                                                                                                                                                                                                                                                                                                                                                                                                                                                           |                                                                                                                                                                                                                                                                                                                                                                                                                                                                                                                                                                                                                                                                                                                                                                                                                                                                                                                                                                                                                                                                                                                                                                                                       |                   |                   |                   |                      |                      |                       |                         |                       |                       |                       |                       |                      |                      |                        |
| 5 1/4 1200 ft .. \$2.55                                                                                                                                                                                                                                                                                                                                                                                                                                                                                                                                                                                                                                                                                                                                                                                                                                                                                                                                                                                                                                                       |                                                                                                                                                                                                                                                                                                                                                                                                                                                                                                                                                                                                                           |                                                                                                                                                                                                                                                                                                                                                                                                                                                                                                                                                                                                                                                                                                                                                                                                                                                                                                                                                                                                                                                                                                                                                                                                       |                   |                   |                   |                      |                      |                       |                         |                       |                       |                       |                       |                      |                      |                        |
| 7in 1200 ft .. \$3.00                                                                                                                                                                                                                                                                                                                                                                                                                                                                                                                                                                                                                                                                                                                                                                                                                                                                                                                                                                                                                                                         |                                                                                                                                                                                                                                                                                                                                                                                                                                                                                                                                                                                                                           |                                                                                                                                                                                                                                                                                                                                                                                                                                                                                                                                                                                                                                                                                                                                                                                                                                                                                                                                                                                                                                                                                                                                                                                                       |                   |                   |                   |                      |                      |                       |                         |                       |                       |                       |                       |                      |                      |                        |
| 7in 1800 ft .. \$3.25                                                                                                                                                                                                                                                                                                                                                                                                                                                                                                                                                                                                                                                                                                                                                                                                                                                                                                                                                                                                                                                         |                                                                                                                                                                                                                                                                                                                                                                                                                                                                                                                                                                                                                           |                                                                                                                                                                                                                                                                                                                                                                                                                                                                                                                                                                                                                                                                                                                                                                                                                                                                                                                                                                                                                                                                                                                                                                                                       |                   |                   |                   |                      |                      |                       |                         |                       |                       |                       |                       |                      |                      |                        |
| 7in 2400 ft .. \$4.75                                                                                                                                                                                                                                                                                                                                                                                                                                                                                                                                                                                                                                                                                                                                                                                                                                                                                                                                                                                                                                                         |                                                                                                                                                                                                                                                                                                                                                                                                                                                                                                                                                                                                                           |                                                                                                                                                                                                                                                                                                                                                                                                                                                                                                                                                                                                                                                                                                                                                                                                                                                                                                                                                                                                                                                                                                                                                                                                       |                   |                   |                   |                      |                      |                       |                         |                       |                       |                       |                       |                      |                      |                        |
| 7in 3600 ft .. \$6.75                                                                                                                                                                                                                                                                                                                                                                                                                                                                                                                                                                                                                                                                                                                                                                                                                                                                                                                                                                                                                                                         |                                                                                                                                                                                                                                                                                                                                                                                                                                                                                                                                                                                                                           |                                                                                                                                                                                                                                                                                                                                                                                                                                                                                                                                                                                                                                                                                                                                                                                                                                                                                                                                                                                                                                                                                                                                                                                                       |                   |                   |                   |                      |                      |                       |                         |                       |                       |                       |                       |                      |                      |                        |
| C60 60 Min .. \$1.65                                                                                                                                                                                                                                                                                                                                                                                                                                                                                                                                                                                                                                                                                                                                                                                                                                                                                                                                                                                                                                                          |                                                                                                                                                                                                                                                                                                                                                                                                                                                                                                                                                                                                                           |                                                                                                                                                                                                                                                                                                                                                                                                                                                                                                                                                                                                                                                                                                                                                                                                                                                                                                                                                                                                                                                                                                                                                                                                       |                   |                   |                   |                      |                      |                       |                         |                       |                       |                       |                       |                      |                      |                        |
| C90 90 Min .. \$2.65                                                                                                                                                                                                                                                                                                                                                                                                                                                                                                                                                                                                                                                                                                                                                                                                                                                                                                                                                                                                                                                          |                                                                                                                                                                                                                                                                                                                                                                                                                                                                                                                                                                                                                           |                                                                                                                                                                                                                                                                                                                                                                                                                                                                                                                                                                                                                                                                                                                                                                                                                                                                                                                                                                                                                                                                                                                                                                                                       |                   |                   |                   |                      |                      |                       |                         |                       |                       |                       |                       |                      |                      |                        |
| C120 120 Min .. \$3.30                                                                                                                                                                                                                                                                                                                                                                                                                                                                                                                                                                                                                                                                                                                                                                                                                                                                                                                                                                                                                                                        |                                                                                                                                                                                                                                                                                                                                                                                                                                                                                                                                                                                                                           |                                                                                                                                                                                                                                                                                                                                                                                                                                                                                                                                                                                                                                                                                                                                                                                                                                                                                                                                                                                                                                                                                                                                                                                                       |                   |                   |                   |                      |                      |                       |                         |                       |                       |                       |                       |                      |                      |                        |
| <h2 style="margin: 0;">S. E. WILLIS TRADING CO.</h2> <p>38 Riversdale Road, Camberwell Junction, Vic. 3124.<br/>Phone 82-5787 Please Include Freight Sorry No C.O.D.</p>                                                                                                                                                                                                                                                                                                                                                                                                                                                                                                                                                                                                                                                                                                                                                                                                                                                                                                      |                                                                                                                                                                                                                                                                                                                                                                                                                                                                                                                                                                                                                           |                                                                                                                                                                                                                                                                                                                                                                                                                                                                                                                                                                                                                                                                                                                                                                                                                                                                                                                                                                                                                                                                                                                                                                                                       |                   |                   |                   |                      |                      |                       |                         |                       |                       |                       |                       |                      |                      |                        |



# EVERYTHING FOR THE HOBBYIST and

## 40 Watt & 60 Watt Instrol-Playmaster GUITAR AMPLIFIERS

All parts now available

Like all Instrol-Playmaster kits, the 116 and 117 Guitar Amplifier Kits are complete in every detail, down to the last nut and bolt, and precisely to "Electronics Australia" specifications. Chassis is ready drilled, cadmium plated and finally passivated to avoid fingermarking. The front label is beautifully finished with black lettering on silver-white background. Kits for both the 116 and 117 include extras such as 3 inputs (circuit included), vibrato and extra treble pull switches, and foot switch complete with chrome housing.

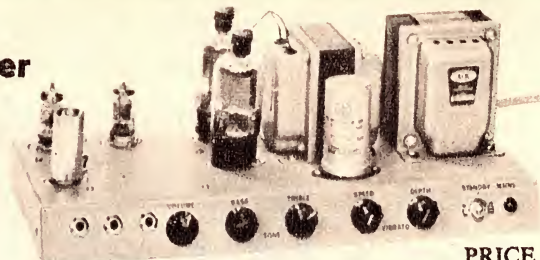

|                                         |                |
|-----------------------------------------|----------------|
|                                         | <b>PRICE</b>   |
| 40 Watt complete kit of parts . . . . . | <b>\$84.36</b> |
| 40 Watt built and tested . . . . .      | <b>\$91.49</b> |
| 60 Watt complete kit of parts . . . . . | <b>\$92.31</b> |
| 60 Watt built and tested . . . . .      | <b>\$98.83</b> |
| (Freight extra)                         |                |

All parts available separately if required.  
 Chassis only . . . . . **\$4.70** (plus 85c postage)  
 Front Label . . . . . **\$2.80** (plus 20c postage)  
 Fuzz Box Kit . . . **\$12.95** (plus 75c postage)



### KEYLESS ORGAN

(Electronics Aust. January 1969)

A useful novelty instrument which can be used successfully by a single entertainer or in conjunction with a group. Includes sharps and flats, built-in vibrato and has a high level of acoustic output.

Kit of Parts, \$35.10. Postage additional



### INSTROL-PLAYMASTER 124 STEREOGRAM ("ELECTRONICS AUSTR." MAY 1969)

A Solid State Broadcast Tuner, combined with the successful 3-PLUS-3 Stereo Amplifier. All major stations for six States engraved on an attractive label.

KIT OF PARTS . . . \$67.70  
 Postage Additional.



### The new INSTROL-PLAYMASTER 115 SOLID STATE STEREO AMPLIFIER ("Electronics Aust.," April-May, 1967).

A fully transistorised 10 Watt Stereo Amplifier using the latest F.E.T. high-efficiency transistors.  
 Crystal/Ceramic Kit . . . . . **\$96.80**  
 Magnetic kit extra . . . . . **\$10.50**

Postage additional

### INSTROL-PLAYMASTER 123 PROGRAM SOURCE

("ELECTRONICS AUSTRALIA" Oct. 68)



A high quality wide band solid state unit, fitted in free-standing metal case, featuring meter tuning and large illuminated dial.

Kit of Parts — with Ceramic Filter . . . . . **\$91.20**

Kit of Parts—without Ceramic Filter . . . . . **\$77.50**  
 Postage additional

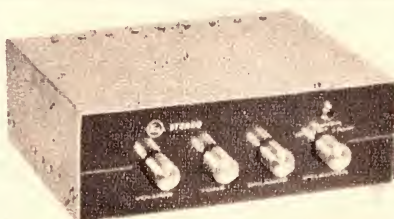

### THE 10-PLUS-10 STEREO AMPLIFIER

("Electronics Australia," November, 1968)

A high quality solid-state 10 watt amplifier. Suitable for crystal or ceramic cartridges.

KIT OF PARTS . . . . . **\$62.74**  
 Postage additional



### THE 3-PLUS-3-STEREO AMPLIFIER,

("Electronics Australia," August, 1968).

A small, modern, 3-watt solid-state audio amplifier.

Kit of parts . . . . . **\$43.50**  
 Postage additional

Tick catalogue required, and please include stamps for postage.

- |                                            |                                          |
|--------------------------------------------|------------------------------------------|
| <input type="checkbox"/> Playmaster        | <input type="checkbox"/> Test Equip Kits |
| <input type="checkbox"/> Toolkit           | <input type="checkbox"/> Metalwork       |
| <input type="checkbox"/> Cannon Connectors | <input type="checkbox"/> Microphone      |

Name . . . . .

Address . . . . .

Post Coupon for Free Catalogue.



Also Available,



EW2  
 1 1/2" x 1/2"  
 EW5  
 1 1/2" x 1/2"

These robust and attractive meters are available in the following sizes:  
 VP4A 1 1/2" x 1 1/2"  
 VP3A 2 1/4" x 2"  
 VP2A 3" x 2 1/4"  
 VP45 2" x 2"

meters with scales to suit the following projects.  
 Transistor Tester, Aug., 1968.  
 Audio Generator, Sept., 1968.  
 Power Supply, Sept., 1968.  
 F.E.T. Voltmeter, Dec., 1968.

|                                   |               |
|-----------------------------------|---------------|
| VP4A 0-500 microamps . . . . .    | <b>\$4.81</b> |
| VP4A 0-1 milliamp . . . . .       | <b>\$4.81</b> |
| VP3A 0-500 microamp . . . . .     | <b>\$5.27</b> |
| VP3A 0-1 milliamp . . . . .       | <b>\$5.16</b> |
| VP2A 0-50 microamp . . . . .      | <b>\$7.11</b> |
| VP2A 0-500 microamp . . . . .     | <b>\$5.96</b> |
| VP2A 0-1 milliamp . . . . .       | <b>\$5.86</b> |
| VP45 0-500uA V.U. scale . . . . . | <b>\$4.81</b> |
| EW5 0-200 microamp V.U. . . . .   | <b>\$3.43</b> |
| EW5 0-200 microamp . . . . .      | <b>\$3.43</b> |
| EW2 0-150 microamp . . . . .      | <b>\$2.51</b> |

(Including Sales Tax and Postage)

# BROADWAY ELECTRONICS



# TECHNICIAN...

## INSTROL EDUCATIONAL ELECTRONIC KIT

In this Electronic Age, every person should have some knowledge, however elementary, of "how it works." The new Instrol 20 in 1 electronic kit will enable you to understand in an absorbing, simple manner the basic principles underlying computers, satellite communications, industrial electronic devices, etc., etc. You make 20 different experimental circuits, including 10 working radio transistor operated radio circuits. Audio Amplifier circuits, home intercom, testing circuits including Audio Frequency Oscillator and Signal Tracer, Morse Code practice set and telegraph transmitter, etc. You use and learn about the amazing SOLAR CELL.



**NO TOOLS OR SOLDERING IRON REQUIRED**

All components pre-wired, ready for clip-on assembly. 50 page Instruction Manual supplied.

**ONLY . . . \$16.90**

(Plus 85c for Registered Post)

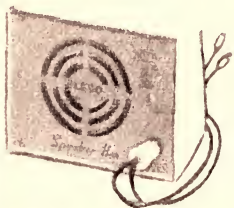
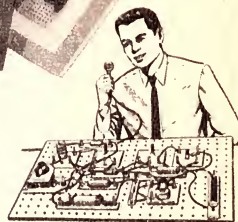

To allow others to hear the results you achieve, why not obtain the Instrol SPI Speaker box. Completely assembled, includes transistorised audio frequency amplifier, dynamic speaker and leads, housed in an attractive plastic box, and ready to plug-in at any appropriate stage of your experiments with the Instrol 20 in 1 Electronic Kit.

**INSTROL SPEAKER BOX. PRICE \$6 plus 10 cents Postage.**

## ELECTRONIC TOOL KIT

### For Hobbyists Students and Servicemen

An inexpensive, yet most comprehensive, pocket-sized tool kit. Ideal for the Student, Hobbyist and Practising Service Technician. The Soldering Iron is an Australian made high efficiency 30 Watt 240 Volt type. All the other hand tools are imported, high grade steel. The complete kit fits snugly into a strong attractive zip-fastening carrying satchet.

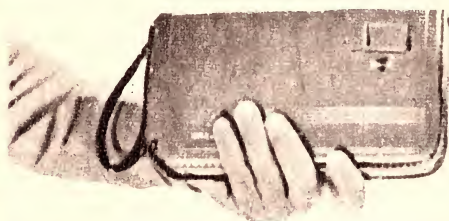

#### COMPONENTS

- 1—Soldering Iron with 3-pin plug 30 Watts 240V
- 1—Set 3 Spanners.
- 1—Coil Resin Cored Solder
- 1—Pair Pliers standard
- 1—Pair Long Nose Pliers
- 1—Pair Side Cutters
- 1—Pair Tweezers
- 1—Screwdriver Set complete with handle and chuck, comprising
- 2—Screwdriver bits
- 1—Philips driver bit
- 1—Pointed awl
- 1—Spintite for tin nuts

**PRICE \$12.50. Plus Regd. Postage \$1.00**



**SOLID STATE V.O.M. (Dec., '68)**

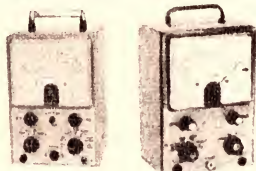

**V.T.V.M. (Feb., '66)**



**LAB. QUALITY POWER SUPPLY (September, 1968)**



**TRANSISTORISED AUDIO OSCILLATOR (Dec., '67)**



**TRANSISTOR TEST SET (August, 1968)**

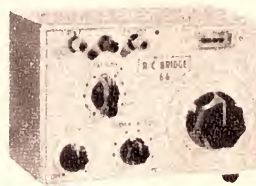

**R.C. BRIDGE (MAY, '66)**

#### TEST EQUIPMENT KITS

**PRICE**

- Solid State V.O.M. . . . Dec. 68 **\$57.00**
  - V.T.V.M. Feb., 66 . . . . . **\$57.51**
  - Transistor Test Set . . Aug. 68 **\$59.47**
  - Audio Oscillator, Dec. 67) . . . **\$57.05**
  - Lab Quality Power Supply, Sept 68 . . . . . **\$67.32**
  - R.C. Bridge . . . . . May, 66 **\$40.99**
- Postage additional on all kits.

# PTY. LTD.

**E. S. & A. BANK BUILDING**  
**CNR. BROADWAY & CITY ROAD, SYDNEY (opp. Grace Bros.)**  
 P.O. Box 43 2007 Phone: 211-4224, 211-4244, 211-4213





# We've got the best chassis in the business...

**and the best cases  
and racks too!**

If figures count, Celotek have a standard range of over 150 different sized electronic enclosures. And should you require a custom-built model, Celotek are the people to see.

All Celotek cases and racks are precision-made from top-quality materials. Standard finishes include blue, silver and dark grey. Special finishes are also available. Celotek prices are unbeatable and their fast, on-schedule delivery will satisfy any customer . . . large or small. So to put it briefly, if you have the equipment . . . we'll cover it!

|                             |
|-----------------------------|
| <b>CELOTEK</b>              |
| <b>INDUSTRIES PTY. LTD.</b> |

800-810 Parramatta Road, Lewisham, N.S.W. 2049.  
Telephone: 560-9572.



# Fundamentals of SOLID STATE

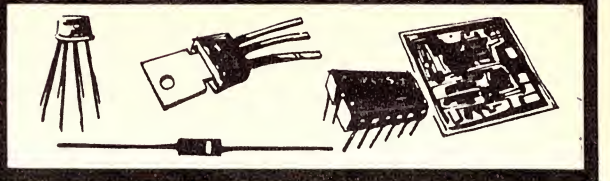

## Chapter 4

by Jamieson Rowe

Non-homogeneous semiconductors—carrier diffusion—“inbuilt” electric fields—drift currents—equilibrium and the Fermi level—the P-N junction—equilibrium, forward and reverse bias conditions—depletion layer width—junction “breakdown”—the semiconductor diode.

In our examination of semiconductor materials in the foregoing chapters, we have, for simplicity, looked only at the properties and behaviour of what might be called “homogeneous” samples—lumps of crystalline material in which the composition is uniform throughout. Thus we have considered, separately, uniform lumps of intrinsic semiconductor and of both N-type and P-type impurity semiconductor. In each case, by considering only a simple homogeneous sample of the material concerned, we have been able to isolate and examine its “basic” properties.

As the reader might suspect, however, such homogeneous samples of semiconductor materials are in fact mainly of academic interest. A large majority of practical solid-state devices depend for their operation upon further interesting properties and aspects of behaviour which arise in the more complex type of situation wherein the semiconductor crystal concerned is not homogeneous, but effectively composed of regions of different types of semiconductor material.

In order that the reader might gain a clear understanding of the operation of practical solid-state devices, it is therefore necessary that the basic concepts of semiconductor properties and behaviour developed earlier are expanded to cover the additional properties and behaviour of non-homogeneous samples.

With this aim in view, the present chapter will introduce and discuss some of the further basic concepts which apply to non-homogeneous semiconductor samples in general, and will then deal at some length with the extremely important “special case” of the P-N junction. Later chapters will show and explain how such P-N junctions, singly or in combination, and in one or another of a variety of physical forms and configurations, form the basis for almost every type of practical solid-state device.

To begin, then. Probably the most basic situation involving a non-homogeneous semiconductor sample, from the theoretical point of view, is a lump of impurity semiconductor crystal in which the impurity doping has not been made uniformly, but rather in a gradually increasing manner from

one end of the specimen to the other. This situation is represented in simplified form in the upper diagram of figure 4.1, which shows a crystal of N-type material, whose donor impurity concentration has been arranged to increase from a low value at one end to a considerably higher value at the other.

We have seen in the preceding chapter that each donor impurity atom in a semiconductor crystal lattice effect-

ively “splits,” with excitation, into two parts—each of which plays a different part in determining the electrical behaviour of the crystal. The fifth or “excess” valence electron constitutes one part, leaving to wander through the lattice as a potential current carrier; the remainder of the donor atom is naturally fixed in the lattice, but having lost one of its original complement of electrons, it becomes a fixed positively charged ion.

Hence the donor impurity “concentration gradient” of the sample in figure 4.1 tends to result in identical gradients for both donor-derived electron carriers and fixed positive ions. This is shown in the lower diagram of the figure.

As a result of the impurity concentration gradient, one might therefore expect to find in such a sample, when it is excited, a gradual increase in the number of fixed positive ions from one end to the other, matched by an exactly equal gradual increase in the number of negatively charged donor-derived electron charges. The charges of the two types of particle would therefore cancel in every part of the crystal sample, and, as the only other

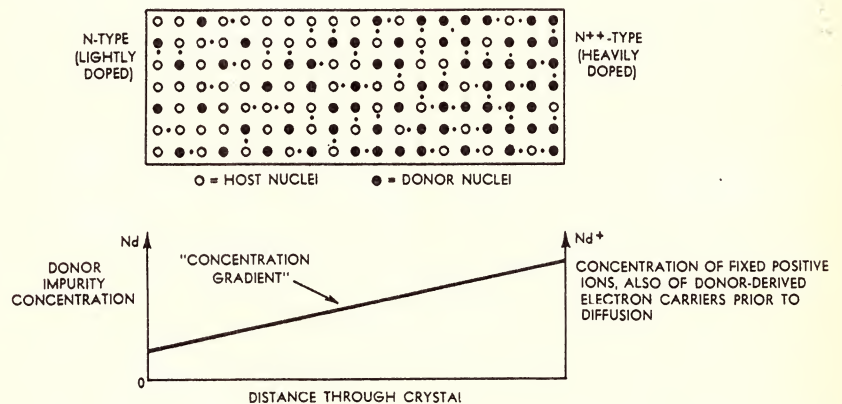

Figure 4.1

ively “splits,” with excitation, into two parts—each of which plays a different part in determining the electrical behaviour of the crystal. The fifth or “excess” valence electron constitutes one part, leaving to wander through the lattice as a potential current carrier; the remainder of the donor atom is naturally fixed in the lattice, but having lost one of its original complement of electrons, it becomes a fixed positively charged ion.

Just as the donor impurity concentration therefore quite naturally determines the number of donor-derived electron carriers and fixed positive ions in an excited homogeneous sample of N-type semiconductor, it similarly also tends to determine the number of these particles present at any point in an excited non-homogeneous sample. Thus, in a lightly doped region of such a sample, there will tend to be relatively few donor-derived electron carriers and fixed positive ions, while

effective charges present would be “intrinsic” electron-hole carrier pairs, the sample would be electrically neutral throughout its length.

If the distribution of donor-derived electron carriers in such a sample was determined only by the impurity concentration, as it is for a uniformly excited homogeneous sample, this satisfying picture would indeed represent the situation. However, the impurity concentration is not the only factor which applies for non-homogeneous material, so that in actual fact the situation is a little more complex.

It may be remembered that in an excited semiconductor crystal lattice, electron and hole carriers do not remain fixed, but move around “at random” as a result of acquired excitation energy. In so doing, they act in a very similar fashion to gas molecules in a container at room temperature. And it happens that, just as this type of motion tends to result in the uniform



# components with a purpose \*

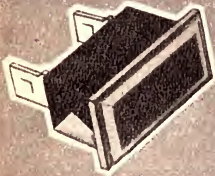

Neon  
Indicator Lamps  
**Telite**

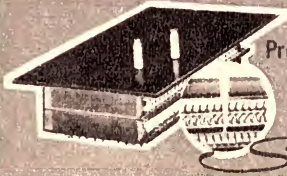

Cordless  
Programming  
Boards  
*Sealoctr*

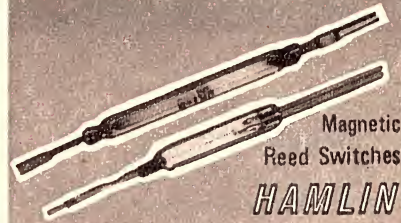

Magnetic  
Reed Switches  
**HAMLIN**

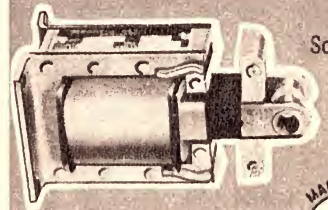

Solenoids



Relays



Potentiometers

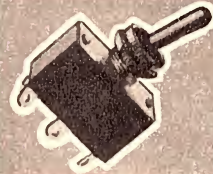

Toggle Switches



Micro Switches

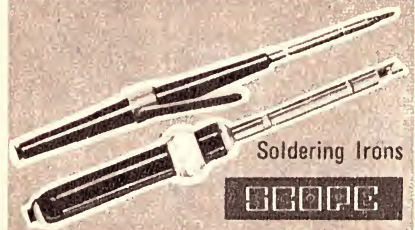

Soldering Irons



Precision Film Resistors

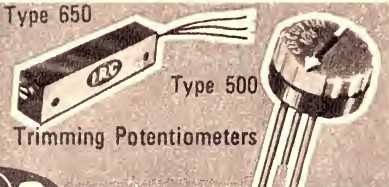

Type 650

Type 500

Trimming Potentiometers



Wirewound Resistors



Power Rheostats

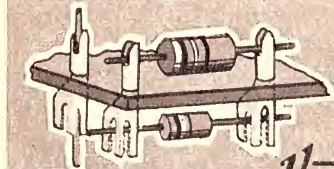

Matrix Boards and Kit-sets



## \* your complete satisfaction

INTERSTATE AGENTS & REPRESENTATIVES

MELBOURNE  
I R H Components Pty. Ltd.,  
Phone 489-1088

BRISBANE  
K.H. Dore & Sons  
Phone 2-1391 (except Magnetic Devices)

PERTH  
Simon Holman & Co.  
Phone 8-2271

HOBART & LAUNCESTON  
W.P. Martin Pty. Ltd.,  
Phone 34-2811 22-844

ALSO  
Underhill Day & Co.  
Phone 70-2141 (Magnetic Devices only)

ADELAIDE  
Collett & Cant Pty. Ltd.  
Phone 23-1971

## **IRH** COMPONENTS PTY. LIMITED

THE CRESCENT  
KINGSGROVE  
N.S.W. 2208  
TEL. 50 0111



diffusion or "spreading out" of gas molecules throughout a container, a similar diffusion of both electron and hole carriers tends to occur in any excited semiconductor sample.

This diffusion effect occurs in all excited crystalline lattices, although in the case of a homogeneous semiconductor it cannot be detected if the material is uniformly excited. The reason for this is that in such a case the excitation itself produces both carriers and fixed ions which are uniformly distributed throughout the sample. The effect of diffusion can be made apparent in a homogeneous semiconductor only if the excitation is applied in a non-uniform manner.

For example: if one end of a bar of uniformly heavily doped P-type impurity semiconductor is heated, while the remainder of the bar is kept at a low temperature, it will be found that the heated end acquires a negative electric charge with respect to the rest of the bar. This occurs because, while the localised excitation at the heated end produces equal numbers of positive hole carriers and fixed negative acceptor impurity ions, the positive hole carriers tend to diffuse throughout the bar while the acceptor ions remain fixed at the heated end. The heated region thus acquires a net negative charge due to excess ions, while the remainder acquires a positive charge due to excess holes.

In an excited semiconductor lattice, then, both electron and hole carriers tend to diffuse themselves throughout a sample. Hence if, for one reason or another, a localised concentration of carriers tends to be produced in some part of a sample, there will accordingly be a tendency for such a concentration to diffuse away. This will occur irrespective of whether the localised carrier concentration is due to localised excitation, as in the case of our heated bar example, or due to a localised impurity concentration as in the non-homogeneous sample of figure 4.1, or due to any other possible cause.

Further, and most importantly, the tendency for a concentration of carriers to diffuse away and spread evenly through a sample is in itself quite independent of any electric field or fields which may be acting through the material, being dependent only upon the excitation level and the degree of carrier concentration. The presence of electric fields can only influence diffusion indirectly, by modifying energy levels in the material in a way which determines the energy necessary for carriers to participate in diffusion in any particular direction.

Because electron and hole carriers are electrically charged, their motion through the crystal lattice constitutes a current regardless of its cause. Hence the motion of carriers due to the diffusion effect may be quite accurately described as **diffusion currents**.

In a uniformly excited homogeneous semiconductor sample, there will fairly obviously be no net diffusion current as all carrier movements will on the average cancel. However, in the previous example of a P-type rod heated at one end there is, in contrast, a net diffusion current of holes from the heated end.

From the foregoing, it may be expected that in our graded-doped specimen of figure 4.1 any tendency for a concentration of electron carriers

to be produced at the heavily doped end as a result of the larger numbers of donor impurities will be opposed by an electron diffusion current toward the lightly doped end. And this is, in fact, exactly what happens.

However, as in the case of the heated bar, the effect of the diffusion current is to upset the electrical neutrality of the specimen. In this case, the diffusion of electrons away from the heavily doped end leaves an excess of positively charged donor ions, while at the same time producing an excess of negatively charged electron carriers at the lightly doped end. The heavily doped end of the specimen thus becomes positively charged, while the lightly doped end becomes negatively charged. A potential difference is thus set up between the ends of the specimen and an electric field appears.

It should perhaps be noted that the potential difference set up in the specimen has exactly the opposite polarity of that which one might intuitively predict from the fact that the heavily

nificant, it always remains quite small relative to the acceleration due to excitation energy. It is because of this that the motion of carriers through a crystal lattice due to an electric field is usually described as a **drift current**.

From the foregoing, it may be seen that when the specimen of figure 4.1 is excited, the electron carriers present in the material are subjected to two opposing tendencies. Firstly, there is the tendency to diffuse uniformly throughout the specimen, which in this case means to diffuse away from the heavily doped end. And, secondly, there is the opposing tendency to drift back in the direction of the heavily doped end as a result of the charge unbalance and electric field set up by the diffusion.

What does this mean? Simply that the specimen will reach an **equilibrium**, in which an electron diffusion current from the heavily doped end to the lightly doped end is balanced by an equal electron drift current in the opposite direction. And as part of this

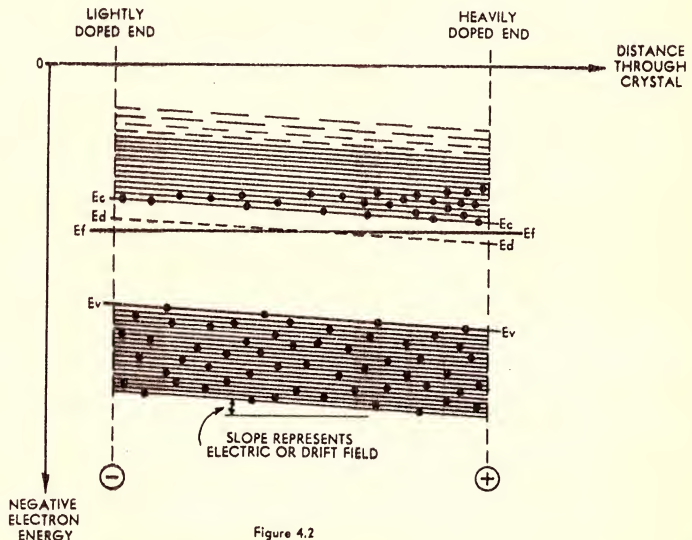

Figure 4.2

doped end has been given a larger proportion of electron DONOR impurity. Surprisingly, perhaps, it is this end which acquires the positive charge!

In an example of graded doping such as that of figure 4.1, therefore, the combined effect of the impurity concentration gradient and the carrier diffusion current is to set up in the material an "inbuilt" electric field, acting in the same direction as the concentration gradient.

We have seen in an earlier chapter that the effect of an electric field acting through a semiconductor lattice is to cause any available current carriers to be accelerated in the appropriate direction. Naturally, this will be the effect of the "inbuilt" field set up in our specimen.

Hence, there will be a tendency for the very electrons which diffused away from the heavily doped end of the material, setting up the electric field, to drift back again under its influence.

Note that the term "drift" has been used here to describe the effect of the electric field on the carriers, suggesting a relatively modest influence. This is quite intentional, because, in fact, although the acceleration produced by practical electric fields acting through semiconductor crystals at normal levels of excitation may be quite sig-

nificant there will be a potential difference between the ends of the material and, accordingly, an electric field through it.

In saying that the specimen reaches equilibrium, it is not implied that when this occurs all current in the specimen ceases. This cannot occur, for the simple reason that the very conditions which would result in cessation of the diffusion current are those which would result in maximum drift current, and vice-versa. For zero diffusion current the carrier concentration would have to be constant throughout, giving a maximum charge unbalance and hence maximum drift current; conversely, for zero drift current the carrier-fixed ion charges would have to be balanced throughout, giving a maximum carrier concentration gradient and therefore maximum diffusion current.

By its very nature, then, the equilibrium must be and is a dynamic one. Both the diffusion and drift currents continue to flow indefinitely in the specimen, although as their magnitudes are equal and their directions opposite, they have no measurable net resultant. Their continued presence in the specimen can only be inferred by the measurable potential difference set up between the ends of the specimen as part of the equilibrium process. The



# THIS IS NO ORDINARY MULTIMETER!

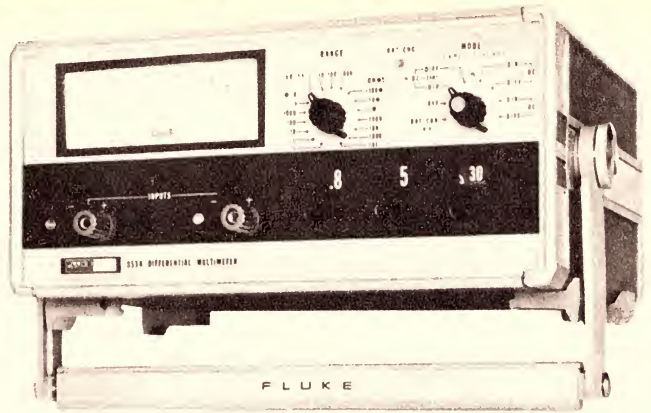

The Fluke 853A has proved itself a most versatile general purpose instrument or laboratory sub-standard.

In the direct mode this instrument is used like any other multimeter. It has the added convenience of one linear scale for all measurements including ohms. Accuracy is 2 per cent DC and ohms 2 per cent AC.

In the differential mode accuracy is increased up to 10 times, resolution 100 times. The instrument then has an incredibly wide range of measuring capabilities as follows:

VOLTS: 1 mv to 1110 volts AC and DC

AMPS: .1 microamp to 11.10 amps AC and DC

OHMS: .1 ohm to 111.0 megohms

ACCURACY: .2 per cent DC and ohms .5 per cent AC (for a minimum of 12 months)

The instrument operates from inbuilt batteries or 240 volts 50Hz and is well protected from overload.

PRICE \$465.00 EX-STOCK

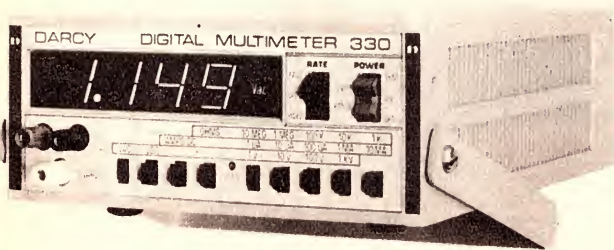

## The New Darcy DM330 Digital Multimeter

### DM330 Basic Specifications

**Display:** 3 full digits, reads 1500 at full scale. Polarity, range, and units. With AC option — AC volts.

**Ranges:** DC Volts:  $\pm 1$  mv/digit to  $\pm 1000$ V full scale. DC input resistance, 10 meg $\Omega$  constant. DC current:  $\pm 1$   $\mu$ a/digit to  $\pm 10$ ma full scale (higher ranges optional).

Absolute maximum input current, 25ma on any range, or 30 times range, whichever is less.

AC volts (optional): 50 Hz to 10 KHz with 10 megohm input resistance shunted by 110 pF.

Resistance:  $1\Omega$ /digit to 10 megohms, full scale.

Maximum voltage across unknown resistor is 10v DC at full scale.

**Ranging:** Pushbutton selected.

**Accuracy (all ranges):**  $\pm 0.1\%$  of reading  $\pm 1$  digit on DC, K $\Omega$  and current functions. 1%  $\pm 1$  digit on AC Volts.\*

**Settling Time:** .1 sec to within .1% of full scale on DC, K $\Omega$  and current functions.

**Normal Mode Rejection:** Infinite at 50 Hz and multiples thereof.

**Common Mode Rejection:** >100 dB up to 1 KHz with 1 K $\Omega$  source imbalance. >120 dB at DC.

**Operating Temperature:** 0°C to +55°C.

**Power Requirements:** 115 or 230 Vrms (specify at time of order), 47-440 Hz, 15 watts.

**Input Isolation From Earth Ground:** 500V DC or peak AC.

**Weight:** 7 $\frac{1}{2}$ lb.

**Dimensions:** 8 $\frac{1}{4}$ " wide x 3 $\frac{1}{4}$ " high (3 $\frac{7}{8}$ " with rubber feet) x 12" long.

\* Over the temperature range of 15°C to 35°C.

| Current through unknown resistor | Resistance range |
|----------------------------------|------------------|
| 1 $\mu$ a                        | 10 meg           |
| 10 $\mu$ a                       | 1 meg            |
| 100 $\mu$ a                      | 100K             |
| 1ma                              | 10K              |
| 10ma                             | 1K               |

Price without AC option \$369.00

Price with AC option \$409.00  
ex-stock

For more information contact:

**ELMEASCO**

**Instruments Pty. Ltd.**

P.O. Box 334, BROOKVALE, N.S.W. 2100. Tel. 93-7944

P.O. Box 213, MT. WAVERLEY, VIC. 3149. Tel. 82-6159



magnitude of the potential difference will naturally depend upon the semiconductor involved and the doping gradient present; for P-type or N-type silicon it could amount to as much as 500 millivolts.

Perhaps it should be noted in passing that while the potential difference generated "inside" such a semiconductor specimen is measurable, it can only be measured using extremely sensitive equipment such as an electrometer. The reason for this is that the equilibrium mechanism involved cannot supply significant power to any "external" circuitry without itself being disturbed.

The example of figure 4.1 illustrates what has been found to be a most important general principle, one which applies to all cases involving non-homogeneous semiconductors. This is that wherever there exists a gradient of doping concentration, an inbuilt electric or "drift" field is set up along that gradient.

Further important aspects of the principle may be appreciated by referring to the energy band picture for such a non-homogeneous semiconductor. The relevant part of the energy band diagram of figure 4.1 is shown in figure 4.2, and it may be seen to reveal a number of interesting points.

Perhaps the most obvious point is that the energy bands are tilted, in exactly the same way which we saw in an earlier chapter to apply when an electric field is set up through a semiconductor specimen by the application of an external potential difference. And, as in such a case, the slope of the tilting is directly proportional to the intensity of the field and the effective potential difference between the ends of the specimen.

What may not be quite so obvious is that here the slope of the bands is precisely such that the average carrier energy level—the Fermi level—remains constant throughout the material, despite the large number of conduction band electrons at the heavily doped end. This may be seen from the fact that the line  $E_f$ , representing the Fermi level, has zero slope.

Although this may seem somewhat fortuitous, it is really nothing more than the natural outcome of the dynamic equilibrium which we have just seen to be set up in the material due to a balancing of the opposing effects of diffusion and drift. As we have noted, the equilibrium occurs when diffusion current of electron carriers in one direction is balanced by an exactly equal and opposite drift current in the other direction; this implies that there is then no net carrier flow in either direction, and consequently that the average carrier energy is constant throughout.

It is found that all non-homogeneous semiconductors, in equilibrium, conform to this pattern. In other words, the electric or drift fields which are set up inside such materials as a result of impurity concentration gradients are always such that the Fermi level—the average carrier energy level—remains constant throughout the material.

Looked at conversely, this fact provides a most important general principle, and one which we will find most useful in understanding the operation of the various solid-state devices which

we will meet in later chapters. This is simply that, for all semiconductors—whether homogeneous or non-homogeneous—we can describe a specimen of material as being in electrical equilibrium if, and only if, the Fermi level is constant throughout the specimen. In actual fact this principle is quite fundamental and applies not just to semiconductors, but to all materials.

Before leaving this general discussion concerning non-homogeneous semiconductors, we should perhaps note that a very useful conclusion may be drawn regarding the intensity of the electric drift fields set up in such materials as a result of impurity concentration gradients. This is simply that, because a high concentration gradient will tend to produce a correspondingly high diffusion current, it will naturally also tend to result in the setting up of an appropriately strong internal drift field, in order to produce the high reverse drift current necessary for equilibrium.

In other words, the intensity of any electric fields set up in non-homogeneous semiconductors, in equilibrium, is directly proportional to the impurity concentration gradients with which they are associated. Thus high gradients, produced by relatively large changes in doping concentration over short distances through the material, set up quite high electric field intensities. Conversely low gradients, produced by either small changes in doping level, or changes spread over relatively

long distances, or both, set up relatively low field intensities. We will find in later chapters that this fact has many implications for solid state device design and operation.

For the present, however, let us turn to consider what is probably the most important basic "special case" of a non-homogeneous semiconductor, knowledge of which is virtually essential for an understanding of the operation of almost any solid state device. This is the P-N junction.

In its most basic form a P-N junction, as the name suggests, is a place in an impurity semiconductor crystal at which there is a relatively abrupt transition between a uniform P-type region and a similarly uniform (but not necessarily equal in resistivity) N-type region. Such a situation is illustrated in figure 4.3(a), which shows a junction between a lightly doped P-type region and a relatively heavily doped N-type region.

There are quite a variety of methods by which this type of situation may be produced in a semiconductor crystal, and a number of the appropriate techniques will be described in a later chapter. However, for our present purposes the method used to produce such a junction is not important. The essential requirement is that we have a crystal specimen in which one region has been uniformly doped with an acceptor impurity to produce P-type material, while closely adjacent to this region is another which has been

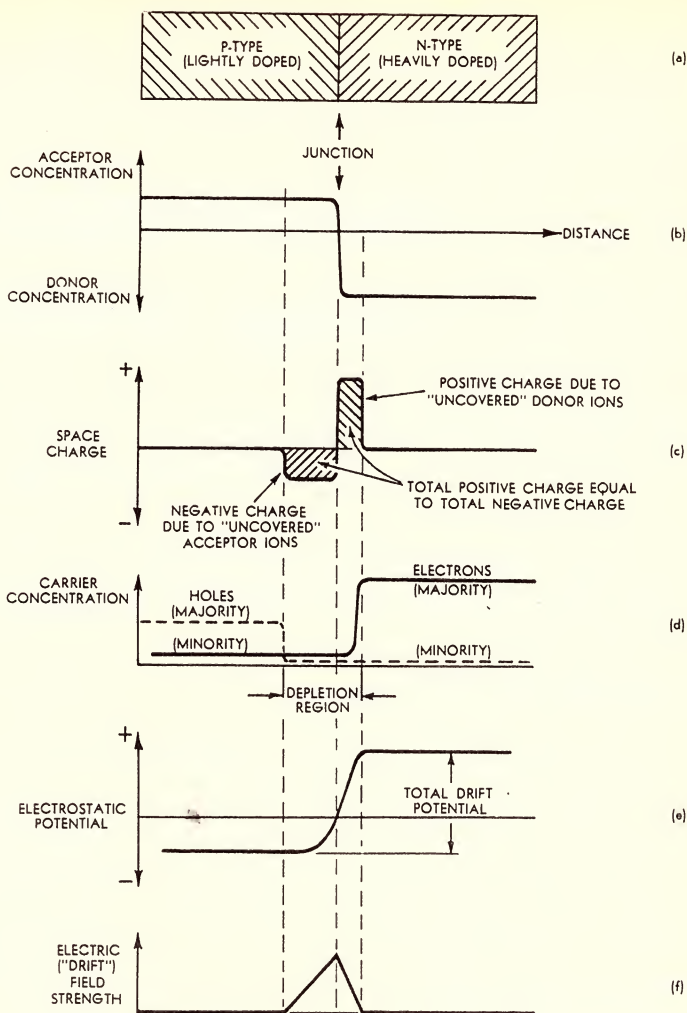

Figure 4.3



# the economics of colour television

Problems that should be ironed out now to make selling easier when the boom arrives.

Colour receivers will be at least twice as expensive and three times more complicated. When Australia starts on colour, the bugs will be out and the receivers will be excellent, but . . .

## Look out for the traps

There will always be a vast difference to black and white, which is relatively simple. Colour TV pictures, by their very nature, are extremely susceptible to interference. If you have ever seen colour TV you will know just what weak signals and ghosting can do to full colour transmission. This will cause more service calls than you'll ever have the margin to cover. More than this, the viewer will be so immersed in his set that he will want it fixed immediately. This will be problem No. 2—not No. 1.

## Problem No. 1

At a cost of, say, \$1,000—selling will not be easy because this will not be the only cost. You will not be able to complete an installation without an efficient colour antenna which will deliver the picture—and the cost of this could be the last straw. Without

this antenna you immediately run into service problems or, worse still, you don't even make the sale.

## You can prepare now to beat both problems

From now on electrical retailers and TV installation companies will be well advised to sell ONLY those antennas which are capable of delivering colour reception. This will immediately give you a sensible story to tell your customers, and will make ultimate colour TV selling easier and profitable. Not only new black and white set selling comes under this category, but the idea of actually starting out now to replace inefficient antennas is a good one—and profitable. What will really surprise you is that, generally speaking, it will cost you no more to swing over to colour-proven antennas, NOW!

Here are the patented antennas available in Australia today which will deliver top quality colour pictures

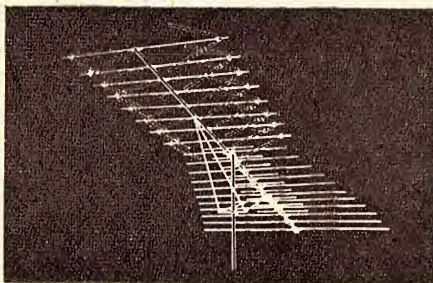

### CHANNEL MASTER

**COLOR CROSSFIRES:** For difficult city areas and the fringe. World's most powerful TV antennas in a full range of sizes.

**COLORAYS:** For normal city/metro-politan reception. Colorays are not expensive and not large—and they will deliver the colour pix.

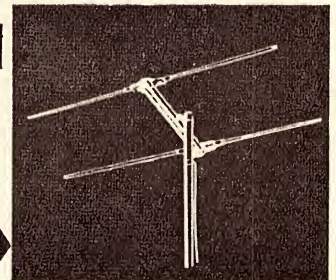

Full technical advice and assistance is freely available. Write or telephone

**FERRIS BROS. PTY. LIMITED**

(A Division of Ferris Industries Limited)

Branches, Manufacturers' Representatives and Distributors throughout the Commonwealth

CM9T/P



uniformly doped with a donor impurity to produce N-type material.

Although both regions of the specimen of figure 4.3(a) are uniformly doped, they are of opposite "type," so that the specimen is therefore not homogeneous. This much the reader may have deduced already; however, a fact which may be less obvious is that the specimen also has a steep impurity concentration gradient, despite the uniform doping on either side of the junction.

The fact is that the concentration gradient occurs right at the junction itself, because here the impurity concentration changes rapidly and effectively "reverses polarity" over a very short distance. This is shown clearly by the impurity concentration curve of figure 4.3(b).

From the foregoing discussion of impurity concentration gradients and their effects, one might predict that the steep concentration gradient represented by a P-N junction would result in a high carrier diffusion current, and consequently an equally high reverse drift current and an associated high-intensity electric field. And this is, in fact, exactly what happens.

Because of the large number of conduction band electrons in the N-type material relative to the number of such carriers in the P-type material, there will tend to be a diffusion current of electrons across the junction in the N-P direction. Similarly, because of the greater number of valence band holes in the P-type material relative to the N-type material, there will tend to be a hole diffusion current across the junction in the P-N direction.

As before, the effect of these diffusion currents is to upset the electrical neutrality of the specimen. The electron diffusion current in the N-P direction leaves an excess of positively charged donor ions in the N-type material, while also tending to create an excess of conduction band electrons in the P-type material. Conversely, the hole diffusion current in the P-N direction leaves an excess of negatively charged acceptor ions in the P-type material, while also tending to create an excess of valence band holes in the N-type material.

The P-type material thus tends to gain an excess of both conduction band electrons and fixed acceptor ions, both of which are negatively charged, while at the same time the N-type material tends to gain an excess of both valence band holes and fixed donor ions—both of which are positively charged. A potential difference is thus set up between the two types of material, with the P-type material negatively charged with respect to the N-type, and hence an intense inbuilt electric "drift" field is set up across the junction.

From the fact that the only impurity concentration gradient present in such a semiconductor sample is confined to the narrow junction region itself, it might be expected that the drift field set up would similarly be confined to this region. However, this is not the case; in fact, the field "spreads" slightly to either side of the actual junction region, to an extent depending upon the doping concentration of the material concerned.

What happens is that, in diffusing across the junction, both holes and electrons effectively leave regions in

which they are the majority carriers, to enter regions in which they are minority carriers. There is thus a very high incidence of carrier recombination on either side of the junction—so high, in fact, that few, if any, free carriers of either type are found near the junction on either side.

As a result of this effective depletion of carriers from the regions immediately adjacent to the junction, there are no electric charges available in these regions to compensate for the fixed charges of ionised impurity atoms. Hence a negative space charge is set up in the region on the P-type side, due to ionised acceptor atoms, while conversely a positive space charge is set up in the region on the N-type side due to ionised donor atoms. It is these space charges which are, in fact, responsible for the drift field set up across the junction.

The total charge unbalance produced by the two space charge regions is just sufficient to produce a drift field such that carrier drift back across the junction balances the diffusion currents. And because the space charge regions are effectively only the result of redistribution of charge within the semiconductor specimen, and not the result of a gain or loss of charge by the specimen as a whole, the net charges

charge region in the lightly doped P-type material is seen to have extended further than the positive region in the heavily doped N-type material, in order to "uncover" an equal number of ionised impurity atoms.

The curves of figure 4.3(d) show the carrier concentrations which correspond to this type of situation. It may be seen that the two space charge regions together constitute a region, extending from either side of the junction, which is nearly exhausted of carriers and thus virtually "intrinsic" semiconductor. From this it should not be surprising to learn that it is usual to call this region the depletion layer.

In figure 4.3(e) is shown the curve of electrostatic potential for the P-N junction of figure 4.3(a), illustrating that the potential difference which appears in the specimen as part of the equilibrium is set up entirely within the depletion layer region. In other words, under equilibrium conditions there is virtually no change in electrostatic potential throughout the remainder of the specimen. Hence, as shown in figure 4.3(f), the electric drift field is confined to the depletion layer region, and reaches its maximum intensity at the junction proper.

Further insight into the P-N junction in equilibrium may be provided by the

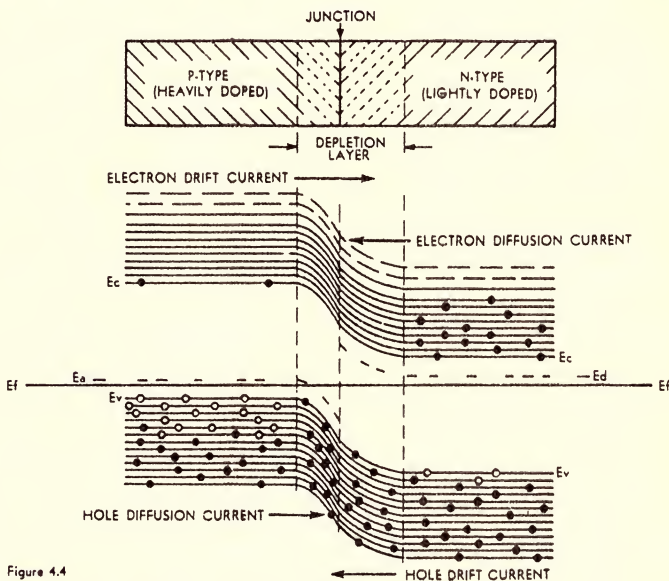

Figure 4.4

contained in the two regions must be equal and opposite.

Because of this, each region is found to extend into the material concerned to a distance just sufficient to "uncover" ionised impurity atoms equal to half the necessary total charge unbalance. If the P-type and N-type materials have equivalent doping concentrations, this will mean that the space charge regions will extend equally on either side of the junction, to a distance inversely proportional to the value of the doping concentration. A high doping level will thus result in narrow space charge regions, and a low doping level in relatively wider regions for the same degree of excitation.

If the doping concentrations of the P-type and N-type materials are dissimilar, as in the example of figure 4.3(a), the space charge regions will naturally extend by differing amounts. This is illustrated by the curve of figure 4.3(c), where the negative space

energy level diagram of figure 4.4. Here the particular junction represented for the purpose of illustration again has an asymmetric doping concentration profile, but the ratio has been reversed from that of the specimen of figure 4.3. In other words the junction is here visualised as between heavily doped P-type material and lightly doped N-type material.

As may be seen, the equilibrium set up between diffusion and drift currents of both conduction band electrons and valence band holes has set up in the specimen the expected potential difference between the P-type and N-type materials, with a value just sufficient to make the Fermi level  $E_f$  constant throughout the specimen. The electric field associated with this potential difference is confined to the depletion layer region, as expected, this being shown by the fact that the energy levels slope appreciably only in this region.



# TRUSCOTT'S

# AUSTRALIA'S GREATEST MAIL ORDER TAPE RECORDER & HI-FI CENTRE

STOCKISTS OF ALL LEADING BRANDS OF TAPE RECORDERS, HI-FI EQUIPMENT, COMPONENT PARTS AND ACCESSORIES

## AMPLIFIERS



KENWOOD TK 20U

Akal — Sound —  
Monarch — Lux —  
Fisher — Compax —  
— Kenwood —  
Pioneer — Trio —  
Sony — Tempo —  
Sansul — Leak —  
Grundig — Cosmos.

DUAL 1009F

## TURNTABLES



Dual — JH — Neat — BSR — PE —  
Compax — Labcraft — Pioneer — Goldring.

## TONE ARMS AND CARTRIDGES

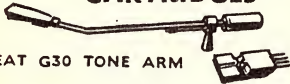

NEAT G30 TONE ARM

NEAT V70 CARTRIDGE

Neat — ADC — Ortofon — All Balance —  
Goldring — Decca — Audio Technica —  
Dual — Shure — Micro.

## SPEAKERS

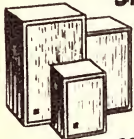

SOUNDMASTER SPEAKER SYSTEMS

Soundmaster —  
Wharfedale — Tesla —  
— Philips — Rola —  
— Kenwood —  
Pioneer — Sansul —  
Akal — Leak.

## ACCESSORIES

Microphones and Stands — Tapes and Spools — Splicing Kits — Record Care Accessories — Speaker Enclosure — Acoustic Cloth and Inner Baffling — Headphones — Pre-packed Leads — Plugs and Connectors — Head Cleaning Kits — Pillow Phones — Bases and Covers, and Many Others.

## COMPONENT PARTS AND ACCESSORIES

Truscott's are stockists of all General Electronic components, including resistors, capacitors, plugs and sockets, solder, Scope irons and spares, hook-up cables, valves, terminals, tag strips, matrix board, cambric spaghetti, fuses, chassis, grommets, solder lugs, alligator clips, valve sockets, D.I.N. connectors, TV connectors, battery savers, and also a large range of semi conductors for all Japanese makes.

## SONY TC 200B TAPE RECORDER



Vertical or Horizontal Operation. Hi-Fi Stereo Tape Recorder. Features Complete 4 track stereo and mono tape recording and playback system. Sound on sound recording. Two complete full range satellite speaker systems. Individual VU meter and volume controls for each channel. Light weight (only 27lb). Two Sony high quality dynamic microphones. Compact carry case, beautifully styled in black and ivory decor. Truscott's price only \$190.

## STEREO HEADPHONES



ELEGA DR-65C

Truscott's carry all the leading brand top quality stereo headphones. Including Elega, Akal, Sony, Pioneer, Sansul, Ashidavox, Foster, etc. Send for details and a T.M.Q.

## SENNHEISER DYNAMIC MICROPHONES



SENNHEISER MD421

This attractively styled Dynamic Microphone Model MD421 has been designed to meet the requirements of professional installations, which require low-priced directional studio microphones. A full range of famous Sennheiser studio microphones for amateur or professional use is available at Truscott's. Send now for specifications and a T.M.Q.

## 220S MULTIMETERS

D.C. Volts 5, 25, 125, 500, 2500.  
A.C. Volts 10, 50, 250, 1000.  
Current: 0.250 uA, 0.250 mA.  
Resistance: 0-10K, 0.1 MEG.  
Truscott's price only \$7.95.

## SAVE YOUR RECORDS... USE THE UNIVERSAL LUSTRE TONE ARM LIFT



LUSTRE SA-202

This beautifully finished and functional universal tone arm lift will fit all tone arms. The lowering action is pneumatically damped and extremely smooth — risk of record damage may now be eliminated — Truscott's price only \$8.50.

## TAPE RECORDERS & DECKS



TESLA B46

Tesla — Akai —  
National —  
Thorn Atlas —  
Julliforder — BSR —  
Toshiba —  
Sanyo — AIWA —  
Philips — Grundig —  
Tandberg —  
Gelosco.

## HI-FI TRANSCRIPTION TURNTABLE COMBINATION

Consists of the one and only JH Synchronous Turntable, the new Neat G30 Tone Arm with lifting/lowering device, Neat V70 magnetic cartridge, and hand-finished oiled TEAK wooden base. Retail \$96.00. Truscott's price only \$77.50. If assembly required — add \$6.00.

## TAPE RECORDER BELTS

Belts available to suit most models of Telefunken, Uher, Philips, Cossor, Stella, Grundig, BSR, Ferguson, Walter and Korting Recorders. When ordering, it is most essential to state the correct make and model of recorder.

## TAPE RECORDER AND HI-FI SERVICE CENTRE

For service on all leading brand tape recorders and Hi-Fi equipment come to the experts. Truscott's modern service centre uses only the finest servicing aids backed up by fully trained professional technicians.

## SPEAKER ENCLOSURE

Truscott's are the leading South Australian stockists of Innerbond and Bonded Courteille. Ensure dust-free padding for your speaker enclosure. Send for a T.M.Q.

## NEAT MAN—THAT'S THE WAY TO ENJOY HI-FI MUSIC

Truscott Electronics are the sole Australian agents for Neat Hi-Fi equipment. Available from your local Hi-Fi store or direct from agents. Listed below are just two of the Neat range of products.

Neat G30 Professional Static Balance Tone Arm. New release now fitted with lifting/lowering device.

A precision built unit, outstanding in appearance and simple to mount and use in any installation. The results obtained are far beyond those usually expected at such an extremely moderate price. It will accommodate all standard cartridges and the tracking weight is easily adjusted to the particular one in use.

Neat V70 Moving Magnet Cartridge. The V70 is a top performance, high quality magnetic cartridge that out-performs many more expensive cartridges. When used with the Neat G30 tone arm, an excellent low priced combination can be obtained. Send now for reviews and test reports by the Gramophone, Hi-Fi Sound and Electronics Australia on both the G30, V70 and all other Neat tone arms and cartridges.

## Fast Mail Order Service

When ordering, please give your full address printed in BLOCK LETTERS. All Truscott equipment is brand new and fully guaranteed. Sales tax is included in all quoted prices. All orders are despatched promptly. All prices quoted are Nett. Postage and freight extra. NOTE: T.M.Q.—Truscott Mail Order Quote.

## CAR RADIO SPECIAL "SOUNDMASTER 8"



The new super sensitive push-button all transistor car radio featuring 8 trans. — 3W output — push-button tuning — built-in noise suppression — high quality speaker — suit any model car — Truscott's price only \$55.00. If aerial required add \$4.00.

## NEW DUAL RELEASE

Send now for details on this new DUAL model 1210 turntable and ask for a T.M.Q.

## P.E. TURNTABLES

Model P.E. 34. Limited stocks available of this very popular German Hi-Fi transcription turntable. Send now for details, and a very attractive T.M.Q. All other model P.E. turntables stocked.

## PHILIPS 82 DICTATION MACHINES

Limited stocks available of this very efficient dictation machine — complete with all accessories. Send now for details and a T.M.Q.

## AKAI TAPE RECORDERS

All latest models in stock — XV, 1710, M9, 1800, X360, 4000D, X150D. Prices slashed to an all time low. Send now for a T.M.Q.

## TRUSCOTT'S HI-FI COMBINATIONS

Select your Hi-Fi equipment from our vast range and send for a Truscott combination price — the lowest in Australia.

## ACOUSTIC SPEAKER GRILLE CLOTH

Truscott's now carry over 50 top grade cloths to select from. Send now for samples and a T.M.Q.

## CASSETTE RECORDERS

A full range of Cassette Recorders and players is available. Write or call for a T.M.Q.



# TRUSCOTT ELECTRONICS

AUSTRALIA'S GREATEST TAPE RECORDER & HI-FI CENTRE

62-64 HINDMARSH SQ. ADELAIDE, 5000 Phone: 233024 233278



At this stage it is hoped that the reader has gained a reasonably clear and satisfying picture of the P-N junction "in equilibrium" — which is, naturally enough, the situation which applies when such a semiconductor specimen is "left to itself" and not disturbed by the application of external electric fields.

Understandably this situation, while basic for an understanding of P-N junction operation, is of little direct interest where solid state device is concerned. Hence we should now turn to consider what happens when the junction is disturbed by external potential differences. However, before doing so it may be worthwhile to conclude the foregoing section with a brief summary which draws attention to the important points.

As we have seen, the steep doping concentration gradient present at a P-N junction results in carrier diffusion currents across the junction, with majority carriers from either side diffusing across to the other side and becoming minority carriers. A high incidence of carrier recombination thus tends to occur in the vicinity of the junction, which leaves a region of low overall carrier concentration and resultant "uncovered" impurity ions extending from the junction on either side. This region is the depletion layer, and corresponds to a layer of effectively "intrinsic" semiconductor material.

The "uncovered" impurity ions in the depletion layer result in a charge unbalance, and an electric "drift" field is set up across the junction. This results in drift currents of carriers across the junction in the reverse directions to the diffusion currents, and an equilibrium is set up when the two types of currents balance.

The higher the doping concentrations of the materials from which the junction is formed, the greater tends to be the concentration gradient at the junction, and the larger the densities of impurity ions in the materials are directly proportional to the doping concentrations, with the result that the overall width of the depletion layer actually decreases with increasing doping concentration. Thus a junction between heavily doped materials tends to be relatively narrow, while a junction between lightly doped materials tends to be wide. The same factors result in unequal depletion layer widths on either side of a junction formed between materials of differing doping concentration, as we have seen.

It may be noted that the diffusion currents are effectively composed of majority carriers, because the carriers concerned are drawn from the majority carrier populations on each side of the junction. In contrast with this, the reverse drift currents are effectively composed of minority carriers, being drawn from the minority carrier populations of each material.

Let us now turn to consider what happens when a P-N junction is disturbed by the application of external potential differences. We shall find that its behaviour will depend quite markedly upon the polarity of the applied potential difference.

In figure 4.5 is shown the effect of connecting to a P-N junction specimen an external "bias" voltage, supplied by

a battery whose positive pole is connected to the P-type semiconductor material, and whose negative pole is connected to the N-type material. This situation is normally called **forward bias**.

We have seen earlier that the effect of a potential difference applied to a semiconductor specimen is to set up an electric field along its length, and effectively raise the energy levels of the end of the specimen connected to the positive polarity relative to those of the end connected to the negative polarity. And this is what happens here, although the situation is complicated by the fact that the effective doping concentration — and hence the electrical resistivity — varies along the specimen.

Whether or not the P-type and N-type materials at either end of the specimen have differing resistivity will depend upon their doping concentrations, of course, and this will vary from specimen to specimen. However,

tion to the "inbuilt" field set up in equilibrium.

It may be seen that the polarity of this new field is opposite to that of the inbuilt field; that is, the two fields oppose. The effect of the forward bias is therefore to reduce the strength of the inbuilt field acting across the depletion layer, by partial cancellation. And, as shown by the electrostatic potential curve of figure 4.5(b), this has the result of effectively reducing the "potential barrier" opposing majority carrier diffusion across the junction. The majority carrier diffusion currents are therefore allowed to increase beyond their equilibrium values.

The minority carrier reverse drift currents in opposition to the diffusion currents cannot increase proportionally to maintain a balance, because they in contrast are almost completely limited by the numbers of minority carriers generated in the bulk of the material by the familiar "intrinsic" excitation mechanism. In short, the drift currents

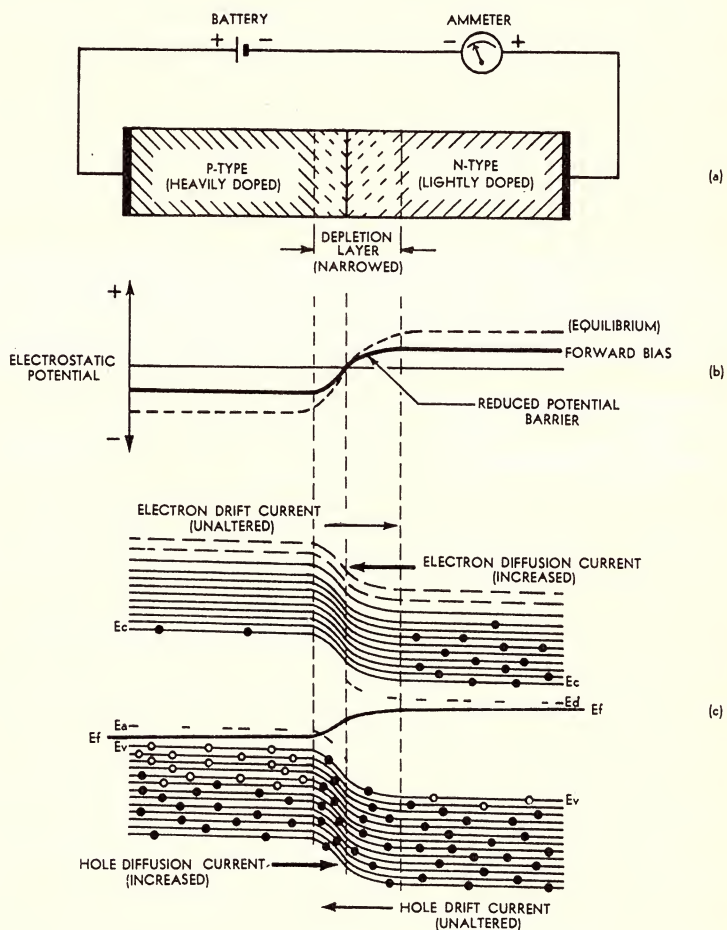

Figure 4.5

regardless of the doping concentrations of these regions, the effective doping concentration of the depletion layer region is, as we have seen from the equilibrium case, very low. In effect, it behaves as "intrinsic" material, and has a relatively high resistivity.

Because of the high resistivity of the depletion layer region relative to the end regions, a major proportion of the applied potential difference is applied across the former. Hence the main effect of the applied forward bias is to tend to set up across the depletion layer a second electric field, in addi-

are "saturated," and virtually independent of the actual value of the potential difference across the depletion layer. (For this reason they are often called the **saturation currents** of the junction.)

When forward bias is applied to a P-N junction, then, the majority diffusion currents increase beyond their equilibrium values while their opposing minority drift currents remain substantially unaltered. A net current flow therefore takes place across the junction, with conduction band electrons moving from the N-type material



# MAGRATH'S

## LEKTROKIT

### CHASSIS CONSTRUCTION SYSTEM

#### WHAT LEKTROKIT IS:

LEKTROKIT is a construction system consisting of a few simple and inexpensive pre-fabricated components, from which experimental electronic chassis, racks, trolleys, etc., can be constructed quickly and cheaply. From sketched diagram to finished model ready for test in a matter of a few hours — no layout work, no drawing effort and no metal fabrication is required.

The dimensions of LEKTROKIT chassis components have been designed to be compatible with a wide range of standard Commercial and Inter-Service electronic components. Complete chassis can be assembled from a few basic LEKTROKIT parts and the standard electronic components available in every laboratory.

LEKTROKIT is designed to allow for almost unlimited expansion during the course of circuit development. Starting with one small LEKTROKIT chassis, the circuit can be expanded continually by the addition of further chassis until some hundreds of valve or transistor stages have been added — all without loss of neatness or accessibility — and the chassis can then be assembled into racks.

The primary purpose of LEKTROKIT is to save time and cost in the initial stages of circuit development. But LEKTROKIT can also be used for more sophisticated construction, such as Factory Test Equipment, Pre-Production Models and even small quantity production. The addition of Front Panels, Covers, etc., from the standard ranges of the LEKTROKIT Chassis or Rack Construction Systems will convert a LEKTROKIT chassis into an elegant and finished piece of permanent equipment.

- Chassis Plates
- Chassis Rails
- Connector Rails
- Side Plates
- Front Panels
- Covers, Plain
- Covers, Perforated
- Rack Brackets
- Heatsinks
- Tag Strips
- Rubber Feet
- Brackets
- Spacers
- Soldering Pins

- Connector Plates
- Edge Connector Adaptors

WRITE FOR DETAILED LEAFLETS AND PRICE LIST

**J. H. MAGRATH & CO. PTY. LTD.**  
208 LT. LONSDALE STREET, MELBOURNE, VICTORIA, PHONE 663 3731

#### R.C.S. SPECIALS



**NEW IMPROVED  
30 WATT**  
NOMINAL  
54w MAX.

#### 12v All Transistor P. A. AMPLIFIER

WIRED READY TO OPERATE  
15 ohm output No. 591D ..... \$62  
125, 250, 500 ohm 592D ..... \$62  
Dimensions: 6 1/2 in. w. X 3 1/2 in. h X  
8 1/2 in. d. For 240V op. \$33 extra.  
10 WATT P.A.  
Inputs 5 MV and 100 MV. 10w R.M.S.  
at 1%. Frequency 40cy.—30kc. For use  
with 1.4 ohm, 2.8 ohm or 4.16 ohm  
speakers in parallel. Same cabinet and  
dimensions as 30w above.  
Wired and tested, No. 485, \$40.  
Freight extra in both cases.



#### R.C.S. COMPLETE DO-IT-YOURSELF KITS

Peak reception,  
low price. No ex-  
pensive test equip-  
ment. Everything  
fits. 1964 RF  
Transports 7.  
Complete kit—No. 640 ..... \$43.50  
Portable car radio, identical to 640  
above, plus extra switch and car coil  
etc. No. 642 ..... \$46.00  
(Write for booklet on 640 and 642)  
Postage \$1.

#### NEW TRANSISTOR PREAMP KIT

SIZE 3 x 2 x 1 1/2 in 2 req. for Stereo.  
LOW IMP. Input 2 trans. 672C ..... \$6.50  
Wired ready for use. 672D ..... \$8  
HIGH IMP. 2 trans. 680C ..... \$6.50  
Wired ready for use 680D ..... \$8  
HIGH IMP. silicon 3 trans. 682C ..... \$8  
Wired ready for use, 682D .. \$9.50  
Postage 10c each. Write for data.

#### HI-FI BROADCAST TUNER UNIT 4 TRANSISTORS — HI SENSITIVITY.



R. F. mixer, I.F., pwr., detr. stages, adjustable aerial  
coupling. Complete as illust., wired and tested with 461  
dial, knobs and switch pot. No. 474D, \$31. Postage \$1.  
WHISTLE FILTER for above set for 8Kc band width (can  
be altered to 9, 10, or 11Kc). No. 128, \$4, Post 10c.

### PRINTED CIRCUITS

For all R. and H., E.A., Mullard, Philips and other designs.  
Clearly coded. White letters and numbers, easy assembly  
and service, polished and resined for easy soldering. With  
blueprint parts list.  
SPECIALS: To your drawing—write for particulars and  
Drafting aids.

| New Printed Circuits      | Number.               | Recent Designs |
|---------------------------|-----------------------|----------------|
| 726 3 x 3 or 10 x 10 w    | 722 Mullard pre-amp   | \$3.00         |
| stereo 68/A8              | 725 Protected supply  | \$2.50         |
| 736 B/C tuner EA 69/TS    | 734 E.A. 69 01 gold p | \$5.00         |
|                           | organ                 | \$2.50         |
| 727 E & A wide band       | 731 E.A. 68 M 12      | \$2.50         |
| tuner 68/8T               | 709 Pre-amp 67-P5     | \$2.50         |
| 728 Audio osc. E.A. 68-09 | 684 Pre-amp 65-P10    | \$2.50         |
|                           | 685 Pre-amp. 65-P12A  | \$2.50         |
| 718 Mullard main amp.     | 686 Pre-amp. 65-P12B  | \$2.50         |
|                           |                       | \$2.50         |

Write for full list. Immediate despatch. Postage 10c.



#### 10W STEREO MULLARD 10 x 10 watts R.M.S.

With output transistor PROTECTION. Frequency response  
40cy. to 30Kc. Distortion 0.5% Treble, bass, boost 20dB.  
Complete kit of parts No. 460C ..... \$74.00.  
Wired and tested No. 460D ..... \$79.00.  
With hi-fi tuner and whistle filter, \$35 extra. Freight extra.  
Write for details. For special Saturday demo, ring 59-6550.

#### MAGNETIC STEREO PRE-AMP

In 5Mv out 250Mv. Bass and  
treble 20D.B. No. 724C \$29.  
Wired ready for use \$31.  
Postage 30c each.  
For crystal ceramic No. 722D  
—\$27.00.



#### TRANSFORMER



Tap 4.6v and 9v D.C. at  
100 milliamps.

Filter, condensers, rectifier, resistor,  
case, etc. \$6.50. Post 10c.

#### PERSONAL PORTABLES 2 TRANSISTORS

Range 30 miles.  
200 with short  
aerial and earth.  
Earpiece only, no  
speaker. Wired  
ready to use. No  
666D, \$10.  
Postage 20c.  
Do-it-yourself kit.  
No. 666C, \$9.00.

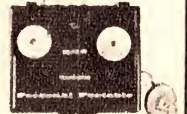

1 TRANSISTOR — 1 DIODE  
593C Do-it-yourself kit, \$5, post 10c.  
593D Wired ready to operate, \$6 post 10c.

#### DIAL KITS SCALE GOLD WITH WHITE LETTERS.

Size 6 3/4 x 2 1/2 in.  
• No. 459 to match 300 pf gang.  
Price .. \$4.30  
• No. 461 to match 200 pf gang.  
Price .. \$4.50  
Post 20c.

#### NEW AUDIO AMPLIFIER

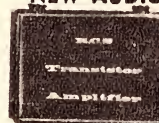

4 transistors.  
1/2 or 1 watt.  
Small size, cab-  
inet 3in x 2in x  
1 1/2 in. p i a s t i c.  
Suitable crystal  
P./up. Inter  
com., micro-  
phone, radio,  
etc. (9 volt).  
DO-IT-YOURSELF KIT 665, \$10 (Post  
10c). Wired ready for use 665D \$11.50

#### COILS & IF's 455 Kc

Aer, R.F. OSC. and IF's .. \$1.80 ea.  
Ferrite Aer. .... \$2  
No. 265 Universal tape OSC. Coils, \$6  
Postage 10c. Write for details and price.

**R.C.S. RADIO PTY. LTD., 651 FOREST ROAD, BEXLEY, N.S.W., 587-3491 587-5385**



to the P-type, and valence band holes moving from the P-type material to the N-type. As the applied forward bias voltage is increased, the predominance of majority diffusion currents increases rapidly as the "inbuilt" potential barrier of the junction is progressively eliminated.

The current passed by a forward biased P-N junction thus increases quite rapidly with applied voltage, its resistivity falling rapidly to a very low value. This is illustrated by the right-hand half of the diagram shown in figure 4.7.

The energy level diagram for such a forward biased junction is shown in figure 4.5(c). Note that the Fermi level  $E_f$  is not constant throughout the material, an immediate sign that equilibrium conditions have been upset. The relatively steep slope of  $E_f$  in the depletion layer region indicates the degree to which the "inbuilt" field has been attenuated, while the corresponding slope in the energy bands themselves indicates the extent to which this field remains.

The composition of the current passing across a forward biased junction will naturally depend upon the impurity doping concentrations of the P-type and N-type materials. If the doping concentrations are equal, the current will be composed of equal numbers of conduction band electrons and valence band holes; however, if one material has a higher doping concentration than the other, the corresponding majority carriers will predominate.

Hence the forward biased junction current of a heavy-P/light-N junction such as that of figure 4.4 will consist mainly of holes, while that of a light-P/heavy-N junction such as that shown in figure 4.3 will consist mainly of electrons. But it should be remembered that conduction band electrons have a greater mobility than valence band holes, and this fact will also influence the exact ratio of currents flowing across the junction:

It should perhaps be noted, in connection with the foregoing discussion of the composition of forward biased junction current, that the composition of the junction current in no way determines the composition of the current entering and leaving the semiconductor specimen from the external circuit. As we have seen, conduction in metallic conductors is effectively composed entirely of conduction band electrons; hence all current entering and leaving the P-N junction as a whole is of this form. What happens is that the "composition" of the current changes in the bulk of the material, due to the complementary mechanisms of "intrinsic" carrier generation and carrier recombination.

A further point to note regarding the forward biased P-N junction is that the width of the depletion layer region of a junction is narrower under forward bias conditions than for the equilibrium situation. This occurs because as we have seen the space charge of "uncovered" impurity ions in the depletion layer is intimately associated with the electric field and potential barrier. Hence when the latter are reduced in value, the space charge also reduces to correspond. The depletion layer thus contracts, leaving a smaller number of ions "uncovered."

If the external bias voltage connected to a P-N junction specimen is connected with the polarities reversed from the situation which we have just considered, its behaviour is somewhat different. This alternative arrangement is known as reverse bias and is illustrated in the diagrams of figure 4.6.

From figure 4.6(a) it may be seen that reverse bias involves the connection of the negative polarity of the external voltage to the P-type end of the specimen, and the positive polarity to the N-type end.

As before, a major proportion of such an applied potential difference is applied directly across the depletion

effectively extinguishes the diffusion currents altogether.

As before, the minority carrier drift currents are virtually unaltered by the new situation, because they are "saturated" or limited by the numbers of minority carriers generated in the material by excitation. However, the magnitudes of the minority drift currents are actually very small—with silicon P-N junctions of modern manufacture, they together usually amount to but a small fraction of a microamp.

In the equilibrium condition, of course, the majority carrier diffusion currents are of equally small and opposite magnitude. However as we have seen, the diffusion currents fall

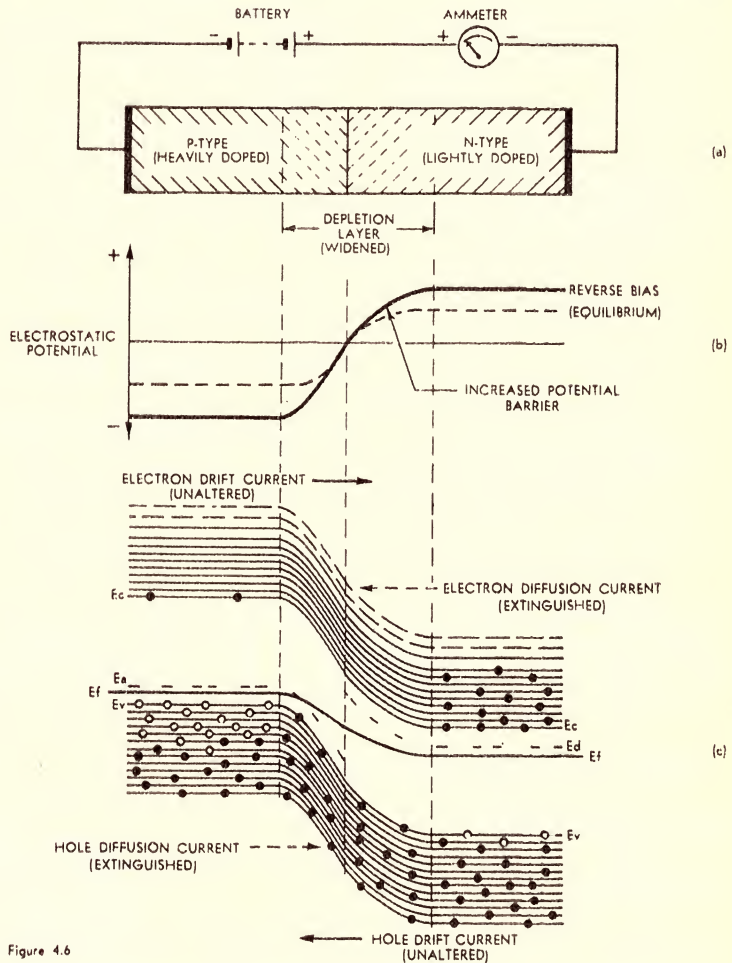

Figure 4.6

layer region, because of its high resistivity, and a second electric field tends to be set up across the depletion layer in addition to the "inbuilt" field. But in contrast with the forward bias case, in which the two fields opposed, here the two fields are acting in the same direction. The field across the depletion layer is therefore increased in intensity from its equilibrium value, rather than decreased.

The effect of this increase in field strength is to effectively increase the height of the potential barrier which majority carriers must surmount in order to diffuse across the junction. This is illustrated in figure 4.6(b). As a result, few if any majority carriers of either type are able to cross the junction, and the diffusion currents fall considerably from their equilibrium values. Increasing the reverse bias voltage beyond about 0.5V

away very rapidly with reverse biasing, virtually extinguishing for applied voltages greater than about 0.5V. For reverse bias voltages above this level the only currents drawn by a P-N junction are therefore the unopposed but very small minority carrier drift currents—the saturation currents.

The current drawn by a reverse biased P-N junction thus tends to increase only very slightly with increasing voltage, rapidly reaching a constant and very low value corresponding to the sum of the saturation currents. This is illustrated by the left-hand portion of figure 4.7.

The energy level diagram for such a reverse biased junction is shown in figure 4.6(c). Again it may be seen that the Fermi level  $E_f$  is not constant throughout the material, indicating non-equilibrium conditions. The steep slope of  $E_f$  again occurs in the



## C.M.I.

### CORONA MOISTURE INHIBITOR LUBRICANT FOR INSULATING AND LUBRICATING ALL ELECTRICAL EQUIPMENT MOISTURE INHIBITOR

#### LUBRICATING NON STAINING SPRAY

- FOR TV, RADIO AND ELECTRICAL EQUIPMENT.
- Apply spray to moisture or E.H.T. Corona arcing of any type under working conditions (after removing excessive dust deposits).
- E.H.T. Transformers prone to discharge can be sprayed whilst operating.
- Will extinguish small E.H.T. fires.
- Ideal for areas troubled by salt deposits — TV chassis and components, noisy pots, radio parts, etc.

SPRAY . . . ELECTRIC MOTORS, CONTACTS, TIMERS. TO REPEL MOISTURE.

SPRAY . . . AIRCRAFT, AUTOMOTIVE and MARINE IGNITION SYSTEMS. Including spark plugs, leads, etc. Industrial Control switches and Circuit Breakers.

NON FLAMMABLE—NON TOXIC.

- Recommended by Turner and TV Companies.
- Will not affect plastic components.

## HELMAR CIRCUIT CHILLER



Non Staining, Non Toxic, Non Flammable Spray.

- For quick identification of thermal breaks.
- For cooling resistors, transistors, diodes, etc.
- Prevents damage by overheating during soldering operation.
- Time saver when locating breakdowns.

Available in 12oz. Aerosol Packs.  
Trade price, \$1.73 ea. Tax included.

#### Aerosol Packs

Trade price 20oz. \$2.40 ea. 6oz.  
\$1.15 ea. Non Taxable.

## HELMAR CHEMICAL PRODUCTS

PTY. LTD.,  
P.O. Box 72, GLADESVILLE, 2111 N.S.W.  
Telephone Sydney 61-2810.

## HELMAR H. 9000

Silicone Grease. For the electrical Industry. Flammable During Application Only.

- As an Insulating Compound.
- Aircraft, Automotive and Marine ignition systems including spark plug connections.
- Insulators and bushings.
- Connecting junctions in wiring systems.
- Electrical assemblies.
- Terminals and connecting plugs.
- Industrial control switches and circuit breakers.
- Antennae.

REDUCES CORROSION ON Switch contacts. Band tightening screws. Battery terminals. TV aerials exposed to salt spray.

#### LUBRICATES

Rubber, plastic, leather, metals, etc. Lamp-bulb bases. Door seals.

#### SEALS OUT MOISTURE

Available in 16oz aerosol packs. Trade price \$3.45 ea. Tax included.

All products available from leading electrical wholesalers.

Wholesale and Trade Inquiries welcomed.

# PETER SHALLEY Electronics Pty. Ltd.

## New 5-WATT Base Station

### JUST RELEASED

#### FEATURES:

- Delivers a full 5-Watt Input Power to the Final Amplifier
- Operates on any of the 6 Citizen's Band Channels.
- Tone Call System for more effective communication
- Stable Crystal-controlled Receiver with RF Stage.
- For short distance communication, Battery Saver slide installed.
- Variable Squelch and full series of Jacks for PA, Mic, External Speaker, External Antenna and External Power connecting.
- All Die-cast Cabinet and Leather Case.

## Also PT51 - New Release

- 11 Transistors
- All metal
- Leather case
- Sep. Spkr. and Mic.
- Ear piece
- Squelch

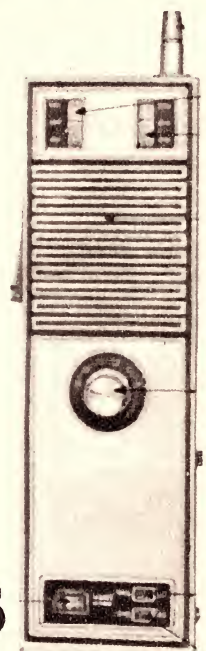

from **\$49.75**

127 YORK STREET (just near Town Hall)

29-7021 29-3767



depletion layer region, here signifying the extent to which the "inbuilt" field and the potential barrier of the junction have been increased. The full extent of the field present at the junction is indicated by the energy bands themselves.

In contrast with the situation under forward bias conditions, it may be noted that the depletion layer of a reverse biased junction is actually wider than for the equilibrium case. As before this occurs because of the intimate association between the space charge of "uncovered" impurity ions and the potential barrier. When the potential barrier is increased due to external reverse bias, the depletion layer therefore widens in order to "uncover" a correspondingly greater number of ions.

Because of this widening of the depletion layer the electric field intensity in the region does not increase as rapidly as it would if the layer width remained constant. However, it does steadily increase with increasing reverse bias, and inevitably a point is reached where one or another of a number of "breakdown" mechanisms occurs. When this occurs the effective resistivity of the junction again falls rapidly, and the current increases sharply from its basic "saturation" value.

The various mechanisms which may be involved when a reverse biased junction "breaks down" are each rather complex, and in fact not entirely understood; hence it will not be appropriate to examine them here in any detail. However, in broad terms the two main mechanisms involved are so-called field emission or Zener breakdown, and avalanche breakdown.

The field emission or Zener breakdown mechanism is usually that responsible for the breakdown of very heavily doped P-N junctions, which generally enter breakdown at reverse bias levels below about 6V. Due to the heavy doping concentrations in such junctions the depletion layer is very narrow, even under reverse bias conditions, and as a result of this the peak electric field intensity at the junction can be extremely high — of the order of  $10^6$  volts per cm, even at the low reverse voltages concerned.

When the electric field intensity reaches this order of magnitude, valence electrons may be effectively ripped from their orbit system, producing both a conduction band electron and a valence band hole. In short, the field itself produces electron-hole carrier pairs, and this explains the term "field emission." The carrier pairs thus produced in the depletion layer region are immediately swept away in opposite directions by the field, and as a result the junction current increases sharply from its saturation or "leakage" level.

**Avalanche breakdown**, the other main breakdown mechanism, is that usually responsible for breakdown in lightly doped junctions — generally those breaking down at reverse voltages above about 10V. As the name suggests, it is a mechanism whereby the minority carrier drift or saturation current itself effectively increases, due to an avalanching or "snowball" action.

In this type of breakdown the depletion layer is wide, both because of the light doping concentrations and as a result of the appreciable reverse

bias voltage. Because of this the minority carriers drifting across the junction are ultimately able to develop sufficient momentum that, when each collides with a fixed atom, it is effectively able to ionise that atom by "knocking out" one or more new carrier pairs.

Such "ionisation by collision" involves a net gain in the number of carriers crossing the junction, because each carrier upon collision with a fixed atom can effectively produce two or more carriers. Hence as a result the junction current again rises sharply from its saturation value.

It should be noted that neither of the "breakdown" mechanisms just described involves inherent damage to the P-N junction; in themselves, they are

ductor devices are in fact designed to operate continuously in the "breakdown" condition, as we shall see in later chapters.

We have seen in the present chapter that the P-N junction behaves in rather different ways when external bias voltage is applied, depending upon the polarity of that applied bias. In one direction it tends to conduct readily, whereas in the other direction it tends to conduct only very slightly. No doubt the thoughtful reader will have already realised that this behaviour is virtually identical to that of the familiar thermionic diode valve, and will have noted the resemblance between the curve of figure 4.7 and the voltage-current characteristic of a diode valve.

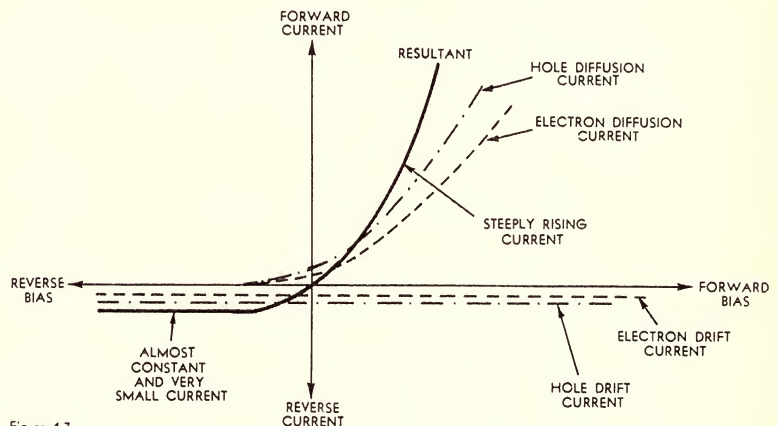

Figure 4.7

merely mechanisms whereby the current drawn by the junction under reverse bias conditions increases markedly from its low saturation value when a particular voltage level is reached. It may be seen that they are thus rather different from the type of "breakdown" which occurs when excessive voltage is applied to dielectric materials such as paper or plastic.

Whether or not a junction sustains damage when it enters "breakdown" is primarily determined by the very same factor which determines whether or not it sustains damage in the forward bias mode: the power dissipation. If the power dissipated in the semiconductor material — most of which is dissipated in the depletion layer region, because of its greater voltage drop — is sufficient to cause overheating and disturbance to the crystal lattice structure, then damage generally results. But if this level is not reached, then the junction will sustain no damage. Some junctions in practical semicon-

ductor devices are in fact designed to operate continuously in the "breakdown" condition, as we shall see in later chapters. It should therefore come as no surprise to learn that the P-N junction is in fact the heart of the modern semiconductor or "crystal" diode, a device used in large numbers in almost every branch of modern electronics. At the same time, P-N junctions either singly or in combination also form the basis of almost every other modern semiconductor device, so that in the foregoing discussion of the P-N junction we have not only been describing the theory of crystal diode operation, but also laying the theoretical groundwork for many of the later chapters.

In the next chapter we take a look at the practical aspects of semiconductor diodes, examining both their various physical forms and their applications. However, before passing to this material the reader might perhaps be well advised to glance back over the material which has been presented in the present chapter, to ensure that he has fully grasped the important concepts involved.

## SUGGESTED FURTHER READING

- BURFORD, W. B., and VERNER, H. G., *Semiconductor Junctions and Devices*, 1965. McGraw-Hill Book Company, New York.
- MORANT, M. J., *Introduction to Semiconductor Devices*, 1964. George G. Harrap and Company, London.
- SHIVE, J. N., *Physics of Solid State Electronics*, 1966. Charles E. Merrill Books, Inc., Columbus, Ohio.
- SMITH, R. A., *Semiconductors*, 1950. Cambridge University Press.





# FORUM

## Astronomy, colour of the moon and all that

If this instalment of "Forum" appears to jump abruptly from one subject to another, it is simply because we have a clipful of letters of that kind. In fact, a good many of them will need to be held over for a month or so, but here goes . . .

### Conducted by the Editor

**ASTRONOMY EXHIBITION:** From Mr C. W. Alexander, spokesman for the Astronomical Society of Victoria, comes the following letter which is both interesting and self-explanatory. After the usual opening courtesies, he says:

"Late in 1968, a proposal was placed before the Council of the Astronomical Society of Victoria to stage an exhibition in the Melbourne Town Hall in 1969. The proposal was accepted and, as a result, the exhibition will be held from Saturday 23rd to Tuesday 26th August.

"Since the adoption of the electric motor and the photocell to the telescope late last century, the science of astronomy has become more and more dependent on electronics to augment the limited abilities of the human body.

"More recently, since the invention of the transistor, the low cost and ready availability of small, lightweight components has provided amateur astronomers with an opportunity to use electronics to considerable advantage.

"The use of oscillators based on designs published in 'Electronics Australia' has permitted accurate drive of amateur telescopes. Precise timing devices using integrated circuit flip-flops have, in part, replaced the less accurate sidereal timepieces. Sensitive micro-voltmeters, coupled with sensitive photoelectric devices are being used to measure the relative brightness of astronomical objects. These and other devices are being used by amateur astronomers.

"With this in mind, I would like to invite readers of this most excellent journal to visit the exhibition on one or more of the dates mentioned. It is relevant to mention that there is plenty to interest children as well as adults.

"Among items on display will be telescopes large and small, astronomical equipment other than telescopes, photographs and colour motion films.

"As the director of the society's Astronautic Division, I am responsible for organising a display showing achievements in manned and unman-

ned satellite research. Material has been provided by NASA and the Hughes Aircraft Company."

(Signed) C. Alexander.

**COLOUR OF THE MOON:** Here's an argument which, strangely enough, appears to be going on in the highest circles — if "high" can be accepted in its oldest sense as being distance above the surface of the earth. It may well have been solved by the time you read this:

"Dear Sir,

"I have been reading 'Electronics Australia' for three years and I have always been impressed by the high standard of accuracy which it strives to maintain.

"I was surprised, however, to see in your July issue two photographs of the moon showing the surface to be brown in colour.

"According to the 'National Geographic Magazine' of May, 1969, the moon is grey, with no trace of any other colour. The 'National Geographic' quotes Lovell (page 620) as saying: 'The moon is essentially grey; no colour.' Anders says (page 616): 'All you really need is black and white film.'

"The magazine has several photo-



(RCA "Electronic Age")

graphs of the moon, all with no colour except black and grey and says (page 619): Apollo 8 crewmen personally assisted 'National Geographic' editors in making colour corrections on these photographs to conform with their observations.

"Why then do the photographs in 'Electronics Australia' show a brown surface?"

(S.W., Concord, N.S.W.)

The answer is very simple: The colour photographs were processed from official film taken by the Apollo 10 astronauts and released by NASA for publication.

We personally inspected quite a batch of official colour films and colour prints and they all showed the same brown tint. What is more, in direct broadcasts from the capsule, the astronauts described the colour of the moon surface as a pattern of lighter and darker shades of brown.

Prior to reproducing the photographs, we studied the colour balance of all the material available to us, having in mind the number of stages particular duplicates may have passed through, the different evaluation necessary for positive prints (as distinct from transparencies) the different times of the lunar day when the pictures were taken and the astronauts' verbal description of what they had seen. The pictures we published were the end result. There may be some room for argument about the final, subtle details of tonal cast and gradation but, one thing is certain, our pictures looked brown because the original copy was brown and because the astronauts said it should be brown.

This should be enough to shoot S.W. down in flames if it were not for one disturbing fact. The crew of Apollo 8 is sticking with their story and their pictures.

They can hardly contradict the crew of Apollo 10 and their cameras. All they're saying is that the moon they saw was grey!

Could the glass in the capsule have something to do with the different evaluation of colour? Does the light from the sun interact differently with colour film when the sun's rays are not filtered by passage through an atmosphere? Could it be that the astronauts became sufficiently disorientated in respect to colour values that they came up with seemingly conflicting information?

Following receipt of S.W.'s letter, I went looking for volunteers from among our technical staff to go along on a future Apollo mission and solve the arguments once and for all — but there were no takers. No ambition. That's what!



# HETERODYNING LIGHT TO PRODUCE RF

NORMANTON HOUSE,  
LAKE,  
NEAR SALISBURY.  
13th May 1933

Dear Sir,

Yours is an ingenious idea,  
but I see no likelihood of a practical outcome.  
The frequency of light is excessive, and the  
amplitude is exceedingly small. The sole reason  
for the energy manifested in light is the high  
frequency. Accordingly if you reduce the  
frequency, the energy becomes insignificant.  
The energy of the radio waves generated by Hertz  
was sufficient to cause sparks in metals on which  
it fell, which means a disturbance of a different  
order from anything attainable in light.

Yours faithfully,

*Oliver Lodge*

LASER: With the publication in this issue of a gas laser for use at tutorial and experimental level, it seems an appropriate time to reproduce a letter which was made available to us some time ago by a reader from Lower Hutt, New Zealand. In forwarding the letter, he explained:

Dear Sir,

When I was very much younger, the idea occurred to me that it might be possible to heterodyne two coherent light waves and, by a suitable detection method, produce a radio wave. The second light wave was to be produced from the first by means of a rotating mirror system using the Doppler Principle.

In those days Sir Oliver Lodge, although not active in the radio field, was well known to amateurs for his pioneer work and so I forwarded my idea to him for comment. His reply is enclosed and I think you will agree that it provides a clear indication of the type of man he was in that he was prepared to reply personally to what must have seemed a hare-brained scheme.

A recent news item mentions that oscillations in the radio spectrum have been produced from two laser derived light waves using the heterodyne principle and I thought that you might like to use this correspondence as an example of the well-known fact that ideas often have to wait a long time before the practical means of their implementation come to hand.

Yours faithfully, R.W.

To this reader, we would express our sincere thanks for the opportunity

to reproduce a most interesting piece of correspondence.

N.Z. BROADCASTING: Last month, we reprinted an article from a 1926 issue of "Wireless Weekly" in which it was seriously suggested that the future for broadcasting in New Zealand would best lie in direct re-broadcasting of Australian programs. Because of the time difference between the two countries, it might be necessary for the New Zealand Government to subsidise east-coast Australian stations so that they could broadcast additional early evening programs, to be available to New Zealand listeners at 8 p.m.

The scheme was not implemented although, up till fairly recently, there might have been plenty of New Zealand residents who, faced with such a limited choice of local programs, might have wished that it had.

To be entirely fair, one must also admit that, faced with the confusion of pop sound in their own country, a fair number of Australian listeners may have opted for the scheme in reverse!

In the face of this, it was interesting to chat for a while with Arthur Cushen, our "Listening Around The World" correspondent, who passed through Sydney on his way home from a most informative world tour of broadcasting organisations.

Arthur pointed out that the New Zealand Government is in the process of licensing a substantial number of additional radio stations, which will cater primarily for local areas. Their role will be rather similar to that

## UNITED TRADE SALES

PTY. LTD.

### MILLER TRANSISTORISED IF STRIPS

455 Kc Selectivity 5 Kc at 6db down.  
Power 6 Volts 2mA gain 50db.  
Price: \$9.70.

### TRIO TR2E

#### 2-METRE TRANSCEIVER

- Triple conversion receiver with crystal locked second and third oscillators for maximum selectivity and sensitivity.
- Separate VFO tuning for both receiver and transmitter.
- Nuvistor RF amplifier.
- Provision for crystal locking of the transmitter.
- 12 volts DC (internal transistor power supply) and 230-240 volts AC operation.
- Noise limiter and squelch.
- 17 tubes, 4 transistors and 7 diodes.
- 1 microvolt sensitivity for 10 db. S/N ratio at 14 Mc.
- "S" meter, RF output meter and "netting" control.

Price: \$282.

#### 3,000 TYPE RELAYS.

Large range.  
Only 50c each.

### NEW PIANO KEY SWITCHES

5 KEY, Special at 1.00 each.

### CAPACITORS

80 for \$2 in Poly Packed Bags.  
Mixed values only.

### VALVES

6J6 30c each. 815 70c ea. 807 70c each.  
6AC7 20c ea. or 12 for \$2.  
6C4 50c ea. 8020 35c ea.  
QS150/15 50c ea. 6H6 Metal 20c ea.  
QB2/250(813) New in sealed cartons,  
\$6 ea.

### TRANSISTORS

2SC73, 2SD65, 2T76, OC66, 2T65  
25c ea. or in 100 lots 20c ea.

### LSG11 SIGNAL GENERATOR

120KHZ to 260 MHZ New in sealed carton \$35, postage \$1.

Playtape Heads, new, \$1.50 ea.

### COMPLETE RANGE OF METERS.

P25's 24sq.  
100uA .. \$6.95 1mA .... \$4.50  
500uA .. \$5.25 50mA ... \$4.50  
10mA .. \$4.50 S'meter .. \$5.25

MULTIMETERS, 200H, 20K ohms per volt, \$11.25, inc. tax. CT 500 20K ohms per volt, \$15 inc. tax. CT 330 20,000 ohms per volt, \$17.25.

RESISTORS. Mixed Values only in Bags: \$2 per 100, or 50 for \$1.  
3,000 Type Relays. New stocks. 50c each. Plus postage.

### TRANSISTOR V.H.F. CONVERTER

Tunable 108-136 Mhz Aircraft Band 1F-600Kc to 1,000Kc. No connecting wires needed, 9V Battery, self-contained, just place alongside broadcast radio. Price only \$14.40 plus 45c postage.

### WANTED BUY:

RECEIVERS, TRANSMITTERS,  
TEST EQUIPMENT.  
All prices subject to alteration without notice.  
All items PLUS POSTAGE.

## UNITED TRADE SALES

PTY. LTD.

280 LONSDALE STREET,  
Melbourne. Phone 663-3815

Opposite Myers

Telephone  
Normanton, Salisbury  
"Lodge, Normanton, Amberbury"  
Amberbury is the station for goods  
Salisbury is a public area.



## RADIO: Unofficial history

During the set building boom of the early thirties, the manager of a small radio factory/showroom sited not far from the Sydney G.P.O. summoned his newest recruit on the assembly line—a big, shy country lad, named Jim.

The manager asked Jim to go to an address in George Street, near Central Station and pick up something he had just arranged for by phone. It was bulky but not heavy. The shop would be shutting for lunch but if Jim went straight away, he would be able to pick it up.

"Take a taxi," said the manager, "and get him to wait for you. He can drop you right back to the door."

Jim took the return taxi fare and while he might not have won any prizes for alertness, he was bright enough to realise that he would be well in pocket if he used a George Street tram instead. It would be a

pretty big parcel if he couldn't squeeze it in the rear driver's compartment on the way back.

Jim arrived at the address to find the owner impatiently waiting to lock up. No sooner had Jim identified himself, than the owner thrust the object at Jim, slammed the door and raced out into the street. The only trouble was that the "object" was a full-size unclad female model, which the manager wanted for a window display.

Jim was trapped. He couldn't retreat; he couldn't stay where he was; he could only go bravely forward.

That was why Jim ended up on the footpath near Central Square, at lunch-time, with his arm around a full-sized, unclad model, trying desperately to intercept a vacant cab.

What a way to begin a career in radio!

(Readers are invited to submit contributions to "RADIO: Unofficial History" and a publication fee will be paid for those used. Stories must be humorous and they must be true. Letters must be signed and the locale of the story indicated as a mark of good faith. The Editor reserves the right to re-phrase contributions as necessary to preserve uniformity of style.)

of commercial and provincial stations in Australia.

The interesting point for Australia is that these stations will have to share channels on the international broadcast band which are already occupied by Australian stations, some of them in the eastern states. Inevitably, this is going to foul up reception of these stations from what are now the fringes of their service area.

This new pressure on broadcast band channels must inevitably complicate the task of the Australian administration in pursuing their avowed policy of developing the medium-wave band to a satisfying limit; it will provide fresh argument for the development in both countries of UHF FM broadcasting.

In this context, we quote briefly from a letter to hand from Southern Broadcasting, P.O. Box 13076, Christchurch, N.Z.

Dear Sir,

Having followed the recent articles in your magazine regarding private radio for New Zealand, I feel sure that you will be interested to hear of the South Island's main applicant — Southern Broadcasting, now being formed into the Canterbury Broadcasting Company Ltd. Soon all business will be conducted under this new name, with the call sign for live shows and eventual transmissions being "Radio One."

Recent news items indicate that the first areas to be considered by the Authority will be Auckland, Hamilton and Dunedin, with the Christchurch and Wellington areas to be attended to after the forthcoming technical con-

ference with Australia, regarding allocation of frequencies.

*The Canterbury Broadcasting Company recording studios have been established at 115 Cashel Street, Christchurch, on the second floor of Whitcomb and Tombs Building; they will soon be handling recording work on a commercial basis.*

(R. B. Porter, Publicity Manager.)

In the face of the Australasian dilemma of too many stations and too few frequencies, it is interesting to contrast the viewpoint taken by Britain's Postmaster General. In saying this, it is necessary to concede that the problems are by no means identical. A news release from the British Post Office reads as follows:

"The Postmaster General, the Rt. Hon. John Stonehouse M.P., has rejected Mr Hughie Green's view that 100 local radio stations could be provided on medium wavelengths. A team of Post Office experts has just completed a detailed examination of his proposals and their conclusions were sent to Mr Green today.

"Mr Green submitted two feasibility studies to the Post Office. Both would have involved the use of directional aerials for some stations, including those for London and Manchester. They would also have involved the use of medium wave frequencies allocated to other countries, under the terms of Article 8 of the 1948 Copenhagen Plan. The Post Office conclusion is that, even by day, not all the stations Mr Green proposed would give satisfactory reception; and, that for the remainder service areas would in general be so reduced after dark as to be com-

pletely unsatisfactory. For example, the station proposed for London would cover only 10 per cent of the Greater London Area after dark.

"Post Office studies reaffirm the conclusions set out in the Government's White Paper on Broadcasting (Cmd. 3169 para. 32 December 1966) that "no general service of local sound broadcasting, which would be available during the hours of darkness as well as in daylight, can be provided only on medium wavelengths allotted to the United Kingdom."

"Notes for Editors: The Postmaster General the Rt. Hon. John Stonehouse M.P. is about to begin his review of the current local radio experiment. When this is completed, he will decide the future for local radio.

"The European Broadcasting Convention 1948 (The Copenhagen Plan) allocated medium wave frequencies for broadcasting services for the European area. Article 8 enables administrations to use frequencies allocated to another country, provided this use would not cause interference to existing services and only if the country to whom the frequency was allocated agrees. Because of the widespread interference on medium wavelengths, especially after dark, the United Kingdom has never invoked Article 8 for United Kingdom domestic broadcasting services."

Having directed attention to the British scene, it is perhaps appropriate to conclude this month's Forum with a letter from an English reader:

FLUORESCENT LAMPS: "I would like to comment on the subject of interference caused by fluorescent lamps, as mentioned by G.B. in the May, 1969, issue.

"Firstly, the power factor correction capacitor is about 8uF for an 80W lamp and is of a type that is largely ineffective at RF anyway.

"In the U.K. the choke and capacitor are often in one sealed ballast unit and the capacitor cannot be cut out of circuit separately. The whole unit has to be replaced. A separate suppressor capacitor is fitted, about .02uF, connected across the lamp itself.

"In my experience, fluorescent lamps always cause some interference at radio and television frequencies, the level of the interference rising as the lamp nears the end of its useful life.

"Interference at television frequencies can sometimes be reduced by fitting a small choke in series with each lead to the lamp, as is done in the brush leads of universal motors. However, it doesn't always work out as well as it might.

"I once spent quite a while experimenting with suppression on a fluorescent lamp in a service department where I was working. I first tuned a receiver to a spot on the band where the interference was worst. Then, using various combinations of chokes and capacitors, I succeeded in eliminating the interference completely — only to find that it has been worsened at other frequencies.

"I can't help but feel that there is no complete answer to this problem."

(F.K., Hawkhurst, Kent, England.) ■



# ENCEL'S AUDIO GUIDE

*"Electronics  
Australia"  
August, 1969*



Mr. Alex. Encel discusses a problem with one of Encel's service technicians.

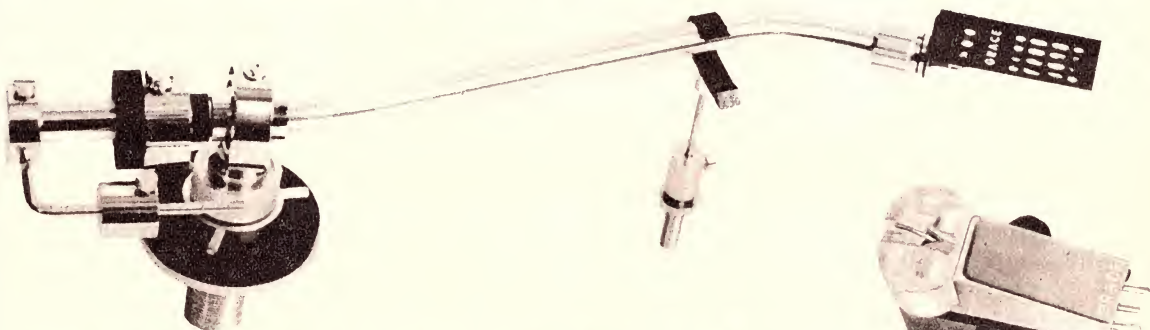

## A NEW, PRECISION MADE TONE ARM—THE GRACE MODEL G-545

Although they've been available only a few months, Grace tone arms are already prized by the audio enthusiast. This new model, the G545, is a winner . . . it will track down to  $\frac{1}{4}$  gram with suitable cartridges and features a gimbal type gyrosopic bearing system. An ultra light weight head shell is supplied . . . and the new arm shape reduces tracking error to the point where this factor may be disregarded.

The main counter balance weight is divided into two for easier, more precise balancing. Sub-weight adjustment sets stylus pressures from 0 to 3 grams. The arm accepts all Ortofon/SME type headshells without modification and all "New Generation" cartridges. Tracking ability of this fine tone arm is best demonstrated with stylus pressures below one gram. Ask for an EMQ or call at Encel Stereo Centres in Melbourne or Sydney for a demonstration.

## TOP PERFORMING GRACE MODEL F-8M STEREO CARTRIDGE

With an output of 7 mV, and a frequency response of 5-35,000 Hz., the Grace F-8M stereo cartridge tracks down to  $\frac{1}{4}$  gram — recommended stylus pressure being  $\frac{1}{2}$  grams. An elliptical diamond stylus 0.2 x 0.8 mil. is standard equipment, tip mass is 0.75 m/grams, and total cartridge weight is only 6 $\frac{1}{2}$  grams. Cross talk is less than —30 dB. at 1 kHz. Musical performance rivals many stereo cartridges selling at twice the Encel price. Write for complete specifications and for prices . . . better still, call and compare when you listen to several top quality cartridges.

**ENCEL**  
ELECTRONICS (STEREO)  
PTY. LTD.

Head Office:

431 Bridge Rd., Richmond, Victoria 3121. Tel. 42 3762.

Sydney Store: Ground Floor, 2SM Building.

257 Clarence Street, Sydney, N.S.W. 2000. Tel. 29 4563, 29 4564.

Australia's Greatest Hi-Fi Centre \*Wholesalers \*Trade-ins accepted



THIS IS THE HEART  
OF A MODERN  
HI-FIDELITY STEREO  
HOME MUSIC  
SYSTEM

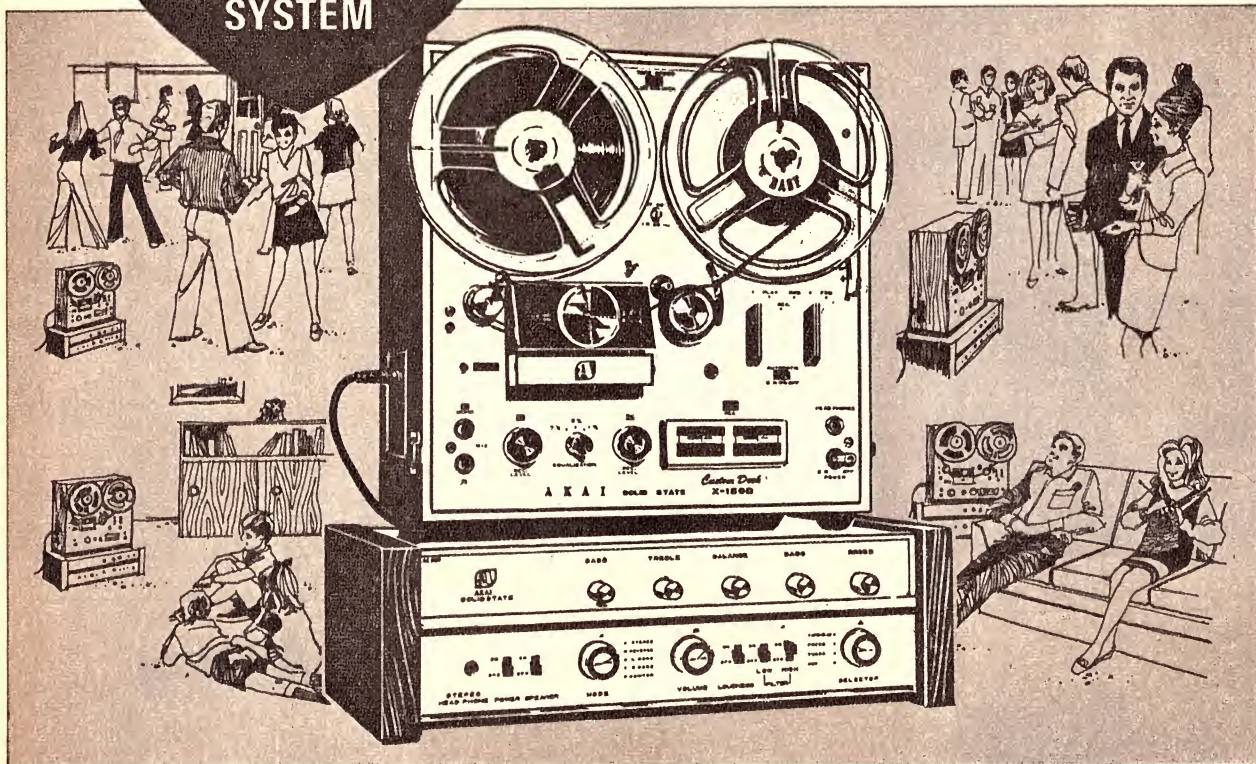

The AKAI fully transistorised Model X150D tape deck plus the AKAI Hi-fidelity AA5000 amplifier (both illustrated) plus your choice of AKAI SW130, SW150 or SW160 loudspeaker systems.

- You can add speakers around your barbecue area, patio or any number of rooms, operated at the flick of a switch.
- You can add a record player to give an alternative system of discs as well as tapes (or make six-hour tapes from your own favourite discs).

But the first step is the important one. Buy the system you can add to—the system that never dates and insist on **matched** AKAI components.

From here on, with this basic system, you can never be out of date.

For full details on the comprehensive AKAI Hi-fidelity music system for your home, see

**AKAI**

**ENCEL**  
**ELECTRONICS (STEREO)**  
**PTY. LTD.**

Head Office:  
431 Bridge Rd., Richmond, Victoria 3121. Tel. 42 3762.  
Sydney Store: Ground Floor, 25M Building,  
257 Clarence Street, Sydney, N.S.W. 2000. Tel. 29 4563, 29 4564.  
Australia's Greatest Hi-Fi Centre \*Wholesalers \*Trade-ins accepted

MI 489



# LUX AMPLIFIERS ARE UNEQUALLED FOR VALUE, QUALITY AND PERFORMANCE



## THE NEW LUX SQ-1220 SOLID STEREO AMPLIFIER OVER 100 WATTS R.M.S. TOTAL OUTPUT!

The new and outstanding Lux SQ-1220 is rated at over 50 watts R.M.S. into an 8 ohm speaker load. Distortion is so minute it is difficult to measure even at high outputs. 40 transistors and diodes. Frequency response is 10-50,000 Hz.  $\pm$  1 dB. Provision is made for separate bass and treble controls in each channel, low and high filters, frequency selectors and tape monitoring. Ask for complete and unabridged specifications for this sophisticated Lux amplifier. Performance can only be described as superlative. Encel price (including Sales Tax) **\$350**

## LUX MODEL SQ-505 SOLID STATE STEREO AMPLIFIER

Rated at 30 watts R.M.S. per channel, the all new Lux Model 505 is a silicon transistor unit. Power transistors are designed to withstand temporary short circuits and overloading — overall frequency response is 10-50,000 Hz. plus or minus 1dB in the power amplifier and 20-50,000 Hz. plus or minus 2dB in the pre-amplifier. Controls and features include volume, balance, mode selector, treble/bass controls, filters, tape monitor, headphone jack, exclusive A/B speaker systems selector, etc. All in all the Lux SQ-505 is a very fine amplifier. **\$259**

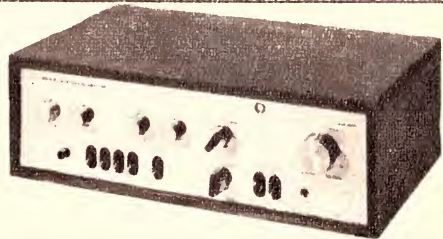

## LUX MODEL SQ-606 SOLID STATE STEREO AMPLIFIER

Rated at over 30 watts R.M.S. per channel, the handsome new Lux Model SQ-606 is an all-silicon unit with 27 silicon transistors. Power transistors are designed to withstand temporary short circuits and overloading. Overall frequency response is 10-50,000 Hz.  $\pm$  1 dB. Acoustic performance is quite outstanding. Controls and features include volume, balance, mode selector, treble/bass controls, filters, tape monitor, headphone jack, etc. All in all the SQ-606 is a very fine amplifier, attractively priced. Inc. sales tax **\$219**

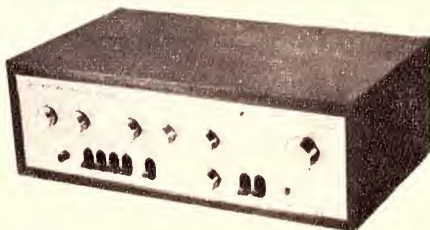

## LUX SOLID STATE STEREO AMPLIFIER — THE MODEL SQ-77TW — \$169

Using silicon power transistors the SQ-77TW is rated at 30 watts R.M.S. in each channel with a 4-6 ohm speaker load. Frequency response is 10-50,000 Hz. plus 0, minus 3dB. Input sensitivity is 1.8mV for magnetic pickup or tape head, aux. inputs being rated at 200 mV and 800 mV. Controls include stereo volume, stereo balance, mode switch, treble and bass (separate controls for each channel), input selector, head-phone jack and switch, tape monitor switch, rumble and scratch filter switches, etc. (including Sales Tax) **\$169**



## NEW LUX MOVING MAGNET STEREO CARTRIDGE

The Lux T-15-M has been acclaimed as a brilliant performer by discriminating audio enthusiasts — frequency response is conservatively quoted at 20-20,000 Hz. and stylus pressure is from 1 to 2½ grams. Tracking angle is 15°, output is 5 mV. at 1 kHz. Stylus sizes available are 0.7 mil. conical diamond and the new elliptical diamond (T-15-ME). T-15-ME: \$29.50. T-15-M7B (conical diamond stylus) Inc. **\$24.50**  
Sales Tax .....

## EXTRACTS FROM REVIEW OF LUX SQ1220 INTEGRATED AMPLIFIER APPEARING IN "HI FI NEWS" JANUARY, 1969.

"Here, then, is an amplifier of Japanese origin which conforms very closely (on some counts, better!) to the published specifications" . . . "The amplifier was run for several weeks under domestic conditions with a wide range of programme sources, pickup cartridges and speakers and at all times it performed perfectly and without flaw." . . . "Nice to look at, nice to use and very well made and designed, I vote the Lux SQ1220 a top-of-the-class amplifier which, I am sure, will hold its own with the best of the other Class-B designs now available."

## EXTRACTS FROM REVIEW OF LUX SQ77 AMPLIFIER APPEARING IN "HI FI SOUND" FEBRUARY, 1969.

"Both design and construction reach very high standards of electronic engineering. Some idea of the excellence of the design of the amplifier can be gleaned from the illustrations. It is also note-worthy that the components employed are of good quality and reasonably rated, especially the mains transformer, so normal servicing should not cost much from one year to the next." . . . "After running the amplifier for several weeks in a typical domestic environment with all sorts of signals and sources, and not encountering any troubles or even mere shortcomings on my ordinary dynamic speaker systems of various kinds, I have no hesitation at all in voting this one of the most worthy of amplifiers I have had the pleasure of testing for a long time. For the power that it delivers and the way it is made it is well worth its price."

# ENCCEL

**ELECTRONICS (STEREO) PTY. LTD.**

Head Office:  
431 Bridge Rd., Richmond, Victoria 3121. Tel. 42 3762.  
Sydney Store: Ground Floor, 25M Building  
257 Clarence Street, Sydney, N.S.W. 2000. Tel. 29 4563, 29 4564.  
Australia's Greatest Hi-Fi Centre \*Wholesalers \*Trade-ins accepted



# Some electronics engineers say Willi Studer is a genius.



## The new REVOX A77 is certainly a fine tribute to his rare talents.

Since its recent release the Revox A77 stereo tape deck has been acclaimed by professionals and tape enthusiasts all over the world. Read this excerpt from a recent review in "Hi-Fi Sound" . . .

*"This recorder is a masterpiece of electronic and mechanical engineering . . ." "The electronic function and motor control system certainly sets a new standard in deck design and performance which, coupled with the really high fidelity electronic performance, puts this new range of REVOX recorders in the connoisseur class."*

### What will your New Revox A77 do for you?

You will make and replay tapes to professional standards—many REVOX recorders are used for precisely this purpose. Every desirable facility is there — sound-on-sound, multi-play, echo, on-off tape monitoring, playback to both European and American equalisation standards. Add to these features calibrated VU meters, electronic speed change for the two tape speeds of  $7\frac{1}{2}$  and  $3\frac{3}{4}$  i.p.s., 3 motor tape transport system, use of silicon planar transistors . . . and you get a frequency response of 30-20,000

Hz. +2, -3 dB at  $7\frac{1}{2}$  i.p.s., a signal-to-noise figure of better than 58 dB. and a wow and flutter figure of a maximum 0.08% at  $7\frac{1}{2}$  i.p.s. Space does not permit detailing of the complete specifications of the REVOX A77. Unabridged data is available now. The REVOX A77 stereo tape deck is on continuous demonstration!

Ask for a trade-in valuation on your old equipment, or, if you cannot come to town, ask for your personal EMQ\*. You'll save more *and more* at Encel Electronics! Call or write now!

\*Encel Mail Quote.

**ENCEL**  
**ELECTRONICS (STEREO)**  
**PTY. LTD.**

Head Office:

431 Bridge Rd., Richmond, Victoria 3121. Tel. 42 3762.

Australia's Greatest Hi-Fi Centre \*Wholesalers \*Trade ins accepted



# SOUND

## THE BIG NAME IN IMPORTED AMPLIFIERS!

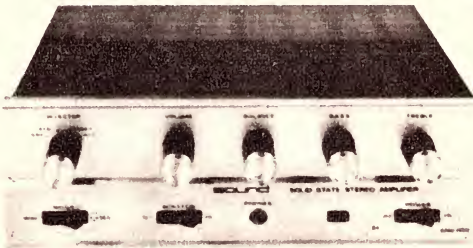

**SOUND MODEL SAQ-203 SOLID STATE STEREO AMPLIFIER**

Frequency response is 30-20,000 Hz, and input sensitivity suits magnetic cartridges at 3 mV. Output is 12 watts R.M.S. or 30 watts E.I.A. peak power, 18 low noise transistors and diodes. Headphone jack, all necessary controls, attractive front control panel. Speaker matching for 4, 8 and 16 ohm speakers or speaker systems. An ideal compact amplifier for use with tape recorders or for building into cabinets and bookshelves. Inc. sales tax

**\$74.50**

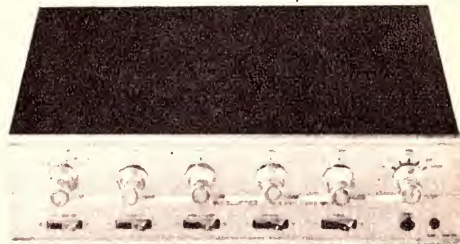

**SOUND MODEL SAQ-505X SOLID STATE STEREO AMPLIFIER**

With an output of 50 watts R.M.S. into 8 ohm speaker systems, the 505X represents outstanding value for money. Frequency response is 20-20,000 Hz.  $\pm 1$  dB, and extends well beyond this range, 20 transistors and diodes. Sensitivity is 3 mV. for magnetic cartridges and all desirable control facilities are incorporated. This powerful amplifier is bargain priced by Encel Electronics at only

**\$119.50**

### SEE THE NEW GRUNDIG STENOIRETTE AT ENCEL'S!

If you need a dictating system, be sure to see the Grundig Stenoirette Model L at Encel Stereo Centres in Melbourne or Sydney. This fine tape cassette machine features a remote control microphone so you can control recording, playback, forward and backspace facilities without moving from your chair. Ask for the complete details and for your special Encel price. Your new Stenoirette will cost you far less than you thought possible!

### GRUNDIG PORTABLE/OFFICE DICTATING SYSTEMS

Away from your office you use the Grundig EN3 electronic notebook and record your reports, notes, memos and instructions on an instant loading 44 minute cassette. It is a completely transistorised battery operated dictating machine which fits in your pocket. In the office the AC operated Grundig EW3 transcriber offers every desirable facility for speedy typing of recorded matter. Foot or keyboard control, fast erasure for security, internal speaker they're all there. Ask for a special price on both units at Encel Electronics stores in Melbourne or Sydney. You'll save more and be left with spending money!

### NEW COMPAX TURNTABLE FEATURES BELT DRIVE—ONLY \$39.50

Belt driven around the perimeter of its 12in non-ferrous platter, the wow and flutter figure of the new Compax III turntable is an amazing .04%. The 12-pole synchronous motor is completely sealed—a unique speed selecting mechanism (pat. applied for) permits choice of 33-1/3 or 45 r.p.m. speeds. The rubber mat on the turntable is of anti-static material. Encel price inc. sales tax **\$39.50**

### POWERFUL PUBLIC ADDRESS AMPLIFIER OFFERS AN OUTPUT OF 35 WATTS R.M.S.—\$73.50

Once more stocks of the Planet MG-300 public address amplifier have arrived. Parallel push-pull 6BQ5s are used in the output stages. Frequency response is 30-15,000 Hz. plus or minus 2 dB. Inputs suit two crystal/dynamic microphones at 5 mV, and an auxiliary input with 300 mV. sensitivity suits tuners, tape recorders, etc. Output impedances include 8 **\$73.50** 15 and 250 ohms as well as a 70V line. Inc. sales tax



## STOP PRESS!

### ENCEL TEST REPORT ON THE SOUND SAQ-505 AMPLIFIER

Our laboratory test report indicates that the actual power output of the unit is 24 1/2 watts R.M.S. per channel. Frequency response is substantially flat, being down 2 dB at 20 Hz, and down 1 dB at 20 kHz. Square wave tests at 1kHz, and 10 kHz, are excellent and show little variation in the audible ranges.

### CANBERRA ENQUIRIES FOR ENCEL EQUIPMENT

If you live in Canberra and you want further information on Encel equipment, please phone Canberra 81-1667.

### LOOKING FOR AN ADC CARTRIDGE? SEE ENCEL ELECTRONICS WITHOUT DELAY!

A full range of renowned ADC cartridges is now available and Encel prices cannot be advertised. However you can overcome this tragedy by writing for a personalised quote or a trade-in valuation. You'll save more at Encel Electronics!

### CASSETTE RECORDERS

If you're looking for a cassette type recorder, write or call at your nearest Encel Stereo Centre for an EMQ. We are not at liberty to reveal the current cash prices for popular cassette recorders through advertising.

### LOW PRICED MICRO MOVING MAGNET STEREO CARTRIDGE—THE MODEL 2100/5 ONLY \$14.50.

With an input sensitivity of 5 mV, the new Model 2100/5 stereo cartridge has a frequency response of 10,28,000 Hz plus minus 3 dB and a tracking angle of 15 deg. Tracking pressure recommended is 1.3 grams; channel separation is 30 dB at 1kHz. Listening to this Micro cartridge can be quite deceptive—some music lovers thought they were hearing a cartridge three times as expensive! A conical diamond stylus is standard equipment. Inc. sales-tax **\$14.50**

With specifications that demand attention and most effective quality control in manufacture, it's not surprising that Sound stereo amplifiers command a high proportion of the markets in their respective price ranges. In Australia Encel prices make Sound amplifiers better value than ever. Ask for a trade-in valuation when you write or call!



**NEW MICRO VF-3100 SERIES STEREO CARTRIDGES PROVE MOST POPULAR EVER!**

With a frequency response of 20-28,000 Hz, and channel separation of 28 dB, the Micro VF-3100 series cartridges have already established new performance standards for lower priced magnetic cartridges. Two models are available, the VF-3100/E with elliptical diamond stylus and the VF-3100/S with a conical diamond stylus. Stylus for both cartridges are replaceable; both track effectively at 1 1/2 grams.

### EXTRACTS FROM REVIEW

In "Electronics Australia," Page 119, February 1969, speaking of the Micro VF3100/E cartridge the following comments were made—"frequency response checked out at plus or minus 2 dB from 30 Hz. to 20 kHz. . . . very good performance indeed."

### LOW PRICED CERAMIC CARTRIDGE FOR BUDGET CONSCIOUS MUSIC LOVERS!

The popular Micro SC-301 cartridge has now been superseded by the new, improved Model SC303D. Only the price remains the same! Frequency response is 20-15,000 Hz, and tracking angle is 15 degrees. With diamond stylus **\$6.90** inc sales tax



**MICRO DUST PICKUPS—\$3.50**

An effective automatic record cleaner which removes dust as the record plays. An ideal gift. **\$3.50** inc. sales tax.

# ENCEL

## ELECTRONICS (STEREO) PTY. LTD.

### Head Office:

431 Bridge Rd., Richmond, Victoria 3121. Tel. 42 3762.

### Sydney Store: Ground Floor, 2SM Building.

257 Clarence Street, Sydney, N.S.W. 2000. Tel. 29 4563, 29 4564.

Australia's Greatest Hi-Fi Centre \*Wholesalers \*Trade-ins accepted



# JBL Precision loudspeaker systems and amplifiers by James B. Lansing

JBL has long enjoyed the reputation of the 'musician's loudspeaker', 'the speaker of the stars' and the first choice of exacting professionals.

Among the readily recognised names who have chosen JBL systems for their personal listening are: Count Basie, Harry Belafonte, Shelley Berman, Rosemary Clooney, Lucille Ball, Duke Ellington, Dean Martin, Frank Sinatra... and at least 70 other well-known Hollywood stars. JBL is the choice of Richard Nixon, Hubert Humphrey, the Presidential Palace, Mexico, the Royal Palace in Bangkok and distinguished people in many parts of the world. JBL Studio Monitors are used by leading American recording companies and the American Broadcasting Corporation.

**JBL Lancer 101**, illustrated. Designed to meet studio monitor standards of reproduction, with reserves sufficient to fill an auditorium. It is one of many loudspeaker systems, solid state amplifiers/preamplifiers and other ultra-sophisticated sound equipment from JBL.



## GOLDRING 60 YEARS OF SOUND BUSINESS

Goldring G99 transcription unit

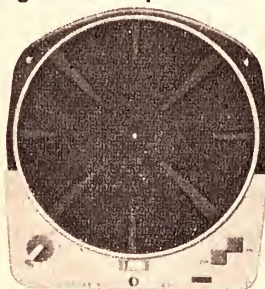

The G99 is a sophisticated transcription unit for advanced enthusiasts who prefer to choose and mount a separate transcription arm. It employs the same kind of drive arrangement as the Goldring-Lenco GL 75 with 4-pole constant velocity motor, infinitely variable speed adjustment and automatic disengagement of the idler wheel. Rumble and hum are negligible. Maximum wow and flutter is 0.2%. Non-magnetic, die-cast, 8 lb. turntable. Click suppressed switch circuit, Neon pilot light and neon-lit built-in stroboscope are extra refinements.

Goldring-Lenco GL75 transcription unit



Integrated transcription motor unit and arm, built to instrument standards of quality and appearance. Unique drive system with constant velocity 4-pole motor with conical shaft coupled to the underside of the turntable by a knife-edged idler (automatic disengagement). Die-cast turntable weighs 9 lbs.; is non-ferrous, dynamically balanced. Transcription arm has knife-edge bearings, full balancing facilities, calibrated stylus pressure adjustment, 'anti-skating' bias compensation and hydraulic lowering device.

Goldring '800' series free field stereo cartridges

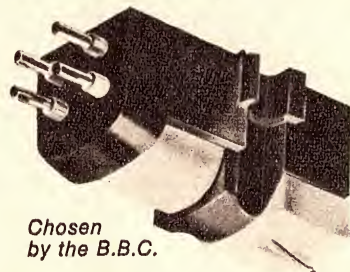

Chosen by the B.B.C.

With a choice of the finest cartridges anywhere in the world, BBC engineers chose the Goldring '800' series. They recognised the unparalleled advantages of the 'free field' system in re-creating the finer shades of original sound. In these cartridges a very lightweight tube of magnetic material lies in a 'free field' generated by a fixed source coupled to a low mass diamond point. They feature low mechanical impedance, tracking at 1 to 3 grams (800) and 0.75 to 2 grams (800E), screening from external hum fields, gold-plated contacts. Stylus is replaceable.

# ENCEL

**ELECTRONICS (STEREO) PTY. LTD.**

Head Office:

431 Bridge Rd., Richmond, Victoria 3121. Tel. 42 3762.

Sydney Store: Ground Floor, 25M Building

257 Clarence Street, Sydney, N.S.W. 2000. Tel. 29 4563, 29 4564.

Australia's Greatest Hi-Fi Centre \*Wholesalers \*Trade-ins accepted



# SONICS

## LOW COST, HIGH PERFORMANCE SPEAKER SYSTEMS FROM ENCEL ELECTRONICS!

Separate speaker systems are essential if you wish to exploit the full potential of your amplifier, tape recorder or radio. Sonics speaker systems are beautifully finished in selected walnut/teak veneers, are styled to blend with period or modern decor and are extremely effective from an audio point of view. The following models are the most popular.

**MODEL AS-60E:** Although only 18 3/8in x 12 3/8in x 5 1/4in the AS-60E is fitted with a bass/mid-range speaker and a separate high frequency reproducer. An excellent speaker system which has proved very popular with audio enthusiasts. Hand finished teak/walnut cabinet. Inc. **\$27.50** Sales Tax.

**MODEL AS-61:** A true "Slimline" enclosure with four bass/mid-range speakers and a high frequency reproducer. Measures only 4 3/8in depth; height is 21 3/8in and width is 17 3/4in. Finish is teak/walnut and the legs are detachable. Probably the most popular multiple speaker system ever offered at this price in Australia. Inc. Sales Tax. **\$38.50**

**MODEL AS-202:** A 3-speaker, 3-way system which measures 20 7/8in x 11 5/8in x 11 5/8in. The AS-202 is a recent addition to the Encel Sonics range. An 8in woofer and a 6 1/2in mid-range speaker are incorporated — and a high frequency reproducer completes the speaker complement. Will handle 10 watts R.M.S. with ease. Beautiful hand finished teak/walnut cabinet. Inc. Sales Tax. **\$46.50**

**MODEL AS-220:** A most effective 3 way speaker system with an 8" bass reproducer, a 6 1/2" mid-range speaker and a high frequency reproducer. Cabinet size is 20 1/8" x 11 5/8" x 11 5/8" and the front grille features a timber fret which matches the teak-walnut veneer cabinet. Handles 10 watts R.M.S. easily. Inc. sales tax **\$56.50**

**MODEL AS-303:** A magnificent hand finished teak/walnut speaker system with three speakers and a 3-way crossover network. A 12in woofer with a long throw voice coil provides excellent bass response, a 6 1/2in mid-range speaker covers the middle ranges and a horn type tweeter comes in at 5kHz. Power handling capacity is over 15 watts R.M.S. Extremely wide frequency response free of coloration. Size 25 1/2in x 14 1/2in x 11in. Inc. **\$68.00** Sales Tax.

**MODEL AS-251:** This is a new deluxe 3-way speaker system with a 10in bass reproducer, a 6 1/2in mid-range speaker and an exponential horn tweeter. A 3-way crossover network assures smooth response over the total range of 40-20,000 Hz. Dimensions are 13in x 22 1/2in x 11 1/2in and finish is in oiled teak/walnut veneer. Encel price including Sales Tax. **\$78.00**

**MODEL AS-330:** The deluxe system of the Sonics range. It is a 3-way system with five speakers including a 12in bass reproducer, a pair of mid-range speakers and two exponential horn type tweeters. The attractive cabinet is hand finished in teak/walnut figured veneer has a most attractive timber fret grille and measures 15 3/8in x 26in x 11 5/8in. Overall frequency response is 30-20,000 Hz. Carefully selected crossover frequencies provide a smooth and musical performance over the frequencies specified. Encel price inc. sales tax is **\$98.50**

**IMPORTANT:** All "Sonics" enclosures are 8 ohms impedance

### SONICS STEREO HEADPHONES FROM \$9.50

The popular Model HS-304 offers fatigue free listening on a personal basis. The headset is very comfortable even over lengthy periods. Price? Only \$12.50 The Models HS-305 and HS-303H (High impedance) are also available. Frequency response is 20-15,000 Hz. and the price only \$9.50. All models have foam rubber earpads. From **\$9.50**

## GET YOUR LOWTHER LOUDSPEAKER AT ENCEL'S AND SAVE



### PM 6 Mk. 1

Gap flux 17,500 gauss.  
Total flux: 196,000 maxwells.  
Frequency range: 20-20,000 Hz.  
Impedance: 15 ohms.  
Capacity: 20 watts.  
Weight: 7lb.

The special design of the PMG drive unit preserves the fundamental to harmonic relationship throughout the entire audio range, thereby ensuring smooth, natural sound. Designed especially to meet the requirements of horn-loaded operation, the PM 6 should never be used as a conventional direct radiator.

### PM 7

Gap flux: 19,650 gauss.  
Total flux: 250,000 maxwells.  
Frequency range: 20-20,000 Hz.  
Impedance: 15 ohms.  
Capacity: 20 watts.  
Weight: 9lb.

The generation of 19,650 gauss from such an efficient mass is the culmination of years of research to improve both available magnetic materials and construction techniques. The increased force in conjunction with a new patented speech coil of very high efficiency give an overall attack and transient response, which has never before been achieved in such a compact unit. The PM 7 may be used as an alternative to the PM 6 in all Lowther systems where maximum efficiency and optimum performance characteristics are required.

Extracts from review in "Hi-Fi News":  
"On switching on the first action was to turn down the volume control due to its high sensitivity. . . . Even more striking than this was the remarkable high note response. The effect of this was to bring all sounds closer to the listener as it were. . . . the source appeared to approach closer than the writer has ever experienced before. . . . a remarkably smooth top response."

Call or write now for a special Lowther price—you'll save more at Encel Stereo Centres in Melbourne or Sydney!

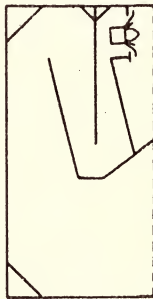

Here is a cross section of the Lowther Acousta speaker enclosure. Plans will be provided or complete cabinets are available in your choice of several popular polished or oiled finishes. Prices on request.

## FOUR HIGH QUALITY MICROPHONES FOR USE WITH YOUR TAPE RECORDER

### LONDON LM-100

An omni-directional dynamic dual impedance microphone with a response of 50-15,000 Hz. An ideal general-purpose unit—robust and designed to withstand studio or field use. Ask for complete specifications. Encel price inc. sales-tax.

**\$9.75**



### LONDON MODEL LM-200

A dynamic cardioid dual impedance microphone with balanced output and a frequency response of 50-15,000 Hz. Discrimination at 180 deg. eliminates unwanted background noise. Natural recordings are possible even under unfavourable acoustic conditions. Weight is only 4 1/2oz including the cable. Ask for complete specifications. Encel price inc. sales-tax.

**\$16.85**

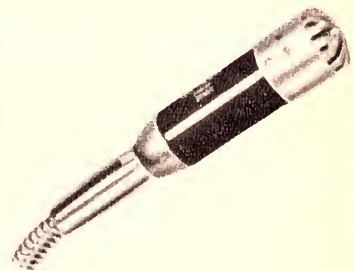

### SWEDISH PML MICROPHONES MODEL RD-36.

Probably the most popular of the PML range is the Model RD-36, a dynamic cardioid dual impedance microphone with a frequency response of 30-20,000 Hz. This slender microphone is recommended for high quality sound recording; even under the most unfavourable conditions it solves problems arising from feedback and background noise. Ask for complete details. Encel price inc. sales-tax.

**\$47.00**

### NEW PML CONDENSER MICROPHONE MODEL EC-71 — ONLY \$102.

A new solid state miniature cardioid condenser microphone with a frequency response of 40-18,000 Hz. Weight is only 1 1/2oz and size only 2 1/8in x 1 1/8in. The PML EC-71 is used by many professionals, and is ideal for use with the Revox A77 tape deck. Encel price includes the power supply.

**\$102.00**

# ENCCEL

**ELECTRONICS (STEREO) PTY. LTD.**

Head Office:  
431 Bridge Rd., Richmond, Victoria 3121. Tel. 42 3762.  
Sydney Store: Ground Floor, 2SM Building,  
257 Clarence Street, Sydney, N.S.W. 2000. Tel. 29 4563, 29 4564.  
Australia's Greatest Hi-Fi Centre •Wholesalers •Trade-ins accepted





# PHILIPS

hi  
fi  
HIGH FIDELITY INTERNATIONAL



**GA 202 "ELECTRONIC" RECORD PLAYER** — the high fidelity record player with electronic brain. (Pre Amp. optional.)

Magneto Dynamic Pickup Cartridge  
Individual electronic controlled precision speed setting for 33 1/3, 45 and 78 R.P.M. ■ Absolutely noiseless  
■ Light actuated automatic stop at the end of record ■ Free floating suspension ■ Fully balanced low mass resonance — free pick up arm  
Sound proof encapsulated motor  
The pick up arm and turntable assembly of the "202 Electronic" were given a free floating suspension to isolate them completely against shock and vibration.

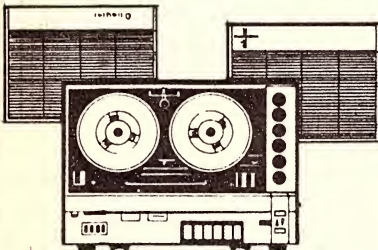

### N 4408 STEREO REEL TO REEL TAPE RECORDER

Horizontal or vertical operation  
Stereo — Mono record/Playback ■ 3 speeds 7 1/2, 3 3/4, 1 7/8, I.P.S. Max 7" Reel ■ 4 Tracks ■ Mixing parallel play ■ Sound on sound ■ Duoplay  
Stereo speaker — headphones can be adapted ■ Solid state amplifier  
Dynamic microphone — one for each channel recording ■ Dimensions 19" x 13" x 8 1/2" ■ Weight 28 1/2 lb

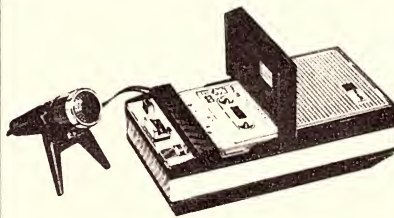

### EL 3302 PORTABLE CASSETTE RECORD/PLAYBACK

Record/Playback up to 2 hours per cassette ■ Two Tracks ■ Dynamic directional with remote control Microphone ■ 5 type C flashlight batteries plays up to 20 hrs. ■ Can be adapted to AC, with Power Transformer (optional) ■ Complete with fitted carrying case, microphone, Cassette and Patch cord ■ Can be fitted in a car together with Car Cradle N6705 enabling you to record and playback music in a car.

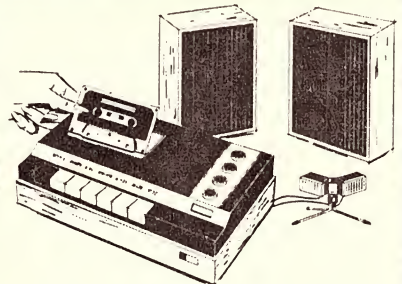

### EL 3312 STEREO CASSETTE RECORD/PLAYBACK

TRACKS 4 (Stereo) 2 (Mono)  
TAPE SPEED 1 7/8" I.P.S. ■ PLAY/RECORD up to 2 hours ■ 2 Satellite speakers ■ Solid State ■ Frequency response 60 — 10,000 HZ = 3 dB  
■ Output 2 x 1.8 watts ■ External speakers/stereo head phones external amplifier (optional)

# ENCEL

**ELECTRONICS (STEREO) PTY. LTD.**

Head Office:  
431 Bridge Rd., Richmond, Victoria 3121. Tel. 42 3762.  
Sydney Store: Ground Floor, 2SM Building,  
257 Clarence Street, Sydney, N.S.W. 2000. Tel. 29 4563, 29 4564.  
Australia's Greatest Hi-Fi Centre \*Wholesalers \*Trade-ins accepted



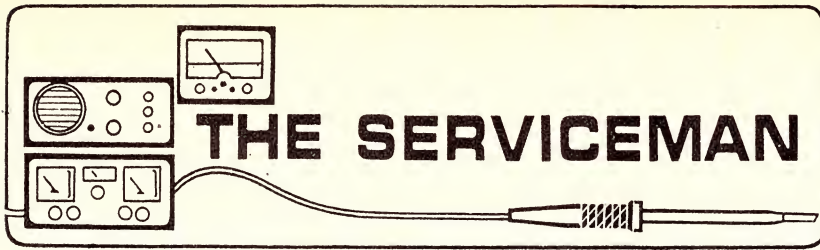

## The portable that fixed itself: Ugh!

What is it that a fly-by-night serviceman doesn't mind but an established serviceman dislikes? Answer: An inconclusive service job; a fault that he is almost certain will recur.

One such job came my way when a client of many years standing brought in a transistor portable receiver with a request that I "have a look at it sometime, when you've got an odd half-hour."

He explained that there were several transistor portables around his house and there was certainly no great hurry for this particular one. It didn't matter if he didn't see it for another month — or more. "Just have a look at it when you can."

As it happened, the next couple of weeks were pretty busy and the portable just sat on the shelf where I had put it. Apart from all the other work, there was another reason why it sat there. It was an odd make, quite unknown to me and one for which I had no circuit diagram. Unless it turned out to be a straightforward fault, I could see myself wasting a lot of time, either getting hold of a circuit or poking around blindly in its unfamiliar innards.

And if the fault turned out to be a "dud" transformer or something, I would be in even more strife.

In due course, however, the uncommitted half-hour did turn up and I reached the set down off the shelf and switched it on. The signals forthcoming were barely audible and horribly distorted. All the stations seemed to be coming in in their right positions, however, and this seemed to indicate that the trouble was in the audio system.

Unfortunately, systematic prodding around the components which could be reached above the printed wiring board made not the slightest difference and dispelled any hope that I was going to find some simple dry joint, needing only to be re-soldered to restore law and order.

There wasn't much scope, either, for checking voltages from the top of the board but I did establish with the multimeter that any active voltages were negative, indicating that the transistors were PNP types. If there were any type numbers on the transistor bodies, they would not have been visible without removing them completely from the board, and I had not the slightest inclination to do this if I could avoid it.

But continued probing did turn up one very strange reading. One lug on the loudspeaker frame had a potential of -9V, the other just enough to nudge the pointer off the stop. Either the

lugs weren't the voice coil connections that they appeared to be, or there was something very wrong somewhere.

Could there be a short circuit? Was the battery perhaps discharging through the voice coil? With this thought in mind, I switched the set off and, with the meter connected across the battery, switched the set on again. The battery voltage hardly budged, which would not have been the case had there been a heavy drain from it.

There was nothing for it but to get more deeply involved so, without much enthusiasm, I unclipped the ferrite rod aerial and took out the screws holding down the printed wiring board. This done, and with the dial knob removed, I could tilt things up enough to see underneath the board.

To minimise the risk of a short circuit, I slipped a couple of layers of heavy paper under the edge of the board, to keep it away from the metalwork and the loudspeaker.

It was at this point that I noticed what I couldn't see earlier: There was a third lug on the loudspeaker frame carrying a capacitor. Switching on again, I read the voltage on all three. Two of them read -9V, the remaining one, the same small negative voltage that I had noticed before.

Switching the set off, I clicked the ohmmeter round to its safest ohms range — low voltage and low current — and took a reading of resistance between the mysterious lugs. Between two of them, I read about 50 ohms.



"You see colour on your black and white set? Well, whaddya wanna fix it for?"

Between these two and the remaining one was a much higher resistance that changed as I watched it. When I reversed the leads, I got another reading, that also changed. Obviously enough, I was reading some circuit which contained an electrolytic capacitor.

Still none the wiser, I turned my attention to the output transistors on the board. They were obvious enough, because they were larger than the rest and fitted with flag heat sinks. The type numbers were obscured however; I couldn't be sure about the connections and the pigtailed were so short, anyway, that I wasn't even sure about the configuration. All I could establish was that there was -9V on one of the connections, no voltage on a couple of others and a very small voltage on the rest.

I might have been staring a fault in the face, or a perfectly normal distribution of voltages in some weird and wonderful output stage configuration, involving voice coil feedback. Oh for one swift glance at a circuit; either that or I was in for a job of circuit tracing!

At that stage the phone rang and I switched the set off while I went to answer it.

Five minutes later, I came back, switched the set on again — and was greeted by beautiful music! To say that it rocked me would be to put it mildly.

Once again, I went over the board pushing and prodding, but, this time, nothing I could do would stop the set. It just played on and on.

What about those strange voltages then?

This time, a check on the loudspeaker lugs showed -9V on each of them. On the output transistors, two connections — apparently collectors — showed -9V; two others — emitters — were very close to chassis potential, with the bases very slightly forward biased.

It seemed obvious enough that the circuit was a straightforward class-B system, involving a centre-tapped loudspeaker voice coil. Apparently, one side of the circuit had been open when I first attacked the set, accounting for the odd voltages and suggesting some other possible circuit configuration.

I checked the leads and the relevant part of the wiring pattern very carefully without finding any hint of a fault. And that, of course, left the finger of suspicion pointed rigidly at the loudspeaker.

Fair enough, except that I could not be optimistic about getting a replacement unit and inquiries hadn't turned one up about a week later, when the owner called in to see whether his set was "going again." In fact, it had been running for the best part of a week on the shop battery saver, with never a falter.

Which put me in the awkward position of having to tell the owner that the set was now working fine — except that I hadn't fixed it! What was more, it would keep on working fine until it broke down again!

When I explained the position, the owner was keen to take it away and see how long it would work — particularly when he heard it playing away so lustily. This, despite my talk of an intermittent fault and a job "half-done."

Since there was no guarantee that



# NOW AVAILABLE IN AUSTRALIA WELLER TEMPERATURE CONTROLLED SOLDERING IRONS!

## Weller Temperature Control.

The tip temperature controls the iron! Using the CURIE POINT principle the ferrite pellet in the tip changes its magnetic state precisely at the control temperature.

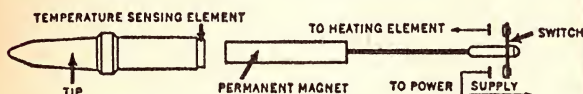

This attracts or repels the permanent magnet opening or closing the heater element switch contacts.

## The only control factor is the actual tip temperature.

No matter how long a Weller W-TCP unit has been idling, it is always ready for use at the selected temperature.

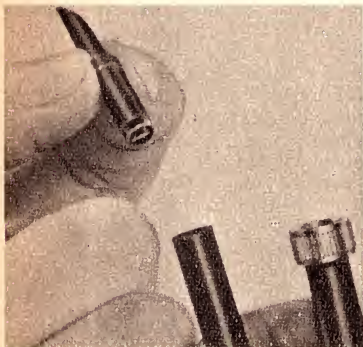

## With Weller you don't change the iron—you simply change the tip.

Four temperature ranges  
500°-800°F (260°-430°C)

Seven tip styles  
1/32-3/16" (0.8-5.0 mm.)

Total of 24 tips available for one Weller TCP—soldering iron.

**Important:** Pre-tinned iron plated tips must never be filed!

## Advantages of Weller W-TCP Soldering Iron

1. Temperature Control — prevents component damage—eliminates burning of solder and flux—ensures consistent results
2. Safety Factors—low voltage iron operation—burn-resistant silicone flex
3. Plated Tips—extra long-life—no filing required
4. Speed of operation—faster warm-up time
5. Less fatigue—light, well-balanced design



The W-TCP unit as illustrated is available boxed complete with—TCP-1 low voltage (24V) soldering iron—PU-1A Power Unit 240V 60W INPUT, 24V 2 Amp OUTPUT

## DISTRIBUTORS:

Available from leading electrical retailers and hardware stores.

## Trade Enquiries

### N.S.W.

1. General Accessories Pty. Ltd.
2. Cema (Distributors) Pty. Ltd.

### VIC.

1. General Accessories Pty. Ltd.
2. Cema (Distributors) Pty. Ltd.

### S.A.

1. General Accessories Pty. Ltd.
2. Cema (Distributors) Pty. Ltd.





I would be able to find and fit a loudspeaker of the right shape and size, I couldn't argue too volubly.

And the service fee?

I could have been tough and demanded payment on a strict time basis.

The owner could have been tough and adopted the attitude: "No fixee; no payee."

As it was, we were both happy enough to split the difference in the knowledge that, if it failed again, I wouldn't have to spend a lot of time looking for the trouble. It would be a matter of either finding a replacement loudspeaker or saying: "Vellee Sollee."

I fear, however, that this is one story that should conclude with the words "To be continued."

Rather ironically, hard on the heels of my writing the above story, came another similar situation. At least it was similar in some respects. It was another portable, of Japanese origin, and of a make I knew nothing about. This latter situation was probably explained by the fact that it had been purchased by the customer on an overseas tour. And, also as in the case of the previous set, the complaint was distortion.

But there most of the similarity ceased. This was no job that I could put on the shelf until a spare half hour presented itself. On the contrary, the customer had bought it as a present for his son's birthday, an event which was only a couple of days away. He was, understandably, most anxious to have it ready by that time.

On test there was no question about the distortion. While not gross, as in the previous case, it was quite bad enough to disturb even an average listener. Quite naturally, I imagined the trouble would be in the audio section.

Thinking thus I opened the case with the intention of identifying the appropriate section and components. As I did so I was agreeably surprised to realise that the makers had had the good sense to paste a copy of the circuit inside the back of the case. To be sure, it was a very small copy of a quite complex circuit; so small in fact that I needed a magnifying glass to read it and many of the decimal points associated with component and voltage values had been lost in the reproduction. Nevertheless, it was a tremendous help in getting the "feel" of the set.

My first impulse was to try to feed some audio signal into the system at the volume control. Unfortunately, the potentiometer terminals were so effectively "built out" that it was impossible to get a test prod near them. On the other hand, it was relatively easy to get at the transistor pigtailed from the top of the board, so I decided to make a voltage check and find my way around the board in the process.

I checked through all the DC voltages on the audio section, which turned out to be a fairly standard push-pull, class "B" output stage, preceded by a driver and voltage amplifier. The only discrepancy I found was in the latter stage, where the bias divider network did not tally with the circuit. According to the circuit this should have been a 47K resistor as the "top" half and a 4.7K in the "bottom" half.

The circuit also showed the collector voltage on this stage as -4.3V. In fact, the top half of the divider was a 22K and the collector voltage was down to -2V. Since this suggested that the transistor was running a good deal closer to saturation that the circuit designer intended, it seemed reasonable to suppose that this could be causing distortion.

Thus encouraged I released the board from its mounting and tackled the 22K pigtailed from the underside. I soon had it loose and replaced it with the recommended 47K. Then I made another check. The voltages on the stage were now within acceptable tolerance of those shown on the circuit. The only snag was, it didn't seem to have made any worthwhile improvement in the distortion level. So much for that theory.

At this stage I made another attempt to feed signal into the audio stage, and with rather more success. The volume control terminals were still out of reach, but I was able to feed it into the base of the transistor, which amounted to much the same thing. As a result of this test I was quickly convinced that there was nothing wrong with the audio section; any level of signal up to out put stage overload could be handled without distortion.

In the light of this I had no option but to accept that the trouble was in the front end. I studied the circuit again and established that it consisted of a self-oscillating mixer, followed by two IF stages. For obvious reasons, no AGC voltage was applied to the mixer and for reasons best known to the designer, it was applied to only one, the first, IF stage.

While a little surprised at this, I was more interested in whether the AGC system was working as intended, since a failure here could be one possible cause of front-end distortion. Accordingly, I connected the VTVM across the AGC line where it came away from the detector. This indicated that ample AGC voltage was being generated from local signal.

Following this I made a thorough check of the front end of the set. I checked all voltages shown on the circuit, and a few others besides, but could find nothing amiss. I unsoldered transistors from the board and checked them in a checker, again with negative results. I even measured resistor values, where it appeared they must be right by reason of associated voltages, just in case there was some "silly" situation where there was more than one fault, and that one was obscuring the other. As before, no result.

Finally, after a couple of hours solid checking and rechecking, I was forced to the conclusion that there was no fault in the receiver, as such. The alternative by implication, was that the set had always been that way, that it was an inherent defect, and essentially a problem of design.

Assuming that I accepted this theory, what aspect of the design was most likely suspect? My mind turned immediately to the AGC system; the fact that there was only one IF stage under control, that the AGC voltage was not only "ample" but, now that I come to think about it, probably a bit more than "ample."

A further check around the controlled stage seemed to confirm this.

Measurement of the transistor's behaviour showed that it was being biased to cut-off even on moderate signals. Was the distortion occurring in the stage by reason of excessive AGC voltage or was it occurring in this second stage because, in spite of the cut-off condition of the first stage, the second stage was still being asked to handle too much signal? Or was it a little of each? In any case it was still only theory. I would have to prove it before I could even think about how to cure it.

Another glance at the circuit suggested a possible solution to the first part of the problem. The second IF stage employed a conventional emitter resistor suitably by-passed. Lifting the by-pass would introduce considerable degeneration, possibly reducing the AGC voltage to a more reasonable value. It would also increase this stage's ability to handle large signals. Of course the gain would be lowered, but it might at least help prove the point.

It took only a few seconds to unsolder one end of the by-pass, whereupon the distortion vanished completely. And, while the gain had undoubtedly been lowered, the effect of this was far less noticeable than I had anticipated. In fact, had I not known, I would not have realized that the set was any different in this respect. As well as the local stations, several of the nearby country stations were clearly audible in daylight; a rough test I often employ when judging the performance of such sets.

All of which seemed to suggest that I had both proved a point and found a cure in the one operation. Would I be justified in returning the set to the owner in this form and regarding the problem as solved?

As I saw it, the basic fault was one of set design, rather than a faulty component. More specifically, the second IF stage should have had at least a proportion of the AGC voltage fed to it. But should I attempt, or be expected, to modify the set along these lines? Quite apart from the fact that the finer points of such circuitry were not something I could quote off the cuff, there were the very practical problems associated with the need to accommodate extra components, and to modify a circuit on a printed wiring board. In short the ideal solution appeared to be impractical.

Which meant, in simple terms, that the owner could have the much simpler and more practical alternative, or nothing. And, knowing how anxious he was to have the thing in working order for the formal presentation in a few days' time, I felt sure that he would settle for this compromise.

Not that I was particularly happy with the idea myself. I prefer a straightforward situation where one can nominate a faulty component, replace it, and restore the equipment to proper working order.

When he called to collect the set, I explained the situation as best I could in non-technical terms. He didn't seem to be particularly worried once I had demonstrated that the set could still give a good performance and remarked that it would only be used around the local beaches anyway.

So everyone was happy. ■



another achievement in  
fine quality stereo from Tempo...



## the **TEMPO** Series 2000 modular stereo system

The new TEMPO 2000 Series, designed and manufactured in Australia, incorporates the latest solid state integrated circuit design. The three separate modular units are attractively finished in oiled walnut, and can be arranged to suit any room. Amplifier and record changer/player unit incorporates the new Garrard 2025 TC automatic changer, and can, for those who prefer manual operation, be used as a player. The Garrard 2025 is fitted with a wide range ceramic cartridge and micro-lift for easy track selection. The two loudspeakers are designed to complement the performance of the amplifier unit, and are perfectly matched, both in quality and appearance, to the TEMPO 2000 amplifier.

**DETAILED SPECIFICATION.** Power Output: 8 watts per channel (8 ohm load) IHFM 16 watts total MUSIC POWER. 5 watts per channel (8 ohm load) RMS. Distortion: Total Harmonic distortion less than 1% measured at 5 watts RMS. Frequency Response: 35 Hz to 50 kHz  $\pm$  2dB. Damping Factor: 10 at 8 ohms. 20 at 16 ohms. Inputs: Pickup. Tape. Tuner. Sensitivity: All inputs 80 mV for full output. Bass control: Continuously variable, plus/minus 10dB at 100Hz. Treble Control: Continuously variable, plus/minus 10dB at 10 kHz. Balance Control: Zero to maximum either channel. **TUNER SECTION.** Sensitivity: 4 Microvolts. Bandwidth: 8 kHz. Tuning Range: 530-1620 kHz. Antenna: Internal ferrite rod. Ext. ant. provision.

Distributed by  
**MAGNECORD SALES & SERVICE**  
276 Castlereagh Street, Sydney. Phone 61-9881.

MC.E10.68



# What is a Fatal Current?

This article, reprinted from "Service Scope,"\* sets out what is currently known about the effects of various values of electric current on the human body.

Strange as it may seem, most fatal electric shocks happen to people who should know better. Here are some electro-medical facts that should make you think twice before taking that last chance.

Offhand it would seem that a shock of 10,000 volts would be more deadly than 100 volts. But this is not so! Individuals have been electrocuted by appliances using ordinary house currents of 110 volts and by electrical apparatus in industry using as little as 42 volts direct current. The real measure of a shock's intensity lies in the amount of current (amperes) forced through the body, and not the voltage.

While any amount of current over 10 milliamps (0.01 amp) is capable of producing painful to severe shock, currents between about 100 and 200 mA (0.1 to 0.2 amp) are lethal.

Currents above 200 milliamps (0.2 amp), while producing severe burns and unconsciousness, do not usually cause death if the victim is given immediate attention. Resuscitation, consisting of artificial respiration, will usually revive the victim.

From a practical viewpoint, after a person is knocked out by an electric shock it is impossible to tell how much current passed through the vital organs of his body. Artificial respiration must be applied immediately if breathing has stopped.

Chart 1 shows the physiological effect of various current densities. Note that voltage is not a consideration. It is important only inasmuch as its value, plus the body resistance between the points of contact, will be the two factors which determine how much current flows through the body. Because the resistance varies over an extremely wide range, it is impossible to nominate voltage in terms of dangerous levels.

As shown in the chart, shock is relatively more severe as the current rises. At values as low as 20 milliamps, breathing becomes laboured, finally ceasing completely even at values below 75 milliamps.

As the current approaches 100 milliamps, ventricular fibrillation of the heart occurs — an unco-ordinated twitching of the walls of the heart's ventricles.

Above 200 milliamps, the muscular contractions are so severe that the heart is often forcibly clamped during the shock. This clamping protects the heart from going into ventricular fibrillation, and the victim's chances for survival are good.

The reason that victims of high-voltage shock usually respond to artificial respiration more readily than the victims of low-voltage shock may well be the merciful clamping of the heart, owing to the high current densities associated with high voltages. However, lest these details be misinterpreted, the only reasonable conclusion that can be drawn is that 75 volts are

just as lethal as 750 volts.

The actual resistance of the body varies depending upon the points of contact and the skin condition (moist or dry). Between the ears, for example, the internal resistance (less the skin resistance) is only 100 ohms, while from hand to foot it is closer to 500 ohms. The skin resistance may vary from 1,000 ohms for wet skin to over 500,000 ohms for dry skin.

When working around electrical equipment, move slowly. Make sure your feet are firmly placed for good balance. Don't lunge after falling tools. Kill all power, and ground all high-voltage points before touching wiring. Make sure that power cannot be accidentally restored. Do not work on underground equipment.

Don't examine live equipment when mentally or physically fatigued. Keep one hand in your pocket while investigating live electrical equipment.

Above all, do not touch electrical equipment while standing on metal floors, damp concrete or other well grounded surfaces. Do not handle electrical equipment while wearing damp clothing (particularly wet shoes) or while skin surfaces are damp.

Do not work alone! Remember the more you know about electrical equipment, the more heedless you're apt to become. Don't take unnecessary risks.

In the event of an accident cut voltage and/or remove victim from contact as quickly as possible — but without endangering your own safety. Use a length of dry wood, rope, blanket, etc., to pry or pull the victim loose. Don't waste valuable time looking for the power switch. The resistance of the victim's contact decreases with time. The fatal 100 to 200-milliampere level may be reached if action is delayed.

If the victim is unconscious and has stopped breathing, start artificial respiration at once. Do not stop resuscitation until medical authority pro-

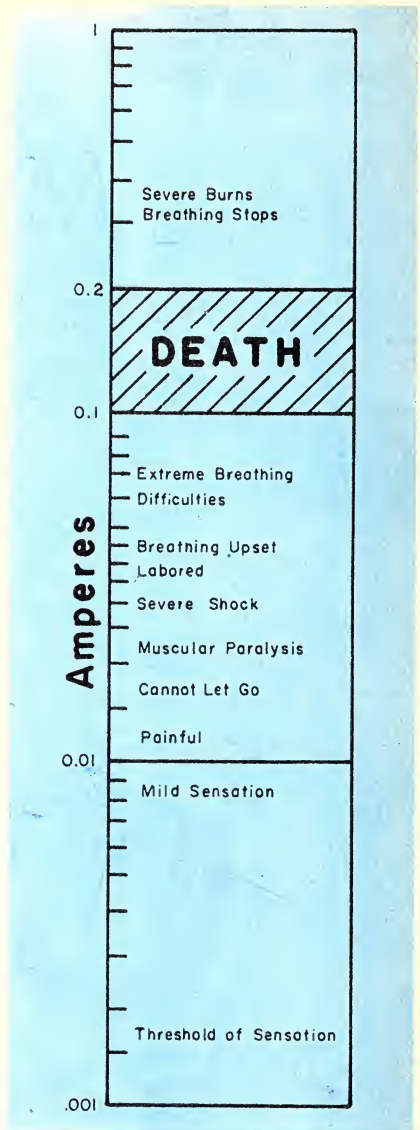

nounces the victim beyond help. It may take as long as eight hours to revive the patient. There may be no pulse and a condition similar to rigor mortis may be present; however, these are the manifestations of shock and are not necessarily an indication the victim has succumbed.

## TEN COMMANDMENTS OF ELECTRONIC SAFETY

1. Beware of the lightning that lurks in an undischarged capacitor lest it cause thee to be bounded upon thy backside in a most ungentlemanly manner.
2. Cause thou the switch that supplies large quantities of juice to be opened and thus tagged, so that thy days may be long on earth.
3. Prove to thyself that all circuits that radiate and upon which thou workest are grounded, lest they lift thee to a high-frequency potential and cause thee to radiate also.
4. Take care that thou use the proper method when thou takes the measure of high voltage, that it not incinerate both thee and the meter; for verily, though thou hast no account number and canst be easily replaced, the meter doth have such and shall bring great woe upon the supply department.
5. Tarry not amongst those who engage in intentional shocks, for they are surely non-believers and not long for this world.
6. Take care thou tamper not with inter-

- locks and safety devices, for this shall incur the wrath of thy seniors, and unlease the fury of the safety officer down upon thy head and shoulders.
7. Work not with energised equipment; for if thou dost, thy buddies will surely be buying beers without thee, and thy space at the bar will be filled by another.
8. Verily, verily, I say unto thee: never service high-voltage equipment alone; for electric cooking is a slothful process, and thou mightest sizzle in thine own fat for hours before thy Maker seeth fit to end thy misery, and draw thee into His fold.
9. Trifle not with radio-active tubes and substances, lest thou commence to glow in the darkness like unto a lightning bug.
10. Commit thou to memory the words of the prophets, which are written in the Instruction Books; they give thee the straight dope and steer thee away from error.

—Anonymous.

\* Published by Tektronics Inc. Oregon, U.S.A.



# THE MAGNIFICENT WORLD



**Model X-2000**

## THREE MOTORS AUTO. REVERSE CUSTOM DECK — X-2000

\*4 track stereo/monaural recording and playback \*CROSS-FIELD HEAD \*3 motors, 3 speeds \*Solid state pre-amplifier with two integrated circuits \*Sensing tape continuous reverse (Auto. reverse) \*Manual reverse \*Magnificent oil-finished wooden cabinet \*For increased stereo enjoyment, use the matching amplifier AA-6000, 120 watt solid state amplifier and the matching speaker SW-160, AKAI 4 way, 6 speaker system with high and midrange level controls.

Prove it by the sound!  
.....prove it with

**AKAI**<sup>®</sup>  
CROSS-FIELD HEAD

AKAI AUSTRALIA PTY. LTD.: 276 Castlereagh St., Sydney, N.S.W./146 Burwood Rd., Hawthorn, VICTORIA/399 Montague Rd., West End, Brisbane, QUEENSLAND/8 Arthur St., Unley, S.A./579 Murray St., Perth, W.A. HOMECRAFTS: Petrie St., Canberra, A.C.T. J.B. YOUNG: Giles St., Kingston, A.C.T.





# A READER BUILT IT

## Car Burglar Alarm System

Those who have had the unpleasant experience of their car being broken into and rifled in their absence will appreciate this idea for a car burglar alarm. Operated by the automatic door light switch, it causes the horn to sound a few seconds after an illegal entry has been made into the vehicle.

When set, the car burglar alarm sounds the horn for a pre-determined time when either front door is opened. The on/off switch is inside the car, so the unit has built-in delays for entering and leaving without operating the alarm. To leave the car without triggering the unit a delay occurs after S1 is closed. The delay results from the time taken for C2 to reach Z1 breakdown voltage when charged through R5. With C2 charged, opening the door will cause TR1 and TR2 to conduct, with almost 12V appearing across R3. At the same time, C1 is charged and will hold TR1 on after the door is closed.

To allow the car to be entered with time to switch off the unit before it operates, the voltage across R3 feeds the delay (R7, C4 and Z2) at TR4. If the unit is not switched off TR4 conducts, picking up the relay, and the horn sounds. The horn will continue to sound until C1 discharges, causing TR1 to reduce the potential across R3 until it drops below that required for Z2 to hold TR4 in the conducting state.

The sequence detailed above occurs if the door is closed quickly after the illegal entry has occurred. However, if the door is left open, C1 would not discharge, and the horn would then operate continuously, until the car's battery was flattened. To prevent this, an additional transistor (TR3) has been added. This has a delay circuit similar to that of TR2 and TR4. When triggered, and the door is left open, it discharges C2, which cuts off TR2 and opens the supply to TR4, thus stopping the horn.

For a more detailed system, further switches may be added, as shown in the circuit. These could be at any point where thieves could gain entry (back doors, bonnet and boot, for example). When connected as shown, they will not operate the roof light.

### NOTES:

D4 protects TR4 by providing a path for the back EMF generated when the relay operates.

The relay contacts are in parallel to

distribute the large current drawn by the horn, and thereby contributing to longer contact life.

The horn relay contacts and earth contacts should be heavy gauge wire. D1, D2 and D3 block positive feeds via the lamp, etc.

R11 and R12 provide discharge paths for C2 and C3.

The circuit should operate with relay coil resistances of between 200 ohms and 1K.

Substitute transistors could be used. When components other than those specified are used, it may be necessary to alter the values of the following resistors, bearing in mind that the lower the value of resistance, the shorter the delay time, and vice versa:

R5, to set excite time (about 10 seconds).

R1, to set horn operating time (45 to 60 seconds).

R7, to set enter time (about 10 seconds).

R8, to set horn time for open door. (45 to 60 seconds).

The circuit is designed for negative earth systems. For positive earth, reverse all diodes, zeners, and capacitors, use NPN instead of PNP transistors, and vice versa.

(Submitted by: Mr I. Robertson, 20 Harper Street, Helensburgh, N.S.W. 2508).

*Main feature of the alarm system is a set of delay circuits to allow legitimate entry and exit without triggering the alarm.*

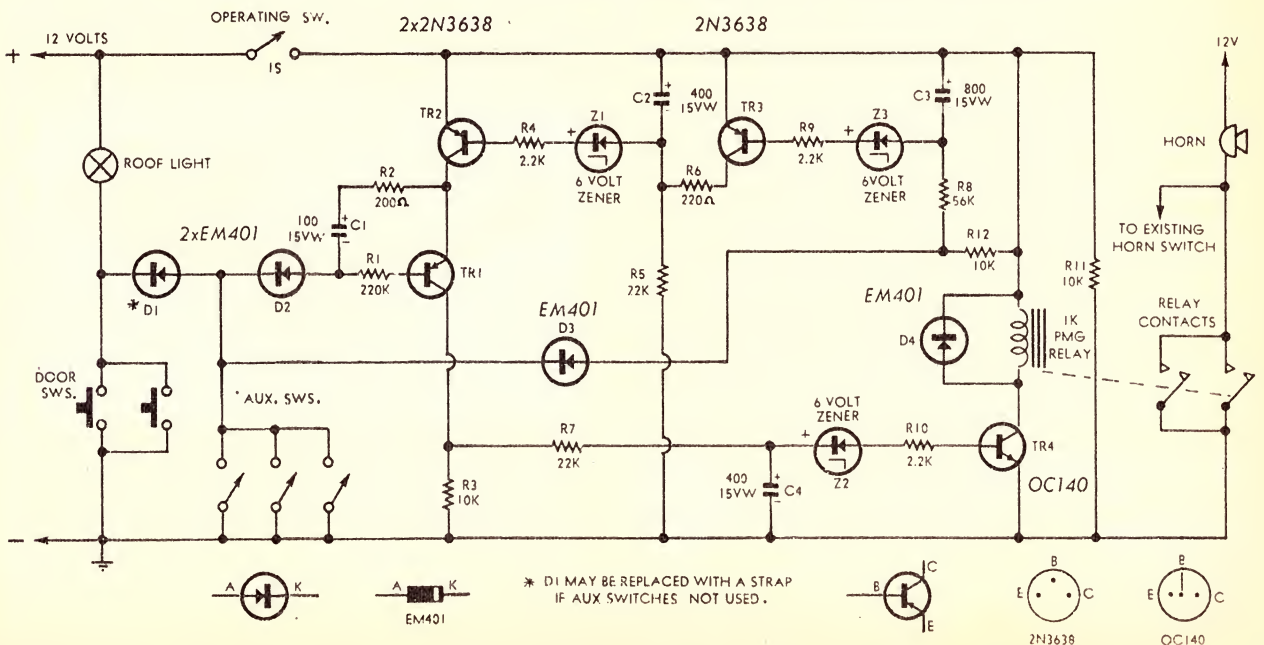



# New Rola C8MX deluxe brings you right down to 30Hz...



for great sound and great value!

What a choice—more bass, more top, more value. C8MX deluxe gives you the widest-range speaker at the lowest cost. Only 8" in diameter, yet with a frequency response of 30Hz-16,000Hz, C8MX deluxe gives an outstanding performance within compact enclosure dimensions. Highly efficient C8MX deluxe is the answer for budget conscious hi-fi enthusiasts. Look for it in the attractive new Blue and Gold carton. Build your own enclosure from plans specially prepared by Rola. Ask for technical publication 54.



**PLESSEY**  
**Rola**



For additional information please contact  
Plessey Rola Pty. Limited  
The Boulevard Richmond Victoria 3121  
Telephone 42 3921 Telex 30383  
NSW Plessey Rola Pty. Limited  
PO Box 2 Villawood 2163 Telephone 72 0133

AR23



## Improved version of parlour game

Working out electronic parlour games appears to be a popular pastime at the moment. This design was inspired by a similar game described in these columns a few months ago, but appears to be a much improved version. At the same time, it is simple enough for anyone to tackle.

This circuit is mainly a modification of Mr Sayers' electronic parlour game, which appeared in the "Reader Built It" section in December, 1968. As stated in that article, the game is played with 20 draughts or other suitable objects. Each player takes turn at removing either 1, 2, or 3 draughts, the object being to force one's opponent to take the last draught.

Mr Sayers' game was constructed in a wooden box with a row of nails protruding from the lid, numbered 0 to 20. The nails were part of the circuit and a crocodile clip on a wander lead was placed on the numbered nail corresponding to the number of draughts remaining, after the player or machine made their alternate moves.

I constructed this game and found it quite satisfactory except that confusion sometimes arose when a player forgot to advance the crocodile clip—mainly on the machine's behalf. Recently I bought a number of ex-P.M.G. components and decided to build a version which would be free from this problem.

The basis of my design is a uniselector; a type of rotary switch with

four or more banks and 25 positions on each bank. The rotor arm is advanced one position every time a pulse is fed to an electro-magnet in the device. The other components are a dial mechanism, a key switch, and a number of lamps and sockets.

A player makes his move by dialling either 1, 2, or 3 on the dial, which advances the uniselector the corresponding number of positions. The machine's decision and play is initiated by operating the key switch, S1a. This is normally in the mid position but is moved to either the right or left-hand position when it is the machine's turn to play. The choice of right or left-hand position is indicated by one of two lights (connected to bank No. 2) which are mounted on each side of the switch.

An indicator board is provided which reads off the number of draughts remaining. Instead of 20 lamps numbered 1 to 20, I have reduced the number to eight, labelled as shown in the diagram. For example, 17 would

be represented by lamps number 15 and 2 both being illuminated at the same time.

Two more lamps are provided (connected to bank No. 3), one to signify that the player has won and the other that the machine has won.

The battery connected to banks 2, 3, and 4 has only to light the various lamps and so its voltage will be chosen accordingly. The battery on bank No. 1 is required to operate the uniselector mechanism and should be between 24 and 50 volts. I used an old 45-volt "B" battery, but plan to replace this with a power supply.

As with Mr Sayers' version of the game, the choice of first turn can be determined by the toss of a coin. If the machine has first turn it cannot be beaten, but it can be beaten if the player has first turn, although this is not easy.

The key switch S1 has two functions. S1a initiates the machine's turn, as already explained. S1b is associated with bank No. 3 and operates the "Player Wins" light.

I constructed my game in a case with a sloping front. It is finished with contact covering and with the addition of coloured bulbs, the whole thing looks very impressive.

(Submitted by: Mr M. Hancock, 17 Merelyn Road, Belrose, N.S.W. 2085)

*A novel feature of this circuit is the method by which only eight lamps are used to count up to 20. Note that a power supply can be substituted for battery 2.*

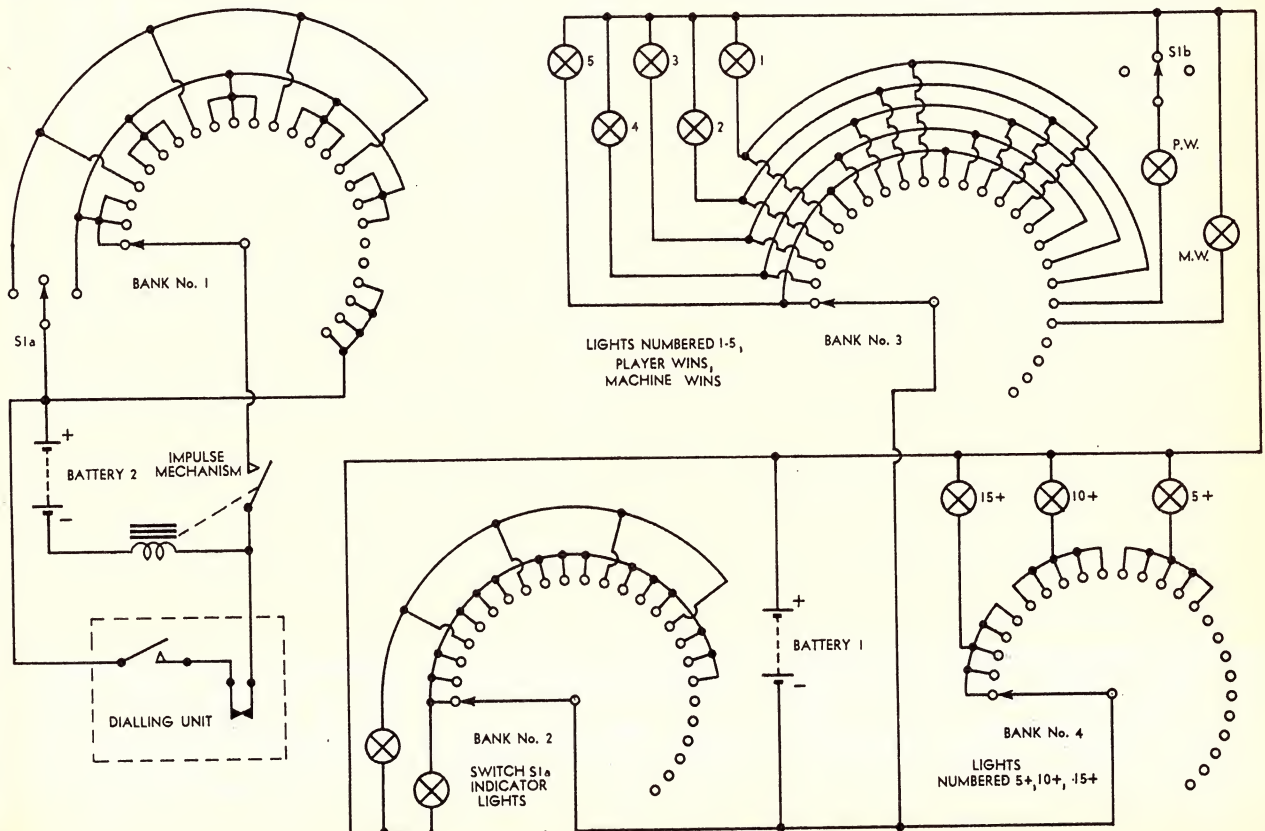



**INTRODUCING . . .**

# An Entirely New Concept in Tape Recording

**Dokorder**

World's first Three-in-One stereo tape recorder with built-in Dub-A-Tape system for professional dubbing.

This is the Dokorder 8010, an original, totally professional 4-track 2-speed stereo tape recorder featuring Dokorder's exclusive Automatic Continuous Reverse and Dub-A-Tape systems which enable it to do the work of three conventional recorders, and to do it better.

The work of two recorders—automatic recording and play-back—is handled by the Automatic Continuous Reverse system, while the work of a third—dubbing—is performed by the special Dub-A-Tape system without the need of any additional component.

Also available as a tape deck. Model No. 8020.

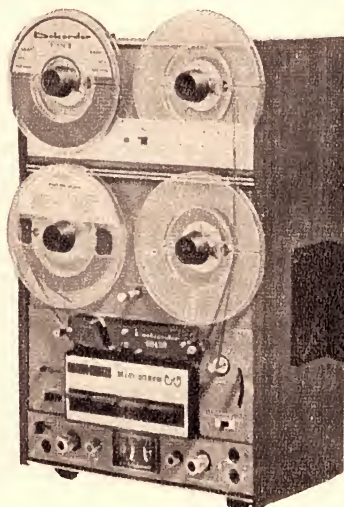

**SPECIFICATIONS:**

Recording system AC bias 4-track stereophonic and monophonic.  
 Tape speeds 7½ ips and 3¾ ips  
 Frequency response 20-20,000 Hz at 7½ ips  
 40-12,000 Hz at 3¾ ips  
 Equalization NAP  
 Signal to noise ratio Better than 50 dB  
 Cross talk 55 dB  
 Wow and flutter Less than 0.15 per cent WRMS at 7½ ips  
 Less than 0.12 per cent WRMS at 3¾ ips  
 Bias frequency 70,000 Hz approx.  
 Input provisions Two line (100 mV) 200 Kohms  
 Two microphone (1mV) 10 Kohms  
 Output provisions DIN (REC) connector  
 Two line 0 dB (0.775V)  
 Stereophones 35mW/channel  
 Speaker (8 ohms) DIN (PLAY) connector  
 Tone control Two separate treble control  
 Power output 12 watts music power  
 Monitor speaker 2 speakers, 4 x 6 inches  
 Recording time 4-track stereophonic  
 7½ ips 1½ hours 3¾ ips 3 hours  
 4-track monophonic  
 7½ ips 3 hours 3¾ ips 6 hours  
 Fast forward and rewind time Less than 45 seconds  
 (1,200-foot tape / 60Hz)  
 Circuit complement 22 transistors, 7 diodes  
 Level indicators Dual illuminated VU meters  
 Heads Five, 2 rec/play, 2 erase, 1 dubbing  
 Motors Four, 1 synchronous capstan, 2 capacitor reel and 1 capacitor dubbing  
 Max. reel size 7 inches  
 Power requirements 100, 110-117, 125, 200, 240V AC  
 50 or 60Hz  
 Weight 48lbs  
 Dimensions 14½inWx7½inDx21¼inH

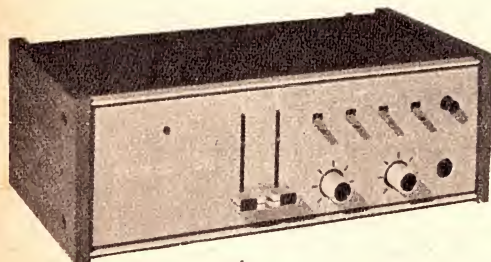

**8060 SOLID STATE STEREO CONTROL AMPLIFIER**

A powerful 100-watt amplifier with the latest IC circuitry for superb performance throughout a 15 to 50,000Hz bandwidth. Distortion is only 0.5% at rated output. This amplifier is made to match the Dub-O-Matic recorder and stands on the top of this recorder.

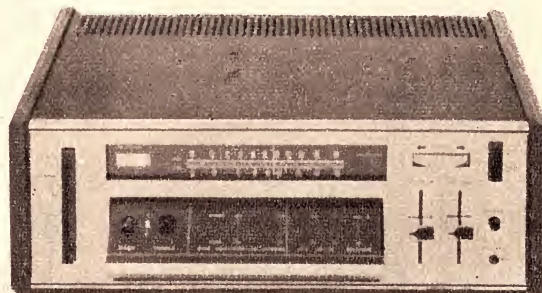

**800A WORLD'S MOST COMPLETE AM/FM MULTIPLEX STEREO RECEIVER**, with 170 watts music power, 1C and FET circuitry.

For all its versatility, the 800A is still a very compact and easy-to-operate receiver. It is easy to look at, too, since most of the less frequently used controls are housed in a special "Kangaroo pocket" control console that conveniently pulls out from the receiver when needed.

If you've been looking for more in a receiver—more in power, more in performance and more in innovation—your search ends here with the striking Dokorder 800A.

A full range of Dokorder speaker systems and stereo headphones available.

All Dokorder equipment carries a one-year factory warranty.

Further information and trade inquiries from the sole Australian distributors:

**A. Y. Carter (Importers) Pty. Ltd.**

CARTER HOUSE, 431 KENT STREET, SYDNEY, Telephone: 29-4337

Melbourne Office: "Stanhill," 34 Queens Road, Melbourne, Vic. Telephone 267-1906.



A Reader Built It . . . continued

## TV TUNER FOR SERVICING

Any device which contributes to easier fault location will be welcomed by those concerned with television receiver servicing. The substitute tuner described below would be a worthwhile addition to any serviceman's kit.

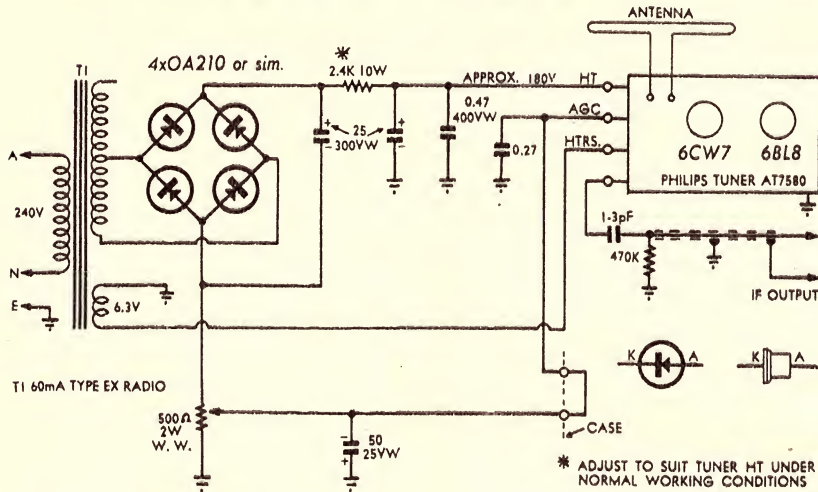

In television servicing, one often finds a need for a substitute tuner, which can be used to isolate the set's own tuner and replace it, thereby easily establishing whether a fault is located in the tuner section. The unit described below can be made up from junk box parts, but for reliability new parts would be preferable. A tuner in good working order salvaged from an old TV receiver would be satisfactory. I used a Philips AT7580, as there are plenty of these around, but other types would be suitable.

The circuit is quite straightforward and no difficulty should be experienced in constructing the device from the accompanying circuit diagram. The tuner has its own power supply with back bias arrangement. However, so that the set's own AGC can be used when it is desirable to do so, a spring clip is provided which allows this to be done quite easily. To prevent the introduction of ripple into the tuner, a back bias filter arrangement is included. The filter capacitor needs to

be not less than 50uF. The output is protected against damage from connection to HT by a small isolating capacitor, thus providing protection against accidental damage to the tuner or HT circuit of the set.

The unit can be comfortably housed in a metal box about 9 x 5½ x 7in, with the channel selector, fine tune control and AGC adjustment on the front panel, and aerial terminals, power lead and AGC spring terminal on the rear panel. A carrying handle and rubber feet are worthwhile additions.

(Submitted by: Mr R. A. Bayley, 14 Jennifer Crescent, Thirroul, N.S.W. 2515.)

*(Editor's Footnote: "Reader Built It" projects are published for the general interest of experimenters and as a source of ideas. Based on readers' contributions, they have not been tested in our laboratory and we cannot accept responsibility for them.)* ■

## EXTERNAL AERIAL FOR PORTABLES

While some of the larger transistor portables perform well in remote areas, the smaller ones are often poor. This may be due to simpler circuitry but it also has to do with the fact that the small ferrite rod aerial they have to use is less effective than a larger rod normally found in bigger sets.

The performance of small portables in remote areas can often be boosted by winding about three turns of plastic wire around the ferrite rod and bringing out the two ends for connection, one to an aerial, one to an earth.

The aerial can also be of plastic

covered wire. It should be 20ft or more in length, strung as high as possible and as clear as possible of iron roofs, metal guttering, etc. The earth wire should connect to a pipe driven into the ground or to a water service. If this is not possible lay 20ft or more of wire along the ground as, for example, under the house where the earth is bare and moist and where no one will trip over the wire.

With a portable battery set, an external aerial is only effective if used in conjunction with an earth or a counterpoise wire lying along the ground. ■

## SAVE ON TV TUBES



Lowest prices in N.S.W.  
MOST TYPES IN STOCK  
2 year warranty



FREE DELIVERY TO MOST SUBURBS



OUR 8th YEAR IN SYDNEY

Our Rebuilding Plant is now the largest in Australia, specialising in rebuilding tubes

## NEW ADDRESS:

We have purchased and moved to much larger premises at

542 KING STREET,  
(Princes Highway)  
NEWTOWN, N.S.W.  
to better serve you

Country customers: Send dud to Sydenham station, Passenger rail.



SURE BRITE Pty. Ltd.

542 KING STREET,  
NEWTOWN, N.S.W.

Telephones:  
519-3403, 51-5928



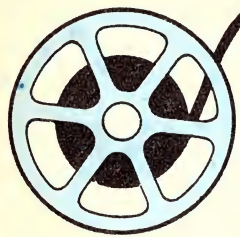

# AUDIO TOPICS



## STEREO RECORDS: SPREAD OR SEPARATION?

When playing stereo records in the home, what should one expect to hear? A very obvious separation between channels or something not so obvious? What is "three-channel" stereo and "reprocessed" stereo? These and other questions are answered in the following article.

by Neville Williams

Before answering the questions, it may be appropriate to make some observations about stereo records in general.

In a stereo disc system, two distinct audio signals are recorded in the spiral, V-shaped groove. Without becoming too involved in detail, it is not far from the truth to say that the two signals are impressed on the respective groove walls. The resultant is a rather complex groove, which is modulated both laterally (side to side) and vertically (in depth).

When the groove is traced or replayed by a suitably designed stereo pickup cartridge, two distinct audio output signals are produced, which are substantially a replica of those which were originally applied to the recording head.

The signals from the pickup cartridge are fed into two separate amplifier channels and thence into two separate loudspeakers or groups of loudspeakers in the listening room. Heard in combination, the two sources can impart a sense of direction and dimension to the reproduced sound that is not present when only single-channel reproduction is available.

If the potential benefit of stereo reproduction is to be realised, attention has to be given to the placement of the separate loudspeakers relative to the listening position. This is sometimes regarded as an imposition on domestic furnishing arrangements but, in fact, it is no more so than the need to arrange seating in relation to the television receiver.

If the living-room is to double as an entertainment centre, as distinct from a mere exercise in furnishing, it is logical to arrange the layout with due attention to the video and audio sources. This leads fairly naturally to the concept of having the stereo loudspeakers and the television receiver arranged along one wall, with a suitable proportion of the seating facing it along the opposite wall.

In an ordinary living-room, say 18ft by 12ft, it is appropriate to have the loudspeakers near the ends of one of the 12ft walls, with the seating grouped at the other end of the room. If most of the listening is done by a couple of people only, they can usually sit fairly centrally, with the loudspeakers angled slightly inward to face them. If more people have to be accommodated, it is sometimes found better to angle the loudspeakers more sharply inward, so that people around the sides of the room get more direct radiation from the loudspeaker which is furthest from them.

As far as possible, the area immediately adjacent to the loudspeakers should be uncluttered by adjacent furniture, to allow the wavefront to spread uniformly across the room. It is not a good idea to have a couple of small enclosures tucked down unobtrusively at either end of a sideboard and further obscured by drapes and furnishings. They should be elevated to where — admittedly — they may be seen but, more importantly, to where they will be heard.

The loudspeakers used in the respective channels of a stereo system should be of the same type or, at the very least, should have a similar performance over the middle and high frequency part of the spectrum. If the systems are notably dissimilar, the sound radiated from them will tend to distribute, not just on the basis of the signals fed to them, but to some extent on the degree to which frequency components may happen to coincide with peaks and troughs in their individual response curves.

A second channel supplied by a poorly matched loudspeaker may certainly be better than no second channel at all, but it will prejudice the listener's ultimate assessment of the stereo effect.

Matched or unmatched, however, the stereo effect cannot be created properly in a room by loudspeakers,

which are merely three feet apart, at opposite ends of a conventional stereo-gram cabinet. Heard from an ordinary and convenient listening distance, it would be fairer to designate the sound as augmented mono, rather than true stereo. By and large, the remarks which follow assume that the listener has installed a system with separate, suitably placed loudspeakers, preferably of the wide-range variety.

A matter which is sometimes overlooked is the need to ensure that the loudspeakers operate in phase. This simply means that, when fed with a similar audio signal, the cones should move forward and backward in unison. A full article on the subject of loudspeaker phasing appeared in these columns in the February, 1969, issue. (Copies of the issue are available from our Back Dates Department for 50c each.)

Also important in the matter of stereo separation is the ability of the pickup cartridge to derive separate and distinct audio signals from the stereo groove. All practical cartridges suffer to some degree from what is known as "crosstalk" — a tendency to reproduce signals intended for either channel, very weakly in the other. Provided the ratio between the deliberate and incidental signal is 15dB or better (a signal voltage ratio of 5:1 or greater) the stereo effect is not markedly impaired. Most modern cartridges will equal or better this figure over most of the frequency range but, if stereo separation in a system is markedly poor, some suspicion must attach to the cartridge being used.

In this connection, readers' attention is drawn to a record which has been on the market for some time and which is just about ideal for observations of this kind. The first track is a recording of a bouncing ping-pong ball, which should be heard first from the left-hand loudspeaker, then from the right-hand loudspeaker. Later it should seem to come from the area between them. Even in a high-quality system, some cross-talk will be evident to a listener crouched in front of the "silent" channel but, from a normal listening distance, the directional illusion should be complete.

The record in question is issued by Festival under the title "Miracle In Sound," Festival Stereo Sampler SFL 2/1 and priced at \$3.95. Other than the bouncing ball, the tracks are all musical excerpts, all pleasant in themselves. It is stocked by most large re-



cord retailers or can be obtained readily on order.

Now for some of the questions posed at the beginning of this article — for example: What should one expect to hear from a stereo record?

Over and above the technical challenge which stereo posed to engineers, there seems little doubt that the original and the "purist" intention was to develop a system which would reconstitute as closely as possible the spatial spread of an orchestra, as it would be heard by a listener somewhere near the centre of a concert auditorium. Instrumental sound coming from the listener's left or right in the concert hall, would seem to come from similar directions when the same sound was reproduced in the home. Similarly, sounds which originated nearer the centre of the orchestra, would seem to come from a similar region between the two loudspeakers.

The classic way to record an orchestra with this objective in view is to suspend a twin microphone assembly fairly centrally above the early rows of seats in the auditorium. Each microphone is fairly directional and the two units are angled to cover the respective halves of the orchestra.

Sounds produced in the orchestra are "heard" by each microphone but, because of their different orientation, there is a subtle difference in both the amplitude and the phase of the signals which each microphone delivers to the stereo recorder. Intermixed with the direct sound, of course, is a two-microphone version of the reverberant sound from the auditorium.

Experience and expertise play a big part in recording an orchestra for the desired stereo effect but the end result can be extremely good. The orchestra appears to spread right across the end of the listening room, with just as much sound seeming to come from between the loudspeakers as from the loudspeakers themselves. In fact, if the loudspeakers were not so plainly visible, their position would not be at all obvious.

This kind of result is normally sought as a matter of course, in stereo recordings of ranking, classical orchestras, irrespective of the country of origin. It is therefore the kind of sound which you can reasonably expect to hear from any stereo recording of a symphony style orchestra, made by a company which is active and experienced in the classical field . . . smooth sound, evenly distributed across the whole listening area.

Classical records which do not fulfil this expectation come mostly from recording companies which are mainly active in the popular field and which are likely to apply other than "purist" thinking to the production of any records, popular or classical.

If your conviction is that you have never heard smooth, evenly spread sound from a classical recording released by a company experienced in this field, then something is very wrong somewhere. You are certainly missing out on what a great many other people enjoy.

Possibilities to consider are:

- The loudspeakers are incorrectly phased. See the earlier reference to this subject.

- Separation in the cartridge is

# the right time



# at a glance

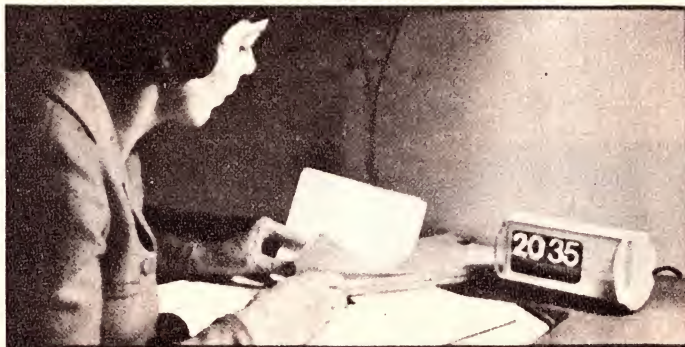

# solari



Solari Cifra 3 — an exceptionally compact digital clock, attractively styled for the modern office or home.

Gives the correct time, minute by minute, in an unmistakable way — there are no hands to misread. Silent, synchronous electric motor; direct-read time legible from at least 33 ft; extremely simple time resetting; unbreakable lightweight plastic case. Only 7" long, 3¾" diameter, 1½ lbs weight. Available in red, green, beige or light grey; with 12 or 24 hour direct-read flaps. Only \$32.00 including tax.

## PLESSEY

### Communication Systems



Plessey Communication Systems Pty Limited  
87-105 Racecourse Road North Melbourne Victoria 3051  
Telephone 329 6333 Cables INTERPHONES Melbourne

Sydney 642 0311 Canberra 95 1596 Townsville 79 5066 Perth 31 1588 Launceston 27 3520  
Newcastle 61 1092 Brisbane 2 3287 Adelaide 76 2022 Hobart 34 2828 Devonport 24 1000  
AS 7



# Introducing the new **LEAK** Stereo 30 Plus

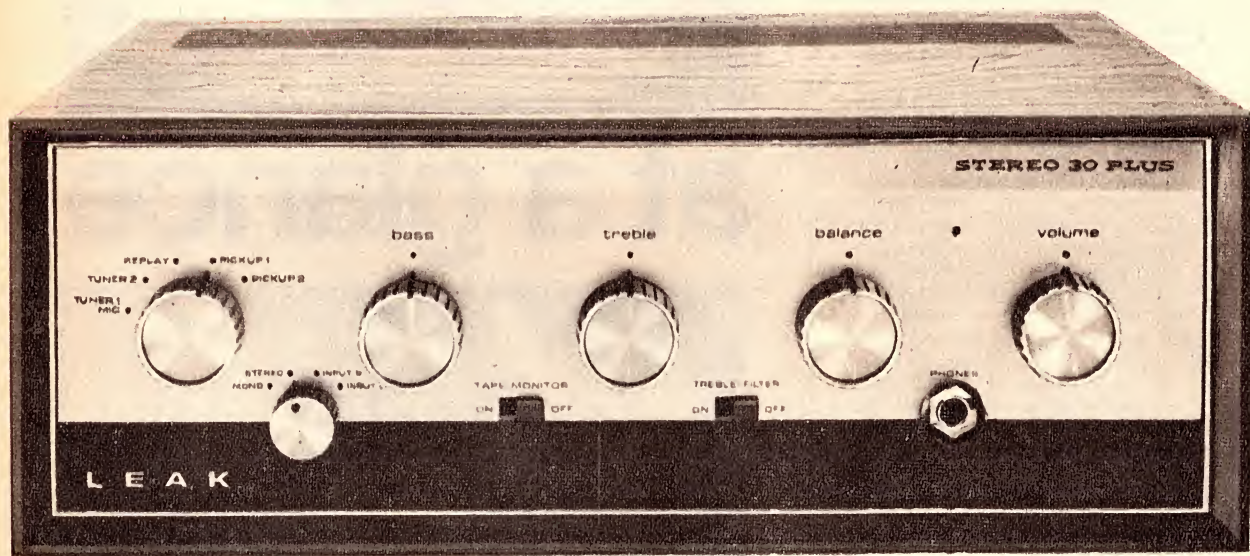

The Stereo 30 was introduced at the 1964 London Audio Fair. Five years later over 40,000 Stereo 30 amplifiers have been sold and it has established records, for popularity, reliability, and outstanding performance.

The new Stereo 30 Plus combines the long proven circuitry of the Stereo 30 with a new range of silicon transistors and facilities up-dated to meet today's needs:—

The use of two turntables and pickups, selection between the two being made by the input switch on the front panel.

The use of stereo headphones for personal listening as an alternative to loudspeakers.

This, backed by the famous LEAK craftsmanship and reliability, makes the Stereo 30 Plus the most technically advanced 15-watt amplifier available.

Power Output (both channels sinewave driven):

15 watts r.m.s. each channel into 8 ohm loudspeakers.

Also see and hear the other famous Leak units.

Sandwich speaker system MK 11. Mini-sandwich speaker system.

Stereo 70 amplifier. Teak cases available as optional extras.

**\$198**  
RETAIL  
NETT

## LEAK

H.J. LEAK (AUST) PTY. LTD.  
P.O. BOX 14  
FRENCH'S FOREST, N.S.W. 2086  
PHONE 94 4902

for descriptive leaflet post coupon

Name \_\_\_\_\_

Address \_\_\_\_\_

Postcode \_\_\_\_\_



inadequate. Spend \$3.95 on the test recording mentioned earlier.

● If the spread seems quite inadequate, your loudspeakers may be too close together. Alternatively, they may be so cluttered by furnishings that listeners in the room only ever hear one of them properly at a time.

● If the sound always appears to come from the two separate loudspeakers and never from the area in between, the loudspeakers are possibly too far apart. The trouble can be compounded by a room which is over-heavy with carpets, curtains and soft furnishings.

● It is just possible that there is nothing wrong at all with the system acoustically and that your eyes (which say that there are only two sound sources) are over-ruling your ears.

On this last point, a few enthusiasts have insisted on installing an actual centre amplifier channel and loudspeaker, fed with a signal artificially compounded from the other two. While the scheme is technically quite legitimate, the majority opinion is that a physical centre channel should not, in fact, be necessary for appropriately recorded discs.

If, for one reason or another, your record library contains more than its fair share of formal music recorded with inappropriate separation, a centre channel might be justified, but scarcely otherwise.

As distinct from what has been referred to as the "purist" method of recording stereo, an alternative approach has been to position a number of microphones in front of, or within an orchestra, directing their outputs through a multi-channel control console on to separate tracks of a multi-channel tape recorder.

As a separate and subsequent operation, the content of the various tracks is mixed onto two tracks for transfer to disc in such a way as to achieve the balance, spread and emphasis that is judged to be appropriate by those musically responsible for the final production.

Many and varied have been the arguments for and against alternative methods of recording stereo but, in terms of the end result, an evenly spread sound can be obtained from a stereo microphone assembly, from multiple microphones, or from a combination of both. If the producer so desires, separate microphones can be used to provide the facility — the desirability of which is often debated — of giving emphasis to soloists or sections of a performing group.

However, the story of stereo does not end at this point. Equipped with multiple microphones and multiple channels, many arrangers and producers have elected to exploit the potential separation of stereo channels to provide the listener with two virtually distinct sounds, which are projected almost independently into the listening room.

A variety of possibilities is open to the producer. A vocalist may be projected through one channel, their accompaniment through the other; the vocalist may dominate one channel, with the orchestra spread out in traditional fashion; instrumental groups can be sub-divided, choirs can be sub-divided and so on. It is quite common-



*The Festival stereo sampler referred to earlier in the article and containing a most useful ping-pong test track. The musical selections are pleasant but they are all recorded with exaggerated separation, appropriate for the popular but not for the classical excerpts.*

place these days for producers, seeking a high degree of isolation, to use acoustic screens, separate studios or over-recording techniques.

This contrived separation between the two channels is commonly referred to as "gimmick" or "ping-pong" stereo—a term which has probably been derived from the kind of recording mentioned earlier, where ping-pong sounds are used to distinguish the channels for test purposes.

As might be expected, the distinction between channels is more obvious from a record which emphasises separation than from one intended to produce a sense of spread — particularly when played on a single-unit stereogram with loudspeakers only two or three feet apart. In fact, people who use such equipment, and who know no better, are likely to reach the mistaken conclusion that certain popular style records achieve recognisable stereo but that the rest are very little different from straight mono!

As an extension of the highly separated "ping-pong" type of stereo, some arrangers and producers have come up with a sound which reviewers are fond of describing as "three-channel" stereo.

This involves recording distinct sections of the accompaniment on each of the two stereo tracks, as for ping-pong stereo. In addition, however a vocalist or featured artist is recorded on a separate microphone and an equal and in-phase signal from it is mixed into both channels.

When reproduced, through a properly set-up system, the equal in-phase, common signal creates a sound that appears to come from the space between the two loudspeakers, exactly as happens when a mono record is played through a balanced stereo system. At the same time, the two channels contribute their own distinct sounds and the total effect is that of three channels — left, right and centre.

It would appear that many listeners do not appreciate the differing intentions and methods by which stereo

## BUY RECORDING TAPE AT WHOLESALE PRICE

### WILCOX BROS. & BARCLAY

are now offering their line of recording tape direct to the Public at wholesale prices. This is a leading American manufacturer's first-grade line especially packed for us in a plain box. We are not allowed to reveal the maker's name.



| TYPE                                 | CODE | LIST PRICE | YOUR Wholesale PRICE |
|--------------------------------------|------|------------|----------------------|
| 5" 900ft Acetate PVC .....           | 5R9  | \$2.75     | \$1.80               |
| 5" 1200ft Tensilized Polyester ..... | 5P12 | \$4.45     | \$2.95               |
| 7" 1800ft Acetate/PVC .....          | 7R18 | \$5.10     | \$3.35               |
| 7" 2400ft Tensilized Polyester ..... | 7P24 | \$8.35     | \$5.50               |

Wholesale prices allow for 33 1/3 per cent trade discount and cash settlement discount an include sales-tax. Freight free throughout Australia.

### MONEY BACK GUARANTEE

WILCOX BROS. & BARCLAY tape is guaranteed to be first-grade splice free recording tape made in the U.S.A. Your money will be refunded in full on return of goods within fourteen (14) days if you are not fully satisfied with your purchase.

### ORDER FORM (capital letters please)

FROM: \_\_\_\_\_  
 NAME: \_\_\_\_\_  
 STREET AND NO. \_\_\_\_\_  
 CITY OR SUBURB: \_\_\_\_\_ POSTCODE: \_\_\_\_\_

PLEASE SHIP:

..... rolls 5R9 at \$1.80. Total \$ .....

..... rolls 5P12 at \$2.95. Total \$ .....

..... rolls 7R18 at \$3.35. Total \$ .....

..... rolls 7P24 at \$5.50. Total \$ .....

I enclose cheque/postal note/ Money Order for Total \$ .....

Return this order to:

**Wilcox Bros. & Barclay**

WHOLESALE MERCHANTS

Mail Order Office:

Room 7, 3rd Fl., 323 Bourke St., Melbourne





# SAFE AND SOUND WITH

# TESLA

A safe investment . . . Tesla equipment. A sound investment . . . Tesla equipment. Why? Because one thing has made Tesla Europe's biggest selling sound equipment manufacturer . . . quality.

Fifty-six factories employing 12,500 scientists and 75,000 skilled workers are all renowned for the excellence that has made Tesla a household word throughout Europe. What's more, mass production techniques developed by Tesla have resulted in low production costs and consequently lower prices.

## LOUDSPEAKER UNITS

Model ARZ 668-8" rolled edge cone woofer. Impedance 4 or 8 OHMS. Resonant frequency 28 cps. Price \$6. 4" tweeter. Impedance 4 OHMS. Range within 6-17 KC/S. Price \$5.50.

A wide range of speakers are available from 1½" to 15". Details on request.

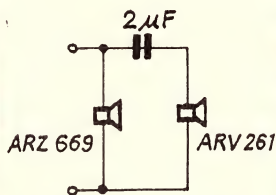

## LOUDSPEAKER COMBINATIONS



Miniature Pair: (ARS710)  
2 speakers in each cabinet, 4" woofer and 3" tweeter, with crossover. \$68 pair.

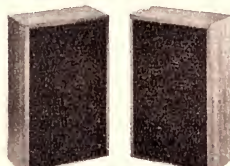

Skylark:  
2 speakers in each cabinet, 8" woofer and 4" tweeter, with crossover network. \$74 pair.

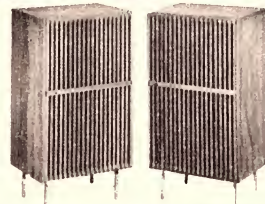

Studio Pair: (RK60)  
3 speakers in each cabinet, with crossover network. Oiled teak finish. \$270 pair.

## AMPLIFIER



Supraphon Studio 1 stereo amplifier and record player to operate with any of the above speaker combinations. 10 watts per channel R.M.S. \$160.

## TURNTABLE



All-balance arm. Stroboscopic speed indicator. Hydraulic arm lift. Fine speed adjustment. Price without cartridge \$108.

• ALL UNITS AVAILABLE IMMEDIATELY • MAIL ORDERS ACCEPTED



**CHARMAC PTY. LTD.** Representatives for Tesla Czechoslovakia.

VICTORIA: 33 Bridge Road, Eltham 3095, 439 9517; General Accessories Pty. Ltd., 153 Sturt Street, South Melbourne 3205, 69 0300. N.S.W.: General Accessories Pty. Ltd., 443 Concord Road, Rhodes 2138, 73 0211, and 116 Clarence Street, Sydney 2000, 29 4451. QUEENSLAND: General Accessories Pty. Ltd.,

54 Lt. Edwards Street, Brisbane 4000, 2 3093. STH. AUSTRALIA: Truscott Electronics, 64 Hindmarsh Square, Adelaide 5000, 23 3024. WESTERN AUSTRALIA: Roy Reid Pty. Ltd., 193 William Street, Perth 6000. TASMANIA: Wills & Co. Pty. Ltd., The Quadrant, Launceston 7250, 2 4641.

CH739



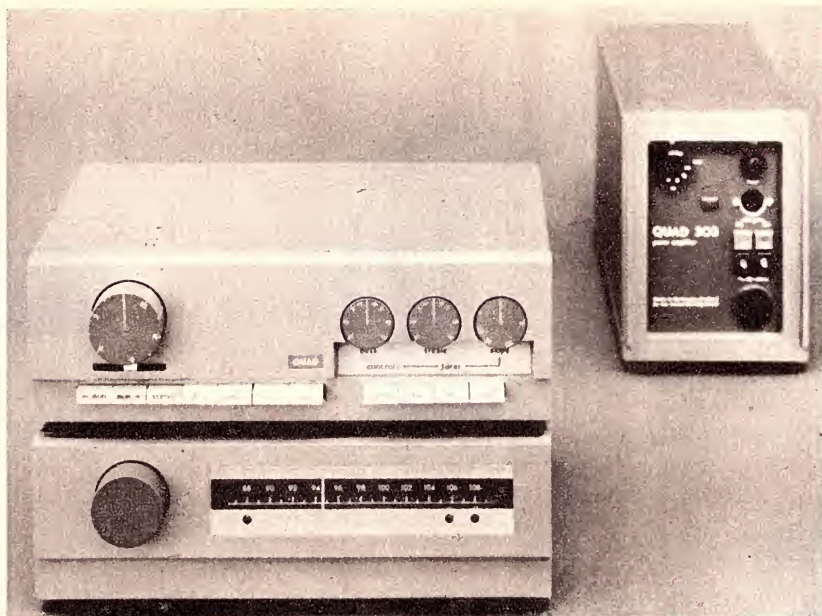

*This Quad stereo system, manufactured by the Acoustical Mfg. Co. Ltd, of Huntingdon, England, was named recently by HRH The Duke of Edinburgh as one of the winners of the 1969 Council of Industrial Design Awards. At the bottom is a VHF stereo/FM tuner, surmounted by a control unit type 33. At the right is a Quad 303 power amplifier. Quad amplifiers are marketed in Australia by British Merchandising Pty. Ltd., 49 York St., Sydney.*

records are produced and one often hears critical comments about records in which the stereo sounds are not separate, or conversely about records in which they are — as if one presentation or the other was completely right and the alternative was completely wrong.

Nothing of the kind.

The simple facts are:

- In many stereo records, the aim is to re-create an even spread of sound across the source area. The producers seek to avoid a hole-in-the-middle and dramatic separation as effects which would be inappropriate to particular types of music. Discs of this type will logically include classical works, brass band performances, most large choirs, and large orchestras in more formal performances of middle-of-the-road music. In no sense does this exclude other material, of course.

- Many other records are deliberately intended to exploit stereo separation, emphasising two or an apparent three channels. This approach is most commonly found in popular vocal and instrumental releases where performance, arrangement and manipulation of the stereo facility are all used to gain maximum sonic impact. Such records are not supposed to produce an even spread of sound and it is debatable whether there is any point in trying to achieve this effect from them.

What then should a listener to a stereo record expect to hear?

Perhaps the best answer is simply: "What the producer expected them to!"

If the reproducing system is properly set up, a record intended to give even spread should produce that kind of spread. Similarly, a record intended

to give a two-channel or three-channel effect should sound that way — exactly.

What if the listener believes that an even spread of sound isn't dramatic enough?

His only resource will be to buy records from labels which specialise in the other approach. There will be no dearth of titles in the popular field but his choice of more formal music will be limited.

What if the listener dislikes "gimmicked" separation?

He should buy the records that his opposite number rejects. If his supply of percussion and pop turns out to be too limited by this course, his only resource will be to provide an extra channel fed with a sample of both signals, in an effort to correct the misdeeds of erring producers!

What is—or was—"stereo action?"

This was a gimmick exploited by RCA in particular, although there is no special reason why other companies should not have produced similar effects. By using multiple microphones and manipulating the appropriate controls, it is not difficult to switch a performer, an instrument or a group of instruments from one channel to the other. Alternatively, by gradual cross-fading, the sound source can seem to slide across stage, just as if the vocalist, the piano or the percussion group was mounted on a silent trolley. It was an intriguing idea but not one that contributed much to listener appeal.

What is "reprocessed stereo?"

Almost invariably it signifies an original (and usually old) mono recording which has been re-recorded through a stereo amplifier/cutter

(Continued on page 191)

## Selectronic Components

- MANUFACTURERS & DISTRIBUTORS
- ELECTRONIC ENGINEERS
- COIL WINDING SPECIALISTS

Available Wholesalers all States

### RADIO AND COMMUNICATION COMPONENTS

A wide range available, including miniature and sub-miniature types for valve and transistor applications of the following:—

- Ferrite Aerials and Aerial Coils.
- R.F. and Oscillator Coils.
- I.F. Transformers (455, 1600, 85 KHz).
- R.F. Chokes and Whistle Filters.
- Unwound Coil and I.F. Assemblies.

### TV COMPONENTS

- Video Peaking Chokes — preferred range 15uH-560uH.
- Horizontal Flyback Transformers.
- Linearity and width Coils.
- Sine Oscillator and Stabilising Coils.
- Adjacent Channel Traps and Attenuators.
- Picture Tube Brighteners.

### TAPE RECORDER COILS

- Bias/Erase Oscillator Coils to suit most popular decks.
- Bias Trap and Equalising Coils.

### ACCESSORIES

- Coil Lacquer.
- Contact Lubricant.
- Core Locking Compound.

**CHAN NEL LOCK**

- Long-reach Electronic and "Little Champ" precision Pliers.
- Heatsorb Clamps.

### MANUFACTURERS' LINES

Special quotes for bulk quantities of:

- R.F. Coils, Chokes and Transformers to order.
- Power Transformers and Chokes to order.
- Iron Dust Cores.
- All types of winding.

### AGENTS:

S.A.: Wm. T. Matthew Pty. Ltd.

QLD.: Keith Percy and Co. Pty. Ltd.

**17 BARRY STREET,  
BAYSWATER, VIC. 3153  
Telephone 729-2992**

SC/12/8/69



# 180 WATT SOLID STATE STEREO AMPLIFIER

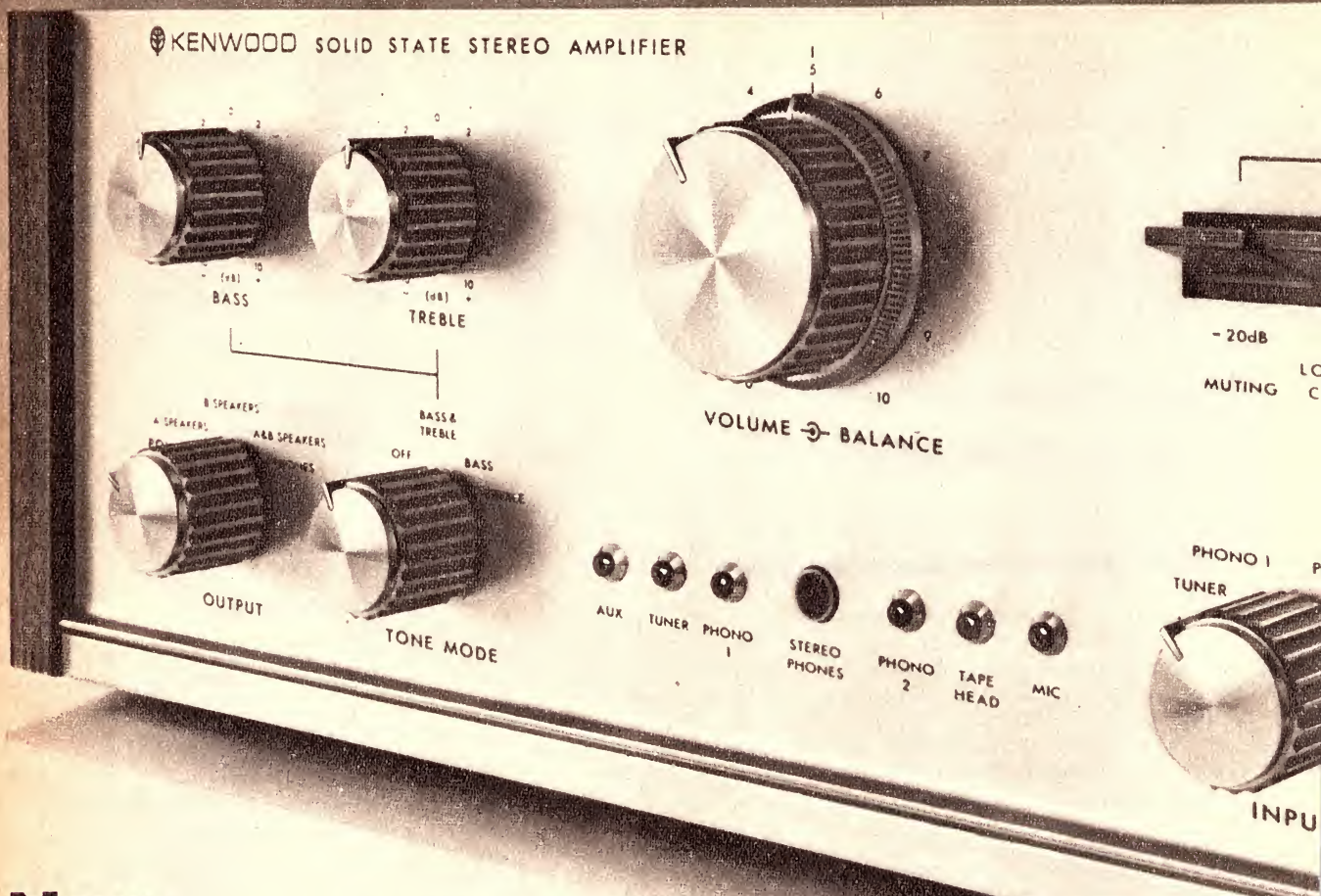

## New KENWOOD's KA-6000 The Musical Powerhouse For Maximum Perfection

You don't have to look elsewhere—KENWOOD's KA-6000 180-watt solid state stereo amplifier has all the power you need for maximum perfection.

It has more than enough power to drive even Hi-Fi speakers of low efficiency.

With its wide power bandwidth of 10Hz to 50,000Hz there is low-low IM distortion.

The KENWOOD exclusive low level phono inputs for low level output phono cartridges of 2mV, 0.5mV or 0.05mV.

There are many other outstanding features in the KA-6000—all the results of high quality engineering—but the final test is in performance. Stop in at your KENWOOD dealer for a KA-6000 demonstration.

Remember, KENWOOD also has other amplifiers with less power.

There's a KENWOOD for every stereo need.

**SOLE AGENT: Jacoby, Mitchell & Co., Pty., Ltd.:** Head office: 469-475 Kent Street, Sydney Tel: 26-2651 **Melbourne:** 15 Abbotsford Street Tel: 30-2491 **Brisbane:** 56 Edward Street Tel: 2-6467 **Adelaide:** 652 South Road, Glandore Tel: 53-8117 **Perth:** United Australia Co., Pty., Ltd., 435 Hay Street, Subiaco Tel: 8-4665 **Tasmania:** K. W. McCulloch Pty., Ltd., 57 George Street, Lounceston Tel: 25-322 **Newcastle:** Edmunds Moir & Co. Pty., Ltd., 18 Wood Street Tel: 61-4991



### BOOKSHELF TYPE 4-WAY 5 SPEAKER SYSTEM KL-660

- \* Mounted speakers: 12-inch, free-edge woofer x 1 (Bass)
- 6½ inch cone squawker x 1 (lower midrange)
- 4 inch cone squawker x 1 (higher midrange)
- Horn-type tweeter x 2 (Treble)
- \* Dimensions: 15" (W), 25½" (H), 11½" (D)

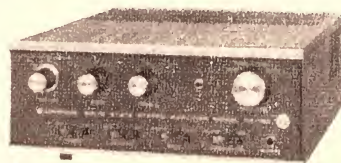

### 40 WATT SOLID STATE STEREO AMPLIFIER TK-150U

- \* 5 pairs of input terminals for MAG, AUX 1, AUX 2, TAPE REC and TAPE PLAY.
- \* Damping factor: 40 (at 16ohms), 20 (at 8ohms)
- \* Dimensions: 10½" (W), 4½" (H), 9¾" (D).

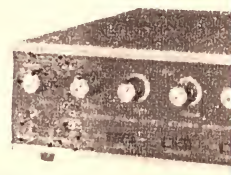

### 60 WATT SOLID STATE STEREO AMPLIFIER TK-250U

- \* 2 sets of stereo speaker terminals
- \* front panel speaker selector switch
- \* Dimensions: 13" (W), 4½" (H), 9½" (D).



# KA-6000

## MODEL KA-6000

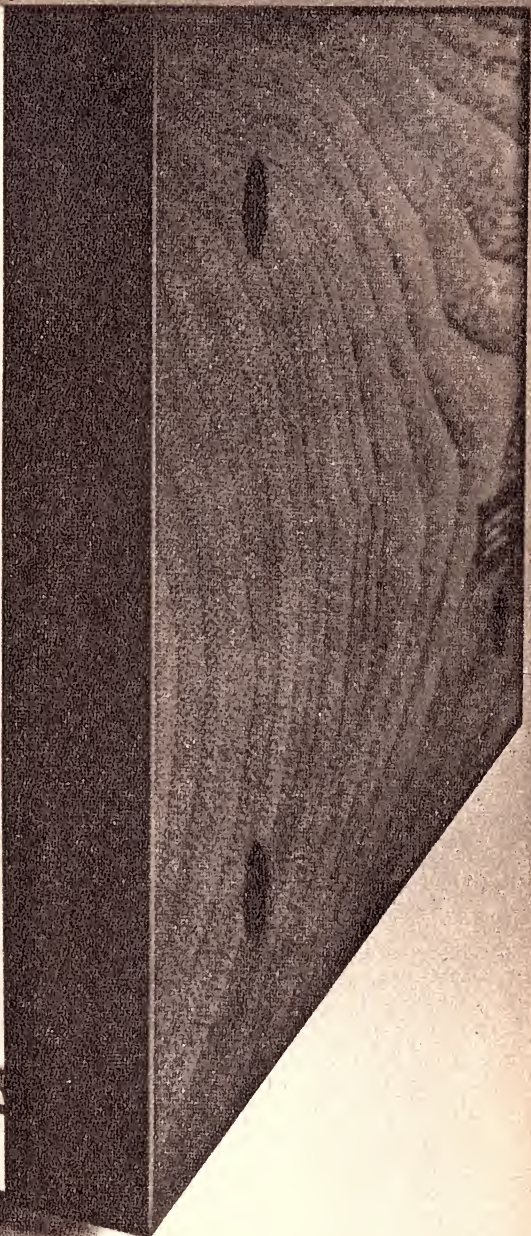
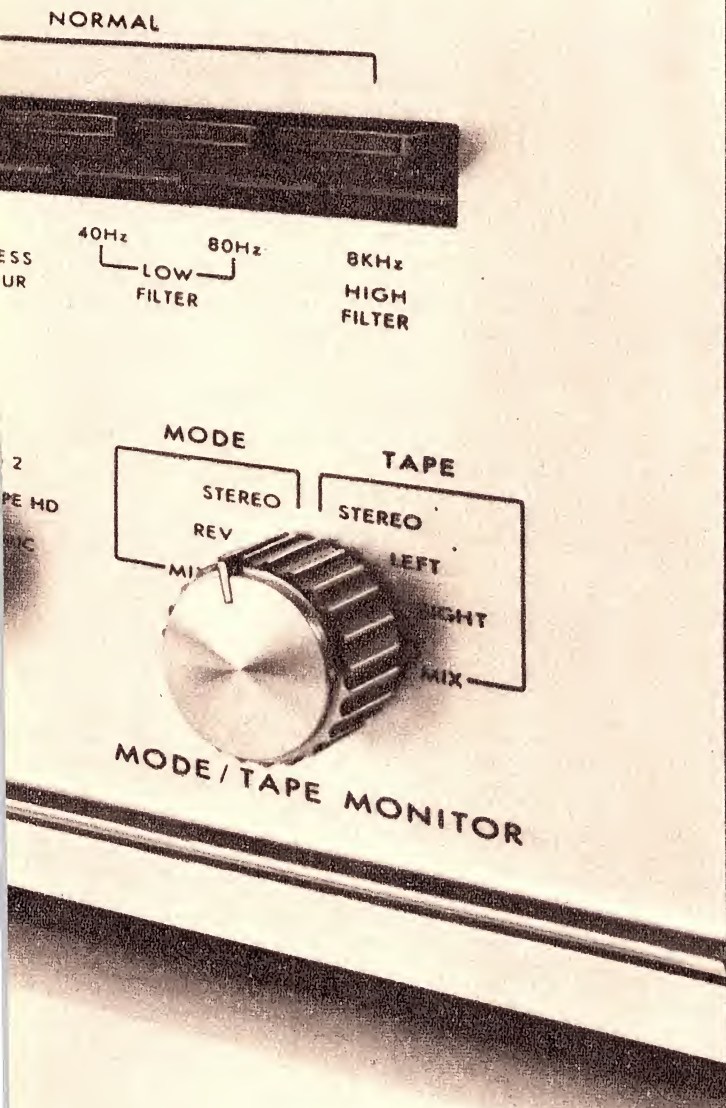

*the sound approach to quality*



# KENWOOD

## TRIO ELECTRONICS, INC.

6-5, 1-CHOME, SHIBUYA, SHIBUYA-KU, TOKYO, JAPAN

Ask for a catalogue or demonstration by your nearest dealer.

To: Jacoby Mitchell & Co., Pty., Ltd. EA  
469-475 Kent St., Sydney.

Send me information on KENWOOD RECEIVER, AMPLIFIERS, SPEAKERS & name of nearest KENWOOD retailer,

NAME: \_\_\_\_\_ AGE: \_\_\_\_\_

ADDRESS: \_\_\_\_\_

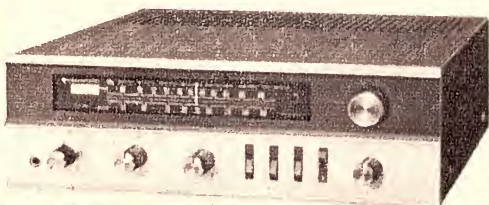

**30 WATT  
FET SOLID STATE AM/FM  
STEREO RECEIVER TK-20U**

\* F.E.T. (Field Effect Transistor) 3 Gang Tuning Condenser front end for superior sensitivity, image rejection and cross modulation ratio.

\* Dimensions: 14 3/8" (W), 4 3/4" (H), 11 1/4" (D).



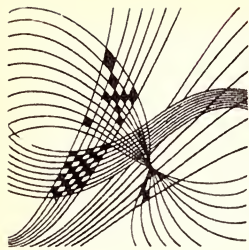

## CLASSICAL RECORDINGS

Reviewed by Paul Frolich

**BOULEZ CONDUCTS BERG: 3 Pieces for Orchestra, op. 6; Chamber Concerto for Violin, Piano and 13 Wind Instruments; Altenberg Lieder, op. 4. Daniel Barenboim, piano; Sachko Gawriloff, violin; Halina Lukomska, soprano; B.B.C. Symphony Orchestra. CBS SBR235305.**

For a number of different reasons, this is one of the most important recordings of "modern" music to come my way. Alban Berg's music, though all of it was written more than 30 years ago, is still little known to the general run of listeners and the works on this disc present an excellent cross-section of his methods and thought. One of them, the *Altenberg Lieder*, has only once been previously recorded and the others are certainly worth hearing in these versions by Pierre Boulez.

Daniel Barenboim is known to us almost wholly from the classical repertoire — Mozart, Schubert, Beethoven, Brahms — and it is a revelation to hear his response to something less "safe." His playing in the *Chamber Concerto* is exceptionally fine and he is brilliantly partnered by Gawriloff, a fiddler I'd not heard before. They are supported by excellent wind players and Boulez's interpretation of the work, which has been successfully recorded by other teams before, seems to me exceptionally lucid and musically inspired, with the result that the music emerges in far clearer detail than in other performances.

In the *Altenberg Lieder*, a cycle of songs dating from 1912 and still virtually unknown, Miss Lukomska employs her rich voice to good effect; the recording of the voice is not, I think, particularly advantageous, but the songs come off very well all the same.

The most problematical item on this record is the "Three Pieces" which had earlier had been very acceptably recorded by Robert Craft and Antal Dorati. Some listeners will, I think, regret a certain lack of warmth in Boulez, but I consider this more than balanced by the effect of the steely precision he brings to this difficult score. Boulez's reading is inspired by Berg's luxurious romanticism, treated in Schonberg's techniques. This is, of course, rather curious music in some ways and I find Boulez's reading of it very convincing and completely lacking in the hysteria which so easily overtakes it.

Whatever you may feel about

Boulez's interpretations, this is certainly a magnificent series of performances, superbly recorded and quite likely to become accepted as the last word on Alban Berg as far as these works are concerned.

\* \* \*

**GINASTERA: Concerto for Piano and Orchestra (1961); Variaciones Concertantes (1953). Joao Carlos Martins, piano; Boston Symphony Orchestra, conductor Erich Leinsdorf. RCA LLSC 3029.**

The *Variaciones*, which had been commissioned by the Argentine Music Society, were first performed under Markevitch's direction in June, 1953. Here, they are quite magnificently played by members of the Boston Orchestra's first desks. This is virtuosic music of the best kind, written for a number of virtuosi of a calibre which, even today, few orchestras could provide better than the Boston one.

By the time this work came to be written, Ginastera had begun to move away from the intense nationalism which distinguished his popular folk-based ballet "Panambi," and he was setting out to write more subjective music. Despite this, the composer's stated aim, this is no anonymously international music and the score is full of Argentine atmosphere, interpreted freely through the composer's own original methods and rhythms.

This work is written with consummate craftsmanship, each one of the variations being given to a different group of solo instruments. It is, as so

often happens with successful pieces, far from avant-garde music, harmonically on a level with Benjamin Britten's, wholly pleasant to listen to and very beautifully played and recorded.

The piano concerto is a very different affair, written for the Koussevitsky Foundation and, to a degree, seeking after sensationalism. Although it, too, is not really unconventional, it will make rather greater demands on unprepared listeners. This music is exceptionally aggressive, highly percussive and based on a twelve-tone series — though this is something not easily recognised.

The concerto begins with ten variants on a bravura piano cadenza; then comes a bird-sound haunted scherzo, played pianissimo. Finally, there is a tearing, shattering toccata in which the piano receives a high-tension battering. Though this may not be music to everyone's taste, it is certainly very exciting, well worth getting to know and distinguished by excellent playing and brilliant recorded sound.

\* \* \*

**ALEXANDER KIPNIS IN MOUS-SORGSKY'S "BORIS GODOUNOV." Victrola VIC 1369 (Mono only).**

Kipnis, who is still alive and, I am told, still sings occasionally in private, was one of the greatest basses of this century, in an era when great bass voices were plentiful. He was not only a spectacular singer but, vocal ability apart, was a rare artist, a fine musician before all else and reputed to be brilliant company as well.

I only heard Kipnis twice, in the thirties and it was my good fortune to hear him as Boris, probably his greatest part. The tragic character of Boris seemed to have been especially written for Kipnis' unique talent and few other singers have been able to invest the part with such sympathy.

The extracts on these low-priced discs are taken from recording sessions held in 1945 and 1946, when Kipnis' voice was still in its prime; they were taped in the U.S.A., where he lives permanently. Kipnis' nobility of voice and sincerity in Boris' portrayal come through extremely well and the absence of the latest in high fidelity

## Andalusian Songs — A Collectors' Item

**SONGS OF ANDALUSIA: Spanish Songs from the Middle Ages and Renaissance. Victoria de Los Angeles, with the Ars Musicae de Barcelona, conducted by Jose M. Lamana. H.M.V. Angel SAN194.**

In sheer presentation, this is about the most sumptuously produced disc I've yet seen, packaged in a separate elaborate album, accompanied by a richly illustrated colour-booklet of articles, texts and other information. Such packaging, of course, raises one's suspicions but they are, on this occasion, groundless. I have not, as far as I can recall, ever heard a poor performance by this singer; on this disc, she is even better than on earlier issues and she is aided by truly magnificent recorded sound. I believe this disc will become a celebrated

collectors' item.

The songs, mostly Moorish, Sephardic and religious pieces, are excellent examples of medieval and Renaissance music. They are given authentic accompaniments by vihuela, krummhorns, rattas, lyres, viols, rebecs, psaltery, recorders and percussion. To add to the authenticity, Miss de Los Angeles has completely abandoned her customary styles and sings in a correct period manner, with only the barest hint of a vibrato.

Although we have, in recent years, been able to hear a fair amount of early music, live and on record, this disc is certainly one of the best ever made in this field and it may serve to overcome the resistance of many listeners who normally prefer to stay with well-known musical traditions.



cannot mar this fine disc. No one hearing Kipnis play the death of Boris could fail to be moved and I believe that every aspiring singer should hear this recording.

★ ★ ★

**PROKOFIEV: Cinderella** (complete ballet). Moscow Radio Symphony Orchestra; conductor Gennady Rozhdestvensky. HMV ASD 2429-30. (2 discs, boxed, with leaflet.)

This is the first complete recording of what is probably the best of modern Russian ballet scores. The recording, re-processed by E.M.I. from Russian masters or tapes, is well above average in sound quality and it is indeed a far cry from the type of recordings that have come out of Russia in the last decade. The surfaces are quiet and balance is excellent, with clear stereo separation.

The performance by one of the many first-rate Soviet orchestras, directed by the most brilliant of young Russian conductors, is remarkably fine. What distinguishes this score is, of course, Prokofiev's warm-hearted imagination. Melodious and witty in turns, the music is as enjoyable for listening as for stage performance.

No doubt ballet specialists will be found to deplore some tempo here, a rhythm there, but if there are vagaries in this reading they seem fully justified in a performance not primarily meant for dancing. The ballet is not one I have seen, but the music (and it is easy to follow the detailed story of the ballet in the leaflet) is such that I feel sure I would enjoy sitting through the whole three acts of it.

★ ★ ★

**A STRADELLA CONCERT** For Trumpet, Ancient Instruments, Strings and Continuo. Edward H. Tarr, soloists and the Jean-Francois Paillard Chamber Orchestra. Record Society No. 6299 (World Record Club).

This is a remarkable disc since Stradella is known to music lovers, merely, if at all, as a rather obscure footnote-entry in histories of music. Although historians, over the centuries, have credited him with being the first composer to develop the concerto grosso style, little else was known about him until recently. There are few indeed who can say they have ever heard any work of his, let alone played it.

We learn now that Stradella lived from 1644 to 1682, that he was a prolific and widely celebrated composer of every type of music, an ardent and energetic philanderer and that he was assassinated (but only at the second attempt!) for good and amorous reasons.

The works on this disc, all of them performed in an exemplary and very stylish manner, are: three Sinfonias; Sonata a quattro; Sonata for trumpet and double orchestra; Symphonia for violins, cello and lute; Concerto Grosso; Sonata di Virole. The instruments employed with great skill, include trumpet, trombone, harpsichord, cornets, lutes and organ; in addition, there are the strings of the Paillard Orchestra, as always playing with flawless precision. The recording, origi-

# Check all systems -

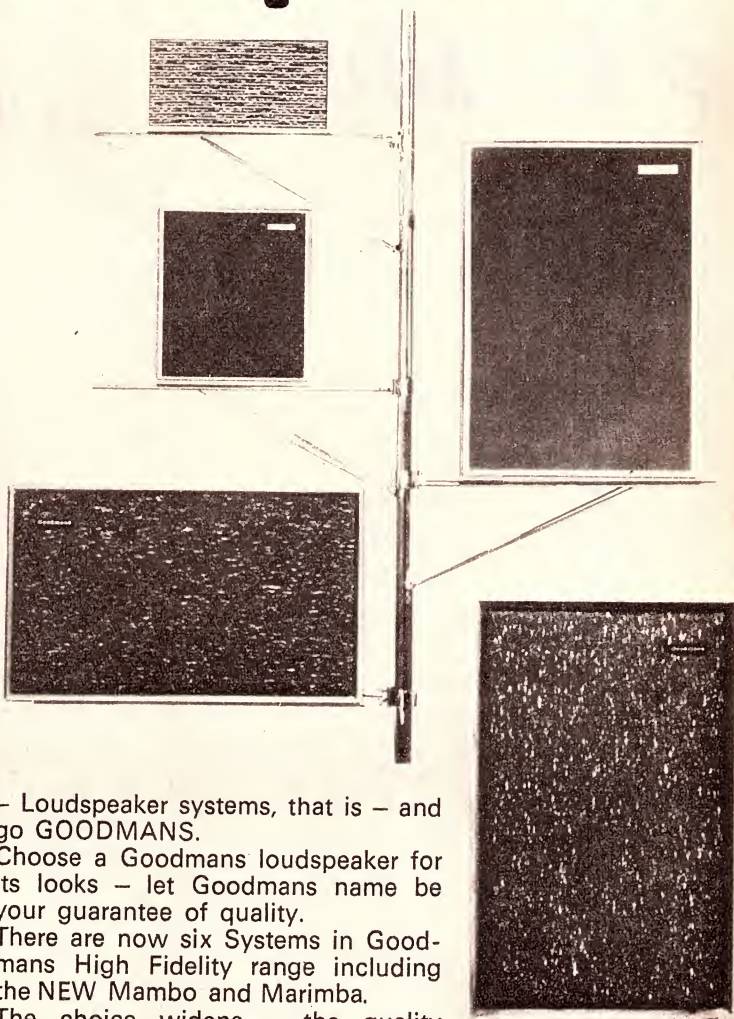

- Loudspeaker systems, that is - and go GOODMANS.

Choose a Goodmans loudspeaker for its looks - let Goodmans name be your guarantee of quality.

There are now six Systems in Goodmans High Fidelity range including the NEW Mambo and Marimba.

The choice widens - the quality remains the same. All offer the finest High Fidelity reproduction anywhere. Check for yourself - at your Goodmans dealer.

- 1 NEW! MAMBO\* 10½" x 8½" x 8" deep.
- 2 MAXIM Mini-system. 10½" x 5½" x 7½" deep.
- 3 NEW! MARIMBA\* For wall mounting. 19" x 13" x 5½" deep.
- 4 MEZZO 11 Flush fitted attenuator. 19½" x 12" x 9" deep.
- 5 MAGNUM-K. 3 speakers. 2 attenuators. 24" x 15" x 11½" deep.

All finished in Teak or Walnut to order.  
\*Sold in ready matched pairs.

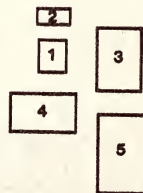

## Goodmans for High Fidelity

For full particulars, write to the Sole Australian Agent:

**BRITISH MERCHANDISING PTY. LTD.**  
Shaw House, 49-51 York St., Sydney. Telephone 29.1571 (3 lines)





# A "Moment of Truth"

## in Hi-Fi Sound

You will have arrived at "A Moment of Truth" when the time comes to choose your speaker system. You will have put out of mind the shrill sounding oriental models and lesser brand names and will have reached the only sensible conclusion — **the art of making speaker systems remains with the English and American manufacturers.** Amongst these, Raymond Cooke is the leading designer in the world today. That is why his designs are used by the British Broadcasting Corporation. We offer the following two systems which are superb reproducers.

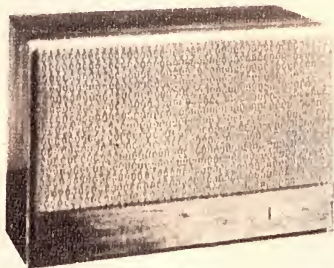

The **CRESTA** 15 watt RMS is afraid of nothing —and that includes Wagner! You'd think a speaker system only 13" x 9" x 7" couldn't do justice to the big, bold brasses, as well as the timid triangle. A lot of people thought so, until they heard the **CRESTA 15** in action. Result? A lot of people now own one — or two. Inside that compact exterior, there are two terrific speakers which handle the entire gamut of musical frequencies. How did we make them work so well in a small, attractive enclosure? It wasn't easy! If you're short of space (or, for that matter, money) and still want the finest of speakers, give the **CRESTA 15** a fair hearing (about 2½ minutes).



Now you can hear the classics as the composers would have wished. The **CONCORD** system by KEF brings out every nuance faultlessly, thanks to the T15 tweeter — pioneered and perfected by Raymond Cooke. But that's only the tweeter — the other half of **CONCORD** offers bass response you can feel, hear and enjoy. But KEF design goes beyond the integration of speakers and enclosures. Ingenious construction of the enclosure itself combines good looks with a grille covering that doesn't upset frequency response or introduce objectionable colouration. And, very important, **CONCORD** is a beautifully designed piece of furniture that fits in with any decor. Size of the **CONCORD**? It's a compact 24" x 15" x 9¾". A 25 watt RMS unit.

**USE OUR FREE CONSULTATION  
AND DEMONSTRATION SERVICE**

Write, Phone or Call for "SOUND ADVICE"

## J. H. REPRODUCERS CO.

293 HUNTINGDALE ROAD, CHADSTONE, VICTORIA. 3148

TELEPHONE: 277-3066

Exclusive Australian Agents for — ADC Cartridges and Amplifiers, Kef speakers, J. H./G. H. Unipoise Pickup Arms, Pritchard Arms, TRANSCRIPTOR TURNTABLES and the popular J.H. Synchronous Turntable.



nally an Erato, is beautifully engineered.

The music itself is among the finest the seventeenth century can offer. Stradella was, beyond doubt, a composer of ingenuity and great inventive talent, highly unconventional and of uncommon technical skill. It would do him less than justice to say that his importance lies in having greatly influenced Corelli and, later, Handel, Geminiani and many others. Stradella was an original thinker, a great innovator with full command of the melodic bel canto style on which he built. This disc is a unique sampler of his fine work, a disc that no serious music lover or student can afford to ignore.

★ ★ ★

**RACHMANINOV:** Piano Concerto No 2.

**BALAKIREV:** Islamey. Julius Katchen, piano; London Symphony Orchestra, conductor Georg Solti. Decca Ace of Diamonds SDD 181.

Coming just a few weeks after Katchen's early death, this disc is to be welcomed, whatever one's reactions are to the 2nd Rachmaninov concerto, which is surely too often recorded. If this frequency were decreased and if it were always played in the Katchen way, I might even get to like this music once again! Katchen's is a nice blend of restraint and poetic affirmation, the kind of treatment this old warhorse rarely receives.

Katchen was very much aware of the concerto's limitless melodic content as well as of its pianistic appeal. I have rarely heard this piece played to greater advantage, even to the jazzy bits of delight in the final movement. Solti and his orchestra provide very generous support for the soloist and the quality of the sound is among Decca's best.

I am not as wholly happy about "Islamey," clearly thought of as a "filler." Katchen was too fastidious and meticulous a musician to allow himself to be seduced by the utter barbarity this music calls for. This piece (it is, of course, for solo piano) is probably better left to the out-and-out virtuosos, preferably of the Russian school. All the same, though perhaps too tasteful, this is a fine performance and one that is certainly quite worth listening to with attention.

★ ★ ★

**SIBELIUS:** Violin Concerto; Two Humoresques. David Oistrakh, violin; Moscow Radio Symphony Orchestra; conductor Gennady Rozhdestvensky.

**SIBELIUS:** Belshazzar's Feast; Romance in C; Valse Triste. Leningrad Philharmonic Orchestra, conductor Gennady Rozhdestvensky. Melodja-HMV ASD 2407.

In the past, most Soviet recordings have been pretty dreadful and I was truly astonished by the superb quality of sound on this E.M.I. transcription from Russian tapes. The sound really is wonderfully good, with every delicate nuance of the scoring clearly audible and a rare overall quality of transparency.

Oistrakh, who has recorded this concerto twice before, plays with his usual lyrical assurance and great

strength and the orchestra, a more than competent ensemble, plays with unhesitating power.

The Leningrad Orchestra sounds a little more sophisticated and gives a brilliant account of "Belshazzar's Feast," a work that has not been available on disc for some 20 years. The music is good enough to deserve a more frequent airing and it is superbly played on this occasion. The other works, though unimportant, receive affectionate attention and the whole disc is one that not only Sibelius' followers will heartily welcome and enjoy.

★ ★ ★

**VERDI:** Falstaff (complete). Geraint Evans, Giulietta Simonato, Ilva Ligabue, Robert Merrill, Mirella Freni, Alfredo Kraus, RCA Italiana Opera Orchestra and Chorus, conductor Georg Solti. RCA LSC 8010 (3 discs, boxed, with illustrated booklet and bi-lingual libretto).

Although this recording was, I believe, first issued overseas in 1964 and even though it has formidable competition from two other versions, I am inclined to welcome it as THE version of "Falstaff." The age of the recording does not seem to have had any deleterious effect; with the exception of a few somewhat over-blown spots, it shows quite excellent recorded sound and is quite in line with Solti's other fine opera sets. The orchestra is not, basically, quite of the same standard as either the Vienna Philharmonic or the Philharmonia, but they are an ensemble who are almost ideal for Verdi

and I cannot find Solti's direction anywhere inferior to either Bernstein's or von Karajan's.

In some respects, I have no doubt that both the above versions will prove to have the edge on the RCA issue; not, however, when it comes to the most important aspect of all, the singing of Falstaff. Although this is an opera, and by Verdi, this does not, I think, exclude consideration of Falstaff as a Shakespearian character, essentially English. Both the other great singers who played Falstaff failed to treat this great comic character correctly, in my (perhaps isolated) opinion. Gobbi sang superbly, but his Falstaff was far coarser than the toper who flirted with the Windsor ladies; Gobbi's Falstaff was an Italian comic character, far removed from Shakespeare's England. Fischer-Dieskau, on the other hand, approached this role with undue delicacy and his Falstaff is far more of a gentleman than I believe to be indicated by the lines. These comments do not, in any way, reflect on the wonderful singing of both, but I will maintain that they did not really enter into the character properly.

Geraint Evans, by comparison, is everything Falstaff should be. He is a lusty, greedy, cowardly braggart who, despite everything, retains a deal of our affection and sympathy, at whom we laugh, seeing ourselves. Evans' Falstaff is as English as crumpets and the Italian text becomes irrelevant . . .

The soloists on this recording are, without exception, excellent and on a par with any used by the competing companies. Solti, surely an exceptional

**TRANSISTORISED**  
Amplification Equipment  
**GUITAR and PUBLIC ADDRESS**





*Fuzzmaster*      MARK IV



**MASTER DISCO CONSOLE**

Shown above is a small selection from our comprehensive range of equipment.

**FOR PRESTIGE SOUND SEE CLAYBRIDGE SOUND**

Secure your **FREE, COLOURED CATALOGUE** of our products & services.



163 CLAYTON RD. CLAYTON VIC. 3168 OR RING 544 6171  
(CNR. DANDENONG RD.)

(ALL HOURS)



# YOUR SOUND SYSTEM IS ONLY AS GOOD AS ITS SPEAKERS

Speakers give the sound from your Hi-Fi system its face, its character and colour. Whether you buy completely integrated speaker systems, singly mounted units, or just the speaker and build your own enclosure, the speaker you choose will decide the sound you hear. For true sound, you could not do better than choose from these.



**Wharfedale.** For decades a most trusted name in speakers.

Now hear the superb NEW SUPER LINTON system, shown here. A speaker system with a big heart in a beautifully styled cabinet (19in x 10in x 10in). Full bass to clearest treble, you won't miss a note.

**Denton speakers.** The smaller version yet (9½" x 14" x 8½"). It would be hard to find a performer equal to this at the same price.

**Melton.** The latest from the Wharfedale stable. A compact (21" x 13" x 10½") featuring a 12" wide-range bass speaker and low mass tweeter unit. Concert hall performance with amazing reality.

**Value.** We've paired a famous woofer and a Super 5" tweeter. The result is a system with a fantastic sound at a most economical price.



**Leak Sandwich.** Still the most revolutionary speaker system, with a three year warranty. Unique design, unique construction and unique performance.

**Kenwood.** A fabulous 5 speaker system with a 30 - 20,000 Hz range. At a price that will pleasantly surprise you.  
**Grille cloth.** Widest range in Sydney, samples provided on request.

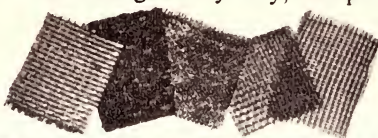

**MASTERSOUND SALES PTY. LIMITED**  
400 KENT STREET,  
SYDNEY. 29-1527

opera conductor, keeps up a cracking pace throughout the rollicking work. In the notes accompanying this set, much emphasis is put on the importance of the orchestra in this score and it is quite true that the orchestra plays a far greater part, dramatically speaking, than it does in other Verdi operas. Solti has paid much attention to orchestral detail and I found it very instructive listening to the instrumental work throughout this opera.

Apart from Evans, the most enjoyable contributions to the performance are made by Simionato as Mistress Quickly, Ilva Ligabue as Mistress Ford and Robert Merrill as her jealous husband. The sound, with the above qualifications, is good and the set must be welcomed as a most enjoyable one.

★ ★ ★

**VILLA-LOBOS: 12 Studies for Guitar,** played by **Mauricio de Oliveira.** Decca Ace of Clubs SCLA 7010.

The title of this recording, "Villa-Lobos e o Violao" issued by E.M.I. with the original Portuguese-language cover, led me to expect a collection of Villa-Lobos' violin music—I did not know (as who would?) that "violao" is Portuguese for guitar! These studies, few of which have appeared on other discs, are brilliantly played. Musically, the pieces are both beautiful and difficult, excellent examples of the composer's work, with its strong Brazilian flavour.

I realise that guitar music is not everyone's choice, but you may find this disc well worth listening to, both for the quality of the unusual music and for the excellent recorded sound, considerably better than that of many another well-played guitar recording.

★ ★ ★

**WALTON: The Bear.** **Monica Sinclair, John Shaw, Norman Lumsden; English Chamber Orchestra; conductor James Lockhart.** World Record Club 4525.

Based on one of Tchekov's "vaudeville" pieces, this short opera was completed in 1966. It had been commissioned by the Koussevitsky Foundation and William Walton describes it as a one-act "Extravaganza."

The story, involving an inconsolable, refined country widow, her faithful servant and a boorish neighbour who ends up wooing her, is a very witty one and this wit is reflected both in the colloquially burbling libretto and in the delightful musical score. The recording, originally issued on the Angel label in England, was made in the composer's presence and the performance is full of good humour and sparkle.

The music, one of Walton's best-balanced scores, has considerable charm and is, of course, ideally suited to the story. The singing is excellent throughout the work and gives both Monica Sinclair and John Shaw the best opportunities for showing their ability that they've yet had.

The English Chamber Orchestra rises to the occasion: the music is played with much subtlety and the quality of the recorded sound is truly excellent, with its blend of intimacy and instrumental richness. This is not "great" music, but it is great good fun, delightful to listen to and quite interesting in many ways. ■



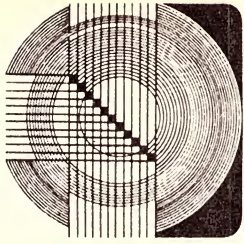

# DOCUMENTARY RECORDINGS

Reviewed by Glen Menzies

**CANTERBURY TALES:** Original Broadway Cast Recording of the Musical Play. Adapted from Chaucer by Nevill Coghill and Martin Starkie. Music by Richard Hill and John Hawkins. Lyrics by Nevill Coghill. Capitol LP STEREO SW 229.

This release follows closely on the heels of the English cast recording issued on the Decca label only a couple of months ago.

Comparison with the English performance is inevitable, and the Americans on this album sound just a little half-hearted in what is, after all, a rather lusty kind of show calling for plenty of swagger in its presentation. I understand that that old trouper, Hermione Baddeley, as The Widow of Bath in the Broadway production, brings considerable expertise to her stage part but somehow sounds a little pallid on this record. The same can be said of Ed Evanko with his twanging American accent and weak voice who sounds positively apologetic in that cheeky song which is one of the highlights of the show, "I Have a Noble Cock." Nicky Henson on the Decca LP sings this one with enormous gusto but also with considerable understatement.

The American presentation makes less sense and loses a great deal without the brief interlinking narrative which is spoken so eloquently in the English production.

Whatever the merits of the Broadway production the cast is seriously handicapped here by a recording lacking in both spaciousness and dynamic range. Stereophonic spread is minimal and fails to reveal the clever juxtaposition of brass choir and rock-style rhythm sections.

Clearly, then, E.M.I. have a winner in the English cast recording, with the American company making a slow finish in second place.

★ ★ ★

**THE LIVING SHAKESPEARE:** JULIUS CAESAR: With John Moffatt, Peter Finch, Patrick Wymark and Company. Directed by Dennis Vance. World Record Club LP Stereo LS/13.

The World Record Club tell me that this particular album in the Living Shakespeare series is in keen demand. Julius Caesar is on the reading list of secondary school English classes in N.S.W. this year.

This well balanced production with the Shakespearean language spoken so fluently by the large cast should help to dispel some of the confusions surrounding the play. Young people will find this an enthralling listening experience, fast paced but with every word

clear, the essence of the drama vividly captured.

In a very perceptive cover note, Bernard Grebanier says: "It may indeed be impossible to present accurately to a child's mind the meaning of a play whose hero, an exalted character, murders his best friend out of high principle. But the most common error is to conceive Mark Antony as the hero. The mistake is no doubt a product of the fact that innumerable generations of unhappy youngsters have been required to memorise the eloquent "Friends, Romans, countrymen" speech. Antony is actually the villain of the piece."

Peter Finch makes an eloquent Antony who, without shouting, gives us the uncomfortable feeling that we are listening to the speech of a demagogue.

John Moffatt's Caesar has all the arrogance of the purely political creature that Shakespeare created. His humourless self-importance can hardly be lost on Twentieth Century listeners.

Patrick Wymark projects the image of the high-minded Brutus, essentially a philosopher who is well out of his depth in the nightmare intrigue surrounding Caesar.

As with previous albums reviewed in this series, the script adaption has been tastefully and intelligently carried out without destroying the spirit of the work. These modern condensed versions of Shakespeare can be enjoyed as they are, but it would be surprising if they didn't lead listeners to look at the whole play sometime.

The condensed text of the play is supplied with the album and may be used by schools and amateur groups without permission.

Excellent recording makes this a fine acquisition for anyone's collection.

★ ★ ★

**THIS AUSTRALIA:** Featuring "Clancy of the Overflow," "The Man From Snowy River," "The Overlanders," etc. With Leonard Teale, Gary Shearston, Sean and Sonja and others. CBS LP STEREO SBP 233645.

There must be someone who buys them, otherwise record companies would not assemble these strange collections purporting to capture the unique flavour of the Australian folk heritage. This one really goes all out for variety and even includes a brass band track of "Waltzing Matilda" and "Advance Australia Fair."

A well written and quite informative cover note about the artists taking part says: "Only recently have Australians become aware of the richness and fascination of their folk heritage. Our traditional songs and ballads no longer suffer from the neglect and scorn once accorded them. Something

quite new in the world of entertainment has developed from this — the professional singer of Australian folk songs and the professional narrator of Australian verse."

These sentiments are admirable as far as they go, but I am still left with nagging doubts about whether Leonard Teale for instance, always gets the most out of the verses either as singer or speaker. Although as a straightforward reading his version of Dorothy McKellar's "My Country" is to be preferred to the somewhat pretentious performance of the same poem at the end of Side 2 by Christine Roberts. (Using multi-tracking techniques she speaks the words to the accompaniment of her own vocal version of the poem.)

Gary Shearston has a sunny and likable personality but his lengthy version of the inevitable "Wild Colonial Boy" does become a bit tedious after 6 minutes, and "Sydney Town," whilst entertaining and topical some years ago, is now quite dated in its references to happenings around Sydney.

The most unusual track on the album features the young folksinging duo Sean and Sonja in two Aboriginal songs, "Jabbin Jabbin" and "Maranoa Lullaby." The treatment of these two little songs is not only harmonically interesting, but also sounds very fresh alongside the stale familiarity of other songs on the record.

Recorded sound throughout is good and the cover reproduction of Arthur Boyd's, "The Waterhole — Central Australia" is entirely admirable. ■

ALWAYS RELY ON R.D.S.

## SPECIALS

**R  
D  
S**

Matched prs., AC127/128 trans., \$1.20 nett.

200V pl diodes at 500MA, 25c each nett

EMG 1065 conds. 1000 mfd at 50V, 80c each nett.

PVD 103. 100MA V.D. transformers. \$10.00 each nett.

PF1229 trans. 340/340 1500MA \$5.00 each nett.

Pkts. mixed resistors and pots. Great value. \$1.00 nett.

Compax transcription turntable, \$39.50 nett.

*The Independent Wholesaler*

**RADIO DESPATCH SERVICE**

Radio and Electrical Distributors

**869 GEORGE STREET, SYDNEY.**

Corner George and Harris Streets  
Telephone 211-0816, 211-0191

**Open Saturday mornings**



With a BSR X3M  
 'compatible' cartridge,  
 almost any mono  
 record playing  
 equipment can take  
 stereo records  
 (without damaging  
 them)

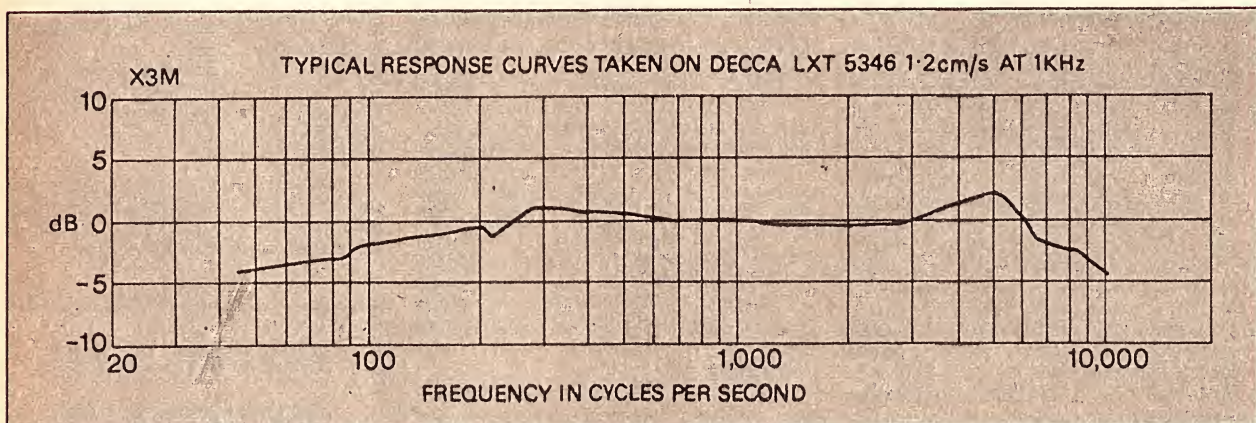
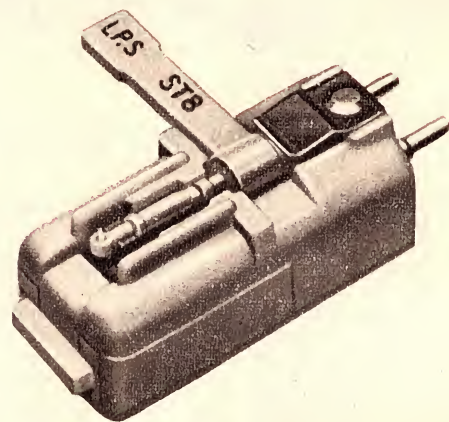

### Why compatible cartridges?

An increasing number of record companies are now making stereo LP records only.

Until now these records could not be played on a mono player without distortion and damage to the records.

When playing stereo records the stylus tip moves vertically and horizontally following groove contours. Mono records have grooves which only move the stylus horizontally so old mono cartridges will not allow vertical movement of the stylus. Playing stereo records with old mono cartridges will damage the vertical component of the groove irrevocably.

The X3M 'compatible' cartridge, designed and perfected by BSR, is the answer to this problem. For a small outlay it allows you to play both stereo and mono records without harming either. Retail price, \$6.00.

### TECHNICAL DATA X3M

Output: 350 mV  $\pm$  2 dB

1 KHz test record Decca  
 LXT 5346 at 1.2 cm/s

Frequency Response: See typical curves above

Dynamic Compliance:

Horizontal  $3.0 \times 10^{-6}$  cm/dyne ( $\pm 20\%$ )

Vertical  $1.0 \times 10^{-6}$  cm/dyne ( $\pm 20\%$ )

Equivalent Capacity: 800 pF

Nominal

Recommended Loading: 2 M. ohm 100 pF

Stylus Pressure: 4-6 grammes  
 depending on pick-up arm

Measuring Temperature: 20° C 68° F

Colour: Beige



BSR (A/ASIA) PTY. LTD.  
 SOUTHERN SECTION INDUSTRIAL ESTATE  
 ST. MARY'S, N.S.W.  
 PHONE: 623-0375, 623-0376



DISTRIBUTORS:  
 GOLDRING ENGINEERING (A/ASIA) PTY. LTD.  
 443 KENT STREET, SYDNEY, N.S.W.  
 OFFICES IN ALL CAPITAL CITIES.

BSR:P100



The BSR McDonald 500 encompasses every fine feature one could desire in an automatic turntable.

- Large 11" diameter turntable
- Dynamic anti-skate control applies continuously corrected compensation at all groove diameters.
- Cueing and pause control lever allows for exact positioning of stylus on record and permits you to interrupt listening and reposition to same groove.
- Micrometer stylus pressure adjustment permits 1/3 gram settings from 0 to 6 grams.
- Automatic lock on tone arm after last record is played.
- Dynamically balanced 4-pole induction motor has high torque, constant speed design—assuring minimum rumble and wow.
- Low mass tubular aluminium tone arm perfectly counter-balanced both horizontally and vertically.
- Resiliently mounted, coarse and fine vernier adjustable counter-weight.
- Tone arm is jam-proof even if it is held during the cycling operation.
- Clip-in cartridge holder, provides universal mounting and quick change. (Optional)



# The total turntable concept



*A complete modular unit ready for use—ebony polystyrene base, smoke-tinted dust cover, mains and audio leads. The only complete packaged, factory-tested unit. Tested under actual playing conditions from specially selected components.*

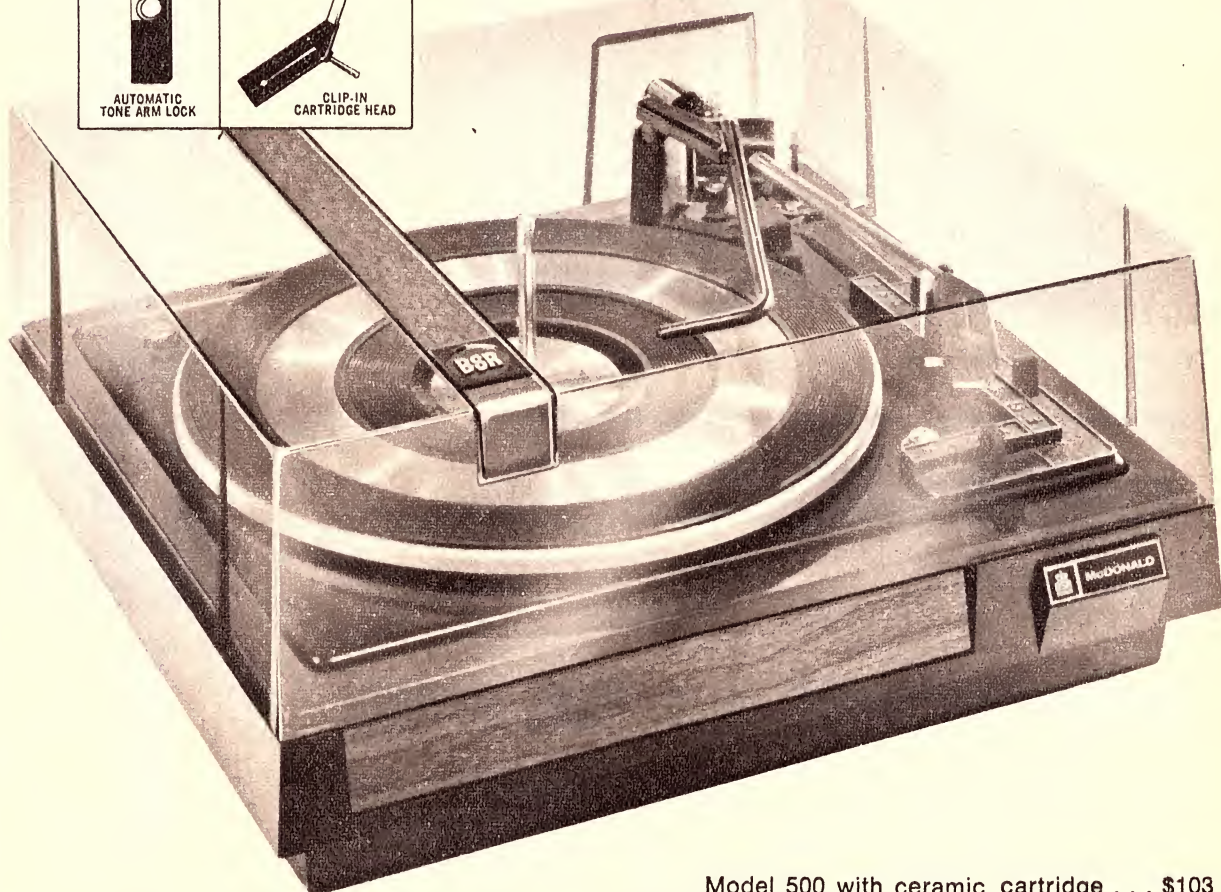

Model 500 with ceramic cartridge . . . \$103  
 Model 500 with 800H magnetic cartridge . . . \$114



Southern Section Industrial Estate,  
 St. Marys, N.S.W.  
 Phones: 623-0375, 623-0376

*Wholesale Distributors*

**Goldring Engineering (A'Asia) Pty. Ltd.**  
 N.S.W.: 443 Kent St., Sydney. Phone 29-1275  
 VIC.: 162 Pelham St., Melbourne. Phone 34-5105  
 QLD.: 415 Adelaide St., Brisbane. Phone 2-3247  
 W.A.: 32 Northwood St., Leederville. Phone 8-4988  
 S.A.: 77 Wright St., Adelaide. Phone 51-5117



**SANSUI** From Melbourne's leading **HI-FI** specialist

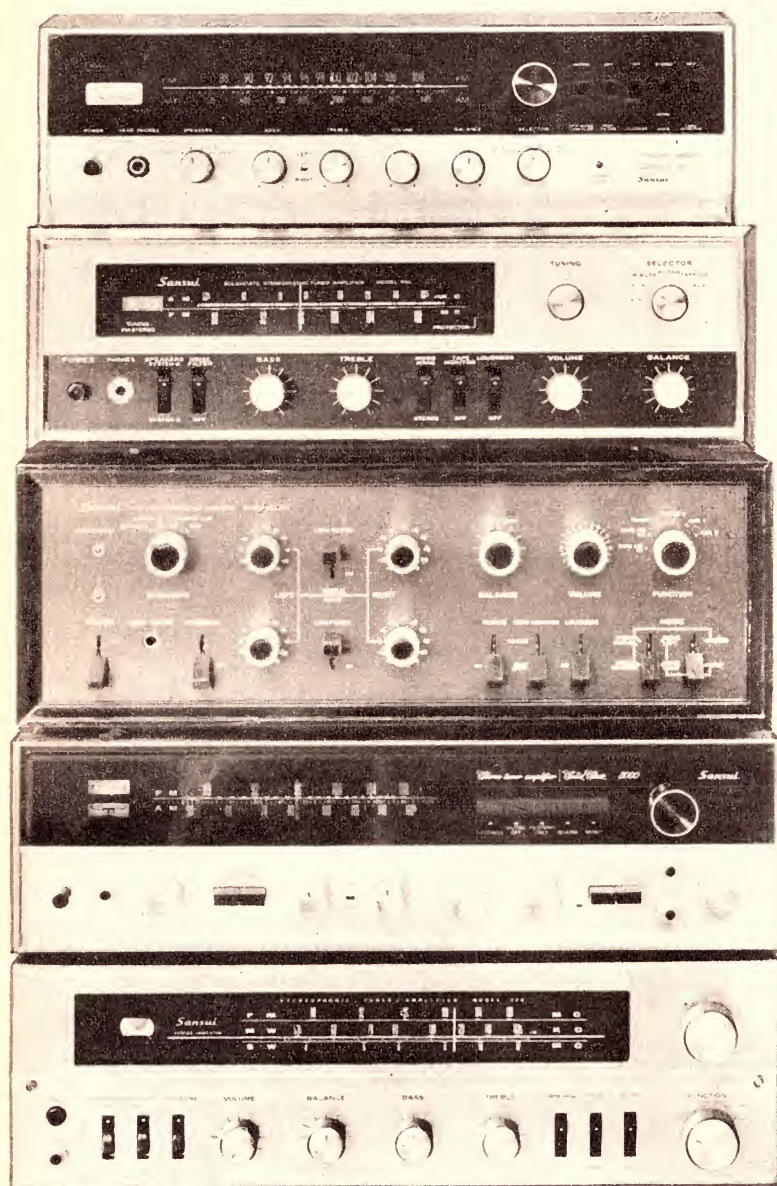

800

400

777

5000

220

**SANSUI**

## SCOOP PURCHASE ON SANSUI SOUND!

Rush this bulk release of Sansui Model 220 tuner amplifier at the amazingly low price of \$154 tax paid

100 only reserved for mail orders.

Check us last for the lowest discount prices on all tape recorders and Hi-Fi sound.

# DOUGLAS TRADING P/L

Inc. City Hi Fi — Tape Recorders (Vic.) — BJD Electronics  
191 BOURKE STREET, MELBOURNE 3000—PHONE 63-9321





# VARIETY FARE

By HARRY TYRER, FORBES CAMERON, NEVILLE WILLIAMS

## Devotional recordings

**TAKE MY HAND PRECIOUS LORD.** George Beverly Shea. Stereo, RCA Camden CAS-2281.

Interest: More Bev. Shea hymns.  
Performance: Good.  
Quality: Good.  
Stereo: Reprocessed.

At first glance I assumed this to be a re-release of an earlier RCA album but the one I had in mind proved to be a quite different collection of hymns under the shorter title "Take My Hand." The fact that this is "reprocessed" stereo might indicate that it is nevertheless an older recording but this shouldn't be held against it. The quality is quite good and the reprocessing just enough to broaden the apparent sound source.

With part organ and part orchestral accompaniment, Bev. Shea brings a program of hymns aggregating about 26 minutes of playing time: Take My Hand, Precious Lord—He Was There—There's A Time—Only A Touch—No One Understands Like Jesus—Break Thou The Bread Of Life—Beautiful Valley Of Eden—Go Down, Moses—We're Marching To Zion—Christ The Lord Is Risen Today.

For those interested in Gospel music, good value at the current Camden price. (W.N.W.)

★ ★ ★

**WHERE NO ONE STANDS ALONE.** Ferlin Husky. Stereo, Capitol (E.M.I. ST-2813).

Interest: Hymns, rhythm style.  
Performance: Capable, pleasant.  
Quality: Good.  
Stereo: Normal.

Ferlin Husky who presents this, his first, inspirational album, has a pleasant bass-baritone voice and is backed by chorus and rhythm-style instrumental that, on another label, would almost automatically have invoked a reference to "The Nashville Sound."

For the most part, the numbers are of recent vintage or enjoying a "re-run": I Believe—I Saw The Light—Peace In The Valley—I'll Fly Away—That Lucky Old Sun—There's A Big Wheel—Just A Closer Walk—Farther Along—It Is No Secret—Lonesome Valley—Where No One Stands Alone—Somebody Touched me.

The style will have an automatic appeal to younger people but the gentle rhythms should appeal to their parents as well—unless they are completely square! A good family devotional album. (W.N.W.)

**SING TO GLORY.** Jimmy Little with chorus and orchestra. Mono, Calendar (Festival) R66-584.

Interest: Gospel plus rhythm.  
Performance: Good.  
Quality: Clean but lacks sparkle.

After a sequence of top quality stereo discs, the rather dull sound on this mono pressing tended to put me off but, fortunately, the sound is quite clean and listenable. Jimmy Little, the popular Australian Aboriginal singer, gives a smooth, pleasant performance using material that is bright enough to interest teenagers but, once again, sufficiently restrained to go over with their parents as well.

He sings: I Am On The Battlefield—Royal Telephone—Just A Closer Walk—The Church In The Wildwood—By And By—Somebody's Knocking At Your Door—When The Saints Go

## Instrumental, Vocal and Humour . . .

**SLAVONIC DANCES (complete).** Dvorak. The Cleveland Orchestra, conducted by George Szell. C.B.S. Stereo SBR 235308.

Interest: Tuneful classics.  
Performance: First class.  
Quality: Excellent.  
Stereo: Good spread.

There is well over an hour of delightfully tuneful music on this disc, and when it is played by such a fine combination as the Cleveland Orchestra under George Szell, the result is a record which can be recommended without reservation. The sound throughout most of the performance is of the usual high standard of C.B.S. recordings, but inevitably it deteriorates towards the end of both sides, where the grooves are cut very close to the label, but only slightly. A most enjoyable disc, with everything in its favour. (H.A.T.)

★ ★ ★

**STEREO SHOWPIECES.** Bournemouth Symphony Orchestra, conductor Constantin Silvestri. Studio 2 Stereo TWO 221.

Interest: Popular classics.  
Performance: Competent.  
Quality: Excellent.  
Stereo: Likewise.

Although by no means a great orchestra, the Bournemouth Symphony has been a favourite of recording companies for the type of light classical fare offered here for many years, and they are quite equal to the demand of the pieces, comprising: Night on the Bare Mountain (Moussorgsky)—Pavane for a Dead Princess (Ravel)—

Marching In—Hornets—Life's Railway To Heaven—Old Time Religion—Each Step Of The Way—Answer The Call Of Jesus.

Not a record to write home about but a safe buy if the material appeals. (W.N.W.)

★ ★ ★

**THE ENDURING HYMNS.** Organ, Ken Griffin and Kirby Griffin. Stereo, Harmony (CBS) HAS-156.

Interest: Well-known hymns.  
Performance: Disappointing.  
Quality: Mediocre.  
Stereo: Not significant.

The hymns featured on this album were chosen by readers of "The Christian Herald" as their favourites—hymns which through the years have been a source of inspiration: The Old Rugged Cross—Abide With Me—Rock Of Ages—Nearer, My God To Thee—Sweet By And By—Onward Christian Soldiers—In The Garden—What A Friend We Have In Jesus—How Great Thou Art—Blessed Assurance—Jesus, Lover Of My Soul—Sweet Hour Of Prayer.

There is no clue on either the jacket or the label as to which organist played which hymns but both adopt the same style: the hymns are played "straight" to the point where they sound stark and even mechanical. And, particularly on side 1, a heavy vibrato—probably from a Leslie system—is used to the point of tedium and with altogether too abrupt a contrast with Vibrato-off.

I'm afraid I can't recommend this album on any grounds. (W.N.W.)

Danse Macabre (Saint Saens)—Finlandia (Sibelius)—In the Steppes of Central Asia (Borodin)—The Sorcerer's Apprentice (Dukas). I must say that I have heard performances of all these works that I prefer to these versions. Nevertheless, these are quite worthy of respect, and if anybody is looking for a new performance of this particular selection, it is certainly worth considering, particularly as it has the advantage of the Studio 2 Stereo recording system. (H.A.T.)

## SERVICE

BILL TURNBULL offers you service on Hi Fidelity equipment tape Recorders, Communication Receivers and Electronic Test Equipment.

25 years experience  
All work guaranteed

BILL TURNBULL

11 ELLALONG ROAD,  
CREMORNE, N.S.W. 90 4825



# Stereo Music Systems Centre of the World's Finest HI-FI and STEREO equipment

## monarch

Amplifier Model SA500

Australia's largest-selling budget-priced amplifier. Check these features: \* 17.5 Watts/channel r.m.s. \* Inputs for magnetic crystal cartridge tuner tape \* Low filter \* High filter \* Loudness.

Check our price in the system of your choice.



### Acoustic Research Speakers

From the inventors of the acoustic suspension bass driver. The natural sound — The tightest bass — The smoothest and best dispersed Highs. These famous American speakers are for the connoisseur, the lover of true high-fidelity.

Don't buy a quality speaker without hearing A.R.

# AR

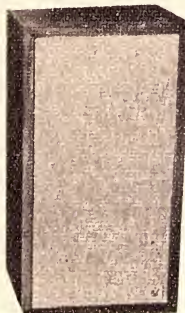

## BOSE 901

What is revolutionary about a speaker system with 18-4" full range speakers — five sides and a direct/reflecting principle? Why not come and hear them! Especially if you have a mighty good speaker system now. You'll have a lot of questions to ask. We can answer them for you. Then —

Go back to your own system — if you can.



We are now also demonstrating the new Stanton range of cartridges and invite you to hear, particularly the 681EE. Hi-Fi Stereo Review said, "The tracking was distinctly better than any other cartridge we have tested. The frequency response was the flattest of the cartridges tested".

For all Hi-Fi requirements plus our unique demonstration facilities and extended guarantee.

# STEREO MUSIC SYSTEMS

Sales and Service  
193 Clarence Street. 29 6681  
(Between King and Market)

**PETER AND THE WOLF** and other pieces for children, *The Little Symphony of London*, conducted by Arthur Davison. Music for Pleasure. Compatible Stereo MFP-A 9025.

Interest: Children's classics.

Performance: Just right.

Quality: Excellent.

Stereo: Carefully channelled.

Ostensibly a program for the kids, but I bet quite a few dads and mums will be sitting in when the disc is played. The works are: Peter and the Wolf (Prokofiev)—Sleigh Ride (Mozart) — Toy Symphony (attributed to Haydn).

"Peter" has the benefit of a very good narrator in Paul Daneman. He tells the tale as a children's story should be told, without talking down and without a trace of the irritating archness which has marred so many performances of this piece. Outstanding among the instrumentalists are the three horns representing the wolf, who are magnificently mean and moody. The other animals are presented very competently, my only complaint being that the clarinet pussy sounds too sleek and well fed to be a serious menace to the flute's bird.

The Mozart piece is a pleasing number, nicely played, but it is the Toy Symphony which I feel will be the major attraction. Conductor Arthur Davison gives his musicians their head and the performance is more notable for energy than finesse, but surely this is how the piece is intended to be. The very off-key toy trumpets are recorded close up, giving them the prominence they should have, as are all the other toy instruments. Conclusion — an outstanding bargain. (H.A.T.)

★ ★ ★

### CONCERTOS BY MOONLIGHT.

Philippe Entremont, piano, with orchestras. C.B.S. (Australian Record Company) Stereo SBR 235312.

Interest: Concerto sampler.

Performance: Plenty of dash, light on lyricism.

Quality: Very good.

Stereo: Normal spread.

This is really a sampler, containing tracks from recordings of concertos made by Entremont with either the New York Philharmonic and Bernstein, or the Philadelphia Orchestra and Ormandy. These are: No. 1 in B-flat minor (Tchaikovsky) first movement—Grieg's in A minor (first movement)—No. 2 in C minor (Rachmaninoff), third movement. Also included are extracts from Rachmaninoff's "Rhapsody on a Theme of Paganini" (the popular eighteenth variation, needless to say); and Gershwin's Rhapsody in Blue. Entremont's style is bravura, with swooping runs and plenty of dynamism, and this works out very well in three of the five tracks. But not in the Grieg work—this concerto above all others requires a lyrical, poetic approach, and it does not get it from Entremont. Comparing this performance with the exquisite playing of Dinu Lipatti in his recording of this concerto, Entremont sounds quite mundane and prosaic. I need hardly add that the



other track to which these remarks apply is the "18th Variation."

The other three tracks are carried off in fine style, the orchestras both exhibiting fine work, with the New Yorkers sounding rather more polished, but the Philadelphians sounding more relaxed and mellow toned. Sound quality is first class throughout, although some may think the piano a little too prominent. (H.A.T.)

★ ★ ★  
**THE ROMANTIC RACHMANINOFF.** The Kingsway Orchestra, conducted by Camarata. Decca Phase 4 Stereo (E.M.I.) PFS 4150. Interest: Rachmaninoff snippets. Performance: Fine. Quality: Brilliant. Stereo: Excellent.

A "bits and pieces" program from the more popular works of Rachmaninoff, plus two preludes, as presented here may not appeal to the experienced listener to the classics, but they are so splendidly played by the Kingsway orchestra that they will certainly find favour with those who enjoy this type of program. Excerpts are presented from: Rhapsody on a Theme of Paganini (18th variation) — Concerto No. 2 in C minor. Presented complete are two movements from the orchestral suite "The Bells (The Silver Sleigh Bells, The Loud Alarm Bells); The Scherzo from Symphony No. 2 in E minor; and the Preludes in G minor and C sharp minor. Even if you do not usually go for "snippets" this program is sufficiently interesting to warrant a try, especially if you are not too familiar with the (to my mind) unjustly neglected orchestral works of Rachmaninoff. (H.A.T.)

★ ★ ★  
**JOHANN STRAUSS FAVOURITES.** The Boston Pops, conducted by Arthur Fiedler. Camden (RCA) Mono only CAL-7051. Interest: As per title. Performance: Lively. Quality: Atrocious.

Opinions may differ about how Viennese Waltzes should be played. Personally I am not overkeen on the approach adopted by the Boston Pops in this program of three waltzes, three

"Full marks" .....

**NEW SOUND TANGOS.** Frank Pourcel and his Orchestra. Columbia (E.M.I.) Stereo SCXO 7893. Interest: Tango evergreens. Performance: Polished. Quality: Excellent. Stereo: Good spread.

Easily the best disc of tangos to come my way for several years, this one gets full marks in all departments: the orchestra exhibits a high standard of musicianship; the arrangements are very polished and imaginative; the sound quality is as good as one could wish; and the selection of tunes will surely appeal: *Amour, Castagnettes et Tango — Jalouse — La Cumparsita — Black Eyes — Isle of Capri — Pilar — Tristesse — A Night in Monte Carlo — Violetta — Ce N'est Que Votre Main, Madam — II Pleur sur la Route — Ole Guapa.* Highly recommended. (H.A.T.)  
.....

polkas and two marches by Johann Strauss, but I am all for the spirited, keen-edged playing of the orchestra in the five pieces which are not waltzes. Despite this, and the low price tag of \$1.99 now asked for Camden discs, I cannot recommend this release, because of the very poor sound quality, in which the limited frequency response and distortion are bad enough, but are made worse by noticeable wow. I assume these tracks are reprocessed from 78rpm discs, but the transfer has not been at all well done. A pity, for the program is basically an attractive one: *Roses of the South — Tritsch Tratsch Polka — Dichterliebe Waltz,* and so on. (H.A.T.)

★ ★ ★  
**HERBIE GOES HAWAIIAN.** The Herbie Marks Trio, with Kon Omaha, vocals. Festival Stereo SFL-933,211. Available in Mono. Interest: Hawaiian melodies. Performance: Disappointing. Quality: Good standard. Stereo: Normal.

As an admirer of the Herbie Marks Trio, I must confess to being disappointed by the performance on this disc. The most pleasing feature of previous performances of the group has been the accordion playing of Herbie Marks himself, and here he hardly touches this instrument, but elects to play his Hohner-Electravox. Dick Carr, who usually plays Spanish guitar exchanges his instrument for the steel guitar—not too big a change—but Innocent Nick, whose normal accomplishments include performances on trumpet, domra, balalaika and bass, has to switch to ukulele. I didn't like it, my main objection being that the group does not sound Hawaiian anyway, although the selection of tunes are in the right direction. These include: *Hawaiian Wedding Song, Song of the Islands, Sweet Leilani, Hawaiian War Chant, Moon of Manakoora, Trade Winds, Aloha Oe.* Unless you have any particular preference for this group, I suggest one of the other Hawaiian discs reviewed in recent issues would be a better proposition. (H.A.T.)

★ ★ ★  
**THE BAND OF THE ROYAL CORPS OF TRANSPORT.** Conducted by Desmond K. Walker, A.R.C.M., P.S.M., R.C.T. Compatible Stereo. Music For Pleasure, MFP-A 8070. Interest: Military band music. Performance: Excellent. Quality: Clean, well-balanced. Stereo: Normal.

Like many of England's brass bands, this one can trace its history back through many long years — in this case to at least 1799, when it was known as The Royal Wagon Train Band. Nor does the present group of bandmen betray that tradition. In a varied and well played program they present: *Famous British Marches — Soldiers' Chorus From "Faust" — Coronation March "Le Prophete" — Marching With Sousa — Battle Of Britain March — Wait For The Wagon — Brigade Star — Cavalry Of The Steppes — Brass Accolade — The Little Hussar — Sullivan On Parade — Evening Hymn and Cavalry Last Post.*

## TRADE ENQUIRIES ONLY

- ★ COMPAX 111 TURNTABLES
- ★ LUSTRE TONE ARMS
- ★ MICRO CARTRIDGES
- See review on Page 119 of February, 1969 Issue, "Electronics Australia."
- ★ COMPAX AMPLIFIERS
- ★ LUX AMPLIFIERS
- ★ PML MICROPHONES
- ★ LONDON MICROPHONES
- ★ GRACE TONE ARMS AND CARTRIDGES
- ★ CELESTION GUITAR SPEAKERS
- ★ PRL TANGENTIAL FANS
- ★ MICRO DUST PICKUPS
- ★ PLANET P.A. AMPLIFIERS
- ★ SOUND AMPLIFIERS
- ★ COMPAX TUNERS
- ★ PIEZO MICROPHONES
- ★ SONICS SPEAKER SYSTEMS

Trade supplies only available from:

## INTERNATIONAL DYNAMICS (AGENCIES) PTY. LTD.

4 Duke St., Abbotsford, Victoria. 3067. Tel. 42 4403



The best  
buy at any  
price!

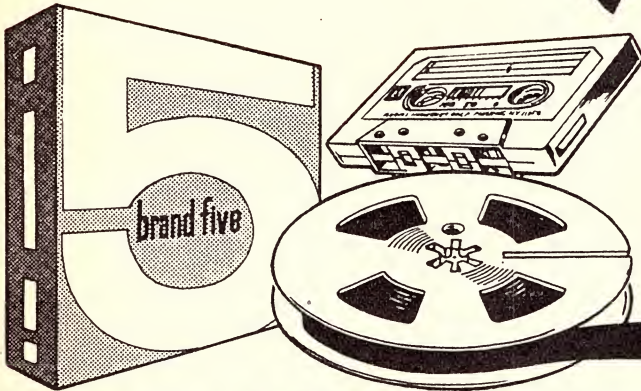

# PROFESSIONAL TAPE AT WHOLESALE PRICES

"BRAND 5"—unconditionally guaranteed and manufactured to highest U.S.A. professional standards and sensationally priced at half that of comparable tapes.

"BRAND 5" has high remanence iron oxide

emulsion coated to highest grade Acetate or Mylar base material.

"BRAND 5" ensures unmatched results in high fidelity mono and stereo recordings, with certain protection against head wear, squeal and gumming of heads.

## FINEST QUALITY! HALF THE PRICE!

| LENGTH              | TYPE No. | DESCRIPTION & MIL. THICKNESS | NORMAL PRICE | OUR PRICE | LENGTH                      | TYPE No. | DESCRIPTION & MIL. THICKNESS | NORMAL PRICE | OUR PRICE |
|---------------------|----------|------------------------------|--------------|-----------|-----------------------------|----------|------------------------------|--------------|-----------|
| <b>7" REELS</b>     |          |                              |              |           | <b>CORRESPONDENCE TAPES</b> |          |                              |              |           |
| 1200'               | 15D7     | 1.5 ACETATE                  | 6.60         | 3.00      | <b>3 1/4" REELS</b>         |          |                              |              |           |
| 1800'               | 10D7     | 1.0 ACETATE                  | 7.25         | 3.25      | 900'                        | 3D32MS   | .33 MYLAR                    | 3.90         | 1.95      |
| 1800'               | 10D7M    | 1.0 MYLAR                    | 9.15         | 3.99      | <b>3" REELS</b>             |          |                              |              |           |
| 2400'               | 5D7M     | .5 MYLAR                     | 10.40        | 4.75      | 150'                        | 15D3     | 1.5 ACETATE                  | .95          | .50       |
| 2400'               | 5D7MT    | .5 TENSIL MYLAR              | 11.90        | 5.25      | 225'                        | 10D3     | 1.0 ACETATE                  | 1.20         | .65       |
| 3600'               | 5D7MS    | .33 MYLAR                    | 13.20        | 6.75      | 225'                        | 10D3M    | 1.0 MYLAR                    | 1.65         | .70       |
| <b>5 1/2" REELS</b> |          |                              |              |           | 300'                        | 5D3M     | .5 MYLAR                     | 1.95         | .85       |
| 1200'               | 10D57    | 1.0 ACETATE                  | 5.50         | 2.55      | 600'                        | 3D3MS    | .33 MYLAR                    | 3.30         | 1.60      |
| 1200'               | 10D57M   | 1.0 MYLAR                    | 6.00         | 2.95      | <b>CASSETTES</b>            |          |                              |              |           |
| 1800'               | 5D57M    | .5 MYLAR                     | 8.90         | 3.75      | C30                         |          | 3.10                         | 1.55         |           |
| <b>5" REELS</b>     |          |                              |              |           | C60                         |          | 3.50                         | 1.65         |           |
| 600'                | 15D5     | 1.5 ACETATE                  | 3.40         | 1.80      | C90                         |          | 4.75                         | 2.65         |           |
| 900'                | 10D5     | 1.0 ACETATE                  | 4.15         | 1.98      | C120                        |          | 6.50                         | 3.30         |           |
| 900'                | 10D5M    | 1.0 MYLAR                    | 5.32         | 2.25      |                             |          |                              |              |           |
| 1200'               | 5D5M     | .5 MYLAR                     | 6.95         | 2.50      |                             |          |                              |              |           |
| 1200'               | 5D5MT    | .5 TENSIL MYLAR              | 8.70         | 2.75      |                             |          |                              |              |           |
| 1800'               | 5D5MS    | .33 MYLAR                    | 9.60         | 3.75      |                             |          |                              |              |           |

\* AVAILABLE AT ALL GOOD RADIO,  
TAPE AND RECORD STORES

GREEN CORPORATION LTD. 88 KING STREET  
SYDNEY. TEL.: 25-1989



**GREEN CORPORATION LTD.** EA669

88 KING STREET, SYDNEY, N.S.W. 2000

Please send me FREE 24-page booklet "TAPE EDITING AND SPLICING".

NAME .....

ADDRESS .....



Technically, the sound quality is excellent and, if you want a traditional military band record, this one is excellent value. (W.N.W.)

★ ★ ★

**GERSHWIN GOES LATIN.** Stanley Black and His Piano. Stereo. World Record Club WRC S/4464.

Interest: Gershwin, Latin style.  
Performance: Good.  
Quality: Excellent.  
Stereo: Normal.

I guess that after you've done playing Gershwin in the Gershwin manner and Latin in the Latin manner, there's no special reason why the two should not be cross-pollinated—and Stanley Black certainly does the job well as any and better than most. He offers: S'Wonderful—Love Is Here To Stay—Let's Call The Whole Thing Off—Nice Work If You Can Get It—Embraceable You—Soon—Bidin' My Time—A Foggy Day—Love Walked In—Somebody Loves Me—But Not For Me—Liza.

The sound is clean and as the jacket says "Eminently danceable." If it appeals, go to it. (W.N.W.)

★ ★ ★

**THE SOUL OF ITALY.** Jerry Murad's Harmonicats. Compatible stereo, Harmony HAS 169.

Interest: As per title.  
Performance: Top-line.  
Quality: Flawless.  
Stereo: Good spread.

When I first heard the three Harmonicats, many years ago, I was impressed by their musicianship, the depth of their sound and the technical care with which their recordings appeared to have been made. The passing years have not changed this reaction and if your collection does not contain at least one Harmonicats album, this would be a good one with which to make good the lack.

And who could deny the appeal of the Italian numbers they play: Ciribiribin—O Sole Mio—Santa Lucia—O Mari—Tra Veglia E Sonno—I Milioni D'Arlecchino—Dicitencello Vuie—Mattinata—Rimpianto—Torna A Surriento—Funiculi Funicula—Taranella Siciliana.

The quality is excellent. You can play it loudly, if you want to, and let the big bass harmonica give the cones a workout. Or you can enjoy it as background, Mediterranean style. (W.N.W.)

★ ★ ★

**FLAMENCO — THE SPAIN OF MANITAS.** Manitas de Plata. C.B.S. Stereo SBP 233646.

Interest: Tuneful flamenco.  
Performance: Highly skilled.  
Quality: Very well recorded.  
Stereo: Normal.

Hard on the heels of a flamenco program by Manitas de Plata reviewed last month comes this further disc from C.B.S. While I do not go along with the sleeve note claim that Manitas is the "greatest living exponent of flamenco music" he is undoubtedly highly skilled in the art, and certainly worth the attention of any flamenco enthusiast. The program here is designed to reflect the style of different regions of Spain. These regions, and the titles of the pieces are: Granada (Arabesque de



*Tom Dickson, a 56-year-old miner of Bannockburn, Scotland, has found a more effective way of coaching his prize-winning canaries in the art of whistling. Soon after they are born, Tom plays to them regularly 13 snatches of bird-song recorded from one of his whistling champions. After three months, he says, "they are ready to burst into show business."*

l'Ahabra—Malaga; (La Ciudad de Don Pablo)—Andalucia (Fandangos de la Malasuerte, Fiesta Andaluza, and Fandango por Soleares a Dos Guitares)—Ronda (Por el Camino de Ronda)—Aragon (Danse Aragonaise)—Andalucia (Seguiriya por Fandangos del Hijo)—Sevilla (Noche de Feria)—Cordoba (Tientos por Tres).

This is an attractive program, if a trifle superficial, providing ample opportunity for Manitas to display his evident skill. The performance is for guitars only, with no taconeo and castanets, and no cantor. However, in some tracks, Manitas is joined by his son. I don't believe anybody buying this disc will be disappointed. (H.A.T.)

**THE BIG LATIN BAND — Henry Mancini.** RCA Stereo LSP 4049.

Interest: Mainly film themes.  
Performance: Very poor.  
Quality: Well recorded.  
Stereo: Normal spread

Henry Mancini is an outstandingly talented and creative composer and arranger. But this album should never have been issued under his name. The arrangements, indeed, are so tired and unimaginative that I find it hard to believe he wrote them.

Mancini composed only two of the tracks, "Touch of Evil" and "Las Cruces," while the remaining nine tracks are mainly film themes including "The Magnificent Seven," "The Good, the Bad and the Ugly" and "Hang 'Em High."

There are at most three worthwhile compositions on the album and the underlying Latin American flavour soon palls. Finally, the playing-time is a mere 25½ minutes. I regard this as the poorest album to come my way this year. (T.F.C.)

★ ★ ★

**HISTORIC ORGANS OF EUROPE.** World Record Club Stereo S/4509.

Interest: See title.  
Performance: Satisfactory.  
Quality: Good.  
Stereo: Normal, adds atmosphere.

This disc is likely to appeal more to those who are interested in organs rather than organ music, although much of the music is attractive enough. The fact is that the music in each case was originally written for the particular organ on which it is played, which rather restricts the repertoire available to the performers.

Spain is represented by the organs at Cavarrubias and Salamanca; France by Marmoutier, Saint-Maximin, L'Isle sur la Sorgue and Souvigny; Italy by Bastia; Denmark by Frederikiborg; and Germany by Trebel and Steinkirkchen. The Spanish instruments are distinguished by their reedy sound, which is not unusual, since the Spaniards of the period apparently had a particular liking for the rasping reed stops. Apart from these, the rest of the instruments sound quite standard,

**ACOS**

**REPLACEMENT LONG LIFE CARTRIDGES**

Acos 90 Series — a family of pick-up cartridges, covering all the main types needed today, each fitted with Diamond Stylus at no extra cost.

- GP91-1 MONO CRYSTAL Stereo Compatible .. \$5.95
- GP91-2 HIGH OUTPUT MONO CRYSTAL Stereo Compatible .. \$5.95
- GP92 MONO CERAMIC Stereo Compatible .. \$6.55
- GP93 STEREO CRYSTAL .. \$7.55
- GP94-1 STEREO CERAMIC .. \$7.95
- GP94-5 STEREO CERAMIC FOR TRANSISTOR AMPLIFIERS .. \$8.95

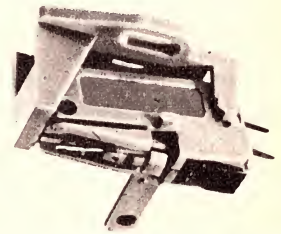

fitted with  
**DIAMOND**  
Stylus at no extra cost.

TECHNICAL DATA SHEETS SENT FREE ON REQUEST

Sole Australian Agents:

**AMPLION (A'SIA) PTY. LTD.**

29 Majors Bay Rd., Concord,  
Sydney, N.S.W. Phone 73 1227



**Peter Clark invites you  
to visit his two floor  
Hi-Fi and Tape  
Recorder sound centre**



**THIS MONTH'S SPECIAL  
SONY TC560 MUSIC CENTRE**

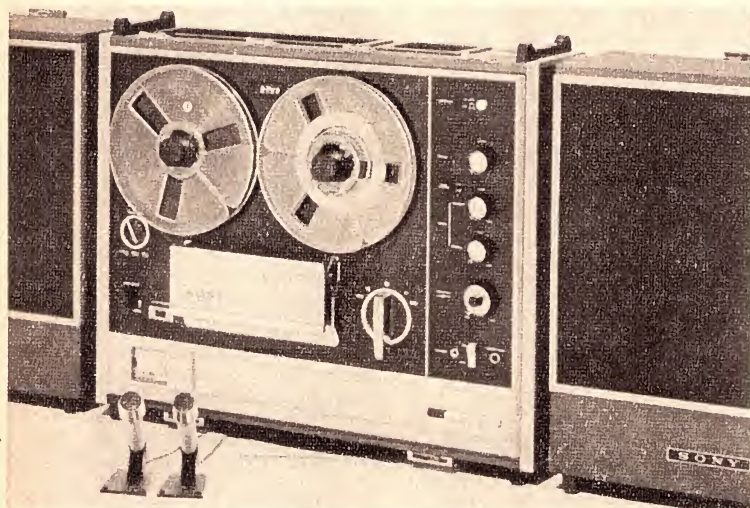

**4 Track 3 Speed Full Stereo  
Frequency Response 20-21000 HZ at 7½ I.P.S.  
20 Watts Total Music Power.**

**List price \$695 our price**

**\$459.95**

**Cash or terms, exclusive 12 month guarantee.  
Free Membership to our Tape Exchange Club.**

**VISIT OUR NEW HI-FI SALON.  
FOR THE BEST VALUES IN SOUND EQUIPMENT.**

**Match up your own system with exciting imported names  
such as FISHER, LEAK, LANSING, AKAI, SANSUI, SONY,  
SANYO, MONARCH, KENWOOD, WHARFDALE, SHURE,  
SHARP.**

**PRICES OF COMPLETE SYSTEMS FROM  
\$179.95. CASH OR TERMS.**

**Magnetic Sound**

**INDUSTRIES**

**387 GEORGE ST., SYDNEY** I door **29-3371**  
from Kodak

Parramatta Branch, 20 Macquarie St., 635-0830 opp. Astra Theatre.

except that the Danish instrument has a particularly light, sweet tone. Brief descriptions of the instruments are given in the informative sleeve note.

The works played are: Spain; Farburdens (Anon) — Canto Llano (Correa de Arauxo) — Batalla (Ximenes). France; Noel X (Daquin) — Messe de Paroisses, excerpt (Couperin) — Fugue No. 3 and Caprice (Roberday)—Organ Books 1 and 2, excerpts (Marchand). Italy; Ricercare (Frescobaldi). Denmark; Variations on "Est-ce Mars" and Toccata (Sweelinck). Germany; Ricercare in C minor (Pachelbel)—Cantio Sacra (Scheidt). Originally from the catalogue of Harmonia Mundi, the disc is released exclusively in Australia through World Record Club. The recording is of good quality, although cut at fairly low level. (H.A.T.)

★ ★ ★

**LOVE AND MARRIAGE.** Dick Leibel at the Organ. Mono, RCA Camden CAL7052.

Interest: Old love songs.  
Performance: Unimpressive.  
Quality: So-so.

Side 1 of this aging mono recording is a collection of old love songs played on solo pipe organ, probably the one in RCA's Radio City auditorium in New York. It might get by as organ mood music were it not for The Wedding March and The Bridal Chorus in the last two tracks, items which definitely don't belong in the mood-music role. Side 2, featuring a number of waltzes by organ and orchestra, is brighter fare but the quality of the recording isn't anything to write home about. Not particularly good value. (W.N.W.)

★ ★ ★

**THE FRENCH TOUCH,** Maurice Larcange, accordion, with the Roland Shaw Orchestra. Phase 4 Stereo, Decca PFS-4149.

Interest: The mood that is Paris.  
Performance: Smooth, pleasant.  
Quality: Very clean.  
Stereo: Good spread.

Whatever other music may come from France, there is a steady stream of "chansons" that seem to identify automatically with France — yet songs that have an almost universal appeal. Here are some of them again:

Marieka—What Now My Love—I Must Be Him—Michelle—I Wish You Love—Voulez-Vous—Plaisir D'Amour—Love Is Blue—The Good Life—I Will Wait For You—Love For Love—It's Only Goodbye.

Maurice Larcange has top billing on the album and while his accordion carries the melody line for a proportion of the time, he leaves plenty of scope for gentle percussion, a variety of other instruments and massed singing strings.

Well orchestrated, well played, well recorded. A pleasant album indeed. (W.N.W.)

★ ★ ★

**SOPHISTICATED SAX.** Tony Daniell. Stereo, Vogue (Festival) SVL-933,204. Also in Mono VL-33,204.

Interest: Sax. with orchestra.  
Performance: Good.  
Quality: Right up to standard.  
Stereo: Ample separation.

Produced by Vogue International Industries, this is indeed an inter-



national effort: Recorded in France by Vogue, it draws all its themes from America and is pressed in Australia for the local market. The themes:

I Left My Heart In San Francisco — It Happened In Monterey — Autumn In New York — Chicago — Do You Know What It Means To Miss Orleans — Moon Over Miami — Moonlight In Vermont — Georgia On My Mind — I'm Coming Virginia — Back Home Again In Indiana — Idaho — Stars Fell On Alabama.

Tony Danieli plays a tidy sax, and the unnamed orchestra under the direction of K. H. Schafer gives backing appropriate to the theme — a touch of moonlight, a touch of swing, a touch of jazz. But mainly it is what it's meant to be — pleasant listening. (W.N.W.)

★ ★ ★

**FLAMENCO GUITAR. Philip John Lee. Music for Pleasure. Compatible stereo MFP-A 8073.**

Interest: "Foreign" flamenco.  
Performance: Brilliant.  
Quality: Excellent.  
Stereo: Not important.

An Englishman playing flamenco! Impossible do you say? Well you will be wrong. Philip John Lee is the equal of the great flamenco artists technically, and his playing has a touch of individuality which I found very refreshing. After careful listening, I came to the conclusion that the difference lies in the melodic structure of his improvisations, which is just that bit different from that employed by the Spanish-born flamenco-ist. Lee has long ago thoroughly absorbed the technique of the flamenco player and plays with all the assurance of those who have been at it all their lives. His program here consists of: Alegrias — Soleares — Tientos por Zambras — Malagueña y Verdiales — Tarrantas — Farruca — Fandango — Solea por Bulerias—Alegrias por Rosa—Seguidilla.

The program has been recorded with the mic. close up, but Lee is a quiet player who does not make too many squeaks and scrapes, so this is no disadvantage. The disc has been cut at high level, so that one is able to keep the volume control well back and minimise noise. Not that the surface is noisy, in fact the reverse is true, and the sound quality is of excellent standard. (H.A.T.)



Say 'yeah' every time this little stick comes down. Got it? ("TV Times")

**CANTOS DE ESPANA. Victoria de Los Angeles with the Paris Conservatoire conducted by Rafael Fruhbeck de Burgos. World Record Club Stereo S/4470.**

Interest: Modern Spanish songs.  
Performance: Enchanting.  
Quality: Excellent.  
Stereo: Normal.

A recital of late nineteenth century and twentieth century Spanish songs is presented here by the great Spanish soprano Victoria de Los Angeles, comprising: Coleccion do Canciones Amatorias (Granados) — Cinco Canciones Negras (Montsalvages)—Quatros Madrigales Amatorios (Rodrigo) — Cinco Canciones Playeres Espanolas (Espla). Also included is an aria from de Falla's "La Vida Breve." As always, Victoria de Los Angeles sings enchantingly, and is admirably supported by the Paris Conservatoire Orchestra. However, the rather specialised nature of the material will, I feel, restrict the appeal of the disc.

There are sharp differences in style between the relatively early works of Granados and de Falla, and the later works of the other three composers, which date from between 1930 and 1947. Quite apart from the more modern harmonies to be found in the music, the texts are typical of the modern poetic style. No doubt these have some meaning to an educated Spaniard, but I feel that to most English-speaking races the words are about as intelligible as Lewis Carroll's nonsense poems would be to a Spaniard. However, for what it is worth, a leaflet is provided with the disc with complete texts in English and Spanish. (H.A.T.)

★ ★ ★

**THE MERRY WIDOW. (Highlights). June Bronhill with Jeremy Brett, Ann Howard, David Hughes and the John McCarthy Singers. Studio 2 Stereo (E.M.I.) TWO 234.**

Interest: The "Widow" in English.  
Performance: Good standard.  
Quality: Fine.  
Stereo: Effective.

Presumably, this new version of highlights from the "Widow" will replace the very successful Bronhill recording with Thomas Round, which has been in the E.M.I. catalogue for some years now. There is always room for a good version of the "Widow" in English. I personally prefer the original German and, for me, the only performance worth considering is the Elizabeth Schwarzkopf recording; but many of my friends will not look at foreign language performances of anything. For people in this category, this new version should prove to be entirely satisfactory. The singing is of high standard throughout, and the diction is perfectly clear. The recording also has the advantage of E.M.I.'s Studio 2 Stereo technique which gives brilliantly lifelike sound.

Besides Bronhill as the Widow, this performance has Jeremy Brett as Danilo, Ann Howard as Valencienne and David Hughes as Camille. I cannot identify the players taking the other parts from the information given. (H.A.T.)

## DANISH HI-FI PTY. LTD. stocks

Quality Components as well as complete stereo systems for records or tape. Write for leaflets and prices.



**Acoustical 3100AB**

Belt drive, 2 speed, built-in strobe speed adjustment, oil damped lift, level, AB Mk. II arm with anti-skate. Also available as model SG without arm. Rumble 45db NARTB, wow and flutter less than 0.07% DIN. Base or cover optional.



**Labcraft Automatic 665**

Belt drive, 3 speeds all with adjustment, balanced arm, plug-in headshells take magnetic or ceramic cartridges. On base with plastic cover. Black or grey mat.



**B & O Stereo Magnetic cartridge 15 deg.**

The distortion is exceptionally low, flat 20 Hz to 20 kHz. Low tip mass. Simple stylus replacement.



**All Balance Mark II Model 2400**

New precision bearings, ball bearings both axes, anti-skate is adjustable and of advanced design, damped counterweight. Arm resonance below 17 Hz, stylus pressure by spring only.

**DANISH HI-FI PTY. LTD.**  
941 Burke Road,  
CAMBERWELL. 3124.  
Telephone 82-4839



## WHY DOESN'T YOUR TURNTABLE LOOK LIKE THIS?

- The ERA arm outperforms even the most recent cartridge; it can track at 1/10th of a gram.
- By principle its pivot eliminates all friction. The pivot is in fact the intersection of four counter-balanced spring blades. They form two X's which do not touch each other.
- The tracking weight is applied directly to the pivot by changing the angle of the blades. In this way the inertia of the arm is not increased with the tracking force as in all other arms. The pickups sound better.
- The arm itself is made of a light alloy H beam which eliminates the resonant frequencies of tubes.

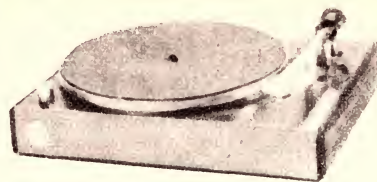

### THIS MONTH'S SPECIAL OFFERS:

Unit 1: Armstrong 426 tuner/amplifier fully transistorised 15-watt RMS per channel, frequency response from 20-20,000 cycles  $\pm$  1 dB less than  $\frac{1}{2}$  % distortion on the full 15 watt RMS complete with 2 Jordan Watts loudspeakers. **Total Price . . . . \$420.00**

Plus P.E. 34 belt driven turntable, hydraulic controlled lowering device, fully balanced arm and Empire 888E cartridge, frequency response from 10 to 30,000 Hz. **Add . . . . \$115.00**  
The same with Dual 1019 turntable. **Add . . . . \$30.00**

Unit 2: ERA Mk. 3 turntable, illustrated above, Empire 888VE cartridge, frequency response from 6 to 32,000 cycles, Harman Kardon Model 210 tuner/amplifier, frequency response  $\pm$  1 dB: 8 to 25,000 Hz at 1 watt, Power Output: 50 watts IFH, 2 Empire Model 8200 loudspeakers, frequency response from 30-20,000 cps. handling capacity 100 watts. **Total Price . . . . \$1,770.00**

Unit 3: Kenwood TK250 Solid State amplifier, Akai Model 4000 tape deck, 2 Wharfedale 10" Super RSDD loudspeakers. **Total Price . . . . \$425.00**

Unit 4: NordMende Professional tape recorder Model 8001/T, sound on sound, sound with sound, mixture stages, 3 speeds, "no compromise" 3 motor tape recorder with multiplay, quarter track, 7" reels, speeds: 1 $\frac{1}{2}$ in, 3 $\frac{1}{2}$ in and 7 $\frac{1}{2}$ in, simplicity of operation insured by colour coded light indicators to show the track which is switched to record or playback at any given time; separate equalising pre-amplifier for recording and playback; built-in monitoring amplifiers and speakers, complete with P.E. 34 turntable (4-speed) and suitable cartridge, plus 2 Schaub-Lorenz speaker systems complete in cabinets. **Total Price . . . . \$750.00**

Unit 5: Armstrong 127 tuner/amplifier AM/FM input for tape recorder, recording and playback, pick-up input, complete with ERA Mk. 4 turntable, Decca Deram cartridge and 2 Goodmans 8" Twinaxiette loudspeakers. **Total Price . . . . \$302.00**

COMPARE AN ARMSTRONG WITH ANY TUNER, AMPLIFIER OR TUNER/AMPLIFIER OF EVEN REMOTELY COMPARABLE PRICE AND YOU WILL FIND THE ARMSTRONG NOT ONLY THE BEST VALUE BUT THE BEST.

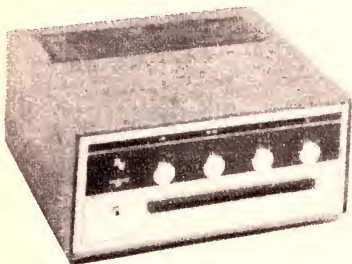

**Specifications:**

|                                    |                                                                                    |
|------------------------------------|------------------------------------------------------------------------------------|
| Power output, continuous sine wave | 25 watts per channel, 8 ohms                                                       |
| Power bandwidth                    | 20—25,000 Hz                                                                       |
| Frequency response                 | 20—20,000 Hz plus or minus 1dB                                                     |
| Harmonic distortion                | Less than 0.5 per cent at 1 kHz measured at 25 watts output plus or minus 1dB      |
| Loudspeaker matching               | Between 4 and 16ohms                                                               |
| Crosstalk                          | Better than 40 dB                                                                  |
| Channel matching                   | Plus or minus 1 dB                                                                 |
| Bass control                       | Plus or minus 10 dB at 70 Hz                                                       |
| Treble control                     | Plus or minus 10 dB at 10 kHz                                                      |
| Balance control                    | Maximum to zero each channel, Minus 5 dB at 30 Hz increasing at lower frequencies. |
| Rumble filter                      |                                                                                    |

|                       |                                                                                               |
|-----------------------|-----------------------------------------------------------------------------------------------|
| Treble filters        | 1. 6.5 kHz—3 dB, 10 kHz—25dB                                                                  |
|                       | 2. 4.5 kHz—3 dB, 9 kHz—40 dB                                                                  |
| Loudness              | At 1 kHz reference (—20 dB), 70 Hz plus 10 dB, 10kHz plus 5 dB                                |
| Tape recording Output | 400 mV low impedance                                                                          |
| Headphone output      | Suitable for all stereo phones                                                                |
| Inputs                | Sensitivity Hum and noise (reference 25w) 400 mV—70 dB, 100 mV—60dB, 60 mV—55 dB, 3.5 mV—55dB |
| Tape playback         |                                                                                               |
| Radio (421 only)      |                                                                                               |
| Pickup 1 ceramic      |                                                                                               |
| Pickup 2 magnetic     |                                                                                               |

Summary of the review in the April 1969, edition of "Hi-Fi Sound" . . . "The 521, due to careful selection of transistors for the preamplifiers, was found to be better than the maker's quote. The radio input yielded —63 dB, tape input —74 dB and pick-up (both inputs) —57 dB. Crosstalk between channels at 1,000 Hz and full output was measured as —46 dB. This is altogether a very good performance and surpasses anything ever achieved with comparable valve amplifier . . . genuine high fidelity performance and excellent engineering. The Armstrong 521 sets a high standard."

Made in England. Sole Agents for Australia: True Fidelity.

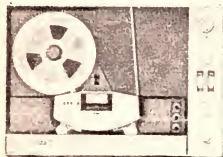

## The Professional Way to Record—The Professional Way to Listen AMPEX — SOLID STATE TAPE RECORDER

Say Goodbye to Scratched Records . . . Tape Lasts a Lifetime.

Sound on Sound, Tape Monitor,  
Sound with Sound, Echo Chamber

The following models are always in stock:  
Models 1163, 2163 and 753 tapedeck.

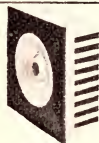

JORDAN WATTS LOUDSPEAKERS made in England. Audio Frequency from 20 Hz to 20,000 Hz RMS at an extremely low distortion level. Power Handling capacity 24 watts (USA rating).

Made in England. Sole Agents for Australia: True Fidelity.

# RECORDED MUSIC SALON

C. PINCZEWSKI

TRUE FIDELITY

23 COLLINS STREET,  
MELBOURNE 3000.  
Telephone 63-6257



**THE IRVING BERLIN SONG BOOK**, sung by the George Mitchell Minstrels with orchestral accompaniment. Stereo, Columbia SCXO-6267.

Interest: Happy sing-a-long.  
Performance: Well arranged and presented.  
Quality: Clean, modern sound.  
Stereo: Well spread.

Happy is the word for this sing-a-long from The Black And White Minstrel Show — B.B.C. TV series. With chorus and orchestra under George Mitchell, featured soloists are Tony Mercer, John Moulter, Dai Francis and Margaret Savage.

On side 1, "Alexander's Ragtime Band" sets some kind of a theme for six other tunes in band one. "This Is The Army, Mr Jones" heads another six, followed by a shorter bracket headed by "Because I Love You." "Top Hat, White Tie And Tails" leads the final group of a dozen Irving Berlin tunes.

Side two contains another 24 tunes including songs like "The Girl That I Marry," "Always," "Blue Skies," "Easter Parade" and "I've Got My Love To Keep Me Warm."

Thirty minutes or more of toe-tapping sing-a-long that should appeal strongly to the matching age group. (W.N.W.)

★ ★ ★

**THE WONDER OF YOU.** The Sandpipers. A & M Stereo SAML-933,297. Available in Mono.

Interest: Popular balladeers.  
Performance: Relaxing.  
Quality: See review.  
Stereo: Normal.

I personally find the pleasing melodies and gentle harmonies of the Sandpipers very relaxing fare, and have enjoyed the previous releases from the group which have come my way. This one is well up to the standard of earlier releases in terms of content and performance, but my impression was that it had not been so well recorded. The vocals did not seem to have the clarity of the earlier offerings and the balance between voices and the supporting instruments was not so satisfactory. However, such defects as there are are not sufficiently noticeable to spoil one's enjoyment, and if you are a Sandpipers fan, don't let the above remarks disturb you unduly. The titles are: Let Go—That Night—Wave—Yellow Days—Lo Mucho Que Te quiero—The Wonder of You—Temptation—The Windmills of Your Mind—If I Were the Man—Kumbaya. (H.A.T.)

★ ★ ★

**HEAR MY SONG.** Joseph Locke. Mono, Music For Pleasure MFP-A8068.

Interest: Timeless tenor.  
Performance: In best tradition.  
Quality: Well remastered.

Born in 1918, Joseph Locke was a policeman in Belfast when it became evident that he might have ahead of him a career as a professional singer. From the local stage, he moved into radio in 1949, then into television and stage shows. His voice is that of a traditional stage tenor but with the advantage, by no means universal, of an unerring sense of pitch.

*Dionne Warwick: "most polished, enjoyable"*

**PROMISES, PROMISES** — Dionne Warwick. Scepter Records (Festival) Stereo SJL 933250 (also in mono).

Interest: Sophisticated soul.  
Performance: Her finest album.  
Quality: Superbly recorded.  
Stereo: Well balanced.

As I have said before in these columns, Dionne Warwick is one of the most talented singers in the business — and one of my favourite artists.

This new L.P. is probably her most polished and enjoyable recording session. It contains, as usual, a number of Bacharach/David compositions, including three from the Broadway production of "Promises, Promises" and her recent hit single, "This Girl's In Love With You." The other outstanding tracks on a uniformly good album are "Where is Love," "Lonely Is My Heart" and the superb ballad "Yesterday I Heard The Rain."

The arranging is shared between Burt Bacharach, Don Sebesky and Peter Matz and, as usual, their writing is sympathetic, tasteful and beautifully scored. Despite the limited playing-time of 33 minutes, this album can be recommended unreservedly to all Dionne Warwick admirers. T.F.C.)

The twelve numbers here are all established favourites. To mention a few: Come Back to Sorrento — I'll Take You Home Again Kathleen—March Of The Grenadiers—The Holy City—The Drinking Song—Count Your Blessings—Goodbye.

For the most part, the tracks have the mark of old mono recordings but, while the sound is limited in frequency range, it is fairly clean and free from surface noise.

Titles and an artist that might stir memories of earlier days. (W.N.W.)

★ ★ ★

**EVEN STEVENS.** Ray Stevens. Stereo, Monument (Festival) SDL-933022. Also in Mono DL-33022.

Interest: Comment on John Citizen.  
Performance: A lot of talent.  
Quality: Excellent.  
Stereo: Normal but not vital.

Ray Stevens, a slapstick vocal comedian of the early 60s, has given place to another Ray Stevens—still a fellow with a lot of vocal and musical talent but now with something more purposeful to offer — debunking comment on the ordinary middle man. He has a song for "The Minority"—small groups scorned, even though they may well be right; "For He's A Jolly Good Fellow"—the man who must pose for the plaudits of his friends, even when he's completely miserable; "Mr Businessman" — a thin veneer of success; "Isn't It Lonely Together"—the honeymoon after a forced marriage; "The Great Escape" — the 9 to 5 clerk who lives for just one moment, the end of each day. Ten such topics altogether.

According to the notes, Ray Stevens was responsible for most of the music,

## COMPLETE HI-FI RADIOGRAM-TAPE RECORDER ALL IN ONE

MODEL TR9



### AS AN AMPLIFIER . . .

- Frequency response, 20-20000 cps.
- 7 Watts RMS. output per channel.
- Distortion less than .25%
- Separate treble and bass controls.

### AS A RADIO . . .

- Being fully transistorised, can be switched on all day at full output without heat problems. Program can be recorded on tape without any external connections.

### AS A TAPE RECORDER . . .

- Freq. response 30-18000 cps.
- 3 speeds. Meter level indicator.
- Push button operation.
- Superimposing.

### PRICES:

2 track mono, \$159.00  
4 track mono, \$169.00  
4 track stereo, \$230.00

RADIO TUNER CAN BE FITTED TO ANY OF THE ABOVE MODELS FOR \$28 EXTRA.

### TAPE DECKS

for the home constructor. COLLARO (Magnavox) tape decks complete with record/play and speed change switch wafers fitted . . .

2 tracks, \$48. 4 tracks, \$55. SPECIAL LOW IMPEDANCE HEADS for transistorised tape amplifier circuits (Mullard) available).

## CLASSIC TAPE RECORDERS

93B LIVERPOOL ROAD,  
SUMMER HILL, N.S.W.  
Telephone 79-2618



# NEW ALL TRANSISTOR STEREO AMPLIFIER ULTIMATE IN DESIGN-LONG DEPENDABILITY USING ALL SILICON TRANSISTORS 40 WATTS - RMS

## SPECIFICATIONS:

**POWER OUTPUT:** 20 watts per channel  
R.M.S. Total output 40 watts R.M.S.

**FREQUENCY RESPONSE:** From 20 cycles to  
20,000  $\pm$  1db.

**HARMONIC DISTORTION:** Less than 1% at  
rated output.

**HUM & NOISE:** Aux. 70db, Mag. 50db.

**INPUT SENSITIVITY:** Mag. 3mv. Aux. and  
tuner 150 mv.

**SPEAKER IMPEDENCE:** 8 ohms.

**EQUALIZED:** Mag. RIAA.

**TONE CONTROLS:** Bass 50 c/s  $\pm$  12db.  
Treble 10 kc/s  $\pm$  12db.

**LOUDNESS CONTROL:** 50 c/s 10db.

**SCRATCH FILTER:** (High filter) at 10 kc/s 9db.

**RUMBLE FILTER:** (Low filter) at 50 c/s 5db.

**PROVISION FOR TAPE RECORDER.** RECORD OR PLAY-BACK WITH DIN PLUG CON-  
NECTION.

**PROVISION FOR HEADPHONES WITH HEADPHONE/SPEAKER SWITCH ON FRONT  
PANEL.**

**THE CIRCUIT INCORPORATES REGULATED POWER SUPPLY WITH TRANSISTOR  
SWITCHING PROTECTION FOR OUTPUT TRANSISTORS. 26 SILICON TRANSISTORS  
PLUS 5 DIODES ARE USED.**



MODEL C300/20

**\$119.00** FREIGHT EXTRA

DIMENSIONS: 16 $\frac{1}{2}$ in x 5 $\frac{1}{2}$ in x 11 in deep  
MOUNTED IN OILED WALNUT OR TEAK  
VENEERED CABINET WITH METAL  
TRIM AND MATCHING KNOBS.

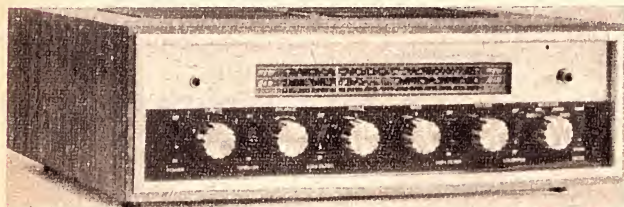

MODEL C300/20/T

12 WATT RMS PER CHANNEL VERSION OF ABOVE AMPLIFIERS AS PREVIOUSLY  
ADVERTISED ALSO AVAILABLE.

**ABOVE AMPLIFIER  
WITH INBUILT A.M.  
TUNER**

**\$144.00** FREIGHT  
EXTRA

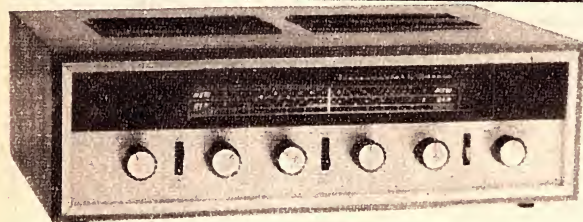

**\$118.00** FREIGHT EXTRA

This amplifier is based on the Playmaster 118 circuit as featured in "Electronics Australia" to which  
has been added the following features.

- Inbuilt high gain A.M. tuner with a coverage of 530 to 1,600 K.C.
- Loudness control giving bass boost at low volume.
- Provision for tape, record and play-back, with din connector.
- Calibrated dial available for all States.
- EM84 tuning indicator giving accurate tuning with ease.

**POWER OUTPUT:** 9 watts per channel R.M.S. **FREQUENCY RESPONSE:** 20 to 20,000 cycles  
incorporating Ferguson O.P.412 grain oriented output transformers. **VALVES USED:** 4-6GW8, 12AX7  
or 12AU7, 6AN7, 6N8, EM84 and 2 silicon diodes.

**MODEL C200V. BASED ON THE  
PLAYMASTER 118 WITH TUNER**

Dimensions 16 $\frac{1}{2}$ in x 5 $\frac{1}{2}$ in x 11in.

CABINET IN OILED WALNUT OR TEAK WITH  
METAL TRIM.

## CLASSIC RADIO

245 PARRAMATTA ROAD, HABERFIELD, N.S.W. PHONE 798-7145



most of the arrangement, much of the recording and mixing, and the final over-recording of his own vocals.

You may or may not have a spot in your library for this middle-aged protest but, if you have, you can be assured that it is well done. A conversation piece, maybe. (W.N.W.)

★ ★ ★

**IT'S TRUE, IT'S TRUE.** Bill Cosby. Warner Bros. Stereo WS 1770.

Interest: Cosby reminisces.

Performance: Impromptu but hilarious.

Quality: Good.

Stereo: Adds atmosphere.

That most diverting raconteur Bill Cosby continues his series of discourses on life in general, with frequent reminiscences of childhood, in this latest release in the series on the Warner Bros. label. In case anybody has lost count, this is the eighth in the series. According to the sleeve note, this 45-minute performance was completely impromptu, from a time when Cosby filled in at a nightclub during a strike of musicians. It sounds that way, too — and I don't mean that to be taken as a criticism. The humour is quite spontaneous, but just as deliciously funny as any of the other Cosby dissertations, which may or may not have been carefully prepared. Some good humoured banter with the audience in this performance is used to cover up the slight discontinuities in the flow of patter. Among

the subjects covered are "the Neighbourhood TV Set" from the days when TV was not so widespread as it is now; "Foreign Countries" and the odd things one finds in them; the usual crack at the odd behaviour of women; and "Spanish Fly." (H.A.T.)

★ ★ ★

**A TIME FOR LIVING, A TIME FOR HOPE.** Ed Ames. RCA Victor Stereo LSP-4128.

Interest: Sentimental ballads.

Performance: Very professional.

Quality: Excellent.

Stereo: Normal.

Ed Ames has all the attributes of a great entertainer — a naturally attractive deep, resonant voice, poise, a polished technique, and complete assurance. He also has good taste and the good sense to ensure that his material has the widest possible appeal. What more is there to say? About him, probably nothing, but I should point out that in this album he has the co-operation of very able arranger/conductors, and RCA has provided them with the usual band of experienced studio musicians. The result is a very successful disc which should appeal to a great many people. Ed's program comprises: Changing, Changing — Somewhere — If I Had a Hammer — Peaceful Waters — What a Wonderful World — If I Can Dream — If I Can Help Somebody — The Sound of Silence — Six Words — Just a Drop of Rain — I Believe. (H.A.T.)

## Popular Jazz

**"BLUE ACKER" — Acker Bilk and the Stan Tracey Big Brass. Columbia Lansdowne Series (E.M.I.) Stereo SCXO 7890.**

Interest: Mainly Tracey's arrangements.

Performance: Outstanding album.

Quality: Superbly recorded.

Stereo: Well balanced.

If, at the height of the English "Trad Boom," someone had suggested that Acker Bilk would one day record an album of this superb quality, he could scarcely have expected his remark to be taken too seriously.

But Bilk has come a long way since those days: He was also very fortunate to work on this occasion with Stan Tracey, in my view the finest jazz pianist, composer and arranger in Britain at the present time.

But Tracey's arrangements for Acker's clarinet, the tenor saxophone of Tony Coe and a brass section which featured Kenny Wheeler and Ian Hamer on trumpet and Keith Christie on trombone are quite exceptional.

The eight tracks include two jazz standards, "Royal Garden Blues" and "Tin Roof Blues"; two Ellington compositions "Mood Indigo" and the lesser-known "Festival Junction"; Bilk's celebrated "Stranger on The Shore"; and three very fine Tracey originals.

There is not a weak track on the album. The bulk of the solo space is, of course, taken by Bilk but Tony Coe and Stan Tracey's piano are also heard to effect. The overall quality of the musicianship throughout is immaculate by any standards.

Even if you dislike Acker Bilk's woody clarinet sound, you should hear the 37 minutes of music on this album for Stan Tracey's adventurous and highly original arrangements. (T.F.C.)

★ ★ ★

**"GETTING TO THE POINT" — Savoy Brown Blues Band. Decca (E.M.I.) Stereo SKLA 4935.**

Interest: Young English Blues group.

Performance: Competent and respectful.

Quality: Well recorded.

Stereo: Good separation.

Savoy Brown was — and still is — one of the more important groups in the English Blues Movement, which probably reached its peak of popularity around the middle of last year. The "father-figures" of this crusade were John Mayall and Eric Clapton and, besides Savoy Brown, two of the more successful groups to emerge were Ten Years After and Chicken Shack.

The music is authentic at least in spirit and these young musicians are fully conscious of the musical heritage of great bluesmen like Muddy Waters and Sonny Boy Williamson.

Savoy Brown has the added advantage of being very competent musically with a very fine lead guitarist in Kim Simmonds and a convincing, if rather mannered, singer in Chris Youlden. The group wrote six of the nine tracks. Particularly impressive are their own "Flood in Houston" and "Mr Down-

## If you want STEREO EQUIPMENT

You'll deal better with  
**H. B. RADIO SALES**

### AUGUST SPECIALS

**KENWOOD TK250 AMPLIFIER/** 2 Wharfedale unit 3 speaker systems. Dual 1019 player on platform, Shure magnetic . . . . . \$398.00

**KENWOOD 150 AMP, 2 Magnavox** 10in speaker systems in Teak. Garrard AT60 on platform, with Shure M44G . . . . . \$275.00  
**SANSUI 555 2 Wharfedale super** 10 dual speakers in R3 teak cabinets, dual 1019 player, Shure M44G, platform and cover \$460.00

**MAGNAVOX or ROLA design** slimline cabinets with 8 W.R. (V.C. 15, 8 or 3 ohms) or 8 CMX speaker fitted . . . . . \$30.00  
Cabinet Kit only . . . . . \$11.00

**MAGNAVOX 10 W.R. and 3 T.C.** Tweeter with Crossover in 2 C.F. cabinet, ½in material . . . \$43.00  
12 W.R. in 3 cubic ft. cabinets . . . . . \$44.00

**GOODMANS design 3 CF Cabinet** and Twin-axiom 10 speaker, ½in material . . . . . \$57.50  
Cabinet Kit and Speaker . . \$45.00

**WHARFEDALE design, 3 CF** cabinet (R3) ½in material and Golden 10 speaker . . . . . \$63.00  
Cabinet Kit and Golden 10 Speaker . . . . . \$50.80

Special quotes for other Wharfedale or Goodmans speakers.

Available in Maple, Walnut or Rosewood colours. Teak veneer \$1 extra for Slimline and Bookshelf models. \$2.00 extra for others.

| BOOKSHELF SPEAKER UNITS   |         |
|---------------------------|---------|
| PLAYMASTER, complete      | \$31.00 |
| CABINET Kit and Parts     | \$23.40 |
| POINT 4, complete         | \$35.00 |
| CABINET Kit and Parts     | \$25.00 |
| PLAYMASTER SUPER          | \$42.00 |
| CABINET Kit and Parts     | \$32.50 |
| Wharfedale Unit 3 (large) | \$54.00 |
| CABINET Kit and Parts     | \$43.50 |
| Wharfedale Unit 3 (small) | \$49.00 |
| CABINET Kit and Parts     | \$39.50 |

Packing charge \$1 per order.  
Freight payable on delivery.

Send for Stereo Catalogue

## H. B. RADIO SALES

Manufacturers of Quality Radio and Radio Furniture for 37 years.

103-105 Catherine Street,  
**LEICHHARDT, SYDNEY**

Telephone 56-5580



# NOW...THE NEW SILCRON

only \$44.50



## a precision built, Australian turntable with belt drive

Superiority of the belt drive principle in turntable design is now firmly established; world wide trends are to *belt driven* turntables.

With a wow and flutter figure of less than 0.04% the new SILCRON two speed turntable has been designed to completely satisfy the requirements of Australian music lovers and audio enthusiasts. Every desirable feature has been incorporated in the advanced design of this *virtually silent* precision-engineered unit.

Speeds are 33 1/3 and 45 r.p.m.; absolute speed accuracy is assured by use of a completely sealed 12 pole synchronous motor. A unique speed change mechanism (patents pending) permits alteration of speeds in less than one second.

Belt driven around its perimeter, the actual turntable platter is cast aluminium, machined to fine tolerances

and dynamically balanced. It's a full 12" in diameter so that records are completely supported. To reduce dust attraction by static charges an anti-static mat is supplied instead of an ordinary rubber mat *without extra cost*.

When operating there are only three moving parts — the rotor, the drive belt and the platter; reliability is assured. Mounting the unit is simplicity itself — a template is provided for the cut-out and depth below the motor board can be as little as 3/4" — maximum height above is 2".

See the new SILCRON turntable at selected audio stores everywhere. Enquiries for supplies or for the name of your nearest SILCRON stockist should be directed to the Simon Gray office or representative in your state.



Australian National Distributors:

**Simon Gray Pty. Ltd.**

Head Office: 28 Elizabeth St., Melbourne, Vic. Tel. 63 8101\*

Sydney Office: 22 Ridge St., North Sydney, N.S.W. Tel. 929 6816

Canberra Office: 31-33 London Circuit, Canberra City, A.C.T.  
Tel. 49 6050

INTERSTATE REPRESENTATIVES:

N.T.: Pfitzner's Music House, Smith Street, Darwin. Tel. 3801

Q'land: Sydney G. Hughes. 154-158 Arthur St., New Farm, Brisbane. Tel. 58 1422

S.A.: Eilco Sales Pty. Ltd., 7-9 Osmond Terrace, Norwood, S.A. Tel. 63 4844

Tas.: K. W. McCulloch Pty. Ltd., 57 George Street, Launceston. Tel. 2 5322

W.A.: Athol M. Hill, 613-615 Wellington Street, Perth. Tel. 21 7861



child" and a very exciting version of Willie Dixon's "You Need Love."

If any readers have a taste for the current English blues scene, they should at least make a point of hearing this album. The playing time is an acceptable 42 minutes. (T.F.C.)

★ ★ ★

"A PORTRAIT OF WES MONTGOMERY" Liberty Records (Festival). Stereo SLYL-933,085 (also in Mono).

Interest: "Doctored" reissues, 1957-59.

Performance: Welcome, historically.

Quality: Good remasterings.

Stereo: Even spread.

Since the tragic death of Wes Montgomery, the various companies for which he recorded have been flooding the market with reissue albums of his superb modern jazz guitar.

The tracks on this album were recorded between 1957 and 1959 for the Pacific label, when he was working and recording mainly with his brothers, Monk and Buddy. They were originally made with a variety of small groups, which also included the great tenor player Harold Land and Pony Poindexter on alto.

Unfortunately, the producer, Richard Bock, commissioned Gerald Wilson to write arrangements for strings and horns which were then over-dubbed on the original recordings. Although Wilson's writing is of a high quality, this practice is, I suggest, completely unacceptable.

Wes Montgomery's recorded work for Pacific rarely hit the peaks of his subsequent Riverside sessions. But three tracks—"Far Wes," "Old Folks" and "Falling In Love With Love" are, nevertheless, outstanding examples of his great talent. Harold Land's muscular tenor is also heard to effect on "Leila" and "Montgomeryland Funk." One track, "A Good Get-Together," featuring the singer, Jon Hendricks,

does not appear to have been previously issued.

Although the guitar work on this album is historically important, there is much better Montgomery available—without the unnecessary addition of a cushion of strings and brass. (T.F.C.)

★ ★ ★

RUNNIN' OUT OF FOOLS/TAKE LIKE YOU GIVE IT — Aretha Franklin. CBS, two-record set S2BP 220036.

Interest: Early Franklin.

Performance: Generally excellent.

Quality: Bright recording.

Stereo: Well balanced.

This handsomely packaged two-record set contains 23 tracks by Aretha Franklin, which were probably recorded some four years ago.

The use of labels in contemporary music is becoming increasingly hazardous but, in general terms, the Franklin of this period was basically a gospel and jazz singer. In the past two years or so, when she has been recording for Atlantic, she has emerged as one of the biggest commercial attractions of the day in America and Europe, riding on the crest of the "soul" wave.

The tracks on these albums are generally first-rate. Miss Franklin's singing is always exciting and, throughout, she displays excellent intonation and great feeling. Some of the outstanding tracks include "Mockingbird," "Walk On By," "It's Just a Matter of Time," "Why Was I Born," "Lee Cross" and "Land of Dreams."

The arrangements by Belford C. Hendricks and Robert Mersey are crisp and tight while the musicians, who are unfortunately not identified, give Miss Franklin strong support.

Generally, this is an excellent collection of Aretha Franklin in the early stages of her professional career. But even at the special retail price of \$9.95 for the two albums, the total playing time of exactly one hour is inadequate. (T.F.C.)

## Historic recordings: "bargain"

### CARNEGIE HALL JAZZ CONCERT.

Benny Goodman. Harmony (CBS) Stereo HAS 165/6 (2 L.P.s, available separately).

Interest: Historic event.

Performance: Classic tracks.

Quality: Adequate.

Stereo: Electronically re-channeled

Readers interested in jazz will probably be very familiar with the recordings on these two L.P.s. They were made at Benny Goodman's historic concert at the Carnegie Hall on January 16, 1938.

At that time, the Goodman Band was at its peak musically and commercially with strong soloists and, more importantly, superb arrangements by Jimmy Mundy and Fletcher Henderson. The musicianship, discipline and excitement of the band can be heard on tracks like "Don't Be That Way," "Blue Room," "One O'clock Jump," "Blue Skies" and the legendary "Sing Sing Sing" with Jess Stacey's remarkable piano solo.

The Goodman Trio and Quartet with Teddy Wilson, Gene Krupa and

Lionel Hampton are featured on "Body and Soul," "China Boy," "Avalon," "The Man I Love" and "I Got Rhythm." These small group tracks still sound as fresh and elegant as they did 30 years ago.

The concert also included a curiously assorted "History of Jazz" segment on which the lasting interest is provided by Bobby Hackett's Beiderbecke feature "I'm Coming Virginia" and the superb Ellington composition "Blue Reverie" with Cootie Williams, Harry Carney and Johnny Hodges.

Finally — and this was undoubtedly the highlight of the concert — a contingent from the Basie Band (including Basie, Lester Young and Buck Clayton) joined Carney, Hodges and some of the Goodman band for a magnificent jam session on "Honey-suckle Rose." This, in my view, is one of the classic tracks of jazz.

Readers who do not, for some reason, possess these historic recordings are strongly advised to remedy this — particularly at the Harmony bargain price of \$2.50 for each of the two L.P.s (T.F.C.)

## "INNERBOND"

(Regd.)

# BONDED ACETATE FIBRES

FOR PACKING IN

## SPEAKER ENCLOSURES

A new resilient Bonded Wadding made from ultra fine Cellulose Acetate Fibres that gives high efficiency for Sound Absorption.

"INNERBOND" is light, clean, dust-free and easy to handle. Because all the fibres are bonded "INNERBOND" will hang as a "curtain" and will not fracture or break down due to vibration.

"INNERBOND" is odourless, highly resistant to attack by bacteria or fungus and is vermin repellent; "INNERBOND" at 16oz sq. yd. has a normal thickness of 1" and at this density is recommended as a packing in Speaker Enclosures for Sound Absorption.

### STOCKISTS:

**SYDNEY:** Arrow Electronics Pty. Ltd., 342 Kent St.; Broadway Electronics (Sales) Pty. Ltd., 32 Glebe Point Rd.; GLEBE: Convoys International Pty. Ltd., 449 Kent St.; Ence Electronics Pty. Ltd., 257 Clarence St.; Kent Hi-Fi, 432 Kent St.; Mastersound Sales Pty. Ltd., 400 Kent St.; Radio Despatch Service, 869 George St.; Stereo Music Systems, 193 Clarence St.; Circuit Components (A/sia) Pty. Ltd., 460 Bexley Rd.; BEXLEY: Classic Radio, 245 Parramatta Rd.; HABERFIELD: Dyna Stereo Pty. Ltd., 331 Prince's Hwy, ST. PETERS: Albert Wright Radio Service, 795 New Canterbury Road; HURLSTONE PARK: H. B. Radio Products, 103-105 Catherine St.; LEICHHARDT.

**NEWCASTLE:** Martin de Launay Pty. Ltd., King and Darby Streets; Dynamic Sound, 587 Hunter Street.

**WOLLONGONG:** Electricon Parts Pty. Ltd., 82 Kelra Street; Martin de Launay Pty. Ltd., 270 Kelra Street.

**MELBOURNE:** J. H. Magrath and Co. Pty. Ltd., 208 Little Lonsdale Street.

**BRISBANE:** A. E. Harrold Pty. Ltd., 123 Charlotte Street; Brisbane Agencies, 78 Wickham Street, Fortitude Valley.

**NORTH QUEENSLAND:** Alvin Communications and Electronics, 38 Peggall St., Pinilco, Townsville.

**ADELAIDE:** Duncan Agencies, 57 Woodville Road, Woodville; General Accessories, 81 Flinders Street; Trustcott Electronics, 62-64 Hindmarsh Square.

**PERTH:** Atkins (W.A.) Ltd., 894 Hay Street; Carlyle and Co. Pty. Ltd., Milligan Street; General Accessories, 46 Milligan Street.

**HOBART:** Homecrafts-Tasmania, 199 Collins Street.

If unobtainable

For 1 sq. yd. as above send \$2.00  
For 2 sq. yds. as above send \$3.75  
For 4 sq. yds. as above send \$6.50

Postage paid in Australia and Territories to the manufacturers.

## WONDER WOOL PTY. LTD.

87 JAMES STREET, LEICHHARDT.

N.S.W., 2040.

Box 548 — G.P.O., Sydney, 2001.

Phone: 56-2780.



**K  
I  
T  
S**

**AMPLIFIERS — PREAMPLIFIERS — TUNERS — CONTROL UNITS —  
GUITAR UNITS — INSTRUMENTS — INVERTERS — CONVERTERS —  
RECEIVERS — TRANSMITTERS — REGULATED POWER SUPPLY —  
TRANSISTOR AND VALVE TYPES.**

**K  
I  
T  
S**

**1967  
ALL WAVE  
3-4-5-6-7**



**ANY PART FROM A  
SINGLE RESISTOR  
TO THE FULL KIT**

**POPULAR KITS - TOP QUALITY - LOWEST PRICES**

**INSTRUMENTS  
C.R.O.**

1. 5in wide range.
2. 1963. 3in cal.
3. Audio.
4. 1966. 3in.
5. 1968—Audio.
6. Electronic SW.
7. W/band Preamp.
- MULTIMETERS  
and V.T.V.M.'s**
8. 20K ohm/Volt  
protected M/M.
9. Probe for above.
10. Protected D.C. M/M.
11. Meterless V/meter.
12. A.C. Millivoltmeter.
13. A.C. Solid State  
Millivoltmeter.
14. Solid State A.F.  
Millivoltmeter.
15. Noise Distortion  
Millivoltmeter.
16. Standard V.T.V.M.
17. 1966—V.T.V.M.
18. 1968—V.T.V.M.

**BRIDGES**

19. Standard R/C.
20. 1966. R/C.
21. 1968 R/C and  
Signal Injector.

**TV INST.'s**

22. Sweep and marker  
Generator.
23. Dual sweep Gen.
24. Silicon diode  
sweep Gen.
25. Silicon diode  
noise Gen.
26. Pattern Gen.
27. Trans. pattern Gen.
28. Wide range  
pulse gen

**AUDIO INST.'s**

29. 1960 Audio Osc.
30. 1962 High perf.  
audio Gen.
31. Crystal locked std.
32. Electronic tuning  
standard.
33. 1965. Solid State  
audio osc.
34. Direct reading  
A.F. meter.
35. Sq. wave Gen.
36. 1967 transistor  
audio Gen.
37. Additive frequency  
meter.
38. A.F. tone burst gen.
- 38A. 1968. Solid state  
A.F. Generator.

**R.F. INST.'s**

39. 6-band service  
oscillator.
40. Trans. wave meter.
- 40a. "Q" Meter.

- 40A. 1969 Dip Osc. Solid  
state.

41. G.D.O. wide range.
42. G.D.O. adaptor.
43. Trans. service osc.
44. Simple signal  
injector.
45. Transistorised signal  
tracer.
46. Transistorised osc.
47. Basic test osc.
48. Transistor test  
oscillator.

**MISCELLANEOUS  
INST., ETC., KITS**

49. 1960 Trans. Tester.
50. 1968 Transistor  
test set.
51. Valve and Transistor  
tester.
52. Electronic Stetho-  
scope.
53. Moisture alarm.
54. Electronic Pistol  
range.
55. Transistor Geiger  
Counter.
56. Light beam alarm.
57. Burglar alarm.
58. Flasher unit.
59. Transistor alarm.
60. Electronic switch.
61. Photo Timer.
62. Direct reading  
impedance meter.
63. Electronic  
anemometer.
64. S.W.R. Indicator.
65. Simple proximity  
alarm unit.
66. Pipe and wiring  
locator.
67. Electronic  
metronome.
68. Monophonic organ.
- 68A. Keyless organ.
- 68B. Theremin.

**BATTERY CHARGERS**

69. Universal unit.
70. 1 amp unit.

**REGULATED POWER  
SUPPLIES**

71. Transistor. 9v.
72. Transistor, fully  
protected supply.
73. 1966 H.T. unit.
74. 1968 lab. type,  
D-30v. supply
- 74A. Simple Pwr. supply.

**VOLTAGE/CURRENT  
CONTROL UNITS**

75. Vari-watt unit.
76. Vari-tach. motor  
speed control.
77. 2KW auto-light  
dimmer.
78. 4KW auto. light  
dimmer.
79. Model train control  
unit.

80. Model train control  
unit with simulated  
inertia.
81. Above-hi-power.
82. No. 81 with  
simulated inertia.

**TACHOMETER UNITS**

83. 6 or 12v Std.
84. 6 or 12v Mullard.
85. 6 or 12v with  
dwell angle.
86. Tachometer and dwell  
angle unit for  
service stations.

**TRANSISTOR IGNITION**

87. Ro-fo. 6 or 12v.
88. Hi-Fire 6 or 12v.  
(transformer).

**POWER CONVERTERS**

89. D.C.-D.C. 60w.
90. D.C.-D.C. 40w.
91. D.C.-D.C. 40w.  
12v—input.
92. D.C.-D.C. 70w  
12v—input.
93. D.C.-D.C. 100w  
12v—input.
94. D.C.-D.C. 140w.  
24v—input.
95. D.C.-D.C. 225w.  
24v—input.

**HIGH FIDELITY  
AMPLIFIERS  
MONO UNITS**

96. Hi-Fi 3.
97. Mullard 3.3.
98. Mullard 5-10.
99. Mullard 5-10  
transistor.
100. Transistor 20w.
101. Transistor 60w.

**STEREO UNITS**

102. Mullard 2-2.
103. Mullard (v) 3-3.
104. Mullard (t) 5-5.
105. Mullard (t) 5-5.
106. Mullard (v) 10-10.
107. Mullard (t) 10-10.
108. Philips Twin 10.
109. S.T.C. 10-10.
110. Wireless world  
transistor 20-20.
111. Hi-Fi 60-60.
112. Playmaster 2-2.
113. Playmaster 3 plus 3.
114. Playmaster unit 3.
115. Playmaster unit 4.
116. Playmaster 10 plus 10
117. Playmaster 101.
118. Playmaster (t) 105.
119. Playmaster (t) 113.
120. Playmaster (t) 115.
121. Playmaster (v) 118.

**P.A. UNITS**

122. 10 watt std.

123. 25 watt std.
124. 35 watt std.
125. 30 watt (t).
126. 100 watt std.
127. stereo P.A.

**GUITAR UNITS**

128. 10 watt std.
129. 25 watt std.
130. 35 watt std.
131. 50 watt std.
132. 70 watt (t).
133. Playmaster 102.
134. Playmaster 103.
135. Playmaster 40w. 116.
136. Playmaster 60w 117.
137. Gultar fuzz box.
138. Gultar Waa-Waa.
139. Reverb unit.
140. Gultar preamp.
- 140a P.M. 50w S/State.

**STEREOGRAMS**

141. Playmaster 105.
142. Playmaster 106.
143. Playmaster 107.
- 143a Playmaster 124.

**CONTROL UNITS**

144. Playmaster No. 9.
145. Playmaster No. 10.
146. Playmaster No. 104.
147. Playmaster No. 112.
148. Playmaster No. 120.
149. Mullard 2v.
150. Mullard 3v.
151. Philips Miniwatt.
152. Wireless world  
stereo system unit.

**PREAMP UNITS**

153. Transistor—Mono.
154. Transistor—Stereo.
155. Transistor—Silicon,  
mono.
156. Transistor F.E.T.  
mono.
157. Transistor dyn. m.c.  
mono.
158. Above-Stereo.
159. Playmaster 115  
F.E.T. Stereo.
160. Playmaster 118 mag.
161. Sound projector.

**MIXER UNITS**

162. Trans. 4 ch.  
(1966).
163. Trans—4 ch.  
(1967).
164. Valve—4 ch.

**TUNER UNITS**

165. Playmaster u/style.
166. Playmaster No. 11.
167. Playmaster No. 114.
168. Playmaster No. 122.
169. Playmaster No. 123.
170. Philips Miniwatt.
180. Trans.—Long range.

**TAPE UNITS**

181. Trans. Preamp.
182. Playmaster 110 (M).
182. Playmaster 110 (S).
183. Power Unit 110.
184. Adaptor 110.
185. Playmaster 119  
Adaptor.
186. Transistor V.O.X.
187. Tape Actuated relay.
188. Mullard Trans Tape  
Amp.

**RECEIVERS**

189. Fremodyne 4.
190. Fremodyne 4.  
R.F. Sock only.
191. Synchronyne.
192. Communications RX.
193. Deltahet RX.
194. 3 Band Double  
Change 5/Het RX.
195. Explorer VHF Trans-  
istor RX.
196. Interceptor 5 Semi-  
Comm. RX.
197. 1967 All-Wave 2
198. 1967 All-Wave 3
199. 1967 All-Wave 5
200. 1967 All-Wave 6
201. 1967 All-Wave 7
202. Transporta 7
203. Transistor 8  
3 Band.
204. 3 Band 2V RX.
205. 3 Band 3V RX.
206. Interstate 5
207. Versatile Mantel Set.
208. All-Wave Transistor 3
209. A.B.C. 3
210. 1968 F.E.T. 3
- 210a. I/C TRF Rx.
- 210b. R.F. Preamp.
- 210c. "Q" Multiplier.

**TRANSMITTERS**

211. 144 MHZ 50W.  
Linear Final.
212. 144 MHZ 20W.
213. 144 MHZ 75W.
214. 144 MHZ 18W.
215. 144 MHZ S.S.B.
216. 3 Band A.M.
217. Basic 3 Band.
218. 5 Band. S.S.B.
219. 1967 S.S.B.

**CONVERTERS**

220. 50 MHZ.
221. 144. MHZ.
222. 50 and 144 MHZ  
Crystal Locked.
223. 1965 S/W
224. 1965 S/W 2 Band.
225. 1966 3 Band.
226. Basic S/W.

**V.F.O. UNITS**

227. Remote Unit.
228. 7, 8 and 9 H.F. and  
V.H.F.
229. All transistor.

Phone 63-3596

**E. D. & E. (SALES)  
PTY. LTD.**

Phone 63-3596

232 FLINDERS LANE, MELBOURNE, VICTORIA 3000



**K  
I  
T  
S**

Public Address Units — Geiger Counters — Metal Locators — Decade Boxes — Mixers — Battery Chargers — Oscillators — Bridges — Parts Supplied for Projects in Electronics (Aust.), Wireless World, Practical Wireless, Electronics World, Electronics Illustrated, Practical Electronics, etc.

**K  
I  
T  
S**



1968 Solid State. V.T.V.M. ELECTRONICS (Aust.), Dec., 1968.

**BATTERY CHARGER 1A**  
ELECTRONICS (Aust.), Feb., 1966

**PLAYMASTER 116 and 117 GUITAR AMP.**

Electronics Australia  
June 1967 — 40 watt  
July 1967 — 60 watt



**3-BAND SHORT-WAVE CONVERTER**  
ELECTRONICS (Aust.), May, 1966.

**LAB QUALITY**

Regulated Power Supply (0-30v)  
ELECTRONICS (Aust.), Sep-  
tember, 1968.

1966 R/C Bridge  
May, 1966.



Excellent frequency response. Low distortion figure. High input sensitivity. All controls self-contained. 10 watts per channel.

**PLAYMASTER STEREO 10 PLUS 10**  
COMPLETE KIT \$86.85



**PUBLIC ADDRESS and GUITAR AMPLIFIERS**

10, 25, 50 and 100 watt units



**3-BAND DOUBLE-CHANGE RECEIVER**  
ELECTRONICS (Aust.), April, 1966.

1966 3in CRO  
ELECTRONICS (Aust.), May, 1966.

Playmaster 122  
Program Source.  
Electronics (Aust.),  
August, 1968.



**FOUR-CHANNEL AUDIO MIXER**  
ELECTRONICS (Aust.) Feb., 1966 & 1967

**3-BAND 3-RECEIVER**  
ELECTRONICS (Aust.), Nov., 1966.

**TRANSISTOR MILLIVOLT METER**

Electronics (Aust.),  
May, 1968.

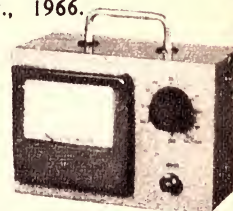

**Enjoy your leisure time and build**

**PLAYMASTER STEREO 3 PLUS 3**  
COMPLETE KIT \$54.25

**MAJOR STOCKISTS OF ALL GENERAL RADIO & ELECTRONIC COMPONENT PARTS -- YOU NAME IT -- WE WILL QUOTE**

VALVES — TRANSISTORS — ZENER & POWER DIODES — SEMI-CONDUCTORS — DIACS — TRIACS — S.C.R.'S. — I/C'S. SPEAKERS — MICROPHONES — COILS — IFT'S. TRANSFORMERS — INST CASES — METALWORK. PLAYERS & CHANGERS — METERS — RELAYS — CONDENSERS — RESISTORS — BEZELS — STYL' II — CARTRIDGES — RECORDING TAPE — PROBES — INSTRUMENTS — POTENTIOMETERS — CRYSTALS — FERRITE BEADS — CORES — BALUNS — TERMINALS — CO-AXIAL PLUGS & SOCKETS — MULTI CONNECTORS — PRINTED CIRCUIT BOARDS — COPPER WINDING WIRE — ETC. — ETC. —

Phone 63-3596

**E. D. & E. (SALES) PTY. LTD.**

Phone 63-3596

232 FLINDERS LANE, MELBOURNE, VICTORIA 3000



# TRADE REVIEWS AND RELEASES

## LUX AMPLIFIER IS EXCELLENT VALUE

The Lux SQ-1220 is an all-silicon, solid-state, stereo amplifier with high power output and an unusual degree of operating flexibility. Compared with amplifier with similar performance it is very keenly priced. It was submitted for review by Encel Electronics (Stereo) Pty. Ltd., the Australian distributors for Lux equipment.

Physically, the amplifier is big — the biggest we have tested to date, with dimensions of  $18\frac{1}{2}$  x  $7\frac{1}{2}$  x  $11\frac{1}{2}$  inches, including knobs and feet. The overall impression is one of robust construction and this is confirmed when the case is removed, revealing a high standard of workmanship inside.

Intended as a free-standing unit, the amplifier is fitted with an oiled palisander case which is included in the basic price. The case is fitted with substantial, rubber-

throughout. The majority of the components are mounted on a shallow tray section. At one end is mounted a generous power transformer and power supply components. Next to these are the large, finned heatsinks associated with the power transistors. At the other end are mounted the five vertically-mounted printed boards which accommodate the amplification circuitry.

The complete circuit of the amplifier contains 29 transistors in all, most of the



tipped, metal feet which raise the amplifier about one inch to allow air to circulate freely through the unit.

The front panel is of gold anodised aluminium with a fine-grained finish. The turned aluminium knobs are finished similarly and have a milled "flat" to give purchase and serve as a setting indicator. All the knobs rotate with a silky smoothness and the lever switches operate positively so that the amplifier is a real pleasure to use. The only complaint that we would have about the front panel layout is that the selector knob is set a little too closely to the mode switch so that one tends to catch fingers when operating the former control.

As well as the selector and mode controls just mentioned, knobs are provided for volume, bass and separate tone controls for each channel. Lever switches are provided for power, tape monitor, scratch filter, rumble filter and low-frequency boost, and two controls which change the "turnover" of the bass and treble controls or disconnect them from the circuit.

The rear panel is quite "busy" with four two-pin mains outlets, two fuses, six pairs of phono sockets for inputs and outputs, and various other features which are mentioned later in the text.

Removing the case and the metal covers from the amplifier reveals neat workmanship and high quality components

*Above is the Lux SQ 1220 shown with the tone and filter switches in the "up" position. Right is a view of the components on top of the chassis.*

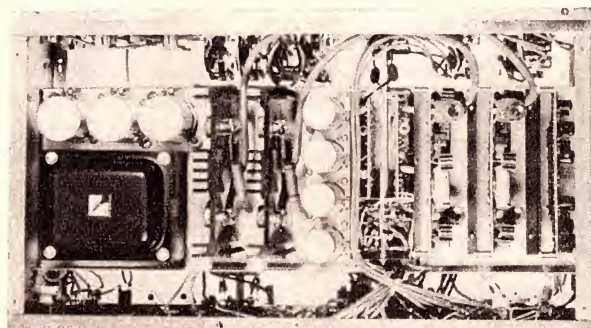

circuitry being fairly conventional. One unusual feature is that many of the resistors and capacitors do not have preferred values. This, however, would not affect performance either way.

The input stage of the amplifier consists of two transistors connected in a feedback pair arrangement and these provide equalisation and a degree of amplification for signals from magnetic cartridges, tape head at 7ips and 3ips, and high level signals. A switch modifies input impedance of the "phono-2" input to 30K, 50K or 100K. Another switch, associated with the "phono-1" socket, enables the cartridge to be used direct

with step-up transformers which plug into sockets on the rear panel of the amplifier.

Following the input stage is the tone control stage consisting of four transistors. As mentioned earlier, the variable tone controls can be disconnected from the circuit or the "turnover" frequency changed from 400Hz to 200Hz in the case of the bass control and from 2KHz to 4KHz in the case of the treble control. This feature is quite useful and, when using today's compact loudspeaker enclosures, one can boost the frequencies below 100Hz using the 200Hz turnover position without unnecessarily boosting the upper bass range. Similarly, one can use the 4KHz turnover for slight boost of the extreme treble. The adjustable turnover facility is accomplished merely by changing capacitors in the feedback circuitry and the result is a far more desirable feature than the so-called loudness control fitted to many amplifiers. Also contained in the tone control circuitry are the components which provide the treble "scratch" filter giving rolloff at 5KHz or 9KHz and the "low bass" boost/cut switch. The treble filter is not sharp enough to be really useful against bad noise and similarly the "low-bass" cut facility is not sharp to enable turntables with a lot of inherent rumble to be used satisfactorily.

The volume control for each channel consists of two potentiometers, one operating at the input and the other at the output of the tone control stage. These two potentiometers are, of course, ganged with the two potentiometers for the other channel. This arrangement has apparently been adopted to maintain optimum signal-to-noise ratio over the whole range of the volume control.

Following the tone control circuitry is a stage consisting of two transistors which serves the purpose of an electronic frequency crossover at around 100Hz. The cross-over is sharp—18dB per octave — and enables a separate power amplifier to be used to drive a loudspeaker handling the bass information for both channels. The bass signal from both channels is mixed and fed to the external amplifier via an emitter-follower stage.

The power amplifier stage consists of six transistors in a direct-coupled feedback amplifier with the output transistors connected in a conventional quasi-complementary configuration. The amplifier stage has

a sensitivity control on the back panel as well as a control which varies the damping factor. This last function appears to be achieved by resistors in series with the output and by varying the negative feedback. In practice, using high quality loudspeakers with large magnet structures, the difference brought about by varying the damping factor was not immediately audible.

A feature of the power supply is the SCR (silicon controlled rectifier) which is used to protect the output transistors from overload due to short circuits or gross overdriving. Once the overload circuitry has been triggered the mains supply must



be disconnected for about ten seconds before normal operation can be restored. In this way it is similar in operating procedure to the 10-plus-10 Stereo amplifier described in the April, 1969, issue of "Electronics Australia."

On actual listening tests the amplifier performed very well, as was to be expected. There was no switch-on transient in the loudspeakers when first turning the amplifier on and at all settings of the volume control the amplifier was extremely quiet, even with bass and treble controls at maximum boost settings. The range and flexibility of the tone controls were mentioned above, although some people who used the amplifier expressed a preference for concentric bass and treble controls instead of a separate knob for each channel.

The rated power output of the amplifier is 100 watts RMS (50 watts per channel) into 8-ohm loads and 70 watts RMS into 16 ohms. Distortion was rated at less than 0.1 per cent at 30 watts into 16 ohms and 40 watts into 8 ohms. We measured power output at 39 watts RMS per channel at the onset of clipping into 8-ohm loads and 50 watts into an 8-ohm load with one channel driven. Power output into 16-ohm loads was 30 watts per channel and 34 watts with one channel driven. These figures were taken using a regulated AC mains supply and measured with a Hewlett Packard HP331A voltmeter/distortion measuring set. The figures are a little down on those claimed, but the difference would certainly not be significant in a domestic situation.

Frequency response referred to a level of 50 watts into 8 ohms at 1KHz was within plus or minus 1dB from 20Hz to 27KHz which is excellent. The LUX designers have clearly opted for a frequency response which is extended well beyond the limits of audibility, but not needlessly so.

Total harmonic distortion was below 1 per cent at all powers up to the onset of clipping and dropped below 0.1 per cent at powers below 10 watts RMS. Separation between channels was very good at 68dB below 50 watts at 1KHz. This was measured with the non-driven channel input unloaded. All the above measurements were made using the auxiliary input at signal levels up to 100mV RMS.

The tone controls, when using the more conventional turnover frequencies of 4KHz and 400Hz gave a range of plus 14 and minus 15 dB at 10KHz and plus and minus 14dB at 50Hz, which is more than adequate. Square-wave response was good throughout the whole range and stability was excellent with all types of load. The unit is quite suitable for driving full range electrostatic loudspeaker systems when a 1 or 2 ohm resistor is used in the output from each channel.

Sensitivity of the various inputs was found to be very close to the figures specified and the overload capability of the low level inputs was excellent. The magnetic cartridge inputs could handle 80mV RMS at 1KHz before overload occurred.

The overload protection of the amplifier was completely effective. We tried shorting the amplifier at all drive conditions into a variety of loads, but in no case did it falter. At no time did we blow one of the fuses which occasionally happens with amplifiers which use circuit-breakers.

To sum up, the LUX SQ1220 amplifier is very well presented. It has power to spare and is a delight to use. At the price of \$350, tax included, it is very competitive when compared with other amplifiers with this power capability.

The amplifier is available from Encel Electronics (Stereo) Pty. Ltd., 257 Clarence Street, Sydney, N.S.W., or their interstate branches. (L.D.S.)

## 3-SPEED TAPE DECK FROM ITALY

Tape recording enthusiasts will be interested in a tape deck made by Incis, a name new to the Australian market. It is manufactured in Milan, Italy, and is assembled in Australia by Audio-Lec of Australia Pty. Ltd., who submitted a unit for review.

The Incis V34 is a four-track tape deck with three speeds of 1-7/8, 3 1/2 and 7 1/2 inches per second. Drive is by one motor which has a separate 24-volt winding for powering transistor circuitry. The speed change switch has a wafer which can accommodate equalising circuitry. Five piano keys control most of the deck functions and the deck can be used with the reels in the horizontal or vertical planes. Reels up to 7 inches in diameter can be used. A pause control and an automatic stop are fitted. This latter facility consists of a microswitch which is held electrically "on" by the tape running past two steel fingers.

The deck is normally supplied with two heads, an erase head and record/replay head, but there is provision for a third head. A revolution counter is fitted, resettable to zero by a push button. At the top of the deck, between the two reels, is a rectangular cut-out which could accommodate an edge-reading VU meter.

The unit is assembled on a steel chassis which is cadmium plated and passivated. We did notice that one of the screws securing the plastic faceplate to the chassis could not be screwed down because of misalignment of holes in the chassis. This prejudiced the operation of the deck, causing the tape spools to foul and the push-buttons to stick. More attention to detail in assembly would seem to be indicated.

Apart from the above reservation, the deck operates as expected, although the rewind and fast forward functions are rather on the slow side. No details were supplied as to bias requirements for the heads and, owing to pressure of other work, it was not possible to test the unit

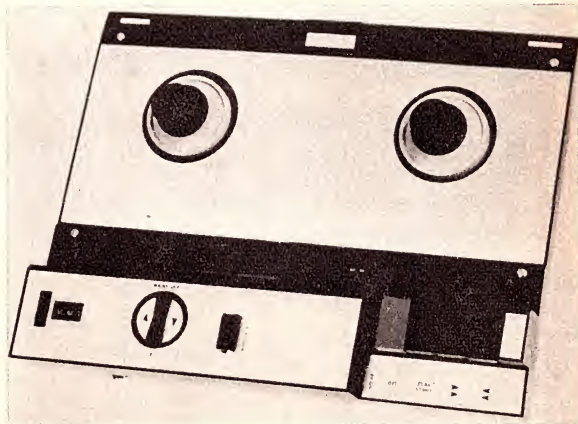

in the replay mode. Pressure pads are used to hold the tape close to the heads for maximum high frequency response.

The retail price of the Incis V34 tape deck is \$68 including sales-tax and they are available ex stock. All inquiries regarding performance, specifications and availability should be directed to the Australian distributors, Audio-Lec of Australia Pty. Ltd., 33 Bridge Road, Eltham, Victoria. (L.D.S.)

**CONVERTERS  
FOR AIRCRAFT,  
MARINE, FIRE,  
AMATEUR BANDS**

**RF FET CONVERTER**

CRYSTAL CONTROLLED—1mHz BAND-  
WIDTH INTERNAL OR EXTERNAL  
BATTERY. CONVERT YOUR CAR  
RADIO OR HOME RADIO INTO  
SENSITIVE VHF RECEIVER.

**\$24.75 Incl. Tax.**

Crystals — State Exact listening Frequency

S. E. WILLIS TRADING CO.,  
38 RIVERSDALE ROAD,  
CAMBERWELL JUNCTION.  
Phone 82-5787. Please include freight.  
**SORRY — NO C.O.D.**

## POCKET MICROSCOPE

**30x Magnification—Superb Definition—length of instrument 4 1/2"—Field of view exceeds 1/8"**

**Complete with illumination unit,**

**Only \$16.50**

*with measuring graticule (smallest division .002")*

**Only \$19.80**

**Money back guarantee.**

**Francis Lord Mfg. P/L**

33 HIGGINBOTHAM ROAD,  
GLADESVILLE, N.S.W. 2111

TELEPHONE: 807-1444

Makers of precision lenses, prisms, mirrors, filters, re-  
pairers of optical components and lens systems.



# HIWAY WEN

## ELECTRIC SOLDERING GUN

**Fastest gun in Australia!**

REACHES WORKING TEMP. IN LESS THAN 15 SECS.  
PERFECTLY SIZED FOR DELICATE WORK  
PLENTY OF POWER FOR HEAVY JOBS



- Lightweight, compact, beautifully balanced
- Cool handle. Heat-power surges from tip
- On/off trigger switch
- Built-in light illuminates tip
- Replaceable long-life iron clad tip

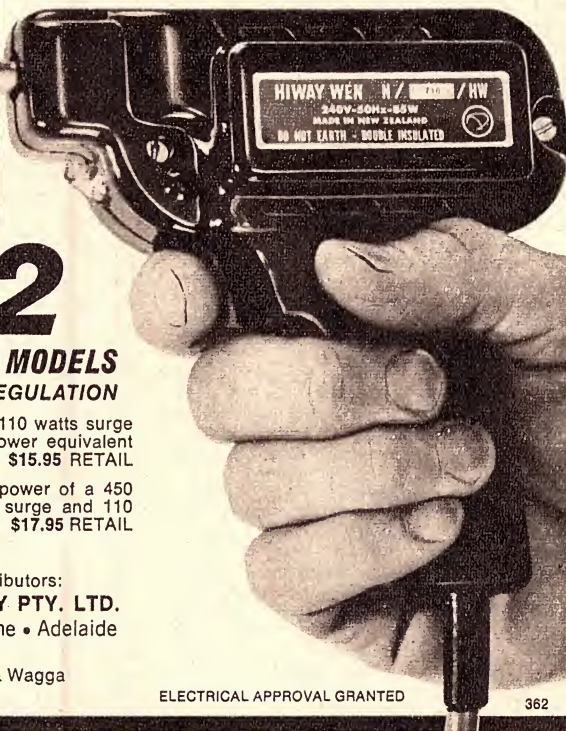

### 2 GREAT NEW MODELS

WITH AUTOMATIC THERMAL REGULATION

**MODEL 222.** Has current draw of only 110 watts surge and 55 watts working. Delivers heat-power equivalent to normal 200-watt device. **\$15.95 RETAIL**

**MODEL 450.** Delivers the heat-power of a 450 watt device on only 220 watts surge and 110 watts working. **\$17.95 RETAIL**

#### TRADE ENQUIRIES

Contact the sole Australian distributors:  
**SUN ELECTRIC COMPANY PTY. LTD.**  
Melbourne • Sydney • Brisbane • Adelaide  
H. C. Little & Co. Pty. Ltd., Perth  
Errol Nazer Pty. Ltd., Canberra & Wagga  
E. T. Burrows, Hobart

ELECTRICAL APPROVAL GRANTED

362

# Homecrafts FOR RADIO PARTS

## 289 Elizabeth St. Melbourne. Phone 60 1442

### PIEZO PICK-UP AND CARTRIDGES

|                                                                  |            |
|------------------------------------------------------------------|------------|
| PU-86 Pickup LP/78 T/O Crystal cartridge. Length 240mm . . . . . | Ea. \$2.95 |
| Y700 Ceramic Cartridge. Mon. LP/78                               | \$2.50     |
| PU-86 Pick-up Ster-LP/78. T/O Cartridge. Length 204mm . . . . .  | Ea. \$4.00 |
| Y200 Ceramic Cartridge. ST LP/78 . . . . .                       | \$3.40     |
| Y400 Crystal Cartridge. LP/45 . . . . .                          | \$1.90     |
| Y130 Crystal Cartridge. T/O Type Ster/LP                         | Ea. \$2.70 |
| Sapphire Replacement Styli. Each Ster/LP                         | 60c        |
| Plus postage 15c.                                                |            |

### PIEZO MICROPHONE INSERTS

|                                                  |            |
|--------------------------------------------------|------------|
| MC-3 Crystal, 50-7K, 35 x 25 x 8mm. -57 DB       | \$1.00 ea. |
| MC-7 Crystal, 100-7K. 39mm Round x 11mm. -56 DB  | \$1.00 ea. |
| MC-8 Crystal, 50-8K. 48mm Round x 17mm. -50 DB   | \$1.00 ea. |
| MC-9 Crystal, 50-8K, 25mm Round x 9mm. -68 DB    | \$1.80 ea. |
| MC-33 Crystal, 50-10K, 33mm Round x 9mm. -60 DB  | \$1.30 ea. |
| MD-5 Dynamic, 100-15K. 33mm Round x 14mm. -55 DB | \$1.80 ea. |
| Plus postage 20c.                                |            |

### TRANSISTOR SET ACCESSORIES

|                                             |     |
|---------------------------------------------|-----|
| Magnetic Earpiece with 3.5mm Plug . . . . . | 75c |
| Crystal Earpiece with 2.5mm Plug . . . . .  | 75c |
| Crystal Earpiece with 3.5mm Plug . . . . .  | 75c |

### LAPEL TYPE CRYSTAL MICROPHONE

|                                                                                     |            |
|-------------------------------------------------------------------------------------|------------|
| With 3.5mm Plug . . . . .                                                           | \$1.00 ea. |
| Plus postage 15c.                                                                   |            |
| Fuses for Japanese equipment 1A, 3A, 5A 3c ea, OR \$2.00 per 100. Plus postage 10c. |            |

|                                                      |        |
|------------------------------------------------------|--------|
| Michigan/Collard—Twin Track Rec/Play Heads . . . . . | \$8.50 |
| Michigan/Collard—Twin Track Erase Heads . . . . .    | \$3.00 |
| Michigan/Collard—Four Track Erase Heads . . . . .    | \$8.50 |

|                               |                          |
|-------------------------------|--------------------------|
| 12-Pin Wafer Sockets. . . . . | 20c ea.                  |
| 12-Pin Plug . . . . .         | 25 ea. Plus postage 10c. |

### OCTAL PLUG AND CORD

Ext. Socket.  
45c pr. Plus postage 10c.

### ALL TYPES AMPHENOL PLUGS AND SOCKETS

Carried in stock.  
Plugs 27c ea. Sockets 30c ea. Meall Covers for same 27c ea.  
Plus postage 10c.

### HALF-INCH MINIATURE PLUGS AND SOCKETS

2, 3, 4 and 5-Pin Plugs 10c ea.  
Sockets 10c ea. Plus postage 10c.

### ELECTROLYTIC CAPACITORS IN METAL CANS

|                                                                                              |            |
|----------------------------------------------------------------------------------------------|------------|
| 16 + 16 450 VW . . . . .                                                                     | 95c ea.    |
| 32 + 32 450 VW . . . . .                                                                     | \$1.30 ea. |
| 50 + 50 450 VW . . . . .                                                                     | \$1.85 ea. |
| 50 + 50 + 50 350 VW . . . . .                                                                | \$1.90 ea. |
| 100 MFD P.V.C. Cover . . . . .                                                               | \$1.15 ea. |
| Jacks, 2.5 and 3.5mm . . . . .                                                               | 26c        |
| 3.5mm Plug and Cord Ext. Jack Pair . . . . .                                                 | 50c        |
| Metal Co-axial Plugs and Line Sockets Pr. . . . .                                            | 65c        |
| "Din" and "Hirschmann." 2, 3, 4 and 5-pin Plugs, Chassis and Line Sockets, carried ex stock. |            |
| Prices on application.                                                                       |            |

|                                  |     |
|----------------------------------|-----|
| P.M.G. type Plugs from . . . . . | 50c |
| P.M.G. type Jacks from . . . . . | 35c |
| P.M.G. Line Jacks from . . . . . | 55c |
| Plus postage 15c.                |     |

### 5 CORE CABLE

7/0076, P.V.C. insulated, P.V.C. covered.  
25c yd.

### 6 CORE CABLE

same spec. as above  
30c yd.

|                                                            |        |
|------------------------------------------------------------|--------|
| Capacitor Substitution Box, 1,000 VW . . . . .             | \$5.00 |
| Resistor Substitution Box, 1 Watt. Plus Post. 20c. . . . . | \$4.90 |

### TRANSISTOR AERIALS

|                                  |        |
|----------------------------------|--------|
| 5in extends to 39in . . . . .    | \$1.70 |
| 5in extends to 39in . . . . .    | \$1.70 |
| 6in extends to 43in . . . . .    | \$1.70 |
| 6in extends to 32in . . . . .    | \$1.00 |
| 6in extends to 28in . . . . .    | \$1.00 |
| 7in extends to 39in . . . . .    | \$1.20 |
| 9in extends to 39in . . . . .    | \$1.50 |
| 5in extends to 4ft 6in . . . . . | \$3.30 |
| 7in extends to 5ft 8in . . . . . | \$3.70 |
| Plus Post 15c.                   |        |

### CRYSTAL SET BUILDERS

|                      |        |                       |         |
|----------------------|--------|-----------------------|---------|
| Coils . . . . .      | 80c    | Tuning Conds. . . . . | \$2.00  |
| Diodes . . . . .     | 35c    | Terms . . . . .       | Ea. 12c |
| Headphones . . . . . | \$2.50 | Plus Postage.         |         |

### TAPE RECORDER ACCESSORIES

|                                                      |        |                                   |        |
|------------------------------------------------------|--------|-----------------------------------|--------|
| 2 1/2in Spools . . . . .                             | 30c    | 3in x 600ft . . . . .             | \$2.35 |
| 3in Spools . . . . .                                 | 35c    | Tape . . . . .                    |        |
| 5in Spools . . . . .                                 | 40c    | 5 3/4in x 1,200ft . . . . .       | \$3.10 |
| 5 3/4in Spools . . . . .                             | 70c    | Tape . . . . .                    |        |
| 7in Spools . . . . .                                 | 50c    | 7in x 1,800ft . . . . .           | \$5.10 |
| 2 1/2in x 100ft . . . . .                            | 60c    | Tape . . . . .                    |        |
| 2 1/2in x 300ft . . . . .                            | \$1.40 | 5in Plastic Tape, boxes . . . . . | 60c    |
| Tape . . . . .                                       |        | 7in Plastic Tape, boxes . . . . . | 90c    |
| Plus postage 20c.                                    |        |                                   |        |
| See us for Tape Recorder Patch Cords, Adaptors, etc. |        |                                   |        |

### STEREO PLUGS AND JACKS

|                       |     |                                 |     |
|-----------------------|-----|---------------------------------|-----|
| Metal Plugs . . . . . | 95c | Bakelite ext. sockets . . . . . | 70c |
| Bakelite . . . . .    | 70c | Chassis Jacks . . . . .         | 66c |
| Plus postage 10c.     |     |                                 |     |

## MAIL ORDER SPECIALISTS



# ELECTRONIC BUILDING BLOCKS

A system of electronic building blocks which require no connecting wires has been developed by the German company Braun AG, primarily for the instruction of students in electronics.

Braun Lectron is an electronic building-block system with which simple working circuits can be assembled. The object of the sets is to impart a knowledge of electronics, not merely how to construct equipment. The building blocks make it very easy to assemble circuits that work and to perform experiments with them. The blocks are obtainable in sets, or may be obtained individually to augment sets as required.

A comprehensive instruction manual supplied with each kit gives suggestions for experiments and explains each in detail. In the instructions, the circuit diagram is shown on one page, while the circuit and the functions of the main components are explained on the facing page.

The suggested experiments range from very simple arrangements, for example to demonstrate discharging a capacitor, to complete assemblies, such as a radio receiver or an exposure meter. The source of power is an ordinary 9V battery, so that the system is safe even for young children.

The unique feature of the system is its simplicity. The experiments are easily set up without using wires, clips, soldered or screwed joints, as the individual building blocks are held together magnetically. Electrical contacts are made through small nickel-silver plates on the sides of the blocks. Thus the assembly of a complete circuit needs no additional aids, such as tools, wire, soldering irons, etc., and the possibility of faulty joints is virtually eliminated.

As a foundation on which the experiments are assembled, the Lectron system contains a metal baseplate. When a block is placed on this plate, it is held in position magnetically. Blocks requiring an "earth" or chassis connection establish contact with the metal plate which functions as the electrical equivalent of a chassis.

Each building block incorporates one electrical or electronic component, such as a connecting wire, a resistor, a capacitor, a coil, a semiconductor diode, a transistor, a zener diode, or a photodiode. To date, 70 different blocks have been designed for the Lectron system. The base size is the same for all blocks; 27 x 27mm.

In addition to the component blocks, there are socket, measuring and isolating blocks. Electronic circuit elements (e.g. resistors) can be plugged into the socket blocks, while instruments can be connected into the circuits via the measuring and isolating blocks.

The body of each block is of clear polystyrene, so that components are clearly visible while protected from damage, dust and moisture. A white top has the standard symbol of the component engraved on it with the positions of the connections to adjoining blocks. When placed side by side, the symbols on the tops of the blocks combine to form a circuit diagram conforming to standard electronic practice.

With the exception of the battery block, the tops are permanently attached to the body of the blocks. Since the battery has to be renewed from time to time, the top of this block is snapped on. Instructions on how to change the battery are given in the instruction book.

The fact that blocks can be inserted in or removed from a circuit very easily permits the functions of a particular component to be observed, as well as the

effect on the circuit of changing one component for another. Further, the magnetic connection minimises wear; nothing should be broken when dismantling a circuit.

To cater for differing requirements of scholars, teachers, and experimenters, a number of Lectron systems are marketed. The smallest, the Mini system, covers the basic principles of electricity and is designed for younger children. The basic system (modern electronics) is for children from about 10 years of age. Supplementary sets 1 and 2 cover respectively modern electro-acoustic and radio circuits, and advanced electronics. There is a laboratory system for advanced students and experimenters. An instructional system, with blocks nine times as large as the basic blocks but containing the same components, is available for demonstration purposes.

The Mini system (illustrated) contains the necessary components for 25 simple experiments demonstrating the basic principles of electricity and electronics. Suggested experiments include: closed circuit and open circuit; switches; semi-conductor diode conducting and blocking; transistor in circuit; fully driven transistor; electricity source; control of a transistor; transistor as an amplifier; microphone transmission; capacitor in a DC circuit; transmission of AC by a capacitor; coil in a DC circuit; radio receivers; feedback generator; Morse generator, flasher, and signalling with two stations; conduction of electricity by water and a salt solution; chemical reaction of water.

The basic system contains components for 20 experiments including: flasher circuits; electrical measurement of light and temperature; electronic temperature monitor; sensitive temperature measuring device; photoelectric detector; twilight switch; automatic brightness control; automatic dimming. Supplementary set 1 contains components for 30 experiments including: indicating electric current with an instrument; proof that current is the same anywhere in a circuit; voltage divider; capacitor as a store of energy; forward current of semiconductor diode; proof of transistor's controllability; loudspeaker as electro-acoustic transducer; record-player amplifiers; simple tone generator; action of AC on an instrument; rectification; radio receivers.

Supplementary set 2 contains components for 40 experiments including: voltage and current amplification by a transistor; Schmitt triggers; exposure

timer; temperature control circuit; multi-vibrators; generating a high voltage; voltage transformation with a transistor; measuring a rectified high voltage; basic circuit of electronic flash; principle of zener diode; voltage stabiliser; relay control; sound level meter; burglar alarm.

System 300 is a self-contained experimental system to give an insight into the basic fundamentals of digital computation. As well as an instruction book (with 100 experiments) and the standard blocks, there are digital building blocks: impulse formers; impedance converters; flip-flops; and AND, OR and NOT gates. The same theme, digital computation, can be pursued with the Supplementary System 3 (combined with the Basic and Supplementary 1 and 2 Systems) as this also contains the book of 100 experiments explaining the functions of the digital building blocks.

The range of Lectron systems is to be extended to include further supplementary



sets for switching algebra (data processing), open-loop and remote control, multi-circuit and VHF receivers, stereo amplifiers, etc.

A number of hobby sets will be available shortly to supplement the Lectron system. These sets will contain all the components required for a given piece of equipment. The circuit elements are to be soldered to a base-plate carrying printed wiring connections between the components. The circuit diagram is printed on the back of the base-plate. A plastic housing will accommodate the complete circuit and battery source. Hobby sets will be obtainable for the more interesting experiments in the Lectron system including radio receiver, sound level meter, burglar alarm, telephone adaptor, record-player amplifier, intercom, etc.

Retail price of the Mini system is \$25.35, including 15 per cent sales tax.

Further details of the range of Braun Lectron systems may be obtained from Haldex Pty. Ltd., 59-61 Pine Street, Chippendale, N.S.W. 2008.

## HIVAC XN TYPE NUMICATORS

Hivac Ltd., a member of the Plessey Group in the U.K., has developed the



XN series of side-viewing indicating tubes. The XN17 range provides 0-9 digital indication incorporating decimal points. These Numicators have 16mm-high numerals and a viewing angle greater than 120 degrees. Other ranges in the series provide plus and minus signs and such symbols as mV, V, A, uS, mS, Hz, kHz, MHz, etc. The XNS1 range consists of single digit Numicator tubes intended primarily to double the readout range of digital equipment. Also available is a special base, part TS1, and a mounting bracket, part NB2.

Inquiries should be addressed to Plessey Ducon Pty. Ltd., P.O. Box 2, Villawood, N.S.W. 2163.



## A vast range of SATO Parts

- For manufacturers
- For TV
- For radio
- For instruments
- For amplifiers
- For kitset builders
- For sound equipment
- For industry
- For stereo equipment
- For educational purposes
- For electronics
- For tape recorders

Distributed by

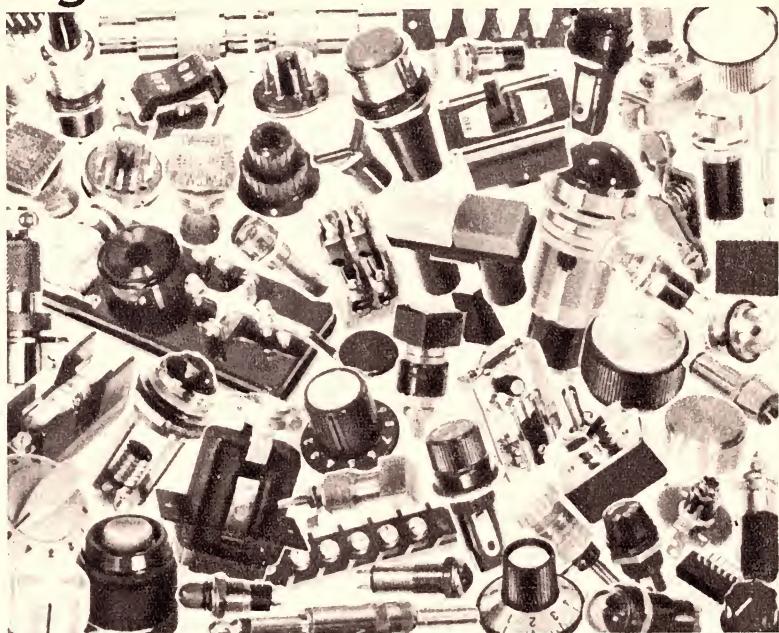

## GENERAL ACCESSORIES

(A DIVISION OF ELECTRONICS INDUSTRIES)

116-118 CLARENCE STREET, SYDNEY 443 CONCORD ROAD, RHODES — 73-0211  
BOTH STORES OPEN SATURDAY MORNING

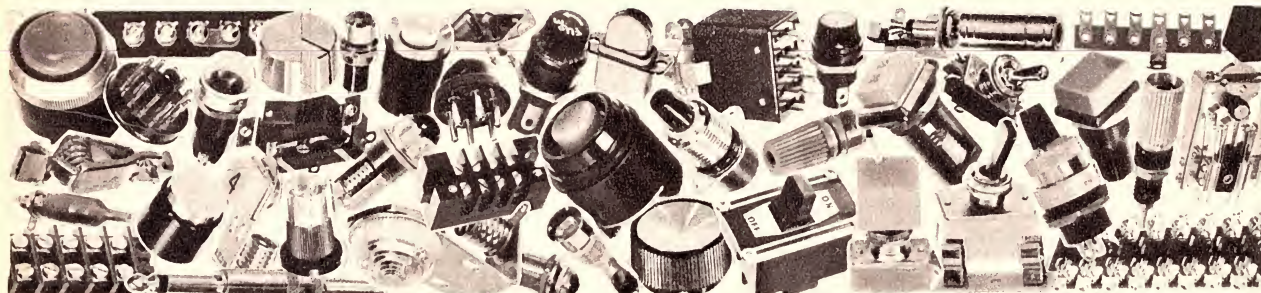

Like being proud of their Kangaroo, Sato's large variety of electrical parts is the favorite choice by Australians. Your inquiries are welcome.

# SATO PARTS

**SATO PARTS CO., LTD.**

HEAD OFFICE: EBISU, SHIBUYA-KU, TOKYO, JAPAN TEL: (442) 8506~8  
BANK ACCOUNT: MITSUBISHI BANK

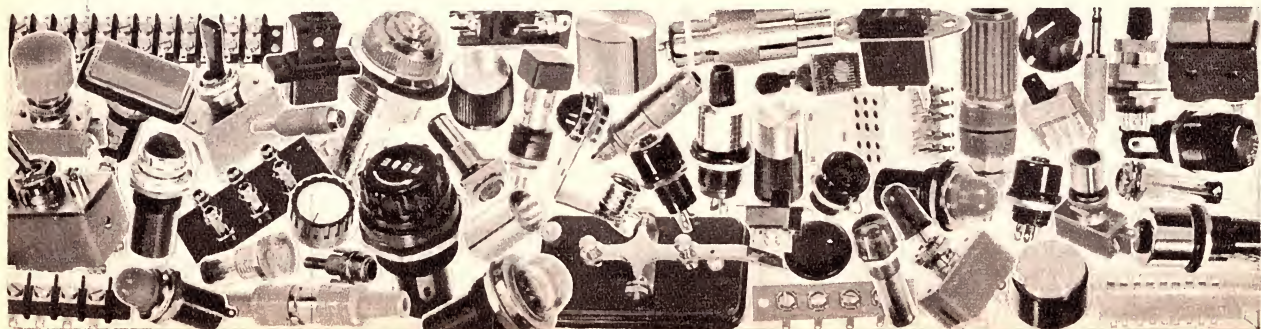



# AEROSOL PACKS FROM HELMAR CHEMICALS

Three new products designed specifically for the electronics industry, and each unique in its own way, have recently been released by Helmar Chemical products Pty Ltd., Sydney. This is the first time that any of these products have been produced in Australia.

The first, C.M.I. (Corona, Moisture Inhibitor), is designed basically to lubricate TV tuners and, although not designed as a cleaner, the propellant used in the aerosol pack does give some cleaning action. Its main job is to provide water repellancy and create a corrosion barrier. It is also an excellent electrical insulator.

C.M.I. is non flammable, non toxic, non staining, and does not effect plastic materials.

Consequently, it can be used in confined spaces and domestic conditions. As well as cleaning and lubricating tuners, it is most valuable in preventing EHT corona or arcing of any kind. EHT transformers prone to corona discharge can be corrected simply by spraying with C.M.I. whilst operating. Small EHT fires can also be extinguished. It is suggested that excessive dust deposits be removed from the components before spraying. In areas troubled by salt deposition, chassis and components can be sprayed to provide protection. C.M.I. has been checked by several well-known TV service companies and found to give excellent results.

C.M.I. is normally packaged in a 20oz aerosol can, but is also available in bulk for use by brushing, spraying, or as a dip.

Unlike the aerosol pack, C.M.I. in this form is flammable.

Another very useful product is an aerosol pack called simply "Circuit Chiller." As its name implies it is a freezing solution designed to provide carefully controlled temperature reduction during servicing or construction. The technique of freezing to isolate intermittent faults is now well known. Printed wiring boards can be frozen in small areas to locate breaks or hair line cracks. Resistors, capacitors, transistors, and other components can be similarly treated if intermittent operation is suspected.

The freezing technique is also valuable when small components, likely to be damaged by heat, are to be soldered into circuit. By reducing the temperature of the component, there is less chance of damage due to overheating by a lengthy soldering process.

Tested in our own laboratory, this mixture proved itself capable of adequate freezing for the applications suggested above. We did note that it was less drastic in its action than some similar products, but this is not necessarily a disadvantage. In fact, it could be an advantage in some cases, where careful control is necessary.

Circuit Chiller is available from wholesalers in 12oz aerosol cans at an extremely competitive price.

The third of the new Helmar releases is a silicone grease, Helmar H9000. Helmar H9000 will prevent the intrusion of moisture and, consequently, corrosion arising from it. It has high insulating qualities and can be used on aircraft,

marine and automotive electrical systems, including insulators, bushings, terminals, and connecting plugs. It has a wide application for use on switchgear, in coal mines, quarries, and in production applications where moisture is troublesome.

Radar and TV antennae, and marine transmitting and receiving antennae may all be treated with Helmar H9000 with advantage. By repelling moisture it pre-



The Circuit Chiller aerosol is a 12oz size, the C.M.I. is 20oz, and the H9000 16oz.

vents the formation of troublesome salt formations. It has proved particularly useful on fishing fleets where reliable reception is essential. It is also used by the Department of Civil Aviation. It is flammable only during application. H9000 is available in a 16oz aerosol can.

The three products described are readily available in all Australian states from electrical wholesalers. The manufacturers will welcome any enquiries regarding these products. Any such enquiries should be directed to Helmar Chemical Products Pty. Ltd., Box 72 P.O., Gladsville, N.S.W. 2111.

## TRADE RELEASES—in brief

**STANDARD TELEPHONES AND CABLES PTY. LTD.**, 252-274 Botany Road, Alexandria, N.S.W. 2015. **Cantata 700 Music System.** A fully automatic programmed music system to provide background music in factories, shops, and offices. Tapes are housed in a cassette, which is easily placed in and removed from the unit. Each standard library contains 700 selections of music without repetition, and plays for 26 hours. A timer adjustment gives automatic programming for: continuous uninterrupted music; 24 minutes play, six minutes silence; or 15 minutes play, 15 minutes silence.

Should it be necessary to broadcast the music over a large area, the unit can drive eight speakers without additional amplification. By plugging in a microphone, it is possible to use the system as

a public address and paging system. The Cantata unit complete with one chosen library costs \$546 including sales-tax. All standard libraries, rhythmic and melodic, are \$136, while special libraries of Christmas, Latin American, Polynesian, and Sacred series are \$96.

**STANDARD COMPONENTS PTY. LTD.**, 10 Hill Street, Leichhardt, N.S.W. 2040. N.S.W. Distributors for Radar TV Replacements Pty. Ltd., North Coburg, Vic. **Solid State Inverters.** Models 12/100, 12/180, and 12/250. Operating from 12V DC input, these units give 240V AC 50Hz square-wave output with power ratings of 100W, 180W, and 250W respectively. The frequency is said to remain on 50Hz plus or minus 1 per cent regardless of load variations or input voltage transients. Similar units are available to order with 24V and 32V DC input voltages. The inverters are said to be suitable for use with sound equipment and to have many commercial and industrial applications as well as operating TV receivers and small household appliances. Also available is a special inverter to operate a 15 or 20W fluorescent lamp from a 12V DC supply.

**RONALD J. T. PAYNE PTY. LTD.**, 385-387 Bridge Road, Richmond Vic. 3121. has been appointed sole Australian representative for Computer Instrumentation Ltd., of Eastleigh, Hants., England. Sales and service is offered for a wide range of peripheral equipment including: digital incremental drum plotters; flat-bed drafting machines; high speed microfilm printers; chart digitising equipment; film digitisers; tape converters. Software and programming assistance can also be provided where necessary. Through Computer Instrumentation, there is access to programs produced by the parent company, United Computing Corporation.

**AMALGAMATED WIRELESS VALVE CO. PTY. LTD.**, Private Mail Bag, P.O., Ermington, N.S.W. 2115. Agents for English Electric Valve Co. Pty. Ltd. **Ceramic Thyratrons.** CX1174 and CX1175 are the first of a 6A range of compact, deuterium filled thyratrons designed for use in modulators for pulse klystrons in linear accelerators. They are also suitable for use in high-power radar equipments. The CX-1174 is a single-gap tube and the CX1175 a double-gap tube. Ratings are: peak pulse current to 6000A at a peak forward anode voltage of up to 40KV (CX1174) or 80KV (CX1175); suitable for average switching applications between 70MW and 100MW, and between 100MW and 150MW respectively; maximum modulator output power 120MW and 200MW respectively.

**Ignitrons.** Type 7703 has a molybdenum anode and complex anode seal, making it suitable for operation under severe applications of high voltage and high current reversal (up to 85pc). Type BK472 has a stainless steel anode with a simpler anode seal, and is suitable for a reduced degree of current reversal and DC switching applications. Type BK474 has a molybdenum anode with the simpler anode seal of the BK472, and is especially suitable for ringing applications at reduced voltage and current. Peak inverse voltage for all three types is 20KV, and the peak anode current is 100KA for capacitor discharge service of 15KA in DC short-circuiting switch service. Peak forward voltage is 20KV in both applications.

**IRH COMPONENTS PTY. LTD.**, The Crescent, Kingsgrove, N.S.W. 2208. **Eccosorb RMP.** A line of flexible microwave absorbers moulded from fabric-reinforced silicone rubber as an array of hollow, square-base pyramids. Two types are available: Eccosorb RMP-75 with one-inch high pyramids, and Eccosorb RMP-78 with three-inch high pyramids. The silicone rubber design permits use in extreme environments, up to 500°F, and at power levels up to 5W per square inch. Both types are insensitive to polarisation and relatively insensitive to incidence angle variation.



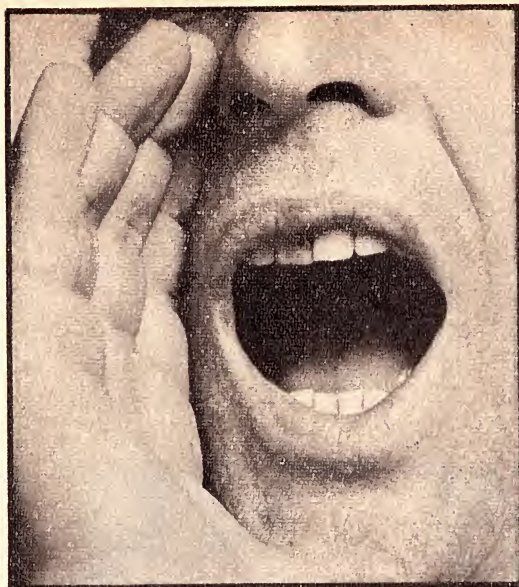

no shouting needed:

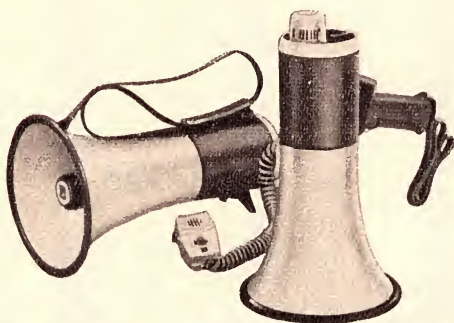

# TOA MEGAPHONES

If you've got something to say, if you direct traffic, train a team, fight a fire, direct construction, start a race, make a movie, or simply sound off.

TOA amplifiers are lightweight, easy to operate, rugged and fully transistorised.

TOA equipment delivers high efficiency, long life and the kind of full colour sound that stretches carrying power even under the most difficult conditions.

ER308 hand-operated pistol type. Fully transistorised, battery operated. Maximum output is 16 watts. Special mic construction makes it

feed-back proof. This enables maximum volume. Projects voice up to 1,000 yds. Weight, 3.5 lb. ER64 shoulder type. Details as ER308.

ER45 shoulder type as ER64. Plus equipped with emergency alarm. Red all over and covered in reflective red tape which glistens in the dark.

ER65 shoulder type as ER64. Maximum output 20 watts (most powerful in the world). Can be installed as stationary type. Projects voice to 1,500 yds. Weight, 6.5 lb.

All models are leakproof and backed by the unrivalled AWA sales and service organisation.



**AMALGAMATED WIRELESS (AUSTRALASIA) LIMITED**

Australia's National Wireless Organisation



**TOA ELECTRIC CO. LTD.**  
Public Address Equipment

**AMALGAMATED WIRELESS (AUSTRALASIA) LIMITED:** Sydney, Newcastle, Canberra, Brisbane, Melbourne, Hobart, Launceston, Adelaide, Perth; and also Chandlers Pty. Ltd., Queensland, and Newton McLaren Ltd., South Australia.



**C. E. ELECTRONICS PTY. LTD.**, 60 Chard Road, Brookvale, N.S.W. 2100. **SSB Transceivers.** A range of SSB transceivers to comply with Australian P.M.G. requirements, available in two models, single-channel and multi-channel. Each has an output of 100W PEP. The sets are hybrid units, including valves and transistors to give the most



economical and reliable solution in the power range, according to the makers. The circuitry includes FETs and very high Q toroids. A wide variety of optional accessories is available, including equipment designed to make the transceivers compatible with existing AM networks.

**AUSTRALIAN GENERAL ELECTRIC PTY. LTD.**, 103 York Street, Sydney, 2000. **SLC-110 Single Line Controller.** Allows an exchange of information between two processors (one GE-100 and a second GE-100 or GE-400 or GE-600) or between a processor and a series of terminals. The SLC-110 series provides the following data communication capabilities: synchronous or asynchronous transmission mode; switched, leased, or telepack transmission line; 150-150,000 band transmission speed. Used with the GE-100 series, they permit the use of the combination as: a real time system with its own network of terminals; a remote terminal of a larger system for remote batch processing; an intermediate system in a larger system operating in real time with feature of communication processor.

**PSC Peripheral Switch.** A device which shares a set of peripheral resources partly common to different central processors. It switches over the same processor on two peripheral sub-systems, or the same sub-systems on to different processors; reduces the total cost of the multi-processor system — producing results which could otherwise be achieved only on large-size systems with complex tech-

niques; increases the processing capabilities of each system (it is possible to divert all or most of a system's resources from one system to another as required); insures continuity of operation of programs — switching the necessary capabilities in order to continue a job.

**DIGITAL EQUIPMENT AUSTRALIA PTY. LTD.**, 75 Alexander Street, Crow's Nest, N.S.W. 2065. **Basic PDP-8/L Type-setting System.** This computerised type-setting system can drive any paper-tape-driven linecaster and file setting machines. The linecasters program can have 25 combinations of column width, type face, and type size. There is room for four non-unit count faces within the system. It includes high-accuracy rules of hyphenation, all standard indentations, and split quadding.

**B.W.D. ELECTRONICS PTY. LTD.**, 331-333 Burke Road, Gardiner, Vic. 3146. **General Purpose Instrument, model bwd 602.** Suitable for use in manufacture, service, education, and experimentation. The instrument provides in one compact cabinet 12 high performance instrument functions; namely, sine/square wave signal generator, voltage and power amplifiers, stabilised DC power supplies, and AC sources. Features include: all outputs overload or short circuit protected; common line isolated for positive or negative operation of power supplies; silicon transistors throughout; power amplifier distortion less than 1pc up to 20KHz; sine wave oscillator distortion below 1pc from 10Hz to 500KHz.

**TECNICO ELECTRONICS DIVISION**, Pye Industries Ltd., 53 Carrington Street, Marrickville, N.S.W. 2204. **Dual In-line IC Boards.** Printed circuit matrix boards on which can be mounted up to ten 14-pin or 16-pin dual in-line integrated circuits. Specifically designed to

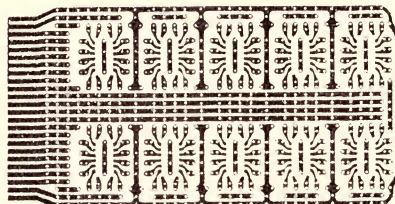

overcome the problems of small clearances and pin fragility of ICs in dual in-line packs. Available from stock in two forms, the GCN383 unplated and GCN-410 which has gold-plated edge connectors, at \$2.10 and \$4.10 each respectively

**E.M.I. (AUSTRALIA) LTD.**, Commercial and Advanced Electronics Division, 14-18 Parramatta Road, Homebush, N.S.W. 2140. **Sweep Generator BISG2.** A compact solid-state two-range unit designed specifically for the rapid and accurate alignment and testing of the RF and IF sections of broadcast receivers. One range covers the complete broadcast band in one sweep for the alignment of the aerial, RF and oscillator sections of MW radios, and is useful for production checking of tracking and frequency coverage of ganged capacitors and car-radio tuning units. The other range is centred on 455KHz with sweep width restricted to  $\pm 50$ KHz for complete IF alignment of receivers and production testing of coils and transformers.

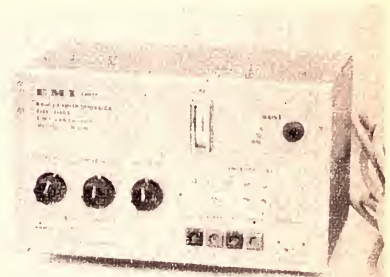

Provision is made for up to seven plug-in crystal markers on each range; however, the standard arrangement is six on the broadcast and five on the IF range. Narrow bright-up marker pulses of both positive and negative polarity are available simultaneously on the front panel for feeding to the Z-modulation input of suitable display units or CROs. The sweep rate is fixed at 25Hz, mains locked, as the best compromise between the conflicting factors of display flicker, response distortion, and marker offset. Positive-going sawtooth voltage is provided for driving the horizontal amplifier of the display unit.

**RUTHERFORD ELECTRONICS PTY. LTD.**, 833 Doncaster Road, Doncaster, Vic. 3108. Agents for National Semiconductor Corporation, U.S.A. **FET Switches, types 2N4091, 2N4092 and 2N4093.** Can also be used as low-level choppers, video and RF amplifiers, or as high-gain and low-noise amplifiers. Typical applications include microvolt amplifiers and meters, multiplexers, commutators, TV equipment, AM receivers, and audio equipment. The devices feature low on-resistance (30 ohms), fast switching (40ps), and low leakage (200pA).

# ELECTROLUBE 2A-X

Registered Trade Mark

**IMPROVES ELECTRICAL CONTACTS  
INCREASES RELIABILITY AND  
LOWERS MAINTENANCE COSTS**

**SAFE ON** POLYSTYRENE, P.V.C. MAKROLON, PAINTS, NATURAL AND SYNTHETIC RUBBER NON-HAZARDOUS VAPOUR

Write for free Products Summary on the range of electrical and mechanical oils and greases



**RICHARD FOOT (Australia) PTY. LTD.**  
63 Hume St., Crows Nest, N.S.W. Tel. 43-0326.

Available from leading electrical wholesalers.



# When is a Watt *not a Watt?*

When it's a Ferrograph watt—then it's like **two** watts! Making a 40 watt amplifier that delivers 40 watts "Music Power" at 1 kHz is easy.

Making a 40 watt amplifier that delivers 40 watts **R.M.S.** at 30Hz and 25kHz is quite a different story. That takes Honest Engineering and Ferrograph Skill. It's the same with distortion. Low distortion at full power at 1kHz is no trouble at all with transistors. But it takes Honest Engineering and Ferrograph Skill to give you low distortion (less than 0.25% T.H.D.) **at any level up to 40 watts R.M.S. into 8 ohms, at any frequency from 30Hz to 25kHz.** If technicalities bore you, just listen and compare. You'll soon realise that Ferrograph's world wide reputation for honest engineering and skill is no myth. And take a look inside. Like the Series Seven recorders, the F307 amplifier is a model of precision electronics construction—the serviceman's dream. That's your guarantee, that you'll keep on getting superlative performance, year after year after year.

SEND FOR  
"WHY  
FERROGRAPH"  
IT'S FREE.

The Ferrograph F307 will cost you \$240.00. That's a lot of money. But then it's a lot of amplifier.

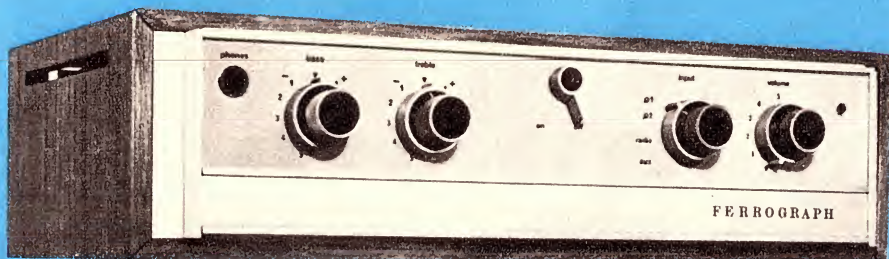

SOLE AUSTRALIAN DISTRIBUTORS

*Leroya Industries PTY. LTD.*

266 HAY STREET, SUBIACO, WESTERN AUSTRALIA, 6008.



**IRH COMPONENTS PTY. LTD.**, The Crescent, Kingsgrove, N.S.W. 2208. Agents for Emerson & Cuming Inc., U.S.A. Eccogel 1265. An epoxy resin, designed to encapsulate components and circuits, it cures to a firm, tough, flexible, clear gel. It gives good environmental protection with shock and vibration resistance. At the same time the unit is visible for inspection. If repair is necessary, the gel can easily be cut with a knife to expose the parts. After repair, additional Eccogel 1265 can be poured into the cavity to restore the encapsulation.

**WATSON VICTOR LTD.**, P.O. Box 100, North Ryde, N.S.W. 2113. Agents for Smiths Industries Ltd., Wembley, Middx., England. **Servoscribe Potentiometric Desk-Type Recorders.** The Servoscribe 2 type RE 520.20 recorder provides two independent input channels for the recording of low-level DC signals on a common time-coincident basis. The two recording pens are arranged one above the other so that they do not mutually interfere, and are therefore both capable of writing over the full recording width of 8in. They are, however, displaced in the time axis by 1mm, which is easily taken into account when evaluating the recordings. Other features are: wide range of measurement (minimum 800uV FSD); six chart speeds; a choice of either chart rolls or graph sheets; a capillary pen inking system using expendable ink cartridges; solid state circuitry used throughout. The standard instrument is supplied with a linear scale, but logarithmic and photometric versions are also available. The Servoscribe type RE 511.20 is a single channel desk-type potentiometric recorder. Recordings can be made with either an ink or ball pen, but in other respects the recorder is similar to the two-channel version.

**3M COMPANY**, P.O. Box 99, Pymble, N.S.W. 2073. **Scotchlok Self-Stripping Connector No. 560.** A low-voltage electrical connector designed for use in cars, boats, alarms, control systems, sound systems, and other electrical applications of 30V or less. Pre-insulated tap splices, in-line splices, and pigtail splices can be made with one connector without stripping, twisting or soldering. Features a self-stripping "U-type" element encased in



buff coloured polypropylene. Connections are made by driving the "U-type" element down over the conductors with pliers. The spring compression reserve in the element supplies holding power and electrical contact with strong, permanent pressure. A hinged cover attached to the connector's case is then snapped into place for additional protection. The connectors can handle 18/0076 to 70/0076 gauge wires or any size in between.

**AMPEX AUSTRALIA PTY. LTD.**, 26 Ridge Street, North Sydney, N.S.W. 2060. **Model PR-500 Tape Recorder.** A low-cost, portable or rack-mounted recording sys-

## PREAMP FOR MAGNETIC CARTRIDGES

Beech Electronics recently submitted for review a sample, twin-channel preamplifier which enables magnetic cartridges to be used with amplifiers which are normally intended to be driven by ceramic or crystal cartridges. It represents a simple way of upgrading a stereo system without modifying the amplifier.



The unit is housed in a small steel box measuring 6½ x 5½ x 2-1/8 inches deep and finished in grey hammertone. Five-pin DIN sockets are used for the inputs and outputs and they are wired to the usual code—pins 1 and 4 for inputs and pins 3 and 5 for outputs. The circuitry used is that published in "Electronics Australia" in October 1965 and contains three transistors per channel. The input transistor is used as a low-noise preamp stage, while the other two are connected in a direct coupled feed-back pair providing equalisation to the RIAA curve.

The gain is easily adjustable by varying one resistor in each channel so that optimum signal-to-noise ratio and overload margin can be realised with a wide variety of amplifiers and cartridges. The resistors are "stood off" the printed board so that they are easily changed without removing the board. Construction of the unit is neat and high quality metallised polyester capacitors and carbon film resistors are used throughout. Power is derived from a small nine-volt battery which, should have a long life due to the low current involved.

We tested the unit with the 10-plus-10 stereo amplifier which has a sensitivity of 100mV for full output and is normally

used with low output ceramic cartridges. The unit contributed very little noise and no hum due to its shielded construction and use of battery power. The amplifier was easily driven to full power with even lightly recorded discs and a low output magnetic cartridge.

Tested with another stereo amplifier which had a sensitivity of 400mV for full power, the unit was not quite sensitive enough as wired. However, when we increased the gain by varying the resistor mentioned above we were able to drive this amplifier to full power also.

All in all, this unit provides a simple answer to those people who wish to upgrade a system previously using a ceramic or crystal cartridge. The price of the unit is \$25, tax inclusive. All inquiries regarding this unit should be directed to Beach Electronics, P.O. Box. 160, Kogarah, N.S.W., 2217. (L.D.S.)

tem convertible for use with either ¼in or ½in magnetic tape. Designed to reproduce a wide variety of scientific and industrial data, such as that obtained in environmental tests, medical research, petrochemical analysis, and aerospace applications on up to seven channels. Up to 12½ hours of data can be stored on a single 10½in reel of magnetic tape then scanned and retrieved in minutes.

Specially designed for pen writer applications. Includes a replay-operated squelch which prevents chattering of pens during periods when there is no data output. Servo drive switchable through six speeds from 15/16ips to 30ips, assuring speed accuracy even under varying line frequency. Bandwidth is 10KHz for FM recording, and 150KHz for direct at 30ips. Dimensions: 22½in high x 13½in long x 20in wide. Weight 80 pounds.

**AGA PRODUCTS AUSTRALIA PTY. LTD.**, 63 Christie Street, St. Leonards, N.S.W. 2065. Australian subsidiary of the Swedish-based AGA group. **Thermovision Infrared Camera System.** This new Swedish-developed system enables still-camera or live-film presentation of temperature distribution and development in fixed and moving objects. The camera records the natural thermal radiation from an object and converts the radiation to a thermal picture on a picture tube. Relative temperature differences on the surface of the object are indicated in a grey tone scale. Absolute temperature levels can be determined with an accuracy of 0.2 deg. C with the help of a reference level and a superimposure of isotherms on the pic-

ture. Typical applications include: heat-flow measurement within the construction industry; temperature measurement in manufacturing processes; design and inspection of electronic circuits; temperature studies in connection with material testing; detection of internal corrosion in boiler tubes; hydrotechnical and geotechnical surveys; military and space research; medical research and clinical work, e.g. early detection of breast cancer.

**BETTER  
RADIO RECEPTION  
FOR ONLY  
20 Cents**

Published by Eddystone, a complete guide how to get the best results from your receiver, contains 24 pages, with illustrations; covers propagation, aerials, interference, and other useful data.

Write now with 20 cent postal note to:

*R.H. Cunningham*  
PTY. LTD.

608 Collins Street, Melbourne,  
Victoria, 3000





# Choose from the full range of quality Palace stereo equipment.

A NEW SOPHISTICATED STEREO TAPE DECK OF UNCOMPROMISING QUALITY.

4-Track Stereo & Monaural Record/Playback

Separate Record/Playback & Erase Heads

Built-in Solid State Stereo Record/Playback Preamplifiers

Records 4-Track Stereo or Mono from FM, AM, FM Stereo or Phono Sources, Live from Mikes

Push Button 2 Speed 3¾ & 7½ I.P.S.

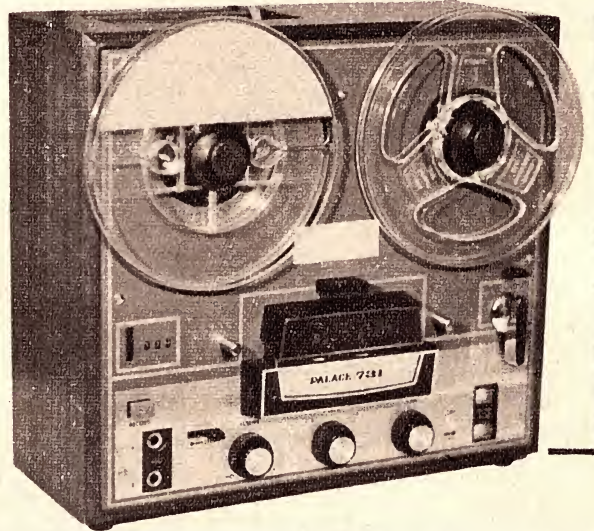

SA80S 4W RMS COMPACT STEREO AMPLIFIER



AM-296 10W RMS SOLID STATE AMPLIFIER



AM-320 16W RMS SOLID STATE PREMAIN AMPLIFIER



AM-323 HIGH POWER 40W RMS SOLID STATE PREMAIN AMPLIFIER

SOLE AUSTRALIAN REPRESENTATIVES.

## GENERAL ACCESSORIES

VIEW THE FULL RANGE OF PALACE STEREO EQUIPMENT NOW AT YOUR LOCAL STATE BRANCH SHOWROOM.

General Accessories  
153 Sturt Street  
South Melbourne 69 0300

General Accessories  
81 Flinders Street  
Adelaide 23 4022

General Accessories  
46 Milligan Street  
Perth 21 2501

General Accessories  
50 Little Edward Street  
Brisbane 2 3093

General Accessories  
443 Concord Road  
Concord West 73 0211  
and Sydney

Homecrafts - Tasmania  
199 Collins Street  
Hobart 2 2711



**ASEA ELECTRIC (AUST.) PTY. LTD.**, P.O. Box 61, Crows Nest, N.S.W. 2065. **Thyristors, types Ty A 290 S and Ty A 490 S.** Provided with a square flat base of nickel-plated copper and with a large mass and contact surface. Very low thermal resistance between the base and a heat sink and therefore higher current carrying capacity than for corresponding stud-type thyristors. Rated forward current: Ty A 290 S, 200A with a surge rating of 4500A; Ty A 490 S, 255A and 7000A. Both available for reverse blocking voltages up to 2000V and with critical rate of rise of off-state voltage up to 500V/uS.

**PLESSEY DUCON PTY. LTD.**, P.O. Box 2, Villawood, N.S.W. 2163. **Subminiature toggle switches.** Designed to meet the highest standards of quality and reliability, these switches combine maximum performance with minimum weight and small size. Features: rugged construction; simple mounting; excellent appearance; long, trouble-free operation; contact rating 240V, 2A; working contacts coin silver standard. **Subminiature push-button switches.** The double throw, momentary snap action, push-button switches are available in one, two, three and four pole models. Features: rugged construction; simple mounting; gold contacts; good appearance; long, trouble-free operation; contact rating 115V AC or 28V DC at 1A.

**ES & I ELECTRONICS**, 81 Prospect Road, Summer Hill, N.S.W. 2130, is operating a mail order service and offers a number of exclusive items. These include: a set of three articles with details for the construction of power supplies from low output to quite high output, priced at \$3; two grades of silicone grease, a transparent grade and a white opaque grade with higher conductivity, in sealed

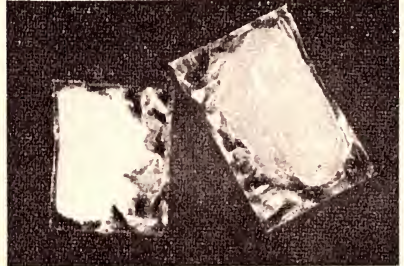

transparent pouches (illustrated) containing 10 grams, priced at 50c per pouch transparent grade and 90c white grade; silicon power transistors, types 2N3055 and 2N3054, priced \$18 and \$17 per 10 respectively; 1W zener diodes, \$13 per 10; EM404 rectifiers, 25c each; heatsinks for T0-1, T0-5 and T0-18 transistors in various profiles, prices on application. Prices are post paid and include sales-tax. A minimum order of \$4 is requested. Trade inquiries are invited for the zeners and transistors. A catalogue will be supplied on request.

**RCA LTD.**, 11 Khartoum Road, North Ryde, N.S.W. 2113, announces that Mr Gary Cutler will be responsible for sales promotion and merchandising of the RCA range of technical products. Recently arrived from the U.K., Mr Cutler was previously market development manager with S.T.C. Mobile Radiotelephones Ltd., London.

**DATAMATIC PTY. LTD.**, 90 Alexander Street, Crows Nest, N.S.W. 2055, has become Australian distributor for Eldorado Electronics, of Concord, California, and the Potter Instrument Co. Inc., of Plainview, New York. Eldorado Electronics is a major U.S. manufacturer of frequency counters, timers, time delay generators, etc., covering the frequency range from DC to 10GHz. Potter Instrument is a leading supplier of computer peripheral equipments including magnetic

# PLESSEY PACIFIC ORGANISATION

A major reorganisation, consolidating the Plessey Pacific group of communications and electronics companies, was announced recently by Sir Giles Chippindall, chairman of Plessey Pacific Pty. Ltd. Under the reorganisation, six new trading companies have been established within the Plessey Pacific group.

The six newly named companies are: Plessey Ducon Pty. Ltd., comprising Ducon Condenser Pty. Ltd. and Garrard Engineering (Aust.) Pty. Ltd.

Plessey Rola Pty. Ltd., previously Rola Company (Aust.) Pty. Ltd.

Plessey Telecommunications Pty. Ltd., previously Telephone and Electrical Industries Pty. Ltd.

Plessey Communication Systems Pty. Ltd., previously Communication Systems of Australia Pty. Ltd.

Plessey Electronics Pty. Ltd., comprising British Automatic Telephone and Electric Pty. Ltd., Vinten Communication Products Pty. Ltd., Standard Frequency Crystals Pty. Ltd., and the Professional Equipment unit of the Rola Company (Aust.) Pty. Ltd.

Plessey Dynamics Pty. Ltd., comprising Hydrac Pty. Ltd. and Plessey Pacific Dynamics Division.

In addition to Ducon and Rola, the brand names Garrard, Vinten, and Hydrac are to be preserved by Plessey Pacific and it is not intended to discontinue manufacture of any existing products.

There has been no change in the composition of the board of Plessey Pacific

as a result of the company reorganisation. Members of the board are: Sir Giles Chippindall, chairman; Mr Robert Hall, managing director (also executive director, The Plessey Co. Ltd., U.K.); Sir Cecil T. Looker; Sir Frederick Scherger; Dr W. A. S. Butement (also director, Plessey Pacific Central Research Laboratory); and Mr G. H. Doust (also managing director, Plessey Components Group, U.K.)

The six new companies operate in four separate areas; components, dynamics, electronics, and telecommunications. The direction of each of these divisions is in the hands of the following executives:

Components, Mr R. W. R. Wiltshire. Dynamics, Mr R. T. Elvish. Electronics, Mr D. G. White. Telecommunications, Mr W. K. Jennings.

The direction of the two components companies is in the hands of the following executives, under Mr Wiltshire:

Plessey Ducon Pty. Ltd., Mr E. Richardson.

Plessey Rola Pty. Ltd., Mr D. G. Walder.

The direction of the two telecommunications companies is in the hands of the following executives, under Mr Jennings:

Plessey Telecommunications Pty. Ltd., Mr R. R. Long.

Plessey Communication Systems Pty. Ltd., Mr F. R. Tew.

All the above executives have been appointed directors of their respective companies.

tape transport systems, disc stores, high-speed chain printers, etc. Interface units are available for immediate plug-on incorporation with a large number of existing computer systems.

**VITRAMON PTY. LTD.**, 534-536 Princes Highway, Rockdale, N.S.W. 2216, has announced that its parent company, Vitramon Inc., has acquired an additional subsidiary company, Microwave International Corporation, of Middlesex, New Jersey, U.S.A., and renamed it Vitramon Microwave Corporation, or V.M.G. The Vitramon product range is thereby widened to introduce advanced microwave hardware and integrated circuits, including pin switches, couplers, filters, solid-state amplifiers, and phase switches. Vitramon's line of special dielectrics is now being applied to the V.M.G. range to yield smaller, lighter, and less costly microwave components.

**IBM AUSTRALIA LTD.**, Bradfield Highway and Kent Street, Sydney, 2000, has appointed Mr Peter Holmes a Court to the newly created position, director of communications. In this new position, he will be concerned with Government relations and IBM's image in industry, commerce and the community generally. Mr Maurice Bevington, formerly communications manager, has been appointed to the newly created position of IBM regional manager, real estate and construction, for activities within the Australia and New Zealand region. He has directed IBM's real estate activities for some years as a joint activity.

**FAIRCHILD AUSTRALIA PTY. LTD.**, 420 Mount Dandenong Road, Croydon, Vic. 3136, has been appointed sole Australian agent for the Elco Corporation of the U.S.A. Inquiries for Elco electrical connectors should be directed to the Elco customer services department at Fairchild.

**WATSON VICTOR HOLDINGS LTD.**, 95-99 Epping Road, North Ryde, N.S.W., has announced the merger of the subsidiary companies Watson Victor Ltd., Andrew Thom Ltd., and A. A. Guthrie Pty. Ltd. These companies are all with the parent company at North Ryde, and will trade under the name Watson Victor Ltd. Present outstanding orders will be supplied and invoiced by the company

holding the order, and Watson Victor Ltd. will assume responsibility for all outstanding quotations from Andrew Thom Ltd. and A. A. Guthrie. Inquiries to Watson Victor Ltd., P.O. Box 100, North Ryde, N.S.W. 2113; telephone 88-6188. ■

±10%

## POLYESTER CAPACITORS

100VW Types—Fully Guaranteed

| MFD    | Price 1-9 | 10+ | MFD   | Price 1-9 | 10+ |
|--------|-----------|-----|-------|-----------|-----|
| 0.001  | 7c        | 6c  | 0.033 | 9c        | 8c  |
| 0.0022 | 7c        | 6c  | 0.047 | 10c       | 8c  |
| 0.0033 | 7c        | 6c  | 0.05  | 11c       | 9c  |
| 0.0047 | 7c        | 6c  | 0.068 | 11c       | 9c  |
| 0.005  | 7c        | 6c  | 0.08  | 11c       | 9c  |
| 0.0068 | 7c        | 6c  | 0.1   | 12c       | 10c |
| 0.01   | 7c        | 6c  | 0.22  | 16c       | 13c |
| 0.002  | 8c        | 7c  | 0.47  | 23c       | 22c |

Pack/Post 10c any order. Prompt. See classified section for resistor and transistor prices.

### KITSETS AUST.

BOX 176, P.O., DEE WHY, 2099, N.S.W.

## COMPUTER BOARDS

**TRANSISTORS 15c Each.**  
**Resistors, Diodes, Capacitors Free.**

**8 BOARDS WITH A MINIMUM OF 30 TRANSISTORS \$4.00**  
Pack and post 25c

**25 BOARDS WITH A MINIMUM OF 100 TRANS. \$12.00**  
Pack and post 50c

Technical information supplied with goods. Minimum order \$1.50. Please add Postage.

**COLSTOK ELECTRONICS**  
Box 178, KELLERBERRIN. 6410



# Let The World University Of Postal Education TRAIN YOU FOR A KEY JOB



## BRANCHES THROUGHOUT THE WORLD

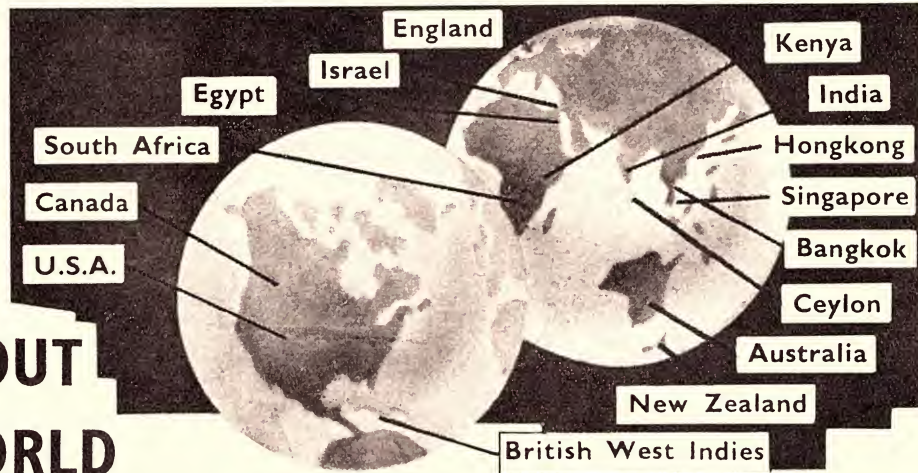

**TODAY** there are wonderful Opportunities for the forward-looking man and woman. However, the best jobs go to those who have the foresight to prepare themselves by proper Training. British Institutes have already trained some 300,000

men and women who have reached the top of the ladder. Therefore, it is up to **YOU** to make something of yourself. Don't delay, act **NOW**. Remember that an enquiry places you under no obligation but could be the turning point in **YOUR** career.

### OVER 500 COURSES

Courses offered by British Institutes include:—

#### TECHNICAL

Aero Engines  
Aeronautical Eng.  
Air Conditioning  
Arch. Drwg. & Design  
Automation  
Auto Elec. Equipment  
Automobile Eng.  
Automobile Repairs  
Building (General)  
Carpentry & Joinery  
Chemical Engineering  
Civil Engineering  
Computers  
Die & Press Tools  
Diesel Engines

Draughtsmanship  
Electrical Engineering  
Elec. Installations  
Elec. Measurements  
Electrical Power  
Electricity Supply  
Electronics  
Foundry Practice  
Garage Management  
Gas Turbines  
Geology  
Hydraulics  
Illuminating Eng.  
Industrial Chemistry  
Jig & Tool Design  
Mach. Drwg. & Design  
Maintenance Eng.

Management  
Marine Engineering  
Mechanical Eng.  
Metallurgy  
Municipal Engineering  
Naval Architecture  
Painting & Decorating  
Patternmaking  
Petroleum Technology  
Plastics  
Production Eng.  
Radar Technology  
Radio Engineering  
Radio Servicing  
Refrigeration  
Reinforced Concrete  
Road Engineering

Rubber Technology  
Sanitary Engineering  
Structural Eng.  
Surveying  
Telecommunications  
Television  
Television Servicing  
Timber Technology  
Tracing  
Welding Technology

#### COMMERCIAL

Accounting  
Advertising  
Auditing  
Book-keeping

Business M'gement  
Commercial Art  
Commercial Law  
Company Law  
Costing  
Economics  
Fiction Writing  
Journalism  
Secretaryship  
Selling

#### GENERAL

English  
European Languages  
Mathematics  
Shorthand  
Typewriting

*And many other Subjects.*

Details of Engineering and Commercial Exams., Certs. of Competency, Matriculation, etc.

### CHECK THESE FEATURES:

- Modern streamlined methods . . . you learn the fast way and make rapid progress.
- Courses based on STANDARD TEXT-BOOKS . . . Lessons and Model Answers written and planned by experts.
- We provide all necessary text-books which remain your own property.
- Moderate fees payable by small monthly sums. Written guarantee.
- Courses can be "tailored" to individual requirements.

### SECURE ONE OF THESE BOOKS



### POST COUPON NOW!

#### BRITISH INSTITUTE OF CAREERS

College House, 113 Pacific Highway, North Sydney, 2060

I am interested in . . .  
Please send me the appropriate Career-Book.

NAME (PLEASE PRINT) . . . . .

ADDRESS . . . . .

E.L.-W-9 . . . . .

Occupation . . . . . Age . . . . .



## BRITISH INSTITUTE OF CAREERS

In association with  
British Institute of  
Engineering Technology

## THE B.I.C. GROUP LEADS THE WORLD IN POSTAL TRAINING



# TECHNICAL BOOKS AND PUBLICATIONS

## "Budget" circuits

**AUDIO AMPLIFIERS.** Edited by J. R. Davies. Data Book Series No. 18. Published by Data Publications Ltd., 57 Maida Vale, London, W.9. First printing January, 1969. Stiff paper covers, 5½ x 8¼ inches, 124 pages, illustrated by photographs and diagrams. Price in England 10/6.

Although not stated in the preface, it is likely that most of the circuits in this book have appeared at one time or another in the English magazine "Radio Constructor." The general style of presentation and circuit diagrams would certainly support this conclusion.

All told, the book contains 15 amplifier circuits, about nine of them using valve circuitry, the remainder solid-state. Included in the latter are some relatively low-powered amplifiers, a 10-watt public address unit and some circuit suggestions for a solid-state tape recorder.

The valve circuits include one for a tape recorder built around the BSR single-speed deck, and another for a home-made but probably rather crude reverberation system. The remaining circuits range from simple bench and record player amplifiers to rather more pretentious push-pull arrangements. One distinctly curious design uses a transistor in an early stage, attended by claims which are, to say the least, debatable.

In all the designs, economy appears to be a strong factor and all are for mono reproduction. On this score the book will exercise an attraction as a source of ideas for budget-conscious constructors, but it is well behind the times in terms of what the average Australian amplifier enthusiast expects to build and use.

Our copy came direct from the publishers. No precise information is available at the time of writing about local price and availability. (W.N.W.)

## Transistor course

**TRANSISTOR FUNDAMENTALS,** Volumes 1-4, published by W. Foulsham and Co., Ltd., Slough, England, 1968. Volume 1, Basic Semiconductor and Circuit Principles, by Robert J. Brite. Volume 2, Basic Transistor Circuits, by Charles A. Pike. Volume 3, Electronic Equipment Circuits, by Martin Gersten. Volume 4, Digital and Special Circuits, by Louis Schweitzer and Reginald H. Penlston. Hard covers, 5½in x 8½in, 240pp., 208pp., 192pp., 208pp., many circuits and diagrams. Price in Australia \$5.95 per volume.

These volumes are Foulsham-Sams publications, originally produced in the U.S.A. by the Howard W. Sams company in conjunction with Training and Retraining, Inc. They employ the "programmed learning" system of content presentation, an adaptation of some of the concepts originally applied to instruction using teaching machines.

It would appear that the aim of the series formed by these volumes is to provide those with little previous knowledge of semiconductor devices with a basic introduction to both their operation and application. And, although many books and courses have appeared with this commendable aim, it seems to this reviewer so

few have achieved it that one could still give a warm and enthusiastic welcome to a new book or series which was in fact successful.

Unfortunately "Transistor Fundamentals" does not appear to be that work. It has a number of good features, to be sure, and no doubt the various volumes either singly or taken together will be of considerable help to those who read them. Yet as a basic introduction to the operation and application of semiconductor devices it seems to this reviewer to be rather short of the ideal. I am not implying that it is any less successful in this regard than many of the existing books: in contrast what I am reporting is the somewhat more disappointing conclusion that it seems to lack any marked superiority.

I think the reason for this is the same which has prevented untold worthy and well-written technical books from rising to the ranks of the "noteworthy" — lack of a clear conception of the eventual reader, his background and his needs.

In this case, given the relatively modest size of the volumes comprising "Transistor Fundamentals," it seems to me that they should have been written on the assumption that the reader would be a hobbyist, technician or student already possessing a reasonable grasp of basic electrical principles, and seeking to build upon this foundation a satisfying theoretical and practical knowledge of solid state electronics. Surely it would only have been possible to achieve this aim, in the limited scope of the series, by making this quite reasonable assumption.

Yet what the planners of this series seem to have in fact done is assume that the eventual reader of the books will be a complete newcomer not only to semiconductors, but to electricity and electronics as a whole. Accordingly the writer of the first volume has had to devote more than 80 per cent of his work to basic principles of electricity and electronic circuit fundamentals, and has been left with only about 40 pages in which to develop the fundamentals of semiconductors.

The other volumes appear to suffer somewhat less from this shortcoming, I must confess. In fact, apart from a small overlapping of material which is probably inevitable with multiple authorship, they seem to build quite well upon a basic knowledge of semiconductor and circuit theory. Perhaps the essence of my criticism is the suggestion that in order to provide himself with this basic knowledge, the typical reader of this series will need to supplement his reading of the first volume by reference to other works.

As for the actual writing and presentation of the four books, they are of a uniformly high standard. The text is concise, direct, and clearly illustrated with simple and uncluttered diagrams. The "programmed learning" system of short text segments interspersed with self-testing questions and answers seems likely to be of considerable value to the reader who is sincerely pursuing knowledge. In short, I can find no significant quibble with the form of the series, but in fact find it very praiseworthy.

To summarise: a series which should be examined by all seeking an intro-

duction to semiconductors, if only to see for themselves whether or not my criticism is valid. I feel sure that the second, third and fourth volumes are likely to prove of considerable value to such readers; but the series as a whole is weakened by the shortcomings of the first.

A final point: Many of the Foulsham-Sams books which have appeared have been English-produced versions of books originally printed in the U.S.A., the essential difference being a replacement title page, together with an added "special chapter for the guidance of the English reader." In common with other reviewers, I have observed from time to time that these "special chapters" have seemed rather pointless, and hardly what one might expect from the impressive direction that "it is essential that the English reader should read this chapter."

By way of illustration, in the chapter added to the second volume, several American terms are translated for the benefit of the poor, confused English reader. The terms, believe it or not, are "phonograph," "schematics," "grounded" and "vacuum tube."

A minor point, perhaps, but one which surely warrants some mention.

Our copies of the books came from Grenville Publications Ltd., who are Australian distributors for Foulsham-Sams, and we are advised that copies are in stock at all major bookstores. (J.R.)

## Reference data

**ELECTRONICS REFERENCE DATA-BOOK.** By Norman Crowhurst. Published by TAB Books, Blue Ridge Summit, PA 17214 U.S.A. Stiff paper covers, 232 pages, 8½in x 5in, illustrated by tables, formulas, diagrams. Australian price \$6.15; \$9.75 for the hard cover edition.

In compiling this book, well known author Norman Crowhurst has attempted to avoid a mere listing of data, which may serve its purpose for reference, but which inhibits any attempt to browse or study. Instead, he has linked the data, tables, graphs and formulas appropriate to various subjects with connective text so that the user can refresh his memory of detail, if he so desires. Indeed, one gains the impression that the author has put a lot of work into preparation of the copy.

The book opens with a discussion and listing of units — electromagnetic, acoustic, heat, volume, angular velocity and so on, with a cross-reference between various unit systems.

Chapter 2, entitled "Basic Electronics" devotes 26 pages to familiar circuit configurations and relevant laws and data — Ohm's Law, Kirchoff's Laws, Thevenin's Theorem, time constants and a variety of other similar information. Reference is made to the use of the slide rule in coping with some of the calculations.

Chapter 3, "Applications of J Operator," covers vectors, filters, bridges, sidebands and correction factors.

The remaining chapters in order are as follows: Exponential and Other Tables — Attenuators and Equalisers — Filter Design — Practical Component Design and Use — Semiconductors and Tubes — Feedback — Transmission Lines.

As an aid to locating particular data, the chapter titles and sub-titles are set out in the front of the book, followed by a list of tables. The book concludes with a subject index.

A certain amount of the material in the text is at a quite elementary level but the bulk of it would be more appropriate to tertiary students, technicians in laboratory situations and engineers who can use another ready-to-hand reference data book.

In short, well worthy of inspection. Our review copy came from Grenville Publishing Co. Pty. Ltd., 401 Pitt Street, Sydney, 2000. (W.N.W.)



## LITERATURE—in brief

**APPLICATION NOTES.** Published by Electronic Products Division, Corning Glass Works, 1202 Plaza Building, 87 Pitt Street, Sydney, 2000.

**Sharpening Television Pictures with Glass Memories.** A 2-page illustrated sheet describes how vertical resolution of a television camera system can be improved by comparing three successive lines of a normal video signal. The process consists of comparing the previously displayed line with the next line to be displayed and generating a correction or contour enhancing signal. Corning delay lines can be cut to the exact time delays dictated by television standards and the particular circuit used. Custom delay modules that incorporate all associated circuitry are also available.

**Time Multiplex Operation of Digital Glass Memories.** A 1-page note explains how Corning high-speed digital glass memories can be used in slower digital systems by multiplexing several data channels into a single memory. This slightly increases circuit complexity but reduces per-bit storage cost and saves power, size and weight, the note says.

**MI CONTACT,** Issue 11 (E). Published by Marconi Instruments Ltd., St. Albans, Herts., England. Inquiries to Amalgamated Wireless (A'asia) Ltd., P.O. Box 96, North Ryde, N.S.W. 2113. Contents include: Canada orders TF 2002AS signal generator; Precision microwave castings; Improved demonstration facilities with new mobile unit; Gilt-edged confidence in Q measurement; Versatile RC oscillator; Wide-band detector; Universal slotted-line system; PCM testing; An even better deal in inductor analysis.

**NEW DEVELOPMENTS,** issue BO43, June 1969. Published by Jacoby, Mitchell and Co. Pty. Ltd., 469-475 Kent Street, Sydney, 2000. Contents: Advance timer counters; Siliconix IC differential amplifier; Bell and Howell pressure transducer; Lionmount universal bridge; Tecnica output power meter; Telonic microwave signal samplers; Telonic VSWR measurement system; Sefram two-channel recorder; Weinschel RF ratio meter; Medistor calibrators and converters; Wiltron transmission text set; Shinkoh tension meter; Alfred variable attenuators.

### Inventors' Journal

We have received a specimen copy of "Inventus," the journal of the Inventors' Association of Australia Ltd. Membership of the association is open to anyone interested in the development of Australia through inventions. Contributions are invited on patents, trademark, design and copyright law or practice, or on the development of inventions. Editorial inquiries and contributions should be addressed to The Editors, Box 3400, G.P.O., Sydney, 2001.

The contents of the specimen included: Foreword, by the national president of the association; Head Office Reports; Sir William Hudson K.B.E., F.R.S., Engineer Extraordinary; The Inventors — a proposed new TV series; Design and the Inventor, by D. G. Terry; Illustrious Inventions of Australian Farmers and Engineers, by Frances Wheelhouse; Sebel Design Award Exhibitor, J. Facchin; New International Patent Treaty under Study; Industrial Research and Development Grant; Midwife to Industry Innovations, by Tony Osman; Sam Ruben, Born to Invent; Technical News.

# Got a housing problem?

## LET'S HEAR ABOUT IT

We can house your instruments in any size or shape of cabinet you need.

Aladdin can supply a whole range of beautifully modern Imhof racks, cases and consoles in a whole range of standard or custom-built styles. Attractive Imhof handles in a variety of styles and finishes.

Imlok framework for cases can be ordered already assembled or delivered ready for easy self-assembly.

Next time you've got a housing problem, call us: Aladdin Industries. We'll put you in good shape.

## IMLOK & IMHOF

# Aladdin

INDUSTRIES PTY. LTD.  
43 Bridge Road, Stanmore.  
2048. Phone 51-2826.

688

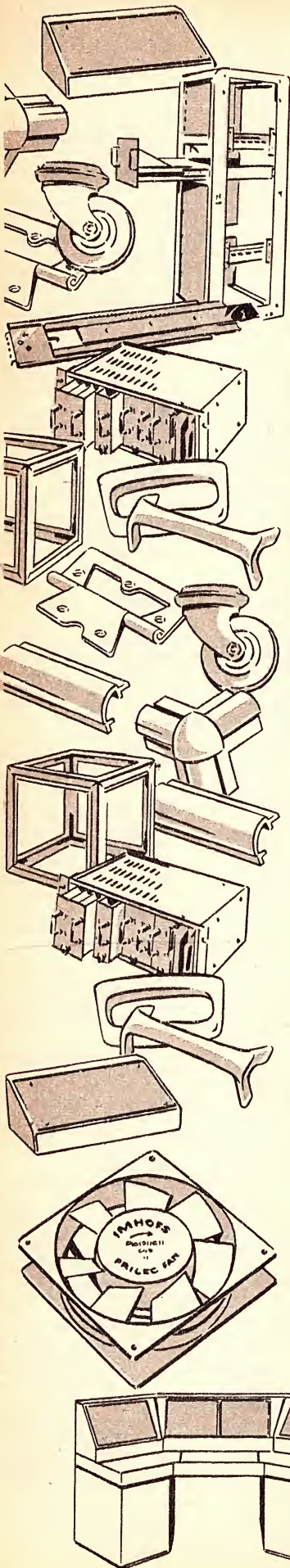



**AUGER ELECTRON SPECTROMETER.** Published by Varian Vacuum Division, Palo Alto, Calif., U.S.A. Inquiries to Varian Pty. Ltd., 38 Oxley Street, Crows Nest, N.S.W. 2065. A 12-page brochure describes the history and operation of Auger spectrometry, and gives applications and details of the Varian instrument. Specifications and drawings of the chief components are included. Auger spectroscopy is a non-destructive technique for identifying surface atoms of a substance.

**INSIDE INFORMATION, No. 2, Dec. 1968.** Published by Marconi Instruments Ltd., St. Albans, Herts., England. Inquiries to Amalgamated Wireless (A'asia) Ltd., P.O. Box 96, North Ryde, N.S.W. 2113. Contents: Servicing Guide to AM Signal Generators Type TF801D and Series — an account of easy testing methods, modifications, general fault finding and correction procedures; Modification Kits TF801D/3M1; Repair Notes TF801 Series and TF2330; Change Notes.

**VARIAN PTY. LTD., 38 Oxley Street, Crows Nest, N.S.W. 2065.** The Varian Statos 3, an 8-channel electrostatic recorder, is described in an 8-page brochure published by the Varian Electrographics Division, Palo Alto, California, U.S.A. The brochure includes system description, principles of operation, a specimen chart, specifications, and a description of accessories and optional equipment.

**A2A VIDEO TRANSMISSION SYSTEM ALIGNMENT,** Hewlett-Packard Application Note 114. Published by Hewlett-Packard Co., Palo Alto, Calif., U.S.A. This 3-page note describes the alignment of A2A local television video loop equalisers and the equipment necessary for doing the job. It discusses the characteristics of coaxial cable losses and the kinds of equalisation needed to compensate video signals for cable losses. Procedures used in aligning the equalisers are described. The note describes the test equipment traditionally used for making alignments and how all necessary functions are combined in a single test oscillator designed specifically for this function. Inquiries to Hewlett-Packard Australia Pty. Ltd., 22-26 Weir Street, Glen Iris, Vic. 3146.

**PUBLICATIONS OF THE NATIONAL BUREAU OF STANDARDS 1966-1967,** by Betty L. Oberholzer. National Bureau of Standards Special Publication 305 issued April, 1969, 213 pages, \$2 (U.S.). Orders to Superintendent of Documents, U.S. Government Printing Office, Washington, D.C. 20402, U.S.A. All published work by N.B.S. authors from mid-1966 to the end of 1967, both in publications issued by N.B.S. itself and in outside publications, is covered in this supplement to the N.B.S. catalogue. Each title is accompanied by complete bibliographic information, plus a list of key-words and an abstract, both prepared by the authors. Information in the catalogue is accessible through two indices: an author index and a key-word index. In addition, there is information on the N.B.S. publishing program, purchase procedures, publication announcement services, and price lists.

N.B.S. publications prior to July 1, 1966 are catalogued in the following: publications of the N.B.S. from 1901 to June 30, 1947 in N.B.S. Circular 460 (\$1.25); from July 1, 1947 to June 30, 1957 in Supplement to N.B.S. Circular 460 (\$1.50); from July 1, 1957 to June 30, 1960 in N.B.S. Miscellaneous Publication 240 (\$2.25); from July 1, 1960 to June 30, 1966 in Supplement to N.B.S. Miscellaneous Publication 240 (\$4). All remittances must be in U.S. exchange and include an additional quarter of the price to cover mailing costs.

**TELECOMMUNICATION JOURNAL,** Vol. 36, No. 6, June 1969. Published by the International Telecommunication Union (I.T.U.), Place des Nations, 1211 Geneva 20, Switzerland. Contents: Part

## Course on Video Communications

The Division of Postgraduate Extension Studies of the University of New South Wales is to present a course on "Video Signals in Communication." The course is of 10 one-hour lectures over Radio University VL2UV and two television seminars over Television University VITU. The course, which commences in late August, is one of a series of courses on communications being presented by the Division and designed to train people in the compilation of information for transmittal by any method.

The fee for "Video Signals in Com-

munication" is \$7, which may be tax deductible. This fee includes the cost of the comprehensive notes which are essential for an understanding of the lectures. Tape recordings of the lectures are available where a group wishes to enrol, or for people beyond the range of the radio broadcasts. The fee for this service is \$21, and three sets of notes are supplied. Further information on this and other courses can be obtained from the Division of Postgraduate Extension Studies, P.O. Box 1, Kensington, N.S.W. 2033, or phone 663-0351, extension 2691.

two of an article by W. J. Fijakowski on "Considerations on the types and essential features of telecommunication technique training establishments set up with Special Fund assistance"; "The acquisition and use of ionospheric data for prediction and other practical applications" by W. R. Piggott; and "Multichannel transmission by tropospheric scatter" by R. Freeman.

The section on Union activities includes reports on the opening meeting of the I.T.U. Administrative Council, the Intelsat Conference which met earlier this year, and a meeting of C.C.I.T.T. Study Group III on general tariff principles. Under the heading "Ideas and Achievements" are described the meteorological satellite Nimbus-3 and a method of computer simulation of semiconductor devices.

**ELMEASCO INSTRUMENTS PTY. LTD., P.O. Box 334, Brookvale, N.S.W. 2100.** An application note, No. 691, describes in detail how a Hewlett-Packard HP8614A Signal Generator can be used in conjunction with a Frequency Engineering Laboratories series 130A Frequency Stabiliser to generate signals with stability and purity normally associated with synthesizers. The stability of the combination is said to be 1 part in  $10^8$  per second or 1 part in  $10^7$  per day over a range of 1.0 to 2.4GHz.

**HIGH-POWER PULSE TWTS.** Published by Varian TWT Division, Palo Alto, Calif., U.S.A. Inquiries to Varian Pty. Ltd., 38 Oxley Street, Crows Nest, N.S.W. 2065. A 10-page brochure describes Varian's line of high-power pulse travelling wave tubes, which cover the 0.5 to 16.5GHz frequency range. The TWTS are typically used as drivers or output tubes in radar, data transmission, etc. The brochure lists performance data, includes a section on applications, and is illustrated with power/frequency curves.

**RELIABILITY REPORTS, June 1969.** Published by National Semiconductor Corporation, Santa Clara, California, U.S.A. Australian distributors are Rutherford Electronics Pty. Ltd., 833 Doncaster Road, Doncaster, Victoria 3108.

**Transfer Mold Encapsulation.** Describes the results of various combinations of possible materials under environmental and life testing conditions. A complete description and step-by-step flow chart of moulded encapsulation process is given. Quality control and production screening are explained. Also described are future plans for moulded packages in continuing reliability programs, new product qualifications, step stress testing, and ultimate military qualifications.

**Linear Integrated Circuits.** Includes results of testing on the LM100 voltage regulator, LM101 operational amplifier, LM102 voltage follower, LM103 regulator diode, LM105 voltage regulator, LM709 operational amplifier, and LM710 voltage comparator. A total of over 850,000 device life test hours at 125 deg. C. is reported. The discussion also covers production processing, quality control, seal environmental and life testing.

**THE NATIONAL ANTHEM, No. 1.** Published by National Semiconductor Corporation, Santa Clara, Calif., U.S.A. A new publication on IC applications. Contents: Higher fidelity op amp — describing an indiscreet, low-current, low-drift operational amplifier; Hong Kong vs La Jolla — how one IC and one FET equal a 24-transistor broadcast receiver; Two ways to save battery power — using a matched pair of positive and negative voltage regulators; One-upmanship in op amps — using a 20K pot to balance a LM101's offset. Australian agents are Rutherford Electronics Pty. Ltd., 833 Doncaster Road, Doncaster, Vic. 3108. ■

## TEL-LEIGH-TUBES PTY. LTD.

(SYDNEY and MELBOURNE)

Manufacturers of premium grade T.V. picture tubes at competitive prices.

### GUARANTEE

**TWO YEARS** written guarantee on all picture tubes at no extra cost.

### DELIVERY:

**FREE** daily delivery service around Sydney and Melbourne. Daily despatches to interstate and country areas.

SYDNEY:

TEL-LEIGH-TUBES PTY. LTD.

(Reg'd Office)

51 REUSS ST., LEICHHARDT.  
N.S.W. 2040. 56-8498

MELBOURNE:

TEL-LEIGH-TUBES PTY. LTD.

32-34 GRAHAM RD, HIGHETT  
VIC., 3190. 95-4086



# University

## Diode Protected, General Purpose Multimeters

COMPLETE WITH TEST LEADS, BATTERIES & INSTRUCTIONS

- AS USED IN
- GENERAL INDUSTRY
  - RADIO & TV SERVICING
  - LABORATORIES
  - MOTOR GARAGES & BOATSHEDS
- WORKSHOPS
  - HOBBYIST
  - COLLEGES & UNIVERSITIES

All backed by "UNIVERSITY" sales, spare parts and 24-hour repair service

MODEL MVA-4 (20,000 ohms/volt)



Price \$14.50  
+15% Sales Tax

**SPECIFICATIONS:**

- D.C.V. : 2.5-10-50-250-1000 (20 K $\Omega$ /V)
- A.C.V. : 2.5-10-50-250-1000 ( 8 K $\Omega$ /V)
- D.C.A. : 50  $\mu$ A-2.5 mA-25 mA-250 mA
- Ohms : 10K-100K-1M-10M
- db : -20/0/+22,+22/+36
- Accuracy :  $\pm$  3% for D.C.  $\pm$  4% for A.C.
- Battery : 3 x 1.5 V
- Size : 6" x 4-3/16" x 2 1/8"
- Weight : 1.34 lbs.
- Optional Extra : Leather case
- Features : Diode overload protection, Multicolour scale, Engraved front panel, 90 day Guarantee.

**SPECIFICATIONS:**

- D.C.V. : 5-25-50-250-500-2.5K (20K $\Omega$ /V)
- A.C.V. : 10-50-100-500-1000 (10K $\Omega$ /V)
- D.C.A. : 50  $\mu$ A-2.5 mA-250 mA
- Ohms : 0.6K — 6M
- db : -20/0/+22
- Accuracy :  $\pm$  3% for D.C.  $\pm$  4% for A.C.
- Battery : 1 x 1.5V
- Size : 4 1/2" x 3 1/2" x 1 1/8"
- Weight : 10 oz.
- Optional Extra : Leather case
- Features : Diode overload protection, Multicolour scale, Engraved front panel, 90 day Guarantee.

MODEL MVA-5 (20,000 ohms/volts)



Price \$10.00  
+15% Sales Tax

MODEL MVA-100 (100,000 ohms/volt)



Price \$35.00  
+15% Sales Tax

**SPECIFICATIONS:**

- D.C.V. : 0.5-2.5-10-50-250-500-1000 (100K $\Omega$ /V)
- A.C.V. : 2.5-10-50-250-1000
- D.C.A. : 10  $\mu$ A-250  $\mu$ A-2.5 mA-25 mA-250 mA-10A
- A.C.A. : 0-10A
- Ohms : 20K-200K-2M-200M
- db : -20/0/+62
- Accuracy :  $\pm$  3% for D.C.  $\pm$  4% for A.C.
- Battery : 2 x 1.5V + 1 x 22.5V
- Size : 7" x 54" x 3"
- Weight : 3 lbs.
- Optional Extra : Leather Case
- Features : Mirror scale, Diode overload protection, multicolour scale, spring loaded shock resistant movement, engraved front panel, 90 day guarantee.

For further information on "University" Multimeters and test equipment, fill in the form supplied and mail it to University Graham Instruments Pty. Ltd.  
All test equipment can be inspected at

## University Graham Instruments Pty. Ltd.

106 Belmore Road, Riverwood, N.S.W., 2210.  
Telephones: 53-8758, 53-0644 (5 lines).  
Telegrams and Cables, Raqup, Sydney.  
or at  
Victoria: Eastern Instrument and Electronic Service Pty. Ltd.  
3 Carroll Cres. Glen Iris, Melb., Vic. 3164.  
Phone: 20-6953.

**REPRESENTATIVES:**

W.A.: Atkins (W.A.) Ltd.,  
894 Hay Street,  
PERTH, W.A. 6000.  
TAS.: W. P. Martin and Company,  
202 Argyle Street,  
HOBART, Tas. 7000.  
And 150 Wellington St.,  
LAUNCESTON, Tas. 7250.  
S.A.: Compar Distributors Pty.  
Ltd.,  
33 Market Street,  
ADELAIDE, S.A. 5000.

QLD.: Keith Percy & Co. Pty. Ltd.,  
Waterloo Street,  
NEWSTEAD, Bris. Qld. 4006.  
N.Z.: Alluin Electrical Co. Ltd.,  
21 Liverpool Street,  
AUCKLAND, N.Z.  
NEWCASTLE DIS.:  
Hunter Engineering Sales Pty. Ltd.,  
Chr. Gordon Avenue and  
Parry Street, Hamilton,  
NEWCASTLE, N.S.W. 2303.  
Phone 61-4321.

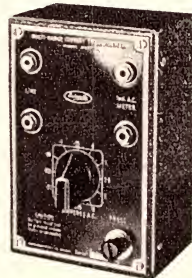

Current Transformer



Heavy Duty Shunt

The A.C. and D.C. Current Ranges of the above multimeters can be extended, with the use of "University" shunts and multi-range current transformers.

Please forward to:—

Mr .....

of .....

.....

information on "University" Multimeters and Test Equipment.





# AMATEUR BAND NEWS AND NOTES

## IARU Regional Conference

The eighth triennial International Amateur Radio Union Region I Division Conference was held between May 5 and May 9 this year in Brussels, Belgium.

by Pierce Healy, VK2APQ

Previous conferences had been held in Paris, Lausanne, Stresa, Bad Godesburg, Folkestone, Malmo and Opatija. This year in Brussels, 20 of the 34 subscribing member societies were represented by delegates and a further seven by proxy.

Also in attendance as observers were the president of the A.R.R.L./I.A.R.U., R. Denniston; the Secretary of I.A.R.U., J. Huntoon; the Secretary of Region II, G. Reusens, OA4AV; and the Treasurer of Region II, N. Eaton, T. Robinson and G. Lander were present as observers from the International Amateur Radio Club.

The societies and countries represented were:

|           |            |          |             |
|-----------|------------|----------|-------------|
| A.R.A.    | Algeria    | P.Z.K.   | Poland      |
| A.R.A.I.  | Ivory Cst. | R.A.L.   | Lebanon.    |
| A.R.I.    | Italy      | R.E.F.   | France      |
| A.R.M.    | Monaco     | R.L.     | Lux'burg    |
| C.R.C.C.  | Czech'kia  | R.S.F.   | U.S.S.R.    |
| D.A.R.C.  | Germany    | R.S.R.   | Rhodesia    |
| E.D.R.    | Denmark    | R.S.G.B. | Unit. King. |
| F.R.A.    | Faroes     | S.R.A.L. | Finland     |
| I.R.T.S.  | Ireland    | S.R.J.   | Yugoslavia  |
| M.A.R.S.  | Malta      | S.S.A.   | Sweden      |
| N.A.R.S.  | Nigeria    | U.B.A.   | Belgium     |
| N.R.R.L.  | Norway     | U.R.E.   | Spain       |
| Oe.V.S.V. | Austria    | U.S.K.A. | Switzerland |
|           | V.E.R.O.N. |          | Netherlands |

The conference was held in the Hotel Metropole, located in the centre of Brussels. One of the leading hotels of the city, the Metropole can provide accommodation for up to 500 visitors. The rooms that were provided for the meetings of Conference Committees ensured excellent working conditions.

It is interesting to note that in 1911 the Conseil de Physique Solvay held a meeting in the Metropole and the distinguished gathering included such names as Madame Curie, Planck and Einstein.

Opening Ceremony: The conference was opened at 10 a.m. on Monday, May 5, 1969, by Mr P. C. Bouchier, Director-General of Radio Communications of the R.T.T. of Belgium. He spoke of his interest in the activities of radio amateurs, saying that they formed a valuable part of the world of radio communication. He urged amateurs to take part in scientific aspects in addition to establishing long-distance contacts.

The following persons were also present at the opening ceremony. Mr Grainson, representing the Minister of P.T.T.; Messrs van den Bulke, Vermeylen and Dierickx, representing the Central Committee of the Red Cross of Belgium; Lt.-Col. Debruyne, representing the communications service of the Gendarmerie; and Mr Pixon, repre-

sending the Mayor of Brussels.

The chair at the opening ceremony was taken by Lt.-Col. P.-A. Kinnman in his capacity as chairman of the executive committee. An appreciation of the attendance and interest of Mr Bouchier was given by Roy F. Stevens.

First Plenary Meeting: At this meeting, held after the conclusion of the opening ceremony, Mr Per-Anders Kinnman paid tribute to the work of the late John Clarricoats, G6CL, the secretary of the Region I Division, and called for one minute's silence in his memory. Mr Kinnman outlined the purpose of the work of the Conference and expressed his appreciation for the preparatory tasks that had already been carried out.

The Conference secretary read a greeting from the South Africa Radio League and a letter from Mr J. Znidarsic, YU1AA, a member of the Executive Committee, who was unable to be present owing to illness.

It was announced that during the week before the Conference the Mauritius Amateur Radio Society had joined the Region I Division. This brings the number of subscribing member societies to 34.

The chairman then called for nominations for the office of chairman and secretary of the various committees. The following were elected: —

Administrative and Operational:  
 Chairman W. J. L. Dalmijn PA0DD  
 Secretary Roy F. Stevens G2BVN

VHF:  
 Chairman C. J. van Dijk PA0QC  
 Secretary F. G. Lambeth G2AIW

Credentials and Finance:  
 Chairman N. Caws G3BVG  
 Secretary

(ex officio) Roy F. Stevens G2BVN

Messrs E. G. Ingram (R.S.G.B.), U. A. Kluge (D.A.R.C.), F. Stoffel (Oe.V.S.V.), and L. Vercruyse (U.B.A.) were elected to serve on the Credentials and Finance committee.

The meeting then considered proposals concerning the election of the Executive Committee which were adopted. A. Deschodt, ON4AK, was nominated as chairman of the Election Committee.

Social events: Immediately after the opening ceremony the visiting authorities were invited by the president of U.B.A., Mr Deschodt, to a reception in the Hotel Metropole. During the reception Mr Bouchier was presented with a specially bound volume of the R.S.G.B. "Radio Communications Handbook."

During the evening of Monday, May 5th, a reception was held in the Martini Club on the 29th floor of a modern building a short distance from the Hotel Metropole. During the course of the reception the members of the Executive Committee and national delegations were introduced to representatives of the sec-

tions of the U.B.A. On the following evening (Tuesday) a reception was held in the Hotel de Ville (Town Hall) of Brussels. After the reception the visitors were shown through the magnificent rooms of this famous building.

During the afternoon and evening of Thursday, May 8th, delegates and ladies participated in a visit to the historic town of Bruges. The visit, which was organised by the local section of the U.B.A., was made by coach and included a journey along the canals of the city which is known as the Venice of the North.

The End of Conference Dinner was held in the magnificent ballroom of the Hotel Metropole. During the evening, Mr Deschodt, president of U.B.A., spoke of the valuable work which had been accomplished during the previous days and expressed the hope that the visitors had enjoyed their stay in Belgium.

Replying, Mr P. A. Kinnman thanked the U.B.A. for their hospitality, for their organisation of the conference itself and of the social functions and ladies' program. He expressed the hope that delegates to the conference would promote greater activity in I.A.R.U. affairs from their respective national societies.

Committee Meetings: Meetings of the Administrative and Operational Committee (whose terms of reference include matters relating to the bands below 30MHz) and the VHF Committee were held during the afternoon of Monday May 5 and throughout the mornings and afternoons of the next two days. In addition meetings took place of two ad hoc working groups concerning Foxhunting (hidden transmitters) and HF Contests. A meeting of the Credentials and Finance Committee was held on May 5.

Executive Committee:  
 At the final Plenary Meeting the members of the Executive Committee were elected as follows:

Chairman, Per-Anders Kinnman SM5ZD  
 Vice-chairman, A. Jacob F3FA  
 Secretary, R. F. Stevens G2BVN  
 Treasurer, W. J. L. Dalmijn PA0DD  
 Members, J. Znidarsic YU1AA; H. Picolin DL3NE.

The members of the Executive Committee will continue in their offices until June 15, 1972. The Committee meets at least once a year, and the venue for 1970 will probably be in the Netherlands.

Next Conference: The delegation of C.R.C.C., Czechoslovakia, offered the hospitality of their society for the next conference in 1972. This offer was accepted with acclamation.

Points from the discussions: Andre Jacob, F3FA, president of R.E.F., was elected vice-chairman of the Executive Committee. He replaces Roy F. Stevens G2BVN, who now assumes the duties of secretary of the Region I Division.

The former annual contribution made by Region I Societies of 75 Sw. centimes per licensed member was reduced to 60 Sw. centimes. This move reflects the healthy financial state of the Division.

The implications of the forthcoming Space Conference were considered and methods of representation discussed. A co-ordinated approach will be made by all Region I societies for the extension of amateur space communication facilities.

The R.S.F. of the U.S.S.R. believe that their authorities will agree to launch a

News and notes of Divisional and Club activities submitted for inclusion in these columns should be forwarded direct to Pierce Healy, 69 Taylor St., Bankstown, N.S.W. 2200.



satellite carrying amateur radio equipment.

The I.A.R.U. Region I booklet "Amateur Radio" has been published in English and French editions. Information about amateur radio to developing countries will be conveyed by articles, radio programs and films.

The activities of all societies with an Intruder Watch are to be co-ordinated by the R.S.G.B. The I.T.U. will again be asked to give approval to the Region I Intruder Watch Organisation.

The next conference will be held in Czechoslovakia during 1972.

Revised rules for European Foxhunting Championships were agreed.

A group of 12 societies expressed a desire to co-operate in the development of emergency networks. The R.S.G.B. will act as convener of this group.

Band Plan — portions between 3500-KHz-3510KHz and 3790KHz-3800KHz are to be used exclusively for inter-continental working.

The World-wide Amateur Beacon Plan of D.A.R.C. was approved. This calls for co-ordination in the setting up of beacon stations and the evaluation of results.

HF Contests — an annual Region I I.A.R.U. Contest will be held. This will replace a national contest in each year.

An agreement was reached to further amateur radio interests among handi-capped persons.

VHF-UHF Band Plan: Amendments to this were agreed.

VHF-UHF-SHF Contests: Alterations and additions were made to existing arrangements.

VHF-UHF Certificates: The A.R.R.L. D.X.C.C. list will be used as a basis for claims. Certificates shall be issued on the basis of a signed declaration by a QSL Manager or Traffic Manager.

The Region I Bulletin is to be continued. Articles in languages, other than English, will be welcome.

This report on the Region I Confer-

ence was received from Roy F. Stevens, G2BVN, to whom due acknowledgment is given and appreciation is expressed.

#### REGION I SOCIETIES

The following statistical information on the societies forming the Region I Division was also received with the report on the conference.

These figures appear to show that in European countries particularly, considerable effort is made to encourage the interest of the younger generation in radio and electronics; also, to urge non-licen-sees to become members of their national societies.

| Country       | Society National | Lic'd Mem-bers | Total Mem-bers |
|---------------|------------------|----------------|----------------|
| Algeria       | A.R.A.           | 26             | —              |
| Ivory Coast   | A.R.A.I.         | 25             | —              |
| Italy         | A.R.I.           | 2,500          | 4,000          |
| Monaco        | A.R.M.           | 19             | 22             |
| Cyprus        | C.A.R.S.         | 14             | —              |
| Bulgaria      | C.R.C.B.         | 406            | —              |
| Czech'vakia   | C.R.C.C.         | 1,970          | —              |
| Germany       | D.A.R.C.         | 11,599         | 19,705         |
| Denmark       | E.D.R.           | 2,857          | 3,900          |
| Faroes        | F.R.A.           | 55             | 100            |
| Ghana         | G.A.R.S.         | 45             | —              |
| Ireland       | I.R.T.S.         | 196            | 308            |
| Malta         | M.A.R.S.         | 16             | 44             |
| Mauritius     | M.A.R.S.         | 44             | 86             |
| Nigeria       | N.A.R.S.         | 12             | 41             |
| Norway        | N.R.R.L.         | 1,220          | 1,484          |
| Austria       | Oe.V.S.V.        | 1,174          | —              |
| Poland        | P.Z.K.           | 2,141          | —              |
| Greece        | R.A.A.G.         | 70             | 200            |
| Lebanon       | R.A.L.           | 50             | 50             |
| France        | R.E.F.           | 2,807          | 6,512          |
| Portugal      | R.E.P.           | 250            | —              |
| Luxemburg     | R.L.             | 87             | 134            |
| East Africa   | R.S.E.A.         | 50             | 113            |
| U.S.S.R.      | R.S.F.           | 5,008          | 114,000        |
| Great Britain | R.S.G.B.         | 7,836          | 15,260         |
| Rhodesia      | R.S.R.           | 133            | 209            |
| Finland       | S.R.A.L.         | 2,000          | 2,232          |
| Yugoslavia    | S.R.J.           | 5,200          | 30,000         |

|             |            |       |       |
|-------------|------------|-------|-------|
| Sweden      | S.S.A.     | 2,361 | 2,867 |
| Belgium     | U.B.A.     | 800   | 1,200 |
| Spain       | U.R.E.     | 1,068 | 2,500 |
| Switzerland | U.S.K.A.   | 750   | 1,413 |
| Holland     | V.E.R.O.N. | 1,299 | 2,900 |

#### NEW ZEALAND CONVENTION

The Annual Conference of the New Zealand Association of Radio Transmitters was held at Gisborne on Saturday, May 31, 1969. Present as guest of the Association was Michael Owen, VK3KI, Federal President of the Wireless Institute of Australia, who, after thanking the association for the invitation, pointed out that he owed his presence at the conference to the resignation of John Battrick, VK3OR as W.I.A. president. He noted that the Association's own president had decided not to stand for re-election this year, and pointed out that the Region III Congress might not have come about but for the dedication of these two men.

Michael referred to the similar situations which exist in Australia and N.Z. in the organisation of amateur radio, in which organisation depended on government regulations, administered in Australia by the P.M.G.'s Department. This system tended to be affected by the personalities of individual administrators, but was preferable to a quasi-judicial system, such as the Federal Communications Commission in the U.S.A., with its "legalistic rule-making procedures." Long-term security lay in the existence of strong national radio societies, such as N.Z.A.R.T. and W.I.A. It was a temptation to solve problems relating to amateur activity by making new regulations: The W.I.A. had a strong distaste for such a solution and sought for less rather than for more regulations.

A recent survey in Australia had shown that 52.3 per cent of all Australian amateurs use mainly home-made equipment, 30.6 per cent use mainly commercial equipment, and 16.2 per cent use



**We're armed  
to meet your  
design,  
development,  
testing and  
production times for  
transformers and coils**

**TELECOMPONENTS**

PTY. LTD.  
(A DIVISION OF FERRIS INDUSTRIES LTD.)

Head Office and Factories—Brookvale, N.S.W. 93-0221.  
Melbourne: 387-1899. Brisbane: 68-4344.  
Adelaide: 57-8153.





half and half. The percentage of commercial gear varied between states, the maximum being 39 per cent in W.A. and the minimum 19.3 per cent in S.A. It was expected that amateurs would spend around \$560,000 this year on their hobby, about \$132 each. Because of import restriction, it appeared that there was a higher percentage of home-made equipment in use in N.Z.

Dealing with the "Australis" project, Michael pointed out that the project, initiated by university students and sponsored by the W.I.A., is one of only two satellites built in Australia. The other was "WRESAT," produced by the Weapons Research Establishment largely from imported components. "Australis" was built entirely from Australian-made components. At one time it looked as though the project would fail because of difficulties in obtaining space on a suitable vehicle, but it now appeared likely that the satellite would go into orbit in 1969 after all. Since it was likely that very short notice would be given of launching, those interested in receiving its signals should be prepared.

On the subject of the I.A.R.U. Region III Association, Michael said: "It gives me great pleasure to tell you, as the president of the society that is presently providing the Secretariat, that the Interim Constitution proposed by the Secretariat following the Sydney Congress has now been accepted by three out of the four societies concerned. The fourth society, the Philippines, has already indicated that it would have no objection to the incorporation of the amendments proposed to the first draft. This means we are now confident that, within a matter of weeks, the I.A.R.U. Region III Association will come into formal existence.

"I have no doubt that your overseas liaison officer will tell you that we have gone perhaps a little further in formulating a detailed Constitution than was expected by the delegates at the Congress in Sydney. Perhaps this is true. May I assure you of two things:

"Firstly, the Federal Executive reached the conclusion after a most careful examination of the problem, that a formal Constitution was an absolute essential, to establish procedural validity of what we did, to enable funds to be transferred from one country to another, and to establish a framework within which we can work.

"Remember, no 'Club' can exist except by virtue of its own rules.

"Secondly, in propounding an Interim Constitution, we did not intend, as the Wireless Institute, in any way to impose ideas that represented the ideas of the

Institute only on the other societies involved. What we intended to do was to follow as precisely as we could, the somewhat broad decisions of the congress, inserting such additional detail as was necessary. I believe that the document that has now been accepted achieves this. If the first draft constitution submitted did not, then this was the fault of the drafter, not the Wireless Institute of Australia.

"The significance of the adoption of this Constitution is considerable; it represents for the first time a precisely formulated agreement within the region—it is a great step forward to say that this soon after the initial meeting of our societies in Sydney in 1968, we have a formal association with detailed formal rules."

The difficulties of the adoption of a final constitution should not be under-rated, and considerable divergence of opinion had been revealed in correspondence to the secretariat. There were few organisations more constitution-conscious than amateur organisations, and the W.I.A. had devoted an unreasonable amount of time to its constitutional problems.

He continued. "Let us, in Region III, not devote a disproportionate part of our time and energy to our Constitution. The Constitution is only a framework. An organisation with the best constitution in the world cannot succeed without the right men both as its members and as its leaders. Organisations are people, not rules. Let us look to people not words. Let us do a workmanlike job with our own Constitution, but let us not distort the importance of it."

Other points from Michael's speech are summarised below:

In view of the strong chance of an I.T.U. Conference in 1970 or 1971, there should be a meeting to decide what the association could do for Region III. Although regarded in Australia as one of the most important developments in amateur radio in recent years, the scheme could easily fail. The support of the N.Z.A.R.T. and other societies in the region would achieve more for the protection of frequencies than any other means.

The possibilities of greater co-operation between the N.Z.A.R.T. and the W.I.A. had been discussed, and looked promising. The two organisations, and the J.A.R.L., were among the few really significant national amateur radio societies in the region, and must be prepared to take the responsibility of leadership in the region. Mutual understanding was essential, and this could not be achieved without personal contact.

## WIRELESS INSTITUTE ACTIVITIES

Plans are well in hand for the celebration in 1970 by members of the W.I.A. of the arrival of Captain James Cook off the East Coast of Australia in 1770, also the Diamond Jubilee of the formation of the Institute. Details of the proposed activities will be publicised as soon as arrangements have been finalised.

### NEW SOUTH WALES

The refurbishing and re-equipping of the divisional transmitting station VK2WI at Dural is going ahead. At the time these notes were being compiled, plans were being finalised to transfer the news broadcasts each Sunday to the Communications Centre at the Wireless Institute Centre, 14 Atchison Street, Crows Nest.

### VHF News

The Mid-Winter Field Day Contest, the rules of which appeared in the June issue, was an outstanding success, with stations operating on all frequencies, including ATV. At various times stations were heard operating portable from mountain tops, mobile, aeronautical

mobile, mobile marine as well as from home-based locations. Details of the results will be included next month.

### Hunter Branch

John Lake, of Mullard-Australia, was the guest lecturer at the June meeting of the Hunter Branch. John described and demonstrated several DC-to-DC power supplies and control systems using solid-state devices.

Each member of the large audience of branch members and visitors was handed a comprehensive brochure outlining the power supplies and other devices described. The lecturer treated the subject in a workmanlike and practical manner and was accorded a hearty vote of thanks by all present.

### Central Coast Branch

Despite bad weather, there was a good roll up of members at the June meeting of the Central Coast Branch. The recommendation by the management committee that the normal monthly meetings of the branch would be devoted to lectures and demonstrations on technical aspects

(Continued on page 169)

## up to ten times longer life



MAXELL Alkaline Dry Cell — this unique new design concept features high capacity and durability that surpasses the performance of the world's top dry cell batteries. The construction of the Maxell Alkaline Dry Cell differs greatly from conventional types of carbon ZINC cells. However, the Maxell Alkaline cells can be used where you normally use a carbon ZINC cell. MAXELL ALKALINE CELLS are especially suitable where there is a demand for increased current, combined with durability and little voltage drop. Even near the end of the cell life the discharge capacity is large and stabilized.

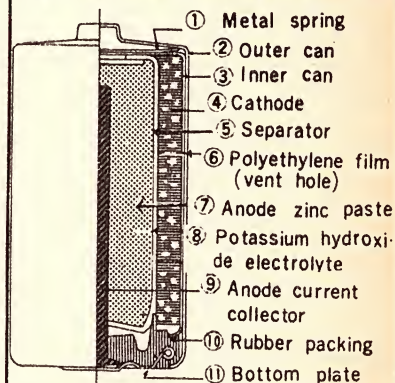

Exclusive new construction minimises leakage. Double cans are used and rubber sealing with the unique spring safety device. (see diagram)

Interior drying is prevented by hermetic sealing, therefore long storage periods are possible (over two years). Even then Maxell Alkaline cells are in the same condition as when they left the production line. These cells will withstand severe temperature changes. Rigid tests have shown extremely stabilized capacities from the low temperature of -4F to the high temperature of 150F at which temperatures dry cells would fail to operate satisfactorily.

### Prices:

AM1 ..... 75c

AM2 ..... 50c

AM3 ..... 40c

Trade enquiries to

TASMANEX PTY. LTD.

17 Parker Street SYDNEY 2000



**D**ESPITE the initial reservations felt by many people, particularly with reference to servicing, the printed circuit is now firmly established in most types of electronic equipment, ranging from the incredibly cheap pocket radios that have flooded the country in recent years, to some of the most sophisticated professional equipment available. Its origins lie in weaponry — a heritage unfortunately common to many good "electronic" ideas, but printed circuitry is, and indeed has been for some time, an attractive system for the amateur who constructs his own equipment, for it solves the mechanical problems of component mounting and eliminates the chores of wiring — as well as facilitating a neat and workmanlike job. For the amateur who has so far shied away from etching his own boards, a new system is now available, which is both economical and easy to use, yet with care, is capable of excellent results. Known as **Cir-kit**, the system utilises bakelite boards, similar to those used commercially, in conjunction with self-adhesive copper strip. This is 1/16in or 1/8in wide — easily cut with scissors or a model knife — and attaches to the boards rather like a piece of Sellotape. The adhesive is very efficient, although the bond is not quite as good as that on pre-laminated boards — which means that care is needed when soldering not to overheat the copper. However, anyone who is competent to solder a transistor or capacitor without causing damage should have no trouble, and the adhesive improves with aging, so that long-term stability is satisfactory. Layouts can normally be planned using the theoretical circuit diagram as a guide, and boards may be pre-punched or drilled according to requirements. With the pre-punched board, the strip can either be laid over the holes, and then punched through with a small drill or a watchmaker's screwdriver, or it can be laid alongside the holes and component leads are inserted through the board, folded over and soldered (see photo). The former method permits a more compact layout.

A few tips on planning layouts. Always be sure that the component spaces you allocate are adequate — it is preferable to purchase the bits before embarking on this task, although capacitors are available in literally dozens of shapes for board mounting and resistors are more or less of standard size, dependent on ratings. Avoid siting adjacently on to your layout components which are in different stages — as this can lead to instability. If instability does occur, of course, **Cir-kit** does permit alterations to be made, although it is as well to investigate the problem before redesigning sections of the board for it may not prove necessary.

The excellence of the system, however, lies in its versatility, for it enables the home constructor to produce a wiring board on a one-off basis for most of the circuits described in this and other journals, and while it will no doubt encourage many to "try their hand," it will also enable many who already build their own equipment to achieve neater, more reliable results with a minimum of fuss.

**AVAILABLE ALL LEADING  
RADIO HOUSES.**

(SOLE AGENT)



**ZEPHYR PRODUCTS PTY. LTD.**  
70 BATESFORD ROAD, CHADSTONE, VICTORIA—PHONE 56-7231  
**MANUFACTURERS OF RADIO & ELECTRICAL EQUIPMENT & COMPONENTS**

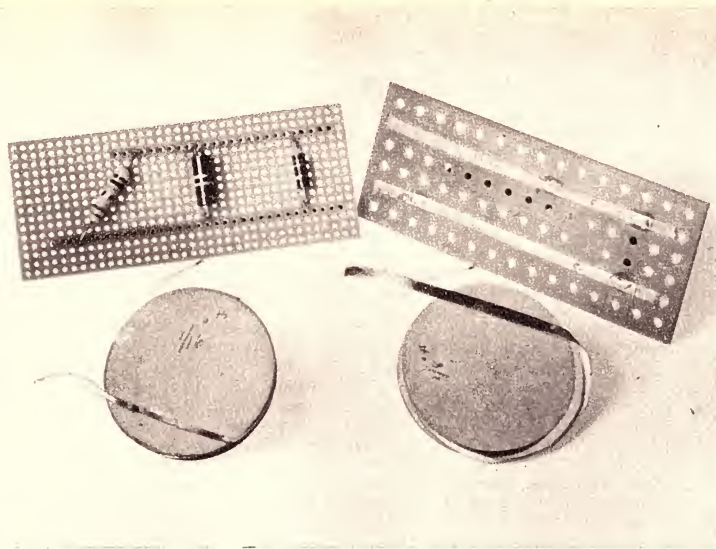

# INSTANT CIRCUITS

**A new method of making component boards using self-adhesive copper strip.**

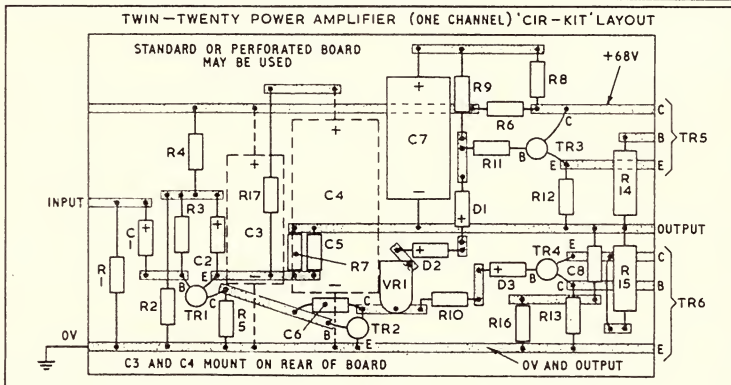
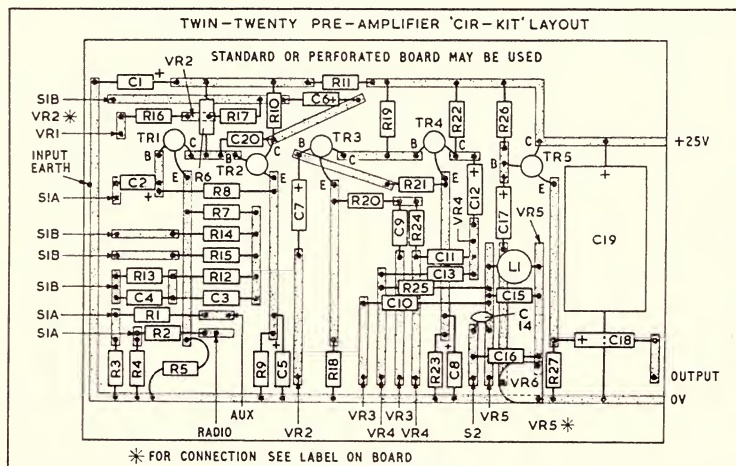







# Deitron

# ELECTRONICS

4-6 TAYLOR ST., TAYLOR SQUARE, DARLINGHURST, N.S.W., 2010

### FERRITE RODS



| Round Type      | Flat Type             |
|-----------------|-----------------------|
| 100 x 8mm .90   | 4 x 15 x 140mm \$1.25 |
| 120 x 8mm 1.00  | 4 x 12 x 140mm \$1.00 |
| 120 x 10mm 1.00 | 5 x 13 x 55mm 90c     |
| 140 x 10mm 1.15 | 5-13 x 60mm 90c       |
| 160 x 10mm 1.25 | 5-14 x 50mm 90c       |
| 180 x 10mm 1.40 |                       |
| 200 x 10mm 1.60 |                       |

All Ferrites come with BC coil windings.

### MINIATURE CAPACITORS



|                 |                 |
|-----------------|-----------------|
| 2 mf 10vw 11c   | .001 100v . 8c  |
| 5 mf 10vw 12c   | .002 100v . 8c  |
| 10 mf 10vw 13c  | .005 100v . 8c  |
| 25 mf 10vw 14c  | .01 100v . 8c   |
| 30 mf 10vw 15c  | .02 100v . 8c   |
| 50 mf 10vw 17c  | .047 100v . 10c |
| 100 mf 10vw 18c | .1 100v . 15c   |
| 200 mf 10vw 20c | .2 100v . 18c   |

### MINIATURE RESISTORS



|                          |        |
|--------------------------|--------|
| 1 ohm—10 meg ohm 1/4w 5% | 8c ea. |
| 1 ohm—1 meg ohm 1/4w 5%  | 6c ea. |
| 1 ohm—1 meg ohm 1/4w 5%  | 6c ea. |

### SPEAKERS



| Round Magnet      | Square Magnet Special |
|-------------------|-----------------------|
| 2" 8 ohm 1.50     | 2 1/2" 8 ohm 1.40     |
| 2 1/2" 8 ohm 1.60 | 2 3/4" 8 ohm 1.50     |
| 2 3/4" 8 ohm 1.80 |                       |
| 3" 8 ohm 2.00     |                       |
| 3 1/2" 8 ohm 2.25 |                       |
| 3 3/4" 8 ohm 2.50 |                       |
| 4" 8 ohm 3.00     |                       |

### CASSETTE TAPES



|                     |        |
|---------------------|--------|
| C-60 (2 x 30 mins)  | \$1.75 |
| C-90 (2 x 45 mins)  | \$2.75 |
| C-120 (2 x 60 mins) | \$3.00 |

### CARTRIDGES



|                       |        |
|-----------------------|--------|
| BSR TC8 Mono XTAL     | \$4.50 |
| BSR TC8 Stereo XTAL   | \$6.90 |
| BSR X1 Mono Ceramic   | \$4.50 |
| BSR C1 Stereo Ceramic | \$6.90 |
| Ronette Mono XTAL     | \$4.50 |
| Ronette Stereo XTAL   | \$6.90 |
| Sonotone 9TA Stereo   | \$6.90 |
| Japanese Mono XTAL    | \$3.80 |
| Japanese Stereo XTAL  | \$5.50 |
| CAC—Stereo Magnetic   | \$9.00 |

### STEREO HEADPHONES



8 ohm. 100-15000Hz.  
\$9.00

### PLASTIC CABINETS



|                                           |        |
|-------------------------------------------|--------|
| Drawers Size L5 1/2" x W2 1/4" x D1 1/4". |        |
| STM12A 12 Drawers, 12 1/2" x 5 1/2" x 6"  | \$5.90 |
| STM16A 16 Drawers, 12 1/2" x 7 1/4" x 6"  | \$7.10 |
| STM24A 24 Drawers, 12 1/2" x 10 1/2" x 6" | \$9.50 |

### CAR ANTENNAS



|                                        |        |
|----------------------------------------|--------|
| Telescopic Lock Down 5 Section, 3' 4"  | \$4.50 |
| Telescopic Lock Down 5 Section, 4' 10" | \$6.00 |
| Telescopic Cowl Mount 3 Section        | \$4.00 |

### THIS MONTH'S SPECIALS

|                             |         |
|-----------------------------|---------|
| 10mm x 10mm IF Transformers | \$1.00  |
| 7mm x 7mm IF Transformers   | \$1.00  |
| 10mm x 10mm OSC COIL        | \$1.00  |
| 7mm x 7mm OSC COIL          | \$1.00  |
| PVC-2 20mm x 20mm PVC GANG  | \$2.00  |
| 5K Standard switch pot      | 30c     |
| 2N2160 UNIJUNCTION          | \$1.40  |
| 2N3646 TRANSISTORS          | 50c     |
| 2N3638 TRANSISTORS          | 60c     |
| 2N3638A TRANSISTORS         | 70c     |
| 2SB101 TRANSISTORS          | \$1.00  |
| 2SB29 TRANSISTORS           | \$1.00  |
| OA91 DIODES                 | 18c     |
| OA202 DIODES                | 45c     |
| 1N914 DIODES                | 20c     |
| 1N4001 100 PIV 1A DIODES    | 25c     |
| EM404 400PIV DIODES         | 30c     |
| MB101 100 PIV 2A BRIDGE     | \$1.50  |
| SD40D TRIAC                 | \$5.00  |
| C106F1 SCR                  | \$1.25  |
| 8 mf 250V CAPACITOR         | 25c     |
| 400 mf 40V CAPACITORS       | 45c     |
| 6GW8 VALVE                  | \$1.50  |
| 6V4 VALVE                   | \$1.00  |
| 6BQ5 VALVE                  | \$1.30  |
| 6EA8 VALVE                  | \$1.30  |
| 12AX7 VALVE                 | \$1.30  |
| 6BM8                        | \$1.50  |
| 12PX SPEAKERS               | \$20.00 |

### REPAIRS

REPAIRS TO ALL BRANDS. RADIO, TAPE RECORDERS, RECORD PLAYERS, TRANSISTOR, T.V. etc.

### TRADE ENQUIRIES

TELEPHONE: 31-5430.

**ALL POSTAGE FREE THIS MONTH ONLY**



# SPACE COMMUNICATIONS CONFERENCE

The Administrative Council of the International Telecommunication Union which met on May 3 in Geneva, and completed its work on May 23, decided that a World Administrative Radio Conference for Space Telecommunications should open in Geneva on June 7, 1971, and last about six weeks.

The agenda will be the following:

To consider, revise and supplement as necessary, existing administrative and technical provisions of the Radio Regulations and adopt, as necessary, new provisions for radiocommunication services, insofar as they use space radio techniques, including those for manned space vehicles, and for the radio-astronomy service, so as to ensure the efficient use of the spectrum.

To consider, revise and supplement, as necessary, the radio regulations to provide for the use of space radio techniques by the aeronautical mobile and maritime mobile services, for communication as well as for radio-determination purposes.

To consider, revise and supplement as necessary, the existing table of radio frequency allocations in the radio regulations for radio-communication services, insofar as they may use space radio techniques, and the radio-astronomy service.

To consider, revise and supplement as necessary, the existing provisions pertaining to the technical criteria and the procedures for frequency sharing between space and terrestrial services, and to establish technical criteria and the proced-

ures for frequency sharing between space systems.

To consider the feasibility at this time of co-ordinated frequency planning for radio-communication satellites including those placed on the geo-stationary orbit, and to take such action as is deemed appropriate.

To make only such consequential changes to the radio regulations as are essential for the effective implementation of the decisions of the conference.

To adopt such resolutions and such recommendations related to the foregoing, as may be necessary.

## Technical co-operation

The council also decided to re-organise the Technical Co-operation Department on a regional basis. The existing Operations and Technical Divisions will be replaced by three Area Divisions each responsible for a geographical region: Africa, the Americas and Euro-Asia. As a result of this new organisation, the planning, programming and implementation of a project will become the responsibility of a single division.

of radio was adopted. At intervals of approximately three meetings there will be general business discussions and a short lecture by a branch member. In between these business meetings the running of the branch will be the responsibility of the committee.

A visitor to the meeting was Tim Mills, VK2ZTM. Tim gave an interesting resume on the current development in the establishment of VHF repeaters in N.S.W.

The feature lecture of the evening was given by Ross Moody, VK2ZRQ, his subject being Fox Hunting. Ross outlined the varied equipment that could be used in a vehicle and some of the techniques that could assist in locating the hidden transmitter.

The branch is looking for radio enthusiasts of any age group who may be interested in lectures and demonstrations that would assist them in preparing for the P.M.G.'s examination for the Amateur Operator's Certificate of Proficiency. This certificate qualifies the holder to be issued with his amateur operator's call sign and to operate his station on the amateur bands. Those interested should contact the Branch Secretary, D. Maitland, 3 Albury Road, Gosford, 2250.

## Illawarra Branch

At the June meeting of the Illawarra Branch, Grahame Dowse, VK2AGV, gave an interesting talk on his 6-metre transmitter. This is a well designed and constructed piece of solid-state equipment.

It is reported that the most intrepid contestant in the Mid-Winter VHF Field Day was Grahame, who sailed out to sea to operate maritime mobile off the Wollongong coast line. Unfortunately, Grahame was not as good a sailor as he is an amateur operator. The result was that the amount of breakfast lost exceeded the contacts made. An early return was made and a change made to land type mobile operation. His fellow Branch members say he should receive a prize for trying.

## VICTORIA

The Annual Dinner of the Victorian Division will be held on September 24th. Bookings may be made by contacting the Secretary at the Institute Rooms, 478

Victoria Parade, East Melbourne, or P.O. Box 36, East Melbourne, 3002. Vic. (Phone 41-3535).

## Geelong Radio and Electronic Society

The Geelong Radio and Electronic Society's Club Rooms were officially opened on Saturday June 28 by Councillor Reynolds, president of the South Barwon Shire Council. More than 200 people were present. Also present as official guests were: Councillor Wood, Mayor of Geelong; Michael Owen, VK3KI, Federal President, W.I.A. and Keith Roget, VK3YQ, President of the Victorian Division W.I.A.

All visitors were welcomed by the Vice-president Harry Michael, VK3ASI and Bill Erwin, VK3WE president of the Geelong Radio and Electronic Society. Bill Erwin gave a brief history of the society during the past six years. Three years ago the society moved into a disused migrant hostel owned by the council, and has spent \$1,200 renovating the building.

Councillor Reynolds, who opened the club rooms by cutting the traditional ribbon, praised the work that members of the society had done on the building.

VK2ANR, the Geelong Radio and Electronic Society club station, operates on both the HF and VHF bands.

## YOUTH RADIO SCHEME

### NEW SOUTH WALES

The 1968 Institution of Radio and Electronics Engineers Pennant Award for the most successful Y.R.S. Club was presented to Camp Technology at the 12th National Convention of I.R.E.E. Australia. The Convention was held in the Wentworth Hotel, Sydney, in May 1969.

Camp Technology is held each year at Mount Victoria in the Blue Mountains during the Christmas-New Year school holiday period.

Thirty-one clubs have registered with the N.S.W. Division of the Y.R.C.S. Among these are two girls' radio clubs, East Hills Girl's High and Canterbury City Ranger Guides, in England.

News broadcasts for Y.R.C.S. members are made on the third Friday of each

# "OXFORD"



## RADIO CHASSIS



## INSTRUMENT CASES



## MINI BOXES "ALUMINIUM"



All printed and engraved panels for "Electronics Aust.", Mullard "Outlook," Philips "Digest."



Any special metalwork and panel engraving to specification.



All stock cases and chassis from our distributors in Brisbane, Melbourne, Adelaide.

## HEATING SYSTEMS PTY. LTD.

24 O'Riordan St.,  
ALEXANDRIA, N.S.W.  
2015.  
69-3764 - 69-7616



# Advance TC8

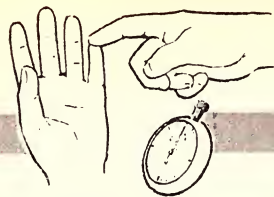

## modular *Timer Counter* system

- Maximum versatility in frequency and time measurement
- Frequency capability up to 500 MHz

**Display Modules.** In-line display by bright, clear, end view neon number tubes with a choice of 4 to 7 digits. Also alternative models with storage.

**Internal Frequency Standard.** A choice of four standard oscillators, depending upon accuracy and resolution required. X7 10 MHz fast warm up crystal in a proportionally controlled oven. Set to an accuracy of 1 part in  $10^7$  at 25° C. Stability  $\pm 1$  in  $10^7$  from + 10° C. to + 40° C. and  $\pm 3$  in  $10^7$  from 0° C. X8 High Stability 10 MHz crystal in proportionally controlled oven. Set to  $\pm 2$  parts in  $10^9$  before despatch. Frequency within 1 part in  $10^7$  within one hour. Temperature coefficient less than  $\pm 5$  in  $10^{10}$  per ° C. from 0° C. to + 40° C.

**External Frequency Standard** may be employed.

**Time Base Modules.** TB1 to TB3 for 100 kHz Standard and maximum gate times of 1, 10 or 100 seconds • TB4 to TB6 for 1 MHz Standard and maxi-

imum gate times of 1, 10 or 100 seconds • TB7 to TB9 for 10 MHz Standard and maximum gate times of 1, 10 or 100 seconds. **Input Modules** P1 input unit. Max. input freq. 1 MHz. P2 input unit with sensitivity control. Freq. range 2 Hz to 15 MHz. P3 input unit with variable trigger level. Freq. range DC to 10 MHz. AC coupled 10 Hz to 10 MHz. P4 2 Hz to 150 MHz. P5 2 Hz to 500 MHz.

**Standard Systems.** TC81—15 MHz 5 digit freq. meter and ratiometer with 1 MHz 1 part in  $10^6$  standard. TC82—10 MHz 6 digit freq. meter with 10 MHz 1 part in  $10^7$  fast warm up standard. TC83—As TC82 but with 7 digit stored display. TC84—150 MHz 7 digit stored display freq. meter with 10 MHz 1 part in  $10^7$  fast warm up standard. TC85—500 MHz 7 digit stored display freq. meter with 10 MHz 1 part in  $10^7$  fast warm up standard. TC86—as TC85 with high accuracy freq. standard.

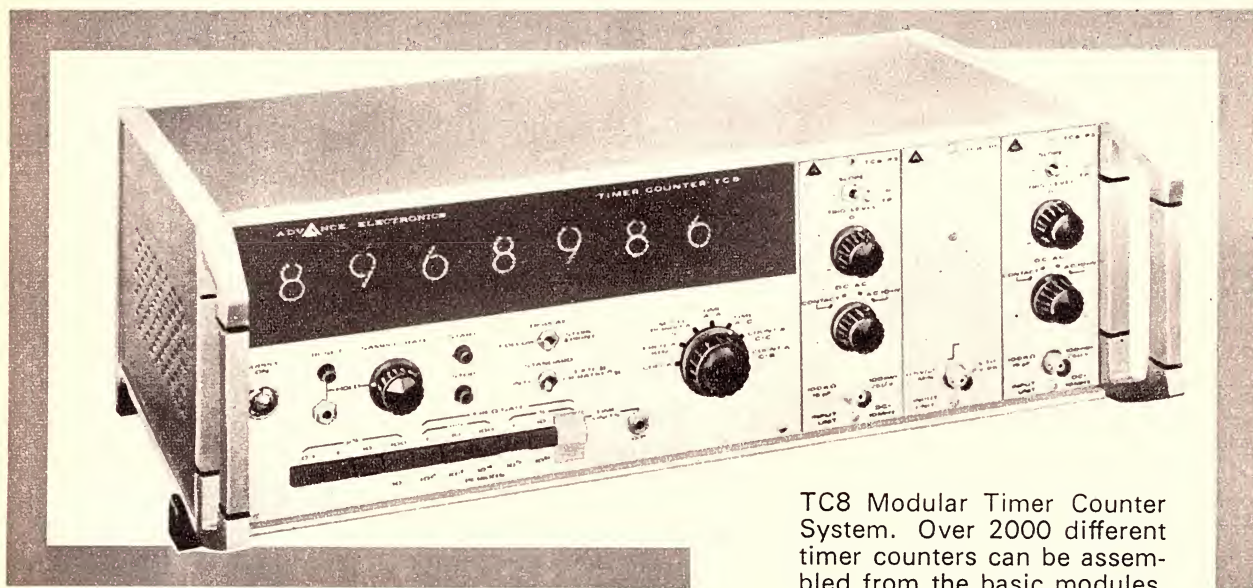

TC8 Modular Timer Counter System. Over 2000 different timer counters can be assembled from the basic modules.



Distributed by—

## jacoby, mitchell & co. pty. ltd.

469-475 Kent Street, Sydney. 26-2651

MELBOURNE  
30-2491/2

ADELAIDE  
53-6117

BRISBANE  
2-6467

PERTH  
28-1102

LAUNCESTON  
2-5322



month from the Wireless Institute Centre, Crows Nest. Transmission commences at 7.30 p.m. on a frequency of 3595KHz under the call sign VK2AWI.

Club news to be included in the broadcast should reach the Secretary on the Thursday prior to the broadcast.

#### Kyeemagh Sea Scouts Radio Club.

In the June issue of these notes, details were given of this progressive club. Since then 4 years' work has been completely disrupted. This has been brought about by vandals, who caused very considerable damage to the Scout Hall and stole all the radio equipment. The incident received wide publicity in the local Press and through W.I.A. broadcasts.

The radio equipment has since been recovered after being dumped on a Sydney beach. Fortunately it had suffered only minor damage. However facilities for club meetings are now non-existent, but it is hoped that alternative premises in the area will be offered to the club.

#### Westlakes Radio Club

From the June issue of the Westlakes Radio Club's monthly newsletter comes this interesting piece of news — "Another of our members still at school has his call-sign. Ken Cunningham, of New Lambton, a fifth-former at Newcastle Boys' High School, is now VK2ZKC. This is the call-sign Ken asked for and he was lucky enough to receive it. He is now busy with the soldering iron and side cutters, getting ready for his first 'C.Q.'"

"Once again the club is out in front with an additional name that can be added to the large list of those who have gained the A.O.C.P. while still at school. This all began at this club with Ian Forrest, VK2AJF, who was the first schoolboy in Australia ever to have gained the A.O.C.P. He gained the licence in 1961, shortly after Rex Black and Ken Mattei started the movement which has made all these things possible, The Youth Radio Club Scheme of the Wireless Institute of Australia.

There is even more excellent news. Barry Finlay and Phillip Brown have been awarded the Intermediate Radio Certificate of the Scheme, giving the club one-third of all these awards which have been issued. In addition, Paul Lorentzen, a first-class short-wave listener, gained a credit pass in the Junior Radio Certificate. It was a very good month for our Club."

The first "Broadcast Ten Award" issued by the Club has been made to Paul Lorentzen of Blackalls Park. To gain the award, acknowledgment of reports are required from four stations in New South Wales, three from other States, one from each island of New Zealand and one from an overseas location. Paul submitted QSL cards from the following stations: N.S.W.; 2DU Dubbo; 2GZ Orange; 2XL Cooma; 2MO Gunnedah; 2VM Moree. Other States: 3TR Sale; 4BC Brisbane; 5RM Berri. New Zealand: 2YA Wellington; 3YZ Greymouth. Overseas: Radio Moscow, U.S.S.R., on 1475KHz.

This effort is very praiseworthy, as only an ordinary domestic dual-wave receiver was used, with no RF stage. Paul will receive his certificate at the July meeting of the Hunter Branch of the W.I.A. together with an incentive prize for his achievement.

The Broadcast Ten Award may be claimed by any person, club member or not. For non-members there is a charge of 75 cents for the certificate.

A lecture on safety and artificial respiration methods was given at the Club on Saturday, May 24, by Mr C. Mahon of the Shortland County Council. Mr Mahon, who took along the latest demonstration equipment for the teaching of the expired air method of lifesaving, gave his talk to a capacity audience in the Club.

Club members were most grateful to Mr Mahon who gave his Saturday after-

noon to lecture on this most important subject.

Candidates for Y.R.C.S. Certificates are required to be familiar with the safety precautions to be observed when using equipment connected to the power mains, and examination questions are asked on the subject. The club has made a knowledge of the methods outlined in the lecture a requirement for all examination candidates.

Full details of the club's activities may be obtained by writing to the Secretary, Bruce Morley, VK2ZNB, P.O. Box 1, Teralba, N.S.W., 2284, or phone Newcastle 59-1667.

#### Maitland Radio Club

The first class to be held in the district for the production of home-made printed circuits was held by the Maitland Radio Club. Fourteen members attended the lecture by the instructor, Bob Thompson of East Maitland. As the class progresses members will construct their own printed circuit boards and assemble a two-transistor amplifier.

Many members have been busy on the building work associated with the club's building. Recently the guttering and draining were completed, as were also the lining and sound proofing of the communications room and the installation of work benches.

During the past month a considerable quantity of radio equipment was donated to the club. Included was a 45ft collapsible tower which will be erected at the club headquarters at Maize Street, East Maitland.

On Friday, June 20, Sgt. E. V. Cahill, of the Maitland Police, presented certificates to seven members. Sgt. Cahill congratulated the club on its progress and said it was doing in the community a form of national service. He outlined how radio amateurs had assisted the police during the severe 1949 and 1955 floods in the Maitland area.

He emphasised that there was a need for people with a knowledge of radio in the telecommunications services as well as other services such as the police and industries.

Elementary Y.R.S. Certificates were presented to:

K. Gromley; D. Cross; G. Wenham; R. Digby; K. Haviland; N. Hawryluck Jnr. and N. Hawryluck senior.

Club member Bob Winston of Cessnock, who passed the P.M.G. Amateur Operators Limited Certificate of Proficiency examination last February, has been allocated the call-sign VK2ZRW and can be contacted when operating mobile on the 146MHz net frequency.

Further information on the club can be obtained by writing to the Secretary, Box 54 P.O., East Maitland, N.S.W. 2323, or by phoning Maitland 33-7286 (STD 049).

#### SOUTH AUSTRALIA

The office-bearers of the W.I.A. Youth Radio Club Scheme — South Australian Division are as follows: —

State Supervisor: Bob Cuthberlet VK5OD  
State Secretary: Allen Dunn, VK5FD  
W.I.A., Y.R.C.S. Liaison

Officer: John Allan, VK5UL  
Club Representative —

Country: Lloyd Douglas,  
Port Augusta Youth Radio Club.

Club Representative —  
Metropolitan: Steven Johnston,  
Elizabeth Amateur Radio Club.

These officers are the Executive Committee who will be responsible for the operation of the Y.R.C.S. in South Australia for the next 12 months. The appointments were made at the annual general meeting which was held at Elizabeth on Saturday, June 7, 1969.

At this meeting each year, Youth Radio Club leaders, gather to discuss matters of common interest in the running of

(Continued on page 172)

## BRIGHT STAR CRYSTALS

PREFERRED BY LEADING MANUFACTURERS  
THROUGHOUT THE COUNTRY FOR —

**ACCURACY - STABILITY - ACTIVITY - OUTPUT**



All types of Crystals Available  
Such as DC11, FT 243 HC6U CRA  
B7G, HC18U, ETC.

TOLERANCES: .0015%, .002%,  
.003%, .005% ETC.

Consult us for Crystals for any Mobile Radio.  
Prices depend on tolerance and frequency  
required.

DISCOUNT FOR QUANTITY ORDERS

Established 36 Years



AMATEUR AIRCRAFT and ULTRASONIC CRYSTALS also AVAILABLE

Our new Factory employing the most modern equipment  
allows us to offer you PROMPT DELIVERY for all your  
CRYSTAL requirements.

DEVOTED EXCLUSIVELY TO THE MANUFACTURE OF

### PIEZO ELECTRIC CRYSTALS

Contractors to Federal and State Government Departments

REPRESENTATIVES AUSTRALIA AND NEW ZEALAND: Messrs. CARREL & CARREL  
BOX 2102, AUCKLAND.

MESSRS ATKINS (W.A.) LTD.,  
894 Hay Street, PERTH.  
MESSRS. A. E. HAROLD PTY. LTD.,  
123-125 Charlotte Street, BRISBANE.

MESSRS LAWRENCE & HANSEN  
ELECTRICAL (VIC.) PTY. LTD.,  
34 Brisbane Street, HOBART,  
and 29 St. John Street,  
LAUNCESTON, TASMANIA.

## BRIGHT STAR RADIO

546-5076

LOT 6 EILEEN ROAD, CLAYTON, VICTORIA

546-5076



# TUDOR RADIO

L. E. CHAPMAN  
ESTABLISHED 1940

103 ENMORE ROAD, ENMORE, N.S.W.  
PHONE 51-1011

Knobs long shaft, push on. Dozen \$1.20  
Knobs for concentric shaft. Dozen \$1.20  
250 mixed screws. BA, Whit., self-tapper  
bolts, nuts, etc. \$1 bag plus 25c post.  
Crystal microphones, good quality, ideal  
tape recorders, etc. \$2.80.  
Transistor speaker transformers, single  
ended, 5 watt. \$1.50.  
Pick up shielded Wire —15 cents yard.

## SPEAKERS

MSP 8-inch dual cone . . . \$6.50  
MSP 12-inch dual cone . . . \$8.50  
MSP 7 x 5 15 ohm . . . \$4.00  
MSP 3½-inch 3 ohm . . . \$2.00  
Rola 6 x 4 15 ohm . . . \$3.50  
Rola 5 x 3 15 or 27 ohm . . . \$2.50  
Rola 5B 3 ohm . . . \$2.00  
MSP 6 x 9 15 ohm . . . \$5.00  
3-inch single cone 15 ohm . . . \$4.20  
6 x 4 33 ohm . . . \$3.00  
MSP 20 Watt . . . \$19.75  
MSP 12-inch 8 ohm . . . \$8.50  
MSP 2-inch 15 ohm . . . \$2.00  
MSP 8-inch dual cone, 8 ohm . . . \$6.50  
MSP 12-inch-3.5 ohm . . . \$6.00  
MSP 4-inch large magnet  
8 ohm . . . \$2.50  
MSP 3-inch 150 ohm . . . \$2.50  
MSP 3-inch 15 ohm . . . \$3.00  
National 8-inch built-in tweeter  
and crossover network . . . \$14.75  
MSP Electro Dynamic, 8in, \$4, or 6 x 9.  
MSP 6 x 2 15 ohm, \$3.  
MSP 6 x 4 15 ohm, \$3.50.  
Peak 607 16 cm Hi-Fi  
Dual Tone 6in . . . \$7.50  
MSP 20-watt radial beam 12pqb \$21.50  
Magnavox 8 ohm 4in tweeter . . . \$2.50  
2 gang tuning condenser . . . \$1.00



**RADIOGRAM CHASSIS** 4 valve including valves and speaker, \$15.50. Size 10½ x 3 x 5.



## SMALL 2-GANG TUNING CONDENSERS

Complete with direct drive scale \$1.75  
TV IF STRIPS . . . \$5 each.  
**ENGLISH PANEL LAMP** with toggle switch 75 cents.

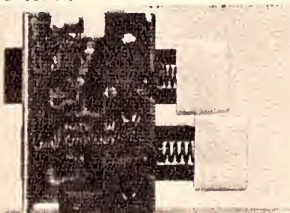

English push-button on/off switches, 75c each. Pack and post 10c.

Vinyl insulating tubing, 13MM wall thickness .030, 25 yards . . . \$1  
Mini cable, 4 strand shielded, lots of uses, including microphone cable, extension speakers etc. . . . 10c yard  
Radio knobs, push on . . . 50c doz.

Miniature valve sockets 7 and 9 pin 15 cents each.  
Speaker Crossover network Condensers 2 MFD — 60 cents.  
Philips IFT's 455KC . . . . . 75c each  
Aerial and oscillator coils . . . 50c each  
Scope soldering iron, standard; mini scope. Scope De Luxe. Vibra scope; National scope transformer.

Transistor IFs, medium size, 75c each  
Record Changers, Garrard 3000. \$35  
**RECORD CHANGERS, B.S.R. UA70. \$40.00. MA75 \$50.00.**

**PORTABLE RADIOGRAM CASES, NEW, SHOPSOILED** . . . \$4  
Pack and Post, 50 cents.

Transistor speaker and drive transformers, large and midget type . . . \$1.00  
Speaker transformers 15,000 and 25,000 to 3 ohms 6 watts . . . \$1.50 each  
5,000 to 3 and 15 ohms . . . \$1.25 each  
Transistor speaker chokes \$1.50 each  
Here's value in pots.

Pots, single log and linear:  
3K, 7½K, 10K, W.W., 20K, 25K, 50K, 100K, 200K, 250K, 500K, 1 Meg, 2 Meg. Dual Concentric Switch Pot \$1.25

Pots 25,000 dual ganged switch pots, \$1.25  
1.5 Meg. Dual Concentric . . . \$1.00  
Pots dual ganged 10K, 50c. 1 Meg. \$1.25

Pots concentric. 100K + 50K, 100K + 2½K, 100K + 10K, 250K + 250K, 500K + 500K, 1 Meg + 1 Meg, 1 Meg + 500K. Various others 2 Meg . . . . . 50c each  
TV power Transformers 300 mill 225v a side, suit amplifiers up to 50 watts voltage doublers available, \$8.00 each  
TV safety glass per sheet . . . \$3.50  
Garrard plug in stereo heads . . . \$4.00  
TV masks, 17, 21, 23in . . . \$1.50 each  
Tuning condensers 2 and 3 gang \$1.00



## STEREO AMPLIFIER KIT SETS

TU 10, 3.5 watt per channel . . . \$19  
TU 11, 3.5 watt per channel, has facilities for tape and microphone channels . . . \$23  
TU 12, 5 watt per channel . . . \$22.00  
TU 13, 5 watt per channel, with TU 11 facilities . . . \$27  
Each kit set includes valves and all components. Front face plate, if required, \$1 extra.  
Single stage amplifier kit set:  
5 watt per channel . . . \$22.00  
Transistor ear plugs . . . 3 for \$1.00  
Tag strips, mixed types . . . Dozen, 60c  
Switches, oak 4 position . . . 50c each  
2 position . . . . . 40c each

½ and ¼ AMP. FUSES \$3.50 100.

Din Plugs, 3 or 5 pin . . . 50c each.

Ceiling Speaker Baffle, suit 5in or 6in Speaker . . . . . \$2.50

Utilux H168 Double contact Holders . . . . . 20c each

Elip Sal. 2-pin, 10 amp, 240 volt plug sockets . . . . . 25c each

## ELECTROS:

3 in one  
50 250 415  
8 350 415  
10 350 415  
75 cents each.



Metal Rectifier . . . . . \$1 each

## TV AERIALS Famous Make

All types \$3.50 to \$20.00 plus post.  
TV aerial lead in . . . . . 10c yard  
Tuning Condensers, 2 gang or 3 gang —\$1 each.

2 amp fuses . . . . . \$3.50 per 100  
Special, 12in speaker, 2 ohm Rola, \$6.00 pack and post, 75c.

Transistor plastic outer case, 50c each  
Transistor carrying straps . . . 20c each  
Stereo pick-up arms, with Xtal, \$6.00 ea.  
Metal rectifiers for battery and electric portables . . . . . 50c each, post 10c

Pilot lamp holders . . . . . 60c per doz.  
TV or cabinet castors . . . 4 for \$1.00  
100 Mixed Knobs including TV channel changers . . . . . \$10.00

240v AC Record Changers, stereo \$21.50, Mono \$20.00. Pack and post, N.S.W. \$1.50, interstate \$2.50.

Gramophone motor and pick-up, 240v AC \$11.50. Pack and post, N.S.W. \$1.00, interstate \$1.50.

OA 70 diodes . . . . . 40c ea.  
Morganite and IRC resistors. At least 33 values. Suit transistors, radios, TV etc., \$2.00 per 100. Pack and post, 25c.

3, 5, and 10 Watt IRC wire wound resistors. Many values.  
20c each, 12 for \$2.00

100 mixed condensers, micas, ceramics, tubular. Fresh stock.  
\$2.00. Pack and post 25c.

50 + 24, 350 vw + 100 mf 25 vw, 75c each  
30, 30mf 300 vw 350vp . . . 75c each  
Many others. Invaluable for service.

**SHEPHERD CASTORS, \$3.00 set of 4.**  
**SMALL AMPLIFIER OR TUNER CHASSIS, \$1.50 each.** Pack and post 25c.

**ALPHA 200VAC ¼ amp push-on switches, 30c each.** Ideal for fridges.  
90 deg. **PICTURE TUBE SOCKETS** 25c each. 152 valve sockets, 25c each.

Transistors AC127, 2N384, 2N217, 2N218, OC71, OC75.  
\$1.00 each. Post and pack 5c.

**THREE WATT AMPLIFIERS,** complete with speaker.  
**NEW. \$10.00.**

Electros 1.8 x 0.9 MF — 20c each  
**AUDIO TRANSFORMERS** 18-4294, 28-4536 . . . . . 75 cents each

**PILOT LIGHTS,** Plug in . . . 10 cents  
**SWITCH WAFERS** 20 cents each.

**R.C.A. plastic Tape Reels, 7 inch type EPR-7 — 85 cents each.**

**NEW GRAMOPHONE MOTORS,** For 4-speed Turntables . . . \$2.50 each

**TRANSISTOR speaker and Case, Plastic, 5-inch speaker with plug and lead, \$4 each.** Pack and Post 25 cents.



Stereo Head Phones, good quality \$9.75.



## NEW VALVES

|        |        |        |        |
|--------|--------|--------|--------|
| 12 AU7 | \$1.25 | SSJ7   | \$1.25 |
| 6SA7   | \$1.25 | 6BH5   | —      |
| 6BU8   | \$1.25 | 6D6    | \$2.00 |
| 6M5    | \$1.25 | EL33A  | \$2.00 |
| 6BM8   | \$1.50 | 6B4    | \$2.00 |
| 1S5    | \$1.00 | 17Z3   | \$1.50 |
| 1T4    | .50    | QVO4-7 | \$2.00 |
| 6CJ6   | \$1.50 | 1954   | \$2.00 |
| 6L18   | \$1.00 | 12AX4  | —      |
| ECL85  | \$1.25 | G.T.B. | \$1.50 |
| SP61   | \$1.00 | 9A8    | \$1.50 |
| UU9    | \$1.00 | 6W6    | \$1.50 |
| 12BE6  | \$1.00 | 6ACT   | —      |
| 6AU4   | \$1.25 | 12AN7  | \$1.25 |
| 6U9    | \$1.25 | 12AH8  | —      |
| 6Y9    | \$1.25 | 6ES6   | —      |
| 6X9    | \$1.25 | 6N7    | —      |
| 6AQ5   | \$1.25 | 6DA6   | —      |
| 1B3    | \$1.50 | 6CJ6   | \$1.50 |
| 1S2    | \$1.50 | 6T8A   | —      |
| 5AS4   | \$1.25 | UL84   | \$1.50 |
| 6DQ6   | \$1.50 | EL81   | \$1.50 |
| 12AT7  | \$1.25 | EF39   | —      |
| 12Ax7  | \$1.75 | 6CH5   | \$1.25 |
| 6B8    | \$1.25 | 17 BFH | \$1.50 |
| 6C H6  | —      | 6BX7   | \$1.25 |
| 6AU5   | —      | 12FR8  | \$1.00 |
| 6SL7   | —      | 6CK5   | \$1.25 |
| 6BW8   | —      | 3OAE3  | \$1.50 |
| 6DC8   | —      | 6AH4   | \$1.25 |
| 6CK6   | —      | UCL82  | \$2.00 |
| 6V9    | —      | 6JN8   | \$1.25 |
| 6BH8   | —      | EF41   | \$1.50 |
| 35W4   | —      | 50EH5  | \$1.50 |
| 6BC8   | —      | 6CD8   | \$1.25 |
| PCL81  | \$2.50 | 25Z5   | \$1.50 |
| 12AH8  | \$1.25 | UF 41  | \$1.50 |
| 6DC8   | —      | 7AN7   | \$1.50 |
| 6BN4   | —      | UF 41  | \$1.50 |
| PCL 83 | \$2.00 | 7AN7   | \$1.50 |
| 12FX8A | \$1.50 | X148   | \$1.50 |
| 6DS8   | \$1.25 | EY86   | \$1.50 |
| 9U8    | \$1.50 | 6BA8   | \$1.50 |
| ECH 42 | \$1.25 | PCC 85 | \$1.50 |
| 6ET6   | \$1.25 | 15A6   | \$1.50 |
| 1AR11  | \$2.50 | Z759   | \$1.50 |
| 6DJ8   | \$1.50 | EY 51  | —      |
| 7FC7   | \$1.50 | 1U4    | \$1.00 |
| UY 85  | \$1.50 | 6DB5   | \$1.25 |
| 12AQ5  | \$1.25 | PCF 80 | \$1.25 |
| 12AV6  | —      | 6S2    | \$1.25 |
| 6BD7   | \$1.25 | 23Z9   | \$1.50 |
| 6AM8   | —      | EF6    | \$1.25 |
| 6AT6   | —      | 6AM5   | \$1.25 |
| ECH35  | \$2.00 | EM85   | \$1.25 |
|        |        | EA50   | \$1.25 |



TV IF COILS, IDEAL FOR COIL FORMERS .. \$1 dozen



### SPEAKER CABINETS

|                                 |                |
|---------------------------------|----------------|
| 13 x 6 1/2                      | \$5.00         |
| 10 x 6 1/2 x 4 1/2              | \$3.50         |
| 12 1/2 x 8 1/2 x 6              | \$5.00         |
| Fuse holders                    | 50 cents dozen |
| Octal valve sockets             | 50 cents dozen |
| Chokes 18 Henry 30 mil.         | \$1.50         |
| M.S.P. 6in SPEAKERS, 3 or 15Ohm | \$4.00         |



TV PORTABLE voltage doubler power trans. C. Core. 240 volt 77V 1 amp. 6.3 Volts 8 amps, \$6.

DIAL DRUMS, 5 inch, 3 1/2, 3 3/4 50c ea.

NATIONAL SPEAKERS, 8 inch built-in Tweeter, Crossover network. \$14.75  
10 inch Bass, mid range Tweeter combined. \$32  
ELECTROS 20 MFD 200 P.V. — 20c



TV POWER TRANSFORMER, \$8.  
300 mil. Two 6.3 windings, 200 volt secondary for Bridge Type Rectifier.

50 M CHOKE \$1.  
Pack and Post 30 cents  
Interstate 60 cents.  
300M Choke \$2.50



VOLTAGE DOUBLER POWER TRANSFORMER. 200 mil 240 volt x 105-110 secondary 6.3V 15 amp. . \$8



BATTERY SAVER, 6 or 9 volt DC  
100MA \$8.50; 300 MA, \$10.00.



SPEAKER ENCLOSURE, complete with 8in M.S.P. dual-cone speaker, 8 or 15 ohm, \$15.80.  
Cabinet without speaker, \$10.  
Cabinet size 16 x 10 x 8.



TRANSISTOR IN EXTENSION SPEAKER. 5in cabinet, \$3.50

Tape Spools and Cassettes. American Tapes, 7/1800 — \$4.40.  
R.C.A. 5 1/2 1800 — \$5.60.  
R.C.A. 5 1/2 1200 — \$5.25.  
R.C.A. 5 1/2 900 — \$2.80.  
HANIMEX 3/225 — \$1.20.  
HANIMEX C60 Cassettes — \$3.40.  
HANIMEX C90 Cassettes — \$4.75  
BASF 5/900 — \$6.14.  
SONY 7/1200 — \$3.25.  
BASF 5 1/2 2400 — \$12.45.

### POTS

1 meg. Dual Ganged Log ..... \$1.25  
1 meg. Dual Ganged Lin ..... \$1.25  
1/2 meg. Switch Pot double pole log ..... 75c  
2 meg. Lin Pots ..... 50c  
R.C.A. 7 INCH TAPE SPOOLS 75 cents

### RECORD CHANGERS

B.S.R. UA25 ..... \$25.00

3 USED TRADED-IN B.S.R. RECORD CHANGERS

New cartridges ..... \$15.00

6 VOLT PILOT LIGHT, screw-in ..... ea. 10c

RESIN CORE SOLDER 5 yards 75c

H.M.V. TRANSISTOR AMPLIFIER AND SPEAKER

9 volt ..... \$15.00

15 INCH M.S.P. SPEAKERS.

Dual cone 8 ohm ..... \$55.00



STEREO RADIOGRAM CHASSIS, NEW ..... \$25.00

STEREO SPEAKER LEAD, 8 Cents yd.

GARRARD MAGAZINE TAPE DECK 3 1/2 Per Second, 2 Track, Left to Right \$25



SPEAKER BOX, unpolished, suit 8in speaker \$3.75. Pack and post 50 cents.  
2N 1108, 2N 1110, 2N 1111: Transistors ..... 50 cents each



GARRARD PLUG IN STEREO CARTRIDGE, \$6.00



### ROBINSON SOLDERING

IRONS, 30 WATT ..... \$6.00  
40 watts ..... \$6.00  
60 watts ..... \$6.25

2 ONLY TRADED-IN STEREO AMPLIFIERS. \$18 each.  
3 1/2 watts per channel.

PATON V.C.T. MULTI-TESTER ADAPTOR for min. valves .... \$22.00

DIAL SCALES, 5in, 1 1/4 x 6, 10 1/2, 3 1/2 9 1/2 x 3/8 ..... 50c

Pots 50 ohm switch ..... 50 cents each.

American or Japanese 2 pin power plugs rubber complete with 2 1/2 yards flex 50 cents. Pack and post 10 cents.

MICROPHONES MAGNETIC OR CRYSTAL ..... \$1.75

SPEAKER CABINET, 16 x 10 x 8, complete with 6 inch MSP dual cone Speaker tweeter, 3 inch and Crossover network — \$18.75.

MAGNAVOX 8 WR, 10 WR

12 WR. Tweeter 3, 4 or 5 inch.

Speaker Plugs, 4 pin ..... 15 cents

Speaker Sockets ..... 15 cents

PUSH PULL AUDIO TRANSFORMERS 10,000 CT 3.5 ohm .. \$3.00 each

STEREO HEADPHONES, \$10 pair. Pack and post 25 cents.

TRANSISTOR DRIVE and OUTPUT TRANSFORMER 23 to 15 ohm. 75 cents a pair.

MSP 6 inch dual cone — \$5.50 each. MSP 3 inch tweeter — \$3.75.

MULLARD BOOKSHELF SPEAKER CABINETS, \$10 each.

STEREOGRAM CHASSIS, 5 watt per channel, complete except speakers. \$35.

NEW POSTAGE RATES PLEASE ADD EXTRA



# LAFAYETTE High Quality Multitesters

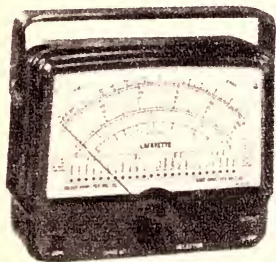

99-5065 \$53.95

## 100,000 OHMS PER VOLT "LAB-TESTER"

- Giant Easy-To-Read 6½" Scale.
- 2 p.c. Accuracy on DC; 3 p.c. on AC.
- ½ p.c. Multiplier Resistors.
- Built-in Meter Protection All Ranges.

**SPECIFICATIONS**  
**SENSITIVITY:** 100K ohms/volt DC, 5K AC.  
**RANGES:** DC 0-5-2.5-10-50-250-1000V. AC 0-3-10-50-250-500-1000V.  
**DB:** minus 10 to plus 49.4 in 4 ranges.  
**DC CURRENT:** 0-10-100 uA, 0-10-100 500 mA. 0-2.5-10 amps.  
**RESISTANCE:** 0-1K-10K-100K-10M-100M.  
**METER MOVEMENT:** 9 uA full scale deflection. **OUTPUT:** to 250 V with built-in series capacitor.

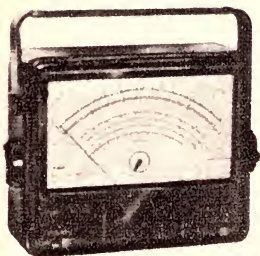

99-5076 \$42.50

## 50,000 OHMS PER VOLT MULTITESTER

- Large 5½" Meter.
- 50K ohms Per Volt DC; 5K on AC.
- Low Voltage Ranges for Transistor Circuitry.
- Built-in Overload Protection.

**SPECIFICATIONS**  
**RANGES:** DC VOLTS 50K ohm/V 0-125-1.25-5-25-500. 25K ohm/V 0-25-2.5-10-50-500-1000. AC VOLTS 5K ohm/V 0-1.5-5-25-125-500. 2.5K ohm/V 0-3-10-50-250-1000. DC mA 0-2.5-25-250. 0-5-50-500. DC AMPS: 0-5-0-10. **RESISTANCE:** 0-2K-10K-100K-1M-10M. DB minus 20 to plus 85 in 10 AC volt ranges.

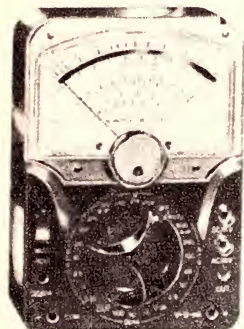

99-5071 \$29.50

## 30,000 OHMS PER VOLT MULTITESTER

- 30K ohms Per Volt DC; 15K on AC.
- 4" Meter, 2 Colour Scale.
- 1 p.c. Precision Resistors.
- Built-in Overload Protection.

**SPECIFICATIONS**  
**RANGES:** DC VOLTS 0-25-1-2.5-10-25-100-250-1000. AC VOLTS 0-2.5-10-25-100-250-500-1000. DC CURRENT 0-0.05-5-50-500 mA. 0-12 amps. **RESISTANCE:** 0-60K-5M-50M. DB minus 20 to plus 55 db. **SHORTS TEST** Internal Buzzer. Audio Output Jack.



99-5073 \$19.50

## 20,000 OHMS PER VOLT MULTITESTER

- 20K ohms Per Volt DC; 10K on AC.
- 3½" Meter, 40 Microamp Movement.
- 1 p.c. Precision Resistors.
- Built-in Overload Protection.

**SPECIFICATIONS**  
**RANGES:** DC VOLTS 0-6-6-30-120-600-1200. AC VOLTS 0-6-30-120-600-1200. **RESISTANCE:** 0-10K-100K-1M-10M. DC CURRENT 0-60uA, 0-6-60-600 mA. DB minus 20 to plus 63 db. **CAPACITY:** 200 mmf to .2 mfd.

## Y.R.S. Notes — contd.

their respective clubs. This year the attendance was less than expected. However it was encouraging to have delegates representing clubs from as far away as Port Augusta.

In South Australia this year, there are nine active Youth Radio Clubs registered with the W.I.A. scheme. New clubs are Plympton High School with 24 members; 3rd Adelaide Boys' Brigade Company—12 members; 5th Elizabeth Boys' Brigade Company—13 members; and 1st St. Marys Scouts—16 members. The last group has enlisted the assistance of an amateur radio operator living in their district. Though relatively inactive in amateur radio circles in recent years, he has agreed to act as the club's instructor.

Last year, 43 Elementary Certificates, 8 Junior Certificates and 4 Intermediate Certificates were issued in South Australia. So far there have not been any senior or advanced certificates issued but, at some clubs, members have received instruction at these levels and subsequently obtained their Amateur Operator's Limited Certificate of Proficiency.

The South Australia Youth Radio Club net has been resumed on the first Friday of each month. Scheduled times of operation are—80 metres (3625KHz approx.) at 8.00 p.m. and 6 metres at 8.30 p.m.

On the last Sunday of each month the W.I.A. broadcast over VK5WI includes a segment of news and notes on the Youth Radio Club scheme in South Australia. The broadcast commences at 9.00 a.m. and is relayed on 40 metres (7146KHz). An ordinary short-wave receiver should be able to receive this broadcast. Thus most Y.R.S. Club members should be able to hear the broadcast.

## VICTORIA

Michael Plummer, supervisor of the Youth Radio Club Scheme in Victoria, is returning to Canada in the near future and has resigned from Y.R.S. activity. His resignation became effective from July 1st. Michael had been associated with the scheme for several years and in the June issue of the shortwave listeners/Y.R.S. magazine "Zero-Beat," expressed his gratitude for the co-operation he had received from those associated with the scheme.

A new radio club has been formed at the Glenroy Technical School. Frank Wrobel is the group leader. Frank has gained the Y.R.C.S. Advanced Senior Radio Certificate.

Correspondence Section: Honours passes have been gained by members of the correspondence groups in recent examinations. The successful candidates were: Junior Certificate: Leigh Benger, Tony Hambling. Elementary Certificate: Malcolm Boyley; Gregory Leader; Robert Serban, Bernard Anderson.

Details of the correspondence section may be obtained from: Bill Tremewen, VK3ZCI, 34 Flower Street, Ferntree Gully, Victoria, 3156.

## Camberwell Grammar School

Chris Holliday, VK3ZYF, has passed the P.M.G. Morse code examination and now has the call sign VK3JU. This achievement now allows the Camberwell Grammar School to operate on the high-frequency bands under the new club call sign VK3BCG.

Using a converted AT5 transmitter, clamp tube modulation, contacts have already been made with New Zealand and New South Wales, Queensland and Tasmania.

The antenna used is a G5RV, one end being fixed by Robert Wills to a pine tree at a point 150 ft above the ground. Work in getting the transmitter on the air was in the main carried out by David Buchanan.

The club station is mostly active during the school lunch periods but some more enthusiastic members have operated at weekends. All members are preparing for the Y.R.S. Certificate Examinations. ■

# LAFAYETTE ELECTRONICS

Division of Electron Tube Distributors Pty. Ltd.

All Mail Enquiries and Orders to:—

**VICTORIAN SALES CENTRE & HEAD OFFICE**  
**94 HIGH ST., ST. KILDA, VIC., 3182. PH: 94-6036**

W.A. Representative: Athol M. Hill Pty. Ltd., 613-615 Wellington St., Perth.

S.A. Representative: Tyquin Distributors Pty. Ltd., 13 Deacon Ave., Richmond.





# LISTENING AROUND THE WORLD

## Using the World Radio Handbook

These days, the radio listener has a great deal of information at his fingertips to enable him to identify stations. The World Radio Handbook, for instance, lists all the broadcasting and television stations in the world, both by country and frequency.

by Arthur Cushen

However, new listeners often look up a frequency only to find that several stations are listed as operating on the channel, so they try to guess which station they are tuned to.

There are several factors which aid in quick identification of a station. First of all you should be certain that you are on the right frequency. A check on nearby English language broadcasts which are on channels you know will enable you to pin-point the frequency more accurately. If your receiver has a 100KHz crystal, or you have a frequency metre, this will aid you in exact frequency fixing.

The knowledge of languages and what they sound like will also help you to identify the station, but you have to be certain of the origin of the program. For instance, a station broadcasting in Spanish need not be located in Spain or South America, as most stations in Europe also carry Spanish programs for overseas.

A knowledge of propagation conditions is also useful. Predictions of the bands expected to give best reception in the Pacific area for certain periods can be obtained from Radio Nederland.

The bigger international broadcasters, using powerful transmitters and directional aeriels, can usually be picked up with a high degree of consistency, and it is only when conditions are really bad that they cannot be received with a satisfactory signal. However, the low-powered stations, using omni-directional aeriels, can be received only spasmodically. It will generally be found that signals from these stations are better in the summer months during the hours of darkness, and during the winter months during the daylight hours.

On the medium-wave band, reception is usually only possible when the signals travel over the "path of darkness," that is, when both the transmitter and the receiver are in their night period. It is perhaps worth remembering that European, African and Near East stations operate with 9KHz separation, whereas the rest of the world has 10KHz separation. Another point is that many European stations quote a wavelength in metres, instead of a frequency in KHz or MHz.

**LOG BOOK.** When reporting a station, the details on time, frequency and location of the station and the date of reception should also be entered in your log book

Notes from readers should be sent to Arthur Cushen, 212 Earn Street, Invercargill, N.Z. All times are GMT. Add 8 hours for Perth, 10 hours for Sydney and 12 hours for Wellington.

and, in due course, the date on which the verification, if any, was received. Another book which is necessary is a verification log. This shows by country (and in the case of the United States by state) all the stations you have verified. This information is a necessity as one cannot always remember if a station actually verified a report you sent to them. With these three necessities — a handbook and information on schedule changes, a log book showing the stations you have written, and a stations verified log, listening will be much easier. You will be more certain of the stations you hear and be able to check quickly whether they confirmed your reception.

### COVERAGE OF RECEIVERS

Radio Japan's latest survey to find the frequency range of receivers used for short wave reception produced the results summarised below. A total of 3,004 listeners participated in the survey. Those with sets capable of receiving frequencies above 15MHz accounted for 75 per cent, a 2 per cent increase over last year's survey. The survey found:

|                        |     |
|------------------------|-----|
| Receivers over 9000KHz | 4%  |
| Receivers over 11MHz   | 16% |
| Receivers over 15MHz   | 10% |
| Receivers over 17MHz   | 17% |
| Receivers over 21MHz   | 48% |
| Unknown                | 5%  |

These figures show a gradual trend of radio manufactures, to include the higher frequencies in new receivers.

### RADIO NEPAL EXPANSION

New frequencies and an extension of schedule have been announced by Radio Nepal, Khatmandu, reports the "Australian DXers Calling" program on Radio Australia. The present schedule is:

| GMT       | KHz         |
|-----------|-------------|
| 0220-0420 | 7105, 11970 |
| 0720-0920 | 7165        |
| 1320-1650 | 7165, 11970 |

News broadcasts in Nepali are at 0250 and 1350GMT and in English 0305 and 1505GMT. A commercial program is broadcast from 1530GMT, and English popular songs have been heard at 1620GMT.

### RADIO CANADA SHORTWAVE CLUB

The Radio Canada Shortwave Club commenced on December 1, 1962, and has expanded rapidly until today there are 7,202 members located in 84 different countries. The club was originally the brain-child of the German-language section and the engineering group of the CBC International Service. It was then, as it is now, a 10-minute program con-

ducted as a club meeting, complete with secretary, agenda and gavel to bring the meeting to order. Originally aired on short-wave in English, French and German to Europe, the club program is now beamed to Europe, Africa, the Caribbean, North, South and Central America, Australia, New Zealand and the Islands of the Pacific. In addition to the original three languages of English, French and German, the program is now broadcast in Czech, Polish, Hungarian, Spanish and Portuguese.

Membership of the club has increased by approximately 80 to 100 new members a month. The oldest club member is 84 years of age and the youngest is a nine-year-old schoolgirl. Members come from all walks of life, in fact, some of the most loyal members are convicts in Blundeston maximum security prison in England.

The script of the club program is written by Basil "Pip" Duke, supervisor of engineering, C.B.C. International Service. Basil Duke is also club president and airs the program weekly in English together with Elane McMaster, club secretary, and Duncan Nicholson, club vice-president. Duncan Nicholson is also assistant supervisor of the International Service engineering group.

To qualify for membership in the club, listeners must send in at least five reception reports of C.B.C.'s International Service shortwave transmissions. Upon qualifying as a member, they receive a suitably inscribed certificate, plus pennants, lapel badges, booklets and so on. To remain a member in good standing they must continue to send in reception reports to Radio Canada.

### I.R.C.s NOT VALID EVERYWHERE

The International Reply Coupon, which can be purchased at any post-office in Australia and N.Z. and is used by listeners to send return postage to overseas broadcasting stations, is not valid in some countries. According to a recent item in "Danish Shortwave International" the following countries do not accept I.R.C.s.

|                          |                 |
|--------------------------|-----------------|
| China (Peoples Republic) | Rhodesia        |
| Congo (Dem. Republic)    | Samoa           |
| Dominican Republic       | Somali Republic |
| Germany (East)           | South Yemen     |
| Guyana                   | Surinam         |
| Lesotho                  | Swan Island     |
| Malaysia                 | Swaziland       |
| Maldiv Islands           | Tonga           |
| Mauritania               | Vietnam (North) |
| New Hebrides             | Vietnam (South) |
| Peru                     |                 |

### RADIO IN SOUTH AFRICA

Broadcasting in South Africa got off to a shaky start in the early twenties. A handful of enthusiasts in Johannesburg, the country's acknowledged, if unofficial, economic capital, made the first successful radio broadcast from that city on July 1, 1924. A similar service was started on September 15 of the same year in Cape Town and on December 10, 1925 an organisation in Durban also began broadcasting.

These were private undertakings, dependent on public financial support which was difficult to obtain. These individual undertakings soon found themselves in financial difficulties. At this point, one





# WARBURTON FRANKI

## AUTOGUARD ANTI-THEFT ALARM Photoelectronic Beam

- A customer warning device; or
- Add an infra-red filter (supplied) flick the switch on the control and the unit becomes an INVISIBLE burglar alarm capable of protecting 30 feet.
- Light Source can be installed in any position with the unique flexible coupling.
- Transistorised "Solid State" unit with no moving parts.
- Low running costs.
- Complete with wire, cable tacks, buzzer and easy to follow instructions.
- Measures only 6" x 2½" x 2".

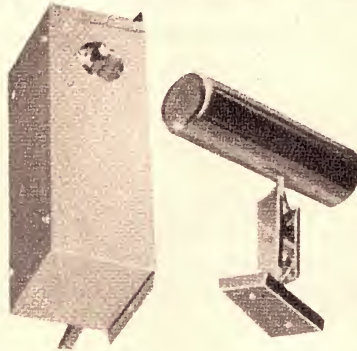

(Model 101)

**PRICE \$39.50 including pack and post**

## NEW! METREX AUTOMATIC SOLDERING GUN

- The Metrex Automatic contains everything you need — solder, flux, heat.
- Simple one-hand operation — trigger action feeds the right amount of solder at the right temperature.
- Weighs only one pound.
- Magazine holds 10ft of solder (refills available).
- Works directly from 240v mains.



**\$9.95**

Plus 25c pack, and post.

### BASIC POWER SUPPLY KIT

Includes Transformer, Contact cooled bridge rectifier and one filter condenser 16/350. This kit will supply 250 Volts D.C. at 60 m.a. and 6.3 volts A.C. at 2 amps.

**\$5.85**

including pack. and post.

### BASIC POWER SUPPLY KIT

Includes Transformer, Contact cooled bridge rectifier and one filter condenser, 1000 mfd. 15 V.W. This kit will supply 9 or 12 volts D.C. at ½ amp. Wiring diagram supplied.

**\$3.85**

including pack and post.

## NEW — CLEANLEC ELECTRICAL CLEANER

- Non-toxic
  - Non-inflammable
  - Non-corrosive
- for cleaning aircraft and automotive components such as—hydraulic and fuel systems, electric motors, generators, relays, etc. Also electronic components such as printed circuits and other devices.

12oz. Pressure Pak Can

**\$2,25**

including pack. and post.

## "CADET" SPEED CONTROLLER FOR ELECTRIC HAND TOOLS

Varies speed from stop to full speed with no loss of torque. Rated capacity 2 amps. Complete with flex and plug.

**\$11.50**

FREIGHT FREE.

## SPECIAL CONDENSER POLYPAC No. 20

Contains 25 assorted condensers, including ceramic, electrolytic, metal pack, mica, paper tubular.

**\$1 plus postage, 10c**  
(or five for \$5, post free.)

## ELECTROLYTIC CONDENSER POLYPAC No. 22

12 assorted miniature electrolytic condensers—\$1 plus 10c pack and post (or five for \$5 post free).

## RESISTOR POLYPAC No. 24

20 Hi-stability 1-watt ± 1% resistors

**\$3.50**

plus 10c pack and post.  
Values may be specified, but if not in stock nearest will be supplied.

## TRANSFORMERS

Let us quote for the supply of special power or stepdown transformers. Quick delivery. Lowest prices.



# WARBURTON FRANKI

220 PARK ST., STH. MELB., VIC. Ph. 69-0151 (30 lines)

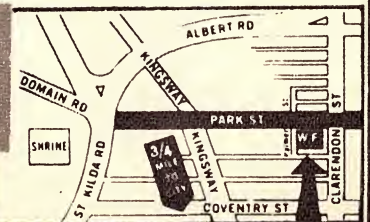



of South Africa's most distinguished financial experts, the late Mr I. W. Schlesinger, decided that he could put the whole thing on a business footing. He took over the existing broadcasting services and united them in a nation-wide radio undertaking known as the African Broadcasting Company. This began operations on April 1, 1927. However, the new enterprise also failed to pay its way, despite the possession of exclusive broadcasting rights.

It became clear that broadcasting in South Africa was not suitable for private entrepreneurs, but it was equally evident that broadcasting was a matter of great public interest, for which the State felt bound to take some responsibility.

Wisely, it was decided that state support should not involve state control. The British Broadcasting Corporation had had rather similar beginnings, and advice was sought from the man who had had most to do with launching that corporation on its successful start. He was Lord Reith, most of whose suggestions were incorporated in Act Number 22 of 1936, which established the present South African Broadcasting Corporation — a public utility corporation like the B.B.C.

In the 33 years which have passed, the range and scope of broadcasting in South Africa have expanded out of all recognition. However, it is since 1961 that the most dramatic developments have taken place, with the introduction of no fewer than 12 new services, including Radio Bantu and the External Services.

Today, separate services are provided in Afrikaans and English, as well as two bilingual commercial services, services in each of the seven languages of the Bantu peoples of South Africa, special programs for South Africans of Indian origin, and for the coloured people of mixed descent. There are also special programs in their own languages for immigrants from Portugal, Germany, Italy, and Greece. These are domestic services broadcast on FM, medium-wave and shortwave. For the benefit of listeners abroad, the S.A.B.C.'s External Service and Radio S.A., the Voice of South Africa, broadcasts in English, Afrikaans, French, Dutch, German, Portuguese, Swahili, and other African languages. These broadcasts go out on powerful shortwave transmitters beamed to Africa, the Middle East, Europe, Britain, the United States and Canada, Australia and New Zealand.

Controlling its own sources of revenue and code of conduct, the S.A.B.C. strives to serve all the peoples of South Africa and to be the true "vox populi" of the country.

#### OPERATIONS AT A RELAY STATION

The number of relay stations in use to rebroadcast programs more effectively into a given area is increasing. Recently, Deutsche Welle, at Cologne, released information on the operation of their relay station at Kigali, Rwanda, in Central Africa.

During the early months of 1968, the programs of Deutsche Welle were sometimes heard by listeners in America from the relay station at Kigali, reception being better than that afforded by the main transmitters at Julich, the Deutsche Welle transmitting site near Cologne. If anything emphasised the importance of the location of a transmitter, this did.

While the coverage of America — especially North America — on the path from Julich had been affected by strong ionospheric and aurora disturbances, many listeners in South, Central and North America could hear the programs beamed from Kigali with a good reception quality, because Kigali is situated two degrees south of the equator thus offering a considerably better outgoing position.

Results like these are the principal reason why Deutsche Welle is currently making preparations for the installation of three more relay stations. These will be in the Caribbean region, in South-

## NEW SCHEDULES OPERATING

### RADIO NORWAY

Broadcasts from Oslo are now carried during our winter months on the following schedule.

| GMT       | KHz                               | Area Served            |
|-----------|-----------------------------------|------------------------|
| 0700-0830 | 15175, 15345, 21655, 21730, 25730 | Australia, New Zealand |
| 1100-1230 | 17825, 21730, 25730, 21655        | Australia, New Zealand |
| 1300-1430 | 21655, 25730, 21730, 21670, 17825 | Australia, India       |
| 1500-1630 | 21655, 21730, 25730, 21670, 17825 | West Africa, U.S.A.    |
| 1700-1830 | 21730, 25730, 21655, 17825, 21670 | West Africa            |
| 1900-2030 | 15175, 21730, 21655, 25730, 21670 | Africa                 |
| 2100-2230 | 25730, 21655, 17825, 21730, 15345 | South America          |
| 2300-0030 | 21655, 17825, 15175, 15345        | South America          |
| 0100-0230 | 11735, 11850, 11860               | U.S.A., Canada         |
| 0300-0430 | 11735, 11850, 11860               | North America, Pacific |

### RADIO SUTANTENZA, BOGOTA

New frequencies have recently been put into operation by Radio Sutantenza at Bogota, Columbia. According to a verification card the frequencies, calls, and power are as follows:

| Call | KHz  | KW |
|------|------|----|
| HJCR | 590  | 10 |
| HJCX | 700  | 10 |
| HJGY | 810  | 10 |
| HJHN | 960  | 10 |
| HJGJ | 1150 | 1  |
| HJGP | 1560 | 1  |
| HJGO | 3250 | 10 |
| HJGC | 5075 | 25 |
| HJGG | 5095 | 50 |
| HJCT | 6075 | 10 |

### SCHEDULE FROM MOROCCO

Radio Television Morocco is operating on shortwave to the following schedule:

| GMT       | KHz                             |
|-----------|---------------------------------|
| 0600-0900 | 7115, 9615, 15345               |
| 1200-1500 | 7115, 9615, 15345               |
| 1500-1800 | 7115, 15345                     |
| 1800-2400 | 6160, 6170, 7115                |
| 0630-0900 | 7225, 11735, 14245, 15410       |
| 1200-1400 | 7225, 11735, 14245, 15410       |
| 1800-2400 | 7225, 9615, 11735, 15245, 15410 |

### ENGLISH BROADCASTS FROM WARSAW

Broadcasts from Radio Warsaw in Poland, are scheduled as follows:

| GMT       | KHz                     |
|-----------|-------------------------|
| 0700-0730 | 9550, 7285, 7125        |
| 1100-1155 | 15275, 11840            |
| 1830-1900 | 9525, 7145              |
| 2030-2100 | 7145, 6135              |
| 1930-1955 | 7145, 6135              |
| 2100-2130 | 11955, 9540, 7125, 5995 |

### HAPPY STATION PROGRAM

The familiar Happy Station, which has been broadcast from Radio Nederland in Hilversum, Holland, for the past 40 years, has been rescheduled with the introduction of the Bonaire relay station. Program times and frequencies are now:

| GMT       | KHz          | Area                   |
|-----------|--------------|------------------------|
| 0630-0750 | 11730        | New Zealand            |
| 0800-0920 | 9715         | Australia, New Zealand |
| 1400-1520 | 17810, 21480 | Asia                   |
| 1830-1950 | 11730, 15220 | Africa                 |

West Europe, and in Asia, so as to ensure a stable reception of programs in areas that so far have not been covered too well.

An important problem is to supply the relay station with sufficient programs for rebroadcasting. The regular program to Africa, beamed from the transmitting station at Julich, is received at Kigali by remote-controlled receiving equipment. This receiving station lies about 10 miles north of the transmitter installation. The tuning of the five receivers installed there is done by signals from the transmitting centre so that the receiving station is operated without personnel. The Rubungo High Ridge, which is situated between the transmitting and receiving centres, provides the necessary screening against radiation of the relay station.

Also the SSB transmissions from the German Bundespost to Kigali and the daily teletype transmissions to Kigali are received there. The transmissions are either directly used for modulation of the transmitter at Kigali, or recorded on tape for use at a later date. Programs which are not of current importance (e.g. certain music programs) are recorded in Cologne and then sent to Kigali by air where they are added to the corresponding programs.

To sum up, the relay station has an assortment of the following programs:

1. The transmissions which are directly rebroadcast after reception.
2. Those recorded on tape by the receiving stations.
3. The program parts which arrive by air mail.

#### ULAN BATOR FREQUENCIES

A new schedule from Ulan Bator shows English transmissions on the air at the following time, with broadcasts intended for international coverage:—1200-1250-GMT, 7340KHz and 9545KHz; 2200-2330GMT, 11810KHz, 11850KHz and 9575KHz.

#### ARDXC BEGINS FIFTH YEAR

The record-making 56-page June edition of "Australian DX News," bulletin of the Australian Radio DX Club, also marked the beginning of the group's fifth year of activity. There are at present four branches in existence in Melbourne, Adelaide, Sydney, and Brisbane. The club's DX session "World at Your Fingertips" is heard on Sunday evenings at 1235GMT over radio 3NE Wangaratta (1600KHz). Programs for the second weekend of each



Sony replaced IFT in this 4-band transistor radio

with the new Murata ceramic filter SFD-455B.

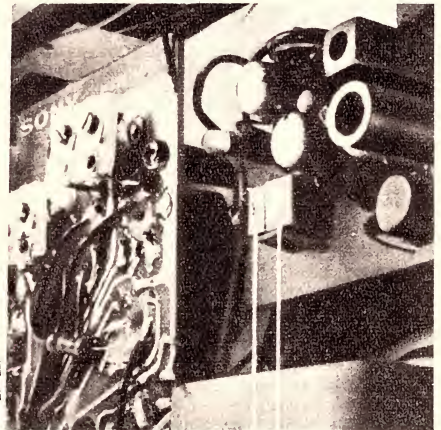

BFB-455A J L SFD-455B

**muRata**



ACTUAL SIZE

SFD-455B

Throughout the world electronic design engineers have begun to realise the many benefits offered by Murata Ceramic Filters. These include high gain, low spurious response, negligible ageing characteristics (0.4% over 10 years) and, since no alignment is necessary, considerable cost saving in production.

Sony engineers have taken advantage of these benefits and have incorporated two Murata Ceramic Filters

SFD-455B and BFB-455A in the quality model TR-1000 4-band transistor radio.

Combining excellent overall response and selectivity characteristics with space saving and production economy, the Murata Ceramic Filters are proving superior to conventional IF transformers.

Include Murata Ceramic Filters in your next design.



MODEL BFB-455A improves the selectivity of transistor radios when used as an emitter by-pass in transistor IF Stages.



MODEL SFD-455B is a resonance type filter of 455 Khz. It replaces the transistor radio's IFT or can be used in combination with IFT's.

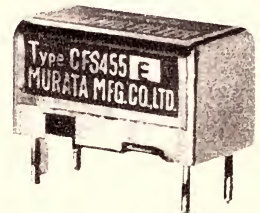

LADDER TYPE Ceramic Filters CFS-455 and CFP-455 (Popular Type) are ideal for IF stages of high quality communication receivers.

**IRH COMPONENTS PTY. LIMITED**

*A Subsidiary of IRH Industries Limited*

THE CRESCENT, KINGSGROVE, N.S.W. 2208. TEL. 50 0111



MAKES THE MOST OF CERAMICS

IRH M2



month are produced by the South Australian branch; all other broadcasts are compiled by the Victorian branch. Readers seeking information regarding the club and its activities should contact the honorary secretary, ARDXC, at 22 Howard Street, Glen Iris, Victoria, 3146.

#### BUDAPEST ON 16 METRES

Radio Budapest has been observed on the rarely heard 16-metre-band channel of 17795KHz. Spanish has been noted just after the tuning signal at 2328GMT, with sideband interference from the B.B.C., London, on 17790KHz. The parallel frequency of 9833KHz has also been heard at this time.

#### RADIO MALDIVES' SCHEDULE

Radio Maldives, formerly known as the Maldivian Broadcasting Service, is best received in eastern Australia at around 1630GMT when the program "World Tomorrow" is presented, on 4740KHz. This frequency is in use from 1515-1730GMT, all programs in this period being in English. Other channels in use are 331KHz, 6150KHz, 9538KHz and 7225KHz. The 7225KHz outlet is in use from 0100-0230GMT, and could be audible in Western Australia under favourable propagation conditions, during the first 30 minutes of the broadcast.

#### INTERESTING CONGO SIGNALS

ARDXC members in Melbourne have reported good reception of Radio Kinshasa, using 7115KHz. The station has been observed at around 2225GMT with African musical selections, and French announcements. It is believed that a transmitter power of 50KW is used on this frequency. The high-frequency outlet on 15245KHz has also been logged, at around 0715GMT, with a French variety program and local music from 0730GMT.

#### GOOD SIGNALS FROM NIGERIA

Radio Television Kaduna, operating on the new frequency of 9570KHz, has been giving good reception in Melbourne recently at 0530GMT when English news is presented. Frequent commercial messages are given. A program in Hausa is heard from 0600GMT.

The Western Nigerian Radiovision Service, at Ibadan on 6050KHz, is rarely heard in Australia, but has been noted from around 2220GMT with African music selections, and with a short period of English news at 2255GMT. Sign-off is just after 2300GMT.

#### LATIN AMERICAN RECEPTION

Listening conditions are now optimum for reception of many stations in the Latin American area. The survey which follows has been compiled from reports contributed by Australian Radio DX Club members and published in the club's bulletin "Australian DX News." These stations should continue to be heard at the times indicated, until the middle of September.

- 3325KHz. Radio Monagas, Venezuela, best at sign-on, 1000GMT.
- 4785KHz. Voz de Manabi, Ecuador, opens at around 1125GMT, with Andean music until fade-out at 1215GMT.
- 4810KHz. Radio Popular, Venezuela, news at 1000GMT.
- 4900KHz. Radio Juventud, Venezuela, with Latin American music at 1040-GMT.
- 4910KHz. Gran Colombia, Ecuador, sign-on at 1130GMT with identification.
- 4937KHz. Radio Tropical, Peru, opens at 1050GMT when all frequencies announced.
- 4995KHz. Radio Brasil Central, Brazil, has Portuguese commercial program at 0845GMT.
- 5025KHz. Radio La Cruz del Sur, La Paz, Bolivia, opens at 1000GMT with Indian religious program. (Sometimes heard on 4985KHz.)
- 5075KHz. Radio Sutatenza, Colombia, now using 300KW on this channel, is

heard to sign-on at 0900GMT, parallel with 5095 and 6075KHz.

6005KHz. Radio Progreso, Bolivia, with Indian announcements at 0915GMT.

6010KHz. Radio America, Lima, Peru, is very strong on Sundays at around 0630GMT.

6060KHz. Radio Nacional, Buenos Aires, Argentina, opens with anthem at 1000GMT, followed by world news in Spanish.

6120KHz. Radio El Mundo, Argentina, has Spanish news at 1000GMT, with interference from 4VEH, Haiti, on same frequency.

6170KHz. Radio Nacional, Venezuela, opens at 0955GMT with anthem, followed by a program of classical music.

9510KHz. Radio Barquisemeto, Venezuela, has world news at 1150GMT.

9520KHz. Radio La Cronica, Peru, opens at 1200GMT, with full identification at this time, followed by news headlines.

9555KHz. Radio Nacional, El Salvador, has been heard with orchestral music at 0435GMT, and signs off at 0502GMT after identification and an anthem.

9590KHz. Radio Presidente Balmaceda, Chile, has been noted in the period 2330-0100GMT with typical Latin American commercial program.

9615KHz. La Voz de La Victor, Costa Rica, has news at 0000GMT, identification at 0010GMT.

9714KHz. Radio Tropical, Peru, has news at 1125GMT, in parallel with 4937KHz.

9750KHz. Radio Minería, Peru, has been noted in the period 2300-0100GMT with many identification announcements.

9772KHz. Radio Amazonas, Peru, heard with Andean melodies at around 1130GMT.

#### AFRICAN SIGNALS

Angola. "Voz de Angola," which uses the transmitters of Radio Angola, at Luanda, has been noted with strong signals from around 2200GMT, on Saturdays (Sunday mornings in eastern Australia) with a football match description in Portuguese. Identification was given at 2235GMT, followed by a program of popular music until after 2315GMT. Radio Angola has been giving consistently good signals on 7245KHz, with Portuguese folk-music at around 2300GMT, and at times has been heard until as late as 0030GMT.

Zambia. The Zambia Broadcasting Service recently made a change to 4960KHz, and has been noted at sign-off at 2200GMT, with English identification announcements.

Biafra. Radio Biafra has been observed with news in English at 2300GMT on 6145KHz, and with a commentary at 2315GMT. The station has also been heard on 7300KHz at around 0700GMT with English.

## FLASHES FROM EVERYWHERE

### EUROPE

ITALY: Rome Radio is using the new frequency of 6095KHz, and has been heard with a program in Arabic at 0445GMT. The familiar bird song is heard at 0505GMT and a program in French follows. Rome is also being heard on 7235KHz and has been noted on this channel opening in English at 2025GMT.

BULGARIA: Radio Sofia is using the new frequency of 17825KHz in a program to Africa. The service includes a broadcast in French at 1930 and in Arabic at 2000GMT. English has been heard at 2100GMT, with the same program on 15310KHz.

GERMANY (EAST): Radio Berlin International has a service in English to Africa at 0615 on the new channel of 9500KHz. This frequency replaces the former 9570KHz. English to South Asia

### VERIFICATIONS

In recent weeks many readers have received some very interesting verifications of their reception of stations reported in these pages. We list below some details on these QSL cards and letters, which have been supplied by our readers, the Australian DX Club, and from our own mail.

PORTUGUESE GUINEA: According to Robert Shepperd from Glen Iris, Victoria, this station recently verified a report, by folding card, in six weeks. All verification details were given in three languages — Portuguese, French and English. It is interesting to note that the report was sent in English, a covering letter also being sent. Return postage was sent in the form of three IRCs. This station is heard in the mornings at around 2200GMT. The frequency is 5041KHz.

KASHMIR: According to Bob Padula, Melbourne, Victoria, Radio Kashmir at Srinagar recently verified an English report sent direct to the station. Commonwealth Reply Coupons were sent with the report and the verification came back in 51 days. The QSL took the form of a personal letter from the Assistant Director, Mr Agrawal. The frequency reported was 3277KHz.

BRAZIL: Radio Globo, using the frequency of 6035KHz is an infrequently reported Brazilian. John Eig of Queensland recently reported this one in English, enclosing one IRC with the report. The reply came back in three weeks in the form of a QSL card showing colour drawings of life in Brazil. Full station information and QSL details are printed in Portuguese and English. The station operates on 6035 and 11805KHz on short-wave, with a power of 10KW on both frequencies. Hours of transmission are from 0900-0400GMT.

CAMEROONS: Radio Yaounde: This station appears to verify each report with two cards. A recent report in English with an IRC was verified in this manner, both cards confirming the report. One card shows in colour a map of the Cameroons with an aerial centred on Yaounde emitting radio waves. The other card, also in colour, shows a map of the world with radio waves emitting from Yaounde to all parts of the world. On the back of each card is full information on all stations which operate in the Cameroons. The frequency reported was 4972KHz.

LATVIAN SSR: Riga has verified in 10 weeks for the frequency of 7140KHz by QSL card and a small station flag. QSL details are printed on the back of the card in Swedish, and a personal letter in English plus a book on Riga were also included. The report was sent in English with three IRCs.

from 0645GMT is best received on 21465KHz.

DENMARK: Radio Denmark in Copenhagen is testing to the Far East and Australia on 15165KHz from 2000-2100GMT with English for the first 30 minutes. Reports are requested on this attempt to put a good signal into the Pacific area.

### AFRICA

TOGO: Radio Loume, Togo is using 5045KHz and has been heard opening at 0530GMT. A further frequency, 6155KHz, has been observed, but suffers interference from Vienna, Austria.

BOTSWANA: Radio Gaborone, has been received on two frequencies by Tony Marr of Auckland, N.Z. Reception has been observed on 3356KHz with a relay  
(Continued on page 180)









## GUITAR AMPLIFIERS

10-Watt, Two-Channel, with Twin Cone Speaker . . . \$53.53  
 14-Watt, 4 Inputs, Bass and Treble Boost, 2 Twin-Cone Speakers, \$63  
 17-Watt, Four-Channel, Bass and Treble Boost, Two Twin-cone Speakers . . . \$76.25

### 35 WATT

4-Channel, Bass and Treble Boost 4 Twin-Cone Speakers — \$109.05  
 Vibrato with foot control and 2 preset controls for frequency and intensity. \$10.50 extra on above models.



## MULLARD MAGNAVOX

### BOOKSHELF ENCLOSURE

Maple, Teak or Walnut Complete \$24.75  
**SUPER BOOKSHELF \$36.75.**

Post: N.S.W. 50c. Interstate \$1.00.

**CABINETS ONLY**

R. H. BOOKSHELVES \$11.50

MULLARD \$10.95

**BOOKSHELF UNITS**

6in 8in 10in 12in  
**\$27.75 \$33.50 \$35.50 \$36.50**



### NEW LOOK SPEAKER ENCLOSURES

Hi-Fi Freq. response. Power rating 5 watts R.M.S. Attractive, modern, oiled teak finish. Size 14 1/2 in x 4 3/4 in x 9.

**\$15.00 EACH**

Post 75c. Interstate \$1.25.



### 11 1/2" FULLY BALANCED PICK-UP ARM.

COMPLETE WITH MAGNETIC Stereo Cartridge . . . \$19.50  
 Arm less cartridge . . . \$11.50  
 Mag. cartridge only . . . \$9.50



### HI-FI STEREO HEADPHONES

8-OHM. Range 25c to 17K.c.  
**\$9.75**  
 Post 35c.

## PIGGY BACK GUITAR AMPLIFIER

Excluding Speakers

30 Watt . . . . . \$79.75  
 45 Watt . . . . . \$99.75  
 60 Watt . . . . . \$119.75  
 4 Inputs, Bass and Treble Boost  
 Vibrato if required, \$10.50 extra.

## PIGGY BACK GUITAR AMPLIFIER

Complete with Speakers, Cabinet  
 30 Watt Lead . . . . . \$138.75  
 30 Watt Bass . . . . . \$146.75  
 45 Watt Lead . . . . . \$158.75  
 45 Watt Bass . . . . . \$166.75  
 50 Watt Lead . . . . . \$218.00  
 60 Watt Bass . . . . . \$234.00  
 Vibrato if required . . . . . \$10.50

### 14 plus 14 WATT

With Reverberation. May be used as 28 Watt or as 14 Watt plus 14 Watt Reverb. Two 9 x 6 Woofer Speakers. Two 9 x 6 Twin-Cone Speakers, 4 Channels, Bass and Treble Boost. Foot Vibrato control included.

**\$163.50**

## 15-INCH HI-POWER SPEAKER

Imported 30 Watts R.M.S. \$30.00  
 Local 50 Watts R.M.S. \$50.00



## 240v A.C. POWERED SOLID STATE STEREO

T.S.135  
 18 Transistor, 15-watt per channel. Inputs for Tape, Mag. P.U., Ger. P.U., Radio, Aux. Freq. Range 30c to 20KC. Max Sensitivity 3 MV. Speaker matching 4 to 15 ohms.

**\$78.00**



## 10 + 10 STEREO AMPLIFIER

With Overload Protection Circuit Kit Set. \$62.75.  
 Wired and Tested . . . . . \$72.75  
 Complete with Broadcast Tuner \$101.75.

## SIGNAL GENERATOR

Deluxe Model TE-20D.  
 Freq. range 120 KC—500 Mcs. 7 Bands. Accuracy 2 per cent. Output 8V. Provision for Xtal. Suitable for self calibration Marker generator. Printed circuit. 240 T.E.20. \$25.50. \$28.50  
 V.A.C.



## AUDIO GENERATOR

De Luxe Model TE-22D.  
 Freq. range, Sine 20 cps—200 KC. SQ. 20 cps—25KC. Output voltage. Sine 7V. SQ. TV P-P. Output impedance 1000 ohms. Acc. 5 per cent. Distortion less than 2 per cent. 4-range attenuation. 1/1, 1/10, 1/100, 1/1K. Printed circuit. 240V A.C.

**\$42.95**

## VOLT-AC VARIABLE TRANSFORMERS

0 to 260V. 10 Amp. 2400 Watts.  
**\$49.50**  
 2 1/2 AMP. . . . . \$25.50  
 5 AMP. . . . . \$37.50

## WIDE BAND OSCILLOSCOPES

### SPECIFICATIONS

#### VERTICAL AXIS

Deflection Sensitivity (at 1 kc) 0.1 V p-p/cm.  
 Frequency Characteristics 1.5 cps—1.5 MC.  
 Input Impedance 2 M ohms 25 pF.  
 Calibration Voltage IV pp-cm.

#### HORIZONTAL AXIS

Deflection Sensitivity 0.9 V p-p cm.  
 Frequency Characteristics 1.5 cps—800 KC.  
 Input Impedance 2 M ohms 20 pF.  
 Sweep Oscillator (5 Range) 10 cps—300 KC.  
 Synchronization Devices Internal (Positive and Negative, External). Power 240V AC 50/60 cps. Cathode Ray Tube 3KFIF.

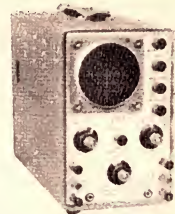

5 Meg Bandwidth Push-Pull vertical and horizontal Amplifiers. 8 positions, high sensitivity vertical Amplifier Frequency Compensated on all positions. Calibrated .02 to 600 volt. Hard time base, 20 cycles to 75K. Latest American R.C.A. circuitry. Complete with probe.

**3-inch \$102.75; 5-inch \$118.75**

## L.S.G. 11 SIGNAL GENERATOR

FREQ. RANGE IN 6 BANDS  
 120KC—130MCS  
 Calibrated Harmonics.  
 120MCS—390MCS.  
 RF output over 100,000UV.  
 120KC-38MC  
 Mod. Freq. 400 and 1000CPS.  
 Crystal Osc. 1-15MCS.  
 AF Output, 3 to 4 Volts.  
 AF Input, 4V approx.  
 240V AC Operation.  
 \$31.75, Post 75c.

## AMPLIFIERS Public Address Range 240V-AC



MINIATURE P.A. AMPLIFIER. 15 WATTS OUTPUT.  
 Multi Match Ferguson O.P. transformer input for crystal mike and pick-up with electronic mixing P.P. EL.84 output \$42.50  
 30 Watt. As above, EL.34 P.P. . . . . \$57.50  
 40 Watt. As above, EL.34 P.P. . . . . \$85.50  
 60 Watt. As above, 6DQ6 P.P. . . . . \$105.50  
 LINE OR VOICE COIL.



## P. A. SPEAKERS

8 WATT.  
 8in Units in Waterproof Projection Horns.  
 15 Ohm Voice Coils.  
**\$15.25**  
 Line Output Transformers to suit. \$1.75 extra.



## 8 TRANSISTOR CAR RADIOS

R.F. Stage for long range reception. 6 or 12 volt operation. On ordering please state polarity requirements complete with lock down aerial and lead. Speaker Selection. 5", 6", 8", 7" x 5" or 6" x 9".  
 De Luxe Push Button Model. \$48.00.  
 Standard Manual Model. Complete with 5" x 3" Speaker. \$43.00. Post \$1.25; Interstate \$2.00  
 Car Aerials complete, with lead. Top coil mounting, 3", 6", \$2.75  
 Lock Down, 3", 6" . . . . \$4.75

## STEREO RECORD CHANGERS

Latest Model, 4-speed.

**\$32.00**

De Luxe Model. Fully machined and balanced. Heavyweight turntable. Ceramic cartridge.

**\$39.00**

Post N.S.W. \$1.25. Interstate \$1.75.

De Luxe Model with mechanical cueing device. Calibrated stylus. Pressure control. Adjustable counter balance. Two spindles.

**\$53.00**

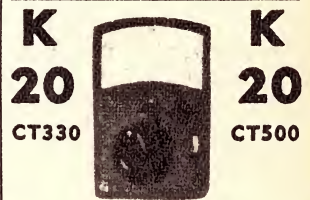

## C.T.330 20K. OPV

D.C. Volts 6, 6, 30, 120, 600, 1,200, 3,000, 6,000, A.C. Volts 6, 30, 120, 600, 1,200. D.C. Current .06-6, 60, 600mA. Resistance, 6K, 600K, 6meg., 60meg., D.B. minus 20 to plus 62. 5 Ranges. Specially suitable for transistor use.

**\$16.45**

## C.T.500 20K.OPV

D.C. Volts, 2.5, 10, 50, 250, 500, 1,000. A.C. Volts, 10, 50, 250, 500, 1,000. D.C. Current, .05, 5.50, 500mA. Resistance, 12K, 120K, 1.2meg., 12meg. D.B. minus 20 to plus 62.

**\$13.25**

## 200H 20K.OPV

D.C. Volts, 5, 25, 50, 250, 500, 2,500. A.C. Volts, 10, 50, 100, 500, 1,000. D.C. Current, 50uA, 2.5, 250mA. Resistance, 6K, 600K, Capacitance, 2 D.B. Ranges.

**\$10.95 Post 50c**

Full range of Kalse-S.K. brand at Special Prices. Send for details.  
 ALL PRICES NET. INC. S-TAX

## PANEL METERS



EDGE METERS, 1mA. Scaled V. U.S. Tuning Stereo Bal. \$2.50.  
 A FULL RANGE OF UNITS. 85 Types, 1/4in to 3/4in. FROM \$3.25.  
 Send for full list.





# TRIO

## SSB transceiver

200 watts PEP—7 Bands—A M & C W  
and  
Power Supply and Speaker Unit



PS 500 AC

TS 500

**SPECIFICATIONS:**

**Frequency:** 80m Band 3.5-4.0 MHz  
40m Band 7.0-7.5 MHz  
20m Band 14.0-14.6 MHz  
15m Band 21.0-21.6 MHz  
10m A Band 28.0-28.6 MHz  
10m B Band 28.5-29.1 MHz  
10m C Band 29.1-29.7 MHz

**Communication Method:** SSB (A3j)  
AM (A 3H)  
CW (A1)

**Maximum Input Power:** (Xmitter final stage)  
200W (PEP)

**Standard Input Power:** (Xmitter final stage)  
180W (PEP) 120W on 28 MHz band only

**Antenna Input Impedance:** 50-75 ohm

**Carrier Suppression Ratio:** More than 40 dB

**Single Side Band Ratio:** More than 40 dB

**Mic. Input Impedance:** High impedance  
(dynamic or crystal mic. recommended)

**Xmitter Audio Frequency Characteristics:**  
300-3,000 Hz (-6 dB)

**Receiver Sensitivity:** 1µV S/N 10 dB  
(14 MHz)

**Receiver Selectivity:** 2.7 kHz (-6 dB)  
5.0 kHz (-55 dB)

**Spurious Rejection Ratio:** More than 45 dB

**Image Ratio:** More than 60 dB

**Undistorted Power Output:** More than 1W

**Receiver Output Impedance:** SP 500 ohm  
PHONE 8 ohm

**Power Consumption (using PS-500AC):**  
450W (At maximum power output)  
250W (Receiving Mode)

**Tubes and Transistors used:**  
17 TUBES, 3 TRANSISTORS, 15 DIODES

**Dimensions:** W: 13 1/8"; H: 8 1/2"; D: 11 1/2"

**Weight:** 17.6 lb

**FOR/FOA SYDNEY: TS 500, \$491.00 ; PS 500 AC, \$98.00**

CONSULT YOUR LOCAL RADIO DEALER, OR

MAIL THIS COUPON *today*

Please forward free illustrated literature and specifications on Trio equipment.

Name.....

Address.....



(A unit of Jacoby Mitchell Holdings Ltd.)

376 EASTERN VALLEY WAY, ROSEVILLE, N.S.W.

Cables and Telegraphic Address: 'WESTELEC.'

Sydney. Phone: 40 1212

of B.B.C. news at 1800GMT. The other channel is 4845KHz, and this has been heard to sign off at 1901GMT.

**BURUNDI:** Radio Bujumbura with the slogan "La Voix de la Revolution" has been received at opening, 0428GMT. The station has a tuning signal at this time, and commences transmissions at 0430GMT.

**SEYCHELLES.** The new FEBC station is expected to test shortly with a power of 3000 watts, the programs being beamed to India, Pakistan and Ceylon. The first test in August will use the following schedule:

| GMT                  | KHz   |
|----------------------|-------|
| 0030-0330, 1300-1630 | 15165 |
| 1300-1630            | 17755 |
| 1700-2000            | 21460 |

### ASIA

**QATAR:** A new schedule is now in effect for Radio Qatar at Doha, which uses the frequency of 9570KHz and the power of 100KW. The transmissions are on the air for two periods daily; 0300-0530GMT (with an extension to 0700GMT on Friday) and 1300-1855-GMT. Programs are in Arabic and news is at 0330, 1430 and 1730GMT, with best reception around 1500GMT.

**CEYLON:** Radio Ceylon's commercial service is being widely reported on 15230KHz with English programs at 0130GMT. The station has also been heard with the Hindi program on 11800KHz at the same time, with frequent commercial announcements.

**SYRIA:** Radio Damascus has been observed with a retimed schedule for its program to Europe. The station, on 15165KHz, has been heard 2030 to 2200GMT in English and a further program in English has been heard at 0800GMT. The frequency of 15290 has been dropped for the European service, and now has only Arabic.

**YEMEN:** The Yemen Royalist Radio is on the air from 1615-1930GMT, with news at 1730 and 1925GMT in Arabic. The station uses three frequencies, 9976, 7400 and 4990KHz.

### OCEANIA

**TAHITI:** Radio Tahiti, ORTF, Papeete, has been received on its three frequencies, 1400KHz (medium wave) 6135KHz and 11825KHz. The station operates daily 0300-0800, 1415-1615 (except Sunday), 1900 to 2130, and on Sunday 1700 to 2130GMT. Native language are 0300 to 0500GMT and 1900 to 1945GMT; all other programs are in French.

**PAPUA and NEW GUINEA:** Radio Western District, which is the slogan of VL8BD at Daru, on 3305KHz, is heard well with ABC news at 1000GMT. The station then has news in Pidgin and at 1015GMT a musical program. Signals on this, and most of the other 90M band Australian Administration station, are well received at this time.

### THE AMERICAS

**ECUADOR:** Radio HCJB in Quito is using a further channel for test basis in the 49M band. The frequencies previously reported, 5985 and 6115KHz, continue to be received at 0700GMT with a transmission to the South Pacific, and the same program is 6050KHz. The new channel 6175KHz, is suffering interference in the early part of the program from Paris Radio, which is on the same frequency.

**MEXICO:** Radio XEWN, using the frequency of 6165KHz and the slogan "La Vox de America Latina," has been heard with typical Spanish programs at 1230GMT. The same program is carried on 9500KHz on XEWW, both stations relaying the medium wave programs from XEW in Mexico City.



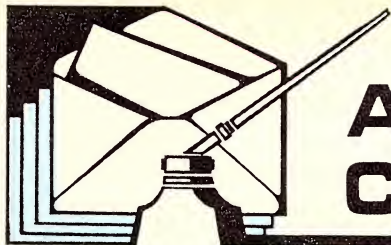

# ANSWERS TO CORRESPONDENTS

**BOOKS ON COLOUR TV:** There must be many readers who would like to know of a good text book on the subject of colour television. Do you know of any suitable books on the subject? (A.D.F., Pennant Hills, N.S.W.)

● We published a list of suitable publications in the June, 1969 "Answers to Correspondents" pages.

**CATHODE RAY TUBES:** I have two cathode-ray tubes, types 902-P1 and VCR138A, and I would like some technical data for them. (J.W., Kyeemagh, N.S.W.)

● Although both of these tubes are rather long in the tooth nowadays, and may not be one hundred per cent reliable, we are supplying the following information, which may also help other readers who may have these tubes on hand. Type 902-P1 is a two-inch indirectly heated cathode tube with a green trace of medium persistence. The filament requirements are 6.3V and 0.6A. Type VCR138A is a three-and-a-half-inch indirectly heated tube, the filament requiring 4V and 1A. It has a green trace. Pin connections and electrode voltages are tabulated below.

| Type   | Pin No. | Electrode | Voltage |
|--------|---------|-----------|---------|
| 902-P1 | 1       | anode-2   | 600V    |
|        | 1       | grid-2    | 600V    |
|        | 1       | X-2       |         |
|        | 1       | Y-1       |         |
|        | 2       | heater    | 6.3V    |
|        | 2       | cathode   |         |
|        | 3       | anode-1   | 150V    |
|        | 4       | X-1       | 5.5V/mm |
|        | 5       | grid-1    | -60V    |
|        | 6       | Y-2       | 4.6V/mm |
|        | 7       | heater    | 6.3V    |
|        | VCR138A | 1         | grid    |
| 2      |         | cathode   |         |
| 3      |         | heater    | 4V      |
| 4      |         | heater    | 4V      |
| 5      |         | anode-1   | 1200V   |
| 6      |         | anode-2   | 200V    |
| 7      |         | shield    |         |
| 8      |         | Y-2       |         |
| 9      |         | X-2       |         |
| 10     |         | anode-3   | 1200V   |
| 11     |         | X-1       | 14V/mm  |
| 12     |         | Y-1       | 6.7V/mm |

**MORE ON JET SOUND:** The effect is produced in the recording studios by combining the original recording and a copy, while moving one of the replay heads manually in the direction of tape travel. The effect cannot be reproduced by electronic means, nor can it be simulated by using a spring in a box. The two signals must be virtually identical for the individual waveforms to interact. The idea of tape recording a performance and playing it back behind another live performance is a sure way to get nowhere fast. The inability to produce jet sound directly is a reason why pop groups use pre-recorded sound in TV shows. If you want to hear jet sound, buy a copy of "The Real Thing," released on Columbia 45rpm by Russel Morris and written by Johnny Young. The centre portion of this production illustrates the effect admirably. (R.B., Orange, N.S.W.)

● Thank you for your letter, which arrived rather too late to include in the "Forum" pages. We have omitted that portion of your letter which parallels what

already appears but the remainder should be of interest to other readers. We note in particular your observation about spring devices.

**APOLLO SPACECRAFT?** Do you know if it is possible to build or buy a radio receiver capable of receiving signals directly from Apollo or other spacecraft, when in line of sight. (J.S. East Burwood, Vic.)

● We have not closely studied the problem with a view to adaption or construction of a receiver. It is noteworthy, however, that space authorities use very large steerable antennas and very specialised receiving techniques to intercept the signals. It is not just a question of getting hold of some receiver which happens to cover the frequency and attaching it to an ordinary aerial. Some university student groups and a few keen amateurs have intercepted signals from communication and weather satellites but it is an exercise which involves a good deal of equipment and know-how. Never having been through the exercise ourselves, we are not in a position to offer you any material from backnumbers. However, the article on Apollo communications in this issue may be of interest to you.

**RECORD CRACKLES:** I have been troubled with crackling on L.P. records since I bought a new scattergram type of equipment. I assume that the trouble is due to dust, although I take every precaution to keep the records clean. It occurs even in new records. I have tried a Dust-Bug and anti-static cloths to no purpose. I don't feel inclined to purchase any more classical L.P.s. (A. J. Mayfield, N.S.W.)

● Our reaction is that clicks on records, particularly new and well-cared-for

records, are not nearly as big a problem as you imply. It is just possible that the pickup or loudspeaker system in your new equipment has a peak in the upper-middle register which is making the clicks much louder than they should be. On the other hand, with new wide-range equipment, and a tendency to listen to every sound that it emits, there is a strong chance that you are over-reacting to occasional clicks, so that they are spoiling your enjoyment of the music. Our advice would be to use the equipment with the treble turned down, for a while, gradually bringing it up later to what is balanced sound—not exaggerated treble. The trouble can be more evident on classical records mainly because they contain passages recorded at low level, and listeners are sometimes inclined to turn up the volume and, with it, the noise level. In fact, soft passages should be played at the same volume setting as loud passages on the same disc; to "ride" the volume control is only to defeat the composer's intention as far as dynamic range is concerned.

**BEGINNERS' CIRCUITS:** Could you publish some circuits for an amateur electrician to build radios, oscillators, blinkers and amplifiers using one or two transistors. (A. W., Broadview, S.A.)

● From time to time, we publish articles describing projects intended for beginners. We reprinted an article last month, describing the construction of simple crystal and transistor sets. An article in March, 1966 on breadboard hookups gave descriptions of simple circuits including amplifiers and oscillators. In March, 1969 we published an article describing flashing warning lights which should meet your demand for blinkers. Copies of the articles are available through the Information Service for 20c each.

## "ELECTRONICS Australia" Information Service

As a service to readers "ELECTRONICS Australia" is able to offer: (1) Photographs, dye-line prints and other filed material to do with constructional projects and (2) A strictly limited degree of personalised assistance by mail or by reply through the columns of the magazine. Details are set out below:

**PROJECT REPRINTS:** For a 20c fee, we will supply data, as available from our files. The amount of data available varies but in no case does it include material additional to that already published in the magazine. For complicated projects involving material extracted from more than one issue, an extra fee may be requested. As a rule, requests for project data will be answered more speedily if the projects are positively identified and the request is not complicated by questions requiring the attention of technical personnel. Where articles are not on file, we can usually provide a photostat copy at 20c PER PAGE.

**PHOTOGRAPHS, DYE-LINE PRINTS:** Original photographs are available for most of our projects, from 50c plus 8c postage for a 6in x 8in glossy print. In addition, metalwork dye-line prints are available for most projects for 50c each; these show dimensions and the positions of holes and cut-outs but give no details of wiring.

**BACK NUMBERS:** A fairly good selection is available. On issues up to six months old the cost is the face value, plus 5c surcharge. From seven to 12 months, 10c surcharge; over 12 months, 20c surcharge. Package and postage is 10c extra per issue. Please indicate whether a PROJECT REPRINT may be substituted if the complete issue is not available.

**REPLIES BY POST:** This provision is made primarily to assist readers in matters relating directly to articles and projects published in "ELECTRONICS Australia" within the last 12 months. Note, however, that we cannot provide lengthy answers, undertake special research or modifications to basic designs. A 20c query fee must be enclosed with letters to which a postal reply is required; the inclusion of an extra fee does not entitle correspondents to special consideration.

**OTHER QUERIES:** Technical queries which fall outside the scope of "Replies by Post" may be submitted without fee and may be answered through the columns of the magazine at the discretion of the Editor. Technical queries will not be answered by interview or telephone.

**COMMERCIAL EQUIPMENT:** "ELECTRONICS Australia" does not maintain a directory of commercial equipment, or circuit files of commercial or ex-disposals receivers, amplifiers, etc. We are therefore not in a position to comment on proposed adaptation of such equipment, or on its general design. "ELECTRONICS Australia" does not deal in electronic components. Prices, specifications or other assistance must be sought from the appropriate advertiser or agent.

**REMITTANCES:** These must be in a form negotiable in Australia. Where the charge may be in doubt, an open cheque, endorsed with a limitation, is recommended.

**ADDRESS:** All requests for data and information, as set out above, should be directed to The Assistant Editor, "ELECTRONICS Australia," Box 2728 G.P.O., Sydney, N.S.W. 2001: 5/69



# NEW RANGE OF RESISTORS, CONDENSERS AND POTENTIOMETERS

We have just purchased the complete stock of Resistors, Condensers and Pots. of a large manufacturer and can offer same at less than 25 per cent of list price.

The resistors are mainly I.R.C. and Morganite and are in a wide range of values from 200 ohm. to 3 meg. in 1/4, 1 and 2-watt, also included are I.R.C. 3-watt wire wound 2,200 ohm, 3,300 ohm, 4,700 ohm, etc. List price \$9.00 per 100, our price, \$2.00 per 100, post. and packing 25c extra.

The condensers are in most popular makes and include standard values, including 4mfd, 8mfd, 16mfd, 300V, Polyester, Paper, Mica, Ceramic and Electrolytic in etc. List price \$11.00 per 100, our price, \$2.00 per 100, post. and packing 50c extra.

The potentiometers are all current types and include switch pots, dual concentric, 1 meg. tandem, 1/4-meg. switch, tab pots, etc. post. and packing 50c extra.

**FREE** With each lot of resistors, condensers or pots, we will supply free one new valve-type 6U7G, 6X5GT, IT4, 6K7G. Resistors, condensers and pots are in individuals lists of values or types. packs of 100 or 12 and we regret we cannot supply to



**LEADER SIGNAL GENERATOR LSG11**  
240V A.C. operated, 6-band 120KC to 390 Megs. Provision for crystal. **\$32**  
Post N.S.W., 75c; Interstate, \$1.25.

## USED HIGH-SPEED 240V. AC/DC MOTORS

These 240V A.C. or D.C. motors are 1/8 H.P. with a speed of 7,000 r.p.m. and are ideal for small drills, grinders, etc. Dimensions: 5 1/2 in x 3 1/2 in, with 5/16 in spindle ... \$3.75  
Postage N.S.W., 50c; Interstate, 85c.

## NEW TRANSISTOR 8 KIT SET

SPECIAL PURCHASE ENABLES US TO OFFER THIS KIT SET AT **\$24.00**

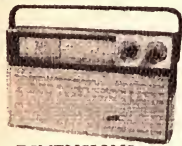

- Complete kit of parts with circuit and full instructions.
- Eight transistors.
- Magnavox 5X3 speaker gives excellent fidelity.
- High sensitivity, suitable for city or, country use.
- Heavy duty battery for economical operation.
- Modern design, plastic cabinet with gold trim.
- Dial calibrated for all States.
- Available in colours of off-white, red, black

DIMENSIONS  
9" x 5" x 3" deep

Postage N.S.W., \$1.25; Interstate, \$1.75.

## NEW 25 AND 35 WATT P. A. AMPLIFIERS



These amplifiers are suitable for installation in clubs, schools, restaurants, factories, etc. Wherever the amplification of speech or music is required.

25 W \$61 SPECIFICATIONS 35W \$71.

- Output impedance Line output (100, 166, 250, 500 ohms)
- Nominal power 25 or 35 watts.
- Inputs two microphone and pick-up radio with separate controls and mixing facilities.
- Tone control.
- Microphone sensitivity 6MV, pick-up or radio 150MV.
- Frequency response 30 to 18,000 CPS.
- Output impedance Line output (100, 166, 250, 500 ohms) or can be supplied with V.C. output (2, 3, 7, 8, 15 ohms).
- Dimensions 11 in x 6 in x 8 in. Weight 25W 23lb, 35W 26lb. Freight extra.

## New Electrolytic Condensers

These condensers are miniature pigtail type insulated new stock in packets of 12, each packet containing: 3 16mfd 300 V.W., 2 32 mfd. 300 V.W., 1 25 mfd. 450 V.W. and 6 low voltage electrolytics. **\$2.50.**

Post and packing 20c extra.

## NEW IMPORTED 4" P.M. SPEAKERS

Available with a 4 or 16 ohm voice coil. **\$2.00.**  
Post and packing 30c extra.

## NEW MINIATURE MOTORS



Ideal for models, toys, etc. 1 1/2 to 3 volts, 6,000 r.p.m. 39c each or \$3.50 per doz. Post 10c.

## NEW ENGLISH and AMERICAN TRANSISTORS AT 1/4 LIST PRICE

Each package of 12 contains 3 each of the following types

|               |             |                       |
|---------------|-------------|-----------------------|
| Mazda XA101.  | Equivalent: | OC45 RF Transistor.   |
| Texas 2N1108. | "           | OC44 OSC. Transistor. |
| Texas 2N1111. | "           | OC75 General purpose. |
| Texas 2N1110. | "           | OC45 R.F. Transistor. |

## PACKET OF 12 FOR \$3.00

THESE TRANSISTORS CAN BE SUBSTITUTED FOR MANY OTHER TYPES.

Post and Packaging 20c extra.

## NEW 240V ELECTRIC MOTORS

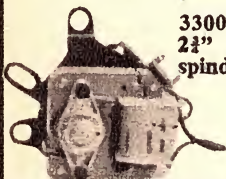

3300 R.P.M. Size 3 1/2" x 2 1/2" x 3 1/2", including spindle.

**\$2.75**

plus 60c postage.



## NEW MIDGET POWER TRANS. \$3.75

40mA prim., 240v. Sec 225 x 225 with 6.3v Fil. Winding. 30mA 240v. Prim. Fil. Winding.

Postage: N.S.W., 25c; Interstate, 45c.

150 x 150v. Sec. with 6.3v.

Postage: N.S.W., 35c; Interstate, 60c. **\$3.75**

**NEW AMERICAN TWIN TELESCOPE TV AERIAL.** Extends to 36in, each section can be used singly for car or portable .. **\$1.50.** Post 20c

**SINGLE TELESCOPIC Aerial,** 12in extends to 33in. 60 cents. Post 10c

## A PREAMP FOR MAGNETIC PICK-UP OR TAPE HEADS

SUITABLE FOR USE WITH THE COLLARO OR B.S.R. TAPE DECKS

Using 3 silicon transistors as featured in October Electronics Australia complete with kit of parts including transistors mono \$7.50, stereo \$13.00, 240 power supply for above \$7.00.

Please specify if required for pick-up or tape heads.



# NATIONAL RADIO SUPPLIES

332 PARRAMATTA ROAD, STANMORE, N.S.W. PHONE 56-7398



# ANSWERS - continued

**FETs, DECIBELS AND SHORT WAVES:** I've been reading your magazine for a few months and have noticed some field effect transistors in one or two circuits. Are the S, G and D electrodes of these the same as the collector, base and emitter of normal transistors? Also could you please explain what are decibels, as I have a multimeter with a decibel scale. Can you recommend an aerial for general short wave reception, and also could you tell me the frequencies of Radio Australia and Radio Peking? Finally, can you tell me whether the die-cast metal boxes used in your projects are readily obtainable, and where. (A.P., Warrnambool, Vic.)

● For a basic introduction to the FET we must refer you to the article published in the February, 1967, issue as part of the "Keeping Up With Semiconductors" series, A.P. We cannot refer you to a recent article explaining the concepts behind and the use of decibels, but we hope to publish an article along these lines soon; until then we can only refer you to one of the standard electronics texts. For general short wave reception we would recommend a "Twin-Doublet" aerial and such an aerial was described in the November, 1963, issue. Copies of the article are available via the 20c Information Service. For the frequency and time schedules used by specific broadcasting systems, including the two you mention, we must refer you to either the stations themselves or to a publication such as the "World Radio Handbook," available from most large bookstores. And finally, die-cast metal boxes as used in certain of our projects are manufactured by at least two firms, Eddystone and S.T.C., and to our knowledge both are available from most trade suppliers.

**STILL PUZZLED:** I have just finished reading the chapter on "Induction" in your book "Basic Electronics." However I am still not very clear as to the nature of an inductor, and would still like to know more about the uses of inductors and transformers. Can you assist? I might add that I have found the book of great value, as far as I have read it. (R.J., Ingham, Qld.)

● Sorry that the chapter concerned didn't answer all your queries, R.J., but as you may appreciate there is a limit to the amount one can cover in the space available. All we can suggest is that

## Worried about "bugs"

**"BUG" DETECTOR:** With the increasing publicity given to "bugs" and their limitless illegal uses, may I suggest that you describe a "bug hunter" in your pages. The unit would be popular among those suspicious of electronic eavesdropping. The device could be a wide-band receiver followed by an audio amplifier to produce acoustic feedback in the presence of a bug. On another subject, it would be helpful if you describe an audio amplifier, possibly built around a battery and a loudspeaker; something like the one in the Therman, for example. It could be used with a variety of devices marked "Break here for audio amplifier." (N.K., Toowoomba, Qld.)

● To be sure, there is a lot of talk about eavesdropping devices (or "bugs") and they feature prominently in television spy and private-eye dramas. Like the radio circuits in many of these dramas, they seem to work amazingly well! In real life, it is quite a problem to pick up intelligible audio in an average semi-noisy reverberant room particularly when the microphone has to be hidden away in a non-optimum place. Then comes the problem of transmitting and

you try obtaining one of the many basic texts on electronics, either from your local library or from a bookstore, and read further. Glad to hear that you have otherwise found the book of value.

**S-METER:** I must congratulate you on an excellent magazine. I would like to turn the tuning meter in my receiver into an S-meter in order to get a better indication of the strength of signals. (L.V., Geelong, Vic.)

● Sorry, but we can't offer individual assistance with your problem. It would involve a detailed knowledge of your receiver and a design exercise to see how a metering circuit could be added which you might be prepared to call an S-meter. A brief article on the subject appeared in "Answer Man" for September, 1965. We have copies of the issue in stock or a copy of the article can be supplied for 20c through the query service. In fact, you may be able to achieve what you require by calibrating your tuning meter so that certain deflections correspond to what are fairly arbitrary definitions of signal strength.

**DECIBELS:** As a younger reader mainly interested in audio equipment, I am confused by your use of "negative decibel" in the specifications panel in each of your projects. I am also confused by the use of decibels in the signal-to-noise ratio, e.g. 54dB with respect to 2.5 watts. Could you explain what is meant by a decibel and how we can have a negative term? (M.S., Regents Park, N.S.W.)

● The decibel (abbreviated to dB) is a unit of loss or gain. It has no absolute value, but is used simply to indicate that a relevant level is above or below a stated reference level by so much. The decibel had its origin in telephone engineering as the result of a need for a system which would relate telephone line losses, expressed in electrical units, to the subjective reaction of the average human ear. The human ear does not respond linearly to audio power. A doubling of audio power does not create a subjective impression of "twice as loud." In fact, the change is only just audible in the majority of cases. A two to one power change represents 3dB, and anything less than this is of little significance. For example, a 2dB change is unlikely to be noticed by the average listener to ordinary program mate-

picking up the usually weak signal from an unobtrusive point close enough for the signal to be heard above the noise. In fact, it is quite difficult to set up an effective eavesdropping system in practical situations and our conviction is that it happens a lot less frequently than you appear to believe. As for the kind of detection device you suggest, you seem completely to have overlooked the fact that the air is filled with powerful television and radar signals, mobile radio and so on — all of them in the VHF spectrum. All of them would trigger or energise an untuned bug far more readily than a weak miniature transmitter. Effective bugging detection more commonly involves a high performance, tuneable receiver, capable of isolating a clandestine signal from among the mass of legitimate ones. We note your suggestion about the audio amplifier. Maybe the one you mention is close to what you are looking for. Terminating a project at "to audio amplifier" sounds attractive but it is a constant source of frustration to those who don't have such an amplifier or who want to build things up as self-contained units.

## HI-FI STEREO SPECIALISTS

MANUFACTURE-SALES-SERVICE  
(Props. C. & B. Rener)

392 Centre Road, Bentleigh, Vic. 3204  
Telephone 97-4832 A.H. 97-5539



### SLEEP LEARNING EQUIPMENT Time Switches 24 Hour

Suits every electrical appliance, ideal for sleep learning.

From \$19.95  
Post 40c.



Pillow Phones with 6ft lead, 3.5mm. plug. \$3.95. Adaptor for phone jack

\$1.00.  
Post 30c.



Endless Tapes. 5in. standard, also special available in 4in. will suit tape recorder up to 7in.

5in. \$9.80.  
Post 40c.



### STEREO EQUIPMENT

Hi-Fi Stereo Belt Drive Player. 2-speed automatic return arm. Less than .15% wow. Less than .1% flutter.

Price \$82.95.  
Post \$1.00.



Synchronous Motor Stereo Player complete with static balance type pipe arm with sub-weight and moving magnet type cartridge. .7 mil. diamond frequency—20—21,000 Hz ± 2db.

Price \$68.25.  
Post \$1.00.

Mail Orders, send postal note, cheque or money order. Please add postage. Inquiries send self-addressed stamped envelope. Our lay-by is at your service. Hire-purchase can also be arranged.



## NEW RH (Radio House) RANGE OF MULTIMETERS

### NEW POCKET SIZE MULTITESTER

LIMITED STOCKS MODEL YT67, \$8.50 POSTED

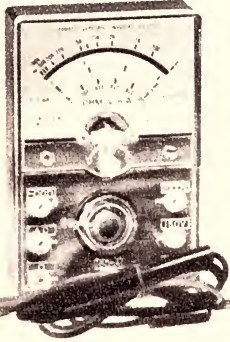

Latest model multitester YT67 now costs only \$8, measures up to 100,000 ohms and continuity.  
 DC volts 0-15, 0-150, 0-1000.  
 AC volts 0-15, 0-150, 0-1000.  
 DC current 150 MA.  
 1,000 ohms per volt, sensitive and clear scale for accuracy. Posted \$8.50 anywhere, with test leads and internal battery complete, ready to use. Size 3½ in x 2½ in.

### Model RH-80 \$18.00 Postage 50c

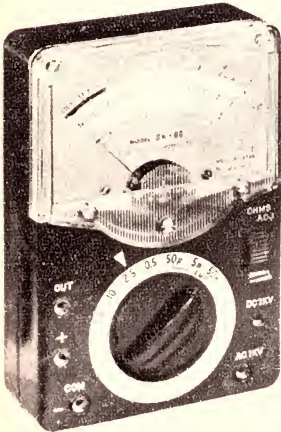

20,000 Ohms per Volt DC  
 10,000 Ohms per Volt AC  
**Specifications:**  
 DC Volts: 0.5, 2.5, 10, 50, 250, 500, 1000 V  
 AC Volts: 10, 50, 250, 500, 1000 V  
 DC Current: 50uA, 5mA, 50 mA, 500 mA  
 Resistance: 5 kΩ, 50kΩ, 500kΩ, 5 MegΩ  
 Decibels: -10 + 62 db  
 Accuracy: DC ±3%, AC ±4% (of full scale)  
 Batteries: Two 1.5V dry cells. Size AA, "Eveready" 915  
 ● Overload-protected by dual silicon diodes. ● Mirror scale.  
 ● Double-jewelled ±2% meter. ● ±1% temperature-stabilized film resistors.

### Model RH-50 \$31.00 Postage \$1.00

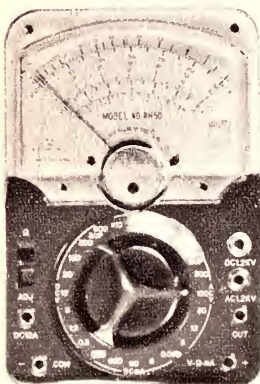

Modern Design. 33 Micro-Amp Meter.  
 300,000 Ohms per Volt D.C.  
 13,000 Ohms per Volt A.C.

#### SPECIFICATIONS

DC VOLTAGES 0-0.25-1-2.5-10-25-100-250-500-1,000 at 30,000 ohms per volt.  
 AC VOLTAGES: 0-2.5-10-25-100 - 250 - 500 - 1,000V at 15,000 ohms per volt.  
 DC CURRENTS: 0-0.5-5-50-500 mA, 0-12 A.  
 Resistance: 0-60K - 6M - 60M (350, 35K, 350K at mid-scale).  
 Decibels: Minus 20 to plus 56dB (0 dB equals 1mW 600 ohms).  
 Audio Out: Capacitor in series with AC Volt ranges.  
 Short Test: Internal buzzer.  
 With leather case \$38.00.  
 Accessory: 1 pr. heavy test leads.

### Model RH-20 \$15.00 Postage 50c

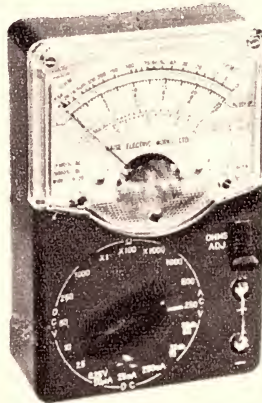

20,000 Ohms per Volt DC  
 10,000 Ohms per Volt AC  
**Specifications:**  
 DC Volts: 0.25, 2.5, 10, 50, 250, 1000 (20,000/V)  
 AC Volts: 10, 50, 250, 500, 1000 (10,000/V)  
 DC Current: 50 uA, 25mA, 250mA  
 Resistance: 7kΩ, 700kΩ, 7MΩ  
 Decibels: -10 +22 (at AC/10V) +20 +36 (at AC/50V). Upper frequency limit 7kc.  
 Accuracy: DC ±3%, AC ±4% (of full scale)  
 Batteries: Two 1.5V dry cells. Size AA, "Eveready" 915  
 ● Overload-protected by dual silicon diodes.  
 ● Double - jewelled ±2% meter. ● ±1% temperature-stabilized film resistors.

### Model RH-55 \$20.00 Postage 50c

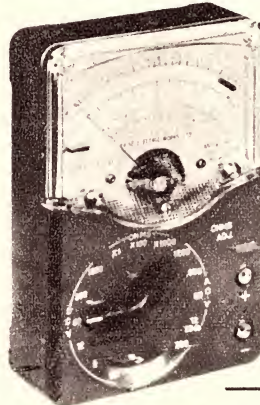

30,000 Ohms per Volt DC  
 14,000 Ohms per Volt AC  
**SPECIFICATIONS:**  
 \*DC Volts: 0.6, 3V, 12V, 60V, 300V, 1200V (30,000 ohms/V).  
 \*AC Volts: 12V, 60V, 300V, 1200V (14,000 ohms/V).  
 \*DC Current: 60 A, 12mA, 300mA.  
 \*Resistance: 10K ohm, 1Meg ohm, 10Meg ohm.  
 \*Decibels: -10 db +23 db.  
 \*Meter Sensitivity: 23 A.  
 ● Overload-protected by dual silicon diodes. ● Mirror scale.  
 ● Double-jewelled ±2% meter. ● ±1% temperature-stabilized film resistors.

### Model RH-60 \$25.00 Postage 50c

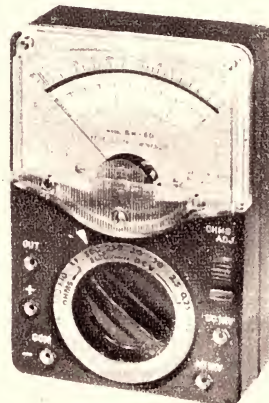

50,000 Ohms per Volt DC  
 10,000 Ohms per Volt AC  
**Specifications:**  
 DC Volts: 0.25, 2.5, 10, 50, 250, 500, 1000 V  
 AC Volts: 10, 50, 250, 500, 1000 V  
 DC Current: 25 uA, 5 mA, 50 mA, 500 mA  
 Resistance: 10 kΩ, 100 kΩ, 1 MegΩ, 10 MegΩ  
 Decibels: -10 +62 db  
 Accuracy: DC ±3%, AC ±4% (of full scale)  
 Batteries: Two 1.5 V dry cells. Size AA, "Eveready" 915  
 ● Overload-protected by dual silicon diodes. ● Mirror scale.  
 ● Double-jewelled ±2% meter. ● ±1% temperature-stabilized film resistors.

#### NOTICE

Our branch shop at No. 6 Royal Arcade will be closed down during rebuilding as from 30th December, 1969.  
 Enquiries at head office 306-308 Pitt St. 26-2817.

# RADIO HOUSE PTY. LTD.

306-308 PITT STREET: 6 ROYAL ARCADE & 760 GEORGE STREET, SYDNEY







# HAM

## RADIO SUPPLIERS Mail Order Specialists

323 ELIZABETH STREET,  
(2 Doors from Little Lonsdale Street)  
MELBOURNE, VIC. 3000  
TELEPHONES: 677329, 674286

|                |        |
|----------------|--------|
| 1B3GT (DY30)   | \$1.45 |
| 1C7            | .50    |
| 1D4            | .75    |
| 1F5            | \$1.00 |
| 1H5            | .75    |
| 1K5            | .50    |
| 1K7            | .50    |
| 1L4            | .50    |
| 1L5            | \$1.00 |
| 1L55           | .50    |
| 1M5            | .50    |
| 1P5            | .50    |
| 1Q5            | .50    |
| 1R5            | \$1.80 |
| 1S2 (DL86)     | \$1.45 |
| 1S4            | \$1.00 |
| 1S5            | \$1.70 |
| 1T4            | \$1.00 |
| 1X2 A/B        | \$1.90 |
| 2D21           | \$1.20 |
| 3S4            | \$1.20 |
| 3V4            | \$1.75 |
| 5AR4 GZ34      | \$2.45 |
| 5AS4           | \$1.30 |
| 5R4GY          | \$2.00 |
| 5T4            | \$1.75 |
| 5U4GB          | \$1.30 |
| 5Y4 (GZ32)     | \$1.50 |
| 5Y3GT          | \$1.20 |
| 5Z3            | \$1.50 |
| 6A8G           | \$2.00 |
| 6AB7 ea.       | \$1.00 |
| 6AC7           | .50    |
| 6AD8 or 5 for  | \$2.00 |
| 6AE8 (X79)     | \$3.50 |
| 6AG5           | .20    |
| 6AG5 or 12 for | \$2.00 |
| 6AG7           | \$1.25 |
| 6AJ5           | \$1.75 |
| 6AKY (EF95)    | \$2.55 |
| 6AL3           | \$1.55 |
| 6AL5           | .75    |
| 6AM5           | .75    |
| 6AM5 or 3 for  | \$2.00 |
| 6AM6 or 3 for  | \$2.00 |
| 6AN7/A         | 1.55   |
| 6AQ5           | \$1.30 |
| 6AR7GT         | \$1.80 |
| 6AU4GT/A       | \$1.50 |
| 6AU6           | \$1.30 |
| 6AV6           | \$1.20 |
| 6AX4           | \$1.50 |
| 6B6            | \$2.00 |
| 6B8            | \$3.00 |
| 6BA6           | \$1.40 |
| 6BE6           | \$1.40 |
| 6BH5           | \$1.35 |
| 6BK8 (EF86)    | \$2.00 |
| 6BL8           | \$1.50 |
| 6BM8           | \$1.60 |
| 6BQ5 (EL84)    | \$1.50 |
| 6BQ6GTB/       |        |
| 6CUG           | \$2.50 |
| 6CUGA          | \$1.50 |
| 6BV7           | \$1.35 |
| 6BX6           | \$1.35 |
| 6BY7           | \$1.95 |
| 6C4            | .50    |
| 6C4 or 5 for   | \$2.00 |
| 6C8            | \$1.00 |
| 6CA4           | \$1.10 |
| 6CA7/EL34      | \$3.00 |
| 6CB6           | \$1.40 |
| 6CD6G/A        | \$4.50 |
| 6CG6           | \$1.50 |
| 6CH6           | \$2.20 |
| 6CK5           | \$2.00 |
| 6CK6           | \$1.40 |
| 6CM5           | \$2.20 |
| 6CQ6           | \$2.20 |
| 6CQ8           | \$1.40 |
| 6CS6           | \$1.30 |
| 6CW4           |        |
| (NUVISTA)      | \$2.75 |
| 6DC6           | \$2.40 |
| 6DC8           | \$1.90 |
| 6DQ6A          | \$2.20 |
| 6DQ6B          | \$2.65 |
| 6DS8           | \$1.80 |
| 6DT6           | \$1.40 |
| 6DX8           | \$1.65 |
| 6EA8           | \$1.55 |
| 6ES6           | \$1.80 |
| 6ES8           | \$1.80 |
| 6FS6           | \$1.25 |
| 6G8G           | \$2.50 |
| 6GV8           | \$1.70 |
| 6GW8           | \$1.70 |
| 6H6GT          | .20    |
| 6HG5 or 12 for | \$2.00 |
| 6HS8           | \$1.50 |
| 6J5GT          | \$1.00 |
| 6J6            | .75    |
| 6J7G or 3 for  | \$2.00 |
| 6J7G or 5 for  | \$2.00 |
| 6J8G           | \$3.00 |
| 6K6            | \$1.00 |
| 6K7            | .50    |
| 6K8GT          | \$1.25 |
| 6K8 Metal      | \$2.00 |
| 6KV8           | \$1.75 |
| 6L6G           | \$2.90 |
| 6L7            | .50    |
| 6M5            | \$1.35 |
| 6N3            | \$1.20 |
| 6N7            | \$1.20 |
| 6N7 or 10 for  | \$2.00 |
| 6N8            | \$1.40 |
| 6Q7G           | \$2.50 |
| 6R3            | \$1.55 |
| 6S2            | \$1.85 |
| 6SA7GT         | \$2.20 |
| 6SC7           | .75    |

|                   |                  |
|-------------------|------------------|
| 6SF5              | .75              |
| 6SF7              | .75              |
| 6SH7              | .50              |
| 6S7 or 5 for      | \$2.00           |
| 6S7 or 3 for      | \$2.00           |
| 6SL7GT            | \$2.00           |
| 6SN7GT            | \$1.00           |
| 6SQ7GT            | \$2.10           |
| 6SS7              | .75              |
| 6U4GT             | \$2.00           |
| 6U7G              | .75              |
| 6U7G or 3 for     | \$2.00           |
| 6U8/A             | \$1.55           |
| 6V4               | \$1.05           |
| 6V4               | \$1.05           |
| 6V6GT             | \$1.75           |
| 6X2               | \$1.25           |
| 6X4               | \$1.00           |
| 6X5GT             | \$1.50           |
| 6Y9               | \$1.90           |
| 7A8               | .35 or .75       |
| 7C5               | 8 for \$2.00     |
| 7E6               | .50 or \$2.00    |
| 7H7               | .50              |
| 7W7               | .50              |
| 9A8               | \$1.90           |
| 9U8               | \$1.75           |
| 12A6              | .50 or \$2.00    |
| 12A7              | .50 or \$2.00    |
| 12A7              | .50 or \$2.00    |
| 12A7              | \$1.50           |
| 12A7              | \$1.45           |
| 12A7              | .75              |
| 12A7/ECL83        | \$1.60           |
| 12BE6             | \$1.75           |
| 12BY7/A           | \$1.75           |
| 12C8              | .50              |
| 12J5              | .50              |
| 12S4GT            | \$1.00           |
| 12SC7             | .50              |
| 12SH7             | .50              |
| 12SK7             | .50              |
| 12SN7GT           | \$1.00           |
| 12SR7             | .50 or \$2.00    |
| 16A8              | \$2.00           |
| 16E6              | \$1.00           |
| 19                | .50              |
| 30                | .50              |
| 42                | \$2.50           |
| 47                | .50              |
| 57                | .50              |
| 78                | \$1.00           |
| 80                | \$1.50           |
| 100TH             | \$3.00           |
| 717A              | \$1.25           |
| 807               | \$1.00           |
| 808               | \$1.00           |
| 832A              | \$7.00           |
| 866A              | \$1.00           |
| 954               | 5 for \$2.00     |
| 955               | .50              |
| 956               | .50              |
| 958A              | 50c or \$2.00    |
| 1625              | 5 for \$2.00     |
| 1629              | .50              |
| 5636              | .75              |
| 9006              | 25c or \$2.00    |
| 10C7              | 10 for \$2.00    |
| BA50              | 12 for \$1.00    |
| ECC35             | \$2.00           |
| ECH35             | \$2.00           |
| EF85/6BK8         | \$2.80           |
| EL34 (6CA7)       | \$3.00           |
| EM84              | \$1.50           |
| EY91              | .50              |
| KT61              | \$3.90           |
| KT66              | \$4.75           |
| KT88              | \$5.50           |
| RL18              | 75c or \$2.00    |
| UL41              | \$1.00           |
| VR150 (Volt Reg.) | \$1.25           |
| 2D21              | \$1.20           |
| 2E26              | \$4.60           |
| 2X2/879           | .75              |
| 6CW4              |                  |
| NUVISTA           | \$2.75           |
| 75C1 Volt. Reg.   | \$4.75           |
| Reg.              | \$2.25           |
| 100TH             | \$3.00           |
| 90C Volt. Reg.    | \$2.50           |
| 108C1/0B2         | \$2.50           |
| 150C4/OA2         |                  |
| Reg.              | \$1.65           |
| 832A              | \$7.00           |
| 866A Reg.         | \$1.00           |
| 807               | \$2.00           |
| 884               | \$2.85           |
| 885               | \$2.85           |
| 2051              | .50              |
| 5765              | \$2.55           |
| 6148A             | \$2.95           |
| 6146B             | \$6.25           |
| OA2/150C4         | \$1.65           |
| OB2/108C1         | \$2.50           |
| QEO3/10           | \$2.55           |
| QEO3/12           | \$2.00           |
| QEO3/20           | \$1.70           |
| QEO6/40           | \$12.95          |
| QVO4/7            | \$1.50 or \$3.75 |
| 3 for             | \$3.75           |

ALSO OTHER TYPES AVAILABLE, P.O.A.



**MODEL OL-64D MULTIMETER**, 20,000/OPV, DC Volts: 0-0.25/1/10/50/250/500/1000V at 20K/OPV, 5000 volts at 10K/OPV, AC Volts: 0-10/50/250/1000V at 8K/OPV, DC/A: 50uA/1mA/50mA/500mA/10 amps. RESISTANCE: 0-4K/400K/4M/40Megohm, DB Scale: —20 to plus 36db. Capacitance: 250pF to .02uF, Induct. 0-5000H, size: 5 3/4 x 4 1/8 x 1 3/4 in.  
**PRICE: \$19.50 post 30c.**



**MODEL 200H MULTIMETER**, 20,000 opv, DC Volts: 0-5/25/50/250/500/2500V (20,000 opv) AC Volts: 0-15/50/100/500/1000V (10,000 opv) DC/Amps: 50uA/2.5mA/250mA, Resistance: 0-60K/6M ohm centre 300 ohm—30K ohm. Capacitance: 10uF to .001uF/.001uF — .1uF, D3 scale 20 db to plus 22 db. Size 4 1/2 x 3 1/4 x 1 1/8.  
**PRICE: \$11.25 post 30c.**



**NEW MODEL US-100**, Overload protection, Shockproof Movement, polarity switch DC volts: 0.25/1/25/10/50/250/1000V (20K/OPV AC Volts: 0-2.5, 10/50/250/1000V (5K/OPV), DC/Amps: 1mA/25mA/500mA and 10A, AC/Amps 10A, RESISTANCE: 0-50M/ohms (centre scale 50) R X 1/10/100/1K/10K, db scale —20 to plus 10 plus 22/plus 35/plus 50db.  
**PRICE: \$28.75 post 40c. Mirror Scale**



**MODEL C-1000 POCKET MULTIMETER**, 1000 ohms/per Volt, AC Volts: 0-10/50/250/1000 (1000 opv) DC Volts: 0-10/50/250/1000 (1000 opv), DC Current: 0-100mA, Resistance: 0-150K ohms (3K centre), 2 colour scale, Range Selector Switch, Dimens.: 3 1/2 x 2 1/4 x 1 in.  
**PRICE: \$6.50 post free**



**MODEL C1500 MULTIMETER**, 20,000/OPV, DC Volts: 0-2.5/10/50/250/500 5000V (20K/OPV) AC Volts: 0-10/50/250/500/1000V (10K/OPV) DC/Amps: 5uA/5mA/50mA/500mA, RESISTANCE: 0-12K/120K/1.2Meg/12Megohms, (scale centre: 60, 600/6K/60K, DB scale: —20db to plus 62db (5 ranges), Size: 5 1/2 x 3 5/8 x 1 3/4 in.  
**PRICE: \$14.95 post 30c.**



**MODEL CT330 MULTIMETER**, 20,000/OPV, DC Volts: 0-6/6/30/120/600/1.2K/3K/6K Volts, AC Volts: 0-6/30/120/600/1.2K Volts (10K/OPV), DC/Amps: 10-0.06/6mA/60mA/600mA, RESISTANCE: 0-6K/600K/6M/60M/600Megohm, (30, 3K/30K/300Kohms) centre scale: Capacitance: 50 uf to .01 uf .001 to 0.2 uf, Decibels: —20 to plus 63db size approx: 5 1/2 x 3 5/8 x 1 3/4.  
**PRICE: \$16.75 post 30c.**



### NEW LAFAYETTE SOLID STATE HA600 RECEIVER

5 BAND AM/CW/SSB AMATEUR AND SHORT WAVE. 150 Kc/s—400 Kc/s, and 550 Kc/c—30 Mc/s. F.E.T. front end • 2 mechanical filters • Huge dial • Product detector • Crystal calibrator • Variable BFO • Noise limiter • S Meter • 24in Bandspread • 230V A.C./12V DC, neg. earth operation • RF gain control. Size 15in x 9 3/4in, 8 3/4in, Wt. 18lb. S.A.E. for full details.  
**PRICE \$199.50**



### "KEW" KYORITSU MO 65 METERS, NEW

Size: 3 1/4 inch, mounting hole 2 1/2 inch, 1 1/2 inch deep.  
All plus Postage 20c.  
1 mA, 5 mA, 10 mA, 25 mA, 50 mA, 100 mA, 150 mA, 250 mA, 500 mA.  
**\$4.50**  
1 amp DC . . . . . \$4.50  
5 amp DC . . . . . \$4.50  
10 amp DC . . . . . \$4.50  
30-0-30 amp DC . . . . . \$5.25  
15v DC, 30v DC, 300v DC . . . . . \$4.50  
300 volts AC . . . . . \$5.50



### STEREO HEADPHONES

Large rubber earpiece, full audible frequency, 100-15,000 cycles.  
**\$9.00 inc. Tax.**



1 1/2 x 2 1/4 inch square, clear plastic face, 2 1/8 inch mounting hole, 3/4 inch deep.  
50 uA . . . . . \$5.75 15 volts d.c. . . . . \$5.50  
100 uA . . . . . \$5.75 25 volts d.c. . . . . \$5.50  
500 uA . . . . . \$5.25 500 volts a.c. . . . . \$5.50  
1, 5, 10, 20, 50 "S" Meter . . . . . \$5.75  
250 and 500 mA . . . . . \$5.00 "VU" Meter . . . . . \$6.50



MR3P 3 3/8 inch square, clear plastic face, 2 3/4 inch round mounting hole, 1 1/2 inch deep.  
50 uA . . . . . \$7.00 50-0-50 uA . . . . . \$5.75  
100 uA . . . . . \$6.75 15 volts d.c. . . . . \$5.75  
500 uA . . . . . \$6.50 25 volts d.c. . . . . \$5.75  
1, 5, 10, 25, 50 30 volts a.c. . . . . \$5.75  
100, 250 and 500 mA . . . . . \$5.75 "VU" Meter . . . . . \$8.25

### S.W.R. METERS, MODEL KSW-10

Specifications.—Standing Wave Ratio: 1:1 to 1:10. Accuracies: Plus or minus 3 per cent. scale length. Impedance: 52 ohms and 75 ohms. Meter: 0-100 DC microamperes.  
**Price \$19 Inc. tax.**



# ANSWERS - continued

**PAT ON THE BACK:** Just a few lines to compliment you on the standard of "Electronics Australia," especially over the last few months. It is well worth the 40c. I enjoy Arthur Cushen's notes each month, "Serviceman," "Forum," "Editorial" and all technical articles I find compulsive reading. I hope you carry on the present run of articles using solid-state techniques, even to a full receiver using transistors. There have been one or two articles in overseas receivers about replacing valves in older receivers with solid state "modules." Would E.A. be in a position to do some work along these lines? The new layout of your magazine is a pleasant change too. The feature articles in front make good reading. In all, a fine effort. (P.C., Plangil, Vic.)

● That's praise indeed; thank you. We have every intention of pressing on with solid-state devices, and a full high-performance transistor receiver is a definite long-term objective. We are not too optimistic about solid-state modules in place of valves. There could be no "universal" replacement modules.

**KITS OF PARTS:** After many years I have again taken up the hobby of radio and stereo. I have bought the latest issues of "Electronics Australia" and am keenly interested in all the subjects covered by your magazine. How do I find out what kits are available to make up the various circuits you describe. I am interested in April's "Micro Plus" and May's "Playmaster 124." (A.A.H., Chiffley, A.C.T.)

● Welcome back, A.A.H., we are pleased to learn of your renewed interest in electronics. To find out what kits of parts are available, check the announcement by various advertisers. Several of our regular advertisers offer kits of parts but, if none is offering the parts for the particular project you are interested in, write to them and ask for a quote. We feel sure that these firms will be only too pleased to help.

**AMATEUR RADIO:** I am an electrical apprentice and I would like to get started in amateur radio. Are there any clubs which I could join? Can you help me with details for transmitters and receivers and how much would these cost? (P.J.W., Banyo, Qld.)

● There are many clubs in existence for amateur radio enthusiasts, many of them affiliated with the Wireless Institute of Australia. We suggest that you get in touch with the Secretary of the Queensland Division, in Brisbane, who should be able to help you. If you give us more details of the type of transmitter and receiver which you need, such as bands to be covered, etc., we may be able to help you with designs which we have published. We are not able to give

prices and you are advised to contact your electronics supplier for this information after you have gained a better idea of the kind of thing which you may want.

**P.A. AMPLIFIER:** Have you ever published a circuit for an amplifier suitable for use with a moderately large P.A. system? (B.F., Brisbane.)

● We have described a wide range of P.A. amplifiers over the years ranging from a few watts to 100 watts, using both valves and transistors, and designed to operate from mains or batteries. It would also be useful to know such other information as the type of microphone(s) likely to be used, whether mixing facilities are required, and what other inputs are likely to be needed. Incidentally B.F., we like all letters to contain the full name and address of the sender, not necessarily for publication, but as evidence of good faith.

**DIGITAL INSTRUMENTS, SOLID STATE TAPE UNIT:** I noticed in the "Answers to Correspondents" pages, a few months back, reference to planning for such interesting future projects as a digital voltmeter and a fully solid-state equivalent to the "Playmaster 119" Tape Adapter. Are these projects likely to be described soon? I would also like to see a main amplifier-control unit version of the recent "10 Plus 10" stereo amplifier, with somewhat more pretentious tone controls. A digital-readout camera shutter timing unit would probably also prove popular. Incidentally designs for simple digital instruments have appeared in recent issues of a popular U.S. electronics magazine. (D.B., Millaa Millaa, Nth. Qld.)

● Although some progress has been made regarding both the planned projects to which you refer, D.B., it is still a little early for us to say when we may be able to publish the details. In both cases we are hastening slowly with the idea of exploring as many possibilities as we can, and arriving thereby at the most attractive designs from both the performance and economic viewpoints. We ourselves have been considering a new main amplifier-control unit stereo amplifier along the lines you suggest, and we may be able to come up with a design in the near future. A camera shutter timing unit is certainly also worth considering, and could well incorporate digital counting and display techniques. No promises, but we will see what can be done. Finally, thanks for your interest in supplying the information regarding articles dealing with digital instruments. We have in fact seen and read the articles concerned, and may be able to use one or two of the ideas incorporated.

## The origin of "SOS"

Although in most cases it is commonly stated that the significance of the above three letters is "Save our Souls," or "Save our Ships," this definition did not occur to the minds of the members of the Wireless Telegraphy Conference held at Berlin in 1906 when the well-known distress signal was adopted. The first suggestion that a special combination of letters should be used by any ship in need of assistance was put forward by the Italian delegates to the preliminary Wireless Conference held at Berlin in 1903. It was then proposed to adopt: SSSDDD, and instructions were to be given to all ships that, in the event of such a signal being received, telegraphic traffic should be immediately stopped.

The other delegates present at this conference agreed to the proposal, in principle, and the final decision was to be left to a special conference. Shortly afterward, however, the Marconi Co. recognised the necessity of the immediate adoption of some special signal to meet the case, and on February 1, 1904, definitely instructed their staff to use the famous CQD, the last letter, coupled with the signal CQ, to indicate danger.

In 1906, in Berlin, the German Government suggested that ships in distress should broadcast the letters SOS, and this was immediately accepted by the Wireless Telegraphy Conference.

The letters were not chosen at random, but on account of the ease by which they could be transmitted, the simplicity of the signal presenting the least possibility of errors. (From "Wireless Weekly," October 22, 1926.)

# ELECTRONIC DESPATCH

P.O. BOX 149, AUBURN 2144  
9-1 DAILY AND SAT.  
16 SHERIDAN ST., GRANVILLE,  
MAIL ORDERS WELCOME

Add postage please.  
We have on view at keen prices, a huge range of Radio, Electronic, Military and Industrial Gear. Computer parts and cabinets, Test Gear, Meters, Oscilloscopes, Communications Receivers and Transceivers. Our 5c and 10c Tables offer 1000s of bargains for your selection. In addition, new stocks of valve semiconductors and components for project builders are held in stock in an increasing variety.

**NEW STOCKS UJTs, FETs, etc.—**  
PROGRAMMABLE UJT D13T1 \$1.20  
FET MPF105 2N5459 \$1.20  
REF. SWITCH HAMILTON DRG2 1A 80c  
PHOTOCELL Cds PHILLIPS LDRs 60c

**COMPUTER BOARDS**  
10c per Transistor, 21c per diode, other parts free. We supply boards to cover the value of your order (min 50c and 10c p.p.).

**NEW TEST EQUIPMENT**  
SE250 SIGNAL INJECTOR \$4.50  
SC2 TRANSISTOR TESTER \$30.00  
TE1 GRID DIP METER \$34.00  
HM50 R.F. Field Strength Indicator \$8.00  
HM55 R.F. Frequency Indicator \$8.00  
SE200 MINILAB TESTER with 200 uA meter provides seven test functions in the one unit: (1) Resistance substitution, (2) Capacitance subst. (3) R.F. signal generator, (4) Audio gen. (5) DC volts and (6) AC volts, 4 ranges to 500V (7) R.F. field strength indicator. Compact 6in x 3in x 3 1/2in. Ten left at \$15.00

**192-264V INPUT GIVING 240V PLUS/MINUS 5 PER CENT AT 10A USED. ELIMINATE COUNTRY TV FADE OUT. UNUSED IN ORIGINAL PACK. FEW LEFT AT \$25.00**

**SOUND ACTUATED DEVICES, MODEL CONTROL.**  
etc. need these Frequency Selective Reeds, responding only to inputs within 2 per cent of resonant frequency, they provide an output to trigger any response function. Four types: 152, 170, 289, 322 Hz. With data sheet \$1.00

**16-PIN PRINTED CIRCUIT EDGE CONNECTORS**  
for cards, vero-board, etc. 0.15in pitch 50c as above, 8in one block \$3.50.

**AXIAL FLOW FANS**  
PABST TYPE for cooling equipment, ventilation, etc. Easy to mount 5in x 5in x 2in, 240V 2800rpm 100cfm \$5.00. Ex computers.

**PANEL SWITCH**  
with THERMAL O'LOAD cutout 2 1/2in x 5/8in at panel front, 2 1/2in deep. Range from 1/2 to 8 amps. Each has limited adjustment. Ex computer. 60c each.

**TRANSMITTER**  
TWIN CHANNEL by TEC. Mod. 1651 2-10meg could be modified to 20meg ft high 19in rack, panel enclosed all round with blower cooling in original packing case, unused, unmarked. \$350. Handbook avail. from TEC.

**RADIO TELEPHONE**  
Model 1650 by TEC. 2.5-10meg AM (A3) 50w. Comprises four 19in rack mtg. chassis. (1) Xmitter. (2) Receiver. (3) Selective calling unit. (4) 240V Power Supply. The four units complete with set new valves incl. 2x 6QE06/10. \$100.00. Spares (1) \$35.00 (3) \$15 (4) \$25. Valves extra. Handbook available for inspection. Unused as received from P.M.G.

**BELL WIRE**  
Hook up, phone, etc. 1 x .036 copper PVC. Suitable for outdoor extensions, etc. 40 yards twisted pair or 80 yards single, either type \$10 per coil. Many colours. Small lots 11c per single wire yard.

**HIGH VOLTAGE**  
SINTERCELS. Small tubular Selenium Rectifier stacks for HV low current supplies. All new stock.  
K3-20 2040P1V 1mA 15c; K3-20 1360P1V 1mA 10c; K3-70 4760P1V 1mA 20c; N8-15 1020P1V 5mA 20c; N8-50 3400P1V 5mA 25c.

**EXCESS STOCK**  
Components to clear. New resistors 1w wirewound, 200, 320, 500, 1000 (min 5) 2c ea. Polyfol caps, modern type, .68, .068, .22 5c ea. 5 amp glass automotive type fuse (min 5) 2c ea.

**VACUUM CONDENSERS, 10pF 32KV, \$6.00**  
**VACUUM CONDENSERS, Adjustable 25-500pF 15KV \$50.00**  
**CRYSTAL OVEN with 710 KHz crystal, A.W.A. \$25.00**  
**HEAT SINKS, Ribbed for TO5s 10c**  
**MICROPHONE CARBON INSERTS 10c**  
**MICROPHONE XFORMER Low-HI 25c**  
**VOLTAGE DEPENDENT resistors 10c**  
**Elapsed Hour Meters, 230V \$5.00**  
**CHASSIS SHOCK MOUNTS 30c**  
**Power Rheostats 25w 5K, New \$1.50**  
**TELEPHONE INDUCTION COIL 15c**  
**SPEAKER XOVER NETWORK \$2.50**  
Capacitors 4wF 400V Block  
Capacitors 2uF 200V Tubular or Block  
VERNIER DIAL No. 11 set precision 20c  
CARPENTER RELAY NEW \$4.00  
CARPENTER EX EQUIPMENT \$2.50  
Fuses Sylvania, Rear Mtg 5A 10c  
RF Choke 6-10 mH adjust 10c  
Polar Trimmers Ceramic Base 100pF 60c  
Polar Trimmers 25pF 40c 15pF 30c



**SOUND PROJECTORS**

Cinevox Prefect and Harmour and Heath 16mm in good working order. 240w operated, complete with speaker and amplifier. **from \$90.00**

**CIRCULAR SLIDE RULE**

3 3/4in diameter. Will do the same work as the conventional slide rule. Instruction book included.

**\$1.25 each**  
Post 10 cents.

**REFLECTOR GUNSIGHT**

Contains these lenses:

- 1 Lens 1in Focus, 1 1/2in diam.
  - 1 Lens 1 11/16in Focus, 1 1/4in diameter.
  - 1 Air-spaced Lens, 1 1/4in diam.
  - 1 Filter Lens, 1 Graticule.
  - 1 Lampholder. **\$1.85**
- Post.: N.S.W. 30c; Interstate: 40c.

**P.M.G. TYPE TELEPHONES**

Standard desk type with magneto bell calling device. Range 30 miles. Uses standard batteries at each phone. Any number can be connected together on single line. **\$23.00**

**(2 TELEPHONE SETS)**

30c cartage to rail. Freight payable at nearest attended railway station.

Please note we are now able to include 1/2 mile of telephone cable FREE with each set of Phones.

**BATTERY CHARGERS**

240 volt A.C. Input. Each battery Charger will charge either 6 or 12 volt batteries.

- 2 amp. without meter, **\$13.75**
- 2 amp. with meter, **\$15.75**

Post N.S.W. 70c; Interstate 95c.

**MINIATURE ELECTRIC MOTORS**

1 1/2 to 3 volts D.C. Ideal for model boats, cars, planes, etc. Strong torque. Only **65 cents each** or **10 for \$4.00.** (Post 7c).

**TRANSCIVER**

(2-way radio) R.C.A. America RT 68, 24 volt, operated 10 watt output 38-54 megacycles F.M. crystal locked. Transmitter and receiver using frequency synthesiser in 100 K/c/s: step 10 channel per meg cycle with power supply. Leads, mike and headphones **\$45**, 60c cartage to rail. Freight payable at nearest attended railway station.

**TRANSCIVER**

(2-way radio) 62 set ideal small ships, Hams, etc. 1.6 to 10 mgs. Crystal locked or V.F.O. controlled 5 watt output. Complete with antenna, headphones and mike **\$60**. 60c cartage to rail. Freight payable at nearest attended Railway Station.

**HEAD PHONES**

Low impedance moving coil fitted with rubber muffler to reduce external noise, fitted with press to talk, dynamic hand microphones. Ideal for use with all types of transceivers. **\$3.50 pair**. Same with black felt muffler, **\$4.50 pair**. Post N.S.W 25c; Interstate 30c.

**12 VOLT D.C.**

DESYNN INDICATOR AND TRANSMITTER UNIT. Suitable for aerial rotation indicator, etc. 0-360 deg., weatherproof mountings. **\$5.00 per set**. Postage: N.S.W., 95c; Interstate \$1.67.

**16'6" WHIP AERIALS**

6-Piece, brand new, **\$5.75**, 60c cartage to rail. Freight payable at nearest attended railway station.

**AVO MULTI METER**

Type CT 38 **\$75.00**

**A.W.A. AUSTRALPHONE**

Transceivers 12 V New Complete Station. 1.6 to 10 mgs on transmit. 0.54 to 16 mgs on receive. **\$150.00**

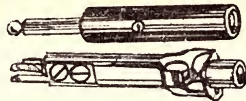

P.M.G. Phone Jack and plugs, 25c each, 45c the pair. Post 7c.

**NIFE CELLS**

1.2 Volt fully charged, 4in x 3in x 1in 4 AH. **\$1.00 each**. Post, N.S.W., 25c; interstate 35c.

**WALKIE TALKIE TWO-WAY RADIOS**

P.M.G. Approved Citizen Band. 9 Transistor. **\$79.00 per set of 2**. Post, N.S.W. 50c; Interstate, 60c.



P.M.G. TYPE KEY SWITCHES. 45c each. Post, 15c.

**BC 221 Frequency Metres \$55.00**

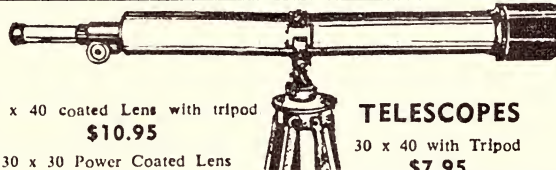

45 x 40 coated Lens with tripod **\$10.95**

30 x 30 Power Coated Lens Brand new. **\$3.75**

60 magnification with a 60mm coated objective lens. With tripod. **\$23.00**

As illustrated.

Postage, 95c; Interstate \$1.20.

**HIGH STABILITY RESISTORS**

1.R.C. brand new, usually 80c ea. 50 assorted values for only **\$3.75**. Post 15c.

**RECEIVER 8C A.W.A.**

With ABC and D Coils. Complete with all spares. **\$90.00**

**522 TRANSCIVERS**

100 to 150 m/cs. **\$35.00**

**TYPE S POWER SUPPLY**

(240 Vac supply for AT 5-ARB) suit most types of Disposal transmitters and receivers outputs 250 volt, 10ma 550 volt 200ma, 300 volt 100ma, **\$30.00**

**TELEPHONE WIRE**

21 gauge copper, plastic covered. Ideal telephone or bell wire. 1,320ft coil of twin (equal 1/2 mile) **\$7 per coil**. Post, N.S.W. 70c; interstate \$1.20.

**SCOOP PURCHASE**

Gramo Motors. New. Made in U.S.A. 4-speed 240 volt A.C. 50 c/c. Only **\$2.75 each**. Post, N.S.W. 30c; interstate, 40c.

**CO-AXIAL SWITCH**

70 ohms 4 positions, can be motor driven completely waterproof 70 ohms type connectors. Housed in metal case 9in x 8in x 8in \$5.00 each. Post N.S.W 70c. Interstate \$1.20.

**MOBILE**

**2 WAY RADIOS**

PYE 70 to 85 M/C.S. 6 Volt Operated. 3 mobiles. 1 base station 240 VAC **\$80 THE LOT**

**VALVES BRAND NEW IN CARTONS**

Special discount for quantity

|        |        |       |        |
|--------|--------|-------|--------|
| 807    | 75c    | X61M  | \$2.20 |
| 65N7GT | 95c    | CV850 | \$1.50 |
| 8989   | \$1.00 | 1H6G  | 30c    |
| 5U4G   | 95c    | 832   | \$5.00 |
| 77     | \$1.00 | 6AK5  | \$1.50 |
| EF50   | 35c    | 6X4   | \$1.00 |
| 6U7    | 75c    | 12SK7 | 50c    |
| 5Y3    | \$1.75 | VR65  | 25c    |
| 6C4    | 50c    | VT4C  | 75c    |
| 2 x 2  | 75c    | AU5   | \$1.00 |
| 6AG5   | 80c    | 80    | \$1.25 |
| 12AU7  | \$1.00 | 6AK5W | \$1.50 |

**CATHODE RAY TUBES**

|           |        |        |        |
|-----------|--------|--------|--------|
| 3FP7      | \$2.95 | 5BP1   | \$3.50 |
| 3J1       | \$2.95 |        |        |
| V1669 4/1 | \$2.95 | CY2184 | \$2.95 |

**PLEASE ADD POSTAGE ON ALL ARTICLES**

**TELESCOPES**

30 x 40 with Tripod **\$7.95**  
Post N.S.W., 70c; Interstate \$1.20

**INSULATION TESTER**

Type C.T. 91 Will test up to 15,000 V. Complete with all leads connectors. Top grade power supp, with E.H.T. low and high power complete with indicator unit and 45 KV and 250 mu meters. **\$150.00**

**C.M.A. CABLE**

240 volt 3/036 black, new and perfect, 100yd rolls **\$3.00**; 6 or more. 30c cartage to rail.

Frequency Counter Cintel type 388, **\$250.00**

VIBRATORS, 6 volts, 7-pin 75c each.

UNISELECTORS, 4 BANK, **\$4.00** Post, N.S.W., 25c; interstate, 30c.

INSTRUMENT TRIPODS, sturdy, wooden frame. Telescope. Extend to 4ft 6in **\$13.00**

SELSON MOTORS MAGSLIP Mk. II **\$5.25 ea.**

No. 19 TWO-WAY RADIOS Sold a sis without power supply, leads, accessories, etc. Only **\$15**. Or complete with above gear, **\$35**.

**BINOCULARS**

PRISMATIC. Coated Lenses Brand new. Complete with case.

- 8 x 30 **\$18.75**
- 7 x 50 **\$22.15**
- 10 x 50 **\$23.07**
- 12 x 5 **\$23.95**
- 20 x 50 **\$26.50**

Post, N.S.W., 70c; Interstate, \$1.20

**3000 TYPE RELAYS**

P.M.G. 200 Ohm — 1,500 Ohm Coils, **\$1.25 each**.

**A.W.A. AMPLIFIERS**

240 VAC with pick up Terminal. Used in good order Ex Studio. **\$15.00**

**MINE DETECTORS**

Ex A.M.F with Instruction Book. Complete in wooden case. Ideal for plumbers, councils for locating buried pipes, etc. Freight payable at nearest attended railway station. **\$39.00**

**4 DIGIT RELAY COUNTERS**

50-volt D.C., suit slot car. Lap counters, etc. **\$1.25 each**. Post 13c.

**ALTEC STUDIO MICROPHONES**

639B Western Electric, top grade, original cost **\$250**, ideal Broadcast Studio, music recording, Church and play recording, etc. Fraction of original cost. Price on Application.

**240 VOLT**

**522 POWER SUPPLY**

Supplies all necessary voltages to operate 522 transceiver from 240 V A.C. Complete and ready to plug in **\$30.00**.

SPECIAL lucky dip valve offer. 15 new valves in cartons for only **\$2.00**. We haven't got time to sort them. So you reap the benefit. Post 60c.

**SOLENOIDS**

Plunger Type 12V 300M.A. Suit electric camera control, miniature trains, radio, etc. **\$1.25**, Post, 10c.

200 Mill. amp., 24 volt, 1/8in push movement. **\$1.25**, Post 10c.

**LENSES**

TOP GRADE ACHROMATIC 2in DIAMETER, 20in FL. Ideal as telephoto lens, telescope objectives. **\$13**. Postage 46c.

**CONDENSER LENS**

2 1/2in DIAM, 2in FL. **\$1.50 each** or **\$2.50 per pair**. Post 21c.

**CONDENSER LENS**

1 1/2in diam. 1 1/2FL. **50c each**. Postage, 17c.

**FOUR CHANNEL BRANCHING AMPLIFIER**

With 4in Vu, meter GLORAD. Complete with Portable Power Converter. 600 ohm balanced input and output. Ideal for outside broadcasting, etc. **\$39.50**

**MONITOR SPEAKER UNIT**

Ex-A.B.C., consisting of low resistance 8in speaker in Acoustic Labyrinth Baffle Box, complete with 10-watt amplifier, 600 ohms plus 8dbm input, 240 volt A.C. operated. **\$37.50**

**TEN CHANNELS VHF TRANSCIVER**

Types TR1934 100-125 meg/cyc. and TR1935 125-150 meg/cycles. 28 volt DC operated AM single crystal locks both TX and RX on same channel complete with generator. **\$33.00**

**RECORDING TAPE**

EX-GOVERNMENT SURPLUS STOCK. Topgrade. 600ft on 5in spool, **\$1.45**, post 13c. 150ft on 3in spool, **65c**, post 9c.

**TELEPRINTER PAPER TAPE**

8 1/4in x 6 5/8in Full Page **\$1.50 per roll**.

**WHEATSTONE BRIDGE**

Top grade In Multiples up to 1000 **\$65.00**

**Deitch Bros.**

70 OXFORD STREET, SYDNEY, 2010

SORRY, NO C.O.D.



# A LAMB TYPE NOISE SILENCER

(Continued from page 69)

brought in and adjusted for optimum effect the noise was virtually eliminated and the audio restored, with breaks corresponding to the noise pulses. In short, a completely readable signal.

The next test was under similar conditions but the signal level was increased to 200uV. With the stronger signal, the interference, while being very noticeable, did not over-ride the signal and the interference could have been tolerated. However, with the silencer brought in, the interference was greatly reduced, making it still worth while.

For the next test, we turned off the modulation on the generator and set the receiver for CW or SSB reception. With 20uV input and the BFO set to give a beat of about 1KHz, the

noise was sufficient to make the signal practically unreadable. The silencer was then brought in and the signal reappeared in a completely readable condition. With an increase of signal level to 200uV, the results were rather similar to that for the AM condition. All the above tests were carried out with a pulse repetition rate of 100pps.

Similar tests were carried out with pulse repetition rates between 8pps and 1000pps. The effectiveness of the silencer is more complete at the lower rates, with a buzz becoming more noticeable as the repetition rate is increased. The maximum rate at which the silencer is effective is of the order of 1000pps. The buzz is due to holes which are punched in the signal at the rate of the interference. With noise

of a random nature, this buzz would not be present as such and is much less noticeable.

To sum up, we have checked the silencer on AM and SSB signals. The effect on AM is very good, and on weak SSB signals little short of miraculous. It means that signals can be copied comfortably, which before were barely audible or not audible at all under severe noise conditions. We are of the opinion that the addition of this silencer to any receiver not already so equipped, is more than worth the effort involved.

## REFERENCES:

Lamb, J. J., "A Noise Silencing IF Circuit for Superhet Receivers," QST, February, 1936.

Hoover, Herbert, jun., "Minimising Interference from Loran on 160 meters," QST, January, 1963.

Fundamentals of Single Sideband, Collins Radio Co., 1959. ■

# APOLLO MISSION COMMUNICATIONS

(Continued from page 15)

compartment of the descent stage after landing.

The two VHF in-flight antennas are also omni-directional, right-hand circularly polarised radiators. An 8-inch conical monopole with 12-inch radials is used between the LM and the space-men equipped with the PLSS. The monopole is mounted on the top of the LM and is erected by an astronaut after landing the LM.

Summing up the communications system aboard the Lunar Module, it might be said that flexibility is the by-word, for in nearly every respect, redundancy of function has been "engineered-in."

Without waxing too poetic, it might be said that despite the superficial ugliness of America's "Spider in the Sky," its real beauty "lies in the harmony of man and his industry" that it represents. ■

# NOTES and ERRATA

CRYSTAL DRIVE CLOCK UNIT, Part 2, July, 1969, page 43. The copper pattern is not transposed, as suggested in the blockline. It is depicted as it would appear if the unit were simply turned over along its lower edge.

SOLID STATE GUITAR AMPLIFIER (July, 1969). Feedback resistor and phasing capacitor in the power amplifier. These were shown in the circuit diagram as 15K and 470pF, and in the wiring diagram as 22K and 220pF; they should be 22K and 470pF. The step circuit correctly shown in the circuit diagram as 820 ohms and 0.1uF across T5's 15K collector resistor is incorrectly shown in the wiring diagram as 1.5K and 0.1uF from collector to ground. However, connection of correct values from collector to either ground or supply is satisfactory. ■

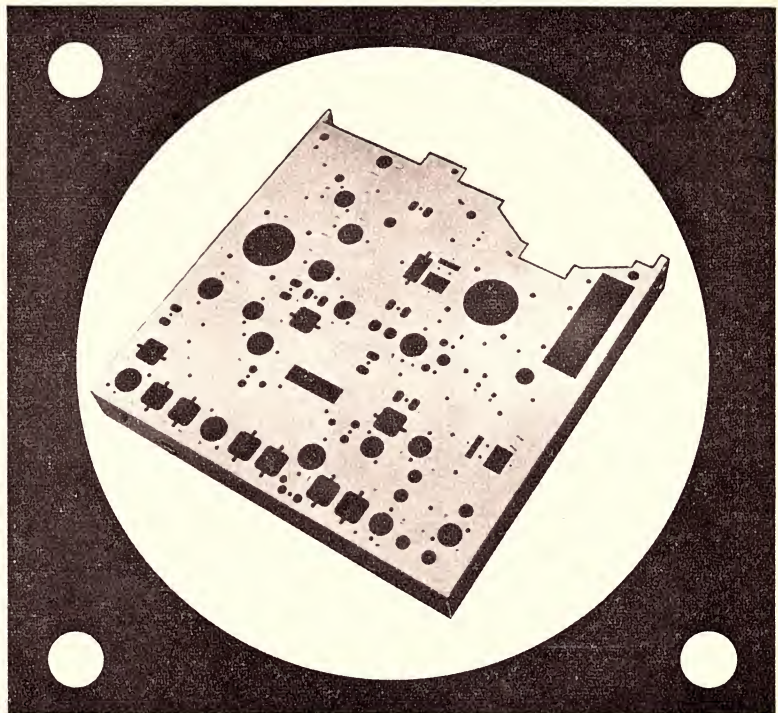

## High precision chassis at under \$4 each can solve your production problem

Plessey manufacture for short and medium runs, cad plated and silk screened chassis that offer distinct price advantages. The example illustrated with folded and welded sides costs under \$4 each for a run of 100.

Accuracy is assured by using a sophisticated fabricator that reproduces the finished part to within .005". Take advantage of this unique service. Consult Plessey now for on-time deliveries that will guarantee profit gains.

**PLESSEY**  
**Components**



For additional information please contact:  
Rola Division  
The Boulevard Richmond Victoria 3121  
Telephone 42 3921 Telex 30383  
NSW Plessey Components Rola Division  
PO Box 2 Willawood 2163 Telephone 72 0133

AR 16



# MARKET PLACE

Send your ads for this page on the form overleaf

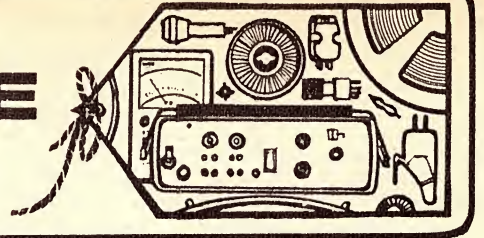

## POSITION VACANT

**VACANCY.** Junior recording technician. Basic knowledge maintenance and audio mixing advantage. Drivers licence essential. Four weeks leave. No shift work. Apply Court Recording Services, 321 William Street, Melbourne, stating experience.



### COMMONWEALTH OF AUSTRALIA DEPARTMENT OF SUPPLY, WEAPONS RESEARCH ESTABLISHMENT, WOOMERA.

Experimental Officer, Class II (a number of vacancies). Interesting professional jobs are available on the Woomera Range for experienced graduates or diplomats in science or engineering who wish to participate in experimental work associated with trials of guided weapons, satellite launching vehicles and high altitude test rockets. The field of work embraces the measurement of performance of rockets launched in flight trials and the gathering of experimental data required for physical research and for weapons development.

**SALARIES:** The salaries payable will depend upon the qualifications and experience of the successful applicants, but will be within the range of \$5332-5989 (actual) per annum.

**DUTIES:** (Positions Nos. 286, 308 and 659). Supervise a section engaged in the operation and maintenance of a tracking data and acquisition system comprising variety of electronic and optical tracking data recording, transmitting and computing equipment.

(Position No. 299). Under direction, manage and supervise the staff of a photographic services section and a photographic quality control section.

**QUALIFICATIONS:** (All positions). A degree or diploma in science or engineering or equivalent, with experience in the development, operation and maintenance of electronic or photographic equipment. Experience in the use of analogue and digital computers and digital data transmission systems would be an advantage for some of the positions.

**NOTE:** (1) A special allowance of \$280 per annum is payable to a married man maintaining a family, others receive \$160 per annum.

(2) An amount of \$90 plus 1/12th of the claim for dependents is allowable for taxation purposes provided at least six months of the financial year are spent residing at Woomera.

(3) Married accommodation will be made available within a reasonable period after taking up duty.

(4) Fares and removal expenses for the successful applicants and their families (wife and children) will be met by the Department.

(5) Payment is made in lieu of excess travelling time.

(6) Successful applicants may be required to fly in fixed or rotary wing aircraft and to drive a Commonwealth vehicle whilst on duty.

**APPLICATIONS:** On forms available from the Regional Director's Office, Department of Supply, in each capital city of Australia should be lodged with:

The Director,  
WEAPONS RESEARCH ESTABLISHMENT,  
Box 1424H, G.P.O.,  
ADelaide, S.A., 5001.  
By: August 15, 1969.

## L.P. RECORDS WANTED

Any quantity. Highest prices paid. Will call with cash within 30 minutes.

### CASTLES RECORDS

323 Church Street, Parramatta  
635-8621 after hours 86-1422

## EXCELLENT ELECTRONICS

Often, in the EEB. Send for sample copy.

**THE AUSTRALIAN EEB**  
P.O. BOX 177, SANDY BAY,  
TASMANIA 7005, AUSTRALIA

## FOR SALE

**STUDIO RECORDERS.** 1: Ampex PR-10-1, mono, full track, 7 1/2 and 15ips, 3 heads, A-B monitoring. Push button relay operation, in portable carrying case, but complete with 4ft custom-made console (c/w monitor amp and speaker), into which recorder fits for studio use. Perfect condition, \$600. 2: Concertone professional deck, 3 motors, 3 heads, 7 1/2 and 15ips, full track. Take 10 1/2" NAG spools. Complete with record/play preamps. Electronics recently rebuilt. Fitted into table-top console but can be rack-mounted. No monitor. Excellent condition, \$100. 3: Concertone deck, as above, fitted into table-top console c/w monitor amp and speaker. Excellent condition, \$120. 4: Concertone deck, as above, without console. Mechanically O.K., but needs work on electronics, \$60. Vista Recording Studios, 78 Robert St, Wickham, N.S.W. 61-4908.

**TRANSFORMER** Ironcore 240V-32V, 750VA, 23A, as new, cost \$50, sell \$39. I. Rattcliffe, Ardmore, Vic., 3629.

**MODEL ENGINEERS** bench drill. Detail blue print, castings, Bolton, 72 King Street, Sydney, G.P.O. Box 1747, Catalogue \$1.50.

**TRANSISTOR BARGAINS.** New, guaranteed. BC108, BC109, OC44, OC45, OC72 all 50c each. AF115, AF116, AF117 all 70c each. AD140, AD149, \$1.30 each. AD161/162, \$2.75 the pair. 10c pack/post any order. Kit-Sets Aust., Box 176, P.O., Dee Why, 2099.

**PRE-SET POTS.** Miniature type for p.c. range: 1K, 2.5K, 5K, 10K, 25K, 50K, 100K, 250K, 500K and 1M, 20c each of 10 for \$1.50, 10c pack/post any order. Kit-Sets Aust., Box 176, P.O., Dee Why, 2099.

**RESISTORS.** Top grade, 5pc, 1/4W and 1/2W types. Both 4c each, \$3.00 per 100, 1 ohm to 10M. We supply to your list. 10c pack/post any order. Kit-Sets Aust., Box 176, P.O., Dee Why, N.S.W., 2099.

**MODEL RAILWAYS:** Rivarossi, Tri-ang, Peco. Prompt mail order service. Write for free price lists. Free packing and postage on all orders. J.P. Productions, 15 Hamilton St., Gisborne, Victoria, 5437.

**CUSTOM BUILT TRANSFORMERS.** Power, audio, etc. Single or quantity production. Amplifiers, P.A. systems, battery chargers, rectifiers, electric motors, transistor radios. General engineering, fitting and turning, sheet metal work, etc. Parkinson Transformers, P.O. Box 523, South Brisbane, Telephone 872-033.

\*\*\*\*\*  
\* Classified Advertisers \*  
\* Your advertisement for the Sep- \*  
\* tember issue must reach our office \*  
\* by August 6th. \*  
\* Address your advertisement to the \*  
\* Advertising Manager, "ELEC- \*  
\* TRONICS Australia," Box 2728, \*  
\* G.P.O., Sydney, N.S.W. 2001 \*  
\*\*\*\*\*

**TAPE RECORDING** year book (English) now here. Lists avail. Tape recorders, equipment, clubs. Articles by experts, \$1.75 post free. B. T. Lovett, Agent, 5 Glover St, Willoughby, N.S.W., 2068.

**SMALL selenium bridge rectifiers** in polycarbonate cases for 50V AC input, 1A 1 1/4in x 1 1/4in, \$1.55; 1.5A 1 1/4in x 1 1/4in, \$2.15. Post and s. tax included. Ideal for DC power supplies, battery chargers, model car and train controllers, etc. Mail orders to: G.E. Pty. Ltd., 375 Pacific H'way, Artarmon, N.S.W., 2064.

BC107-8-9, 60c ea.; AD161, \$1.45; AD162, \$1.40; AD161/162 matched pair, 85c; AD161, 105c; 10 1/2" sil. diodes 400 PIV, 60c; 1A 800 PIV min. type IN4006, 75c. Post free. T. & M. Electronics, Box 57, P.O., Haberfield, N.S.W., 2045. Sorry no C.O.D.

**AUDIO** equipment, all the famous brands at prices we cannot advertise. Sony, Kenwood specialists. Peerless, Wharfedale speakers. J.H. Silicon, Labcraft turntables. Compact tuners. Sound, Lux amps. Brand tapes heavily discounted. Mail-order, Duratone Hi-Fi, P.O. Box 125, Curtin, A.C.T., Canberra, Ph 81-2549

NEW OC71, 2N3638, 5 for \$2 or 50c ea. OC44, 45, BC108, 109, 2N3638A, 4 for \$2 or 60c ea. 2N3643, OC171, 2N370, 371, AF116N, 117N, 70c ea. OC72, 84, AC128, 5 for \$3.50 or 75c ea. BF15, 2N694, AC127, 60c ea. Power type, 2N176, \$1 ea. 2N301, \$1.20 ea. OC28, 29, 35, 36, \$1.50 ea. 2N3055, \$2 ea. OA210, EM404, 50c ea. OA211, BY100, EM410, 70c ea. UJT 2N2160, PFT 2N4360, \$1.20 ea. PPF105, 2N549F, 90c ea. BA100, 80c ea. OAB, 85c, 91, 92, 10 for \$2 or 25c ea. No S.A. sales. Post and pack 15c. Custom Electronics, Box 1452, G.P.O. Adelaide, 5001

## FOR SALE

**SIGNAL** generator, Marconi 801A 10-300MHz. Perfect and as new. \$100. Melbourne 96-5024.

**GOODMANS** Axlom 22 Mk 2 speaker in attractive corner vented enclosure. Cost \$120. Quick sale \$39. Sydney 42-4729.

**AMPERNOL.** New connectors 4-pin cable M 50c each, 4-pin chassis F 40c each, Acme 3-pin chassis new F 40c each. The following are used 3-pin cable connectors all in good order. Ampernol M and F 40c each, Acme M and F 30c each. Good quantities available in all types. Order what you need. Post free. Hodges Sound, 35 Lewis St, Balgowlah, N.S.W., 94-4193.

**ANTIQUE** radios approx. 1926 vintage complete working order \$10. Incomplete \$4. Three triacne cells \$3. R. J. Kerr, 56 Dudley St, Rochester, 3561.

**VIDEO** and sound tape recorder, transistorised, kit assembled, as is, bargain \$375 o.n.o. Must sell. Also Philips GM2891 pattern generator \$125 o.n.o. Tel-Mend, 21 Adelaide Avenue, Rosebud, Victoria. Phone 6-1103.

**TRANSISTOR** ignition system capacitor discharge type, \$32.00. 12V systems only. State whether positive or negative side of battery connected to car body. Two Way Radio Service, 31 Rotherham Street, Kangaroo Point, Brisbane, Queensland.

**TRANSISTORS,** 14c each, on computer boards. Other parts free. Tech. Inf. supplied. Parts free. Add postage. Prof. Hi-Fi Repairs, 26 Percy St, Newport, Vic., 3015. Tel. A.H. 391-3115.

**RECORDING TAPE** new, guar. 3 1/4 x 900, 1.55; 5 x 1200, \$2.7 x 4800, \$9.80. All brands and sizes. Write for full list. Cassettes C 60, \$1.55. 5in empty reels, 30c. Stereo tape recorders, new and fully guaranteed from \$137.50. Lowest prices for all your needs. A1 Mail Order, Box 15, Footscray, Vic., 3011

**S/WAVE** receiver AR8 with power supply, electronic antenna, 92 Adelaide St, Greenacre, Sydney 648-1541 (business)

**BUYER "100" SERIES** Professional tape recorder, Triple-head assembly, 1/2-track stereo. Speeds 7 1/2 and 15 ips. Independent record and playback facilities. Input/output 600 ohms balanced. Contact Mr Blinn at W. & G. Record Processing Co. P./L. 186 Batman St., West Melbourne. Phone 329-7255.

**AERIAL** specially made for No. 19, No. 22, No. 62 radio sets, \$3.85 and \$4.85. Waltham Dan, 96 Oxford St, Sydney, 31-3360.

**CAPACITORS** best quality polyester foil 160V, 10pc tolerance-1000pF, 1500pF, 2200pF, 3300pF, 4700pF, 6800pF, 8200pF, 01uF-7c each; .015, .022-8c each; .033-10c each; .047, .068, .082-12c each; .1, .15-14c each; .22-16c each; .33-20c; .47-24c. Miniature styrofoam 400V, 10pc, 56pF, 68pF, 100pF, 150pF, 220pF, 330pF, 470pF, 560pF, 680pF, 820pF, all 5c each. Please include 25pc sales tax, 15c post. Electro-Pak, P.O. Box 731, Canberra City, A.C.T., 2601.

**CHANNEL MASTER "Telstar"** transistorised aerial booster amplifiers. Ideal for fringe or low signal areas, \$25 ea. Channel Master automatic rotators, excellent where a number of channels are received from different directions, or drive that ham rig, \$40 ea. Quality of surplus TV test equipment, all in good condition. Write for list. J. Valden, 21 Oxford St, Glen Innes, N.S.W., 2370.

**RADAR,** Decca 212 with handbooks, 8in screen, 10KW pulse, range 50yds to 30 mls., required 230VAC 700W input, \$390. O'Brien, Edgar Road, San Remo, 3925. Phone 107.

**VORTEXIAN** CBL/s 80 tape recorder only 18 months old for sale. 80 Lansdowne Rd., 5th Perth, W.A. Phone 67-2182.

**BURGLAR ALARMS.** 12V, 15uA. Transistor control units, \$12 plus 12 p.c. s.t. Unit on 4 x 2 plate and case, \$16 plus s.t. 41v rotary sirens, \$10.50. All above plus 6c p. and post. Foil tape terminals, mats, key switches, bells, red switches, infra-red ray unit. Complete quote and installation service to insurance requirements. EDROE ENTERPRISES, 802 Doncaster Rd., Doncaster, Vic. 848-1386.

## READER SERVICE

**TOP-QUALITY** discs from your tapes. Any quantity, all sizes and speeds. We guarantee our work because we take every precaution to ensure satisfaction. Write for details, A.A.V.R., 873 Kentwell St., Balmain, 2041, Sydney. Phone 82-5158.

**RADIO TV TAPE** service, all spares available, trade discounts on parts. Amplifiers, microphones, Nichols Radio, 91 Wellington Street, Launceston, Tas.

(Continued opposite page)



# STEREO RECORDS: SPREAD OR SEPARATION

(Continued from page 117)

system, with some effort made to contrive a difference between the signals fed to the respective channels.

Most noteworthy examples have been a few records which have been painstakingly reprocessed using frequency filters, reverberation circuits and manipulation of the console controls to give an illusion that certain instrument groups were located predominantly to right, left or centre.

However, this painstaking approach is too costly for anything but prestige historical performances, for which a high re-sale rate can be anticipated. Most reprocessed or simulated or reconstituted stereo records are made simply by feeding the signal through

filters so that the high frequencies predominate on the left — where the lead strings are traditionally located — and the lower frequencies predominate on the right. Sometimes, artificial reverberation is added in phase to both channels to combat the acoustic "dryness" of old recordings and to give the illusion of distance and depth behind the frequency-separated channels.

Despite their artificiality, reprocessed stereo records can be quite acceptable as mementos of historical performances. In fact, being re-recorded from the original "mother" or from a non-grainy pressing, and with the benefit of discrete compensation, frequency division and reverberation, they can sound a good deal better than commercial shellac pressings of the day.

Can stereo be accurately reconstituted from an original mono recording?

Many would-be inventors have claimed that it can by methods which have ranged all the way from playing two pickups in the one groove to disposing multiple loudspeakers around a room.

Such methods can produce various effects with various types of sound, which may or may not be considered worthwhile; this much is not denied.

However, no ordered method can re-

create information about random events, which were not recorded at the time. Simulated stereo may have a little more ambience than the original mono recording and sound a little less confined but it cannot have the spread or the definition of an original stereo recording.

And, finally, how should a mono recording sound on a stereo system?

In a highly symmetrical stereo system, heard from a position equidistant from the loudspeakers, the sound should appear to come from a point midway between them. If there is a TV set in the mid-position, voices in particular will appear to come from it, as if it contained the only operating loudspeaker. The more startling the effect the better is the balance of the system.

With music, particularly complex music, the illusion will be less strong, partly because the widely ranging frequencies may discover slight differences in the response of the individual sections of the cartridge and the individual loudspeakers. And, within the room itself, differing reflection paths will tend to strengthen sound from one loudspeaker or the other over individual portions of the range. If anything, this slight random dispersion of the sound tends to add acoustic interest and most people prefer to listen to mono records in the stereo mode, rather than to disable one channel. ■

## MARKET PLACE . . . cont.

### READER SERVICE

**TRANSFORMERS** wound, output or mains and specials to order. Par's Electronics, 7a Burton St. Darlinghurst, N.S.W. 31-3273.

**COILS, CHOKES, R.F.s, I.F.s, etc.**, wound to your own specifications or on contract basis. Reply with S.A.E. Paris Radio Electronics, 7a Burton St. Darlinghurst, N.S.W. 31-3273.

**DUPLICATING:** James E. Smith Duplicating Service for photostats, photo copies, electronic stencils, addressing service, extensive duplicating coverage. Customers wanted. P.O. Box 48, Albion, Qld., 4010. Phone 57-6612.

**PRE-RECORDED TAPES** hired to members of Australian Tape Recording Society. Bi-monthly release. "The Microphone," newspapers, round robins, sales, service, tape-sponding. Send 5c, 5in x 4in SAE to ATRS, Box 9, P.O. Crow's Nest, N.S.W., 2065, or phone (2) 43-6681, after hours.

**FREE** stereo pre-recorded tape, cartridge or cassette when you join the Rondo Reef Pre-recorded Tape Service. Est. 5 yrs. Save 20 p.c. on all your pre-recorded tape, etc., over 25 labels to choose from. Interstate, N.G. and Fiji inquiries welcome. Regular new releases posted to all members. Details Rondo Reef, Box 162, Rockdale, N.S.W., 2216, Aust.

**ELECTRONIC ORGANS.** Do not build yourself an organ without first finding out about the superb Schober (U.S.A.) Assemble-It-Yourself Kits. Inquiries to Schober Organs (Australia) 124 Livingstone Ave., Pymble, N.S.W., 2073 (Mail only, please.)

**REPAIRS** to receivers, transmitters, construction testing; TV alignments; Xtal convs, specialised electronic equip. Eccleston Electronics, 146a Cotham Road, Kew, Vic. 80-3777.

**TV PICTURE TUBES.** Sure Brite Pty. Ltd., now at 642 King St. Newtown, N.S.W. Now, the largest factory of its kind in N.S.W. Daily delivery Sydney suburbs, and to railway station. Lowest prices in Sydney to the trade. Duds bought. Send all duds to Sydneyham station freight paid. Customer sales room building. Phones 519-3403, 51-5928. Brisbane area: 1120 Oxley Rd., Oxley, 79-6828.

**TAPE RECORDING MAGAZINE.** English monthly. Free introductory copy send 5c S.A.E. to 5 Glover Street, Willoughby, N.S.W. 2068.

**CUSTOM** built hi-fi furniture—cabinet kits made to order — stereo equipment supplies. Inquiries welcome. Robert N. Smallwood, Sound Specialist, 205 Brisbane Rd., Booval, Qld., 4304. Ph. 82-1550 anytime.

**TAPE** to disc service. Take advantage of W. and G. Records' professional experience when next needing a tape to disc service. W. and G. Record Processing Co., 185 A'Beckett Street, Melbourne. Tel. 329-7255.

### WANTED

**TV** and transistor circuit manuals. Any condition. Coiller, 84 Orange Parade, Wyoming, Gosford, 2251.

**CYLINDER** phonograph, Edison discs and cylinder records. Horn type radio. Reply Box 22, Fairy Meadow, 2519.

**PAIR** Whartedale Super 3a, reasonable. 17 Beeby Street, Nundah, Brisbane. 66-8107.

**BENDIX** compass receiver, any condition. MN.26.A, MN.26.C or RA.10 F.A, BC433.G. G. J. Wilson, Parattah, 7204.

**DEVIATION** meter to cover VHF mobile bands. Alrmec, Marconi or similar. Box 836, Launceston, Tas.

**VACUUM TUBE** volt-meter, good condition. Also mantel radios, any condition. Spot cash. Melbourne 211-2261.



## MINIATURE ELECTRONIC ORGAN

The attention of the trade is drawn to the fact that the **STYLOPHONE** Miniature Electronic Organ at present being marketed in Australia is protected by Australian Patent Application No. 35859/68. The only authorised agents for the sale of this organ in Australia are **Goldring Engineering (A'asia) Pty. Ltd.** and retailers and distributors who receive such organs from **Goldring Engineering (A'asia) Pty. Ltd.** Action for infringement will be considered should any infringing organs come onto the Australian market.

*For further details contact sole agents*

**Goldring Engineering (A'asia) Pty. Ltd.**  
**443 Kent Street, Sydney 2000 'Phone 29-5802.**

Vic.: 162 Pelham Street, Carlton 3053, Phone 34-5105.  
Qld.: 415 Adelaide Street, Brisbane 4000, Phone 2-3247.  
S.A.: Farley & Fahy Pty. Ltd., 75-77 Wright Street, Adelaide 5000, Phone 51-5117.  
W.A.: 32 Northwood Street, Leederville 6007, Phone 8-4988.







# I'm alright, Jack.

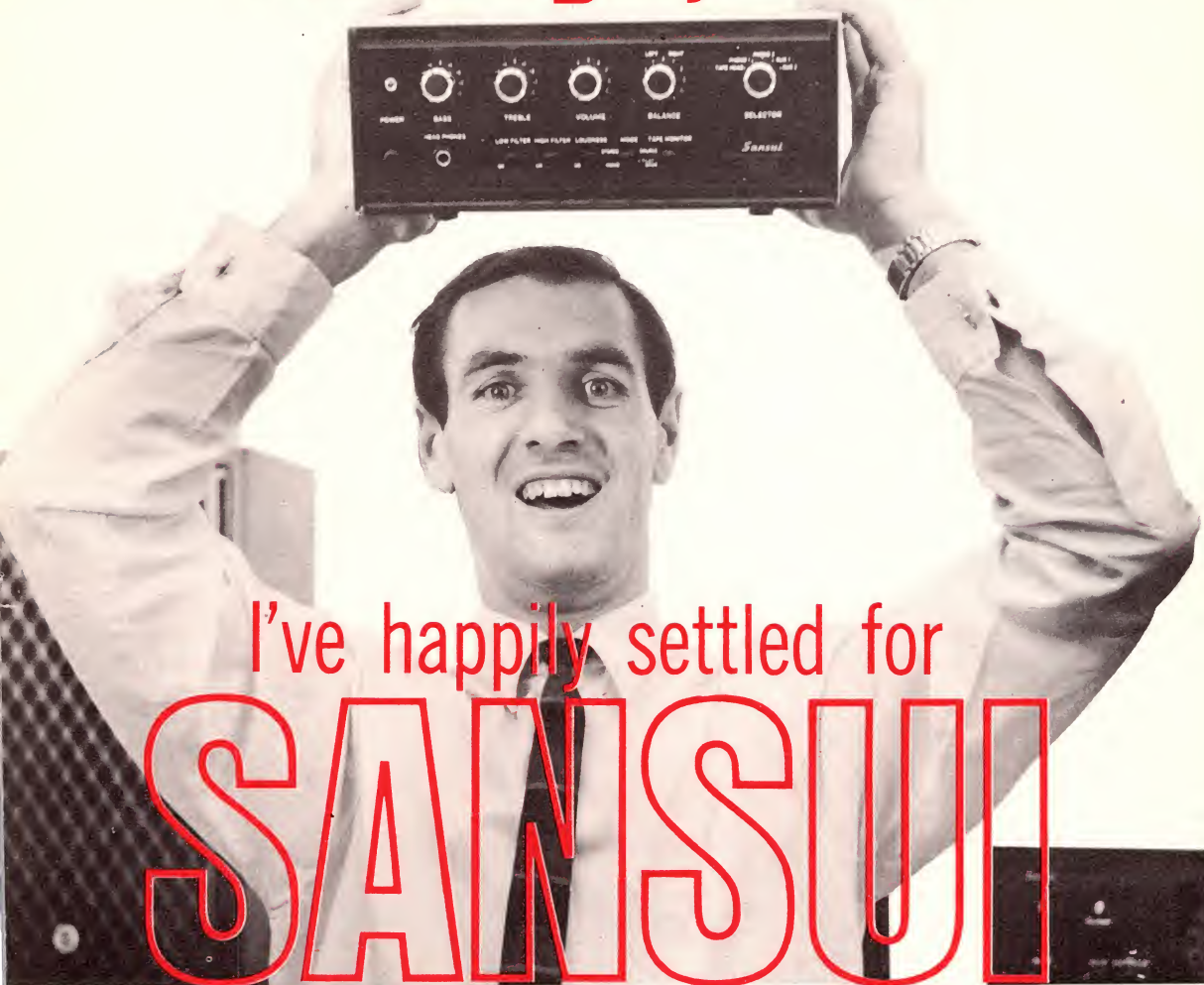

I've happily settled for  
**SANSUI**

All over Australia discriminating music lovers are settling for nothing less than Sansui. Sansui is Japan's top quality brand . . . and costs a little more than lesser makes. And with Sansui you get what you're paying for—the priceless ingredient that is *quality*. Two new solid state stereo amplifiers have now been

released in Australia — both offer *real* value for money. The new Model AU555 costs \$217 and the Model AU222 is priced at \$180. Examine the specifications; then see your nearest Sansui supplier and *listen* to these fine amplifiers. We know you'll agree with us, and *invest* in Sansui.

**IMPORTANT: Ask for complete unabridged specifications. Then you can see how much more you get when you buy Sansui. See your local Sansui agent!**



MODEL AU555 PRICE: \$217 inc. sales tax



MODEL AU222 PRICE: \$180 inc. sales tax

**OUTPUT:** 60 watts music power at 4 ohms  
**FREQUENCY RESPONSE:** 20-80,000 Hz. + 1 dB. **IMPEDANCE:** 4-16 dhms  
**SENSITIVITY:** Mag. p.u. 2mV.  
 Tape head 1.5mV. Aux. 1 200mV.  
 Mic. 3.8mV. Plus other inputs.

**OUTPUT:** 46 watts music power at 4 ohms  
**FREQUENCY RESPONSE:** 20-30,000 Hz. + 1 dB. **IMPEDANCE:** 4-16 ohms  
**SENSITIVITY:** Mag. p.u. 2mV.  
 Tape head 1.5mV. Aux. 1 150mV.  
 Aux. 2 150mV. Plus other inputs.

Australian National Distributors:

**Simon Gray Pty. Ltd.**

Head Office: 28 Elizabeth St., Melbourne, Vic. Tel. 63 8101\*  
 Sydney Office: 22 Ridge St., North Sydney, N.S.W. Tel. 929 6816  
 Canberra Office: 31-33 London Circuit, Canberra City, A.C.T.  
 Tel. 49 6050

INTERSTATE REPRESENTATIVES:

N.T.: Pfitzner's Music House, Smith Street, Darwin. Tel. 3801  
 Q'land: Sydney G. Hughes, 154-158 Arthur St., New Farm, Brisbane. Tel. 58 1422  
 S.A.: Eilco Sales Pty. Ltd., 7-9 Osmond Terrace, Norwood, S.A. Tel. 63 4844  
 Tas.: K. W. McCulloch Pty. Ltd., 57 George Street, Launceston. Tel. 2 5322  
 W.A.: Athol M. Hill, 613-615 Wellington Street, Perth. Tel. 21 7861

S.G. 511/68



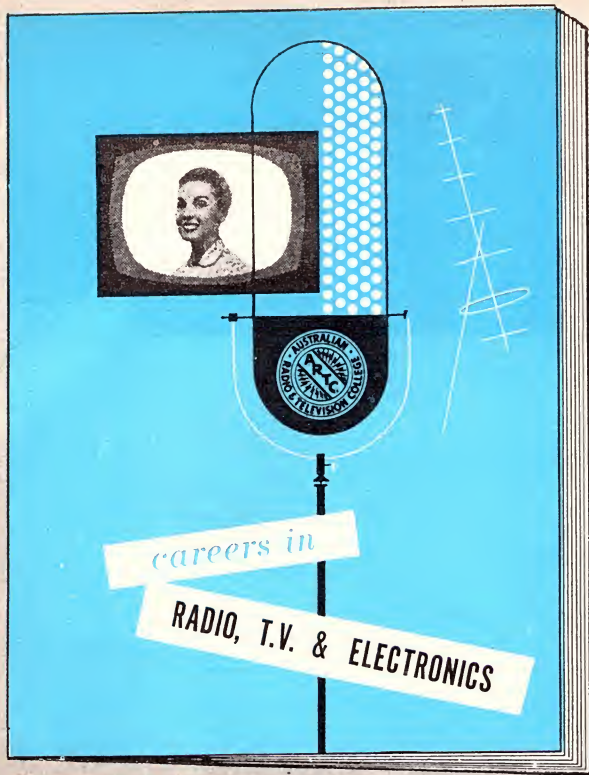

# THIS

# FREE BOOK

# COULD BE THE TURNING POINT

# IN YOUR CAREER

### ASK YOURSELF THESE 3 QUESTIONS

1. Am I in a dead-end job?
2. Can I use my spare time to get ahead?
3. Am I capable of earning more money?

If the answer is yes, there is room for you in radio-television. Does your job really offer security — worthwhile prospects? If not, now is the time to do something about it. Send the coupon below for the free booklet "Careers in Radio, TV & Electronics" which shows you just how A.R.T.C. training can help you to a bright future with good prospects.

### TRAIN AT HOME OR AT THE COLLEGE

With A.R.T.C. you can obtain the training you need at the benches and lecture halls of Australian Radio and Television College or in your own home by correspondence . . . you can be taught every important aspect of radio-television, details of the fundamental principles of Electronics.

### GET INTO ONE OF THESE PROFITABLE CAREERS IN RADIO/TELEVISION

There is a profitable career for you in the many phases of radio-television including manufacturing, radio servicing, television servicing, research, sales, broadcasting and television executive, armed forces. A.R.T.C. can help you gain one of these much-sought-after positions, but remember, it is only the trained men who succeed and A.R.T.C. can give you the complete training which is necessary for success in Electronics.

### Make Spare-Time Money

If you wish, you can make your spare time earn money for you by training at home and many students make extra money after only the first few weeks. However, if it is not convenient for you to train at home, then you may use the modern A.R.T.C. workshops. The course is intensely practical and individual. Safeguard your future . . . mail the coupon today.

### A.R.T.C. CAN TRAIN YOU AS IT HAS THOUS- ANDS OF OTHERS!

Thousands of ambitious men have realised the benefits offered by A.R.T.C. training and are now making money in radio. You can join the ranks of the skilled men. . . and it costs only pence a day.

### MAIL COUPON NOW

You are invited to mail the coupon below which can be your first step towards securing a job or business of your own with good prospects, security and big money. A.R.T.C. will mail to you, in return, at no obligation to you, the free booklet "Careers in Radio TV & Electronics." This booklet will show you definite steps you can take for a better job . . . how you can succeed in life. Post the coupon, phone or call NOW

## AUSTRALIAN RADIO AND TELEVISION COLLEGE

PTY. LTD.

E. S. & A. BANK BUILDING,

Cnr. Broadway and City Road, Sydney.  
(Opp. Grace Bros.) Phone 211-4244 (3 lines.)

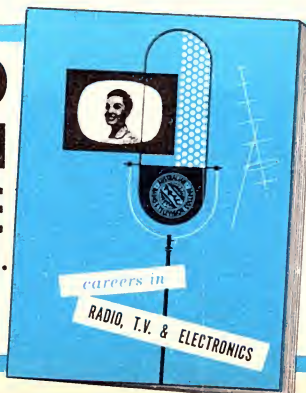

### AUSTRALIAN RADIO & TELEVISION COLLEGE PTY. LTD.,

206 Broadway, Sydney, N.S.W.

Dear Sir,

Please send me, without obligation, your free booklet, "Careers in Radio, TV and Electronics."

NAME .....

ADDRESS .....