

ELECTRONICS

Australia

July, 1969



40¢

Ikara, Australia's anti-sub. missile (See page 10)

APOLLO TO THE MOON — LIFT-OUT COLOUR SUPPLEMENT
50W GUITAR AMPLIFIER ● CASSETTE PLAYERS IN CARS



NATIONAL CASSETTE RECORDERS

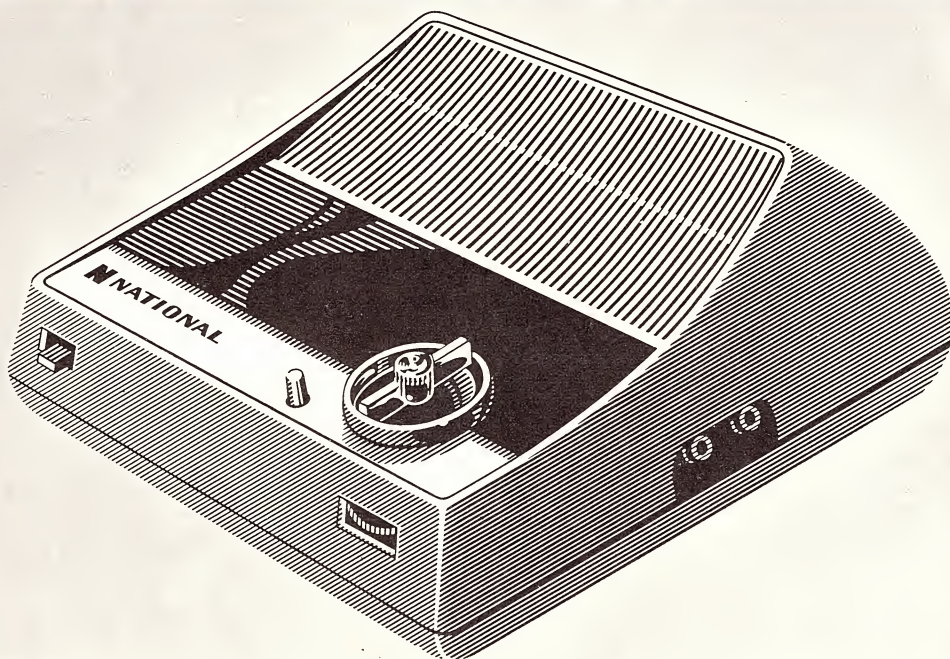

Meet the performance giants — up to 3 watts from brilliant new circuits!

National cassette recorders outperform and out-feature the field. With highly advanced circuits, (including IC in the incredible mini-model) plus automatic volume control*, you can get a National cassette recorder to suit you exactly — including models with dual power! Here's the line-up . . .

Illustrated above:

RQ205S
1.6W music power. 7 solid-state devices. Battery op. 8 $\frac{7}{8}$ " x 4" x 9 $\frac{1}{2}$ ". (Available in Red or Cream).



RQ219S
2W music power. 9 s/s devices. Battery op. 5 $\frac{1}{2}$ " x 2 $\frac{3}{4}$ " x 10 $\frac{1}{4}$ ".

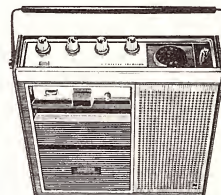

RF7270
Car radio/cassette portable. 3W music power. 27 s/s devices. 10 $\frac{5}{8}$ " x 10 $\frac{1}{4}$ " x 3 $\frac{3}{8}$ ".

* All models except RF7270

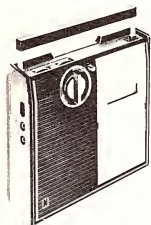

RQ203S
2.5W music power. 7 solid-state devices. Dual power. 9 $\frac{5}{8}$ " x 3" x 9 $\frac{1}{4}$ ".



RQ210S
600mW music power. 9 s/s devices. (Integrated Circuits). Battery op. 3 $\frac{3}{4}$ " x 6 $\frac{3}{8}$ " x 1 $\frac{7}{8}$ ".



RQ230S
2.5W music power. 10 s/s devices. Has a.m. radio. 10 $\frac{3}{8}$ " x 2 $\frac{3}{4}$ " x 8 $\frac{5}{8}$ ".

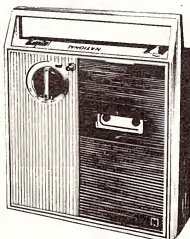

RQ204S
1.6W music power. 6 solid-state devices. Battery op. 8 $\frac{5}{8}$ " x 2 $\frac{3}{4}$ " x 10 $\frac{5}{8}$ ".



**SEND COUPON
FOR FREE INFORMATION TO:**

HACO DISTRIBUTING AGENCIES PTY. LIMITED
57/69 Anzac Parade, Kensington, N.S.W. 2033.

NAME.....

ADDRESS.....

..... POSTCODE.....

S669

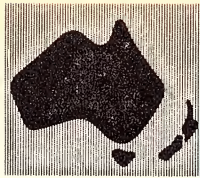

ELECTRONICS Australia

incorporating RADIO, TELEVISION & HOBBIES

ABC certified circulation in excess of 47,000

volume 31, number 4

CONTENTS — JULY, 1969

IKARA: Developed in Australia, Ikara is far from being a "limited budget" weapon. It is almost certainly the most effective anti-submarine missile in current use. Page 10.

GUITAR AMPLIFIER: For those who want a genuine 50 watts of guitar sound, the amplifier on page 82 is what you have been waiting for. It has full control and vibrato facilities.

HI-FI LOUDSPEAKER SYSTEM: Rola's latest loudspeaker, housed in the enclosure described on page 110 adds up to a fine, inexpensive hi-fi loudspeaker system.

ORGAN ENTHUSIASTS: Don't overlook the item in "Reader Built It" on page 105.

Editorial Office:
12th Floor, 235-243 Jones Street,
Broadway, Sydney, Australia.
Phone 2-0944.

Postal Address:
Box 2728, G.P.O., Sydney, 2001, Australia.

Advertising:
Manager, Selwyn Sayers,
Sydney Representative, Bill Summons.
Office: 8th Floor, 235-243 Jones Street,
Broadway, Sydney. Phone 2-0944.
Melbourne Representative, Clarrie Levy.
Office: 392 Little Collins Street,
Melbourne, 3000. Phone 67-8131.

Circulation:
Alan Parker, Manager.
Office: 9th Floor, 235-243 Jones Street,
Broadway, Sydney. Phone 2-0944.

Subscription Rates: See back page.

Representation:
Melbourne—John Fairfax and Sons Ltd., 392 Little Collins Street, 3000. Phone 67-8131.

Brisbane—Sungravure Pty. Ltd., 78 Elizabeth Street, 4000. Phone 2-6688.

Adelaide—John Fairfax and Sons Ltd., 104 Currie Street, 5000. Phone 51-3502.

Perth—Sungravure Pty. Ltd., 847 Hay Street, 6000. Phone 23-4513.

Newcastle, N.S.W.—Associated Newspapers Ltd., 22 Bolton Street, 2300. Phone 2-3696.

London—John Fairfax and Sons (Aust.) Ltd., Reuter Building, 85 Fleet Street.

New York—The Sydney Morning Herald Ltd., 1501 Broadway, New York, N.Y., 10036.

Distribution:
Distributed in N.S.W. by Sungravure Pty. Ltd., Jones Street, Broadway, Sydney, N.S.W.; in Victoria by Sungravure Pty. Ltd., 392 Little Collins Street, Melbourne; in South Australia by Sungravure Pty. Ltd., 104 Currie Street, Adelaide; in Western Australia by Western Press; in Queensland by Gordon and Gotch (A'sia) Ltd.; in New Zealand by Truth (N.Z.) Ltd.; in Tasmania by Davies Bros. Ltd., "Mercury," Hobart.

features

- 3 Editorial—Destination Moon
- 10 Ikara anti-submarine weapon
- 18 Mars landing in 1973
- 20 Wavelengths of life and death
- 23 Aust. radio programs for N.Z. (historical)
- 24 Optical information store for computers
- 89 Apollo to the Moon (colour supplement)

technical digest

- 27 Electronic oil change indicator
- 29 Computers fashion aspheric lenses
- 31 Price display system for stock exchange

technical articles

- 40 Crystal clock drive unit, part 2
- 48 Simplifying Boolean Algebra expressions
- 57 Fundamentals of solid state—chapter 3
- 70 Using your tape recorder in a car
- 77 Simple crystal and transistor sets
- 82 Solid-state guitar amplifier

regular features

- 33 Scientific and industrial news
- 52 Forum
- 100 Serviceman
- 105 Reader built it
- 110 Audio topics—compact speaker enclosure
- 116 Record reviews—classical
- 121 Record reviews—documentary
- 125 Record reviews—devotional, popular, jazz
- 137 Trade reviews and releases
- 149 Technical books and publications
- 152 Amateur band news and notes
- 165 Listening around the world
- 171 Answers to correspondents
- 179 Market place
- 180 Index to advertisers
- 151 Notes and errata

PHILIPS THUMBWHEEL SWITCHES

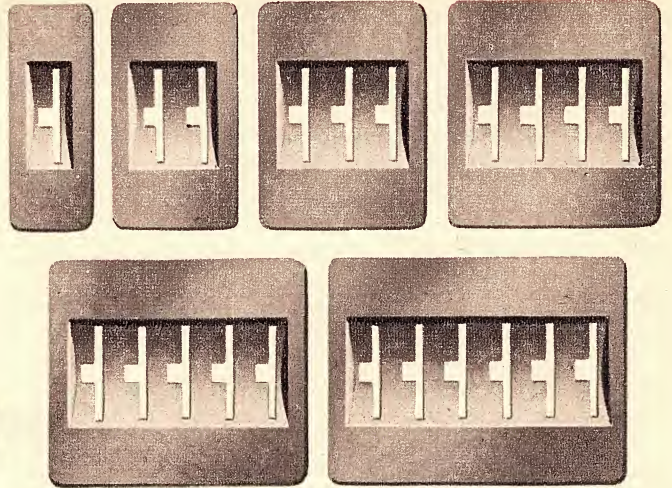

Now guaranteed to last 5 times longer than before

(guaranteed for 100,000 complete revolutions)

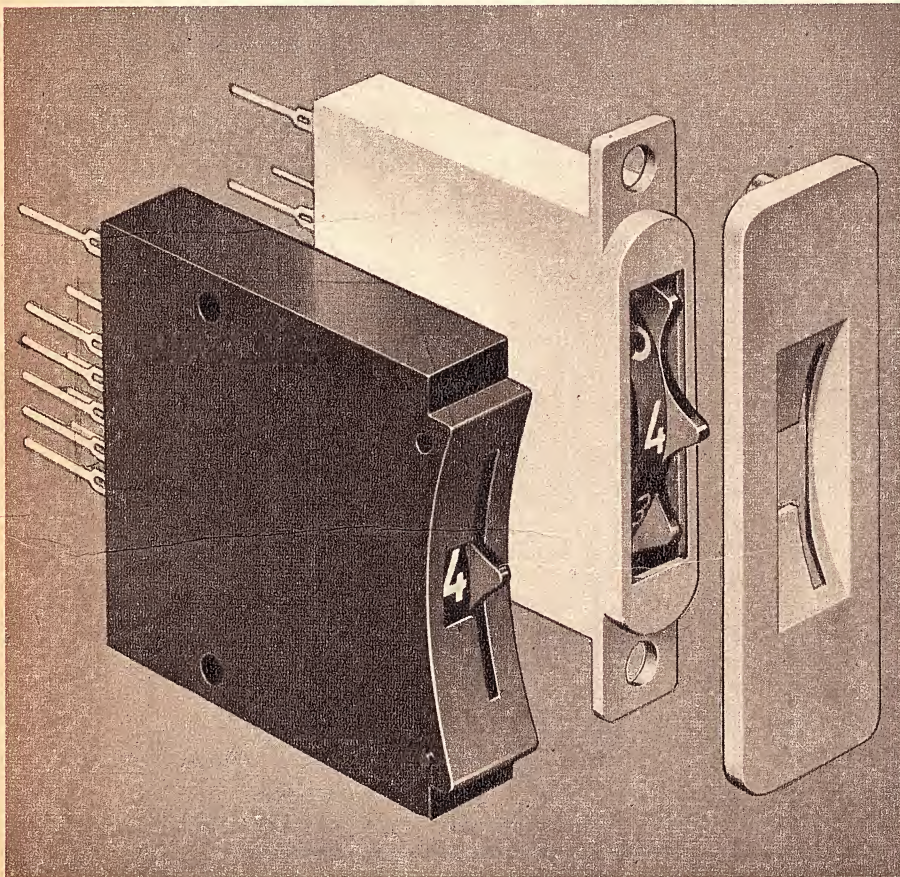

Philips Thumbwheel Switches are a small part of an electronic circuit. However, it is essential that their performance matches that of the electronic components which they serve. These switches have been designed and constructed with a scrupulous eye for detail.

Although we guarantee a life of 100,000 complete revolutions, probable life is about twice this.

The FM Series of Thumbwheel Switches are designed to be used with the Front Mounting Facade. This range has now been supplemented by a Block Mounting (BM) Series, which will permit more freedom in panel layouts.

WRITE FOR FREE
DETAILED BROCHURE

"Miniwatt"
20 Herbert St.,
Artarmon N.S.W. 2064

"Miniwatt"

ELECTRONICS DIVISION OF PHILIPS
ELECTRICAL PTY. LIMITED.

Sydney • Melbourne • Brisbane
Adelaide • Perth • Canberra.



38.2518



EDITORIAL VIEWPOINT

by Neville Williams

Destination Moon . . .

Around 1950, I remember going along to see the George Pal film "Destination Moon." I haven't seen it since and I'm not sure how it would stand up to present-day viewing but I recall that, at the time, the producers were credited with having taken more than the usual pains to make the film credible from the scientific point of view. In the editorial office, and over morning tea, we chatted about the various technical aspects in a detached kind of way, without any special conviction that we would soon enough see fiction become fact.

That was in 1950 and here we are in mid-1969, publishing a profile plan for an actual moon landing, scheduled to take place before the end of the month. The mission may be delayed, of course, or it could even end in failure, but the plan is not a piece of science fiction worked out between an ardent film maker and a panel of technical advisers; it is the product of the most comprehensive technological effort the world has yet seen. What is more, all but the actual touch-down has already been accomplished. Men have been rocketed to the moon, have skimmed within nine miles of its surface, and have returned to earth bringing back pictures of the kind reproduced in our lift-out supplement.

Unfortunately, we have become so blasé about technological achievement that the average person shows little more reaction to the moon mission than to a long-distance flight. London or the Moon — what's the difference?

One way to dispel this feeling and to invoke a sense of history in the making is to study the chart on pages 90-91 of this issue. It depicts only the sequence of major events but it is enough to indicate the enormous complexity of the venture and the long chain of interlocking technology involving some kind of outreach in just about every known branch of science, from biology and geology to materials and rocketry, and on to a vast array of electronics.

In science fiction, and in the mind of the man in the street, the problem of space travel has largely been equated with that of building bigger rockets and of providing more adequate crew-space. There have to be dials, loudspeakers and radar screens, of course, but any long distance vehicle has to have these! What is not so evident is the complete dependance of the entire mission on electronic facilities, monitoring and control. There is very little scope for intuitive, seat-of-the-pants manoeuvres. Only complex, high-speed computers can cope with the mass of terrestrial, lunar and vehicle data necessary to predict situations and requirements and to make the necessary split second decisions.

Only the most highly developed communications techniques can maintain the circuits along which these data must flow — and provide colour TV as a bonus! All credit to those who produced the vehicle but I suspect that just as many laurels are due to the men behind the dials, the loudspeakers and the radar screens.

On the cover

Our picture shows one of the Royal Australian Navy's Ikara anti-submarine missiles at launch. Once in the air, the missile is flown by radio control to the known area of a hostile submarine, where the homing torpedo it carries is released into the sea. No other known anti-submarine missile has this facility. Designed, developed and manufactured entirely in Australia, Ikara is recognised at the most advanced anti-submarine warfare system available in the world. It has been adopted by Britain's Royal Navy as its anti-submarine weapon following intensive evaluation trials. (See story beginning on page 10).

EDITOR

Neville Williams
M.I.R.E.E. (Aust.)
(VK2XV)

ASSISTANT EDITOR

Philip Watson
A.M.I.R.E.E. (Aust.)
(VK2ZPW)

TECHNICAL EDITOR

Jamieson Rowe
B.A. (Syd.),
B.Sc. (Tech., N.S.W.)
A.M.I.R.E.E. (Aust.)

TECHNICAL STAFF

Ian Pogson (VK2AZN)
Harry Tyrer (VK2ZHH)
Anthony Leo (VK2ZHK)
John Horsfield
Robert Flynn
Leo Simpson

ON SALE

THE

FIRST MONDAY

OF EACH MONTH

NOW hi-fi from only \$199

INSTROL HI-FI SYSTEMS

Fully assembled and tested

complete with all leads and fittings

SYSTEM No. 2 \$229.00

This very compact, shelf or table mounting system offers the additional advantage of a Teak cabinet to house both the Amplifier and Player. It features the BSR MA70 Changer with CI cartridge; the Instrol 20-20 Amplifier; 2 Instrol Mullard Mini Speaker Systems; and the Instrol Model 75 Amplifier/Player Cabinet (Teak) which features hinged perspex top.

SYSTEM No. 4 \$379.00

This well balanced suggestion features the Kenwood TK150U Amplifier, together with the Garrard AP75 Player (with Shure M44G Magnetic Cartridge); the speakers used are 2 Wharfedale Super 8RS DD Speakers fitted to 2 Instrol Vented Speaker Enclosures; the System is made complete with an Instrol No. 75 Amplifier/Player Case with Perspex cover.

SYSTEM No. 6 \$688.00

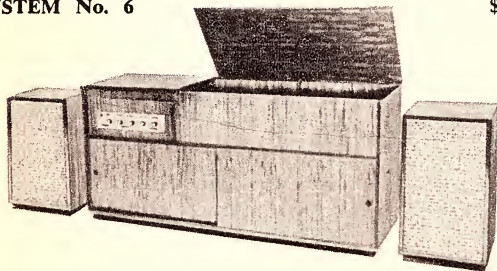

Here is the ideal system for the enthusiast who wishes to include a tape deck in his selection. It features the Kenwood TK150U Amplifier; the Garrard AP75 Player (with Shure M44G magnetic cartridge); the Sony TC255 Tape Deck; and the 2 Wharfedale Super 10 Speakers fitted into Instrol Vented Enclosures. The Instrol Model 375RS cabinet, which features record storage space, adds the finishing touches to this system. All cabinet work would be in Teak. The system would cost even less than \$688.00 if either Maple or Walnut finish was desired.

SYSTEM No. 8 \$980.00

Once again, a tape deck is included in this selection, which combines to produce true high fidelity. The system features the Leak Stereo 70 Amplifier; the Dual 1019 Player (with Shure M75E cartridge); 2 Leak Sandwich Speaker Systems; the Sony TC255 Tape Deck; all fitted into the Instrol model 375RS cabinet, finished in Teak.

SYSTEM No. 1 \$199.00

This exceptional system offers quality high fidelity at very low cost. It features a Garrard 3500 changer with Sonotone 9TA in Teak Stand; an Instrol 20-20 Amplifier in Teak Case; 2 Mullard Mini Speakers with 2 Teak Speaker Enclosures. Alternatively, the BSR MA70 Changer with CI cartridge might be preferred. Yet all this still costs no more than \$199.00.

SYSTEM No. 3 \$264.00

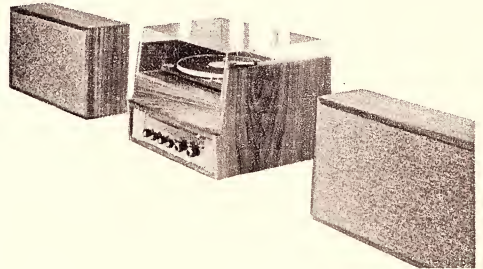

Once again a compact shelf or table mounting system, but featuring the popular Instrol-Playmaster Bookshelf Speaker System. It features the Instrol 20-20 Solid State Amplifier; the Garrard AT60 Mark II Changer with Decca Deram Cartridge; 2 Instrol-Playmaster Bookshelf Speaker Systems (All Teak); plus the Instrol No. 50 Amplifier/Player Cabinet with perspex cover.

SYSTEM No. 5 \$459.00

This splendid selection features an attractive cabinet which includes record storage space. Take the Instrol model 250RS Cabinet, with 2 Wharfedale Super 10 Speakers fitted into Instrol Vented Enclosures. The cabinet work may be Queensland Maple, Teak or Walnut. The Amplifier used is the Kenwood TK150U, and also included is the Garrard AP75 Player (with Shure M44G Magnetic Cartridge).

SYSTEM No. 7 \$717.00

This prestige system is based on the magnificent new Instrol Cabinets "Series One Thousand." We suggest the Kenwood TK250 Amplifier and Dual 1019 Player (with Shure M75G magnetic cartridge), plus 2 Wharfedale Super 12RS DD Speakers all fitted in Instrol Teak Cabinets; 1 model 1002, and 2 Speaker Enclosures model 1001. This fine combination can be built and tested for only \$717.00.

SYSTEM No. 9 \$1,580.00

This ultimate system for the perfectionist, features the Quad 33/303 Amplifier/CONTROL Unit; the Garrard 401 Transcription Turntable (with SME 3009 pick up arm and Shure V15 cartridge); the Sony TC355 Tape Deck; all fitted into the Instrol Teak Cabinet model 1003. The speakers used are the Goodman "Sherwood" 3 way speaker systems.

SAVE UP TO \$100 ON THE ABOVE SYSTEMS

You can save up to \$100 by assembling your own Hi-Fi furniture from the Instrol, easy-to-assemble kits of parts. All designs featured in the above systems, are available in kit form, from which you can assemble your own cabinet in a completely professional manner — at little more than half the cost. Kits are absolutely complete with easy to follow assembly instructions. All you supply is a few hours of your own time, and yet save up to \$100.

The savings for each of the above systems are as follows:

System No. 2, save \$9.	System No. 3, save \$16.
System No. 4, save \$37.	System No. 5, save \$63.
System No. 6, save \$60.	System No. 7, save \$78.
System No. 8, save \$32.	System No. 9, save \$100.

Yes, we carry a large range of imported loudspeakers, players, amplifiers and tape recorders, as well as Australian equipment. Please state your requirements and we will gladly quote. All well known brands are stocked, including the following:

A.D.C., Akai, B.S.R., Decca, Dual, Elac, Fisher, Garrard, Goodmans, Instrol, Kenwood, Labcraft, Leak, Magnavox, Quad, Sansui, Shure, Sony, Tempo, and Wharfedale.



ASK FOR OUR FREE HI-FI BROCHURES AND CATALOGUE.

Send in the coupon on the opposite page, ticking the square marked Instrol Hi-Fi.

INSTROL cabinet kits . . .

and now INSTROL MEDITERRANEAN and PERIOD STYLE Hi-fi furniture . . .

We are in the process of adding Period and Mediterranean styling to some of the models from our standard range of Instrol hi-fi furniture. The photographs show Model 600 equipment cabinet with Wharfedale speaker enclosures rendered in Mediterranean and Queen Anne period styling. These stylings are equally attractive for other models from the Instrol range.

PRE-CUT KITS OR BUILT AND FINISHED

All Period and Mediterranean Styles are available as pre-cut kits to assemble yourself or as built and finished furniture. By assembling yours from an Instrol pre-cut kit, you can make your own antique style furniture for little more than half cost. Ideal for finishing to an almost exact replica of cedar, mahogany, rosewood, etc., and really magnificent when finished in any of the new Estapol Antique colours. Each kit is complete, with all necessary pre-cut timber parts, legs, antique handles, moulding, carvings, nails, screws, etc., plus fully illustrated easy to follow instruction manual.

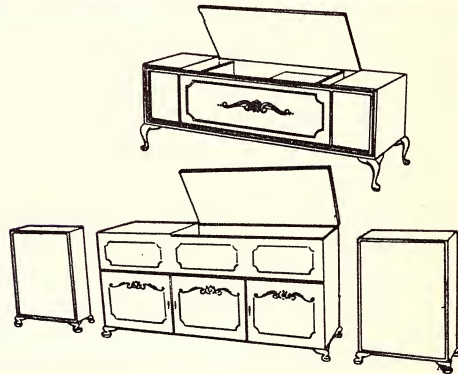
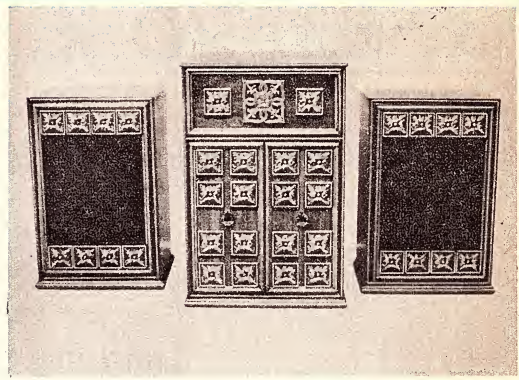

EQUIPMENT CABINETS

There are more than sixteen Instrol equipment cabinet designs, all available built and polished or as kits of parts to assemble yourself. They range from massive floor units to compact table models, and include cabinets for record storage and wall shelf units.

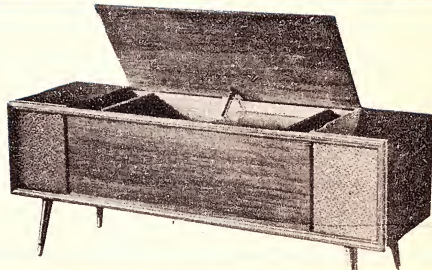

SPEAKER ENCLOSURES AND SYSTEMS

Name your speaker and Instrol can supply an enclosure to suit. If it's not in the standard range we can quickly produce enclosures to suit speaker manufacturers' specifications. Enclosures only or complete speaker systems are all available built and polished or as kits.

PLAYER STANDS

The Instrol range includes a wide variety of player stands and combination amplifier-player cabinets. High quality perspex covers (clear and tinted) are also available, some hinged, others separate.

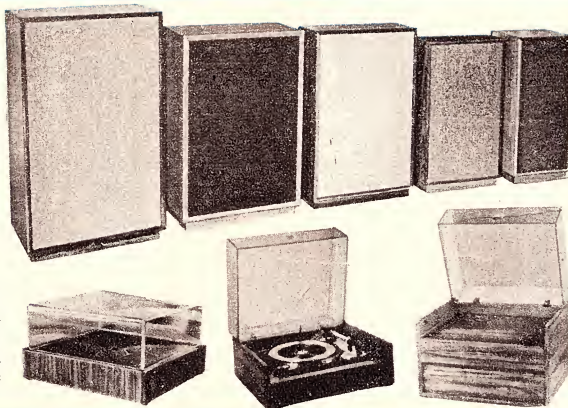

Post coupon, call, or phone for free fully illustrated Instrol hi-fi cabinet brochure. It includes full specifications and down to earth price details of all Instrol cabinet designs. (If writing please include postage stamp.)



FREE
INSTROL
CABINET
CATALOGUE

BROADWAY ELECTRONICS (SALES)

PTY. LTD.

32 GLEBE PT. ROAD, GLEBE, N.S.W.

Telephone 660-1171. Only 100 yards from Broadway.

OPEN SATURDAY MORNINGS.

Send Coupon for **FREE CATALOGUE**.
(Please enclose postage stamp.)

NAME

ADDRESS

.....

.....

Instrol Hi-Fi Instrol Cabinets

Fantastic is the word for the

The new GRUNDIG TR6000 is no set for just everyone. Its technical brilliance, extraordinary ease of operation and its sturdy, fascinating looks will satisfy the most meticulous radio enthusiast.

See and hear it at:

Goldring Sales & Service (N.S.W.) Pty. Ltd.
443 Kent St., Sydney

or at leading retailers in all States

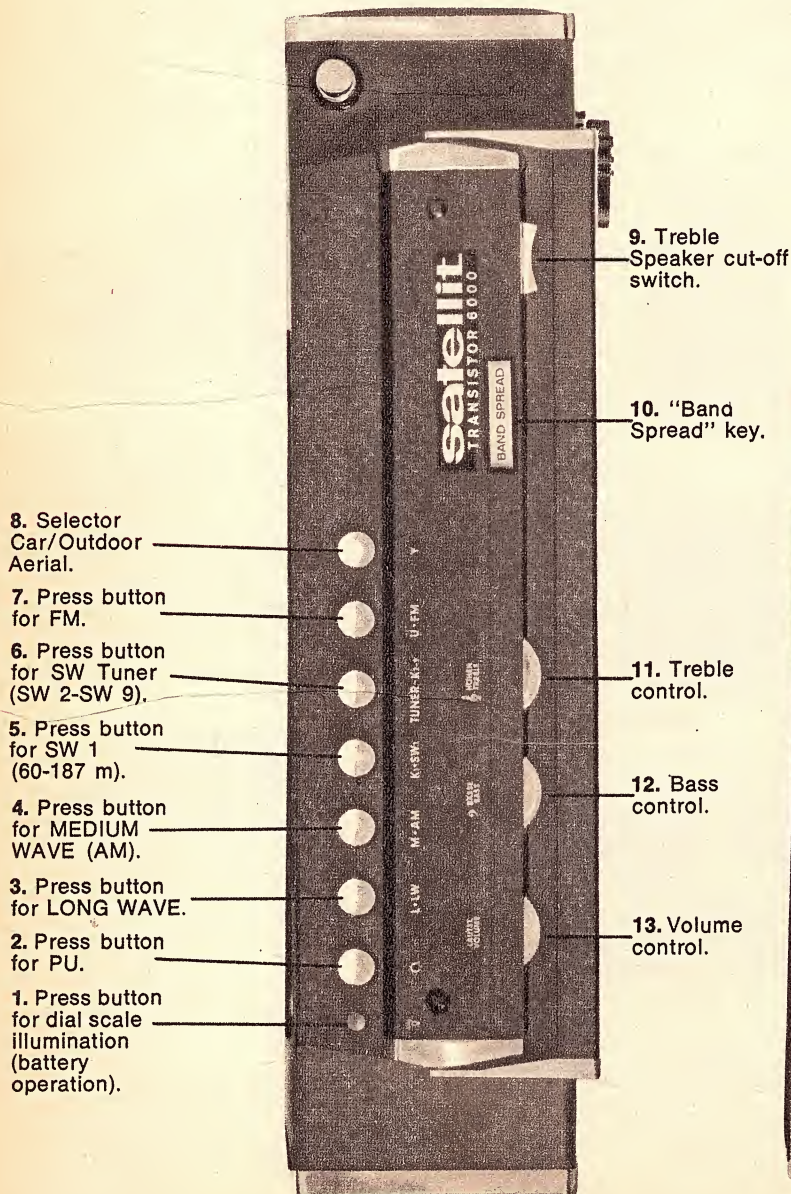

GRUNDIG

Transistor 6000

Technical Specifications:

20 tuning ranges: FM, 17 x SW (SW 1: 60-187 m, SW 2: 42-60 m and 49 m band, SW 3: 36-50 m and 41 m band, SW 4: 26,5-37 m and 31 m band, SW 5: 21,5-30 m and 25 m band, SW 6: 16,5-24 m and 19 m band, SW 7: 14-20 m and 16 m band, SW 8: 12-16,7 m and 13 m band, SW 9: 10-14 m and 11 m band), Medium Wave (AM) and Long Wave • circuits: FM 14 (3 can be tuned), AM (without SW Tuner) 9 (3 can be tuned); SW Tuner 14 (3 can be tuned) • 19 + 1 transistors (17 of these are silicon trans) • best possible cross modulation by field effect transistors • 14 + 2 diodes • tuned-in first stage on all ranges • double superimposition of SW Tuner with 4-circuit band filter • gain control: AM 3-stage, SW Tuner 3-stage with additional control, FM 1-stage • ferrite aerial for MW (AM) and LW; MULTI-MATCH telescopic aerial for FM and SW (switchable) • DUPLEX Single Selector tuning • separate SW rotating drum selector drive by means of a pull-and-push

tuning knob • colour marks for station tracing • SW fine tuning for SW 1 • "Band Spread" key • switchable AFC on FM • AM band width selector switch • tuning indicator (S-meter) • battery voltage indicator • 2 Superphone speakers (treble speaker can be switched off) • bass and treble control • 2 Watts push-pull output stage • battery operation by 6 x 1,5 V mono cells • built-in mains power pack TN 12 • dial scale illuminated • sockets for external power supply, earphone, external speaker, outdoor aerial, car aerial, outdoor dipole antenna, ground, record player/tape recorder • receptacles for SSB device with switch-over to manual control, sound filter, product demodulator • cabinet: wood, w/leatherette covering, in black and walnut.

Size approx. 44 x 26 x 12 cm
(= 18½" x 10¼" x 5")

Weight (incl. power pack), approx. 6.1 kg
(w/out batt.)

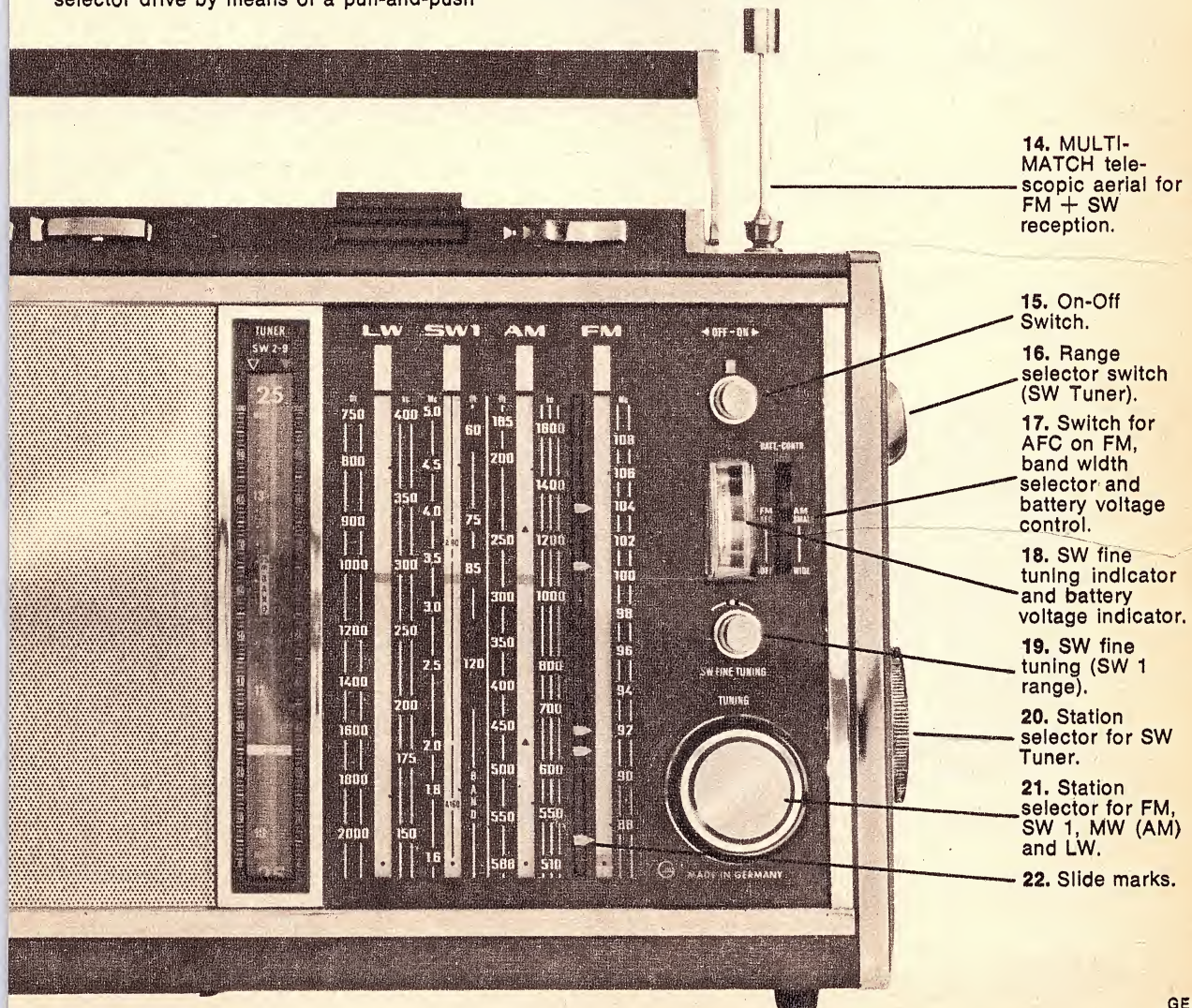

14. MULTI-MATCH telescopic aerial for FM + SW reception.

15. On-Off Switch.

16. Range selector switch (SW Tuner).

17. Switch for AFC on FM, band width selector and battery voltage control.

18. SW fine tuning indicator and battery voltage indicator.

19. SW fine tuning (SW 1 range).

20. Station selector for SW Tuner.

21. Station selector for FM, SW 1, MW (AM) and LW.

22. Slide marks.

Sansui's systematic way

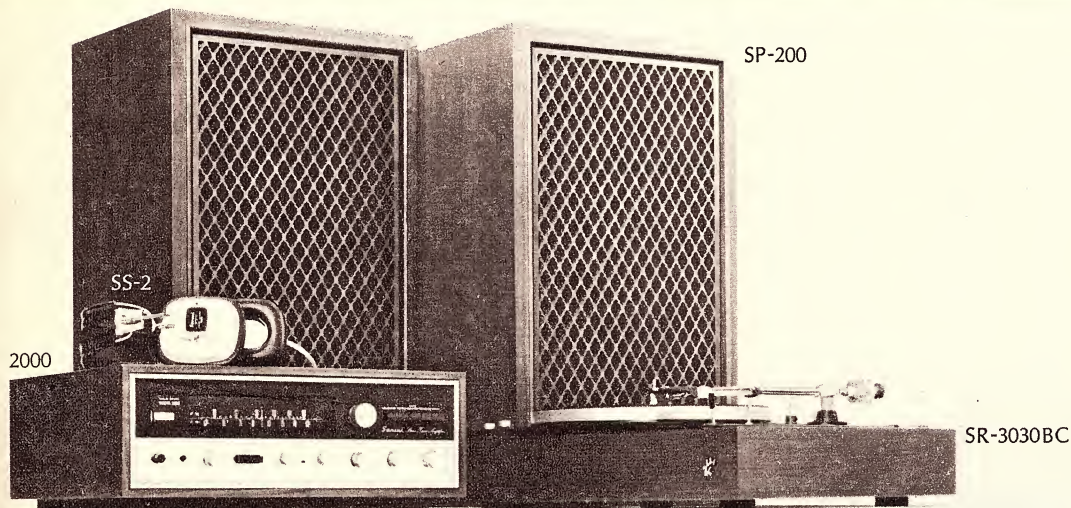

For a start, check into this attractive 100 watt system. The solid state 2000 AM/FM multiplex stereo tuner amplifier handles the other components like they were made for each other. And they were. Beginning with audio characteristics that include 100 watts in output power, wide power bandwidth from 20 to 40,000Hz and a distortion factor of less than 0.8%, the 2000 gets total performance from every component, including its own FM tuner section with FET circuitry.

The SP-200 is a 3-way 5-speaker high fidelity system with a 40 watt handling capacity and the latest tap-type level controls. The SR-3030BC is a 2-speed manual turntable incorporating a unique belt-drive system, heavy platter and tubular tonearm for flawless characteristics of wow and flutter. The SS-2 is a moving coil type headphone set that gives you "you are there" stereo faithfulness throughout a wide 20 to 18,000Hz frequency range.

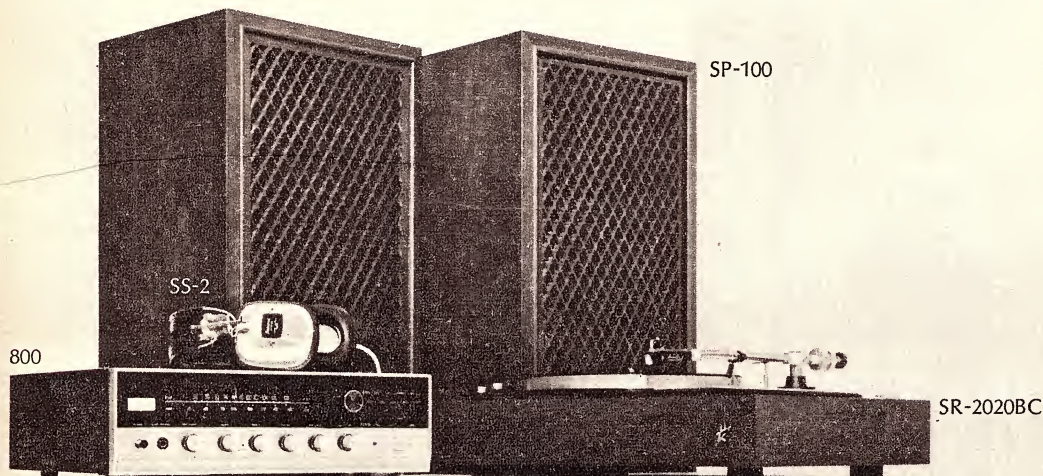

Or, check into this 70 watt system. It combines the Sansui 800 AM/FM multiplex stereo tuner amplifier with the SP-100 3-way 3-speaker high fidelity speaker system, SR-2020BC 2-speed manual turntable and SS-2 headphone set.

Like the larger 100 watt system, the components that make up this one feature compatibility in both design and performance. It brings larger system performance into the medium power and price range. Ask your nearest authorized dealer for spec sheets for either of these systems. What you see will surprise you and what you hear will surprise you even more if you haven't heard a Sansui system before.

to better sound.

If you're looking for something even more professional, ask your dealer to show you the Sansui AU series of professional stereo control amplifiers. They turn on at 70 watts (AU-777), 60 watts (AU-555) and 46 watts (AU-222), respectively.

And they turn on some of the finest engineering features ever offered to stereo enthusiasts anywhere. Wide dynamic ranges, low distortion factors, high S/N ratios and independent pre- and main-amplifier sections for the two larger models.

Sansui also makes matching AM/FM Multiplex Stereo Tuners for these models, which is something to keep in mind for the time when multiplex broadcasts become operational in Australia.

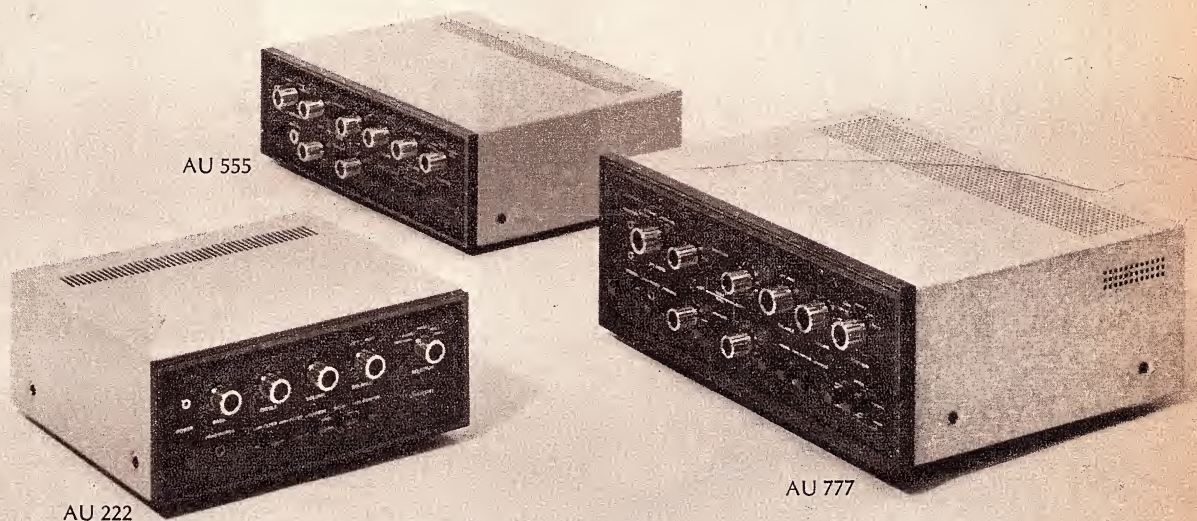

Sansui[®]

SANSUI ELECTRIC CO., LTD. 14-1, 2-chome, Izumi, Suginami-ku, Tokyo, Japan

IKARA—world's best anti-submarine

Australia's long-range anti-submarine warfare system Ikara was originally designed because the Royal Australian Navy staff was not satisfied with the systems then available in the U.S.A. and Britain. Designed and developed entirely by Australian engineers, it is recognised as the most advanced system of its type in the world, and has been adopted by the Royal Navy as its standard anti-submarine weapon.

Ikara is an advanced anti-submarine warfare (A.S.W.) guided weapon system proven in service over a number of years and unmatched for range, accuracy and reliability by any other A.S.W. system in service or under development in the free world. The success of this project is due largely to an integration of the many complex and diverse disciplines and activities, including research, development, and design, required to develop a superior weapon system for service use. Australian development and production of Ikara has resulted in a system which fully meets the Royal Australian Navy (R.A.N.) Staff Requirement and offers a major logistic advantage compared with procurement of an overseas weapon system; other advantages are the ease with which necessary changes and modifications may be introduced at minimum cost to suit essential service requirements.

The Ikara system has growth potential permitting incorporation of improved target detection systems, facility to carry heavier payloads, and possible increase in range.

During trials to demonstrate the practicability of the weapon system at sea, a technical mission from the United Kingdom visited Australia to investigate Ikara. Subsequently the decision was taken to develop Ikara for use by the Royal Navy, as the original R.A.N. system was the only one which closely approached an R.N. Staff Requirement and a NATO requirement for an anti-submarine weapon system.

The protection of convoys and task forces against attack by submarines would be a major wartime role for units of the R.A.N. For this purpose the R.A.N. uses Australian-built River Class Destroyer Escorts (DE) which are based on a British design and have a capability for detecting and attacking submarines. The ships are fitted with several sonar acoustic detection systems, able to detect submarine activity out to the greatest possible range.

For the attack tasks the R.A.N. uses the Australian-designed, developed and produced Ikara anti-submarine weapon system. The development of the system was dictated by the needs of modern naval warfare, and Australian ingenuity has produced a weapon using advanced techniques which achieve maximum effectiveness against the submarine menace.

Prior to the introduction of Ikara, the R.A.N.'s major A.S.W. system used target information from a short range sonar to direct a 3-barrelled mortar which ballistically throws pre-set charges towards the position of the submarine. This system, known as the Mortar Mk. 10, does not have the range to exploit fully the sonar detection capability available to the ship. It was decided in 1959, during the initial construction phase of the third Australian River Class DE, H.M.A.S. Stuart, that a new weapon system designed to use the full capabilities of the detection systems should be developed. This new weapon system could also exploit the capabilities of torpedoes of improved design which were becoming available.

LEFT: An Ikara missile, with torpedo, in position on its launching platform. The torpedo is released in flight, and floats down to sea level by parachute.

RIGHT: A model of the Ikara used by the Aeronautical Research Laboratories, Melbourne, for conducting wind tunnel tests.

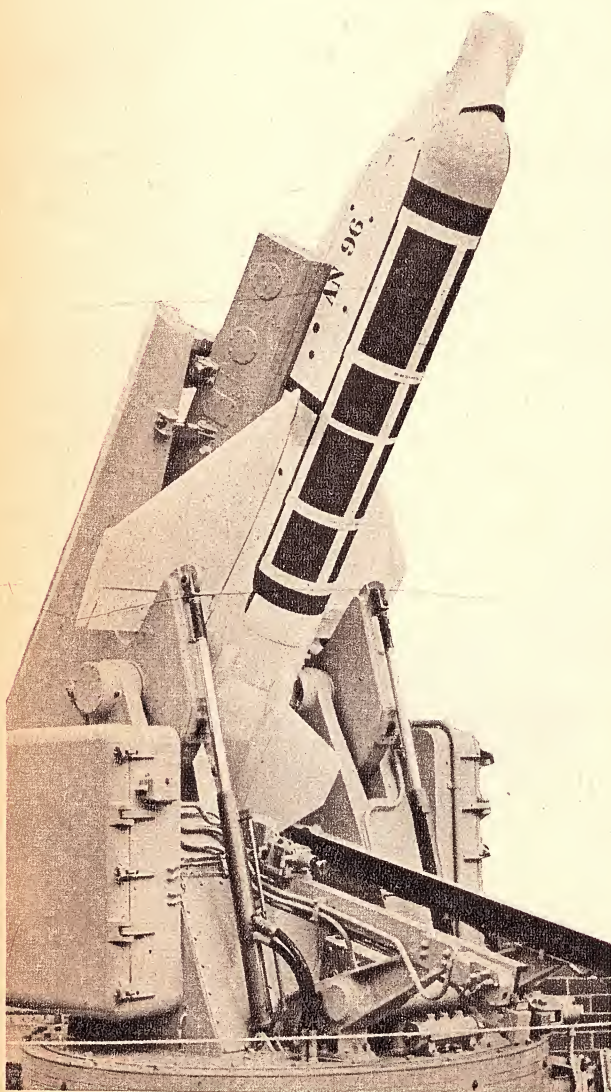

weapon system

Two weapon systems being developed overseas which might have met this requirement were investigated. The first of these, ASROC, is an anti-submarine rocket developed for the United States Navy. It consists of a solid-fuel rocket motor arranged in tandem with a homing torpedo. It is approximately 15ft long, 2ft 6in over the fins and weighs approximately 1,000lb. Flight is ballistic, unguided and at a pre-determined point the rocket separates from the torpedo, which is lowered into the water by a parachute. The system will place the torpedo on the future position of the target, which is computed prior to firing; the system accuracy is limited when used at the longer ranges against a modern, highly manoeuvrable fast submarine, because of the extensive unguided flight time.

The second system examined, MATCH (Medium-range Anti-submarine Torpedo Carrying Helicopter), a British design, employs a manned helicopter carrying homing torpedoes. Upon detection of the submarine, the helicopter is directed to the contact and the torpedoes dropped at the position assumed most favourable to seek out and home onto the target.

Use of ASROC was rejected because:

- (a) A longer-range weapon was required.
- (b) The weapon was considered to be insufficiently effective at its longer ranges; if the range were to be increased the effectiveness would be further reduced.
- (c) The system constituted too great a weight/space penalty if fitted to a River Class DE.

Use of MATCH was rejected because:

- (a) The low speed of reaction due to the excessive time taken to reach a target area at long range.
- (b) The system lacked a true all-weather capability.
- (c) Extensive structural alterations would be required to the after end of the ship to provide a helicopter launching and landing pad.

As a result of these investigations, the decision was taken to develop in Australia a missile which is actively guided by a system capable of receiving target information during flight, processing this information and directing the missile so that a homing torpedo is delivered into the water at a point as close to the target as possible.

The entire program has been a combined task

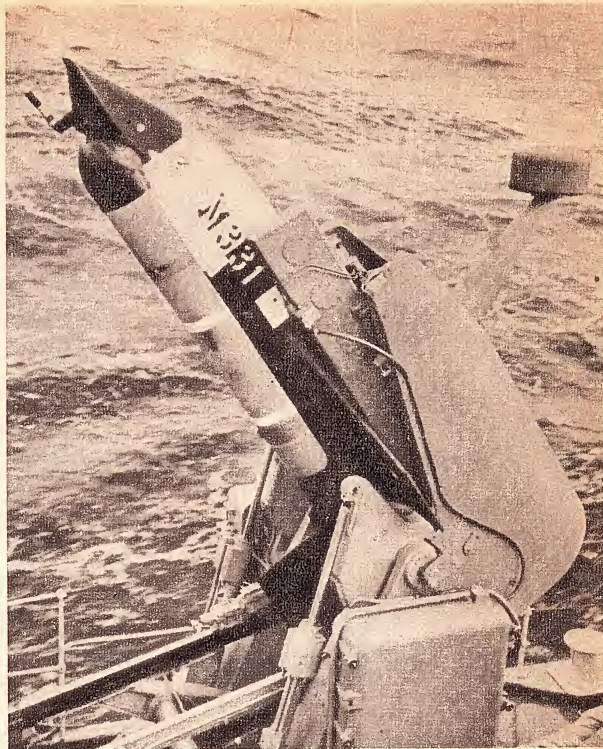

Ikara, in the role for which it is intended, aboard a missile carrying destroyer, guarding Australia's extensive coastline.

between the Departments of the Navy and Supply, with assistance from industry. The Department of the Navy specified the detailed characteristics required for operational service and also assumed responsibility for the design, development and proving of the magazine, handling and launching system. In this task, assistance was obtained from industry, the prime contractor being the Commonwealth Aircraft Corporation, Melbourne. The Department of Supply assumed responsibility for the research, development, design and manufacture of the vehicle (missile less payload), the associated data processing, tracking and command guidance systems and the evaluation of system performance.

Studies were also conducted, in association with the Department of the Navy, to determine the optimum tactical deployment of the system. The Department of Supply responsibilities for research, development and design have been divided primarily between Aeronautical Research Laboratories, Melbourne, and Weapons Research Establishment, Salisbury, S.A. Altogether about 200 sub-contractors have contributed to manu-

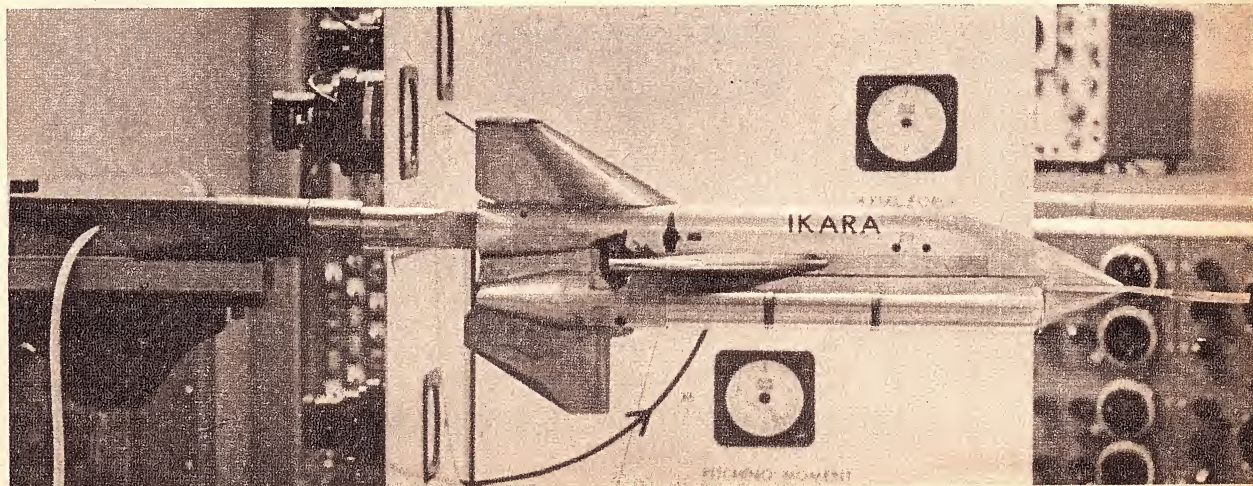

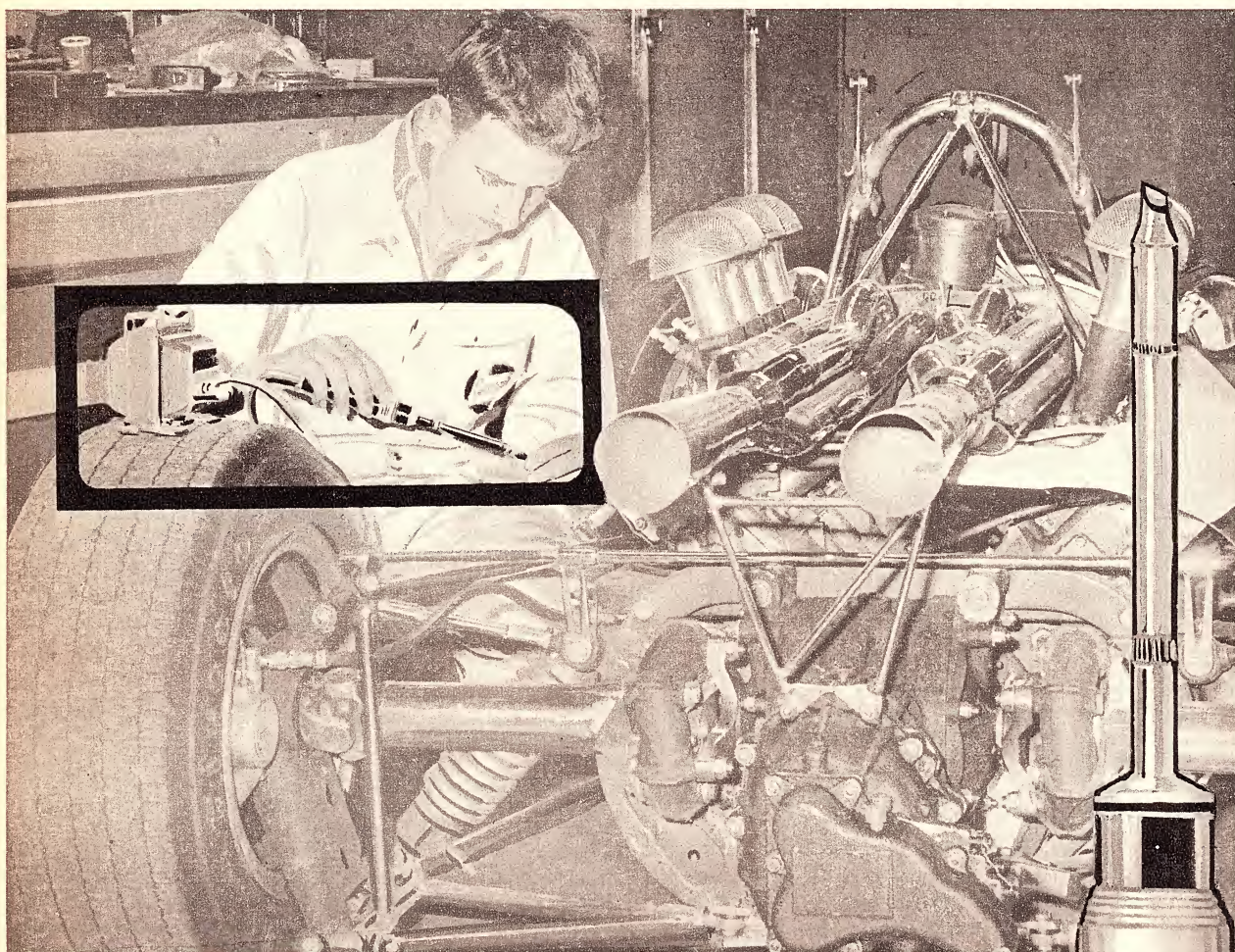

"The Scope Soldering Iron is a World Champion" says-

HEATS in seconds automatically switches off when not in use.

CARBON element can't burn out easily replaced when used up.

COPPER tip is a cinch to change.

MAINTENANCE a breeze spares readily available.

WEIGHT only 3½ ozs. but equal to conventional 150 W irons.

PERFECTLY SAFE WORKS OFF LOW VOLTAGE.

SCOPE Available from all leading retailers, automotive suppliers, hardware stores, electrical wholesalers nation wide.

Leslie L. Heffernan

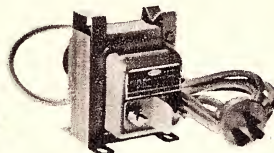

De Luxe Irons are beautifully presented in a handy re-usable plastic pouch-pack, complete with one spare tip and two spare elements.

De Luxe Irons operate on voltages from 2.5V to 6.3V A.C. or D.C. or from 240V A.C. mains through a "Natronic" Scope Transformer fitted with 6 ft. 3-core flex and 3 pins mains plug.

AUSTRALIAN & OVERSEAS AGENTS:

IRH COMPONENTS PTY. LIMITED

(A subsidiary of International Resistance Holdings Ltd.)

THE CRESCENT, KINGSGROVE, N.S.W. 2208. TEL. 50 0111



facture or detail design of Ikara equipments and components; prime contractor for the vehicle and its associated equipments is the Government Aircraft Factories, Melbourne. The lead contractor for guidance and fire control is E.M.I. (Australia) Ltd., Salisbury.

The Aeronautical Research Laboratories in Melbourne played a major part in the development of the Ikara, and was responsible for ensuring the system performance was met. They were also responsible for the aerodynamics, control system and structure of the missile. The development of the missile test and firing equipment was supervised by A.R.L. The torpedo deployment system was developed at A.R.L., as were the parachute system for torpedo deployment and missile vehicle recovery.

Numerous low speed and high speed wind tunnel model tests were carried out at A.R.L. in conjunction with extensive simulation studies during all stages of the design, to ensure the performance of the missile. The simulation work permitted the rapid determination of missile and system parameters and was also widely used on trials planning.

The Ikara weapon system comprises:—

- (a) Own ship sonars of British manufacture providing target information.
- (b) A data processing and display system based on an analogue computer of local design and manufacture.
- (c) Missile tracking and command guidance systems of high accuracy and reliability.
- (d) A guided airborne vehicle carrying a homing torpedo and having a designed growth potential to permit carrying alternative payloads at a later stage.
- (e) A shipboard handling and launching system.

With the purchase of the Charles F. Adams class destroyers from the United States, the decision was taken to fit Ikara in place of the ASROC system normally fitted for the U.S. Navy, retaining the standard U.S. 5in guns and Tartar surface-to-air armament. This involved the use of twin launchers and modified magazine and handling arrangements, which have proved satisfactory, the system having been in operational service for several years. The system works in conjunction with a digital computer, as shown in the simplified functional diagram of the system below.

The primary source for the provision of target range, bearing, course and speed is the ship's sonar equipment. Provision is also made for the incorporation of additional information from helicopters fitted with "dunking" sonars and other ships in the attack area which are not necessarily fitted with Ikara. This external data system, known as EXDAK, uses a computer and an attack console to provide command guidance for the missile and fire control facility.

The computer relates sonar ship and missile data in a continuous automatic process to select the optimum water entry point for the torpedo and provides corrections to missile flight path and torpedo release point which may become necessary due to target manoeuvres.

The attack console, illustrated above, provides the system controller with fire control, a visual display of all relevant tactical data, and the means to manually vary the torpedo water entry point should this be considered necessary for tactical reasons.

The missile is continuously tracked during flight by the shipborne radar. A fully stabilised tracking aerial located in a radome uses a broad beam to gather the missile after launch, locking on with a fine tracking beam following missile acquisition. Prior to firing, the tracking aerial is trained by the computer. A command transmitter receives missile guidance data from the computer and converts this to coded command signals which are transmitted to the missile.

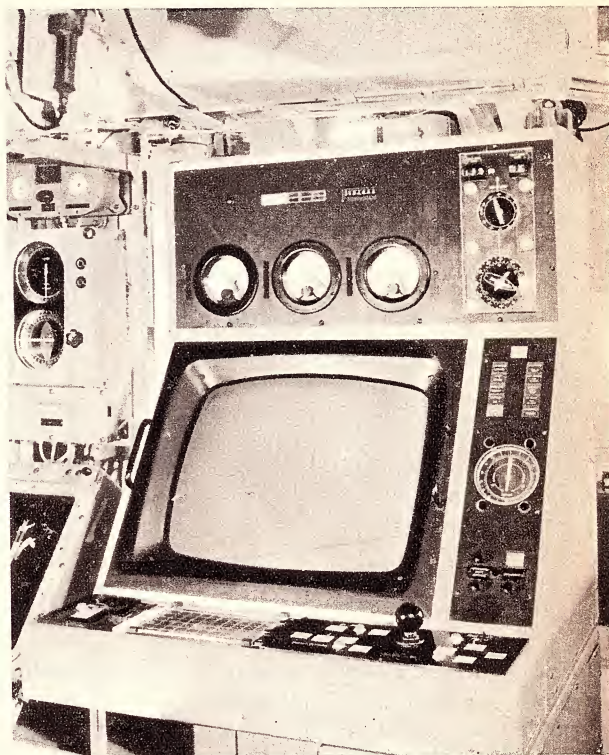

The attack console for the Ikara system. Using information obtained by sonar and radar, the missile can be steered to the best position for the homing torpedo to find its target after it is released. The position of target and missile are continually plotted and displayed on a screen.

BELOW: Simplified block diagram of the complete Ikara system. At the heart of the system is the computer, which automatically trains the missiles before firing, and thereafter provides data to allow it to be controlled from the attack console.

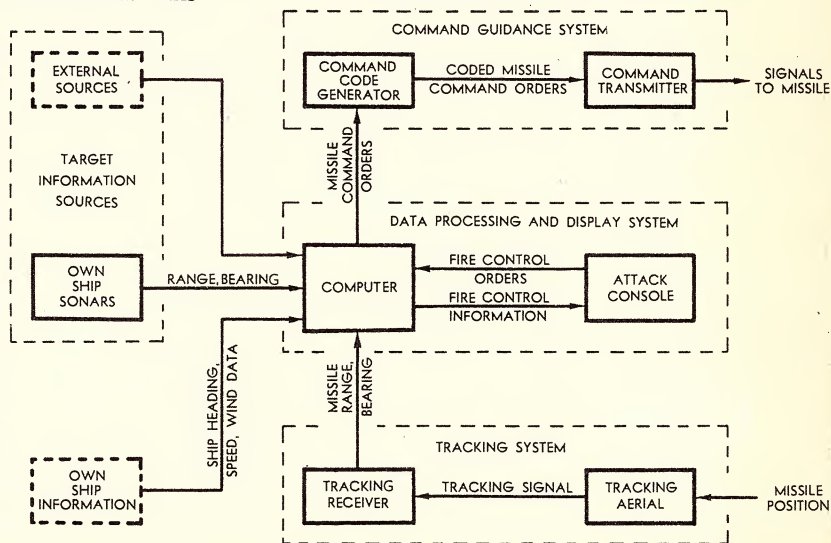

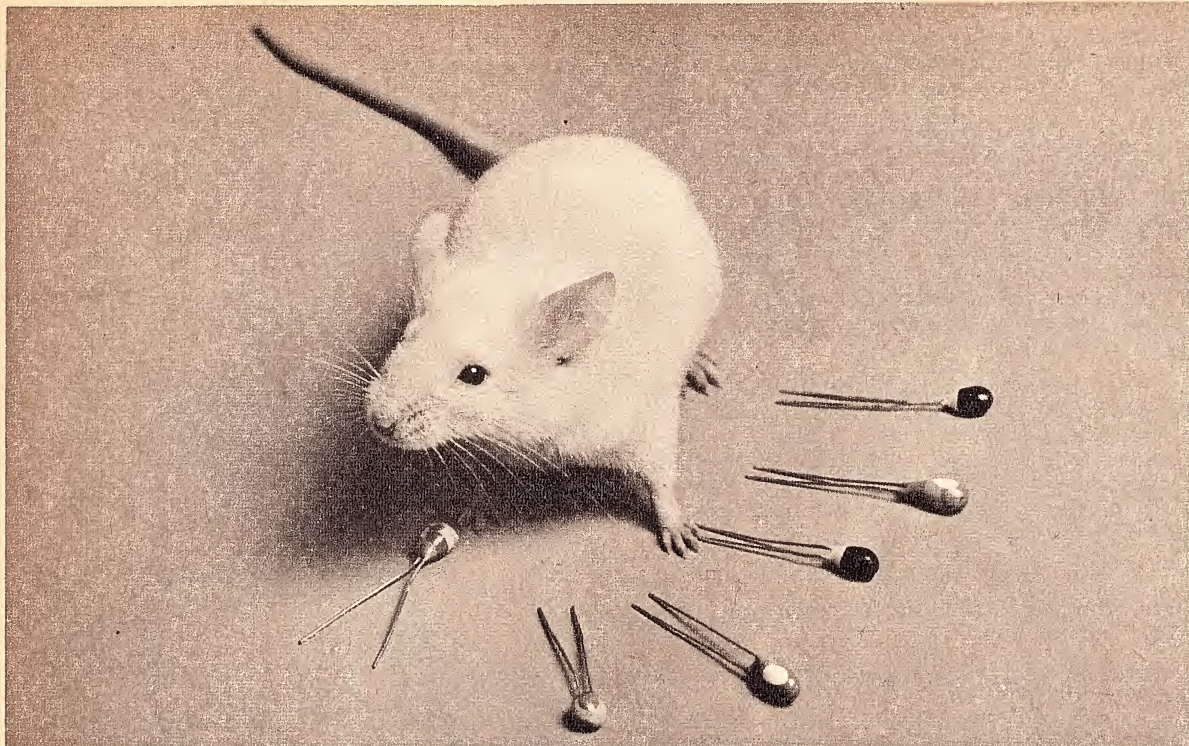

Do you have a circuit for a 68 μ F/3V mouse?

Meet Alice. She tried to make history. Tried to polish off one of our new TAG tantalum capacitors. (It would take her weeks to get through a conventional electrolytic capacitor). TAG looked just right. Sort of mouse size. And that's the point: where space is limited, or if miniaturisation is your aim, you'll find one tiny TAG capacitor will do the same job as the normal electrolytic type. Actual size is about the same as

a match head. Just small enough to save you a lot of sweat. And time. And money. We have a free booklet that tells you all about TAG. To get your copy, simply contact:
 Components Division, **Standard Telephones & Cables Pty. Limited**, Moorebank Ave, Liverpool, N.S.W. 2170. Phone Sydney 602.0333 or phone Melbourne 480.1255, Canberra 49.8667, Brisbane 47.4311, Adelaide 51.3731, Perth 21.6461, Newcastle 61.5172, Wollongong 2.7974.

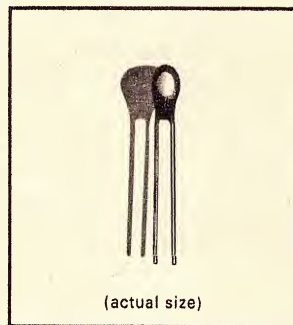

(actual size)

TAG Tantalum Capacitors
 3 to 35V., 0.1 μ F to 100 μ F,
 .30" to .38",
 -55°C. to +85°C.

AN **ITT**
 ASSOCIATE

world-wide telecommunications and electronics



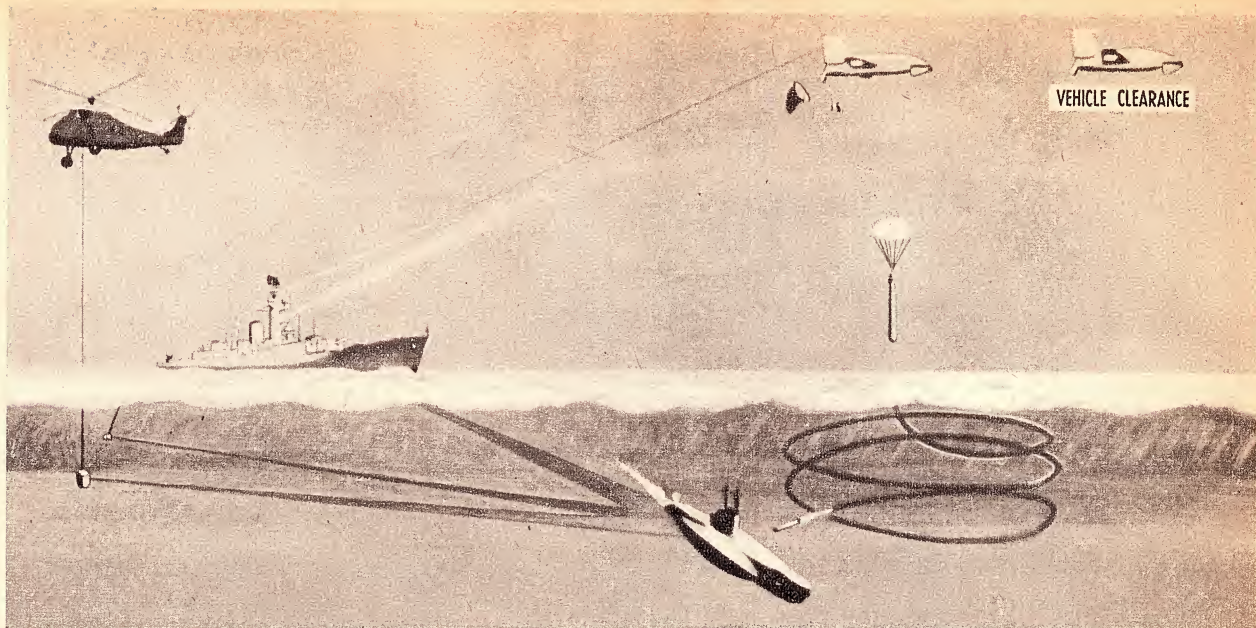

Ikara attack sequence

To carry out an attack following location of a target by sonar or other information source, the sequence of events is as follows:

- Information from the source is processed by the computer to indicate future target position, to train the launcher and tracking aerial and, following firing, to provide guidance commands to the missile, i.e., steer right, steer left, release torpedo.
- The processed target information is also shown

on the attack console in order that the anti-submarine warfare officer may be kept informed of the attack progress and the tactical situation.

- Immediately after firing, the missile is gathered in the broad tracking beam, which is switched to the fine tracking beam on acquisition.
- The missile flies to the computed release point, where the torpedo is released and lowered by parachute to the desired water entry point.
- The torpedo seeks out the target and attacks it.
- The vehicle remains aerodynamically stable after torpedo release and flies clear of the target area.

The missile design is based on the following main requirements:-

- (a) The missile should be guided in flight to achieve high overall effectiveness.
- (b) The missile itself should be as small and light as possible for utility of shipborne fitment, which also requires that all wings and fins be readily detachable and interchangeable with other missile sets.
- (c) The vehicle should remain aerodynamically stable and controllable after torpedo release in order to avoid interference with torpedo delivery.
- (d) Boost dispersion (i.e. departure of the missile from the nominal flight path during the boost phase of the flight) should be as small as possible in order to maintain short range accuracy.

The requirements of in-flight guidance of minimum size and weight led to the adoption of twist and steer aerodynamic control which requires a minimum number of control surfaces. The need for control of the vehicle following torpedo release is satisfied by attaching the torpedo beneath the main body of the vehicle, thus minimising centre of gravity shift following torpedo release. The missile is rocket propelled and as the

minimum range is dependent to a large degree on the boost dispersion, it is necessary that the overall centre of gravity be accurately aligned with the normal boost centre line.

Propulsion is by an Australian designed and developed rocket motor in which boost and sustainer sections are combined in a single unit. This unit is an essential part of the missile structure and alignment is achieved by adjusting the torpedo position on its mountings. As the propulsion motor case forms part of the structure there is little weight penalty compared with a separating boost, and the added complication of a jettison system is avoided.

A closed loop system in the missile controls height and bank angle automatically. The missile flies to a height which has been chosen to achieve reliable command guidance. Guidance is affected by commanding bank angle via a radio link provided by a shipborne command transmitter. A tracking receiver and its associated aerial tracks the missile and gives missile position information. The lightweight torpedo is designed to detect, home on and destroy submarines.

Missiles are stowed in a separate magazine from which they may be readily extracted as required. The

handling system is automatic and permits extraction from the magazine and loading into the launcher with minimum delay. The launcher (picture, page 10) is specially designed to fire missiles under all weather conditions while placing minimum restrictions on arcs of fire; it is trainable in azimuth to put the missile on track early in its flight.

The use of aeronautical design techniques has resulted in considerable weight saving in the Ikara magazine, handling and launching system.

Initial missile proving trials were carried out at the Department of Supply Weapon Range at Woomera where scaled down models were used to prove aerodynamic and control system features; these trials were followed by full scale missile trials. The guidance system was proved initially by using an aircraft fitted with missile guidance components and conducting fly-over trials covering the entire range and bearing spectrum of the system.

With the completion of the H.M.A.S. Stuart installation, firing trials were carried out at sea to demonstrate the practicability of the system by initially firing programmed missiles to prove the launching sys-

TELEQUIPMENT



economic price performance portability

The double beam D52 by Telequipment is a tough little portable oscilloscope for a sensible price. Here are a few of its outstanding characteristics:

- True double beam
- Large 5" flat faced P.D.A. Tube
- Matched Y amplifiers—
100mV/cm, DC-6MHz
10mV/cm, DC-1MHz
- Calibrated sweep speeds—
18 (+variable)
- Triggering modes—full range,
including TV sync
- Weight 24 lb
- Write or phone for more details

Distributed by Tektronix Australia Pty. Limited
N.S.W. 80 Waterloo Rd., North Ryde 2113. Phone 88 7066
VIC. Suite 20, 67 Queens Rd., Melbourne 3004. Phone 51 1592
S.A. 128 Gilles Road, Adelaide 5000. Phone 23 2811



TEKTRONIX



tem and safety aspects and subsequently firing a series of fully controlled missiles.

During the next phase, evaluation of the production prototype system at sea, more extensive instrumentation was required to monitor and record missile performance in flight, guidance and other system characteristics, and to measure the distance of torpedo water entry point relative to a fixed target. In order to simulate a moving target, missiles were programmed to carry out appropriate changes in heading during flight so that missile dynamic response could be determined.

To record data at sea, instrumentation was installed in the firing ship. The instrumentation included telemetry receiving equipment, a system for encoding and recording data in digital form, cameras to measure initial flight characteristics, and

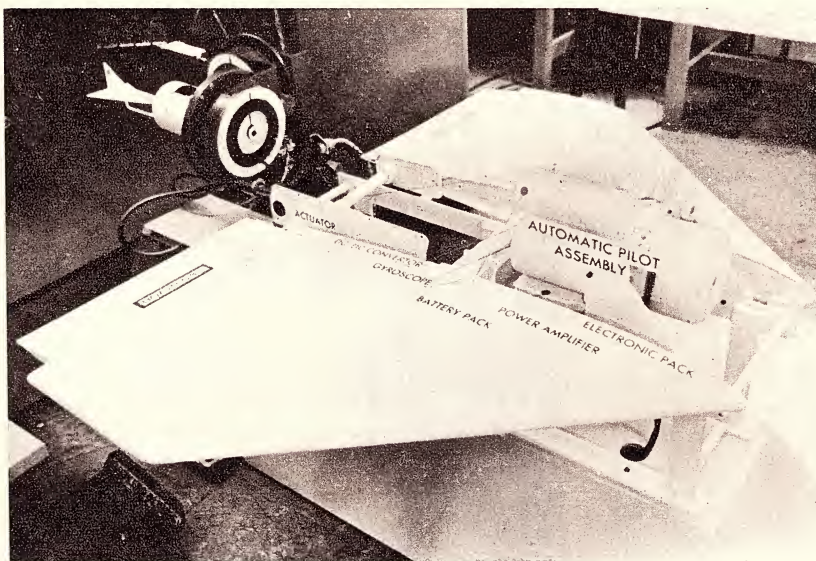
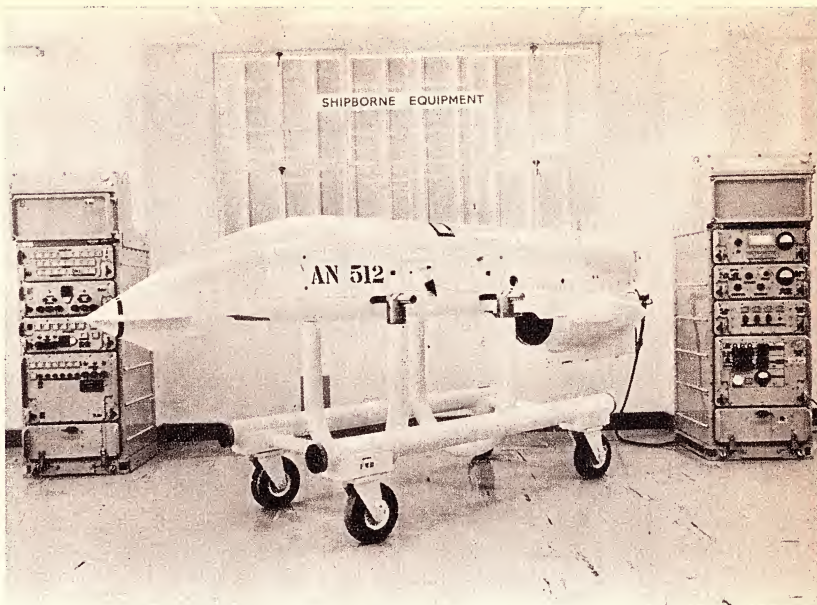

The Aeronautical Research Laboratories, Melbourne, played a major part in the development of Ikara, and featured the system in an exhibit during a series of open days held at the Laboratories recently. Above: The fuselage section in its transporting trolley with the firing sequence equipment (rack at left) and the control system test equipment. Left: The wing section was coded to show the disposition of parts, and visitors were able to operate the controls from an associated panel.

sequencing equipment. In the target area additional instrumentation was set up to record the terminal flight phases of both the missile and the torpedo.

During later trials, operations were carried out using actual submarines as targets and instrumented exercise torpedoes to measure underwater performance.

The concept of missile guidance in flight was proven during the trials program to give a very high torpedo delivery accuracy; this, together with the fact that the latest possible target information is being used, has been shown in associated Operational Effectiveness studies to give a higher weapon system effectiveness than can be achieved by alternative weapon systems. Experience with Ikara fitted in R.A.N. ships shows that it maintains the high accuracy achieved during development trials and in addition operates with a high order of reliability. ■

SWORD on display at Paris Air Show

A new navigation, weapon delivery and flight control system designed for combat aircraft of the next decade was exhibited for the first time at the recent Paris Air Show.

The new system is called SWORD (Strike and Weapon Ordnance Delivery), and has been planned by Elliott Flight Automation, of U.K., around the comprehensive group of sensors, airborne digital computers, controls and instruments the company already has in advanced development or quantity production.

The full SWORD system consists of the Elliott E.3R miniature inertial platform with digital electronics unit: 920M digital computer as central flight management, navigation and weapons aiming processor; head-up display with digital electronics unit as the main flight instruments system; projection map display, control/indicator panel, head-down electronic display and horizontal situation indicator together performing all the functions of tactical display, navigation and flight instru-

mentation; an autopilot and autostabiliser system providing, if required, fail-operative safety for high-speed flight at very low level; central air data computer; KU band ranging radar or laser rangefinder for line-of-sight ranging in weapon delivery; dual-frequency KA/X band high definition radar for terrain following and target acquisition as well as ranging; low-light television for passive target acquisition; doppler radar as an alternative navigation sensor. Also available as part of SWORD are the Marconi AD-1410 VHF/HF communications and homing radio and the Marconi VOR/ILS navigation receiver.

Airborne elements of SWORD are complemented by the Elliott C.700 computer-controlled automatic test equipment and by the Retriever air control system, a mobile computer-controlled miniature operations centre capable of being installed in a field car to provide forward control of low-level tactical strike and reconnaissance operations. ■

MARS LANDING IN 1973

Speculation about life on Mars may be finally resolved when the U.S.A.'s Viking space probe lands on the planet in about four years from now.

By William Clothier

The possibility of life on other planets has fascinated man for centuries, but only recently has he been able to send a flying machine millions of miles into space, place it in a precisely determined orbit around a planet, or land it on the surface of another world.

In mid-1973 two unmanned spacecraft, developed for the National Aeronautics and Space Administration's Viking program, are scheduled to leave Cape Kennedy bound for Mars. Nearly eight months after launch, 10 days apart, the two spacecraft will intercept the Red Planet in its nearly 900-million-mile swing around the sun. By that time they will have travelled more than 265 million miles in a looping trajectory and their straightline distance from Earth will be about 150-million miles.

At the proper moment, braking rockets will fire and both spacecraft will enter orbits around Mars. Each Viking spacecraft will survey potential landing sites from orbit. When a suitable site has been determined, a lander will detach from each orbiter and ease down softly on the surface of Mars.

The exact nature of the experiments to be carried on by the Viking spacecraft will not be determined for some time. The Mariner spacecraft flights of 1969 and 1971 will influence these decisions. But the general purpose of the Mars landing is to increase man's knowledge of the Martian surface and atmosphere with particular emphasis on information about planet life.

Viking is an important step in a carefully planned NASA program of Mars exploration. This year, two Mariner spacecraft will be launched on trajectories which will swing them past Mars at a distance of about 2,000 miles. Pictures taken during the fly-by missions are expected to show surface features, such as craters, measuring 800 feet or more in diameter. In 1971, two more Mariners will go to Mars, this time to be placed in orbit, providing a tenfold increase in scientific information about the planet. Two years later the Viking missions, with their soft landings on the planet, will add still more information, including Martian conditions which might support life.

Such scientific seek and fetch is not expected to show that little green men with waving antennas scuttle across bleak Martian deserts. Life, in the sense used by the scientists, is not that limited in scope. Biological experiments in the planet's atmosphere and on its surface are designed to detect both the presence of living organisms and the conditions which might be suitable for life.

However, the goals of NASA's planetary exploration programs are

much broader than the search for extraterrestrial life, important as that is. These goals include a better understanding of the origin and evolution of the solar system and the dynamic processes within it which control man's home—the Earth.

Last year a select group of the National Academy of Sciences pointed out in a special report that investigation of planetary atmospheres, surfaces and interiors not only will help unravel the complex history of the solar system, but also will lead to a better understanding of processes now under way in Earth's atmosphere, oceans and deep interior. In short, finding out what's happening out there will help explain what's happening here.

It seems likely that all nine solar system planets and their 32 satellites — including Earth and its moon —

Saturn 5 moon rocket and has technical integration and evaluation responsibilities to NASA for the overall Apollo/Saturn 5 program.

As a team partner General Electric would place its emphasis on the Mars atmospheric entry phase. G.E. has been active in atmospheric entry programs for more than 12 years, and has been successful with about 98 per cent of the hundreds of re-entry missions it has flown in connection with the nation's space and missile programs.

The other partner, Hughes Aircraft Company, would concentrate on the terminal landing phase of the mission. Hughes brings its experience as builder of the Surveyor spacecraft. Five Surveyors made successful landings on the moon, the only U.S. spacecraft to soft-land on another celestial body.

Viking will challenge even this collection of talent. Engineers and biologists must join forces during spacecraft design and construction. One such co-operative effort involves preventing the contamination of Mars with life from Earth. The Committee on Space Research (COSPAR) has decreed that spacecraft must be sterilised to prevent the transport of live Earth microorganisms to Mars.

Communications between Earth and the spacecraft will impose another restraint — a time lag of 13 minutes. Telemetry radio signals travel at the same speed as light — 186,000 miles per second. But even at that speed these signals require about 13 minutes to

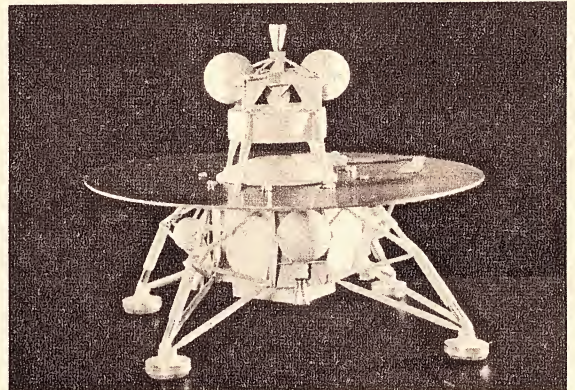

A model of Boeing's proposal for the Viking space probe.

were formed of the same basic material. The material was probably primordial hydrogen and the time several thousand million years ago. Dr Isaac Asimov, a Russian-born American author of books on science and science fiction, simplified one creation theory thus: "The solar system consists of Jupiter plus debris." As riders on part of that debris, the human race needs to know more about the processes which are shaping — or have shaped — Earth and its planetary neighbours.

The Boeing Company has submitted proposals for the Viking program to NASA's Langley Research Centre. Teaming with Boeing are the General Electric Company and Hughes Aircraft Company. If this team wins the Viking assignment, Boeing will be the prime contractor and systems integrator — a role it has played before in space and related programs. In addition to its experience on the Lunar Orbiter satellite, Boeing is at present systems integrator on the Minute-man intercontinental ballistic missile program for the Air Force, builds the first stage and merges all three stages of the

traverse the 150 million miles from Mars to Earth. This means that Mars flight operations cannot be conducted in "real time." Events must be predicted and programmed.

Although it is widely agreed that the Mars landing is technologically feasible, it is not universally accepted that such a program is reasonable and necessary. Arthur C. Clarke, an English scientist-writer and one who believes man's drive for knowledge is essential to his life, puts it this way:

"Though man and civilisations may yearn for rest, for the dream of the lotus-eaters, that is a desire that merges imperceptibly into death. The challenge of the great spaces between the worlds is a stupendous one; but if we fail to meet it, the story of our race will be drawing to a close."

Dr Frederick Seitz, president of the National Academy of Sciences, can see no alternative to pushing ahead to new knowledge. He said recently, "Our children will wonder what manner of people we were, that we ever questioned the value of space exploration."

LUX AMPLIFIERS ARE UNEQUALLED FOR VALUE, QUALITY AND PERFORMANCE



THE NEW LUX SQ-1220 SOLID STEREO AMPLIFIER OVER 100 WATTS R.M.S. TOTAL OUTPUT!

The new and outstanding Lux SQ-1220 is rated at over 50 watts R.M.S. into an 8 ohm speaker load. Distortion is so minute it is difficult to measure even at high outputs. 40 transistors and diodes. Frequency response is 10-50,000 Hz. ± 1 dB. Provision is made for separate bass and treble controls in each channel, low and high filters, frequency selectors and tape monitoring. Ask for complete and unabridged specifications for this sophisticated Lux amplifier. Performance can only be described as superlative. Encel price (including Sales Tax) **\$350**

LUX MODEL SQ-505 SOLID STATE STEREO AMPLIFIER

Rated at 30 watts R.M.S. per channel, the all new Lux Model 505 is a silicon transistor unit. Power transistors are designed to withstand temporary short circuits and overloading — overall frequency response is 10-50,000 Hz. plus or minus 1dB in the power amplifier and 20-50,000 Hz. plus or minus 2dB in the pre-amplifier. Controls and features include volume, balance, mode selector, treble/bass controls, filters, tape monitor, headphone jack, exclusive A/B speaker systems selector, etc. All in all the Lux SQ-505 is a very fine amplifier. **\$259**

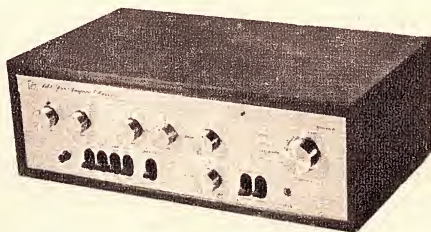
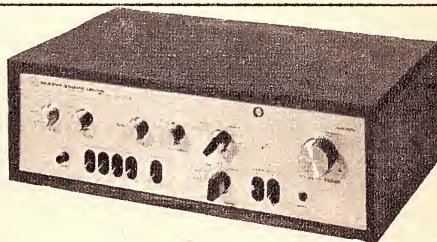

LUX MODEL SQ-606 SOLID STATE STEREO AMPLIFIER

Rated at over 20 watts R.M.S. per channel, the handsome new Lux Model SQ-606 is an all-silicon unit with 27 silicon transistors. Power transistors are designed to withstand temporary short circuits and overloading. Overall frequency response is 10-50,000 Hz. ± 1 dB. Acoustic performance is quite outstanding. Controls and features include volume, balance, mode selector, treble/bass controls, filters, tape monitor, headphone jack, etc. All in all the SQ-606 is a very fine amplifier, attractively priced. Inc. sales tax **\$219**

LUX SOLID STATE STEREO AMPLIFIER — THE MODEL SQ-77TW — \$169

Using silicon power transistors the SQ-77TW is rated at 30 watts R.M.S. in each channel with a 4-6 ohm speaker load. Frequency response is 10-50,000 Hz. plus 0, minus 3dB. Input sensitivity is 1.8mV for magnetic pickup or tape head, aux. inputs being rated at 200 mV and 800 mV. Controls include stereo volume, stereo balance, mode switch, treble and bass (separate controls for each channel), input selector, head-phone jack and switch, tape monitor switch, rumble and scratch filter switches, etc. (including Sales Tax) **\$169**

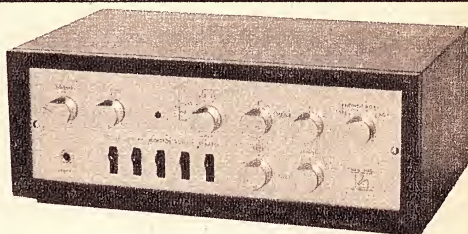

NEW LUX MOVING MAGNET STEREO CARTRIDGE

The Lux T-15-M has been acclaimed as a brilliant performer by discriminating audio enthusiasts — frequency response is conservatively quoted at 20-20,000 Hz. and stylus pressure is from 1 to 2½ grams. Tracking angle is 15°, output is 5 mV. at 1 kHz. Stylus sizes available are 0.7 mil. conical diamond and the new elliptical diamond (T-15-ME). T-15-ME: \$29.50. T-15-M7B (conical diamond stylus) Inc. **\$24.50**
Sales Tax

EXTRACTS FROM REVIEW OF LUX SQ1220 INTEGRATED AMPLIFIER APPEARING IN "HI FI NEWS" JANUARY, 1969.

"Here, then, is an amplifier of Japanese origin which conforms very closely (on some counts, better!) to the published specifications" . . . "The amplifier was run for several weeks under domestic conditions with a wide range of programme sources, pickup cartridges and speakers and at all times it performed perfectly and without flaw." . . . "Nice to look at, nice to use and very well made and designed, I vote the Lux SQ1220 a top-of-the-class amplifier which, I am sure, will hold its own with the best of the other Class-B designs now available."

EXTRACTS FROM REVIEW OF LUX SQ77 AMPLIFIER APPEARING IN "HI FI SOUND" FEBRUARY, 1969.

"Both design and construction reach very high standards of electronic engineering. Some idea of the excellence of the design of the amplifier can be gleaned from the illustrations. It is also note-worthy that the components employed are of good quality and reasonably rated, especially the mains transformer, so normal servicing should not cost much from one year to the next." . . . "After running the amplifier for several weeks in a typical domestic environment with all sorts of signals and sources, and not encountering any troubles or even mere shortcomings on my ordinary dynamic speaker systems of various kinds, I have no hesitation at all in voting this one of the most worthy of amplifiers I have had the pleasure of testing for a long time. For the power that it delivers and the way it is made it is well worth its price."

ENCCEL

ELECTRONICS (STEREO) PTY. LTD.

Head Office:
431 Bridge Rd., Richmond, Victoria 3121. Tel. 42 3762.
Sydney Store: Ground Floor, 25M Building,
257 Clarence Street, Sydney, N.S.W. 2000. Tel. 29 4563, 29 4564.
Australia's Greatest Hi-Fi Centre *Wholesalers *Trade-ins accepted



Wavelengths of Life and Death

With the ever increasing use of the higher radio frequencies for radio, television, radar and communication, our planet is becoming more and more immersed in radiation of various kinds. The author suggests that it is time to examine the "radiation environment" in which we live, rather than wait until dangers of particular radiations become apparent.

by *C. Maxwell-Cade* *

We are, from the moment of conception, bathed in a sea of electromagnetic waves. Some of these waves are benign, or even beneficial, while others are definitely harmful. Part of this radiation is natural and part is man-made. Natural radiation includes the light, radio-waves and cosmic rays from the sun, moon and stars; background radiation from the rocks, soil, water and atmosphere of our planets; and the internal radioactivity of our own bodies. Man-made radiation, which forms an increasingly large proportion of the whole, includes radio and radar waves; radioactive fallout from nuclear processes (both military and civil); and X-rays and other "hard" radiation used in therapy, scientific research and industry.

We now know that even the most innocent-seeming waves may have unexpected and sometimes tragic biological effects, but we were slow to learn. X-rays seemed innocuous enough at first; in the early days the cumulative nature of radiation damage to the human body was quite unknown, and many of the pioneer workers paid the price of ignorance. Radiographers working with the first low-voltage X-ray appliances developed radiation dermatitis, especially of the arms and face. The lesions were slow to develop and difficult to heal, and they left permanent scars. Much later, sometimes even as long as 50 years, some of the scars turned to cancers. Not all the cancers were long-delayed, and 54 cases of skin cancer were reported in the first 16 years (1895-1911) of the use of roentgen rays.

It is obvious that we must be more or less immune to any kind of radiation which normally reaches us from outer space, yet earthworms are killed by sunlight even when kept damp and cool, and occasionally human children are born who are abnormally photosensitive and eventually die from the effects of sunlight. Moreover, sunlight can induce skin cancer as well as an attractive tan, and certain drugs have a strongly photosensitising effect, which makes it necessary for patients who are taking them to use a barrier cream against the enhanced action of ultraviolet rays.

Supernovae ("new stars") are rare astronomical events, but in recent years several writers have pointed out the dangers from a Type II supernova within a few tens of light years. Russian astronomers have suggested that the death of the giant reptiles during the Cretaceous Period, like the sudden proliferation of vegetation during the Carboniferous, might both have been due to genetic changes induced by the intense nuclear radiations from near supernovae. There is, too, some suggestion of a connection

between supernovae during historical times and plagues. Another effect, which I first pointed out in 1961, could be the complete disruption of radio communication and radar systems — which, so far as the human race is concerned, might produce second-order biological effects!

For some years now, there have been occasional warnings about the possible dangers from high-intensity microwaves, such as are used in the distant early warning installations. It has been known for at least 25 years that powerful radio waves can literally cook an animal's internal organs whilst externally it appears unharmed. There have also been many cases of severe optical inflammation, and even permanent blindness, resulting from the careless exposure of human eyes to strong microwaves. Much more recently it has been found that microwaves can apparently produce genetic changes resulting in the birth of mongoloid children, although no mechanism has yet been discovered for this effect.

Within the past seven years there have been many reports concerning previously unnoticed effects of radio waves on animals.

The Canadian National Research Council has used radio waves of 1.8cm wavelength in experiments to clear airfields of birds which might endanger aircraft. The report refers to "dramatic nervous system disturbances" produced in birds by microwave fields. At intensities of only 10 to 30 milliwatts per sq. cm, chickens collapse within a few seconds, although apparently without permanent injury. Such fields are too weak for heating effects to be involved, and researchers in the department of physiology at the University of Ottawa are trying to elucidate the physiological mechanism. In 1960, Dr Swann at Rome Air Force Base (New York State) carried out experiments on Rhesus monkeys, irradiating their heads with weak 91 centimetre waves. The animals died in about two minutes. In 1966, Dr Susan Krobek at the University of Arkansas, found that rats were rendered "lethargic, irritable and more susceptible to seizures induced by noise or electric shock" when irradiated for prolonged periods with very weak (one to two milliwatts per sq. cm) radiation at wavelengths between 86 and 94cm.

Even more strange is the discovery that different radiations acting simultaneously or in sequence can produce effects which are different from those caused by either radiation alone. Research has been carried out in the United States on the feasibility of conditioning astronauts so as to give them increased resistance to the dangerous radiations encountered in outer space. Work carried out on dogs showed that exposure to controlled doses of microwaves protected the animals against the effects of X-rays. In one of these experiments, 34 dogs were given a heavy dose of X-rays, such as an astronaut might receive on the sunlit face of the moon, and 23 of

*The author is chief research engineer (infra-red devices) and manager (medical physics) with Smith's Industries Ltd., U.K. The article is reproduced from "New Scientist" by arrangement.

Police traffic radars may help to keep death off the roads, but are they contributing to a hazard of another kind?

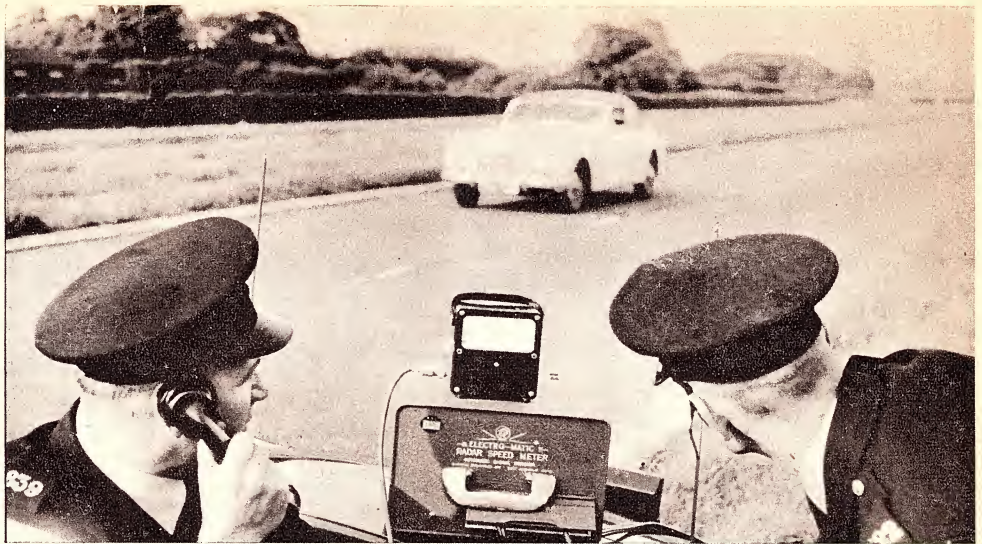

them died with 15 days — a mortality of 68 per cent. Six different dogs were conditioned with 10cm microwaves for continuous periods of from three to six hours before being given the same dose of X-rays. Only one of these six dogs died with 30 days of the exposure to X-rays. Later experiments showed that microwave conditioning, either before or together with exposure to X-rays, always lessened the harmful effects and sometimes appeared to confer complete protection to the dogs.

But the interaction of man with his radiation environment is not just a question of the presence of harmful waves: the absence of certain wavelengths can also be injurious. With radiation, as with food, both quality and quantity are important, and things which are beneficial or even vital in small quantities can be fatal in a larger dose. Savages, who may go for long intervals without food, sometimes die from the effects of excessive meat-eating when at last their hunting is successful. Others die from either an overall shortage of food or a lack of protective vitamins or mineral "trace" elements. The radiation equivalents of these nutritional diseases are not easy to define, but heavy doses of any very short wavelengths are fatal, and ill-health, if not death, will result from an insufficiency of visible light and also from lack of the near-infrared and near-ultraviolet rays.

Various investigators have found that light entering the eyes of animals is directly concerned with stimulation of the pituitary and hypothalamus. By one of those strokes of serendipity which make scientific studies so rewarding in unexpected ways, Dr J. Sterne, a French toxicologist, discovered that the resistance of mice to poison is proportional to the hours of daylight to which they are exposed. His experiments, which occupied three years, involved the administration of an accurately standardised near-fatal dose of poison to 28,000 mice. The only variable which correlated with the proportion of mice dying with 24 hours of treatment was the length of day—the longer the day, the greater the proportion of survivors.

We will not know whether "trace" wavelengths are essential to our well-being until extensive experiments have been carried out on animals in illuminated but electromagnetically shielded chambers. Studies already made of bees and cockroaches confined in Faraday cages suggest that their oxygen consumption was reduced, so that there is possible a relationship between radio waves and basal metabolic rate.

Electromagnetic radiations are not the only kind of waves to affect our health. Sound waves, which are simply waves of alternate compression and decompression in the air, can be lethal. The human ear detects, as sound, vibrations between 16 per second (16Hz) and 20,000 per second (20,000Hz). Above 20,000Hz comes the region known as ultrasound, and below 16Hz is the region of infrasound. Sufficiently intense sound of any wavelength can be dangerous, but, on the other hand, absence of sound, like any other form of sensory deprivation, can cause a general fall-off in efficiency.

In the past decade various research centres have begun investigations of the biological effects of ultrasound. These waves have, of course, been used for many years for submarine detection, fish-finding, and the non-destructive testing of mechanical components and structures. Since the early 1950s, ultrasound has been widely used in medi-

cine, both for diagnosis and for therapy. Just as happened with X-rays, however, the medical use of ultrasound became fairly widespread before any dangers were recognised. Today we know that not only can these waves cause tissue destruction when sufficiently intense (an effect which is usefully exploited in surgery), but that much weaker concentrations can still produce metabolic and genetic changes which may not reveal their presence for a long time but can eventually have serious consequences.

At present, the hazards due to sound or ultrasound have not been thoroughly investigated. Yet the risks may sometimes be serious, at least for people working in high noise-levels for prolonged periods, and to those subjected so sonic bangs from aircraft. It is fairly well-known that protracted exposure to loud noises can produce both deafness and nervous disorders, but it is only very recently that experiments on animals have shown that mutilated children may be born as a result of the mother being exposed to sonic bangs during pregnancy.

Infrasound is the latest part of the sonic spectrum to be studied. Beginning from an accidental observation of vibration-induced sickness, the French National Centre for Scientific Research has developed an "infrasonic death-ray." Working at very low frequencies, it causes the organs of the body to resonate and to rub against each other, and even at relatively low power-levels it makes victims seriously ill. Seven hertz has been established as the most potent frequency, although the whole subject of infrasound is still in its infancy.

The ancient Egyptians worshipped the sun as the life giver, and there are several senses in which they were right. To mention two obvious examples, there is the part played by radiation in providing the necessary energy for the building up of complex organic substances from the inorganic atmosphere of a primeval planet, and there is the process of photosynthesis by which plants use the energy of sunlight to build up their own tissues and ultimately, through the food-chain, to nourish animals and man. On the other hand, space research has shown that the solar radiation — when undiminished by the absorption of the earth's atmosphere — can readily be lethal, and there is some evidence that supernovae can be a factor in epidemic diseases, as well as a possible major influence upon evolution. There is at least one sense in which our lives are influenced by the stars, even though we have freed ourselves from the superstition of astrology!

It is becoming clear that man today, as a result both of his exploration of new environments in space and of his technological command of a rapidly widening spectrum of radiation, is exposing himself increasingly to dangers which are rarely understood and often unsuspected. Moreover, the experiences of men in orbit, and a number of recent biological observations, have shown that the mammalian brain can respond directly to a variety of magnetic and electromagnetic stimuli with subjective effects which vary from conscious awareness of illusion or hallucination to states bordering upon the so-called "transcendental experiences" induced by drugs or religious ecstasy. No directly relevant, but similar enough to be borne in mind, are the new arts of electrosleep and electronarcosis (electrical induction of sleep and of anaes-

(Continued on page 177)

If you haven't got a microscope you won't see all the improvements in our 6CM5 valve.

You can't miss the big improvement in performance

The brand new Beam Plate considerably reduces screen current and consequently operating temperature. Also, we've cut electrolysis in the stem and seal area by introducing a button stem which again reduces operating temperature. The new cementless base construction eliminates



cracks in the seal area. New techniques of assembly under a microscope have made possible improvements in grid location which helps stabilise screen current. A new 'Coiled Hairpin' heater minimises heater-cathode shorts. Small changes? AWV Valves work better and live longer because of them.



AMALGAMATED WIRELESS VALVE COMPANY PTY. LTD.

AWV120



Australia Should Provide N.Z. Radio Programs

Before anybody starts getting hot under the collar about the proposition posed above, we hasten to explain that it was made in 1926, when conditions were very different to what they are today. The suggestion was made in an editorial in "Wireless Weekly", from which "Electronics Australia" eventually evolved, and is reproduced here for historically minded readers.

DURING the past week or two, there have appeared in the daily Press paragraphs relating to the possibility of arranging for the co-operation of the Australian broadcasting stations to provide entertainment for broadcast listeners in New Zealand, and it is stated that Mr W. R. Blow, representative of the New Zealand Government in Sydney, is supporting the proposal. It has been suggested to the New Zealand Government that negotiations be opened up with a view to arranging a special weekly program, to be broadcast from Sydney, picked up by the New Zealand stations, and re-broadcast throughout the Dominion.

Some months ago the New Zealand Broadcasting Company was established in the Dominion, and it was decided to install four 500 watt stations, one in each of the principal cities. The first of these stations was erected at the Exhibition at Dunedin, and many of the broadcasts from there were received by listeners-in situated in Australia. Since the establishment of this station, a great deal of controversy has been carried on in the Press of New Zealand, and if the published announcements are to be believed, then quite a number of New Zealand broadcast listeners are dissatisfied with the present arrangement, although, of course, it must be realised that there

has been scarcely time yet to offer an authoritative opinion as to whether the scheme laid down in the Dominion is the best that could have been devised.

At the present time the bulk of the radio audience across the Tasman depends upon the Australian stations for its broadcast entertainment, and practically the whole of the radio columns of the daily papers and the broadcasting items published in the two technical journals deal with Australian broadcasting stations. Some idea of the interest that is taken in New Zealand in our stations may be gained from a letter published recently in a Christchurch paper protesting emphatically against the Daylight Saving Bill, on the ground that if it becomes law, the Australian stations will not commence their evening programs till 10.30 p.m., New Zealand time, during the summer, instead of 9.30 p.m., as at present. There can be no doubt that practically all the valve sets in the Dominion are tuned in every night to Australian stations, although the \$3 licence fee which is paid in each case is primarily intended for the New Zealand Broadcasting Company.

Under normal conditions, even a one valve set is capable of receiving the high power Australian stations very well. The position is different, how-

ever, with regard to crystal sets, and the owners of these stand in a most unfortunate position when compared to those people who have valve sets, since they are necessarily limited to whatever is broadcast from their local station. While the musical and artistic talent available in New Zealand may be of a high standard, still it is limited, of course, by the size of the country, and its comparative isolation. Under these circumstances, therefore, provided whatever technical difficulties may lie in the way can be overcome, the re-broadcasting of Australian programs will bring within the scope of the crystal enthusiasts far better programs than they could otherwise obtain.

There is an important factor which must be taken into account in this matter, and that is the differences in time between the two countries. New Zealand is one and a half hours ahead of Sydney, so that in order to commence a program at 8 p.m., Dominion time, the Sydney station would have to commence its transmission at 6.30 p.m. Naturally this would involve a considerable amount of extra expense, and obviously this would have to be borne by somebody other than our local broadcasting station.

Provided, therefore, that some mutually satisfactory financial arrangement could be made between Australia and New Zealand, and that no inconvenience is suffered by Australian broadcast listeners, we see no reason why this question of broadcasting special programs to New Zealand should not be taken up without delay, and it is to be hoped that the New Zealand Government will give official recognition to the Australian stations, and at the same time increase the popularity of broadcasting in the Dominion. ■

OPTICAL INFORMATION STORE FOR

British computer engineers and scientists working on methods of enlarging the capacity of computers have developed an inexpensive and versatile storage system using standard photographic techniques. Once data has been recorded on a photographic master it can be readily reproduced to make a series of identical data stores.

by G. G. Scarrott

Manager, Advanced Research and Development Division, International Computers Limited

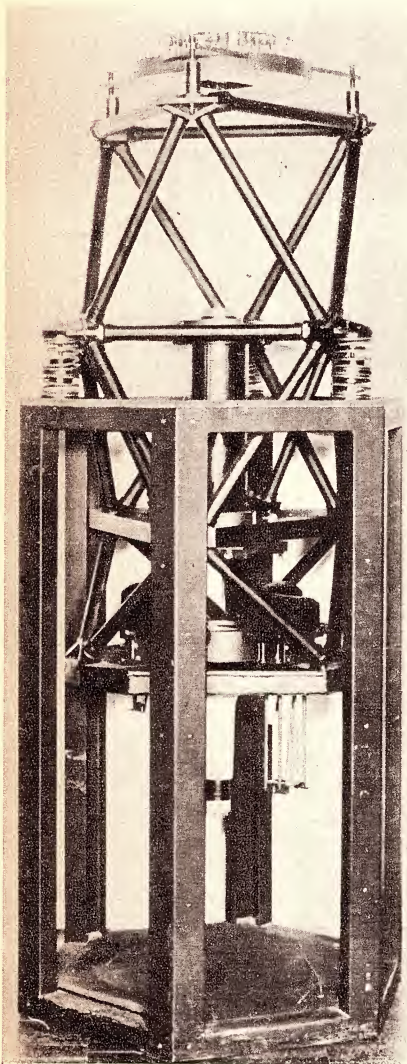

To prevent disturbance to the components of the optical store, they are mounted in a tetrahedral framework with anti-vibration mountings, as illustrated.

The volume of useful work a modern computer can perform depends as much on its software as on its hardware. Several independent and unrelated jobs can be performed all at the same time on the larger machines and control over these tasks to prevent them from interfering with each other is exercised by supervisory programs held permanently within the computer.

Software is the term used to describe the lists of instructions (programs) that must be stored within the computer to tell it what specific action to take in any given circumstances. The hardware is the computer itself and its peripheral equipment.

The recent development of multi-access, supervisory programs enables several different users at remote points to communicate directly with the same computer to give it information, ask it to retrieve data previously supplied, or perform specific calculations. To be employed in such a manner not only must the computer have a central processor that can manipulate data rapidly, it must also be able to store vast quantities of data to which access can be obtained reasonably quickly—in computer terms that means within a few microseconds.

More than one million logical operations can be performed each second by the central processor of a large modern electronic computer, so no problem exists now in sheer data manipulating. Where problems do arise is in the provision of sufficient storage capacity from which data can be retrieved rapidly.

In a crude sense information needed by a computer can be classified as variable or fixed. The programs detailing the particular jobs to be undertaken and the data on which they operate are variable, while the supervisory programs and other operating information used to control the computer installation may be regarded as unchanging, or fixed.

Supervisory programs and other fixed information required for immediate use have to be held in a computer's main core store which depends on the magnetisation of small "cores" of ferrite material. Core stores are expensive and, therefore, usually only limited data storage capacity is available for such information. Furthermore, core stores were designed primarily for handling variable information and possess qualities that are primarily for handling variable information. For instance, information can be written into a core store as rapidly as it can be read. But fixed information need only be retrieved rapidly

— writing speed is not critical. So computer engineers are searching now for new techniques of storing fixed information en masse which dispense with some of the expensive facilities of conventional computer stores.

A secondary though no less important reason for trying to get a new type of store for fixed information is the desirability of having on-call other software such as compilers. These translate programs written in different languages into the special coded instructions required by the machine. Standardised information handling procedures such as data sorting and editing routines come into the same category. At present this software is loaded into a computer, often on magnetic tape, the relevant sections being transferred to the core store when required, but it would be far better if this software were immediately available within the machine at all times.

Strictly speaking, the fixed information is slightly variable since the system programs need occasionally to be corrected as errors and omissions are discovered. However, it is common practice in up-to-date system designs to make all accesses to stores via an indirect path, using a directory. In such systems, corrections to fixed information can be put in an ordinary store with full writing facilities by modifying the directory. With this method of updating fixed information it is possible to minimise the inconvenience of using a mass store with poor writing facilities.

The general requirement, therefore, is for a means of storing vast quantities of fixed information at low cost. The rate at which fixed information can be recorded in the store is not important, but access speed is. Moreover, fixed information must be retrieved at random and as rapidly as with a conventional computer store—that is within 2 to 3 microseconds.

Scientists and engineers at International Computers Ltd.'s Advance Research and Development Division, at Stevenage, near London, have been working on this problem and one of the experimental devices they have produced is an optical information store. Photo-optical methods are attractive for this purpose because information stored on plate or film can be easily and accurately reproduced by simple, reliable and cheap techniques that already exist. To achieve the necessary speed of response obviously the data must be handled electronically and the current research at I.C.L. is trying to combine the best features of optics and electronics in a new type of store. The store has been

COMPUTERS

designed specifically to provide a cheap way of holding permanent information to which access is required rapidly, but which seldom changes.

The research model of the store constructed to try out the idea can accommodate 65,000 computer words. A computer handles information in small groups known as "words," each word comprising a specified number of binary digits (bits), that is, the figures 0 or 1. The word length chosen for the optical store is 68 bits. It is envisaged that 50 of these bits would be used for data with up to 18 available, if necessary, for checking purposes. Access time to a word is expected to be 2 microseconds—all 68 bits being retrieved simultaneously.

The optical store has a cathode ray tube, a minifying lens, a mirror tunnel, a projection lens and a photo-electric cell assembly. The data are stored as a pattern of black and white areas on a circular glass photographic plate 10in diameter.

A spot of light appearing on the screen of the cathode ray tube focused by the minifying lens in the plane of the aperture of the mirror tunnel. This tunnel consists of four mirrors arranged in the form of a square with their reflecting surfaces inwards. The tunnel is 14in long with sides 0.7in wide. It produces a pattern of light spots from the one spot generated by the cathode ray tube, acting as a kaleidoscope. The internal reflections of the single spot within the tunnel make a multiple array at its exit. This image is then focused on to a photographic plate by the projection lens.

Within the 10in diameter target area of the experimental store a pattern of 69 light spots is generated from the single spot on the cathode ray tube. If the position of the spot on the screen of the tube is changed, the positions of all the spots on the photographic plate also change. In effect the area covered by the screen of the cathode ray tube is reproduced as 69 one-inch squares on the photographic plate. One of the 69 one-inch squares is used for control purposes leaving 68 available for data.

The spot on the cathode ray tube screen can be projected at 256 positions across and the same number vertically, so it can be shown at any one of 65,536 (256 x 256) different positions on the face of the tube. Similarly, the spots projected in each of the 69 one-inch squares on the photographic plate can occupy any of 65,536 separate positions within each square.

Data are read from the store in the

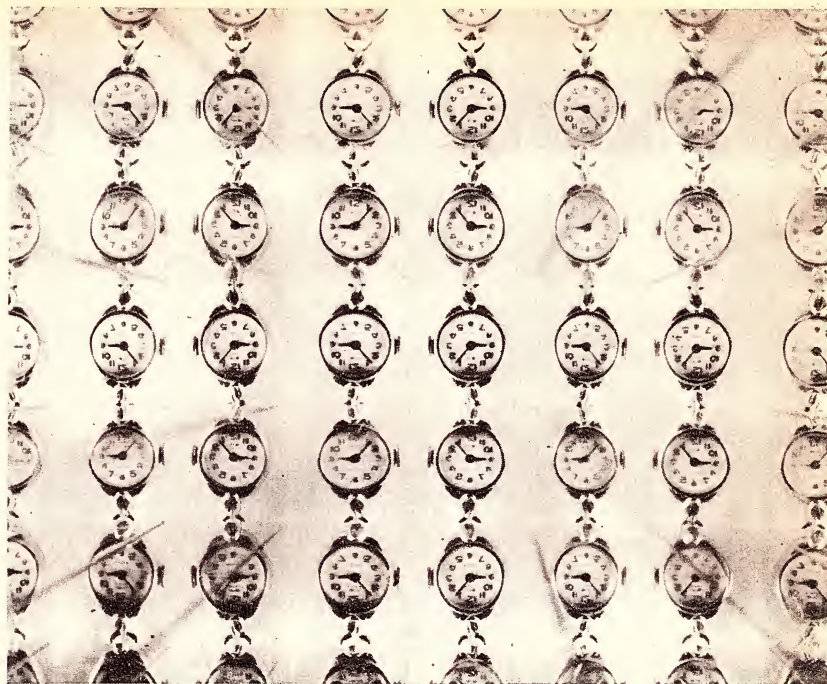

Example of multiple images produced from a single object viewed through the mirror tunnel.

following manner. Assume that a photographic plate containing fixed data is fitted in the store. The data will be recorded as clear or opaque areas in each of the 65,000 or so possible positions in each of the 69 one-inch squares on the plate. Behind each one-inch square area is a sensitive photo-electric detector cell. To read a specific computer word, a spot of light is placed on the screen of the cathode ray tube at the relevant position. As a result 69 spots of light will be projected in the corresponding positions on all 69 one-inch squares on the photographic plate. Where these spots fall on clear areas in the photographic emulsion the light will be transmitted through the plate and be detected by the photo-electric cell situated behind that particular one-inch square. As a result the cell will issue an electric signal. Conversely, where the spot of light falls on an opaque area, no signal will issue from the corresponding cell. Hence, the projected light spots interrogate a specific location in all 69 areas of the photographic plate simultaneously and the signals from all 69 photocells will be converted into the 69 bits (68 data bits plus one control bit) of the complete word stored at that location.

One of the problems that had to be solved to enable the machine to work at all was how to place the interrogating spot on the screen of the cathode ray tube at an accurate location (or address) relative to the remainder of the optical system. This is achieved by means of a digital servo system. A cylindrical mirror aligned along one axis reflects light from the cathode ray tube spot on to a digitally coded scale. In this manner the exact position of the spot, expressed digitally, along one axis is obtained. A similar optical system is used to detect the position of the spot along the other axis. The actual co-ordinate position of the spot is then compared with the position commanded and control voltages applied to the cathode ray tube

to move the spot to the correct position and maintain it there.

Besides being precise, this control system enables any cathode ray tube of the correct type to be fitted to the optical store because the accuracy of spot placing does not depend on the characteristics of a particular tube.

The technique used to produce a master photographic plate for the optical store is akin to reading except that a special shutter mechanism required. This shutter will expose only a single one-inch square of the plate at a time. To prepare a plate the shutter is set to expose the required one-inch square and the spot on the cathode ray tube is controlled to stay where binary 0 is to be recorded at each of the 65,000 positions on the screen. In such positions the film, when developed, will be opaque. When binary 1 is to be recorded the position is left unexposed and the corresponding area on the film after development will be transparent.

The entire data recording sequence will be controlled by computer and to record bits in all 65,000 positions in all 69 one-inch squares is estimated to take about one hour. Once a master photographic plate has been made, however, duplicate plates can be produced in quantity quite simply by normal photographic methods.

The store has been designed so that the photographic plates can be quickly and easily changed. In fact, one of the major design requirements is that the photographic data plates be interchangeable between stores.

To avoid temperature changes and vibration affecting operation the optical elements of the store are fixed in a tetrahedral framework of struts which is supported on three low-frequency anti-vibration mountings. Optical distortion is overcome by holding the mirror tunnel vertically with the cathode ray tube below and the photographic data plate above. ■

AUDIO-TECHNICA

Approach to  the Original

"Natural Sound"

TONE ARMS

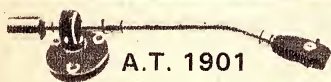

A.T. 1901

A low cost arm with simplified mechanism; but maintains precision bearings. Universal type, accepts standard plug-in heads. Direct reading calibration of stylus pressure. Overall length: 275 mm. Tracking error: less than 3°3'. Recommended Cartridge Weight: 5.5-17 grams.

List Price: \$18.75



A.T. 1503

Specially selected materials are used to manufacture this extraordinarily durable mechanism. Universal type plug-in heads. Calibrated stylus pressure. Overall length: 340 mm. Tracking error: less than 1°55'. Recommended Cartridge Weight: 8-28 grams.

List Price: \$46.75

ALSO AVAILABLE

A.T. 1005. Universal Type. Standard plug-in heads. 322 mm. arm length. List Price: \$37.50.

A.T. 1007. Arm length 330 mm. Accepts Cartridges 3.5-22 grams. List Price: \$65.95.

Most people prefer "natural sound". And natural sound starts with Audio Technica.

All Audio Technica lightweight pick ups will reproduce the groove, the whole groove and nothing but the groove. This is the reason why Audio Technica cannot help sounding natural if the record and the rest of the reproducing equipment are of equally high quality.

Extreme clarity, precise reproduction of transients, complete lack of colouration, vivid presence — natural sound is immediately apparent to the listener.

AudioTechnica is used by the leading manufacturers producing a variety of stereo equipment and in hundreds of thousands of homes where people listen to music.

Whether you are amateur, musician or technician, you will appreciate the truly rewarding experience that Audio Technica pick ups offer you. They are the closest approach to the original natural sound.

MAGNETIC CARTRIDGES



A.T.-66

DM (Duexciting Magnet) type Stereo Cartridge. Frequency response 20-20,000 Hz. Channel separation: 25 db at 1 kHz. Output voltage 4 mV at 1 kHz. 5 cm./sec. r.m.s. Load resistance 50 K. Tracking force 0.5-2.5 grams.

List Price: \$8.50



A.T.-33

VM (V—Magnet) type Stereo Cartridge. Unique wired damper mechanism supports lightweight moving element. Frequency response 20-20,000 Hz. Channel separation 27 db at 1 kHz. Output voltage: 5 mV at 1 kHz. 5 cm./sec. r.m.s. Load: 50 K. Tracking force 0.5-2.5 grams.

List Price: \$13.95

ALSO AVAILABLE

A.T. 21S DM type Stereo, low tracking (spherical stylus) \$11.50

A.T. 21X (elliptical stylus) \$26.90

A.T. 35S (spherical stylus) \$30.95

A.T. 35X (elliptical stylus) \$41.95

AUDIO-TECHNICA

Distributed by: **jacoby, mitchell & co. pty. ltd.**

469-475 Kent Street, Sydney. 26-2651

MELBOURNE 30-2491/2 ADELAIDE 53-6117 BRISBANE 2-6467

Jacoby, Mitchell & Co. Pty. Ltd.
469-475 Kent St., Sydney, N.S.W., 2000.

Please send me information on Audio Technica Products and nearest Audio Technica Retailer.

NAME.....

ADDRESS.....

POSTCODE.....

EA/769

JM/18(A)69

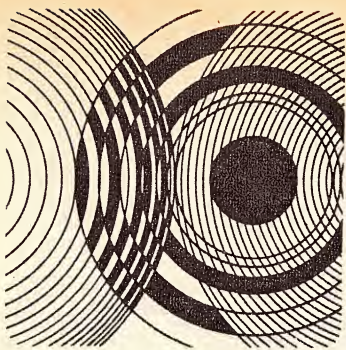

TECHNICAL DIGEST

Electronic Oil Change Indicator

An electrolytic cell, developed in the U.S.A., allows the time for a car oil change to be computed accurately. The idea is outlined in this article by J.B. Dance, M.Sc.

Motorists are advised by car manufacturers to change their engine oil each time they complete a certain mileage, since the oil will then be polluted and the additives used up to such an extent that the oil is no longer able to lubricate the engine efficiently. However, the distance travelled is not the only factor which determines the time at which oil should be changed. In particular, the number of times the engine is started from cold is important and, in the case of cars which are not used a great deal, the time for which the oil has been in the engine should be taken into account.

In an attempt to take all these factors into consideration, the Bissett-Berman Corporation of Santa Monica, California, has designed a circuit which computes the time when an oil change is due and indicates this by means of lamps, one of which operates when the engine is being started.

The basic circuit shown in the diagram is designed around a special electrolytic cell (E) which functions purely as a timing device. A new cell of this type contains a predetermined amount of a platable material deposited on its anode. When a current passes through the cell, this material is gradually dissolved from the anode and is deposited at the cathode; the rate at

which this occurs is accurately proportional to the current passing. When all of this material has been removed, the potential difference across the cell rises from a few millivolts to about one volt.

In the circuit the connection marked "Time" is always connected to the +12 volt supply, no matter whether the car is being used or not. The potential at point A is only about 1.5 volts and this drives a very small current through R3 and through the cell. This small current enables the cell E to account for the total time the oil has been in the car. The second connection (marked "Run") is connected to the +12 volt supply only when the engine is running — or, to be precise, when the ignition key is turned. This results in a much larger current flowing through the cell E during the time the engine is being used.

The third connection (marked "Start") is connected to the +12 volt supply only during the time the starter switch is operated, but the current is much larger than either of the other currents, since R5 is much smaller than R4 or R3. Thus the electrolytic cell can be used to add the various currents, taking into account the relative importance of each factor.

When an oil change is not yet required, the voltage across the cell E

is very small. The base current flowing in TR1 will therefore be small. When the starting switch is operated, this transistor passes a negligible current, but a current flows through the indicator lamps L1 and L2. Only L2 will light, since it has a higher filament resistance than L1.

When an oil change is due, the voltage across the cell E rises and produces a base current in TR1. If the starting switch is now operated, TR1 conducts and L1 is illuminated, L2 being short-circuited by the conducting transistor. A suitable indication is thus provided. When the oil change has been carried out, the connections of the electrolytic cell should be reversed so that the platable material is again on the anode and the cell can be used again. If L1 burns out, L2 will not light at any time showing the system requires attention.

The type of electrolytic cell employed can be chosen according to the type of car and the type of oil used. If, for example, a long life oil is employed, a cell with a relatively large amount of the platable material should be used so that the oil change will not be indicated so early as with the type of cell used with ordinary oils.

It is interesting to note that electrolytic cells of this type have a wide range of other applications, for example in long delay timers and in very low frequency oscillators (giving a few oscillations per year). ("Radio Constructor," March, 1969.)

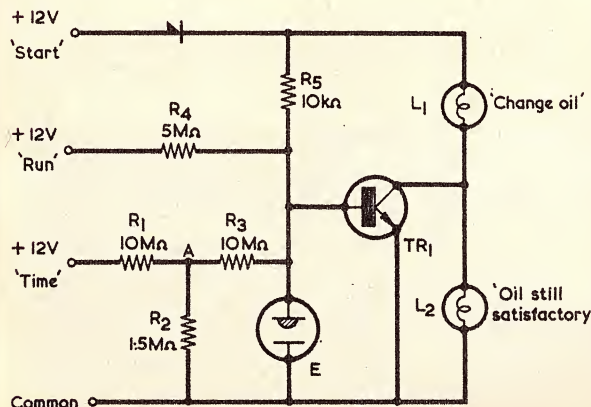

The basic circuit of the oil change indicator using the special electrolytic cell.

Gauge checks crankshafts

The world's largest automatic gauge — tall as a two-story house — is being used to check 57 critical dimensions of automotive crankshafts and pinpoint flaws to tolerances as small as plus or minus 0.0005 inch. The machine, made by RCA, has been put into operation by a major U.S. car manufacturer. It can handle 200 crankshafts an hour and is capable of being incorporated into computer-controlled, fully automated production systems that the industry might develop in the future. It will accept either of two sizes of crankshafts, which are fed automatically to it at random. The gauge automatically colour codes each measuring point to indicate whether the dimension is acceptable, oversize, or undersize. ("Electronic Age," Winter 1968/69.)

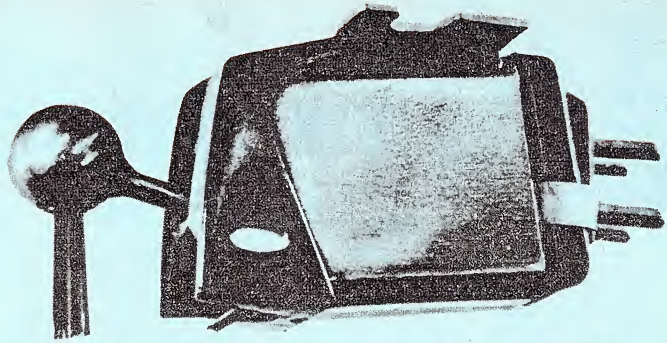

**There are 5 really superb cartridges
in the world;
one of these, the
STANTON 681EE, has**

**The best trackability.
The smoothest frequency response.
The best channel separation.
The lightest weight.
The lowest price. \$60.00**

Here's more proof of STANTON superiority.

The Review of the Stanton 681EE in the December 1968 issue of "Audio Magazine" included the following statements:—
"The 681's low-mass stylus assembly is probably responsible for the cartridge's superb tracking performance at such low forces as 1 gram."
"We found that the Stanton 681EE tracked some previously "unplayable" records."
"The Stanton 681EE is certainly a smooth one, too. Its frequency response shows a wide-range response that is free of peaks. Even the usual high-frequency resonant peak is well damped. Response measured within ± 2 dB through the 20 Hz to 20 kHz range."
"Average separation at 1 kHz measured 30 dB." "This is the *best* channel separation figure at this frequency that we've measured over the years."
"The 681EE is not at all susceptible to hum pick-up."
"The Stanton 681EE was a pleasure to listen through. It brought new life to some old favorites, performed marvellously well with new, bright stereo releases, eliminated the

"fuzz" that accompanied some of the heavily cut records."
"High frequencies, as produced by brush work on cymbals, for example, exhibited a realistic airiness with the Stanton 681EE. Lows and middles were equally natural, without any noticeable favouring of particular frequencies. The stereo effect was pronounced."
"There are many things that measurements cannot reveal, of course. For example, one has to *listen* to determine the degree of coloration produced by a transducer. The Stanton 681EE is, a neutral-sounding stereo cartridge, the type of sound we favour, frankly. Discs sound absolutely great when the source material is good and the stereo playback equipment is excellent."
"The 681EE stands among the top few cartridges on the market."
No matter what cartridge you are using, you will find that the Stanton 681EE will make a definite improvement to your stereo system. If you are buying your first cartridge, choose the best first. It's cheaper in the long run.

TRADE AND WHOLESALE ENQUIRIES INVITED

Leroy Industries PTY. LTD.

226 Hay Street. SUBIACO, WEST. AUSTRALIA. 6008. Phone 81 2930.



COMPUTERS FASHION ASPHERIC AND OTHER LENSES

In a basement in the heart of Leicester, England, optical engineers are commissioning a machine, little bigger than a kitchen table, which is costing around £20,000 to assemble. It has a diamond cutter controlled by punched tape that shapes discs of glass, with the ease of a lathe turning free-cutting steel, to accuracies that would stretch the jig borer's art.

Optical lenses are normally ground, for their surfaces are usually spherical in shape, a contour that is fairly easy to achieve accurately for it tends to be self-generating under the action of the polishing head. But there is a growing demand for lenses of much more complex contour; aspheric lenses, as they are called, now being used in zoom lenses, TV camera optics and the equipment used in mass radiography.

The diamond point generator is the latest attempt by Rank Precision Industries to bring advanced methods of production engineering to bear on a craft problem.

The value of non-spherical lenses has been appreciated for well over three centuries, since Descartes described a lens design that used an elliptical surface to avoid some of the aberrations of the spherical lens. To quote Gordon Cook, Rank's manager of optical research and development, "Spherical surfaces can never be perfect, but aspherics can."

But glass is a difficult substance to work. It can be moulded, of course, but not with the precision required for lenses of photographic quality. A camera lens, for example, must be within 10 millionths of an inch of a true sphere.

Little progress was made toward a production technique for reproducing aspheric surfaces until Bernardt Schmidt, in the 1930s, proposed a lens design using an aspheric corrector plate to minimise the area of lens surface needed for relatively large apertures and angles of field. His design has since proved immensely valuable to astronomers.

Schmidt also proposed a technique for reproducing an accurate aspheric surface in a flat plate of glass. He cemented the glass to a drum, from which he pumped out the air, causing the glass to depress by a few hundredths of an inch. He then ground and polished the distorted plate to a shallow spherical surface. Once released from the drum the glass plate took on an aspheric shape on one side.

But Schmidt's method was costly and, to quote Mr Cook, "the thought of producing 50 a week was just stark, staring mad."

The Taylor Hobson company, as it

was then called, set out to develop a machine that would sculpt glass to a pattern. The generator now being commissioned is the third and most advanced of a series on which work began just before World War II. It brings Rank to the point "where we can now use aspherics wherever economics allow." It costs only about twice as much to machine an aspheric lens as to grind a spherical lens of similar specification.

Like its two predecessors, this generator is the brain-child of Mr G. O. R. Rawstron, who manages the lens department at Leicester. It can take a lens blank of optical glass up to 8 inches across, costing upwards of £100, and turn it into a lens worth a great deal more.

The machine has two basic motions, one of which drives the single-point diamond across the blank to turn a spherical surface, taking cuts of up to 10 thousandths of an inch. The other motion superimposes the asphericity by moving the lens itself.

This movement is controlled by instruction on a punched tape, each hole in the tape moving the lens in increments of about a quarter of a wavelength of light.

Six feet of concrete founded on blue clay insulate this "machine tool" from external vibrations.

Still more costly, however, is the facility adjoining the generator, for testing the lens. "We can't do as the car maker does—rely on the customer to test the product," points out Mr J. A. Stafford, director of research and development co-ordination for Rank Precision Industries. "We have to provide a 100,000 'optical transfer function' facility, where the lens response to light waves is analysed in a way analogous to the response of an audio amplifier and loudspeaker to sound waves. Tests on a zoom lens for a colour TV camera may well take a day and involve 90 set-ups on the SIRA-Beck Eros IV apparatus Rank has recently installed."

Rank estimates its present output of aspheric lenses rather vaguely at "tens per week." Even with the new generator and test gear the chance are, thinks Mr Stafford, "they'll cost more" than spherical lenses, "so we won't use them if we don't need to."

You could take an existing design

for a lens and improve it by using aspherics, says Cook, "but that's not where we see the advantage." Computer design could probably improve the lens anyway, and this is the area into which much of his research and development effort is going. He already has a computer program for the automatic design of lenses of fixed focal length, and is perfecting another for zoom lenses.

This program, Cook believes, will "quite possibly boost the demand for zoom lenses using aspherics." He is also at work on the design of an "entirely new" zoom lens, exploiting aspherics in combination with a growing expertise in vacuum depositing optical coatings in very large numbers of layers.

Rank marketed the first zoom lens with aspheric surfaces in 1958. This was the Varatol 3 zoom lens for TV outside broadcasts, where the aspheric surface greatly simplifies the design. Another application lies in the relay optics for TV cameras, where aspherics allowed the designers to produce a lens with a relative aperture of f0.6. Wide-aperture lenses for recording from an oscilloscope and TV projection systems for large-screen displays are among the lens systems which now incorporate aspherics.

Applications for much bigger aspheric lenses than anything Rank can fashion have been mooted, particularly by American scientists, who have ideas for "massive optics" in space observatories and aerial and space reconnaissance, and in such apparatus as bubble chamber cameras and flight simulators. Lenses which were feet rather than inches across would be needed for some of these proposals. But "I find it hard to take seriously the need for aspherics much bigger than we can machine," concludes Mr Stafford. ("Financial Times," 25/4/69.)

Television zoom lenses

An order for \$1 million worth of the latest Rank Taylor Hobson zoom lenses has been placed by RCA, who will put them into high-class television cameras. The new zoom lens, although no bigger than the present standard zoom lens, can get closer to the scene than ever before without sacrificing any of the long-shot capability. It can get so close, optically speaking, that it can fill a whole screen with one human eye. (See "Electronics Australia," April, 1969 page 33.)

The lens could be used by drama producers for closer-than-close shots. It can help educational television, giving larger-than-life illustrations of biological specimens or any object which would be held close to an eye to see the fine detail. This could save money by avoiding the need for drawings. ("BBC London Letter.")

Radiography certifies tiny electronic parts on Telstar

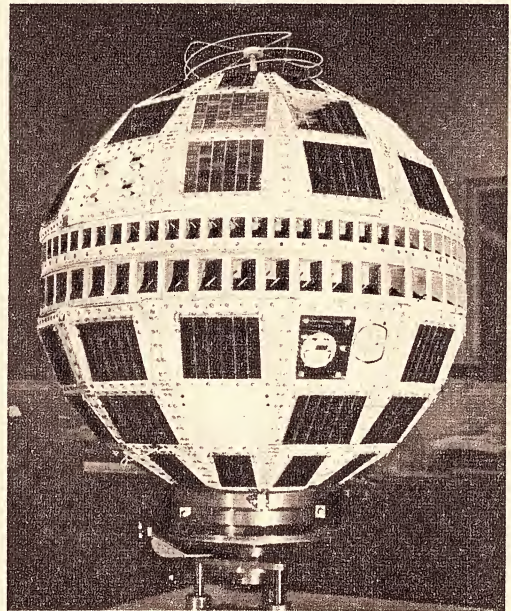
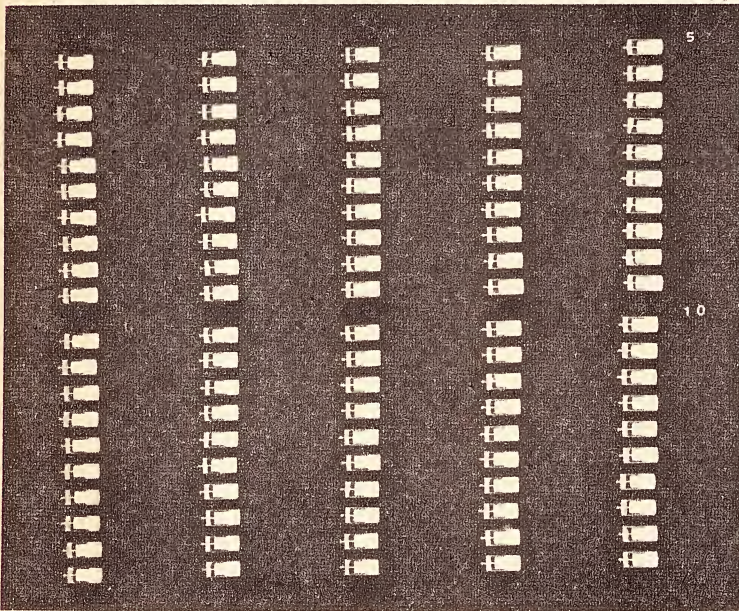

The thousands of parts in Telstar must perform perfectly, including solid tantalum capacitors shown in the radiograph reproduced here. These capacitors were radiographed on Kodak film to show whether their anodes were positioned and plotted properly, and to search for stray solder globules.

The uses of radiography in industry are practically endless. Castings and welds can be inspected for soundness. Even sealed internal assemblies can be inspected. For quality control of the smallest capacitor or largest transformer radiography can save you time and money and help you build a reputation for quality.

Kodak's outstanding range of industrial x-ray films includes general-purpose films; fine-grain films for highest quality production radiography, as well as for extra critical radiography; also single-coated films for maximum detail under high magnification.

Ask your Kodak technical sales representative for further information or write to:

Kodak Radiography Markets Division,
KODAK (Australasia) PTY. LTD.
Branches in all States.

K.1986



PRICE DISPLAY SYSTEM FOR STOCK EXCHANGE

The potential benefits of a price display system as opposed to the traditional method of price dissemination are outlined in this article by R. Holliday, Communications Manager of the London Stock Exchange.

The London Stock Exchange will soon start commissioning a completely new system for the display of market prices by closed circuit television at a cost in the region of £200,000. The system, initially available only to members, will shortly after the opening date be available to the press, banks, finance houses and other financial institutions.

It is envisaged that on the opening date some 800 22-channel receivers will be in use in over 140 different locations. There is no real limit, assuming that the Post Office is able to serve all the buildings concerned with the necessary coaxial cable connections.

At present each member firm employs male clerks known as "blue buttons." They collect the prices from jobbers on the floor of the Exchange, and these are reported back to the individual firm.

A few years ago it was thought that an integrated electronic method for the dissemination of prices could be efficiently run and could show saving to member firms over the old methods. To this end, a committee was formed to look at the technical and cost implications of the methods currently available. The method finally chosen was a computer based digital-to-video conversion system, with coaxial cable distribution at radio frequencies and television receivers for the display of the information.

Ferranti Ltd. was awarded the contract for the digital to video conversion equipment and the Argus processor, and Standard Telephones and Cables Ltd. the contract to supply the special 22-channel receivers and associated tuners, and install the local internal distribution.

The new system will considerably streamline price dissemination. A list of 700 of the most active stocks has been prepared and broken down into suitable quantities for allocation to the various channels. In addition there will be two "feature" channels for the display of the prices of stocks not normally shown but warranting a place due to some special interest.

Also, there will be two "news" channels which will give a precis of any company news or announcements which could affect share prices. There will also be a news flash in large characters across the bottom of each price channel so that a subscriber's attention may be drawn to any specific points on the news channel.

Subscribers to the new service will

be using the most-up-to-date system of its kind in the world, with fingertip control of a wealth of up-to-the-minute information on the state of the market and news from companies as soon as it is received.

Data input to the system from the market floor is by means of a Honeywell keyboard, and each stock is identified using a four-character alphanumeric code. Each key depression generates an eight-bit code. Associated with each keyboard is a monitor so that the current new-line information may be read out of the central processor.

On receipt of the desired code from the keyboard operator, the central processor displays the corresponding current line on the operator's monitor. The operator then keys in the latest price, which immediately appears on

terminal addressing of all stored information, controls formatting of individual lines on stock channels, and controls location and transfer or deletion of complete messages on news channels. A copy of all transactions is made on punched paper tape.

Of the 30 channels available from the magnetic drum store, 20 are used for display on the TV receivers, made up of 16 price channels, two news channels and two feature channels, all in small character format. One channel is allocated to the large character requirements. Five feed the operator's monitors. This leaves four channels for future expansion which will at some stage be used to increase the number of operator's channels.

The Post Office is supplying the modulation equipment, and the channels are spaced at 8.3MHz intervals between 46.5 and 220MHz. Distribution is at VHF via a G.P.O. coaxial network.

Amplification is by means of Thorn line amplifiers, and local feeds to the individual buildings by means of branch units and Thorn terminal amplifiers. The level out of each terminal

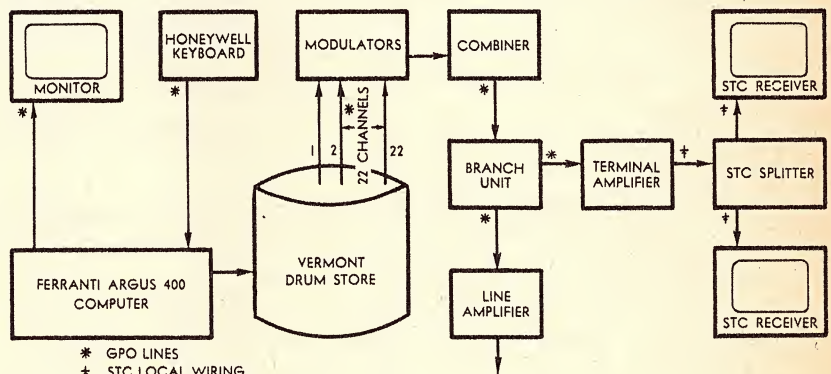

The schematic arrangement of the London Stock Exchange closed-circuit television system. Any one of 22 price, news and feature channels can be displayed on the receivers by use of remote control push-button units on the executive desk.

the monitor at the end of the current line.

If it is correct, the "accept" button is pressed and the new information becomes available to all the brokers' TV receivers via the magnetic drum store. If not acceptable, depression of the "delete" button removes the displayed information. If the "accept" button is used in error, editing can take place by means of the "correct" button.

For each stock the processor stores in its memory the opening price, the latest price and each price change when received. The store also holds overnight all item identification with associated last prices expanded to full form to provide the next day's opening.

The processor also organises the in-

amplifier is 30dB relative to 1mV. STC is providing the local distribution to each receiver outlet using a solid coaxial cable for main distribution with double screened flexible coaxial cable to local outlets. Teleng amplifiers and splitter units will be used as required. The system has been designed for a level of 1 to 3mV at each TV receiver.

An interesting part of the system is STC's 22-channel television receiver. It is a single standard receiver for 625-line signal with a modified scan system. Incorporated is a 22-channel tuner unit designed by AB Electronics for STC. This is remote controlled and uses varactors to give instantaneous switching from channel to channel from a 22-button desk unit. ("Electronics Weekly," 30/4/69.)

HEATSINKS

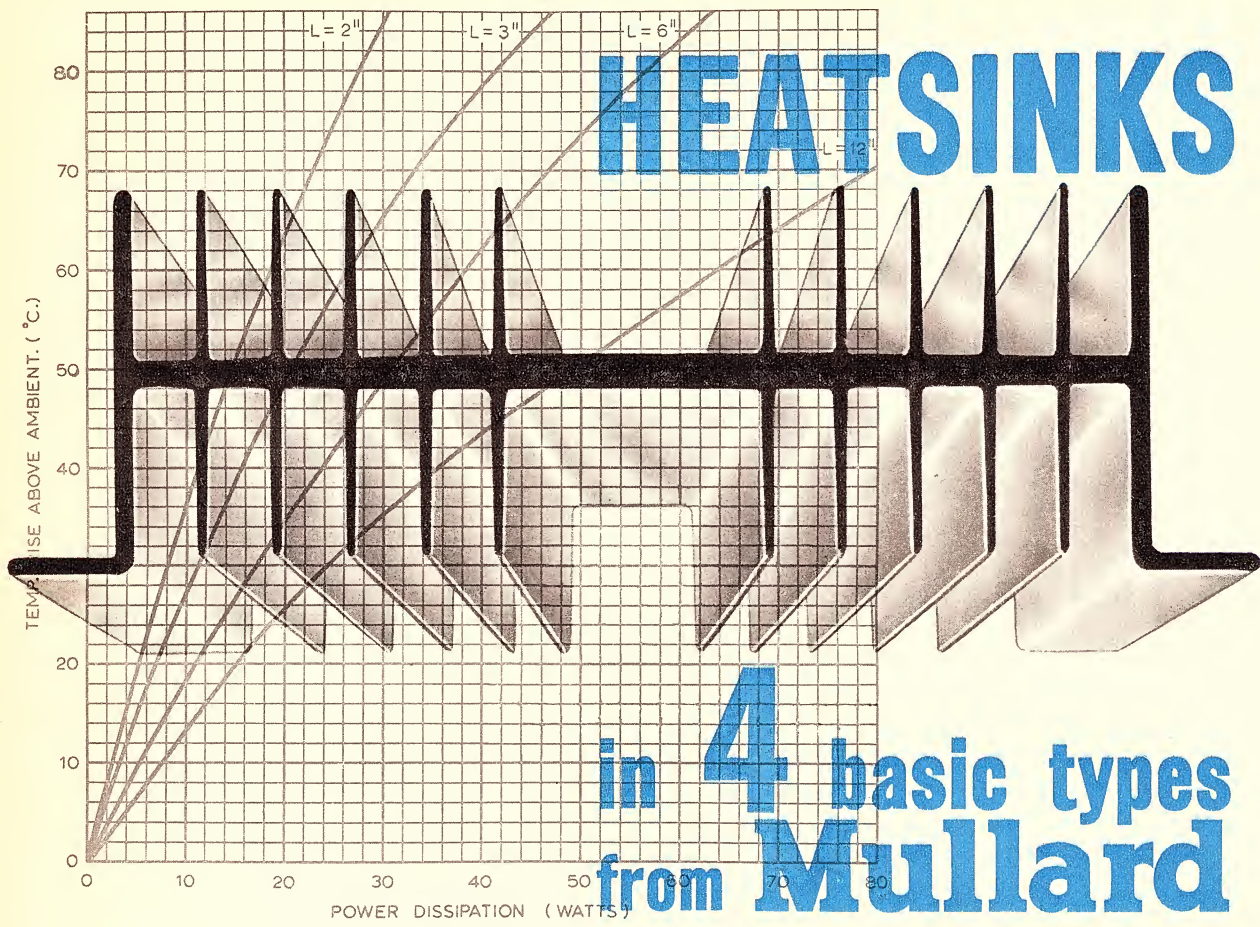





in **4** basic types
from **Mullard**

The Mullard preferred heatsink extrusions listed below are manufactured in Australia and offer design engineers "off the shelf" heatsinks for most power semi-conductor applications.

Type	Standard Lengths	Finish
35D	2" 3" 4" 6"	Anodised
45D	3" 4" 6"	Anodised
55D	4" 6" 8"	Anodised
65D	4" 6" 8"	Plain

Bulk material is available in 36" and 72" lengths. Non-standard lengths, subject to quotation, can be supplied in minimum quantities of 100 pieces. Further details are available from Mullard offices throughout the Commonwealth.

 <p>1 35D</p> <p>For use with lower power transistors and silicon diodes.</p>	 <p>2 45D</p> <p>For use with medium power transistors, thyristors and silicon diodes.</p>
 <p>3 55D</p> <p>For use with high power transistors, thyristors and silicon diodes.</p>	 <p>4 65D</p> <p>For use with high power thyristors and silicon diodes under transient current conditions.</p>

Mullard

MULLARD-AUSTRALIA PTY. LTD., 35-43 CLARENCE ST., SYDNEY, N.S.W., 2000.
29 2006 • 123 VICTORIA PDE., COLLINGWOOD, VIC., 3066. 41 6644 • CNR.
LIGHT ST. & ST. PAUL'S T'CE., BOWEN HILLS, QLD., 4006. 51 5151.

Associated with MULLARD LIMITED, LONDON.

M204A



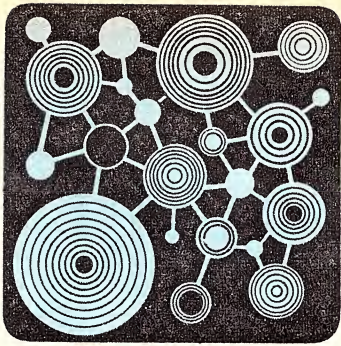

SCIENTIFIC AND INDUSTRIAL NEWS

Electron source

Semiconducting forms of silicon carbide may be of considerable use wherever high performance and extremely long life are required from cathode ray tubes and similar electron-beam devices, following research by G.E.C.-English Electric in the U.K. Single crystals of silicon carbide which are processed to form the emitters are grown by sublimation at a temperature of about 2,500 deg. C. They average about 1cm across, and are used as the substrates on top of which are grown the layers to form the PN junction. These layers are produced by a solution growth technique or by vapour deposition from trichlorosilane and hexane, both at about 1,600 deg. C.

The material is more expensive than conventional thermionic cathode materials, but has the advantages of very low power (50 to 100mW) and compatibility with transistorised circuits. The principle behind the work is that electrons in solid material can be accelerated to high energies and, if near enough to the surface, can escape before their energy is reduced by collisions. The surface layers of a solid crystal can thus emit electrons while the crystal remains at ambient temperature.

Systems Development Institute

An Australian Systems Development Institute is to be established in Canberra at an estimated cost of \$4 million. The institute will become fully operational early in 1970 with the installation of an IBM System 360 Model 67 computer. The institute will provide facilities for research and development work in advanced data-processing projects of special interest to Australian Government, industry, medicine and research. Provision will be made for undergraduate, post-graduate, and post-doctorate fellowships.

The Model 67 was selected for the institute because the computer was specifically designed for advanced time-sharing applications. A communications network of terminals will link scientists working in Melbourne, Canberra and Sydney with the system. The institute will house a comprehensive library on software technology. A computerised selective dissemination of information system will automatically notify users about incoming literature related to their own specific needs as registered with the computer.

Measurement of Mars' temperature

A precision radiometer, designed and built by the Hughes Aircraft Co. Santa Barbara Research Centre in the U.S.A., will measure the temperature of Mars during a fly-by of two Mariner spacecraft in July and August. By studying the temperature characteristics, scientists hope to learn something about the surface of the planet and possibly about its atmosphere. The two-channel radiometer will measure temperature in two basic ranges and has four major purposes: to measure the temperature of the surface of the planet; to complement the information from TV cameras and relate physical features to temperature changes; to measure the cooling curve as the

Video recorders

Colour television equipment was featured by Ampex Australia Pty. Ltd. at the recent I.R.E.E. Convention held at the Wentworth Hotel, Sydney. The Ampex exhibit included demonstrations of the VR-2000B high band colour videotape recorder used throughout the world by television stations and television production firms. Also demonstrated was the HS-100 slow-motion video disc recorder, with facilities for slow-motion and stop-motion familiar to viewers as the "instant replay" of sportcasts.

Among the other items on display was the combination of a VR-3000 high band portable colour videotape recorder (which can be used to record NTSC, PAL or SECAM colour TV signals) and a BC-300 hand-held monochrome camera (right).

instrument scans across the line from light to dark and, by determining how fast the surface cools, tell something about the composition of the surface; to scan the polar cap and if possible establish if the cap is composed of dry ice (frozen carbon dioxide), water ice, or a mixture of both.

The radiometer uses highly sensitive thermopile detectors using antimony-bismuth junctions deposited on a sapphire substrate by thin-film evaporation techniques. The two channels are 8 to 12 microns, for detecting around 27 deg C, and 18 to 25 microns, for around -130 deg. C. The instrument uses two telescopes, each with a 1in aperture to focus light on the detectors. A simple three-position stepping mirror allows the telescope fields to view space, the planet, or an internal reference surface. In this way the instrument uses space as a zero radiation point so that absolute radiometric measurements of the planet's surface can be made.

Studies in electronic music

The University of Adelaide has announced a centre for the teaching, practice and performance of electronically synthesised music. Mr Peter Tahourdin is in charge of the teaching of electronic music to undergraduate and post-graduate students at a North Adelaide recording studio where an imported music synthesiser has been installed. The first music composed on the synthesiser is expected to be heard at a public recital late this year.

The decision to explore this comparatively new field followed an offer by Mr D. E. Jolly to the Professor of Music, Professor David Galliver. Mr Jolly offered to make available electronic equipment at his recording studios and to import a Moog Synthesiser, Mark III. This compact, portable device which produces the electronic sounds includes oscillators, amplifiers, filters and a computer. Any new sound discovered during research can be recorded for later use by noting the "switchboard" connections and other instrumentation settings.



STOP RUST OUTDOORS 2 YEARS -- OR MORE!

Lubricates Penetrates Stops Rust

DRY YOUR ELECTRICAL SYSTEMS
with LPS — the NON-GREASY ONE

**STOPS
Squeaks!**



LPS is NOT a paint, lacquer or a varnish, and will NOT damage paint, rubber, fabrics, plastics, or finishes.

Displaces Moisture Fast!

TECHNICAL INFORMATION

Physical Properties:

LPS 1

Less than .0001 inch non-greasy molecular film with capillary action that spreads evenly and easily to seal out moisture at very low cost.
Rust Inhibitor: Protects all metals from rust and corrosion.

Water Displacing Compound: Dries out mechanical and electrical systems fast.

Lubricant: Lubricates even the most delicate mechanisms; non-gummy, non-sticky; does not pick up dust or dirt.

Penetrant: Penetrates to loosen frozen parts in seconds.

Volume Resistivity per ASTM D-257: Room temperature, ohm/cm; 1.04×10^{12}

Dielectric Constant per ASTM-877:

Dielectric Constant 2.11 Dissipation Factor: 0.02

Dielectric Strength per ASTM D-150:

Breakdown Voltage 0.1 inch gap. 32,000 volts

Dielectric Strength volts/inch 320,000 volts

Flash Point (Dried Film)

Fire Point (Dried Film) 900 degrees F

TESTS AND RESULTS: 950 degrees F

Lawrence Hydrogen Embrittlement Test for Safety on High Tensile Strength Steels: Passed.

Certified safe within limits of Douglas Service Bulletin 13-1 and Boeing D6 17487.

Mil Spec. C-16173D-Grade 3

Passed

Mil Spec. C-23411

Passed

Swiss Federal Government Testing Authority for Industry: Passed 7 Day Rust Test for acid and salt water. Passed Weiland Machine Test for Lubricity as being superior to mineral oil plus additives.

HOW LPS SAVES YOU TIME AND MONEY

1. LPS PROTECTS all metals from Rust & Corrosion.
2. LPS PENETRATES existing rust — stops it from spreading.
3. LPS DISPLACES moisture on metal—forms fine protective film
4. LPS LUBRICATES even the most delicate mechanisms at extreme temperatures.
5. LPS PENETRATES to free rust frozen parts, nuts, bolts, etc.
6. LPS PREVENTS equipment failures due to moisture (drives it out).
7. LPS LENGTHENS LIFE of electrical & electronic equipment—improves performance.
8. LPS RESTORES equipment damaged by water contamination & corrosion.
9. LPS PENETRATES AND PROTECTS plated and painted metal surfaces.
10. LPS PROTECTS metals from salt atmosphere, acid & caustic vapours.
11. LPS LOOSENS dirt, scale, minor rust spots & cleans metal surfaces.
12. LPS ELIMINATES squeaks where most everything else fails,

LPS PRODUCTS CONFORM TO
FEDERAL MIL SPECS
C-23411 and/or C-16173D



LPS RESEARCH LABORATORIES, INC.
7050 COTNER AVE. • LOS ANGELES, CALIF. 90028

(SOLE AGENT)



ZEPHYR PRODUCTS PTY. LTD.

70 BATESFORD ROAD, CHADSTONE, VICTORIA — PHONE 56-7231

MANUFACTURERS OF RADIO & ELECTRICAL EQUIPMENT & COMPONENTS

Automatic landings

A demonstration of the increasing confidence in electronic autocontrol systems in airliners was given recently when a Super VC10 made two fully automatic landings at London's Gatwick airport during its very first test flight. The aircraft was fitted with a production Elliott Flight Automation dual monitored autopilot system. BOAC's whole fleet of Super VC10s is being equipped with the Elliott system.

Forming diodes with lasers

The Components Division of International Business Machines Co., New York, U.S.A., has discovered that laser energy can drive enough impurities into silicon to form diodes wherever needed on an integrated circuit. The process consists of painting phosphorus on the chemically polished surface of a silicon wafer. This is expected to a 5mS pulse of laser light. The laser energy drives the phosphorus into the silicon to make a diode at that point. IBM reports that there is no apparent damage to the silicon crystals at low energy levels, and at high levels the damage is confined to the radiated area. Since the laser beam can be focused to an extremely small spot, the process can be used to produce a diode at any point on a silicon wafer without damaging surrounding materials.

Black TV display

The National Aeronautics and Space Administration of the U.S.A. is carrying out research on a television receiver with a high-intensity screen. The aim is to develop a display tube which would give pilots a high-contrast picture of their instrument readings in high ambient light. A series of filters would absorb the prevailing light from the cockpit and prevent any back reflections, thus leaving the tube face black except where the signals would be shown. Thus, even under direct sunlight, a pilot could quickly scan the data from his instruments to control the air craft.

Lunar landing exercise

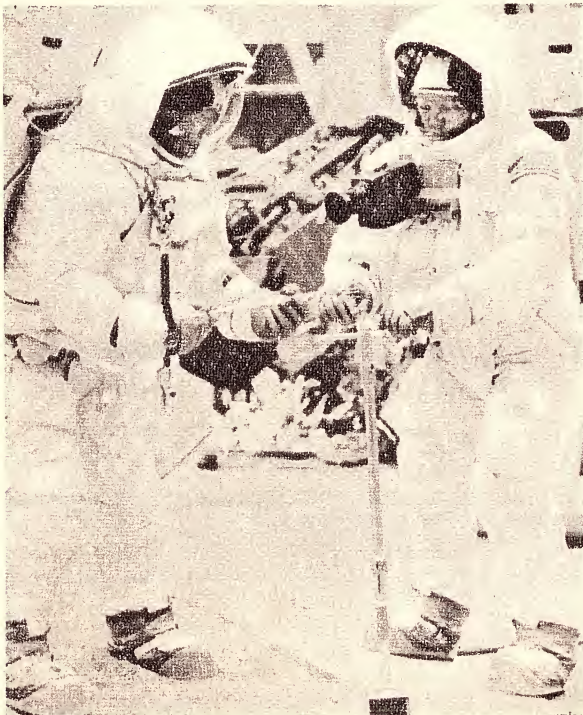

Two members of the Apollo 11 lunar landing mission participate in a simulation of deploying and using lunar tools during a training exercise. Neil Armstrong (left) holds a bag for a sample which Edwin Aldrin has picked up with tongs. A mock-up of the lunar module is in the background.

AUSTRALIAN COMPUTER CONFERENCE

The Fourth Australian Computer Conference is being organised by the Australian Computer Society Inc. and will be held in Adelaide from August 11 to 15, 1969.

Excellent facilities at the University of Adelaide have been made available for the holding of sessions and the equipment exhibition. The proceedings on the opening day will be at the Town Hall, Adelaide. Previous Australian computer conferences were at Sydney (1960), Melbourne (1963) and Canberra (1966).

In organising the 1969 conference, particular emphasis has been placed on the provision of a wide range of commercial papers, as well as those of a scientific or technical nature. The conference will be of interest and benefit to all concerned with computers and their effective use. Speakers will include top men in their field from both Australia and overseas. The feature guest speaker is John Kenneth Galbraith, Professor of Economics, Harvard University. He is a distinguished lecturer, a former presidential adviser, a noted economist and commentator on international commerce, and the author of "The Affluent Society" and "The New Industrial State."

Other principal speakers include: Mr K. M. Archer, O.B.E., Commonwealth Statistician, Australia; Mr Paul Armer, Director Computation Centre, Stanford University, California, U.S.A.; Academician A. A. Dorodnicyn (U.S.S.R.), President International Federation for Information Processing (IFIP); Academician V. M. Glushkov, Director Institute of Cybernetics, Ukrainian Academy of Cybernetics, U.S.S.R.; Mr P. D. Hall, Director, International Computers Ltd. (ICL), U.K.; Mr Nick Jonas, Managing Director, IBM Information Systems Ltd., U.K.; Mr B. L. Neff, Second Vice-President, Metropolitan Life Assurance Co., New York, U.S.A.; Professor R. N. Robertson, Chairman, Australian Research Grants Committee; Professor Daniel Teichroew, Chairman, Department of Industrial Engineering, University of Michigan, U.S.A.; Mr Wayne Nelson, Software Management, Burroughs Corporation, U.S.A.

To enable delegates to choose sessions to suit their particular interests the program has been scheduled in three streams: commercial, industrial and management topics; computer technology, hardware and software topics; scientific, professional and academic topics. The commercial stream will conclude each day with a panel discussion of delegates' questions arising from the day's papers. For the other streams, each session will conclude with a discussion period.

Further information on the conference may be obtained from local branch secretaries of the Australian Computer Society, or from the Conference Secretary, Australian Computer Conference, Adelaide, 1969, Box 404B, G.P.O. Adelaide, S.A. 5001.

Those interested may stay on in Adelaide for the follow-on activities: a seminar on "The Role of the Computer in the Secondary School" from August 16 to 17 — details from the Secretary, Australian Computer Society, c/o Australian National University, Canberra; the ANZAAS Conference from August 18 to 22 — details from Hon. Secretary, c/o University of Adelaide, North Terrace, Adelaide, S.A.

Distress signal

A new marine distress signal made in Britain, called the Radarflare, not only puts up two ordinary red flares when fired, but also produces a flare visible on the radar screens of searching aircraft and ships. It does this by releasing, at a height of 1200 feet, nearly a quarter of a million miniature radar reflectors. These are silver-coated nylon hairs thrown out by an explosive device. They appear on the radar screen of a search aircraft or ship up to about 20 miles away as a sudden flare of light which fades gradually over up to half an hour. The radar reflectors can be seen when thick fog obscures the ordinary flares. The signal, which has already been supplied to Australia and Canada, is about the size of a large electric torch making it easy to pack into survival kits.

Electric mail vans

Battery-powered electric mail vans are to be introduced by the British Post Office in a number of areas later this year. With a top speed of about 20mph, each van will be able to carry 240 cu. ft., or about 30 cwt., of mail. Initially they will carry mainly parcels but later may be put to other uses. Although initial cost is higher than for diesel vans of comparable capacity, they are expected to be cheaper to run and maintain, and to last longer. On runs with many stops their lower top speed will make little difference. In a test at High Wycombe, the aim will be to see if it is economical to use vans of this type on certain letter deliveries in largely residential areas normally performed by postmen on foot. Two postmen will use a van as a mobile base.

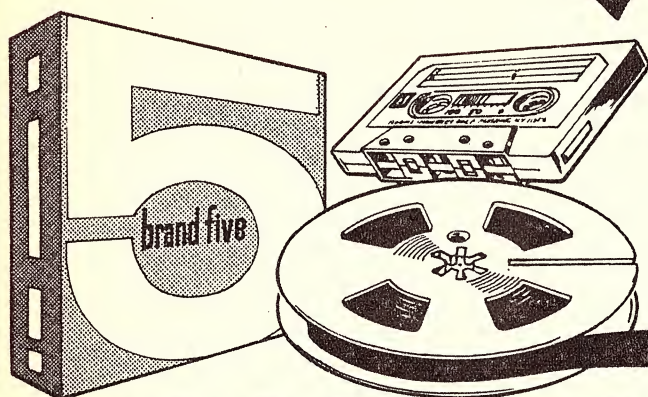

The best
buy at any
price!

PROFESSIONAL TAPE AT WHOLESALE PRICES

"BRAND 5"—unconditionally guaranteed and manufactured to highest U.S.A. professional standards and sensationally priced at half that of comparable tapes.

"BRAND 5" has high remanence iron oxide

emulsion coated to highest grade Acetate or Mylar base material.

"BRAND 5" ensures unmatched results in high fidelity mono and stereo recordings, with certain protection against head wear, squeal and gumming of heads.

FINEST QUALITY! HALF THE PRICE!

LENGTH	TYPE No.	DESCRIPTION & MIL. THICKNESS	NORMAL PRICE	OUR PRICE	LENGTH	TYPE No.	DESCRIPTION & MIL. THICKNESS	NORMAL PRICE	OUR PRICE
7" REELS					CORRESPONDENCE TAPES				
1200'	15D7	1.5 ACETATE	6.60	3.00	3 1/2" REELS				
1800'	10D7	1.0 ACETATE	7.25	3.25	900'	3D32MS	.33 MYLAR	3.90	1.95
1800'	10D7M	1.0 MYLAR	9.15	3.99	3" REELS				
2400'	5D7M	.5 MYLAR	10.40	4.75	150'	15D3	1.5 ACETATE	.95	.50
2400'	5D7MT	.5 TENSIL MYLAR	11.90	5.25	225'	10D3	1.0 ACETATE	1.20	.65
3600'	5D7MS	.33 MYLAR	13.20	6.75	225'	10D3M	1.0 MYLAR	1.65	.70
5 1/2" REELS					CASSETTES				
1200'	10D57	1.0 ACETATE	5.50	2.55	C30			3.10	1.55
1200'	10D57M	1.0 MYLAR	6.00	2.95	C60			3.50	1.65
1800'	5D57M	.5 MYLAR	8.90	3.75	C90			4.75	2.65
5" REELS					C120				
600'	15D5	1.5 ACETATE	3.40	1.80				6.50	3.30
900'	10D5	1.0 ACETATE	4.15	1.98					
900'	10D5M	1.0 MYLAR	5.32	2.25					
1200'	5D5M	.5 MYLAR	6.95	2.50					
1200'	5D5MT	.5 TENSIL MYLAR	8.70	2.75					
1800'	5D5MS	.33 MYLAR	9.60	3.75					

* AVAILABLE AT ALL GOOD RADIO,
TAPE AND RECORD STORES

GREEN CORPORATION LTD. 88 KING STREET
SYDNEY. TEL.: 25-1989



GREEN CORPORATION LTD.

EA669

88 KING STREET, SYDNEY, N.S.W. 2000

Please send me FREE 24-page booklet "TAPE EDITING AND SPLICING".

NAME.....
ADDRESS.....

Ozone measuring technique

Measurement of ozone concentration in the atmosphere is the conventional indicator of air pollution or smog intensity. Present methods of measurement provide only a gross measure of total oxidants, with no means of separating the ozone constituent. At the Lockheed Aircraft Service Company, Ontario, California, U.S.A., electrochemists have completed research on a technique which measures the concentration of ozone itself to a high degree of accuracy. The technique involves measurement of the shift in the level of acidity as polluted air is passed through a series of processing solutions into an electrochemical cell containing a special electrolyte. Dr E. L. Littauer, the company's electrochemistry manager, reports that the invention is now ready for licensing, and that a patent application has been filed.

Medical telemetry

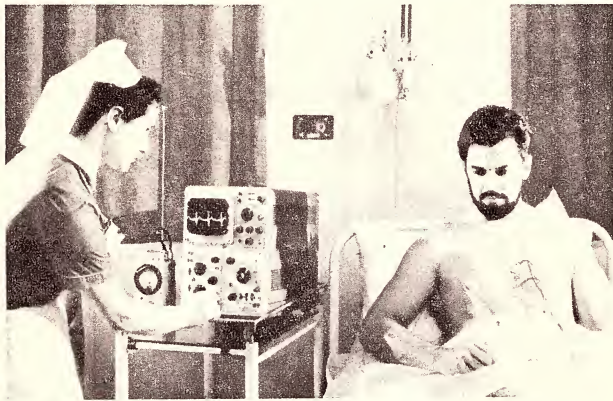

A short range telemetry system for patient monitoring has been developed by the United Kingdom Atomic Energy Authority in collaboration with the Middlesex Hospital Department of Clinical Measurement. The patient has electrodes fixed to his chest by adhesive, and wires from these electrodes are connected to a small radio transmitter (here held in the patient's hand). Signals are picked up by a receiver (far left) and are shown as an electro-cardiogram on the oscilloscope.

Extension of National TV Service

The Australian Government has authorised the expenditure of almost \$5 million for the establishment over a 4-year period of 38 low power National television stations. Some of these stations will be established at strategic locations along Post Office broadband telephone routes — existing and proposed — using the normal television relay channel or, where one is not provided, the stand-by bearer which is available. Others will be established in areas which are not on broadband telephone routes but to which programs can be provided by means of minimum type microwave links provided specifically for the purpose.

The centres concerned are as follows: N.S.W. — Mungindi, Queensland — Alpha, Augathella, Barcardine, Blackall, Charleville, Clermont, Cloncurry, Cunnamulla, Dirranbandi, Emerald, Goondiwindi, Hughenden, Julia Creek, Longreach, Mary Kathleen, Miles, Mitchell, Morven, Richmond, Roma, St. George, Springsure, Winton. South Australia — Ceduna, Woomera. Western Australia — Carnamah, Carnarvon, Dampier, Esperance, Mingenew, Moora, Norseman, Port Hedland, Southern Cross/Bullfinch, Three Springs. Tasmania — King Island. Northern Territory — Alice Springs.

The distance between Alice Springs and existing stations, and the absence of relay channels to that centre, necessitates special measures being taken to make a television service available.

Rod-pushing machine for UG cables

A mechanised rodding and cabling system for underground cable ducts has been developed by the British Post Office. A continuous rod is power-driven from one end of a duct route to the other. The cable, attached to the end of the rod, is drawn into the duct by the subsequent retraction of the rod to its original position. The task of hand-rodding and the separate operation of winching the cable into position as at present are eliminated. The rod is led into the duct by a flexible guide tube, then driven smoothly through the duct at speeds up to 160 feet per minute with a thrust of up to 900lb. (pounds force). The system also includes a live centre conductor and an oscillator to indicate the location of any blockage in the duct. The full length of the rod (200 yards) can be driven through ducts even when the ducts are partly occupied by other cables.

Colour TV display by AWA

During the I.R.E.E. Convention in May, colour television equipment was demonstrated by Amalgamated Wireless (Australasia) Ltd. in a fully operational studio erected at its North Ryde works. In conjunction with The Marconi Company of the U.K., AWA demonstrated a comprehensive range of studio colour equipment including the latest version of the Marconi Mark VII studio camera and telecine channel. Marconi engineers explained the operation during the demonstrations. In addition to the studio demonstrations, the camera output was fed to an AWA TVH-5A colour transmitter and the received pictures were displayed on a colour TV receiver in the studio area.

Miners' TV network approved

The Federal Government has given its approval for the Australian Mining Industry Council to go ahead with its plans for a TV network to serve outlying mining towns. (See "Electronics Australia," June, 1969 page 35.) A new division 5B has been introduced into the Broadcasting Control Act to provide and grant licences for what have been termed television repeater stations and for their operation. The A.B.C. would have the authority to provide for the stations the programs of the commission, prepared on magnetic tape at a recording studio, established specially for the purpose, and forwarded to the stations for replaying. Only the cost of the proposed stations remains to be considered and whether or not the stations are built now depends on the Mining Industry Council and its members.

Stronger metals

The Materials Sciences Laboratory at Lockheed Missiles and Space Co., California, U.S.A., has been engaged in improving the mechanical properties of lightweight alloys, high-strength metals, and high-temperature materials through the control of microstructure by thermal-mechanical treatments. A process for producing and controlling the crystallographic texture of a commercial titanium-base alloy has been developed. Lockheed says that the new processes have resulted in a 50pc increase in strength for biaxial stress applications, typical of those experienced in pressurised tanks and vessels.

Discoveries have also been made in the manner by which metallurgical structure governs the strength and ductility of dispersion-strengthened alloys. Treatments for a molybdenum-base alloy have produced what is claimed to be the highest strength-to-weight ratio of any known metallic material at 2,400 deg. F. Knowledge gained is being applied to improve the properties of columbium and titanium alloys at high temperatures. Work on a columbium alloy demonstrated that a 300-fold increase in creep resistance at 2,200 deg. F. and a six-fold increase in yield strength at room temperature can be produced by simple thermal treatments to control the amount and distribution of oxygen atoms.

IC production technique

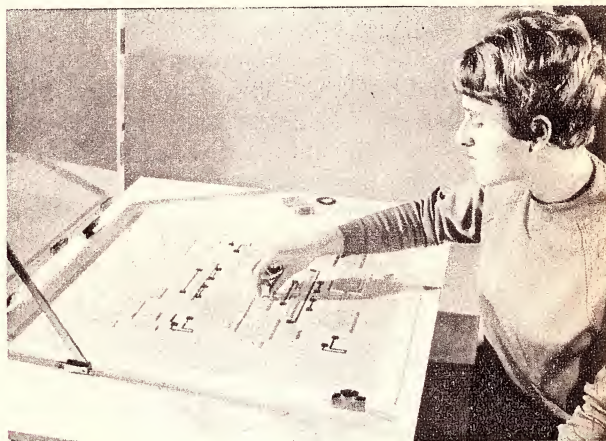

A new technique perfected by Standard Telecommunication Laboratories Ltd., Harlow, Essex, England, is said to cut integrated circuit production from four weeks to two days. The customary drawing, artwork and preparatory photographic reduction have been eliminated by using laser machining, computer techniques and new layout methods. Scaled-up coded plastic tiles, representing circuit elements, are moved about on a grid to establish the circuit layout (above). Connections are then taped-in on a hinged transparent overlay grid. A single pair of position co-ordinates and the code for each tile, and similar data for interconnections, are punched on to cards and fed into a computer. This translates the information into more detailed data required for laser machining. Mask cutting by laser then takes place automatically at ten times actual size, producing masks ready for further reduction in a step-and-repeat machine.

JBL

OF CALIFORNIA USA

In the field of high fidelity and professional sound, JBL (James B. Lansing Sound Inc.) is the name that is synonymous with superior performance, sophisticated design and engineering, exquisite workmanship, precise construction and the essence of durable dependability.

JBL systems were chosen for the residences of Richard Nixon, Hubert Humphry, the Presidential Palace, Mexico, the Royal Palace in Bangkok and the homes of more than 70 leading Hollywood stars. JBL studio monitors are used by the American Broadcasting Company and the majority of major recording studios in the U.S.A.

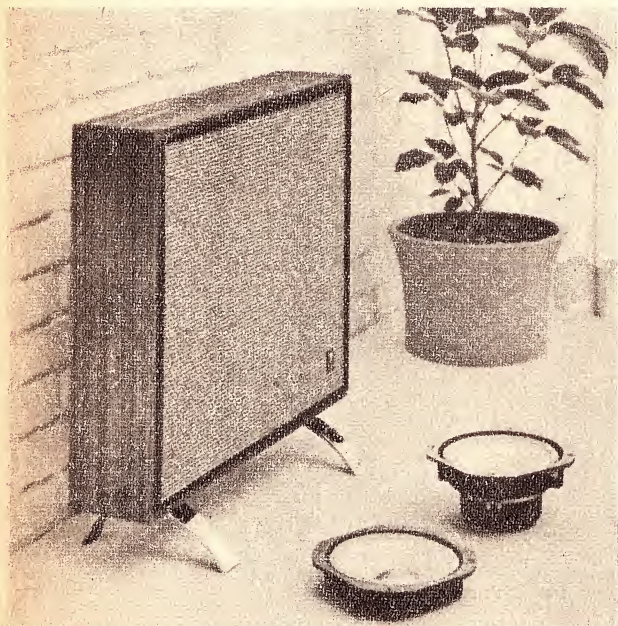

JBL TRIMLINE 54 This unit features the JBL LE8T, a remarkably smooth extended response speaker. It has a 6½ lb. magnet structure, edge-wound aluminium ribbon voice coil, dural high frequency dome. It is augmented by the PR8 passive radiator which doubles the radiating cone area, giving fuller bass and smoother sound well up into the midrange. 23¾" x 20" x 5½" deep. Oiled walnut.

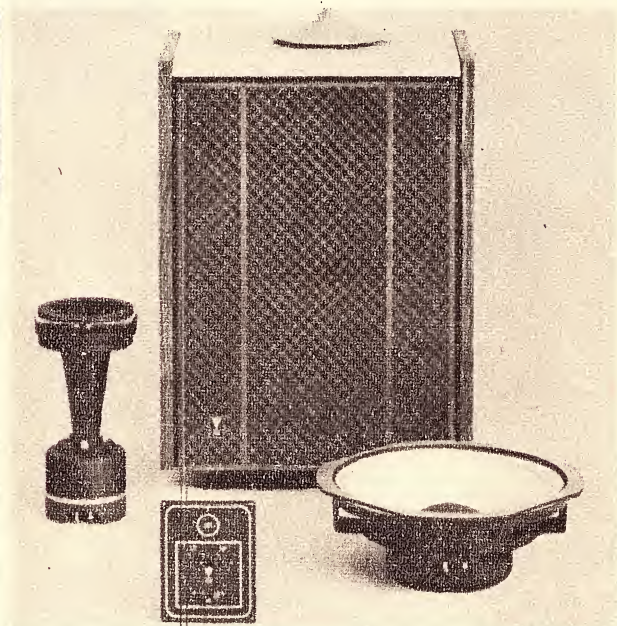

JBL LANCER 101 The Model LE14A 14" low frequency speaker delivering prodigious bass response, is combined with the renowned LE175-DLH, a massive professional assembly consisting of compression driver, cast exponential horn and 14-element acoustic lens. These are matched electrically by the LX 8 dividing network. Enclosure has hand-carved fretwork grille, walnut side panels and a top of genuine Adriatic marble. 23" x 17½" x 12¾" deep.

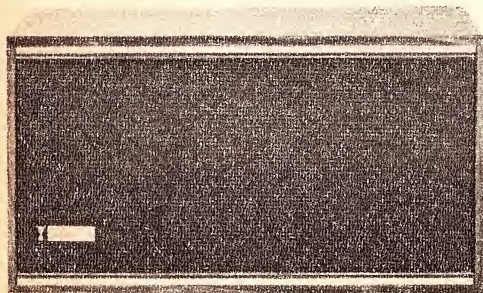

JBL LANCER 77 A highly sophisticated system, in which virtually all of the speaker panel is utilized as direct radiating area. It combines the LE10A low frequency driver with the PR10 passive radiator which crosses over at 2500 cps through the LX 4 - 2 dividing network to a high-frequency direct radiator. The combination gives a seamless purity of overall sound. 14" x 23½" x 11¾" deep. Oiled walnut. Also in the JBL range is a 120 watt solid state amplifier/preamplifier and ultra-sophisticated sound equipment.

AURIEMA

In association with Goldring Engineering

Trade enquiries invited.
For free illustrated brochures and the name of your nearest JBL dealer contact Auriema (Australasia) Pty Limited
443 Kent Street Sydney 2000 Telephone 29 6144

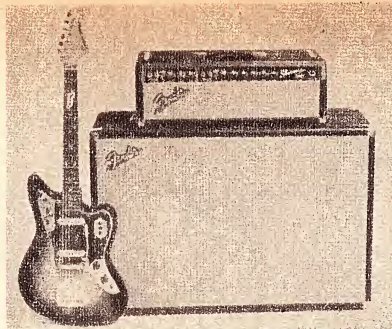

MUSICAL INSTRUMENT SPEAKERS

JBL-USA

These are the first professional-quality loudspeakers designed for use with electrical musical instruments. Their unique engineering features and careful craftsmanship provide the amazing "JBL Sound": Lowest bass, sharp mid-range, bright smooth treble, instantaneous response and effortless total sound which is not available with any other speaker, regardless of price or size. Used by The Beach Boys, The Rolling Stones, Trini Lopez and hundreds of other talented professionals, these are the same speakers used in top-quality amplifiers such as Ampeg, Echolette, Epiphone, Fender, Gibson, Kustom and Standel.



The D110F, 10", D120F, 12", and D130F, 15", create new dimensions in total sound - crisp, spacious, each note has all the bite and body needed for the most demanding assignments. The new D140F, illustrated, is specifically designed for bass guitar or organ, delivering rich, full, solid bass at any loudness level.

Trade enquiries invited.

For free illustrated brochures and the name of your nearest JBL Dealer contact

AURIEMA

(Australasia) Pty Limited
443 Kent Street Sydney 2000
Telephone 29 6144

In association with Goldring Engineering.

GE:PS18

Checking control tapes

Speedier checking of tapes made for the control of machine tools is possible with a new program developed by I.C.S.L. Stoke-on-Trent, England. Checking of these control tapes is usually done either by comparing the co-ordinates on the tape print-out with an engineering drawing, or by running the tape on the machine tool with the cutters removed so that each position is visited but no metal removed. The I.C.S.L. program enables the path to be taken by the tool to be drawn on a graph plotter associated with a KDF-9 computer. The production engineer, knowing the positions to be machined and the path to be followed, can decide if clamps or other obstructions will be in the way of the cutting heads.

Millimetre-wave gear

Millimetre-wave test equipment, valued at \$50,000, has been supplied by Hitachi Ltd., Tokyo, Japan, to Bell Telephone Laboratories Inc. for installation in laboratories in Holmdel, N.J., Murray Hill, Ky., Merrimack Valley, Mass., and Allentown, Pa. The equipment will be used in connection with development work on a commercial TV telephone for operation in the millimetre-wave region. The equipment is capable of measurements within the 50-75GHz and 75-110GHz bands. It was developed to specifications provided by Bell.

Bollard light



This low-level pedestrian lighting bollard, a winner in the 1969 British Council of Industrial Design Awards, has four main features: it is highly efficient and lights without glare; the cost per unit is less than conventional column lighting; it is easier and less expensive to maintain than overhead lights; it fits unobtrusively into modern architectural scenes. The awards were presented, by H.R.H. Duke of Edinburgh on board the liner Queen Elizabeth II on May 29. They are given annually for outstanding products from both the capital and durable consumer industries.

Light-emitting diodes

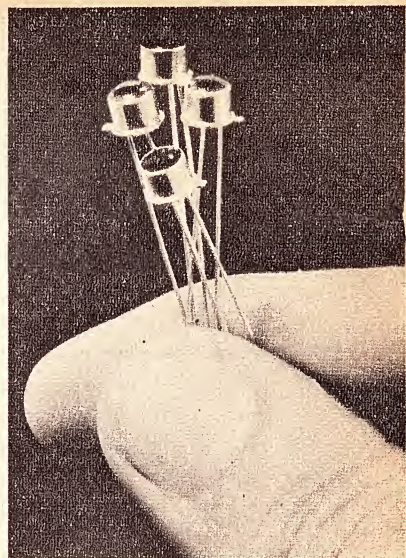

Gallium-arsenide-phosphide light-emitting diodes which produce a bright red light have been introduced by Hewlett-Packard as panel and circuit status indicators where low drive and high reliability under adverse conditions are important. With an input power of 15mW (10mA at 1.5V), they achieve a brightness typically of 120 foot-lamberts. Maximum brightness under steady-state conditions is about 200fL, but the diodes can be pulsed to much higher levels of brightness. The limit is determined by the maximum dissipation (15mW continuous). The diodes are packaged in a modified TO-46 transistor enclosure with a window on the top. Life is expected to exceed 100,000 hours to half brightness.

Colour TV transmission

The first ever transmission of PAL colour television across Sydney was made during the recent I.R.E.E. Convention. The transmission was by microwave link from the showrooms of Philips Electrical Pty. Ltd. at 79 Clarence Street to the ballroom of the Wentworth Hotel, the venue for the exhibition associated with the Convention. On the ground floor of the Philips showrooms a colour television studio was set up with all the necessary equipment for production of colour pictures. It was aimed to show engineers associated with television not only the technical equipment, but also proper lighting and production techniques.

At the Wentworth Hotel there were not only colour and monochrome receivers for simultaneous reception, but some of the material was also shown through a large screen projector. This gave a 6ft x 4ft picture, but the same projector could be used to fill a full-size theatre screen.

Large plastic lens

A 6ft x 2ft flat prismatic lens for use in a tubular fluorescent lighting fixture has been made by the injection moulding process by Rolinx, of Manchester, England. It is one of the largest injection mouldings for the lighting industry to be made by Rolinx. Moulded into the surface of the sheet are more than 50,000 conical prisms which control the direction in which the light is emitted. The injection moulding process used ensures that all the prisms are sharp, accurate and identical. It is claimed that a standard of quality is achieved which cannot be matched by the extrusion embossing process, a method used for producing patterned sheets. The lens weighs 9½ pounds and has a base thickness of .090in.

A CRYSTAL CLOCK DRIVE UNIT... PART TWO

by Ian Pogson

Last month we discussed the design considerations and practical circuitry of a crystal controlled clock. In this, the second part of the article, we discuss the physical construction of the unit, the method of setting up the frequency dividers, the final adjustment for maximum accuracy, and the various time standards against which this can be done.

The complete drive unit is housed in an Eddystone diecast metal box and most of the components are accommodated on a 7in x 4in printed board. A coded picture gives the location of each component, which should make assembly quite easy.

The test points on the board are brought by means of looped pieces of (about) 20 gauge tinned copper wire which stand off the surface of the board by about half an inch. This allows easy connection by means of a crocodile clip or test prod.

The AC128 transistor is fitted with the conventional flag type heat sink. The two output transistors are fixed to the board with two screws each, 1/8in Whit. x 1/2in long. The transistors are stood off the board, using these screws as spacers, by using two extra nuts for the purpose. As these transistors are run well below their normal ratings, we did not fit heat sinks. They do run just slightly warm but the temperature is well within limits. However, if the unit is to be operated at a significantly higher ambient temperature, we suggest that a heat sink be fitted. This could conceivably consist of a piece of aluminium, bent up in the form of a "U," to give some extra area in the restricted space. The washers and insulators normally provided will have to be used.

The board is mounted on the "lid" of the box, and stood off with five 1in brass pillars. As the 1in afforded by the pillars is scarcely enough to provide adequate clearance in all cases, we added a 1/8 Whitworth nut as a spacer to increase this dimension.

In the prototype, we mounted the crystal by clamping it to the inside of the case and at the end nearest the oscillator. We wrapped foam plastic around the crystal holder before clamping it in position. A pair of leads are run from the board to the crystal socket, which is slipped over the holder pins. The 27pF NPO ceramic capacitor is wired in series with the appropriate lead, with one leg of the capacitor soldered to the board.

The idea of mounting the crystal as we have done, although convenient and easy, is by no means the best way. It involves the use of leads

which are about 8in long. As a result, it is possible for these leads to be moved, with a consequent change in capacitance, resulting in a slight change in the crystal oscillator frequency. Although it will be dictated to a degree by the type of crystal holder used, it would be better to mount the crystal on the board, at the oscillator end.

VNG TIME SIGNALS

MHz (AM)	Transmission Times E.A.S.T.
4.500	1945—0645
7.500	1945—0645 0700—1930
12.000	0700—1930
MHz (SSB)	
20.500	0600—2000
25.500	0600—2000

The accuracy of these signals is in accordance with International Co-ordinated Time standards which permits a maximum deviation of not more than $\pm 1\text{ms}$. In fact, the signals are derived from an atomic standard in the P.M.G. laboratories, and would normally be a good deal better than this.

Some form of clamping, with foam plastic could be devised to achieve this. The leads could then be kept short and rigid enough to avoid any frequency shift problem.

At the other end of the box, we mounted the output transformer. Here we must offer a word of warning. There is not a great deal of space here and there will not be room for a transformer any larger than the one which we used. The 0.1 μF capacitor which is connected across the high voltage side of the transformer is, in fact, connected right at the transformer terminals. A small tag strip is mounted under one of the transformer mounting feet. This provides an anchor point for the positive side of the 1000 μF output electrolytic, the other end being terminated on the appropriate transformer lug.

On one side of the box and adjacent to the output transformer, are two sockets. One is a simple coaxial type and is the output to the clock move-

ment. The other is a two-pin speaker miniature type socket and this is used for the 12 volt DC input from the power supply. These sockets have been deliberately made different, so that no mistake can be made in their identity. The coaxial cable feeding the clock movement also provides some shielding against possible interference troubles. Leads from these two sockets are run to the transformer and the board. The 250 μF electrolytic is wired directly to the power input socket.

Finally, the two push-button switches, to advance and retard the movement, are mounted on the "bottom" face of the box. Again, leads are run from these to the board. Contrary to the leads associated with the crystals, all other leads mentioned are not critical.

The method of assembling the components of the overall unit is so straightforward that this aspect scarcely calls for any comment. However, the usual care must be taken with soldering, so as not to overheat any of the more critical components, such as transistors and diodes. Furthermore, as this is potentially a precision instrument, considerable care should be taken with the whole construction. A truly neat and workmanlike job should be done and particular attention should be given to the very best of soldered joints. A "dry" joint can be a serious problem, so don't take any chances.

Having completed the constructional part of the project, the most interesting part is still to be done. We will assume that a decision has been made about the method of supplying power to the unit and that a suitable supply is available.

Firstly, a thorough check should be made, to see that there are no omissions and more important, that there are no incorrect connections. This applies more particularly to the polarity of electrolytic capacitors, zener and other diodes, and all transistors. Make particularly certain that the matched output pair of transistors are in the right places.

As a preliminary check, set up the complete system, with the clock movement connected across the output and the power supply connected and ready to be switched on. Turn back the potentiometer which feeds the output of the last multivibrator into the emitter follower. Connect an AC voltmeter, set to the 250 volt range or whatever is nearest, across the output and clock movement.

Switch on the power supply. Advance the control potentiometer and the voltage should rise on the meter. Continue to increase the level until it will not rise any further. Do not turn

SHURE

the finest range of high quality tone-arms, microphones and cartridges available.

V15 Type II	\$87.50*
M75EJ Type 2	\$38.00*
M75E Type 2	\$45.00*
M75G Type 2	\$35.00*
M75-6 Type 2	\$29.50*



M55E	\$32.50*
M44E	\$28.50*
M44-5	\$20.00*
M44G	\$19.50*
M44-7	\$19.50*
M44C	\$18.00*
M31E-EP	\$25.00*
M32E-EP	\$25.00*



PRE-MOUNTED CARTRIDGES

M80E-D19	\$38.00*
DUI0-M75E—Type 2	\$48.00*
M75E-D19—Type 2	\$50.00*
M75E-95G—Type 2	\$50.00*

MICROPHONE MIXERS

M62 "Level Loc"	\$108*
M67-2E (illustrated)	\$348*
M68FC-2E	\$164*
PE70RM-2	\$185*



MICROPHONES:

Model 515SA (illus.)	\$47.50*
Model 515SB	\$42.00*
Model 585SB	\$69.00*



Contact your local representative for detailed literature on SHURE quality products.

N.S.W.: Audio Engineers Pty. Ltd., 342 Kent Street, Sydney.
 W.A.: Athol M. Hill Pty. Ltd., 613-15 Wellington St., Perth.
 QLD.: Ron Jones Pty. Ltd., 7-9 Merton Rd., Woolloongabba, Brisbane.
 VIC.: Audio Engineers (Vic.), 2A Hill St., Thornbury.
 Phone 44-3295.

* Recommended Resale Price.

Finally, set the audio generator to 1KHz so that you get a 10:1 lissajous pattern on the screen. This point should correspond closely to the 1KHz calibration point of the generator scale.

Disconnect the CRO from the second test point and connect it to the third test point, which is the output of the 1KHz multivibrator. The same procedure is repeated as for the previous stage. Adjust the potentiometer of the 1KHz multivibrator, until a lissajous pattern of 1:1 is achieved. Again, there may be some movement evident in the pattern, due to some shift in the audio generator. This can be easily reset. As before, the moving arm of the potentiometer should be set to the mid position of the range over which it stays in lock.

Instead of carrying on as with the previous two stages, it may be easier to use the mains 50Hz to set the last (50Hz) multivibrator. To do this, you will need a low voltage, such as a 6.3 volt heater supply, obtained via a transformer connected to the mains supply. This is fed into one of the amplifiers of the CRO. The other CRO amplifier is connected to the 50Hz from the clock board. This reference may be taken from the fourth test point, after the emitter-follower, or it may be taken from the junction of the 100uF electrolytic and the output transistor emitters.

With this set up, adjust the potentiometer of the 50Hz multivibrator, until it comes into lock and gives a 1:1 lissajous pattern once again. As before, the potentiometer rotor should be set to the mid point of its travel, where it stays in lock at 50Hz. After a short while the lissajous pattern will drift slowly. This is due to the slight variations of the mains frequency, as compared with the crystal generated 50Hz. It is of no consequence as far as the adjustments are concerned, but it is an important item of interest.

Now is the time to check the "advance" and "retard" push buttons. Push each one in turn and the lissajous pattern will rotate quite rapidly and then restore to normal when the button is released.

This completes the setting up of the divider chain. The next step will be to set the clock dial to the correct time. We will assume that it is to be set against the normal hourly radio time signal. The sweep second hand should be set precisely to zero (12 o'clock) with the whole system switched off. At the last "pip," switch on and the system will be under way. If the movement is not self-starting switch on before the time signal and then start the movement as closely as possible to coincide with the last pip.

It will be necessary to wait for the next hourly time signal to determine the setting-up error. Whatever the error may be it is unwise to attempt to correct it at this stage since, with only hourly checks available, this could be a long and tedious process. It is better to simply note the error, let the system run for 24 hours, then make another check against the time signal. This then, becomes a check on the behaviour of the crystal oscillator. To adjust this use the 3-30pE trimmer in the crystal oscillator. Screw the trimmer IN if the clock has



STEP DOWN TRANSFORMERS.

All transformers in this range are suitable for connecting to a 240 volts, 50 Cycles, Single phase supply and, where applicable, comply with Australian Standard C126 - 1950 under approved Number N158.

FUSEMASTER RANGE :-

All transformers housed in steel cases ("A" and "B") fall into the above category.

A Type

- * Fuse protection of output
- * Three core primary Flex 6'6" long
- * Conduit or grommet knockouts.
- * Primary and Secondary Terminal Blocks
- * Carrying handle
- * Provision for wall mounting
- * Two outlets provided on 125W rating and over.

B Type

- * Fuse protection of output.
- * Three core primary Flex 6'6" long
- * Carrying Handle
- * Provision for wall mounting

SECONDARY VOLTS	TYPE NO.	RATING DIMENSIONS					WEIGHT 9 LBS.
		V.A.	AMPS	H.	W.	L.	

FUSEMASTER RANGE - Enclosed In Steel Cases

6	TS6/60B	60	10	5	3 $\frac{5}{8}$	7	6 $\frac{1}{2}$ lb.
12	TS12/12B	12	1	2 $\frac{1}{4}$	2 $\frac{5}{8}$	5 $\frac{5}{8}$	1 $\frac{3}{4}$
12	TS12/30B	30	2.5	4 $\frac{1}{2}$	3	6	4 lb.
12	TS12/60B	60	5	5	3 $\frac{5}{8}$	7	6 $\frac{1}{2}$ lb.
12	TS12/125B	125	10.42	5 $\frac{1}{4}$	4 $\frac{1}{4}$	9	11 $\frac{1}{4}$ lb.
24	TS24/30B	30	1.25	4 $\frac{1}{2}$	3	6	4 lb.
24	TS24/60B	60	2.5	5	3 $\frac{5}{8}$	7	6 $\frac{1}{2}$ lb.
24	TS24/125B	125	5.2	5 $\frac{1}{4}$	4 $\frac{1}{4}$	9	11 $\frac{1}{4}$ lb.
24	TS24/200B	200	8.33	5 $\frac{1}{4}$	4 $\frac{1}{4}$	9	14 $\frac{1}{2}$ lb.
32	TS32/30B	30	.94	4 $\frac{1}{2}$	3	6	4 lb.
32	TS32/60B	60	1.88	5	3 $\frac{5}{8}$	7	6 $\frac{1}{2}$ lb.
32	TS32/125B	125	3.9	5 $\frac{1}{4}$	4 $\frac{1}{4}$	9	11 $\frac{3}{4}$ lb.
32	TS32/200B	200	6.25	5 $\frac{1}{4}$	4 $\frac{1}{4}$	9	14 $\frac{1}{2}$ lb.
32	TS32/300B	300	9.4	5 $\frac{1}{4}$	4 $\frac{1}{4}$	9	18 lb.
32	TS32/500A	500	15.6	6 $\frac{3}{4}$	5 $\frac{1}{2}$	6 $\frac{1}{2}$	26 lb.
32	TS32/750A	750	23.44	8 $\frac{1}{4}$	6 $\frac{1}{4}$	6 $\frac{1}{4}$	38 lb.
32	TS32/1000A	1000	31.35	8 $\frac{1}{4}$	6 $\frac{1}{4}$	8 $\frac{1}{4}$	51 $\frac{1}{2}$ lb.
115	TS115/30B	30	.26	4 $\frac{1}{2}$	3	6	4 lb.
115	TS115/60B	60	.52	5	3 $\frac{5}{8}$	7	6 $\frac{1}{2}$ lb.
115	TS115/125B	125	1.09	5 $\frac{1}{4}$	4 $\frac{1}{4}$	9	11 $\frac{1}{4}$ lb.
115	TS115/200B	200	1.74	5 $\frac{1}{4}$	4 $\frac{1}{4}$	9	14 $\frac{1}{2}$ lb.
115	TS115/300B	300	2.61	5 $\frac{1}{4}$	4 $\frac{1}{4}$	9	18 lb.
115	TS115/500A	500	4.35	6 $\frac{3}{4}$	5 $\frac{1}{2}$	6 $\frac{1}{2}$	26 lb.
115	TS115/750A	750	6.53	8 $\frac{1}{4}$	6 $\frac{1}{4}$	6 $\frac{1}{4}$	38 lb.
115	TS115/1000A	1000	8.7	8 $\frac{1}{4}$	6 $\frac{1}{4}$	8 $\frac{1}{4}$	51 $\frac{1}{2}$ lb.
115	TS115/2000A	2000	17.4	10 $\frac{1}{2}$	8 $\frac{1}{4}$	8 $\frac{1}{4}$	79 lb.

SOLDERING IRON TRANSFORMERS - Enclosed in pressed steel cover - suitable for Mico or Oryx Soldering Irons.

5, 6, 7,	TS7/20	20	2.85	3 $\frac{3}{8}$	2 $\frac{1}{2}$	2 $\frac{1}{4}$	2 $\frac{1}{2}$
10, 11, 12,	TS12/40	40	3.33	3 $\frac{3}{8}$	2 $\frac{1}{2}$	3 $\frac{1}{4}$	3 $\frac{1}{2}$

FERGUSON TRANSFORMERS PTY. LTD.

331 HIGH STREET, CHATSWOOD, N.S.W., 42-0261.

Agents in all States.

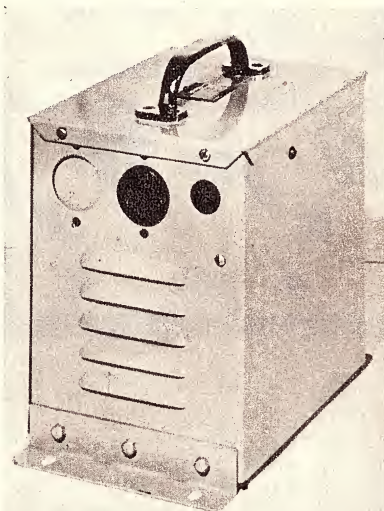

"A" TYPE TRANSFORMER

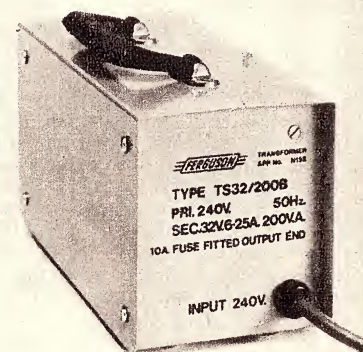

"B" TYPE TRANSFORMER

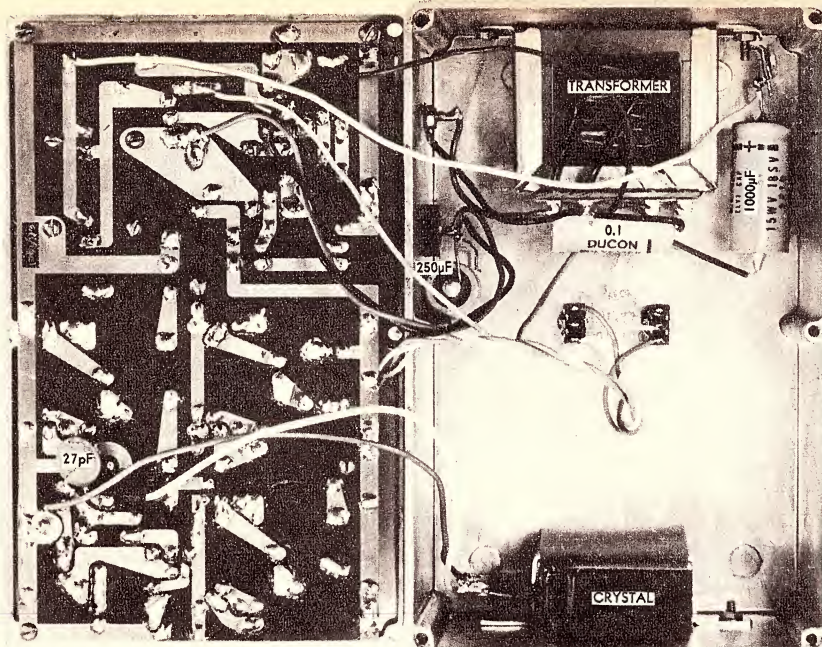

The complete assembly, with the printed board mounted in the lid.
The major components have been coded.

of 10KHz. Determine the range of travel of the potentiometer rotor, which gives this division and set it midway between these extremes.

Move to the third test point and go through the same procedure, this time setting up the output at 1 KHz.

Finally, the frequency counter is connected to the fourth test point, or to the primary of the output transformer.

The same procedure is followed as before, this time setting up for 50Hz. A check can also be made at this time on the two push buttons. The "retard" button should divide by 21 and so give a frequency of about 47.6Hz. The "advance" button, dividing by 19, will result in a frequency of about 52.6Hz.

This completes the initial setting up by this method and the final regulation will be done in the same way as previously suggested.

Setting up with a double-beam CRO is perhaps the easiest way. Connect the first test point to one vertical amplifier and connect the second test point to the other vertical amplifier. Adjust the potentiometer of the first divider until locking occurs. Then the ratio must be counted and an adjustment arrived at which satisfies the midpoint of the 10 times division. Move both connections along so that the second and third test point are under test. The same procedure is followed for this adjustment.

Move both connections once again, to the third and fourth test points. This adjustment is not quite so easy in that we are dividing by 20 and the task of counting becomes somewhat more exacting. However, this is no great hardship and the same procedure will be followed as before. At the same time, check the "advance" and "retard" buttons and see if they are dividing

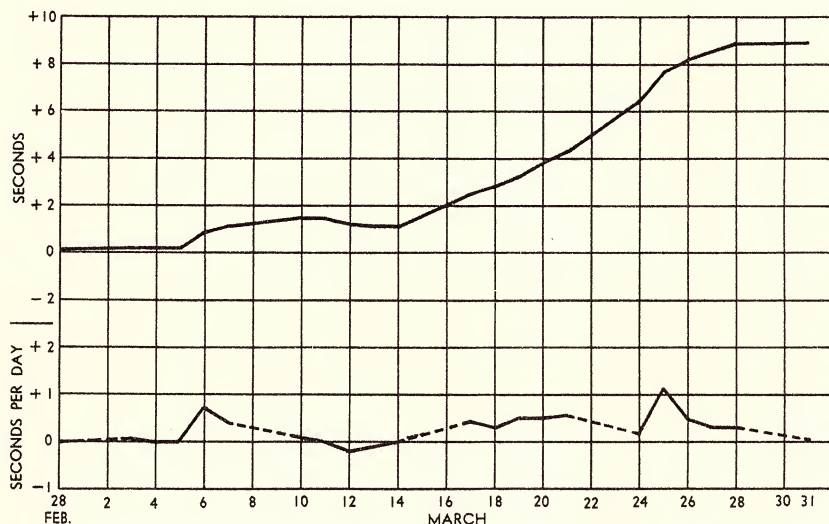

This graph shows (upper curve) the actual time deviation over a test run of 31 days and (lower curve) the mean daily rate.

ON TELEX



from

Cunningham

Call . . .

Melbourne:

31447

Sydney:

21707

FOR SERVICE.



Bob Cunningham

To beat the slow communications in this modern era, we have installed full TELEX facilities for customer service. This is your means of obtaining rapid answers and deliveries from our extensive range of BULGIN, EDDY-STONE, GELOSO, SENNHEISER, VITAVOX, DOW-KEY, etc., components from our Melbourne, Sydney, Brisbane & Perth offices.

WHAT'S NEW?

W.A. Office: Sure, we reckon there is a terrific future in W.A. for years to come, that's why we opened a branch there under the command of Bob McGrath, at 34 Wolya Way, Balga; phone 49-4919. A complete Cunningham service is being provided and good stocks are carried on the spot. Call Bob now!

BESWICK-ALERT Fuses. There are fuses and fuses and British-made "Beswick-Alert" fuses stand on their own. They are used extensively by the P.M.G., D.C.A., and many major Australian manufacturers. We can offer slow-blow, quick-acting, ceramic or glass-mounted fuses in possibly the widest range available today.

GELOSO Microphones. Geloso has gained a wide reputation for P.A. equipment. The M68 series of microphones for instance has become a hot favourite for high-quality P.A. work, and is priced at only \$16.00 (plus S.T.). You can't go wrong for quality, and if some monster throws the mike out of the ring, you haven't lost too much financially. Send for free technical brochure.

VITAVOX Waterproof Microphone. Vitavox Ltd. (U.K.), is one of the very few manufacturers in the world producing waterproof microphones, and certainly the only one available in Australia (from Cunningham's of course), is the B60 series of dynamic mikes. Heavily encased in rubber, they are fitted with a press-to-talk switch for relay circuits. This mike is capable of withstanding water pressure to 1½ p.s.i., at a depth of 3ft of water for two hours. The B60 is admirable for rugged industrial and marine purposes. Price: \$32.84 (plus S.T.).

R.H. Cunningham
PTY. LTD.

VIC.: 608 Collins St., Melbourne.
N.S.W.: 64 Alfred St., Milsons Point.
W.A.: 34 Wolya Way, Balga.
QLD.: 95 Central Ave., Sherwood.
L. E. Boughen and Co.

SANWA

SANWA ELECTRIC
INSTRUMENT CO. LTD.

Top value, protected MULTI-TESTERS

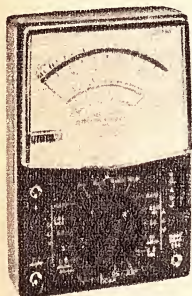

MODEL
U-50D
\$19.00
INCL. S.T.

The Model U-50D is a pocket-size, high performance circuit tester equipped with a meter movement of 35 microamperes in sensitivity.

The high internal resistance of 20k ohms per volt for DC and 8k ohms per volt of AC ranges accurately measures voltages of high impedance circuits. A protection circuit safeguards the meter movement. Shunt adaptors are available to give ranges up to 25 amperes DC.

Measurement ranges available
DC voltage: 0.1v, 0.5v, 5v, 50v, 250v, 1000v (20k Ω/v)
AC voltage: 2.5v, 10v, 50v, 250v, 1000v (8k Ω/v)
DC current: 50 μ a, 0.5ma, 5ma, 50ma, 250ma
Resistance: From 50 ohms to 50k ohms in four ranges
Volume level: — 20~ + 62db

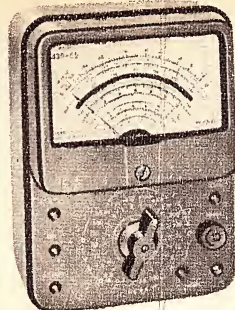

MODEL
430 ES
\$53.50
INCL. S.T.

This unit has a 10 micro-ampere movement giving sensitivity of 100k ohms/volt for all DC ranges to 300 volts. The movement is supported by spring backed jewels and is protected by a parallel diode. Frequency response is to 100 KHZ

Measurement ranges available

DC Voltage: 0.3v-3v-12v-30v-120v-300v (100k Ω/v)
1.2kv-6kv-30kv (with probe) (16.6k Ω/v)
DC Current: 12ma-0.3ma-3ma-30ma-300ma-1.2a-12a-300mv
AC Voltage: 3v-12v-30v-120v-300v-1.2kv (5k Ω/v)
AC Current: 1.2a-12a
Resistance: Up to 50 megohms (40 ohms to 400k ohms midscale)—decibel scale is provided

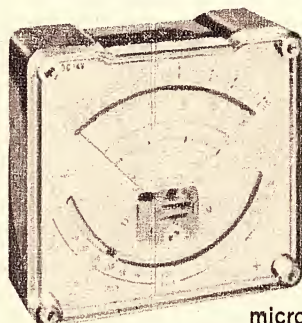

MODEL
F80 TRD
\$33.40
INCL. S.T.

The high-sensitivity suspension band movement of 34.5 microampere is frictionless and accurate. Structurally, the moving part is shock-proof, withstanding impact and vibration. Ranges are smoothly changed over by a unique designed rotary-ring switch. The meter movement is automatically protected from accidental impression of high current. The LI and LV scales provided check all types of semi-conductors. The germanium diode rectifier extends frequency response of the low AC voltage ranges up to 100k cycles. Even the AC 250 volt range checks voltages of 20k cycles.

Measurement ranges available
DC voltage: 0.25v, 2.5v, 10v, 50v, 250v, 500v, 1000v (25k Ω/v)
AC voltage: 2.5v, 10v, 50v, 250v, 500v, 1000v (5k Ω/v)
DC current: 40 μ a, 0.5ma, 5ma, 50ma, 500ma
Resistance: From 100 ohms to 250k ohms Midscale in four ranges. Load current: LI — 15ma, 1.5ma, 150 μ a
Load voltage: LV — 1.5v
Volume level: — 10~ + 10db, + 5~ + 36db

AVAILABLE EX STOCK FROM



WARBURTON FRANKL

ADELAIDE: 56-7333. BRISBANE: 51-5121.
HOBART: 2-1841. LAUNCESTON: 2-1318.
MELBOURNE: 69-0151. MT. GAMBIER: 2-3841.
NEWCASTLE WEST: 61-4077. PERTH: 8-4131.
SYDNEY: 29-1111. WOLLONGONG: 2-5444.

by 19 and 21 respectively. If locking does not occur at these points but locking is lost from the normal 20, this could still be satisfactory. The only difference will be the actual amount of advance or retard rate achieved. On the other hand, it is possible to juggle the two resistors involved in the switching, but this can be a tedious job.

The initial setup is now complete by this method and the final adjustment will be carried out as mentioned earlier.

In assessing performance of our own clock we have used nothing more refined than visual observation of the sweep second hand against a dial marked in seconds, checked against audible pips from the Lyndhurst transmitter. Fractions of a second have been determined by simple visual interpolation to the best of our ability. While not a highly precise method, it is capable of quite good accuracy when undertaken by an experienced observer. Provided that this point is kept in mind when interpreting the figures and graphs quoted, there should be no misunderstanding.

At the time of writing, the prototype has had quite a good and uninterrupted run of 31 days from 28th February, to 31st March. During this time we have made a daily check (except Saturday and Sunday) against the time signals from the Post Office transmissions at Lyndhurst. The results are given in the graphs, showing the indicated time for each day and the mean daily rate. The latter graph is really more important in telling the real story. Over this period, the clock gained 8.8 seconds. Actually, it showed 8.9 seconds but there was an uncorrected residual of 0.1 second at the start of the run.

The mean daily rate, spread over this period is very close to 284 milliseconds. Now the measure of the real performance of the clock is the amount of deviation in any one day from this mean daily rate. The worst case, as can be seen, is where the mean rate over one particular day, was 1100 milliseconds. This is a deviation of 1100-284, or about 816 milliseconds, departure from the overall mean daily rate.

Our study of the individual daily rates, points quite strongly to a relation to changes in ambient temperature. With the temperature fairly high, as would be expected at the beginning of March, the rate was very low indeed. When the temperature increased, a slight losing rate was observed. On the other hand, when a cool change occurred, the rate increased rather noticeably.

So far, so good. Many readers may consider this performance as being very good and adequate for their purpose. On the other hand, there will be some who consider these figures as being something which could be improved upon. Before going further, we hasten to reiterate that this unit is quite an unpretentious piece of equipment and "cesium beam" results could hardly be expected from it. Nevertheless, we agree that it may well be possible to improve on this performance, by making certain changes.

Perhaps one of the simplest possibilities would be to introduce some negative temperature compensation in-

DIGITAL READOUT CLOCK MOVEMENT

Illustrated at right is an interesting digital readout clock movement recently submitted for our inspection. Sold under the trademark "Tymeter," it is made by the Penn-wood Numechron Co. of Pittsburg 8, Pennsylvania, U.S.A. It was submitted to us by a New Zealand firm, R. H. Culpan Ltd., 163 Rodney Street, Wellsford, New Zealand. The unit shown is designated model STD-

24H, the 24H indicating a 24-hour movement. A number of other movements are available, including both 12 and 24-hour versions. Retail price in New Zealand for the STD-24H is quoted as \$38.95.

The unit is designated for 240V 50Hz operation and is rated at 3.4W. In spite of this last figure, which is roughly twice that of the power available from our Crystal Drive Unit, the clock started immediately and ran reliably when connected to it. The seconds presentation takes the form of a continuously moving drum, but all the other figures employ a "jump" movement.

While the digital presentation would present worthwhile advantages in certain situations, the relatively small "seconds" drum and close spacing of the calibrations makes it rather more difficult to interpolate fractions of a second, such as might be desired when assessing the deviation of a drive unit over 24 hours. On the other hand, the digital readout is a particularly convenient way of presenting the 24-hour time scale.

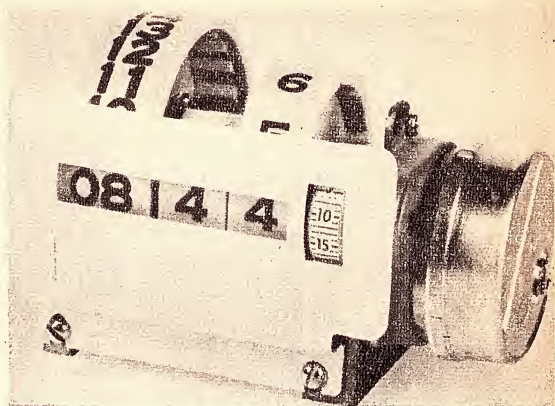

to the crystal oscillator circuit. There are two possible places where this could be tried. The 39pF NPO capacitor from the base of the first oscillator transistor, could be replaced with say, a 39pF N750 ceramic. This is a stab in the dark, in that this may give far more compensation than necessary. This can only be determined under actual running conditions, and where there is observed a marked change in ambient temperature. Should the compensation prove to be too much, then two capacitors could be used in parallel, one N750 and one an NPO, adding up to 39pF. The ratio would need to be selected so that close to optimum compensation was achieved.

The other possibility is to use an N750 capacitor, of 3.3pF, in series with the crystal. In any case, the ramifications are very wide and the best approach is to try certain amounts of compensation and observe the results. All this can be complicated by such other factors as the actual cut and temperature characteristics of the crystal being used, the influence of the two transistors, as well as other components and the operating voltages of the oscillator.

The crystal most likely to be used by readers is the +5°X cut. The temperature-frequency curve is parabolic, with a turnover point at about 47°C. Generally, this is satisfactory, as most crystals would be operated below this temperature and reasonably good compensation should be possible. The DT cut crystal has a similar shaped temperature-frequency curve but the turnover point can be controlled and set to any suitable temperature. This could mean that the crystal could be operat-

ed at about the temperature of the turnover point, where it is reasonably flat over a limited range. This would reduce temperature effects due to the crystal.

The GT cut crystal has a virtually flat temperature characteristic curve, over a very wide range. This means that the crystal is virtually immune to temperature changes and temperature effects would be reduced to other components in the oscillator. Unfortunately, the GT cut crystal is very expensive and not readily available in Australia. It should also be pointed out that the use of such a crystal in the circuit which we are using, would not be using it to best advantage. In short, an oscillator designed for GT cut crystals should be used.

Another alternative in the chase for high crystal frequency stability, is the old and proved oven principle. This is most effective and can lead to a high degree of stability. However, there are two points which cannot be overlooked. Firstly, an oven setup can be quite expensive. Secondly, there is naturally an extra power requirement for heating the oven. With a fixed installation, this need not be an obstacle, but it would have to be seriously considered before using it for mobile or other operation where batteries are used.

To sum up on the question of temperature problems, there appears to be a lot of scope for experimentation with the idea of using negative temperature coefficient capacitors. This could be a fascinating pursuit but it will necessarily require a great deal of long term patience and a well organised approach.

Electrical Simplification of Boolean Algebra Expressions

This simple device can be used to simplify Boolean Algebra Expressions, whether written using AND/OR notation or using the union/intersection notation of set mathematics.

by JOHN BODDINGTON

An article on a "Simplified Electric Brain" — the "Syllogizer" — was published in "Radio, Television and Hobbies," October, 1962. The syllogizer used several multi-pole rotary switches to perform the logical reasonings of the syllogism.

The same type of device can be used to simplify Boolean Algebra expressions, and this article describes a circuit which can simplify various expressions with two variables, X and Y, for example.

$$(\overline{X+Y}) \cdot (\overline{X \cdot Y}) = \overline{(X+Y)}$$

The expressions can be used in two senses: (i) as logic with true/false statements using the \cdot / $+$ (AND, OR)

notation; (ii) as set mathematics using the \cap (union intersection) notation. The two are mathematically identical (they are both Boolean Algebras) and differ only on the symbols used. In this article, the first system is used because it is the system applied in electronics (see "An Introduction to Digital Electronics," by Jamieson Rowe), but those who wish to use the device for set mathematics the alternative symbols are listed in the box below.

COMPUTER LOGIC		SET MATHEMATICS	
X, Y	True statements	X, Y	The sets (X) and (Y)
\cdot	AND	\cap	Intersection
$+$	OR	\cup	Union
\overline{X}	Complement of X	X'	Complement of X
1	Always true	\cup	Universal set
0	Always false	\emptyset	Empty set

- $(\overline{X+Y}) + (\overline{X+Y}) = (\overline{X+Y})$
- $(\overline{X+Y}) + (X+Y) = 1$
- $(\overline{X+Y}) + (\overline{X \cdot Y}) = (\overline{X \cdot Y})$
- $(\overline{X+Y}) + (X \cdot Y) = \text{No Simplification}$
- $(\overline{X+Y}) \cdot (\overline{X+Y}) = (\overline{X+Y})$
- $(\overline{X+Y}) \cdot (X+Y) = 0$
- $(\overline{X+Y}) \cdot (\overline{X \cdot Y}) = (\overline{X+Y})$
- $(\overline{X+Y}) \cdot (X \cdot Y) = 0$
- $(X+Y) + (\overline{X+Y}) = 1$
- $(X+Y) + (X+Y) = (X+Y)$
- $(X+Y) + (\overline{X \cdot Y}) = 1$
- $(X+Y) + (X \cdot Y) = (X+Y)$
- $(X+Y) \cdot (\overline{X+Y}) = 0$
- $(X+Y) \cdot (X+Y) = (X+Y)$
- $(X+Y) \cdot (\overline{X \cdot Y}) = \text{No Simplification}$
- $(X+Y) \cdot (X \cdot Y) = (X \cdot Y)$
- $(\overline{X \cdot Y}) + (\overline{X+Y}) = (\overline{X \cdot Y})$
- $(\overline{X \cdot Y}) + (X+Y) = 1$
- $(\overline{X \cdot Y}) + (\overline{X \cdot Y}) = (\overline{X \cdot Y})$
- $(\overline{X \cdot Y}) + (X \cdot Y) = 1$
- $(\overline{X \cdot Y}) \cdot (\overline{X+Y}) = (\overline{X+Y})$
- $(\overline{X \cdot Y}) \cdot (X+Y) = \text{No Simplification.}$
- $(\overline{X \cdot Y}) \cdot (\overline{X \cdot Y}) = (\overline{X \cdot Y})$
- $(\overline{X \cdot Y}) \cdot (X \cdot Y) = 0$
- $(X \cdot Y) + (\overline{X+Y}) = \text{No Simplification.}$
- $(X \cdot Y) + (X+Y) = (X+Y)$
- $(X \cdot Y) + (\overline{X \cdot Y}) = 1$
- $(X \cdot Y) + (X \cdot Y) = (X \cdot Y)$
- $(X \cdot Y) \cdot (\overline{X+Y}) = 0$
- $(X \cdot Y) \cdot (X+Y) = (X \cdot Y)$
- $(X \cdot Y) \cdot (\overline{X \cdot Y}) = 0$
- $(X \cdot Y) \cdot (X \cdot Y) = (X \cdot Y)$

- $\overline{X} + (X+Y) = 1$
- $X + (X+Y) = (X+Y)$
- $\overline{X} \cdot (X+Y) = (\overline{X} \cdot Y)$
- $X \cdot (X+Y) = X$
- $\overline{X} + (\overline{X+Y}) = \overline{X}$
- $X + (\overline{X+Y}) = (X+Y)$
- $\overline{X} \cdot (\overline{X+Y}) = (\overline{X+Y})$
- $X \cdot (\overline{X+Y}) = 0$
- $\overline{X} + (X \cdot Y) = (\overline{X} + Y)$
- $X + (X \cdot Y) = X$
- $\overline{X} \cdot (X \cdot Y) = 0$
- $X \cdot (X \cdot Y) = (X \cdot Y)$
- $\overline{X} + (\overline{X \cdot Y}) = (\overline{X \cdot Y})$
- $X + (\overline{X \cdot Y}) = 1$
- $\overline{X} \cdot (\overline{X \cdot Y}) = \overline{X}$
- $X \cdot (\overline{X \cdot Y}) = (X \cdot Y)$
- $\overline{Y} + (X+Y) = 1$
- $Y + (X+Y) = (X+Y)$
- $\overline{Y} \cdot (X+Y) = (X \cdot Y)$
- $Y \cdot (X+Y) = Y$
- $\overline{Y} + (\overline{X+Y}) = \overline{Y}$
- $Y + (\overline{X+Y}) = (\overline{X+Y})$
- $\overline{Y} \cdot (\overline{X+Y}) = (\overline{X+Y})$
- $Y \cdot (\overline{X+Y}) = 0$
- $\overline{Y} + (X \cdot Y) = (X+Y)$
- $Y + (X \cdot Y) = Y$
- $\overline{Y} \cdot (X \cdot Y) = 0$
- $Y \cdot (X \cdot Y) = (X \cdot Y)$
- $\overline{Y} + (\overline{X \cdot Y}) = (\overline{X \cdot Y})$
- $Y + (\overline{X \cdot Y}) = 1$
- $\overline{Y} \cdot (\overline{X \cdot Y}) = \overline{Y}$
- $Y \cdot (\overline{X \cdot Y}) = (\overline{X \cdot Y})$

Designing the circuit. Suppose we have a statement (or set) X. An expression may include the following forms involving X:

$$X + X, X \cdot X, \overline{X} + X, \overline{X} \cdot X$$

The simplification of these forms are, in order:

$$X, X, 1 \text{ and } 0.$$

A circuit can be made to demonstrate these simplifications using multi-pole rotary switches, see figure 1. The lower switch (circled) can be eliminated and replaced by a single wire since both sides of it lead to the same result. The complete circuit uses the same basic principles as this simple example. The circuit has been arranged so that an absolute minimum number of poles on each switch is used.

The expression forms which the device will simplify are:

$$(X \text{ or } Y) \text{ Complement or no complement} \quad + \quad (X \text{ or } Y) \text{ Complement or no complement}$$

In addition, the form on the left side may be replaced by a single X or a single Y. In most cases replacement

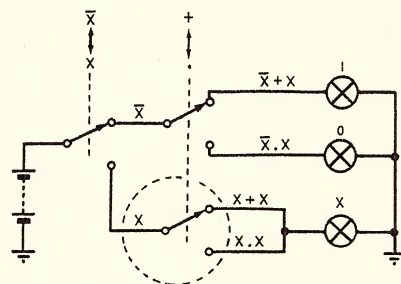
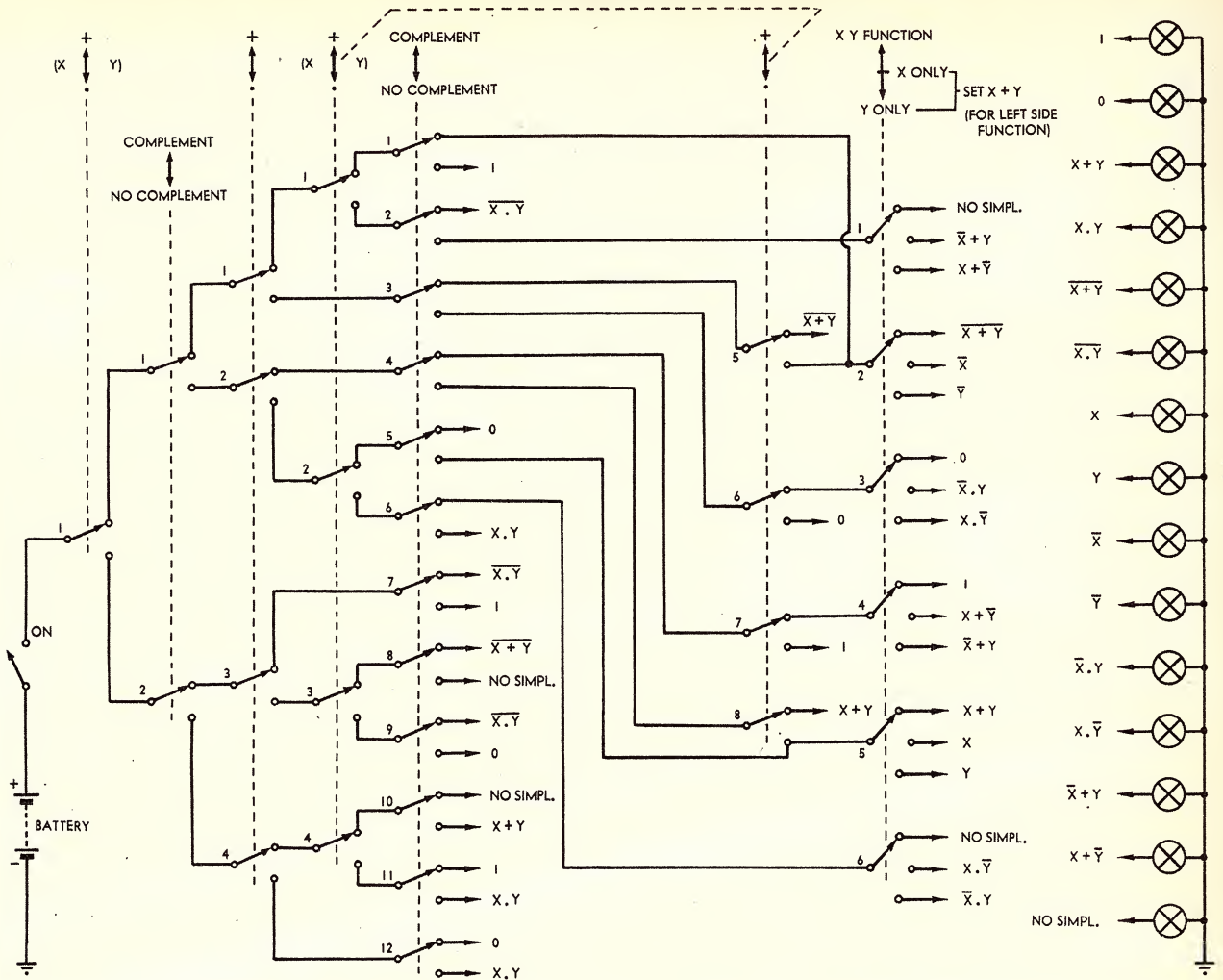

Figure 1. A circuit to demonstrate the simplification of simple expressions using multi-pole rotary switches.

The 64 expressions which can be selected — with their simplifications.



by a single X or a single Y results in the same simplification as $(X + Y)$ on the left side. For example:

$$\begin{aligned} (X + Y) + (X + Y) &= X + (X + Y) \\ &= Y + (X + Y) \\ &= (X + Y) \end{aligned}$$

The circuit design takes advantage of this fact. Therefore, in operating the device for a single X (or Y) the left side must be set at $(X + Y)$.

In all, 64 possible expression forms can be selected. These are listed separately, along with their simplifications.

for checking the device. The expression selected is set up on the switches and, when the power is turned on, the light indicating the simplification glows. There are 15 output bulbs as follows:

1	$\bar{X}.\bar{Y}$	$\bar{X}.Y$
0	X	$X.\bar{Y}$
$X + Y$	Y	$\bar{X} + Y$
$X.Y$	\bar{X}	$X + \bar{Y}$
$\overline{X + Y}$	\bar{Y}	No Simplification

PARTS LIST

- 1 on/off switch.
- 1 rotary switch, 1 pole, 2 pos.
- 1 rotary switch, 2 pole, 2 pos.
- 1 rotary switch, 4 pole, 2 pos.
- 1 rotary switch, 8 pole, 2 pos.
- 1 rotary switch, 12 pole, 2 pos.
- 1 rotary switch, 6 pole, 3 pos.
- 15 light bulbs and sockets.
- 1 battery (to suit bulbs).
- 6 indicator knobs.
- 1 suitable case or board for mounting.

The circuit. For simplicity the output bulbs are shown separately in the circuit. As each branch of the circuit tree terminates, the output bulb it leads to should be noted. A wire must then be connected from that point to the appropriate bulb. A common return leads from the other side of each bulb back to the battery, thus completing the circuit.

The poles on each multi-pole switch are numbered to assist in wiring. This also helps to clarify the unusual arrangement of the circuit for the right hand AND/OR switch which has some poles drawn separately (but linked by a dashed line). This arrangement was evolved in the process of minimizing the number of poles.

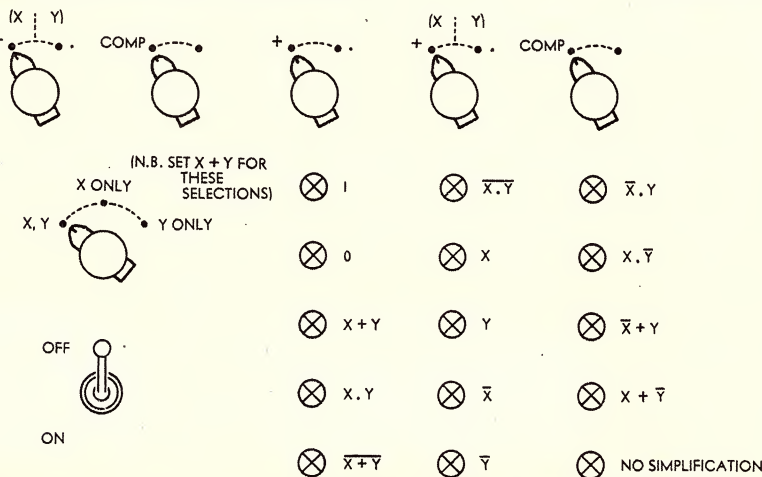

The panel layout of the device. The main function switches perform either AND/OR or COMPLEMENT/NO COMPLEMENT functions, as indicated.

180 WATT SOLID STATE STEREO AMPLIFIER

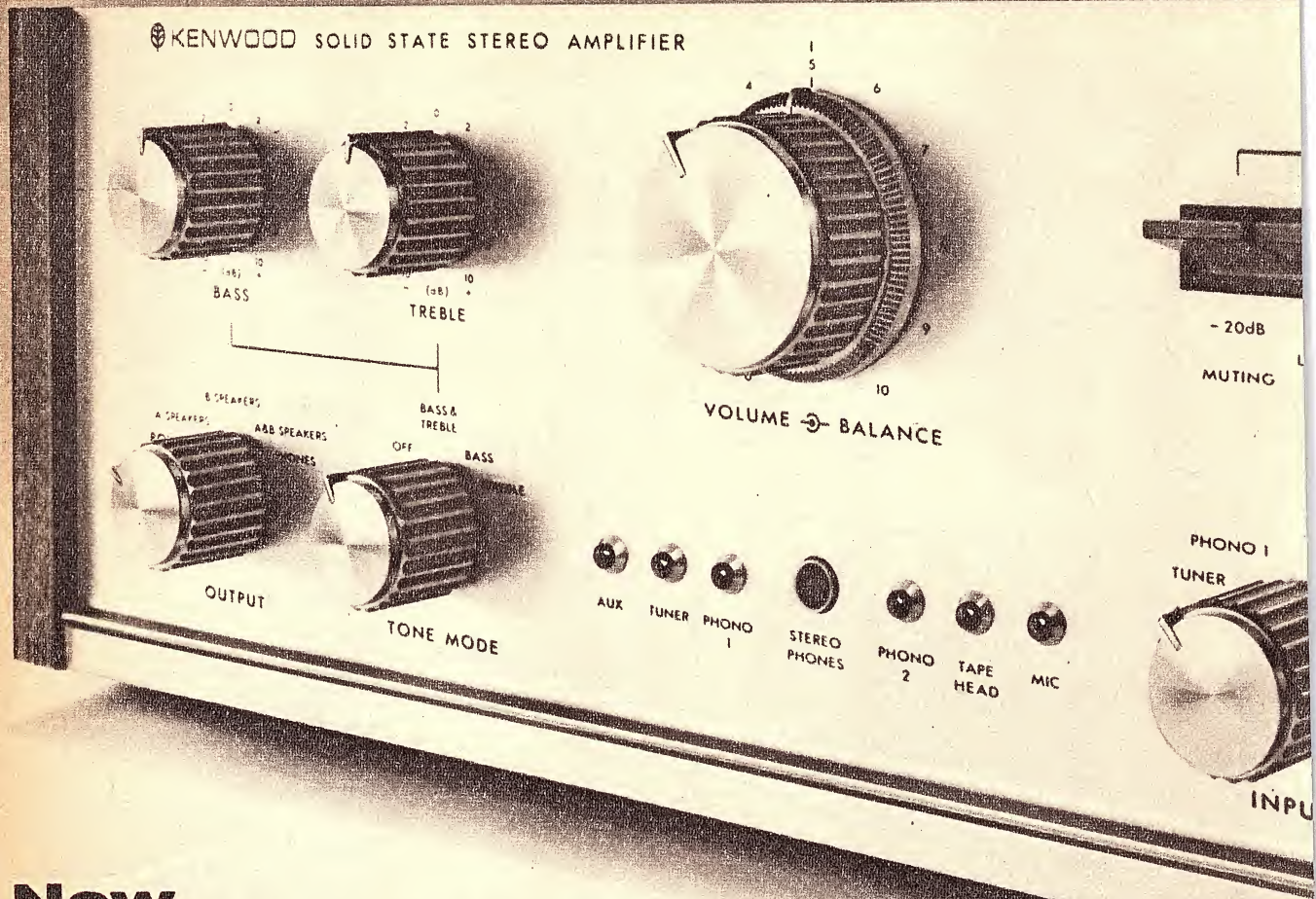

New KENWOOD's KA-6000 The Musical Powerhouse For Maximum Perfection

You don't have to look elsewhere—KENWOOD's KA-6000 180-watt solid state stereo amplifier has all the power you need for maximum perfection.

It has more than enough power to drive even Hi-Fi speakers of low efficiency.

With its wide power bandwidth of 10Hz to 50,000Hz there is low-low IM distortion.

The KENWOOD exclusive low level phono inputs for low level output phono cartridges of 2mV, 0.5mV or 0.05mV.

There are many other outstanding features in the KA-6000—all the results of high quality engineering—but the final test is in performance. Stop in at your KENWOOD dealer for a KA-6000 demonstration.

Remember, KENWOOD also has other amplifiers with less power.

There's a KENWOOD for every stereo need.

SOLE AGENT: Jacoby, Mitchell & Co., Pty., Ltd. Head Office: 469-475 Kent Street, Sydney Tel: 26-2651 Melbourne: 15 Abbotsford Street Tel: 30-2491 Brisbane: 56 Edward Street Tel: 2-6467 Adelaide: Truscott Electronics, 64 Hindmarsh Square Tel: 23-3024 Perth: United Australia Co., Pty., Ltd., 435 Hay Street, Subiaco Tel: 8-4665 Tasmania: K.W. McCulloch Pty., Ltd., 57 George Street, Louceston Tel: 25-322

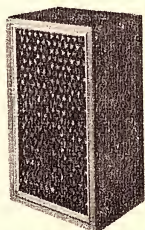

BOOKSHELF TYPE 4-WAY 5 SPEAKER SYSTEM KL-660

- * Mounted speakers: 12-inch, free-edge woofer × 1 (Bass)
- 6½ inch cone squawker × 1 (lower midrange)
- 4 inch cone squawker × 1 (higher midrange)
- Horn-type tweeter × 2 (Treble)
- * Dimensions: 15" (W), 25½" (H), 11½" (D)

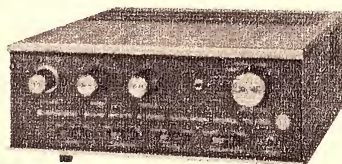

40 WATT SOLID STATE STEREO AMPLIFIER TK-150U

- * 5 pairs of input terminals for MAG, AUX 1, AUX 2, TAPE REC and TAPE PLAY.
- * Damping factor: 40 (at 16ohms), 20 (at 8ohms)
- * Dimensions: 10½" (W), 4½" (H), 9½" (D).

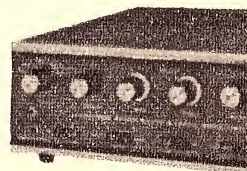

60 WATT SOLID STATE STEREO AMPLIFIER TK-250U

- * 2 sets of stereo speaker terminal at front panel, speaker selector switch
- * Dimensions: 13" (W), 4½" (H), 9½" (D).

KA-6000

MODEL KA-6000

NORMAL

40Hz
80Hz
LOW
FILTER

8KHz
HIGH
FILTER

MODE

TAPE

STEREO
REV

STEREO

LEFT

RIGHT

MIX

MODE / TAPE MONITOR

the sound approach to quality



KENWOOD

TRIO ELECTRONICS, INC.

6-5, 1-CHOME, SHIBUYA, SHIBUYA-KU, TOKYO, JAPAN

Ask for a catalogue or demonstration by your nearest dealer.

To: Jacoby Mitchell & Co., Pty., Ltd. EA
469-475 Kent St., Sydney.

Send me information on KENWOOD RECEIVER, AMPLIFIERS, SPEAKERS & name of nearest KENWOOD retailer,

NAME: _____ AGE: _____

ADDRESS: _____

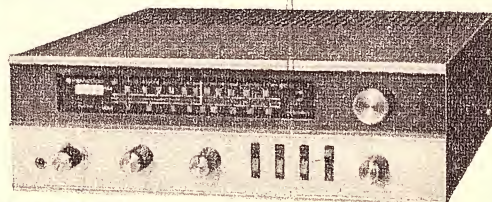

**30 WATT
PET SOLID STATE AM/FM
STEREO RECEIVER TK-20U**

* F.E.T. (Field Effect Transistor) 3 Gang Tuning Condenser
frontend for superior sensitivity, image rejection and
cross modulation ratio.

* Dimensions: 14 1/8" (W), 4 3/4" (H), 11 1/2" (D)



FORUM

"Jet Sound" and how to produce it

An enquiry in the May issue about "Jet sound" as exploited by certain pop groups has produced a number of letters from readers explaining what the sound is and the means that are adopted to obtain it. We publish the letters for the interest of readers who may be keen to "get with it."

Conducted by the Editor

When the original inquiry came to hand, we had to plead ignorance, doubtless to the disgust of our teenage readers. However, now that the meaning of the term has been explained, we are in a better position to comment. But first the letters:

THREE RECORDERS: "The sound which D.G.O. is referring to is not produced by an electronic circuit at all and—bad news for small groups—cannot be reproduced 'live.'"

"Jet sound is a special effect produced by recording engineers. To produce the 'Jet' or 'phase-splitting' effect you have to start with suitable material on which to operate. You need three recorders and a keen sense of accuracy. It is an easy effect to produce but a very hard one to control.

"First, the music to be treated is laid down either by a single performance (most common with small groups) or by combining multiple performances.

"After the material has been taped on, say, recorder number 1, it is copied on to recorder number 2, exactly as originally recorded. The outputs of both these machines are then paralleled, ready to feed to recorder number 3. Recorders number 1 and 2 must be able to be started together and replay at exactly the same speed at which they originally recorded, note for note.

"With recorders 1 and 2 in the 'play' mode and number 3 recording, the effect is produced by letting the finger of one hand touch the supply reel of recorder 1 or 2 very gently. This will perceptibly slow the particular machine and pull the sound progressively out of phase, the number 3 recorder picking up the combined sound with the gradually changing phase.

"Care must be exercised not to press the reel too hard or for too long, or the phase delay will become excessive and a straight echo will result. The time difference involved is only a matter of thousands of a second.

"To restore the phase relationship,

the reel of the other machine is touched. It can be imagined how difficult this is to control.

"Other names for the effect are 'sound slurring,' 'synchronised differentiation' and 'Skying.'

"I have described one method of producing the effect. Others include manually twisting the tape of a stereo machine on the record/playback head, and a manual linkage added to an existing recorder. This last method offers a superb control over the effect but is expensive and troublesome to install on some machines.

"For sheer exaggeration of the effect, listen to 'Big Hurt' by Del Shannon." B.D. (Concord, N.S.W.)

At right, the method suggested by R. L., involving use of an extra head and track. If the erase head was not arranged to scan both tracks, a clean tape would have to be used. Below, the method suggested by G. K. The behaviour would obviously vary with the width of the scanning gap and its position on the tape.

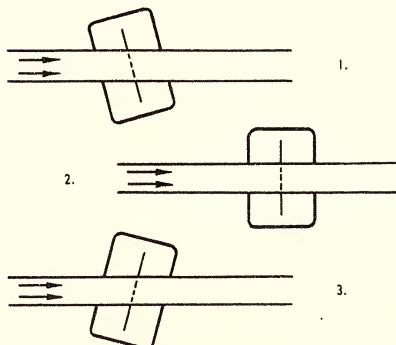
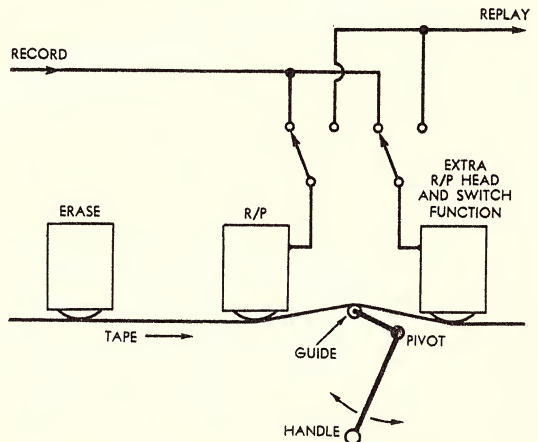

TWO HEADS: "The device under discussion is loosely called a 'phaser' and, in a sense does to audio what atmospheric and ionospheric layers do to long distance radio transmissions. The audio signal is fed into two channels then subsequently re-combined after a substantial and variable phase difference has been introduced by means of a time delay circuit.

"One method of accomplishing this is to use a tape recorder with second record/play head either mounted 'upside down' or arranged to record and replay one track lower than the first.

The two heads are mounted about an inch apart.

"The signal to be recorded is fed to both heads but the length of the tape between the heads is continually varied by manipulating the position of an extra tape guide or roller between the heads, as illustrated in the accompanying sketch.

"When the tape is replayed on the same machine, with the output from the two heads combined and used to feed an amplifier system, the effect of the manipulation becomes evident and is heard as the desired sound. The fastest speed and the shortest distance between the two heads should be used, otherwise the effect tends to turn into an echo.

"I have heard that there are circuits involving transistorised flip-flops, preamplifiers, etc., but, although I have never seen or heard one, I would expect the simplest to be ineffective and the most effective to be far too complex for construction by a homebuilder.

"I would certainly like to see you come up with the circuit for a device which would produce this effect 'live' on stage."

R.L. (Highgate, S.A.)

TOO MANY DISCS OFF CENTRE

TILTING HEAD: "I have made a brief study of jet-sound which is called 'phasing' by most people in the business.

"It can be generated by various methods but all of them relate to tape and tape heads. The sound can be compared with the fading-out and coming-in sounds of overseas radio transmissions and involves a Doppler shift in the phase of the signal.

"For example, it can be done by slowly moving a replay head in and out of azimuth while a tape, with signal already recorded, is running over it, as illustrated.

"In condition 1, signals reach the gap first at the top. At 2, all arrive at the head at the same instant. At 3, the condition is the reverse of 1. As the head is rocked back and forth, it produces a hiss, like the sound of a jet take-off, until the head is aligned. The same thing happens in reverse as the head is taken through the other extreme.

"This is one method of achieving a Doppler phase shift. Others are available, generally more complex. It is essential, however, to keep wow and flutter to a minimum while phasing.

"If anybody wants to try out the effect, it can be made to work sufficiently well for purposes of illustration by manipulating a replay head held carefully in the hand.

"As yet, I do not know of any electrical methods which will achieve the same effect as I imagine it would be difficult to obtain sufficient time delay to gain the desired effect."

G.K. (Vaucluse, N.S.W.)

COMPLEX TONES ONLY: "Most pop music is composed of harsh, peaky waveforms and it is on this harshness that the phasing effect largely depends. Depending on the relationship of the two sources, the waveforms cancel or add, creating a "whooshing" sound, completely changing the sound of a singer or an instrument and, most noticeably, of cymbals.

"An interesting aspect of the trick is that it can create a sustaining effect on certain notes, usually those of lower frequency, but only on complex tones. It will not work on sine or near-sine waveforms.

"As far as I know, the effect has not been created successfully, live. At present I am working on a phase-shift amplifier system, the audio being fed through two paths, one straight and the other through a capacitor/resistor variable delay network. Although an effect can be observed on a C.R.O., the time constant is not long enough to be audibly evident."

K. T. (Bayswater, W.A.).

COMMENT: Well now we all know. In terms of electrical and acoustical quantities, "jet sound" falls somewhere between vibrato and echo, though its effect is quite different from either.

It involves a Doppler frequency or phase change which could variously be compared and contrasted with electronic or Leslie-type vibrato, but with a time function approaching that involved in reverberation. And herein lies the core of the problem, as related to obtaining jet sound live on stage.

No one has yet been able to come up with practical electronic circuitry which will delay audio signals by a time interval which is significant in the

"My attention has been drawn to a letter published some time ago in 'Forum' (October, 1968), in which your correspondent complained about off-centre gramophone records.

"I have had relatively little experience of Australian pressings and it may be that more quality control is practised here than elsewhere. As far as overseas pressings are concerned, my experience has been entirely in line with your correspondent's remarks about wow in 5 per cent to 10 per cent of records.

"The incidence of this fault bears no obvious relation to the cost of the record. I have met it as much in the full-priced discs from the best-reputed sources, as from others. It may be more expensive to eliminate such random faults in mass-production than your correspondent imagines, but I agree with him that there is no reason why we should accept this fault 'philosophically,' as you appear to do.

"Such records are not fit for the purpose for which they are sold and both purchaser and retailer should be encouraged to ask for a replacement. I believe that few manufacturers would make any bones about providing one.

"The question was raised as to whether this fault bothers other people. Judging by the prevailing indifference to the extremes of wow often met in film soundtracks, I would guess that most people are conditioned to accept this as a 'natural' part of the unreality of canned music. Evidently, they are not agonised by it, as a minority of us are. Nevertheless, elimination of this fault should have a high priority in any pretensions to high-fidelity reproduction, particularly where piano and organ are concerned.

"Personally, I am not convinced that the gramophone record is a satisfactory medium in this respect for pitch-sensitive ears and a bit of elementary arithmetic has confirmed my suspicions.

"L.P. discs are commonly recorded to within 2 $\frac{1}{2}$ in of the centre. Both turntable spindles and record centre-holes vary somewhat in size but, even in favourable conditions, one surely has to reckon with .0025in clearance between the two. If so, this alone, regardless of fluctuations in the recording groove itself or in the turntable,

could contribute 0.1 per cent wow in the inner grooves.

"Little wonder that many of us find 15ips original tape-recordings of the piano or organ (in which combined record/replay fluctuations can be kept within 0.1 per cent peak to peak) more consistently natural than any commercial disc. Since faulty records are often off-centre by well over 1/32in, we have to reckon in such cases with a wow of the order of 1.0 per cent. In the face of this, the quoting of percentage of wow in turntables is certainly 'little more than a giggle.'

"There is surely too much complacency about the prevailing standards of high-fidelity reproduction. No doubt, much progress has been made in recent years, as in a few aspects of top-class (and top-price) equipment, notably gramophone pickups. But, in some respects, popular standards have been drastically lowered.

"The fact that some manufacturers of international reputation do not dare to quote distortion figures for their amplifiers at the inflated power ratings they now advertise may not be important in itself. But it is surely symptomatic. Does not the vast majority of transistor power amplifiers, sold in the past five years, compare most unfavourably with modest push-pull pentode output designs of 10 years ago, for distortion at average program levels?

"You mentioned in the same 'Forum' indifference of many professional musicians to 'high-fidelity' reproduction. No doubt, this is partly explained, as you suggested, by their ability to remember the reality of live performance, regardless of the quality of the stimulus. But I believe that many are repelled by the unnatural high-frequency distortion and peakiness of response so often heard in demonstrations of high-fidelity equipment.

"Perhaps they are judging (quite correctly) that this is less NATURAL than the restricted response but smooth roll-off of many modest machines of 10 years ago. In my experience, professional musicians are delighted by true high-fidelity reproduction, as distinct from the fuzzy sound, mis-called 'hi-fi'. But the genuine article remains expensive and its installation calls for expert supervision, which too few retailers can provide. G.N. (Clayton, Vic.)

audio sense. Manufacturers of electronic musical instruments have been on the lookout for years for such a device, to simplify the creation of synthetic echo and reverberation. Public address operators could use it to phase reinforced and more direct sound in large buildings, and it would have application in recording studios and broadcast stations as well.

However, the simple fact is that all audio delay systems contrived to date have had to rely on an acoustic or mechanical link—an echo chamber, an acoustic transmission line, an echo plate or spring system, or a tape link, to provide the delay needed.

While jet sound does not appear to require a delay time as long as that for

reverberation and echo, it is still long enough to be well beyond what can be accomplished electronically—and therefore beyond the circuitry used for vibrato (as discussed in our March issue).

It also apparently relies on the ability to sweep the phase relationship smoothly between limits, at will, and this would appear to militate against ideas of sampling tappings along an acoustic delay line. This is not to say that it can't be done or that it would not produce an acoustically interesting effect. But it doesn't look too promising.

So, we have the tape systems referred to by our correspondents in letters which, happily, are complemen-

Some electronics engineers say Willi Studer is a genius.



The new REVOX A77 is certainly a fine tribute to his rare talents.

Since its recent release the Revox A77 stereo tape deck has been acclaimed by professionals and tape enthusiasts all over the world. Read this excerpt from a recent review in "Hi-Fi Sound" . . .

"This recorder is a masterpiece of electronic and mechanical engineering . . ." "The electronic function and motor control system certainly sets a new standard in deck design and performance which, coupled with the really high fidelity electronic performance, puts this new range of REVOX recorders in the connoisseur class."

What will your New Revox A77 do for you?

You will make and replay tapes to professional standards—many REVOX recorders are used for precisely this purpose. Every desirable facility is there — sound-on-sound, multi-play, echo, on-off tape monitoring, playback to both European and American equalisation standards. Add to these features calibrated VU meters, electronic speed change for the two tape speeds of $7\frac{1}{2}$ and $3\frac{3}{4}$ i.p.s., 3 motor tape transport system, use of silicon planar transistors . . . and you get a frequency response of 30-20,000

Hz. +2, -3 dB at $7\frac{1}{2}$ i.p.s., a signal-to-noise figure of better than 58 dB, and a wow and flutter figure of a maximum 0.08% at $7\frac{1}{2}$ i.p.s. Space does not permit detailing of the complete specifications of the REVOX A77. Unabridged data is available now. The REVOX A77 stereo tape deck is on continuous demonstration!

Ask for a trade-in valuation on your old equipment, or, if you cannot come to town, ask for your personal EMQ*. You'll save more *and more* at Encel Electronics! Call or write now!

*Encel Mail Quote.

ENCEL
ELECTRONICS (STEREO)
PTY. LTD.

Head Office:
431 Bridge Rd., Richmond, Victoria 3121. Tel. 42 3762.

Australia's Greatest Hi-Fi Centre • Wholesalers • Trade-ins accepted

FOUR HIGH QUALITY MICROPHONES FOR USE WITH THE REVOX A-77 TAPE RECORDER

LONDON LM-100
An omni-directional dynamic dual impedance microphone with a response of 50-15,000 Hz. An ideal general purpose unit — robust and designed to withstand studio or field use. Ask for complete specifications. Encel price inc. sales tax **\$9.75**



LONDON MODEL LM-200
A dynamic cardioid dual impedance microphone with balanced output and a frequency response of 50-15,000 Hz. Discrimination at 180° eliminates unwanted background noise. Natural recordings are possible even under unfavourable acoustic conditions. Weight is only 4½ ozs. including the cable. Ask for complete specifications. Encel price inc. sales tax **\$16.85**

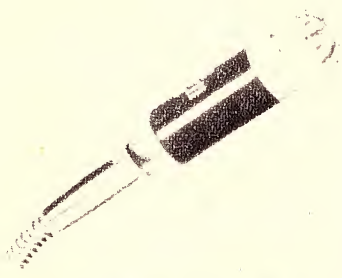

SWEDISH PML MICROPHONES MODEL RD-36
Probably the most popular of the PML range is the Model RD-36, a dynamic cardioid dual impedance microphone with a frequency response of 30-20,000 Hz. This slender microphone is recommended for high quality sound recording; even under the most unfavourable conditions it solves problems arising from feedback and background noise. Ask for complete details. Encel price inc. sales tax **\$47.00**

NEW PML CONDENSER MICROPHONE MODEL EC-71 — ONLY \$102.
A now solid state miniature cardioid condenser microphone with a frequency response of 40-18,000 Hz. Weight is only 1½ ozs. and size only 2-11/16" x 1-1/16". The PML EC-71 is used by many professionals, and is ideal for use with the Revox A77 tape deck. Encel price includes the power supply **\$102.00**

Encel

ELECTRONICS (STEREO) PTY. LTD.

Head Office:
431 Bridge Rd., Richmond, Victoria 3121.
Tel. 42 3762.
Sydney Store: Ground Floor, BSM Building,
257 Clarence Street, Sydney, N.S.W. 2000.
Tel. 29 4563, 29 4564
*Wholesalers *Trade-ins accepted
Australia's Greatest Hi-Fi Centre

tary in their content. If you have the equipment, the incentive and the initiative, you can use one or other of these methods, not only to modify the recorded sound of your own group, but to make other recordings sound quite different from what the original artists ever intended. Nor do you have to stop at pop.

Electronic musicians have just produced "Switched On Bach" (May issue pages 119, 127) so why not "Shoo-Shoo-Schubert" or "Fancy Phase Franck"?

Changing the subject, the letter set out on the previous page is from a Victorian correspondent who feels that far too many disc records contain a discernible amount of wow. He goes so far as to suggest that some wow is almost inevitable, by reason of the fit tolerance between the centre hole in the record and the turntable spindle. I suggest you read the letter carefully and, if so inspired, submit your own observations, in agreement or otherwise.

COMMENT: Unless I miss my guess, G.N. picked up the idea that we accepted recording faults philosophically from the original correspondent in the October, 1968, issue who used this phraseology.

Over and above a couple of practical issues, my own comment was to query the estimate of 5-10 per cent of discs as being faulty, suggesting that I, personally, had noted the effect only on the occasional record. The proportion would have been nothing like 1 in 20 or 1 in 10. When a record like this turns up I would regard it as a positive fault and the fact would be noted in the review of that record, to warn prospective buyers. This is a far cry from accepting wow "philosophically."

It must be admitted, of course, that sensitivity to wow is a highly subjective matter. If, after having gone through a statistically valid sample of the discs on hand, G.N. insists that he can hear annoying wow in 5-10 per cent of them, no one can possibly contradict him.

However, if it should transpire that his sensitivity is unique or completely unrepresentative of consumers generally, one could hardly expect recording companies to be over-keen to meet those requirements or to abandon the disc system altogether.

To say this is not to stretch the sense of G.N.'s letter, for he does speculate whether "the gramophone record is a satisfactory medium in this respect for pitch sensitive ears." (Or as pitch sensitive as G.N.'s ears would appear to be.)

In view of the current huge-volume sales of records to apparently satisfied customers, it might be difficult to convince record manufacturers that they are turning out a technically unsound product.

They might also speculate as to how G.N. can still enjoy 90-95 per cent of their products, if his spindle and hole observations are valid.

Indeed, one might have to question whether any practical and marketable medium would come up to G.N.'s requirements. An original 15ips tape recording may be superb indeed but it is a completely non-commercial item.

Add the high-speed copying and the generations that have to be accepted

before the marketable tape product emerges and haggle about the price of the ultimate replay equipment, and one is left with a result which may equally fail to satisfy critical ears.

One point in the letter does intrigue me somewhat, namely the reference to the problem of wow in respect to the reproduction of piano and organ music.

Piano music, yes! If one wants to check disc or tape reproducers for wow, in terms of practical music reproduction, listen to a piano recording which contains sustained tones.

But a grand organ is so unprecise in terms of pitch and so characterised by free-phase components, producing slow beats, that I have not regarded it is anywhere near as sensitive an indicator to wow effects as a piano. In fact, one of the tricks which designers of electronic organs use, to give them a "pipe-like" quality, is to introduce a frequency modulation component by means of a slowly rotating Leslie loudspeaker system.

One thing I have noticed about acoustic organ recordings is a tendency for die-away chords to sound flat. The fact that they sound flat rather than sharp on occasions, or undulating, has led me to believe that the effect is not wow (for which it could readily be mistaken) but rather an impression based on the way in which complex mixtures progressively die away in a large, reverberant building — high frequencies first.

It would be interesting to hear further comment on this point.

Finally, I am not impressed by G.N.'s summary of what has happened in the field of sound reproduction. I would be prepared to argue that cartridges, pickup arms and motors have improved AT ALL LEVELS over the past decade. Records other than "quickie" pops have certainly not regressed. My impression is that amplifier manufacturers generally have shown a keen awareness of distortion figures and DO publish them. There is room for suspicion that the performance of some amplifiers at playing level falls below the high-level performance but let's remember that the distortion could multiply three or four times and still be below one-half per cent!

CITIZEN BAND: "I have just finished reading that hilariously funny letter on page 71 of the March issue. from A.L. (Stratford, N.Z.)

"Shades of 'Star Trek' and Mr Spock! Where does A.L. get his science fiction receiver from? Apparently it automatically not only identifies a dead carrier on 27MHz as belonging to a CB'er, but also that the owner of the offending equipment is a member of a particular club.

"Seriously, let's get the record straight:

"(a) 27MHz is not a CB frequency in New Zealand.

"(b) The regulation on an external CB antenna states simply 'Not more than 10 feet in length and fed by a non-radiating line'. Groundplanes are perfectly legal.

"(c) On the citizen band, CQ is a 'mayday' call and I would need more proof than the word of A.L. that its use is extensive.

"(d) CB'ers do not call themselves
(Continued on page 177)

Electronic Technicians Earn Big Money!

Why not YOU?

With training through T.T.I., you could qualify for a start in the Electronics Industry as a:

- Radio-television technician • Telecommunications technician • Instrumentation technician • Business machine technician • Automatic control technician • Industrial electronic technician—and many other skilled positions.

WILL YOU FILL THE BILL WHEN THE TIME COMES?

The "good job" you hold down today may offer less and less opportunity for advancement as Electronics increase their impact on all branches of industry.

TECHNICAL TRAINING INTERNATIONAL, a world-wide company with 30 years' experience in the field of specialised technical training, offers the latest Electronics training programmes available in Australia.

GAIN FULL PRACTICAL EXPERIENCE BY BUILDING YOUR OWN LABORATORY AT HOME. With T.T.I. training you build over 100 circuit-proving projects. In addition, you actually construct the professional test equipment illustrated here.

IF YOU ARE BETWEEN 18 AND 45 YEARS, AND EARNING LESS THAN \$80 PER WEEK . . . IF YOU ARE SERIOUSLY INTERESTED IN TRAINING FOR A CAREER IN ELECTRONICS, FILL IN THIS COUPON FOR FURTHER INFORMATION, WITHOUT OBLIGATION.



To: Technical Training International Pty. Ltd.
P.O. Box 328 Chatswood, N.S.W. 2067.

Please tell me more about T.T.I. Electronics Training, without obligation to me.

Name _____

Address _____

Age _____ Present occupation _____

T.T.I.—The industry-approved Technical Training Organisation. EA/K

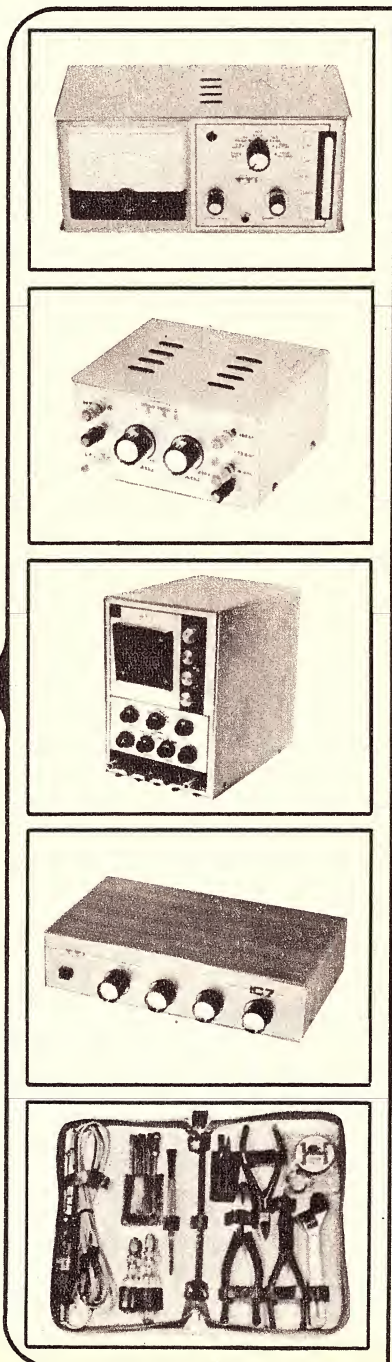

Fundamentals of SOLID STATE

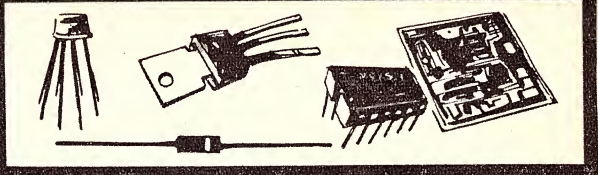

Chapter 3

by Jamieson Rowe

Doping and impurity semiconductors—donor impurities and N-type impurity semiconductor—majority and minority carriers—doping concentration and its effects—acceptor impurities and P-type impurity semiconductor—resistivity and excitation—Fermi level and the Fermi-Dirac distribution—compensation.

As we have seen, electrical conduction cannot take place in intrinsic semiconductor materials such as pure silicon and germanium when they are in the ground state, because of the completely filled valence band. However excitation of the crystal lattice results in the production of electron-hole pairs, of which the electrons become available as negative current carriers moving in the conduction bands, and the holes become available as positive current carriers moving in the valence band.

Increasing the excitation of the lattice, by raising its temperature, for example, thus causes the conductivity of such materials to increase. Or looked at in another way, their resistivity falls. At room temperature their resistivity has typically fallen to a value which, while quite high compared with metallic conductors, is still low compared with an insulator such as diamond.

Actually semiconductors such as silicon and germanium only exhibit this so-called **intrinsic behaviour** when they are extremely pure—something like 99.9999999% pure, in fact, with any other elements present in the crystal lattice as “impurities” kept to less than one part in 10^9 . Even microscopic amounts of certain impurities can radically alter their electrical behaviour, and in different ways.

From this may be judged the degree of precision which has been evolved by modern semiconductor technology, which is not only concerned initially with the controlled alteration of their pure materials such as silicon and germanium, but also and consequently with the controlled alteration of their electrical behaviour to an accurate extent. The latter technique, which is known as **doping**, involves the addition of precise microscopic quantities of selected impurities. Typical concentrations range from a few parts in 10^9 to a few parts in 10^7 .

As we shall see, the presence of impurities in a semiconductor results in the availability, under normal conditions, of many more current carriers than are available in an intrinsic semiconductor. As a result the resistivity

of such an **impurity semiconductor** is typically considerably lower than that of an intrinsic semiconductor, while the influence of temperature and other forms of excitation is less pronounced—again under normal conditions. As figure 3.1 shows, the resistivity is still infinite for zero excitation (the ground state), and still drops proportional to excitation at very high levels; but at moderate excitation levels there is a “plateau” not present in the characteristic of an intrinsic semiconductor.

Although all impurities tend to alter

electrons, of which both silicon and germanium atoms have four. Each atom in the lattice is bound to its four neighbouring atoms by a so-called “covalent” bond, involving one valence electron of each atom in a common “shared pair” orbit. A simplified two dimensional representation of this was given previously in figure 2.7.

When atoms of elements such as phosphorus, arsenic, antimony or bismuth are present as impurities in such a crystal lattice, they are for the most part incorporated into the lattice structure in a simple “replacement” or substitutional manner. Four of their valence electrons are engaged in covalent bonds with the neighbouring “host” atoms, so that in this respect an impurity atom is quite equivalent to a host atom.

Of course an impurity atom cannot be fully equivalent to a host atom, because it will have both a different nucleus mass and positive charge, and

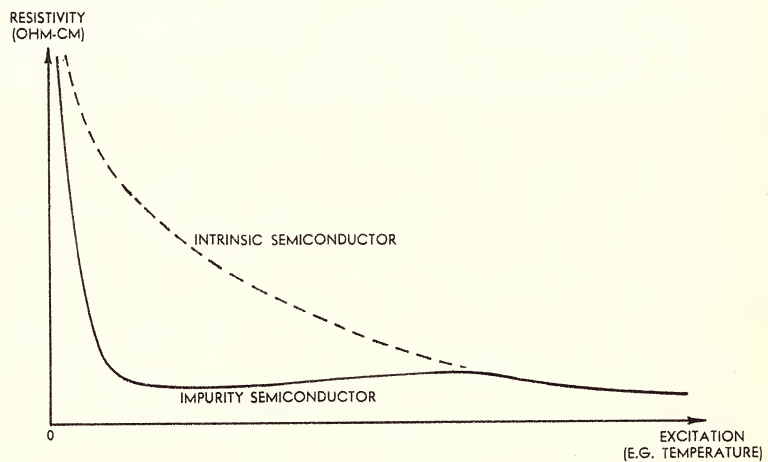

Figure 3.1

the broad electrical behaviour of a semiconductor in this fashion, there are in fact two different and somewhat complementary mechanisms by which this can occur. Each mechanism is associated with a particular group of impurity elements, so that when used for doping the elements of the two groups produce two different “types” of impurity semiconductor material. The differences between these two types of impurity semiconductor are vital for the operation of virtually all semiconductor devices, so that we should now examine each in turn.

We have seen that the atoms of a silicon or germanium crystal lattice are bound together by the valence

a correspondingly different number of surrounding electrons. The latter is of particular importance because in the case of phosphorus, arsenic, antimony and bismuth there are in fact **five valence electrons**, one more than is present in silicon or germanium.

Because of this, when an atom of these elements is present as an impurity in a silicon or germanium crystal lattice there is one valence electron “left over” after the atom has engaged itself in covalent bonds with its neighbours. This is illustrated in figure 3.2, where the “left over” fifth electron is shown occupying an orbit surrounding its parent phosphorus nucleus in a silicon lattice.

B.W.D. OFFERS "EXCEPTIONAL TRIGGER STABILITY, HIGH SENSITIVITY WITH WIDE BANDWIDTH"!

STOP PRESS!
10 MHz 5mV

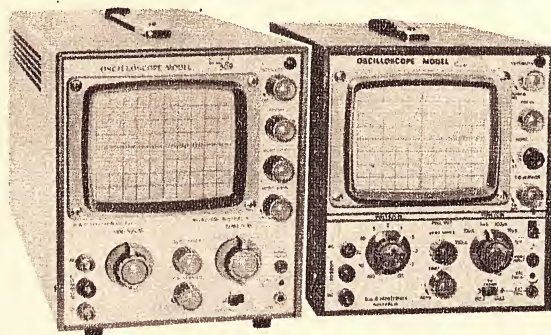

Model bwd 509

Model bwd 505A

\$220.00 \$289.00

List price plus sales tax (if applicable)

These two 5" oscilloscopes, from the wide range of B.W.D. electronic test instruments, are outstanding value for money. The reason? B.W.D. instruments offer top quality engineering and unbeatable performance at prices below those of comparable imported makes. Remember! No duty is applicable to Australian-made instruments. Send for technical data sheets and check for yourself, what the B.W.D. boys are offering. They're leaders in Australian Electronic Instrumentation.

Send for technical data sheets

Phone, write, or call:
B.W.D. ELECTRONICS PTY. LTD.
331-333 Burke Road, Gardiner, Victoria, 3146.
Telephone: 25 4425
127 Blues Point Road, North Sydney, N.S.W. 2060.
Telephone: 929 7452



bwd 3

Homecrafts FOR RADIO PARTS 289 Elizabeth St. Melbourne. Phone 60 1442

<p>PIEZO PICK-UP AND CARTRIDGES</p> <p>PU-86 Pickup LP/78 T/O Crystal cartridge. Length 240mm Ea. \$2.95 Y700 Ceramic Cartridge. Mon. LP/78 . \$2.50 PU-86 Pick-up Ster-LP/78. T/O Cartridge. Length 204mm Ea. \$4.00 Y200 Ceramic Cartridge. ST LP/78 . . \$3.40 Y400 Crystal Cartridge. LP/45 \$1.90 Y130 Crystal Cartridge. T/O Type Ster/LP Ea. \$2.70 Sapphire Replacement Styl. Each Ster/LP 60c Plus postage 15c.</p> <p>PIEZO MICROPHONE INSERTS</p> <p>MC-3 Crystal, 50-7K, 35 x 25 x 8mm. -57 DB \$1.00 ea. MC-7 Crystal, 100-7K, 39mm Round x 11 mm. -56 DB \$1.00 ea. MC-8 Crystal, 50-8K, 48mm Round x 17mm. -50 DB \$1.00 ea. MC-9 Crystal, 50-8K, 25mm Round x 9mm. -68 DB \$1.80 ea. MC-33 Crystal, 50-10K, 33mm Round x 9mm. -60 DB \$1.30 ea. MD-5 Dynamic, 100-15K, 33mm Round x 14mm. -55 DB \$1.80 ea. Plus postage 20c.</p> <p>TRANSISTOR SET ACCESSORIES</p> <p>Magnetic Earpiece with 3.5mm Plug . . 75c Crystal Earpiece with 2.5mm Plug . . . 75c Crystal Earpiece with 3.5mm Plug . . . 75c</p> <p>LAPEL TYPE CRYSTAL MICROPHONE</p> <p>With 3.5mm Plug \$1.00 ea. Plus postage 15c. Fuses for Japanese equipment 1A, 3A, 5A 3c ea, OR \$2.00 per 100. Plus postage 10c.</p> <p>Michigan/Collard—Twin Track Rec/Play Heads \$8.50 Michigan/Collard—Twin Track Erase Heads \$3.00 Michigan/Collard—Four Track Erase Heads \$8.50</p>	<p>12-Pin Wafer Sockets. 20c ea.</p> <p>OCTAL PLUG AND CORD Ext. Socket 45c pr. Plus postage 10c.</p> <p>ALL TYPES AMPHENOL PLUGS AND SOCKETS Carried in stock. Pluss 27c ea. Sockets 30c ea. Meall Covers for same 27c ea. Plus postage 10c.</p> <p>HALF-INCH MINIATURE PLUGS AND SOCKETS 2, 3, 4 and 5-Pin Plugs 10c ea. Sockets 10c ea. Plus postage 10c.</p> <p>ELECTROLYTIC CAPACITORS IN METAL CANS</p> <p>16 + 16 450 VV 95c ea. 32 + 32 450 VV \$1.30 ea. 50 + 50 450 VV \$1.85 ea. 50 + 50 + 50 350 VV \$1.90 ea. 100 MFD P.V.C. Cover \$1.15 ea. Jacks, 2.5 and 3.5mm 20c 3.5mm Plug and Cord Ext. Jack Pair . . 50c Metal Co-axial Plugs and Line Sockets Pr. 65c "Din" and "Hirschmann," 2, 3, 4 and 5-pin Plugs, Chassis and Line Sockets, carried ex stock. Prices on application. P.M.G. type Plugs from 50c P.M.G. type Jacks from 35c P.M.G. Line Jacks from 55c Plus postage 15c.</p> <p>5 CORE CABLE 7/0076, P.V.C. insulated, P.V.C. covered. 25c yd.</p> <p>6 CORE CABLE same spec. as above 30c yd.</p>	<p>Capacitor Substitution Box, 1,000 VW . . \$5.00 Resistor Substitution Box, 1 Watt. Plus Post, 20c. \$4.90</p> <p>TRANSISTOR AERIALS</p> <p>5in extends to 39in \$1.70 5in extends to 39in \$1.70 6in extends to 43in \$1.70 6in extends to 32in \$1.00 6in extends to 28in \$1.00 7in extends to 39in \$1.20 9in extends to 39in 95c 5in extends to 4ft 6in \$1.80 7in extends to 5ft 8in \$3.70 Plus Post 15c.</p> <p>CRYSTAL SET BUILDERS</p> <p>Coils 80c Tuning Conds. . . \$2.00 Diodes 35c Terms . . . Ea. 12c Headphones . . . \$2.50 Plus Postage.</p> <p>TAPE RECORDER ACCESSORIES</p> <p>2 1/2in Spools . . . 30c 3in x 600ft Tape \$2.35 3in Spools 35c 5 1/4in x 1,200ft Tape \$3.10 5in Spools 40c 7in x 1,800ft Tape \$5.10 5 1/4in Spools . . . 70c 5in Plastic Tape, boxes 60c 7in Spools 50c 7in Plastic Tape, boxes 90c 2 1/2in x 100ft Tape 60c 2 1/2in x 300ft Tape \$1.40 Plus postage 20c. See us for Tape Recorder Patch Cords, Adaptors, etc.</p> <p>STEREO PLUGS AND JACKS</p> <p>Metal Plugs 95c Bakelite ext. sockets 70c Bakelite 70c Chassis Jacks . . 65c Plus postage 10c.</p>
---	--	--

MAIL ORDER SPECIALISTS

Although the electron is shown in an orbit surrounding its parent impurity nucleus, it may be remembered that electrons at the valence and high energy levels in a pure crystalline solid tend to be the "common property" of all the nuclei in the lattice. Thus while the additional positive charge on an impurity nucleus does produce a small local "dip" in the electron energy pattern of the lattice, with a consequent tendency for the fifth valence electron to remain, this effect is in fact quite slight. Very little energy is required in order to free the electron, so that even when the lattice is only slightly excited such electrons are virtually all freely wandering around the crystal and available as negative current carriers.

Because of this effective "donation" of electrons as additional negative current carriers to the basic semiconductor lattice, impurity elements such

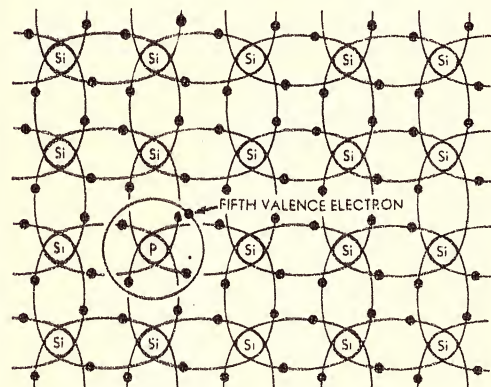

(NUCLEI AND CORE ELECTRONS NOT SHOWN)

Figure 3.2

as phosphorus, arsenic, antimony and bismuth are known as **donor impurities**. And because with such donor impurities present there is an excess of negative current carriers, in contrast with the equal numbers of positive and negative carriers present in an excited intrinsic semiconductor lattice, a crystal lattice which has been doped with a donor impurity element is termed an **N-type impurity semiconductor**.

The energy band diagram of such an N-type impurity semiconductor is shown in figure 3.3. It may be seen that in the ground state the fifth valence electrons of the donor impurity atoms occupy localised segments of a single energy level, which is only slightly below the bottom of the lowest conduction band. The electrons occupy a single new level rather than a multi-level band because, being relatively isolated from one another, they are not subject to coupling interaction effects.

The small gap between this "donor level" and the bottom of the conduction band represents the small energy increment required to free the electrons from their ground-state orbits. It may be seen that only a slight excitation of the crystal lattice will cause most of the donor level electrons to be transferred to the conduction band levels, so that the resistivity of the material will fall rapidly with excitation to a value which is many times lower than an intrinsic semiconductor under normal conditions.

At this point the reader may perhaps be wondering whether the electrons which transfer from the donor level to the conduction band leave holes behind. The answer to this is no, because the donor level simply corresponds to the isolated "fifth valence electron" orbits shown in figure 3.2, rather than to a complete binding orbit system, and the concept of a hole has little if any meaning except with reference to a complete binding system. To extend an earlier analogy, an empty

available as negative current carriers; while there are also an equal number of positively charged donor impurity ions which are fixed and therefore not themselves available as current carriers. We will see later on that while the fixed impurity ions cannot act as current carriers themselves, they can despite this play an important part in controlling the behaviour of the carriers.

Although the electrons "donated" by the donor impurity atoms are the main

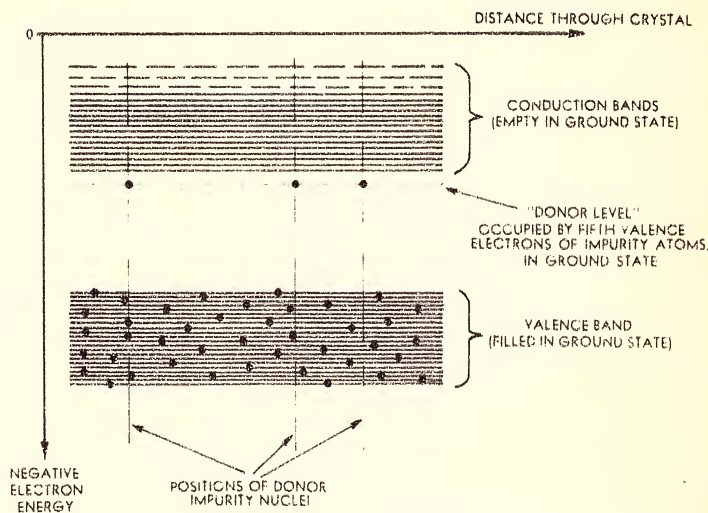

Figure 3.3

isolated orbit is somewhat like a test-tube emptied of water, in which an "air bubble" can scarcely have any meaningful existence.

When a fifth valence electron leaves its parent donor impurity atom to wander through the crystal lattice, then, it does not leave behind a hole. But this is not to say that the parent impurity atom then becomes indistinguishable from any of the host atoms; this can never occur, because it may be remembered that the nucleus and core electron system of the impurity atom will be always different from that of the neighbouring silicon or germanium atoms.

In fact, a donor impurity atom which has lost its fifth valence electron to the lattice will have a net positive charge. This being the case it should strictly no longer be called an "atom," but given the name by convention applied to a charged particle — an **ion**. It will be a positive ion, naturally, and will be fixed rather than movable because of its covalent bonding with the neighbouring host semiconductor atoms.

Under moderately excited "normal" conditions, then, N-type impurity semiconductor material contains two types of localised electric charge whose presence can be attributed to the addition of impurity atoms to the crystal lattice. On the one hand are an appreciable number of electrons moving through the crystal with an energy level which places them in the conduction band, and which are therefore

current carriers in N-type impurity semiconductor material, they are not the only available current carriers. The reason for this is that there will still be electron-hole carrier pairs produced by excitation of the lattice in the same fashion as in an intrinsic semiconductor.

As one might expect, a particular degree of excitation of an impurity crystal tends to produce as many electron-hole carrier pairs as in an intrinsic semiconductor crystal at the same degree of excitation. However in an impurity semiconductor the effective number of such carrier pairs present at any degree of excitation is considerably lower than in intrinsic material.

In the case of the N-type impurity semiconductor material which we have been considering, the reason for the reduction is that with a considerable number of donor-derived conduction electrons already wandering through the crystal lattice at the conduction band levels, there is an increased probability that wandering holes and electrons will meet to annihilate one another by recombination. Naturally such recombinations "remove" equal numbers of conduction-band electrons and valence-band holes from the crystal lattice, so that the numbers of both types of carrier effectively available in addition to the donor-derived conduction-band electrons will be somewhat smaller than the numbers of carrier pairs available in intrinsic material under the same conditions.

The total population of current carriers available in N-type impurity semiconductor material under normal conditions thus consists mainly of conduction-band electrons, with a small minority of valence band holes.

INDUSTRY IS CLAMOURING FOR ELECTRONICS ENGINEERS

Train now to go straight to the top

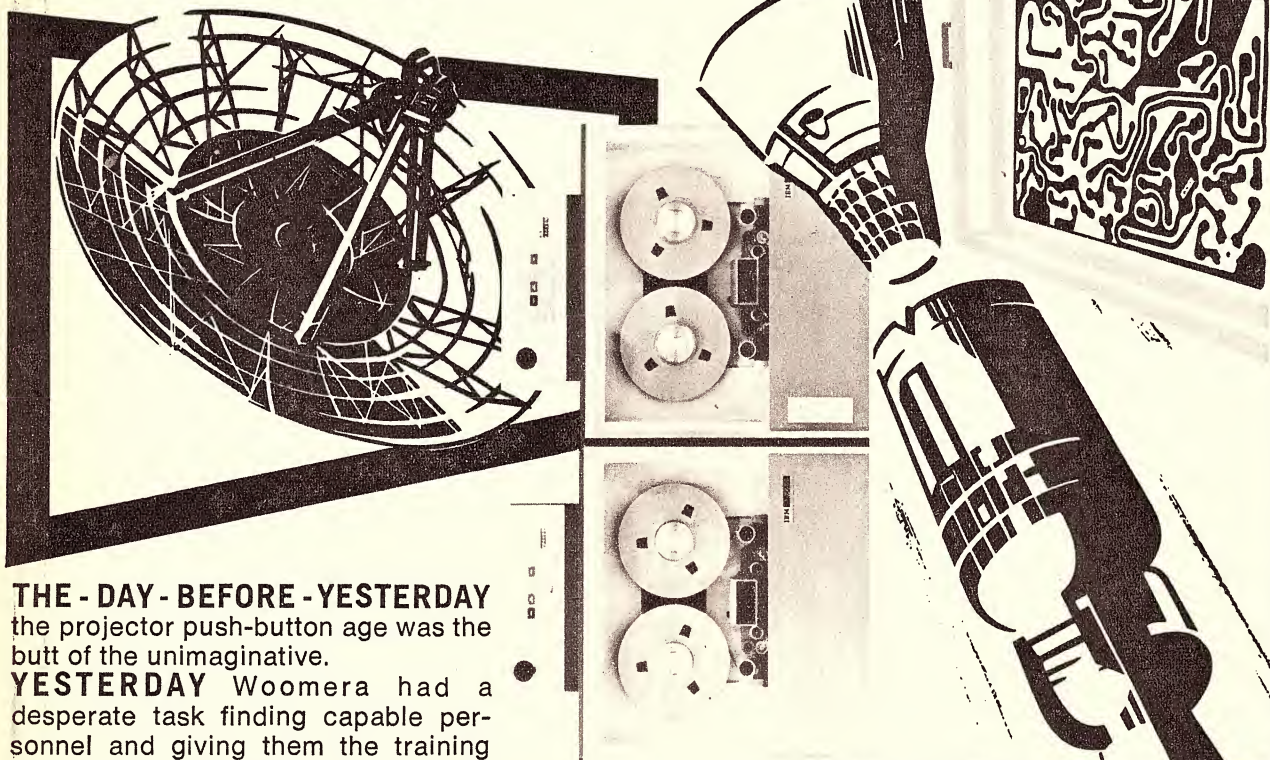

THE - DAY - BEFORE - YESTERDAY

the projector push-button age was the butt of the unimaginative.

YESTERDAY Woomera had a desperate task finding capable personnel and giving them the training to man the electronics functions of the space research complexes.

TODAY all Australian industry is committed to an immediate future of electronic concepts. These expose splendid new frontiers of production, of work output in commerce, of living standards. The lack of skilled personnel alone could retard this progression into a totally new world. Eventually the lack will and *must* be overcome. Meantime, Australia will search desperately about the world for the people with electronic skills. Already there is a dearth of them in Australia, *and overseas!* Trained Australians can choose their workplace from the whole world. If you train now with I.C.S., you will be rewarded well. You will reach the top of your profession while many thousands are just beginning to train.

Make your decision for success now!

These specialised subjects are available from I.C.S. for home study.

- | | |
|--|---|
| <input type="checkbox"/> Audio: Hi-Fi, Stereo | <input type="checkbox"/> Monochrome and Colour TV |
| <input type="checkbox"/> Automation Electronics | <input type="checkbox"/> Electronic Drafting |
| <input type="checkbox"/> Automatic Controls | <input type="checkbox"/> Printed Circuits, Conventional |
| <input type="checkbox"/> Industrial Applications | <input type="checkbox"/> Printed Circuits, Micro Integrated |
| <input type="checkbox"/> Nuclear Instrumentation | <input type="checkbox"/> Fringe Equipment |
| <input type="checkbox"/> Digital Techniques | Also Computer Programming for Commerce, Research, Industry. |
| <input type="checkbox"/> Transistors & Semi-Conductors | |
| <input type="checkbox"/> Communications | |

Read the **FREE I.C.S. Illustrated Prospectus**

Send Coupon today!

International Correspondence Schools,
Dpt. 527, Division of Electronics,
400 Pacific Highway, Crows Nest, N.S.W. 2065.
Branches in all States and New Zealand.



Please send me **FREE** Prospectus about.....

Name..... (Please print)..... Age.....

Address..... State.....

Postcode..... Phone..... Dpt. 527

In this material electrons can thus be termed the **majority carriers**, and holes the **minority carriers**. Both these terms serve to emphasise the contrast with the equal-numbers-of-electrons-and-holes situation which applies with an intrinsic semiconductor.

As one might expect, increasing the number of donor-derived conduction band electrons in the material further reduces the effective additional proportions of "intrinsically produced" electron-hole pairs. And not surprisingly, the number of donor-derived electrons is in turn directly proportional to the number of donor impurity atoms originally added to the lattice — the **doping concentration**.

Hence we can say that in N-type impurity semiconductor material, the

may be remembered, are pentavalent. They have five valence electrons, in other words, one more than the four possessed by intrinsic semiconductors such as silicon and germanium. As one might perhaps expect, there also exists a second group of important impurity elements which are in contrast trivalent — possessing only three valence electrons, and hence in this case one less than silicon and germanium. Elements which fall into this group include boron, indium, aluminium and gallium.

When atoms of one of these elements are present as impurities in a semiconductor crystal, they are for the most part incorporated into the lattice in much the same "substitutional" manner that applies in the case of

aluminium—effectively brings with it into the crystal lattice nothing other than a positively charged valence-band hole.

Although in the common-property valence electron binding system of the crystal lattice, the hole has a weak tendency to remain in the vicinity of its parent impurity nucleus. This is because of the lower positive charge or "relative negativity" of the impurity nucleus compared with the neighbouring host nuclei. However, as with the fifth valence electron of a donor impurity, the hole binding is very weak, and very little energy is required for the hole to effectively move away through the crystal in the manner which we previously examined.

This means that even for quite low levels of excitation, the holes introduced into the lattice by the impurity

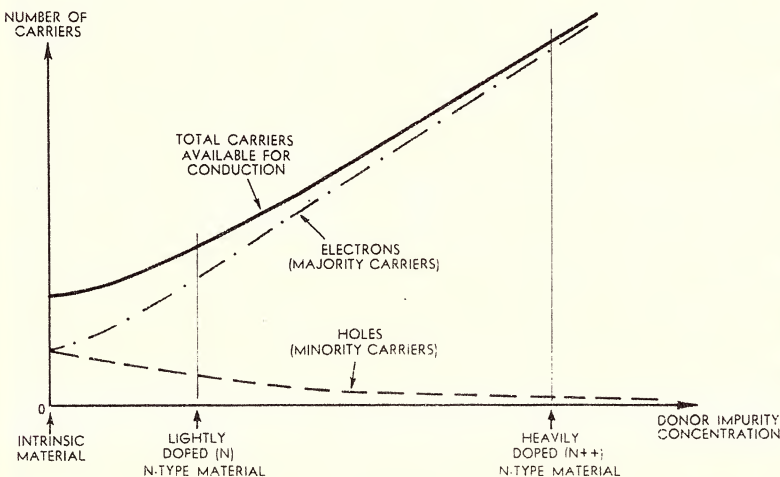

Figure 3.4

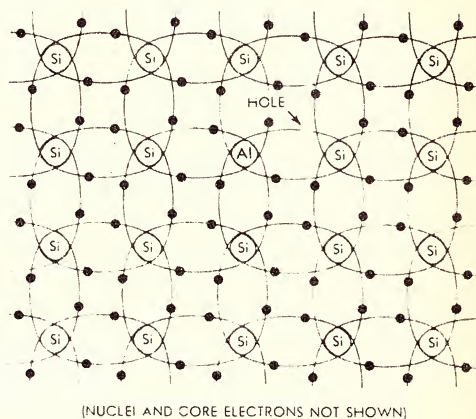

Figure 3.5

proportion of total available current carriers represented by the majority carriers — in this case electrons — is directly proportional to the doping concentration. Highly or heavily doped material can thus be considered to be "more N-type" than lightly doped material, because it will have a higher proportion of majority-carrier electrons and a lower proportion of minority-carrier holes.

Figure 3.4 illustrates the foregoing by showing the effective numbers of electron and hole carriers which will normally be present in a crystal sample for various doping concentrations. It may be seen that for intrinsic material with zero donor impurity, there are present equal and modest numbers of electrons and holes — the "intrinsic" electron-hole pairs. With the progressive addition of donor impurity the number of electrons rises rapidly while the number of holes falls, so that while the total number of carriers available for conduction rises rapidly with donor impurity concentration, it progressively becomes composed more and more of electrons or majority carriers, and less and less of holes or minority carriers.

Having looked fairly closely at one of the two types of impurity semiconductor material, let us now examine the second type. We may well expect to find a similar but complementary set of situations involved, and this in fact turns out to be the case.

Those impurity elements which act as electron carrier donors to an intrinsic semiconductor crystal lattice, it

donor impurities. However, having only three valence electrons, they are able to enter into the required covalent bonds with only three of the neighbouring host atoms. With the remaining neighbour atom they can form only a weaker "non-contributory" bond involving a single electron.

As the illustration in figure 3.5 shows, the weakened fourth bond is of exactly the same type which we saw to be present in an intrinsic semiconductor lattice bond when an electron has been removed by excitation. In short, the impurity atom—in this case

atoms will be found wandering through the crystal and available as positive current carriers. At the same time the impurity atoms themselves, having gained a valence electron, will have become fixed negatively charged ions.

It may be seen that in contrast with the behaviour of donor impurities, the impurity atoms have in this case effectively "accepted" valence electrons from the crystal lattice. To distinguish this behaviour from that of donor impurities, elements such as boron, indium, aluminium and gallium are known as **acceptor impurity elements**. And be-

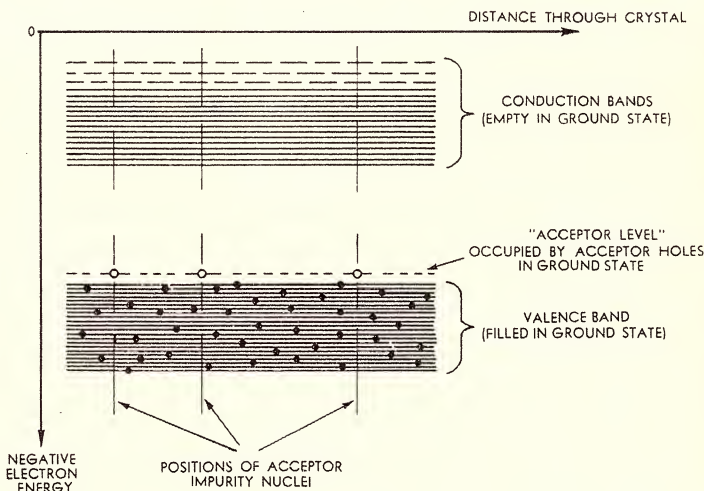

Figure 3.6

R.C.S. SPECIALS



**NEW IMPROVED
30 WATT
NOMINAL
54w MAX.**

12v All Transistor P. A. AMPLIFIER

WIRED READY TO OPERATE

15 ohm output No. 591D \$62
125, 250, 500 ohm 592D \$62
Dimensions: 8 1/2" h. x 5 1/2" w. x 2 1/2" d.
8 1/2" h. d. For 240V op. \$33 extra.
10 WATT P.A.

Inputs 5 MV and 100 MV, 10w R.M.S. at 1%. Frequency 40cy.—30kc. For use with 1.4 ohm, 2.8 ohm or 4.16 ohm speakers in parallel. Same cabinet and dimensions as 30w above.
Wired and tested, No. 485, \$40.
Freight extra in both cases.



R.C.S. COMPLETE DO-IT-YOURSELF KITS

Peak reception, low price. No expensive test equipment. Everything included. 1964 RF Transports 7.

Complete kit—No. 640 \$43.50
Portable car radio. Identical to 640 above. Plus extra switch and car coil etc. No. 642 \$46.00
(Write for booklet on 640 and 642) Postage \$1.

NEW TRANSISTOR PREAMP KIT

SIZE 3 x 2 x 1 1/2 req. for Stereo, LOW IMP. Input 2 trans. 672C \$6.50
Wired ready for use. 672D \$8
HIGH IMP. 2 trns. 680C \$6.50
Wired ready for use 680D \$8
HIGH IMP. silicon 3 trans. 682C \$8
Wired ready for use. 682D .. \$9.50
Postage 10c each. Write for data.

HI-FI BROADCAST TUNER UNIT 4 TRANSISTORS — HI SENSITIVITY.



R. F. mixer, I.F., pwr. decr. stages, adjustable aerial coupling. Complete as illust. Wired and tested with 461 dial, knobs and switch pot. No. 474D, \$31. Postage \$1.

WHISTLE FILTER for above set for 8Kc band width (can be altered to 9, 10, or 11Kc). No. 126, \$4, Post 10c.

PRINTED CIRCUITS

For all R. and H. E.A., Mullard, Philips and other designs. Clearly coded. White letters and numbers, easy assembly and service, polished and resined for easy soldering. With blueprint parts list.

SPECIALS: To your drawing—write for particulars and Drafting aids.

New Printed Circuits	Number.	Recent Designs
726 3 x 3 or 10 x 10 w stereo 68/AB	722	Mullard pre-amp \$3.00
736 B/C tuner EA 69/18	723	Protected supply \$2.50
	734	E.A. 69 01 gold D organ \$5.00
727 E & A wide band tuner 68/8T	731	E.A. 68 M 12 \$2.50
728 Audio osc. E.A. 68-09	709	Pre-amp 67-P5 \$2.50
	684	Pre-amp 65-P10 \$2.50
718 Mullard main amp	685	Pre-amp. 65-P12B \$2.50
	686	Pre-amp. 65-P12B \$2.50

Write for full list. Immediate despatch. Postage 10c.



10W STEREO

**MULLARD 10 x 10
watts R.M.S.**

With output transistor PROTECTION. Frequency response 40cy. to 30Kc. Distortion 0.5% Treble, bass, boost 20dB. Complete kit or parts No. 460C \$74.00.
Wired and tested No. 480D \$79.00.
With hi-fi tuner and whistle filter, \$35 extra. Freight extra. Write for details. For special Saturday demo, ring 59-6550.

MAGNETIC STEREO PRE-AMP

In 5Mv out 250Mv. Bass and treble 20D.B. No. 724C \$29.
Wired ready for use 531.
Postage 30c each.
For crystal ceramic No. 722D \$27.00.



TRANSFORMER

Tap 4.6v and 9v D.C. at 100 millamps.

Filter, condensers, rectifier, resistor, case, etc. \$6.50. Post 10c.

PERSONAL PORTABLE 2 TRANSISTORS

Range 30 miles. 200 with short aerial and earth. Earpiece only, no speaker. Wired ready to use. No. 666D, \$10.
Postage 20c.
Do-it-yourself kit, No. 666C, \$9.00.



1 TRANSISTOR — 1 DIODE
593C Do-it-yourself kit, \$5, post 10c.
593D Wired ready to operate, \$6 post 10c.

DIAL KITS SCALE GOLD WITH WHITE LETTERS

Size 6 1/2 x 2 1/2 in.
No. 459 to match 300 pf gang. Price \$4.50
No. 461 to match 200 pf gang. Price \$4.50
Post 20c.

NEW AUDIO AMPLIFIER

4 transistors. 1/2 or 1 watt. Small size, cabinet 3in x 2in x 1in Plastic. Suitable crystal P/up. Inter comm. micro-phones, radio, etc. (9 volt).

DO-IT-YOURSELF KIT 665, \$10 (Post 10c). Wired ready for use 665D \$11.50

COILS & IF's 455 Kc

Aer. R.F. OSC. and IF's .. \$1.80 ea.
Ferrite Aer. \$2
No. 265 Universal tape OSC. Coils. \$5
Postage 10c. Write for details and price.

R.C.S. Order by Mail Order, Postal Note, or Money Order (add post.), direct to —
RADIO PTY. LTD., 651 FOREST ROAD, BEXLEY, N.S.W., 587-3491 587-5385

PETER SHALLEY Electronics Pty. Ltd.

127 YORK STREET, (just near Town Hall) 29-7021 29-3767

New 5-WATT Base Station

Just Released

FEATURES:

- Delivers a full 5-Watt Input Power to the Final Amplifier.
- Operates on any of the 6 Citizen's Band Channels.
- Tone Call System for more effective communication.
- Stable Crystal-controlled Receiver with RF Stage.
- For short distance communication, Battery Saver slide installed.
- Variable Squelch and full series of Jacks for PA, Mic, External Speaker, External Antenna and External Power connecting.
- All Die-cast Cabinet and Leather Case.

Price \$179.00 each

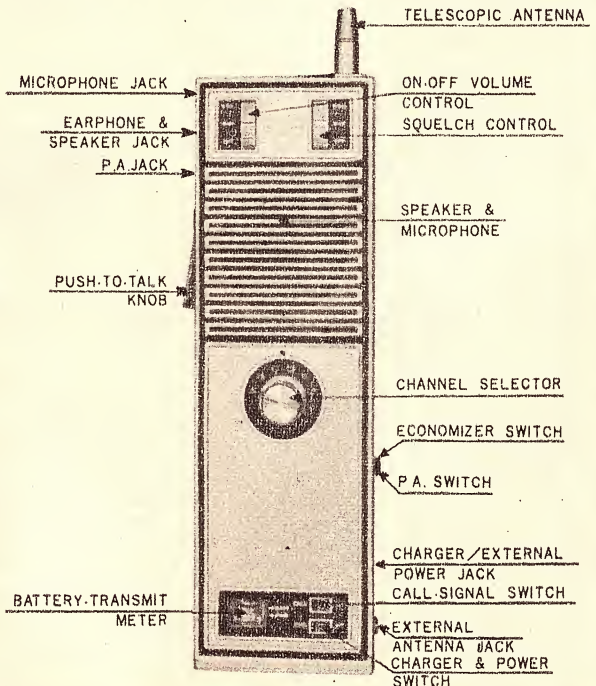

cause with an acceptor impurity present a semiconductor crystal has an excess of positive current carriers under normal conditions, compared with intrinsic material, a crystal which has been doped with an acceptor impurity is termed a **P-type impurity semiconductor**.

The energy band diagram of a P-type impurity semiconductor is shown in figure 3.6, and the reader may care to compare it with that for N-type material shown in figure 3.3. It may be seen that the holes which "belong" to the acceptor impurity atoms in the ground state again occupy localised and isolated segments of a single energy level, but that in this case the impurity level is slightly above the top of the valence band.

The small gap between the "acceptor level" and the top of the valence band represents the small energy increment required for electrons in the valence band to transfer into this level, "filling" a hole but leaving behind another in the valence band itself. Only slight excitation of the lattice is therefore required for most of the acceptor level holes to be filled, leaving many holes behind in the valence band to act as positive current carriers. The resistivity of P-type material thus falls rapidly with excitation in almost exactly the same fashion as with N-type material, and like the latter it has, under normal conditions, a resistivity many times lower than intrinsic semiconductor.

Just as the donated electrons are not the only carriers present in N-type impurity semiconductor, so the holes derived from acceptor atoms are simi-

larly not the only carriers present in P-type material. As before there will be "intrinsic" electron-hole pairs produced by the normal excitation mechanism, although again the effective numbers of these carriers is lower than in intrinsic material.

The reason for the reduction is again carrier loss by recombination, due in this case to the relatively large number of holes moving through the crystal lattice at valence band level. As before this means that the numbers of both types of "intrinsic" carrier effectively fall with increasing doping concentration.

Accordingly the effects of doping concentration for a P-type impurity semiconductor may be represented as in figure 3.7, which is a similar diagram to that of figure 3.4 for an N-type semiconductor. Here the holes are the majority carriers and the electrons are the minority carriers, but otherwise the relationships are very similar. As before the total number of carriers available for conduction rises rapidly with impurity concentration, and progressively becomes composed more and more of the majority carriers and less and less of the minority carriers.

It may be seen from the foregoing descriptions of the two types of impurity semiconductor that both types have available under normal conditions

where virtually all the electron or hole carriers derived from the impurity are available for conduction; at this point the resistivity tends to flatten out.

Further increase in excitation tends to produce little if any reduction in resistivity, because the tendency for increased numbers of electron-hole pairs to be produced is largely balanced by a corresponding increase in recombination. In fact the resistivity of the material tends to increase slightly, because with increasing activity within the crystal lattice the motion of the carriers becomes impeded by an increasing number of "collisions." This reduction in carrier mobility explains

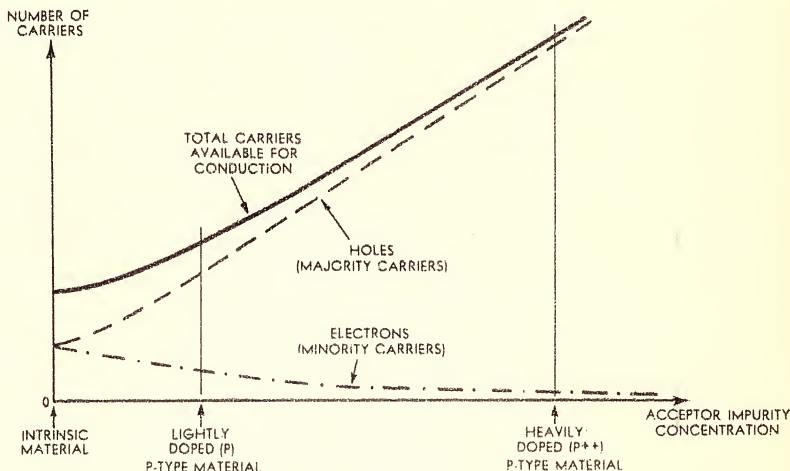

Figure 3.7

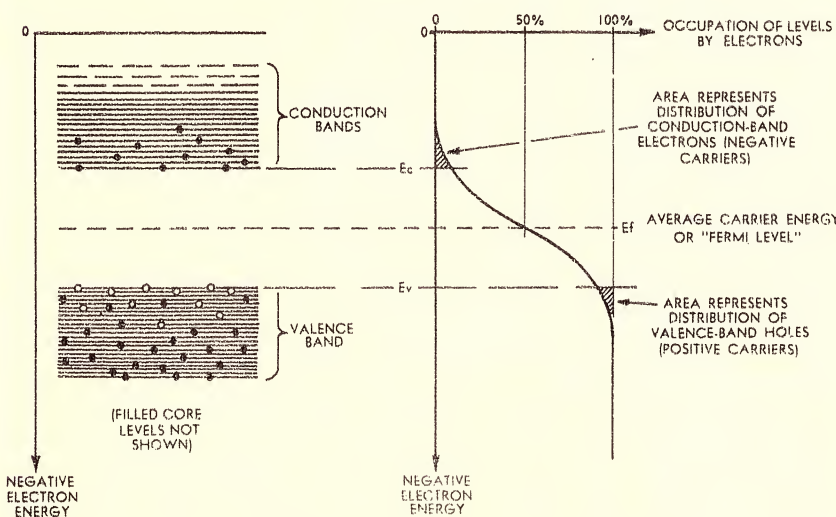

Figure 3.8

larly not the only carriers present in P-type material. As before there will be "intrinsic" electron-hole pairs produced by the normal excitation mechanism, although again the effective numbers of these carriers is lower than in intrinsic material.

The reason for the reduction is again carrier loss by recombination, due in this case to the relatively large number of holes moving through the crystal lattice at valence band level. As before this means that the numbers of both types of "intrinsic" carrier effectively fall with increasing doping concentration.

Accordingly the effects of doping

of excitation considerably greater numbers of current carriers than are available in intrinsic semiconductor material. The numbers are of different composition in each case, to be sure, but the total numbers are in both cases greater—by an amount proportional to the concentration of the appropriate doping impurity.

With applied excitation the resistivity of both types of impurity semiconductor thus tends to fall much more rapidly than with intrinsic material, and this explains the steeper initial slope of the solid curve given earlier in figure 3.1. However, increasing excitation rapidly results in the situation

the slight upward slope of the plateau in figure 3.1.

If the increase in excitation is continued still further, a point is eventually reached where the production of "intrinsic" electron-hole carrier pairs simply swamps the recombination mechanism. When this happens the majority-minority carrier situation gives way to the equal numbers situation, while resistivity again begins to fall. Thus in effect both N-type and P-type impurity semiconductor materials revert back to "intrinsic" semiconductor at very high excitation levels.

From the foregoing it may be seen that both the total number of carriers available in a semiconductor, and the proportions of negative and positive carriers making up that number are determined by three factors. These are the presence and concentration of any impurities present, the type of impurity and the degree of excitation.

It has been found of considerable value to describe this rather complex situation using two very useful concepts; that of an "average carrier energy level," and that of a statistical "spread" or distribution of the carriers above and below the average level. As with some of the concepts introduced earlier, a full understanding of these concepts requires considerable background in quantum mechanics and is thus beyond the present discussion. However, the basic ideas involved are not unduly difficult, and can help considerably in understanding practical semiconductor device operation.

As we have seen, conduction in semiconductor materials takes place by movement through the crystalline lat-

New, low cost



3" Hi-Flux Tweeter

is an outstanding performer

Here at last is a low cost high frequency tweeter with the performance of expensive elaborate designs.

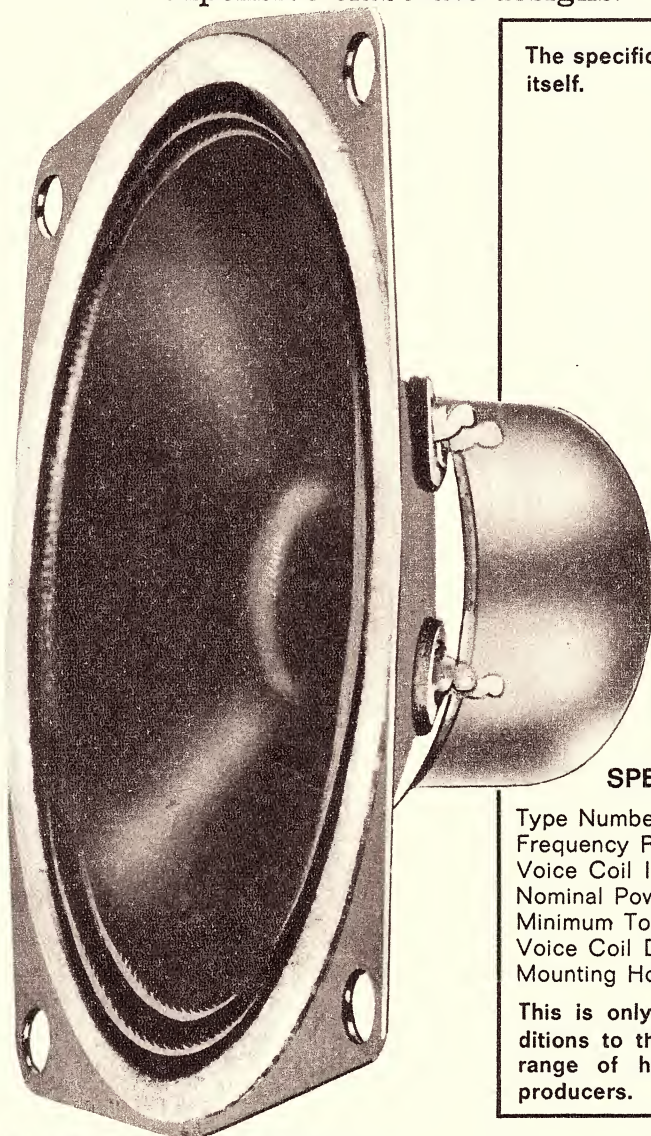

The specification below speaks for itself.

SPECIFICATION

Type Number 53418/3LB/15 HF
Frequency Response 5000-16000 Hz
Voice Coil Impedance 15 ohms
Nominal Power Handling 2 Watts
Minimum Total Flux 12000 Lines
Voice Coil Diameter 5/8"
Mounting Hole Centres 3 P.C.D.

This is only one of the latest additions to the comprehensive MSP range of high quality sound re-producers.



**MANUFACTURERS
SPECIAL
PRODUCTS
PTY. LTD.**

47 York Street, Sydney. 2 0233

ADELAIDE: Newton McLaren Ltd. 51 0111. **BRISBANE:** Chandlers Ltd. 31 0341. **HOBART:** Amalgamated Wireless (Australasia) Ltd. 3 3836. **LAUNCESTON:** Amalgamated Wireless (Australasia) Ltd. 2 1804. **MELBOURNE:** Amalgamated Wireless (Australasia) Ltd. 67 9161. Radio Parts Pty. Ltd. 30 1251. J. H. McGrath & Co. Pty. Ltd. 32 3731. **PERTH:** Amalgamated Wireless (Australasia) Ltd. 28 3425. Atkins (W.A.) Ltd. 21 0101. Carlyle & Co. (1959) Pty. Ltd. 21 9331. **SYDNEY:** Electronic Parts Pty. Ltd. 533 1277. George Brown & Co. Pty. Ltd. 29 7031.

tice of two types of carrier—negative carriers which consists of electrons possessing an energy which places them in the conduction band, and positive carriers which consists of hole possessing an energy which places them in the valence band. Because of this, the most useful measure of the excitation level of the material from an electrical viewpoint is one which takes both types of carrier into account, in terms of both numbers and energy distribution. We may thus talk meaningfully of an “average carrier energy level” of a semiconductor crystal, representing the average of the energy levels of all the carriers available in the crystal lattice.

In the case of an intrinsic semiconductor it may be recalled that for any degree of excitation the number of conduction band electrons and valence band holes are equal. Hence the average carrier energy level for such material will be exactly midway between the valence and conduction bands. This is illustrated in figure 3.8, where the average carrier energy level is given its more usual name of **Fermi level** (in honour of the physicist Enrico Fermi), and labelled E_f .

It has been found that the distribution of carriers in the various energy

valence band, is essentially a theoretical interpolation or “fill in.” It is arranged so that the curve is symmetrical above and below the Fermi level E_f , with the intersection at E_f corresponding to the theoretical point of 50 per cent level occupation.

In figure 3.8 the small cross-hatched area above the level E_c represents the distribution of electrons in the conduction band — i.e., the number and distribution of negative carriers. Similarly the lower small cross-hatched area below level E_v represents the distribution of electron vacancies or holes in the valence band levels — i.e., the number and distribution of positive carriers. Note that the two areas are equal, and equal in shape.

The shape of the Fermi-Dirac curve changes to describe the way in which the number of carriers available in the material varies with excitation. Its shape as shown in figure 3.8 corresponds to a moderate degree of excitation, where the “tails” of the curve indicate a modest number of each type of carrier.

In figure 3.9 is shown the way in the shape of the curve varies

However although this is the case, the new and changing distributions of carriers are still described by the Fermi-Dirac distribution curve, providing its 50 per cent point is kept in alignment with the Fermi level.

Figure 3.10 shows the Fermi level positions and carrier distributions for N-type impurity semiconductor at three degrees of excitation. The energy band structure of the material is not shown, but as before E_c and E_v represent the bottom of the conduction band and the top of the valence band respectively. The donor level is represented by E_d .

As may be seen, in the ground state the Fermi-Dirac curve is again a step curve with the “step” at the Fermi level. But the latter is now at a somewhat higher level than in the case of intrinsic material. Its position will naturally vary with the donor impurity doping concentration, to take account of the changing carrier ratio illustrated in figure 3.4; thus the position between E_d and E_c shown in figure 3.10 will correspond to a quite heavily doped N-type material. With lower doping concentrations E_f will be lower

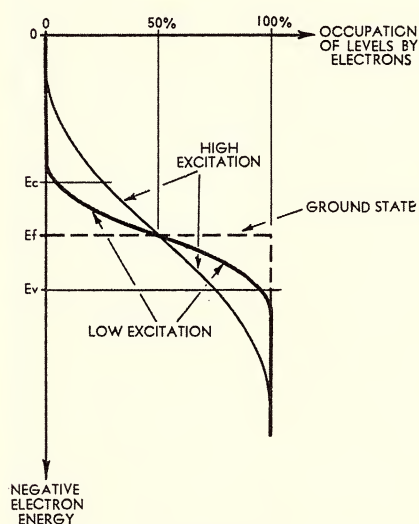

Figure 3.9

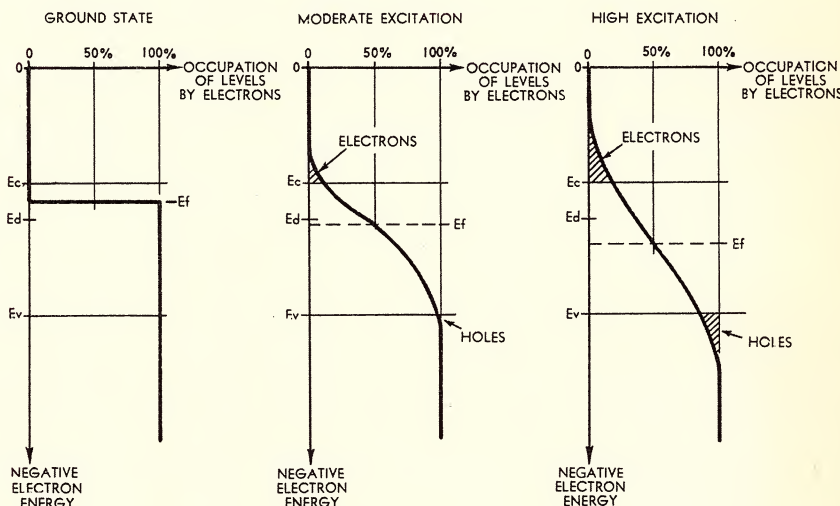

Figure 3.10

bands above and below the Fermi level can be described quite accurately by the type of curve shown. The shape of the curve corresponds to what mathematicians call the **Fermi-Dirac distribution**.

As may be seen from figure 3.8—which, it should be remembered, corresponds to an intrinsic semiconductor only — the curve represents a plot of the relative occupation by electrons of any allowed energy level, expressed as a fraction or percentage of the level capacity. Hence the curve has a value of 100 per cent for the lower filled levels, then slopes over to a value of 0 per cent for the uppermost empty levels.

Note that the continuous nature of the curve is not intended to imply that electrons are occupying levels other than the allowed levels of the various bands. Hence the portion of the curve between level E_c , marking the bottom of the conduction band, and E_v , marking the top of the

with excitation. For the ground state or zero-excitation case, it is not a curve at all, but a sudden “step,” as excitation increases the “corners” of the step round off, producing longer and longer “tails.” It may be seen that this results in larger and larger areas above E_c and below E_v , corresponding to the increased numbers of carriers available with increasing excitation.

It should be noted that both figures 3.8 and 3.9 are drawn for intrinsic material, in which as we have seen the Fermi level is fixed and exactly midway between E_c and E_v . Naturally this same situation cannot be true with either of the two types of impurity semiconductor, because in these cases there are not only unequal numbers of negative and positive carriers, but the ratio between the two varies with excitation.

Actually it turns out that the Fermi level of each of the two types of impurity semiconductor is different, and also that it varies both with the type of impurity and the excitation.

down than this, although it will always be higher than the forbidden-gap-midpoint position — which as we have seen corresponds to intrinsic material.

With moderate excitation, illustrated in the centre diagram of figure 3.10, two things have happened. Probably the most obvious thing is that the carrier distribution curve has developed “tails,” as before, and that because the Fermi level is higher than the forbidden gap midpoint, the curve tails indicate the expected majority/minority carrier unbalance. But the more subtle thing that has occurred is that the Fermi level E_f has started to fall, slightly but perceptibly, to correspond to the effect of “intrinsic” (balanced) carrier generation.

The third diagram of figure 3.10 shows what happens at a very high degree of excitation. The Fermi-Dirac curve has spread well out, as before, while at the same time the Fermi level itself has fallen almost to the forbidden gap midpoint. Hence while there are large numbers of carriers, it can be seen that they are now made up of

5 watt C.B. Transceiver

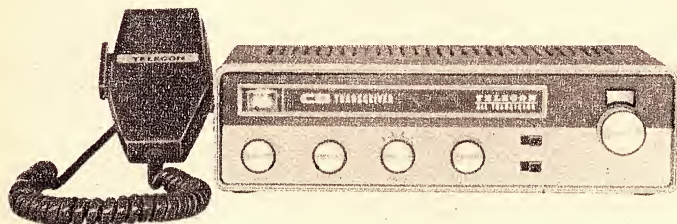

\$168.55

INC. TAX

Telecon TMC-703A

Features: 12 and 240 volt operation, tuneable or crystal locked receiver, 19 transistors and 10 diodes, .5 micro volt sensitivity, 3.5 watts r.f. output, public address and external speaker facility, 3 transistor voltage regulator, 6 month warranty.

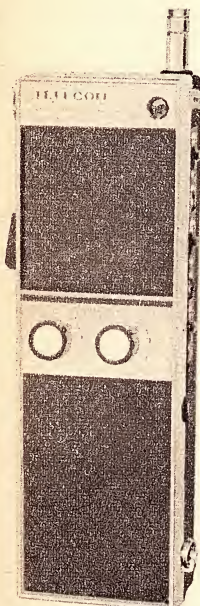

1 watt, 214 A

\$99.95

inc. tax

- Battery Meter
- Squelch, noise limiter
- Rugged metal case
- Sold to 50 Govt. Depts.
- Ext. Power, antenna, speaker, mike jacks

.1 watt, 204 A

\$49.95

inc. tax

- Battery meter
- Leather case
- 12 ozs. with battery
- Pocket size
- 1 microvolt sensitivity

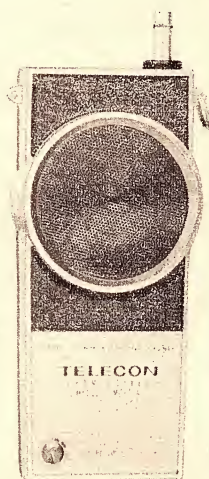

ALSO: Base and mobile antennae from \$5, SWR bridges \$12.45, multimeters, bench power supplies, microphones, crystals, spare parts, co. axial cable, fittings.

Australasian Agents:

Strato Communications Pty. Ltd.,

25 WENTWORTH ST., PARRAMATTA, N.S.W. 2150

Telephone 635-9856, 635-5569.

TEDCO PTY. LTD.,
579 Murray St.,
Perth, W.A.

HOMECRAFTS-TAS.,
199 Collins St.,
Hobart, TAS.

FRED HOE & SONS
Block 23, Industries Road,
Salisbury North. Brisbane.
QLD.

AUSTRALIAN SOUND &
TELEVISION Co. Pty. Ltd.,
35-39 Yarra Bank Road,
South Melbourne. VIC.

almost equal numbers of electrons and holes — showing that the material has almost completely reverted to an effective “intrinsic” semiconductor.

In figure 3.11 are shown equivalent diagrams for a P-type impurity semiconductor, and it may be seen that the situation is here very similar. The only difference is that the Fermi level in this case occupies in the ground state a position somewhat lower than the forbidden gap midpoint, and moves up with excitation. As before its ground-state position is determined by the doping concentration; the position shown between the acceptor level E_a and the top of the valence band E_v corresponds to a quite heavily doped P-type material.

another when they are present in small quantities. Due to the compensation effect, the effective type and impurity concentration of a practical semiconductor material is really the resultant or net effect of whatever types of impurity are present in the lattice.

Hence in practice an N-type impurity semiconductor is one in which a donor impurity is present in greater proportion than any other impurities, and a “heavily doped” N-type material is one in which this dominance is even greater. Similarly P-type material is material in which an acceptor impurity is dominant, again to a degree which determines the effective doping concentration.

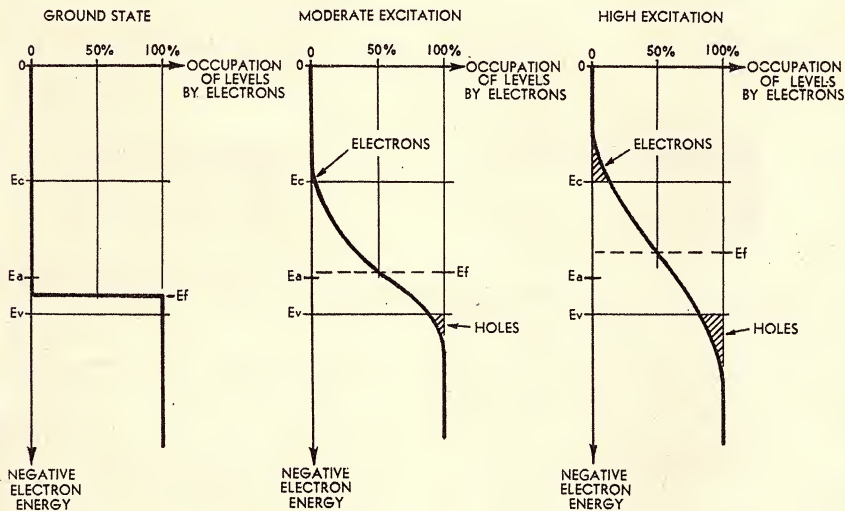

Figure 3.11

Thus far, in considering impurity semiconductor materials we have assumed that only one type of impurity is present. Although modern semiconductor technology can approximate this situation, this is all that can be done. In practice, a number of different impurity elements are almost always present, in electrically significant amounts. The reader may therefore well wonder what effect such “spurious” impurities have on the concepts which we have looked at in the foregoing.

The answer to this is that there occurs an effect called **compensation** whereby opposite types of impurity element tend to “cancel out” one

The same argument applies in the case of “intrinsic” semiconductor material. If a material has equal and minute amounts of opposite types of impurity, mutual compensation cancels out their effect so that in practice the behaviour of the material is indistinguishable from a perfect intrinsic semiconductor. The success of modern semiconductor technology in producing “pure” samples of intrinsic semiconductors such as silicon and germanium is therefore not due solely to reduction of impurity levels, but also to the development of ways of ensuring that the inevitable residuals of impurities compensate one another to a highly accurate degree.

SUGGESTED FURTHER READING

- BURFORD, W. B., and VERNER, H. G., *Semiconductor Junctions and Devices*, 1965. McGraw-Hill Book Company, New York.
- MORANT, M. J., *Introduction to Semiconductor Devices*, 1964. George G. Harrap and Company, London.
- SCROGGIE, M. G., *Fundamentals of Semiconductors*, 1960. Gernsback Library, Inc., New York.
- SHIVE, J. N., *Physics of Solid State Electronics*, 1966. Charles E. Merrill Books, Inc., Columbus, Ohio.
- SMITH, R. A., *Semiconductors*, 1950. Cambridge University Press.

LOW COST, HIGH PERFORMANCE SPEAKER SYSTEMS FROM ENCEL ELECTRONICS!

Separate speaker systems are essential if you wish to exploit the full potential of your amplifier, tape recorder or radio. Sonics speaker systems are beautifully finished in selected walnut/teak veneers, are styled to blend with period or modern decor and are extremely effective from an audio point of view. The following models are the most popular.

MODEL AS-57. A bookshelf unit measuring only 15½" x 5½" x 8½". Fitted with a wide range oval speaker . . . ideal for use with tape recorders and stereo systems where space is a vital consideration. Hand finished teak/walnut cabinet. Inc. sales tax **\$22.50**

MODEL AS-60E. Although only 18½" x 12½" x 5½" the AS-60E is fitted with a bass/mid-range speaker and a separate high frequency reproducer. An excellent speaker system which has proved very popular with audio enthusiasts. Hand finished teak/walnut cabinet. Inc. sales tax **\$27.50**

MODEL AS-61. A true "Slimline" enclosure with four bass/mid-range speakers and a high frequency reproducer. Measures only 4½" in depth; height is 21½" and width is 17½". Finish is teak/walnut and the legs are detachable. Probably the most popular multiple speaker system ever offered at this price in Australia. Inc. sales tax **\$38.50**

MODEL AS-202. A 3 speaker, 3 way speaker system which measures 20½" x 11½" x 11½", the AS-202 is a recent addition to the Encel Sonics range. An 8" woofer and a 6½" mid-range speaker are incorporated — and a high frequency reproducer completes the speaker complement. Will handle 10 watts R.M.S. with ease. Beautiful hand finished teak/walnut cabinet. Inc. sales tax **\$46.50**

MODEL AS-220. A most effective 3 way speaker system with an 8" bass reproducer, a 6½" mid-range speaker and a high frequency reproducer. Cabinet size is 20½" x 11½" x 11½" and the front grille features a timber fret which matches the teak/walnut veneer cabinet. Handles 10 watts R.M.S. easily. Inc. sales tax **\$54.50**

MODEL AS-303. A magnificent hand finished teak/walnut speaker system with three speakers and a 3 way crossover network. A 12" woofer with a long throw voice coil provides excellent bass response, a 6½" mid-range speaker covers the middle ranges and a horn type tweeter comes in at 5 kHz. Power handling capacity is over 15 watts R.M.S. Extremely wide frequency response free of coloration. Size 25" x 14½" x 11". Inc. sales tax **\$68.00**

MODEL AS-251. This is a new deluxe 3 way speaker system with a 10" bass reproducer, a 6½" mid-range speaker and an exponential horn tweeter. A 3 way crossover network assures smooth response over the total range of 40-20,000 Hz. Dimensions are 13" x 22½" x 11½" and finish is in oiled teak/walnut veneer. Encel price inc. sales tax **\$78.00**

MODEL AS-330. The deluxe system of the Sonics range. It is a 3 way system with five speakers including a 12" base reproducer, a pair of mid-range speakers and two exponential horn type tweeters. The attractive cabinet is hand finished in teak/walnut figured veneer, has a most attractive timber fret grille and measures 15½" x 26" x 11½". Overall frequency response is 30-20,000 Hz. Carefully selected crossover frequencies provide a smooth and musical performance over the frequencies specified. Encel price inc. sales tax is **\$98.50**

IMPORTANT: All "Sonics" enclosures are 8 ohms impedance.

Encel
ELECTRONICS
(STEREO)PTY. LTD.

Head Office:
431 Bridge Rd., Richmond, Victoria 3121.
Tel. 42 3762.

Sydney Store: Ground Floor, 25M Building,
257 Clarence Street, Sydney, N.S.W. 2000.

Tel. 29 4563, 29 4564.

*Wholesalers *Trade-ins accepted

Australia's Greatest Hi-Fi Centre

40 Watt & 60 Watt Instrol-Playmaster GUITAR AMPLIFIERS

All parts now available

Like all Instrol-Playmaster kits, the 116 and 117 Guitar Amplifier Kits are complete in every detail, down to the last nut and bolt, and precisely to "Electronics Australia" specifications. Chassis is ready drilled, cadmium plated and finally passivated to avoid fingermarking. The front label is beautifully finished with black lettering on silver-white background. Kits for both the 116 and 117 include extras such as 3 inputs (circuit included), vibrato and extra treble pull switches, and foot switch complete with chrome housing.

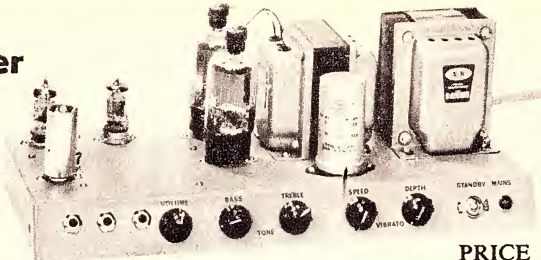

	PRICE
40 Watt complete kit of parts	\$84.36
40 Watt built and tested	\$91.49
60 Watt complete kit of parts	\$92.31
60 Watt built and tested	\$98.83
(Freight extra)	

All parts available separately if required.
 Chassis only \$4.70 (plus 85c postage)
 Front Label \$2.80 (plus 20c postage)
 Fuzz Box Kit \$12.95 (plus 75c postage).



KEYLESS ORGAN

(Electronics Aust. January 1969)

A useful novelty instrument which can be used successfully by a single entertainer or in conjunction with a group. Includes sharps and flats, built-in vibrato and has a high level of acoustic output.

Kit of Parts, \$35.10. Postage additional

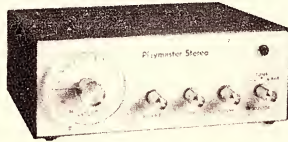

INSTROL-PLAYMASTER 124 STEREOGRAM ("ELECTRONICS AUST." MAY 1969)

A Solid State Broadcast Tuner, combined with the successful 3-PLUS-3 Stereo Amplifier. All major stations for six States engraved on an attractive label.

KIT OF PARTS \$67.70
Postage Additional.



The new INSTROL-PLAYMASTER 115 SOLID STATE STEREO AMPLIFIER ("Electronics Aust.," April-May, 1967).

A fully transistorised 10 Watt Stereo Amplifier using the latest F.E.T. high-efficiency transistors.

Crystal/Ceramic Kit \$96.80
Magnetic kit extra \$10.50

Postage additional

INSTROL- PLAYMASTER 123 PROGRAM SOURCE



("ELECTRONICS
AUSTRALIA" Oct.
68)

A high quality wide band solid state unit, fitted in free-standing metal case, featuring meter tuning and large illuminated dial.

Kit of Parts — with Ceramic Filter \$91.20

Kit of Parts—without Ceramic Filter \$77.50

Postage additional

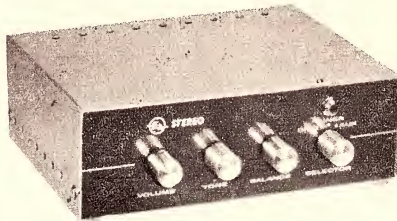

THE 10-PLUS-10 STEREO AMPLIFIER

("Electronics Australia,"
November, 1968)

A high quality solid-state 10 watt amplifier. Suitable for crystal or ceramic cartridges.

KIT OF PARTS \$62.74
Postage additional



THE 3-PLUS-3-STEREO AMPLIFIER,

("Electronics Australia," August, 1968).

A small, modern, 3-watt solid-state audio amplifier.

Kit of parts \$43.50
Postage additional

Tick catalogue required, and please include stamps for postage.

- | | |
|--|--|
| <input type="checkbox"/> Playmaster | <input type="checkbox"/> Test Equip Kits |
| <input type="checkbox"/> Toolkit | <input type="checkbox"/> Metalwork |
| <input type="checkbox"/> Cannon Connectors | <input type="checkbox"/> Microphone |

Name
Address

Post Coupon for Free Catalogue.

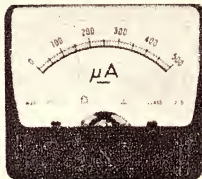

These robust and attractive meters are available in the following sizes:

- VP4A 1 1/2" x 1 3/8"
- VP3A 2 1/4" x 2"
- VP2A 3" x 2 3/8"
- VP4S 2" x 2"

Also Available, meters with scales to suit the following projects.



- EW2 1 1/2" x 1 1/2"
- EW5 1 1/2" x 1 1/2"

- Transistor Tester, Aug., 1968.
- Audio Generator, Sept., 1968.
- Power Supply, Sept., 1968.
- F.E.T. Voltmeter, Dec., 1968.

VP4A 0-500 microamps	\$4.81
VP4A 0-1 milliamp	\$4.81
VP3A 0-500 microamp	\$5.27
VP3A 0-1 milliamp	\$5.16
VP2A 0-50 microamp	\$7.11
VP2A 0-500 microamp	\$5.96
VP2A 0-1 milliamp	\$5.86
VP4S 0-500uA V.U. scale	\$4.81
EW5 0-200 microamp V.U.	\$3.43
EW5 0-200 microamp	\$3.43
EW2 0-150 microamp	\$2.51

(Including Sales Tax and Postage)

TECHNICIAN...

INSTROL EDUCATIONAL ELECTRONIC KIT

In this Electronic Age, every person should have some knowledge, however elementary, of "how it works." The new Instrol 20 in 1 electronic kit will enable you to understand in an absorbing, simple manner the basic principles underlying computers, satellite communications, industrial electronic devices, etc., etc. You make 20 different experimental circuits, including 10 working radio transistor operated radio circuits. Audio Amplifier circuits, home intercom, testing circuits including Audio Frequency Oscillator and Signal Tracer, Morse Code practice set and telegraph transmitter. etc. You use and learn about the amazing SOLAR CELL.



NO TOOLS OR SOLDERING IRON REQUIRED

All components pre-wired, ready for clip-on assembly. 50 page Instruction Manual supplied.

ONLY . . . \$16.90

(Plus 85c for Registered Post)

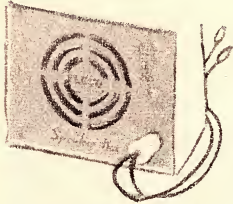
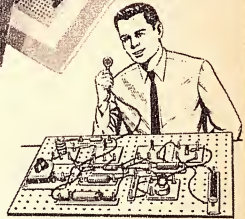

To allow others to hear the results you achieve, why not obtain the Instrol SPI Speaker box. Completely assembled, includes transistorised audio frequency amplifier, dynamic speaker and leads, housed in an attractive plastic box, and ready to plug-in at any appropriate stage of your experiments with the Instrol 20 in 1 Electronic Kit.

INSTROL SPEAKER BOX. PRICE \$6 plus 10 cents Postage.

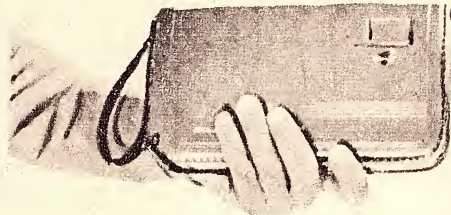

ELECTRONIC TOOL KIT

For Hobbyists Students and Servicemen

An inexpensive, yet most comprehensive, pocket-sized tool kit. Ideal for the Student, Hobbyist and Practising Service Technician. The Soldering Iron is an Australian made high efficiency 30 Watt 240 Volt type. All the other hand tools are imported, high grade steel. The complete kit fits snugly into a strong attractive zinfastening carrying satchet.

COMPONENTS

- 1—Soldering Iron with 3-pin plug 30 Watts 240V
- 1—Set 3 Spanners.
- 1—Coil Resin Cored Solder
- 1—Pair Pliers standard
- 1—Pair Long Nose Pliers
- 1—Pair Side Cutters

- 1—Pair Tweezers
- 1—Screwdriver Set complete with handle and chuck, comprising
 - 2—Screwdriver bits
 - 1—Philips driver bit
 - 1—Pointed awl
 - 1—Spintite for 4in nuts

PRICE \$12.50. Plus Regd. Postage \$1.00

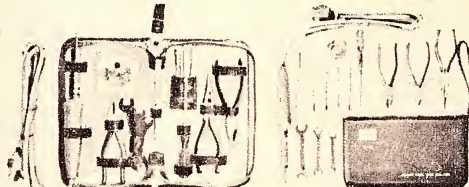

SOLID STATE V.O.M.

(Dec., '68)

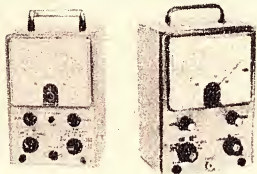

V.T.V.M. (Feb., '66)



LAB. QUALITY POWER SUPPLY
(September, 1968)

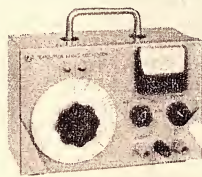

TRANSISTORISED AUDIO OSCILLATOR
(Dec., '67)



TRANSISTOR TEST SET
(August, 1968)



R.C. BRIDGE
(MAY, '66)

TEST EQUIPMENT KITS

PRICE

Solid State V.O.M.	Dec. 68	\$57.00
V.T.V.M. Feb., 66		\$57.51
Transistor Test Set	Aug. 68	\$59.47
Audio Oscillator, Dec. 67)		\$57.05
Lab Quality Power Supply, Sept 68		\$67.32
R.C. Bridge	May, 66	\$40.99

Postage additional on all kits.

PTY. LTD.

E. S. & A. BANK BUILDING
CNR. BROADWAY & CITY ROAD, SYDNEY
(OPP. GRACE BROS.) Phone: 211-4224, 211-4244, 211-4213

Using Your Tape Recorder

In A Car



For the many people who wish to use cassette recorders in cars, here is an article giving details of adaptor units which will enable the machines to be used in cars with 12-volt electrical systems. It also discusses external loudspeakers and precautions to be taken to prevent short-circuits.

By Leo Simpson

The number of people who like the facility of music-while-you-drive is evidenced by the high proportion of cars on the road fitted with car radios. In many instances, however, the car radio fails to fulfil its purpose. The programs available at a particular time are not always suitable, the signal level may be unsteady or the program may be marred by ignition noise, atmospheric or interference from roadside power mains.

Such circumstances have largely been responsible for the upswing in popularity of stereo tape players using endless-loop, multi-track, drop-in cartridges. Catering for a wide range of musical tastes, these tape cartridges are easy to use and give a sound quality far better than is available from a car radio, particularly if the stereo facility is exploited.

Being intended mainly for use in cars, cartridge players are designed, for the most part, to operate from a 12-volt automotive electrical system and are provided with an in-built tolerance to voltage variation and polarity with respect to the car body. In this respect, they are similar to car radios.

As distinct from tape cartridge players, the market is fairly well supplied, these days, with miniature tape cassette players. Some of these are mains powered and intended for use in the home, but the vast majority of cassette players are portable units, with in-built batteries, intended to be carried and used more like portable radios.

The cassette system, developed by the world-wide Philips organisation, uses 1/7-inch wide tape, operating at a speed of 1-7/8 inches per second. It can accommodate four tracks, normal pre-recorded cassettes carrying two stereo pairs. In mono cassette players, the respective stereo pairs are scanned by a single half-track head and reproduced as a composite mono signal.

The system has the same flexibility as ordinary reel-to-reel tape systems, in that music and speech can be recorded on blank cassettes, and fast-forward and fast-rewind is available.

Over and above replay for entertainment, cassette players are commonly used for dictating letters for recording interviews and for making verbal notes of clients' requirements, jobs to be done, details of scenes being photographed and such like.

While portability is a strong feature of such cassette players, the running time from a set of batteries is a factor to be considered.

The current drain of portable cassette players typically varies from a minimum of 100mA in record and replay mode to as much as 400mA on musical peaks in the higher-powered units. Depending on the level at which the sound is reproduced, the life of the internal batteries will range from 10 to perhaps 20 hours. If the unit is to be used more than just occasionally in fixed situations, an external power supply to substitute for the batteries has a clear attraction.

Pictured is a "battery saver" unit manufactured by the A. and R. Electronic Equipment Company, of 42-46 Lexton Road, Box Hill, Victoria, and handled by trade outlets throughout Australia. Intended to plug in to the power mains, it produces a nominal 6V or 9V at the flick of a switch, with a current capability and an order of regulation adequate for most portable cassette players.

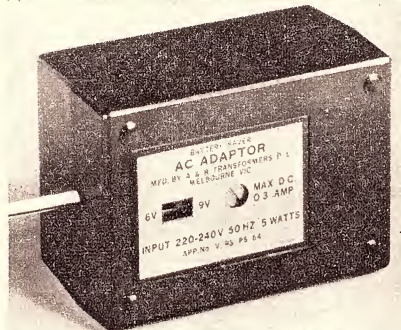

A typical commercial power supply, as mentioned in the text, designed to operate from the mains.

If the supply is fitted with a connector appropriate to the particular player, it is usually only a matter of plugging it in and switching on. With many cassette players, the act of inserting an external power plug automatically disconnects the internal batteries.

Not surprisingly, there has been a fair demand for a means to operate cassette players from the electrical system in cars, again with a view to conserving the internal batteries. Particularly is this the case where the owner wishes to use the player in an improvised cradle or on the seat to provide the kind of music he likes while on long journeys.

The question does arise as to whether the limited power output of a portable player is adequate in the rather noisy environment of a fast-moving vehicle. Compared with a car radio feeding from 2 to 5 watts into a 6 to 9-inch loudspeaker, cassette players may deliver more like 0.25 to 1.0 watt into a 3-inch loudspeaker. Before becoming too involved in the selection of a cassette player for casual use in a car, purchasers should take some steps to determine whether it will provide an adequate sound level for their purposes in their kind of car and their kind of driving situation.

An adaptor enabling cassette players to be used in cars with 12-volt batteries must supply the necessary 6 to 9 volts that most units run from, at varying current drain, while the battery voltage ranges from as low as 11 volts when the car is idling with lights on to as high as 16 volts under certain other conditions.

Two circuits are presented here, the first using a zener diode in a shunt regulator and the second using a power transistor and zener diode in a series regulator. Both will function equally as well and will cost about the same for parts.

Before describing the units in detail, certain points should be mentioned. There is a variety of cassette players on the market and these may or may not have their positive or negative supply rail connected to exposed metal parts of the case. For portable service, as originally intended, it is quite unimportant. Typically, however, if a cassette player with its positive supply rail connected to the case is used in a car

with a negative earth system (negative pole of the battery connected to chassis) a short-circuit would occur if the cassette case came into contact with the metal structure of the car.

Hence, if you are using a cassette player with the positive rail connected to case in a car with a negative earth system (or a cassette player with negative rail connected to case in a car with a positive earth system) you will have to take care to see that shorts do not occur. If the recorder is cradled under the instrument panel or on a console between bucket seats, it should be insulated from chassis with a sheet of vinyl, rubber or other insulating material. In fact, when energising any cassette player from any car electrical system, it is a good flat rule to keep the metal parts strictly isolated.

In both the supplies described, the question of damage due to a possible short has been kept in mind. Precautions are desirable, even if the "damage" amounts to nothing more than a blown fuse. Not every motorist has a spare fuse ready to hand, nor the aptitude to install it.

Initially, when developing these adaptor units we used a 20-watt zener diode, BZY93, as the basis of our tests; this is combined with a suitable value of resistor to form a shunt regulator. A shunt type regulator has a major advantage over the series regulator in that the regulating element, be it zener diode or transistor, does not require protection against damage due to excess current drain in the external circuit.

However, a disadvantage of a shunt type regulator is that, for a given supply and output voltage, it will consume the same amount of power whether it is connected to a load or not. This means that at normal sound levels from the cassette player a fair proportion of the power drawn from the battery will be dissipated in the regulator circuitry, so that it will exhibit a

For voltages to just below the "avalanche" or breakdown figure, negligible current flows through the diode. As the voltage rises to the breakdown point the zener diode begins to conduct heavily, effectively limiting any further voltage rise to a few per cent. The breakdown effect does not cause any damage to the zener diode, provided the current is kept within the ratings for the particular device.

Thus, a practical circuit for the shunt regulator will contain a series resistor of suitable value which will pass sufficient current to the load and zener diode at the lowest battery voltage to be encountered, yet still limit the current through the zener diode to a safe value when the load is disconnected and the battery voltage rises to its maximum value.

To avoid unnecessary current drain and unnecessary heating in the regulator circuit, the series resistor should have as high a value as possible, consistent with these requirements. However, it should maintain the zener diode in conduction under normal playing conditions at the lowest expected battery voltage, otherwise the supply to the tape player will assume a poorly regulated, high impedance characteristic, resulting in increased distortion.

The zener diode used in the prototype shunt regulator is a type BZY93/C7V5R, a nominal 7.5 volt unit and the resistor is 15 ohms with a dissipation rating of 10 watts. The current drain, with the load disconnected and the battery voltage at 16 volts, is of the order of 500mA. Current drain with a 12 volt supply will be about 350mA. The regulation of such a circuit will be more than sufficient for the purpose and any wow and flutter apparent on the tape will certainly not be due to supply variations. This unit would be suitable for units requiring a 7.5v supply at a

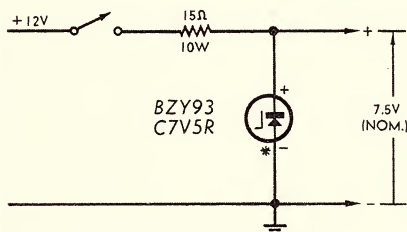

FOR CARS WITH NEGATIVE EARTH

* STUD CONNECTION

FOR PLAYERS WITH DRAIN UP TO 200mA
USE 27Ω RESISTOR

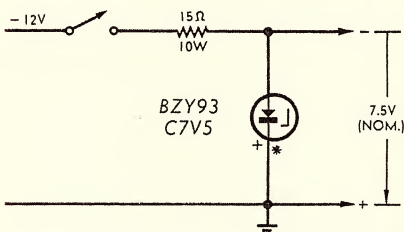

FOR CARS WITH POSITIVE EARTH

* STUD CONNECTION

FOR PLAYERS WITH DRAIN UP TO 200mA A 27Ω/5W
RESISTOR AND BZZ17 MAY BE SUBSTITUTED

The simple shunt type regulator employing a zener diode. The circuit on the left is for negative earth cars, the one on the right for positive earth types. Note the difference in the zener diodes.

substantial temperature rise. In a vehicle this is of minor importance as the current drain will be less than that for the lights on the instrument panel and the power dissipated will be well within the ratings of the components one would normally use.

Operation of the simple shunt regulator is based on the characteristics of the zener diode. The zener diode is designed to exhibit a breakdown characteristic in the direction of reverse bias at a particular voltage. Zener diodes are freely available with breakdown voltage ratings between about 4 and 75 volts.

current drain of up to 400mA on audio peaks and with an average current drain of around the 200mA mark or less.

At normal battery voltages, the zener diode and resistor will dissipate several watts each and steps have to be taken to ensure that their operating temperature stays within acceptable limits. The aluminium box in which the unit is assembled is used as a heatsink both for the diode and the resistor. The box is intended to be mounted on the lower edge of the dash panel where it is easily accessible and where the heat generated within will

If you want STEREO EQUIPMENT You'll deal better with H. B. RADIO SALES JULY SPECIALS

KENWOOD TK250 AMPLIFIER/
2 Wharfedale unit 3 speaker systems. Dual 1019 player with Shure magnetic cartridge on platform **\$398.00**

KENWOOD 150 AMP, 2 Magnavox 10in speaker systems in Teak. Garrard AT60 with Shure M44G on Platform, **\$275.00.**

SANSUI 555

2 Wharfedale super 10 speakers in R3 teak cabinets, dual 1019 player with Shure M44G, platform and cover **\$460.00**

MAGNAVOX or ROLA design slimline cabinet with 8 W.R. (V.C. 15, 8 or 3 ohms) or 8 CMX speaker fitted **\$30.00**
Cabinet Kit only **\$11.00**

MAGNAVOX 10 W.R. and 3 T.C. Tweeter with Crossover network in 2 C.F. cabinet $\frac{1}{2}$ " material **\$43.00**
12 W.R. in 3 cubic ft. cabinets **\$43.00**

GOODMANS design 3 CF Cabinet and Twin-axiom 10 speaker, $\frac{1}{2}$ in material **\$57.50**
Cabinet Kit and Speaker **\$44.20**

WHARFEDALE design, 3 CF cabinet (R3) $\frac{1}{2}$ in material and Golden 10 speaker \$62.00
Cabinet Kit and Golden 10 Speaker **\$48.00**

Special quotes for other Wharfedale or Goodmans speakers.

Available in Maple, Walnut or Rosewood colours. Teak veneer \$1 extra for Slimline and Bookshelf models. \$2.00 extra for others.

PLAYMASTER Bookshelf Speaker System. Complete, \$31.00
Cabinet kit only **\$7.40**

All other parts, including speakers, innerbond, etc., **\$16.00.**

POINT 4. BOOKSHELF UNIT, complete kit of parts, cabinet, speaker, innerbond, etc., \$25.00.
Complete. Price **\$35.00.**

PLAYMASTER Super Bookshelf System. Complete \$41.00
Cabinet kit only **\$10.50.**

All other parts, including speakers, innerbond, etc., **\$25.00.**
Wharfedale Unit 3. Complete kit of parts, cabinet size, 14in x 9in, $\frac{3}{4}$ in ($\frac{1}{2}$ in)—\$41.25 (made \$49).
Cabinet size 11 $\frac{1}{2}$, 21in 9 $\frac{1}{2}$ in ($\frac{1}{2}$ in)—**\$45.50 (made \$54).**

Packing charge **\$1 per order.**
Postage: N.S.W., \$1.00; Qld., Vic., Tas., \$1.40; other States, \$2.00.

Send for Stereo Catalogue

H. B. RADIO SALES

Manufacturers of Quality Radio and Radio Furniture for 37 years
103-105 Catherine Street, LEICHHARDT, SYDNEY
Telephone **56-5580**

MULTIDRAWER

**A TRANSPARENT MULTI-COMPARTMENT DRAWER
AND OUTER CASE MADE OF STRONG CLEAR PLASTIC**

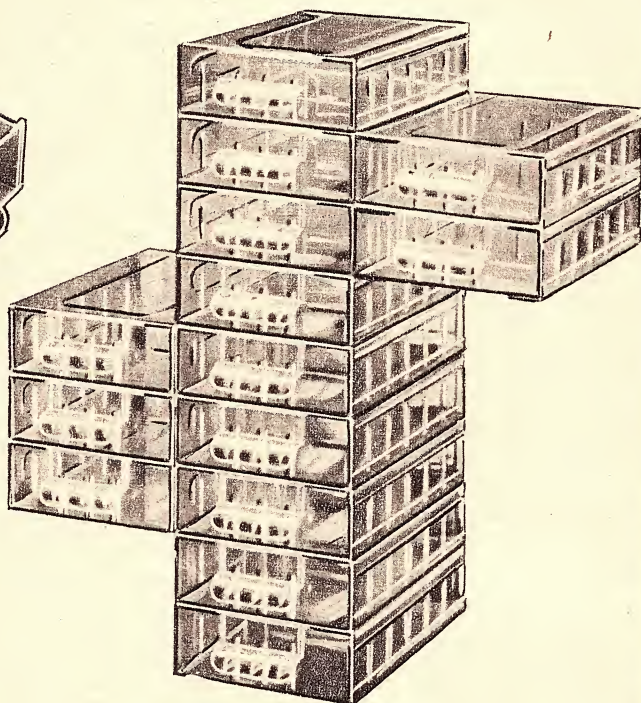
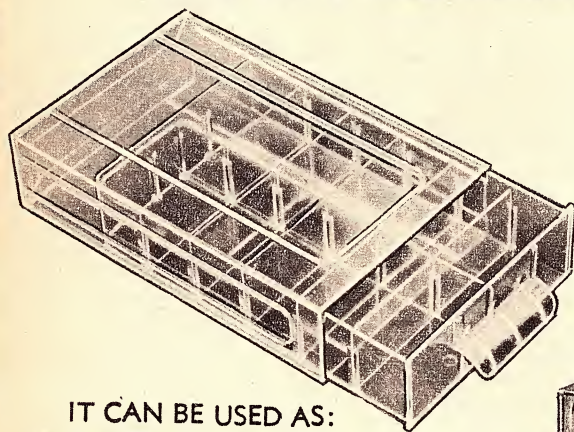

IT CAN BE USED AS:

- a self contained STORAGE BOX UNIT
 - or a MULTIDRAWER CABINET by joining the individual units
- IMMEDIATE ASSEMBLY**
by sliding action
NO GLUE — NO TOOLS NECESSARY!

Each drawer can be partitioned into 12 varieties of compartment arrangements by removable dividers.

The Multidrawer consists of a drawer sliding into an outer case. Both parts are made of strong clear plastic to ensure immediate visual location of stored articles (opaque outer case also available). The outer case has built-in integral dovetails and grooves for vertical and horizontal assembly by means of sliding the corresponding sides. This assembly is achieved instantaneously without using any tools or cement.

The drawer has built-in grooved side ribs, which allow its partitioning into 13 possible combinations of compartments by simply dropping into the grooves standard dividers, available in 4 lengths. The longest of the dividers is provided with the same ribs as the drawer in corresponding positions, to firmly hold the smaller dividers.

The dividers can be left as removable for any future rearrangement, or could be cemented in by using TRICHLORETHYLENE.

The assembled cabinet will firmly stand on any flat surface and will not require additional reinforcement.

AT HOME: as a box for sewing, jewellery, haberdashery, hair accessories, cosmetics, medicaments, fishing accessories, writing utensils, small hardware, cigarettes and cigars, photographs, colour slides and many others.

AND IN: SHOPS, OFFICES, WORKSHOPS, LABORATORIES, STORES and FACTORIES.
for visible storage of small parts and also as production assembly aid.

THE MULTIDRAWER — THE STORAGE BOX OF 101 USES

SPECIFICATIONS: Drawer — transparent. Outer case — opaque (steel grey). Dimensions—Identical for both models are: Outer Case: Length: 9 5/16", width: 6 7/16", Height: 2 3/8". Drawer: Length, 9 3/8", Width: 6", Depth: 2". Protrusions of the handle — 3/4". Weight of the unit — 12 ozs.

Also available from General Accessories interstate Branches.

Trade Enquiries Invited

Write to General Accessories for further information and Price List.

GENERAL ACCESSORIES

(A DIVISION OF ELECTRONICS INDUSTRIES)

116-118 CLARENCE STREET, SYDNEY 443 CONCORD ROAD, RHODES — 73-0211

be conducted away to the surrounding metalwork.

The zener diode is a stud mounting type and, since one electrode is connected to the car chassis via the metal box, a reverse-polarity type must be used for cars with a negative-earth system. This has the stud connected to the cathode (the negative electrode) whereas most stud-mounting zener diodes have the anode connected to the stud; hence the "R" on the end of the type number, BZY93/C7V5R. For cars with positive earth system, the normal polarity zener, BZY93/C7V5, may be used.

The resistor is a 10 watt unit made by I.R.H. Components Pty. Ltd., type

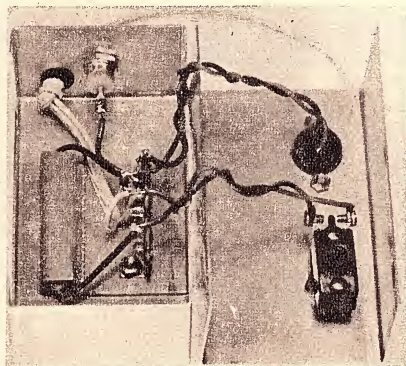

Interior view of the shunt type supply. Note the resistor clamped to the case which functions as a heat sink. The switch is optional.

PW10, which has a square cross-section, enabling it to be clamped to the metal box to improve heat conduction.

We have shown two circuit diagrams for the shunt regulators, one for cars with negative earth system and one for cars with positive earth. The purpose is to specify clearly the type of zener diode to be used and to show that the series resistor must be connected in the active line from the battery (i.e., the side not connected to the car chassis). This is to preclude the possibility of blown fuses or worse, damaged wiring, if the supply is shorted out due to the causes listed at the beginning of the article. As it is, a short-circuit

will merely cause a maximum current of less than one amp to flow.

Some cassette players, such as the Philips unit illustrated, function at current drain of less than 200 milliamps. This means that the series resistor can be increased to 27 ohms, reducing the battery current drain and heat rise. Also, for cars with positive earth only, a lower-rated zener diode type BZZ17, can be substituted. The BZZ17 cannot be used in cars with negative earth system, as it is not available in reverse-polarity form.

Some readers may consider that an electrolytic capacitor connected across the output of the regulator would be desirable to decrease the impedance of the supply and so reduce distortion in the audio output of the cassette player. In fact, the effective output impedance of the supply is quite low, and the electrolytic capacitor needed to produce a significant further decrease in the impedance would be very large. In addition, many cassette players have a large electrolytic connected across the supply to reduce the impedance of their internal batteries. If it is felt that the electrolytic capacitor is desirable, it should be installed in the cassette player if possible, not in the regulator case, as the interior becomes quite hot, especially on hot summer days, and this could tend to dry out the electrolyte.

When we constructed the prototype shunt regulator we incorporated a power switch, as shown in the accompanying photograph. Some readers may regard this as a mixed blessing since, even with the recorder disconnected, there will be a drain on the battery if the switch is accidentally left in the "on" position. Use of a four pin output plug eliminates this problem. The plug is wired with two of the pins linked, as shown in the circuit diagram of the zener diode regulators, so that the unit draws current only when the output plug is inserted into the socket.

The prototype shunt regulator gave a nominal 7.5V output and while this will be ideal for many cassette players, such as the one made by Philips in the illustration, other cassette players use a 6-volt supply. Unless the manufacturer states otherwise, they should not be operated much above their nominal supply voltage.

Since BZY93 zener diodes are no longer available in ratings below 7.5 volts, some other approach is necessary

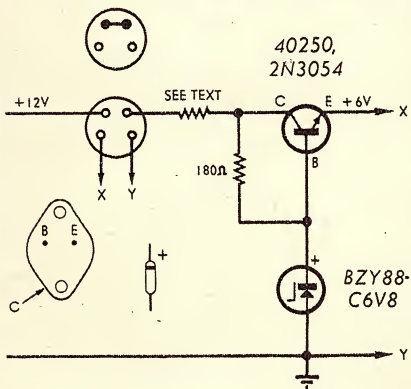

FOR CARS WITH NEGATIVE EARTH

FOR 7.5V SUPPLY USE BZY88/C7V5
FOR 9V SUPPLY USE BZY88/C9V1

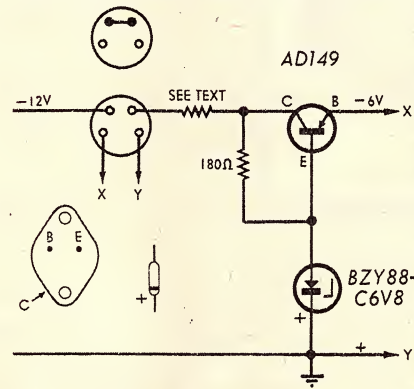

FOR CARS WITH POSITIVE EARTH

FOR 7.5V SUPPLY USE BZY88/C7V5
FOR 9V SUPPLY USE BZY88/C9V1

Circuits for series type regulators. The one on the left is for negative earth systems, that on the right for positive earth. Note the change of transistor type to accommodate the changed polarity.

The HI-FI experts

Have expert advice on your choice of a stereo system. Come to Kent Hi-Fi and choose from our complete range of imported, world-famous brand Turntables, Amplifiers and Speakers. We'll advise you on latest trends and on the best value system for your price. Our personal six months' guarantee covers every unit sold, delivered and installed free of charge.

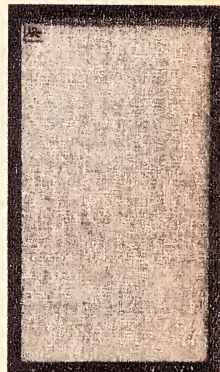

AR



If you want a high performance Stereo System, consider the famous American Acoustic Research. A & R Equipment is designed to reproduce a musically natural sound — not one that is distorted or "pepped-up" — but one which, as the term "hi-fi" implies, produces the highest possible degree of fidelity to the original. A & R turntables, amplifiers and speakers are now available from Sydney's top "Hi-Fi" Shop!

KENT HI-FI

432 Kent Street, Sydney. 29 2743

(20 yards from Druiit Street)

PIONEER®

WORLD-FAMOUS BRAND IN HI-FI REPRODUCTION



C 3500
COMPACT STEREO SYSTEM

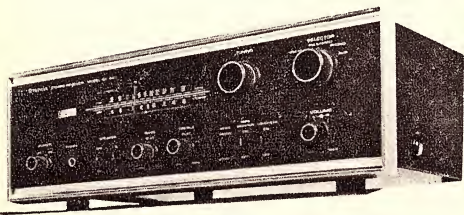

SX 440 SOLID STATE TUNER AMPLIFIER



SA 500 SOLID STATE AMPLIFIER

YOU DON'T SEE PIONEER

among the 'one day specials', the 'packaged deals' or marked 'even less with trade in'.

THERE IS A VERY GOOD REASON.

Your PIONEER Dealer is in business to stay - and to do this, he must give you demonstrations, sound advice, after-sales assistance, warranty service if needed and so on.

He just can't afford to have you become anything but a completely satisfied customer.

No chance here of artificially inflating prices just to offer a so-called discount.

If you want to enjoy the purest, cleanest sound of perfectly reproduced recorded music, ask your Hi-Fi Dealer or Music House to demonstrate the PIONEER range - individual players, amplifiers, speaker enclosures, or complete stereo systems.

Also for the Home Builder, every component of a Hi-Fi system, each without equal in its class.

Ask for attractive brochures giving full specifications.

SEE PIONEER! HEAR PIONEER! DEMAND PIONEER!

At Authorized PIONEER Retailers Everywhere.

All Trade Enquiries to:-

Sole Australian Importers and Representative

ASTRONICS AUSTRALASIA PTY. LTD. - ALL STATES.

MELBOURNE: "ASTOR HOUSE", 161-173 STURT STREET, SOUTH MELBOURNE. PHONE: 69 0300.

SYDNEY: 121 CROWN STREET, EAST SYDNEY. 2010. PHONE: 31 6721.

ADELAIDE: "ASTOR HOUSE", 81-97 FLINDERS STREET, 5000. PHONE: 23 4022.

BRISBANE: "ASTOR HOUSE", 50-54 LITTLE EDWARD STREET, 4000. PHONE: 2 0271.

PERTH: 14 GOLDING STREET, WEST PERTH. 6005. PHONE: 28 6111.

HOBART: 199 COLLINS STREET, 7000. PHONE: 2 2711.

to obtain a 6-volt supply from a 12-volt battery. The logical approach is to use a power transistor as a series regulator with reduced current drain and heat rise, and a more modest heat sink.

For cars with a negative earth system we used an NPN silicon power transistor, type 40250, as the series regulator. A low power zener diode, type BZY88, provides the reference voltage, the actual load voltage being

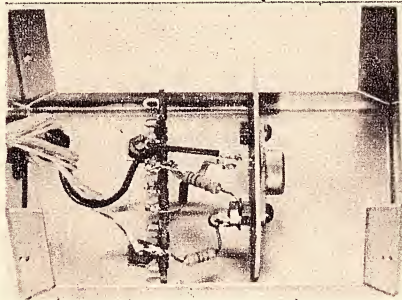

Interior view of the series type supply. The output socket is on the lid of the box. Note the heat sink for the power transistor and the terminal strip for minor components.

about half a volt less than the reference voltage. If 40250 transistors are in short supply at the time you wish to build the unit, a 2N3054 may be substituted or, failing that, the much higher rated type 2N3055/BDY20 may be used. At the time of writing, all the above transistors are in good supply.

The configuration used in the series regulator is commonly referred to as the "emitter-follower" mode. This is because the load voltage is a near replica of the reference voltage, largely independent of the voltage at the collector. As long as there is sufficient battery voltage to supply the requirements of the transistor and load, variations in the battery voltage have a minimal effect on the load current and voltage.

If a higher voltage than 6 volts is required a higher voltage zener diode may be substituted, as indicated on the circuit diagram. No other changes are necessary. For cars with a positive earth system, we used a germanium PNP transistor, type AD149, which again enables the series regulating element to be placed in the active line from the battery.

As mentioned earlier, these series regulators require protection against short circuits as they would otherwise be destroyed the very moment an overload occurred, fuses notwithstanding. For this reason, we have specified a resistor in series with the collector of the transistor. This can have a value from 5.6 to 6.8 ohms and will have minimal effect on the regulation. The current is thus limited to a value within the maximum current rating of the transistors specified. However, if the short is sustained, the power dissipated within the transistor will cause a steady temperature rise due to the small heatsink.

To ensure that this does not rise above acceptable limits and ultimately destroy the transistor the resistor must be a $\frac{1}{4}$ -watt carbon film type, as typically made by Philips. Under short

circuit conditions, the resistor will be grossly overheated and after 30 seconds or so, will burn up and become a high resistance, with a value of around 5,000 ohms. Thus, it effectively acts as a fuse which limits the current to a safe value before it is blown. This does not happen with an ordinary fuse as the current can rise to many times the nominal value before the fuse finally blows.

Only carbon film resistors may be used. Wirewound types, as made by I.R.H. Components Pty. Ltd., which are encased in a moulded phenolic body, are not suitable as they may not "fuse." If the short circuit is removed after about 10 seconds or so the resistor will not be damaged. So there it is, a means of protecting the transistor with less than 10 cents worth of resistor.

If readers consider the above protection system too much of an inconvenience, in having to change the damaged resistor, a 10-ohm resistor with a rating of at least two watts can be substituted. This will have a greater effect on the regulation than the above system but will mean that components do not have to be replaced after an accidental overload. An electrolytic capacitor, with a value of at least 1000uF, may be connected across the output of the regulator and may be installed inside the case of the regulator. In most cases, however, it will not be necessary.

The series regulator was installed in a box a little larger than that for the shunt regulator. The transistor is mounted on an L-shaped piece of 18-gauge aluminium the same width as that of the box. The transistor is insulated from the box by the usual pair of nylon washers and sheet of mica. When mounting the transistor

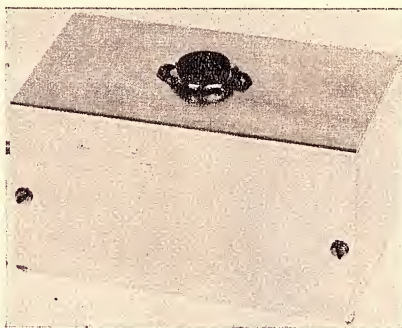

The complete series power supply. The four pin outlet socket also completes the input circuit via a shorting link in the matching plug.

silicone grease should be lightly applied to, both the transistor and the heatsink, to ensure efficient heat transfer. Under normal conditions, the power transistor will dissipate less than 3 watts, depending on the current drain and voltage rating of the zener diode, so that it will be just warm to the touch.

The two resistors and zener diode are wired between the transistor and a miniature tagstrip. For the output of the regulator we used a four-pin plug and socket. The plug has a link in it, as shown on the appropriate circuit diagram, and this serves the purpose of a switch. When the output plug is

COMPLETE HI-FI RADIOGRAM-TAPE RECORDER ALL IN ONE

MODEL TR9

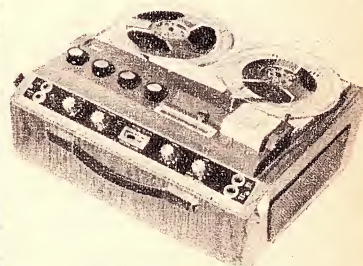

AS AN AMPLIFIER . . .

- Frequency response, 20-20000 cps.
- 7 Watts RMS. output per channel.
- Distortion less than .25%
- Separate treble and bass controls.

AS A RADIO . . .

- Being fully transistorised, can be switched on all day at full output without heat problems. Program can be recorded on tape without any external connections.

AS A TAPE RECORDER . . .

- Freq. response 30-18000 cps.
- 3 speeds. Meter level indicator.
- Push button operation.
- Superimposing.

PRICES:

- 2 track mono, \$159.00
- 4 track mono, \$169.00
- 4 track stereo, \$230.00

RADIO TUNER CAN BE FITTED TO ANY OF THE ABOVE MODELS FOR \$28 EXTRA.

TAPE DECKS

for the home constructor. COLLARO (Magnavox) tape decks complete with record/play and speed change switch wafers fitted . . .

2 tracks, \$48. 4 tracks, \$55. SPECIAL LOW IMPEDANCE HEADS for transistorised tape amplifier circuits (Mullard) available.

CLASSIC TAPE RECORDERS

93B LIVERPOOL ROAD,
SUMMER HILL, N.S.W.
Telephone 79-2618

HI-FI STA STEREO ELECTRONICS SPECIALISTS

MANUFACTURE-SALES-SERVICE
(Props. C. & B. Renner)

731 Centre Road, East Bentleigh, Vic.
3165.

Telephone 579-1519 A.H. 97-5539



MODEL
NIKKA
KA-1000
\$111.00

SPECIFICATIONS

TYPE: Solid State 40 Watts all transistor Stereo Amplifier.

OUTPUT POWER: 20 watts per channel peak power.

OUTPUT IMPEDANCE: 8-16 ohms.

FREQUENCY RESPONSE: 20-20,000 Hz.

HARMONIC DISTORTION: less than 1%

HUM AND NOISE LEVEL: Phono and tape better than 45 db.

Tuner and Auxiliary — better than 60 db.

EQUALISER: Tape—NARTB Curve, Phono RIAA curve.

INPUT FOR MAXIMUM OUTPUT: Phono/Tape 0.5 mV.

Auxiliary/Tuner 150 mV.

SELECTOR SWITCH FUNCTION: Phono-tuner-tape-auxiliary.

MODE SWITCH FUNCTION: Stereo-reverse-monoral.

TREBLE CONTROL: Plus 10 — —15 db.

BASS CONTROL: Plus 10 — —15 db.

POWER SUPPLY: 117/240 Volts, 50/60 Hz A.C.

TRANSISTORS: 20 (2SB347-2, 2SB175-4, 2SB176-2, 2SD32-2, 2SB173-2, 2SA102-2, 2SA70-2, 2SB449-4.)

DIMENSIONS: 12 5/16" — width, 4" — height, 8 1/16" — depth.

THIS MONTH SPECIAL
10 Watt RMS per channel PALACE Stereo Amplifier.

2 Bookshelf Speakers
3 speed Record player,
Base and Cover.

FANTASTIC OFFER AT \$185.

Mail Orders, send postal note, cheque or money order. Please add postage.

disconnected the battery voltage is also disconnected.

To connect the battery voltage to the input of the regulator we used a polarised figure-8 flex (one side has a coloured stripe) with the coloured side used for the active line of the battery. The unit should be connected to the accessory terminal on the ignition switch or the appropriate terminal for the accessory fuse.

Most people would wish to obtain the best reproduction from their cassette machines by using an external loudspeaker, if this can be done with the particular unit. If the machine is used mainly for note-taking or dictation then the internal loudspeaker would suffice. The impedance of the external loudspeaker should be the same as that specified by the manufacturer. It may be higher, which will result in a reduction of power output, but it should not be lower. For example, if an 8 ohm loudspeaker is specified, a 15-ohm unit could be used but anything substantially less than 8 ohms should be avoided.

The loudspeaker should be as large as is practical, to obtain the best efficiency and bass response and may even be a twin-cone unit to ensure good treble reproduction. Both sides of the voice coil should be isolated from the chassis of the car to avoid the possibility of shorting the output of the recorder, which would almost certainly result in the demise of the output transistors.

If a car radio is already installed in the car then its loudspeaker could be used, but only if it is completely dis-

connected from the car radio at the time. Typically, both sides of the loudspeaker could be isolated from the car radio with a DPDT (double-pole, double-throw) change-over switch when the cassette machine is in use. The observations about loudspeaker impedance must also be observed, of course.

A note on the installation of loudspeakers is appropriate here. If a stereo machine is used, one speaker may be installed in the instrument panel and the other could be mounted under a cut-out in the rear parcel shelf. This may make the purists shudder, but the sound quality will still be better than that from a mono unit.

Perhaps the most attractive position for the loudspeakers is mounted face-up beneath the sloping front or rear windows, but this can be impracticable in many cars which may not have the necessary space for installation. Alternatively, good presentation of the sound may be obtained with a speaker mounted in each door panel, but care must be taken to ensure that the speakers are sealed against the ingress of water. Other alternatives are the kick panels near the bulkhead or the panels adjacent to the rear seat, all depending on the design of the car.

If the loudspeakers are to be mounted face up, they should preferably be types intended for use in cars. Such units often have small holes punched around the base of the cone to allow dust to fall through, rather than permeate into the voice coil gap. Ordinary loudspeakers can be protected to some extent by sealing them in a plastic bag before installation.



BATTERY SAVER—A/C ADAPTOR

Permits A/C Mains operation of Transistors and other 6-9V Battery Powered Equipment

— at Negligible Power Cost!

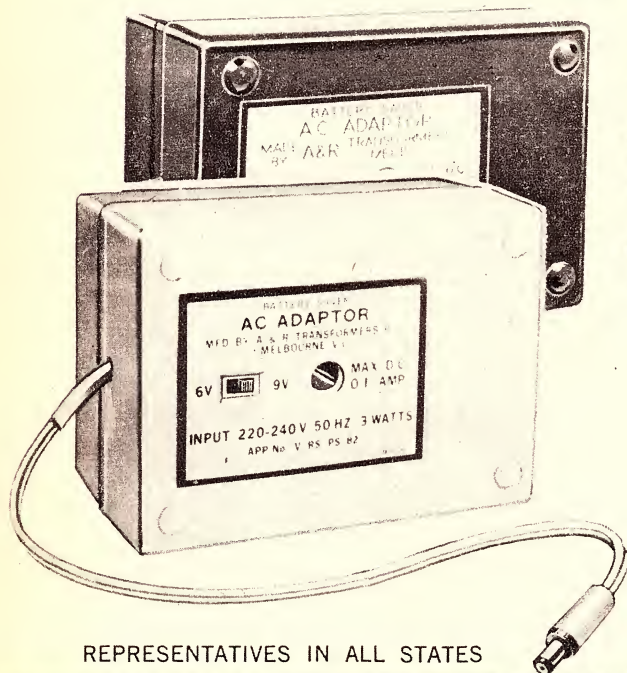

REPRESENTATIVES IN ALL STATES

- 6 or 9 Volt (Nominal Voltage) selected by external switch
- Double insulated for absolute safety.
- Handsome cabinet complete with 3 pin power point plug, and radio lead with plug.
- Measures a compact 3½ ins. x 2½ ins. x 2 ins.
- Suitable for any 6 or 9 Volt Battery Operated Transistor Equipment.

APPROVED BY ELEC. SUPPLY AUTHORITIES

PS 64 Specially for Tape Recorders
PS 82 Specially for Transistor Radios

Manufactured by:

A & R ELECTRONIC EQUIPMENT CO. PTY. LTD.
42-46 Lexton Rd., Box Hill, Vic. 3128.

Phone: 89 0238

S.A. SCOTT THOMPSON P/L, 93 Gilles St., Adelaide 23 2261 N.S.W. SOANAR ELECTRONICS P/L, 82 Carlton Cres., Summer Hill 798 6999
W.A. EVERETT AGENCY P/L, 17 Northwood St., W. Leederville 8 4137 Q'LAND. R. A. VENN P/L, 71-73 Doggett St., Valley, Brisbane 51 5421

SIMPLE CRYSTAL AND TRANSISTOR SETS

"Please send me the circuit for a crystal set" is one of the most regular pleas through our Information Service. This, despite the fact that we have described many crystal sets through the years and that we have tried to encourage beginners to start with something only slightly more expensive but certainly much more satisfying.

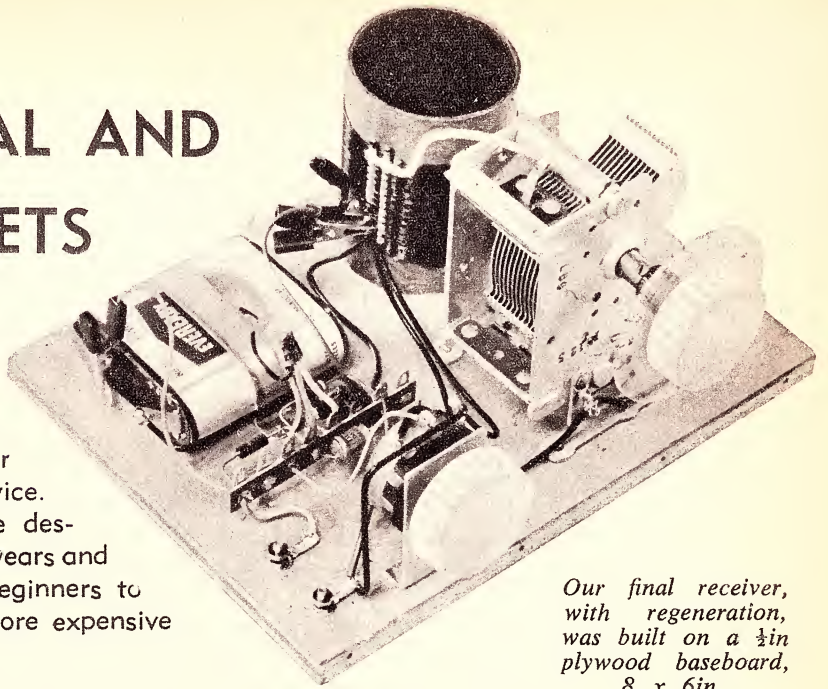

Our final receiver, with regeneration, was built on a 1/2 in plywood baseboard, 8 x 6 in.

What follows is an attempt to satisfy the honour of all parties — information which will allow you to build a crystal set if you really want to, or to take the further and recommended step into transistor circuitry.

Therefore, in easy-to-follow steps, beginning with the crystal set, we progress to an amplified crystal set, then to a regenerative receiver.

It will be found by comparison with the crystal set that the performance of our final receiver certainly justifies the very small additional expense involved. It is also likely that this project will assist members of the Wireless Institute of Australia's Youth Radio Clubs in attaining their Amateur Operator's certificates.

With these thoughts in mind and the fact that many will be on limited budgets, we have confined our thinking mainly to the use of "junk box" parts and to simple "breadboard" construction.

This article appeared originally in our March, 1963, issue. Since then, it has proved to be one of our most popular projects for beginners, and we receive numerous requests for reprints through our Information Service. In view of this, we have decided to represent the article, up-dated where necessary.

Firstly, let us consider the theoretical side of things. The function of a crystal set is to select the desired signal by a selective tuning circuit and convert the radio frequency signals into audio frequency signals by the process of demodulation or detection.

To understand how this latter process works, it is desirable to understand, first of all, something of the action which takes place at the broadcast station. The transmitter generates a radio frequency signal or "carrier" which is of constant average amplitude and this is used as a medium for transporting the required intelligence from the transmitter to the receiver. Music or speech is caused to "modulate" or vary the carrier amplitude at a rate which is governed by the frequency of the modulating signal. In fact, the term amplitude modulation (AM) is given to the type of transmission normally used.

If the incoming signal were applied to the phones directly, nothing would be heard because the phones are unable to respond to the rapid alternations of the carrier. But if we remove alternative half-cycles of the carrier wave by passing it through a rectifier, each successive half-wave pulse will be in the same direction and the movement of the diaphragm of the phones will be according to the average carrier strength.

(These matters, as well as other sub-

jects covered in this article, are explained in more detail in our book "Basic Electronics," available by post from "Electronics Australia," Box 2728, G.P.O. Sydney, 2001, price \$2.20 including postage.)

Early crystal sets generally depended upon the rectifying properties of "galena" crystal (lead sulphide, PbS) to carry out the detection process. This substance exhibited to some extent the properties of the valve diode in its ability to pass current in one direction and impede it in the opposite direction. The crystal was held in a clamp while a thin wire "catswhisker" was adjusted to make contact with it at a point which gave the best signal.

This, as dad will probably remember, was quite a fiddly adjustment and the family had to tread warily in order that the "whisker" would not be bumped from the sensitive spot.

In this "solid state" age, a whole series of germanium and silicon diodes is available, which are widely used as detectors. Most of these are inside tiny glass envelopes and are able to withstand quite heavy vibration without ill effect.

The first circuit described here, the crystal set, uses a germanium diode which consists of a small wafer of germanium containing a small amount of arsenic or antimony to produce N type semiconductor material, in contact with a phosphor bronze wire. This

Circuit A (left) is for a simple crystal set. A germanium diode or the base - to - emitter junction of a transistor can be used for the detector.

Circuit B (right) shows how few extra parts are required to obtain an amplified signal.

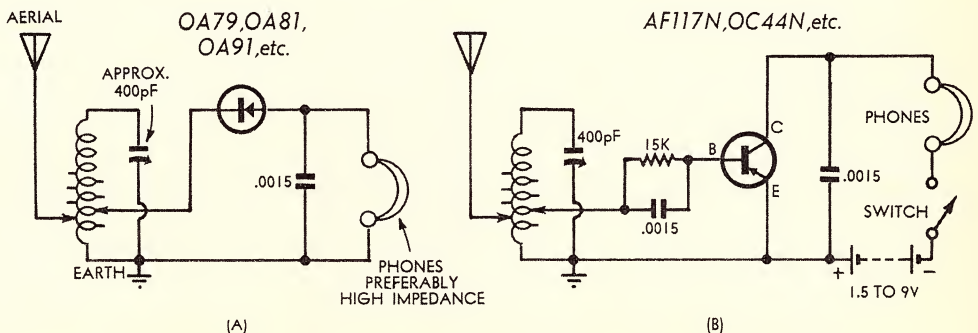

**FAMOUS
ACUFINE
AND
DIAFINE**

Film developers



ACUFINE—For high resolution and finest grain. A maximum acutance, ultra fine grain film developer combining optimum quality with the highest effective speeds currently available with single solution developers. For instance ASA 125/FP3 Film is indexed at ASA 250 with Acufine development of 3½ minutes at 70 deg. temperature.

PRICE: Quart \$1.16, Gallon \$4.12. (Post Free).

DIAFINE (Two bath)—For Highest speeds and widest latitude. Usable over a wide temperature range with one developing time for all films. Fast, medium and slow films can now be developed simultaneously without adjustment in developing time. Produces greatest effective speeds as indicated by the exposure index of 200 ASA for Ilford Pan F. normally rated at 50 ASA.

PRICE: Quart \$3.52, Gallon \$9.96. (Post Free).



**DORMA H3
ELECTRONIC FLASH
HIGH POWER
LOW COST
ONLY \$16.95**

40 JOULES F.F. 40 K'CHROME
WORKS FROM 4 PENLIGHT CELLS

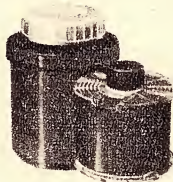

JOB TANKS AND SPIRALS

No. 35F—Tank and Spiral 35mm .. Automat .. \$7.37	No. 160D — 2 x 35mm or 2 x 127 or 2 x 120 .. \$8.62
No. 16/35 — 2 x 35mm .. \$15.33	No. 16/160D — 16mm or 2 x 35mm or 2 x 127 or 2 x 120 .. \$8.62
No. 16mm or 35mm (20) .. \$7.64	Reporter — 5 x 35mm or 4 x 127 or 3 x 120 .. \$18.66
No. 110 — 35mm (20) .. \$5.74	
No. 160 — 35mm or 2 x 127 or 2 x 120 .. \$7.64	



**MACBRO
FLAT BED**

**DOUBLE SIDED GLAZERS and
STAINLESS STEEL SHEETS**

TOP QUALITY GLAZERS OF MODERN DESIGN

Flatbed Glazers	Glazing Sheets
14" x 10" Double Sided .. \$34.50 Plus tax	14" x 10" Stainless Steel .. \$3.80
20" x 16" Double Sided .. \$54.55 Plus tax	20" x 15" Stainless Steel .. \$5.83

MAIL ORDER • FASTEST SERVICE
DELIVERY — PROMPT AND FREE

**HALOGEN LIGHTING FOR PHOTOGRAPHIC
& TELEVISION
STUDIOS**

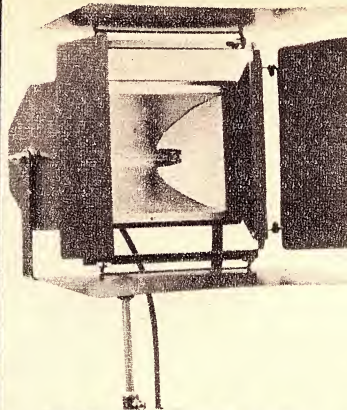

BROAD BEAM LAMP

A strong floodlight, 80 deg., 1000 watt, 7in Phillips Quartz Iodine Halogen lamp equivalent to 4 photofloods, lasts 2000 hours at 3200 deg. K. Lamp head \$37.25. Heavy duty stand \$21.75. Lamp \$10.50. Barn door \$22.45. All prices plus Tax.

NARROW BEAM LAMP

Beam 55 deg. with 800 watt, 4-11/16" long lamp. One stop stronger than broad beam. Light and portable. Heat-insulated handle, fully tiltable. Lamp head \$29.95. Stand \$21.75. Barn doors \$13.90. G.E. lamp, 250 hours, \$13.50. Jap. Ushio lamp \$7.80. All prices plus Tax.

Send for special Brochure.

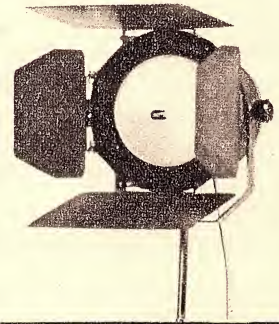

COSMICAR LENSES



f1.9 12.5mm
wide Angle

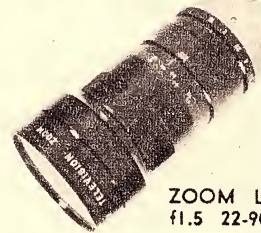

ZOOM LENS
f1.5 22-90mm

FOR CLOSED CIRCUIT
TELEVISION AND 16mm CAMERAS

- 'C' Mount • Focusing & Iris
- Top Japanese Quality

	Tax included
WIDE ANGLE f1.9 12.5mm	\$50.97
WIDE ANGLE f1.4 12.5mm	\$78.04
NORMAL ANGLE f1.9 25mm	\$24.36
NORMAL ANGLE f1.4 25mm	\$37.08
LONG FOCUS f1.9 50mm	\$38.59
LONG FOCUS f1.4 50mm	\$59.95
LONG FOCUS f1.4 75mm	\$35.48
LONG FOCUS f1.4 75mm	\$75.71
TELEPHOTO f2.8 135mm	\$64.72
ZOOM f2.8 20-55mm	\$119.63
ZOOM f1.5 22-90mm	\$323.71

ZOOM f1.5 22-90mm ALSO AVAILABLE AS A
MOTORIZED & REMOTE CONTROLLED MODEL

- Trade enquiries • Tax free quotes • Send for brochure showing full specifications.

R. H. WAGNER & SONS PTY. LTD.

FOR EVERYTHING PHOTOGRAPHIC

524 FLINDERS ST., MELB. 3000
TELEGRAMS: WAGSONS 62-3114

WAGNERS CAMERAS, 43 ELIZABETH ST.
CNR. FLINDERS LN., MELB. 62-3114

R. H. WAGNER & SONS (CHADSTONE) PTY. LTD.
SHOPPING CENTRE, CHADSTONE, 56-5814

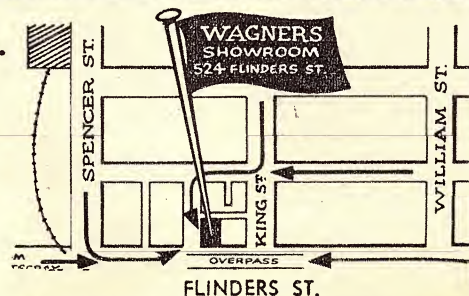

has the peculiar property of allowing electrons to flow only in the direction of semiconductor to contact.

Diodes of this type, subjected to a voltage in the forward conducting direction, can have a resistance of a few hundred ohms. When subjected to a voltage in the reverse or non-conducting direction, their effective resistance may be several hundred thousand ohms.

The detection process is accomplished by applying the incoming signal across the diode in series with a detector load which, in the case of a crystal set, is a pair of high impedance headphones.

It is usual, though not essential, to connect a capacitor across the phones which assists in smoothing out the half-wave pulses of carrier signal delivered by the detector. The capacitor charges during each pulse of carrier and maintains this charge during the intervals between pulses, resulting in a smooth audio signal closely resembling the original modulating signal at the transmitter.

So much for detection, but what of the unit's ability to detect a particular signal and reject all others?

This calls for a parallel tuned circuit consisting of a tapped coil and a variable tuning capacitor, capable of resonating at any desired frequency within the band used by the broadcast stations.

Signals reaching the set via the aerial are fed to a tapping on the coil, while the capacitor is adjusted to resonate with the coil at the frequency of the desired signal. Stations on other frequencies are rejected, while the wanted signal is retained by the tuned circuit. This selected signal is then fed to the detector via an appropriate coil tapping.

These tappings on the coil are to enable the aerial and detector to be suitably matched into the coil in order to obtain the best compromise between signal level (sensitivity) and ability to select wanted stations (selectivity).

Thus, tapping the aerial across a larger proportion of the winding may result in louder signals, but the selectivity will be poorer, resulting in stations overlapping. Bringing the tapping closer to the earth end, on the other hand, will improve the selectivity at the expense of signal strength. The tapping which gives the best balance, in any particular situation, between selectivity and sensitivity is the one which should be used.

The results just discussed will vary with the length of the aerial. Generally speaking, a long aerial will have to be connected to a tapping close to the earthed end while a short aerial will connect toward the "hot" end. Location (i.e., proximity) and number of local stations will also affect the final selection of tappings.

The optimum tapping for the diode is also a compromise between maximum signal with reduced selectivity and maximum selectivity with reduced signal. Tapping the diode across a major portion of the winding is like placing a resistor across the coil, damping it and reducing the selectivity.

The results obtained from the crystal set are good, providing that you are in a reasonably strong signal area and have a good earth and aerial. The fundamental limitation is that the only

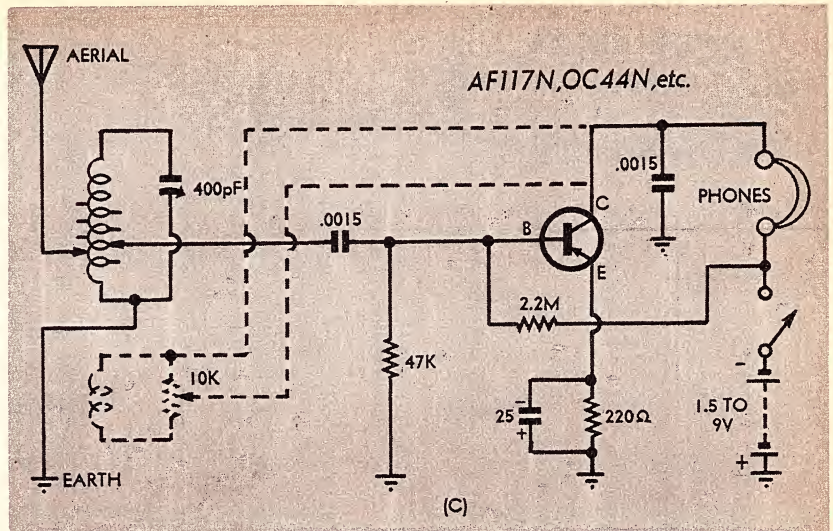

The final circuit, with and without regeneration. When functioning as a simple detector-amplifier, the collector connects directly to the headphones. When regeneration is used (dotted section) the regeneration winding is connected in series with the headphones.

power available to drive the headphones is that which is collected by the aerial. It cannot amplify the incoming signals, it can only make them audible.

If you desire to build just the crystal set, then you can purchase one of the diodes suggested in circuit A and construct it from the details given. But if you take our advice, you will invest in a transistor of the type called for in circuit C. By using only two leads of the device, it will be possible to make the crystal set, but you will also be able to use it for larger sets.

But firstly, what is this transistor?

The PNP junction transistor used in circuits B and C is basically a thin wafer of N-type germanium sandwiched between two regions of P-type material, together forming the PNP transistor. Suitable leads are connected to the three regions and the unit is sealed into a metal or glass envelope.

When wired into circuit, one junction is normally "biased" in the forward direction which results in a low resistance to current flow, while the other junction is biased in the reverse direction, resulting in a high resistance to current flow.

Because the N region is thin, charges or "current carriers" so-called, flowing into the N region, due to the forward bias, continue through to the region of the reverse biased junction. A high proportion of this current passes through to the high resistance P region, while the small remaining current flows out of the N region via its external connection.

Because the input current is fed into a low resistance circuit and appears in a high resistance output circuit, the device effectively exhibits power amplification.

In all transistors, the outer electrode of the forward biased junction is called the "Emitter," the centre electrode the "Base" and the reverse biased electrode the "Collector."

In general, a transistor can be compared to a thermionic valve in that the base is similar to the grid of the valve which serves to control the flow of electrons through the unit. The emitter

and the cathode of the valve both provide the source of current carriers; the collector and the plate of the valve are similar, in that they are both normally part of the output circuit.

The transistor's input and output impedance, along with other characteristics, is governed by the method or configuration in which it is used, somewhat similar to that of the valve. In each case, one electrode is common to both input and output circuits and is referred to as being either grounded or common.

The method of operation most commonly used in transistor circuits is that used in our circuits here, called "common emitter," which is roughly equivalent to the common cathode circuit used with valves. In this configuration, the emitter is connected to "earth," which in this case is the negative supply rail. It thus forms the negative connection for both the base and collector circuits. In this arrangement, input and output impedances are considered as medium, while voltage and current amplification, and thus power amplification, are all fairly high.

The symbol used for the current amplification in common emitter is "Beta" and the upper frequency limit is the "Beta Cut-Off Frequency."

In all transistor circuits, it is important that the maximum ratings of collector voltage, current and operating temperature must not be exceeded. At high temperature the collector leakage current can increase to the extent where "thermal runaway" will occur. This comes about when an increase in temperature leads to sufficient rise in leakage current to cause still further rise in temperature, and to a degree where the process keeps on going.

Thermal runaway is thus the transistor's cumulative process of self destruction.

In order to minimise the chances of this occurring it is always desirable to provide some means whereby a change in base to emitter voltage will maintain the collector current within acceptable limits for a reasonable range in operating temperature. This is referred to as bias stabilisation and should receive due attention.

LOW COST, HIGH PERFORMANCE!

LOW PRICED MICRO MOVING MAGNET STEREO CARTRIDGE — THE MODEL 2100/5 . . . ONLY \$14.50

With an input sensitivity of 5 mV, the new Model 2100/5 stereo cartridge has a frequency response of 10-28,000 Hz. \pm 3 dB, and a tracking angle of 15°. Tracking pressure recommended is 1.3 grams; channel separation is 30 dB. at 1 kHz. Listening to this Micro cartridge can be quite deceptive — some music lovers thought they were hearing a cartridge three times as expensive! A conical diamond stylus is standard equipment. Inc. sales tax **\$14.50**



NEW MICRO VF-3100 SERIES STEREO CARTRIDGES PROVE MOST POPULAR EVER!

With a frequency response of 20-28,000 Hz. and channel separation of 28 dB, the Micro VF-3100 series cartridges have already established new performance standards for lower priced magnetic cartridges. Two models are available, the VF-3100/E with elliptical diamond stylus and the VF-3100/5 with a conical diamond stylus. Stylus for both cartridges are replaceable; both track effectively at 1½ grams.

LOW PRICED CERAMIC CARTRIDGE FOR BUDGET CONSCIOUS MUSIC LOVERS!

The popular Micro SC-301 cartridge has now been superseded by the new, improved Model SC-303D. Only the price remains the same! Frequency response is 20-15,000 Hz. and tracking angle is 15°. With diamond stylus inc. sales tax **\$6.90**



MICRO DUST PICKUPS—\$3.50

An effective automatic record cleaner which removes dust as the record plays. An ideal gift. \$3.50 inc. sales tax.



SONICS STEREO HEADPHONES—FROM \$9.50

The popular Model HS-304 offers fatigue free listening on a personal basis . . . the headset is very comfortable even over lengthy periods. Price? Only \$12.50. The Models HS-303 and HS-303H (High impedance) are also available . . . frequency response is 20-15,000 Hz. and the price only \$9.50. All models have foam rubber earpads. From **\$9.50**

**Encel
ELECTRONICS
(STEREO)PTY. LTD.**

Head Office:
431 Bridge Rd., Richmond, Victoria 3121.
Tel. 42 3762.

Sydney Store: Ground Floor, 25M Building
257 Clarence Street, Sydney, N.S.W. 2000.
Tel. 29 4563, 29 4564.

*Wholesalers *Trade-ins accepted

Australia's Greatest Hi-Fi Centre

The wiring diagram for the simple crystal set of circuit A, showing the layout of the components and the small amount of wiring required. Either the diode OR the transistor can be used, but not both.

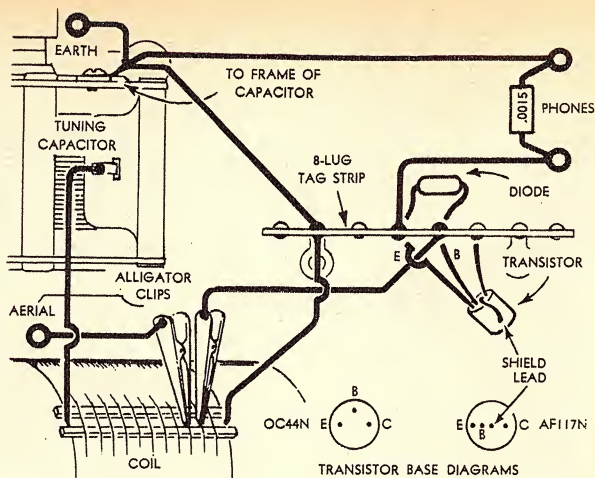

Our transistor can be used in circuit A simply by ignoring the collector lead and using just the base and emitter leads.

But we need not stop here. From circuit B it will be seen that an attempt has been made to use the collector in conjunction with a small battery to obtain an amplified version of the detected signal.

The signals obtained in our first attempt were strong but distorted. The addition of a resistor/capacitor network in series with the base lead across which the audio could develop improved things somewhat. But, even so, with this circuit it was apparent that the transistor, although functioning effectively as a detector was not operating under optimum conditions for audio amplification.

We therefore set about to devise a circuit in which the base and emitter electrodes could function as a detector and also, along with the collector, provide efficient audio amplification.

This involved the provision of a forward bias network and bias stabilisation as can be seen in circuit C. A voltage divider across the battery consisting of a 47K ohm and 2.2M ohm resistor enables the base-emitter junction to be slightly forward biased, while the base-collector junction is reversed biased.

A form of bias stabilisation is provided by the use of an emitter resistor across which portion of the supply voltage is developed. If the collector current increases above the quiescent point, the voltage drop across this resistor will increase, reducing the effective base-emitter potential.

This circuit constitutes an extremely good "amplified crystal set" and is well worth the slight extra cost. The high sensitivity achieved with this set enables a coil tapping nearer to the earthed end to be used for both aerial and base connection, resulting in improved selectivity.

However, in order to obtain a still further improvement in selectivity, we recommend that the final step be taken

in the addition of a regeneration winding and control.

As before, the signal is tuned, detected and amplified. But the added requirement of the transistor is to amplify the incoming radio frequency signals sufficiently to enable a controlled portion of this signal to be coupled into the tuned winding in such a manner as to produce positive feedback.

This will be seen, in the dotted portion of circuit C, in that the collector load now consists of a pair of headphones in series with an untuned winding, which is positioned at the earthed end of the tuned winding. The headphones provide the load for the audio frequency signal as before and are bypassed to radio frequencies while the regeneration winding is the load for the radio frequency signals.

It will be appreciated that the polarity of this winding is of major importance, in that the feedback signal must assist the received signal to the extent of being able to produce an audible oscillation in the headphones as the control is advanced.

However, the amount of regeneration is vital when actually listening. Too little, and the signals may not be separated sufficiently or loud enough; too much and the detector will commence to oscillate.

We then have two frequencies, the incoming signal and that of the oscillating detector. These produce a heterodyne note which appears as a continuous whistle, along with the required signal.

Optimum performance is normally obtained with the detector adjusted just short of active oscillation.

The transistor originally used in all the circuits, including the elementary crystal set arrangement, was a 2N370, which has a fourth lead interposed between the base and collector leads. It serves as a shield in special applications, but you can please yourself whether you connect it to the emitter or leave it disconnected as we have done. A possible alternative for

COIL WINDING DATA

Diameter	TUNED WINDING		Turns/tap	REGEN. WINDING	
	Length*	Turns		Turns	Turns
1½in	2.75in	130	10	21	
2in	1.9in	90	7	15	
2½in	1.6in	75	6	12	

* Based on 24B&S gauge wire.

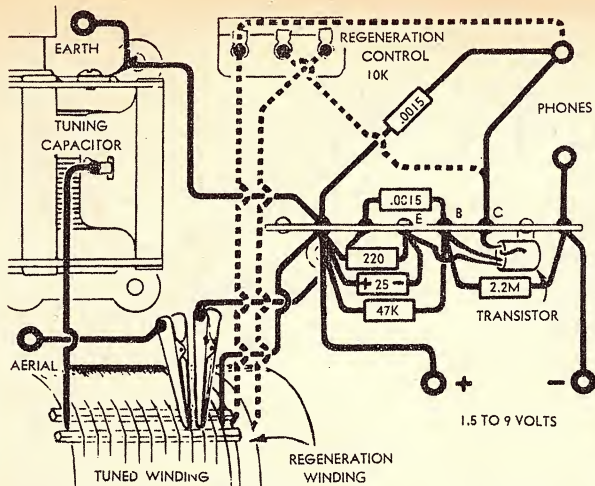

This slightly more complex diagram shows the wiring connections required to construct circuit C. No battery ON/OFF switch has been shown. We used an alligator clip for connection to one terminal, but any type of switch could be used.

the above is type 2N1636, which has the more conventional three leads.

However, more specialised types of transistors have been developed since our article first appeared, and some of these have been designated "preferred types" for certain applications. Therefore, the transistor we now recommend for circuits B and C is the AF117N, although there is no reason why the other types should not be used, if they are already to hand.

By the way, the above types of transistor are also recommended for the Simple All-wave Two Transistor Set described in the June, 1960, issue, along with data on coils operating up to 20MHz. This could open the way to further development of the circuit after the regenerative set, if you want to continue your experiments.

The tuning capacitor can be of almost any type, providing that it has a maximum capacitance of about .0004uF (microfarad).

Almost any junk box will contain at least one of these, be it either a single or a double section ganged type either of which will suit. If the latter is used, only one gang is used.

Our capacitor consists of about 12 plates held rigidly in a metal frame by insulating supports and a second set of about 13 plates which can be rotated so that the two sets may be interleaved to obtain the desired capacitance. Make sure, by the way, that the plates do not touch as the spindle is rotated.

Many of the large capacitors of the type used in our set have a 3/8in diameter shaft intended to fit the many standard dials used with larger sets. As most instrument knobs available are designed for 1/2in diameter shafts, it will be necessary to use a reduction shaft which itself has a 1/2in spindle, but fits over the 3/8in shaft of the capacitor. Both the very early types and the latest miniature type have 1/2in diameter shafts and will not require an extension shaft.

All later-type tuning capacitors have provided with them a set of mounting feet which allow them to be attached to the baseboard. Older types may lack this feature and a special bracket will need to be made from a scrap of aluminium.

To make the coil, you will need a coil former and a length of enamelled copper wire. The former can have a diameter between 1 1/2in to 2 1/2in and this can be purchased in the form of a bakelite or cardboard tube or made

from stiff cardboard.

Our coil was wound on a 2 1/2in former, using 24 B&S enamelled copper wire, but a slight variation either way will not alter things greatly.

What will alter things is the coil diameter in that the number of turns will have to be adjusted to give the same inductance for different diameters. A small diameter coil will require proportionately more turns than a large diameter one in order to have the same inductance.

Therefore we have included a table giving details for three likely coil diameters.

The regeneration winding included in this table will be used for the regenerative detector and can be either wound at this stage or left until you require it.

The following remarks on coil winding should assist those readers who have not as yet constructed a coil.

Firstly, to anchor the wire to the former at the start, drill two small holes toward one end about 1/4in apart. Then wind one end of the wire through the holes a couple of times, allowing about 6in of free lead for connecting into circuit. Proceed to wind until it is required to provide a tapping as given in the table.

Before laying this turn, place a wooden matchstick along the former and pass this turn over it. Wind on more turns, passing the wire under the matchstick until the next tapping point at which the wire again passes over the matchstick. Continue in this manner until the total number of turns have been wound in accordance with the table. Drill two more holes in the former to anchor this end and again allow 6in of wire for connection into circuit.

Next, push a second matchstick alongside the first under the raised turns, then push the two matches apart by about 1/4in. These wires will now be clear of the remaining turns, enabling the enamel to be scraped away without damaging the adjacent wire, so that connecting leads can be soldered.

The regeneration winding is wound in the same direction and the ends anchored similar to those above.

With regard to headphones, the high resistance types of between say 2,000 and 4,000 ohms are most suited for our sets, particularly the crystal set. Next best in terms of performance are the relatively low impedance ex-disposals

type, having a resistance of several hundred ohms.

The ex-disposals dynamic type headphones, the type fitted with earmuffs and of about 45 ohms resistance, are quite unsuitable for these circuits.

As an alternative to purchasing a set of headphones, one of the hearing aid type earpieces could be used. There are two types available, the low impedance magnetic, which is unsuitable for our circuits, and the crystal type which can be used, though with some loss in performance.

As with all crystal devices, there is no path through which a direct current can flow in order to fulfil the requirements of the associated circuitry.

We therefore suggest that a resistor of say 15,000 ohms be connected across the phone terminals. The earpiece connects across this resistor, in series with a .01uF capacitor.

The supply used in the latter circuits could be either a single 1.5-volt cell or a battery up to 9 volts. There is surprisingly little difference in performance with large variations in supply voltage, so you need not spend extra money if a couple of torch cells are available.

Remember that the positive battery terminal is the one to be earthed when using PNP transistors. A reversal of the supply terminals could result in permanent damage to the transistor.

Care should also be taken that excessive heat is not applied to the transistor by the soldering iron. The suggested idea is to hold the lead with a pair of long-nose pliers until the joint has cooled.

With the aid of the wiring diagrams there should be no difficulty in constructing these sets. There are no problems with layout except possibly the need to allow some space between the coil and the tuning capacitor.

With the regenerative receiver, optimum performance is normally obtained with the regeneration control adjusted just short of active oscillation and the actual position of the control will vary from station to station. Some adjustment to the placement and number of turns of the feedback winding is permissible if you desire to experiment.

These circuits should provide interesting hours during construction, followed by more hours of enjoyable listening.

SERVICE

BILL TURNBULL offers you service on Hi Fidelity equipment tape Recorders, Communication Receivers and Electronic Test Equipment.

**25 years experience
All work guaranteed**

BILL TURNBULL
11 ELLALONG ROAD,
CREMORNE, N.S.W. 90 4825

Something You've Been Waiting For . . .

A SOLID STATE GUITAR AMPLIFIER

Here is a fully solid state guitar amplifier rated at a nominal 50 watts continuous power. Featuring two totally independent tone control channels and a fully transistorised tremolo facility, the amplifier offers unique flexibility of application in a light and compact unit.

By Anthony Leo

Nearly two years ago, in the June, 1967, issue, we described a 40-watt guitar amplifier using valves. In the following (July) issue we presented the Playmaster 117 amplifier, a 60-watt version with additional input facilities. Subsequently, the 117 proved to be one of the most popular guitar amplifiers we have ever described.

In part, at least, the enthusiastic reception of the 117 amplifier among guitarists and home constructors can

While we realise that it is desirable to use separate amplifiers to minimise the dangers of amplifier overload and intermodulation distortion, this is not always possible for reasons of economy or convenience or both. Hence, most commercial guitar amplifiers, unless designed specifically for bass work only, provided multiple inputs for additional instruments; not necessarily guitars.

When we developed the valve amplifiers we considered the implications of

enthusiasts wanting one must resign themselves to paying, perhaps, an inflated price for an imported article.

Thus, in circumstances of considerable demand from both the local industry and readers of the magazine we are presenting a 50 watt all transistor guitar amplifier.

In broad terms the specifications of the new guitar amplifier are similar to those of the Playmaster 116 and 117, embodying the same precepts of

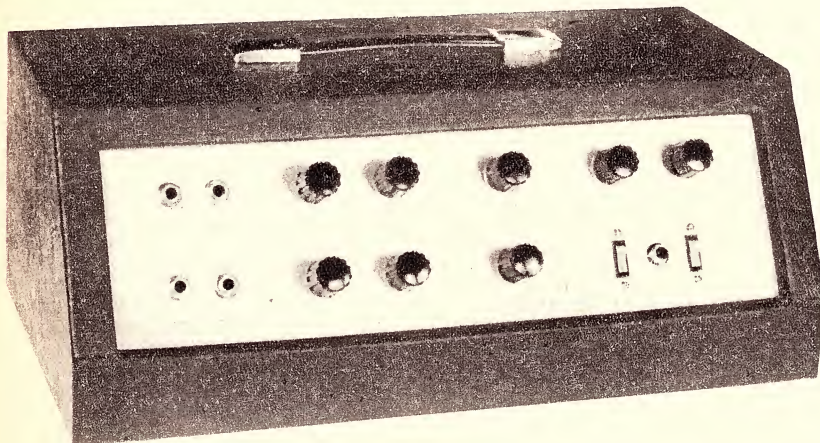

be credited to a genuine flexibility in application provided at the best possible price. These same characteristics guided our thinking in the development of this 50-watt solid state amplifier.

Output power in the 117 amplifier is generated by two pentode valves, operating in class AB mode, via a multi-tapped output transformer making provision for various load impedances. In addition, three other dual function valves are used for phase splitting, voltage gain and tremolo.

With a grain oriented output transformer, giving good low frequency response, and tailored tone control contours the amplifier can be used with bass guitars as well as rhythm and lead. By selecting full treble cut with the required amount of bass boost the amplifier serves as a fully adequate bass unit.

And for the situation where, of necessity, the amplifier has to be used simultaneously with two or more guitars, requiring a compromise tone control setting, three frequency selective inputs are provided. Thus, by connecting bass rhythm and lead guitars to the respective inputs "bass," "flat" and "treble" an amount of independent tone compensation can be provided

transistors versus valves, and the problems likely to be encountered in the development of a transistor design, at that time. The availability of suitable transistors was of particular concern and, in addition, the preference of guitarists themselves was a further consideration.

While the attitude toward transistor amplifiers did vary among the fraternity, with discussion centring around supposed differences between "transistor tone" and "valve tone," the general consensus was a preference for valve equipment. In part, at least, this reserve was probably due to the small number of solid state amplifiers on the market, plus a natural reluctance to accept something new.

Thus, after consideration of current trends and economics, and having a background of suitable circuitry with transformers readily available, the valve amplifiers were evolved.

Since then, however, the attitude of guitarists has changed considerably. There is now a strong demand for solid state amplifiers, by reason of their inherent reliability and low operating temperatures. But, there are still very few locally manufactured high power transistor amplifiers available, and

SPECIFICATIONS

POWER: 50 watts continuous power, 55 watts music power.

DISTORTION: Total harmonic distortion at 40 watts continuous power, 0.8 per cent. At 45 watts, 1.8 per cent. At 50 watts 4 per cent.

INPUT SENSITIVITY: Two pre-amplifier channels are provided, each having separate high and low input sensitivities of 25 and 200 millivolts for 50 watts output at 500Hz.

LOAD IMPEDANCE: Amplifier will tolerate loads from 16 ohms to 8 ohms, where maximum power is obtained. Amplifier is stable with reactive loads.

TOPE CONTROLS: Separate bass and treble controls in each preamplifier channel. Extra overall treble boost switch. One channel fitted with a tremolo facility.

economy with flexibility in application without sacrificing the demands of a good design.

However, a somewhat different philosophy has been adopted in regard to inputs and tone control preamplifiers. Two separate control preamplifiers have been provided to obviate the somewhat stopgap measure of providing frequency selective inputs for multiple instrument amplification. In addition, each channel has two inputs, giving a choice of high and low sensitivity.

These changes have been deemed necessary to comply with current trends in commercial amplifiers, whether they use valves or transistors. However, the facilities are more easily provided with transistors because of the intrinsically simpler circuitry, affording considerable cost and space economy.

A fully transistorised, all electric tremolo facility is an attractive feature of this amplifier. The tremolo circuit employing a FET was first described as

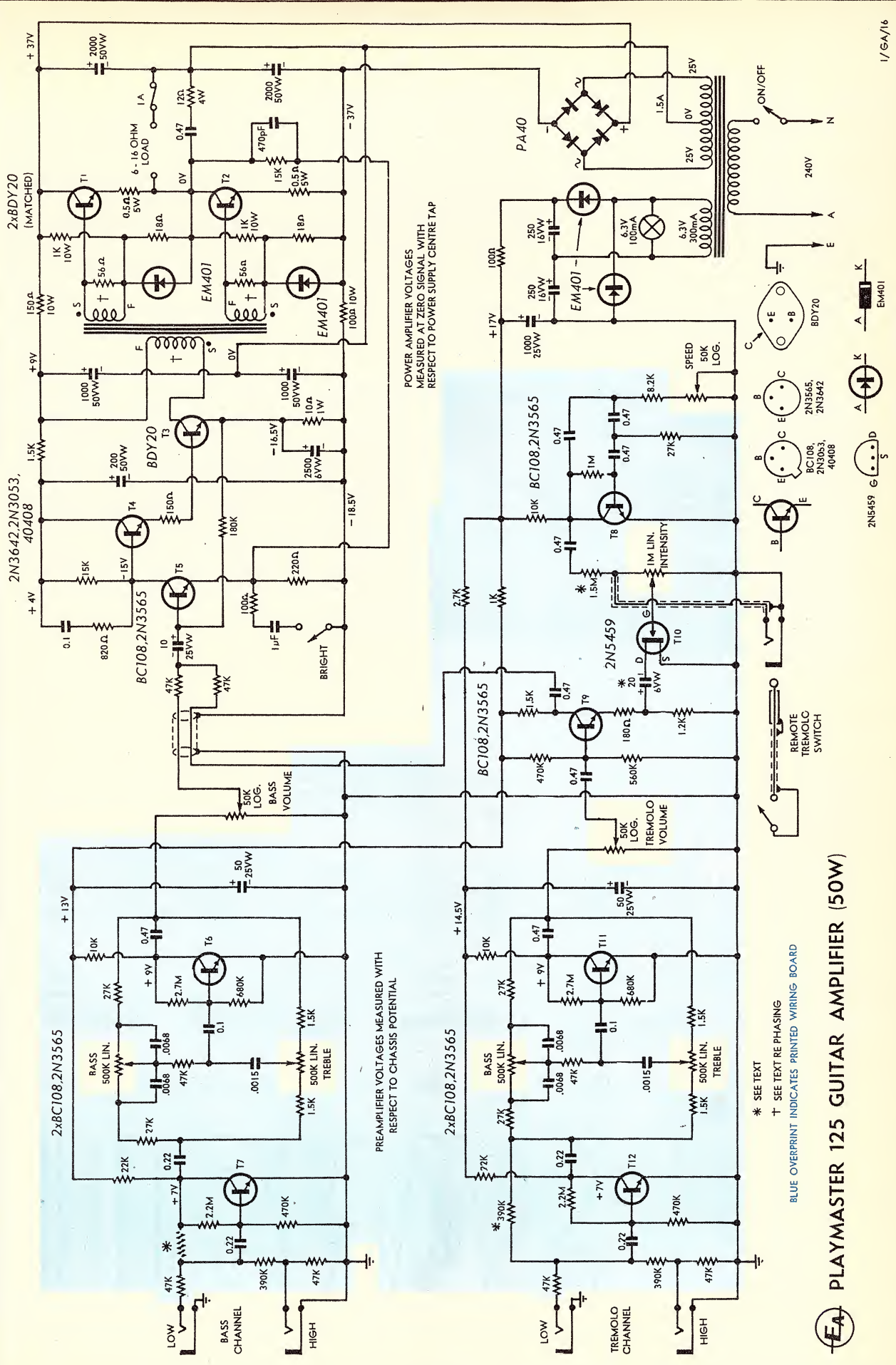

PLAYMASTER 125 GUITAR AMPLIFIER (50W)



* SEE TEXT
 † SEE TEXT RE PHASING
 BLUE OVERPRINT INDICATES PRINTED WIRING BOARD

POWER AMPLIFIER VOLTAGES
 MEASURED AT ZERO SIGNAL WITH
 RESPECT TO POWER SUPPLY CENTRE TAP

PREAMPLIFIER VOLTAGES MEASURED WITH
 RESPECT TO CHASSIS POTENTIAL

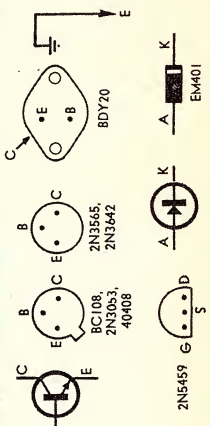

can you afford to buy anything less than SANSUI?

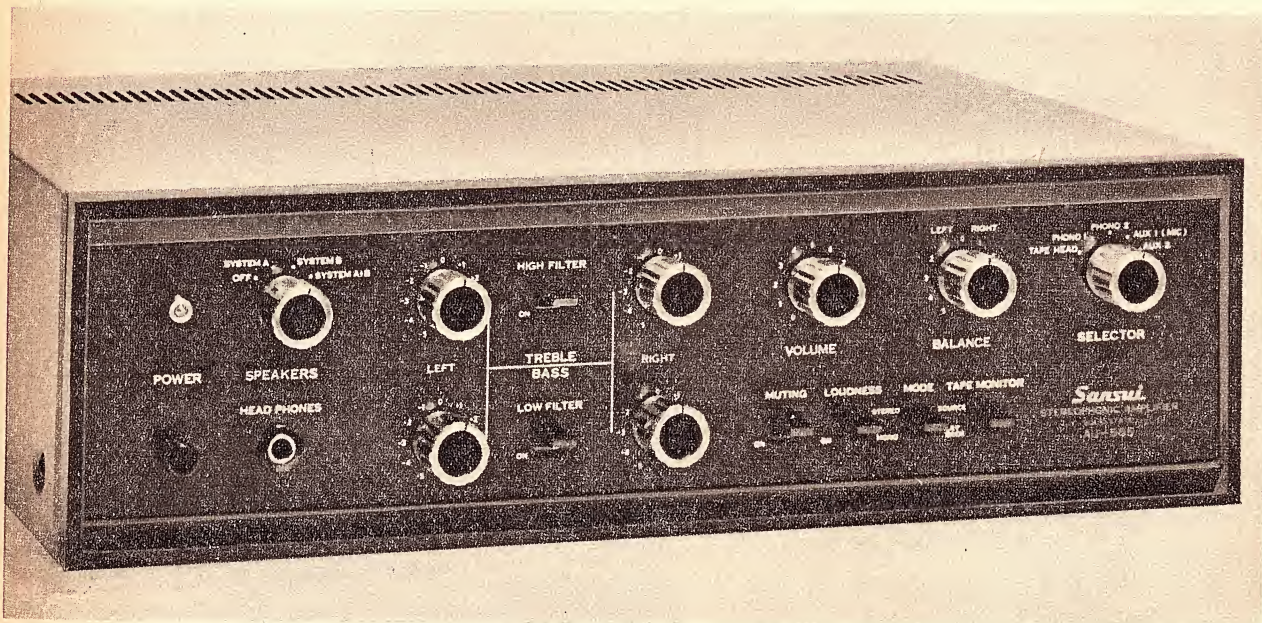

Illustrated this month: Sansui Model AU 555 Amplifier, 60 watts music power.

Twelve months from now you will have forgotten precisely how much you paid for your Sansui Amplifier. Price will have become irrelevant. The only important factor in your mind will be how satisfied you are — how glad you paid that little bit more for the first class workmanship that has been put into your Sansui.

On the other hand, if you bought something that was a "bargain" and maybe only bought it because it was cheap, you will most likely regret it for ages. Measure it this way: Over a ten year period of enjoyment and complete satisfaction with your amplifier, is it worth jeopardizing all this to save a few dollars?

12 models to choose from



... and appearance wise they look what they are . . . top performance combined with smart styling.

SANSUI

Imported direct from Japan by: Magnecord International Pty. Ltd., Chapman House, 276 Castlereagh Street, Sydney, 2000. Phone: 61-9881. Tokyo Office: Tokyo Ginza Building, 5-6 Chome, Ginza, Tokyo.

an add-on unit in the November, 1968, issue.

In the design of a high-power audio amplifier there are several factors which influence output power and, collectively, determine the maximum obtainable power. Perhaps the most significant one is the limitation imposed by transistor voltage and current ratings. For it is the output transistors' supply voltage and load impedance which determine the actual output power being delivered.

While it would be natural to select transistors having the highest voltage and current ratings, this might not always be prudent. In our situation, where many of the available transistors are imported only to order, a careful selection has to be made to ensure that devices would always be available ex-stock.

After consideration of the devices currently available, two types appeared to have ratings suitable for a high power output stage. They are silicon NPN transistors, types 2N3055 and BDY20. Of these the BDY20 seemed to be most readily available ex-stock, and in addition it can be obtained in matched pairs.

While it is not absolutely necessary to use matched output transistors they do simplify construction for home builders by eliminating the need to adjust for optimum quiescent conditions. But, if necessary, unmatched 2N3055s or BDY20s could be used, as we will explain later.

With regard to the general power level required from the amplifier we chose to operate the transistors in a class B push-pull configuration, a somewhat natural choice as it affords maximum power efficiency. In turn, maximum power efficiency means that minimum heat will be dissipated in the out-

put transistors and the power supply requirements will be eased.

Next, we had to decide whether to use audio coupling transformers or formulate a transformerless design with some obvious advantages. Transformers are expensive items and they can compromise an amplifier's performance at high and low frequencies.

Readers more familiar with transistor techniques will have seen trans-

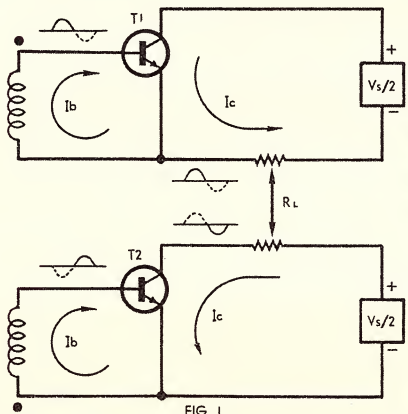

FIG. 1

The output stage in the amplifier may be considered as two separate amplifiers with individual power supplies as shown in figure 1, above.

formerless designs, no doubt, and will agree that transistors are well suited to such application. The quasi-complementary symmetry transformerless configuration is perhaps the most common approach in high fidelity transistor amplifiers nowadays.

PARTS LIST

- 1 Chassis, front panel and wooden cabinet.
- 1 Printed wiring board, 69p5.
- 1 Power transformer, 240V to 50V at 1.5A, and 6.3V at 300mA.
- 1 Driver transformer, ratio 3:1+1.

TRANSISTORS

- 1 Matched pair of BDY20 transistors.
- 1 BDY20.
- 1 2N3642, 2N3053 or 40408.
- 7 BC108, TT108 or 2N3565.
- 1 2N5459 field effect transistor.

DIODES

- 1 Bridge rectifier, module, ED1 type PA40 or equivalent.
- 4 EM401 power diodes, or equivalent.

CAPACITORS

- 1 2500uF 6.4VW electrolytic.
- 2 2000uF 50VW electrolytic, can mounting.
- 2 1000uF 50VW electrolytic.
- 1 1000uF 25VW electrolytic.
- 2 250uF 16VW electrolytic.
- 1 200uF 50VW electrolytic.
- 2 50uF 25VW electrolytic.
- 1 20uF tantalum electrolytic.
- 1 10uF 25VW electrolytic.
- 1 1uF plastic.
- 9 0.47uF plastic.
- 4 0.22 uF LV plastic.
- 3 0.1uF plastic.
- 4 .0068uF LV plastic.
- 2 .0015uF LV plastic.
- 1 470pF plastic or ceramic.

RESISTORS

($\frac{1}{2}$ -watt 5 p.c. unless otherwise specified.)

- 2 2.7M 10 p.c., 2 x 2.2M 10 p.c., 1 x 1.5M 10 p.c., 1 x 1M, 2 x 680K, 1 x 560K, 3 x 470K, 3 x 390K, 1 x 180K, 8 x 47K, 5 x 27K, 2 x 22K, 2 x 15K, 3 x 10K, 1 x 8.2K, 1 x 1.7K, 6 x 1.5K, 1 x 1.2K, 2 x 1K 10 watt, 1 x 1K, 1 x 820 ohms, 1 x 200 ohms, 1 x 180 ohms, 1 x 150 ohms 10 watt, 1 x 150 ohms, 1 x 100 ohms 10 watt, 2 x 100 ohms, 2 x 56 ohms, 2 x 18 ohms, 1 x 12 ohms 4 watt, 1 x 10 ohms 1 watt, 2 x 0.5 ohms 5 watt.

POTENTIOMETERS

- 1 1M linear taper.
- 4 500K linear taper.
- 3 50K logarithmic taper.

MISCELLANEOUS

- 4 shorting type jack sockets.
- 1 non-shorting jack socket.
- 1 2-pin speaker plug and socket.
- 2 miniature "rocker" switches.
- 1 fuse holder and 1A fuse.
- 1 6.3V 100mA pilot lamp.
- 8 Knobs.

Power flex and cable clamp, connecting wire and sleeving, nuts and bolts, solder, etc.

Tag strips: 1 x 8-lug, 2 x 7-lug, 1 x 4-lug, 2 x 3-lug, 1 x 2-lug miniature. One 15-lug length of miniature resistor panel.

SIMPLIFY INTRICATE WORK with



'1000' RANGE
SPECIAL PURPOSE
PLIERS

Designed specifically for instrument and electronic technicians to handle fine, precision work, the Elliott-Lucas 4 1/2" size '1000' series is available in Box Joint or Single Joint Tools. All bright finish, in individual Display Packs or in Plastic Tool Roll sets of three or six.

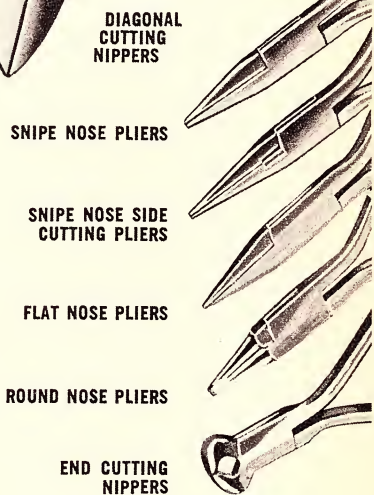

Australian Representatives:

THOMAS C. BROWN

& CO. PTY. LTD.

Sydney • Melbourne • Adelaide
Brisbane • Perth

TCB/82

FLY TO THE MOON—with the new ADC25 Pickup

● A NEW CONCEPT BY PETER PRITCHARD

● NEW HEIGHTS OF MUSICAL MAGNIFICENCE ACHIEVED



This unique cartridge, this musician's cartridge, is of such ultimate perfection that poetry is needed to describe it.

The ADC25 represents the most significant advance in pickup design in a decade as it tracks and traces **not just marginally, but noticeably better** than any of its would-be competitors. **MANY RECORDS PREVIOUSLY THOUGHT UNPLAYABLE ARE FOUND TO BE INNOCENT OF RECORDING FAULT AND CAN BE REPRODUCED PERFECTLY BY THE ADC25.** To prove this, try it on the well-known plus-16 db recording of a bass drum on the W. & G. Professional Test Record — 25/2434 — we know of no other cartridge capable of tracing this track. This has previously been considered an unfair test for any cartridge but ADC25 sails through it with a tracking force applied of not more than 1 gram. **The adjective "trackability" has at last become meaningful.**

● Three readily interchangeable styli are included as a cleaner playback can often be achieved if the stylus rides either higher or lower in the groove. This facility enables the critical audiophile to obtain the optimum sound reproduction from the many record brands, each with their individual groove characteristics.

● **MANY ENTHUSIASTS HAVE RECOGNISED THIS NECESSITY AND OWN SEVERAL CARTRIDGES. THE ADVENT OF THE ADC25 ELIMINATES THE COST OF TWO CARTRIDGE BODIES AND TWO SPARE HEADSHELLS.**

The **special** spherical stylus provided is intended for use with those recordings such as RCA Dynagroove, where a compensation is applied to the recording of the inner grooves in order to offset the distortion that would normally be present when these grooves are played back with a spherical stylus. An elliptical stylus under these conditions gives less than optimum results.

SPECIFICATIONS — ADC 25 STEREO PICKUP SYSTEM

Type	Induced magnet	Stylus tip radii	#251 elliptical (red)—Contact radius .0003", Lateral radius .0007"
Sensitivity	4 mv at 5.5 cms/sec. recorded velocity		#252 elliptical (blue)—Contact radius .0003", Lateral radius .0009"
Tracking force range	½ gram to 1¼ grams	Vertical tracking angle	15 degrees
Frequency response	10 Hz to 24,000 Hz ± 2 db	Recommended load impedance	47,000 ohms
Channel separation	30 db from 30 Hz to 12,000 Hz 20 db from 12,000 Hz to 24,000 Hz	Replacement Styli	#251, #252, #253 (See specifications above)
Compliance	35 x 10 ⁻⁶ cms/dyne		

J. H. REPRODUCERS PTY. LTD.

293 HUNTINGDALE ROAD, CHADSTONE, VICTORIA. 3148
TELEPHONE: 277-3066

Exclusive Australian Agents for — ADC Cartridges and Amplifiers, Kef speakers, J. H./G. H. Unipoise Pickup Arms, Pritchard Arms, TRANSCRIPTOR TURNTABLES and the popular J.H. Synchronous Turntable.

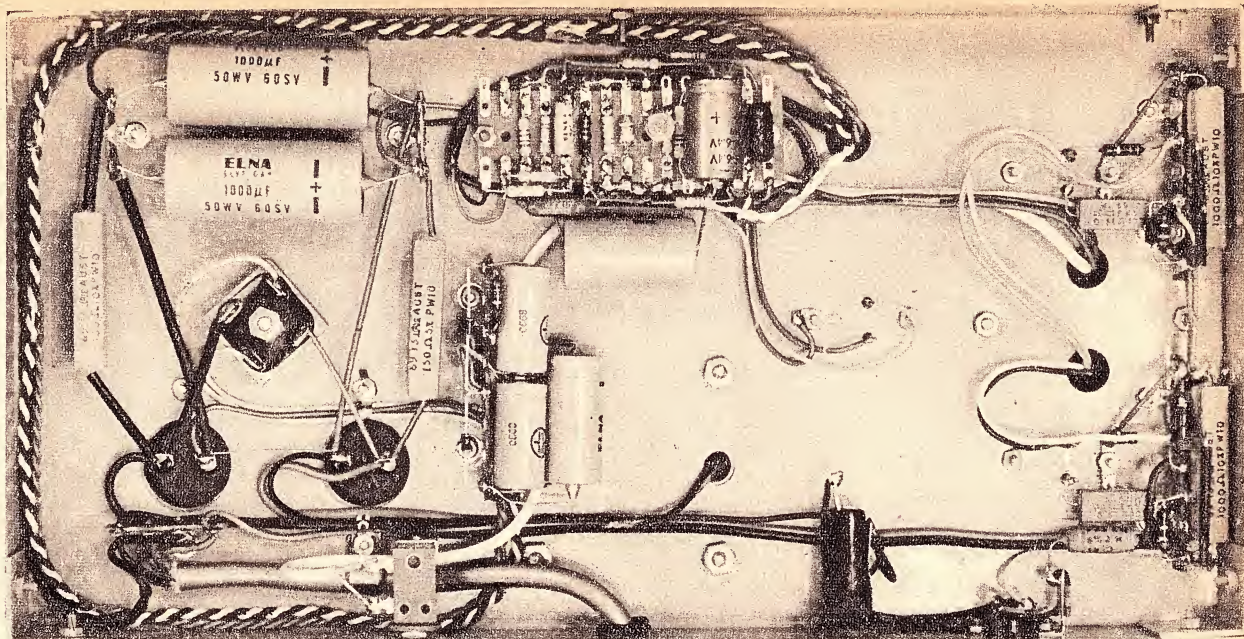

The power supply components are at the left hand end of the chassis, the driver stage components on the restor strip at top centre, and the output transistors at the right hand end.

But, for several reasons, we felt that a quasi-complement amplifier would not be the best choice for a guitar amplifier. Firstly, additional transistors are required to provide "push-pull" phase inversion and, with their necessary high-voltage ratings, they are quite expensive and often difficult to obtain.

Also, the quasi-complementary configuration can be quite critical to variations of component parameters, particularly with regard to the transistors. Invariably, this means that each amplifier must be individually adjusted for the particular components used.

Fault finding in a quasi-complementary amplifier can be extremely difficult because of the intimate coupling between transistors and the extensive AC and DC feedback loops. When a fault occurs within a feedback loop it can be very difficult to isolate the offending component by means of simple voltage analysis, because the fault is reflected throughout the whole loop.

And quite often, if a fault occurs a high-power quasi-complementary amplifier, it will result in the destruction of many expensive transistors.

Looking at the circuit diagram, readers will notice that we have used a transformer to couple the driver amplifier to the output stage. This transformer performs the dual function of providing impedance transformation and the necessary phase inversion.

However, the amplifier's load is directly coupled between the output transistors and power supply thus offering the main advantage of a quasi-complementary amplifier. That is; obviating the need for an output transformer operating at high power levels with the attendant problems of core saturation at low frequencies.

It is often difficult to maintain amplifier stability when applying large amounts of feedback if an output transformer is used. Thus the require-

ment of stability usually limits feedback in a transformer coupled amplifier design.

At low frequencies particularly, as well as high frequencies, there are appreciable phase shifts through a trans-

former which can cause normally negative feedback to become positive. This will inevitably cause an amplifier to oscillate unless preventative measures are taken.

Generally, instability resulting from high-frequency phase shift is relatively easy to cope with by the appropriate use of phasing capacitors and step circuits. A step circuit is simply the series

TRANSISTOR

RANGE
OF
GUITAR
AMPS.



POWER

STOP PRESS... SEE OUR SPECTACULAR DISPLAY OF EXCLUSIVE PRODUCTS & SERVICES at the AUDIO & VISUAL FAIR. EXHIBITION BLD. MELB. JULY 18-25

50 TO 800 RMS.WATTS.

FOR PRESTIGE SOUND SEE CLAYBRIDGE SOUND

Secure your **FREE, COLOURED CATALOGUE** of our products & services.



163 CLAYTON RD. CLAYTON VIC. 3168 OR RING 544 6171
(CNR. DANDENONG RD.)

(ALL HOURS)

ABOVE
ALL IN
PERFORMANCE
AND STYLE.



ADCOLA

"M" SERIES PRECISION SOLDERING & DE-SOLDERING TOOLS

"The soldered joint is the link between components in the most scientifically designed and developed apparatus the world has ever known. One faulty joint can upset the functioning of the apparatus."

"The first important decision in Radio or Electronics is the careful selection of a Precision Soldering Tool."



M20 1 OZ. 1/8" DIA. TIP:

FOUR "TRICLAD" TIP SIZES

MICRO MINIATURE ELECTRONICS
6 volt, 12 volt, 24 volt, 32 volt, AC/DC

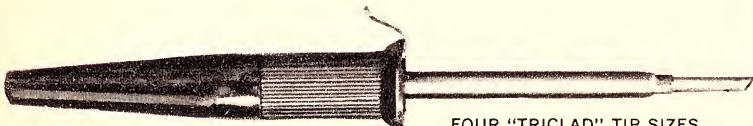

M64 3 1/2 OZS. 3/16" DIA. TIP:

FOUR "TRICLAD" TIP SIZES

RADIO AND TV ASSEMBLY AND
SERVICING
230-250 volt and all lower voltage
ranges AC/DC

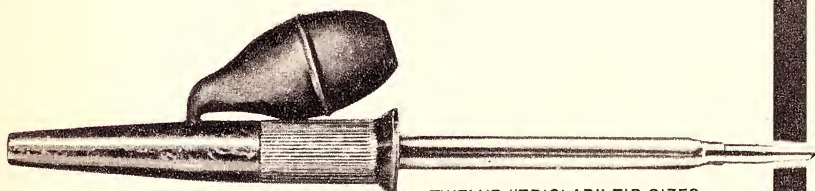

M207 4 OZS. 1/4" DIA. TIP:

TWELVE "TRICLAD" TIP SIZES

RADIO AND TV SOLDERING AND DE-
SOLDERING
230-250 volt and all lower voltage
ranges AC/DC

PRECISION MADE
THOROUGHLY TESTED
ACCURATELY CALIBRATED
EASILY APPLIED
EFFICIENT AND RELIABLE
CORRECT TIP TEMPERATURE
RIGHT TIP SIZE AND SHAPE
LIGHT WEIGHT
FINE BALANCE
FINGERTIP GRIP
SLIM BARREL
CONSTANT OPERATION
MAINS VOLTAGE APPROVED
AVAILABLE ALL VOLT RANGES
NO TRANSFORMER NECESSARY
STANDARD IN R.A.N.
STANDARD IN ARMY
STANDARD IN R.A.A.F.
STANDARD IN P.M.G.
STANDARD IN COMPUTER FIRMS
STANDARD IN SPACE TRACKING
AUSTRALIAN MADE
SERVICE IN ALL STATES
QUALITY GUARANTEED

ADCOLA

Available from all Principal Radio and Electrical Components Suppliers

Further information is available from:

N.S.W.: Adcola Products Pty. Ltd., 17 Burwood Rd., Burwood, N.S.W. 747-1606

S.A.: F. R. Mayfield Pty. Ltd., 11 Halifax Street, Adelaide. Tel.: 8-4131.

QLD.: T. H. Martin Pty Ltd., 56-74 Edward Street, Brisbane. Tel.: 2-0555.

W.A.: Everett Agency Pty. Ltd., 17 Northwood St., West Leederville. 6007. Tel. 8-4137

ADCOLA PRODUCTS PTY. LIMITED, 22 FIRTH STREET, DONCASTER, VICTORIA. 3108.

Tel.: 848-3777.



Lunar landscape photographed from Apollo 10 from a height of 69 miles

CONQUEST OF THE MOON

Lift-out supplement to "ELECTRONICS Australia" July 1969

PROFILE OF THE LUNAR LANDING MISSION

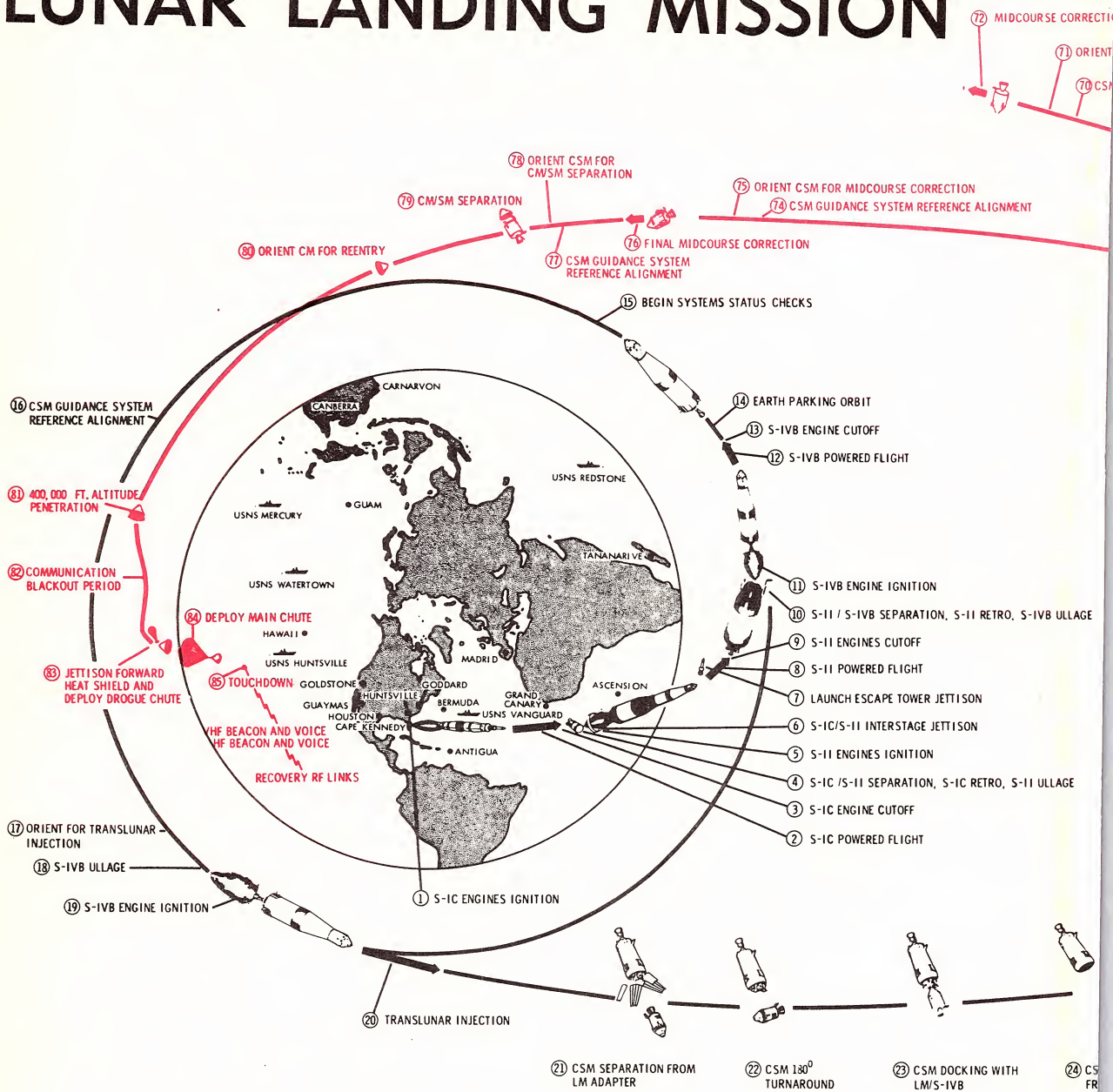

This diagram illustrates the sequence of operations involved in a complete, return mission to the moon. The enormous complexity of the project will become evident if the diagram is studied in detail. The separate operations are indicated by a sequence of numbers, beginning with (1) the actual launch from Cape Kennedy. At (14) having shed stages I and II, the vehicle is in an earth parking orbit which is closely analysed before setting out on the journey to the moon (20). The recovery and return journey is picked out in red, beginning with a pre-launch check-out (53) and culminating in a touch-down in mid Pacific (85). According to reports, the Apollo 10 mission uncovered an unexpectedly wide variation in gravitational attraction close to the surface of the moon. The relevant data is currently being examined to determine its possible influence on the Apollo 11 mission. NASA authorities are adamant that

the natural hazards of the mission shall not be increased by unknown factors capable of determination, or by technological problems capable of being anticipated by on-site testing. The communications back-up for the Apollo missions is fantastic in its proportions involving, on earth, a vast network of space tracking centres, wire, radio and satellite links, data recording equipment and computers for vehicle control and data processing. Orbiting the moon, the Command and Service vehicle will rely heavily on S-Band radio links (above 2000MHz) to transmit to earth voice, TV, ranging, biomedical, telemetry, etc. Its communication with the Lunar Module will be mainly on VHF in the range 250 to 300MHz. The Lunar Module carries matching VHF equipment but also S-Band equipment for direct transmission to earth, the latter aided by a portable S-Band dish which will be erected on the lunar surface.

RED - RETURN JOURNEY

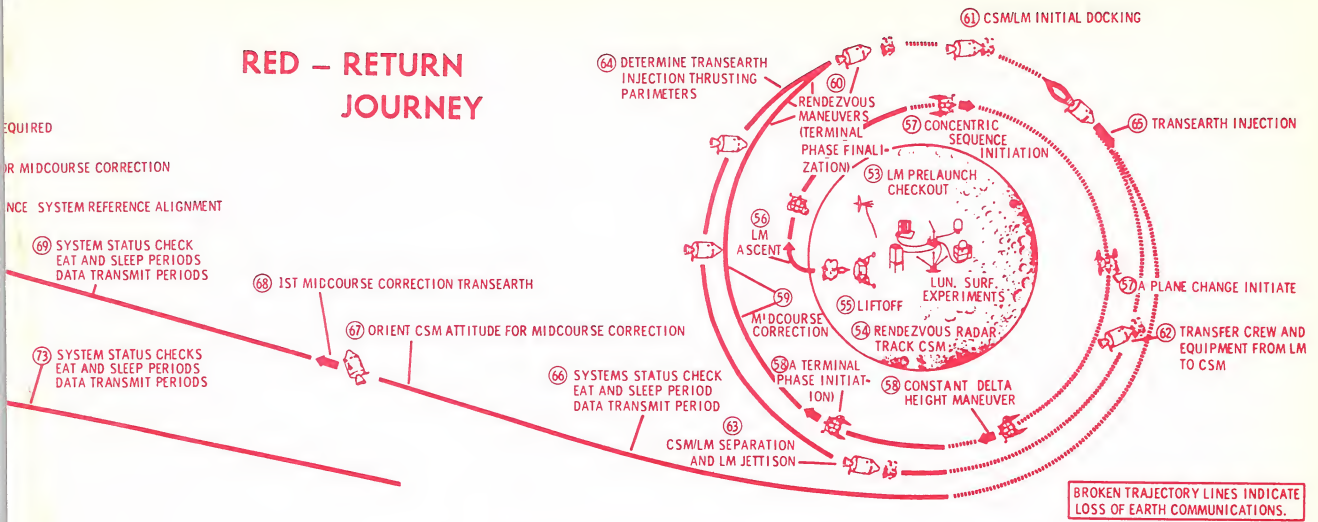

THIS CHART HAS BEEN PURPOSELY DRAWN OUT OF SCALE TO BETTER ILLUSTRATE THE MAJOR EVENTS OF THE MISSION.

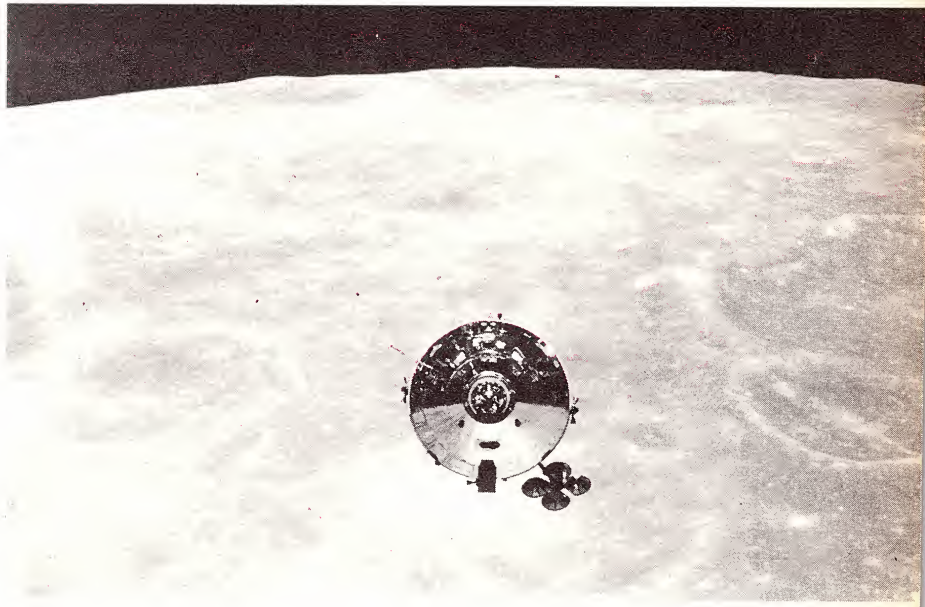

The Apollo 10 Command and Service Modules (CSM) photographed from the Lunar Module (LM) in the full glare of the Lunar mid-day sun.

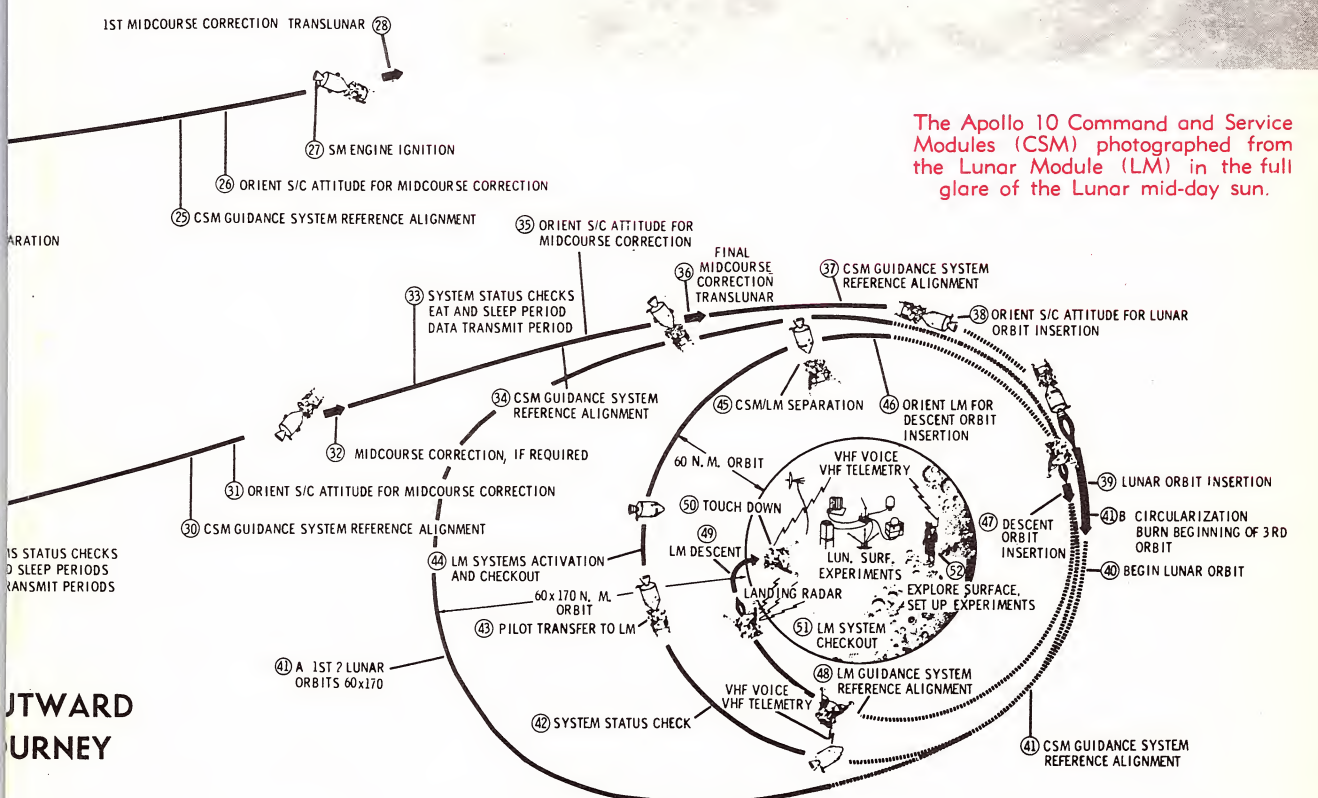

FORWARD JOURNEY

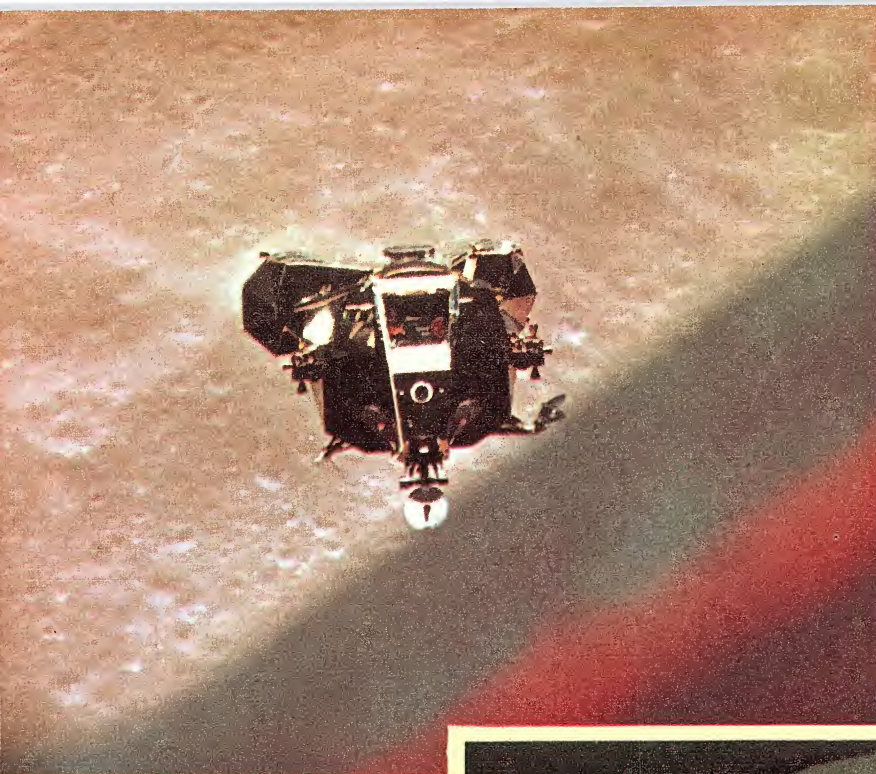

The lunar module viewed from the command and service vehicle above the surface of the moon. At this stage the lunar module had completed its descent to within about nine miles of the moon's surface; it had jettisoned its descent stage and is approaching the command and service module from below, ready for docking. The heavy, coloured bands at the bottom right of the picture are an out-of-focus image of the edge of the spacecraft's window.

The National Aeronautics and Space Administration has named these three astronauts as the prime crew of the Apollo 11 landing mission. Left to right: Neil A. Armstrong, commander; Michael Collins, command module pilot; Edwin E. Aldrin Jr., lunar module pilot. If the mission goes as planned, these men will turn fiction into fact. Success of the mission, and the safety of the crew, hangs on a fantastically long chain of technology, involving every branch of science.



This colour television picture of the earth was transmitted from Apollo 10, on May 18 last, when the spacecraft was nearly 25,000 miles out in space. The astronauts brought back a large amount of colour film which shows the lunar surface and the distant earth in fine detail but, in a sense, the live television pictures are more historic. The ability to carry colour TV equipment and transmit successful pictures over the distances involved is a measure of modern spacecraft communications.

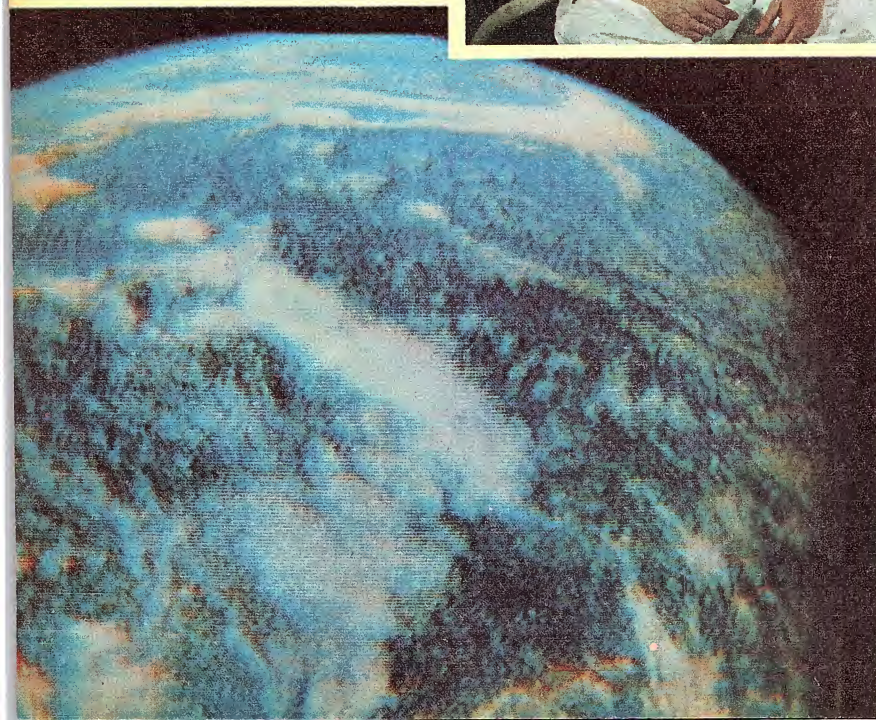

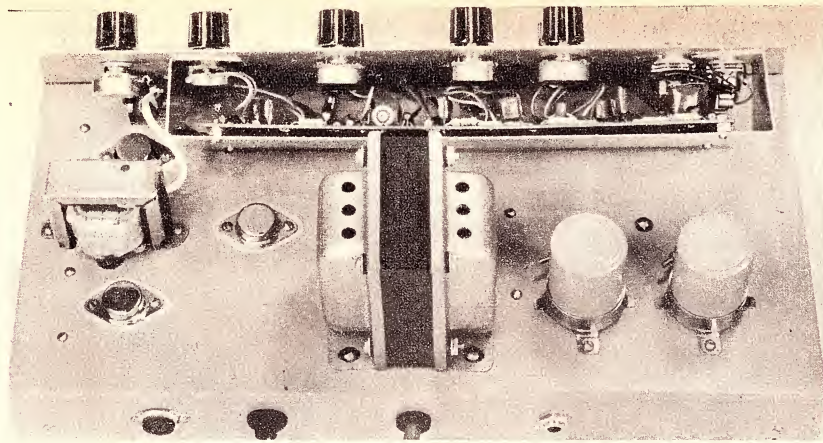

The main power supply electrolytic capacitors are on the right, the driver transistor is immediately to the left of the power transformer and the driver transformer at the extreme left with the output transformers in front of and behind it.

combination of an inductor and resistor or a capacitor and resistor, the latter being most frequently used. With such a circuit an amplifier's gain can be reduced, at a point sufficiently below the frequency of critical phase shift, so that oscillation does not take place.

The low-frequency end is a different matter. It is not so easy to suddenly reduce the gain of an amplifier to maintain stability and, in practice, negative feedback must be kept to a safe level. Thus, with an output transformer the overall performance of an amplifier in terms of its frequency response and harmonic distortion may be adversely affected, by the need to restrict the feedback level.

While we do use a transformer in the present design, and it is included in the main feedback loop, it is operating at a low level and low-frequency phase shifts are not a problem.

In any transformer there is significant low-frequency phase rotation and loss of bass response when the magni-

approaches the point of impracticality as output power is increased.

But, this situation does not arise in a low-level driver transformer where it is relatively easy and more economical to provide a large primary inductance.

From the foregoing readers can appreciate the advantages in having a transformer-driven output stage with directly coupled load. And, as such, we believe it is about the best approach for an economical and reliable audio amplifier giving high output power from a relatively simple circuit.

Having decided upon the output-stage configuration and the general power level required, we were able to lay down the power supply specifications. In this amplifier the power supply is vitally linked with the operation of the output stage and as such it may be considered as an integral part of the output-stage design.

In a transformerless output stage we have a choice of two popular arrangements. By providing a centre tapped

Wiring of the miniature resistor panel which contains most of the components in the driver amplifier is shown in the diagram at the right.

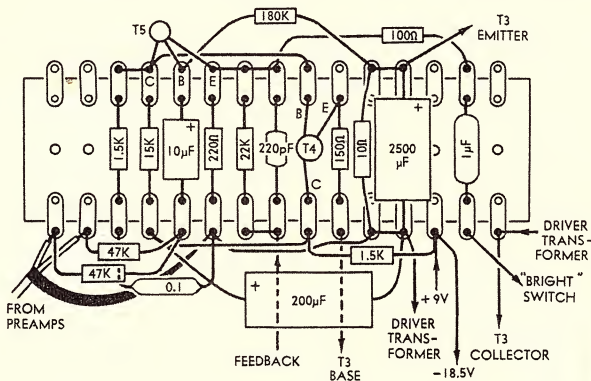

tude of primary reactance falls to a value comparable with the reflected primary load resistance. In order to minimise these low-frequency effects the primary winding must have a high inductance, necessitating lots of turns.

In the output transformer of a transistor amplifier delivering high power there will be a high primary current and although winding resistances are kept to a minimum there would be significant power loss. Thus there are the conflicting requirements of many turns for high inductance and few turns for low winding resistance and minimum power loss. The necessary compromise

power supply the amplifier's load can be connected directly to the output transistors. Alternatively, by coupling the load through an electrolytic capacitor, we can manage with a simpler power supply. The disadvantage of using an electrolytic capacitor is that it has to handle the total load current and, irrespective of capacitance, must be physically large and will, therefore, be expensive.

On the other hand, a centre-tapped transformer will be more costly than a single-winding variety. Nevertheless, this approach can be justified on the basis of increased reliability and a pos-

2

POPULAR SOLID STATE STEREO AMPLIFIERS FROM THE SOUND/ENCEL STABLE!

With specifications that demand attention and most effective quality control in manufacture, it's not surprising that Sound stereo amplifiers command a high proportion of the markets in their respective price ranges. In Australia Encel prices make Sound amplifiers better value than ever. Ask for a trade-in valuation when you write or call!



SOUND MODEL SAQ-203 SOLID STATE STEREO AMPLIFIER

Frequency response is 30-20,000 Hz. and input sensitivity suits magnetic cartridges at 3 mV. Output is 12 watts R.M.S. or 30 watts E.I.A. peak power. 18 low noise transistors. Headphone jack, all necessary controls, attractive front control panel. Speaker matching for 4, 8 and 16 ohm speakers or speaker systems. An ideal compact amplifier for use with tape recorders or for building into cabinets and bookshelves. Inc. sales tax **\$74.50**



SOUND MODEL SAQ-505X SOLID STATE STEREO AMPLIFIER

With an output of 25 watts R.M.S. into 8 ohm speaker systems, the 505X represents outstanding value for money. Frequency response is 20-20,000 Hz. ± 1 dB. and extends well beyond this range. Sensitivity is 3 mV. for magnetic cartridges and all desirable control facilities are incorporated. This powerful amplifier is bargain priced by Encel Electronics at only **\$119.50**

ENCEL TEST REPORT ON THE SOUND SAQ-505 AMPLIFIER

Our laboratory test report indicates that the actual power output of the unit is 24½ watts R.M.S. per channel. Frequency response is substantially flat, being down 2 dB. at 20Hz. and down 1 dB. at 20 kHz. Square wave tests at 1 kHz. and 10 kHz. are excellent and show little variation in the audible ranges.

Encel

ELECTRONICS (STEREO) PTY. LTD.

Head Office:
431 Bridge Rd., Richmond, Victoria 3121.
Tel. 42 3762.

Sydney Store: Ground Floor, 25M Building,
257 Clarence Street, Sydney, N.S.W. 2000.
Tel. 29 4563, 29 4564.

*Wholesalers *Trade-ins accepted
Australia's Greatest Hi-Fi Centre

CT 500/P MULTIMETER

6 DC Voltage Ranges: 0 - 5000V
 5 AC Voltage Ranges: 0 - 1000V
 4 DC Current Ranges: 0 - 500mA
 4 Resistance Ranges: 0 - 12M
 Sensitivity: DC 20,000 ohms per Volt,
 AC 10,000 ohms per Volt

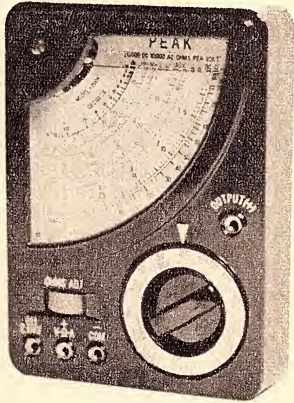
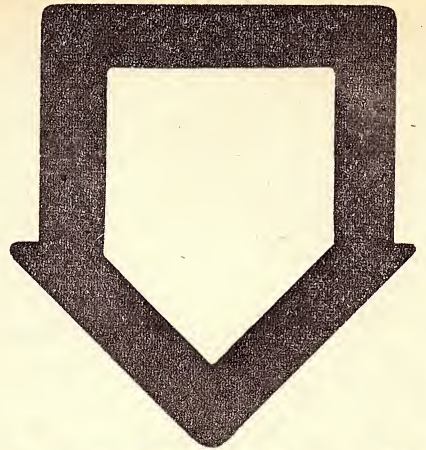
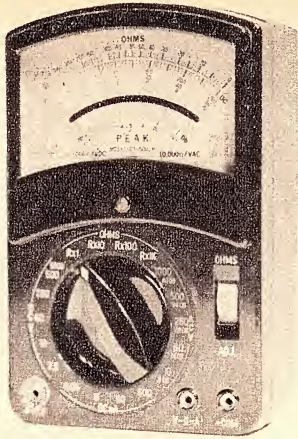

200H MULTIMETER

6 DC Voltage Ranges: 0 - 2500V
 5 AC Voltage Ranges: 0 - 1000V
 3 DC Current: 0 - 250mA
 Resistance: 0 - 6K, 6M
 Capacitance: 10pF - 0.1MFD
 Sensitivity: DC 20,000 ohms per Volt
 AC 10,000 ohms per Volt

**MEASURE UP TO A
 MULTIMETER FROM
 GENERAL ACCESSORIES
 THE METER SPECIALISTS**

SERVING THE RADIO & ELECTRICAL INDUSTRY THROUGHOUT AUSTRALIA.

DIVISION OF ELECTRONIC INDUSTRIES LIMITED.

N.S.W. 443 CONCORD ROAD, CONCORD WEST. Phone: 73 0211
 W.A. 46 MILLIGAN STREET, PERTH. Phone: 21 2501
 T.A.S. 199 COLLINS STREET, HOBART. Phone: 2 2711
 QLD. 50 LITTLE EDWARD STREET, BRISBANE. Phone: 2 3093
 S.A. 81 FLINDERS STREET, ADELAIDE. Phone: 23 4022
 VIC. 153 STURT STREET, SOUTH MELBOURNE. Phone: 69 0300

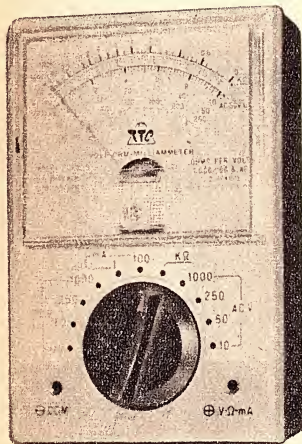

C 1000 MINIMULTIMETER

4 AC Voltage Ranges: 0 - 1000V
 4 DC Voltage Ranges: 0 - 1000V
 2 DC Current: 0 - 100mA
 Resistance: 0 - 150K Ohms
 Sensitivity: 1000 ohms per Volt AC, DC

CT 330 MULTIMETER

8 DC Voltage Ranges: 0 - 6000V
 5 AC Voltage Ranges: 0 - 1200V
 4 DC Current: 0 - 600mA
 4 Resistance: 0 - 60Meg Ohms
 Capacitance: 50pF - 0.2MFD
 Sensitivity: DC 20,000 ohms per volt, AC
 10,000 ohms/volt

CT 330/P With Diode Protection

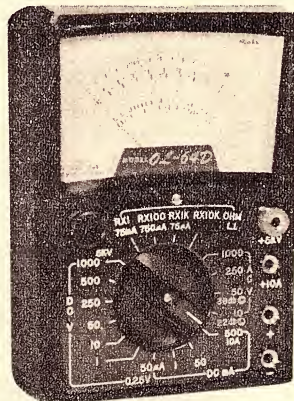
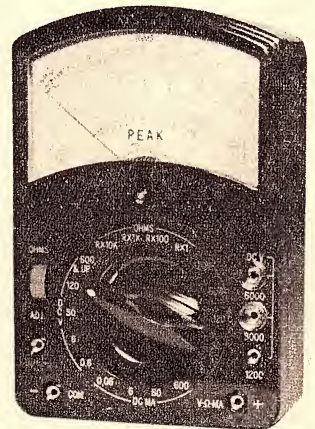

OL 64D MULTITESTER

*Measuring Range

8 DC Voltage Ranges: 0 - 5000V at 20 Ohms/V
 4 AC Voltage Ranges: 0 - 1000V
 5 DC Current Ranges: 0 - 10A
 4 Resistance Ranges: 0 - 40 meg Ohms
 Capacitance: 250pF - 0.02µF
 Inductance: 0 - 5000H
 Sensitivity: 20,000 ohms per Volt DC
 8,000 ohms per Volt AC

sible overall saving on electrolytic capacitor costs.

Figure 1 has been included to clarify the operation of the output stage and power supply. As the figure indicates, operation may be considered in respect of each output transistor and half the total supply voltage ($V_s/2$).

Consider the operation of the output transistors under conditions of sinusoidal input. Each device conducts over only half the cycle and, neglecting for the moment the small voltage which appears across the transistors when they are saturated, the peak load voltage will be $V_s/2$.

Thus, as a first approximation, the power output will be given by: $\text{Power} = 0.7(V_s/2)^2/R_l$. Assuming an 8 ohm load impedance (R_l) this means that $V_s/2$ must be no less than 28V for 50W load power.

In practice, there are losses which necessitate a somewhat higher supply voltage. In addition to the transistor saturation voltage, which will be typically 1 to 2 volts for silicon devices, there will, at high current levels, be a significant voltage across any emitter feedback resistors which may need to be fitted.

For an output of 50 watts into the designed load of 8 ohms, the load current will be about 3.5 amps peak. That is, each transistor is required to handle 3.5 amps at the peak of its respective half cycle.

Considering the worst condition, where the transistors have a minimum current gain of 20, the base current for each transistor will be a maximum of 175mA peak. The base current must, of course, be provided by the driver amplifier via the coupling transformer.

Unfortunately the base input resistance is not constant over the whole half cycle during which the respective transistors are conducting. This presents an additional problem as it can be a source of considerable distortion.

One way to overcome the distortion due to base resistance non-linearity is to, in effect, swamp these variations with additional resistance in the external base circuit.

Although there is not a resistor physically in series with the bases of T1 and T2, the driver amplifier's "source resistance" can be considered as effectively in series with each secondary winding. Thus a high "source resistance" in the driving amplifier is used to swamp base resistance variations.

Another method is to apply negative current feedback to each output transistor. This is done by inserting small resistors in the emitter circuit of each output transistor, effectively increasing and linearising the base resistance.

In this amplifier we have been able to reduce the distortion to a reasonably low level with 0.5 ohm emitter resistors and the application of overall negative feedback. At 40 watts output the total harmonic distortion is only 0.8 per cent, rising to 1.8 per cent at 45 watts and 4 per cent at 50 watts, where power supply limiting takes place.

The amplifier will provide more power under music conditions and, in fact, we measured 55 watts on an IHF music power test. This involves measuring output power when the am-

plifier is fed with a 10 millisecond burst of sine wave signal. We used a "tone burst gate" to supply 8 cycles of an 800Hz signal and measured the peak-to-peak voltage across the load.

Three transistors are used in the DC coupled driver amplifier to provide the necessary current and voltage gain. Drive power for the BDY20 output transistors (T1 and T2) is developed in the primary winding of the inter-stage transformer by a third BDY20 (T3) operating in a class A mode.

Coupled directly into the base of T3, the emitter follower T4 provides current amplification. The 150 ohm resistor, connecting emitter and base of T33 and T4 is necessary as a "stopper" to prevent local instability in the driver amplifier.

The third transistor in the driver amplifier (T5) provides further voltage amplification. Bias for the driving triple is derived from a voltage developed across the emitter resistor of T3.

Overall negative voltage feedback is applied to this stage, from the output via a 15K resistor to the 220 ohm emitter resistor. In addition to the more usual effects of reduced distortion and noise, plus, broadened frequency response, the voltage feedback tends to reduce the amplifier's output impedance, making it approach the ideal concept of a constant voltage source.

A 470pF capacitor across the 15K feedback resistor compensates for any high-frequency phase rotation in the feedback loop, thereby contributing to amplifier stability. In addition to this capacitor, there are two step circuits as further stabilising measures.

One, 820 ohms and 0.1uF is connected across the 15K load resistor for T5, and the other, a 12 ohm and 0.47 uF, is connected from the output to the power supply centre tap. With these circuits included the amplifier will tol-

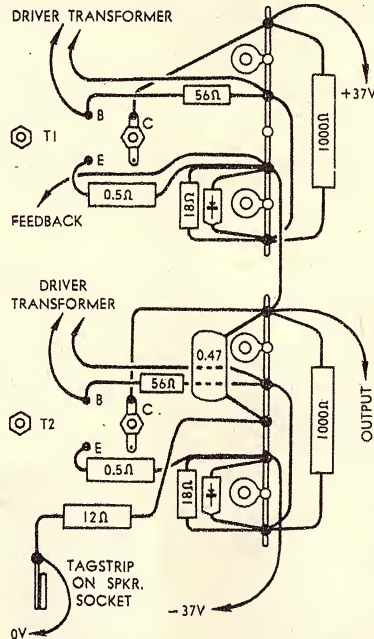

A wiring diagram for the output transistors is shown above. Take particular note of the polarity markings on the silicon diodes which shunt the 18 ohm resistors.

TECHNOCENTRE TOPICS

At our Technocentre you receive friendly advice and guidance from our highly qualified consultants. An invaluable service to those building or altering a home. The equipment you buy at Convoy will serve you well for many years and have a good resale value. This is your real cost! Make sure you visit the Technocentre before you buy any item of Hi-Fi equipment.

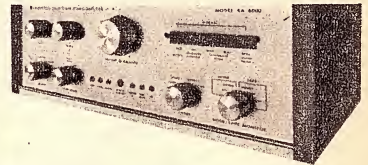

- ★ At its price, the Kenwood KA6000X Amplifier, 100 watt RMS, is the outstanding buy of the moment for connoisseurs, P.U. input to .05 Mv., In Tuner Amplifiers, the Pioneer SX440 rated 30 watts RMS is a smooth machine with luminescent tuning scale and black finish — FM and Multiplex, too!
- ★ The Electronics review of Revox 77A Tape Recorder has brought a slight blush to our cheeks. We have confidently said, "the best ever," after appraising this machine. It is good to know our opinion is now supported by the unbiased technical experts of Electronics. Call, see, hear, then own the best, A Revox Tape Deck or Full Recorder with 20 watt amps and Speakers.
- ★ Stereo Headsets by A.K.G. make private Hi-Fi listening a totally new experience. The A.K.G. series of microphones are of professional standards, but we can choose them to suit your requirement and budget.
- ★ The Peerless of Denmark, Sherwood 15" three-way Speaker System in new enclosures is an experience to hear. Compare it with other speaker systems. We have imported Peerless speakers in teak enclosures from \$100.00 pair. Also Poly-Planar Speakers less than one inch deep, 20Hz 20KHz—Speaker Cloth and innerbond stocked.
- ★ STOCKTAKE SPECIALS. June is the month to pick up a real bargain at the Technocentre—Amps., Speakers, Turntables, Tape Decks, Cartridges — You'll be surprised at the low prices.

SERVICE AND MAINTENANCE

—Let the Technocentre specialists care for your sound equipment. We service all brands—Sony—Akai—National — Pioneer — Trio—Philips —Sharpe, etc.

Convoy

FOR SOUND SATISFACTION

TECHNOCENTRE
449 KENT STREET,
SYDNEY 29-6475

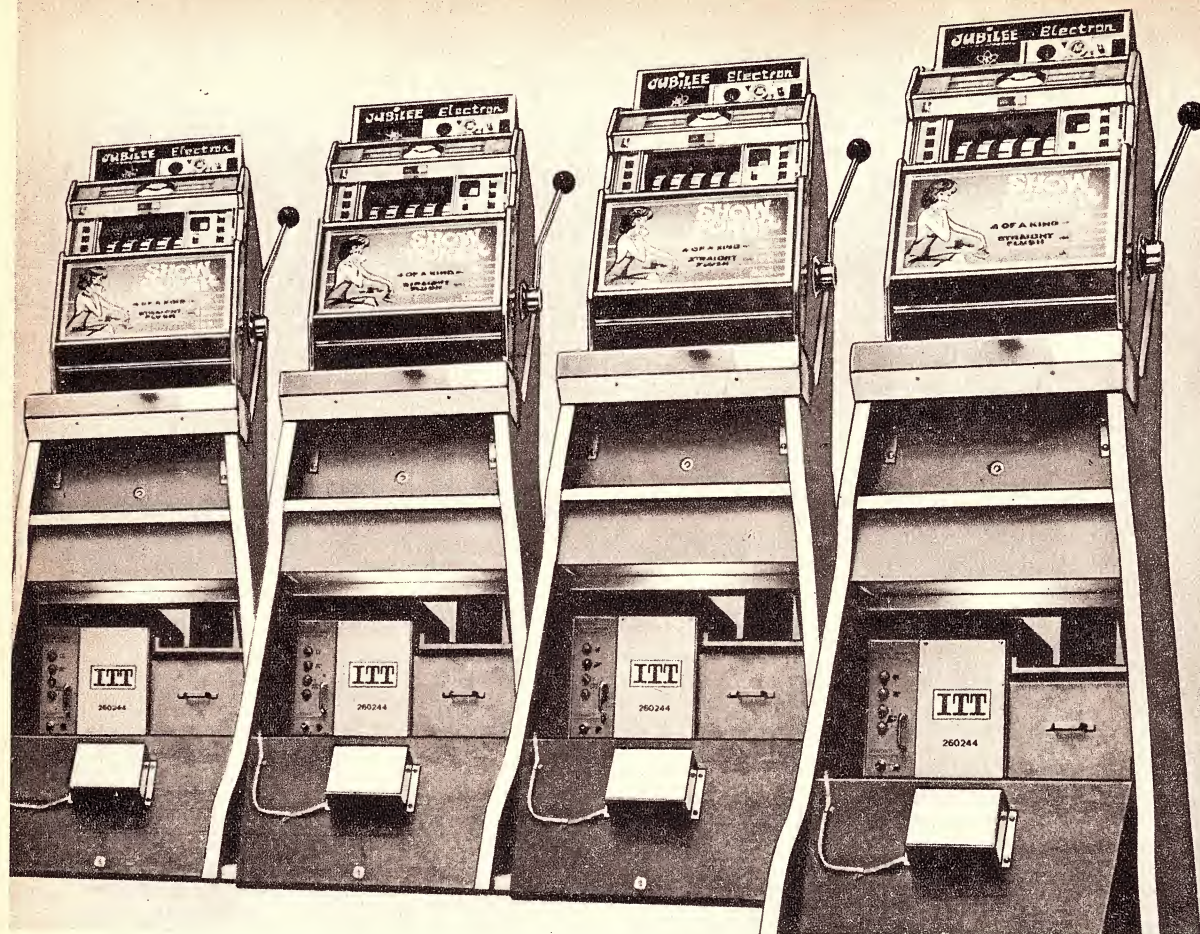

How STC put Computer technology into Nutt and Muddle's business:

Before we start let's get one thing straight. STC are not in the poker machine business. We produce solutions to communications problems.

Nutt and Muddle had a problem. They wanted to build a new type of poker machine. One that really could play poker; and pay out on real poker hands. You may not know it, but even the most modern poker machines work on a simple 19th century mechanical principle.

Yesterday's mechanics simply could not solve Nutt and Muddle's problem. That's where we came in. STC.

We built a poker machine with a new brain. An electronic brain. Every piece of the new poker machine's electronic brain is made from STC stock components.

This poker machine computer, designed in the Applications Laboratory at STC is the heart of a poker machine which will



play to the full rules of poker. The positions of the wheels are detected by electrical contacts and the resulting signals are coded and converted to serial logic.

Various counting and logic circuits then decide if a payout is to be made. When there is, a coin discharge control system is programmed to pay out the correct number of coins.

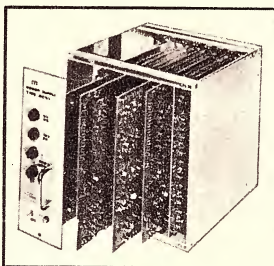

The circuits use discreet components in multi-function logic circuits not available in integrated circuits, so that both logic complexity and manufacturing cost are considerably less than an equivalent integrated circuit design.

Nutt and Muddle are now happy. They have a great new 20th century poker machine. STC have a new satisfied customer.

All we need now are some new sticky problems. Ask us to do something.

Standard Telephones and Cables Pty. Limited, Electronic Components Division, Moorebank Avenue, Liverpool 2170. Telephone 602 0333.

AN
ITT
ASSOCIATE

worldwide telecommunications and electronics



erate a wide range of reactive loads without suffering any instability.

A switched step circuit, 100 ohms and 1uF, across T5's emitter provides a fixed amount of treble boost in the power amplifier. This facility is used to brighten the amplifier's response when used with a lead guitar. Note that the boost is applied in the main amplifier and will consequently affect both input channels.

As we said previously, we have provided two channels for independent tone control of two guitars. Each channel has two inputs, designated "Hi" and "Lo."

The input sensitivities are approximately 200 and 25 millivolts respectively, and an input impedance of about 47K for both. However, the sensitivities can be adjusted to suit particular instruments and there is no reason why this should not be done.

Shunt feedback applied to each input stage (T7 and T12) allows easy adjustment of gain and provides a very low input impedance at the bases of these transistors. The low base impedance has the advantage of providing good isolation between inputs which are coupled via 47K and 390K resistors.

AC feedback is applied from collector to base of transistor T12 via the resistor marked with an asterisk. This resistor has been omitted in the bass channel (T7) to give maximum gain, but is shown dotted. A suitable value, determined experimentally, can be fitted if necessary.

The value of the feedback resistor and the resistors in series with the input terminals (47K and 390K as shown) determine input sensitivity. Varying the feedback resistor will vary the input sensitivity of both inputs at the same time and should be increased to increase sensitivity.

Maximum sensitivity is obtained with a 47K input resistor in series and no feedback resistor, as in the "Lo" bass input. In the "Hi" channel gain is reduced by the 390K resistor, while input impedance is maintained by a 47K resistor shunting the input.

The input stage of each channel is followed by a feedback tone control stage providing an exceptional amount of boost and cut at both bass and treble frequencies. The circuitry for these stages, comprising transistors T6 and T11, has been used on previous occasions for high fidelity amplifier tone control networks.

However, for application in a guitar amplifier, we modified component values to produce the special response contours required for a guitar amplifier. In keeping with the extreme range of tone control required and the frequencies to be handled, the cross-over point is around 700Hz with 16dB bass boost at 100Hz and 20dB treble boost at 10,000Hz.

In the bass channel output is taken directly from T6 and coupled to the power amplifier via a 50K volume control potentiometer. However, signal from the volume control in the tremolo channel is applied to the all transistor tremolo modulating stage, T9. From T9, the modulated signal is then passed to the main amplifier and mixed with signals from the bass channel.

Mixing isolation for the two channels is provided by two 47K resistors in series with the input to the main amplifier. Interaction by the bass

volume control is negligible and, if necessary, the isolating resistors could be reduced in value by a small amount to provide additional sensitivity. This applies particularly to the "tremolo" channel resistor which may be as low as 22K.

As already stated, the tremolo circuitry was described in a previous article. However, there are a few points which should be mentioned again.

The value of the resistor in series with the tremolo intensity control, shown as 1.5M. This may need adjustment to suit the particular field effect transistor being used. If there are any "clicks" in the tremolo modulation, or if the low frequency modulating signal can be heard when no signal is passing through the amplifier, then the 1.5M resistor should be increased in value until they disappear.

The second point concerns the 20uF capacitor coupling the FET (T10) to the emitter circuit of T9. Ideally, this should be a tantalum "dry" electrolytic capacitor for minimum DC leakage current, and because this type of capacitor is not prone to aging and subsequent loss of capacitance.

Power for the preamplifier stages is derived from a full wave voltage doubler, independent of the main supply. A 6.3V winding on the power-transformer is used for this purpose, and also supplies a 100mA pilot lamp.

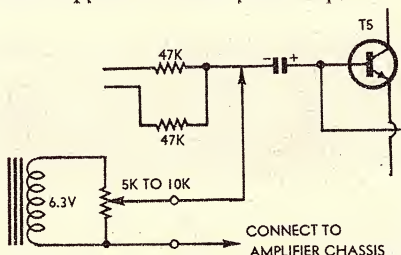

Figure 2. A simple test set-up to determine whether the amplifier is working correctly.

In the construction of the amplifier we have endeavoured to present a style which would be completely acceptable for a commercial product and, at the same time, to keep metalwork as simple as possible. In addition we have constructed a relatively simple vinyl covered wooden cabinet to complete the unit.

As we fabricated it, the chassis is in two sections; a rectangular dish for the power supply and power amplifier, and a sloping front panel on which are mounted the controls and preamplifier wiring board. The front panel sits flush with the ends of the chassis proper and the whole assembly slides into the rear of the sloping front cabinet.

Invariably there are problems in marrying a front panel and cabinet in an attractive presentation while, at the same time, retaining a simple and economical assembly. This amplifier has been no exception, and we would stress at this point that the way we have tackled the problem may not offer the best nor most economic solution. We would therefore strongly recommend that kit suppliers investigate this aspect in the light of production requirements and facilities which they may have.

The 9½in x 3in wiring board is mounted on a long "U"-shaped bracket which is in turn fastened to the front

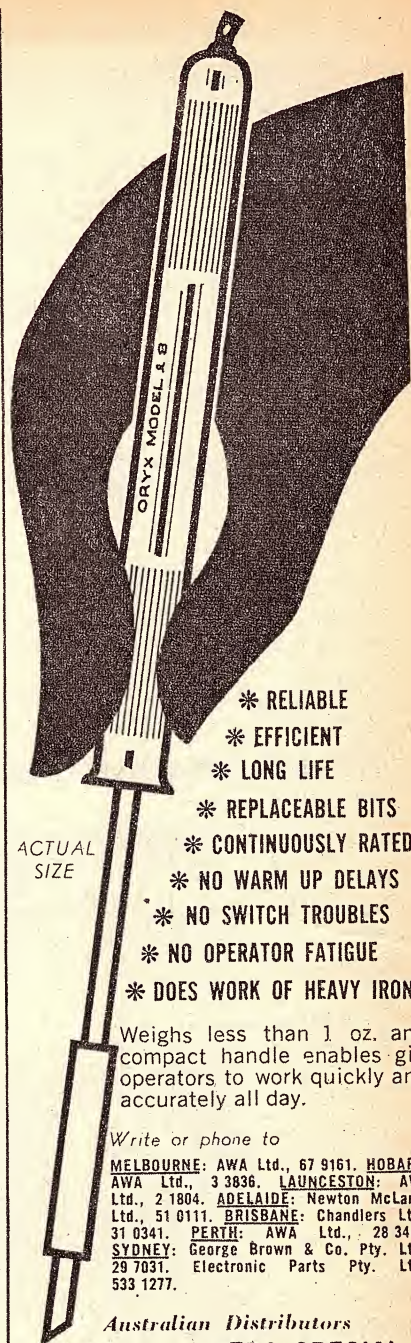

- * RELIABLE
- * EFFICIENT
- * LONG LIFE
- * REPLACEABLE BITS
- * CONTINUOUSLY RATED
- * NO WARM UP DELAYS
- * NO SWITCH TROUBLES
- * NO OPERATOR FATIGUE
- * DOES WORK OF HEAVY IRONS

Weighs less than 1 oz. and compact handle enables girl operators to work quickly and accurately all day.

Write or phone to

MELBOURNE: AWA Ltd., 67 9161. HOBART: AWA Ltd., 3 3836. LAUNCESTON: AWA Ltd., 2 1804. ADELAIDE: Newton McLaren Ltd., 51 0111. BRISBANE: Chandlers Ltd., 31 0341. PERTH: AWA Ltd., 28 3425. SYDNEY: George Brown & Co. Pty. Ltd., 29 7031. Electronic Parts Pty. Ltd., 533 1277.

Australian Distributors
MANUFACTURERS SPECIAL
PRODUCTS PTY. LTD.

47 York Street Sydney, 2 0233, Ext. 284

WANTED

BY ALL
PRODUCTION ENGINEERS

ORYX

miniature
soldering instruments



Bang & Olufsen— for those who consider design and quality before price.

Bang & Olufsen audio equipment is made for those who consider design and quality first. There is a wide range of radios, record players, amplifiers, loudspeakers and radiograms, all designed to give unprecedented pleasure to ear and eye. Your B & O dealer will advise you how to start a system that will give you enjoyment for the years ahead. Here is just one selection.

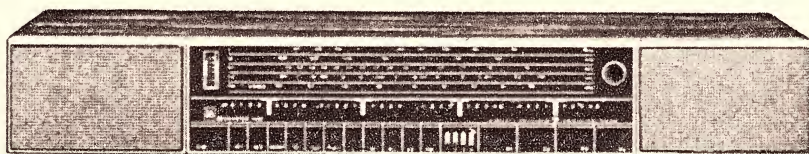

BEOMASTER 1400K

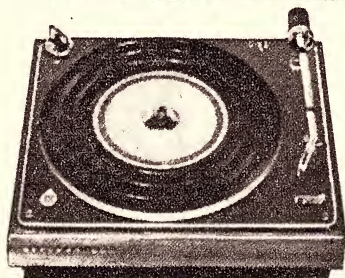

BEOGRAM 1000

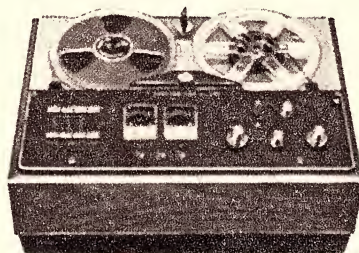

BEOCORD 1500 DE LUXE

BEOMASTER 1400K A sophisticated and versatile five waveband stereo radio receiver/audio amplifier. Completely modern in Danish styling, this new Beomaster is available with or without built-in pressure chamber loudspeakers—making it a complete table radio of the highest quality, or a central unit in a comprehensive stereo audio system. Five wavebands cover F.M., Long, Medium, Shortwave 1 (66—200m) and Shortwave 2 with bandspread (16—49). Special features

include 4 pre-tunable pushbuttons in the F.M. waveband, giving instant programme selection, and a built-in decoder for stereo radio broadcasts. Facilities for using gramophone, tape recorder and two sets of stereo loudspeakers via the high quality stereo amplifier, which gives an output of 15 watts per stereo channel. Available in teak or rosewood finish, to match other equipment in the Bang & Olufsen range.

BEOGRAM 1000 A stereo transcription turntable unit mounted on a suspended shockproof plinth and featuring the world famous ST/L 15° tone arm, hydraulic lowering device and SP7 cartridge with diamond stylus. Specially engineered speed selector with vernier adjustment. Available in teak or rosewood finish.

BEOCORD 1500 DE LUXE stereo/mono tape recording deck. Working through a quality radio/amplifier—such as Beomaster 1400—with tape recorder connexion, the Beocord 1500 gives the facilities of a complete tape recording system. Available in teak or rosewood finish.

Danish Hi-Fi Pty. Ltd.

941 BURKE RD., CAMBERWELL, VIC. 3124. Phone 82 4839

panel. The bracket is held at one end by a jack socket and at the other by the vibrato - speed potentiometer.

We suggest that the constructor commence with the main amplifier. This can be assembled, wired, tested, and brought to working condition from the description we will give this month. Details of the preamplifier, such as the printed wiring board pattern, wiring diagram, components and assembly will be given in next month's article.

From the photographs readers will have a fair idea of major component positions. Looking at the chassis top it will be noticed that the power transformer is placed approximately centre chassis so that the amplifier will balance when carried by a cabinet handle.

Two can mounting electrolytics are placed to the right of the power transformer while the three power transistors (T1, T2 and T3) are bolted directly to the chassis on the left side. In this way the transistors, as sources of heat, are placed remote from the electrolytics. This is necessary to prevent unnecessary heating and subsequent drying out of the electrolytics.

The driver transformer is bracket mounted between the two output transistors T1 and T2. Two grometed holes for transformer leads are located directly under the winding bobbin.

The power transistors are mounted in the normal way using mica washers for electrical insulation. Both the transistors and the chassis mounting area should be liberally coated with silicone grease to minimise thermal resistance between transistors and chassis.

Overall dimensions are considerably reduced by using the chassis for transistor heat sinking, rather than attaching finned heat radiators. Under normal conditions the chassis does become warm but there is no danger of transistor "runaway" even under the worst conditions.

We made extensive temperature measurements using a thermocouple meter and found that under conditions of maximum transistor dissipation (this does not occur at maximum output power for class B operation) the actual transistor base temperature did not rise above 62 degrees centigrade. Under normal music conditions the case temperatures did not rise above 54 degrees centigrade.

The chassis area under the power transistors must be left bare of paint to maintain minimum thermal resistance between the chassis and the transistor. This is most important. A high thermal resistance will result in dangerously high transistor temperatures. The chassis material and gauge will also affect heatsink efficiency. It should not be thinner than 18g and, if of steel, should not be painted, as this will reduce its heat radiating capability. It can be plated or passivated. If of aluminium it can be painted.

With all the hardware mounted on the chassis, the power amplifier wiring can be completed. Just where to start does not matter particularly, but it might be logical to complete and install the miniature resistor panel.

Then wire both power supplies, commencing with the main supply. Retain the full lead length on the 150 and 100 ohm 10 watt resistors, to maintain maximum thermal isolation between them and the 1000uF electro-

lytics. The low voltage supply is wired on an eight-lug tag strip.

Finally, complete the wiring associated with the output and driver transistors, including the driver transformer. The biasing components for each output transistor are wired to seven-lug tag strips, visible on the right hand side of the under chassis photograph. The step circuit comprising a 12 ohm resistor and a 0.47uF capacitor across the output is wired from T2's tag strip (T2 is closest to the output socket) to a two-lug tag strip at the output socket.

Driver and power transformers are available from either A. and R. Transformers Pty. Ltd. or Ferguson Transformers Pty. Ltd. The A. and R. type numbers are TD32 and 6586 and Ferguson TRD258 and PF3113 respectively.

When wiring the driver transformer it is very important to observe correct phasing polarity, otherwise the amplifier could either oscillate or destroy the output transistors.

Fortunately, both manufacturers have used the same lead colour coding and the following description is applicable to both makes.

On the circuit diagram we have indicated the phasing polarity of the driver transformer in two ways. As is often done in text books, we have shown the winding phase with a dot at one end of each winding. The dot can indicate either all winding starts or all winding finishes.

In addition, we have indicated how we connected the prototype transformer with regard to winding starts and finishes, using the designations "S" and "F" which are self explanatory.

The driver transformer primary starts with a blue lead and finishes with red. Blue is connected to the collector of T3, and red to the positive supply.

The secondary connected to T1 starts with yellow, which is connected to the base; it finishes with orange which is connected to the biasing resistors. The secondary winding to T2 is connected with opposite phase to that of T1. T2's secondary winding starts with white, which is connected to the biasing resistors; it finishes with brown which is connected to the base of T2.

Complete the under-chassis wiring up to but short of connecting any part of the amplifier to the power supply. Connect the mains supply and measure all power supply voltages to ensure correct operation. Without the amplifiers connected the supply voltages will be a little higher than those on the circuit diagram.

Having established correct supply operation the driver amplifier can be connected to the supply and the various DC voltages checked against those on the circuit diagram.

Note that all voltages in the power amplifier are measured with respect to the power supply centre tap as indicated. Voltage measured in the completed amplifier may not be exactly the same as those indicated on the diagram. A voltage-tolerance of about plus and minus 10 per cent is quite in order.

At this point we are ready to connect the output transistors to the power supply. It is necessary to use heavier gauge wire for this to avoid voltage losses due to the heavy currents drawn by the output transistors. "Figure eight" flex, with conductors

(Continued on page 178)

TRANSISTOR SERVICE

All Japanese and local sets repaired

including . . .

Aristone	Aurora	Belair
Berlin	Crown	Fujiya
General	Hitachi	Kenco
Mariner	Mitsubishi	Nanaola
National	Nivico	Sanyo
Sony	Spica	Standard
Sharp	Toshiba	Yashica

We do not sell spare parts

PETER G. BROUGHTON
211 George Street, Sydney.
Tel. 27-5831 (3 lines)



MAKE YOUR OWN PRINTED CIRCUITS

Copper clad 1/32 laminate in handy stock size

6 x 3	25c	9 x 6	60c
6 x 6	45c	12 x 12	\$1.55
12 x 3	45c		

Complete Etching Kit comprising: Ferric Chloride, resist paint, resin, camel hair brush and instructions . . . \$1.15 each

All prices include Sales Tax, postage, etc. 50c

RADIO SUPPLY STORES EVERYWHERE

WATKIN WYNNE PTY. LTD.

32 Falcon Street, Crows Nest, N.S.W. 2065. 43-2107

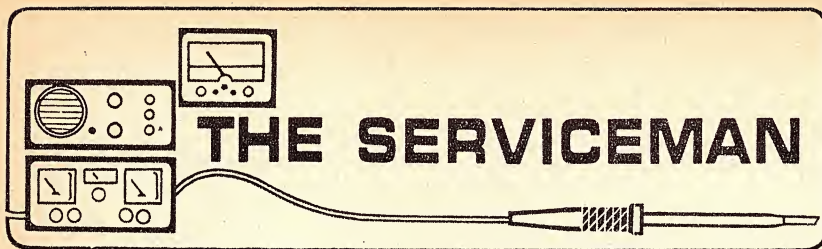

THE SERVICEMAN

Servicing a car radio the easy way

I wonder how many otherwise serviceable combination controls have been discarded because the switch on the back failed? The first story gives me the opportunity to make a point about this. Another story describes a very unusual TV fault.

I have remarked on other occasions about customers who seem all too ready to imagine the worst about their television and radio receivers—particularly the latter. When something goes wrong, they seem half convinced that the thing has “had it” and the best thing they can do is to buy a new one.

At the other end of the scale are the people whose standard phrase to the serviceman is that “some little thing has gone wrong with it . . . maybe just a valve or transistor.” In most cases, they wouldn’t have a clue what the trouble really was. Presumably the “some little thing” bit is an unconscious effort to reassure themselves that the serviceman could not possibly, in any conscience, charge them more than a trifling fee.

Typical was the man who drove up to my shop the other morning and hurried in to ask whether I could give his car radio “a quick once-over.”

I try not to get tangled up with car radios any more than I have to—the term “tangled up” having a very deliberate second meaning. Standing on my head under the instrument panel of a car, with feet up near the roof lining or dangling in the gutter alongside, is not exactly my idea of fun. But this would-be customer was in no mood to wait around while I expressed any such diffidence. In the sheer act of trying to hold a conversation, I found myself lured out the door and into the car out front.

“It is just a little thing,” he explained. “The volume knob doesn’t click any more and the set won’t come on.”

I’m afraid I had to disillusion him that, while the symptom was indeed very simple, the cure was anything but. The volume knob wouldn’t click because the switch mechanism was probably broken and one couldn’t possibly get at the switch without taking the set right out of the car and opening it up on the bench. What was more, the switch couldn’t be fixed; it had to be replaced completely. Worse still, if the switch was part of some odd brand of control, it would be a matter of replacing the entire unit—a concentric volume control, tone control and switch.

“Well, can’t you put something outside to switch the set on?”

Again, my answer had to be in the negative. Because of the broken switch,

the power circuit was open inside the receiver—and that’s where the circuit had to be restored, whether it was done with a new switch or a wire soldered across the now useless connections.

Having got the message, the motorist quickly decided that he couldn’t spare the time to stand around while I removed the receiver. His movements later in the day would be uncertain — as would mine — and tomorrow would be just as bad . . . etc.

Then he had a bright idea. He knew nothing about the inside of a radio set, but he knew enough about cars generally to take the set out himself. If he did that, and dropped it in, would I fix it up for him? Then he could put it back himself.

I would be delighted to co-operate! Early next morning, the set arrived at the shop, with the motorist in the same breathless hurry as on the previous day. He paused only long enough to confide that there seemed to be one other trouble. He had worked out that the knobs pulled straight off the shafts, but they seemed to have been jammed on with “cotton and some sort of gunk.” How he’d fit them back, he didn’t know.

When I took the covers off, some familiar looking components were revealed and, best of all, the name “Ducon” was evident on the combined volume control and switch. I would have been just as happy to see “I.R.C.” because both these local manufacturers make replacement switch units available for their controls—at least for the controls manufactured in the past few years and having a rotary switch action.

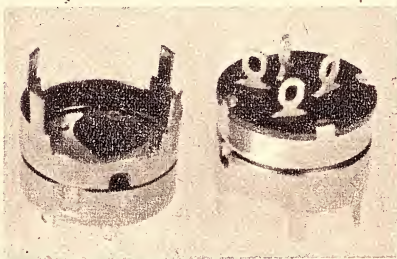

Not all readers may be aware that replacement switches can be obtained for some combination controls.

Instead of having to replace the entire unit, it is necessary only to unclip the little tabs holding — in this case — cover of the rear resistance element and to pull the cover and faulty switch off. The new unit can be clipped into place, the wires transferred and the set is back in business. With a bit of luck and a small iron, the changeover can be effected without even disturbing the main body of the control or the wiring.

In this case it was just as well, for apart from the control being a dual concentric with switch, the threaded shank was much longer than usual, being part of the dial assembly mechanism. It was obviously a “special” and I found myself wondering how long I might have had to wait to obtain a replacement control, had this been necessary.

As it was, the replacement switch came out of my stock and the job was done in a few minutes.

The availability of these replacement switches is well known to servicemen, but I wonder how many hobbyists know that they can be had over the counter from component stockists for about 40 or 50c?

I would add one small word of advice. The new covers are plain and, before you fit them to a potentiometer, take a few moments off to scratch the value and the taper law on to the metal, similar to the markings on the cover you are discarding. It will make things easier for anyone who may have to replace the control at a later date.

So much for the switch. What about the knobs?

Examination indicated that the knobs were push-on concentrics, obviously intended to match other knobs on the control panel of the car. The rear knobs just slipped on and engaged slots in the outer shafts. They were meant to be held in place by the smaller, front knobs. These were of the kind normally containing spring inserts, which engage flats on the shafts, being held in place by a strong friction grip.

It was apparent that, somewhere back in the history of the car, the metal inserts had been lost and the knobs had been packed on to the shafts with cotton or a piece of rag aided, apparently, by some sort of glue. I could hardly regard it as being the right kind of approach!

To check on the position, I rang my regular parts supplier, who seems to know most of the answers as to what can be bought and from whom. But he was most unhelpful. He knew the knobs but they were unavailable. He’d also been trying to get his hands on a supply of spring inserts for friction-fit knobs but he hadn’t been able to locate any. He couldn’t even offer a knob which could be robbed of inserts to suit the knobs I had.

Without any optimism, I went through my own stock of oddment knobs but the only inserts I could find were intended for use on ¼in shafts, not 5/32in or whatever the size was.

There was only one hope left. I reached down an old Griffiths tea tin, into which I have tossed metal scraps for years — odd nuts, washers, bolts, springs — anything, in fact, that “might come in handy one of these days.”

A scrap of spring steel caught my eye and I hopefully fashioned two little pieces about the right width and length. But the moment I tried to bend them, they promptly snapped. Another couple of scraps met the same fate, even after I'd warmed them over the gas ring.

Ah, heck!

And then a piece of spring, plated brass caught my eye — a clip that had once held a capacitor against the chassis of, most likely, a military set. This time, I snipped and filed a couple more scraps, bent them to shape and gingerly pushed the knobs on to the shafts. They fitted like the proverbial glove.

I left them there and wrote a little note for the owner in case he should call when I was out:

"When you pull the knobs off, be careful not to lose the two little clips that hold them to the shaft ...etc."

Needless to say, I left another piece of paper with the set, carrying some quite different information — the amount that he owed me.

And the little piece of spring brass I've put away carefully until next time!

On a completely - different theme, here is a story about a TV set which, at one stage, looked as though it was going to beat me. I was seriously considering kicking it, but hesitated to do so for fear that this wouldn't cure it and I would be left with nothing more to try.

Quite seriously, it was a proper stinker. In a broad sense the fault was simple enough; the line output stage just wasn't functioning properly, to the point where there was very little EHT — about 1/8in — and, as a result, no raster. The problem was, why?

Naturally, I went through the valves in the line output stage; the line output bottle itself, the EHT rectifier, and the damper diode. There appeared to be nothing wrong with any of them. I checked the drive to the line output stage and this appeared to be normal. Then I went over the line output stage with a meter and measured every voltage and resistance I could lay the prods on. I found nothing.

In desperation, I went over most of these points a second time. And as anyone who has been in a similar position will appreciate, it seemed no time at all before I had run up a couple of hours labour on the job. In return for this, the only progress I had made — if one could call it progress — was that I now knew about two dozen things that WEREN'T causing it. Which might be a nice philosophy in some circumstances but is cold comfort when the fault seems as far away as ever and time and money is galloping down the drain.

The only other clue I had observed during all this time suggested that the fault was in some degree intermittent. Normally, there was no visible raster on the screen even in the most favourable circumstances but, for a couple of brief periods, a faint image had appeared. All that I was able to determine was that it was only about half as wide as it should be; which really didn't tell me anything that I didn't already know, namely, that the line output stage was sick.

I took a break, had a cup of tea, then took another look at the situation. Since I could find nothing wrong with voltages and similar operating con-

ditions for the stage, there seemed a reasonable chance that the fault was of a more dynamic nature, like an accidental load of some kind which was hampering performance.

Several possibilities suggested themselves but, for one reason or another, they didn't seem to fit in. Then, from somewhere in the dim recesses of my memory, I seemed to recall a story about a faulty yoke which created similar symptoms. I couldn't remember much about it, and it certainly had not been one of my own cases, but it put me on the track.

As nearly as I could remember, it involved leakage between the horizontal and vertical windings, the load thus presented to the horizontal stage being sufficient to wreck its performance. Without much confidence I unplugged the yoke, identified the appropriate pins, and checked between them with the high ohms range of the VTVM.

The result was somewhat inconclusive. There was leakage between the windings to be sure, but of the order of 50 megohms. Could such a value produce the symptoms I had observed? It seemed unreasonable but, on the other hand, the measurement was being made at a level of only a few volts. At the much higher voltages which would be encountered when the set was working it was entirely possible that a fault like this could present a very much lower resistance.

So, without further ado or speculation, I substituted a new yoke. And that was the cure. A simple enough explanation when you know the answer, but enough to drive you up the wall when you have to find it.

A subject that has been cropping up at odd intervals in these columns concerns the possible damage to portable and car radios by reason of either powerful transmitters in the immediate vicinity or static electricity being applied to the aerial. (January, April, and May, 1969). And, while there still seems to be some difference of opinion as to the exact circumstances in which powerful RF radiations can cause damage, the evidence seems to be mounting that static electricity, generated a variety of ways, can do a lot of damage. The following comment is taken from the "B.B.C. Newsletter."

"Portable radios, fresh from the factory, were recently found to be faulty on arrival in the shops. Quite a mystery, for they had all passed their final tests at the makers. The explanation turned out to be that these radios had been packed in plastic bags. These bags, like almost any dry piece of plastic material, had become charged with static electricity. It so happened that when the static discharged itself it went through the aerial into the receiver and destroyed the first transistor.

"A B.B.C. reporter, warning against this trouble, stated in a recent broadcast that similar disasters have been known to overtake car radios. Cars often pick up a static charge in dry weather. If you get out and then touch the radio aerial all you feel is a slight tingle, but the radio set loses a transistor. Fortunately, there is a simple remedy. It is to connect a miniature neon tube to the aerial circuit of the receiver. When a static discharge occurs, the neon lights up momentarily and absorbs the electrical energy."

NEXT MONTH

Gas Laser ...



For the first time ever in an Australian technical publication, next month's issue will contain full construction details of a low power economy helium-neon gas laser especially intended for high schools, science and radio clubs, universities and technical colleges. The article includes a full description of laser operation, together with examples of the many fascinating experiments which may be performed with the unit.

IF Noise Silencer ...

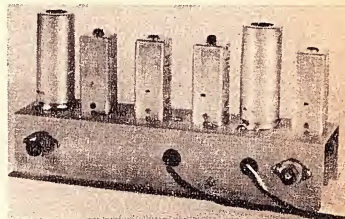

An IF noise silencer, based on the now famous "Lamb" silencer, has been produced in our laboratory. It is capable of giving excellent results in the quest for noise reduction. It is particularly effective on impulse type noise, such as that produced by automotive ignition, and is also equally effective for SSB, CW and AM signals. The unit is so constructed that it may be fitted into most existing receiver cabinets and may be electrically connected with the minimum of access to the receiver circuits.

Apollo communications

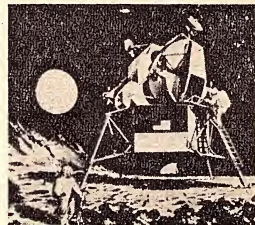

The story of the elaborate and costly electronics equipment designed for the Apollo astronauts, by means of which they will keep contact with earth and each other. The frequencies used for all parts of the system are given in full. The moon-to-earth television link to enable viewers on earth to follow the progress of this historic mission is also described.

**AMPLIFIERS — PREAMPLIFIERS — TUNERS — CONTROL UNITS —
GUITAR UNITS — INSTRUMENTS — INVERTERS — CONVERTERS —
RECEIVERS — TRANSMITTERS — REGULATED POWER SUPPLY —
TRANSISTOR AND VALVE TYPES.**

**1967
ALL WAVE
3-4-5-6-7**

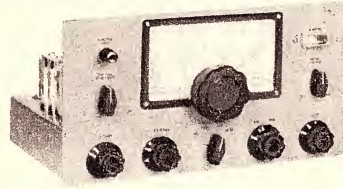

**ANY PART FROM A
SINGLE RESISTOR
TO THE FULL KIT**

POPULAR KITS - TOP QUALITY - LOWEST PRICES

- | | | | | |
|---|---|--|---|---|
| <p>INSTRUMENTS C.R.O.</p> <ol style="list-style-type: none"> 1. 5in wide range. 2. 1963. 3in cal. 3. Audio. 4. 1966. 3in. 5. 1968—Audio. 6. Electronic SW. 7. W/band Preamp. <p>MULTIMETERS and V.T.V.M.'s</p> <ol style="list-style-type: none"> 8. 20K ohm/Volt protected M/M. 9. Probe for above. 10. Protected D.C. M/M. 11. Meterless V/meter. 12. A.C. Millivoltmeter. 13. A.C. Solid State Millivoltmeter. 14. Solid State A.F. Millivoltmeter. 15. Noise Distortion Millivoltmeter. 16. Standard V.T.V.M. 17. 1966—V.T.V.M. 18. 1968—V.T.V.M. <p>BRIDGES</p> <ol style="list-style-type: none"> 19. Standard R/C. 20. 1966. R/C. 21. 1968 R/C and Signal Injector. <p>TV INST.'s.</p> <ol style="list-style-type: none"> 22. Sweep and marker Generator. 23. Dual sweep Gen. 24. Silicon diode sweep Gen. 25. Silicon diode noise Gen. 26. Pattern Gen. 27. Trans. pattern Gen. 28. Wide range pulse gen <p>AUDIO INST.'S</p> <ol style="list-style-type: none"> 29. 1960 Audio Osc. 30. 1962 High perf. audio Gen. 31. Crystal locked std. 32. Electronic tuning standard. 33. 1965. Solid State audio osc. 34. Direct reading A.F. meter. 35. Sq. wave Gen. 36. 1967 transistor audio Gen. 37. Additive frequency meter. 38. A.F. tone burst gen. 38A. 1968. Solid state A.F. Generator. <p>R.F. INST.'s.</p> <ol style="list-style-type: none"> 39. 6-band service oscillator. 40. Trans. wave meter. | <ol style="list-style-type: none"> 41. G.D.O. wide range. 42. G.D.O. adaptor. 43. Trans. service osc. 44. Simple signal injector. 45. Transistorised signal tracer. 46. Transistorised osc. 47. Basic test osc. 48. Transistor test oscillator. <p>MISCELLANEOUS INST., ETC., KITS</p> <ol style="list-style-type: none"> 49. 1960 Trans. Tester. 50. 1968 Transistor test set. 51. Valve and Transistor tester. 52. Electronic Stethoscope. 53. Moisture alarm. 54. Electronic Pistol range. 55. Transistor Gelger Counter. 56. Light beam alarm. 57. Burglar alarm. 58. Flasher unit. 59. Transistor alarm. 60. Electronic switch. 61. Photo Timer. 62. Direct reading impedance meter. 63. Electronic anemometer. 64. S.W.R. Indicator. 65. Simple proximity alarm unit. 66. Pipe and wiring locator. 67. Electronic metronome. 68. Monophonic organ. 68A. Keyless organ. <p>BATTERY CHARGERS</p> <ol style="list-style-type: none"> 69. Universal unit. 70. 1 amp unit. <p>REGULATED POWER SUPPLIES</p> <ol style="list-style-type: none"> 71. Transistor. 9v. 72. Transistor, fully protected supply. 73. 1966 H.T. unit. 74. 1968 lab. type. D-30v. supply. 74A Simple Pwr. supply. <p>VOLTAGE/CURRENT CONTROL UNITS</p> <ol style="list-style-type: none"> 75. Vari-watt unit. 76. Vari-tach. motor speed control. 77. 2KW auto-light dimmer. 78. 4KW auto. light dimmer. 79. Model train control unit. | <ol style="list-style-type: none"> 80. Model train control unit with simulated inertia. 81. Above-hi-power. 82. No. 81 with simulated Inertia. <p>TACHOMETER UNITS</p> <ol style="list-style-type: none"> 83. 6 or 12v Std. 84. 6 or 12v Mullard. 85. 6 or 12v with dwell angle. 86. Tachometer and dwell angle unit for service stations. <p>TRANSISTOR IGNITION</p> <ol style="list-style-type: none"> 87. Ro-Fo. 6 or 12v. 88. Hi-Fire 6 or 12v. (transformer). <p>POWER CONVERTERS</p> <ol style="list-style-type: none"> 89. D.C.-D.C. 60w. 90. D.C.-D.C. 40w. 91. D.C.-D.C. 40w. 12v—input. 92. D.C.-D.C. 70w 12v—input. 93. D.C.-D.C. 100w 12v—input. 94. D.C.-D.C. 140w. 24v—input. 95. D.C.-D.C. 225w. 24v—input. <p>HIGH FIDELITY AMPLIFIERS MONO UNITS</p> <ol style="list-style-type: none"> 96. Hi-Fi 3. 97. Mullard 3.3. 98. Mullard 5-10. 99. Mullard 5-10 transistor. 100. Transistor 20w. 101. Transistor 60w. <p>STEREO UNITS</p> <ol style="list-style-type: none"> 102. Mullard 2-2. 103. Mullard (v) 3-3. 104. Mullard (t) 5-5. 105. Mullard (t) 5-5. 106. Mullard (v) 10-10. 107. Mullard (t) 10-10. 108. Philips Twin 10. 109. S.T.C. 10-10. 110. Wireless world transistor 20-20. 111. Hi-Fi 60-60. 112. Playmaster 2-2. 113. Playmaster 3 plus 3. 114. Playmaster unit 3. 115. Playmaster unit 4. 116. Playmaster 10 plus 10 117. Playmaster 101. 118. Playmaster (t) 105. 119. Playmaster (t) 113. 120. Playmaster (t) 115. 121. Playmaster (v) 118. <p>P.A. UNITS</p> <ol style="list-style-type: none"> 122. 10 watt std. | <ol style="list-style-type: none"> 123. 25 watt std. 124. 35 watt std. 125. 30 watt (t). 126. 100 watt std. 127. stereo P.A. <p>GUITAR UNITS</p> <ol style="list-style-type: none"> 128. 10 watt std. 129. 25 watt std. 130. 35 watt std. 131. 50 watt std. 132. 70 watt (t). 133. Playmaster 102. 134. Playmaster 103. 135. Playmaster 40w. 116. 136. Playmaster 60w 117. 137. Guitar fuzz box. 138. Guitar Waa-Waa. 139. Reverb unit. 140. Guitar preamp. 140A. Guitar - 50w - Solid State. <p>STEREOGRAMS</p> <ol style="list-style-type: none"> 141. Playmaster 105. 142. Playmaster 106. 143. Playmaster 107. 143A. Playmaer 124. <p>CONTROL UNITS</p> <ol style="list-style-type: none"> 144. Playmaster No. 9. 145. Playmaster No. 10. 146. Playmaster No. 104. 147. Playmaster No. 112. 148. Playmaster No. 120. 149. Mullard 2v. 150. Mullard 3v. 151. Philips Miniwatt. 152. Wireless world stereo system unit. <p>PREAMP UNITS</p> <ol style="list-style-type: none"> 153. Transistor—Mono. 154. Transistor—Stereo. 155. Transistor—Silicon. mono. 156. Transistor F.E.T. mono. 157. Transistor dyn. mic. mono. 158. Above-Stereo. 159. Playmaster 115 F.E.T. Stereo. 160. Playmaster 118 mag. 161. Sound projector. <p>MIXER UNITS</p> <ol style="list-style-type: none"> 162. Trans. 4 ch. (1966). 163. Trans—4 ch. (1967). 164. Valve—4 ch. <p>TUNER UNITS</p> <ol style="list-style-type: none"> 165. Playmaster u/style. 166. Playmaster No. 11. 167. Playmaster No. 114. 168. Playmaster No. 122. 169. Playmaster No. 123. 170. Philips Miniwatt. 180. Trans.—Long range. | <p>TAPE UNITS</p> <ol style="list-style-type: none"> 181. Trans. Preamp. 182. Playmaster 110 (M). 182. Playmaster 110 (S). 183. Power Unit 110. 184. Adaptor 110. 185. Playmaster 119 Adaptor. 186. Transistor V.O.X. 187. Tape Actuated relay. 188. Mullard Trans Tape Amp. <p>RECEIVERS</p> <ol style="list-style-type: none"> 189. Fremodyne 4. 190. Fremodyne 4. R.F. Sock only. 191. Synchrodyne. 192. Communications RX. 193. Deltaet RX. 194. 3 Band Double Change S/het RX. 195. Explorer VHF Transistor RX. 196. Interceptor 5 Semi-Comm. RX. 197. 1967 All-Wave 2 198. 1967 All-Wave 3 199. 1967 All-Wave 5 200. 1967 All-Wave 6 201. 1967 All-Wave 7 202. Transporta 7 203. Transistor 3 Band. 204. 3 Band 2V RX. 205. 3 Band 3V RX. 206. Interstate 5 207. Versatile Mantel Set. 208. All-Wave Transistor 3 209. A.B.C. 3 210. 1968 F.E.T. 3 <p>TRANSMITTERS</p> <ol style="list-style-type: none"> 211. 144 MHZ 50W. Linear Final. 212. 144 MHZ 20W. 213. 144 MHZ 75W. 214. 144 MHZ 18W. 215. 144 MHZ S.S.B. 216. 3 Band A.M. 217. Basic 3 Band. 218. 5 Band. S.S.B. 219. 1967 S.S.B. <p>CONVERTERS</p> <ol style="list-style-type: none"> 220. 50 MHZ. 221. 144. MHZ. 222. 50 and 144 MHZ Crystal Locked. 223. 1965 S/W. 224. 1965 S/W 2 Band. 225. 1966 3 Band. 226. Basic S/W. <p>V.F.O. UNITS</p> <ol style="list-style-type: none"> 227. Remote Unit. 228. 7, 8 and 9 H.F. and V.H.F. 229. All transistor. |
|---|---|--|---|---|

Phone 63-3596

E. D. & E. (SALES) PTY. LTD.

Phone 63-3596

232 FLINDERS LANE, MELBOURNE, VICTORIA 3000

**K
I
T
S**

Public Address Units — Geiger Counters — Metal Locators — Decade Boxes — Mixers — Battery Chargers — Oscillators — Bridges — Parts Supplied for Projects in Electronics (Aust.), Wireless World, Practical Wireless, Electronics World, Electronics Illustrated, Practical Electronics, etc.

**K
I
T
S**

MULLARD STEREO 3-3

Full kit

(As per Mullard leaflet).



1968 Solid State. V.T.V.M.
ELECTRONICS (Aust.), Dec., 1968.

BATTERY CHARGER 1A
ELECTRONICS (Aust.), Feb., 1966

PLAYMASTER 116 and 117
GUITAR AMP.

Electronics Australia
June 1967 — 40 watt
July 1967 — 60 watt

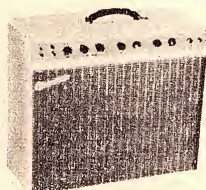

3-BAND SHORT-WAVE CONVERTER
ELECTRONICS (Aust.), May, 1966.

LAB QUALITY

Regulated Power Supply (0-30v)
ELECTRONICS (Aust.), Sep-
tember, 1968.

1966 R/C Bridge
May, 1966.

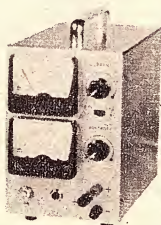

**PUBLIC ADDRESS and
GUITAR AMPLIFIERS**

10, 25, 50 and 100 watt
units

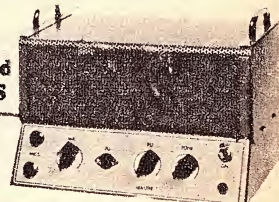

3-BAND DOUBLE-CHANGE RECEIVER
ELECTRONICS (Aust.), April, 1966.

1966 3in CRO
ELECTRONICS (Aust.), May, 1966.

Playmaster 122
Program Source.
Electronics (Aust.),
August, 1968.



FOUR-CHANNEL AUDIO MIXER
ELECTRONICS (Aust.) Feb., 1966 & 1967

3-BAND 3-RECEIVER
ELECTRONICS (Aust.), Nov., 1966.

**TRANSISTOR MILLIVOLT
METER**

Electronics (Aust.),
May, 1968.

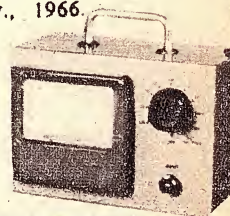

**MAJOR STOCKISTS OF ALL GENERAL RADIO & ELECTRONIC COMPONENT
PARTS -- YOU NAME IT -- WE WILL QUOTE**

VALVES — TRANSISTORS — ZENER & POWER DIODES — SEMI-CONDUCTORS
— DIACS — TRIACS — S.C.R.'S. — 1/C'S. SPEAKERS — MICROPHONES —
COILS — IFT'S. TRANSFORMERS — INST CASES — METALWORK. PLAYERS
& CHANGERS — METERS — RELAYS — CONDENSERS — RESISTORS — BEZELS
— STYL II — CARTRIDGES — RECORDING TAPE — PROBES — INSTRUMENTS
— POTENTIOMETERS — CRYSTALS — FERRITE BEADS — CORES — BALUNS
— TERMINALS — CO-AXIAL PLUGS & SOCKETS — MULTI CONNECTORS —
PRINTED CIRCUIT BOARDS — COPPER WINDING WIRE — ETC. — ETC. —

Excellent frequency
response. Low distortion
figure. High input
sensitivity. All
controls self-contain-
ed. 10 watts per
channel.

PLAYMASTER STEREO 10 PLUS 10
COMPLETE KIT \$93.60



**Enjoy your
leisure time
and build**

PLAYMASTER STEREO 3 PLUS 3
COMPLETE KIT \$52.65

Phone 63-3596

**E. D. & E. (SALES)
PTY. LTD.**

Phone 63-3596

232 FLINDERS LANE, MELBOURNE, VICTORIA

EVERY BLACK BOX SHOULD HAVE A DJINNI.

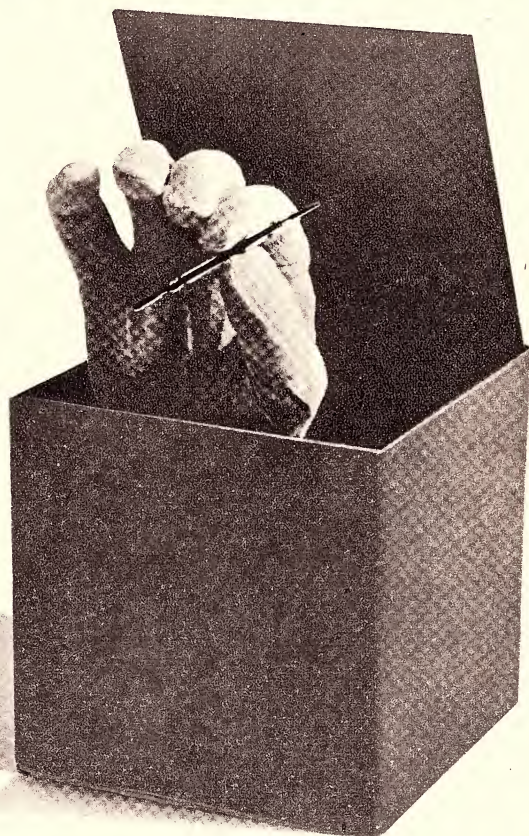

The reed switch is the greatest thing that's happened to electronic control devices since the Arabian Nights. It's encased in a little glass bottle you don't even have to rub. A coil turns it into a relay. A bar magnet makes it the most versatile electro-mechanical switch yet invented.

The reed switch is isolated in its glass container with a controlled atmosphere. It stays free of dust, damp and corrosion. There are no armatures, springs or pivots to wear. Life can easily exceed 100

million operations. Sensitivity is readily controlled. Speed is the next best thing to transistorized logic at a mere wisp of the circuit cost. Even RF switching is practical.

If this isn't magic, what is?

If you are not as familiar with magnetic reed switches as you should be, ask for technical literature. With this information at your fingertips you may devise machine, flow or control uses no other engineer has conjured up yet.

IRH
COMPONENTS
PTY. LIMITED

A Subsidiary of International Resistance Holdings Limited

THE CRESCENT, KINGSGROVE, N.S.W. 2208. PHONE 50 0111

INTERSTATE TELEPHONES

<small>MELB. VIC.</small>	<small>489.1088</small>	<small>BRIS. QLD.</small>	<small>70.2141</small>
<small>HOB. TAS.</small>	<small>34.2811</small>	<small>PERTH W.A.</small>	<small>8.2271</small>
<small>LAUN. TAS.</small>	<small>22.844</small>	<small>ADEL. S.A.</small>	<small>23.1971</small>

HAMLIN

MAGNETIC REED SWITCHES.
THE FIRST AND FINEST IN THE FIELD.

2119



A READER BUILT IT

"Pedal" bass from an organ manual

An electronic organ can sound fine — provided the player can make proper use of the bass pedals. If they can't, this suggestion from a reader can go a long way towards making good the lack.

As the constructor of a "Julius" organ, I found your recent article on the addition of a 16ft stop to similar instruments of great interest. Our experience with the abovementioned organ in a small church may similarly be of interest to readers.

While small churches can usually turn up one reasonably competent organist, it sometimes happens that someone else has to "fill in," who is not able to manage the foot pedals. A person who has been trained as a pianist would obviously be in this position. For congregational singing, in particular, the "body" given by the 16ft notes is missed and it was decided, in our case, to add a full 16ft stop to one manual.

However, the plan to do this was dropped after more accurately assessing the problem with the help of a similar organ which already had a full 16ft stop fitted. Played with full chords on both hands on the manual so equipped, it sounded very "muddy" and anything but pleasant. This is in line with your own observations in your article on the subject.

It emphasised that what we wanted, in fact, was a means of simulating pedal notes — one 16ft note at a time, not a full 16ft chord. It was a matter of getting back to fundamentals.

In a normal monophonic pedal system, contacts are arranged so that, if two or more pedals are pressed, only the highest note sounds. What was needed was the reverse of this system such that, when the left hand was used to play a chord, only the lowest note depressed would sound in 16ft, all notes sounding normally, however, in the smaller footages.

Three methods of achieving this de-

sired result came to mind: relays — rejected as being too bulky, too expensive and possibly noisy in operation; diode-switching — not seriously considered; additional key contacts —

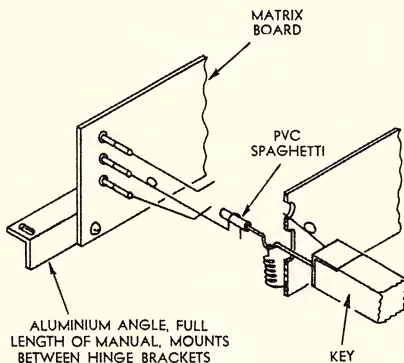

Above: A very cunning method of adding an extra set of contacts to keyboards as used in a number of electronic organs.

Right: The frequency divider. The input components, typically 100K and .01uF, have to be selected to give reliable triggering.

the method actually adopted after a lot of head-scratching!

In the particular organ, lack of space seemed to preclude any attempt to modify the swell manual, which is set back hard against its tone generator chassis. There are a few inches to spare behind the great manual and attention was concentrated on this.

The final solution is shown in the accompanying sketch. The idea of a pick-a-back contact like this is, I believe, quite novel but it does work well and it does not interfere in any way with the normal playing of the organ. It is not possible to detect any difference in the touch of the keys. The small piece of insulating tubing is essential, of course, to maintain isolation of the extra circuit.

Having provided the appropriate key switching, the next step was to decide how to produce the 16ft note. Use of the existing pedal generator seemed too cumbersome, because of the need to change over control from the pedals to the keys.

A single divider switched from oscillator to oscillator by the keys was also considered but ruled out, because the oscillators were slightly detuned by the loading of the divider.

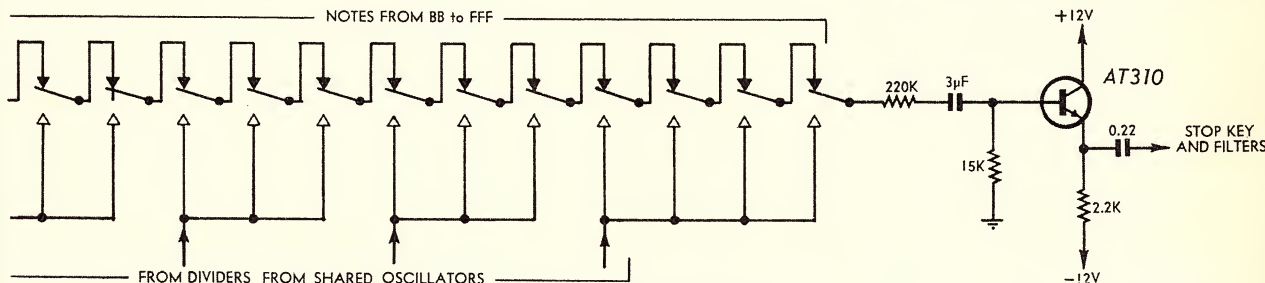
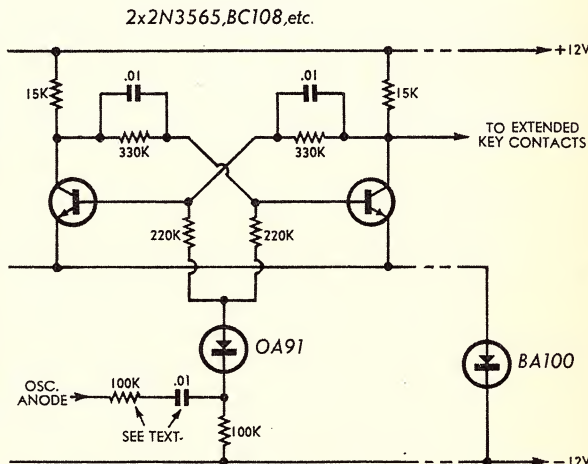

The keyboard switching circuit is a series system so arranged that a 16ft voice is sounded only for the lowest note in a bass chord, the signal circuit to all all other key switches being automatically broken.

UHER

TAPERECORDERS

Made in Western Germany

"The World's Most Reliable Name for Precision Taperecorders"

NOW every Amateur and Enthusiast can benefit from this experience because

ATRAM PTY. LTD.

presents to you **ACTION and SOUND**
with the **NEW BREED** styled Uher Taperecorders available to you without restrictions!

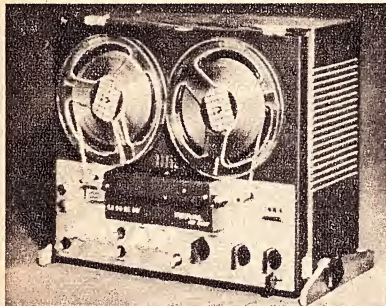

All New Uher Royal Deluxe Stereo

Stereo Home Studio of the ultimate hi-fi class 20 watts rms push/pull output by separate amplifier—fully transistorised—4 or 2 track operation (stereo)—4 speeds—4 heads—A & B monitoring—4 amplifiers—VOR—11 exclusive recording functions, operated by one control—all new tape comparator—dia pilot-echo sound mixing—frequency response 20-20,000 cps at 7½ ips. Teakwood cabinet, can be hung on wall.

ATRAM PTY. LTD.

Sole Australian Importer and General Agent.
5 McLaren Street, North Sydney, Tele.: 92-4177.

N.S.W.: John Border Photographics Pty. Ltd.,
175 Liverpool Street, Sydney.
Tel.: 26-1106.
N.S.W.: Milversons Sound Centre,
791 Pacific Highway, Chatswood.
Tel.: 41-4365.
N.S.W.: Glen Dor Camera Centre,
43 The Corso, Manly.
Tel.: 92-2709.
A.C.T.: Canberra Sound & Recording Service,

109 Majura Avenue, Dickson,
Tel.: 45980.
VIC.: Atram Pty. Ltd.,
1 Corr Street, Moorabbin,
Tel.: 95-5633.
VIC.: Klapp Electronics Pty. Ltd.,
224 Chapel Street, Prahran.
Tel.: 51-4653.
S.A.: Kallin Distributors (W.I.S.) Pty. Ltd.,
140 Gawler Place, Adelaide.

Tel.: 8-7171, (11 lines).
W.A.: Alberts TV and Hi-Fi Centre Pty. Ltd.,
282 Hay Street, Perth.
Tel.: 21-5004.
QLD.: A. E. Harrold Pty. Ltd.,
123-125 Charlotte Street, Brisbane.
Tel.: 31-3081.
N.T.: N.T. Musical & Electrical W.I.S. Pty.,
Ltd., 54 Cavanagh Street, Darwin.
Tel.: 3072.

MAGRATHS

MELBOURNE'S ELECTRONIC HOBBIES CENTRE

YES — A Genuine reduction of \$14 on the Versatile, Compact, T.T.1. OSCILLOSCOPE

Here's your opportunity to acquire a practical oscilloscope at a truly unrepeatable price. Indented from a leading Japanese manufacturer, the TT1 CO-50 is an amazing versatile and compact oscilloscope. It is an indispensable instrument to have in the Lab. or on the workbench. A compact portable 240V unit at this fantastic price.

\$69

COMPLETE WITH HANDSOME
VINYL CARRYING CASE
Price includes Sales Tax and
freight within Aust. and
Territories.

APPLICATIONS INCLUDE —

- **ORDINARY APPLICATION** — most widely used for waveform observation and measurement of voltages.
- **CHECKING I.F. SELECTIVITY CURVES** — this is done together with a Sweep Generator and the two instruments are important tools for efficient I.F. alignment.
- **UTILIZATION OF LISSAJOUS FIGURES** — this method is used for frequency measurements.
- **MEASURING PERCENTAGE OF MODULATION** — the Test signal is routed DIRECT to the deflection plates. This is used for adjusting transmitters.

STOCKTAKING SPECIAL

LAST
CONSIGNMENT

LIMITED
NUMBER

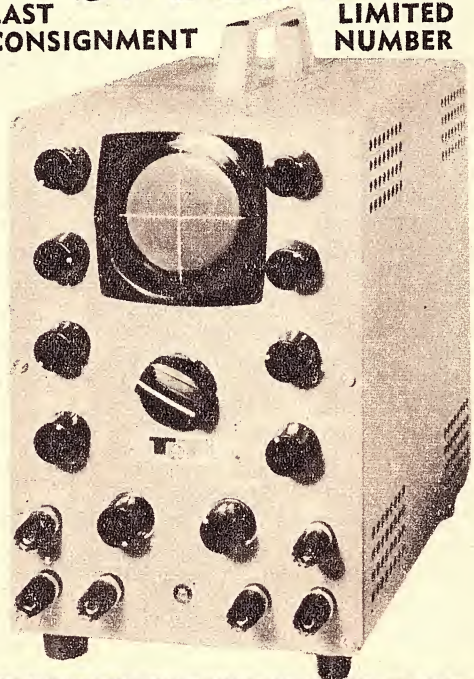

J. H. MAGRATH & CO. PTY. LTD.

208 LT. LONSDALE STREET, MELBOURNE, VICTORIA, PHONE 663 3731

The next logical step was to provide each oscillator with its own permanent divider, only the outputs being switched. As a suitable printed wiring board and the components were already on hand, this scheme was adopted and is now working well.

The divider circuit used, which is not original, is shown. The input coupling resistor and differentiating capacitor are critical and had to be selected for each oscillator. Only time will tell whether reliable triggering will be maintained as the components age.

The output of the "bus" amplifier is fed via a tab key directly to the existing 16-foot stop filters. Impedance levels are such that the normal pedal notes are severely attenuated when the "melodic 16-foot coupler" is on. This minimises the chance of strong beats which could be objectionable if a player used the 16-foot pedals and coupler simultaneously.

It was also considered undesirable to have 16-foot vibrato and this is prevented by a second pole on the coupler tab which is connected in parallel with the "vibrato gt." switch.

Some of the above remarks apply particularly to the Julius organ, but the general idea of a "16-foot melodic coupler" and a monophonic system

superimposed on a polyphonic manual may be of wider interest particularly, for example, in a portable instrument which has no pedals. (From D. M. Snowdon, A.M.I.R.E.E., 27 Wylde Street, Telopea, N.S.W. 2117.)

EDITOR'S COMMENT: The idea should indeed be an interesting one for many readers. A further possibility which the constructor appreciated but did not pursue, would be that of using the extra contacts to operate an entirely separate monophonic generator—either a valve type as used in the original Stromberg-Playmaster organ, or a solid-state generator along similar lines to the more recent monophonic or key less organs. The switching would have to be arranged so that pressing a key brought into circuit an adjustable resistor necessary to produce the desired note, breaking the circuit to other notes higher in the manual. In other words, instead of tapping along a series string, each note would require its own separate resistor. From the contributor's remarks, the divider circuit shown appears to be rather more critical of adjustment than the one shown in our own article in the February, 1969, issue. Incidentally, the contact system would be a good one to keep in mind for readers experimenting with percussion.

on any of the tests, so the circuit is foolproof in this respect.

Construction is very simple because of the small number of parts. The only difficulty likely to be encountered is finding a supply of transistor sockets, since these are now rather scarce. I solved this problem by using subminiature plastic three-pin sockets. These have the further advantage that plugs are available to fit them so that a set of flying leads may be made up for testing transistors already mounted in a piece of equipment. (Editorial note: In such case it would be necessary to disconnect at least two of the circuit connections from the transistor.)

It is almost impossible to damage a transistor in this test-set, as the voltage is so low and the dissipation is limited to less than 1mW. (Submitted by: Mr B. Currie, 433 Cardigan Street, Carlton, Vic. 3053.)

(Editor's Footnote: "Reader Built It" projects are published for the general interest of experimenters and as a source of ideas. Based on readers' contributions, they have not been tested in our laboratory and we cannot accept responsibility for them.)

Another simple transistor test circuit

While transistors do not vary over their working life in the same manner as valves, most experimenters have a need to test transistors on occasions, either to confirm that they are still functioning, or perhaps as an aid to identifying a transistor from which the type number has been erased. The circuit is simple and not unduly expensive.

Here is a description of a simple, almost foolproof, transistor tester. It will test NPN or PNP germanium or silicon transistors for excess leakage, opens, shorts, etc., and also reads beta from 10 to 1000 at a test current of about 1mA.

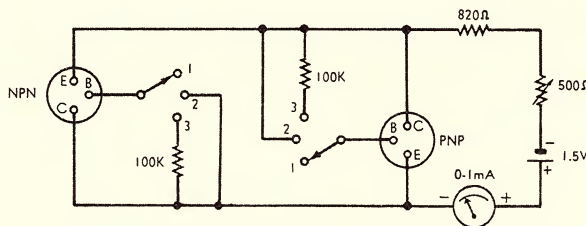

SWITCH POSITIONS : 1 : LEAKAGE
2 : SET FULL-SCALE
3 : β , 10-1000

An almost logarithmic scale for beta is achieved by returning the base resistor to the collector rather than the supply rail.

Meter calibration is as follows:

Beta	Im	Beta	Im
0	0	200	.67
10	.19	500	.83
20	.17	1000	.91
50	.33		
100	.5	Inf.	1.0

To test a transistor, plug it into the appropriate socket and turn the switch to "Leakage." Germanium transistors should show a slight deflection, silicon types, none. Move the switch to "Set F.S." This connects base to collector, simulating the situation where beta is infinite. Adjust the 500 ohm pot to give full-scale deflection on the meter. Set the switch to "beta" and the DC beta (hFE) may be read directly.

The most common transistor faults—open circuit base and collector—

emitter short—show up as no deflection or over full scale deflection respectively.

Note that plugging a transistor into the wrong socket gives no deflection

METERS FOR ALL ELECTRONICS AUST. PROJECTS

Direct from the manufacturer.
Send for free literature.

FERRIER ELECTRICAL INSTRUMENTS

45 Albany Street, Crow's Nest,
N.S.W. 2065. Tel. 43-5596.

RESISTORS

(Carbon Film ± 5 P.C. Tol.)

$\frac{1}{4}$ W: 4c each or \$3.00 per 100

$\frac{1}{2}$ W: 4c each or \$3.00 per 100

1W: 7c each or \$5.50 per 100

Range: All values between 1 ohm and 10Meg.

Note: We supply to your list. Post/Pack, 10c any order. Our new catalogue now available.

KITSETS AUST.

Box 176, P.O. DEE WHY, 2099, N.S.W.

CHANGE OF ADDRESS

Selectronic Components

Wish to announce they have moved to new and larger premises. This has been necessary owing to the rapid expansion of their business.

The new address is

**17 BARRY STREET, BAYSWATER,
VICTORIA. 3153 Phone 729-2992**

WHY DOESN'T YOUR TURNTABLE LOOK LIKE THIS!

- The ERA arm outperforms even the most recent cartridge; it can track at 1/10 gram.
- By principle its pivot eliminates all friction. The pivot is in fact the intersection of four counter-balanced spring blades. They form two Xs which do not touch each other.
- The tracking weight is applied directly to the pivot by changing the angle of the blades. In this way the inertia of the arm is not increased with the tracking force as in all other arms. The pickup sounds better.
- The arm itself is made of a light alloy H beam which eliminates the resonant frequencies of the tubes.

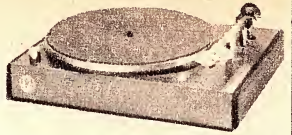

UNIT 1: Ampex Model 1263 Solid State Stereophonic Tape Recorder Player, the ultimate in home tap recorder player. Only

the Ampex offers automatic threading, automatic reverse and bi-directional recording plus outstanding reliability, magnificent sound reproduction and beautiful styling. Exclusive to RMS. 2 Jordan Watts loudspeakers, frequency response on axis: 30-17,000 Hz plus minus 3 dB; 25-20,000 Hz plus minus 6 dB (also on axis) 30 degree off axis: 30-17,000 Hz plus minus 6 dB. Armstrong Model 521 Amplifier. Most perfect stereo integrated fully transistorised amplifier, power output, continuous sine wave 25 watts per channel, 8 ohms. Power Bandwidth: 20-25,000 Hz. Frequency response: 20-20,000 Hz plus minus 1 dB.

Total Price \$1,095.00.



UNIT 2: 2 Jordan Watts Loudspeakers, frequency response on axis: 30-17,000 Hz plus minus 3 dB; 25-20,000 Hz plus minus 6 dB; 30-degree off axis: 30-17,000 Hz plus minus 6 dB. Complete with Armstrong Model 426 tuner/amplifier, 15 watts RMS per channel frequency response

from 20-20,000 cycles plus minus 1 dB less than 1/2 p.c. distortion on the full 15 watt.

Total Price \$420.00
With ERA Mk4 turntable and Empire 808 cartridge, frequency response from 10-20,000 cycles
Add \$114.00



UNIT 3: Armstrong Model 127 integrated tuner/amplifier with P.E. 34 turntable, Decca Deram cartridge, 2 Goodmans 8in Twinaxlette loudspeakers, frequency range from 40-18,000 cycles.

Total price \$274.00

UNIT 4: Schaub-Lorenz Model 4000 tuner/amplifier made in Germany. 25 watt per channel, is the most beautiful looking tuner amplifier available on the world market. 2 Schaub-Lorenz Model STL201 loudspeakers.

SPECIAL PRICE \$440.00

With Dual 1019 Turntable including Empire 808E cartridge, frequency response from 10 to 25,000 cycles.

ADD \$137.00

UNIT 5: Empire Model 888VE cartridge, frequency response from 6 to 32,000 cycles; the best stereo equipment must have an Empire cartridge. Harman Kardon Model 210 tuner/amplifier, power output: 50 watts IHF, frequency response: plus-minus 1 dB: 8 to 25 Hz at 1 watt normal listening level; 10 to 23,000 Hz at full rated power, harmonic distortion; less than 1 p.c.; 2 Empire Model 2000 loudspeakers, frequency response: 50 to 18,000 cycles. Components: 10-inch high-compliance woofer with 2in voice coil. Mid-range/tweeter direct radiator. Minimum Power: 20 watts. Maximum Power Requirements: 60 watts undistorted. Impedance: 8 ohms. ERA Mk4 turntable.

Total Price \$1378.00

UNIT 6: Sansul Model AU-777 amplifier, Dual 1019 turntable.

Total Price \$345.00

With 2 Jordan Watts loudspeakers, Add . . . \$100.00

With Empire 888E cartridge, frequency response from 20-25,000 cycles.

Add \$40.00



UNIT 7: 2 Empire Model 2000 loudspeakers, Armstrong Model 226 tuner/amplifier magnetic input 10-watt RMS per channel. Frequency response from 30-20,000 cycles plus-minus 1 dB less than 1/2 p.c. distortion measured at 8-watts RMS per channel. ERA Mk3 turntable, world's most brilliantly designed belt driven turntable made in France. Empire 888TE cartridge, frequency response from 6-32,000 Hz.

Total Price \$820.00



UNIT 8: Kenwood Model TK250U transistorised amplifier, P.E. 34 turntable with Empire 808 cartridge, frequency response from 10-20,000 cycles, 2 Wharfedale Super 8" RSD loudspeakers.

Total Price \$281.00

Our stand at the forthcoming "Audio & Visual Fair" is No.21. Please come for a demonstration of world's most perfect products.

RECORDED MUSIC SALON

C. PINCZEWSKI

TRUE FIDELITY

23 COLLINS STREET,
MELBOURNE 3000.

Telephone 63-6257

MEASURE 100 AMPS AC or DC with

University

HEAVY DUTY AC-DC

INDUSTRIAL MULTIMETER

MODEL MET

An industrial multimeter for checking the currents in solenoid, coils, condensers and motors. Separate 100 ampere rated terminals are provided for the two higher current ranges and all terminals are fully insulated. The meter has a 3 1/2 in mirror scale and a high torque movement with fully-hard polished pivots spring loaded and end-stopped sapphire jewel bearings for maximum shock resistance and durability. High stability carbon resistors, conservatively rated are used in series multipliers and low temperature coefficient manganin shunts are used for D.C. ranges.

UNIVERSITY GRAHAM INSTRUMENTS PTY. LTD.

106 BELMORE ROAD, RIVERWOOD, N.S.W., 2210. Telephones: 53-8758, 53-0644 (5 lines). Telegrams and Cables, Raqup, Sydney. VICTORIA: EASTERN INSTRUMENT AND ELECTRONIC SERVICE PTY. LTD., 3 Carroll Crescent, GLEN IRIS, Melb., Vic. 3164. Phone 20-6953.

REPRESENTATIVES:

W.A.: Atkins (W.A.) Ltd.,
894 Hay Street
PERTH, W.A. 6000.
Phone: 21-0101.
TAS.: W. P. Martin and Company,
202 Argyle Street,
HOBART, TAS., 7000.
Phone: 34-2811.
And
150 Wellington Street,
LAUNCESTON, TAS., 7250.
Phone: 22-844.

S.A.: Compar Distributors Pty. Ltd.
33 Market Street,
ADELAIDE, S.A., 5000.
Phone: 51-5263.
QLD.: Keith Percy and Co. P./L.,
Waterloo Street,
NEWSTEAD BRIS., QLD., 4006.
Phone: 51-5461.
NEWCASTLE DISTRICT:
Hunter Engineering Sales Pty. Ltd.,
Cnr. Gordon Avenue and
Perry Street, HAMILTON, N.S.W.,
2303. Phone: 61-4321.

University

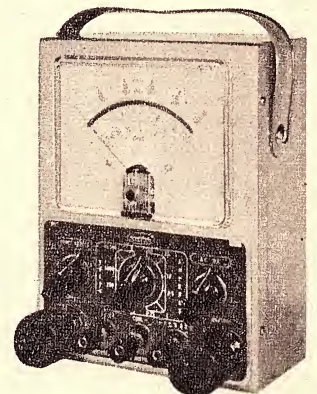

SPECIFICATIONS

- A.C. VOLTS: 0-10-50-250-1000.
- D.C. VOLTS: 0-10-50-250-1000 (500 ohms/V)
- A.C. AMPS: 0-0.25-1-2.5-10-25-100.
- D.C. AMPS: 0-0.25-1-2.5-10-25-100.
- OHMS: 0-500 (centre scale 5 1/2) and 0-50,000 (centre scale 550) Read .1 ohm easily.

BACKED BY UNIVERSITY SPECIALISED SERVICE.

A SIMPLE REACTION TIMER

A reaction timer can be an amusing party novelty, but our contributor here suggests a more serious application for such a device when the party is over and the guests depart.

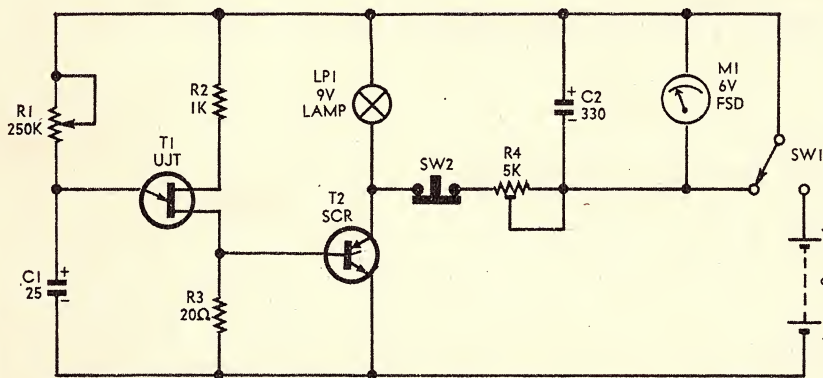

Most people who are not teetotallers will have attended a party or social function where they drink, and are then faced with the decision of whether to drive home or take a cab. Could that last drink have brought blood alcohol level above the legal limit? How is one to know?

The major evil for drinking drivers is that their reaction time is slowed. Let us then modernise the Breathalyzer and make it a Reactionalyzer. All that is required is an alarm light to simulate a stop light on a vehicle ahead; a stop button, the operation of which corresponds to the driver braking his own vehicle; and a short-interval timer. The circuit for this arrangement appears above. The values shown are not critical. However, R4 and C2 will vary with the type of lamp used, and the sensitivity of the meter, and will have to be determined experimentally. M1 is a 5V or 6V meter with a sensitivity of not less than 5000 ohms/volt (200μA meter movement). SW1 is a SPST switch and SW2 a press-to-operate switch. T1 is a unijunction.

The circuit can be set up in several ways. A CRO may be used as a timer, watching the pulses of "start" and "stop" and adjusting R4 so that the meter reads FSD, or a short-interval timer or triggered timer clock reading better than 0.1 sec. could be used.

To operate the device, and test your reaction time, R1 is left in a fully clockwise position (maximum resistance) and SW1 is operated to apply power to the circuit. T1 will operate at a time fixed by C1 and R1. When SW1 has been operated, R1 is slowly wound back. When T1 operates, a signal is fed to the gate of T2. This switches T2 on and LP1 operates at the same time, as C2 begins to charge through the preset resistor R4 and T2. M1 will record the rising voltage on C2 until the press-button switch SW2 is operated. M1 is calibrated (zero to one second) and will indicate the time

taken from switch-on of LP1 to breaking of the circuit by SW2. The device can then be reset by turning SW1 to the OFF position, shorting out C2, and R1 is rewound to the start position.

(Contributed by: Mr B. L. Howells, 11 Richardson Road, Elizabeth South, S.A. 5112.)

(EDITOR'S NOTE: The contributor's remarks relating to the determination of fitness to drive should not be taken too literally. Whatever results were achieved with such tests, they would have no standing in law. We suggest that the Reactionalyzer should be regarded purely as an amusing party novelty.)

RADIO ENTHUSIASTS

Learn amateur radio in your spare time.

Whatever your interests are in amateur radio, there's a Stott Radio course for you. Easy to follow. Practical. Modern. Guidance all the way by top-flight radio engineers.

Radio for amateurs

Learn the exciting skills of building modern radio receivers. Learn about the latest advances in electronics, design, construction and operation. Let Stott's show you how.

Amateur Operator's Certificate Course: Broadcasting is fascinating. Stott's offer an entirely new course that enables you to sit for the Amateur Operator's Certificate of Proficiency Examinations with complete confidence.

Get full details now on Stott's Radio Courses.

POST THIS COUPON TODAY

Stotts



TECHNICAL CORRESPONDENCE COLLEGE

159 Flinders La, Melbourne. 383 George St, Sydney
290 Adelaide St, Brisbane. 45 Gilles St, Adelaide.
1130 Hay St, Perth.

Please send me, free and without obligation, full particulars of your courses in Radio for Amateurs.

Mr Mrs Miss

Address

Age

No sales representative will call

EA 769

THE AUSTRALIAN RADIO DX CLUB

The Australian Radio DX Club welcomes enquiries regarding membership from persons interested in long-distance radio reception. The Club bulletin, "The Australian DX News," published monthly, contains up-to-the-minute information on all aspects of DX listening, and the weekly Club broadcast, "World at Your Fingertips," is heard every Sunday night over radio 3NE Wagaratta 1600 kHz, at 10.35 p.m. THE AUSTRALIAN RADIO DX CLUB is a hobby organisation, serving the needs of DX listeners throughout Australia. Full details concerning the Club and its activities will gladly be supplied on request, and all enquiries should be sent to: THE HON. GENERAL SECRETARY, AUSTRALIAN RADIO DX CLUB, 22 HOWARD STREET, GLEN IRIS, VICTORIA, 3146.

TEL-LEIGH-TUBES PTY. LTD.

(SYDNEY and MELBOURNE)

T.V. PICTURE TUBES AT COMPETITIVE PRICES

Premium quality TV picture tubes are now available at very competitive prices and carry a written

Two Years Guarantee

Free daily delivery service around Sydney and Melbourne. Tubes despatched daily to country and interstate customers.

Please send old tubes freight paid to Petersham Station, N.S.W., or Highett Station, Victoria.

TEL-LEIGH-TUBES PTY. LTD.

(Reg'd Office)
51 REUSS ST., LEICHHARDT.
N.S.W. 56-8498

TEL-LEIGH-TUBES PTY. LTD.

32-34 GRAHAM RD, HIGHETT VIC.
95-4086

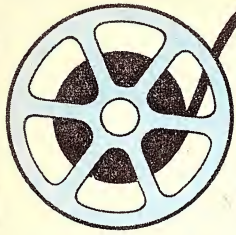

AUDIO TOPICS



A COMPACT, FREE-STANDING LOUDSPEAKER SYSTEM

We introduce here the Playmaster "One-Point-Three" loudspeaker system, which in physical size, falls midway between the compact and "Bookshelf" systems and the big free-standing enclosures of an earlier era. Modest in cost and capable of excellent results, it draws its name from its internal volume—1.3 cubic feet.

By LEO SIMPSON

Since December, 1964, we have described several compact loudspeaker enclosures fitted with locally manufactured or locally available components. These have been built literally in thousands, giving a quality of sound reproduction equal to many imported and more costly systems.

All those described have been two-way systems, with the audio spectrum divided nominally at 2.5 or 5KHz, the lower frequencies being fed to one or two 6-inch loudspeakers. The Playmaster "Bookshelf" systems used the Magnavox 6WR, which has a natural cone resonance of about 50Hz. The rather more compact Playmaster "Point Four" system used the Philips AD3703 or the Rola C65-O, both of which have a natural cone resonance of about 28Hz.

All these enclosures have been filled with "Innerbond," "Bonded Courtelle" or similar sound-absorbent material, with the idea of reducing internal reflections and offsetting the natural rise in the frequency and amplitude of cone resonance, which occurs when a loudspeaker is mounted in a sealed enclosure. As a result, the systems have exhibited a smoothly tapering bass response, readily complemented by a degree of bass boost from the amplifier.

For the high frequency end of the spectrum we have used one or other of the 3-inch or 5-inch diameter tweeters made by Magnavox and Rola. These do the job very well, the 3-inch tweeters being somewhat smoother in frequency response and having better high frequency dispersion. However, some people express a preference for the brighter, more "forward" tone of the 5in types. The closed-back construction of the tweeters is ideal in that it obviates the necessity for a separate, sealed section of the enclosure to prevent the woofer "pumping" the tweeter.

While these systems have been—and

still are—a very good proposition, there has been a demand for something a little larger from readers not quite so concerned about conserving space in the listening room.

This would most logically involve an 8-inch woofer, rather than the 6-inch types used to date, but with a "free-air" resonance well below 50Hz so that it could be installed in an enclosure of still modest dimensions. However, by virtue of the larger cone area and the increased enclosure volume, the system could be expected to have somewhat higher efficiency and

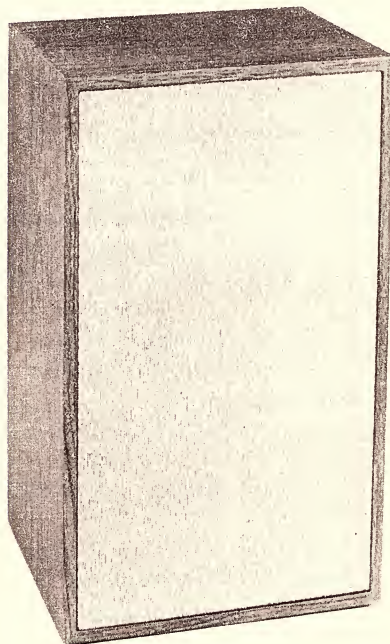

The new Playmaster speaker system which uses Rola loudspeakers. The enclosure measures 22 x 13 x 10½ inches.

be less dependent on bass boost from the amplifier.

Thoughts along these lines were brought more sharply into focus when the Rola Division of the Plessey Components Group released the C8MX De Luxe, a wide-range, 8-inch speaker with a nominal "free-air" resonance of 35Hz. It appears to be a revised version of their C8MX speaker, a wide-range unit with a "free-air" cone resonance of 55Hz—more suited for use in bass reflex enclosures. The new speaker has a specially treated main cone with circumferential ribs and a new tweeter cone.

When Rola sent us a sample of the new speaker we lost no time in working out dimensions for the proposed enclosure. It transpired, however, that the dimensions of our proposed enclosure were very similar to those recommended in the Rola enclosure leaflet which came to hand shortly afterwards. Accordingly, we decided to specify the same internal dimensions as in the Rola leaflet, giving a volume of about 1.3 cubic feet.

Our specifications differ, however, in that we show a baffle of ¾-inch material. All other panels can be cut from ½-inch material although some internal bracing is suggested to minimise drumming effects.

Having obtained the enclosure, we installed the new C8MX de luxe loudspeaker and, for the initial tests, blocked the tweeter hole. Using an amplifier and signal generator, the resonance of the loudspeaker was measured at 70Hz in the sealed enclosure, the amplitude of the resonance being quite high. High level glide-tone testing revealed some vibration of the back panel of the enclosure, with a resulting colouration in the sound.

Internal bracing was accordingly added, taking the form of ¾-inch timber glued to the sides as well as the rear panel. Thicker material would have achieved the same result, but the enclosure would be heavier and more costly.

The next step was to determine the effect of lightly filling the enclosure with a material such as Innerbond or Bonded Courtelle. This material should not be regarded as a cure-all for badly designed enclosures but as an aid to securing the smooth bass response that low-resonance speakers are capable of producing in small enclosures. In broad terms it may be thought of as increasing the mass and viscosity of the enclosed air,

effectively lowering and damping the lower frequency system resonance. Note that this only occurs with a suitable amount of filling; too much will begin to raise the resonance and adversely affect sensitivity.

It transpired that a suitable amount of Innerbond for the enclosure was a piece, six feet by three feet, which when rolled up lightly, filled the enclosure without being compressed. This brought the system resonance down to around 56Hz and reduced the amplitude by more than half. Glide tone testing now revealed a particularly smooth bass characteristic, tapering but nevertheless well maintained to below 40Hz. The bass was fundamental, with sign of little frequency doubling, even when driven hard.

At this juncture, listening tests with a variety of music showed that, while the lower register was good and the middles were giving any amount of "presence," the high frequency response was somewhat lacking when judged by critical high fidelity standards; this despite the tweeter cone. Reference to a response curve of the speaker showed a broad peak in the region from 1KHz to 3KHz and it is reasonable to suppose that this was masking the highs which, according to the response curve, are quite well maintained to the limit of audibility.

While the system is capable of very pleasant sound in this basic form, we decided to add a tweeter to brighten the top end and it seemed logical to select the "stable-mate" of the C8MX Deluxe, the Rola 3DX.

In the enclosure, the hole for the tweeter is 3 inches in diameter, with generous chamfer to avoid any "resonant pipe" effect. For simplicity the tweeter can be fed through a series capacitor to roll off the input below about 5KHz. However, remembering

noticeably higher than the smaller units we have featured in the past. This would mean in practice that a 10W per channel amplifier would have more than ample power reserve in the average domestic situation.

Rola rate the C8MX Deluxe at 7W RMS in the enclosure, but we assume that this would refer to a continuous tone rating, having only limited significance as far as music signals are concerned. In a stereo system, the total sound level would certainly be very high before there was danger of loudspeaker overload. Nevertheless, if your amplifier is capable of 15W RMS or more per channel, it would be wise

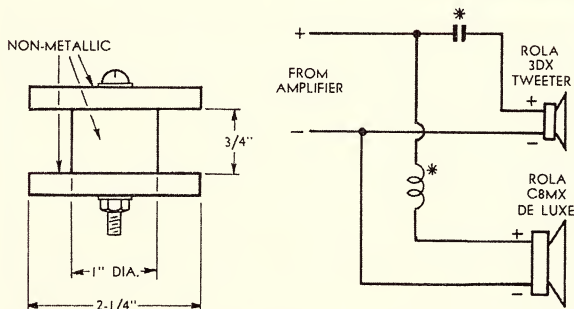
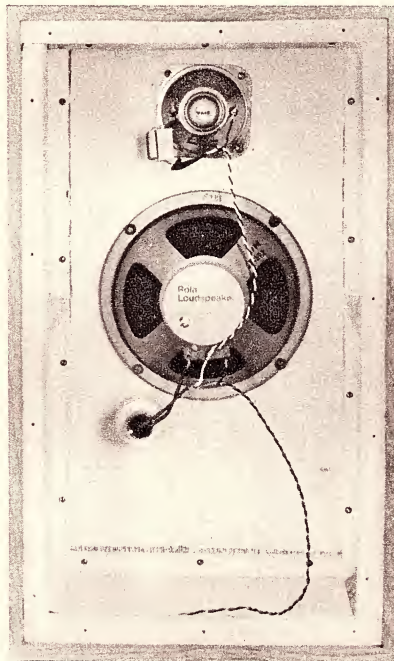

FOR 0.5mH, 140 TURNS, FOR 1mH, 198 TURNS, 18 B AND S OR 19 SWG ENAMELLED COPPER WIRE

* 4μF AND 0.5mH FOR 8 OHM SPEAKERS
2μF AND 1mH FOR 15 OHM SPEAKERS

Above is a view showing the layout inside the enclosure and at left are details of the network and the crossover inductor.

lessons learnt from the "Bookshelf" and "Point-Four" systems, we decided to incorporate a 1/4-section cross-over network which can contribute to clarity in the mid-range. Since we suspected that the C8MX was a little overbright in the mid-range, we decided to use a larger inductor than was nominally necessary for a 5KHz cross-over system. This would reduce the input signal to the woofer before the full signal was applied to the tweeter, thus reducing the mid-range output by a worthwhile degree. This, in fact, worked out quite well, and overall sound quality was now very good.

With a little bass boost the bass response assumed a solid, non-resonant quality and the overall efficiency was

to treat the volume control with reasonable respect. Used sensibly, there would be very little likelihood of damaging the loudspeaker systems.

Having explained at some length how the new Playmaster "One-Point-Three" system came into being, it is appropriate to give constructional details. Doubtless, many readers will merely purchase completely finished units. No doubt, these will be available from the same sources as earlier Playmaster loudspeaker designs, and will be advertised in the pages of this magazine.

The prototype cabinet featured materials which are relatively new to the Australian market. While the cabinet was made of flakeboard it was covered

ALWAYS RELY ON R.D.S.

SPECIALS FOR JUNE

**R
D
S**

ALL KIT SETS FOR ELECTRONICS AUSTRALIA AVAILABLE.

2-stage intercom., \$7.94
3-stage intercom., \$12.88

CT 500 Meter with mirror scale \$14.38
200H Meter \$11.50
ST.708 Stereo Amp. 3½ watts per channel \$41.25 nett



The Independent Wholesaler

RADIO DESPATCH SERVICE

Radio and Electrical Distributors

869 GEORGE STREET, SYDNEY.

Corner George and Harris Streets
Telephone 211-0816, 211-0191

Open Saturday mornings

PLAYMASTER by BEECH

PRE AMPS FROM E. A. CIRCUITS
MAGNETIC P.U. Stereo, 6 trans. \$25.00
TAPE HEAD Stereo, 6 trans. . . \$25.00
GUITAR/MICROPHONE, 47k Input \$10.50
GUITAR Treble Boost, 26DB . . \$10.75
Ready to use, metal case, Battery, Pack and Post 50 cents.
MIXER 4 Channel Audio, E.A. Feb. '66. Two high gain Mic., two P.U. 7 trans. Ready to use \$35.00
Pack and Post 50 cents.
PLAYMASTER 117 GUITAR AMPLIFIER 60 watts R.M.S. Complete in black vinyl covered case. Extra Treble switch, Vibrato with chrome foot switch, Three inputs. Immediate despatch. Ready to use. \$149.50. GUITAR/P.A. Enclosures, quotes available.

JULY SPECIALS

Immediate despatch — Limited number only.
3 PLUS 3, Stereo all trans. Amp. Ready to use \$48.00
PLAYMASTER 118, Stereo Amp. Tape and Tuner facilities. Metal case. Ready to use \$85.12
PLAYMASTER 106, Stereo Amp/Tuner. Tape facilities. Metal case. Ready to use \$92.88

We offer an efficient and reliable mail order service.
Please add freight where applicable.

BEECH ELECTRONICS

P.O. Box 160, KOGARAH, N.S.W., 2217

TRUSCOTT'S AUSTRALIA'S GREATEST MAIL ORDER TAPE RECORDER & HI-FI CENTRE

STOCKISTS OF ALL LEADING BRANDS OF TAPE RECORDERS, HI-FI EQUIPMENT, COMPONENT PARTS AND ACCESSORIES

AMPLIFIERS



KENWOOD TK 20U

Akal — Sound —
 Monarch — Lux —
 Fisher — Compax —
 Kenwood —
 Pioneer — Trilo —
 Sony — Tempo —
 Sansul — Leak —
 Grundig — Cosmos.

TURNTABLES

DUAL 1009F



Dual — JH — Neat — BSR — PE —
 Compax — Labcraft — Pioneer — Goldring.

TONE ARMS AND CARTRIDGES

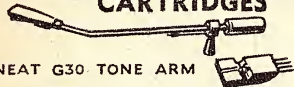

NEAT G30 TONE ARM

NEAT V70 CARTRIDGE

Neat — ADC — Ortofon — All Balance —
 Goldring — Decca — Audio (Technica) —
 Dual — Shure — Micro.

SPEAKERS

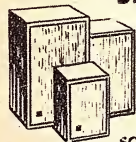

SOUNDMASTER SPEAKER SYSTEMS

Soundmaster —
 Wharfedale — Tesla —
 Philips — Rola —
 Kenwood —
 Pioneer — Sansul —
 Akai — Leak.

ACCESSORIES

Microphones and Stands — Tapes and Spools — Splicing Kits — Record Care Accessories — Speaker Enclosure — Acoustic Cloth and Inner Baffling — Headphones — Pre-packed Leads — Plugs and Connectors — Head Cleaning Kits — Pillow Phones — Bases and Covers, and Many Others.

COMPONENT PARTS AND ACCESSORIES

Truscott's are stockists of all General Electronic components, including resistors, capacitors, plugs and sockets, solder, scope irons and spares, hook-up cables, valves, terminals, tag strips, matrix board, cambric spaghetti, fuses, chassis, grommets, solder lugs, alligator clips, valve sockets, D.I.N. connectors, TV connectors, battery savers, and also a large range of semi conductors for all Japanese makes.

SONY TC 200B TAPE RECORDER



Vertical or Horizontal Operation. Hi-Fi Stereo Tape Recorder. Features: Complete 4 track stereo and mono tape recording and playback system. Sound on sound recording. Two complete full range satellite speaker systems. Individual VU meter and volume controls for each channel. Light weight (only 27lb). Two Sony high quality dynamic microphones. Compact carry case, beautifully styled in black and ivory decor. Truscott's price only \$190.

STEREO HEADPHONES



ELEGA DR-65C

Truscott's carry all the leading brand top quality stereo headphones, including Elega, Akai, Sony, Pioneer, Sansul, Ashidavox, Foster, etc. Send for details and a T.M.Q.

SENNHEISER DYNAMIC MICROPHONES



SENNHEISER MD421

This attractively-styled Dynamic Microphone Model MD421 has been designed to meet the requirements of professional installations, which require low-priced directional studio microphones. A full range of famous Sennheiser studio microphones for amateur or professional use is available at Truscott's. Send now for specifications and a T.M.Q.

220S MULTIMETERS

D.C. Volts 5, 25, 125, 500, 2500.
 A.C. Volts 10, 50, 250, 1000.
 Current: 0-250 uA, 0-250 mA.
 Resistance: 0-10K, 0.1 MEG.
 Truscott's price only \$7.95.

SAVE YOUR RECORDS... USE THE UNIVERSAL LUSTRE TONE ARM LIFT



LUSTRE SA-202

This beautifully finished and functional universal tone arm lift will fit all tone arms. The lowering action is pneumatically dampened and extremely smooth — risk of record damage may now be eliminated. Truscott's price only \$8.50.

TAPE RECORDERS & DECKS



TESLA B46

Tesla — Akai —
 Sony — National —
 Thorn Atlas —
 Juicorder — BSR —
 Toshiba —
 Sanyo — AIWA —
 Philips — Grundig —
 Tandberg —
 Gelsoso.

HI-FI TRANSCRIPTION TURNTABLE COMBINATION

Consists of the one and only JH Synchronous turntable, the new Neat G30 Tone Arm with lifting/lowering device, Neat V70 magnetic cartridge, and hand-finished oiled TEAK wooden base. Retail \$96.00. Truscott's price only \$77.50. If assembly required — add \$6.00.

TAPE RECORDER BELTS

Belts available to suit most models of Telefunken, Uher, Philips, Cossor, Stella, Grundig, BSR, Ferguson, Walter and Kortling Recorders. When ordering, it is most essential to state the correct make and model of recorder.

TAPE RECORDER AND HI-FI SERVICE CENTRE

For service on all leading brand tape recorders and HI-FI equipment — come to the experts. Truscott's modern service centre uses only the finest servicing aids, backed up by fully trained professional technicians.

SPEAKER ENCLOSURE

Truscott's are the leading South Australian stockists of Innerbond and Bonded Courtelle. Ensure dust-free padding for your speaker enclosure. Send for a T.M.Q.

NEAT MAN—THAT'S THE WAY TO ENJOY HI-FI MUSIC

Truscott Electronics are the sole Australian agents for Neat Hi-Fi equipment. Available from your local HI-FI store or direct from agents. Listed below are just two of the Neat range of products.

Neat G30 Professional Static Balance Tone Arm. New release now fitted with lifting/lowering device. A precision built unit, outstanding in appearance and simple to mount and use in any installation. The results obtained are far beyond those usually expected at such an extremely moderate price. It will accommodate all standard cartridges and the tracking weight is easily adjusted to the particular one in use.

Neat V70 Moving Magnet Cartridge: — The V70 is a top performance, high quality magnetic cartridge that out-performs many more expensive cartridges. When used with the Neat G30 tone arm, an excellent low priced combination can be obtained. Send now for reviews and test reports by the Gramophone, Hi-Fi Sound and Electronics Australia on both the G30, V70 and all other Neat tone arms and cartridges.

Fast Mail Order Service

When ordering, please give your full address printed in BLOCK LETTERS. All Truscott equipment is brand new and fully guaranteed. Sales tax is included in all quoted prices. All orders are despatched promptly. All prices quoted are Nett. Postage and freight extra. NOTE: T.M.Q.—Truscott Mail Order Quote.

CAR RADIO SPECIAL "SOUNDMASTER 8"



The new super sensitive push-button all transistor car radio, featuring 8 trans. — 3W output — push-button tuning — built-in noise suppression — high quality speaker — suit any model car — Truscott's price only \$55.00. If aerial required add \$4.00.

SAVE ON PIONEER

All latest model Pioneer amplifiers and turntables are available. Prices slashed — send now for a T.M.Q.

P.E. TURNTABLES

Model P.E. 34. Limited stocks available of this very popular German Hi-Fi transcription turntable. Send now for details, and a very attractive T.M.Q. All other model P.E. turntables stocked.

PHILIPS 82 DICTATION MACHINES

Limited stocks available of this very efficient dictation machine — complete with all accessories. Send now for details and a T.M.Q.

AKAI TAPE RECORDERS

All latest models in stock — XV, 1710, M9, 1800, X360, 4000D, X150D. Prices slashed to an all time low. Send now for a T.M.Q.

TRUSCOTT'S HI-FI COMBINATIONS

Select your HI-FI equipment from our vast range and send for a Truscott combination price — the lowest in Australia.

ACOUSTIC SPEAKER GRILLE CLOTH

Truscott's now carry over 50 top grade cloths to select from. Send now for samples and a T.M.Q.

CASSETTE RECORDERS

A full range of Cassette Recorders and players is available. Write or call for a T.M.Q.

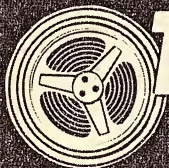

TRUSCOTT ELECTRONICS

AUSTRALIA'S GREATEST TAPE RECORDER & HI-FI CENTRE
 62-64 HINDMARSH SQ. ADELAIDE, 5000 Phone: 233024 233278

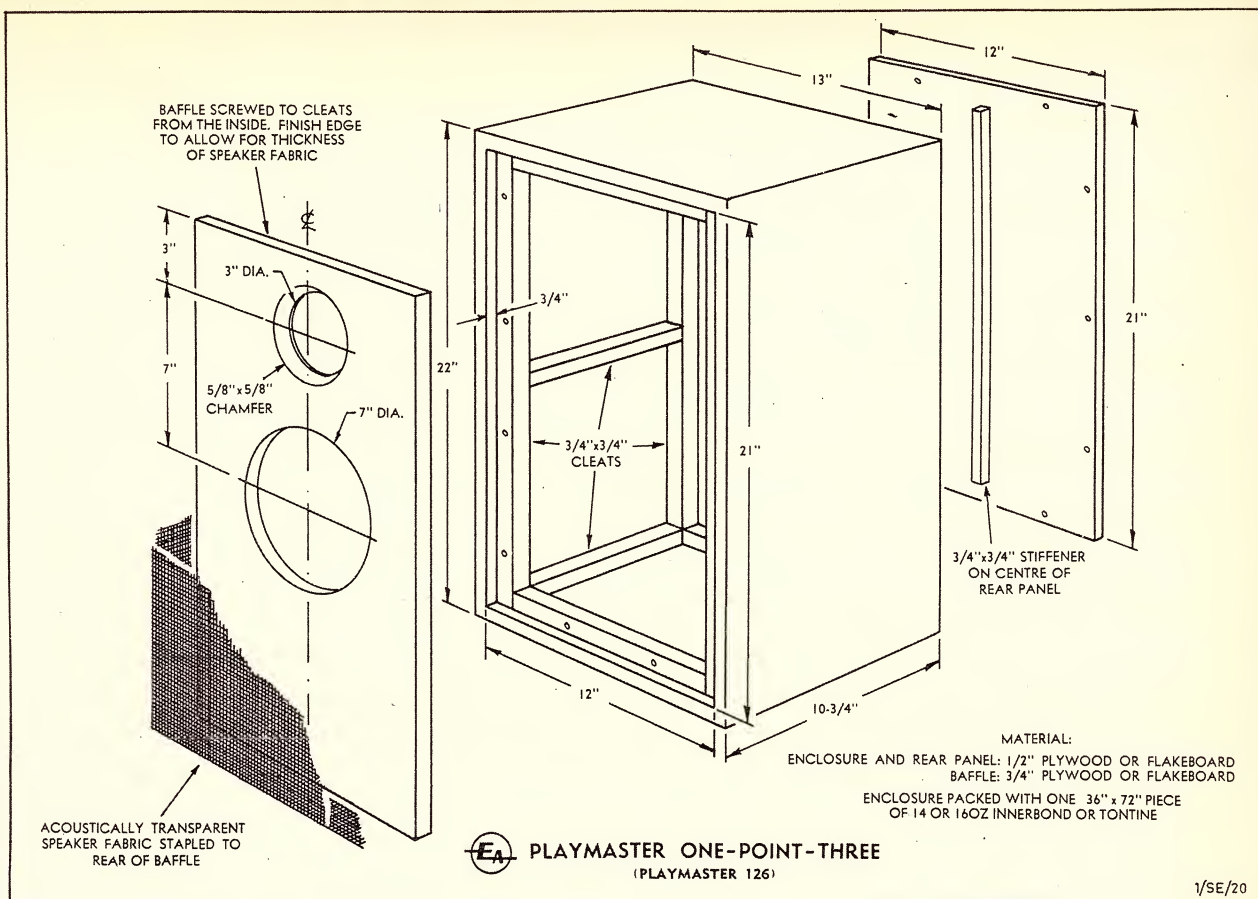

Constructional details of the enclosure for the Playmaster "One-Point-Three" loudspeaker system. Prime requirements for the enclosure are airtightness and rigidity. Note that the baffle should be sprayed black before fitting the grille cloth.

with a vinyl-like material which is applied to the cabinet with furniture glue. It has a simulated wood grain, both in colour and texture and, from a few feet away, it looks remarkably like genuine oiled teak. It is cheaper than the plastic laminates and, to the author's mind, looks more attractive. This is strictly a matter of personal opinion, as some people have an automatic reaction against any material which is not "real" wood.

The speaker fabric was also new, appearing very dense to the eye but when held up to the light it is quite transparent. It appears to be acoustically just as efficient as the more commonly known speaker grille fabrics. The prototype enclosure was built for us by Beech Electronics, P.O. Box 160, Kogarah, N.S.W., who will no doubt also be able to supply cabinets in the more commonly used materials for readers who desire them.

The accompanying diagram gives the essential dimensions and the arrangement of cleats to hold it all firmly together. The proportions can be varied somewhat to suit individual preferences but the internal volume should not be changed. Reducing the volume may make the bass lumpy, while increasing it will reduce loading on the cone and render the loudspeaker more prone to damage.

As we remarked above, all panels apart from the front baffle may be made from half-inch thick material but bracing, as shown in the diagram, should be included. Alternatively, all panels can be made from 3/4 inch thick

material, remembering not to reduce the internal dimensions. In no circumstances should material thinner than half-inch thick be used.

Plywood or flakeboard may be used for the panels but the cleats should preferably be made from ordinary timber, as screw holes in flakeboard tend to become enlarged if the screws are wound in and out a few times.

A basic requirement is that the enclosure must be airtight — the air pressures developed by the cone can be surprisingly high. It is important that all joints in the cabinet, apart from the baffle and back panel, be close-fitting and glued. The baffle and back panel should be dressed to a "push-fit" and held with a pattern of 14 screws, as seen from the photograph of the rear of the enclosure. When making the baffle, allow for the thickness of the speaker fabric on all sides, otherwise it will not fit. Bevel the corners, slightly on the rear of the baffle to accommodate the folds of the speaker fabric.

The baffle and the edges of the speaker holes should be painted black so that the loud-speaker cones do not show through the speaker fabric. As mentioned earlier, the tweeter hole must be chamfered to avoid a resonant cavity effect.

Provided that there are no gaps between the cleats, there should be no problem in sealing the enclosure. You can test for airtightness by feeding a low frequency signal to the loud-speaker (from a test record or music with a lot of bass) at a moderately loud

level and feeling with the palm of your hand, slightly moistened, for leaks from the cabinet joints. We stress that airtightness is very important, as leaks can modify the bass characteristic markedly and add a hissing sound of their own. If the cabinet is leaky, it can be sealed with thin strips of foam rubber or felt, glued to the cleats to form a resilient seal. A pellet of non-hardening putty in the corners will finish the job.

Finally, don't spoil all the good work by merely passing the speaker leads out through large clearance holes in the cabinet. Fit connectors or plug the holes with a non-hardening compound. Polarised two-pin plugs and sockets are the best solution, since it simplifies phasing of speakers in a stereo system. It is also a good idea to record the loudspeaker types, impedance and system polarity on the rear of the enclosure for future reference.

Connection of the loudspeakers and details of the inductors are given in the accompanying diagrams. The system can be built to suit amplifiers with 8 or 15 ohm outputs. Most transistor amplifiers will deliver more power to an 8-ohm load. Whatever you decide, make sure that the tweeter and woofer speakers have the same impedance and use the correct inductor and capacitor specified in the connection diagram.

The woofer and tweeter should be connected so that they are in phase, as shown in the diagram. The "positive" side of the speakers are usually shown

(Continued on page 177.)

With a BSR X3M
 'compatible' cartridge,
 almost any mono
 record playing
 equipment can take
 stereo records
 (without damaging
 them)

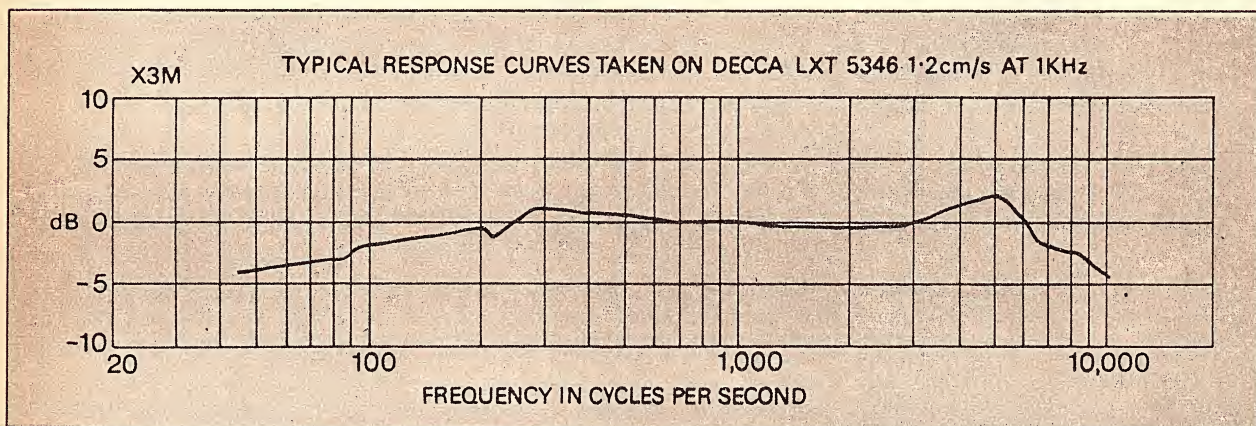
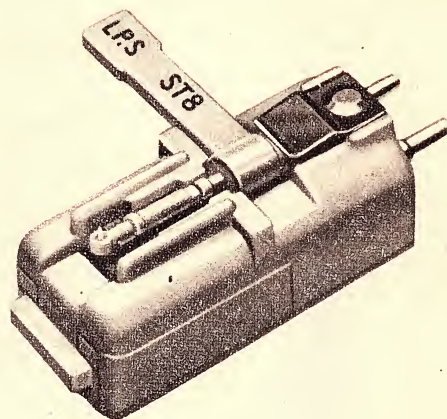

Why compatible cartridges?

An increasing number of record companies are now making stereo LP records only.

Until now these records could not be played on a mono player without distortion and damage to the records.

When playing stereo records the stylus tip moves vertically and horizontally following groove contours. Mono records have grooves which only move the stylus horizontally so old mono cartridges will not allow vertical movement of the stylus. Playing stereo records with old mono cartridges will damage the vertical component of the groove irrevocably.

The X3M 'compatible' cartridge, designed and perfected by BSR, is the answer to this problem. For a small outlay it allows you to play both stereo and mono records without harming either. Retail price, \$6.00.

TECHNICAL DATA X3M

Output: 350 mV \pm 2 dB

1 KHz test record: Decca
 LXT 5346 at 1.2 cm/s

Frequency Response: See typical curves above

Dynamic Compliance:

Horizontal 3.0×10^{-6} cm/dyne ($\pm 20\%$)

Vertical 1.0×10^{-6} cm/dyne ($\pm 20\%$)

Equivalent Capacity: 800 pF

Nominal

Recommended Loading: 2 M. ohm 100 pF

Stylus Pressure: 4.6 grammes
 depending on pick-up arm

Measuring Temperature: 20° C 68° F

Colour: Beige



BSR (A/ASIA) PTY. LTD.
 SOUTHERN SECTION INDUSTRIAL ESTATE
 ST. MARY'S, N.S.W.
 PHONE: 623-0375, 623-0376



DISTRIBUTORS:
 GOLDRING ENGINEERING (A/ASIA) PTY. LTD.
 443 KENT STREET, SYDNEY, N.S.W.
 OFFICES IN ALL CAPITAL CITIES.

BSR:P100

Now BSR McDonald Total Turntable



BSR McDonald 600

Every BSR McDonald automatic turntable is precision made in Great Britain to the most exacting specifications. Upon their arrival in Australia, every model is unpacked and re-tested under actual playing conditions. That's why BSR service calls are the lowest in the industry—and perhaps that also explains why BSR sells more turntables than anyone else in the world.

The BSR McDonald 600 encompasses every fine feature one could desire in an automatic turntable.

- Heavy cast, specially balanced turntable.
- Dynamic anti-skate control applies continuously corrected compensation at all groove diameters.
- Cueing and pause control lever allows for exact positioning of stylus on record and permits you to interrupt listening and reposition to same groove.
- Micrometer stylus pressure adjustment permits $\frac{1}{3}$ gram settings from 0 to 6 grams.
- Automatic lock on tone arm after last record is played.
- Dynamically balanced 4-pole induction motor has high torque, constant speed design—assuring minimum rumble and wow.
- Low mass tubular aluminium tone arm perfectly counter-balanced both horizontally and vertically.
- Resiliently mounted, coarse and fine vernier adjustable counter-weight.
- Tone arm is jam-proof even if it is held during the cycling operation.
- Clip-in cartridge holder, provides universal mounting and quick change. (Optional)

BSR McDonald 600—\$109 (with C1/ST4 cartridge).

BSR (A'Asia) Pty. Ltd.,

Southern Section Industrial Estate,
St. Marys, N.S.W.
Phones: 623-0375, 623-0376

Wholesale Distributors

Goldring Engineering (A'Asia) Pty. Ltd.
N.S.W.: 443 Kent St., Sydney, 29-1275
Vic.: 368 Little Bourke St., Melbourne, 67-1197
Qld.: 235 Edward St., Brisbane, 2-7010
W.A.: 91 Hay St., Subiaco, Perth, 8-4988
S.A.: 77 Wright St., Adelaide, 51-5117

ELECTRONICS Australia, July, 1969



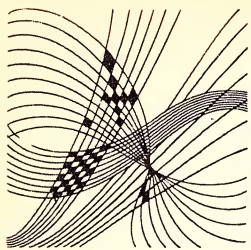

CLASSICAL RECORDINGS

Reviewed by Julian Russell

ENGLISH MUSIC FOR STRINGS:
Vaughan Williams — *Concerto Grosso*. Delius — *Air and Dance*. Warlock — *Serenade to Delius on his 60th Birthday*. Elgar — *Serenade in E Minor*. Bournemouth Symphony Orchestra conducted by Norman del Mar. EMI Stereo OASD2351.

To those who like occasionally to get away from these inquiring times and return to shelter in the security of Edwardian comfort, I recommend this disc which, while all its material might not be first class, has nevertheless much that's attractive.

Elgar's *Serenade* used to be a favourite piece on concert programs but has, alas, like so much music of its period nowadays become something of a rarity in concert halls. It was good to hear it again, especially as given here, conducted by a musician whose love for it is manifest in every bar even if his performance does not quite measure up to the best I have heard.

Better played, but a little less interesting, is the Vaughan Williams *Concerto Grosso* which here appears on disc for the first time. Newcomers to the music of the composer might first be struck by what appears to be the monotony of his modal style. Others, who know him and love him well, will be delighted by the vast resources he displays in a deliberately chosen, somewhat narrow medium. They will find subtleties in the harmony, melody and the magisterially used orchestral colour in every one of the five short pieces that make up the suite. And I can with confidence describe the playing as really first rate.

Frederick Delius was not at his best in the *Air and Dance* but rich compensation is to be found in the beautifully played violin solo. If the piece is slight it is none the less unremittingly graceful. Peter Warlock, represented here by his *Serenade to Delius* on his 60th Birthday, was also not in top form in a piece that might even be a gentle parody of his old friend's style. Warlock was also a dear friend of mine and together we used to visit Delius at his house at Gres-sur-Loing, a few miles out of Paris, during the late 1920s. At that time Delius was both paralysed and blind. He seldom displayed any interest in anyone's music but his own, and to please him Warlock and I would rummage about in old trunks to find some of his early songs which we played to him.

One work of Warlock's in particular I would like to find issued in Australia is his suite for voice and instruments

on texts by Yeats entitled "The Curlew," which I haven't heard since it was privately recorded on 78s back in the middle thirties. The *Serenade* never matches this delicious piece of sound in inspiration or workmanship but makes a useful fill in an enjoyable disc.

* * *

CHOPIN—Valses. Philippe Entremont (piano). CBS Stereo 235302.

There used to be something a little slapdash about Entremont's playing at times, both in his recordings and during his tours of Australia for the A.B.C. In this new recording, he eschews such youthful exuberance while remaining as elegant as any of his fellow Frenchmen could desire. His interpretation of the Valses is essentially that of a young man of the mid-twentieth century. If his style lacks a little of the aristocratic that distinguishes Arthur Rubinstein's or the sensitivity characteristic of Ashkenazy's, most of the Valses gave me great pleasure. To some he imparts an almost Viennese lilt, others sparkle. In a few his rubato is a little self-indulgent and an occasional phrase is ended I thought too abruptly.

And while his playing might generally be described as brilliant rather than seductive, the latter adjective cannot be omitted in describing the slower pieces. Rhythmically he is always interesting, and it is perhaps in his insistence on this aspect of the music that gives his readings such a contemporary flavour. The piano tone is recorded with the utmost fidelity.

* * *

RIMSKY-KORSAKOFF: Scheherazade. Tsar Saltan — March and Flight of the Bumblebee. London Symphony Orchestra conducted by Andre Previn. RCA Stereo LSC 3042.

Andre Previn, recently appointed conductor of the LSO, started his musical career as a jazz pianist. He has composed the music for stage and film musicals, and is at present busy on the score of a film version of Dickens' "Great Expectations." He was made conductor-in-chief of the Houston Symphony Orchestra in 1967 but as recently as May this year it was announced that his contract with this organisation would not be renewed. It appears that the Houston authorities were unhappy about the time he spent with the LSO and still further displeased by Previn's visiting Houston's nightclubs dressed in blue jeans and accompanied by the young actress Mia

Farrow. This is the first record I have heard of his since he took over the LSO from Kertesz in 1968.

I must confess to having been slightly disappointed with it. I thought some of his tempos unusually slow, even to the extent of depriving much of the music of its vitality, and one senses throughout a tendency to hold the orchestra in check. True he produces some gorgeous splurges of colour, especially from the strings when he gives them their head. And the first desk soloists, which include some of the world's best, have plenty of opportunities to demonstrate their skill and taste in Rimsky's brilliant score. Previn seems to be trying above all other considerations, to be a very respectable young man and reluctant to give the music its true oriental splendour.

Another point — to bring the very pianissimo passages in at a comfortable level an increase in volume is required and this picks up some surface noise on my pressing. I much prefer the version by the Bournemouth Symphony under the late Constantin Silvestri issued by EMI last year. However the brief fills from Tsar Saltan are so bewitchingly played and admirably recorded, that they tend to make one forget — if not perhaps forgive — some of the shortcomings of the major work.

* * *

RAVEL—Daphnis and Chloe (complete Ballet). New Philharmonia Orchestra and the Ambrosian Singers conducted by Rafael Fruhbeck de Burgos. EMI Stereo OASD2355.

There have been many complete recordings of "Daphnis and Chloe," among which my favourite has for many years been — and still is — the 1959 performance by Monteux and the LSO for Decca. You will find much to admire in the new EMI, notably first rate recording, a well-nigh perfect ensemble, faultless contributions by orchestral soloists one has come to expect from the New Philharmonia, and a well managed chorus. But I prefer Monteux' reading because of his obvious commitment to the music—he conducted the first performance of the ballet in Paris back in 1912—and for his treatment of it as the symphonic masterpiece it is.

If you happen to have the Monteux performance, play it and sense what is obviously the old Frenchman's savouring of the flow of sensuous sound that makes the work one of the most breath-takingly beautiful pieces of orchestration ever put on to paper. Fruhbeck tends to make his reading sound no more important than an excellent accompaniment to a ballet. True he makes it an impressive accompaniment — few could do less — but lacking is the poetry and often the sheer drive that made his rival's performance so memorable.

The playing of most of the individual movements is satisfactory enough — I exclude however the 7/4 movement in the first part and the superb opening scene which accompanies the dawn in the ballet — but it just simply does not match Monteux' conception of the work as a whole.

Yet it cannot be dismissed out of hand. The accuracy of the playing and its occasional moments of excitement

might tempt one to prefer its more modern engineering to the now 10-year-old Decca, which however wears surprisingly well. But there is one important consideration that should be borne in mind when making a choice — the Decca is likely to be issued in Australia on that company's budget-priced "Ace of Diamonds" label in the very near future.

★ ★ ★

BEETHOVEN—Symphony No. 1 in C Major, Op. 21 Symphony No. 2 in D Major, Op. 36 New York Philharmonic Orchestra conducted by Leonard Bernstein. CBS Stereo SBR235307.

With so many impressive competitors on the Australian market, CBS showed great courage in issuing this new recording of two works so well represented in current catalogues. However the sheer vitality of the performances should earn them a respectable public and Bernstein is one of the most popular conductors recording today. One's first impression of the playing is the winged precision of the fast movements. There is never a hesitation, hint of a blunder, or even a smudged passage. An enormous amount of work must have gone into the preparation for them to be presented so exhilaratingly.

Neither symphony has a true slow movement in the Beethoven sense — though one must except a few introductory bars here and there. And even these latter Bernstein keeps moving without ever seeming to be in too much of a hurry. He finds plenty of time throughout each symphony to provide long stretches of enchanting delicacy, that provide welcome contrasts to the agile bustle of the others. I found his treatment of both symphonies immediately attractive and, perhaps more important, refreshing.

★ ★ ★

MOZART — II Re Pastore (Opera in Two Acts). Reri Grist (Aminta); Lucia Popp (Elisa); Arlene Saunders (Tamiri); Nicola Monti (Agenore); Luigi Alva (Alessandro). The Orchestra of Naples conducted by Denis Vaughan. RCA Stereo LSC8009.

The conductor of this opera, if it can be so described nowadays, is Melbourne-born Denis Vaughan, who has won a considerable reputation overseas as an authority on period style and textual authenticity. A few years ago he created considerable interest in a paper he wrote exposing what he described as multiple mistakes in the published scores of operas by Verdi and Puccini. When he visited Australia for the Elizabethan Theatre Trust some few years ago, he used Moussorgsky's original version of "Boris Godounov" instead of the more popular, and to me, better revision by Rimsky-Korsakoff. He was a protege of the late Sir Thomas Beecham, and it was with this in mind that I expected great things from this set. I was not disappointed.

We have no record as to how the work was originally presented. It is suspected that it was given in concert form. But however you listen to it — and it is perhaps at its best in recorded shape — it has much delicious music which Vaughan ensures is most

LITTLE SHORT OF REVOLUTIONARY

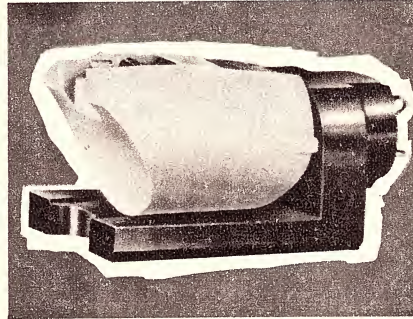

DECCA Deram

MICROGROOVE "CERAMIC" CARTRIDGE
fitted with diamond stylus
for stereo or mono microgroove records

Micrographs of a groove recorded with a 10 KHz signal taken from three copies of a Decca stereo frequency test record SXL 2057.

UNPLAYED MICROGROOVE



AFTER ONLY 1 PLAYING
with a good, average-priced
cartridge. Arrows show damage



NO DAMAGE AFTER 250
PLAYINGS with Decca Deram.



THE DECCA DERAM DOES LESS DAMAGE AFTER 250 PLAYINGS THAN THE AVERAGE CARTRIDGE DOES AFTER ONLY ONE

The Decca Deram has a tip mass of 0.6 milligramme; its compliance is 9×10^{-9} cms/dyne (lateral) and 5×10^{-9} cms/dyne (vertical); tracking weight 2.5 gms.; frequency response ± 3 dBs 18Hz to 18KHz. Output 50MV/CM/Sec.

Retail Price
\$12.60

Sole Australian Agent:

BRITISH MERCHANDISING PTY. LTD.

Shaw House 49-51 York St., Sydney, N.S.W. Telephones 29.1571 (3 lines)

Dual

NEW RELEASE 1210

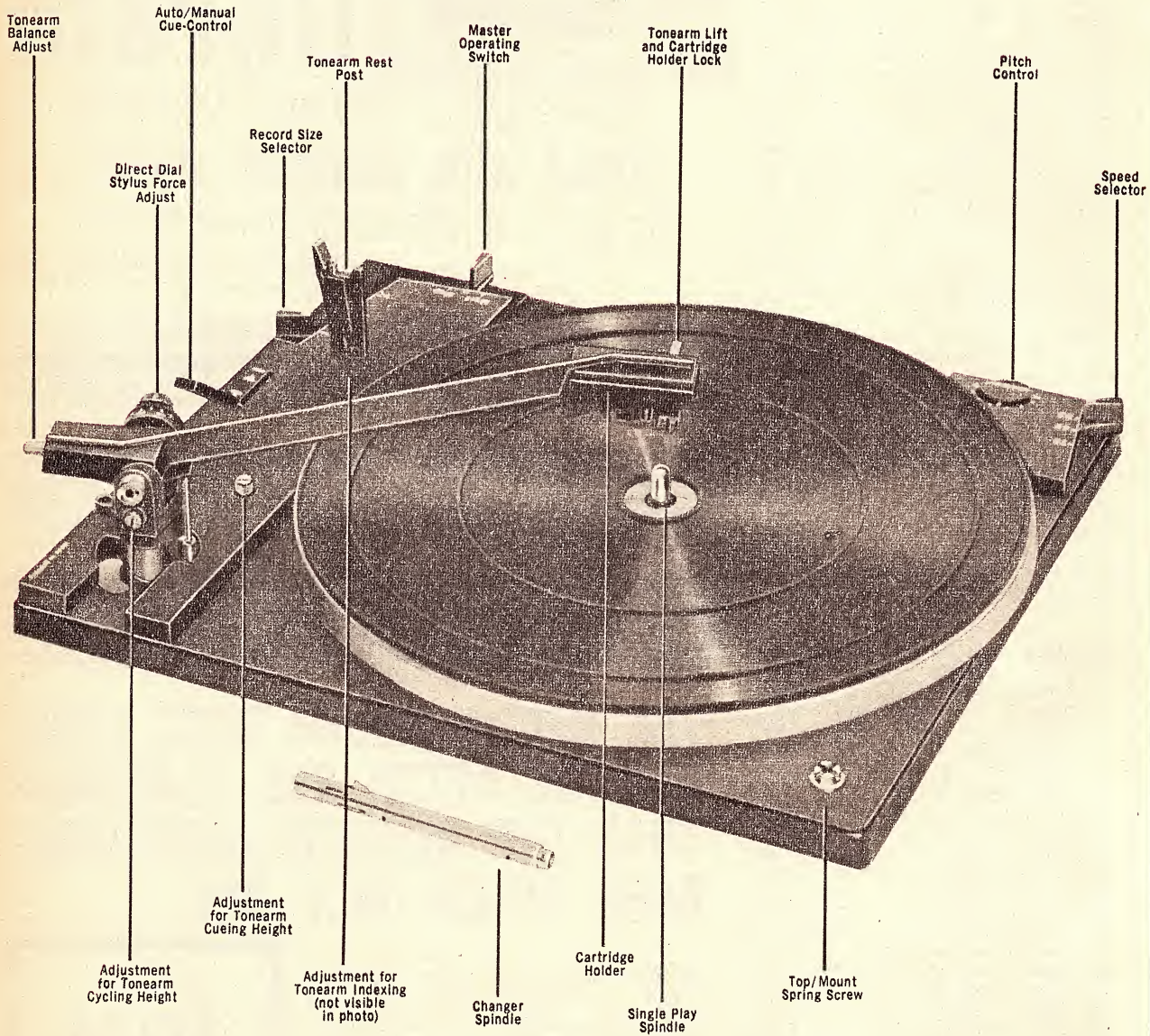

FRED A. FALK (SALES) PTY. LTD.

28 KING STREET, ROCKDALE, N.S.W. — PHONE 59 4783—59 7731

Distributors:

N.S.W.—All leading Electrical Houses.

VIC.—Radio Parts & Electrical Houses.

QLD.—Ron Jones P/L, 7-9 Merton Rd., Sth. Brisbane.

S.A.—Truscott Electronics & all leading Electrical Houses

W.A.—Athol M. Hill, 613 Wellington St., Perth.

TAS.—All leading Electrical Houses.

JULIAN RUSSELL ON EUROPEAN TOUR

beautifully played. A stickler for period style, Vaughan has restored the appoggiaturas and decorations which disappeared during the last century. These have a very happy effect on phrase endings, especially in the many attractive vocal numbers, and Vaughan is careful to see that they are matched by the orchestra.

The plot of "Il Re Pastore" is almost completely uneventful — which is why I questioned its description as an opera earlier in this review. The cast consists of three sopranos and two tenors only. As its title suggests it is pastoral in character and I fancy it will be unknown to all but serious Mozart scholars. But I can recommend it with the greatest confidence to all Mozart lovers who will learn to ignore the fact that the otherwise entrancing score is a little top heavy with recitative.

★ ★ ★

SCHUBERT—Wanderer Fantasia, Op. 15, Moments Musicaux, Op. 94, Wilhelm Kempff (piano). DGG Stereo 139372.

To some pianists the "Wanderer" Fantasia is a vehicle to advertise showy virtuosity, to others it is a serious work demanding the same close examination as a Beethoven sonata. That Kempff belongs to the latter school is evidenced in his performance here. There is nothing gaudy in his presentation of even the most florid passages, no sentimental wallowing in the beauties of the slower ones. Instead you will find the gentle but penetrating introspection of a man whose respect for the work is boundless. His climaxes when they come carry you with them on a great wash of sound. In the quieter parts his sensitively controlled touch adds beauty to the composer's intentions.

Of course, those who prefer the first school of exponents will accuse Kempff of over-restraint, of missing countless opportunities to display technical brilliance at any cost. Admirers of the second school will know from his playing that his technique would permit him to play it any way he liked. I enjoyed the whole performance enormously.

And he contradicts the people who might accuse him of anti-romanticism by his poetic presentation of the six "Moments Musicaux." These he plays with the utmost lyricism, producing sound that I found exquisite in its nuancing. There are many pianists, some of them still students, others adepts, who think these exquisite little pieces should be tossed off as airy trifles signifying nothing. These I urge to play the famous "Moment Musical" in F—the one that was featured in the stage musical "Lilac Time" based on Schubert's life—and hear what it can be made to sound like under the fingers of such a master.

★ ★ ★

DVORAK: Piano Quintet in A Major, Op. 81, "American" Quartet in F Major, Op. 96, Smetana String Quartet with Pavel Stepan (piano). EMI Stereo OASD2350.

Dvorak lovers will find another disc to please them in an EMI recording which offers the Smetana Quartet in Dvorak's Piano Quintet (Pavel Stepan, piano) and the "American" Quartet in

Since by the time this appears in print, I shall have left for overseas to attend the Vienna and other European music festivals, this will be the last of my record columns to appear for four months. In the meantime my place will be filled, to your utmost satisfaction, I think, by Paul Frolich, a knowledgeable writer, and well-known in Sydney musical circles. He has had considerable experience in reviewing records and has a good memory for past recordings.

At the suggestion of the Editor of

F Major. The playing is superb, the compositions rich in romantic melodies treated with an abundance of developmental resource. The Smetana group have often visited Australia and those who heard them might recall that they play everything by what used to be called "heart." This means that they never use scores during a recital.

In fact they know the works they play so well that they can ignore the mechanics of finding the right notes and concentrate on interpretation. Not unexpectedly their unanimity of purpose is never less than impressive and their perfect balance the result of being able to pay full attention to the contributions of their colleagues. No player tries to lord it over the ensemble.

Add to this the fact that the members of the quartet are Czechs, and that

"Electronics Australia," Neville Williams, I shall endeavour (by means of a special article) to give readers some idea of how best to spend their time in Europe if they wish to attend the numerous music festivals held there every year. These, of course, range all the way from the Baroque to the avant garde, and readers might find it useful to learn just when and where they are to be found, their relative merits, and other off-beat information. In the meantime, au revoir, and thanks for your patience.

Czechs have a special genius for presenting the music of their fellow-countrymen, Dvorak and others, and you have all the elements of a most enjoyable experience. And that's the way I found it.

★ ★ ★

WALTON — Viola Concerto (revised version).

HINDEMITH—Der Schwanendreher, Paul Doktor (viola) and the London Philharmonic Orchestra conducted by Edward Downes. CBS Stereo 235298.

Here are two works which, so far as I can trace, have not been recorded in recent years. Many critics, including myself, consider the Viola Concerto Walton's finest work. It receives a splendid performance on this disc,



BARGAIN PACKS!

<p>SEMI-CONDUCTOR PACKS, BRAND NEW AND TESTED! SILICON AND GERMANIUM TYPES</p> <p>10—RF Type Similar BF115, AT325, AY1101 \$2.95</p> <p>10—AUDIO Type Similar AT326, BC108 \$2.95</p> <p>10—AUDIO Output, Matched Pairs 2N3055 \$3.25</p> <p>1—PNP Hi Power Output, 2N3055 \$2.00</p> <p>5—Pair Complementary Output, 2N3055 \$3.25</p> <p>1—PNP RF Type SIM AF116 or \$1.60</p> <p>10—SIM AF116 or \$5.00</p> <p>1—PNP Power Output Sim. 2N2149, 2N301. \$1.30</p> <p>1—PNP Audio Similar OC70 .50</p> <p>FET's</p> <p>MPP 102—2N5459 \$1.10</p> <p>MPP 105—2N5485 \$1.30</p> <p>MPP 106—2N3819 \$1.00</p>	<p>NEW WIDE BAND PLAYMASTER 122 TUNER Based on Playmaster design. Ceramic filters. Tuning meter. Whistle filter, etc. \$62.00, plus tax. Teak cabinet, 56 extra.</p> <p>TRANSISTORISED TUNERS New, low-priced model, wood grain finish. Without power supply.</p> <p>ONLY \$19.50, plus tax.</p> <p>UNIT 10—with RF stage and power supply, 8 Kcs bandwidth—\$31, plus tax.</p>	<p>SPECIAL!!!! 1st RELEASE! 8 TRANSISTOR RADIO KIT! USES SILICON TRANSISTORS AND DIODES. Complete with instructions and carrying case. \$17.50. Wired and Tested. \$18.50.</p>
<p>SILICON RECTIFIERS</p> <p>50V, 100V, 200V, 400V at 36c each.</p> <p>800V, \$1 ea; 1000V, \$1.30 ea</p>	<p>GERMANIUM DIODES</p> <p>OA90 Type 27c ea or 10 for \$2.50</p> <p>OA90 Type 27c ea or 10 for \$2.50</p> <p>AN1102, BA100, 27c ea or 10 for \$2.50</p>	<p>NEW 1969 TRANSISTOR RADIO KIT</p>  <p>6 Silicon Transistors and complete with instruction Book, carrying case and earphone. Special price, \$11.25</p> <p>Wired, \$13.50</p> <p>Post and Pack, 75c.</p> <p>"Super-Fast" Solder — Special Resin Cored, 2 1/2lb reels. ONLY \$2.75.</p>
<p>RECORDING TAPE, POPULAR MAKE AT WHOLESALE PRICES</p> <p>3in 150ft60</p> <p>3in 225ft72</p> <p>3in 300ft99</p> <p>5in 600ft1.80</p> <p>5in 900ft2.35</p> <p>5in 1200ft2.50</p> <p>5 1/2in 900ft2.65</p> <p>5 1/2in 1200ft3.00</p> <p>7in 1800ft4.10</p> <p>7in 2400ft4.97</p> <p>7in 3600ft6.65</p>	<p>PHILIPS TYPE CASSETTS</p> <p>C60, 60min \$1.95</p> <p>C90, 90min \$2.75</p> <p>C120, 120min \$3.50</p>	<p>UNIT 4. Pre-amp tone Control Stage.</p> <p>UNIT 11. 65W HI-FI Amplifier.</p> <p>Transistor Modules—</p> <p>Unit 1. 25W RMS Amplifier.</p> <p>Unit 2. 10W Amplifier.</p> <p>Unit 3. 10W RMS Amplifier.</p> <p>TRANSISTORS AND DIODES AT SPECIAL PRICES. ALSO ALL COMPONENTS, TAPE, FILM, etc.</p> <p>SEND S.A.E. FOR DETAILS AND LIST.</p>
<p>Palace 10-Watt solid state amplifier 15-19,000 KHz \$33.50.</p> <p>PIONEER speakers 15in guitar type, 60-watt \$30.00 each.</p>	<p>Peak 7W Stereo Amplifier, 50-20,000 Hz, in oiled timber cabinet, \$34.50, complete.</p>	<p>BOYS' CRYSTAL SET KIT Complete with plastic cabinet, earphone and instructions. \$2.20</p>

S. E. WILLIS TRADING CO.

38 Riversdale Road, Camberwell Junction, Vic. 3124.
Phone 62-5787. Please include Freight. Sorry No C.O.D.

SUPERB SOUND— LOW LOW PRICES

Arrow Electronics have been selling prestige high fidelity sound equipment for over 20 years.

Now to cater for the ever increasing demand for more moderately priced equipment ARROW are using their know how and past experience to put together complete stereo systems priced from as low as \$260.00.

Who else but ARROW could come up with a system such as the one shown here, the "CRITERION MODULE," for \$300.00.



This attractive stereo system boasts

- ★ SHURE magnetic cartridge.
- ★ DUAL 1015 turntable.
- ★ LAFAYETTE solid state 24W RMS Amplifier.
- ★ CRITERION 50 speakers with separate woofer, tweeter and cross over network.
- ★ Attractive Walnut cabinetry and smoked perspex lid.

This is just one of the many systems we can tailor to suit your particular taste and budget that not only sounds great, is handsome to look at, but is easy to afford through our simple terms. We invite you to come in—browse around—ask questions, let our knowledge and experience be your best guide to happy Hi-Fi buying.

THE WORLD'S VERY BEST

For those people who want the ultimate in high fidelity components and systems we offer outstanding value with equipment that ARROW ELECTRONICS have become renowned for. Equipment by such famous manufacturers as

LEAK WHARFEDALE KENWOOD GOODMANS QUAD
TANBERG THORENS SME and SHURE

For over 20 years ARROW have been Sydney's foremost Hi-Fi Centre.

AE **ARROW ELECTRONICS** **342 Kent St.**
SYDNEY
NOW AT 29-6731

Opposite 2UW between KING & MARKET Sts.

with an outstandingly persuasive contribution by the viola soloist, Paul Doktor. Under Edward Downes the orchestral part is ably handled, too.

Unfortunately the engineering is a good deal less than satisfactory—not a point that can be made frequently about CBS products. Its chief fault is in the placing of the soloist so far in front of the orchestra that important accompanying passages go for nothing. But an even more serious fault is that the volume of Doktor's tone is so monotonously loud—perhaps because of monitoring—that the dynamic range sometimes becomes tiresomely without variety.

I can remember when the Hindemith piece was first issued on 78s back in the 1930s. I didn't like it very much then, and I haven't grown any fonder of it since. To me it is much too cerebral, too drained of lyrical impulse, to move me, though I am aware that Hindemith, some 30-odd years ago, had an unassailable reputation as a "modern" composer. He is much more rarely heard in concert halls today. But the work has one particular merit—its transparent scoring makes the balance between soloist and orchestra sound much more satisfactory.

★ ★ ★

DVORAK: Cello Concerto in B Minor, Op. 104. Waldesruhe, Op. 68. Rondo in G Minor, Op. 94. Maurice Gendron (cello) and the London Philharmonic Orchestra conducted by Bernard Haitink. Philips Stereo SAL3675.

Most admirers of Dvorak's Cello Concerto—and there are many who think it his most impressive work—will already own Rostropovitch's superb performance with Boult and the Royal Philharmonic issued some eight years ago. Although my pressing is a mono I thought is unlikely that a successful challenger would appear during my lifetime. But this new stereo one by Gendron and the London Philharmonic under Bernard Haitink runs it so close that only marginal difference separate the two, and some listeners might even prefer it to its older competitor.

Its chief challenge is in the engineering. The earlier version was entirely worthy. The new one gives the orchestra additional presence, has a better established balance between soloist and orchestra, and reveals more picturesque detail in the orchestral scoring. Moreover despite the fact that Rostropovitch was, and continues to be, one of the very greatest cellists of his generation, Gendron's playing can be in no way labelled inferior to his rival's. Naturally his reading differs slightly from the Russian's, but you might well be shocked to find that you prefer Gendron's divergencies. Both players are eloquent beyond words, and both play noble instruments.

But if you're looking for another feature to help you prefer the Philips issue, you will include the two fills, short Dvorak pieces for cello and orchestra, which are well worth owning. "Waldesruhe" is a brief, quite unpretentious sigh of content, the "Rondo" is honestly described in the sleeve notes as "a good natured display piece." The Rostropovitch, you may recall, had no fill, but devoted the two whole sides to the concerto alone. ■

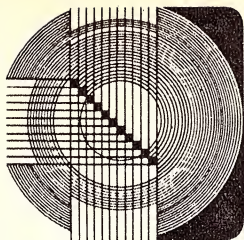

DOCUMENTARY RECORDINGS

Reviewed by Glen Menzies

THE FIGHT GAME: A Radio Ballad by Ewan McColl, Peggy Seeger, and Charles Parker. Produced by Charles Parker. Recorded with the co-operation of B.B.C. Radio Enterprises. Argo Mono RG 539.

Of the Radio Ballads reviewed so far, this one may have a wider appeal to Australian record buyers, simply on the grounds that the "Fight Game" arouses two distinct attitudes, either strongly for, or strongly against. Recent discussion about the future of boxing as a "sport" in Australia seems to have died lately with the rise to prominence of Lionel Rose.

Like any good documentary should, this one presents as complete a picture as is possible in the time. As in the other Radio Ballads "The Fight Game" is based on on-the-spot tape recordings; made in gymnasiums, boxing rings, dressing-rooms or out on the streets during early morning training sessions. Boxers, trainers, managers and boxing fans all have their say.

One telling point is that it is mostly poor men who take up boxing as a profession — rich men rarely become boxing champions. Another is that the ring is "one of the loneliest places in the world." One boxer confesses that he lives for the moment when the match is over, and another one says, "I always hate an opponent—you're in there to do a job. When he's knocked down I'd say to myself, 'Just stay there! Just stay there for another couple of seconds until it's 10.' But once he gets up you just can't love him enough, you know, you just can't do enough for him. You rush over and see if he's O.K."

This is typical of the unselfconscious and forthright comments. Ewan McColl found splendid material on which to base his songs and in this album they are particularly apt. These are songs which match the deadpan irony as well as capturing the passionate partisanship of the boxing world. Peggy Seeger showed great skill in integrating sound effects of the boxing world with the in-training sequences. The gladiatorial atmosphere of the big fights is vividly captured in sound and brilliant use is made of two trumpets in musical "combat" to depict the boxers in the ring.

There is a natural progression from talk of earlier days and heroes of the ring, through training sessions to the night of the big fight where "the crowd roars and groans and sighs like some enormous animal." In the main fight

sequence, telling use is made of the actual ringside effects. The rhythmical thud of a punchbag in use has a much more violent sound than the confused in-training sound effects to supplant sounds of men in the ring. As the sleeve-note comments, "also such effects can carry overtones of savage irony in reminding us of the rigorous training these men undergo, tuning and toughening their bodies to physical perfection—for this brute battering."

Whilst I have little interest in boxing as such I judge this to be an exciting example of the Radio Ballad form.

★ ★ ★

POETRY OF THE BLACK MAN: Read by Sydney Poitier and Doris Belack. Music by the Brooks Male Chorus with Margaret Ross, Harpist; Gordon "Specs" Powell, Percussion and Piano. United Artists, Stereo SUAL-933,226. Released through Festival Records.

The poetry here ranges all the way from the words of Spirituals like "Some times I Feel Like A Motherless Child" and "Lift Every Voice and Sing" through lyric poetry to more modern verses with their use of stark imagery which are explicit in protesting the black man's lot in modern American society.

I am glad to have been introduced to a poet such as Paul Laurence Dunbar, the Ohio-born son of a former slave. He died at the early age of 34, but built up a huge following for the more popular of his verses and short stories, which were favourite repertory items at church socials and teas. However, he is represented here by the tender and sad "Ere Sleep Comes Down to Soothe the Weary Eye" and a short poem on a more bitter note, "We Wear The Mask."

"To John Keats, Poet at Springtime" celebrates both Keats and Spring and reveals a gifted poet in Countee Cullen, as does his "Yet I Do Marvel" with its apt lines:

"Yet do I marvel at this curious thing,

To make a poet black—and bid him sing!"

Langston Hughes was a poet who began to develop in the ferment of the thirties, singing songs to black washerwomen and drawing on the blues for the background of some of his poetry, i.e., "Blues at Dawn":

"If I thought thoughts in bed, them thoughts would bust my head.

So I don't dare start thinking in the morning."

"When You Have Forgotten Sunday" by the leading black woman poet Gwendolyn Brooks, is a powerful and moving statement of remembered love.

Miss Bellack is a natural poetry reader who projects her voice well and deserves equal billing with Mr Poitier. I take exception to the bottom heavy, close-miked echo reinforced recording technique used for some of the poems. Mr Poitier suffers most from this treatment, which is really quite unnecessary; the words are eloquent enough without the aid of gimmicks.

Having said that, I would still give the album a high recommendation simply because it introduces us to several highly talented American Negro poets. It is in other respects well produced; the simple percussion effects by Specs Powell behind several of the poems are highly imaginative and add considerably to the overall effect, particularly in poems like "Debate of Dark Brothers" and "We Wear the Mask." Two of Mendelssohn's "Songs Without Words" played on the harp make a perfect background to "At Candle Lightin' Time" and "To John Keats, Poet at Springtime."

★ ★ ★

THE GOOSE GIRL: With Celia Johnson, Stella Moray, Janet Waters, Susan Hampshire and Company. Music by Cyril Ornadel with lyrics by David Croft.

SNOW WHITE AND ROSE RED: With Barbara Leigh, Hermione Harvey and Company. Music by Cyril Ornadel. Both performances produced by Fiona Bentley for the Children's Record Guild of Australia. Released through the World Record Club. EP45s CG35 and CG3.

Two charming fairy-tales produced with a light touch and no unnecessary melodramatics. "The Goose Girl" will appeal especially to little girls with its story of the lovely Princess whose position is usurped by the wicked servant girl, but in which good triumphs in the end. The Princess marries her Prince and the wicked servant is banished.

Celia Johnson ties all the bits together very nicely and the rest of the cast are equally convincing in the dialogue sections.

"Snow White and Rose Red" has a somewhat more complex story line with several strands to the tale. This is indeed one of the most delightful of the many stories by the Brothers Grimm. It contains all the elements that are likely to appeal to both boys and girls.

This is the tale about two sisters who lived in a forest, of how they befriended a bear (a Prince in disguise), outwitted a thoroughly disagreeable dwarf, recovered a fortune and eventually married a Prince and his brother.

Barbara Leigh and Hermione Harvey have just the right kind of warmth for playing the two sisters and the rest of the company, which is not named, act and sing equally well.

Good recording completes two very satisfactory presentations for the younger children.

NEW Releases!

IN HI-FI STEREO EQUIPMENT BY CLASSIC BASED ON THE PLAYMASTER 118 AMPLIFIER

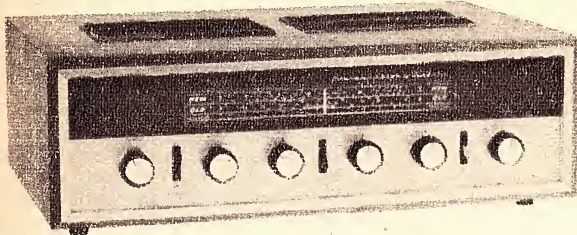

MODEL C200V. BASED ON THE PLAYMASTER 118 WITH TUNER

Dimensions 16½in x 5½in x 11in.

CABINET IN OILED WALNUT OR TEAK WITH METAL TRIM.

\$118.00

FREIGHT EXTRA

This amplifier is based on the Playmaster 118 circuit as featured in "Electronics Australia" to which has been added the following features.

- Inbuilt high gain A.M. tuner with a coverage of 530 to 1,600 K.C.
- Loudness control giving bass boost at low volume.
- Provision for tape, record and play-back, with din connector.
- Calibrated dial available for all States.
- EM84 tuning indicator giving accurate tuning with ease.

POWER OUTPUT: 9 watts per channel R.M.S. FREQUENCY RESPONSE: 20 to 20,000 cycles incorporating Ferguson O.P.412 grain oriented output transformers. VALVES USED: 4-6GW8, 12AX7 or 12AU7, 6AN7, 6N8, EM84 and 2 silicon diodes.

NEW AMPLIFIER AND TUNER BASED ON THE PLAYMASTER 107

107 AMPLIFIER AND TUNER \$85.00

FREIGHT EXTRA

107 AMPLIFIER

● Output 5 watts per channel (10 watts). Ferguson output transformers with a response of 30 to 20,000 cycles.

Valves used: 6AN7, 6N8, 2-6BQ5, and 6CA4 rectifier.

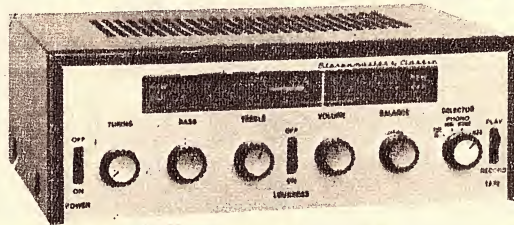

SPECIFICATIONS

- Inbuilt high-gain tuner with a frequency coverage of 530 to 1,600K.C.
- Two-channel tone control stage with separate bass and treble controls.
- Switching facilities for pick-up and stereo or mono tape recorder for record or play-back.
- Loudness control giving bass boost at low volume.
- Chassis plated and mounted in attractive metal case finished in grey with control panel in silver and black with matching knobs and switches.
- Dimensions: 13½in x 5½in x 11in.
- Fully guaranteed.

The above amplifier supplied with the new Garrard 40 Mk II Changer with Sonatone ceramic cartridge and diamond stylus and two Magnavox BWR or Rola 8CMX Hi-Fi speakers.

\$132.00 FREIGHT EXTRA

MULLARD MAGNAVOX MINI SPEAKERS

These units designed by Mullard and Magnavox engineers compare favourably with imported B/S Speakers costing more than twice the amount and are ideal where space is limited. Incorporates the Magnavox 6WR 6-inch Speaker and the new 3TC Mk. II tweeter frequency response, 50 to 18,000 cycles. Power rating max. 8 watts. Available in 7½ or 15-ohm impedance.

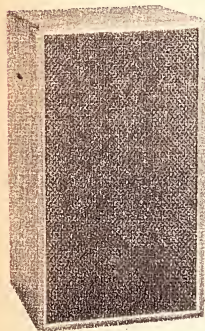

Dimensions: 14in x 8½in x 8½in.

\$27.00

Post and Packing: N.S.W. \$1.50. Interstate, \$2.00.

NEW BOOKSHELF SPEAKER SYSTEMS

PLAYMASTER 4

Incorporates the new 6in Philips Speaker and Magnavox 3TC tweeter. Frequency response 45 to 18,000 cycles. Power rating 10 watts. Dimensions. 14in x 8in x 8in.

Available in 8 ohms only.

\$36.00

Post and Packing: N.S.W. \$1.50. Interstate, \$2.00.

PLAYMASTER SUPER BOOKSHELF

Using two of the new Magnavox 6WR Speakers and one 3TC tweeter. Dimensions: 19½in x 10in x 8in.

Available in 15 ohms or 8 ohms.

\$40.00

Post and Packing: N.S.W. \$2.00. Interstate, \$3.00.

ALL SPEAKER UNITS FINISHED IN OILED WALNUT OR TEAK WITH SILVER TRIM

CLASSIC RADIO

245 PARRAMATTA ROAD, HABERFIELD, N.S.W. PHONE 798-7145

NEW ALL TRANSISTOR STEREO AMPLIFIER ULTIMATE IN DESIGN-LONG DEPENDABILITY

USING ALL SILICON TRANSISTORS

40 WATTS – RMS

SPECIFICATIONS:

POWER OUTPUT: 20 watts per channel
R.M.S. Total output 40 watts R.M.S.

FREQUENCY RESPONSE: From 20 cycles to
20,000 \pm 1db.

HARMONIC DISTORTION: Less than 1% at
rated output.

HUM & NOISE: Aux. 70db, Mag. 50db.

INPUT SENSITIVITY. Mag. 3mv. Aux. and
tuner 150 mv.

SPEAKER IMPEDENCE. 8 ohms.

EQUALIZED: Mag. RIAA.

TONE CONTROLS: Bass 50 c/s \pm 12db. Treble 10kc/s \pm 12db.

LOUDNESS CONTROL: 50 c/s 10db.

SCRATCH FILTER: (High filter) at 10 kc/s 9db.

RUMBLE FILTER: (Low filter) at 50 c/s 5db.

PROVISION FOR TAPE RECORDER. RECORD OR PLAY-BACK WITH DIN PLUG CONNECTION.

PROVISION FOR HEADPHONES WITH HEADPHONE/SPEAKER SWITCH ON FRONT PANEL.

THE CIRCUIT INCORPORATES REGULATED POWER SUPPLY WITH TRANSISTOR SWITCHING PROTECTION FOR OUTPUT TRANSISTORS. 26 SILICON TRANSISTORS PLUS 5 DIODES ARE USED.

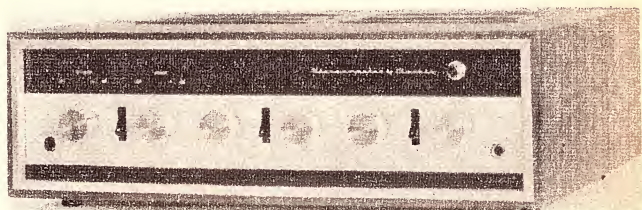

MODEL C300/20

\$119.00 FREIGHT EXTRA

DIMENSIONS: 16½in x 5½in x 11 in deep
MOUNTED IN OILED WALNUT OR TEAK
VENEERED CABINET WITH METAL
TRIM AND MATCHING KNOBS.

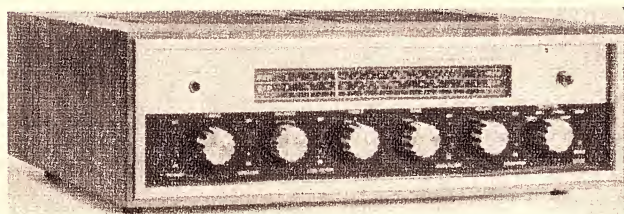

MODEL C300/20/T

**ABOVE AMPLIFIER
WITH INBUILT A.M.
TUNER**

\$144.00 FREIGHT
EXTRA

12 WATT RMS PER CHANNEL VERSION OF ABOVE AMPLIFIERS AS PREVIOUSLY
ADVERTISED ALSO AVAILABLE.

CLASSIC RADIO

245 PARRAMATTA ROAD, HABERFIELD, N.S.W. PHONE 798-7145

SONY® FROM MELBOURNE'S

LEADING TAPE RECORDER SPECIALIST



SONY . . . TC 560. New E.S.P. auto reverse stereo tape recorder

- The Sony E.S.P. (Electronic Sensory Perceptor) completely automatic tape reversing system with newly developed three heads and two capstans.
- Functions as a "stereo music centre."
- Lid-integrated high-compliance roll-edge speakers.
- Servo-controlled tape transport.
- AC/DC 2-way operation either in vertical or horizontal position.
- Single-lever control for easy operation.
- Retractable pinch roller for simple tape threading.
- Extremely compact in a beautiful leatherette covered wooden cabinet.
- Noise suppressor.
- 4 track.
- 3 speeds.
- 20-21,000 HZ at $7\frac{1}{2}$ IPS.
- Wow & Flutter 0.15 at $7\frac{1}{2}$ IPS.
- Power output 10 watts RMS (20 watts music power).
- Separate bass and treble controls.
- Magnetic pickup input.

Scoop purchase of this latest 1969 superb Sony, model TC 560, brings the price down to nearly half.

Check our amazingly low prices on the entire range of Sony.

DOUGLAS TRADING P/L

Inc. City Hi Fi — Tape Recorders (Vic.) — BJD Electronics
191 BOURKE STREET, MELBOURNE 3000—PHONE 63-9321

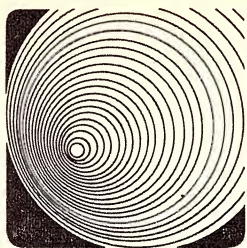

VARIETY FARE

By HARRY TYRER, FORBES CAMERON, NEVILLE WILLIAMS

Devotional recordings

FOR THE QUIET HOUR. Soothing moods from the violin of Raymond Mosley. Stereo, Word WST-8427-LP. (From Sacred Productions Aust., 181 Clarence St., Sydney, and in other capitals).

Interest: Melodic violin.
Performance: Capable musician.
Quality: Excellent.
Stereo: Not important here.

English violinist Raymond Mosley came to the notice of the Word Record Company when they hired the services of his orchestral group, the Westminster Sinfonia. Teamed here with another well known English musician, organist Geoffrey Tristram, Raymond Mosley presents 35 minutes of music which is aptly described by the title. Apart from one or two brief stanzas, the big pipe organ remains mostly in the background with the violin at centre stage, close-up on mic.

The track titles: Once To Every Man And Nation — Be Thou My Vision — Meditation From "Thais" — Largo (Vivaldi) — Nobody Knows The Trouble I've Seen — Air On A G String — My Jesus As Thou Wilt — At The Name Of Jesus — Gweedore Brae — Praise My Soul The King Of Heaven (These last two out of order on the label).

In the field of devotional or near devotional music, dominated by vocalists and vocal groups, a solo violin album is automatically of some note and this performance by two experienced professional musicians is especially so. (W.N.W.)

★ ★ ★

SONGS OF A SINNER. Brother William, with the Claire Poole Singers. Arranged and directed by Geoff Harvey, produced by Eric Dunn. Stereo, World Record Club W.R.C. S/4472.

Interest: See comments.
Performance: Simple, sincere.
Quality: Good.
Stereo: Normal.

Born in England in 1926, William S.S.F. (his full name is not given) worked in industry before he entered the Anglican Society of St. Francis in 1952. Before coming to Australia in 1964, he spent 10 years as a friar, ministering to drop-out boys in Dorset. In this context he wrote songs of devotion and occasional protest, borrowing touches of western, folk, "Liverpool," ballad, bossa nova, jazz and the rest, in an effort to involve the boys in a modern expression of age-old truth.

In Australia, he has found time to

continue a similar activity and this record is the result. In the notes, Brother William warns that these are simple songs, more suitable for individual listening than for public performance in church meetings. To be sure, his vocal powers are limited, but the voice somehow fits the role of a Franciscan friar.

I found the record interesting and listenable and much of the credit for this must go to well-known Sydney TV musician, Geoff Harvey. With a small orchestra and the Claire Poole Singers (the latter used more sparingly than the credit would suggest) Geoff Harvey establishes the beat and the mood of each individual number, in a way which is gently and subtly effective and which seems perfectly to complement the vocal.

There are twelve numbers on the two sides, all composed by Brother William and playing for about 40 minutes. To list the unfamiliar titles would be pointless, however. An interesting album by an interesting man. (W.N.W.)

★ ★ ★

DEVOTION. The Luton Girls' Choir, conducted by Arthur Davies. Mono, Columbia OEX-9444.

Interest: Well-known group.
Performance: In itself, good.
Quality: Well below standard.

In 1932 Arthur Davies founded a junior choir from scholars of a Luton (Bedfordshire, England) Baptist Sunday School. Following success at Eis-

teddfods, the choir was restricted to girls and opened to all those living within 5 miles of the Luton town hall. From the photograph on the cover, one would judge the present choir to be about 50-strong, composed mainly of teenagers.

Their program here is in keeping with the variety of religious faiths and attitudes represented in such a group: The Lord Is My Shepherd — The Day Thou Gavest — He Shall Feed His Flock — Panis Angelicus — Sun Of My Soul — The Lord's Prayer — Abide With Me — Great Is he Lord — Dear Lord, Father Of Mankind — There But For The Grace Of God Go I — Praise My Soul — Song Of A Thankful Heart.

Unfortunately, what could be a pleasant and well planned program is heavily compromised by the original taping and those with a critical ear will be able to chalk up examples of just about every pitfall in the game. There is tape hiss, wow, flutter and a curious swishing effect that is probably caused by head-tape contact. There are strange noises in the background, from sibilants of speech to birds in the belfry. For good measure, certain organ notes excite some resonance and turn into dominating whistles. Add to all that some rather obvious monitoring and traces of distortion and you have a pretty dismal report.

One I couldn't recommend. (W.N.W.)

★ ★ ★

HYMNS WE LOVE. Lawrence Welk and his Orchestra, with Soloists and Choir. Stereo, Rainwood (Festival) SFL-933,158. Also in mono.

Interest: Well-known hymns.
Performance: Professional.
Quality: Good.
Stereo: Normal.

Lawrence Welk, the "champagne music" man of the American A.B.C. television network, takes time off from his normal soft lights and sweet music to produce this album of traditional hymns. Influenced probably by television techniques he adopts (for records) the unusual formula of using his band only as a backdrop for a number of featured vocalists. The result is a pleasantly varied record, though one which will have its strong-

ACOS

REPLACEMENT LONG LIFE CARTRIDGES

Acos 90 Series — a family of pick-up cartridges covering all the main types needed today, each fitted with Diamond Stylus at no extra cost.

GP91-1 MONO CRYSTAL Stereo Compatible ..	\$5.95
GP91-2 HIGH OUTPUT MONO CRYSTAL Stereo Compatible ..	\$5.95
GP92 MONO CERAMIC Stereo Compatible ..	\$6.55
GP93 STEREO CRYSTAL ..	\$7.55
GP94-1 STEREO CERAMIC ..	\$7.95
GP94-5 STEREO CERAMIC FOR TRANSISTOR AMPLIFIERS ..	\$8.95

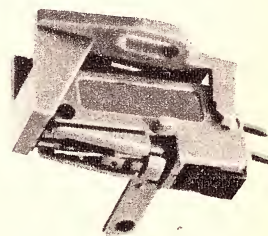

fitted with
DIAMOND
Stylus at no extra cost.

TECHNICAL DATA SHEETS SENT FREE ON REQUEST

Sole Australian Agents:

AMPLION (A'SIA) PTY. LTD.

29 Majors Bay Rd., Concord,
Sydney, N.S.W. Phone 731227

Now, The Most Complete Model, X-360!

- **Magnetic Brake:** Developed to bring the tape to an immediate stop in a split second, without making it saggy or too taut.
- **Automatic Volume Control (Comput-O-matic):** Developed to automatically adjust the sound level for perfect high fidelity recording. The operator is relieved of the burden to manipulate the volume control watching the VU meters, as the occasion warrants.
- **Automatic Dust Minder:** Developed to indicate the dust deposits on the heads. Such deposits account for 90% of the failures in most tape recorders. Clean the heads as dictated by the indication of the lamp.
- **Three Speed Motor For Capstan Drive:** Developed 3 tape speeds (7- $\frac{1}{2}$, 3- $\frac{3}{4}$ and 1- $\frac{7}{8}$ ips), which can be determined by the electrical selection of the motor speed. The 15 ips tape speed is made possible by the capstan and pinch wheel unit.
- **Cross Field Head:** Developed to permit low tape speeds with amazing frequency response and perfect high fidelity recording.
- **4 track stereo/monaural recording and playback**
- **50 watt solid state amplifier**
- **Automatic continuous reverse (Reverse-O-matic)**

X-360D tape deck is also available.

There are others too, all making for perfection in sounds for your maximum enjoyment.

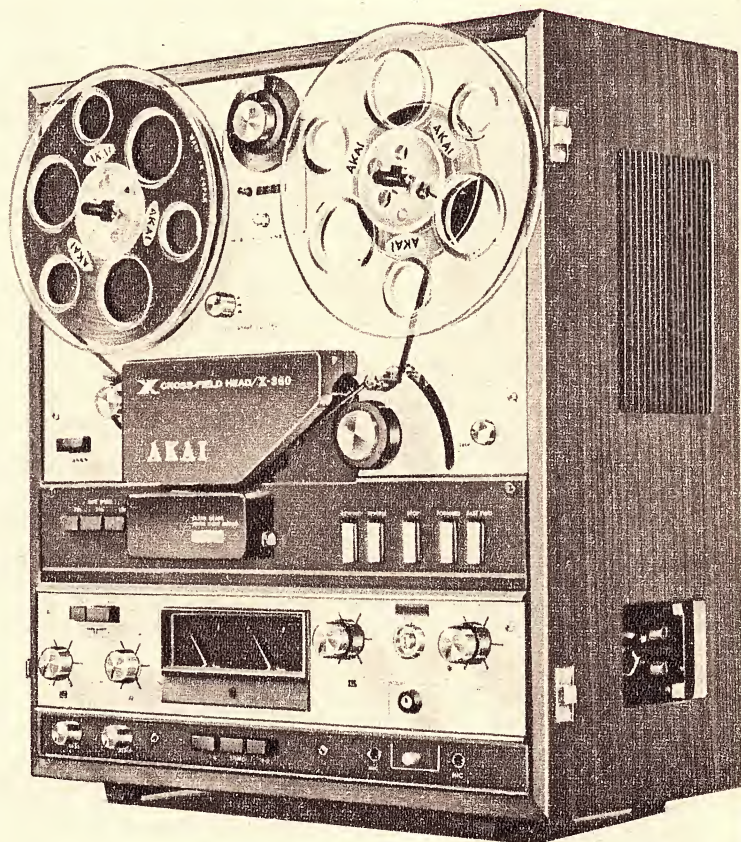

AKAI
AKAI ELECTRIC CO., LTD.
HIGASHIKOJIYACHO OHTA-KU TOKYO JAPAN

N.S.W.: Magnecord Australasia Pty., Ltd. 210 Clarence St., Sydney CANBERRA AND A.C.T.: Homecrafts, Petrie St., Civic Centre
VICTORIA: Magnecord Sales & Service, 146 Burwood RD, Hawthorn 3122 QUEENSLAND: Magnecord Sales & Service 399 Montague
Bd., West End; Brisbane: S.A.: Magnecord Sales & Service, 8 Arthur St., Unley W.A.: Magnecord Sales & Service 579 Murray
St., Perth

est appeal to those who seemingly never tire of particular hymns: The Old Rugged Cross — Rock Of Ages — How Great Thou Art — Faith Of Our Fathers — Sweet Hour Of Prayer — Softly And Tenderly — In The Garden — What A Friend We Have In Jesus — I Love To Tell The Story — Abide With Me — Holy, Holy, Holy — Nearer My God To Thee.

Rather like a TV presentation—without the video! (W.N.W.)

* * *

TAKE-OVER BID. Presented by the Salvation Army Youth Department. Lyrics, Capt. John Gowans; music by Capt. John Larsson. An original cast album. Stereo, Festival SFL-933,202. Also in mono.

Interest: Salvation Army musical. Performance: Non-professional.

Quality: Good. Stereo: Normal.

"Take-over Bid" received news coverage when it was presented, some time ago, in Sydney's super-annuated Tivoli Theatre by Salvationists, for Salvationists. Written by two S.A. captains, its theme is the alleged dissatisfaction of youth with the old

army methods and their determination to run things their way. I didn't see the performance but gather that it all ended happily enough, musical style, with each group seeing the other's point of view and expressing their willingness to get on with the job.

"Take-over Bid" carries the stamp of a modern musical and my impression is that the two captains have done an impressive job with lyrics, music and script. Unfortunately, however, the contrast is just too great between the amateur cast and their professional counterparts, against which they must be judged. The spoken lines are forced and unnatural, the soloists are not equal to the demands of close recording and even the brass is more exuberant than precise. As a memento of an occasion, the recording will command its own special audience but I doubt that it will have much appeal outside Salvation Army circles. At least, not until it has the benefit of production by a more professional company.

Taped by Hal Saunders in the Salvation Army Temple, in Dulwich Hill, Sydney, the recording itself is good. (W.N.W.)

.....

Instrumental, Vocal and Humour . . .

SUITE ESPANOLA. (Albeniz) New Philharmonia Orchestra conducted by Rafael Fruhbeck de Burgos. Decca (E.M.I.) Stereo SXL 6355. Available in Mono.

Interest: Spanish light music. Performance: Ravishing. Quality: Outstanding. Stereo: Wide and smooth.

Albeniz wrote only piano music, but his music has a peculiar quality in that it always seems to gain something from a competent orchestration—as witness his "Iberia" suite and such items as his "Tango in D." This suite is no exception, and I suggest that anybody who has a liking for the original piano work will enjoy this arrangement at least as much, if not more. The arrangements here are by the conductor himself, one of the leading interpreters of Spanish music today. Readers of these columns may remember a review of Spanish music by the same conductor/orchestra combination last year, in which I wrote in very warm terms.

In this arrangement, the conductor has omitted the piece entitled "Cuba" and substituted the very beautiful "Cordoba" from the same composer's "Cantos de Espana." Personally, I entirely agree with this move, since not only do I find the "Cuba" movement the least attractive of the suite, but it is also an outsider, in that all the other pieces represent districts of Spain itself.

In consequence of the aforementioned disc of last year, I expected great things from this one, and I was not in the least disappointed. In fact, I can say categorically that the music is sheer delight from start to finish for anybody with a liking for Spanish style music. I personally now regard the New Philharmonia Orchestra as one of the world's best, and their performance here I can only describe as ravishing. The recording by Decca is of the highest possible quality. (H.A.T.)

INVITATION TO THE WALTZ. The Bournemouth Symphony Orchestra conducted by Walter Susskind. Stereo, EMI Studio 2, SCXO-7863.

Interest: Traditional favourite waltzes. Performance: Very good. Quality: Excellent. Stereo: Nicely spread.

This recording has all the quality, the sparkle and the zest to warrant featuring it as loudly as you like but, in the mood that it caught me, relaxing one evening in front of the fire, I was quite happy to let it play along at modest level for the full 45 minutes. Heaven alone knows how many times these waltzes have been played and re-played, but they're still pleasant listening when you're in the mood: Voices Of Spring (Johann Strauss) — Invitation To The Dance (Weber) — The Skaters (Waldteufel) — Music Of The Spheres (Josef Strauss) — Waltz from "Eugene Onegin" (Tchaikovsky) — Waltz From "The Masquerade" (Khachaturian) — Waltz From "The Merry Widow" (Lehar).

Recorded in the Winter Gardens, Bournemouth, the sound is clean and nicely spread. A good record if you have a spot for it. (W.N.W.)

* * *

SEMPRINI PLAYS GOLDEN MELODIES OF TCHAIKOWSKY, with the New Abbey Light Symphony Orchestra conducted by Vilem Tausky. Studio 2 Stereo (E.M.I.) TWO 198.

Interest: Need you ask? Performance: Pleasant enough. Quality: Typically excellent. Stereo: Widely spread.

Semprini is a specialist in the type of light confection offered here, having been concerned with it as long as I can remember. For the past eleven years he has had his own program on B.B.C. radio under the title "Semprini Serenade" and I am sure it is because

of the popularity of this program that E.M.I. have issued three discs featuring Semprini on their Studio 2 label, each within a few months of the other. Semprini knows the type of music that listeners to his program appreciate, but of course this does not apply to everybody.

All I can say is, if you like this kind of light fare, the selection will have automatic appeal, being some of Tchaikowsky's most popular melodies: Waltz from "Swan Lake" — Troika — Chants sans Paroles — Waltz from "Serenade for Strings in C for String Orchestra" — Nocturne — Andante

M.B.H. AUDIO SALES

33 MARLBOROUGH ROAD,
HOMEBUSH, N.S.W. 2140.

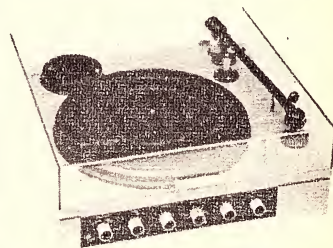

The new "Saraband" player gives you genuine fidelity with compactness, simplicity and reliability.

Completely Australian made and backed by service.

If you want to hear your records at their very best you need M.B.H. quality.

**SEND TODAY FOR YOUR
'SARABAND' BOOKLET**

TECHNICIAN Tape Recorders

We have a position of interest and variety for a senior technician in our service department. His duties will be to service the full range of Akai recorders and associated Hi-Fi audio equipment.

This is a permanent position with a rapidly growing organisation.

Telephone: Mr Mackison,
61-9881.

AKAI AUSTRALIA PTY. LTD.
276 CASTLEREAGH STREET,
SYDNEY.

NOW...THE NEW SILCRON

only \$44.50



a precision built, Australian turntable with belt drive

Superiority of the belt drive principle in turntable design is now firmly established; world wide trends are to *belt driven* turntables.

With a wow and flutter figure of less than 0.04% the new SILCRON two speed turntable has been designed to completely satisfy the requirements of Australian music lovers and audio enthusiasts. Every desirable feature has been incorporated in the advanced design of this *virtually silent* precision-engineered unit.

Speeds are 33 1/3 and 45 r.p.m.; absolute speed accuracy is assured by use of a completely sealed 12 pole synchronous motor. A unique speed change mechanism (patents pending) permits alteration of speeds in less than one second.

Belt driven around its perimeter, the actual turntable platter is cast aluminium, machined to fine tolerances

and dynamically balanced. It's a full 12" in diameter so that records are completely supported. To reduce dust attraction by static charges an anti-static mat is supplied instead of an ordinary rubber mat *without extra cost*.

When operating there are only three moving parts — the rotor, the drive belt and the platter; reliability is assured. Mounting the unit is simplicity itself — a template is provided for the cut-out and depth below the motor board can be as little as 3/4" — maximum height above is 2".

See the new SILCRON turntable at selected audio stores everywhere. Enquiries for supplies or for the name of your nearest SILCRON stockist should be directed to the Simon Gray office or representative in your state.

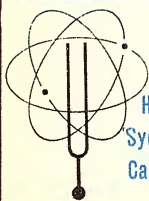

Australian National Distributors:

Simon Gray Pty. Ltd.

Head Office: 28 Elizabeth St., Melbourne, Vic. Tel. 63 8101*

Sydney Office: 22 Ridge St., North Sydney, N.S.W. Tel. 929 6816

Canberra Office: 31-33 London Circuit, Canberra City, A.C.T.
Tel. 49 6050

INTERSTATE REPRESENTATIVES:

N.T.: Pfitzner's Music House, Smith Street, Darwin. Tel. 3801

Q'land: Sydney G. Hughes, 154-158 Arthur St., New Farm, Brisbane. Tel. 58 1422

S.A.: Eilco Sales Pty. Ltd., 7-9 Osmond Terrace, Norwood, S.A. Tel. 63 4844

Tas.: K. W. McCulloch Pty. Ltd., 57 George Street, Launceston. Tel. 2 5322

W.A.: Athol M. Hill, 613-615 Wellington Street, Perth. Tel. 21 7861

Cantabile from Quartet No. 1, Op. 11 — Waltz from "Sleeping Beauty" — Trepak from "The Nutcracker"—Barcarolle — Chanson Triste, Op. 40 — Concerto No. 2 in G minor, second movement — None But the Lonely Heart.

The New Abbey Light Symphony Orchestra is new to me, but I was very impressed with the standard of their playing, in particular the string tone. The sound quality is of high standard, as is common with all the other discs on this label I have heard. (H.A.T.).

★ ★ ★

LEISE KLINGT DIE BALALAIKA (Softly plays the Balalaika). The Nowgorod National Ensemble. Decca (E.M.I.) Stereo SKLA 7469.

Interest: Russian folk music.
Performance: Very competent.
Quality: High standard.
Stereo: Well spread.

Although issued under the Decca label, this disc appears to have been originally recorded and marketed in Germany, since all the sleeve information is in German. Despite the title, the balalaika does not play a major role in the presentation, a single instrument of this type being used to give atmosphere. In general, this is a fairly normal light orchestra. The subtitle says the songs are played and sung, but in fact the male choir, which contributes only minimally in a few tracks, hums the tunes. The orchestral playing is of a high standard throughout.

The material consists of Russian folk tunes, beginning with a set of variations on the well-known "Black Eyes." The other tunes may not be as well known, but they are the typical, slightly melancholy, minor-dominated melodies of the Slav races. The titles are (my translations): Black Eyes — Beloved Amuschka — Sonja, Sonja, Dance with Me — Petruschka — Old Moscow — Come Back, Maruschka — Softly Sounds the Balalaika — Ninotschka — Old Russia—The Surging Boat—Moonshine over the Volga — Cossacks. The disc is pleasing enough of its type, and if you have a particular liking for this type of music it is worth hearing. However, to my mind the disc by the London Balalaika Ensemble reviewed last month has much more appeal. (H.A.T.).

★ ★ ★

THE FIREBIRD. Russian orchestral favourites, played by the London Symphony Orchestra, conducted by Leopold Stokowski. Decca (E.M.I.) Stereo PFS 4139.

Interest: See title.
Performance: Brilliant.
Quality: Excellent.
Stereo: Good spread.

Stravinsky's first great success has always remained a firm favourite among concert goers in its suite form as presented here. Listening to it now, it is hard to realise that at one time this music was considered avante garde. Certainly there are some passages of sheer orchestral savagery, but such dissonances as there are never disturbing in their context. And if anybody is bold enough to suggest that Stravinsky is not a melodist, then he has never heard the "Dance of the Princess" and the "Lullaby" from this suite.

In this recording, the combination of Stokowski and the London Sym-

phony Orchestra is so successful that I doubt whether even the most severe critic is likely to carp. Personally, I enjoyed every second of this fine performance. The more tender sections are lovingly phrased, and the fireworks really fly in the "Dance Infernal of King Kastchei." If you still need a "Firebird" recording for your collection, look at this one.

In addition to the major work, there is an absolutely hair-raising performance of Mussorgsky's "Night on Bare Mountain" and a lush rendering of Tchaikowsky's "Marche Slav." Stokowski recounts how he examined Mussorgsky's original sketches and as a result decided to make certain changes and additions to the Rimsky-Korsakoff version which is usually played. I can vouch for the effectiveness of these modifications, but don't play this just before going to bed if you are subject to nightmares. It's grim. The effect is heightened by Decca's brilliantly realistic recording in their Phase 4 system. Highly recommended (H.A.T.).

★ ★ ★

COOL WATER and other songs of the West. The Melachrino Strings. Camden (RCA) Stereo CAS-2204.

Interest: Western evergreens.
Performance: Good standard.
Quality: Very good.
Stereo: Normal

The Melachrino Strings are as pleasing to hear as any other group of the "singing strings" type that I know, and I agree with the message splashed in large black type across the back of the sleeve — "A wonderful collection of your favourite Western songs." The

particular selection here does include most of my favourite songs of this type, as it happens, and I am sure I am not alone in this: Cool Water — Riders in the Sky — Tumbling Tumbleweeds — Big D — Wagon Wheels — Red River Valley — Home on the Range — Empty Saddles — San Francisco — The Last Round Up. However, I would point out that these are songs, and there is no vocal provided in any of them. I have a personal preference for tunes of this type to be sung by a good male voice, otherwise for me the effect is rather like crackers without cheese. The flavour is missing.

Apart from this quibble, I can find nothing to complain about. The orchestra plays well, the arrangements are good, with the right type of sound effects and the sound is of excellent quality. (H.A.T.)

★ ★ ★

LEGEND OF THE GLASS MOUNTAIN. Ron Goodwin and his Orchestra, Studio 2 Stereo (E.M.I.) SCXO 7886.

Interest: Film classics.
Performance: Rather robust, but generally fine.
Quality: First class.
Stereo: Good spread.

Ron Goodwin holds a pre-eminent place in British cinema music, for not only has he composed the music for many recent British films, including such epics as "Those Magnificent Men in Their Flying Machines" and "633 Squadron" but I believe he has had a long experience on the performing side of film soundtrack music. He is



STOP PRESS... SEE OUR SPECTACULAR DISPLAY OF EXCLUSIVE PRODUCTS & SERVICES at the AUDIO & VISUAL FAIR, EXHIBITION BLD. MELB. JULY 18-25

THE FANTASTIC NEW

TRANSISTORISED MASTER DISCO CONSOLE

THE ULTIMATE IN SOUND BROADCAST.

FOR PRESTIGE SOUND SEE CLAYBRIDGE SOUND

Secure your FREE, COLOURED CATALOGUE of our products & services.

Claybridge SOUND 163 CLAYTON RD. CLAYTON VIC. 3168 OR RING 544 6171
(CNR. DANDENONG RD.) (ALL HOURS)



NEW from QUAD

SOLID STATE

303 POWER AMPLIFIER AND 33 CONTROL UNIT

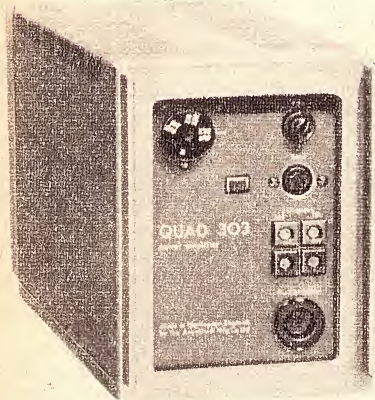

QUAD has introduced two new models, the SOLID STATE Quad 303 and Quad 33. What's new in these models? . . . 30 watts power rating (R.M.S.) per channel with frequency response of—1 db, 20 to 35,000 Hz. Fully silicon transistorised.

Entirely new circuit design provides outstanding high quality reproduction and output circuit protector which cannot be accidentally upset by misuse, overdriving, shorting or disconnecting speakers. Distortion is less than 0.03% at any level up to 45 watts per channel into an 8 ohm load at 700 Hz and is 10 times lower than in the best of valve amplifiers. With the professional look and the professional touch, the price of these two new Quad units is \$486.00.

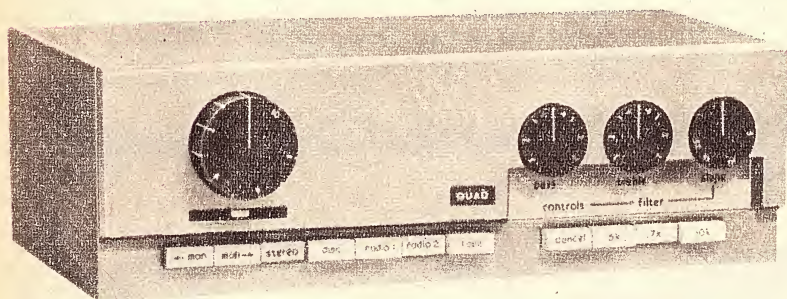

QUAD ELECTROSTATIC LOUSPEAKER

Using closely coupled moving elements some 200 times lighter than the diaphragms of moving coil loudspeakers, and being entirely free of cabinet resonances and colouration, this loudspeaker overcomes the usual major problems of loudspeaker design and provides remarkably natural reproduction of sound. The real test is to listen to the music it reproduces—a comparative demonstration is strongly recommended.

QUAD for the closest approach to the original sound.

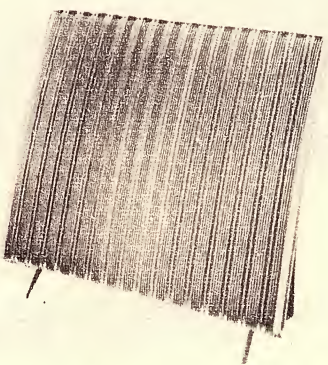

Please send me a copy of the new QUAD leaflet.

NAME

ADDRESS

BRITISH MERCHANDISING PTY. LTD.
49-51 York St., Sydney. Telephone 29-1571.
(sole Australian agent.)

therefore on very familiar ground with the material included here, consisting entirely of film music, and mainly of the quasi-classical interludes composed especially from films with a musical theme: Legend of the Glass Mountain — The Dream of Olwen — Intermezzo from "Escape to Happiness" — Theme from "The Way to the Stars" — Warsaw Concerto — Spitfire Prelude and Fugue — Theme from "Limelight" — Tara Theme—18th Variation from Rhapsody on a Theme of Paganini (Rachmaninoff) — Theme from "Moulin Rouge" — Cornish Rhapsody. Anybody interested in film music will certainly know all these pieces, so it is unnecessary to enlarge on them.

The orchestra has a fine full-bodied sound, but as in previous discs from this combination I feel a certain lack of sensitivity, a too robust treatment of passages which require a rather more delicate touch. Apart from such slight lapses, there is nothing else to fault, and for the most part the performance is entirely satisfactory. It is noteworthy that for the second time within a few weeks a complete performance of the "Warsaw Concerto" is provided, the other being in the Leonard Pennario disc reviewed below. (H.A.T.)

★ ★ ★

CLASSICAL GAS, Hugo Winterhalter and his Orchestra, with Eddie Heywood at the Piano. C.B.S. (Australian Record Company) Stereo SBP-233625.

Interest: Current hits.
Performance: Smooth and relaxed.
Quality: Excellent.
Stereo: Normal.

Hugo Winterhalter uses a large orchestra with a 20-member string section so that one is not surprised to find the string tone dominating these tracks. This is a first-class band of musicians, playing excellent arrangements of popular tunes, and the performance is as smooth and relaxed as one could wish. Eddie Heywood's piano contributions also show a high standard of musicianship. The selection comprises: Classical Gas — For Love of Ivy — MacArthur Park — Love Theme from "Romeo and Juliet" film — Theme from "Elvira Madigan" — Glad for You, Sad for Me — Land of Dreams — Rosemary's Baby — Love is Blue — Winds in Autumn — Harlem Blues — Theme for Margaret. An ideal disc for an hour's quiet relaxation. (H.A.T.)

★ ★ ★

THE BEST OF LEONARD PENNARIO, Leonard Pennario, piano, with various orchestras and conductors. Capitol (E.M.I.) Stereo SP 8675.

Interest: Light classics.
Performance: Typically "schmaltzy."
Quality: Good.
Stereo: Normal.

Leonard Pennario may not be everybody's idea of a brilliant pianist, but there is no denying the sheer charm in his playing, especially in the type of romantic fare presented here: Hungarian Rhapsody No. 2 (Liszt — Adagio from "Moonlight Sonata" (Beethoven) — Rustle of Spring (Sinding) — Warsaw Concerto (Addinsell) — First Movement from Piano Concerto No. 2 (Rachmaninoff) — Rhapsody in Blue (Gershwin). To the listener of light classics to which this disc is directed,

this selection will have automatic appeal. It is good to have the full performance of Addinsell's "Warsaw Concerto" for a change, since this piece usually suffers the fate of being truncated into "Theme from." The "Rhapsody in Blue" is also presented complete. If you like the program and the style of the artist, you need have no worries about either the performances or the sound quality. (H.A.T.)

★ ★ ★
THE PRIME OF MISS JEAN BRODIE. The music from the sound track of the film. Words and music by Rod McKuen. 20th Century-Fox Records (Festival) Stereo STL-933,243. Available in Mono.

Interest: Film music.
 Performance: Very pleasing.
 Quality: Excellent.
 Stereo: Good spread.

Folk singer Rod McKuen has written a most attractive score for this British made film featuring an unconventional schoolmarm in the Edinburgh of the 1930s. His songs have always had a lyrical quality, but he has surpassed himself in the attractive melodies composed for the film. The main theme turns up in various guises, under the title "Edinburgh Morning" first, then as "Jean," with and without vocals, and as "End Title." However, it is such an appealing melody that it can stand this kind of repetition. Other titles are: Jenny's Theme — Flanders Field—Winter Like My Life is Passing — Bend Down and Touch Me—The Ivy That Clings to the Wall — The Other Tango — Somebody's Crying — Lloyd's Room—Outside with the Brodie Set — The Favourite Sweet of Little Princess Margaret Rose—A Red, Red Rose—Goodbye Jennie.

This music has such wide appeal that when the disc was played in my listening studio, there was the unusual spectacle of "square oldies" and "swinging teens" sitting quietly together listening right through both sides with only approving comments — a rare event in my household. The sound quality is excellent except for slight distortion towards the ends of both sides, where the grooves run very close to the label. (H.A.T.)

★ ★ ★
ORIGINAL "GUITAR BOOGY." Arthur "Guitar Boogy" Smith. Calendar (Festival) Stereo SR66-9,579.

Lively performance with swinging guitar and well played orchestral backing. A good party record. The 12 tracks include: Guitar Boogy — Panhandle Rag — Three-way Boogie — Guitar Polka — Third Man Theme — I'm Confessin'. Good sound and stereo, and good value at \$2.95. (H.A.T.)

★ ★ ★
ENTREMONT PLAYS THE CHOPIN WALTZES. Philippe Entremont, piano. C.B.S. (Australian Record Company) Stereo SBR 233302.

Interest: As per title.
 Performance: Brilliant style.
 Quality: Very good.
 Stereo: Not significant.

The playing of Entremont seems to me to be more noteworthy for its brilliance and dash than for its lyrical qualities. Thus, he plays brilliantly through the faster passages of these waltzes, but I personally like the slower passages to sound just a little more

lovingly phrased, with just light touches of rubato. Entremont seems to be a trifle impatient to get through the slower parts, to plunge again into the sections where he can display the full powers of his finger technique again.

There is certainly plenty to admire in this performance. The touches of individuality make one respect Entremont's musicianship—for example, he manages to suggest an internal melody in the downward runs of the C sharp minor waltz—but it is not the performance of the Chopin waltzes I would choose for my permanent collection. However, I do not doubt that many people would prefer this approach to Chopin rather than the more schmaltzy performances which appeal to me. The best I can suggest is, if you are looking for a disc of the Chopin waltzes, try to get your dealer to play a few tracks for you, if you think Entremont's style is the one which would please you. I suggest you also try to hear the Rubenstein version on an RCA disc at the same time, for a comparison. (H.A.T.)

★ ★ ★
EVOLUTION . . .! Gene Bertoncini, guitar with orchestra. Festival Stereo SFL-933,186. Available in Mono.

Interest: Current hits.
 Performance: In total—excellent.
 Quality: Good standard.
 Stereo: Well spread.

I can't claim to be well acquainted with the previous work of Gene Bertoncini, and despite the effusive sleeve note, I was not more than moderately impressed by his playing

here. However, the work of the orchestra and arranger are outstanding, and for their contribution alone the disc is well worth having. Perhaps this is not surprising when one sees the personnel involved: Bucky Piazzarelli and Ralph Casale on rhythm guitar; Al Casamenti, electric guitar; Bobby Rosengarden, Jack Jennings and Phil Kraus, percussion; Dick Hyman and Paul Griffin, organ — and others of equal standing. Perhaps this kind of support made Bertoncini unduly modest, since he sounds rather too reticent for a lead guitarist in some tracks. However, the overall result is excellent—a most entertaining program of currently popular tunes.

The selection consists of: Elenore—Gla's Theme — Little Green Apples — You Are a Story—The Heather on the Hill — Chuva — One, Two, Three — I Say a Little Prayer—Mrs Robinson—Soon It's Gonna Rain—Here, There and Everywhere—Hey Jude. The disc was originally a Stereo Dimension recording, a label I have not previously encountered. The sound and stereo are both of excellent standard. (H.A.T.)

★ ★ ★
THE ART OF MANITAS DE PLATA. World Record Club Stereo, S/4522.

Interest: Flamenco.
 Performance: Brilliant but superficial.
 Quality: Good.
 Stereo: Normal.

The nimble fingers of the popular flamenco guitarist Manitas de Plata are used to very good effect in his recital, delivering traditional flamenco styles in

GET WITH THE BIG NAME GROUPS



H
I
B



STOP PRESS... SEE OUR SPECTACULAR DISPLAY OF EXCLUSIVE PRODUCTS & SERVICES at the AUDIO & VISUAL FAIR, EXHIBITION BLD. MELB. JULY 18-25

THE GEAR WITH GUTS!
CLAYBRIDGE GEAR

FOR PRESTIGE SOUND SEE CLAYBRIDGE SOUND

Secure your FREE, COLOURED CATALOGUE of our products & services.



163 CLAYTON RD. CLAYTON VIC. 3168 OR RING 544 6171
(CNR. DANDENONG RD.) (ALL HOURS)

LEADER TEST INSTRUMENTS

SINE-WAVE / SQUARE WAVE AND COMPLEX

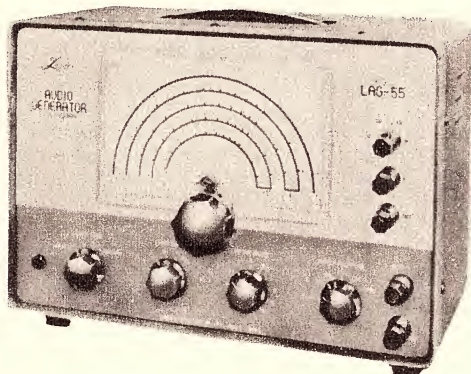

LAG - 55

Budget priced unit indispensable for any serious audio measurements.

Specifications:

Frequency Range 20-200,000Hz in four 10 : 1 bands
 Calibration Accuracy Within $\pm 2\% + 2\text{Hz}$
 Sine Wave Output 20-200,000Hz; level constant within $\pm 0.5\text{dB}$ below 100kHz; Output 5 V rms below 100kHz
 Square Wave Output 20-20,000Hz; Output 10 Vp-p
 Complex Wave Output Above 5,000Hz combined with line frequency
 Amplitude ratio 4 : 1 (low to high); Output 10Vp-p

AUDIO SIGNAL GENERATOR WITH METERED OUTPUT AND FREQUENCY METER

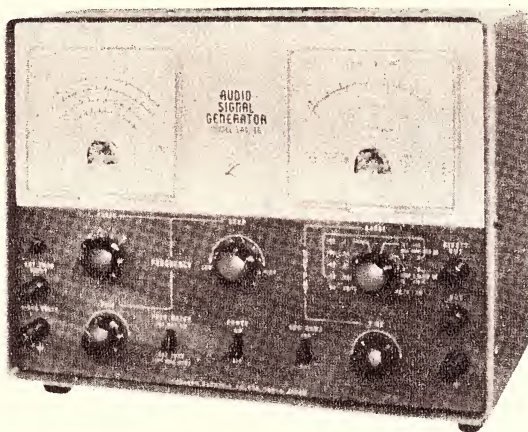

LAG - 66

Top quality Leader Unit.

Specifications:

Generator		Frequency Meter	
Frequency Range	11 to 110,000Hz in 4 bands 600 Ohms: 0-1V in 6 ranges 10k Ohms: 0-10V in 2 ranges	Range	10 to 110,000Hz in 4 ranges
Output Voltage		Input Impedance	200,000 Ohms, approx.
Distortion	Less than 0.3%, 20 to 20,000Hz	Accuracy	$\pm 1.5\%$, full scale: 10 to 11,000Hz

FROM ALL GOOD TRADE HOUSES

WHOLESALE ENQUIRIES ONLY TO
 SOLE AUSTRALIAN REPRESENTATIVES:
 ASTRONICS AUSTRALASIA PTY. LTD.,
 ALL STATES.

the quicksilver fashion for which he is noted. Those fairly new to flamenco are sure to be greatly impressed by this performance, as I have already noted from my own circle of acquaintances. However, more experienced flamenco enthusiasts may find it rather on the superficial side, since the brand of flamenco presented is of the kind designed to please tourists and television audiences.

The selection comprises: Soleares—El No-No — Por Alegrias — Danse de Manitas — Una Tarentes — Guitarra de Camargue — Rumbas Gitanas — Bulerias — Ay Que Te Quiero — Castagna — Rumba D'España. As an introduction to flamenco, this has much to recommend it, as the skill of the artist is outstanding, and the music is attractive and tuneful. World Record Club has issued this disc at the special price of \$2.95. (H.A.T.)

★ ★ ★

BACK IN TOWN. The Kingston Trio.
 World Record Club Stereo S/4473

Interest: "Live" performance.

Performance: Very enjoyable.

Quality: Mostly fine, but slight defects.

Stereo: Normal.

The "Clown Princes" of the folk movement are here again recorded at the Hungry i restaurant in San Francisco. The disc of their first appearance there was released by World Record Club last year. I enjoyed this performance much more than I did their first appearance at the Hungry i, and I believe they did too, since the audience does not laugh moronically in all the wrong places as they did before, and the Trio sounds happier and more relaxed. I thought the material was better here too. This comprises: Georgia Stockade — Ann — Ah, Woe, Ah, Me — Walkin' This Road to Town — World I Used to Know — Salty Dog — Let's Get Together — Isle in the Water — Farewell Captain — Tom Dooley — Three "Them" Poems of Mason Williams — So Hi.

There is a goodly amount of rollicking humour in this performance, which is spiced with the usual witty comments one expects of the Trio, as well as some more serious folk fare. I liked it tremendously, and I believe this will prove to be a very popular release. Although the recording engineer must have been subjected to the usual difficulties of recording a live performance, the sound is clean and bright for most of the time, the only defect being what appears to be a faulty microphone used by one of the Trio from time to time. However, the effects of this are not too serious. (H.A.T.)

★ ★ ★

AUSTRIAN FOLK SONGS. The Vienna Boys' Choir. Columbia Worldwide Series (E.M.I.) Stereo SCXO 6274.

Interest: As per title.

Performance: World's best.

Quality: Good standard.

Stereo: Well spread.

In their Worldwide Series, dealing with music of many lands, Columbia have already dealt with Germany, in a disc featuring various types of folk and cafe music. Now that it is the turn of Austria, whose culture and music are so similar to that of Germany, the producer was faced with something of a dilemma. By a flash of inspiration

he has hit on the idea of presenting a whole program by the Vienna Boys' Choir. Not only is this quite different in concept from the German disc, but the material did not have to be newly recorded, since there are literally dozens of discs from which to choose the contents for this issue. Furthermore, the choir with its 400 years of singing tradition, is as essentially Austrian as a Strauss waltz.

Needless to say the singing is absolutely first class, and the material selected is pleasing all the way through the generous 22 tracks included. The titles are too numerous to give in full but here are some of the better known ones: Zwa Sterndl — Komm Lieber Mai (Mozart) — Heidenroslein (Werner) — Gruss (Mendelssohn) — Maiglockchen and die Blumelein (Mendelssohn) — Fruhling (Mozart) — Andreas Hofer — Leise Zieht Durch Mein Gemut (Mendelssohn) — Schon Blumlein (Schumann) — Schlafe Mein Prinzenchen, Schlaf! Ein. Many of the other titles are simple folk melodies and I doubt whether these will be familiar to Australian buyers. A strange omission is anything by Schubert, probably one of the most famous of former choirboys. Even the "Heidenroslein" is presented in the Werner version instead of the better known Schubert one. (H.A.T.)

★ ★ ★

ROLF HARRIS LIVE AT THE TALK OF THE TOWN.
Columbia (E.M.I.) Stereo SCXO 6313.

Interest: Nightclub act.
Performance: Slightly blue, but good fun.
Quality: Good standard.
Stereo: Hardly noticeable.

Those who know Rolf Harris only from his performances for the strait-laced B.B.C. may be surprised by his performance on this disc, where he reveals another side to his nature by telling blue jokes and sprinkling his dialogue liberally with what is known as the "great Australian adjective." Of course, he is relieved of B.B.C. restriction here, for he is performing before a night club audience in London's Talk of the Town. Some of the material is familiar, including "Jake the Peg" and "If I Were a Rich Man," which he has already recorded. Apart from this, the material is fairly straightforward but enlivened throughout by Rolf's breezy humour. The highlight of the act for me was his account of the various translations to which his "Tie Me Kangaroo Down" has been subjected, many having no relationship, some of them having distinctly different meanings from the original. The translation into "American Hill-Billy" is brilliantly treated by Rolf, with appropriate sound effects.

Here is the full list of track titles: Jake the Peg — Hey What D'You Say — Lad-Di-Dah — Side by Side — If I Were a Rich Man — Tie Me Kangaroo Down, Sport, with variations — Gypsy — Moon River — Let the Rest of the World Go By — London Town. For "Moon River," Rolf uses the miniature stylus organ which created so much interest when he used it on television. To sum up, excellent entertainment, but not for the very young or those who find blue jokes and swear words objectionable. (H.A.T.)

I'M A LONELY WANDERER. Slim Whitman I & R (Festival) Mono only, IRL-32,680.

Interest: Popular C & W singer.
Performance: Typically pleasant.
Quality: Good mono sound.

I believe this is the eleventh in the current set of re-issues of earlier Slim Whitman discs, probably dating from five to 10 years ago. Slim is always good to hear, being one of the most accomplished of C & W singers, and certainly one of the most popular. The trouble is, what can one say about the eleventh disc within a few months without repeating oneself. If you are already a Slim Whitman fan, you will need no urging if the selection appeals: Prisoner's Song—Lonely Wanderer—What Kind of God—Cryin' for the Moon—Tell Me—You've Got Warm Lips—Backward, Turn Backward—In a Hundred Year or More—My Love is Growing Stale—Since You've Gone—Round up in Glory—Ride Away.

On the other hand, if you are a newcomer to the C & W field, I am sure you will not fail to enjoy Slim's pleasant light baritone, with its frequent excursions to the falsetto region. The mono only sound is not noticeably inferior to present day discs. (H.A.T.) ★ ★ ★

J. J. J. and J. Four Jacks and a Jill. RCA Victor Stereo LSP-4103.

Interest: Folk group.
Performance: Pleasing style.
Quality: Very good.
Stereo: Good spread.

The five members of this group must be counting the recent retirement of The Seekers as a major blessing, since they are just about tailor-made to fill

the gap. They, too, sing pleasantly harmonised ballads of the modern folk type, with the girl member dominating the vocals, while the male members provide a pleasant harmonic background. However, Glenys Harding has a slightly more husky and intimate sounding voice than Judy Durham's clear, forthright one.

Their program material is pleasantly unhackneyed, slightly whimsical, and tuneful throughout. As such it should appeal to former Seekers fans. The titles are: Hey, Mister—Mama Come Home — Click Song — Thru Little Billy's Window—Three Little Bears—Butchers and Bakers—Huckleberry Ferry Land—Sad Little Pigeon—Pata —Freckle Face—Bread and Butter. I hesitate to suggest that they will achieve the phenomenal success of the Seekers, but I do predict that we shall be hearing quite a lot of this group in the next year or two. (H.A.T.)

CORRECTION

JUNE 1969 ISSUE

The A.D.C. cartridge prices quoted in the J. H. Reproducers advertisement were incorrectly shown. They should have read:

A. D. C. 770 \$22.50
A. D. C. 660 \$35.00

L.P. RECORDS WANTED

Any quantity. Highest prices paid. Will call with cash within 30 minutes.

CASTLES RECORDS
323 Church Street, Parramatta
635-8621 after hours 86-1422

FOR WAY OUT SOUND

STOP PRESS... SEE OUR SPECTACULAR DISPLAY OF EXCLUSIVE PRODUCTS & SERVICES at the AUDIO & VISUAL FAIR. EXHIBITION BLD. MELB. JULY 18-25

\$20 WILL SECURE YOUR Fuzzmaster MARK IV

FOR PRESTIGE SOUND SEE CLAYBRIDGE SOUND

Secure your **FREE, COLOURED CATALOGUE** of our products & services.

Claybridge SOUND 163 CLAYTON RD. CLAYTON VIC. 3168 OR RING 544 6171
(CNR. DANDENONG RD.) (ALL HOURS)

POST FREE! ANYWHERE!

Introducing the

new **LEAK** Stereo 30 Plus

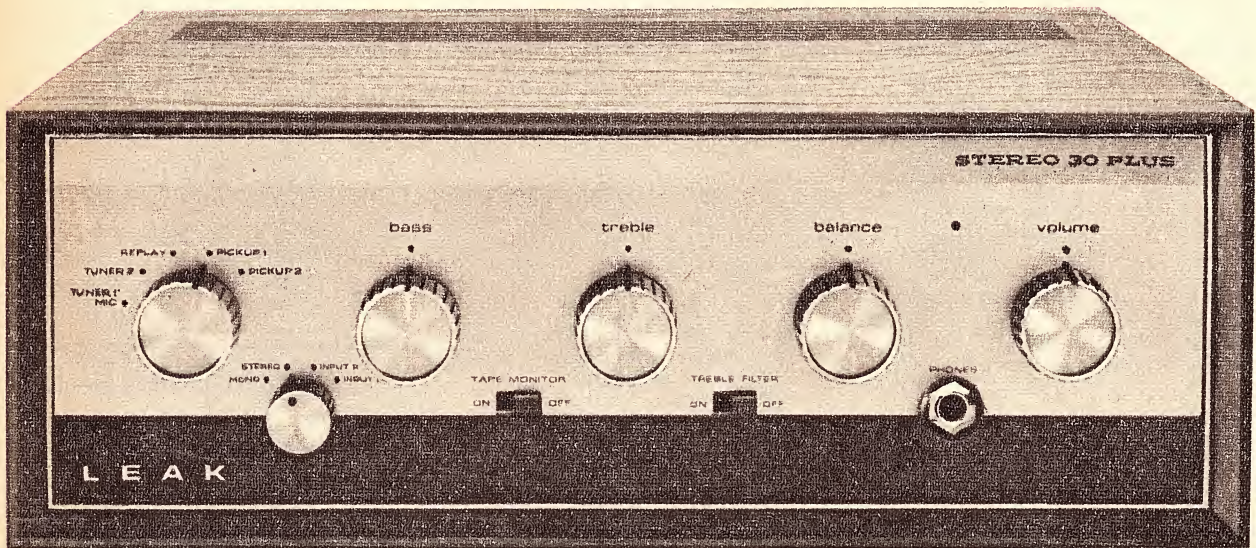

The Stereo 30 was introduced at the 1964 London Audio Fair. Five years later over 40,000 Stereo 30 amplifiers have been sold and it has established records, for popularity, reliability, and outstanding performance.

The new Stereo 30 Plus combines the long proven circuitry of the Stereo 30 with a new range of silicon transistors and facilities up-dated to meet today's needs:—

The use of two turntables and pickups, selection between the two being made by the input switch on the front panel.

The use of stereo headphones for personal listening as an alternative to loudspeakers.

This, backed by the famous LEAK craftsmanship and reliability, makes the Stereo 30 Plus the most technically advanced 15-watt amplifier available.

Power Output (both channels sinewave driven):

15 watts r.m.s. each channel into 8 ohm loudspeakers.

Also see and hear the other famous Leak units.

Sandwich speaker system MK 11. Mini-sandwich speaker system.

Stereo 70 amplifier. Teak cases available as optional extras.

\$198
RETAIL
NETT

LEAK

H.J. LEAK (AUST) PTY. LTD.
P.O. BOX 14
FRENCH'S FOREST, N.S.W. 2086
PHONE 94 4902

for descriptive leaflet post coupon

Name _____

Address _____

Postcode _____

Popular Jazz

"THE JOKER IS WILD" — John Sangster. Festival Stereo SFL-93,063 (also in Mono).

Interest: Commercially - slanted Australian Jazz.

Performance: Very enjoyable.

Quality: Well recorded.

Stereo: Normal separation.

This album is a difficult one to assess. On the one hand, John Sangster is perhaps the most creative and talented jazz musician that Australia has yet produced; on the other hand, the producer of the album, Pat Aulton, was clearly aiming at a market considerably broader than the specialist jazz collectors.

To that extent, therefore, the album fails to do John Sangster complete justice, but it is a considerable step forward from his first LP, "The Trip."

Once again, Sangster successfully multi-tracked his vibes, drums and a bewildering variety of other percussion instruments. The group was completed by George Thompson and Ed Gaston on bass, Graeme Lyall and Don Burrows on woodwinds and George Golla on guitar. As one would expect, the musicianship is impeccable.

The tracks I liked best on this very enjoyable album were "Love Is Blue," "The Joker," "What Now My Love" (with an incredible solo by Graeme Lyall), Leroy Anderson's "Serenata" and, most of all, the two Sangster originals "Kaffir Song" and "Expo." Indeed, one must regret that Sangster was not given the freedom to record

an album made up entirely of his own compositions.

Jazz enthusiasts will discover more than enough in this LP to interest them, while less committed listeners will, I think, find the 40 minutes of music pleasant and rewarding (T.F.C.)

★ ★ ★

THE GRAEME LYALL QUINTET.
Columbia (E.M.I) Stereo SCXO-7897.

Interest: Australian Modern Jazz.

Performance: Superb.

Quality: Very well recorded.

Stereo: Evenly balanced.

Eric Dunn of EMI records is to be congratulated for his sympathetic production of Graeme Lyall's first LP as a leader.

The majority of recent recordings by Australian modern jazz musicians has tended to be directed squarely towards the popular market. Fortunately, this brilliant young alto and tenor saxophonist has escaped this fate and the result is an outstandingly good album, which could more than hold its own overseas.

The two major pieces on the album are Part III of Lyall's fascinating "Psychedelia Suite" and pianist Dave McRae's "Spaniard In The Works." These feature probing, imaginative and beautifully constructed solo statements by Lyall, McRae and trombonist Bob McIvor.

"Tuck," another original composition by Lyall (in effect a thinly disguised "Sweet Georgia Brown") is distinguished by Ed Gaston's superb bass playing.

The third of Lyall's compositions, "Tom Terrific" and Bobby Hebb's standard "Sunny" are respec-

tively features for Graham Morgan's drums and Dave McRae's piano and the latter, in particular, more than consolidates his reputation as the most creative pianist in Australia today.

The album is completed by the beautiful ballad "When Sunny Gets Blue" and Graeme Lyall's alto playing on this track alone establishes him as a musician of world class.

By any standards, this is a highly successful and stimulating album, carefully produced and very well recorded. I hope that it receives the attention and support which it merits (T.F.C.)

Duke Ellington — "valuable collection"

PRETTY WOMAN.—Duke Ellington. RCA Vintage Series LPV 553.

Interest: Ellington 1945-46.

Performance: Valuable collection.

Quality: Well remastered.

Once again, RCA are to be commended for their intelligent and constructive approach to reissue albums. They have already given us the bulk of the Ellington material which is available to them and the tracks on this L.P., which cover the period May, 1945 to September 1946, take us right up to the time when Ellington began to record for Musicraft briefly, and then Columbia.

Three tracks, "Back Home Again in Indiana," "Long, Strong and Consecutive" and "Hey Baby," are previously unissued, while many of the other thirteen tracks on the LP were very hard to obtain.

The years 1945/46 were not particularly good ones for the Ellington organisation. He had just lost Rex Stewart, and Otto Hardwick departed at the beginning of 1946. A particularly serious loss was the death of Joe Nanton in July 1946. Nevertheless, the band still included outstanding names like Cat Anderson, Shorty Baker, Taft Jordan, Ray Nance, Lawrence Brown, Johnny Hodges, Harry Carney and Oscar Pettiford. Indeed, I have always held the view that the Ellington output for RCA at this time, and subsequently for Musicraft, has been slightly undervalued.

The only significant criticism which one could make about this album is that there are rather too many vocals — Al Hibbler on "Pretty Woman" and "Lucky So-and-So"; Joya Sherrill on "I Let a Song Go Out of My Heart" and "Long, Strong and Consecutive"; Marian Cox on "St. Louis Blues"; and the inimitable Ray Nance on "My Honey's Lovin' Arms," "Hey Baby" and the delightful "Just Squeeze Me."

But superb instrumentals like "Midriff" and "Esquire Swank" from September 1946 and the two Ellington/Strayhorn piano duets "Tonk" and "Drawing Room Blues" from January 1946 will be of lasting interest to Ellington collectors.

This album may not have immediate appeal to the casual listener. But for those readers who recognise that, for more than forty years, Duke Ellington has led the greatest jazz orchestra in the world, this LP must be regarded as essential buying. With 16 tracks and a retail price of \$3.95 it represents quite exceptional value. (T.F.C.)

NEW EQUIPMENT CABINETS

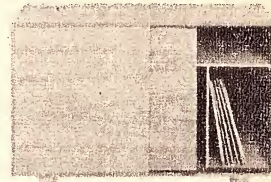

MODEL 192

Record storage or equipment cabinet. Dimensions 36in wide, 21in high, 15½in deep, plus 9in legs.

Record bins: 14in high, 8½in wide. Horizontal shelf 5½in high. Features: Sliding doors, mitred corners, semi-square legs.

Price complete maple, teak, etc. \$57.60
Kit of parts (maple) \$31.50; teak \$6 extra. Packing \$1.30.

New Player Platform model 175 is 16in x 14in x 3½in. Price \$7.50 for maple or walnut. Kit of parts \$4.00. Teak, 50c extra. Perspex cover, 3½in or 5½in high, \$8.20 and \$1.50 extra if required hinged. Please specify cut out required.

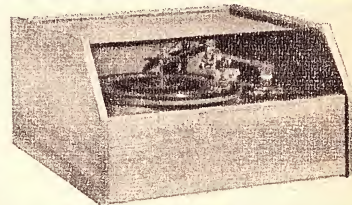

MODEL 186

New Player Cabinet model 186 is 9½in high, 16in wide, 16½in deep and 5½in above shelf. Finished with attractive hinged, tinted perspex top. Price: \$21.00 for maple or walnut or teak.

Kit of Parts \$14.00

Teak: \$1.00 extra (kits only)

Height of this model can be increased to take various amplifiers. Tailored cut out. Ask for quotation.

Free on rail.

Packing charge \$1 per order.

Write for Catalogue and Player Guide

H. B. RADIO SALES

Manufacturers of Quality Radio and Radio Furniture for 37 Years

103-105 CATHERINE STREET,
LEICHHARDT, SYDNEY.

TELEPHONE 56-5580.

THE MONARCH IS NOW AT MASTERSOUND

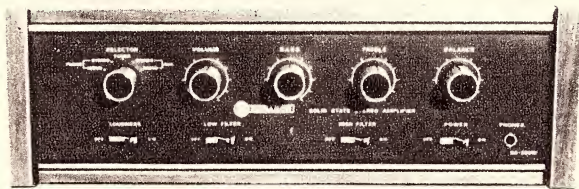

Mastersound now have the **Monarch SA500**, a power packed solid state amplifier that's a real asset to any system. The Monarch SA500 Solid State amplifier features—

Freq. resp. 20-20,000Hz (\pm 1db) — Power output 12/12 watts R.M.S. per channel — Loudness controls — Balance control — High and low filter — Bass and Treble.

Our price \$112.00. In wooden cabinet \$123.00.

SP80 Speakers \$124.00 pr.

KENWOOD COMPACT MINOR

The amazing Kenwood 150 amplifier with Dual 1015 automatic record changer and famous Shure Magnetic Cartridge, **\$248.00.**
YOU CHOOSE YOUR OWN SPEAKERS!

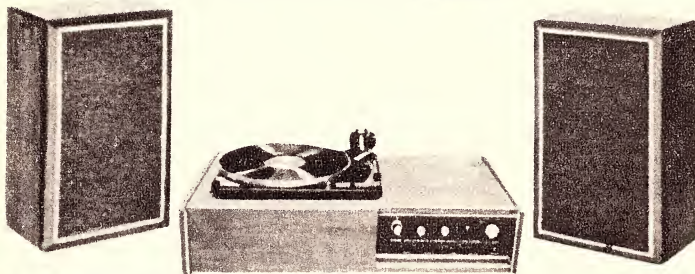

KENWOOD COMPACT MAJOR

A Kenwood 250 amplifier, Dual 1009 player and Shure Magnetic Cartridge all housed in an attractive teak cabinet with cover. Plus a new Wharfedale "Denton" speaker system. A magnificent combination for only **\$499.00.** Or if you prefer, team one of our many other speaker systems with this unit.

GRILLE CLOTH

If you're thinking of making your own speaker enclosure or just remodelling your present set then see **MASTERSOUND'S** wide range of grille cloth patterns. B.A.F. wadding is also available.

The Sensational Sound of LEAK

If you haven't yet experienced the magnificent LEAK Combination of the STEREO 70 amp. and the LEAK Sandwich speakers then you're missing out on a lot. Hear them both at **Mastersound.**

SANSUI

Our **SANSUI** range is the most comprehensive in town and features all the famous Sansui models such as the 222, 555, 777, AU70, 2000 and 800.

MASTERSOUND SALES PTY. LIMITED
400 KENT STREET,
SYDNEY. 29-1527

THE GOLDEN TRUMPET — Harry James, Decca Stereo PFS-4142.

Interest: Big band nostalgia.

Performance: Enjoyable.

Quality: Well recorded.

Stereo: Normal separation.

Despite all the economic and musical difficulties, the Harry James Orchestra has managed to remain active throughout the 1960s. Since he formed his first big band in January 1939 (after two years with Benny Goodman), James has always set a high standard and, in some ways, the James Orchestra between 1960 and 1965 was his finest.

Unfortunately the sleeve contains no personnel details or recording dates but presumably the sessions were held fairly recently.

The music on the album is professional and polished but rather less jazz-oriented than in the mid-1960s when Neal Hefti, Ernie Wilkins and Thad Jones were writing the bulk of the arrangements for the James band. Most of the tracks heavily feature his technically formidable but rather flamboyant trumpet-playing but he sounds most comfortable on old favourites like "You Made Me Love You," "Sleepy Lagoon" and "Cherry."

The band also has a very able saxophone section, however, and they are heard to advantage on numbers like "Two O'Clock Jump," "A Train" and "Satin Doll," when the sound is very much in the Basie tradition.

The James Orchestra is not one of the great big bands nor does this album capture it at its peak. But it is an enjoyable L.P. particularly for readers who share my nostalgia for the 1930s. (T.F.C.)

★ ★ ★

SWING IS KING — Ted Heath and his music, Decca, Stereo PFS 4135.

Interest: Big band "tributes."

Performance: Superb musicianship.

Quality: Very well recorded.

Stereo: Good separation.

Although ill-health has forced Ted Heath into virtual retirement after about 25 years as a bandleader, the Ted Heath Orchestra continues in existence under the leadership of pianist, Ralph Dollimore.

Once again, the sleeve note for this L.P. contains no details either of recording dates or of the band personnel. However, the superb musicianship and crisp arrangements which have always distinguished the Ted Heath Orchestra are very much in evidence throughout the 12 tracks.

The music, in fact, is a tribute to the Swing Era of the late 1930s and to the outstanding band leaders of the period. The tracks include "Begin The Beguine," "Woodchoppers' Ball," "In The Mood," "Take The A Train," "Cherokee," "Song Of India" and "Sing, Sing, Sing."

The arrangements are thoroughly contemporary and there are some excellent trombone (perhaps Don Lusher), clarinet (Henry McKenzie), trumpet (Derek Watkins), alto (Ronnie Chamberlain) and tenor (Bob Efford), solos throughout the album.

The 42½ minutes of music on this L.P. may not represent any new musical developments. But it does feature one of the greatest of the big bands in sparkling form and can safely be recommended to readers with a taste for this kind of music. (T.F.C.)

TRADE REVIEWS AND RELEASES

Communications Receiver From Eddystone

Eddystone Radio Limited, of Birmingham, England, have recently developed an all solid state, high stability communications receiver. This unit is noteworthy in that it covers the full frequency range from 10KHz to 30MHz, in ten ranges.

A prototype of this receiver was flown out from England just in time to be shown at the recent I.R.E.E. Convention which was held in Sydney. As such, we appear to have had the privilege of being the first to make a close inspection of this most interesting development in top-line communications receivers.

Identified as type No. 958, it becomes immediately obvious that this unit is produced for professional use, as little if any expense has been spared. Not surprisingly, this is confirmed by the price tag.

Externally, it appears much the same as many other good quality receivers, being fitted into a metal box, measuring 16½in x 17½in x 5½in. This is the bench version but a standard rack-mounted unit is also available. The weight is about 42 pounds.

The front panel layout is anything but symmetrical. This is not meant to be a criticism. In fact, it is refreshing to see this sort of thing, as the effect can be a welcome change from symmetry. The dials, controls, etc., have been brought out to positions on the panel, which meet the general physical requirements, together with convenient location of controls from an operating point of view.

The dial system, although deceptively unimpressive from the front panel, is of particular interest. The scale is in the form of a small internal disc on which the calibration appear as a photographic transparency. An optical projection system presents an enlarged image on a ground glass screen on the front panel, where it is easily read. This system produces an effective scale length of the order of 50in. As ranges are switched, the appropriate scale is automatically selected for projection. A second dial system is also presented, giving incremental tuning over a range of 100KHz.

We did notice a small amount of backlash in the dial movement, when making critical CW or SSB adjustments. As the receiver being checked is, we understand, a prototype, we have no doubt that a small point such as this would be cleared up in production models.

Frequency range selection is achieved with a panel knob which turns an elaborate turret system. The operation of this switch is particularly heavy but this is not surprising considering the size of the turret. The action gives the impression of being very positive.

A meter on the front panel and to the right of the dials, can be switched to measure RF signal level, AF level across the output line, or as a centre zero position for use as FSK tuning monitor. The AF level scale is calibrated in mW and the RF signal scale simply from 0 to 10. The meter movement is well damped, to the point where the action seems to be sluggish. From an operating point of view, we would like to have a movement which was a little faster. This no

doubt, would be a matter of personal choice.

Removal of the outer case reveals that the modern practice of modular construction is used. The impression immediately gained is that the complete receiver is built in a professional manner of the highest order. By removing a side cover, we were able to take a close look at the turret construction. Each "card" is a printed board on a fibreglass base and with coils, very much miniaturised, in each appropriate section.

The designers have made use of silicon transistors, together with FETs and ICs, where these have been considered desirable.

An elaborate switching arrangement sets the ranges 10-54KHz and 125-295-KHz, such that the system is a single

the drift amounted to just under 7KHz. After two hours, the total drift was about 8KHz and at the end of three hours, 10KHz. By this time, the unit had virtually stabilised.

We consider that this performance is more than acceptable for the system of operation. Furthermore, we also noted that the beat note under CW conditions was particularly clean, which speaks well for the first oscillator design.

When high stability operation is required, a 1MHz oven-temperature-controlled crystal oscillator is brought into operation. The output of the 1MHz crystal oscillator is first divided by 10. The 100KHz is then passed through a harmonic generator, with harmonics available up to 30.4MHz. With an AFC loop, the relevant 100KHz harmonic point is selected and used to lock the first oscillator to this frequency. The stability of this oscillator then becomes equal to that of the 1MHz crystal oscillator. It should be noted that this mode is only available on the ranges between 1.6 and 30MHz.

When the high stability mode is brought into operation, the 100KHz point must be selected for the locking of the high-frequency oscillator. The 100KHz range above this point is then tuned with the incremental tuner, or tunable IF. The dial associated with this latter tuning is calibrated with 200Hz divisions and interpolation to 100Hz should be perfectly practical.

We made no effort to make any serious measurements of the high stability mode of operation. Suffice to say that the makers claim that the long-term stability of the crystal oscillator is of the order of one part in 10⁷. There are two other oscillators involved, that for the incremental tuning and this tunes from 550 to 650KHz. Also, the BFO for CW operation, on about 100KHz. As

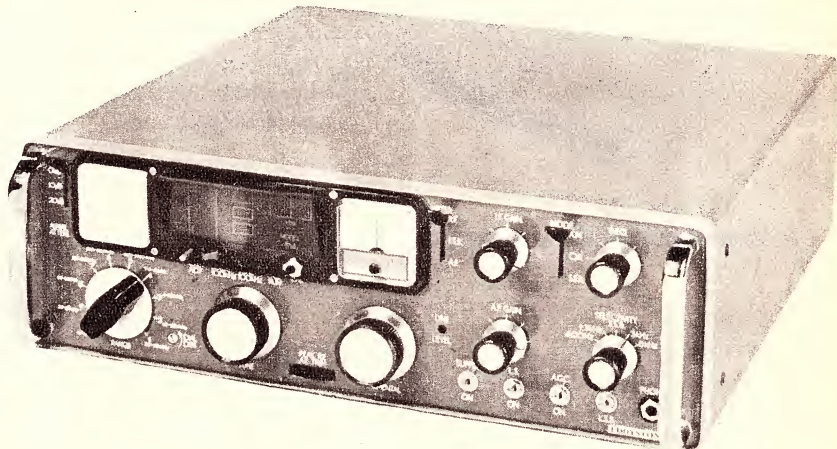

conversion superhet, with an IF of 100-KHz. The ranges 53-126KHz and 290-1650KHz, change to a double conversion system, the first IF being 250KHz. This apparent mixup of ranges and conversions is fairly obviously done to avoid IF breakthrough problems and is rather cunningly devised.

From 1.6MHz to 30MHz, a further IF is introduced ahead of the 250KHz channel. This IF is nominally 1335KHz but it is also variable from 1235 to 1335KHz. Under "free running" conditions, this tunable IF can be used to interpolate over a 100KHz range, anywhere between 1.6-MHz and 30MHz.

Under "free running" conditions, the receiver is an ordinary superhet, with conversions just outlined, and with a tunable first oscillator. This is the least stable condition of the receiver and it is tuned in the ordinary way. Under these conditions, we made a rather severe check on the stability, with the receiver tuned to 25MHz. For the test, we used the built-in 1MHz crystal calibrating oscillator as the reference. In the first hour,

both of these oscillators are operating at fairly low frequencies, it is possible to maintain a high degree of stability. For SSB operation, the BFO is not used, 100KHz derived from the 1MHz crystal being used instead. So the stability for SSB is virtually that of the 550 to 650-KHz oscillator.

While on the subject of SSB reception, tuning this mode under the high stability condition of this receiver is something which must be experienced to be fully appreciated. However, it is also worth noting that SSB can be tuned quite readily in the free running mode, although this is not likely to be the general means of receiving SSB.

An interesting sidelight relating to the system of using a high-stability crystal oscillator, with harmonics to lock a normally free running self-excited oscillator, is that the writer tried this method just a few years ago. It worked all right but there were so many technical problems that the project was abandoned. Since then, the same system was mentioned in a paper by the now famous

SAFE AND SOUND WITH TESLA

A safe investment . . . a Tesla tape recorder! A sound investment . . . a Tesla tape recorder. The many additional features have made Tesla Europe's biggest selling, top quality tape recorder. So, feel safe and sound with a Tesla tape recorder



MODEL B46 incorporating Tesla's long life record and play-back head with a guaranteed 2000 hours of enjoyment. Records stereo or mono with instantaneous pause and remote control facilities. Complete with microphone, tape, spare fuses, plugs and lead all in a high tensile plastic case.

MODEL B43A. A full stereo tape recorder for sound on sound, mono and synchronous recording with instantaneous pause control which can be operated remotely up to 100 yds. Simple function, push-buttons with light indicators. Housed in an elegant polished timber or teak case.

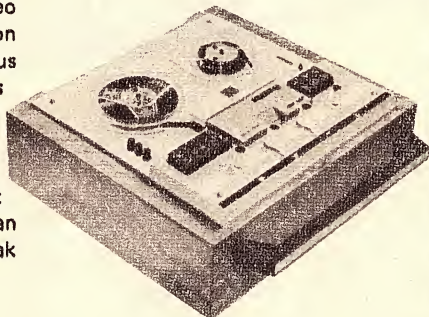

CHARMAC PTY. LTD.

Representatives for Tesla Czechoslovakia.

VICTORIA: 33 Bridge Road, Eltham, 3095. 439.9415
S. AUST: TRUSCOTT ELECTRONICS
64 Hindmarsh Square, Adelaide, 5000. 23.3024.

CH319

Dr Wadley, and he too, considered that there were many problems to the system. However, to give credit where it is due, the Eddystone Engineers have solved these problems in no uncertain manner.

Just one of the problems to be solved was that of keeping the generated harmonics from the crystal from getting into tuned circuits where they would show up as spurious signals. In the unit under test, there is no evidence of spurious signals from this source. There is one possible exception and this is what appears to be an internally generated signal on 100KHz. However, we could find no others.

Another point which we did notice when switching to the high stability system, was a shift in frequency of the now controlled local oscillator. The amount of frequency shift, between the free running condition and the locked condition, was anything up to about 2KHz, depending upon the fundamental frequency involved. This could be a function of alignment and an adjustment would no doubt put things right.

Upper and lower sideband reception conditions are selected by switching in either a 150 or 350KHz crystal oscillator, to the third mixer, thus converting from 250KHz, to 100KHz, and providing the correct sideband for the following filter.

Immediately following the mixer preceding the 100KHz IF channel, are five selectable filters. The nominal bandwidths are, 400Hz, 1.3KHz, 2.65KHz (SSB), 3KHz and 8KHz. The bandwidths quoted are for the -6dB points, except for the SSB filter, which is quoted for -3dB. With the exception again of SSB, which uses a multi-pole crystal filter, all other bandwidths are determined with LC filters.

AGC is available for all modes of reception, or it may be switched out of circuit, control then being effected manually. As the various reception modes are selected, the time constants of the AGC system are changed to best suit the particular mode. In common with other high-grade receivers, the AGC holds the audio level within narrow limits, for a very large change in signal level.

Facilities are provided for diversity operation and the receiver may also be used in conjunction with a frequency synthesiser. Output at the 100KHz IF is available, and facilities for external control of fine tuning are provided.

There are two audio amplifiers, one providing line outputs at 150 ohms and 600 ohms. The other amplifier provides drive for an external loudspeaker, or a pair of headphones. In place of the external loudspeaker, a 2in loudspeaker on the front panel, may be used. Considering its small dimensions, this loudspeaker gives remarkably good quality, much better than we have become accustomed to expect from such units.

It would be interesting to get an explanation from the designers, as to why they used a separate 1MHz crystal oscillator for calibration purposes, rather than use the highly stable oven-controlled crystal. Obviously the calibrating crystal is not as accurate, which was borne out by checking against WWV on 10MHz. Similarly, we would be interested to know why no means are provided to combat received noise, such as a silencer or limiter of some kind.

We could go on with comments, facts and figures but space limitation dictates that we cannot cover all the salient points of this interesting receiver. To sum up, this unit is of the highest quality and performance and we have no doubt that much more will be seen and heard of it in the near future.

The model for review was supplied by R. H. Cunningham Pty. Ltd., 608 Collins Street, Melbourne, Vic. 3000. Further details, including price etc. may be had from the above address, or Sydney inquiries may be directed to the Sydney office, 64 Alfred Street, Milson's Point, N.S.W. 2061 (I.L.P.)

REGULATED BATTERY ELIMINATOR

A regulated power supply has been developed specially for larger battery operated tape recorders by A & R Electronic Equipment Co. Pty. Ltd., of Box Hill, Victoria.

This unit, submitted for review by A & R through their N.S.W. agents Soanar Electronics Pty. Ltd., fills the need for a mains supply for battery operated tape recorders which have a high current drain. It is short circuit proof and has a range of output between 4.5 and 12V DC at 500 mA.

The relevant specifications of the unit are as follows:

Input voltage: 240V, 50Hz.

Output voltage: 4.5V, 6V, 7.5V, 9V and 12V, set by selector plug.

Maximum current: 0.5A.

Regulation: Approx. 10 p.c. on 12V range and approx. 5 per cent on the other ranges.

Ripple: Less than 100mV RMS for loads up to 0.5A.

Size 4 x 5½ x 2½ inches.

The unit is housed in a folded steel case which should be rugged enough to stand all normal use and abuse. The output voltage is selected by pulling the "voltage selector" knob out till it is free to rotate and then pushing it back into the socket so that the white line on the knob points to the desired voltage. The output is taken from a two-pin, polarised plug which has the DC polarity marked on the case.

All the semiconductors used are made by ITT but they are not all silicon, as might be implied by the advertising literature. On the other hand, the fact that they are not all silicon in no way prejudices the performance. The resistors are high quality carbon film or wire wound types in the interest of reliability.

The circuitry consists of a power transformer and full wave rectifier followed by a large filter capacitor which supplies voltage to the collector of an NPN power transistor, type TT3055, connected as a series regulator. The reference voltage for the series regulator is derived from a voltage divider formed by a resistor and the "error amplifier" transistor, a germanium PNP type which has its bias varied by the selector plug to set the output voltage. The series regulator also has an electrolytic capacitor connected from base to the negative supply rail so that it performs filtering as well as regulation. Both positive and negative supply rails are isolated from the case which is earthed via the mains cord.

Under short circuit conditions the current is limited by a further germanium PNP transistor which monitors the output current through a 1-ohm resistor. When

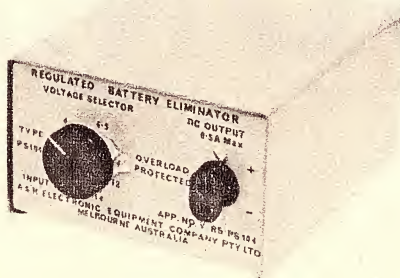

the current rises to a pre-determined value the transistor begins to conduct, removing some of the bias for the series regulator transistor, and effectively limiting the current to less than 800mA.

In operation, we found the unit to perform as the manufacturer claimed. Ripple was below 100mV RMS for currents below 0.5A and the hum and noise added to the output of a typical cassette recorder were negligible. The short circuit protection appears to be foolproof, although A & R state that the unit should not be operated under these overload conditions for more than five minutes, to avoid overheating internal components. Commonsense would agree with that.

The unit would also be a useful addition to the service bench where it will provide power for most battery operated appliances. Even transistor car radios with class-A output stages could possibly be checked if they had the dial lights disconnected to reduce the current to around 500mA.

Retail price of the unit is \$21.45, including sales tax and the normal trade discounts apply. Inquiries should be addressed to A & R Electronic Equipment Co. Pty. Ltd., 42-46 Lexton Road, Box Hill, Vic. 3128, or to agents in all States. (L.D.S.)

BASF LOW-NOISE AUDIO TAPE

A new range of low-noise, high-output tapes manufactured in Germany by BASF will be available in Australia about the middle of this month.

Production at a new \$18-million BASF magnetic products factory commenced recently with a new range of long play, double play and triple play ¼ in audio tapes for the domestic market. They are distinguished by a large green and black "LH" overstamped on the outer wrapping. Price of the LH tapes will be approximately 7 to 8 per cent higher than the standard range, which will remain in present form.

Simultaneously, a new computer-styled audio spool will be supplied with all BASF tapes. The new reel is said to have advantages in strength and rigidity. The exclusive BASF library storage system in single and multiple boxes has also been improved by the use of semi-flexible, high-impact, shatter-proof plastic.

Further information can be obtained from the Australian distributors, Maurice Chapman and Co. Pty. Ltd., 210 Clarence Street, Sydney, 2000.



Illuminated Switches and Annunciators

Associated Controls Pty. Ltd. of 14 Enterprise Avenue, Padstow, N.S.W., have available a wide range of illuminated push button switches and annunciators. The illuminated button-screens, which can be engraved as desired, are available in the following colours; white, red, green, yellow, blue and black.

Miniature illuminating lamps can be

obtained in a range of voltages between six and 60. For higher voltages a series lamp resistor is supplied with the switch or annunciator. The lamps are provided with a separate pair of terminals and may be removed from the front by removing the illuminated screen.

Switches with a variety of contact configurations are available with "step" or "impulse" action. Contacts are pure silver or gold-plated silver.

Associated Controls Pty. Ltd. have many other switches in their range. Enquiries should be directed to their address, above.

TRADE CORRECTION

MINIWATT ELECTRONICS DIVISION, Philips Electrical Pty. Ltd., 20 Herbert Street, Artarmon, N.S.W. 2064.

VARIABLE MAINS TRANSFORMER. The company has advised of errors in the review of these items which appeared in the June, 1969 issue of "Electronics Australia." The type number should read 2422.530.01407, the output voltage should read 0-240V instead of 0-180V, and the price for small quantity should read \$13.00 each excluding sales-tax. Further, while the spindle is adjustable to protrude either end, it is in fact 70mm in length; and, although a different spindle of suitable length could be fitted, only the standard spindle is available from Miniwatt.

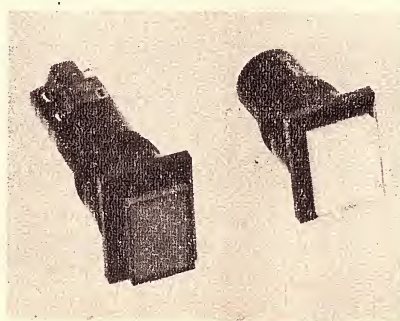

POWER TRANSISTORS	
2N 3055 (BDY20)	\$2.00, 10 for \$18.00
2N 3054 (sim. 40250)	.. . \$1.70
EM 404	.. . 25c
To — 1 transistor	.. . 5 for 20c
Silicone grease	.. . 50c for 10g
1 Watt Zeners, 2.4 — 16V	.. \$1.50
\$4.00 minimum order.	
Mail order only, please. Post free.	
E.S. & I. ELECTRONICS.	
81 Prospect Road, Summer Hill.	
N.S.W. 2130.	

HIGH FIDELITY

THE name is

GOODMANS

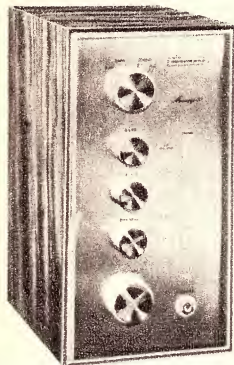

MAXAMP 30 is a fully transistorised stereophonic High Fidelity Amplifier using Silicon Transistors throughout. It is precision engineered and fullest use is made of printed circuits. It will deliver continuously up to 15 watts of power on each channel and it looks as good as it is. Its polished wood cabinet with 'Danish Silver' scratchgrain control panel blends with any decor.

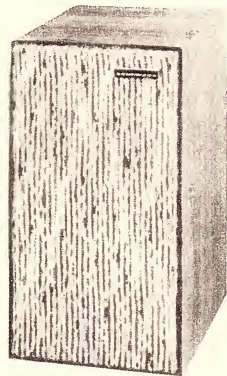

MAXIM. The ORIGINAL and unequalled High Fidelity Loudspeaker mini-system. Complete full-range Hi-Fi reproduction (45-20,000 c/s)—yet within shoe-box size and handling 8 watts. Meticulously finished enclosure in hand rubbed Teak or Walnut. 10½" x 5½" x 7¼"

FULL RANGE SINGLE UNIT LOUSPEAKERS

8 inch



AXIETTE 8
8"—6 watt

TWIN AXIETTE 8
8"—6 watt

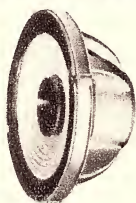

9½ inch

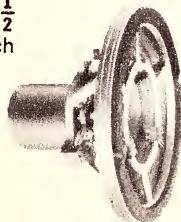

AXIOM 80
9½"—6 watt

AXIOM 10
10"—10 watt

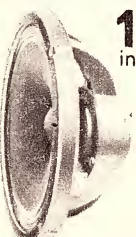

10 inch

12 inch

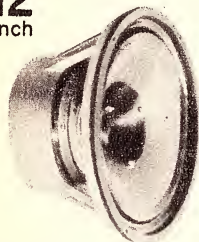

AXIOM 201
12"—15 watt
AXIOM 301
12"—20 watt

TRIAxiOM 1220c
12"—20 watt
TRIAxiOM 212c
12"—15 watt

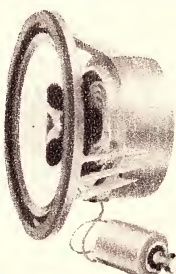

BASS UNITS

12 inch

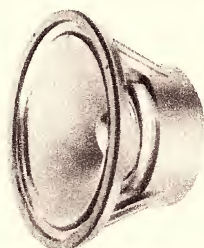

AUDIOM 51 BASS
12"—15 watt
AUDIOM 61 BASS
12"—20 watt

15 inch



AUDIOM 81 BASS
15"—25 watt

18 inch

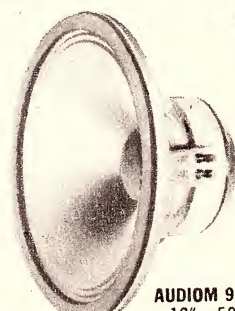

AUDIOM 91 BASS
18"—50 watt

Standard Versions of all Audiom speakers are available for Public Address work and Musical Instrument amplification (Electric guitars etc.)

GOODMANS MULTIPLE SPEAKER HIGH FIDELITY SYSTEMS

For a very low distortion, high sensitivity loudspeaker system choose a Goodmans 3-way system, employing an Audiom Bass unit, and pressure-driven horn-loaded Midax mid-range and Trebax high frequency units, with crossover network and attenuators.

TREBAX 100 Range: 2,500-20,000 c.s. 25 watt	TREBAX 5K/20XL Complete with XO and attenuator. Range: 2,500-20,000 c.s. 20 watt	MIDAX 650 Range: 650-8,000 c.s. 25 watt.	XO/950/5000 Crossover frequencies: 950 and 5,000 c/s.	XO/950 Crossover frequency: 950 c/s.	XO/5000 Crossover frequency: 5,000 c/s.	ATTENUATOR 8-step

● Impedance of each speaker is 15-16 ohms, unless otherwise stated.

Each of the six loudspeakers in this range covers the full audible frequency range, and mounted in an enclosure of the correct design each is a complete High Fidelity system. There is a unit to suit every requirement—amplifier output, room size, pocket and personal taste—from the economical Axiette 8 and TwinAxiette 8, through the more powerful Axiom 10 and Axiom 201, the Axiom 301, the world's most advanced twin cone 12" speaker, to the connoisseur quality hand-built Axiom 80 transducer and the triple element Triaxiom 1220c and 212c with built-in Treble control.

If you choose an Axiom 201, 301 or 10, the unit's performance can be further enhanced, if desired, by the later addition of Trebax High Frequency and Midax Mid-range units.

GOODMANS LOUSPEAKERS LTD

AXIOM WORKS · WEMBLEY · MIDDLESEX · ENGLAND

Sole Australian Agents: **BRITISH MERCHANDISING PTY., LTD.** · 49-51 York St · Sydney · N.S.W. Telephone: 29 1571

NEW MICROPHONES FROM PHILIPS

Philips Electrical Pty. Ltd. has recently introduced eight microphones each developed for a specific purpose. The Philips' range of microphones now extends from ruggedised noise cancelling microphones for industrial public address purposes to quality dynamic lavalier and roving microphones for radio and TV applications.

Brief characteristics of the new microphones are as follows:

The EL 6035 uni-directional microphone. For applications in theatres and other installations with stringent quality requirements, it offers excellent properties for both speech and music. Front-to-rear ratio of 20dB makes it virtually insensitive to acoustic feedback.

EL 6036 omni-directional microphone. Excellent for both speech and music, it is similar to the EL 6035 except for the directional properties.

EL 6037 uni-directional microphone. A luxury microphone with rosewood hand grip especially for vocalists and other entertainers, it is insensitive to acoustic feedback to a high degree, allowing greater freedom in positioning. A dual impedance connection permits use with either valve or transistorised amplifiers. The front-to-rear ratio is 20dB.

EL 6041 uni-directional microphone. Suitable for theatres, clubs and high-quality sound systems, it is fitted with a bass attenuation switch for speech at close range. The front-to-rear ratio is 20dB.

EL 6042 slimline omni-directional microphone. Combining high quality with very small circular dimensions, it is suitable for exacting installations where the microphone must be unobtrusive.

EL 6061 noise-cancelling hand microphone. A heavy-duty close-talking microphone in a diecast aluminium housing, it is intended for industrial systems where high ambient noise, dust and chemical actions can be a nuisance. A suspension bracket of black nylon is supplied.

LBB 9001 omni-directional lavalier microphone. Combining high quality with mechanical strength and small size, it is

hung from the neck of the user leaving the hands free. The lavalier attachment boosts high frequencies for optimum intelligibility.

LBB 9002 omni-directional microphone. A universal microphone in the lower price class, suitable for general public address, home entertainment and tape recording. Supplied with table stand and an adaptor for a floor stand.

Inquiries should be addressed to the Audio Products Department, Philips Electrical Pty. Ltd., 35-43 Clarence Street, Sydney, 2000.

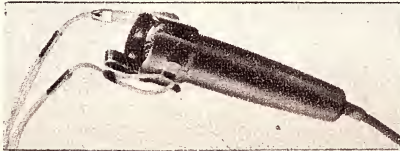

TOP: LBB 9001 omni-directional lavalier microphone. **ABOVE:** EL 6035 microphone in dust-free case. **LEFT:** EL 6037 hand microphone for vocalists. **BOTTOM LEFT:** EL 6041 high quality microphone. **BOTTOM CENTRE:** EL 6061 noise cancelling microphone. **BELOW:** LBB 9002 general purpose microphone.

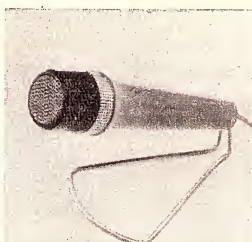
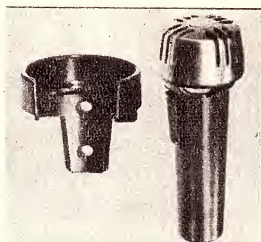

up to ten times longer life



MAXELL Alkaline Dry Cell — this unique new design concept features high capacity and durability that surpasses the performance of the world's top dry cell batteries. The construction of the Maxell Alkaline Dry Cell differs greatly from conventional types of carbon ZINC cells. However, the Maxell Alkaline cells can be used where you normally use a carbon ZINC cell. MAXELL ALKALINE CELLS are especially suitable where there is a demand for increased current, combined with durability and little voltage drop. Even near the end of the cell life the discharge capacity is large and stabilized.

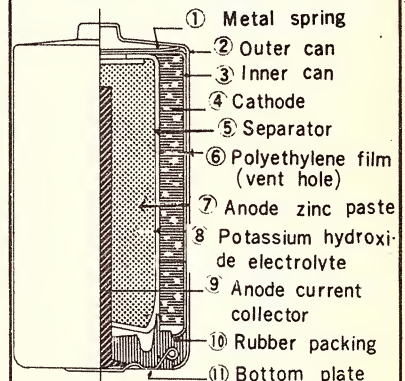

Exclusive new construction minimises leakage. Double cans are used and rubber sealing with the unique spring safety device. (see diagram)

Interior drying is prevented by hermetic sealing, therefore long storage periods are possible (over two years). Even then Maxell Alkaline cells are in the same condition as when they left the production line. These cells will withstand severe temperature changes. Rigid tests have shown extremely stabilized capacities from the low temperature of -4F to the high temperature of 150F at which temperatures dry cells would fail to operate satisfactorily.

Prices:

AM1 75c
AM2 50c
AM3 40c

Trade enquiries to
TASMANEX PTY. LTD.
17 Parker Street SYDNEY 2000

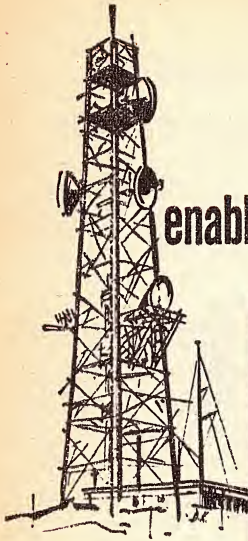

ALLIED CAPACITORS

specialised facilities and years of experience
enable Allied to design and manufacture for your specific needs



- Ceramics
- Plastic Film
- Electrolytics
- Silvered Mica
- Potentiometers
- Paper Capacitors
- Connectors
- Switches
- Trimmers
- Centralab Packaged Electronics



ALLIED CAPACITORS PTY. LIMITED



A Member of the Australian Telecommunications Development Association

Distributed by

Ferris Bros. Pty. Limited, 752 Pittwater Rd.
Brookvale, N.S.W. 2100. Ph. 93-0221 (10 lines)

Write for catalogue and service information to
Allied Capacitors Pty. Limited,
752 Pittwater Rd., Brookvale, N.S.W. 2100.

NAME.....PHONE.....

ADDRESS.....

EA.....POSTCODE.....

FB4211/69

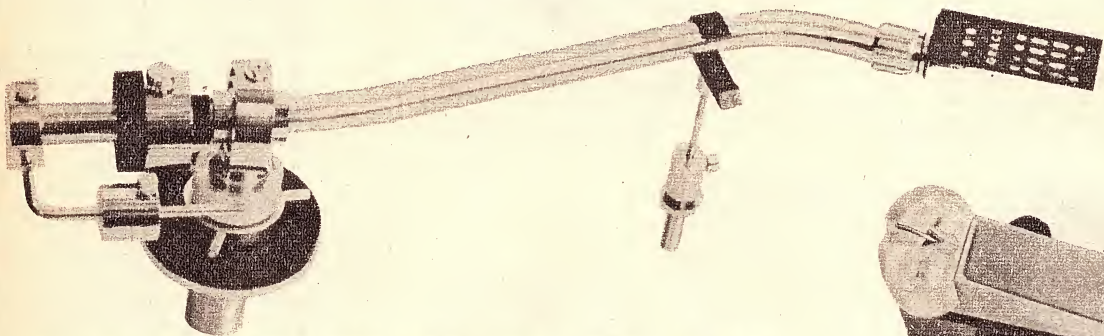

A NEW, PRECISION MADE TONE ARM—THE GRACE MODEL G-545

Although they've been available only a few months, Grace tone arms are already prized by the audio enthusiast. This new model, the G545, is a winner . . . it will track down to $\frac{1}{4}$ gram with suitable cartridges and features a gimbal type gyroscopic bearing system. An ultra light weight head shell is supplied . . . and the new arm shape reduces tracking error to the point where this factor may be disregarded.

The main counter balance weight is divided into two for easier, more precise balancing. Sub-weight adjustment sets stylus pressures from 0 to 3 grams. The arm accepts all Ortofon/SME type headshells without modification and all "New Generation" cartridges. Tracking ability of this fine tone arm is best demonstrated with stylus pressures below one gram. Ask for an EMQ or call at Encel Stereo Centres in Melbourne or Sydney for a demonstration.

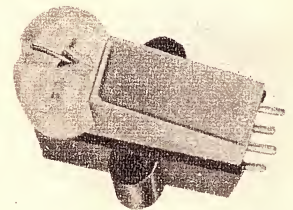

TOP PERFORMING GRACE MODEL F-8M STEREO CARTRIDGE

With an output of 7 mV, and a frequency response of 5-35,000 Hz., the Grace F-8M stereo cartridge tracks down to $\frac{1}{4}$ gram — recommended stylus pressure being 1-2 $\frac{1}{2}$ grams. An elliptical diamond stylus 0.2 x 0.8 mil. is standard equipment, tip mass is 0.75 m/grams, and total cartridge weight is only 6 $\frac{1}{2}$ grams. Cross talk is less than -30 dB. at 1 kHz. Musical performance rivals many stereo cartridges selling at twice the Encel price. Write for complete specifications and for prices . . . better still, call and compare when you listen to several top quality cartridges.

ENCCEL

**ELECTRONICS (STEREO)
PTY. LTD.**

Head Office:

431 Bridge Rd., Richmond, Victoria 3121. Tel. 42 3762.

Sydney Store: Ground Floor, 25M Building

257 Clarence Street, Sydney, N.S.W. 2000. Tel. 29 4563, 29 4564.

Australia's Greatest Hi-Fi Centre *Wholesalers *Trade-ins accepted

TRADE RELEASES -- in brief

DISTRIBUTORS CORPORATION PTY. LTD., 24 Johnston Street, Fitzroy, Vic. 3065. **NUS Model 6100 Laboratory Velocimeter.** Designed to measure sound velocity in a variety of liquids. Determines precisely the dissolved salt content, acidity and liquid composition of a solution by relating sound velocity to solution concentration. Sensing head can be supplied for mounting directly into production plant piping. Can be used to monitor progress of chemical and biological reactions for the quality control of liquid mixtures in bulk production, and to characterise the physical and chemical properties of liquids, such as the bulk modulus, compressibility, specific acoustic impedance, and density.

HEWLETT-PACKARD AUSTRALIA PTY. LTD., 22-26 Weir Street, Glen Iris, Vic. 3146. **Transmission and Noise Measuring Set Model 3555B.** A voltmeter designed specifically for telephone transmission quality measurements. Has wide band-width for transmission-level measurements and is RMS-responding for noise measurements. Built-in, noise-weighting filters and impedance-matching transformers. As a transmission measuring

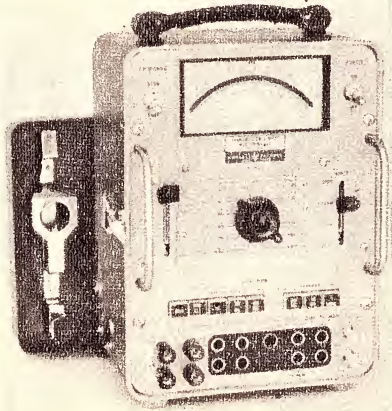

set, it has a frequency range of 20Hz to 3MHz, accuracy of 0.2dB midrange and better than 0.5dB at 1MHz, sensitivity of -90dBm. As a noise measuring set, has four noise-weighting characteristics selected by a lever switch. (C message, 3KHz flat, 15KHz flat, and program). Inputs terminated or bridging for 135, 600, and 900 ohm balanced, and for 75 ohms unbalanced impedances.

STABLE FREQUENCY STANDARD

ASTRONICS AUSTRALIA PTY. LTD., 622 - 626 Nicholson Street, North Fitzroy, Vic. 3068. Distributors for Rhode & Schwartz, West Germany. **Frequency Standard Type XSS.** Developed to meet the requirement for a highly stable frequency standard for measurement and control purposes. Contains a rugged shock-proof and extremely accurate 5MHz overtone crystal with an accuracy of 10^{-10} . The output frequencies of 5MHz, 1MHz, and 100KHz are delivered with a maximum error of less than five parts in 10^{10} per day and two parts in 10^{11} per second of measuring time. Since the frequency can be adjusted by the amount of five parts in 10^7 , the unavoidable aging of the crystal can be compensated.

Each output delivers 1V into 50 ohms. High spectral purity is ensured by using a low-noise, amplitude-controlled oscillator circuit; a DC amplifier for thermostat regulation, and mumetal shielding of the complete oscillator circuit. Permissible ambient temperature range is from -20 to +40°C. The thermostat temperature is set to the inversion point of the temperature coefficient of the crystal frequency, hence the frequency error due to fluctuations of the ambient temperature is less than five parts in 10^{11} per °C. No frequency overshoot occurs with abrupt changes in temperature, therefore brief changes in the ambient temperature have no effect.

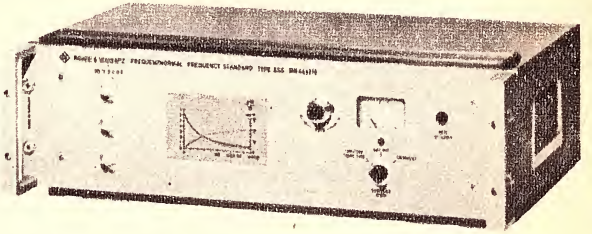

tor circuit; a DC amplifier for thermostat regulation, and mumetal shielding of the complete oscillator circuit. Permissible ambient temperature range is from -20 to +40°C. The thermostat temperature is set to the inversion point of the temperature coefficient of the crystal frequency, hence the frequency error due to fluctuations of the ambient temperature is less than five parts in 10^{11} per °C. No frequency overshoot occurs with abrupt changes in temperature, therefore brief changes in the ambient temperature have no effect.

AUSTRALIAN GENERAL ELECTRIC PTY. LTD., 103 York Street, Sydney, N.S.W. 2000. **A15 Rectifier.** Said to be significantly cheaper than stud or other lead-mounted units (depending on configuration). Available in quantity for applications such as time delay circuits, battery chargers, communication equipment, and small portable appliances. Rating 3A at 70 deg. C; 200 to 800V models are transient protected up to 1000 watts for 20µs in reverse direction; dual heat-sink design gives low thermal impedance and easy adaptation to printed circuit board mounting; sealed in an all-diffused glass passivated junction structure.

TECNICO ELECTRONICS DIVISION, Pte Industries Ltd., 53 Carrington Road, Marrickville, N.S.W. 2204. Distributors for Princeton Applied Research Corporation, U.S.A. **Princeton Model 220 Lock-in Amplifier.** Measures the amplitude of a low-level signal of constant frequency in the presence of noise. Continuously tunable from 1Hz to 110MHz with an output filter whose time constant is variable from 1ms to 30S. Sensitivity (dependent on the pre-amplifier) may be as great as 100nV full scale when used with the Princeton model 210 selective amplifier and model 211 pre-amplifier.

Continuously variable phase shifter. Operates either from externally generated synchronising signals or from its own internal reference signal.

RUTHERFORD ELECTRONICS PTY. LTD., 833 Doncaster Road, Doncaster, Vic. 3108. Distributors for National Semiconductor Corporation, U.S.A. **Field Effect Transistors, 2N3823, 2N4416, and 2N4416A.** Features; 18dB Power gain at 100MHz or 10dB gain at 400MHz; low noise figure of 2.0dB at 100MHz; or 4.0dB at 400MHz; low capacitance of 0.8pF; high gain of 4500µMhos. Suitable for VHF/UHF applications, such as RF, IF, video, wideband, and bilateral amplifiers, mixers and oscillators. Equipment uses include AM, FM, and SSB receivers and tuners; TV equipment; oscilloscopes; microwave receivers. **Read Only Memory MM521.** Constructed on a single silicon chip using a thick oxide P-channel MOS process, this 1024-bit read only memory is arranged as 256 x 4-bit words. It is ideally suited for code conversion, random logic synthesis, character generators, etc. Programming of the memory contents is accomplished by changes in one mask during the device fabrication. This procedure produces a non-volatile



Registered Trade Mark

ELECTROLUBE 2A-X

IMPROVES ELECTRICAL CONTACTS
INCREASES RELIABILITY AND
LOWERS MAINTENANCE COSTS

SAFE ON POLYSTYRENE, P.V.C. MAKROLON,
PAINTS, NATURAL AND SYNTHETIC
RUBBER NON-HAZARDOUS VAPOUR

Write for free Products Summary on the range of electrical and mechanical oils and greases

RFA

RICHARD FOOT (Australia) PTY. LTD.
63 Hume St., Crows Nest, N.S.W. Tel. 43-0326.

Available from leading
electrical wholesalers.

AVAILABLE LOCALLY



WORLDWIDE EXPANSION WITH SINCERITY & DEVELOPMENT

PALACE
ITOKA PRODUCTS CORPORATION
No. 1-4, 3-chome, Mita, Minato-ku, Tokyo, Japan.

A comprehensive range of products from the ITOKA CORPORATION

- Amplifiers
- Bookshelf speaker systems
- Tape decks.
- Microphones
- Preamplifiers
- Stereo and mono microphone mixers
- Stereo headphones
- Tuners
- Solid state modules
- Phono preamplifiers
- Tape preamplifiers
- Audio power amplifiers
- Code oscillators
- Guitar amplifiers

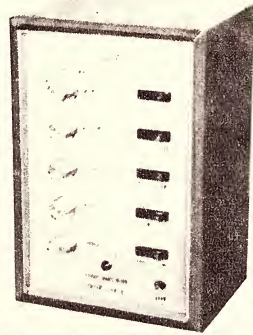

GENERAL ACCESSORIES

(A DIVISION OF ELECTRONICS INDUSTRIES)

116-118 CLARENCE STREET, SYDNEY 443 CONCORD ROAD, RHODES — 73-0211

BOTH STORES OPEN SATURDAY MORNING

HIWAY WEN

ELECTRIC SOLDERING GUN

Fastest gun in Australia!

REACHES WORKING TEMP. IN LESS THAN 15 SECS.
PERFECTLY SIZED FOR DELICATE WORK
PLENTY OF POWER FOR HEAVY JOBS



- Lightweight, compact, beautifully balanced
- Cool handle. Heat-power surges from tip
- On/off trigger switch
- Built-in light illuminates tip
- Replaceable long-life iron clad tip

2

GREAT NEW MODELS

WITH AUTOMATIC THERMAL REGULATION

MODEL 222. Has current draw of only 110 watts surge and 55 watts working. Delivers heat-power equivalent to normal 200-watt device. **\$15.95 RETAIL**

MODEL 450. Delivers the heat-power of a 450 watt device on only 220 watts surge and 110 watts working. **\$17.95 RETAIL**

TRADE ENQUIRIES

Contact the sole Australian distributors:

SUN ELECTRIC COMPANY PTY. LTD.
Melbourne • Sydney • Brisbane • Adelaide

H. C. Little & Co. Pty. Ltd., Perth
Errol Nazer Pty. Ltd., Canberra & Wagga
E. T. Burrows, Hobart



ELECTRICAL APPROVAL GRANTED

362

data storage. Gate protection diodes are used on all inputs to protect against static charge build up. Features include DC coupled logic on chip with no clocks required and high-speed operation of less than 1 μ S. The MMS21 is completely compatible with DTL or TTL logic.

CANNON ELECTRIC (AUST.) PTY. LTD., 58 Cluden Street, Brighton East, Vic. 3187. Agents for Motorola Semiconductor Products Inc., U.S.A. Inquiries on company letterhead only. **Monolithic Linear Multiplier MC1595.** A four-quadrant multiplier which gives an output voltage which is a linear product of two input voltages and a constant scale factor. Circuit designed so that the scale factor and the input/output voltage ranges may be adjusted to accommodate a wide variety of applications. Features: excellent linearity (typically 0.5 per cent for the X-input and 1 per cent for the Y-input); excellent temperature stability; wide input-voltage range to ± 10 V. Typical applications include: arithmetic operations, detection, modulation and demodulation, frequency doubling, direct-reading power measurements, trigonometric operations, and electronic gain control. **Plastic Encapsulated Transistors.** Two pairs of low-cost plastic encapsulated silicon transistors for use in complementary audio amplifiers. Encased in compact package (5/8 x 1/2 x 1/8in) for easy mounting. Efficient heat transfer with high power dissipation. MJE205 (NPN) and MJE105 (PNP) are 5A transistors for complementary audio amplifiers up to 20W. They have a collector-emitter rating of 50V, power dissipation

of 65W, and current gain of 25 to 100 at a collector current of 2A. MJE 2801 (NPN) and MJE2901 (PNP) are 10A transistors for use in amplifiers up to 35W. They have a collector-emitter rating of 60V, power dissipation of 90W, and current gain of 25 to 100 at a collector current of 3A.

SOLARTRON AUSTRALIA, 112 High Street, P.O. Box 138, Kew, Vic. 3101. **Digital Multimeter A.1613.** Includes digital measurement of capacitance as well as AC and DC voltages, AC and DC current, and resistance. Available with optional BCD printer output. Ranges: AC-



DC voltage 100 μ V to 1000V; AC/DC current 0.1 μ A to 2A; resistance 0.1 ohm to 2M; capacitance 0.1pF to 2 μ F. Accuracy ranges from 0.1pc of reading ± 1 digit on DC voltage to 0.3pc of reading ± 1 digit on capacitance. Common mode noise rejection is 130dB.

INDUSTRIAL & DOMESTIC EQUIPMENT CO., P.O. Box 163, Dandenong, Vic. 3175. Agents for Delco Radio, U.S.A. Inquiries on company letterhead. **Power Transistors.** 2N5241 NPN triple diffused silicon power transistor

for high voltage and switching applications. 2N5157 NPN triple diffused silicon power transistor for use in deflection circuits, switching regulators, and line-operated amplifiers. 2N5155 PNP germanium Nu-Base transistor for high peak power switching applications, e.g. high current inverters and ignition applications. DTS-100 series NPN triple diffused silicon power transistors for general use in voltage regulators, power amplifiers, and high efficiency switching circuits. DTS-410 NPN triple diffused silicon power transistor for switching applications of all types.

AUSTRALIAN RECORD CO. LTD., 11-19 Hargrave Street, East Sydney, N.S.W. 2010, has a new telephone number, 31-0255. The postal address of the company is P.O. Box 267, Darlinghurst, N.S.W. 2010.

INFORMATION ELECTRONICS LTD., 42 Mort Street, Braddon, A.C.T. 2601, has announced the formation of a marketing subsidiary, Computer Accessories Pty. Ltd. The managing director of the new company is Mr W. H. Andrew, formerly manager of his own Canberra company, known as A.D.P. Accessories and General Liaison Enterprises, the interests of which have been merged with those of Computer Accessories and I.E.L. Computer Accessories will continue to provide the products formerly offered by E.D.P. Accessories, and will expand that product range with other equipment manufactured by I.E.L. Mr Andrew was previously New Zealand sales manager and Canberra manager for International Computers (Aust.) Pty. Ltd.

GROUP ELECTRONICS PTY. LTD. is a recently formed company with a modern factory and offices at 47 Southern Road, Mentone, Vic. 3194; telephone 550-1085. The company has been formed by John Wright, formerly with D. R.

INSTRUMENTS FROM ANRITSU

WATSON VICTOR LTD., P.O. Box 100, North Ryde, N.S.W. 2113. Agents for Anritsu Electric Co. Ltd., Tokyo Japan. **Universal Counters MF47A, MF48A/B/C, MF51A/B/C.** Counters specifically designed with all IC components for the utmost reliability. The display consists of Nixie tubes with display storage — MF47 5 digits, MF48 7 digits, and MF51 8 digits. The frequency measuring ranges are 0.1Hz to 10MHz (MF47), 0.1Hz to 40MHz (MF48) and 10Hz to 100 MHz (MF51). The period measuring ranges are 67nS to 0.1S (MF47 and MF51), and 67nS to 10S (MF48). The counters can also be used for measuring frequency ratio, and for totalising. A digital output of 1-2-4-8-BCD is available for connection to data processing equipments. The input impedance is 1M shunted by less than 30pF. The model letters A, B and C indicate the internal standard frequency stability, model C being the most stable.

Digital Difference Calculator, MH35A. Used with any of the universal counters (MF47A, MF48A/B/C, and MF51A/B/C) it can provide the following functions: visual indication of a difference between an arbitrary reference standard and a frequency under measurement, and further display of evaluation as to whether its outcome is within the rated value or not; display checks of an indicating value measured by such a universal counter as to whether it is properly set within the limits; act as a pre-set counter.

Frequency Synthesisers, MC51A/B/C. Ultra-precision oscillators embodying the latest frequency synthesising techniques, and using a stable quartz crystal oscillator. Output frequencies of very high accuracy and purity in steps as small as 1Hz or 10Hz within the ranges from 200Hz to 10MHz and from 100KHz to 100MHz respectively. Selection is either by manual control using seven decade dials, or by electronic command for remote control at switching speeds up to 2mS.

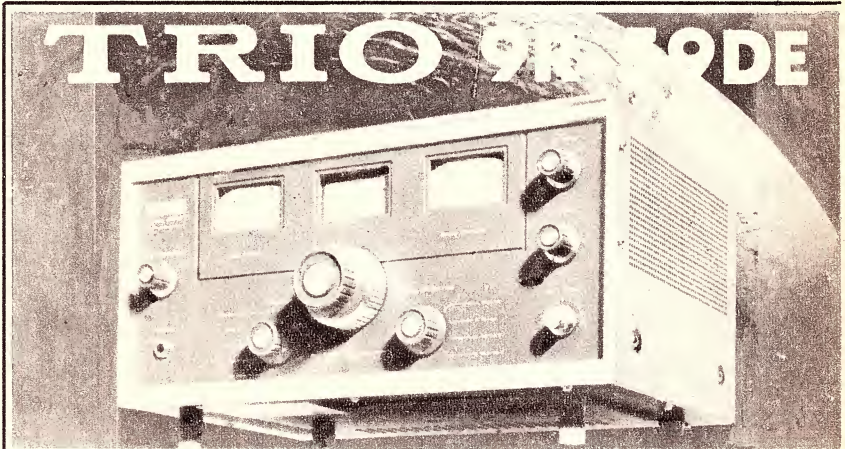

COMMUNICATIONS RECEIVER

- 4 BANDS COVERING 540 Kcs. TO 30 Mcs.
- TWO MECHANICAL FILTERS ENSURE MAXIMUM SELECTIVITY.
- PRODUCT DETECTOR FOR S.S.B. RECEPTION.
- AUTOMATIC NOISE LIMITER.
- LARGE TUNING AND BAND-SPREAD DIALS FOR ACCURATE TUNING.
- CALIBRATED ELECTRICAL BANDSPREAD.
- "S" METER AND B.F.O.
- 2 MICROVOLTS SENSITIVITY FOR 10 dB S/N RATIO.

PRICE: FOR/FOA SYDNEY: \$175.00

CONSULT YOUR LOCAL RADIO DEALER, OR

MAIL THIS COUPON *today*

Please forward free illustrated literature and specifications on Trio equipment.

Name

Address



SYDNEY, AUSTRALIA

(A unit of Jacoby Mitchell Holdings Ltd.)

376 EASTERN VALLEY WAY, ROSEVILLE, N.S.W.
Cables and Telegraphic Address: 'WESTELEC',
Sydney. Phone: 40 1212



The OS25 has set new standards for a low cost, dual trace oscilloscope. It is rugged, simple to operate and maintain and is attractively styled. Triggering facilities are unusually comprehensive for a low cost instrument of this type and include internal triggering from either channel.

This oscilloscope has a vertical amplifier bandwidth from DC to 5MHz with a maximum sensitivity of 100mV/cm on each channel. The time base gives sweep speeds from 1 sec/cm to 0.5 μ S/cm using switched and fine controls. The operating mode best suited to the time base speed is automatically selected by the time base range switch; beam switching for the two slowest speeds and alternate sweep for the four highest speeds.

A bright clear display is obtained on a 5 inch helical PDA tube operating at a potential of 3kV overall.

5 MHz Dual Trace Oscilloscope OS25

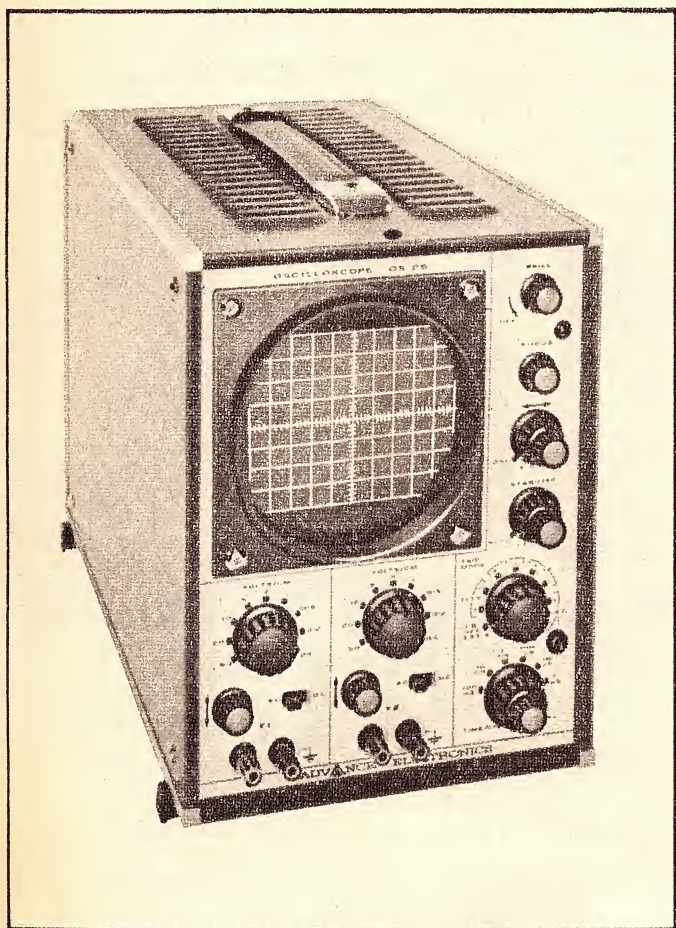

\$225

plus Sales Tax

EXCLUSIVE AUSTRALIAN DISTRIBUTORS FOR . . .

ADVANCE INSTRUMENTS

JACOBY MITCHELL
MELBOURNE
30-2491/2

ADELAIDE
53-6117

BRISBANE
2-6467

jacoby, mitchell & co.pty.ltd.
469-475 Kent Street, Sydney. 26-2651
PERTH
28-1102

LAUNCESTON
2-5322

FORTY YEARS WITH PHILIPS

The managing director of Philips Electrical Pty. Ltd., Mr E. W. Burnett (right), is congratulated on his completion of 40 years' service with Philips by the chairman of Philips Industries Ltd., Mr A. J. W. van Agt. Mr Burnett joined Philips in 1929 as a clerk in the Radio Valve Department at the Sydney head office. Following various promotions, he was appointed manager of the Miniwatt Division, and assisted in the establishment of Philips' manufacturing plant at Hendon, near Adelaide. In 1957, Mr Burnett was appointed an associate director of Philips



Electrical Industries and, in 1964, became a director of that company. In 1965, he was elevated to managing director of Philips Electrical Pty. Ltd., the major trading company of the group.

Johnston and Co. Group Electronics has negotiated a number of arrangements with several American organisations, covering the industrial, military and medical electronics markets. The policy envisaged by the company is to manufacture certain equipments under licence from overseas principals.

HAWKER DE HAVILLAND AUSTRALIA PTY. LTD. has reached an agreement with Coubro and Scrutton Ltd. (U.K.) for the marketing and manufacture in Australia of communication antenna systems. Coubro and Scrutton is a leading U.K. designer and manufacturer of communication antennas ranging from LF to microwave. Hawker de Havilland will market the full range of equipment; local manufacture will be to Coubro and Scrutton designs. Mr Peter Park, formerly managing director of Coubro and Scrutton's Australian subsidiary, has been appointed communications manager of the Electronics Division of Hawker de Havilland, and will be responsible for the new activity.

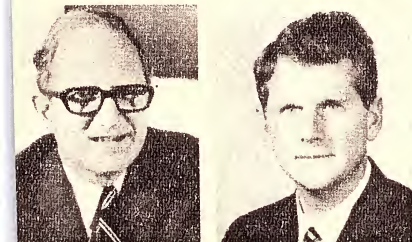

Mr Peter Park Dr J. G. Campbell

PERKIN-ELMER PTY. LTD., 269 Princes Highway, Dandenong, Vic. 3175, as announced that the company managing director, Dr James G. Campbell, is overseas on an 8-week tour. He is visiting the headquarters of the Perkin-Elmer Corporation in the U.S.A., and subsidiary affiliated manufacturing plants and offices in Africa, Europe, North America and East Asia. Mr Peter Sadesky, southern sales manager of the company, has returned from visiting Perkin-Elmer manufacturing plants in the U.S.A., U.K. and West Germany. He also attended the society of Applied Spectroscopy Conference in Cleveland, U.S.A., and Labex International in London, England. Mr Sadesky also took part in a mass spectrometer symposium at Perkin-Elmer's office in Gothenburg, Sweden.

RCA OF AUSTRALIA PTY. LTD., 11 Hartoum Road, North Ryde, N.S.W.

2113, has changed its name to RCA Limited. The company has also announced that Mr Ray Sheldrick has been appointed to the newly created position of merchandising manager, Technical Products Division. Formerly, Mr Sheldrick had been stationed in RCA Great Britain television field service, and was then transferred to the camera products management division in Camden, New Jersey, U.S.A. There he was involved with the training of studio staff for the operation and maintenance of the TK 42 colour television camera. He returned to Australia to exhibit the TK 42 camera at the 1967 I.R.E.E. Convention and also at ATVO, Melbourne. He has since assisted in the development of the TK 44 colour camera, demonstrated at the 1969 I.R.E.E. Convention.

SIEMENS INDUSTRIES LTD. has constructed a new seven-storey building for its Communications Division adjacent to the present office building at Richmond, Victoria. The additional 79,300 square feet of floor space will enable Siemens to expand its production of teleprinters, cradle relays and channel modulator equipment. Many components previously imported are now mass-produced at Siemens' factory. Siemens is exporting precision teleprinter camshafts, cradle relays and teleprinters to various countries.

AURIEMA INTERNATIONAL GROUP has been appointed international marketing managers for the Instrument System Division of ISD Whittaker Corporation, and for the newly developed range of microwave products of Electromagnetic Information Processing Laboratories (EIP), both companies of the U.S.A.

ISD Whittaker is a combination of established companies in the instrumentation field, and represents a single source for a wide range of instrumentation equipment and accessories. Companies included in the combine are: Pace Engineering Co., Wiancko Engineering Co., Photocon Research Products, Micro-Systems Inc., and Fluid Components Co. Their products derive principally from requirements in aerospace, aircraft, ground support equipment, rockets, wind tunnel, and atomic energy fields.

The microwave product line of EIP includes the Model 101A YIG-tuned Crystal Video Spectrum Analyser (0.7 to 18.0GHz), the Model 202A Frequency Converter (which extends the range of the 101A down to 50MHz), and the Model 301A Frequency Meter (covers 3 to 18GHz in a single unit). Further information about ISD Whittaker and EIP products may be obtained from Auriema (Australasia) Pty. Ltd., 443 Kent Street, Sydney, 2000.

UNITED TRADE SALES

PTY. LTD.

SPECIAL

8020 H.W. RECTIFIERS.
NEW, 35 cents each.
G.E.C. SM5 24 volt 670 ohm Sealed Relays. 50 cents ea
Pack and Postage 20 cents

VALVES

ATS25 (807) 70c ea. 815's 70c. 6J6 30c ea. 6AC7 20c ea. VR 150/30 75c ea. QB2/250 Phillips \$7 ea. DM71 30c ea.
Pack and Post 10 cents

CATHODE RAY TUBES

GEC 14" E4412 \$3 ea. E4103 \$3 ea. Data and Pin Connections supplied with each Tube.
Pack and Post 30 cents.

RELAYS

3000 Type 50c ea.
Pack and Post 20 cents.

MILLER TRANSISTORISED IF STRIPS

455 Kc Selectivity 5 Kc at 6db down Power 6 Volts 2mA gain 50db.
Price: \$9.70.

NEW PIANO KEY SWITCHES

5 KEY, Special at \$1.00 each.

CAPACITORS

80 for \$2 in Poly Packed Bags. Mixed values only.

COMPLETE RANGE OF METERS

P25's 2½sq
100uA .. \$6.95 1mA .. \$4.50
500uA .. \$5.25 50mA .. \$4.50
10mA .. \$4.50 S'meter .. \$5.25

MULTIMETERS, 200H, 20K ohms per volt, \$11.25, inc. tax. CT 500 20K ohms per volt, \$15 inc. tax. CT 330 20,000 ohms per volt, \$17.25.

RESISTORS. Mixed Values only in Bags: \$2 per 100, or 50 for \$1. 3,000 Type Relays. New stocks. 50c each. Plus postage.

TRANSISTOR V.H.F. CONVERTER Tunable 108-136 Mhz Aircraft Band IF-600Kc to 1,000Kc. No connecting wires needed, 9V Battery, self-contained, just place alongside broadcast radio. Price only \$14.40 plus 45c postage.

WANTED BUY:

RECEIVERS, TRANSMITTERS, TEST EQUIPMENT.
All prices subject to alteration without notice.

All items PLUS POSTAGE.

UNITED TRADE SALES

PTY. LTD.

280 LONSDALE STREET,
Melbourne. Phone 663-3815
Opposite Myers

Let The World University Of Postal Education TRAIN YOU FOR A KEY JOB

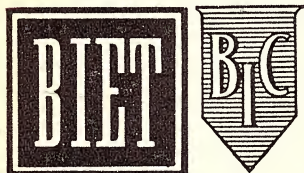

BRANCHES THROUGHOUT THE WORLD

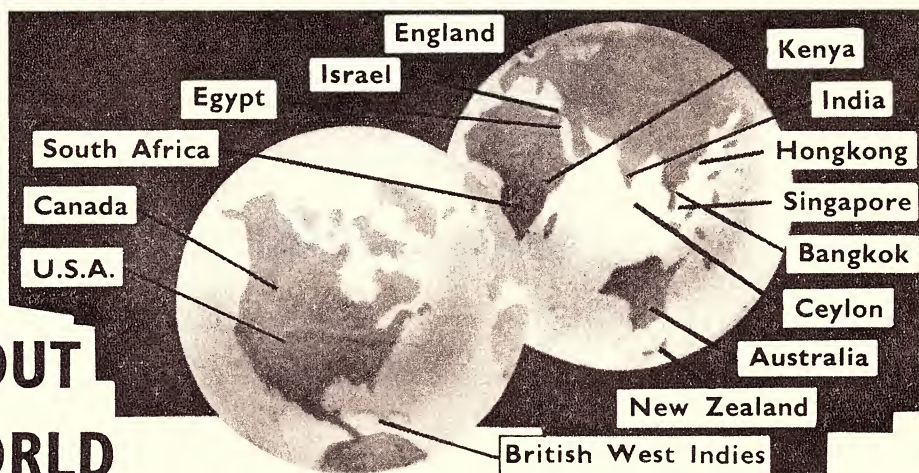

TODAY there are wonderful Opportunities for the forward-looking man and woman. However, the best jobs go to those who have the foresight to prepare themselves by proper Training. British Institutes have already trained some 300,000

men and women who have reached the top of the ladder. Therefore, it is up to **YOU** to make something of yourself. Don't delay, act **NOW**. Remember that an enquiry places you under no obligation but could be the turning point in **YOUR** career.

OVER 500 COURSES

Courses offered by British Institutes include:—

TECHNICAL

Aero Engines
Aeronautical Eng.
Air Conditioning
Arch. Drwg. & Design
Automation
Auto Elec. Equipment
Automobile Eng.
Automobile Repairs
Building (General)
Carpentry & Joinery
Chemical Engineering
Civil Engineering
Computers
Die & Press Tools
Diesel Engines

Draughtsmanship
Electrical Engineering
Elec. Installations
Elec. Measurements
Electrical Power
Electricity Supply
Electronics
Foundry Practice
Garage Management
Gas Turbines
Geology
Hydraulics
Illuminating Eng.
Industrial Chemistry
Jig & Tool Design
Mach. Drwg. & Design
Maintenance Eng.

Management
Marine Engineering
Mechanical Eng.
Metallurgy
Municipal Engineering
Naval Architecture
Painting & Decorating
Patternmaking
Petroleum Technology
Plastics
Production Eng.
Radar Technology
Radio Engineering
Radio Servicing
Refrigeration
Reinforced Concrete
Road Engineering

Rubber Technology
Sanitary Engineering
Structural Eng.
Surveying
Telecommunications
Television
Television Servicing
Timber Technology
Tracing
Welding Technology

Business M'gement
Commercial Art
Commercial Law
Company Law
Costing
Economics
Fiction Writing
Journalism
Secretaryship
Selling

COMMERCIAL

Accounting
Advertising
Auditing
Book-keeping

GENERAL

English
European Languages
Mathematics
Shorthand
Typewriting

And many other Subjects.

Details of Engineering and Commercial Exams., Certs. of Competency, Matriculation, etc.

CHECK THESE FEATURES:

- Modern streamlined methods . . . you learn the fast way and make rapid progress.
- Courses based on STANDARD TEXT-BOOKS . . . Lessons and Model Answers written and planned by experts.
- We provide all necessary text-books which remain your own property.
- Moderate fees payable by small monthly sums. Written guarantee.
- Courses can be "tailored" to individual requirements.

SECURE ONE OF THESE BOOKS



POST COUPON NOW!

BRITISH INSTITUTE OF CAREERS

College House, 113 Pacific Highway, North Sydney, 2060

I am interested in
Please send me the appropriate Career-Book.

NAME (PLEASE PRINT)

ADDRESS

E.L.-W-9

Occupation Age

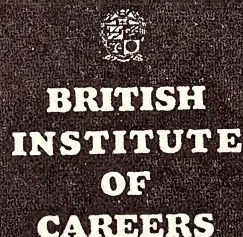

In association with
British Institute of
Engineering Technology

THE B.I.C. GROUP LEADS THE WORLD IN POSTAL TRAINING

TECHNICAL BOOKS AND PUBLICATIONS

Network analysis . . . "Commendable text"

INTRODUCTORY TOPOLOGICAL ANALYSIS OF ELECTRICAL NETWORKS, by Shu-Park Chan. Published by Holt, Rinehart and Winston, Inc., New York, 1969. Hard covers, 6in x 9½in, 482 pp., circuits and diagrams. Price in Australia \$16.75.

As the title itself will probably convey, this is a book intended primarily for graduates, senior undergraduate students and practising circuit designers. The author is Professor of Electrical Engineering at the University of Santa Clara, California, and the book is based largely upon his lecture notes prepared for courses covering modern network analysis and network graph theory.

In view of the growing application of digital computers to electronic circuit design and analysis, Professor Chan has strongly orientated his book toward analytical techniques which are evolving as those most valuable for "C.A.D." (computer-aided design). Hence the emphasis upon matrices, flow graphs, and other types of topological analysis.

The chapter headings of the book are as follows. 1—Elementary Network Topology; 2—Matrices of a Graph; 3—Duality; 4—Matrix Representation of Network Equations; 5—Topological Analysis of Passive One-Ports; 6—Passive Two-Port Topological Analysis; 7—Flow-Graph Techniques of Linear System Analysis; 8—Topological Analysis of Active Net-

works; 9—Topological Applications to Switching Networks; 10—Introduction to Topological Synthesis and Other Applications.

In order to make the book self-contained as much as possible, there are five appendices intended as introductions or reviews of the basic prerequisite concepts necessary for meaningful reading of the book itself. In turn, the appendices deal with theory of determinants, matrices, and systems of linear equations, and then with the methodological concepts of "necessary and sufficient conditions" and "methods of proof."

To this reviewer the book seems to be written with a commendably smooth and concise style, and possesses a high readability level. There are numerous illustrative examples given throughout the text, while all definitions, proofs and important concepts are stated concisely and emphasised in a most thorough manner. Each chapter concludes with a set of tutorial problems, while at the end of the book itself the author has provided a list of some 85 suggested references to assist those wishing to pursue the various topics further.

In short, then, a book which I find highly commendable in every way, and one which seems destined to become a standard text for courses in modern circuit and network analysis.

The review copy came from the local office of the publisher, who advises that the book is already in stock at most major bookstores. (J.R.)

Microcircuit design and application

MICROCIRCUITS AND THEIR APPLICATIONS, Edited by W. Gore. Published by Iliffe Books Ltd., London, 1969. Hard covers 8½in x 5½in, 250 pp., many circuits and diagrams. Price in U. 90s.

An up-to-date treatment of microcircuit design techniques and applications, written by a group of specialists in the field. While quite broad in scope it is at the same time detailed and thorough, features which should make it of interest both to the practising engineer seeking a guide for use of the new technology, and also to the engineering student and advanced amateur seeking an introduction to the broad concepts.

Probably the most efficient way to convey both the scope and current relevance of the book is to list the chapter headings, which are as follows. 1—Manufacturing Techniques for Silicon Integrated Circuits; 2—The Specifications and Design of Film and Hybrid Integrated Circuits; 3—The Evolution of Transistor-Transistor

Logic Circuits; 4—The Philosophy of Linear Integrated Circuit Design; 5—Linear Integrated Circuits; 6—Quality and Reliability Assurance Procedures for Monolithic Microcircuits; 7—Packaging Techniques for Electronic Systems; 8—General Purpose Linear Circuit Applications; 9—Integrated Circuit System Design; 10—Digital Techniques in Microelectronics; 11—A Philosophy of Microminiature Computers; 12—Microcircuits in the Control of Thyristors; 13—Design Considerations for 1-2nS Circuits and The Interconnection Possibilities of E2CL Gates; 14—Cost Evaluation: The Economics of Integrated Circuits versus Discrete Components; 15—Metal Oxide Semiconductor—Techniques; 16—Large-Scale Integration; 17—Domain Originated Functional Integrated Circuits; 18—Future Trends in Large-Scale Integration.

Variations in style and even readability tend to be the inevitable outcome of multiple authorship; however, fairly close examination of the present book suggests to this reviewer

that in this case the variations are quite minor. The communication level of the various contributions seems consistently high throughout, and is matched by a notable similarity of style. In short there seems every evidence that both the contributors and the editor of the work have worked hard to avoid the pitfalls into which other works of this general type have fallen.

For those seeking an up-to-date picture of modern microcircuit technology, here is one with very worthy qualities.

The review copy came directly from the publishers, and no information is to hand concerning local price and availability. However as the publication date in the U.K. was early this year, it is likely that stocks will be held by the larger Australian bookstores by the time this review appears. (J.R.)

Thermal physics

THERMAL PHYSICS, by Edward A. Desloge. Published by Holt, Rinehart and Winston, Inc., New York, 1968. Hard covers, 6in x 9½in, 363pp, many diagrams. Price in Australia \$10.45.

A basic text on thermodynamics, intended particularly for undergraduate courses in science and engineering. The author is Associate Professor of Physics at Florida State University, and has written the book with the aim of helping the student to gain somewhat greater insight into the subject than tends to be provided by the traditional treatment combining historic and "macroscopic" approaches.

The approach which Professor Desloge has adopted involves the initial proposition of a basic set of theoretical postulates using a "molecular" or microscopic viewpoint based on atomic theory. The postulates are then methodically examined both historically and in terms of macroscopic phenomena, providing the student with a unified and consistent picture of the subject and one which may more easily be correlated with concepts gained in other fields.

The text of the book is divided into seven parts, whose titles are as follows. 1. The Basic Principles of Thermodynamics for Simple One-Component

A.R.R.I. THE RADIO AMATEURS HANDBOOK 1969

For over forty years an indispensable part of the amateur's equipment.

Treatment of radio communication problems in terms of how-to-do-it rather than by abstract discussion.

PRICE \$5.85. Post 35c.

R.S.G.B. RADIO COMMUNICATION HANDBOOK

The fourth edition of the handbook is invaluable not only to the amateur but also the professional engineer.

PRICE \$10.50. Post 50c.

Available from:

COLLINS BOOK DEPOT PTY. LTD.
363 SWANSTON ST., MELB. 3000.
Phone 663-3787

Stock lists available free of charge on any subject of interest to you.

THE

TANNOY

Monitor

GOLD

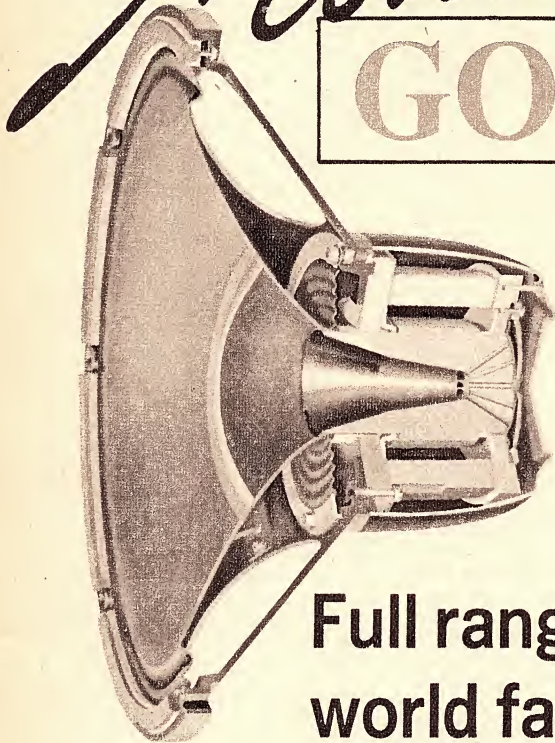

Full range world famous dual concentric loudspeakers

The Monitor Gold is a further refinement in the almost legendary range of Tannoy Dual Concentric Loudspeakers. An entirely new crossover network not only provides facilities for adjusting treble energy to suit prevailing acoustic conditions, and treble roll-off to accommodate variations in programme material, but also gives a smoother frequency response in the middle treble register together with a more constant impedance characteristic; thus ensuring the highest performance from modern transistor amplifiers. The impedance is nominally 8 ohms but never falls below 5 ohms.



Distributed through the Consumer Products Division of

AMALGAMATED WIRELESS (AUSTRALASIA) LIMITED

554 PARRAMATTA ROAD, ASHFIELD. 71 0791

167 Queen Street, Melbourne. 67 9161 • 70 Merivale Street, Brisbane. 4 1631
• Cnr. Darby and King Streets, Newcastle. 2 5166 • 231-233 Bulwer Street,
Perth. 28 6400 • 48 King William Road, Goodwood, Adelaide. 72 2366 • 42
Frederick Street, Launceston. 2 1804 • 123 Murray Street, Hobart. 3 3836-7

Systems; 2. Methods of Thermodynamics; 3. Some Consequences of the Basic Principles of Thermodynamics; 4. Application of Thermodynamics to Some Simple Systems; 5. Thermodynamics of Multicomponent Systems; 6. Thermodynamics of General Systems; 7. Thermodynamics of Steady States. Following the text itself there are seven appendices dealing with specific mathematical techniques, 14 data tables of physical quantities, a comprehensive bibliography, answers to tutorial problems given throughout the text, and an index.

Throughout the book the exposition is both lucid and highly concise, and in the opinion of this reviewer the author has succeeded admirably in presenting a unified, satisfying and up-to-date treatment of a subject which not long ago was one of the most poorly presented, and hence difficult, elements in science and engineering degree courses. I have therefore no hesitation whatever in warmly commending the book both to students and to lecturers responsible for the appropriate courses.

The review copy came from the local office of the publisher, who advises that copies are already in stock at all major bookstores (J.R.)

LITERATURE—in brief

TELECOMMUNICATION JOURNAL, Vol. 36, No. 5, May, 1969. Published by the International Telecommunication Union (ITU), Place des Nations, 1211 Geneva 20, Switzerland. Contents: The Doppler effect in radio astronomy, by A. J. Higgs; Evolution of the international routing plan, by I. A. Newstead; The effect of income and social class on residential telephone demand, by Bjorn Wellenius. The section "Union Activities" includes a report on the Secretary-General's visit to East Africa, and a report on training of technical staff for the P.T. and T. Ministry in Kuwait.

Under the heading "Ideas and Achievements" are described optical communications experiments at 6328A and 10.6 microns, the Mariner mission to Mars, and a new radio telescope under construction in the U.K. A large map showing details of ITU's technical co-operation projects throughout the world is included as a supplement.

MI CONTACT, Issue 10 (E). Published by Marconi Instruments Ltd., St. Albans, Herts., England. Contents include: Low-cost counters make their mark; Iran airports contract; More Autotest ordered; Government sales and service; 10Hz to 10MHz oscillator; Slightly used instruments for sale; MI Sanders introduce new microwave oscillators; Waveguide business booming; New microwave signal sources; General purpose klystron power supply; Direct reading microwave frequency meter; Measuring frequencies up to 510MHz; Record American orders; TF 2700 Universal Bridge a best seller; Short form catalogue. Inquiries should be directed to the Australian representatives, Amalgamated Wireless (Asia) Ltd., P.O. Box 96, North Ryde, N.S.W. 2113.

OPERATIONAL AMPLIFIER SPECIFICATION GUIDE. Published by National Semiconductor Corporation, Santa Clara, California, U.S.A. This folder provides essential data on National Semiconductor's line of military and commercial integrated circuit operation amplifiers. Inquiries should be addressed to the Australian representatives, Rutherford Electronics Pty. Ltd., 833 Doncaster Road, Doncaster, Vic. 3108.

INDUSTRIAL RESEARCH NEWS, No. 74, March, 1969. Published by the Industrial and Physical Sciences Branch, Commonwealth Scientific and Industrial Research Organisation, 314 Albert Street, East Melbourne, Vic. 3002. Contents: Optical gratings now made in Australia; Research leads to milk protein exports; Railway to Gulf?; FLATEST program; Versatile new tiles.

NEW TECHNOLOGY, No. 26, March, 1969. Published by the British Ministry of Technology and the Central Office of Information. Available free of charge from the Central Office of Information, Hercules Road, Westminster Bridge Road, London SE1, England. Contents: The Changing Face of Telecommunications; The Mixed-Flow Fan Club Grows—with Help from NEL; Industrial Hydrodynamics at NPL; Drilling Rig Tests at HRS; News, Statistical Indicators.

MULLARD OUTLOOK, Vol. 12, No. 2, March-April, 1969. Published by Mullard-Australia Pty. Ltd., 35-43 Clarence Street, Sydney, 2000. Contents: Viewpoint with Mullard; Colour television, part 4 — historical survey; Voltage controlled oscillators using FC family of integrated logic circuits; Original Wentworth Hotel historic links with I.R.E.E. Australia; Electronics in domestic appliances, part 2 — thyristor ratings and characteristics; Low level amplifier using TAA293; New EHT rectifier with 12KV rating; New range of Ferroxcube inductor cores; The YIG (typical application as a light modulator); New capstan transistors for VHF mobile transmitters; Integrated microphone preamplifier; Chromaticity diagram cover; Clean room at Mullard U.K. research laboratories; "CN" approval for integrated circuits; 20W and 40W power amplifier.

STANDARDS ASSOCIATION OF AUSTRALIA is seeking comment on a draft Australian standard code of recommended practice for the control of undesirable static electricity. The draft is being issued as Doc. 1393. The draft includes recommendations for controlling static electricity where it may cause hazards or inconvenience. Considerable introductory material explaining the factors associated with static electricity generation and control is also included together with principal methods for controlling static electricity generated by solid objects, persons, liquids, dusts and gases. Copies of Doc. 1393 may be obtained without charge from the Headquarters of the Association, 80 Arthur Street, North Sydney, N.S.W. 2060, or from branch offices in State capital cities and Newcastle. Comment should reach the Association not later than August 31, 1969.

PLANAR, April/May 1969. Published by Fairchild Australia Pty. Ltd., 420 Mount Dandenong Road, Croydon, Vic. 3136. Contents: Putting the uA741 to work — some of the many applications of this monolithic operational amplifier; The Fairchild 7050 digital multimeter — the specifications of this latest addition to the Fairchild range of digital meters; Time marches on precisely — the principles of a digital clock; Radiation resistant devices — types and effects of radiation on devices to meet military specifications; Micromatrix wins top product award — the Fairchild 4500 Bipolar Micromatrix Array containing the electrical equivalent of 352 discrete components.

HEWLETT-PACKARD JOURNAL, Vol. 20, No. 4, December, 1968. Published by the Hewlett-Packard Company, Palo Alto, Calif., U.S.A. Contents: Rapid analysis of low frequency spectra — the use of automatic amplitude ranging and electronic sweeping; High dynamic performance X-Y recorder — introducing the HP Model 7004A X-Y recorder with a pen capable of an acceleration in excess of 1200in/sec or 3G; A low-cost, general-

purpose oscillator — two small, light-weight Wien-bridge oscillators; Amplitude stability with a zener level detector — a method of improving the amplitude stability of an oscillator by biasing a peak detector from its own output. Inquiries to Hewlett-Packard Australia Pty. Ltd., 22-26 Weir Street, Glen Iris, Vic. 3146.

PROCEEDINGS OF THE 5TH INTERNATIONAL CYBERNETICS CONGRESS, held in Namur, Belgium, from 11 to 15 September, 1967. Published by the International Cybernetics Association, Palais de Expositions, Place Andre Rijckmans, Namur, Belgium. This Congress marked the 10th anniversary of the founding of the Association and concluded with an academic session honoured by the presence of H.M. the King of the Belgians. The aim of the Association is to maintain a permanent and organised liaison between scientists whose work in various countries is connected with any aspect of cybernetics. The association also publishes a quarterly journal, "Cybernetics."

TECHNICAL COMMUNICATIONS, Vol. 10, No. 97. Published by Mullard Ltd., Torrington Place, London W.C.1, England. Contents: Channel multiplier plates for imaging applications — the exploitation of single-channel electron multipliers to produce two-dimensional arrays of multipliers for image detection and intensification; Pincushion correction and convergence for 625-line colour receivers — simple circuits for a high standard of convergence with good raster shape; Magnetic units in SI — the SI magnetic units derived from basic magnetic theory, with a conversion table for cgs and SI units; DC amplifier to drive an electrolytic ampere-hour meter — a long-tailed pair transistor amplifier converts a DC signal from up to 100mV input to a 5mA current to be passed through an electrolytic A-H meter. Inquiries to Mullard Australia Pty. Ltd., 35-43 Clarence Street, Sydney, 2000.

LEL DIVISION, Varian Associates, Copiague, N.Y., U.S.A., has published a 17-page catalogue describing the division's line of microwave, RF and IF receiving systems and components. The catalogue includes sections on integrated circuits, microwave receivers, converters and mixer preamplifiers. In addition it describes the LEL line of strip line components. Inquiries to Varian Pty. Ltd., 38 Oxley Street, Crows Nest, N.S.W. 2065.

NOTES AND ERRATA

ECONOMY Q-METER (June 1969): A small number of copies of the June 1969 issue were printed with the top-most illustration of page 47 laterally reversed due to a printing error. The illustration concerned is a reproduction of the rear of the instrument front panel, and should have appeared with the rear of the meter barrel visible on the right-hand side, as shown in the small reproduction below.

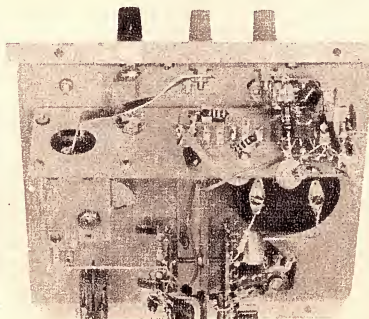

PLAN YOUR FUTURE

CHOOSE a career in the field of ELECTRONICS* — the Nation's most progressive and fastest expanding industry.

✳ Advancement in this modern science demands technical ability, a sound knowledge of basic principles and applications.

YOU can master the subject by training at the MARCONI SCHOOL and be ready to grasp the opportunities that occur in the three fundamental branches of Radio-technology.

KNOW WHERE YOU'RE GOING

A = APPLIED SERVICING

Comprehensive training in the maintenance and repair of radio and television receivers offers substantial rewards to competent technicians. Marconi School training covers all aspects of radio and television receiver circuit applications, practical exercises in fault finding and alignment procedures.

B = BROADCASTING

A thorough and practical grounding is available to students in broadcasting transmitter performance standards and maintenance techniques, with individual instruction in station operation and studio control and testing.

C = COMMUNICATIONS

Combines all the foregoing, together with radio aids to navigation, mobile telephony, marine service application and international wireless telegraph regulations, qualifying the successful student for the Commonwealth Government Certificate of Proficiency and the Marconi School Diploma in Radiotechnology.

Classes are conducted at 21 Pier Street, Sydney (at the foot of Goulburn Street).

Daily: 9.30 a.m. to 4.30 p.m.

Evenings: 6 p.m. to 8.30 p.m.

or by Home-Study Courses (except practical instruction on equipment).

STUDY NOW

Send for training syllabus. There is no obligation.

NAME.....
ADDRESS.....

the MARCONI SCHOOL of wireless

G.P.O. Box 2516, Sydney
A Service of Amalgamated Wireless (Australasia) Ltd.



AMATEUR BAND NEWS AND NOTES

International Call Areas Award Announced

The latest issue of the International Amateur Radio Club newsletter gives details of the formation of an organisation to promote a new world-wide DX award.

by Pierce Healy, VK2APQ

The decision to promote the award followed a meeting of several DXers from five continents, meeting in Geneva, then in London, who expressed their wishes to have an international award that would promote and stimulate friendly and skilful DX operation on ALL BANDS from 1.8MHz to 29.7MHz, all modes possibly being used.

In order to find out if this new approach to international co-operation in the amateur radio service was feasible, a private investigation was made by Gerard de Buren, HB9AW/WA6QAU, in August, 1968. Some 40 DXers, many on the top of the DXCC Honours Roll, were consulted. No objections to the proposal were received.

A working group was organised in London and a draft of the rules set out. It was decided to set up an international organisation with a board of directors chosen from among the most active and respected amateurs of each continent. Geneva, the international city of this age, was chosen for the headquarters.

The name decided on for the new body is International DX Organisation (IDXO). Roy Stevens, G2BVN, has accepted the office as chairman of the board of directors for an initial term of two years. Gerard de Buren, HB9AW/WA6QAU, who originated the idea in 1967, is co-ordinating the project and handling the secretarial work. He is assisted by Len Jarrett, HB9AMS/VE3EWE, administrative director of the Boy Scouts World Bureau, now in Geneva; and by a team of competent DXers.

It is pointed out that this new organisation is not, and will not be, in conflict with either the International Amateur Radio Union or the International Amateur Radio Club (IARC). Neither of these has an international award similar to the new "International Call Areas Award (ICAA)," therefore no point of friction could ever occur. The IDXO will put emphasis on some very important aspects of the amateur radio service.

1. It will adhere strictly to the I.T.U. Regulations (Geneva 1959) etc. This means that:
 - a. Banned countries will not count. Luckily, there are only three.
 - b. Prefixes not in line with I.T.U. Regulations will not count. The IDXO will not recognise the following prefixes: AC; AC3; AC4 (but 9A1 is acceptable); PX; UB5; UY5 (but UT5 is acceptable); UR2 and 7G1.

lowing prefixes: AC; AC3; AC4 (but 9A1 is acceptable); PX; UB5; UY5 (but UT5 is acceptable); UR2 and 7G1.

- c. The 1 series as 1M, 1S not being in agreement with I.T.U. Regulations, will not count either.
2. It shall be the general principle, normally, that UNINHABITED islands or places or demilitarised and neutral zones, will not be recognised. This means that Bajo Nuevo, Bouvet, Clipperton, Cormoran, Heard, Malpelo, Maria Theresa, Nevasa, St. Peter and St. Paul, San Felix, Serrana, and perhaps a few others, will not count.
3. Consideration will be given to:
 - a. Wide-spaced areas for propagation research and studies;
 - b. Radio amateur population.

IARU Region I Convention

As these notes went to press, a report was received on the IARU Region I Convention held in Brussels in May at which 34 societies were represented. A full report will be given next month. VK2APQ.

Here, a brand new concept, and a good one according to the first DXers reactions, is presented for the first time since 1937. The DXers will have to forget to think in "countries" and from now on will talk about so many "Call Areas" worked and/or confirmed and QSL's exchanged.

For the ARRL/DXCC, the United States of America counts as one country: but for the IDXO/ICAA there will be 48 Call Areas, each State counting separately.

4. Promoting ALL SIX BAND OPERATION and INCREASING THE USE of all HF bands around the world are the basic motivations of this world-wide project.

Here recognition and tribute are paid to the pioneering work of the DARC (German Amateur Radio Club) for their excellent all band promoting award: the WAE (Worked all Europe).

Congratulations also to ARRL for their one-shot extension of DXCC into 5BDXCC.

5. The International Call Areas Award will not be and cannot ever be saturating.

6. Several categories are available for the award and also separate classes for single operator and for multi-operator/radio clubs.
7. A certain number of call areas have to be worked and confirmed irrespective of the bands, like the DXCC, but the same call areas will have to be worked on different bands to reach the minimum of points required for the category of award aimed at, as for the WAE.
8. Record books will be made available to those participating in the contest.
9. Commencement working date, on six bands: January 1, 1969.

A full set of rules adopted by the IDXO board of directors will be released and published, world-wide, in the very near future.

Time will tell to what extent the efforts involved in the project will be rewarded.

In answer to the question, "Is it worth while trying?" one of the top DXers in the world said:

"With the present problems, which have developed in connection with DXCC, there is need for a new and popular DX award. Several attempts have been made by different groups; however, none of these seem to have caught on. Perhaps the international aspect of the ICAA will permit it to succeed where others have failed. In any event, I certainly agree that the attempt is very worthwhile."

Commenting on the project, one of the directors wrote:

"I think this should be a very exciting program, and a very popular award once it is publicised. What makes it particularly interesting is that the original members of IDXO have gone to the effort to include a multitude of high population areas, in the U.S.A., Japan, etc. This will make it a lot more popular."

It is hoped to give further details of this new award as soon as full details of the rules and sections come to hand.

Result of IARC DX Competition

Logs were received from 130 entrants in the 1968 IARC DX Competition and 90 entrants qualified for the CPR (Contributed to Propagation Research) Certificate.

The highest scores recorded were:
Single Operator—Single Band
CW—UA9BZ 17,520 points
Phone—SM7CSN 35,664 points
Single Operator—All Bands
CW—OK2RZ 87,550 points
Phone—XW8AX 238,100 points
Multi-operator Mixed Modes
PE2EVO 94,714 points

Mobile
ZL2AQV 3,800 points
Radio Teletype
PE2EVO 1,134 points

The best Australian and New Zealand scores were:

Single operator—Single Band
CW—14MHz ZL1BDN 3,720 points
ZL1QW 3,480 points
Phone—21MHz VK3ABA 3,474 points
Single operator—All Bands
Phone—VK2XT 89,595 points

I.A.R.U. Region III

Three of the national amateur radio bodies, the Wireless Institute of Australia, Japan Amateur Radio League, and

News and notes of Divisional and Club activities submitted for inclusion in these columns should be forwarded direct to Pierce Healy, 69 Taylor St., Bankstown, N.S.W. 2200.

the New Zealand Association of Amateur Radio Transmitters, have signed the Interim Constitution of the International Amateur Radio Union, Region III Association. At the time these notes were compiled, a reply was still awaited from the Philippines Amateur Radio Society Inc., the fourth society represented at the first Region III Congress, held Easter 1968 in Sydney.

Convention in India

Some prominent amateur radio operators in India and others keenly interested in amateur radio have made preliminary arrangements to hold the First All India Radio Convention. The venue is Bombay and the date December 27 to 30 inclusive, 1969. The purpose of the convention is to discuss matters connected with the development of amateur radio, particularly the following points:

1. Problems and difficulties of amateur radio and ways and means of solving them.
2. Local availability of components and equipments of use to amateurs and to examine the possibility of promoting interest in marketing items needed but not available in the country.
3. Development of amateur radio in the service of the nation.
4. Form a united body of radio amateurs in India with or without a Federation of all societies and clubs in India.

The Executive Committee for the convention will be:

Shri B. S. Dutt, VU2AJ—Chairman.
 Shri T. P. Sheth, VU2TP—Hon. Secretary.
 Shri G. V. Sulu, VU2GV—
 Hon. Liaison Secretary.

It is also proposed to operate an amateur station under the call sign VU2HAM from the convention.

New Zealand

The result of the 1969 Executive Council elections of the New Zealand Association of Radio Transmitters was as follows:

President: W. R. Hamer ZL2CD

ZL1 Councillors:

A. G. Godfrey ZL1HV
 E. C. Amon ZL1ACL
 D. E. Johnston ZL1AMN
 D. E. Cleland ZL1IY
 B. F. Kidd ZL1HZ

ZL2 Councillors:

K. Grove ZL2BBT
 G. C. Studd ZL2AFZ
 W. Forsyth ZL2ALO
 R. T. Woodfield ZL2VN
 R. S. H. Morgan ZL2GQ

ZL3 Councillors:

R. A. Urlwin ZL3MG
 R. A. Garlick ZL3AAA

ZL4 Councillors:

P. W. Johnson ZL4LV
 A. F. Frame ZL4GA

The retiring President Harry Burton, ZL2APC did not stand for re-election.

VHF World Record

This year is one during which great emphasis has been placed on man's interest in the moon. Amateur radio operators being no exception.

Quite a number of VHF contacts have been made using moon-bounce techniques. However, the most notable of these successful experiments was the two-way contact reported in the May issue of the official Journal of the New Zealand Association of Radio Transmitters—"Break-In."

This world record earth-moon-earth contact was made by Jack Morgan, ZL1AZR near Auckland, New Zealand, and Kjell Rasmusson, SM7BAE, Djurslov, Sweden. The distance was 11,370 miles across the earth's surface, but the transmission path was 476,000 miles to the moon and return, an outstanding achievement.

The frequency used was 144MHz and the first contact was made between 1700 and 1800GMT on March 4, 1969. The second contact was made between 1500

Sub-Miniature switches

The best the World can offer

TYPE	MODEL	CIRCUIT	250 V.A.C. RATING	CIRCUIT ARRANGEMENT
ROTARY	MRY-106	1 POLE	1A	1-6 USABLE POSITIONS
	MRX-108	1 POLE	1A	1-8 USABLE POSITIONS
	MRX-204	2 POLE	1A	1-4 USABLE POSITIONS
	MRX-402	4 POLE	1A	2 POSITION
TOGGLE	S-2012	SPDT	5A	ON-ON
	S-2013	SPDT	2A	ON-OFF-ON
	S-2022	DPDT	5A	ON-ON
	S-2023	DPDT	3A	ON-OFF-ON
	S-2025	DPDT	3A	ON-MOM ON
	S-2042	4PDT	5A	ON-ON
PUSH BUTTON	S-2043	4PDT	3A	ON-OFF-ON
	SB-2011	SPDT	2A	ON-ON (MOMENTARY)
	SB-2061	DPDT	3A	ON-ON (MOMENTARY)
	SB-2065	SPDT	2A	ON-ON (DOUBLE ACTION)
SEE SAW	SB-2085	DPDT	3A	ON-ON (DOUBLE ACTION)
	SW-3012	SPDT	3A	ON-ON
LAMP LIGHTED	MLB-2061*	DPDT	3A	ON-ON (MOMENTARY)
	MLB-2085*	DPDT	3A	ON-ON (DOUBLE ACTION)

*THE MLB SERIES OF LAMPLIGHTED SWITCHES ARE AVAILABLE WITH RED, GREEN AND TRANSPARENT BUTTONS. THE LAMP VOLTAGES AVAILABLE ARE:— 6V, 12V, 18V, AND 24V

IRH COMPONENTS PTY. LIMITED

(A subsidiary of International Resistance Holdings Ltd.)

THE CRESCENT, KINGSGROVE, N.S.W. 2208, PHONE 50 0111

POST TODAY

Please supply Sub-Miniature and Standard switch catalogue.



NAME

ADDRESS

IRC.692 R



WARBURTON

FRANKI

AFTER STOCKTAKING SPECIALS

PICK-UP CARTRIDGES

Swiss made—"ALPHON" Turnover type. **Monaural** with diamond L.P. and Sapphire Standard Stylus.

\$4.95

Stereo with diamond Stereo/L.P. and Sapphire Standard Stylus.

\$7.60

Including pack & post.

BASIC POWER SUPPLY KIT

Includes Transformer, Contact cooled bridge rectifier and one filter condenser 16/350. This kit will supply 250 Volts D.C. at 60 m.a. and 6.3 volts A.C. at 2 amps.

\$5.85

Including pack & post.

BASIC POWER SUPPLY KIT

Includes Transformer, Contact cooled bridge rectifier and one filter condenser, 1000 mfd. 15 V.W. This kit will supply 6 or 9 volts D.C. at 1/2 amp. Wiring diagram supplied.

\$3.85

Including pack & post.

SWITCHES

Rocker type. Single hole mounting SPST 2A, 250V. **75c** including pack and post.

Rotary type. Single hole mounting. Inbuilt red neon indicator in knob. S.P.D.T. 2A, 250V.

\$2.50

Including pack & post

DUCON BLOCK CONDENSERS

20 mfd-400vD.C.W.-250vA.C.W.

\$2.50 Each

including pack & post.

BEZEL LAMP HOLDERS

Front loading type. Takes 6 or 12 volt M.E.S. tubular lamps. Available with either red or green tops. **35c**
Lamps to suit 6 volt **10c**
Lamps to suit 12 volt **12c**

Including pack & post.

SPECIAL CONDENSER POLYPAC No. 20

Contains 25 assorted condensers, including ceramic, electrolytic, metal pack, mica, paper tubular. **\$1** plus postage, 10c (or five for **\$5**, post free).

ELECTROLYTIC CONDENSER

POLYPAC No. 22

12 assorted miniature electrolytic condensers—**\$1** plus 10c pack and post (or five for **\$5** post free).

RESISTOR POLYPAC No. 24

20 Hi-stability 1-watt $\pm 1\%$ resistors—**\$3.50**, plus 10c pack and post.

Values may be specified, but if not in stock nearest will be supplied.

NEW! PICK-UP STYLUS TIMING DEVICE

Attaches to turntable and shows on dial number of hours stylus has been in use.

\$5.75 including pack and post.

"CADET" SPEED CONTROLLER FOR ELECTRIC HAND TOOLS

Varies speed from stop to full speed with no loss of torque. Rated capacity, 2 amps. Complete with flex and plug.

\$11.50

Freight free.



PICO SOLDERING IRON KITS

Handyman's or hobby kit. Includes straight and angle bits, small file, screwdriver, rubbing down brush, resin core solder. **\$7.95** Post free.

TONTINE 75

Bonded acoustic batting. Approved by "Electronics Australia" for use in speaker cabinets. Rolls 5ft x 3ft

\$2.50 including pack & post.

Special price for full rolls of 20yds on application.



WARBURTON FRANKI

220 PARK ST., STH. MELB., VIC. Ph. 69-0151 (30 lines)

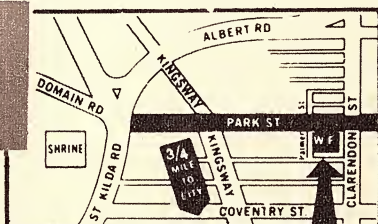

and 1600GMT on March 31. During a sked on March 22, SM7BAE was heard but no contact was made.

John's first real DX on 144MHz was in 1964 when he worked across the Tasman to Australia. In 1968 and early 1969 he had unsuccessfully tried to work the United States on 144MHz via moonbounce. However it was not until after his contact with Sweden that, on April 2, he was successful in working KOMQS, Richard Hart, in Cedar Falls, Iowa, the distance being 8,015 miles. The two-way contact was made between 1050 and 1140GMT.

The equipment used by these stations was:

ZL1AZR: Transmitter: Pushpull 4/400's triode connected in grounded grid configuration. 550W output.

Receiver: 2N4416 FET masthead pre-DIGFET converter, output at 14MHz, variable frequency and bandwidth active audio filter-bandwidth 200-10Hz.

Antenna: 96-element array of 6/6 slot fed Yagis, hand steerable.

SM7BAE: Transmitter: 4CX250R's 1.5-KW.

Receiver: 2N4416 FET masthead pre-amp.

Antenna: 160-element Yagi, 10 x 16 elements.

KOMQS: Transmitter: 1KW.

Receiver: No details available.

Antenna: Eight stacked 50 wavelength rhombics.

John, ZL1AZR, suggests that his antenna is only "marginal" for moonbounce with its 20dB gain. The full effective aperture to the eight bays could not be realised because of space limitations. The vertical spacing is correct but the horizontal spacing is only half the optimum figure.

The array is 25ft wide, 21ft high and 7ft deep. The centre height is 20ft above ground. Originally a coax. phasing feed system was tried and rejected as equal power could not be distributed to the array. Several quarter-wave transformers and three adjustable matching stubs were introduced and the whole antenna could then be tuned up with a 1:1.1 or 1:1.2 standing wave ratio.

All the equipment used by ZL1AZR was home constructed.

Congratulations to John for such an outstanding achievement.

Apollo 10

On Wednesday, May 28, from 0815 to 0925GMT, Jack Jeffrey, VK2AJY, at Toukley on the central coast of New South Wales, contacted the Apollo 10 recovery ship 400 miles east of Pago Pago. The contact was made on SSB, the frequency 14.265MHz.

The call-sign used from the recovery ship was WA6UDH/MM Zone 3. Jack spoke to Commander Chuck Smiley, the pilot of the helicopter, for the full time of the contact and discussed a large number of points which dealt with the recovery operation.

The commander said he had been stationed at the R.A.N. Air Base at Nowra about two years ago. A point of interest was that a doctor on the helicopter asked Commander Smiley to radio the astronauts to ask how they felt. The reply was: "Tell the Doc to take an Aspro and everything will be OK."

The equipment used by WA6UDH/MM was a NC5 transceiver. The antenna was a piece of wire hung from a porthole on the ship.

Australis Satellite

From Richard Tonkin, co-ordinator of the Australis amateur satellite project, comes the information that an amateur radio organisation named AMSAT, located in Maryland on the east coast of the U.S.A., is negotiating with the National Aeronautics and Space Administration as

VERON - Netherlands Section of the IARU

P.A.C.C. (PA-Century Club): This award is issued to every licensed transmitting amateur who can prove by QSL cards or other written confirmation to have established two-way CW, phone or mixed contacts with at least 100 different PA or PI stations. All QSOs must have been made after June 1, 1945.

Stickers are available also for 200 and 300 different PA or PI stations contacted, i.e. PACC-200 and PACC-300.

Code Proficiency Award: This award is issued to anyone who can prove to have been able to copy for at least one minute, without faults, a text transmitted by VERON's Society station, PA0AA. Transmissions are each Friday evening of the month at 21.30 hours GMT on 3.6MHz; or 14.1MHz. The code runs are transmitted at speeds of 15, 20, 25, 30, 35 and 40 words per minute for a period of five minutes each.

The award is issued for the basic speed of 15 words per minute, and stickers are available for each higher speed copied faultlessly for at least one minute. The original hand-written copy of PA0AA's transmission has to be sent in. No mechanical aids of any kind (typewriters, etc.) are allowed.

This award is free of charge, but applicants must send three IRCs to cover mailing expenses.

Applications for the above-mentioned awards should be addressed to:—

Traffic Bureau VERON,
C/- Mr G. Vollema, PA0LV,
P.O. Box 9,
Amsterdam, The Netherlands.

PA0AA, VERON Society Station Transmitting Schedule

PA0AA transmits each Friday evening on 3.6MHz and 14.1MHz with the following program:

GMT

1830 Preamble.

1900 DX and society news in Dutch language.

1915 DX and society news in English language.

1930 Morse code exercises for beginners.
2000 Morse code exercises for advanced operators.

2030 RTTY-news bulletin in English language.

2100 News in Dutch language (repeat).

2115 News in English language (repeat).

2130 PA0AA stands by on 3.6MHz and 14.1MHz for calls on phone, CW and RTTY.

A.D.X.C.—Amsterdam DX Certificate:

This award is issued by the Amsterdam Branch of the VERON, the Radio Club Amsterdam, to any licensed transmitting amateur who proves to have established two-way contacts with at least 10 members of the R.C.A.

The applicant's QSL cards must be in possession of the Amsterdam amateurs contacted, before the award is issued. QSOs must have been made after January 1, 1957.

Applications for this award only, with a list of claimed contacts, the QSLs and five IRCs have to be addressed to:

Mr G. Leenheer, PA0OI,
Boerhaveplein 14,
Amsterdam, the Netherlands.

to the possibility of launching the Australis satellite as a secondary payload on a N.A.S.A. space vehicle. There is now every possibility that these negotiations will be successful.

This news follows information received last April that it was most unlikely that there would be any further launchings of OSCAR satellites. The reasons were not stated.

The Australis satellite will carry 144MHz and 29MHz transmitters and transmit telemetry signals containing information on temperature, battery voltage, current drain, etc., as well as an identification code signal "HI."

The Australis satellite was shipped to the U.S.A. in June, 1967, and technical details were published in these notes during that year. It is hoped to have further information in next month's notes.

the contest is being conducted by the N.Z.A.R.T. and special awards are to be made.

NEW SOUTH WALES

Following the decision of the Council of the New South Wales Division to rebuild and expand the communication facilities at the divisional station VK2WI, at Dural, the technical committee was requested to report on the immediate and future use of the station. The committee has recommended the following features to be incorporated:

A complete electrical rewiring to provide 415 volts supply. Two operating positions—one to combine HF and VHF facilities and the other VHF facilities only.

All monitoring of the transmitters to

W.I.A. ACTIVITIES

Following further consideration given to the venue of the 1970 Federal Convention by the Western Australian Division, W.I.A., it now seems certain that the alternative venue of Adelaide in lieu of Perth will be agreed to by the Federal Council. In view of this change it is possible that the 1971 convention will be held in Perth, W.A.

In line with decisions made by the Federal Council at the 1969 Federal Convention, held in Canberra last Easter, plans are in hand to celebrate, jointly, the bi-centenary of Captain James Cook's landing on the east coast of Australia and the Diamond Jubilee of the W.I.A.; these celebrations will commence in January, 1970.

However, the 1969 VK—ZL—Oceania Contest, to be held in October, will commemorate the landing of Captain Cook in New Zealand. This contest is conducted jointly by the New Zealand Association of Radio Transmitters and the Wireless Institute of Australia. This year

CALLING ALL PROSPECTIVE AMATEURS

The Wireless Institute of Australia was established in 1910 to further the interest of Amateur Radio. With over 45 years experience, who could be more experienced in the teaching of this subject?

We are a non-profit making Organisation. Correspondence Courses are available at any time. Personal Classes commence in February of each year.

For further information write to:

**THE COURSE SUPERVISOR, W.I.A.,
14 Atchison Street,
CROWS NEST, N.S.W.**

DESPITE the initial reservations felt by many people, particularly with reference to servicing, the printed circuit is now firmly established in most types of electronic equipment, ranging from the incredibly cheap pocket radios that have flooded the country in recent years, to some of the most sophisticated professional equipment available. Its origins lie in weaponry — a heritage unfortunately common to many good "electronic" ideas, but printed circuitry is, and indeed has been for some time, an attractive system for the amateur who constructs his own equipment, for it solves the mechanical problems of component mounting and eliminates the chores of wiring — as well as facilitating a neat and workmanlike job. For the amateur who has so far shied away from etching his own boards, a new system is now available, which is both economical and easy to use, yet with care, is capable of excellent results. Known as **Cir-kit**, the system utilises bakelite boards, similar to those used commercially, in conjunction with self-adhesive copper strip. This is 1/16in or 1/8in wide — easily cut with scissors or a model knife — and attaches to the boards rather like a piece of Sellotape. The adhesive is very efficient, although the bond is not quite as good as that on pre-laminated boards — which means that care is needed when soldering not to overheat the copper. However, anyone who is competent to solder a transistor or capacitor without causing damage should have no trouble, and the adhesive improves with aging, so that long-term stability is satisfactory. Layouts can normally be planned using the theoretical circuit diagram as a guide, and boards may be pre-punched or drilled according to requirements. With the pre-punched board, the strip can either be laid over the holes, and then punched through with a small drill or a watchmaker's screwdriver, or it can be laid alongside the holes and component leads are inserted through the board, folded over and soldered (see photo). The former method permits a more compact layout.

A few tips on planning layouts. Always be sure that the component spaces you allocate are adequate — it is preferable to purchase the bits before embarking on this task, although capacitors are available in literally dozens of shapes for board mounting and resistors are more or less of standard size, dependent on ratings. Avoid siting adjacently on to your layout components which are in different stages — as this can lead to instability. If instability does occur, of course, **Cir-kit** does permit alterations to be made, although it is as well to investigate the problem before redesigning sections of the board for it may not prove necessary.

The excellence of the system, however, lies in its versatility, for it enables the home constructor to produce a wiring board on a one-off basis for most of the circuits described in this and other journals, and while it will no doubt encourage many to "try their hand," it will also enable many who already build their own equipment to achieve neater, more reliable results with a minimum of fuss.

**AVAILABLE ALL LEADING
RADIO HOUSES.**

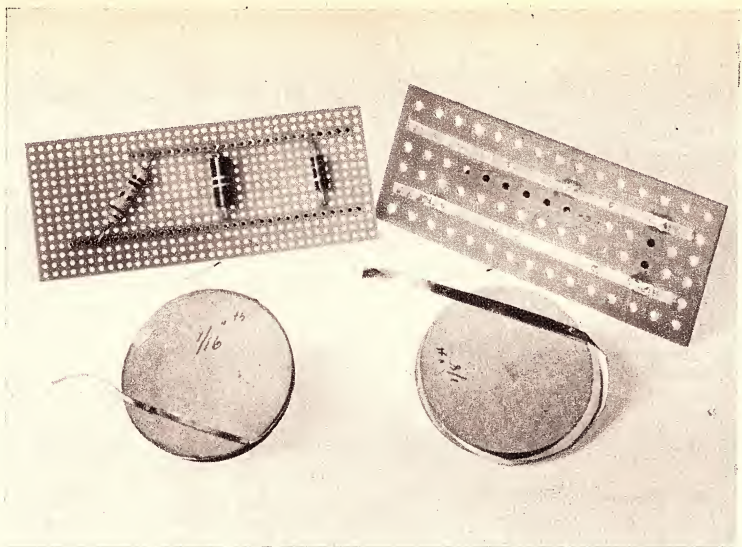

INSTANT CIRCUITS

A new method of making component boards using self-adhesive copper strip.

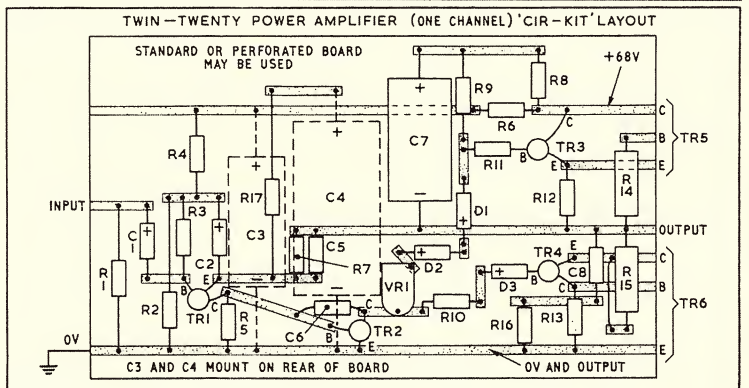
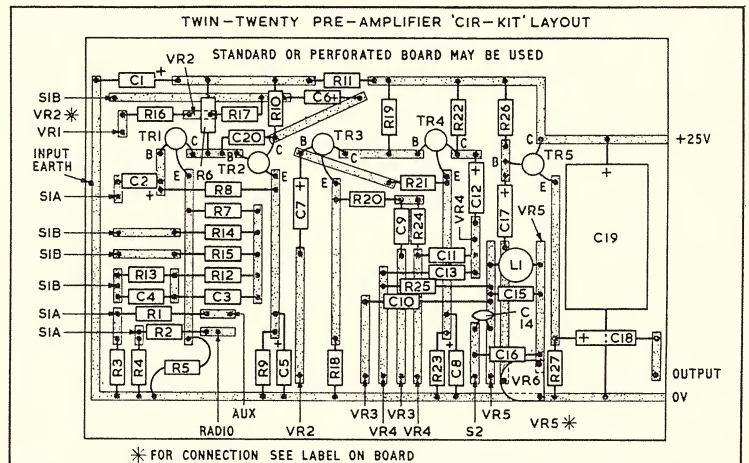

(SOLE AGENT)



ZEPHYR PRODUCTS PTY. LTD.

70 BATESFORD ROAD, CHADSTONE, VICTORIA—PHONE 56-7231

MANUFACTURERS OF RADIO & ELECTRICAL EQUIPMENT & COMPONENTS

INDEPENDENCE OF COLUMBIA CONTEST 1969

This contest is also known as the:
"DX HK Contest by L.C.R.A. and
L.C.R.A. DX Club."

The contest takes place every year to celebrate the independence of Colombia, on July 20, 1810, and is held during the weekend nearest to that date. During the contest, "HK" stations have to work the greatest number of stations in the rest of the world, and the foreign stations have to make the greatest number of contacts with "HK" stations and also with stations in other countries.

Date:
From 0001GMT, Saturday, July 19, to 2359GMT, Sunday July 20.

Bands:
3.5MHz; 7.00MHz; 14.00MHz;
21.00MHz; 28.00MHz.

Modes:
SSB, AM, and CW, but no cross-mode contacts are permitted.

Points:
For stations outside Colombia:
Stations outside America with a "HK" station, 5 points
Stations in America with a "HK" station, 3 points
Contacts between non "HK" stations, 1 point

Multiplier:
The total multiplier is made by the addition of the total number of HK zones plus the total number of countries worked in each band.

be done from the operating consoles.

Transmitting facilities to be provided on all amateur bands 1.8MHz to 432MHz with the exception of 21MHz and 28MHz. The 1.8MHz band has been introduced to improve the signal coverage around the metropolitan area for those who do not have VHF equipment, and to practice that which the W.I.A. preaches—"Use the bands or lose them."

Antennas to be provided for all bands.

Provision to be made for links to the Wireless Institute Centre, so that it will be possible to remote control the Dural facilities from the Atchison Street, Crow's Nest, headquarters. Translator/repeater facilities to be installed.

Easy access to all equipment for maintenance purposes to be a feature of the new look at VK2WI, and the equipment room to contain a small workshop.

The currently used AR7 receivers and various converters to be pensioned off and replaced. A complete survey is being made of all receiving equipment and it is hoped to make a substantial gain in this area of the station's operation.

Provision will also be made for amateur television transmissions from the station. The intention is to have a transmitter which can be used to radiate test patterns for the alignment of converters and general checking of ATV equipment.

It will be appreciated that the period between a block facility diagram and completion date for the station will be fairly lengthy and a lot of work will be involved.

Stage one will be the renewal of the power mains supply facilities. In order that some power will be available during the rewiring of the station, the overhaul of the existing emergency power plant will be made immediately.

Regular news of progress and calls for assistance will be made from time to time and council requests that any member who has professional experience in any phase of the work to be done, to contact any member of the technical committee.

Total Score:

Assessed by the addition of all contact points in the different bands multiplied the addition of HK zones plus different countries worked on all bands.

Call:
CQ HK Contest.

Serial Numbers:
These will consist of RS for Phone or RST for CW followed by a contact serial number commencing at 001.

Colombian stations will give the RS or RST report followed by the HK zone in which they are located.

Logs:
Are to be sent before September 30, 1969, to:

Independence of Colombia Contest,
C/- L.C.R.A.,
Ap. 584, Bogota, Colombia, S.A.

Categories:

Single operator, single station.

Multi-operator, single station.

Multi-operator, multi-station.

Don't forget:

1. To send your own computation of the score made.
2. Each country worked in a different band is a new multiplier.
3. HK0 San Andres counts as HK Colombia—HK0 San Andres and HK0 Zone. So keep a look out for that one. Awards or Certificates for the first place in Colombia and first in the world. Also for continental winners and highest scorers by country, modes and bands, will be awarded by the L.C.R.A.

As much of the work as possible will be planned so that those assisting may do it in their own workshop.

While the station is off the air at Dural the Sunday news bulletins will be broadcast from the communications centre at Wireless Institute Centre.

This is a major undertaking and voluntary assistance from members will be appreciated by council and the technical committee.

Hunter Branch

A successful WICEN familiarisation exercise was held during May among radio amateur operators in the Newcastle, Hunter Valley and Central Coast areas. Using the call sign VK2AWX portable as the control station, located on Great Mount Sugarloaf, it was possible to pass practice messages between stations located within a 25-mile radius of the control station.

The stations taking part were VK2TX; VK2VW; VK2ZGK; VK2ZFX. VK2ZWM; VK2ZMO; VK2AMM; VK2ZKW/mobile; VK2UX and VK2BGH portable. Signals were audible at excellent strength during the 40 minutes of the test, which was conducted on the 146MHz FM channel "B."

Six candidates from the Hunter Branch area have been notified of their successes in the Amateur Operators Limited Certificate of Proficiency. They are John Tomkins and Norm Cameron of the Muswellbrook Radio Club; Ken Cunningham and Robert Butler of Westlakes Radio Club; Colin Hay of Maitland Radio Club and Edward (Herb) Herivel a non-club participant. All six are preparing to go on the air as soon as they receive their call signs.

From Keith Howard, VK2AKX, has come the following interesting comments relating to 7MHz antennas used in the United States and by a Hunter Branch member:

"Perhaps you may think that your 40-metre dipole is just the thing and gives superior performance over any other dipole in the area. But how much better would it be if you had a three element yagi on 40 metres?"

"Some very good signals from the U.S.A. proved the effectiveness of such

ELECTRONIC DESPATCH

P.O. BOX 149, AUBURN 2144

9-1 DAILY AND SAT.

16 SHERIDEN ST., GRANVILLE,

MAIL ORDERS WELCOME
Add postage please.

COMPUTER BOARDS

10c PER TRANSISTOR

2½c PER DIODE

OTHER COMPONENTS FREE. DATA SHEET ON MOST TRANSISTORS SUPPLIED WITH ORDER.

SEMICONDUCTORS

ADY 22 .. \$1.25	2G 1025 .. 50c
ADY 23 .. \$1.50	SE 3030 .. \$3.00
AF 116 .. 50c	TS3 (AF185) 25c
ASY 50 .. 50c	TS .. (AC126) 50c
ASY 53 .. 50c	2 5B 110)
BC 108 .. 60c	2 5B 111) AC126
BC 109 .. 75c	2 5B 112) 50c
BC 148 .. 55c	2 5C 139 .. 60c
BF 115 .. 70c	BLY 10 .. \$1.50
BFY 15 .. 50c	BSY 28 .. 50c
BFY 22 .. 50c	OC304/1
BFY 23 .. 50c	(ASY/31) 25c
BFY 30 .. 50c	OC304/3
2N291 (AC128) 50c	(ASY 32) 25c
2N442 .. \$2.00	OC308
2N456A .. \$2.50	(AC128) 50c
2N513B .. \$4.00	OC440
2N 1613	(BCY30) 50c
2N291 (BFY67) 50c	OC440K
2N 3055 .. \$2.50	(BCY30) 50c
2N 3563 .. 50c	OC445
2N 3564 .. 60c	(BCY30) 50c
2 G 526	OC469
(AC128400MW) 40c	(BCY34) 50c
2 G 527 .. 50c	OC470
	(BCY34) 50c

POWER DIODES

1N 604 .. 50c	1N 605 .. 50c
1N 1342 .. \$1.00	PE 501 .. 70c
1N 539 .. 50c	FST 3/8 .. 50c
15540 .. 50c	

SIGNAL DIODES

1N 277 (OA91) 20c	GD 12 (OA90) 5c
GDS .. 5c	

NEW RESISTORS CARBON FILM

½W 5% 4.7 OHM TO 10M .. 6c
VDR 150V 1MA .. 10c

ELECTROLYTIC'S

400 MFD 300 \$1.00	8,000 MFD \$4.00
500 MFD 700V .. \$1.00	11,500 MFD \$1.50
1000 MFD .. \$6.00	15,000 MFD \$1.50
1.500 MFD 60V .. \$1.50	15,000 MFD \$3.00
1.500 MFD 100V .. \$2.00	15,000 MFD \$4.00
1.500 MFD 150V .. \$3.00	1,900 MFD \$2.50
3,000 MFD 55V .. \$2.00	24,000 MFD \$3.00
3,300 MFD 100V .. \$4.00	28,000 MFD \$4.00
4,000 MFD 55V .. \$4.00	42,000 MFD \$4.00
700 MFD 13V .. \$1.50	70,000 MFD \$5.00
7,500 MFD 21V .. \$2.00	

TRANSMITTING VALVES

QQE06/40 .. \$10.00	TD03/10 .. \$10.00
QQE02/5 .. \$4.00	12 E14 .. \$1.50
TT15 .. \$1.00	3D21A .. 1.00

VALVES

6AM4 .. \$2.00	12AX7* .. \$1.25
6AM5 .. \$1.30	12 AT7 .. \$0.50
6AK5 .. \$1.50	5R4GY .. \$2.00
6AL5 .. \$0.80	6V4 .. \$1.00
6AN7 .. \$1.50	6 BAC* .. \$0.90
6AV6 .. \$1.20	5AL5* .. \$1.00
6AQ5 .. \$1.30	

* SPECIAL QUALITY
ALL NEW IN CARTONS

REED RELAYS

HAMLIN DRY REED SWITCH TYPE DRG2 1A-250VAC .. 80c each
--

NEW RH (Radio House) RANGE OF MULTIMETERS

NEW POCKET SIZE MULTITESTER

LIMITED STOCKS MODEL YT67, \$8.50 POSTED

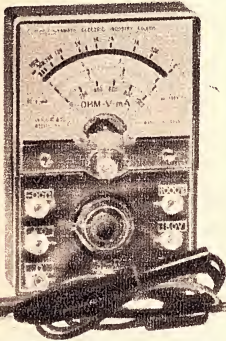

Latest model multitester YT67 now costs only \$8, measures up to 100,000 ohms and continuity.

DC volts 0-15, 0-150, 0-1000.

AC volts 0-15, 0-150, 0-1000.

DC current 150 MA.

1,000 ohms per volt, sensitive and clear scale for accuracy. Posted \$8.50 anywhere, with test leads and internal battery complete, ready to use. Size 3 1/4 in x 2 1/4 in.

Model RH-80 \$18.00 Postage 50c

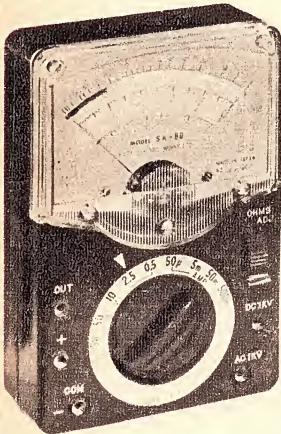

20,000 Ohms per Volt DC
10,000 Ohms per Volt AC

Specifications:

DC Volts. 0.5, 2.5, 10, 50, 250, 500, 1000 V

AC Volts. 10, 50, 250, 500, 1000 V

DC Current: 50uA, 5mA, 50 mA, 500 mA

Resistance. 5 kΩ, 50kΩ, 500kΩ, 5 MegΩ

Decibels. -10 + 62 lb

Accuracy. DC ±3%, AC ±4% (of full scale)

Batteries. Two 1.5V dry cells. Size AA, "Eveready" 915

• Overload-protected by dual silicon diodes. • Mirror scale. • Double-jewelled ±2% meter. • ±1% temperature-stabilized film resistors.

Model RH-50 \$31.00 Postage \$1.00

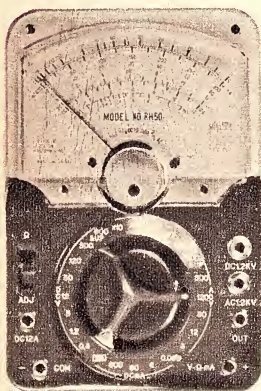

Modern Design. 33 Micro-Amp Meter.

300,000 Ohms per Volt D.C.
13,000 Ohms per Volt A.C.

SPECIFICATIONS

DC VOLTAGES 0-0.25-1-2.5-10-25-100-250-500-1,000 at 30,000 ohms per volt.

AC VOLTAGES: 0-2.5-10-25-100 - 250 - 500 - 1,000V at 15,000 ohms per volt.

DC CURRENTS: 0-0.5-5-50-500 mA, 0-12 A.

Resistance: 0-60K - 6M - 60M (350, 35K, 350K at mid-scale).

Decibels: Minus 20 to plus 56dB (0 dB equals 1mW 600 ohms).

Audio Out: Capacitor in series with AC Volt ranges. Short Test: Internal buzzer.

With leather case \$38.00.

Accessory: 1 pr. heavy test leads.

Model RH-20 \$15.00 Postage 50c

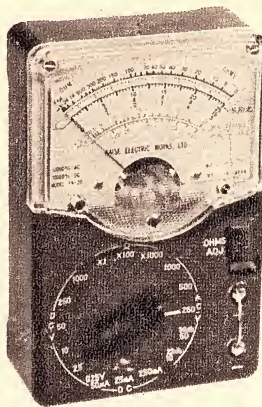

20,000 Ohms per Volt DC
10,000 Ohms per Volt AC

Specifications:

DC Volts: 0.25, 2.5, 10, 50, 250, 1000 (20,000/V)

AC Volts: 10, 50, 250, 500, 1000 (10,000/V)

DC Current. 50 uA, 25mA, 250mA

Resistance. 7kΩ, 700kΩ, 7MΩ

Decibels. -10 +22 (at AC/10V) +20 +36 (at AC/50V). Upper frequency limit 7kc.

Accuracy: DC ±3%, AC ±4% (of full scale)

Batteries: Two 1.5V dry cells. Size AA, "Eveready" 915

• Overload-protected by dual silicon diodes. • Double - jewelled ±2% meter. • ±1% temperature-stabilized film resistors.

Model RH-55 \$20.00 Postage 50c

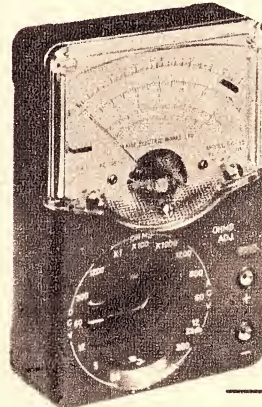

30,000 Ohms per Volt DC
14,000 Ohms per Volt AC

SPECIFICATIONS:

*DC Volts: 0.6, 3V, 12V, 60V, 300V, 1200V (30,000 ohms/V).

*AC Volts: 12V, 60V, 300V, 1200V (14,000 ohms/V).

*DC Current: 60 A, 12mA, 300mA.

*Resistance: 10K ohm, 1Meg ohm, 10Meg ohm.

*Decibels: -10 db +23 db.

*Meter Sensitivity: 23 A.

• Overload-protected by dual silicon diodes. • Mirror scale.

• Double-jewelled ±2% meter. • ±1% temperature-stabilized film resistors.

Model RH-60 \$25.00 Postage 50c

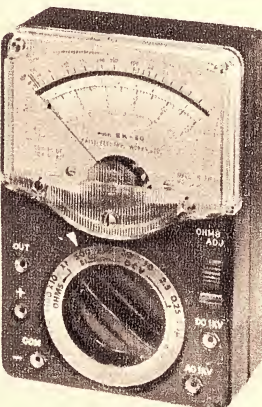

50,000 Ohms per Volt DC
10,000 Ohms per Volt AC

Specifications:

DC Volts: 0.25, 2.5, 10, 50, 250, 500, 1000 V

AC Volts. 10, 50, 250, 500, 1000 V

DC Current. 25 uA, 5 mA, 50 mA, 500 mA

Resistance: 10 kΩ, 100 kΩ, 1 MegΩ, 10 MegΩ

Decibels. -10 +62 db

Accuracy: DC ±3%, AC ±4% (of full scale)

Batteries. Two 1.5 V dry cells. Size AA, "Eveready" 915

• Overload-protected by dual silicon diodes. • Mirror scale.

• Double-jewelled ±2% meter. • ±1% temperature-stabilized film resistors.

NOTICE

Our branch shop at No. 6 Royal Arcade will be closed down during rebuilding as from 30th December, 1969.

Enquiries at head office 306-308 Pitt St. 26-2817.

RADIO HOUSE PTY. LTD.

306-308 PITT STREET: 6 ROYAL ARCADE & 760 GEORGE STREET, SYDNEY

1969 JOHN MOYLE CONTEST

The results of the John Moyle Memorial National Field Day Contest held on February 1 and 2, issued by the Federal Contest Committee, W.I.A. are:

Six-Hour Division		VX2AAH/P		7313 points
Section (a) Portable/Mobile transmitting phone:		VK3ATL/P		4271 points
VK1ML/P	62 points	VK3APC/P		4214 points
VK2ASZ/P	541 points	VK3ATO/P		3210 points
VK2AHV/P	225 points	VK410/P		1365 points
VK2RJ/P	115 points	VK9XI		623 points
VK3AQP/P	429 points	Section (f) Receiving —		
VK3AYZ/P	304 points	6 hour Division:		
VK3AIH/P	253 points	L3366 D. Elkan		315 points
VK3AOT/P	247 points	L3377 T. Hambling		310 points
VK4PJ/P	406 points	L4018 K. Sutcliffe		185 points
VK4GT/P	268 points	M. Joyce		130 points
VK4PF/P	100 points	L5096 G. Hannaford		1015 points
VK5WV/P	172 points	L5015 W. Clayson		189 points
VK5XY/P	108 points	L5088 S. Ruediger		129 points
VK5ZEJ/P	66 points	24-hour Division:		
VK5EEK/P	76 points	L2246 B. Beamish		445 points
VK5OZ/P	56 points	L3308 K. Cox		430 points
VK5TL/P	34 points	L3042 E. Trebilcock		175 points.
Section (b) Portable/Mobile transmitting C.W.:		To VK2AAH/P and party of seven operators and two associates go top marks for their excellent score of 7313 points. Some of the details of their set up and breakdown of the scoring contacts will no doubt be of interest: Power supply—7.5KVA generator. Equipment—Two KWM2 transceivers Two SW400 transceivers Three linears running 400W A large amount of "Homebrew" VHF gear plus FM units. The aerial systems were:		
VK2JM/P	123 points	3.5MHz Bottom loaded vertical.		
VK2YB/P	111 points	7MHz Quarter-wave vertical.		
Section (c) Portable/Mobile transmitting Open:		14MHz Two-element yagi 45ft high.		
VK3HE/P	150 points	21MHz Two-element yagi 30ft high.		
Section (d) Portable/Mobile transmitting Multiple Operation		28MHz Three-element yagi 30ft high.		
Open only:		52MHz Four-element yagi.		
VK3KI/P	729 points	144MHz Ten-element yagi.		
Section (e) Fixed transmitting stations working Portable/Mobile stations,		Multi-element stacked colinear.		
Open only:		146MHz Four-element yagi.		
VK2UG	30 points	Location:		
VK5TN	120 points	4000ft mountain near Lithgow about 52 miles west of Sydney.		
24-Hour Division		Log entries:		
Section (a) Portable/Mobile transmitting phone:		MHz	Points	Contacts
VK3DY/P	1019 points	3.5	200	27
VK3ADP/P	358 points	7	1219	212
VK3AQQ/P	273 points	14	2920	574
VK5ZET/P	112 points	21	1231	244
Section (b) Portable/Mobile transmitting C.W.:		28	1142	228
VK3ALZ/P	160 points	52	130	25
VK5ZE/P	186 points	144	471	101
Section (c) Portable/Mobile transmitting Open:				
VK3EZ/P	314 points			
Section (d) Portable/Mobile transmitting Multiple operation				
Open only:				
VK1ACA/P	2075 points		7313	1411

"OXFORD"



RADIO CHASSIS



INSTRUMENT CASES



MINI BOXES "ALUMINIUM"



All printed and engraved panels for "Electronics Aust.", Mullard "Outlook," Philips "Digest."



Any special metalwork and panel engraving to specification.



All stock cases and chassis from our distributors in Brisbane, Melbourne, Adelaide.

HEATING SYSTEMS PTY. LTD.

24 O'Riordan St.,
ALEXANDRIA. N.S.W.
2015.
69-3764 - 69-7616

an antenna at the QTH of W2ACW. The beam is constructed to rotate and is mounted at the top of an 82ft mast. It certainly lifts the signal considerably into Australia.

"Apparently W2ACW has had such success with the new beam that an 80-metre model is planned for later this year. With a "wingspan" of about 130ft the 80 metre yagi will be installed on a 120ft mast at the same location as the 40-metre beam. It is believed, however, that this will only be a two-element affair. W2ACW also mentioned that he intends to operate on the 160 metre band—using a rotatable beam perhaps?

"Of course, it is not necessary to look to the U.S.A. for beams on 40-metres. At Toronto, on the shore of Lake Macquarie, near Newcastle, Jim Thompson, VK2AHT, has a two-element beam on 40 metres, mounted with his other aeriels, including a three-over-three wide-spaced yagi for 20 metres on the 90ft steel mast in Jim's garden. Naturally, it and the other fantastic aeriels at Jim's QTH do give him a certain preference when the going gets tough."

Illawarra Branch

Forty members, and four visitors from Sydney, attended the May meeting of the

Illawarra Branch, in the Committee Room of the Wollongong Town Hall. Films on transistor amplifiers and soldering techniques were shown. There was also a display of equipment by members of the Branch.

VHF activity on the six-metre net frequency 53.998MHz continues on most nights of the week around 7.00 p.m. Also on Sunday mornings between 10.00 a.m. and 10.30 a.m.

Activity on 144MHz is somewhat restricted, due to interference from TV channel 5A, particularly on the low-frequency end of the band. However, several converters using field effect transistors in the RF stages as well as good circuit design and proper shielding have overcome most of the problems.

Branch meetings are held on the second Monday of each month, commencing at 7.30 p.m. in the Committee Room of the Wollongong Town Hall. Visitors are always welcome.

A.O.C.P. Class: The Amateur Operators Certificate of Proficiency classes conducted by Eric Fisher, VK2DY, are progressing very satisfactorily. The attendance each week continues to average between 35 and 40 members. Lectures on receiver theory are the current topic at the classes. Anyone residing in the Wollongong area

A vast range of SATO Parts

- For manufacturers
- For TV
- For radio
- For instruments
- For amplifiers
- For kitset builders
- For sound equipment
- For industry
- For stereo equipment
- For educational purposes
- For electronics
- For tape recorders

Distributed by



GENERAL ACCESSORIES

(A DIVISION OF ELECTRONICS INDUSTRIES)

116-118 CLARENCE STREET, SYDNEY 443 CONCORD ROAD, RHODES — 73-0211
BOTH STORES OPEN SATURDAY MORNING



Like being proud of their Kangaroo, Sato's large variety of electrical parts is the favorite choice by Australians. Your inquiries are welcome.

SATO PARTS

SATO PARTS CO., LTD.

HEAD OFFICE: EBISU, SHIBUYA-KU, TOKYO, JAPAN TEL: (442) 8506~8
BANK ACCOUNT: MITSUBISHI BANK

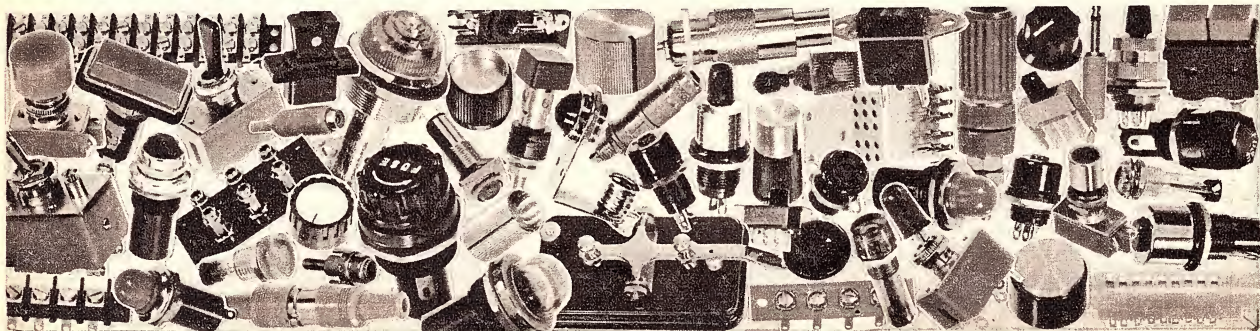

who is interested in attending the course are invited to contact either:

Eric Fisher VK2DY
2 Oxlade Street
Warrawong. 2502.
or

Illawarra Branch Secretary
Hank Laauw VK2BHL
443 William Beach Road
Dapto. 2530 (Phone 61-2279).

Blue Mountains Branch

The annual meeting of the Blue Mountains Branch of the New South Wales Division was held late in April. The officers elected for the coming year were:

President: Bill Moore, VK2HZ.
Vice-president: Alex Outtrim, VK2EX.
Secretary: Danny Clift, VK2ZDE.
Treasurer: Alf Grifford, VK2ZMV.
Catering Officer: Jerry Vale, Assoc.

The task of publicity officer is being carried out by the secretary, Danny Clift, VK2ZDE.

The regular meeting of the branch is held on the third Friday of each month in the club rooms at the old Lawson Council Chambers, San Jose Avenue, Lawson.

Visitors are always welcome and those interested in learning more about amateur radio are invited to attend the interesting lectures and discussions on various aspects of the hobby.

For full details write to the Secretary, Danny Clift, 152 Rusden Road, Blaxland, 2774, N.S.W.

WESTERN AUSTRALIA

Following the annual general meeting of the Western Australia Division, the election of officers for the coming year was finalised. The appointments made were:—

President: Bob Elms, VK6BE.
Vice-presidents: Harry Pride, VK6HP;
Graham Byass, VK6ZDB.
Secretary: Neil Penfold, VK6ZDK.
Treasurer: Ken Moore, VK6KM.
Assistant Treasurer: Bob Lockley.
Minute Secretary: David Priestley, VK6ID.

Youth Radio Superintendent: Bob Trepp, VK6BT.

Auditor: Kiffin Miller, VK6KL.
VHF Officer: Tony Stanicic, VK6ZK.
Bulletin Editor: Jack Sullivan, VK6ZFO.

"AR" Notes: Ross Greenaway, VK6DA.
QSL Officer: Jim Rumble, VK6RU.
Technical Officers: Graham Byass, VK6ZDB; Kevin Bicknell, VK6ZCB.
Disposals: David Priestley, VK6ID.
Broadcast Officer: Bob Elms, VK6BT.
Program Officers: David Priestley, VK6ID; Graham Byass, VK6ZDB.

The president reported there had been a steady increase in membership and a 30 per cent increase in attendance at divisional monthly meetings. Also, following the Meckering earthquake, WICEN was revived within the division. Thirty stations have indicated their willingness to participate and a loosely organised network has been formed.

VHF Band Opening

In last month's notes mention was made of several long distance contacts made on 144MHz during the period that a very large high-pressure system was moving across the south-east portion of Australia. Several of these contacts were between western New South Wales stations and stations in the Australian Capital Territory.

From Eddie Penikis, VK1VP, comes this report on the activity of stations in Canberra, A.C.T.

The opening took place on April 25 and was first observed in Canberra at 1700 hours E.S.T. All contacts were made on the 146MHz net frequency and in most cases the equipment was commercial FM mobile units converted for amateur frequency operation. Except where stated, the power input to the transmitter was 15 to 20W.

Charlie Rann, VK1CR, worked VK-

2AKC, Dubbo, using a TCA 1674 with a dipole antenna from his home station. Col Harvey, VK1AU, worked VK2AKC, Dubbo, also using a TCA 1674 and a quarter-wave whip antenna.

Wal Pywell, VK1ZWP, worked VK2AKC, Dubbo. His transmitter was a TCA unit with 120W input, and the Receiver a MR10A. The antenna was a ground plane 30ft high. Wal reported that a 10-element beam made very little difference to the signals.

Andrew Davis, VK1DA, worked VK2AKC, Dubbo and VK2ACT, Dubbo, while operating mobile from Black Mountain using a MR20B and quarter-wave whip antenna.

Reg Miles, VK1ZMR, worked VK2AKC and VK2ACT, Dubbo while operating mobile from Mount Majura using a TCA 1674 and quarter-wave whip antenna. Reg also had a patchy contact with John Thornthwaite in Sydney via the Orange Radio Club translator at Mount Canobolas.

Eddie Penikis, VK1VP, worked VK2AKC, Dubbo, using his home station transmitter, 100W input to a five-element yagi antenna, and again operating mobile from Black Mountain using an MR20B to a quarter-wave whip antenna.

The operators at Dubbo were Cec Kearines, VK2AKC and Bill Brook, VK2ACT. All contacts were made between 1700 and 1930 EST.

Space Frequency Conference

With the I.T.U. Space Frequency Conference scheduled to be held in Geneva, in 1970-1971, it is desirable that a comprehensive account of amateur VHF-UHF frequency activity throughout the world be compiled.

All Australian VHF amateur operators are invited to send details of their activities on the various bands to the VHF Group of the Wireless Institute of Australia in their call area.

YOUTH RADIO SCHEME

Westlakes Radio Club

With the award of Intermediate Radio Certificates to another two Westlakes Radio Club members, the club has now won a third of all the Intermediate awards made by the Youth Radio Club Scheme.

The recipients of the latest awards are Phillip Brown and Barry Finlay, both of the Newcastle suburb of Kotara. These young men have been club members for over three years and they have made the best use of the facilities offered by the Y.R.C.S. to follow radio as a hobby and to make electronics their careers.

Phillip Brown, a former student of Broadmeadow High School, is now a trainee technician with the Department of Civil Aviation in Sydney. He still finds time to come to the club each Saturday and to take part in hidden transmitter hunts and other activities organised for club members.

Barry Finlay, a former student of Newcastle Technical High School is now an Electrical Engineering Cadet with Broken Hill Pty. Co. Ltd. in Newcastle. He is also a regular attendee at club meetings and field activities.

They have also taken a keen interest in the constructional side of radio and have many interesting projects to their credit. Phillip is at present building himself a complete communications receiver of his own design.

The certificates were presented at the

(Continued on page 164)

BRIGHT STAR CRYSTALS

PREFERRED BY LEADING MANUFACTURERS
THROUGHOUT THE COUNTRY FOR —

ACCURACY - STABILITY - ACTIVITY - OUTPUT



All types of Crystals Available
Such as DC11, FT 243 HC6U CRA
B7G, HC18U, ETC.

TOLERANCES: .0015%, .002%,
.003%, .005% ETC.

Consult us for Crystals for any Mobile Radio.
Prices depend on tolerance and frequency
required.

DISCOUNT FOR QUANTITY ORDERS

Established 36 Years



AMATEUR AIRCRAFT and ULTRASONIC CRYSTALS also AVAILABLE

*Our new Factory employing the most modern equipment
allows us to offer you PROMPT DELIVERY for all your
CRYSTAL requirements.*

DEVOTED EXCLUSIVELY TO THE MANUFACTURE OF

PIEZO ELECTRIC CRYSTALS

Contractors to Federal and State Government Departments

REPRESENTATIVES AUSTRALIA AND NEW ZEALAND: Messrs. CARREL & CARREL
BOX 2102, AUCKLAND.

MESSRS ATKINS (W.A.) LTD.,

894 Hay Street, PERTH.
MESSRS. A. E. HAROLD PTY. LTD.,
123-125 Charlotte Street, BRISBANE.

MESSRS LAWRENCE & HANSEN
ELECTRICAL (VIC.) PTY. LTD.,

34 Brisbane Street, HOBART.
and 29 St. John Street,
LAUNCESTON, TASMANIA.

BRIGHT STAR RADIO

546-5076

LOT 6 EILEEN ROAD, CLAYTON, VICTORIA

546-5076



GUITAR AMPLIFIERS

10-Watt, Two-Channel, with Twin Cone Speaker \$53.55
 14-Watt, 4 Inputs, Bass and Treble Boost, 2 Twin-Cone Speakers, \$63
 17-Watt, Four-Channel, Bass and Treble Boost. Two Twin-cone Speakers \$76.25

35 WATT

4-Channel, Bass and Treble Boost 4 Twin-Cone Speakers — \$109.05
 Vibrato with foot control and 2 preset controls for frequency and intensity, \$10.50 extra on above models.

ELECTRIC GUITAR

Pickup Units \$8.75
 Accordion Pickup Units . . \$8.75
 Harmonica Pickup Units . \$1.95
 Post, N.S.W., 40c; Interstate, 75c.

FUZZ BOX

FUZZ BOX E. AND A. AUG. WIRED AND TESTED. \$15. Post. 75c.

REVERB UNIT

COMPLETE WITH AMPLIFIER. E.A. October issue. Kitset \$39.95. Wired and tested, \$41.95.



MULLARD MAGNAVOX

BOOKSHELF ENCLOSURE

Maple, Teak or Walnut Complete \$24.75

SUPER BOOKSHELF \$36.75.

Post: N.S.W. 80c. Interstate \$1.00. CABINETS ONLY
 R. H. BOOKSHELVES \$11.50
 MULLARD \$10.95
 BOOKSHELF UNITS
 6in 8in 10in 12in
 \$27.75 \$33.50 \$35.50 \$36.50

PLAYMASTER 106

WIRED AND TESTED \$94.75
 107

WIRED AND TESTED \$83.75



NEW LOOK SPEAKER ENCLOSURES

Hi-Fi Freq. response. Power rating 5 watts R.M.S. Attractive, modern, oiled teak finish. Size 14 1/2 in x 4 3/4 in x 9.

\$15.00 EACH

Post 75c. Interstate \$1.25.

14 plus 14 WATT

With Reverberation. May be used as 28 Watt or as 14 Watt plus 14 Watt Reverb. Two 9 x 6 Woofer Speakers. Two 9 x 6 Twin-Cone Speakers. 4 Channels, Bass and Treble Boost. Foot Vibrato control included.

\$163.50

PIGGY BACK GUITAR AMPLIFIER

Excluding Speakers

30 Watt \$79.75
 45 Watt \$99.75
 60 Watt \$119.75
 4 Inputs. Bass and Treble Boost Vibrato if required, \$10.50 extra.

PIGGY BACK GUITAR AMPLIFIER

Complete with Speakers, Cabinet
 30 Watt Lead \$138.75
 30 Watt Bass \$146.75
 45 Watt Lead \$158.75
 45 Watt Bass \$166.75
 50 Watt Lead \$218.00
 60 Watt Bass \$234.00
 Vibrato if required \$10.50

UA 41A - 20-20

SOLID STATE STEREO

20 watts per channel. Inputs for tape, magnetic and ceramic P.U. Tuner and aux. Teak cabinet.

\$88.00



240v A.C. POWERED SOLID STATE STEREO

T.S.135
 18 Transistor, 15-watt per channel. Inputs for Tape, Mag. P.U. Ger. P.U. Radio Aux. Freq. Range 30c to 20KC. Max Sensitivity 3 MV. Speaker matching 4 to 15 ohms.

\$78.00



10 + 10

STEREO AMPLIFIER

With Overload Protection Circuit Kit Set.

\$62.75.

Wired and Tested \$72.75
 Complete with Broadcast Tuner \$101.75.

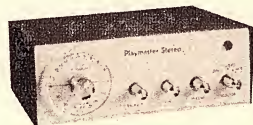

PLAYMASTER 124

As per May '69 E.A. Wired and tested . . . \$78.00



11 1/2" FULLY BALANCED PICK-UP ARM.

COMPLETE WITH MAGNETIC Stereo Cartridge . . . \$19.50
 Arm less cartridge . . . \$11.50
 Mag. cartridge only . . . \$9.50



T.C. 2

VALVE TESTER

Tests all valves, diodes, rectifiers, checking filaments, shorts. Merit on direct reading. Good-bad meter. Complete with tube chart.

WIDE BAND OSCILLOSCOPES

SPECIFICATIONS

VERTICAL AXIS

Deflection Sensitivity (at 1 kc) 0.1 V p-p/cm.
 Frequency Characteristics 1.5 cps—1.5 MC.
 Input Impedance 2 M ohms 25 pF.
 Calibration Voltage IV pp-cm.

HORIZONTAL AXIS

Deflection Sensitivity 0.9 V p-p cm.
 Frequency Characteristics 1.5 cps—800 KC.
 Input Impedance 2 M ohms 20 pF.
 Sweep Oscillator (5 Range) 10 cps—300 KC.
 Synchronization Devices Internal (Positive and Negative, External). Power 240V AC 50/60 cps. Cathode Ray Tube 3KF1F.

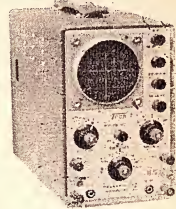

5 Meg Bandwidth Push-Pull vertical and horizontal Amplifiers, 8 positions, high sensitivity vertical Amplifier Frequency Compensated on all positions. Calibrated .02 to 600 volt. Hard time base, 20 cycles to 75K. Latest American R.C.A. circuitry. Complete with probe.

3-inch \$102.75; 5-inch \$118.75

MINI V.T.V.M.

240 V.A.C. Operation. 0 equals 100 megohms. 3 ranges. Voltages, 0-1000 Volts A.C. and D.C. Six Ranges. Size 4 1/4" x 4" x 3 1/2".

\$27.75

Post. 80c. Interstate \$1.25.



MINI-LAB.

7-IN-ONE TEST INSTRUMENTS. BATTERY OPERATED. SPECIFICATIONS—

Resistance Substitution: Resistors 1/2w 5% tolerance, Five values 100 ohms, 1K ohm, 10K ohm, 100K ohm and 1 megohm.
 Capacitance Substitution: Five values: .002ufd, .005ufd, .02ufd, .1ufd (oil) at 600V and 10ufd (electrolytic) at 350V.
 RF Signal Generator: Frequency: Fixed at 455kc (up to 700kc adjustable). Output: 35 mV (approx).
 Audio Generator: Frequency: 400 c/s (approx.). Output: 35 mV (approx).
 DC and AC Voltmeters: Meter Movement: 0 to 200uA. input Resistance: 4,000 ohm/volt. Four Ranges: 0-15, 0-50, 0-150 and 0-500V. Accuracy: Plus or minus 5% of full scale.
 R.F. Field Strength Indicator: Frequency Range: 1 to 140 Mc. Antenna: 5 section, 10 3/4 in.

PRICE \$12.95 Post 75c.

RESISTANCE SUBSTITUTION BOX

0-10 Megohms. 24 Steps. CAPACITANCE SUBSTITUTION BOX
 100PF - .22UF, 9 Steps. Complete with Leads and Alligator Clips.

\$2.95 each Post 40c.

G.D.O. UNITS

Post., N.S.W., 50c; Pstate, 75c. T.E. 15 Transistorised, 7 Bands. 360 Kc to 270 Megs.

\$35.75

T.V. BOOSTER

240VAL. Especially designed for fringe area reception. Also up to 3 TV sets can be operated off common aerial for improved signal strength. \$15.95 Post Free.

TRANSISTOR AND DIODE TESTER

E.A. August, '68. \$57.00
 Wired and Tested. KIT SET \$48.00



T.O. 2" Oscilloscope

IDEAL TV AID

240 V-AC 2 BPI CRO Tube Vert. Sen. 10V P-P/CM. 50v P-P/CM.
 Vert. Input imp. 2 Meg. 25pf. Vert. Freq. 2 cps/1 Meg.-3DB. Sweep Freq. 2 Ranges, 60cps-75KC. \$64.50.

SIGNAL GENERATOR

Deluxe Mod 1 TE-20D. Freq. range 120 KC—500 Mcs. 7 Bands. Accuracy 2 per cent. Output 8V. Provision for Xtal. Suitable for self calibration Marker generator. Printed circuit. 240 T.E.20. \$25.50. \$28.50 V.A.C.



AUDIO GENERATOR

De Luxe Model TE-22D. Freq. range, Sine 20 cps—200 KC. SQ. 20 cps—25KC. Output voltage. Sine 7V. SQ. TV P-P. Output impedance 1000 ohms. Acc. 5 per cent. Distortion less than 2 per cent. 4-range attenuation. 1/1, 1/10, 1/100, 1/1K. Printed circuit. 240V A.C. \$42.95

15-INCH HI-POWER SPEAKER

Imported 30 Watts R.M.S. \$30.00
 Local 50 Watts R.M.S. \$50.00

L.S.G. 11

SIGNAL GENERATOR

FREQ. RANGE IN 6 BANDS
 120KC—130MCS
 Calibrated Harmonics.
 120MCS—390MCS.
 RF output over 100,000UV.
 120KC-38MC.
 Mod. Freq. 400 and 1000CPS.
 Crystal Osc. 1-15MCS.
 AF Output. 3 to 4 Volts.
 AF Input. 4V approx.
 240V AC Operation.
 \$31.75. Post 75c.

T. E. 46 RESISTANCE-CAPACITANCE

Bridge and Analyser. Capacity 20 pf to 2,000 mfd. Resistance 2 ohm to 200 meg. Also tests power factor, leakage, impedance, transformer ratio, insulation resistance to 200 meg. at 600V. Indications by eye and meter. \$49.75

PLAYMASTER 115

The new solid state Stereo-Amp. lifier. April issue. Wired and tested . . . \$104.00
 Kit Set \$90.00
 Pre-amp to suit magnetic Cartridge \$12.00



TRIO

SSB transceiver

200 watts PEP—7 Bands—A M & C W
and
Power Supply and Speaker Unit

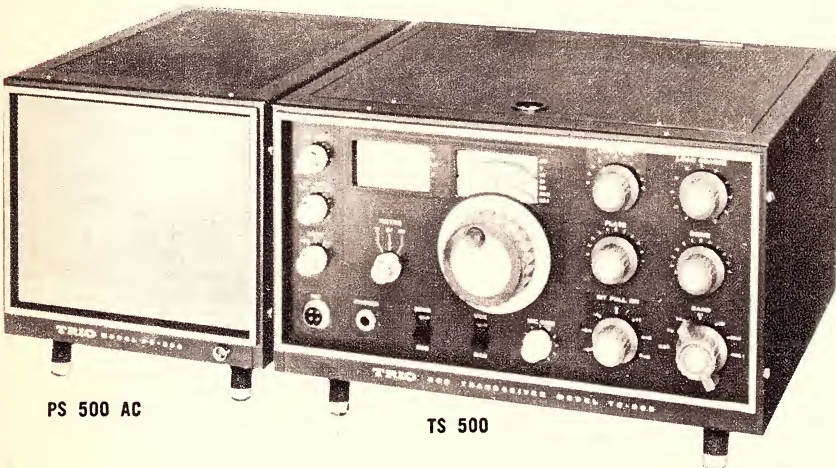

PS 500 AC

TS 500

SPECIFICATIONS:

Frequency:	80m Band	3.5-4.0 MHz
	40m Band	7.0-7.5 MHz
	20m Band	14.0-14.6 MHz
	15m Band	21.0-21.6 MHz
	10m A Band	28.0-28.6 MHz
	10m B Band	28.5-29.1 MHz
	10m C Band	29.1-29.7 MHz

Communication Method: SSB (A3j)
AM (A 3H)
CW (A1)

Maximum Input Power: (Xmitter final stage)
200W (PEP)

Standard Input Power: (Xmitter final stage)
180W (PEP) 120W on 28 MHz band only

Antenna Input Impedance: 50-75 ohm

Carrier Suppression Ratio: More than 40 dB

Single Side Band Ratio: More than 40 dB

Mic. Input Impedance: High impedance
(dynamic or crystal mic. recommended)

Xmitter Audio Frequency Characteristics:
300-3,000 Hz (-6 dB)

Receiver Sensitivity: 1 μ V S/N 10 dB
(14 MHz)

Receiver Selectivity: 2.7 kHz (-6 dB)
5.0 kHz (-55 dB)

Spurious Rejection Ratio: More than 45 dB

Image Ratio: More than 60 dB

Undistorted Power Output: More than 1W

Receiver Output Impedance: SP 500 ohm
PHONE 8 ohm

Power Consumption (using PS-500AC):
450W (At maximum power output)
250W (Receiving Mode)

Tubes and Transistors used:
17 TUBES, 3 TRANSISTORS, 15 DIODES

Dimensions: W: 13 $\frac{1}{8}$ " ; H: 8 $\frac{1}{2}$ " ; D: 11 $\frac{1}{2}$ "

Weight: 17.6 lb

FOR/FOA SYDNEY: TS 500, \$491.00 ; PS 500 AC, \$98.00

CONSULT YOUR LOCAL RADIO DEALER, OR

MAIL THIS COUPON *today*

Please forward free illustrated literature and specifications on Trio equipment.

Name.....

Address.....



(A unit of Jacoby Mitchell Holdings Ltd.)

376 EASTERN VALLEY WAY, ROSEVILLE, N.S.W.

Cables and Telegraphic Address: 'WESTELEC.'

Sydney. Phone: 40 1212

June meeting of the Hunter Branch, held in the Newcastle Technical College, Tighes Hill.

Details of the Westlakes Radio Club's activities may be obtained by telephoning the secretary, Bruce Morley, VK2ZNB, (Newcastle 59-1667).

Camberwell Grammar School

A review at the end of the first term showed that, thanks to the work of the committee and members, very good progress had been made. Much of the credit goes to Mr Trean, who supervises and tests all 30 members of the club at the various levels in the Y.R.S. courses.

Club president David Buchanan, who has gained the A.O.L.C.P., and vice-president Chris Holliday have been responsible for building several pieces of equipment for the use of club members.

Publicity officer Timothy Robinson reports that the prospects for further progress during the remaining portion of the year are particularly good.

Maitland Radio Club

The Maitland Radio Club has commenced another series of instructional classes. The course is being held fortnightly on Saturday afternoons and deals with home-made printed circuits, their uses, and methods of manufacture.

This series of lectures is being conducted by club member, Bob Thompson, who has had considerable experience in this field.

Six members of the club gained certificates for their success in the Y.R.C.S. Elementary Certificate examination held on May 10. They were:

Pass: G. Whenham.
Credit: R. Digby, N. Hawryluck jun.

Honours: K. Gormly, D. Cross.

The Maitland Radio Club now has four members who, having attended the club's A.O.C.P. course, gained their amateur operator's licence. They are A. Counsel, VK2ZFH; R. Johnston, VK2ZVR; C. Hay and R. Winston. The latter two are awaiting the issue of call-signs by the P.M.G. Department.

The club's social activities include the introduction of new members to various field events. This was done recently at a picnic held at Birubi Point, north of Newcastle, when 80 members and their families attended. Hidden transmitter hunts and many other events of luck and skill saw keen competition among those present.

At the conclusion of the day's events, Frank Hinks, District Radio Inspector in Newcastle, presented the successful competitors with their prizes. Another feature of these days is the barbecue which adds to the picnic atmosphere and ensures an enjoyable time for all.

Work on the club rooms and equipment has been continuing. The lining of the main meeting room and soundproofing the communications centre have both been completed.

An important addition to the lecture room is a 7ft rack which will house Morse code training equipment, switching equipment, amplifiers, and audio equipment as well as a 146MHz FM transmitter and receiver. The lecture room and equipment will double as a local WICEN control centre in the event of any emergency in the Maitland or surrounding areas.

The Hunter Valley County Council has donated a VHF FM transceiver to the club. This will be converted to 146MHz and used as a club-to-member communication unit as well as a training aid in the A.O.C.P. courses.

This club is a striking example of the work of amateurs and public-minded members of the community and an activity that could be fostered in many other similar country areas.

Information regarding the activities of the Maitland Radio Club may be obtained by writing to the:

Secretary,
Box 54, P.O.
Maitland. 2323.



LISTENING AROUND THE WORLD

Satellite relay for Voice of America

The Voice of America is to use a satellite relay over the Pacific to carry its programs from California to the Philippines, which should result in excellent reception.

by Arthur Cushen

In the past the transmissions from Washington studios have been carried by landline to Dixon and Delano in California, then broadcast to Asia for relay by stations in the Philippines, Okinawa, Thailand and Ceylon, and also from MW stations in South Vietnam. The use of the satellite will reduce the interference on the transmission from California to the Philippines, so the signal in the Philippines and other relay points should be as good as when they are broadcast at Dixon.

This is one of the many new innovations for the VOA services to this area. A visit to the huge transmitter site at Dixon in the Sacramento Valley gives one an idea of this side of the VOA activities. The site, 800 acres, has a vast array of antenna towers and the main transmitting hall has recently been remodelled and new transmitters installed. The station was built in 1943 on a site chosen because of the low cost of the land rather than its transmitting possibilities. Reminders of the war time days are four arrays beamed on Australia and New Zealand, the focal point of the VOA activities in that time of World War II.

New Transmitters

In the new extensions to the building, three 250KW Collins transmitters are being made ready to put into service. The station also has one 200KW, two 100KW, and two 50KW transmitters in use, and a further two 50KW units for SSB transmission. The antenna towers carry 14 antenna systems; eight of these are the curtain type.

VOA CHANGES

The Voice of America has rescheduled its programs, and now is using longer time blocks on each frequency. In the past at Tangier it called for 70 frequency changes and 180 antenna changes in one day. To simplify this, longer time on each frequency is now being scheduled. In the Philippines, 10 new transmitters for short-wave operation are being built at Tinang, with the receiver site at Baguio receiving direct short-wave and satellite signals. In Greece, at Thessaloniki, there are four 35KW short-wave transmitters and a 40-KW medium wave transmitter, all designed to penetrate the Balkan area. To this a further series of 250 KHW outlets are

under construction. At present the VOA is operating 107 transmitters and has a further 22 under construction.

VETERAN LISTENER

During my stay in Los Angeles I visited the home of August Balbi, well known as the world's oldest active DXer, and a familiar name in DX bulletins and in DX sessions. August, now 78, is a monitor for Radio Australia and has a keen interest in reception of the South Pacific. He has short-wave stations' verifications as far back as 1930, with pride of place for the 50 watt Kanimbla, which operated from this vessel off the coast of Australia. He has a huge collection of verifications, but his major interest these days is less in reporting radio stations, and more in keeping up to date the times, frequencies and changes in schedules of many stations. His information, which is based on his outstanding knowledge of short-wave radio, is widely used by many listeners and frequently produced in these pages.

He lives in the Glendale area, about eight miles from down-town Los Angeles. With his communication receiver and a short horizontal inverted-L antenna he gets amazing results. DXing for nearly 40 years he has a vast knowledge of the conditions in the early days of short-wave radio, and is a little despondent at the short-wave broadcaster of today, with the lack of interest in listeners shown by some stations, and the deliberate blocking and jamming of frequencies. He is also critical of stations who fail to heed the advice of listeners and schedule programs at poor listening times, or use frequencies which do not propagate to a given area, despite the expert knowledge he can supply to the station. One of the older school of listeners, he has memories of what DX was in the early days. These days are still vivid in his mind, and he tends to compare them with short-wave conditions today, where powerful propaganda stations tend to take away much of the fascination and thrill of listening to low-powered distant signals.

SHORT-WAVE BOOST

Short-wave listening is receiving a boost in the Los Angeles area from MW station KABC, which, in the period from midnight to 5 a.m., has well-known DXer Ray Breen comparing the program. His show is based on the idea that while he can telephone a listener in any country, his audience can also reach this country by short-wave radio. In early April he telephoned me in Invercargill and talked for 20 minutes about Radio New Zealand and short-wave listening in general. This was carried live to the Southern California audience by KABC. When I

was in the Sacramento area, he again telephoned me, and we discussed further the role of the short-wave listener, his part in the community and the value of his knowledge of the world about him which he obtains from his short-wave receiver. KABC Radio is the key station on the West Coast for the American Broadcasting Company. Ray Breen was somewhat staggered when I told him I had verified over 1,000 United States broadcast stations and 170 in California, including KABC. The fact that this was a little difficult for him to understand is proof of the excellence of my New Zealand location for world-wide reception on both medium and short wave.

SIGNALS FROM AFRICA AT PEAK

At this time of year, we note the seasonal increase in reception of broadcasters located in the African area. With the general lessening of sunspot activity as observed in recent months, signal strengths of these stations have considerably improved, as compared to conditions over the past three years when sunspot activity was at its peak. The following summary lists those stations which have actually been heard by members of the Australian Radio DX Club, as reported to the Club's bulletin "The Australian DX News," and these stations should continue to give good reception until around the September equinoxal period.

2446KHz REUNION. St. Denis, fade-in at around 1730GMT, French programming, sign-off at 1830GMT with "La Marseillaise."

3232KHz MALAGACHE. Tananarive, in French at around 1815GMT; also heard on 3288KHz and 4960KHz at this time.

3295KHz BURUNDI. "La Voix de la Revolution," Bujumbura, telephone requests, in Vernaculars, at around 1935-GMT.

3331KHz COMORO ISLANDS. Radio Moroni, piano accordion music at around 1745GMT, consistently heard, good level.

3339KHz TANZANIA. Radio Tanzania, Zanzibar, native chanting, and announcements in Vernaculars, at around 1755-GMT.

3356KHz BOTSWANA. Radio Botswana, Gaborone, BBC-produced drama at 1800GMT, then commentary in local language at 1830GMT.

3370KHz MALAGACHE. Radio Universite, French announcements with a program of light music at 1740GMT. Good level.

3373KHz MOZAMBIQUE. Lourenco Marques, heard regularly at around 2030-GMT until 2100GMT with English religious programs. Also noted on 4762-KHz in parallel.

4750KHz CONGO. Radio Lubumbashi, noted with African rhythms at around 2115GMT and French announcements. Also heard in parallel on 5958KHz. Other Congolese transmitters heard include Radio Kinshasa 4880KHz, Radio TV Congolaise, 4765KHz, noted at around 2100GMT with French announcements and African style music.

4807KHz SAO TOME. Radio Clube de Sao Tome, observed at 2125GMT with the re-broadcast of the French service from Lisbon, and in English from 2145-GMT.

Notes from readers should be sent to Arthur Cushen, 212 Earn Street, Invercargill, N.Z. All times are GMT. Add 8 hours for Perth, 10 hours for Sydney, 12 hours for Wellington. All frequencies are in KHz.

DUAL 1019 TURNTABLES ON SPECIAL OFFER!
Write or call now for a very special Encel proposition — we're not at liberty to advertise the low Encel price.

SEE THE NEW GRUNDIG STENOIRETTE AT ENCEL'S!

If you need a dictating system, be sure to see the Grundig Stenoiretette Model L at Encel Stereo Centres in Melbourne or Sydney. This fine tape cassette machine features a remote control microphone so you can control recording, playback, forward and backspace facilities without moving from your chair. Ask for the complete details and for your special Encel price. Your new Stenoiretette will cost you far less than you thought possible!

GRUNDIG PORTABLE/OFFICE DICTATING SYSTEMS

Away from your office you use the Grundig EN3 electronic notebook and record your reports, notes, memos and instructions on an instant loading 44 minute cassette. It is a completely transistorised battery operated dictating machine which fits in your pocket. In the office the AC operated Grundig EW3 transcriber offers every desirable facility for speedy typing of recorded matter. Foot or keyboard control, fast erasure for security, internal speaker — they're all there. Ask for a special price on both units at Encel Electronics stores in Melbourne or Sydney. You'll save more and be left with spending money!

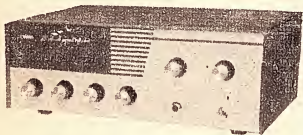

POWERFUL PUBLIC ADDRESS AMPLIFIER OFFERS AN OUTPUT OF 35 WATTS R.M.S. — \$73.50
Once more stocks of the Planet MG-300 public address amplifier have arrived. Parallel push-pull 6BQ5's are used in the output stages . . . frequency response is 30-15,000 Hz. plus or minus 2 dB. Inputs suit two crystal/dynamic microphones at 5 mV. and an auxiliary input with 300 mV. sensitivity suits tuners, tape recorders, etc. Output impedances include 8, 15 and 250 ohms as well as a 70V. line. Inc. sales tax **\$73.50**

SAVE MORE ON ALL LEADING MAKES OF TAPE RECORDER

Encel Stereo Centres stock all the best makes . . . Akai, Sony, National, Toshiba, Philips, Revox, Tandberg, Nivico and many more. You'll be wise to secure an Encel price before you commit yourself elsewhere. Save at Encel's!

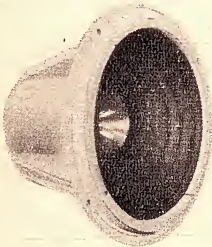

NOW . . . A NEW 8" CO-AXIAL SPEAKER WITH UNIQUE PERFORMANCE AND SIX POWERFUL MAGNETS . . . ONLY \$34.50!

Can any 8" speaker be worth \$34.50? Easily . . . when you see and hear the remarkable CX-20D. Here at last is a total-performance 8" co-axial speaker with six magnets, a horn type tweeter, an electrical crossover, high compliance and unusually robust ribbed construction. Total weight is almost 8 lbs. and frequency response is 35-20,000 Hz. The response curve is substantially flat; from an engineering viewpoint the CX-20D is superb in design and construction. The matching enclosure is easy to make and any handyman can make it from readily available materials. We want you to hear the CX-20D and make your own appraisal. It's tremendous value for money! Inc sales tax **\$34.50**

NOW . . . SHURE CARTRIDGES AT ATTRACTIVE ENCEL PRICES!

Perhaps you've been saving for a Shure Cartridge . . . now you can make your purchase sooner than you expected. Encel prices include sales tax, all cartridges are brand new, each one is fully guaranteed.

KEF SPEAKER SYSTEMS

Ask for an EMQ on the KEF system of your choice; copies of reviews are available for most current KEF speaker systems.

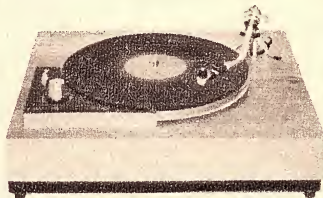

NEW COMPAX TURNTABLE FEATURES BELT DRIVE — ONLY \$39.50

Belt driven around the perimeter of its 12" non-ferrous platter, the wow and flutter figure of the new Compax III turntable is an amazing 0.04%. The 12 pole synchronous motor is completely sealed — a unique speed selecting mechanism (pat. applied for) permits choice of 33-1/3 or 45 r.p.m. speeds. The rubber mat on the turntable is of anti-static material. Encel price inc. sales tax **\$39.50**

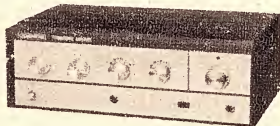

NEW SHIPMENT OF HIGH QUALITY, LOW PRICED COSMOS STEREO AMPLIFIERS

Once more the popular Cosmos Model SW-30C stereo amplifiers are in stock. Output is 8 watts R.M.S. or 15 watts I.H.F.M. in each channel, all necessary control facilities are included and the price is only \$79.50. (IMPORTANT: The sensitivity of the Cosmos suits magnetic cartridges at 5 mV.) Provision is made for use of stereo headphones and a DIN socket permits connection of tape recorders. The pre-amplifier is fully transistorised. Speaker outputs allow for use of 4, 8 and 16 ohm. speakers or speaker systems. The Cosmos is ideal for use with tape recorders and tape decks. When used with high quality stereo pick-ups and wide range speaker systems, results are very satisfying. Encel price, inc. **\$79.50**

A NEW ENCEL STEREO SYSTEM FEATURING THE COSMOS STEREO AMPLIFIER—ONLY \$239!

We supply the Cosmos Model SW-30C stereo amplifier, the popular Compax III belt driven turntable, the Lustre Model CP-3 tone arm, your choice of a Shure or Micro stereo magnetic cartridge with a diamond stylus, an oiled teak base for the turntable and a matched pair of Sonics Model AS-61 speaker systems. Each enclosure houses four bass/mid-range speakers and a tweeter. Total Encel price inc. sales tax is only **\$239**

BUY YOUR NEW PHILIPS STEREO RECORDER FROM ENCEL ELECTRONICS

You'll save more when you buy your new Philips recorder from Encel's. Models currently in stock include EL3302, EL3312, N4308 and the new model N4408. The latter is one of the most effective stereo recorders ever available, and extremely good value at the low Encel price. It features 3 speeds, 4 tracks, 2 VU meters, stereo speakers and it is completely solid state. It takes 7" reels, frequency response at 7 1/2 i.p.s. is 40-18,000 Hz. ± 3 dB. The fast forward and fast rewind rate is 1800" within 200 seconds. An automatic selector enables the operator to find sections of the tape accurately and quickly. Encel's prices cannot be advertised because of agreements with manufacturers. Write or call for your trade-in valuation or an EMQ (Encel Mail Quote).

CANBERRA ENQUIRIES FOR ENCEL EQUIPMENT

If you live in Canberra and you want further information on Encel equipment, please phone Canberra 81 1667.

DEMAGNETIZE YOUR TAPE HEADS AND IMPROVE TAPE PERFORMANCE!

Simply plug the "Sonics" tape head demagnetizer into any AC power point and pass over the heads. Takes only five seconds and can make a world of difference. Single probe. Inc. sales tax **\$3.90**

SAVE WITH AN ENCEL QUOTE ON YOUR NEW SANSUI AMPLIFIER

The full Sansui range is available—and Encel end-user prices are most attractive. Trade-in valuations on your old equipment are also at an all time high . . . so ask for a price now!

LOOKING FOR AN ADC CARTRIDGE? SEE ENCEL ELECTRONICS WITHOUT DELAY!

A full range of renowned ADC cartridges is now available and Encel prices cannot be advertised. However you can overcome this tragedy by writing for a personalised quote or a trade-in valuation. You'll save more at Encel Electronics!

SAVE YOUR RECORDS . . . USE THE UNIVERSAL NIKKA-LUSTRE TONE ARM LIFT!

This beautifully finished and functional universal tone arm lift will fit all tone arms . . . the lowering action is pneumatically damped and extremely smooth. Risk of record damage may now be eliminated. Including Sales Tax **\$8.50**



THE NEW LUSTRE MODEL ST-510 TONE ARM . . . TRACKS AT LESS THAN 1/2 GRAM . . . AND COSTS ONLY \$19!

Orders for the new Nikka-Lustre Model ST-510 tone arm can now be filled immediately. Miniature ball races are used throughout, the head shell accepts all standard 1/2" mounting cartridges, finish is satin chrome and anodised aluminium. An outrigger bias adjustment is fitted and stylus pressure is adjusted with the counter balance weight. The Model ST-510D is fitted with a lifting/lowering device and costs \$24.50. The Model ST-510 (without lift), inc. sales tax is priced at **\$19**

"DITTON 10's" AND "DITTON 15's" ARE ONCE MORE IN PLENTIFUL SUPPLY

The Celestion Ditton 15 measures only 2 1/2" x 9 1/2" x 9 1/2" and incorporates the HF 1300 Mark II tweeter, a new type of bass drive unit and the revolutionary auxiliary bass radiator. Frequency response is 30-15,000 Hz. and extends well beyond these figures. Many favourable reviews have been published.

"Hi Fi Sound!"—"it was difficult sometimes to realise that so small a loudspeaker was really producing such well-defined low frequency sounds. It goes without saying that the treble performance was fully up to the standard of the HF 1300."

"The Gramophone!"—"the listening tests made an excellent impression. Treble was bright and forward; the bass was clean and powerful enough to produce a good balance."

"Hi Fi News!"—"the quality of bass sound was above average, plenty of bass, but always clean and clear . . . a very wide range of programme material was enjoyed and nothing caught it out or gave cause for reservation."

The Celestion Ditton 10 measures 12" x 6 1/2" x 8 1/2" and features a specially designed bass unit and the well known Celestion tweeter. Both 3 and 15 ohm impedances are available. One review of the Ditton 10 in "Records and Recording" says "on a wide range of music it proved to be a clean-sounding speaker with the sort of characteristics which would make it one of the most popular in its class."

Prices: "Ditton 15" (including Sales Tax) . . . **\$89**
"Ditton 10" (including Sales Tax) . . . **\$64.50**

ENCCEL
ELECTRONICS (STEREO)
PTY. LTD.

Head Office:
431 Bridge Rd., Richmond, Victoria 3121. Tel. 42 3762.
Sydney Store: Ground Floor, 2SM Building,
257 Clarence Street, Sydney, N.S.W. 2000. Tel. 29 4563, 29 4564.
Australia's Greatest Hi-Fi Centre *Wholesalers *Trade-ins accepted

4814KHz UPPER VOLTA. Ouagadougou, logged at 2110GMT with a French political commentary.

4865KHz AZORES. Ponta Delgada, at around 2050GMT with Portuguese, relayed from the Home Service Network from Lisbon.

4932KHz NIGERIA. Benin City regional outlet of NBC, at around 2125GMT with African chants, and announcements in English.

5047KHz TOGO. Radio Lome, at 2130GMT with popular music, French announcements, fade-in noted as early as 2000GMT.

9650KHz GUINEA. Conakry, at 2215GMT in French, African music at 2230GMT.

TRANSMISSIONS RESCHEDULED

Radio Japan in Tokyo has retimed its overseas broadcasts to some areas of the world. The new times and areas affected are:

GMT	Area
1745-1915	North Africa
0100-0300	American Service
0645-0845	European Service
0930-1130	Latin America
1200-1530	South East Asia
1500-1730	South Asia.

HELSINKI USING 9550KHz

Transmissions from the Finnish Broadcasting Company, Helsinki have been received on two frequencies in the 0600-GMT transmission. Transmissions open at 0555GMT with an interval signal, followed by an announcement in Finnish and English, and a 30-minute service for listeners in Europe.

The transmission schedule of the Helsinki station is:

GMT	KHz
0600-0630 weekdays	9550, 11805
0630-0650 Sunday	9550, 11805
1000-1110 daily	9550, 11805, 15185

Best reception is on 9550KHz which suffers from only light interference. The 11805KHz suffers from heavy sideband interference which makes reception difficult.

The present schedule of the Finnish Broadcasting Corporation is as follows:

GMT	KHz
0400-2200	6120
0600-0630	9550
1000-1115	9550, 11805, 15185
1200-1315	9550, 11805, 15185
1500-1555	15185
1500-1830	9550, 11805
1600-1830	15185
2000-2100	9550, 11805, 15185
2300-2400	15185

SCHEDULE FROM MONTREAL

Radio Canada in Montreal has issued a schedule which came into effect on 4th May, 1969. The overseas transmissions are shown below.

GMT	KHz
0815-0945	5970
0058-0705	9625
0825-0935	9630
1055-1215	9625
2350-2400	9625
0045-0600	11720
0650-0715	11720
1215-1345	11720
2145-2300	11720
0600-0650	11765
0700-0815	11765
2150-0400	15190
1850-2200	15320
1045-1850	15325
2145-0100	17720
1315-2200	17820
1045-1215	21595
1345-2200	21595

RADIO QATAR

The history of this new broadcasting station was published recently in "Contact", and introduces yet another new country to the shortwave band.

The advent of a "new country" on the broadcast bands is an event that is be-

NEW SCHEDULES OPERATING

RADIO FIJI CHANGES

Some frequency changes have been made to the Radio Fiji shortwave coverage schedule. Radio Fiji provides good reception at certain times in Australia and New Zealand.

GMT	KHz	Location	Language
1800-1030	560	Suva	English
1800-1030	1320	Lautoka	English
1800-1030	930	Nadroga	English, Hindi, Fijian
1800-2115	3230	Suva	English
0345-1030	3230	Suva	English
2115-0345	6005	Suva	English
1800-1030	710	Suva	Fiji-Hindi
1800-1030	890	Lautoka	Fiji-Hindi
1800-2130	3284	Suva	Fiji-Hindi
0330-1030	3284	Suva	Fiji-Hindi
2130-0330	5955	Suva	Fiji-Hindi
On Sunday a special English program is heard 2000-2400GMT on Saturday.			
2000-2400	840	Suva	English
2000-2400	4756	Suva	English

ENGLISH FROM PORTUGAL

The schedule for English broadcasts from Radio Portugal, Lisbon is:

GMT	KHz	AREA
0200-0245	9680, 11935, 6025	United States
0345-0430	9860, 11935, 6025	United States
0200-0345	11840	Canada
2045-2130	6025	Great Britain
0730-0900	21495, 17880	Australasia
1345-1430	21495, 17895	South East Asia
1815-1915	17895	South Africa
1815-1915	21495	South Africa

coming rarer as the years go by, and it is usually heralded by many announcements that the event is imminent. Not so the case of Qatar. DXers throughout the world read with some surprise in the summer of 1968 that Qatar was actually "on the air" with test programs in Arabic, and shortly afterwards the station went into regular operation.

Qatar is one of the British Protected States located on the Persian Gulf, covering the Peninsula of Qatar, with an area of some 4000 square miles, and having a population of some 70,000. Considerable exports of oil are made from Qatar which continues to develop its economy in many ways. Its capital city is Doha, which has an estimated population of about 50,000.

In various editions of our "DX News" we have reported Qatar B.S. as operating on 9570KHz from 0330-0500 and 1400-1730GMT, with an extension on Friday of the morning session until 0700. However, the afternoon period has recently been extended and the station now continues until well after 1730, broadcasting news in Arabic at that time.

Reception in the U.K. has been very good in late afternoon, and we recently invited the Director of Q.B.S., M. Taher Shihabi, to contribute some information to "Contact" about his station and its QSL policy. In a very informative reply, confirming our report, M. Shihabi says that Q.B.S. is operated by the Government of Qatar and goes on to say:

"This report, coming so far from outside our normal service area of about 2,000 miles, is surprising bearing in mind the heavy interference from nearer and more powerful stations. It says a lot for your receiver selectivity and your handling of it.

"The transmitting station is located in Doha, the equipment at present is one Marconi 100KW HF transmitter feeding into a quadrant aerial, one Marconi 50KW MF transmitter feeding into a quarter-wave radiator, and one Marconi 10KW transmitter feeding into a 'T' aerial array as standby. Broadcasting House consists of two talks and two drama studios, with the usual administration offices and newsrooms.

"The studios and transmitters are about 2½ miles apart. The program is fed by a VHF link on 86.1MHz, and the engineer's control circuits by a link on 144MHz.

"The station was officially opened by

His Royal Highness, the Ruler, on June 25, 1968 and numerous reception reports have been received from many parts of the world. Considerable expansion is planned for the not too distant future.

"Regarding reception reports — whilst they are not specifically requested, when received they are appreciated and always answered by letters confirming or otherwise. Since this station opened, numerous reports have been received. I.R.C.s would therefore be appreciated. As to reports submitted, I am sure you will agree that for your information to have any real value at all, cross-checking with our transmission logs is essential; therefore vague indefinite reports incapable of being so verified are not likely to be confirmed, although the reports will be acknowledged.

TIME STATIONS AND LISTENERS

Around the world, many time and frequency stations are in operation which are of great benefit to the short-wave listener. These stations use a very accurate frequency, which enables the listener to calibrate his radio dial correctly, while the frequent time announcements enable him to keep his clock exact to the second. In a recent broadcast, Radio Nederlands listed details of these stations which we are sure will be of benefit to our readers. All the stations listed below give voice identification.

CHU Dominion Observatory, 3 Observatory Crescent, Ottawa 4, Ont., Canada. Continuous transmission on 3330KHz, (3KW), 7335KHz (3KW) and 14670KHz (3KW).

FFH Centre National d'Etudes des Telecommunications, 196 rue de Paris, 92 Bagneux, France. Transmission Monday to Friday at 0800-1625GMT on 2500-KHz (5KW).

IAM Istituto Superiore, Ministero della Poste Telecomunicazioni, Rome, Italy. Transmissions Monday to Saturday at 0730 and 0830GMT on 5000KHz (1KW).

IBF Istituto Elettrotecnico Nazionale, Corso Massimo d'Azeglio 42, Turin, Italy. Daily transmissions on 5000KHz (5KW) at 0645-0700 and for 15 minutes preceding the hours 0900, 1000, 1100, etc. until 1800GMT.

JJY Radio Research Laboratories, Koganei, Tokyo, Japan. Transmissions on 2500, 5000, 10000, and 15000KHz (all 2KW), continuous except for an interruption at 29-34 minutes past each hour.

DIRECT DISPOSALS Mail Order Specials

Mail orders to DIRECT DISPOSALS 36 HELEN ST. VALLEY, BRISBANE, 4006 • 3 shops Brisbane • Phone 5 4833

Brand New/10-Transistor
WALKIE/TALKIE
TRANSCIVER

\$85
PER SET

Pack post \$1.50

A portable battery operated walkie talkie featuring squelch control, 48" telescopic antenna, 9 volt batteries, battery indicator, die cast metal cabinet, 2 1/2" speaker/microphone, leather hand strap. Weight 2 1/2 lb. each. Size 7 1/4" x 2 3/4" x 1 1/4". Range 0.3 to 5 miles. Unit is fully approved by P.M.G. throughout the Commonwealth. Full 180 days warranty.

DIGITAL COUNTERS \$1.75
Post 15c. Works from 3 to 13 volts or MECHANICALLY. Reads to 9999. Handy for counting lap circuits, in fact 9999 of anything.

6" Engineers' Calipers — brand new; for inside diameters, 25c. Post 10c.

ANTENNA RODS \$1.25 — 6-Piece telescopic model with heavy chrome finish. Extends from 5 1/2" to 27". Button top. Pack, post 25c.

CUTOUTS \$9.50 — Reverse current 50 amps. 24 volt (12 volt also available). Solid silver contacts. Post 25c.

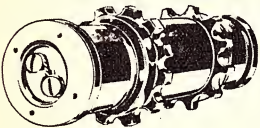

**"HUGHES" AIRCRAFT
GEARED MOTOR \$5.50**

Post 50c. 1/2 h.p. geared motor made by Hughes Aircraft Co., U.S.A. for feeding ammo. belts to gun turrets. Has 2 sprockets turning at approx. 100 R.P.M. "A little power baby" with many uses; including turntables, small winch, etc. For 24/32v. D.C. use (works perfectly on 12v.).
1/2 h.p. "Crompton Parkinson" 240v A.C. motor. Single phase ball bearing, fan-cooled. List price \$44.50. Now only \$35. freight collect.

Various 1/2 h.p. 240v single phase electric motors in good used condition. \$10.95 each. post \$2.

24 volt English Selsyn (synchro) Repeater Motors (Slave) for indicators and other mechanisms. 4" x 4" x 3". Shaft 3/2" x 1/4". Also works on 12v or 32v. Type B2. Ref. No. 5U/4317. Freight 50c. \$4.50 single phase.



Famous Make and Brand New
INTERCOMS \$9.50

Post 50c. Two station intercommunication system comprising master and sub-station. A faultless unit with volume control and connecting wire. Fully transistorized. Has press-button buzzer on each station. Operates up to 1-mile. Battery operated. Neatly packed in cartons.

Student's microscope. 3 turret 100/300/500 mag. Has light, sample slides, 20 clear slides, tweezers, scalpels, drying fluid. Only \$7.95. Post 50c

Hand operated Electric Generators \$2.45, post 50c. Brand new in carton with handle. Output up to 12 volts.

BATTERY CHARGERS

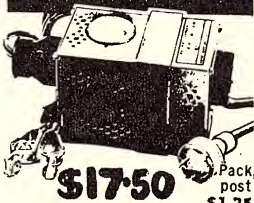

\$17.50 Pack, post \$1.25

• Charges 6V and 12V Batteries overnight • High 4-amp. charge rate • 12 months written GUARANTEE.

Top quality! Top performance! A fantastic direct deal from top manufacturer. They are usually sold at \$30.00. Finest quality components; steel case. Charges 6v. and 12v. batteries from 240v. A.C. mains. Complete with trolley, ammeter, long lead with alligator clips for battery terminals and long flex with 3-pin plug. Units are brand new in carton and have passed strict electrical authorities test.

Use also for electric fences and electric model trains. Special condenser for electric fences and electric model trains, extra \$1.75.

240v. Electric Pumps

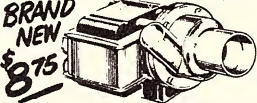

Direct English Purchase from a famous manufacturer. We purchased their entire stock of these ABSOLUTELY BRAND NEW in carton 240-volt electric motorised pump unit. Usually sell for \$25.00. Full 3 MONTH GUARANTEE. Special Neophrene impeller pump will handle corrosive fluids, fuel and water. Pumps 300-400 g.p.h. To be gravity fed and will lift to 8'. Ideal for fuel or water transfer, fountains, fish ponds, etc. Pump entirely non-corrosive. Rush your order now as stocks will not last at this price. Pack and Post 75c.



BURGLAR SIREN \$11.50

Post 75c. Comprises a very efficient, beautifully made rotary siren (can be heard up to 1/2-mile away); battery pack (with 4 1.5V "C" batteries); leads and manual switch, which can be positioned anywhere handy. Siren can be installed inside or outside of house — sounds for 3 hours on batteries (or until switched off). Easily installed in minutes. Ideal for properties, schools (lunch break, etc.) cars, boats. Siren sold separately for 6V D.C. use \$7.95 (post 50c). Fire alarm temperature sensor operates siren when temperature reaches 135°F. extra \$4.50. MICRO door/window switch triggers siren when door is opened; extra \$2.25 each.

STEREO HEADSETS \$10.50

Pack, post 25c. Beautifully made and top quality. Complete with JACK PLUG — 8 ohm. FREQUENCY RANGE: 50-40,000 C.P.S. Sensitivity 118 Db. Usually sell for \$17.

MICA FUSE PANELS (for cartridge fuses) 25c, post 5c. 6 and 12 volt MICA SELECTOR PANELS (brass contacts) 15c, post 5c.

WRITE FOR OUR FREE CATALOGUE



Brand New "Pocket Tester"
MULTIMETERS \$6.95

Post 25c. Brand new circuit tester with high sensitivity and ruggedly built for checking any electric apparatus; and truck ignitions, motors, shorts, broken leads, etc. Measures all voltages to 1,000 volts A.C. and D.C. . . . D.C. current (amps.) resistance, etc. Complete with full instructions and probes.

Also famous make 20,000 ohm, 200H model with overload protection. Extremely sensitive, for use in laboratories, etc., and for checking any electrical apparatus; measures to 2,500 volts, etc., as illus. \$9.75. Post 50c.

BRAND NEW VOLTMMETERS & AMPMETERS



Beautifully made. Moving coil. Extremely accurate. Brand new 1969 models in cartons. Save \$4 0-50 volt D.C. voltmeters in two-volt division \$4.50. (post 30c). 0-50 amp. D.C. ammeters in two amp. division with inbuilt shunt \$6.95 (post 30c).

Brand New 40-Piece
TAP & DIE Sets \$9.95
Freight \$1.50. 40-piece stock and dies covering the full range S.A.E. and WHIT. In the one box. TUNGSTEN STEEL 1/4", 3/8". Complete with dies, stock, tap wrench, tap holder, pitch gauge, driver — in strong metal case. A bargain 1/2 price.

Brand New 32-Piece
Socket Sets \$3.75
Freight \$1. Full range 3/16" to 15/16". Chrome-plated, drop-forged, alloy steel in S.A.E. or WHIT. Complete with 2 "L" handles, 2 ratchet handles, three-piece adaptor, flex handle, plug wrench, tommy bar . . . all in strong metal case. A bargain usually twice this price. Please state S.A.E. or WHIT.



TANK PERISCOPES

\$1.25

Freight 75c. Beautifully made by "Minneapolis-Honeywell" U.S.A. 12" high, 6" wide.



Brand new ENGLISH Electric
PAINT SPRAYERS \$13.95

(Pack, Post 50c) Save \$12. These famous English spraying outfits are usually \$26. Comprises complete modern electric spraying outfit complete with variable jet, adjustable by knurled knob. Has container, flex and plug. Built-in 240V A.C. reciprocating motor gives 60 P.S.I. at nozzle. For professional finishes on all paint jobs and enamels and spraying insecticides.

HALF-PRICE SPECIAL HI-FI RECORDING TAPE

BRAND NEW!

Fantastic purchase of "Mylar" professional recording, computer tape (the best money can buy). Famous 3-name brand (one we can't mention due to huge price reduction). Silicon lubrication. Suits all tape recorders, hi-fi and stereo. Selling well under half price. Post 10c each.

3" 200ft. 65c
5" 600ft. \$1.50
5 1/2" 900ft. \$2.25
7" 1200ft. \$2.50
7" L.P. 1800ft. \$3.25
Empty spools 3" 35c, 5" 65c.
Post 10c each.

TRANSISTORS 95c

Brand new all one price.
PXA 101 0C44
PXA 102 0C45
PXB 100 0C70
PXB 103 0C71
PXB 104 0C72

SILICON DIODE RECTIFIERS

800 PIV, 0.5 amps. \$1.50
50 PIV, 1.5 amps. \$1.00
GERMANIUM JUNCTION (G.J.M.)
70 PIV, 0.5 amps. \$1.25
Diodes 140 PIV, 3 amps. \$1.25
Diodes, 18 amps., Push . . . \$1.50

G.E.T. 8 TRANSISTORS in matched pairs. Operates up to 30v. and two give up to 40 watts in push-pull. Pair \$3.50.

AIRCRAFT PLUNGER SWITCH

— Heavy duty. Ball bearing operates 2 pole, 2 way switch mounting plate. Size 5 1/2 in. long. \$1.25.

32 VOLT 10 AMP. — two position, 2 pole switches. Spring loaded. Size 1 1/4" x 2" x 2" 35c.

NIFE BATTERIES—95c

(Pack, despatch and post 10c ea.) Brand new! Nickel iron, spill-proof, leak-proof cells—Lasts forever, 4 A.H., 1.2 volts. Sizes 3 1/2" x 2 1/2" x 1". Couple together for any voltage—superb for spotlights, lamps, bells, flash equipment, etc. Set of 10 gives 12 volts 4 A.H. \$7.95 (Pack post \$1); Set of 5 for 6 volts, 3.95 (Pack post 50c).

Large size 1.5 volt 15 amps. hours: 8" x 4" x 2" \$2.75. Post 75c. Set of 8 for 12 volt \$20. Freight \$4. Set of 4 for 6 volt \$10. Freight \$2.50.

"ACOS" REPLACEMENT CRYSTAL CARTRIDGES, each brand new in box with STYLUS. Post 20c.

GP 91-2 high output MONO. Usually \$6 — now \$2.50.
GP 73-2A STEREO. Usually \$7.50 — now only \$3.75.

**English 240 Volt
ELECTRIC MOTORS \$2.65**

These are finest quality English manufacture. Fully ball-bearing—3000 r.p.m.—shaft for drive. Are for cont. duty; beautifully made; brand new in carton. Original cost \$8.50 — 3-bladed plastic extractor fan; ideal for removing kitchen, cooking fumes, 79c. Post 50c.

English Heavy Duty
Selenium Rectifiers

Full Wave bridge, fresh current production, all new. For 3, 6, 12, 17 volts, 2 1/2 amps. \$1.50; 4 amps. \$3.75; 8 amps. \$6.25; 10 amps. \$8.75. Post 25c.

High pitch BUZZERS, suitable for Morse keys. Operate off 3 volt. 69c, post 10c.

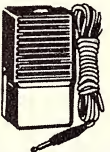

Model CM21 MICROPHONES (Crystal)—\$1.40 (post 10c). Load resistance 500K-1M ohms and also Model CM62, 69c (post 10c).

INDUCTION MICROPHONES

Will pick up sound waves from a distance. Has suction cap, long cord and plug for tape recorder, etc. Sticks to wall or case of telephone for recording speech. \$1.25.

ENGLISH SINGLE THROAT MICROPHONES 65c

Strap on guitar for amplification. Many other uses.

English Microphone TRANSFORMERS . . . suits all types of microphones . . . 65c

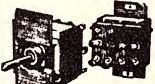

"Cutler Hammer" TOGGLE SWITCHES

(Post pack 10c.) 4 pole 3-way (3-position) panel switches (centre off). Handles 10 amps. at 12 or 24 32 volts D.C. Ideal for panels, control boards. 75c

BURGLAR ALARM SIREN MODULE

\$3.95
Needs only 8-ohm loudspeaker, switch, and microswitch (or reed switch and magnet) to complete. Post 25c.

PUBLIC ADDRESS AMPLIFIERS—\$3.95

Needs only crystal or dynamic microphone of either high or low impedance and any loudspeaker to complete, and power from a 6 volt battery to operate. Fully encapsulated. Size only 1 1/2 x 1 1/2 x 2". Post 25c.

Famous "Ashby Barton" SAFETY ISOLATION TRANSFORMERS

\$3.95. Freight collect. Latest model, 750 watt, output 3.12 amps. 240 volt AC. Prevents shocks. Use for safety with drills and all other powered hand tools. List price \$54.00. Fully guaranteed.

LENSATIC ENGINEER COMPASSES—\$1.50

Post free. Gives accurate bearing on any object. Brand new in carton with instructions. Fully luminous.

Key Ring Lights, 30c, post 5c. Has rechargeable cell.

WATCH FOR NEW RELEASES . . . COMPUTER CARDS, NEONS, TAPE RECORDER, CASSETTES

LOL Observatorio Naval, Avenida Costanera Sur 2099, Buenos Aires, Argentina. Transmits the following schedule on 5000, 10000, and 15000KHz (all (2KW)). From 0000 1st Sunday in October to 0000 1st Sunday in April, 1 hour transmissions beginning at 1100, 1400, 1700, 2000, and 2300GMT. From 0000 1st Sunday in April to 0000 1st Sunday in October at 1200, 1800, 2100 and 0000GMT.

VNG Station VNG, c/o Assistant Director General, Radio Section, Postmaster-General's Dept., 57 Bourke Street, Melbourne 3000 Australia. The following daily schedule is valid: 4500KHz (1KW) at 1200-1230, 7515Hz at 1200-2200 (10KW) and at 2230-1200 (1KW) and 12005KHz (10KW) at 2230-1200GMT.

WVW Radio Station WVW, Box 83-E, Route 2, Fort Collins, Col 80521, U.S.A. Transmissions on 2500, 5000, 10000, 15000, 20000 and 25000KHz. (2.5, 10, 10, 10, 2.5, 2.5KW resp.), continuous except for an interruption at 45-49 minutes past each hour.

WVWH Radio Station WVWH, Box 578, Puueneene, Maui, Hawaii. Transmissions on 2500 (1KW), 5000 (2KW), 10000 (2KW), 15000 (2KW), continuous except for an interruption at 15-19 minutes past each hour.

NEW FEBC STATION

Further information is to hand concerning DXJO which is located at Jolo some 650 miles south of Manila, in the Philippines.

DXJO, FEBC's new radio station, went on the air for test broadcasts in Jolo on October 16.

The station frequency will be 1460KHz. Its 1KW power will project information and the Good News from 100 to 200 miles radius. DXJO can cover the entire Sulu Archipelago up to Basilan City and part of Zamboanga City on the north-east; Tazitawi and part of Sabah on the south-west. It will have a potential listening population of approximately two million people in the southern Philippines and Sabah. DXJO is one of FEBC's six stations serving the Philippines. FEBC has also 15 other international short-wave frequencies blanketing the area where two-thirds of the world's three thousand million people live. Three of these transmissions use 50KW, and are beamed overseas from Manila.

Plans are under way for other satellite stations in strategic provinces, such as those envisioned for Cebu, Guimaras in Iloilo, Naga City in Camarines Sur, and others in northern Luzon. DXJO is the second provincial station in the island of Mindanao. The first one was DXKI in Marbel, Koronadal of South Cotabato.

NEW AUSTRIAN RADIO SERVICE

ARDXC members report good signals of the newly established service for East Africa from Vienna, operating on 15200-KHz. Transmission times are from 2000-2200GMT, and reception has been noted in Melbourne from around 2030GMT, with a program of Viennese waltz music.

RADIO MILNE BAY VERIFIES

Operating on 3235KHz with 250 watts, Radio Milne Bay recently verified Alan Evans and Bob Padula of Melbourne with a folding-type QSL card. These are the first verifications reported since the station began operations in 1968. It was indicated that languages used are Wedau, Suau, Doba and Misima. The station serves the people of Milne Bay District, approximately 98,000 population, and transmission times are from 0700-1200GMT. Reception is best at around 1000-1200GMT, and DX reports should be sent to P.O. Box 6, Samarai, Milne Bay District, Papua.

RARE KOREAN VERIFICATION

A recent issue of the Australian DX News highlighted the rare QSL received by Robert Shepherd, of Glen Iris, Victoria, from the station operated by the Republic of Korea Army, on 6170KHz.

The very attractive and colourful card

was received after a delay of almost one year, and all QSL details are given in English, together with the schedule. Power on this outlet is given as 500 watts, with sign-on time being 1230GMT, and programs in Korean.

BRAZZAVILLE EXTENDS SCHEDULE

Reception in Australia in recent weeks has indicated that the Radio Brazzaville transmitter has extended its 19-metre band schedule, and the station has been heard at good level on 15190KHz, with the relay of the French news from Paris at 0500GMT. English is carried at 0515GMT, and at 0530GMT a relay of the home-service network from Paris is heard, until fade-out at 0830GMT.

NEW FREQUENCIES FOR CAIRO

The shortwave schedule for Radio Cairo, effective until September 7th, shows a number of new outlets now in use. These include 9860KHz, from 0600-0800-GMT, 9830KHz from 1730-2000GMT, and 17670KHz, from 0800-1800GMT. Each of these transmissions carries Arabic broadcasts, beamed to the Middle East, North Africa, and South Europe.

GOOD SIGNALS FROM MAURITIUS.

Australian Radio DX Club member Stephen Morgan, of Bendigo, Victoria, advises good reception of the Mauritius Broadcasting Service, Forest Side, on 4850-KHz. Stephen advises that he has now verified this station, for his reception at 1800GMT of a relay of the BBC English news. His verification was in the form of a QSL card, which was sent airmail. The station has also been noted by ARDXC members on medium-wave, on 683KHz, at the same time, with parallel programming. According to Cyril Anderson, in Perth, transmissions on this latter frequency can be heard as early as 1700-GMT, with an orchestral musical program, and announcements in French.

LONG ROUTE SENEGAL SIGNALS

According to ARDXC member John

Eig, of Toowoomba, Queensland, Radio Senegal, Dakar, has been monitored on 4950KHz, at around 0715GMT, with a French transmission. Propagation at this time was across the South American continent, and the Pacific, as distinct from our morning reception of African stations, which takes place via the Indian Ocean path.

FREQUENCY CHANGE FOR BEIRUT

Radio Beirut is now using the new outlet 15285KHz for the service to the Americas, from 0130-0400GMT. This is a change from 11820KHz, and English is presented from 0230-0300GMT.

PRAGUE USING NEW CHANNEL

Radio Prague recently took into use a new channel in the 13-metre band, for its daily service to Australia and New Zealand, 0700-0800GMT. The new outlet is 21485KHz, replacing 21450KHz. The transmission is also heard in parallel on 21700KHz and 15310KHz.

ALL INDIA RADIO CHANGES

All India Radio has been observed recently by ARDXC members on two new frequencies in the 16-metre band, with the home news in English at 0800GMT. Outlets monitored have been 17743KHz and 17842KHz, and the program continues in a native language from 0815GMT.

BERLIN SERVICE TO AFRICA

Robert Shepherd, Glen Iris, Victoria, advises that Radio Berlin International now uses 15255KHz for the transmission to Africa commencing at 0530GMT. The transmission begins in French, and continues in English at 0615GMT. Signals have been good, and the English broadcast beamed to the Far East area from 0645-0730GMT continues to provide good reception on 21465KHz. The evening transmission to South Asia, at 1200-1245GMT, is radiated on 21540KHz and 17700KHz.

A BREAKTHROUGH

IN ECONOMICAL, HIGH POWERED, PUBLIC ADDRESS AMPLIFICATION EQUIPMENT

Fully Transistorised. ——— 50 to 800 RMS Watts.

FOR PRESTIGE SOUND SEE CLAYBRIDGE SOUND

Secure your FREE, COLOURED CATALOGUE of our products & services.

Claybridge
SOUND

163 CLAYTON RD. CLAYTON VIC. 3168 OR RING 544 6171

(CNR. DANDENONG RD.)

(ALL HOURS)

LAFAYETTE HA-600

Transistorised Communications Receiver

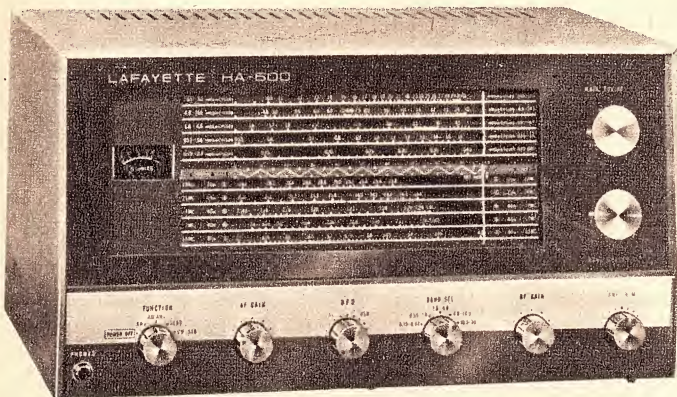

HA-600T \$199.50

2 FIELD EFFECT TRANSISTORS 10 Transistors
7 Diodes 1 Zener Diode

5 BANDS 150-400 KC, 550-1600 KC (Broadcast Band),
1.6-4.8 MC, 4.8-14.6 MC, 10.5-30 MC.

This new receiver, Model HA-600, combines the latest solid state electronics with attractive modern appearance to achieve a superb blend of performance and style. Advanced circuitry utilises two Field Effect Transistors in the mixer and oscillator stages to assure high sensitivity with lowest noise factor. 10 Transistors, 7 Diodes plus 1 Zener Diode complement the F.E.T.'s to provide top performance with exceptional stability. Series Gate noise limiter and automatic volume control provide efficient noise and audio blasting suppression. Built-in variable BFO permits clear reception of code and single sideband signals. Continuous electrical bandspread calibrated for amateur bands 80 to 10 metres facilitates tuning.

- Operates from 12 volts DC (negative ground) or 220-240 volts 50 cps. (17 watts).
- Two Mechanical Filters for Exceptional Selectivity.
- Product Detector for SSB/CW.
- Huge Edge Illuminated Slide Rule Dial with "S" Meter.
- Electrical Bandspread Calibrated on Amateur Bands 80 to 10 metres.
- Engineered by Lafayette to their highest quality standards.

SPECIFICATIONS: Sensitivity: 1 μ V at 10db signal to noise ratio. Selectivity: + or - 2 KC at 6 db down + or - 6KC at 60 db down. Intermediate Frequency: 455 KC. BFO Frequency: 455 KC + or - 2.5 KC. Antenna Impedance: 50-400 ohms. Audio Power Output: 3 Watts at 4 ohms. Speaker Impedance: 4, 8 and 500 ohms. Headphone Impedance: 8 ohms. **CONTROLS:** Function, BFO, Volume, Band Selector, RF Gain, Antenna Trimmer.

LAFAYETTE ELECTRONICS

Division of Electron Tube Distributors Pty. Ltd.

All mail enquiries and orders to:

**VICTORIAN SALES CENTRE
AND HEAD OFFICE,**

94 HIGH STREET, ST. KILDA,
VIC., 3182. Ph. 94-6036

LAFAYETTE Communications receivers are also available from:

RADIO HOUSE PTY. LTD., 306 Pitt Street,
6 Royal Arcade, 760 George Street,
Sydney, N.S.W. 2000.

TISCO AGENCIES, Cverend and Hampton
Streets, Woolloongabba, Q'land 4102.

RADIO PAKISTAN EXPANSION

According to Sweden Calling DXers, Radio Pakistan, Karachi, has been using new channels and is also building up its transmitters. It has been noted in English at 1500-1515 on the new frequencies 15190 and 17885KHz. The home service of Radio Pakistan is heard with good strength at 1100-1830GMT on a new frequency of 15520KHz. Two new 100KW short-wave transmitters have been installed at Dacca and Islamabad respectively. The main aim is to provide a radio link between East and West Pakistan. Three new radio stations will go into operation by 1970; this will bring to 14 the total number of short-wave stations in Pakistan

FLASHES FROM EVERYWHERE

EUROPE

LUXEMBOURG: Radio Luxembourg is using the 19-metre band channel of 15350KHz and has been heard at 1800GMT in French. The station has a power of 6KW, but plans to increase this to 100KW by the end of this year.

SPAIN: Radio Nacional de Espana at Madrid is using the new frequency of 9605KHz. This channel can be received at 2230GMT, and closes at 2245GMT. It also uses 15420KHz which is directed to Latin America, sign off is at 0500GMT.

BELGIUM: Radio ORU in Brussels is using a new 13-metre band channel of 21475KHz. It opens at 1045GMT in Swahili. The signal suffers sideband interference from the BBC London on 21470KHz. The transmission includes the usual interval signal, plus announcements in French before regular programs commence.

AFRICA

GHANA: Radio Ghana at Accra is using several new frequencies, according to the American Short Wave Listeners Club. The Accra signals have been observed on 3350KHz with a local program at 0600GMT. English news at 0700GMT is observed on 4915 and 4980KHz. On 11850, 9545, and 9760 KHz there is news at 2000GMT in a program on the air to 2100GMT.

ETHIOPIA: Radio ETLF, Addis Ababa, is reported to be using 11730KHz opening at 0255GMT, with program commencing at 0300GMT in French. Channel 9600KHz is reported to carry English at 0345GMT and another new channel, 7125KHz, is heard at 0340GMT in a local language program. English to East Africa from ETLF is on the air at 1935GMT, using 11910KHz.

ANGOLA: Radio Official Luanda has made a change in frequency, and now uses 7289KHz which replaces 7245KHz, and heard at 0645GMT in Portuguese. Channel 4820KHz opens at 0500GMT, with 5960KHz in parallel.

ASIA

ULAN BATOR: Radio Ulan Bator, Mongolia, is using 7345KHz and is received at 1230GMT. It is also noted on 5052-KHz at 2200GMT. The station indicates that they no longer require an International Coupon when verification reports are submitted.

SARAWAK: According to the Japanese Short Wave Club, Radio Kuching, Sarawak, is observed on 7145KHz opening at 1400GMT with an English program. The station has also been observed on 4950KHz at 1100 to 1230-GMT with programs in English.

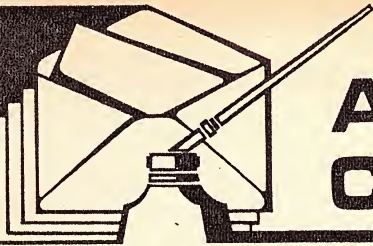

ANSWERS TO CORRESPONDENTS

WAVE ANALYSER: In your April, 1969 issue on page 70, in the article "What is a Wave Analyser?" you have a graph showing harmonics at increasing frequencies. At 50KHz it is a 0dB, but the caption says it is 0dB at 50Hz. I thought I should bring this to your notice, in case you want to print a correction. (M.B., W. Pymble, N.S.W.)

● Thank you for pointing out this error. Unfortunately, despite every care being exercised in the checking of proofs, small errors of this type slip through from time to time.

MICROCIRCUIT STEREOGRAM: I like your "Micro One" a lot but I would like to see a full stereo gram using integrated circuits with a superhet tuner. I would like it to be a high quality unit with good high frequency response and low distortion at about 5 watts per channel. I would also like to see a few simple projects using tunnel diodes. What is the difference between IF transformers? Congratulations on a fine magazine. (M.T., Mortdale, N.S.W.)

● Undoubtedly, we will be doing something along the lines you request at some time in the future. At the moment, the proposition is less attractive than might first appear. In particular, integrated circuit IF channels require that the band-pass characteristics be established right at the input, rather than distributed along the channel as with discrete components. This necessitates the use of special IF filter blocks rather than conventional IF transformers. A complete IC design will only become attractive when peripheral components are readily and cheaply available, as well as the ICs. We will keep in mind your request for tunnel diode projects, but feel that these devices are well enough known nowadays to warrant setting them stand on their own feet, as were. If a tunnel diode commends itself for the job in hand, we will use it. If not, we will use the more attractive alternative. It would be quite impossible to answer your question about IF transformers in the space of a letter. It would demand much larger space and, even then, could only be covered in general terms.

TV MASTHEAD AMPLIFIERS: I live in a bad TV reception area and I tried to increase the signal gain of my antenna with only slight improvement. I remember that you published details of a signal amplifier about a year ago. I can't find the issue, so could you give me some advice as to how to increase the antenna signal. (A.G., Balgownie, N.S.W.)

● We are not surprised that you have not been able to locate an article on TV masthead amplifiers, since we have never published such an article. In fact, we feel that construction of a unit would pose too many problems for the average home constructor. Apart from this, we believe there is considerable misunderstanding of the whole matter of TV masthead amplifiers. If the signal arriving at the antenna is weak, an amplifier will certainly raise the signal strength, but it will also raise the noise level, so that the most obvious result is that the "snow" is easier to see. The real function of a masthead amplifier is to compensate for feeder losses in those cases where the antenna has to be located

a considerable distance from the receiver. The best way to tackle the problem is to use one of the high-gain aeriels recommended by the manufacturers for your area. This should be mounted as high as possible, preferably clear of obstructions. If it is possible to mount the aerial on high ground, and this proves to be some distance from the set, then a masthead amplifier can make a useful contribution, to overcome line losses. We suggest your best approach to the problem is to contact antenna manufacturers who are fully familiar with the problems which exist in various areas, and are usually only too willing to give advice on how the problem can be overcome.

AUDIO TOPICS: I have become interested in audio topics and I have acquired speakers for a good speaker system, but in the wiring I have come up against the problem of polarity. Could you tell me which way the cone jumps when a battery is connected? Also, could you provide me with, or tell me of, a circuit for a simple audio amplifier for a crystal radio. I have a small one-transistor amplifier designed for earplug use, but I have it working with a speaker with sufficient volume for my bedroom. I believe it came from an issue of "Radio and Hobbies" but I am not sure which issue. If I want to have an article in "Reader Built It" what do I have to do? Do you have any plans for a vibrato for organs, other than verbatape to suit Yamaha organs. Finally, I should like to say how much I like your magazine, especially "Audio Topics." (E.A., Warwick, Qld.)

● The subject of phasing speaker systems was covered in detail in Audio Topics in the February, 1969 issue. If you do not have that issue, it is avail-

able through our Information Service for 35c plus 10c postage. Briefly, when the cone moves forward, the terminal connected to the positive of the battery should be nominated as the positive terminal. A simple transistor amplifier for a crystal set was described in our August, 1963 issue. A copy of the article is available through the Information Service for 20c. We regret we cannot identify your crystal set from the information provided. Articles for "Reader Built It" should be submitted clearly written or typed, with relevant diagrams, addressed to the Editor. Drawings do not have to be of professional standard since our own draughtsman will redraw them for publication. A vibrato system for electronic organs was described in our March, 1969 issue. A copy of the issue can be obtained on the conditions mentioned above, or in this case the article only can be purchased from the Information Service for 20c.

ELECTRO FLASH: I am very keen on photography and have reasonable understanding of basic electronics. I am deeply interested in electronic flash. I have several obsolete units which are not fully operational and would like to try to combine their components to make a mains operated auxiliary unit. Have you published any articles of general interest explaining electronic flash? I am well aware of the high energy stored in capacitors used in units of this type, and the dangers involved. (G. O'C., Lakemba, N.S.W.)

● We have published a number of articles on the subject. In August and September, 1952 we published articles describing a high-voltage (over 2000V) unit. These were followed in April and May, 1954 by articles describing a low-voltage unit operating from dry batteries. A further

"ELECTRONICS Australia" Information Service

As a service to readers "ELECTRONICS Australia" is able to offer: (1) Photographs, dye-line prints and other filed material to do with constructional projects and (2) A strictly limited degree of personalised assistance by mail or by reply through the columns of the magazine. Details are set out below: **PROJECT REPRINTS:** For a 20c fee, we will supply data, as available from our files. The amount of data available varies but in no case does it include material additional to that already published in the magazine. For complicated projects involving material extracted from more than one issue, an extra fee may be requested. As a rule, requests for project data will be answered more speedily if the projects are positively identified and the request is not complicated by questions requiring the attention of technical personnel. Where articles are not on file, we can usually provide a photostat copy at 20c PER PAGE.

PHOTOGRAPHS, DYE-LINE PRINTS: Original photographs are available for most of our projects, from 50c plus 8c postage for a 6in x 8in glossy print. In addition, metalwork dye-line prints are available for most projects for 50c each; these show dimensions and the positions of holes and cut-outs but give no details of wiring.

BACK NUMBERS: A fairly good selection is available. On issues up to six months old the cost is the face value, plus 5c surcharge. From seven to 12 months, 10c surcharge; over 12 months, 20c surcharge. Package and postage is 10c extra per issue. Please indicate whether a PROJECT REPRINT may be substituted if the complete issue is not available.

REPLIES BY POST: This provision is made primarily to assist readers in matters relating directly to articles and projects published in "ELECTRONICS Australia" within the last 12 months. Note, however, that we cannot provide lengthy answers, undertake special research or modifications to basic designs. A 20c query fee must be enclosed with letters to which a postal reply is required; the inclusion of an extra fee does not entitle correspondents to special consideration.

OTHER QUERIES: Technical queries which fall outside the scope of "Replies by Post" may be submitted without fee and may be answered through the columns of the magazine at the discretion of the Editor. Technical queries will not be answered by interview or telephone.

COMMERCIAL EQUIPMENT: "ELECTRONICS Australia" does not maintain a directory of commercial equipment, or circuit files of commercial or ex-disposals receivers, amplifiers, etc. We are therefore not in a position to comment on proposed adaptation of such equipment, or on its general design. "ELECTRONICS Australia" does not deal in electronic components. Prices, specifications or other assistance must be sought from the appropriate advertiser or agent.

REMITTANCES: These must be in a form negotiable in Australia. Where the charge may be in doubt, an open cheque, endorsed with a limitation, is recommended.

ADDRESS: All requests for data and information, as set out above, should be directed to The Assistant Editor, "ELECTRONICS Australia," Box 2728 G.P.O., Sydney, N.S.W. 2001: 5/69

HAM RADIO SUPPLIERS

Mail Order Specialists

323 ELIZABETH STREET,
(2 Doors from Little Lonsdale Street)
MELBOURNE, VIC. 3000
TELEPHONES: 677329, 674286

1B3GT (DY30)	\$1.45
1C7	.50
1D5	.50
1F5	\$1.00
1H5	.75
1K5	.50
1K7	.50
1L4	.50
1L5	5 for \$2.00
1LN5	\$1.00
1M5	.50
1P5	.50
1Q5	.50
1R5	\$1.80
1S2(DL86)	\$1.45
1S4	\$1.00
1S5	\$1.70
1T4	\$1.00
1X2 A/B	\$1.90
2D21	\$1.20
3S4	\$1.00
3V4	\$1.70
5AR4 GZ34	\$2.45
5AS4	\$1.30
5R4GY	\$2.00
5T4	\$1.75
5U4GB	\$1.30
5V4(GZ32)	\$1.50
5Y3GT	\$1.20
5Z3	\$1.50
6A8G	\$2.00
6A8T	\$1.00
6AC7 ea.	.50
or 5 for	\$2.00
6AD8	\$1.35
6AE8 (X79)	\$3.50
6AG5	\$2.00
or 12 for	\$2.00
6AC7	\$1.25
6AJ5	.75
6AK5(EF95)	\$2.55
6AL3	\$1.55
6AL5	.75
6AMS	.75
or 3 for	\$2.00
6AM6	.75
or 3 for	\$2.00
6AN7/A	\$1.55
6AQ5	\$1.30
6AR7GT	\$1.80
6AU4GT/A	\$1.50
6AU6	\$1.30
6AV6	\$1.50
6AX4	\$1.50
6B6	\$2.00
6B8	\$3.00
6BA6	\$1.40
6BE6	\$1.40
6BH5	\$1.35
6BK8 (EF86)	\$2.00
6BL8	\$1.50
6BM8	\$1.60
6BQ5 (EL84)	\$1.50
6BQ6GTB/	
6CU6	\$2.50
6BO7A	\$1.50
6BV7	\$1.30
6BX6	\$1.35
6BY7	\$1.95
6C4	.50
or 5 for	\$2.00
6C8	\$1.00
6CA4	\$1.00
6CA7/EL34	\$3.00
6CB6	\$1.40
6CD6G/A	\$4.50
6CG7	\$1.50
6CH6	\$2.40
6CK5	\$2.00
6CK6	\$2.40
6CN5	\$2.40
6CQ6	\$2.20
6CQ8	\$1.40
6CS6	\$1.30
6CW4	
(NUVISTA)	\$2.75
6DC6	\$2.40
6DC8	\$1.90
6DQ6A	\$2.20
6DQ6B	\$2.65
6DS8	\$1.80
6DT6	\$1.40
6DX8	\$1.65
6EA8	\$1.55
6E56	\$1.80
6E58	\$1.80
6F6G	\$1.25
6G8G	\$2.50
6GV8	\$1.70
6GW8	\$2.70
6H6GT	.20
or 12 for	\$2.00
6HG5	\$1.50
6HS8	\$1.50
6LSGT	\$1.00
6J6	.75
or 3 for	\$2.00
6J7G	.50
or 5 for	\$2.00
6J8G	\$3.00
6K6	\$1.00
6K7	.50
6K8GT	\$1.25
6K8 Metal	\$2.00
6KV8	\$1.75
6L6G	\$2.90
6L7	\$1.50
6M5	\$1.35
6N3	\$1.20
6N7	.30
or 10 for	\$2.00
6N8	\$1.40
6OTG	\$1.00
6R3	\$1.55
6S2	\$1.85
6SA7GT	\$2.20
6SC7	.75

6SF5	.75
6SF7	.75
6SH7	.50
6SJ7	or 5 for \$2.00
or 3 for	\$2.00
6SL7GT	\$1.25
6SN7GT	\$1.00
6SOTGT	\$2.10
6S57	.75
6U4GT	\$2.00
6U7G	.75
or 3 for	\$2.00
6UB/A	\$1.55
6V4	\$1.05
6V4	\$1.05
6V6GT	\$1.75
6X2	\$1.95
6X4	\$1.00
6X5GT	\$1.50
6Y7	\$1.90
7A8	.35 or \$2
7C5	8 for \$2
7E6	.50 or \$2
7H7	5 for \$2
7W7	.50 or \$2
9A8	5 for \$2
9U8	\$1.75
12A6	.50 or \$2
12AH7	5 for \$2
12AT7	.50 or \$2
12AU6	\$1.50
12AU7	\$1.45
12AV6	.75
12AX7/ECL83	\$1.60
12B6	.75
12BY7/A	\$1.75
12C8	.50
12J5	.50
12LA7GT	\$1.00
12SC7	.50
12SH7	.50
12SK7	.50
12SN7GT	\$1.00
12SR7	.50 or \$2
16A8	\$2.00
35L6	\$1.00
39	.50
42	\$2.50
47	.50
57	.50
58	.50
78	\$1.00
80	\$1.00
100TH	\$3.00
717A	
807	\$1.25
808	\$1.00
832A	\$1.00
866A	\$1.00
954	50c or \$2
955	5 for \$2
956	.50
958A	50c or \$2
1625	5 for \$2
1629	5 for \$2
5636	.75
9006	.25c or \$2
BA50	10 for \$2
or 12 for	\$1
ECC35	\$2.00
ECH35	\$2.80
EF86/6BK8	\$2.00
EL34 (6CA7)	\$3.00
EM84	\$1.50
EY91	.50
KT61	\$3.90
KT66	\$4.75
KT88	\$5.30
RL18	75c or \$2
3 for	\$1.00
UL41	\$1.00
VR150	
(volt Reg.)	\$1.25
2D21	\$1.20
2E26	\$4.60
2X2/879	.75
6CW4	
NUVISTA	\$2.75
6DO5	\$4.75
75C1 Volt.	\$2.25
Reg.	\$3.00
100TH	
90C1 Volt.	\$2.50
Reg.	\$2.50
108C1/OB2	\$2.50
150C4/OA2	
Reg.	\$1.65
832A	\$7.00
866/A Reg.	\$1.00
807	\$1.20
884	\$2.85
895	\$2.85
2051	.50
5763	\$2.55
6146A	\$5.95
6146B	\$6.25
OA2/150C4	\$1.65
OB2/108C1	\$1.65
QE03/10	\$2.55
QE03/12	\$2.65
QE03/20	\$1.70
QE06/40	\$12.95
QVO4/7	\$1.50 or \$3.75
3 for	\$3.75

ALSO OTHER
TYPES AVAILABLE,
P.O.A.



MODEL OL-64D MULTIMETER, 20,000/OPV, DC Volts: 0-0.25/1/10/50/250/500/1000V at 20K/OPV, 5000 volts at 10K/OPV, AC Volts: 0-10/50/250/1000V at 8K/OPV, DC/A: 50uA/1mA/50mA/500mA/10 amps. RESISTANCE: 0-4K/400K/4M/40Megohm, DB Scale: —20 to plus 36db. Capacitance: 250pF to .02uF, Induct. 0-5000H, size: 5 3/4 x 4 1/8 x 1 3/4 in.

PRICE: \$19.50 post 30c.



MODEL 200H MULTIMETER, 20,000 opv, DC Volts: 0-5/25/50/250/500/2500V (20,000 opv) AC Volts: 0-15/50/100/500/1000V (10,000 opv) DC/Amps: 50uA/2.5mA/250mA, Resistance: 0-60K/6M ohm (scale centre 300 ohm—30K ohm. Capacitance: 10uF to .001uF/.001uF — .1uF, D3 scale 20 db to plus 22 db. Size 4 1/2 x 1 1/8.

PRICE: \$11.25 post 30c.



NEW MODEL US-100, Overload protection, Shockproof Movement, polarity switch DC volts: 0.25/1/25/10/50/250/1000V (20K/OPV) AC Volts: 0-2.5, 10/50/250/1000V (5K/OPV), DC/Amps: 1mA/25mA/500mA and 10A. AC/Amps 10A. RESISTANCE: 0-50M/ohms (centre scale 50) R X 1/10/100/1K/10K, db scale —20 to plus 10 plus 22/plus 35/plus 50db.

PRICE: \$28.75 post 40c.
Mirror Scale



MODEL C-1000 POCKET MULTIMETER, 1000 ohms/per Volt, AC Volts: 0-10/50/250/1000 (1000 opv) DC Volts: 0-10/50/250/1000 (1000 opv), DC Current: 0-100mA, Resistance: 0-150K ohms (3K centre), 2 colour scale, Range Selector Switch, Dimens.: 3 1/2 x 2 1/4 x 1 in.

PRICE: \$6.50 post free



MODEL CT500 MULTIMETER, 20,000/OPV, DC Volts: 0-2.5/10/50/250/500 5000V (20K/OPV) AC Volts: 0-10/50/250/500/1000V (10K/OPV) DC/Amps: 5uA/5mA/50mA/500mA. RESISTANCE: 0-12K/120K/1.2Meg/12Megohms, (scale centre: 60/600/6K/60K, DB scale: —20db to plus 62db (5 ranges). Size: 5 1/2 x 3 5/8 x 1 3/4 in.

PRICE: \$14.95 post 30c.



MODEL CT330 MULTIMETER, 20,000/OPV, DC Volts: 0-6/6/30/120/600/1.2K/3K/6K Volts, AC Volts: 0/6/30/120/600/1.2K Volts (10K/OPV), DC/Amps: 0-0.06/6mA/60mA/600mA. RESISTANCE: 0-6K/600K/6M/60M/600Megohm. (30/3K/30K/300Kohms) centre scale; Capacitance: 50 uf to .01 uf .001 to 0.2 uf. Decibels: —20 to plus 63db size approx: 5 1/2 x 3 5/8 x 1 3/4.

PRICE: \$16.75 post 30c.

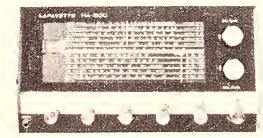

NEW LAFAYETTE SOLID STATE HA600 RECEIVER
5 BAND AM/CW/SSB AMATEUR AND SHORT WAVE. 150 Kc/s—400 Kc/s and 550 Kc/c—30 Mc/s. F.E.T. front end • 2 mechanical filters • Huge dial • Product detector • Crystal calibrator • Variable BFO • Noise limiter • S Meter • 24in Bandsread • 230V A.C./12V DC, neg. earth operation • RF gain control. Size 15in x 9 3/4in, 8 1/4in. Wt. 18lb. S.A.E. for full details.

PRICE \$199.50

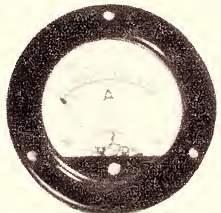

"KEW" KYORITSU MO 65 METERS, NEW
Size: 3 1/4 inch, mounting hole 2 1/2 inch, 1 1/2 inch deep.
All plus Postage 20c.
1 mA, 5 mA, 10 mA, 25 mA, 50 mA, 100 mA, 150 mA, 250 mA, 500 mA.
\$4.50
1 amp DC \$4.50
5 amp DC \$4.50
10 amp DC \$4.50
30-0-30 amp DC \$5.25
15v DC, 30v DC, 300v DC \$4.50
300 volts AC \$5.50



STEREO HEADPHONES
Large rubber earpiece, full audible frequency. 100-15,000 cycles.
\$9.00 inc. Tax.



P25 2 1/4 inch square, clear plastic face, 2 1/8 inch mounting hole, 3/4 inch deep.
50 uA . . . \$5.75 15 volts d.c. . \$5.50
100 uA . . . \$5.75 25 volts d.c. . \$5.50
500 uA . . . \$5.25 500 volts a.c. . \$5.50
1, 5, 10, 20, 50 "S" Meter a.c. . \$5.75
250 and 500 "VU" Meter . \$5.75
mA . . . \$5.00 "VU" Meter . \$6.50

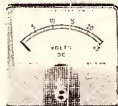

MR3P 3 8 inch square, clear plastic face, 2 3/4 inch round mounting hole, 1 1/2 inch deep.
50 uA . . . \$7.00 50-0-50 uA . . \$5.75
100 uA . . . \$6.75 15 volts d.c. . \$5.75
500 uA . . . \$6.50 25 volts d.c. . \$5.75
1, 5, 10, 25, 50 25 volts d.c. . \$5.75
100, 250 and 30 volts a.c. . \$5.75
500 mA . . \$5.75 "VU" Meter . \$8.25

S.W.R. METERS, MODEL KSW-10
Specifications.—Standing Wave Ratio: 1:1 to 1:10. Accuracies: Plus or minus 3 per cent, scale length, Impedance: 52 ohms and 75 ohms. Meter: 0-100 DC microamperes.
Price \$19 inc. tax.

ANSWERS – continued

article in June, 1954 added a vibrator supply to this design. We described how to add a second flash to either of these designs in an article published in October, 1954. Finally we published a series of articles from September to December, 1966 which took advantage of more modern components in the designs presented. Copies of the complete articles are available for the latest series (20c per article) and diagrams (only) for the earlier projects through the Information Service.

STEREO BROADCASTING: Why don't we have at least one radio station transmitting stereophonic programs? Is it too expensive, or are there other complications involved? In the U.S.A. it seems to be very common to have such facilities, and I can imagine every Australian hi-fi fan would be in favour of stereo. Also, the radio industry would be able to bring out receivers and be in the race with the rest of the world. (H.J., **Ermington, N.S.W.**)

● The subject of FM broadcasting has been thrashed out very thoroughly in the popular press, in technical journals and in Parliament. The basic fact is that the Federal Government is not prepared to allow FM broadcasting to take place on a fragmented basis and with this we can only agree. The Government's policy is to institute a complete system, when the time comes, operating in the UHF spectrum. Most people in the industry have come to accept this as the most logical course to follow from where we now stand. The contentious point hangs on the phrase "when the time comes." Proponents of FM would like to see it in operation as soon as possible and before the Government becomes involved in colour television. The Government's policy is apparently to exhaust the possibilities of AM broadcasting first, to cope with colour television next, and worry about FM later.

TRF FOR SHORT-WAVE: The article on a TRF receiver using the LM372 micro-circuit (April, 1969 issue) was very good. However, I think a similar type of receiver suitable for the short-wave bands would also be widely appreciated. I think the ideal short-wave receiver should cover at least from 2 to 30MHz, and for simplicity should use an IC. As various ICs are

now available in Australia, there should be no difficulty in devising a suitable circuit, perhaps including a high-gain stage. Finally, I wish to congratulate you on your superb magazine. (J. F., **East Bentleigh, Vic.**)

● Thank you for your components and appreciative comments. We do not feel there are any prospects for such a receiver as you outline being featured in "Electronics Australia" in the near future, since the order of performance which could be obtained probably would be inferior to what could be achieved using conventional circuitry. The object of the exercise in the IC broadcast receiver was to give a simple, practical example of their use, but it was specifically pointed out in the article that there had been concessions to performance in the interests of simplicity. Any short-wave receiver designed on the same lines would have limitations on performance which would not be acceptable to the majority of readers.

SOLID STATE: I have just read the first chapter of "Fundamentals of Solid State" in the May issue. I found it both interesting and educational, and am looking forward to the next chapter. Although I studied the electron shell at school, we did not go into it as deeply as this article does. The article enabled me to extend my understanding beyond that given at school, without having to wade through technical papers and books that assume a degree of knowledge far beyond what I possess at present. Has any series similar to this one been run in early editions of the journal? (B.H., **Bairnsdale, Vic.**)

● We are glad to note your reaction to the series. The response from readers generally has been very good. No, we have not run this series before in the magazine, nor anything like it. We did run "The Basic Radio Course," which is a broader, less specialised series. This is now available as a separate book entitled "Basic Electronics." It costs \$2.00 from our office, plus 20c postage.

JET SOUND: I understand that "jet sound" is not produced electronically, but is an effect achieved by using multiple recorders. (G.B., **French's Forest, N.S.W.**)

● Thank you for your note. You will find more information on the subject in this issue under "Forum."

Longest-standing subscriber?

I won a crossword puzzle in the twenties conducted by "Radio In Australia And New Zealand." The prize: A two-valve Marconiphone with a two-valve amplifier, the presentation being made by Charles Maclurcan (2CM) in the Sydney Town Hall. Am I correct in assuming that your publication was originally the one referred to above? Have you any subscribers that can go back further than that? We have call signs with prefixes 2, 3, 4, etc. Whatever happened to 1? Was it reserved for use in Federal territory? Havng made up a few of the most recent of your projects, I must say that you are still really on the ball. Would you be interested in a radio telescope suitable for solar work, operating probably on the 18cm band? A certain English magazine promised readers something of the sort but that was four years ago and nothing has come of it. (H.P., **Murwillumbah, N.S.W.**)

● If you were young in those days, so were the rest of us and, short of researching the subject, we can't be absolutely certain of our answer to your direct question. As far as we know, the journal you mention was not a member of our family tree. We descended from "Wireless Weekly" and we have in our possession a copy of the very first issue dated August 4, 1922. We also have the first copy in its "reorganised form" issued on July 23, 1926. You would have to establish regular readership of "Wireless Weekly" to lay claim to be one of our oldest subscribers. An interesting thought: We wonder who is our subscriber of longest standing? Yes, the prefix 1 was reserved for Federal Territory and is used by amateur stations at least. We are not sure whether you are asking for or offering an article on a solar telescope. If you are asking for one, we are not likely to be able to assist. If you are offering an article and feel that the project would not be unduly complex or unduly expensive for what it has to offer, we would be interested to hear more.

GET YOUR LOWTHER LOUDSPEAKER AT ENCEL'S AND SAVE!



PM 6 Mk. 1

Gap flux: 17,500 gauss.
Total flux: 196,000 maxwells.
Frequency range: 20-20,000 Hz.
Impedance: 15 ohms.
Capacity: 20 watts.
Weight: 7 lb.

The special design of the PM 6 drive unit preserves the fundamental to harmonic relationship throughout the entire audio range, thereby ensuring smooth, natural sound. Designed especially to meet the requirements of horn-loaded operation, the PM 6 should never be used as a conventional direct radiator.

PM 7

Gap flux: 19,650 gauss.
Total flux: 250,000 maxwells.
Frequency range: 20-20,000 Hz.
Impedance: 15 ohms.
Capacity: 20 watts.
Weight: 9 lb.

The generation of 19,650 gauss from such a small mass is the culmination of years of research to improve both available magnetic materials and construction techniques. The increased force in conjunction with a new patented speech coil of very high efficiency give an overall attack and transient response which has never before been achieved in such a compact unit. The PM 7 may be used as an alternative to the PM 6 in all Lowther systems where maximum efficiency and optimum performance characteristics are required.

Extracts from review in "Hi-Fi News"

"On switching on, the first action was to turn down the volume control due to its high sensitivity . . . Even more striking than this was the remarkable high note response. The effect of this was to bring all sounds closer to the listener as it were. . . the source appeared to approach closer than the writer has ever experienced before . . . a remarkably smooth top response."

Call or write now for a special Lowther price—you'll save more at Encel Stereo Centres in Melbourne or Sydney!

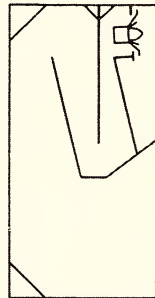

Here is a cross section of the Lowther Acoustica speaker enclosure. Plans will be provided or complete cabinets are available in your choice of several popular polished or oiled finishes. Prices on request.

Encel

ELECTRONICS (STEREO) PTY. LTD.

Head Office:

431 Bridge Rd., Richmond, Victoria 3121.

Tel. 42 3762.

Sydney Store: Ground Floor, 2SM Building.

257 Clarence Street, Sydney, N.S.W. 2000.

Tel. 29 4563, 29 4564.

*Wholesalers *Trade-ins accepted

Australia's Greatest Hi-Fi Centre

SOUND PROJECTORS

Cinevox Prefect and Harbour and Heath 16mm in good working order. 240v operated, complete with speaker and amplifier.
from \$90.00

CIRCULAR SLIDE RULE

3 3/4 in diameter. Will do the same work as the conventional slide rule. Instruction book included.

\$1.25 each
Post 10 cents.

REFLECTOR GUNSIGHT

Contains these lenses:
1 Lens 1 in Focus, 1 1/2 in diam.
1 Lens 1 11/16 in Focus, 1 1/4 in diameter.
1 Air-spaced Lens, 1 1/4 in diam.
1 Filter Lens, 1 Graticule,
1 Lampholder. **\$1.85**
Post.: N.S.W. 30c; Interstate: 40c.

P.M.G. TYPE TELEPHONES

Standard desk type with magneto bell calling device. Range 30 miles. Uses standard batteries at each phone. Any number can be connected together on single line.
\$23.00

(2 TELEPHONE SETS)

30c cartage to rail. Freight payable at nearest attended railway station.

Please note we are now able to include 1/2 mile of telephone cable FREE with each set of Phones.

BATTERY CHARGERS

240 volt A.C. Input. Each battery Charger will charge either 6 or 12 volt batteries.
2 amp. without meter, **\$13.75**
2 amp. with meter, **\$15.75**
Post N.S.W. 70c; Interstate 95c.

MINIATURE ELECTRIC MOTORS

1 1/2 to 3 volts D.C. Ideal for model boats, cars, planes, etc. Strong torque. Only **65 cents each or 10 for \$4.00.** (Post 7c).

TRANSCEIVER

(2-way radio) R.C.A. America RT 68, 24 volt, operated 10 watt output 38-54 megacycles F.M. crystal locked. Transmitter and receiver using frequency synthesiser in 100 K/cs; step 10 channel per meg/cycle with power supply. Leads, mike and headphones \$45, 60c cartage to rail. Freight payable at nearest attended railway station.

TRANSCEIVER

(2-way radio) 62 set ideal small ships, Hams, etc. 1.6 to 10 megs. Crystal locked or V.F.O. controlled 5 watt output. Complete with antenna, headphones and mike \$60, 60c cartage to rail. Freight payable at nearest attended Railway Station.

HEAD PHONES

Low impedance moving coil fitted with rubber muffler to reduce external noise, fitted with press to talk, dynamic hand microphones. Ideal for use with all types of transceivers. \$3.50 pair. Same with black felt muffler, \$4.50 pair. Post N.S.W. 25c; Interstate 30c.

12 VOLT D.C.

DESIGN INDICATOR AND TRANSMITTER UNIT. Suitable for aerial rotation indicator, etc. 0-360 deg., weatherproof mountings.

\$5.00 per set.
Postage: N.S.W., 95c; Interstate \$1.67.

16'6" WHIP AERIALS

6-Piece, brand new, \$5.75, 60c cartage to rail. Freight payable at nearest attended railway station.

AVO MULTI METER

Type CT 38
\$75.00

A.W.A. AUSTRALPHONE

Transceivers 12 V New Complete Station. 1.6 to 10 megs on transmit. 0.54 to 16 megs on receive.
\$150.00

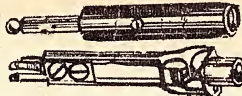

P.M.G. Phone Jack and plugs, 25c each, 45c the pair. Post 7c.

NIFE CELLS

1.2 Volt fully charged, 4in x 3in x 1in 4 AH. \$1.00 each Post, N.S.W., 25c; Interstate 35c.

WALKIE TALKIE TWO-WAY RADIOS

P.M.G. Approved Citizen Band. 9 Transistor, \$79.00 per set of 2. Post, N.S.W. 50c; Interstate, 60c.



P.M.G. TYPE KEY SWITCHES. 45c each. Post, 15c.

BC 221

Frequency Metres
\$55.00



45 x 40 coated Lens with tripod.
\$10.95

30 x 30 Power Coated Lens Brand new.
\$3.75

60 magnification with a 60mm coated objective lens. With tripod.

\$23.00

As illustrated.

Postage, 95c; Interstate \$1.20.

HIGH STABILITY RESISTORS

I.R.C. brand new, usually 80c ea. 50 assorted values for only **\$3.75** Post 15c.

RECEIVER 8C A.W.A.

With ABC and D Coils. Complete with all spares.
\$90.00

522 TRANSCEIVERS

100 to 150 m/cs.
\$35.00

TYPE S POWER SUPPLY

(240 Vac supply for AT 5-ARB) suit most types of Disposal transmitters and receivers outputs 250 volt, 10ma 550 volt 200ma, 300 volt 100ma, \$30.00

TELEPHONE WIRE

21 gauge copper, plastic covered. Ideal telephone or bell wire. 1,320ft coil of twin (equal 1/2 mile) \$7 per coil. Post, N.S.W. 70c; interstate \$1.20.

SCOOP PURCHASE

Gramo Motors. New. Made in U.S.A. 4-speed 240 volt A.C. 50 cye. Only **\$2.75 each.** Post, N.S.W. 30c; Interstate, 40c.

CO-AXIAL SWITCH

70 ohms 4 positions, can be motor driven completely waterproof 70 ohms type connectors. Housed in metal case 9in x 8in x 8in \$5.00 each. Post N.S.W. 70c. Interstate \$1.20.

MOBILE

2 WAY RADIOS

PYE 70 to 85 M/CS. 6 Volt Operated. 3 mobiles, 1 base station 240 VAC

\$80 THE LOT

VALVES BRAND NEW IN CARTONS

Special discount for quantity

807	75c	X61M	\$2.20
65N7GT	95c	CV850	\$1.50
8989	\$1.00	1H6G	30c
5U4G	95c	832	\$5.00
77	\$1.00	6AK5	\$1.50
EF50	35c	6X4	\$1.00
6U7	75c	12SK7	50c
5Y3	\$1.75	VR65	\$2.00
6C4	50c	VT4C	75c
2 x 2	75c	AU5	\$1.00
6AG5	80c	80	\$1.25
12AU7	\$1.00	6AK5W	\$1.50

CATHODE RAY TUBES

3FP7	\$2.95	5BP1	\$3.50
3JP1	\$2.95		
V1669 4/1	\$2.95	CY2184	\$2.95

PLEASE ADD POSTAGE ON ALL ARTICLES

MINE DETECTORS

Ex A.M.F. with Instruction Book. Complete in wooden case. Ideal for plumbers, councils for locating buried pipes, etc. Freight payable at nearest attended railway station. **\$39.00**

4 DIGIT RELAY COUNTERS

50-volt D.C. suit slot car. Lap counters, etc. **\$1.25 each.** Post 13c.

ALTEC STUDIO MICROPHONES

639B Western Electric, top grade, original cost **\$250**, ideal Broadcast Studio, music recording, Church and play recording, etc. Fraction of original cost. Price on Application.

240 VOLT

522 POWER SUPPLY

Supplies all necessary voltages to operate 522 transceiver from 240 V A.C. Complete and ready to plug in **\$30.00.**

SPECIAL lucky dip valve offer, 15 new valves in cartons for only **\$2.00.** We haven't got time to sort them, so you reap the benefit. Post 60c.

SOLENOIDS

Plunger Type 12V 300M.A. Suit electric camera control, miniature trains, radio, etc. **\$1.25.** Post, 10c. 200 Mill. amp., 24 volt, 1/8in push movement. **\$1.25.** Post 10c.

LENSES

TOP GRADE ACHROMATIC 2in DIAMETER, 20in FL ideal as telephoto lens, telescope objectives. **\$13.** Postage 46c.

CONDENSER LENS

2 1/2in DIAM. 2in FL. **\$1.50 each or \$2.50 per pair.** Post 21c.

CONDENSER LENS

1 1/2in diam. 1 1/2FL. 50c each. Postage, 17c.

FOUR CHANNEL BRANCHING AMPLIFIER

With 4in Vu. meter GLORAD. Complete with Portable Power Converter. 600 ohm balanced input and output. Ideal for outside broadcasting, etc. **\$39.50**

MONITOR SPEAKER UNIT

Ex-A.B.C., consisting of low resistance 8in speaker in Acoustic Labyrinth Baffle Box, complete with 10-watt amplifier, 600 ohms plus 8dbm input, 240 volt A.C. operated. **\$37.50**

TEN CHANNELS VHF TRANSCEIVER

Types TR1934 100-125 meg/cys. and TR1935 125-150 meg/cycles. 28 volt DC operated AM single crystal locks both TX and RX on same channel complete with generator. **\$33.00**

RECORDING TAPE

EX-GOVERNMENT SURPLUS STOCK. Topgrade, 600ft on 5in spool, \$1.45, post 13c. 150ft on 3in spool, 65c, post 9c.

TELEPRINTER PAPER TAPE

8 1/4in x 6 5/8in Full Page
\$1.50 per roll.

WHEATSTONE BRIDGE

Top grade In Multiples up to 1000
\$65.00

Deitch Bros.

70 OXFORD STREET, SYDNEY, 2010

SORRY, NO C.O.D.

ANSWERS - continued

This tuner for amateur band receivers was described in our January 1958 issue. It combined switched coils with panel controls for bandset and circuit tracking. Properly constructed, and associated with a reasonable 455KHz IF channel, the tuner will give good results on AM and CW signals. Performance on SSB signals will be limited by oscillator stability and IF passband shape. An article in the following issue, February 1958, described a modification of the tuner to include double frequency change. In both cases, care is essential with layout to ensure stable operation. Copies of both articles are available for 20c each. Letters should be addressed to The Assistant Editor, Electronics Australia, Box 2728, G.P.O., Sydney, 2001.

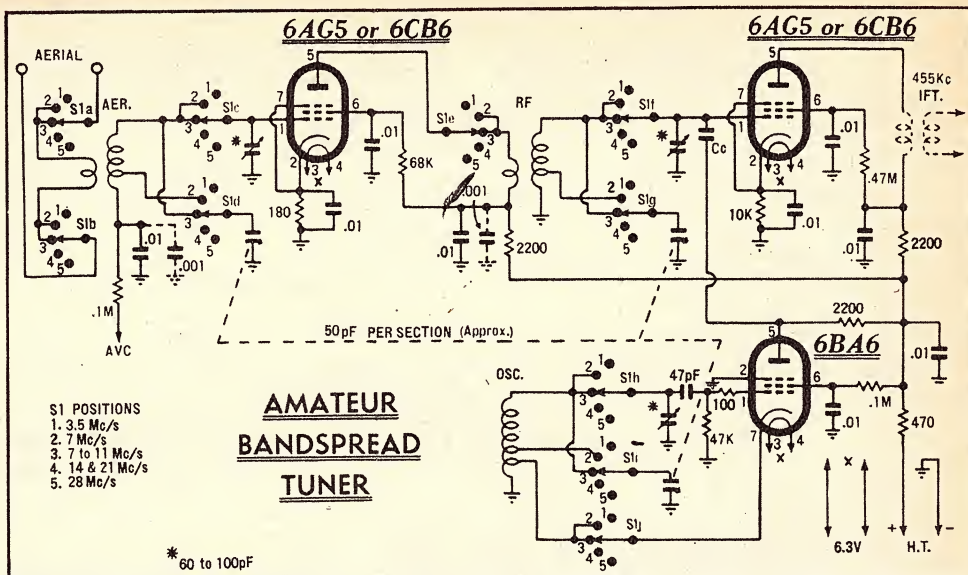

COIL DATA

3.5MHz Band (8mm formers in cans).

- Aerial: Pri.—10T 34 B&S enam.
- Sec.—80T 34 B&S enam. spaced 1/16in from pri.
- RF: Pri.—20T 34 B&S enam.
- Sec.—80T 34 B&S enam. spaced 1/16in from pri.
- Oscillator: 75T 34 B&S enam. tapped at 20T.

All coils closewound.

7.0MHz Band (8mm formers in cans).

- The 7 to 11MHz range is also covered with this set of coils.
- Aerial: Pri.—6T 34 B&S enam.

Sec.—52T 28 B&S enam. spaced 1/16in from pri. Tapped at 25T.

RF: Pri.—12T 34 B&S enam.
Sec.—52T 28 B&S enam. spaced 1/16in from pri. Tapped at 25T.

Oscillator: 48T 28 B&S enam. tapped at 10T & 23T.

All coils closewound.

14 & 21MHz Bands (½in formers).

- Aerial: Pri.—3T 28 B&S enam. closewound.
- Sec.—12T 24 B&S enam. spaced ½in. Tapped at 3½T. 1/16in from pri.
- RF: Pri.—6T 28 B&S enam. closewound.
- Sec.—12T 24 B&S enam. spaced ½in. Tapped at 3½T. 1/16in from pri.

Oscillator: 12T 24 B&S enam. spaced ½in. Tapped at 3T & 3½T.

Secondaries wound on 16tpi grooved formers.

28MHz Band (½in formers).

- Aerial: Pri.—2T 28 B&S enam. closewound.
- Sec.—7T 24 B&S enam. spaced 7/16in. Tapped at 1½T. 1/16in from pri.
- RF: Pri.—4T 28 B&S enam. closewound.
- Sec.—7T 24 B&S enam. spaced 7/16in. Tapped at 1½T. 1/16in from pri.

Oscillator: 7T 24 B&S enam. spaced 7/16in. Tapped at 1T and 1½T.

Secondaries wound on 16tpi grooved formers.

MOOG SYNTHESISER: Following your reference to the Moog Synthesiser in connection with the record "Switched on Bach," could you please answer the following questions: What is the Moog Synthesiser? How exactly does it work? Is it played by man or entirely by computer? (J.S., Woolahra, N.S.W.)

● We could not possibly answer your questions in this column and we cannot refer you to any back issue containing the answers to your questions. If we can line up an article on the unit, we will present it for the interest of readers. The Synthesiser would appear to have grown out of earlier experiments which involved the use of fairly ordinary audio tone sources, the notes being individually selected, shaped, recorded, then fitted together, adding up to an extremely tedious operation. From the pictures we have seen, the Moog Synthesiser has a keyboard to select individual notes and a variety of formant and envelope shaping controls, plus a lot of other audio gadgetry. By the use of the keyboard and controls, it is possible to create the desired sounds much more expeditiously and, if desired, play segments of individual parts in a composition. These can then be assembled into a musical entity. It would be entirely possible to marry this gadgetry to punched tape or automatic gating circuits to produce "mechanised" phrases or to use a computer to generate random characteristics.

KIT SET FOR LEARNER: I saw the circuit for the simple TRF receiver in the April, 1969 issue, using the microcircuit

LM372. This gave me an idea for making an electronics kit for my younger brother, aged 15. Unfortunately, I haven't the slightest idea how to design circuits, therefore I thought that maybe you would use your knowledge of designing circuits to produce such a kit, using the LM372 as a centre point (if there are sufficient requests from other subscribers). If this is not possible, would you consider designing such an outfit, for about 8-12 projects, privately, at a price you consider reasonable. Should neither of these courses be possible, I would have to try to design my own circuits. If this is the only way out, would you please inform me of references on the subject of designing, with semiconductors and other components. (M.G.B., Malvern, Vic.)

● Your suggestion is worthy of consideration but it would not necessarily involve a microcircuit and we may not be able to act upon it quickly enough to meet your present needs. The idea of one of our staff members concentrating on the requirements of an individual reader is impractical. However, we draw your attention to the series of small projects using Veroboard, which appeared in our March, 1966 issue. This had six easily constructed devices, including an amplifier for crystal sets and crystal microphone pre-amplifier. A copy of the article can be acquired through the Information Service for 20c. By the way, what is wrong with using one of the electronics kits already on the market. (See the Broadway Electronics advertisement in the May issue, page 93).

CHOOSE THE BEST - IT COSTS NO MORE

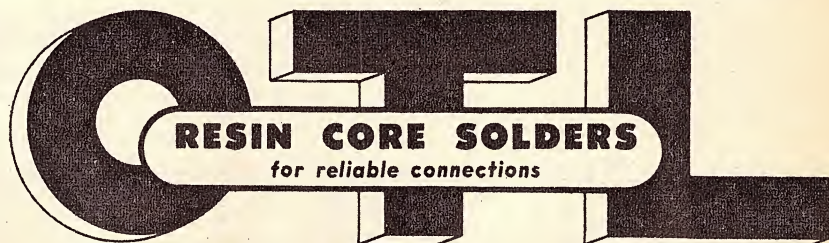

O. T. LEMPRIERE & CO. LIMITED. Head Office: 27-41 Bowden Street, Alexandria, N.S.W.
and at Melbourne • Brisbane • Adelaide • Perth

NEW RANGE OF RESISTORS, CONDENSERS AND POTENTIOMETERS

We have just purchased the complete stock of Resistors, Condensers and Pots. of a large manufacturer and can offer same at less than 25 per cent of list price.

The resistors are mainly I.R.C. and Morganite and are in a wide range of values from 200 ohm. to 3 meg. in $\frac{1}{2}$, 1 and 2-watt, also included are I.R.C. 3-watt wire wound 2,200 ohm, 3,300 ohm, 4,700 ohm, etc. List price \$9.00 per 100, our price, \$2.00 per 100, post. and packing 25c extra. The condensers are in most popular makes and include Polyester, Paper, Mica, Ceramic and Electrolytic in standard values, including 4mfd, 8mfd, 16mfd, 300V, etc. List price \$11.00 per 100, our price, \$2.00 per 100, post. and packing 50c extra. The potentiometers are all current types and include switch pots, dual concentric, 1 meg. tandem, $\frac{1}{2}$ -meg. switch, tab pots, etc. List price, \$12.00 per dozen, our price, \$2.50 per dozen, post. and packing 50c extra.

FREE With each lot of resistors, condensers or pots, we will supply free one new valve-type 6U7G, 6X5GT, IT4, 6K7G or 12AT7. Resistors, condensers and pots are in packs of 100 or 12 and we regret we cannot supply to individuals lists of values or types.



LEADER SIGNAL GENERATOR LSG11

240V A.C. operated, 6-band 120KC to 390 Megs. Provision for crystal. Post N.S.W., 75c; Interstate, \$1.25. **\$32**

NEW TRANSISTOR 8 KIT SET

SPECIAL PURCHASE ENABLES US TO OFFER THIS KIT SET AT **\$24.00**

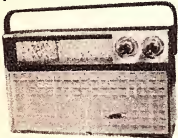

- Complete kit of parts with circuit and full instructions.
- Eight transistors.
- Magnavox 5X3 speaker gives excellent fidelity.
- High sensitivity, suitable for city or country use.
- Heavy duty battery for economical operation.
- Modern design, plastic cabinet with gold trim.
- Dial calibrated for all States.
- Available in colours of off-white, red, black or light green.

DIMENSIONS
9" x 5" x 3" deep

New Electrolytic Condensers

These condensers are miniature pigtail type insulated new stock in packets of 12, each packet containing: 3 16mfd 300 V.W., 2 32 mfd. 300 V.W., 1 25 mfd. 450 V.W. and 6 low voltage electrolytics. **\$2.50.**

Post and packing 20c extra.

NEW IMPORTED 4" P.M. SPEAKERS

Available with a 4 or 16 ohm voice coil. **\$2.00.**
Post and packing 30c extra.

USED HIGH-SPEED 240V. AC/DC MOTORS

These 240V A.C. or D.C. motors are 1/8 H.P. with a speed of 7,000 r.p.m. and are ideal for small drills, grinders, etc. Dimensions: 5 $\frac{1}{2}$ in x 3 $\frac{1}{2}$ in, with 5/16in spindle **\$3.75**

Postage N.S.W., 50c; Interstate, 85c.

NEW 25 AND 35 WATT. P. A. AMPLIFIERS

These amplifiers are suitable for installation in clubs, schools, restaurants, factories, etc. Wherever the amplification of speech or music is required.

25 W \$61 SPECIFICATIONS 35W \$71.

- Nominal power 25 or 35 watts. • Inputs two microphone and pick-up radio with separate controls and mixing facilities.
- Tone control. • Microphone sensitivity 6MV, pick-up or radio 150MV. • Frequency response 30 to 18,000 CPS.
- Output impedance Line output (100, 166, 250, 500 ohms) or can be supplied with V.C. output (2, 3, 7, 8, 15 ohms).
- Dimensions 11in x 6in x 8in. Weight 25W 23lb, 35W 26lb. Freight extra.

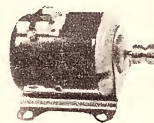

NEW MINIATURE MOTORS

Ideal for models, toys, etc. 1 $\frac{1}{2}$ to 3 volts. 6,000 r.p.m. 39c each or \$3.50 per doz. Post 10c.

NEW ENGLISH and AMERICAN TRANSISTORS AT 1/4 LIST PRICE

PACKET OF 12 FOR \$3.00

Ideal for the experimenter or service man.

Each package of 12 contains 3 each of the following types

Mazda XA101.
Texas 2N1108.
Texas 2N1111.
Texas 2N1110.

Equivalent:
" "
" "
" "

OC45 RF Transistor.
OC44 OSC. Transistor.
OC75 General purpose.
OC45 R.F. Transistor.

THESE TRANSISTORS
CAN BE SUBSTITUTED
FOR MANY OTHER
TYPES.

Post and Packaging 20c extra.

NEW 240V ELECTRIC MOTORS

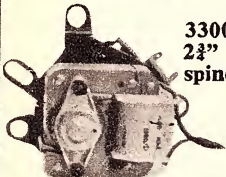

3300 R.P.M. Size 3 $\frac{1}{2}$ " x 2 $\frac{3}{4}$ " x 3 $\frac{1}{2}$ ", including spindle.

\$2.75

plus 60c postage.

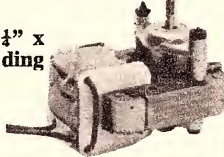

NEW MIDGET POWER TRANS. \$3.25

40mA prim., 240v. Sec 225 x 225 with 6.3v Fil. Winding. 30mA 240v. Prim. Fil. Winding.

Postage: N.S.W., 25c; Interstate, 45c.

150 x 150v. Sec. with 6.3v.

Postage: N.S.W., 35c; Interstate, 60c. **\$3.25**

NEW AMERICAN TWIN TELESCOPE TV AERIAL.

Extends to 36in, each section can be used singly for car or portable .. **\$1.50.** Post 20c
SINGLE TELESCOPIC Aerial, 12in extends to 33in. 60 cents. Post 10c



A PREAMP FOR MAGNETIC PICK-UP OR TAPE HEADS

SUITABLE FOR USE WITH THE COLLARO OR B.S.R. TAPE DECKS

Using 3 silicon transistors as featured in October Electronics Australia complete with kit of parts including transistors mono **\$7.50**, stereo **\$13.00**, 240 power supply for above **\$7.00.**

Please specify if required for pick-up or tape heads.

NATIONAL RADIO SUPPLIES

332 PARRAMATTA ROAD, STANMORE, N.S.W. PHONE 56-7398

AUDIO TOPICS

(Continued from page 113)

with a "plus" sign or a red grommet. By fairly common agreement, this indicates that a positive voltage applied to the speaker according to the polarity signs will cause a forward movement of the cone. Following this practice, ensures that the speaker cones are in phase with each other, i.e., the speaker cones move in the same directions with the same voltage applied.

Perhaps we can forestall another question: Is it feasible to use the Magnavox 3TC tweeter, provided it is of the same impedance as the C8MX Deluxe? The answer is "Yes" and the overall sound quality will be much the same. However, there is no local equivalent to the Rola C8MX Deluxe and this is the only loudspeaker recommended for "woofer" duty in this system at this stage.

The cost of one complete enclosure should be about the same as that for the Playmaster "Point Four" system, depending on the finish of the cabinet. At this price, we think all who hear them will agree that they are well worth it.

WAVELENGTHS OF LIFE AND DEATH

(Continued from page 21)

thesia). Electro-phonetic hearing, the process by which people with good high frequency hearing can "hear" hissing and buzzing sounds when in the beam of a radar transmitter, is another phenomenon showing that the nervous system can respond directly to electromagnetic radiation. Since whatever can stimulate can, in appropriate circumstances, overstimulate, it is time that we seriously asked whether we are not in danger of drowning in the new sea of man-made waves.

When radiation hazards are mentioned, it is the effects of ionising

FORUM

(Continued from page 55)

radio amateurs. To come across a group of CB'ers and say 'Oh you are hams' would be like walking up to a group of Israeli soldiers and embracing them as 'brave fighters for the U.A.R.'

"(e) CB frequencies in New Zealand are 26.425, 26.450, 26.475, 26.500, 26.525, 26.550, 26.575, known as channels 1 to 7 respectively. Why is A.L. talking about 27MHz?"

"(f) Of the approximately 7,000 to 8,000 CB'ers in New Zealand, fewer than 200 belong to the New Zealand Citizen Band Radio Club. There are, however, 8 or 9 other CB clubs in this country.

"If an impartial observer puts together the facts (a) to (f), he would come to the inescapable conclusion that A.L. has run across an inconsiderate ham or two."

C.G. (Wellington, N.Z.)

COMMENT: The depth of feeling indicated and implied in this letter suggests a pretty deep chasm between so-called "CB-ers" in New Zealand, and radio amateurs.

radiations which are normally understood. This shows how we are in danger of losing sight of the wood (problems of interaction between Man and environment) because of the trees (specific risks.) Various organisations are studying different kinds of risk — sonic bangs, ionising rays, low frequency vibration, and so on — but the overall problem of the total radiation environment is largely overlooked. The problem must be looked at as a whole, not piecemeal, because of the evidence for the existence of both synergic and anti-synergic effects (i.e. some radiations mutually reinforce their effects whilst others are mutually antagonistic.

We are remarkably careless in some ways. It is only about 10 years since X-ray machines were to be found in most shoe stores as an aid to comfortable fittings. We know better now, but only a few weeks ago I saw a police radar trap in South London set up in such a way that the beam (when not interrupted by passing cars) was directed through the open gates of a school playground. No danger has ever been mentioned in connection with such rays, and unquestionably the energy of the beam is too low for there to be any appreciable heating effects, but there is now plenty of evidence (e.g. the experiments of Dr Swann on Rhesus monkeys) to show that physiological damage can occur in the absence of heating, and it has been suggested that specific wavelengths may produce strong effects in specific types of nerve.

Certainly we do not want to become radiation hypochondriacs, but, if we are to avoid a repetition of the tragedies which followed the early unprotected use of X-rays, we must be much more careful in our employment of radio waves as well as of ionising radiations. A thorough study of the radiation environment, including interaction effects between radiation, will involve administrative as well as technical difficulties, but a more complete knowledge of the sea of waves in which we live may well be a matter of life or death.

To my mind (a) is a quibble. The use of a round figure to identify a band is commonplace in electronic terminology. Amateurs use round figures to identify their bands, model controllers likewise. VHF radio telephones are commonly defined as operating either on the "70-meg." or the "160-meg." band. And so on.

I also find the conclusion at the end less "inescapable" than G.G. apparently believes it to be. Or maybe it's a question on whose side one is being "impartial"!

It is hard to escape the feeling that the "CB Club" concept is basically anomalous. The original intention of CB type regulations was to facilitate communication between specific parties for specific purposes — here a structural team, somewhere else a couple of bushwalkers, and so on. The moment the means of communication is made an end in itself and the basis for club activities, it must surely be outside the spirit of the regulations as they now stand.

"INNERBOND"

(Regd.)

BONDED ACETATE FIBRES

FOR PACKING IN

SPEAKER ENCLOSURES

A new resilient Bonded Wadding made from ultra fine Cellulose Acetate Fibres that gives high efficiency for Sound Absorption.

"INNERBOND" is light, clean, dust-free and easy to handle. Because all the fibres are bonded "INNERBOND" will hang as a "curtain" and will not fracture or break down due to vibration.

"INNERBOND" is odourless, highly resistant to attack by bacteria or fungus and is vermin repellent; "INNERBOND" at 16oz sq. yd. has a normal thickness of 1" and at this density is recommended as a packing in Speaker Enclosures for Sound Absorption.

STOCKISTS:

SYDNEY: Arrow Electronics Pty. Ltd., 342 Kent St.; Broadway Electronics (Sales) Pty. Ltd., 32 Glebe Point Rd.; GLEBE: Convoys International Pty. Ltd., 449 Kent St.; Encei Electronics Pty. Ltd., 257 Clarence St.; Kent Hi-Fi, 432 Kent St.; Mastersound Sales Pty. Ltd., 400 Kent St.; Radio Despatch Service, 869 George St.; Stereo Music Systems, 193 Clarence St.; Circuit Components (A/sia) Pty. Ltd., 460 Bexley Rd., BEXLEY; Classic Radio, 245 Parramatta Rd., HARBURFIELD; Dyna Stereo Pty. Ltd., 331 Prince's Hwy., ST. PETERS; Albert Wright Radio Service, 795 New Canterbury Road HURLSTONE PARK; H. B. Radio Products, 103-105 Catherine St., LEICHHARDT.

NEWCASTLE: Martin de Launay Pty. Ltd., King and Darby Streets; Dynamic Sound, 587 Hunter Street.

WOLLONGONG: Electricon Parts Pty. Ltd., 82 Keira Street; Martin de Launay Pty. Ltd., 270 Keira Street.

MELBOURNE: J. H. Magrath and Co. Pty. Ltd., 208 Little Lonsdale Street.

BRISBANE: A. E. Harrold Pty. Ltd., 123 Charlotte Street; Brisbane Agencies, 78 Wickham Street, Fortitude Valley.

ADELAIDE: Duncan Agencies, 57 Woodville Road, Woodville; General Accessories, 81 Flinders Street; Trustcott Electronics, 62-64 Hindmarsh Square.

PERTH: Atkins (W.A.) Ltd., 894 Hay Street; Carlyle and Co. Pty. Ltd., 1 Milligan Street; General Accessories, 46 Milligan Street.

HOBART: Homecrafts-Tasmania, 199 Collins Street.

If unobtainable

For 1 sq. yd. as above send \$2.00
For 2 sq. yds. as above send \$3.75
For 4 sq. yds. as above send \$6.50

Postage paid in Australia and Territories to the manufacturers.

WONDER WOOL

PTY. LTD.

87 JAMES STREET, LEICHHARDT.
N.S.W., 2040.

Box 548 — G.P.O., Sydney, 2001.
Phone: 56-2780.

AN AUSTRALIAN MADE PICK-UP

THE M.B.H. HEAD AND EQUIDYNE ARM

AN INTEGRATED DESIGN USED
EXTENSIVELY BY THE
BROADCASTING INDUSTRY

Most manufacturers make heads to fit "any arm," and others make arms to take any make of head. How can a pick-up head be put into any one of the many quite different arms on the market, and each time give the same performance? Or, can one arm suit all the different heads available? One must admit that this hardly seems reasonable. M.B.H. heads and arms suit each other, and perform in a predictable and balanced fashion, avoiding resonances at troublesome frequencies.

THE STEREO EFFECT—SEPARATION

The end results of good design and careful assembly in the magnetic circuits, is a high degree of channel separation and equal channel sensitivity. These two factors together create the stereophonic effect. In the M.B.H. "L" type stereo heads, channel sensitivity is equal to within 1db at 1,000 c/s. Channel separation is 30db or more at 1,000 c/s and over 20db at 10Kc/s, measured by absolute methods

WRITE FOR BROCHURES AND
PRICE LIST TO VICTORIAN
DISTRIBUTORS:

WILLIAM WILLIS & CO. PTY. LTD.

430 ELIZABETH STREET,
MELBOURNE, VIC., 3000.
PHONE 34-6539

GUITAR AMPLIFIER

(Continued from page 99)

separately coloured red and black for polarity identification, serves the purpose well. It can be seen in the under-chassis photograph running almost the length of the chassis parallel to the mains cable.

Before connecting the output transistors to the supply, current limiting resistors (not shown in the circuit diagram) should be temporarily fitted to protect the output transistors until correct amplifier operation has been established. The output transistors could be destroyed if the driver transformer was wired with the secondary windings out of phase, and nothing to limit output transistor current.

Two 47 ohm 5 watt resistors are connected in the positive and negative supply rails to the output transistors. Connect one end of each 47 ohm resistor to the positive and negative leads in the flex. Connect the other ends of the resistors to the positive and negative terminals respectively on the canmounting electrolytic capacitors.

The amplifier can now be switched on again and checked for correct overall operation. In this condition it should deliver about 2 watts into an 8 ohm load, and this may be checked in two ways.

Perhaps the simplest way is to connect the amplifier to a loudspeaker and feed in program material from a radio or similar source. The amplifier should give an output of reasonable volume in an average room before going into distortion. The amplifier will overload and distort if the input signal is ex-

cessive, and a potentiometer should be used to adjust the input signal level. If the amplifier distorts at all levels, even the lowest, there is something wrong. It should be thoroughly checked, paying special attention to the driver transformer connections.

Another way is to measure the output voltage across an 8 ohm resistive load, using a sinoidal input from a generator. If a generator is not available, use the test circuit shown in figure 2. A filament or soldering-iron transformer provides a low voltage source of 50Hz signal and potentiometer adjusts the output voltage.

The amplifier should deliver about 3.5V RMS before waveform clipping occurs. If driven into severe overload a maximum voltage of about 5V RMS can be measured. If the output is less than about 0.5V RMS there is a fault and, again, it could be the driver transformer wiring.

Having established that the amplifier is working correctly the 47 ohm limiting resistors can be removed. When this is done, connect a voltmeter across the output terminals to check for the presence of any DC voltage. Ideally there should be zero volts across the output terminals but a voltage of up to 1V is acceptable. This check for DC unbalance should be made without any input signal.

Unmatched output transistors, such as 2N3055s, may produce a voltage difference in excess of 1V. If the voltage on the transistor side of the output socket is positive with respect to the other side of the output socket, then the 18 ohm resistor associated with T1 should be reduced. If on the other hand, the voltage is negative, the 18 ohm resistor associated with T2 should be reduced.

Do not replace the 18 ohm resistor with the next lowest preferred value. Use higher value resistors to shunt it. As a temporary shunt use a wire wound resistor of around 300 ohms, but be careful not to set it to zero ohms. Set the pot. to give zero volts across the output, switch off, remove the pot., and measure its value.

(To be continued.)

BUY RECORDING TAPE AT WHOLESALE PRICE

WILCOX BROS. & BARCLAY

are now offering their line of recording tape direct to the Public at wholesale prices. This is a leading American manufacturer's first-grade line especially packed for us in a plain box. We are not allowed to reveal the maker's name.



TYPE	CODE	LIST PRICE	YOUR Wholesale PRICE
5" 900ft Acetate PVC	5R9	\$2.75	\$1.80
5" 1200ft Tensilized Polyester	5P12	\$4.45	\$2.95
7" 1800ft Acetate/PVC	7R18	\$5.10	\$3.35
7" 2400ft Tensilized Polyester	7P24	\$8.35	\$5.50

Wholesale prices allow for 33 1/3 per cent trade discount and cash settlement discount an include sales-tax, Freight free throughout Australia.

MONEY BACK GUARANTEE

WILCOX BROS. & BARCLAY tape is guaranteed to be first-grade splice free recording tape made in the U.S.A. Your money will be refunded in full on return of goods within fourteen (14) days if you are not fully satisfied with your purchase.

ORDER FORM (capital letters please)

FROM:

NAME:

STREET AND NO.

CITY OR SUBURB:

POSTCODE:

PLEASE SHIP:

..... rolls 5R9 at \$1.80. Total \$

..... rolls 5P12 at \$2.95. Total \$

..... rolls 7R18 at \$3.35. Total \$

..... rolls 7P24 at \$5.50. Total \$

I enclose cheque/postal note/ Money Order for Total \$

Return this order to:

Wilcox Bros. & Barclay
WHOLESALE MERCHANTS
Mail Order Office:
Room 7, 3rd Fl., 323 Bourke St., Melbourne

**W
B&B**

COMPUTER BOARDS

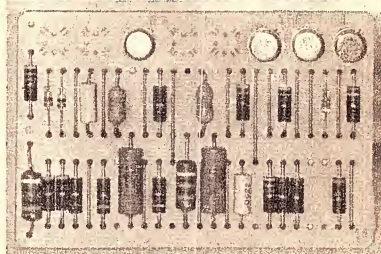

TRANSISTORS 15c Each.

Resistors, Diodes, Capacitors Free.

8 BOARDS WITH A MINIMUM
OF 30 TRANSISTORS \$4.00

25 BOARDS WITH A MINIMUM
OF 100 TRANS. \$12.00

Pack and post 25c
Technical information supplied with goods.
Minimum order \$1.50.
Please add Postage.

COLSTOK ELECTRONICS

Box 178, KELLERBERRIN. 6410

Proven wharfedale high fidelity sound from two low priced compact speaker systems!

Several years of intensive research have resulted in the release of two new compact speaker systems by Rank Wharfedale Ltd. The problems associated with small speaker enclosures have finally been solved; until now these limiting factors have been restricted frequency response and lack of musical quality.

The "Denton" measures only 9 3/4" x 15" x 9" . . . the "Super Linton" is 19" x 10" x 10". Both systems feature a new type of bass/mid-range 8" drive unit with an exclusive Wharfedale Flexiprene surround, an extra-long throw voice coil and a new-type ceramic magnet. A specially designed paper cone is employed as laboratory tests reveal that a well-designed paper cone is far more sensitive to musical sound than those made from plastics or man-made fibres. Lower registers are reproduced without restraint or collapse.

Treble response is smooth, clean and satisfying; a new H.F. pressure unit incorporated in both enclosures features an "Acoustiprene" dome — the lightest material ever used in speaker manufacture.

Frequency response of the "Denton" is conservatively quoted at 65-17,000 Hz. Response of the "Super Linton" is 40-17,000 Hz. Impedance is 4-8 ohms.

Cabinets are finished in selected oiled teak or polished walnut veneers and have been designed to match both modern and period decor. Both "Dentons" and "Super Lintons" are supplied in acoustically matched pairs for optimum stereophonic performance.

When first you listen to these compact Wharfedale multiple speaker systems you will find it hard to believe; after several weeks you will still wonder how Wharfedale succeeded in putting high fidelity Wharfedale sound into extremely compact enclosures.

the new Wharfedale Denton

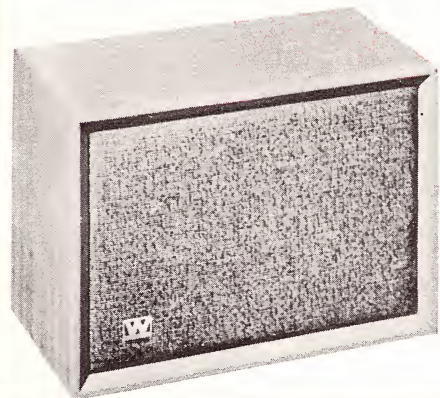

\$61.40
ea. inc.
sales tax.

the new Wharfedale Super Linton

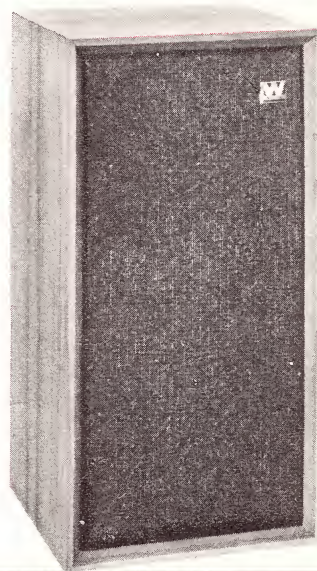

\$78.
ea. inc.
sales tax.

Australian National Distributors:

Simon Gray Pty. Ltd.

Head Office: 28 Elizabeth St., Melbourne, Vic. Tel. 63 8101*

Sydney Office: 22 Ridge St., North Sydney, N.S.W. Tel. 929 6816

Canberra Office: 31-33 London Circuit, Canberra City, A.C.T.
Tel. 49 6050

INTERSTATE REPRESENTATIVES:

N.T.: Pfitzner's Music House, Smith Street, Darwin. Tel. 3801

Q'land: Sydney G. Hughes, 154-158 Arthur St., New Farm, Brisbane. Tel. 58 1422

S.A.: Eilco Sales Pty. Ltd., 7-9 Osmond Terrace, Norwood, S.A. Tel. 63 4844

Tas.: K. W. McCulloch Pty. Ltd., 57 George Street, Launceston. Tel. 2 5322

W.A.: Athol M. Hill, 613-615 Wellington Street, Perth. Tel. 21 7861

SGW7/68

YOU

CAN EARN

BIG MONEY

IN RADIO-TELEVISION



ASK YOURSELF THESE 3 QUESTIONS!

1. Am I in a dead-end job?
2. Could I earn more by learning more?
3. Could I use my spare time to get ahead?

If the answer is yes, there is room for you in radio/television/electronics.

NOW IS THE TIME TO TRAIN!

Does your job offer good prospects — real security? Does it hold your interest? If not, now is the time to do something about it. Television is expanding daily. It's the most exciting subject you can study. The sky's the limit for the trained man . . . but only the trained man. Radio and television technicians are in huge demand. Train for success now, in Australia's fastest-growing industry! Join the ranks of skilled men . . . the Australian Radio and Television College can train you for a bright future with unlimited prospects. Send for the free booklet "Careers in Radio, TV & Electronics" and find out how A.R.T.C. can bring you success—in your own business or as well-paid technical staff!

A.R.T.C. CAN TRAIN YOU AS IT HAS THOUSANDS OF OTHERS

For nearly 40 years A.R.T.C. has successfully trained thousands of progressive Australians who realised how much the training could mean to

them. Now they're making big money in radio and television. Training can bring you success, too.

FOR A FEW PENCE PER DAY YOU CAN STUDY THE A.R.T.C. WAY

. . . in your spare time, you can equip yourself for a rewarding career in radio/television. The future belongs to the trained. The A.R.T.C. "Service Engineering Course" teaches you from the ground up . . . step by step . . . at your own pace. Remember, opportunity is always knocking for the trained man!

PRACTICAL UP-TO-DATE LESSONS

At the work benches and lecture halls of A.R.T.C. — or in your own home by correspondence — you can learn every necessary aspect of radio and television, every application of fundamental principles. The Course gives you both basic and advanced instruction.

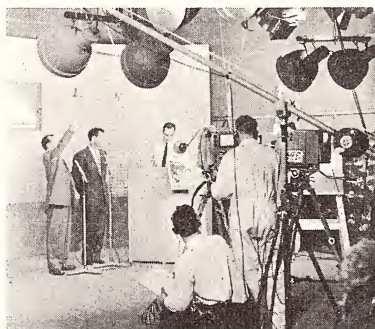

No previous experience or high educational standard required . . . only enthusiasm and normal intelligence. A.R.T.C. will give you

all the instruction you need. Each lesson made easy to understand by numerous illustrations and diagrams. The Course adapts itself to your requirements, your speed. It's up to you! Instruction is individual and intensely practical.

THOUSANDS OF SUCCESSFUL STUDENTS HAVE PROVED THIS

Make your spare time earn money for you while training at home.

Many students make extra money after only a few weeks' tuition. Train at the modern A.R.T.C. workshops, in more convenient.

GET INTO ONE OF THESE PROFITABLE CAREERS IN RADIO/TELEVISION

There is a career for you in one of the many phases of radio/television, including manufacture, servicing, research, sales, executive positions, armed forces, audio, etc., etc.

A.R.T.C. can help you gain one of these sought-after careers. Remember it's the trained man who wins, every time!

MAIL COUPON NOW!

Safeguard your future! You are invited to see in the coupon below. A.R.T.C. will mail you by return their big free and post-free booklet "Careers in Radio, TV and Electronics." This exciting book shows you definite steps you can take towards a big future—how you can succeed in life and find satisfaction in doing a worthwhile job well.

AUSTRALIAN RADIO AND TELEVISION COLLEGE PTY. LTD.
E. S. & A. BANK BUILDING,
 Cnr. Broadway and City Road, Sydney.
 (Opp. Grace Bros.) Phone 211-4244 (3 lines.)



AUSTRALIAN RADIO & TELEVISION COLLEGE PTY. LTD.
 206 Broadway, Sydney, N.S.W.

Dear Sir,
 Please send me, without obligation, your free booklet "Careers in Radio TV and Electronics."

NAME

ADDRESS

.....