

# ELECTRONICS

## Australia

June, 1969



40¢

Jindivik: Aero-electronic success story (see page 18)

TRACKING 250M/Sec. SOLAR WINDS ● AN ECONOMY Q-METER  
A CRYSTAL-CONTROLLED CLOCK ● BUILDING A THEREMIN





# NATIONAL RS790S STEREOCORDER

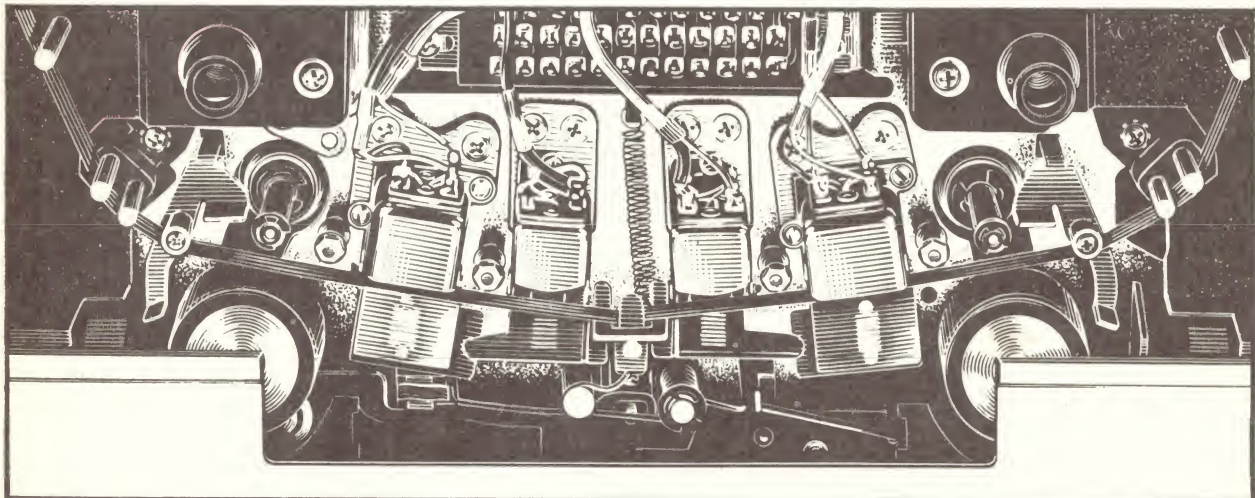

## Big Daddy blasts into town with 4 heads and dual capstan drive

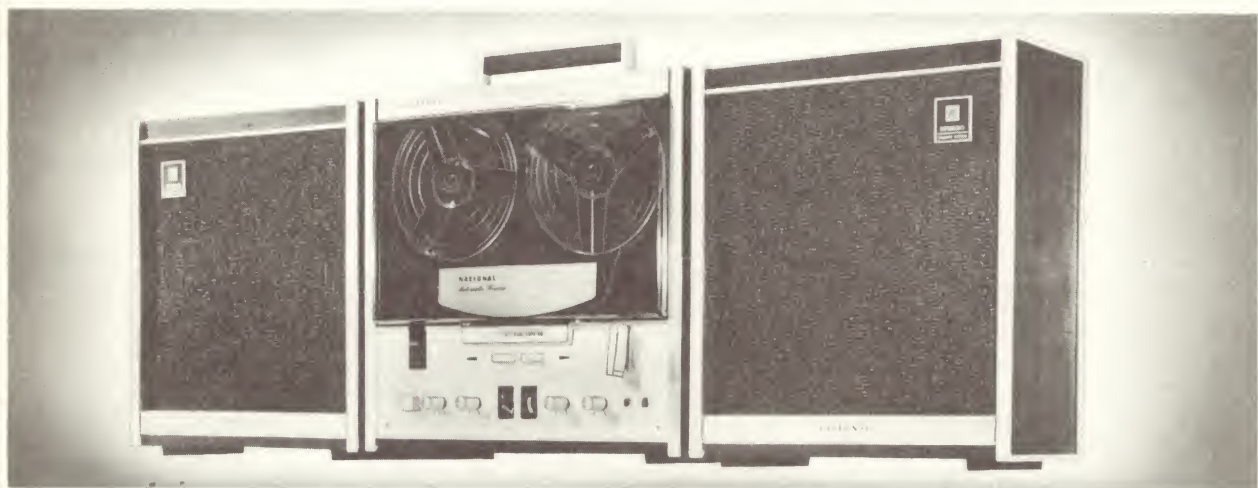

And that's just openers. National's Big Daddy RS790S stereocorder is an electronic miracle-box. With continuous automatic reverse, automatic stop, sound-on-sound, instant P.A., balanced 4-pole motor, and a 20 watt output that sounds more like 30, Big Daddy gives you crystal clear sound every time. Wow and flutter are under 0.09%, response 30—20,000 c.p.s., it's solid state, and has 3 speeds. One of National's unique "Golden Mechanism" series, Big Daddy gives

you a mighty lot of stereocorder for the money. And then some. See it. Hear it . . . soon!



To HACO DISTRIBUTING AGENCIES PTY. LIMITED  
57-69 Anzac Parade, Kensington, N.S.W. 2033

Please send me further information on National RS790S stereocorder.

Name.....

Address.....

Postcode..... G604





# ELECTRONICS Australia

incorporating RADIO, TELEVISION & HOBBIES

ABC certified circulation in excess of 47,000

volume 31, number 3

**CRICKETS:** *When you read the article on page 16, you may be moved to write to the R.S.P.C.C. But, before you do, read the whole article.*

**CLOCK:** *The clock unit on page 82 will yield an accuracy of, typically, better than 1 second per week.*

**THEREMIN:** *An instrument about which readers have been asking for a long time. Easy enough to construct but a challenge to play! See page 98.*

**COURSE:** *The second instalment in an up-to-the-minute course on diodes, transistors and other solid-state devices. Page 54.*

## CONTENTS — JUNE, 1969

### features

- 3 Editorial—Pardon our nostalgia
- 10 Studying the solar winds
- 12 Opto-electronic devices
- 16 Temperature control system
- 18 Jindivik—Australian success story
- 21 Equipment pods for radar maps
- 25 Flexible laminates in U.K.

### technical digest

- 27 Tubeless television camera
- 29 Planning for 150mph trains
- 31 Electret microphone

### technical articles

- 40 Economy "Q" meter
- 54 Fundamentals of solid state — chapter 2
- 68 Finishes for labels and panels
- 73 Test set-up for digital circuits
- 79 Hints on reading capacitor codes
- 82 Crystal control unit for clocks
- 98 Solid state Theremin
- 114 Sound and voice magnifiers (historical)

### regular features

- 33 Scientific and industrial news
- 64 Forum
- 91 Serviceman
- 108 Reader built it
- 113 Audio topics—laboratory test record
- 116 Record reviews—classical
- 121 Record reviews—documentary
- 125 Record reviews—devotional, popular, jazz
- 140 Trade reviews and releases
- 153 Technical books and publications
- 161 Amateur band news and notes
- 173 Listening around the world
- 181 Answers to correspondents
- 191 Classified advertising
- 192 Index to advertisers
- 155 Notes and errata

#### Editorial Office:

12th Floor, 235-243 Jones Street,  
Broadway, Sydney, Australia.  
Phone 2-0944.

#### Postal Address:

Box 2728, G.P.O., Sydney, 2001, Australia.

#### Advertising:

Manager, Selwyn Sayers,  
Sydney Representative, Bill Summons.  
Office: 8th Floor, 235-243 Jones Street,  
Broadway, Sydney, Phone 2-0944.  
Melbourne Representative, Clarrie Levy.  
Office: 392 Little Collins Street,  
Melbourne, 3000, Phone 67-8131.

#### Circulation:

Alan Parker, Manager.  
Office: 9th Floor, 235-243 Jones Street,  
Broadway, Sydney, Phone 2-0944.

Subscription Rates: See back page.

#### Representation:

Melbourne—John Fairfax and Sons Ltd., 392 Little  
Collins Street, 3000, Phone 67-8131.  
Brisbane—Sungravure Pty. Ltd., 78 Elizabeth Street,  
4000, Phone 2-6688.  
Adelaide—John Fairfax and Sons Ltd., 104 Currie Street,  
5000, Phone 51-3502.  
Perth—Sungravure Pty. Ltd., 847 Hay Street, 6000,  
Phone 23-4513.  
Newcastle, N.S.W.—Associated Newspapers Ltd., 22  
Bolton Street, 2300, Phone 2-3696.  
London—John Fairfax and Sons (Aust.) Ltd., Reuter  
Building, 85 Fleet Street.  
New York—The Sydney Morning Herald Ltd., 1501  
Broadway, New York, N.Y., 10036.

#### Distribution:

Distributed in N.S.W. by Sungravure Pty. Ltd., Jones  
Street, Broadway, Sydney, N.S.W.; in Victoria by Sun-  
gravure Pty. Ltd., 392 Little Collins Street, Melbourne;  
in South Australia by Sungravure Pty. Ltd., 104 Currie  
Street, Adelaide; in Western Australia by Western Press;  
in Queensland by Gordon and Gotch (A'sia) Ltd.; in  
New Zealand by Truth (N.Z.) Ltd.; in Tasmania by  
Davies Bros. Ltd., "Mercury," Hobart.



**Miniwatt  
have a  
heatsink  
design  
for all  
power  
semi-  
conductor  
applications**

Write, phone or call for FREE booklet on "Miniwatt" Heatsink Designs

SYDNEY  
20 Herbert St, Artarmon,  
Sydney N.S.W. 2064  
phone 43.2171  
ADELAIDE  
11-13 West Terrace, Adelaide,  
S.A. 5000,  
phone 516051  
BRISBANE  
56-58 Cordelia Street, South  
Brisbane, Qld. 4101,  
phone 422471  
CANBERRA  
86 Wentworth Avenue  
Kingston, Canberra, A.C.T.  
2604,  
phone 90321-2-3

HOBART  
2A Pierce Street, Moonah  
Hobart, Tas. 7009,  
phone 84691  
MELBOURNE  
252 Sturt Street, South  
Melbourne, Vic. 3205,  
phone 690141  
NEWCASTLE  
194 Parry Street, Newcastle  
West, N.S.W. 2302,  
phone 615001  
PERTH  
672 Murray Street, Perth,  
W.A. 6000,  
phone 213131

*"Miniwatt"*

ELECTRONICS DIVISION OF PHILIPS  
ELECTRICAL PTY. LIMITED.



Sydney, Melbourne, Brisbane  
Adelaide, Canberra, Hobart,  
Newcastle, Perth.





## EDITORIAL VIEWPOINT

by Neville Williams

### *Pardon our nostalgia*

Last month, we reprinted an article by the late Edwin Armstrong, originally published in an Australian journal in 1921. In it, the author advanced the superheterodyne principle as a promising way of avoiding "internal oscillations" in multi-stage tuned amplifiers. Two now-classic solutions to the problem still lay somewhere in the future: neutralisation and screened grid valves.

This month, we have reprinted an article of a different kind from the same period: a survey of the methods then current for amplifying audio signals. Valve amplifiers, loudspeakers and public address were just emerging, but electro-mechanical methods of magnifying signals were still very much in the picture. How gross the distortion content must have been. Even much later, when valve amplifiers and horn loudspeakers were common, I remember that one of the things you noticed about a receiver was whether or not the announcer could be understood readily!

Elsewhere in this issue is an example of a technical query and a reply, penned in 1926. It provides an interesting sidelight on the experimenters-cum-listeners of the day and on a receiver design so uncautious that a simple capacitor short burnt out nine valves — twice! Imagine, if you can, the dismay of burning out 18 valves in 1926, each worth about a quarter of a week's pay.

Surrounded, as we are now, by relatively sophisticated electronics equipment, it is rather fantastic to realise that these early and primitive situations obtained within the living memory of many of our readers. To browse through some of the early issues of our own ancestor, "Wireless Weekly," is, for the older members of our staff, a fascinating experience — re-living the atmosphere of the twenties.

To the younger members of our staff, reared on a diet of solid-state physics, the same material has an almost fictional Dad-and-Dave quality. They have to believe it but it seems so unreal, so unrelated to the present, that I doubt that they really comprehend it.

"Electronics Australia" has to stay abreast of developments to stay on top, and first call on our editorial space must, of necessity, be for what is current, what is new and what lies in the future. But, as space permits, we want to resurrect and reprint some of this historic material: articles, comment and projects from a past era.

Travel in a modern jet is enriched by the memory of fabric biplanes that once traversed our skies. Appreciation, or otherwise, of a modern building is broadened by a knowledge of the old and the ancient. In just the same way, as one peers through a microscope at the heart of an integrated circuit, there is something to be said for seeing it, not as the result of what somebody did yesterday, but as a milestone in a road that stretched back to and beyond galena crystals and bright emitter valves.

The technicalities of one era become the romance of the next.

### *On the cover*

*At the R.A.N. Station, Nowra, N.S.W., a Jindivik pilotless jet target aircraft is prepared for flight. Still regarded as one of the world's best target aircraft after nearly 20 years of service, the Jindivik has been sold to the U.S.A. and Sweden, and is used in large numbers in Britain. A recent order from Britain for 24 more Jindiviks brings the total of export sales to well over the \$20-million mark. Member companies of the Australian Telecommunications Development Association have played a major part in the development and manufacture of the Jindivik's electronic guidance system. (See story, page 18.)*

#### EDITOR

Neville Williams  
M.I.R.E.E. (Aust.)  
(VK2XV)

#### ASSISTANT EDITOR

Philip Watson  
A.M.I.R.E.E. (Aust.)  
(VK2ZPW)

#### TECHNICAL EDITOR

Jamieson Rowe  
B.A. (Syd.),  
B.Sc. (Tech., N.S.W.)  
A.M.I.R.E.E. (Aust.)

#### TECHNICAL STAFF

Ian Pogson (VK2AZN)  
Harry Tyrer (VK2ZHH)  
Anthony Leo (VK2ZHK)  
John Horsfield  
Robert Flynn  
Leo Simpson



# INSTROL *hi-fi systems . . .*

There's a custom built Instrol hi-fi System to suit every possible purpose. For example, this prestige system, based on the magnificent new Instrol Cabinets "Series One Thousand." We suggest the Kenwood TK250 Amplifier, and Dual 1019 Player (with Shure M75G magnetic cartridge), plus two Wharfedale Super 12 RSDD Speakers all fitted in Instrol Teak Cabinets one Model 1002 and two of enclosure 1001. Built and tested for \$717.00. Many fine combinations can be produced to suit your requirements, with and without tape recorders, in any of the craftsman-made cabinets from the Instrol range. Let us quote you for your choice. You can save more money if you prefer to assemble your own from Instrol Cabinet Kits.

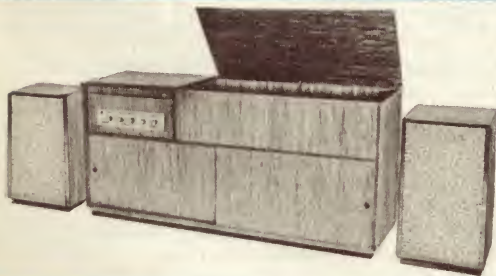
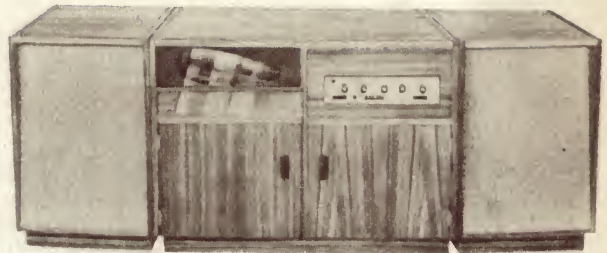

Here's another splendid selection. Take Instrol model 375 R.S. Cabinet with two Wharfedale Super 10 speakers fitted with Instrol vented enclosures. The cabinet work may be Queensland Maple, Teak or Walnut. For your amplifier, what better than Instrol solid state Model 20-20, or Kenwood TK 150, Add Sony TC 255 tape Deck, and Garrard AP75 (with Shure M44G magnetic cartridge). Cost within the range of \$653.00 and \$688.00. The same systems but within tape deck and fitted in Instrol Model 250 R.S. Cabinet between \$446.00 and \$477.00.

## SPECIAL

Two compact, shelf or table mounting systems — quality at very low cost.

(A) Instrol 20-20 Solid State Amplifier, plus BSR MA70 Player, fitted to Instrol Model 75 Cabinet (Teak) which features hinged perspex top. Add two Instrol-Mullard mini speaker systems. \$229.00

(B) Instrol 20-20 Solid State Amplifier, Garrard AT60/2 Player, in Model 50 Cabinet, plus two Instrol-Playmaster Bookshelf speaker Systems (all Teak), \$249.00.

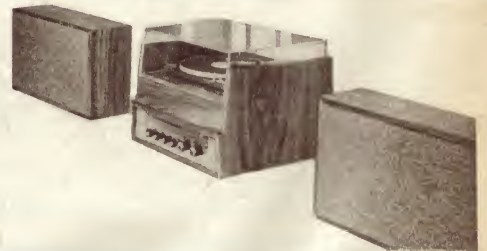

### PRICE DETAILS:

T101 TUNER (in Metal Case) . . . . .	\$72.00
T101 TUNER (without case) . . . . .	\$69.80
20-20 AMP. (in Teak Case) . . . . .	\$99.00
Combined 20-20-T101 in Teak Case . . .	\$176.00

## INSTROL WIDE BAND TUNER Solid State Model T-101

A high quality hi-fi tuner designed to operate with all makes of valve and solid state amplifiers.

- Wide band 530 to 1600KHz
  - Tuning Meter. ● Efficient Noise filter.
  - R.F. Stage.
  - Built-in AC. Power Supply.
  - Major Stations, all States clearly marked on large illuminated scale.
- Housed in smart metal box. Available as Amp/Tuner in combination, with the Instrol 20-20 Amplifier, in attractive Teak cabinet (as illustrated) or less cabinet for panel mounting.



Yes, we carry a range of imported Loudspeakers, Players, Amplifiers and Tape Recorders. Please state your requirements and we will gladly quote. All well-known brands stocked.

- |              |               |            |
|--------------|---------------|------------|
| ● INSTROL    | ● A.D.C.      | ● GARRARD  |
| ● FISHER     | ● DECCA       | ● SONY     |
| ● KENWOOD    | ● QUAD        | ● BRENNELL |
| ● SANSUI     | ● LABCRAFT    | ● AKAI     |
| ● WHARFEDALE | ● ALL BALANCE | ● TEMPO    |
| ● GOODMAN'S  | ● DUAL        | ● LEAK     |
| ● SHURE      | ● ELAC        |            |





# INSTROL cabinet kits . . .

## And Now INSTROL PERIOD STYLE Hi-fi furniture . . .



We are in the process of adding period styling to some of the models from our standard range of Instrol hi-fi furniture. The photograph shows Model 600 equipment cabinet with Instrol Wharfedale speaker enclosures rendered in Queen Anne period styling. This styling is equally attractive for other models from the Instrol range. Soon, some Instrol models will be available in Spanish-Mediterranean styling.

### PRE CUT KITS OR BUILT & FINISHED

All Period Styles are available as pre-cut kits to assemble yourself or as built and finished furniture. By assembling yours from an Instrol pre-cut kit, you can make your own period style furniture for little more than half cost. ideal for finishing to an almost exact replica of cedar, mahogany, rosewood, etc., and really magnificent when finished in any of the new Estapol Antique colours.

Each kit is complete with all necessary pre-cut timber parts, legs, antique handles, moulding, carvings, nails, screws, etc., plus fully illustrated easy-to follow instruction manual.



### EQUIPMENT CABINETS

There are more than sixteen Instrol equipment cabinet designs, all available built and polished or as kits of parts to assemble yourself. They range from massive floor units to compact table models, and include cabinets for record storage and wall shelf units.



### SPEAKER ENCLOSURES AND SYSTEMS

Name your speaker and Instrol can supply an enclosure to suit. If it's not in the standard range we can quickly produce enclosures to suit speaker manufacturers' specifications. Enclosures only or complete speaker systems are all available built and polished or as kits.

### PLAYER STANDS

The Instrol range includes a wide variety of player stands and combination amplifier-player cabinets. High quality perspex covers (clear and tinted) are also available, some hinged, others separate.

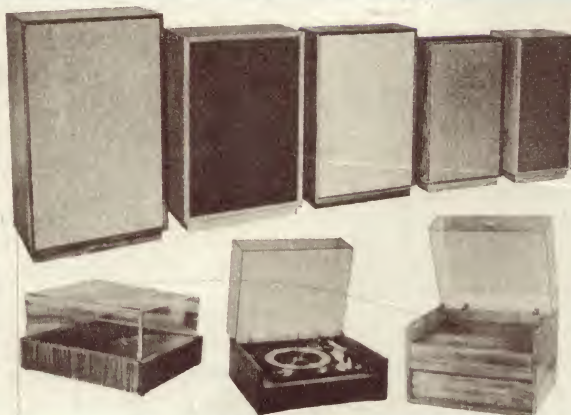

Post coupon, call, or phone for free fully illustrated Instrol hi-fi cabinet brochure. It includes full specifications and down to earth price details of all Instrol cabinet designs. (If writing please include postage stamp.)



**FREE**  
**INSTROL**  
**CABINET**  
**CATALOGUE**

## BROADWAY ELECTRONICS (SALES) PTY. LTD.

32 GLEBE PT. ROAD, GLEBE, N.S.W.

Telephone 660-1171. Only 100 yards from Broadway.

OPEN SATURDAY MORNINGS.

Send Coupon for **FREE CATALOGUE.**  
(Please enclose postage stamp.)

NAME .....

ADDRESS .....

.....

.....

Instrol Hi-Fi  Instrol Cabinets



With a BSR X3M  
 'compatible' cartridge,  
 almost any mono  
 record playing  
 equipment can take  
 stereo records  
 (without damaging  
 them)

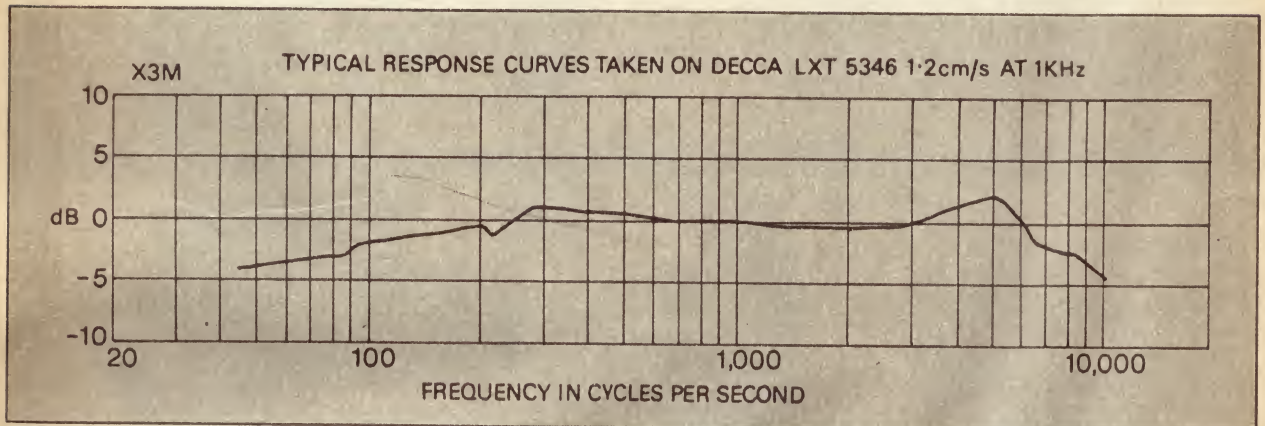
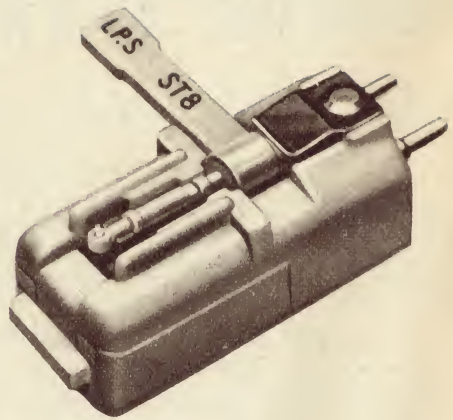

### Why compatible cartridges?

An increasing number of record companies are now making stereo LP records only.

Until now these records could not be played on a mono player without distortion and damage to the records.

When playing stereo records the stylus tip moves vertically and horizontally following groove contours. Mono records have grooves which only move the stylus horizontally so old mono cartridges will not allow vertical movement of the stylus. Playing stereo records with old mono cartridges will damage the vertical component of the groove irrevocably.

The X3M 'compatible' cartridge, designed and perfected by BSR, is the answer to this problem. For a small outlay it allows you to play both stereo and mono records without harming either. Retail price, \$6.00.

### TECHNICAL DATA X3M

Output: 350 mV  $\pm$  2 dB

1 KHz test record Decca  
 LXT 5346 at 1.2 cm/s

Frequency Response: See typical curves above

Dynamic Compliance:

Horizontal  $3.0 \times 10^{-6}$  cm/dyne ( $\pm 20\%$ )

Vertical  $1.0 \times 10^{-6}$  cm/dyne ( $\pm 20\%$ )

Equivalent Capacity: 800 pF

Nominal

Recommended Loading: 2 M. ohm 100 pF

Stylus Pressure: 4-6 grammes  
 depending on pick-up arm

Measuring Temperature: 20° C 68° F

Colour: Beige



BSR (A/ASIA) PTY. LTD.  
 SOUTHERN SECTION INDUSTRIAL ESTATE  
 ST. MARY'S, N.S.W.  
 PHONE: 623-0375, 623-0376



DISTRIBUTORS:  
 GOLDRING ENGINEERING (A/ASIA) PTY. LTD.  
 443 KENT STREET, SYDNEY, N.S.W.  
 OFFICES IN ALL CAPITAL CITIES.

BSR:P100



# not short on features



## BSR's Brilliant New Anti-Skate MA65

Once again BSR presents an outstanding automatic turntable embodying fine high fidelity features found only in the most expensive models . . . plus anti-skate control. The new MA65 has a heavy deep-drawn 11-inch diameter turntable, low mass tubular tone arm with automatic lock, cueing and pause control lever, low mass cartridge shell with finger lift. And to achieve the ultimate in performance, BSR has brought to perfection the adjustable dynamic anti-skate control. The MA65 has a light tracking jam proof tone arm, automatic shut-off, wow less than 0.2% rms, flutter less than 0.06% rms. And many more quality features.



## BSR (A'ASIA) PTY LTD

Southern Section Industrial Estate  
St. Marys NSW 623-0375 623-0376

WHOLESALE DISTRIBUTORS  
GOLDRING ENGINEERING (A'ASIA) PTY LTD

NSW 443 Kent St Sydney 2000 Tel 29 5802

VIC 162 Pelham St Carlton 3053 Tel 34 5105

QLD 415 Adelaide St Brisbane 4000 Tel 2 3247

SA Farley & Fahy Pty Ltd 75-77 Wright St Adelaide 5000 Tel 51 5117

WA 32 Northwood St Leederville 6007 Tel 8 4988

GE-P515



# Sansui's systematic way



For a start, check into this attractive 100 watt system. The solid state 2000 AM/FM multiplex stereo tuner amplifier handles the other components like they were made for each other. And they were. Beginning with audio characteristics that include 100 watts in output power, wide power bandwidth from 20 to 40,000Hz and a distortion factor of less than 0.8%, the 2000 gets total performance from every component, including its own FM tuner section with FET circuitry.

The SP-200 is a 3-way 5-speaker high fidelity system with a 40 watt handling capacity and the latest tap-type level controls. The SR-3030BC is a 2-speed manual turntable incorporating a unique belt-drive system, heavy platter and tubular tonearm for flawless characteristics of wow and flutter. The SS-2 is a moving coil type headphone set that gives you "you are there" stereo faithfulness throughout a wide 20 to 18,000Hz frequency range.



Or, check into this 70 watt system. It combines the Sansui 800 AM/FM multiplex stereo tuner amplifier with the SP-100 3-way 3-speaker high fidelity speaker system, SR-2020BC 2-speed manual turntable and SS-2 headphone set.

Like the larger 100 watt system, the components that make up this one feature compatibility in both design and performance. It brings larger system performance into the medium power and price range. Ask your nearest authorized dealer for spec sheets for either of these systems. What you see will surprise you and what you hear will surprise you even more if you haven't heard a Sansui system before.



# to better sound.

If you're looking for something even more professional, ask your dealer to show you the Sansui AU series of professional stereo control amplifiers. They turn on at 70 watts (AU-777), 60 watts (AU-555) and 46 watts (AU-222), respectively.

And they turn on some of the finest engineering features ever offered to stereo enthusiasts anywhere. Wide dynamic ranges, low distortion factors, high S/N ratios and independent pre- and main-amplifier sections for the two larger models.

Sansui also makes matching AM/FM Multiplex Stereo Tuners for these models, which is something to keep in mind for the time when multiplex broadcasts become operational in Australia.



*Sansui*®

SANSUI ELECTRIC CO., LTD. 14-1, 2-chome, Izumi, Suginami-ku, Tokyo, Japan



# STUDYING THE 250mile/sec.

A satellite put into orbit by the European Space Research Organisation (ESRO) last December is sending back to earth valuable information about the "solar winds" which prevail throughout our solar system.

by Dr G. Morfill

(Department of Physics, Imperial College of Science and Technology, London.)

The direct exploration of space during the past decade has been restricted by limitations in rocket power and spacecraft technology to that region lying close to the ecliptic plane and bounded roughly by the orbits of Venus and Mars. Nevertheless, we now have a broad picture of the conditions that must prevail in much of interplanetary space and it turns out that the dominant feature is the solar wind. This wind consists of a low density, fully ionised, hydrogen plasma which blows radially outwards from the sun with a velocity which lies generally in the region 350 to 400KM per second but gusting to perhaps 1000KM per second at times of great sunspot activity. This wind appears to be a permanent feature of our part of the solar system and as far as we can tell there is no lull even at times of minimum sunspot activity.

Like any other highly ionised plasma, the solar wind is a good electrical conductor and this has the important consequence that it has a built-in magnetic field. This field arises in the first place because the sun's surface is itself threaded by magnetic field lines generated by electric currents flowing below the surface and these field lines, trapped by the high conductivity of the plasma, stream outwards in the wind like streamers in a terrestrial wind—one end remaining fixed to the solar surface. The radial motion of the wind combined with the rotation of the sun causes the magnetic field lines to form a spiral pattern which stretches far beyond the orbit of earth. We do not know how far the solar wind and associated magnetic field stretches before it merges with the interstellar magnetic field but it may well be fifty times the distance from earth to sun.

The magnetic fields at the sun which provide the roots of the interplanetary field have a strength of the order of 1 gauss which is only slightly stronger than the magnetic field of the earth. The magnetic fields on sunspots are generally several thousand times stronger than this

but the spot regions are not typical of the solar surface generally. The strength of the interplanetary magnetic field falls off steadily with increasing distance from the sun and at the orbit of the earth it is ten thousand times weaker than the earth's surface field. Even though it is very weak the interplanetary field is nevertheless quite important.

The solar wind speed is many times the speed of sound in the plasma and consequently the situation of the earth in the solar wind is analogous to that of an object in a supersonic wind tunnel. The object does not however correspond to the solid earth. Instead it corresponds to the earth plus its magnetic field. This is because the geomagnetic field out to a distance of about 14 earth radii behaves like a solid object in the path of the wind. At this distance there is a well-defined boundary which is not penetrated by the wind, while the field at greater distance is torn off and swept along so that it streams out away from the sun like smoke from a fire on a windy day. This region, where the earth's field carves a hollow in the solar wind, is called the magnetosphere and it is this region which contains the Van Allen belts.

In considering the streaming of the solar wind past the earth we can just as well think of the solar plasma as being stationary, with the earth moving through it at supersonic speed. A shock wave is produced like that from a supersonic aircraft. The shock wave is, of course, stationary relative to the planet and lies just a little upwind of the boundary of the magnetosphere.

Although the broad picture is now well established there are many important aspects which are not understood. We do not, for instance, understand how the energy of the solar wind is used to accelerate the Van Allen particles or to produce magnetic storms and auroral displays. Neither do we understand the nature of the explosively violent outbursts called solar flares which occur

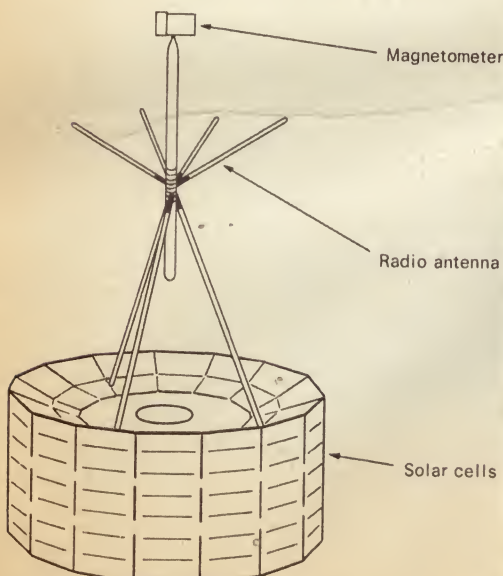
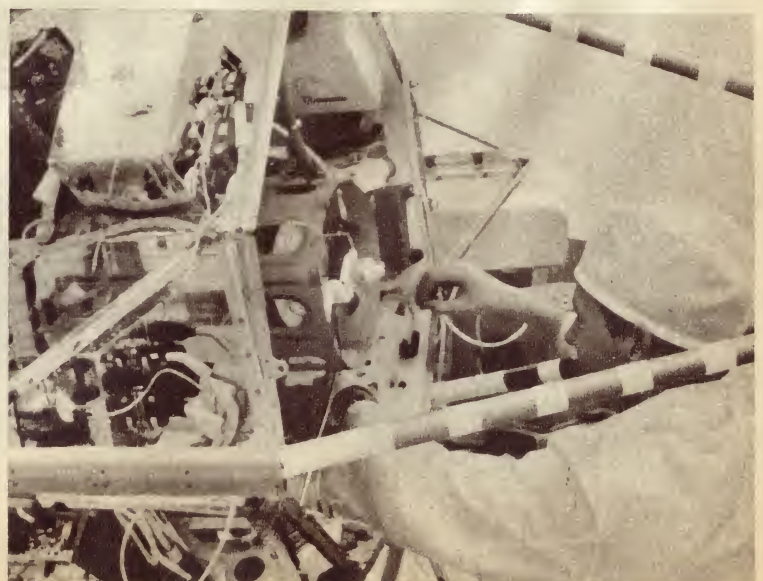

Diagram showing the general arrangement of the HEOS satellite



A technician carries out final checks on HEOS before the installation of panels of solar cells.



# SOLAR WINDS

Gusts reach speeds up to 650 miles/sec.

Diagram showing the highly elliptical orbit followed by the HEOS satellite. The shaded areas close to the earth are the various levels of the radiation belts.

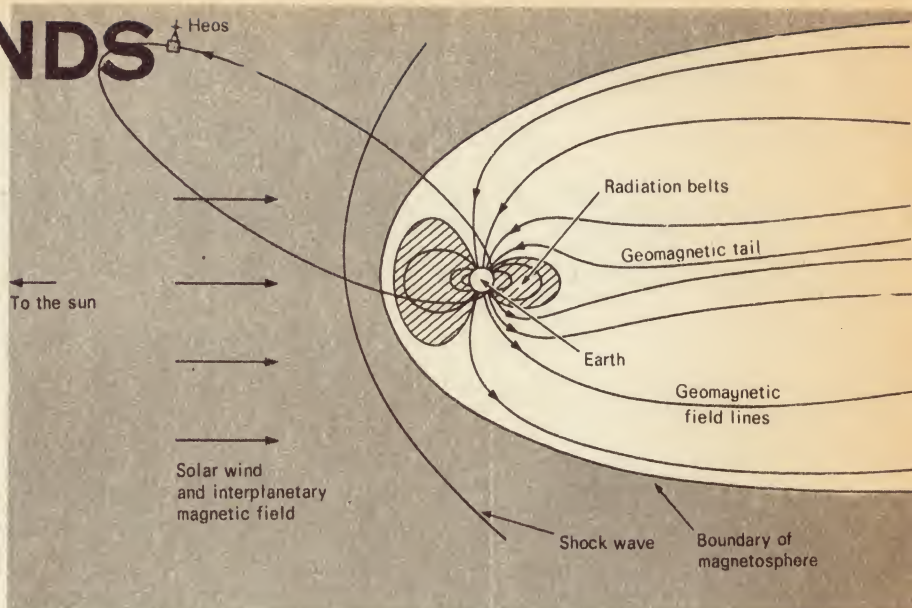

from time to time in the sun's atmosphere above sunspots. These flares generate blast waves which travel outwards through the solar wind and trigger off magnetic storms, auroral displays and sudden changes in the Van Allen belts at the earth. They also generate bursts of radio noise, X-rays and charged particles which have been accelerated to energies comparable with those produced in present day laboratory accelerators used for nuclear physics research. These bursts of energetic charged particles consist of electrons, protons,  $\alpha$ -particles and heavier atomic nuclei and are guided out from the sun by the spiral interplanetary magnetic field lines so travelling outwards past the earth into interstellar space. Because of the radiation damage they cause, these particles constitute a hazard to astronauts and will have to be reckoned with in high flying supersonic airliners.

The scientific objective of the European Space Research Organisation's space probe HEOS (Highly Eccentric Orbit Satellite) which was launched from Cape Kennedy on December 5, 1968, is the further investigation of the solar wind, its associated magnetic field and the way in which the energetic solar particles and cosmic rays are propagated through the interplanetary magnetic field. The orbit of HEOS is highly elliptical and the launch time was chosen to correspond with maximum solar activity.

The greatest distance from the earth that is reached by HEOS is about 224,000KM at apogee, which is rather more than halfway to the moon, well beyond the boundary of the magnetosphere and the shock wave. The distance of closest approach to the earth at perigee is a mere 400KM. It will take four and a half days to complete one orbit. Most of this time is spent in interplanetary space since the spacecraft is travelling relatively slowly at apogee, speeding up as it approaches the earth. The choice of an orbit of this kind permits maximum observing time by the spacecraft outside the magnetosphere and at the same time ensures that its maximum distance from earth remains within close limits. A space probe in an orbit round the sun would, of course, spend the whole of its time outside the magnetosphere but its distance from the earth would increase to such a degree that communication would be impossible using the existing European tracking network. This was the reason for choosing an elliptical earth orbit rather than a solar orbit.

The spacecraft carries a total of eight experiments provided by various European space groups. Two of them, designed by groups in Italy and Belgium, are measuring the velocity and angular distribution of the solar wind particles. One from France measures the energy spectrum of solar flare particles and another from Italy is investigating the energy spectrum of cosmic ray electrons. A fifth experiment prepared in Germany released a cloud of barium vapour in space with which observers on the ground are able to study the effects of electric and magnetic fields by means of optical measurements. The remaining three experiments, designed by the Imperial College Cosmic Rays and Space Physics Group, represent the British contribution.

One of them uses a fluxgate magnetometer to monitor

the strength and direction of the magnetic field in interplanetary space and in the outer regions of the earth's magnetic field. The three mutually perpendicular magnetometer sensors are placed at the end of a boom 6ft 8in from the centre-of-gravity of the satellite in order to minimise the effects of stray magnetic fields from the spacecraft itself. This arrangement, coupled with considerable care in the design and construction of the satellite, has reduced the disturbing field at the sensor location to such a degree that it is 20 times weaker than the typical interplanetary field.

Because of the great distance of the spacecraft at apogee the rate at which information can be transmitted over the telemetry system is limited and only one magnetic vector can be transmitted every 20 seconds. To study field variations on a shorter time scale than this, data can be stored in a magnetic memory over short periods with ten times better time resolution than that normally available. These stored measurements are then transmitted over a long period at a low rate. In fact, several alternative combinations of operational modes and measurements rate are available on command from the ground. The spacecraft programming circuitry itself contains a decision-making section which starts the recording of measurements when the magnetic field is showing rapid changes with time. The experiment also incorporates a magnetic gradiometer for verifying the magnitude of the disturbance field of the satellite and a timing circuit for periodically generating data on the performance of the instrument.

Also included in the Imperial College group of experiments is a detector designed to collect information about the bursts of energetic particles emitted from solar flares. This detector responds to protons in the energy range 1 to 24MeV. Protons of this energy follow the interplanetary field lines and by studying their behaviour in detail it is possible to glean information about the interplanetary magnetic field configuration close to the solar surface where direct measurement of it is impossible. The solar proton detector consists of two identical "telescopes" which respond to protons arriving within a relatively small solid angle. Each telescope is made up of four silicon solid-state particle detectors arranged in coincidence one behind the other with disks of copper absorber between them. This arrangement produces a directionally sensitive device and permits a rough measurement of the energy of the protons to be made at the same time. One of the telescopes points along the spin axis of the spacecraft whilst the other looks out perpendicular to this direction and scans the sky as the spacecraft turns. By this means it is possible to build up a picture of the angular distribution of the particle intensity and to relate this to the magnetic field direction.

The third experiment is designed to perform a similar function for the much higher energy cosmic ray protons which come from outside the solar system. These, too, are affected by the interplanetary magnetic field but in a way which is not yet fully understood. Coming from outside the solar system, they provide direct information about

(Continued on Page 89)



# BRIGHT FUTURE FOR "OP-ELECTRONICS"

Scientists in the U.S.A. are making steady progress towards the ultimate goal of using the electromagnetic properties of light directly, without first having to convert them to established electrical phenomena, as is done in the cases of solar cells, television cameras, and similar equipment.

Using a variety of new electronic materials and novel effects, they are presently training light to drill holes in diamond dies, carry radio and TV signals, align tunnel-boring equipment, track earth satellites, provide inertial guidance for missiles, and produce optical memory and logic circuits for computers. In the process, they are also fashioning a new opto-electronics technology that has been popularly dubbed "op-electronics."

But nowhere are the potential benefits of this developing technology more evident than in the field of visible displays. A series of recent breakthroughs promises to revolutionise everything from wrist watches and automotive dashboards to computer read-outs, television screens, and phonograph records.

In its strictest sense, "op-electronics" is not new. It was derived, originally, from the work of Julius Plucker, a German physicist. In 1859, Plucker discovered the phenomenon of cathodo-luminescence: that light is given off when certain phosphors are struck by beams of electrons, which were called cathode rays in his day, hence the name.

Thirty-eight years later, Karl Ferdinand Braun, also a German, employed this and other discoveries to build the first cathode ray oscilloscope: a vacuum tube with a phosphor screen that produced a beam of electrons that could be deflected up, down, or sideways by external magnets. The beam could be followed visually by the bright spot it created on the screen.



Among the direct descendants of this ingenious tube are the laboratory oscilloscope for observing high-speed electrical phenomena, the radarscope for monitoring the flight of aircraft and missiles, and the TV kinescope.

Thus, the Braun tube was the first practical opto-electronic device. And it still serves, 71 years later, as the technological touchstone and inspiration for many of the modern efforts being made to surpass it. This is especially true in those cases where the only change contemplated is in substituting a new material for the phosphor screen found at the viewing end of most display tubes.

Three such changes that have already been demonstrated experimentally might prove revolutionary if they become practical.

The first involves the use of a screen composed of lasers of a remarkable cathodo-luminescent type — tiny crystalline flakes of such materials as cadmium sulphide or zinc oxide. These flakes can be activated (pumped) by an electron beam of sufficient energy, causing them to emit a parallel beam of intense coherent light.

By substituting these for the phosphors in a conventional TV screen, Dr Frederick Nicoll, of the RCA Laboratories in Princetown, N.J., hopes to produce a bright visual display that could ultimately be viewed directly or be intensified still further for projection onto a wall or movie screen.

He has already built and successfully operated an experimental tube that contains several such lasers in a short row, and plans to add more in the future. As an immediate aim, a tube with a full row of lasers might be used as a kind of coherent light "flying spot scanner" — a device using a single scan of light to convert the images on constantly moving film to television signals.

Another approach of equal scientific interest and far-reaching applications potential is that involving the use of a photochromic instead of a phosphor screen.

Since the invention of paint and the development of clothing dyes, it has been known that certain materials change colour when exposed to sunlight. Though virtually everyone has experienced these subtle, often exacerbating, effects at one time or another (housewives even take advantage of them by hanging white laundry out to be both dried and bleached by the sun), it was not until recently that anyone undertook to determine precisely what atomic mechanisms are involved in producing them. Ironically, it was unwanted and deleterious bleaching occurring in the "sun-pumped" crystal laser, announced by RCA in 1962, that triggered such investigations.

This laser, built by Dr Zoltan Kiss, was a single crystal of calcium fluoride containing traces of the rare earth, dysprosium, that could be activated either by exposure to sunlight or by the intense radiance of a mercury vapour lamp. Unfortunately, as it turned out, this same illumination also bleached the material and steadily degraded its performance. Though concerned, at first, with counteracting the effect, Dr Kiss soon became engrossed with trying to exploit it instead. Finally, after an exhaustive series of analytical studies, he was able to show that the

*The image on this liquid crystal display device shows that it is capable of high contrast and fine detail. However there are practical difficulties which make it unlikely that they will be used in domestic television receivers in the foreseeable future, if at all.*



## by Bruce Shore

(Reproduced from "Electronic Age," by arrangement with RCA Publications Department.)



*Experimental set-up for producing images on photochromic surfaces by exposing them to light of one colour through a negative, and erasing the image by light of another colour.*

dysprosium atoms, which were responsible for the laser action, were slowly losing electrons to the defects in the surrounding crystal. As a result, they were becoming absorbers of the very light they were supposed to emit.

Since these crystal defects or "electron traps," as they are called, could not be controlled or easily eliminated, Dr Kiss decided to add traces of a second rare earth, europium, to the crystal. He reasoned that the atoms of this material would have greater affinity than the crystal defects for the electrons being lost by the atoms of the first rare earth and would enhance the photochromic effect as well. Going a further step, he substituted the rare earth samarium for dysprosium. Happily, the strategem worked. Furthermore, he found that the bleaching or discolouration produced when light of one frequency "kicked" electrons from the samarium to the europium atoms could be reversed by light of another frequency. The latter tended to kick the electrons back again, returning the material as a whole to its original state and hue. Thus, with outside light of at least two distinct frequencies or colours, he found that he could produce a kind of atomic "ping-pong game" within the crystal. This could be the basis for "writing" and "erasing" information on a photochromic surface by means of light.

In subsequent studies, he even determined that such "writing" could be accomplished on one side of the material with an electron beam and, if the material were thin enough, erased by light on the other. Thus was born the cathodo-chromic electron tube — an experimental device with a photochromic instead of a phosphor screen. Its great advantage is that it can be written on by standard television techniques and will retain its pictures or data for up to a half hour, even when the tube is turned off. This makes it especially well-suited for the display of data that

change periodically — airline departure and arrival schedules, stock transactions and last sales, pari mutuel odds, and the like. Moreover, data displayed in this way can be altered or updated from outside, or erased entirely by a light pen, laser beam, or some other source of illumination.

The third candidate for replacing phosphors in the screens of TV tubes is the nematic liquid crystal. The liquid crystal state is a transition, or "twilight zone," that occurs in many organic compounds somewhere between their solid and completely liquid states. Materials in this state possess the physical properties of a liquid as well as the optical properties of a polycrystalline solid. Hence their name.

This condition was first identified in 1888 when Friedrich Reinitzer, an Austrian botanist, found that certain organic compounds he was investigating did not melt cleanly. Thereafter, others found that there are three types of liquid crystals, a smectic variety, whose molecules arrange themselves vertically like cans of soup stacked on top of each other on a supermarket shelf; cholesteric types, whose molecules are laid out horizontally but are stacked in helical fashion like steps in a winding staircase; and nematic brands, whose molecules are also laid out horizontally but are stacked like stick matches in a box. All of these architectural arrangements, it develops, are due to van der Waals forces — weak electrical attractions between the molecules — whose discovery won a Nobel prize in 1910 for the Dutch physicist Johannes van der Waals. Still later, in 1931, Wilhelm Kast, a German chemist, found that liquid crystal molecules could be forced to line up in an electric field.

Such intriguing features were bound to capture the attention of electronics scientists sooner or later, and, in the early 1960s, impelled Dr Richard Williams of RCA Laboratories to initiate an intensive study of nematic liquid crystals, in particular. Subsequently, new insights developed during this study led Dr George Heilmeier, a co-worker, to believe it might be possible to employ such materials to achieve all-electronic displays of a novel, reflective type.

Starting with materials that exhibited nematic behaviour only within a narrow temperature range of from 90 deg. to about 110 deg. C., Heilmeier and his research team made their first important discovery—that, when a film of the usually transparent material was trapped between two plates of glass and subjected to a small electric voltage, it became instantly opaque. Ions—in this case electrically charged



*A TV test pattern from a New York station received at the RCA Laboratories is displayed on a liquid crystal screen.*





## General Electric's 3 amp hermetic A15 replaces costlier rectifier diodes

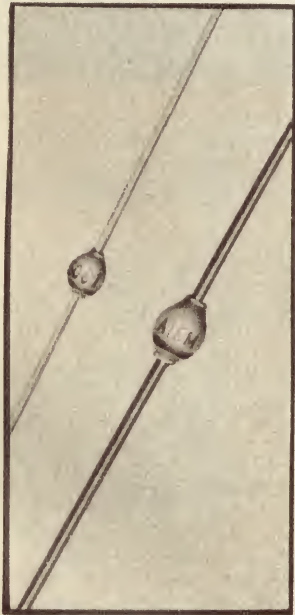

A14/A15

General Electric offers a higher rated companion to its field-proved, 1 amp A14 rectifier at a significantly lower cost than stud or other lead mounted units (depending upon configuration). The A15 is rated 3 amps at 70C and the 200 to 800 volt models are transient voltage protected up to 1000 watts for 20  $\mu$ S in reverse direction. This means there is no worry of surface breakdown during absorption of household and industrial voltage transients.

A15's dual heat sink design means low thermal impedance and easy adaptation to PC board mounting . . . reduced installation cost.

Both the A15 and A14 are hermetically sealed in an all-diffused, glass passivated junction structure. No internal cavity means more resistance to environmental stresses . . . thus increased reliability.

High power A15 is now available in quantity for applications including time delay circuits, battery chargers, communication equipment and small portable appliances.

For more details on General Electric's A14 or A15 rectifiers, write *Australian General Electric Pty. Ltd.*, 103 York Street, Sydney, N.S.W. 2000. Telephone 29 8711; or 552 Lonsdale Street, Melbourne, Victoria 3000. Telephone 67 8221.

**GENERAL**  **ELECTRIC**  
U. S. A. Reg. Trademark





Portrait image obtained on a photochromic surface by exposing it to blue light through a photographic negative. It can be erased by exposure to yellow light.

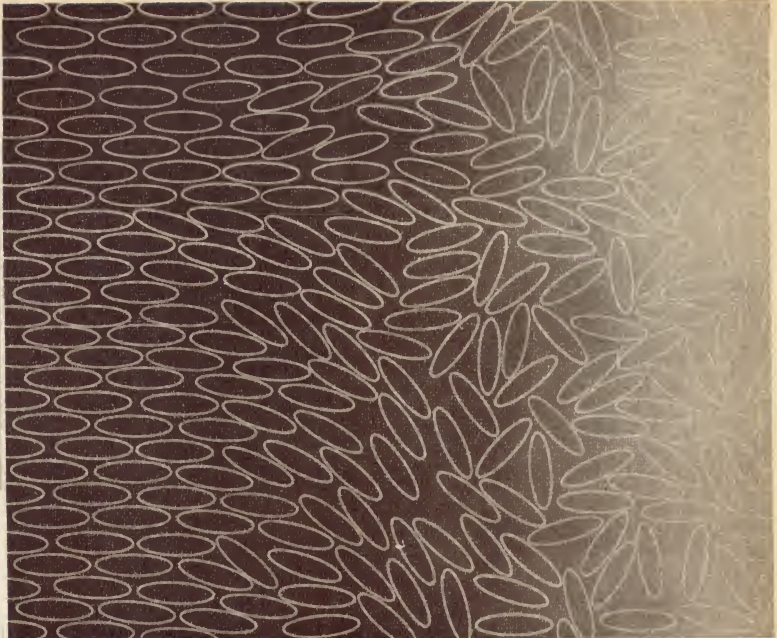

Artist's sketch of molecular arrangements in liquid crystal screen. Molecules are normally transparent and line up parallel (left of drawing). When subjected to an electric field, they become disordered and cause light to scatter (right).

molecules generated in the film by the voltage—were moving from one of the glass plates to the other, disrupting the orderly molecular arrangements of the liquid crystal and causing it to scatter rather than transmit light. In fact, the higher the voltage, up to a certain limit, the more the scattering.

Next, Heilmeyer's team went to work on the temperature problem. Could a nematic material be found or fabricated that would have a wider temperature range? After several months of trial and error and patient chemistry, a second important discovery was made. It was possible to produce a material whose liquid crystal state could be maintained over a range below freezing to the boiling point of water.

Proof was obtained several months later when Dr John Van Raalte, also

of RCA Laboratories, succeeded in building a tube with a small liquid crystal screen that could be scanned by an electron beam in the conventional manner and could receive and display standard broadcast pictures. These differed from ordinary TV pictures only in that they were seen by reflected light from their surroundings (in the same way a printed page is seen), rather than by light that they themselves emitted, as in the case of phosphors. (See "Electronics Australia," April, 1969, page 25.)

As indicated by Dr Heilmeyer's original discovery, however, it is not necessary to use an electron beam to activate a liquid crystal screen. A simple electric field produced between two electrodes is sufficient to make it scatter light. If one or both of these electrodes is transparent—tin oxide is ideal as such an electrode—it is possible to produce flat displays. These can be used, for example, as the face of an all-electronic watch, a speedometer or other dashboard instrument, a silent cash register or desk calculator, and an alpha-numeric read-out. It might even make possible a flat television display one day, although this would require more than just a flat screen. It also needs some means, other than an electron beam, of lighting up or darkening about 250,000 points on the screen every second. This is the number of "bits," roughly, that make up a standard TV picture.

Cathodo-luminescent lasers, photochromic materials, and liquid crystals all figure prominently in the effort to achieve new forms of electronic displays based on the way certain materials generate, absorb or reflect light. Still others are being worked on, however, that depend upon how certain materials transmit light. Some of the most dramatic of these use lasers as their source of light. Mosaics of

tiny electro-optical or magneto-optical "windows" produce rapid changes in intensity at various points in the laser beams as they pass through on their way to a distant screen.

Such systems are based upon the fact that the electric and magnetic fields, which make up light, vibrate both vertically and horizontally as they propagate through space. Furthermore, it turns out that the electric field in this partnership can always be resolved at any instant into two right-angle components much like the cross hairs in a bomb sight. Finally, because of the way these vertical and horizontal components interact with certain transparent materials, it is possible to suppress one of them (to polarise the light) as the light passes through or to change its direction (to rotate the plane of its polarisation). Some materials do this naturally by virtue of the way they are constructed. Others do so only when subjected to an electric or magnetic field.

Focusing on this latter category, scientists have now fashioned materials from which they are able to build tiny, mullioned "windows" whose optical characteristics can be altered electronically and in any pattern. Thus, as light passes through them, their action is combined to produce a sort of electro-optical or magneto-optical "transparency" that can be projected directly on to a screen.

To the standard television technique of producing images by controlling the emission of light from an array of phosphors, scientists are now adding an extraordinary ability to produce these same images by controlling the absorption, reflection, and even transmission of light by other, more exotic materials. In the process, they are paving the way for a myriad of new products built on the developing technology of "optoelectronics."



Experimental display unit designed by RCA engineers to prove the feasibility of a laser display capable of projecting colour TV pictures onto a wall.



# TEMPERATURE CONTROL USING THE HOUSE CRICKET

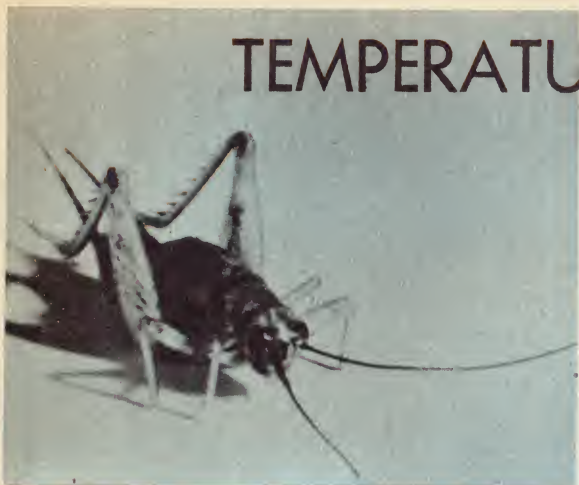

*Grillus domesticus* with wings removed to show the serrated back legs which are used to produce the "chirp."

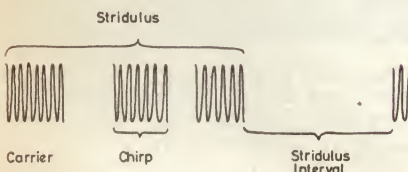
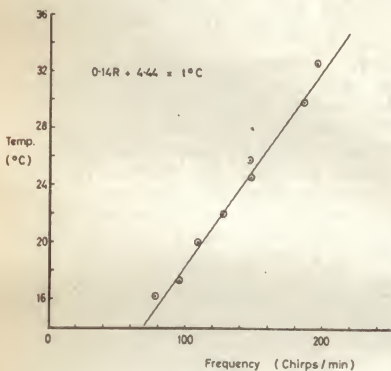

Figure 1. Nomenclature used to describe cricket signals.



Some time ago a problem arose in the Institute connected with the dispatch of insect larvae in regular consignments to another laboratory in another country. The difficulty was that the temperature of the larvae needed to be kept at a level related to humidity and it occurred to us that we might try using another insect as the temperature sensor so as to control a heater powered by a small battery. This project led to the discovery of a rather interesting property of the house cricket *Grillus domesticus* which makes it particularly suitable for inclusion in a feed-back control system.

As far back as 1919, Franz Eugler, the celebrated German zoologist, had suggested in his book, "Tiere helfen Menschen" that the countryman's tale that he could measure environmental temperature by listening to the chirping of crickets might be turned to practical advantage. The formula which was quoted then was:

$$\text{Temp. in } ^\circ\text{F} = \text{chirps in } 15\text{S} + 40.$$

Figure 1 illustrates the terms used in describing the sounds made by a cricket. The carrier frequency within the chirp varies between individual

members of a species because it is probably only a function of the physical properties and dimensions of the vibrating parts and is not appreciably temperature sensitive. The chirp is the unit of sound which is counted and a stridulus is a run of chirps which usually lasts for more than fifteen seconds. The first laboratory investigation concerned itself with the confirmation of Eugler's quoted relationship. In figure 2 a linear relationship is demonstrated between temperature in  $^\circ\text{C}$  and chirp frequency. The regression equation is:

$$T^\circ\text{C} = 0.14R + 4.44.$$

where R is the chirp frequency in chirp/min. Below  $16^\circ\text{C}$  the relationship breaks down and many crickets will not chirp at all.

Interesting as this relationship is, the stridulus intervals make it difficult to use a cricket as a temperature sensor directly, because during the intervals no control signal would be available. In the meantime, however, another set of experiments had been started. In these a cricket was placed in a well insulated box (figure 3), fitted with a small heater similar to that which was to be used for the dispatch

ABOVE LEFT: Figure 2. Relationship between chirp frequency and temperature for *Grillus domesticus*.

CENTRE LEFT: Figure 4. Time/temperature plot showing how two different crickets used as illustrated in figure 3 stabilised at different temperatures.

BELOW LEFT: Figure 5. Diagrammatic representation of the calibration device.

BELOW: Figure 3. Schematic circuit arrangement by which a cricket can be used as a temperature control element.

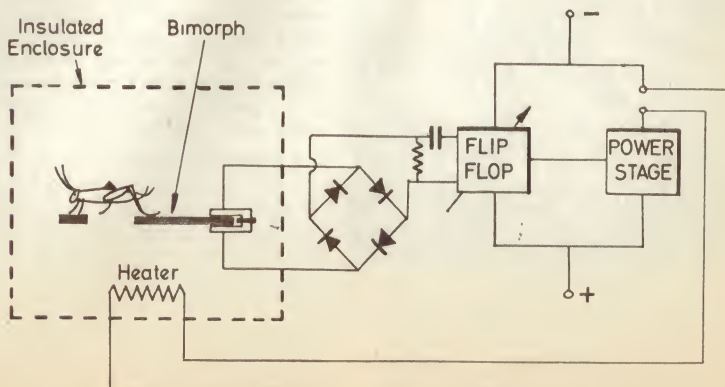
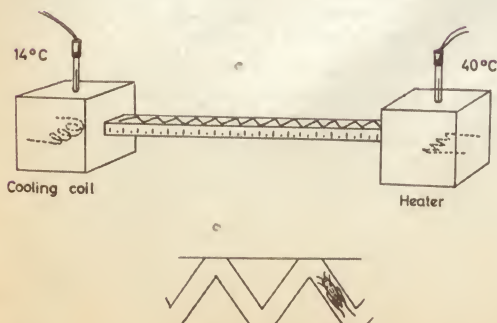
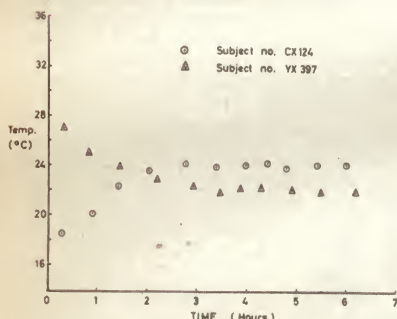



*The premises of the Calibrated Cricket Company, in Cornwall, U.K.*



of the larvae. The back legs of the cricket were fixed to two bimorph crystal elements — similar to those used in a gramophone pickup, with a special glue, which not unexpectedly became known in the laboratory as "cricket pitch." The crystals picked up the vibrations due to the chirp and converted them into an electrical signal, which was used to turn the heater off for a short time after each chirp, with the result that the more often the cricket chirped, the less heat was supplied to the box.

Figure 4 shows what occurred when two different crickets were successively put into the box and started off at different temperatures. After a time both of them had adjusted their rate of chirping so as to keep the temperature steady almost as if they felt comfortable at that temperature. An even more interesting fact which emerged from the experiment was that although the two crickets were of the same species, they finally settled down at different temperatures. Further investigation showed that not only did individual crickets have their individual preferred temperatures, but that taking the British species as a whole, a temperature range of between 19° and 32°C could be covered.

The utilisation of this hitherto un-

suspected property of the cricket makes it much easier to incorporate it into temperature control systems, the only requirement being the selection of an individual with its plateau at the appropriate temperature, a process which is known as calibration. Since the original application, the use of crickets in temperature control systems has proved to be sufficiently popular to justify commercial exploitation of the process. The Calibrated Cricket Co. Limited, Cornwall, England has been granted a licence by the Institute and is now capable of supplying crickets calibrated to  $\pm 0.7^\circ\text{C}$  by airmail to any part of the world. In order to calibrate the crickets, the relatively simple apparatus shown in Figure 5 was developed. It consists of two tanks — one with the temperature kept accurately at 40°C and the other 14°C—the two tanks being connected by a well-insulated bar, along which a linear temperature gradient is thus established. A zig-zag groove is machined into the top face of the bar (with 26 zig-zags, one for each °C gradient) wide and deep enough to admit a cricket in comfort. The groove is covered with a thick transparent lid.

To calibrate a cricket it is introduced into the groove, somewhere near the middle. Within a short time it

begins to move in the direction of its chosen temperature and by the end of about five minutes it will become stationary — chirping happily at a definite point on the temperature gradient. The girl technician in charge of this operation then notes the precise position of the cricket and reads the temperature by means of the gradations on the aluminium bar. Two coloured dots appropriate to the temperature (using the international resistor colour code) are then painted on to the back of the cricket, marking it with its calibration temperature.

For dispatch the crickets are placed in a small plastic box fitted with a ventilated lid, together with a food supply more than adequate for the journey. A number of different foods have been tried and at the time of writing the most successful mixture consists of dehydrated banana, moistened with water and containing a small amount of glycerine, a harmless preservative and an anti-oxidant.

Crickets can be supplied already mounted on bimorph crystals, ready for immediate insertion into a temperature control system. The stability of calibration for periods of up to seven days is within the tolerance of  $\pm 0.7^\circ\text{C}$ . Crickets appear to be comparatively free from disease, at least as indicated by their calibration stability, apart from a virus infection, which, however, kills them so quickly that this almost always occurs before installation.

Most of the crickets used are bred either in the laboratory, or the factory, though wild specimens are collected in order to increase the available temperature range. Recently, a cobalt gamma-ray source had been used to produce mutated specimens, though it is too early to say whether these will exhibit the same stability of calibration as the naturally occurring species.

Among other "transducers" being investigated is the death-watch beetle, the ticking frequency of which appears to be related to local oxygen partial pressure.

(EDITOR'S NOTE: Some members of our staff have expressed doubt as to whether there is any future for the Calibrated Cricket Company. The fact that the article appeared in the April 1 issue of "Spectrum" may have some bearing on their suspicions.)



*Close up of the zig-zag groove in the aluminum bar in which the calibration process takes place. Note the two crickets in position.*





# JINDIVIK

## An Australian Success Story

*An early Jindivik in action. The guided weapon is presumably unarmed*

With production now in excess of 350, Australia's Jindivik radio-controlled target aircraft is still regarded as one of the world's best, after nearly 20 years of operational service.

The Jindivik came into being as a result of a requirement by the British Government for a target-towing aircraft to be used at Woomera for testing guided weapon systems. In the late 1940s, the Australian Government Aircraft Factories were asked to develop a suitable aircraft. The requirement was for a fast flying aircraft capable of extending defence systems designed to combat fast, high-flying aircraft. It had to be reasonably cheap, yet rugged and reliable. The eventual design produced by Australian engineers has proved to be so successful that, after nearly 20 years in service, it is still regarded as one of the best target aircraft in the world. With a continuing program of modification and up-dating, it is expected to continue in its present role until well into the 1970s.

Since 1950, the Government Aircraft Factories have delivered more than 350 Jindiviks, some of which have been sold to the U.S.A. and to Sweden. In Australia, they are used by the Navy

and the Department of Supply's Weapons Research Establishment. But the biggest user has been Britain's Royal Aircraft Establishment and Defence Forces. A recent order from the U.K. Government for 24 more of these highly successful aircraft brings the export sales value of Jindiviks to well over \$20 million.

In its early days, the Jindivik designers depended heavily on electronic equipment imported from Britain, but present versions are equipped with an Australia-made guidance system. Member companies of the Australian Telecommunications Development Association have played a major part in the development and manufacture of the electronic equipment used in the system.

One of the major factors which has contributed to the success of the Jindivik is its versatility. Guided weapon defence systems are of various types, some intended for use against low-flying "terrain following" aircraft, while

others have been designed as a defence against aircraft designed to attack from high altitudes. The Jindivik can operate equally successfully to test both types of guided weapon system, since its operating range is astonishingly wide—from under 100ft to well over 60,000ft. Its normal operating speed is around 650 miles per hour.

The secret of its versatility lies in what the designers call "variable wing geometry," which, in everyday language, means that the wing size can be altered. For low level flying the normal wing span of 19ft 8in is used. By simply fitting extension pieces, the wing span can be increased to 26ft 8in for flights up to 58,000ft, and to 32ft 4in for operation up to the maximum operating height of 67,000ft; which, incidentally, is nearly 13 miles high. This is above the normal operating range of any conventional military aircraft at present in service, and in fact, the Jindivik is the highest flying aircraft at present operating in Britain.

The target towed by the Jindivik can be of various types, to simulate the various types of target required for the particular weaponry under test. For infra-red or visually guided weapons, the target can be a torpedo shaped body carrying infra-red generating devices of visual flares. However, some weapons are designed to combat large high-flying military aircraft, and it is important that the weapon's guidance systems should "see" something resembling the intended target. Obviously the Jindivik cannot tow a body the size of a large jet bomber, so how can the target be successfully simulated?

The answer is in the use of passive radar reflectors known as Luneberg lenses which have the facility of looking much larger than they actually are to a radar system. Active radar devices are also used for some special purposes.

With modern weapons system testing, it is not sufficient to record a simple "hit" or "miss" for a test firing — if it is a miss, it is required to know by exactly how much the weapon has missed the target. For this reason Jindiviks can carry wing tip cameras focused on the target which record the performance of the weapon under test.

(Continued on page 151)



*One of the latest Marks of Jindivik, on display at the recent series of Open Days staged by the Department of Supply's Aeronautical Research Laboratories. The Laboratories contributed to the development of the Jindivik with high and low speed tunnel testing, aero-elastic structural tests, and tests to improve the installed engine thrust.*



**THE NEW LUSTRE MODEL ST-510 TONE ARM . . . TRACKS AT LESS THAN 1 GRAM . . . AND COSTS ONLY \$19!**

Orders for the new Nikka-Lustre Model ST-510 tone arm can now be filled immediately. Miniature ball races are used throughout, the head shell accepts all standard 1" mounting cartridges, finish is satin chrome and anodised aluminium. An outrigger bias adjustment is fitted and stylus pressure is adjusted with the counter balance weight. The Model ST-510D is fitted with a lifting/lowering device and costs \$24.50. The Model ST-510 (without lift), inc. sales tax is priced at . . .

**\$19**

**NEW MICRO VF-3100 SERIES STEREO CARTRIDGES PROVE MOST POPULAR EVER!**

With a frequency response of 20-28,000 Hz and channel separation of 28 dB, the Micro VF-3100 series cartridges have already established new performance standards for lower priced magnetic cartridges. Two models are available, the VF-3100/E with elliptical diamond stylus and the VF-3100/5 with a conical diamond stylus. Stylus for both cartridges are replaceable; both track effectively at 1 gram.

**EXTRACTS FROM REVIEWS**

These items were reviewed in "Electronics Australia", Page 119, February, 1969. Speaking of the complete unit the following comment was made—"they gave good performance at a very reasonable price". Regarding the Compax turntable . . . "the unit performs very well . . . the claim of 0.04% wow and flutter would appear to be true . . . rumble . . . impossible to measure . . ." Regarding the Nikka-Lustre ST510 tone arm . . . "the arm has low bearing friction and will track well at stylus pressures below 1 gram . . . very good value for the price". On the Micro VF3100/E cartridge the following comments were made—"frequency response checked out at plus or minus 2dB from 30 Hz. to 20KHz. . . very good performance indeed."

**DEMAGNETISE YOUR TAPE HEADS AND IMPROVE TAPE PERFORMANCE!**

Simply plug the tape head demagnetiser into any AC power point and pass over the heads. Takes only five seconds and can make a world of difference. Two models—single and double probe. Both (inc. Sales Tax) . . .

**\$4.50**



**SOUND MODEL SAQ-203 SOLID STATE STEREO AMPLIFIER**

Frequency response is 30-20,000 Hz. and input sensitivity suits magnetic cartridges at 3 mV. Output is 12 watts R.M.S. or 30 watts E.I.A. peak power. 18 low noise transistors. Headphone jack, all necessary controls, attractive front control panel. Speaker matching for 4, 8 and 16 ohm. speakers or speaker systems. An ideal compact amplifier for use with tape recorders or for building into cabinets and bookshelves. Inc. sales tax . . .

**\$74.50**



**SOUND MODEL SAQ-505X SOLID STATE STEREO AMPLIFIER**

With an output of 25 watts R.M.S. into 8 ohm. speaker systems, the 505X represents outstanding value for money. Frequency response is 20-20,000 Hz. plus or minus 1 dB, and extends well beyond this range. Sensitivity is 3 mV. for magnetic cartridges and all desirable control facilities are incorporated. This powerful amplifier is bargain priced by Encel Electronics at only . . .

**\$119.50**

**"DITTON 10's" AND "DITTON 15's" ARE ONCE MORE IN PLENTIFUL SUPPLY**

The Celestion Ditton 15 measures only 21" x 9 1/2" x 9 1/2" and incorporates the HF 1300 Mark II tweeter, a new type of bass drive unit and the revolutionary auxiliary bass radiator. Frequency response is 30-15,000 Hz. and extends well beyond these figures. Many favourable reviews have been published.

"Hi Fi Sound"—"it was difficult sometimes to realise that so small a loudspeaker was really producing such well-defined low frequency sounds. It goes without saying that the treble performance was fully up to the standard of the HF 1300."

"The Gramophone"—"the listening tests made an excellent impression. Treble was bright and forward; the bass was clean and powerful enough to produce a good balance."

"Hi Fi News"—"the quality of bass sound was above average, plenty of bass, but always clean and clear . . . a very wide range of programme material was enjoyed and nothing caught it out or gave cause for reservation."

The Celestion Ditton 10 measures 12" x 6 1/2" x 8 1/2" and features a specially designed bass unit and the well known Celestion tweeter. Both 3 and 15 ohm impedances are available. One review of the Ditton 10 in "Records and Recording" says "on a wide range of music it proved to be a clean-sounding speaker with the sort of characteristics which would make it one of the most popular in its class."

Prices: "Ditton 15" (including Sales Tax) . . . **\$89**

"Ditton 10" (including Sales Tax) . . . **\$59**

**WORN STYLII**

Worn stylus wreck records. A worn stylus in your cartridge can ruin your favourite records quite quickly. Regular inspection is a must. Encel's now have a stock of stylus inspectors which are priced at only (incl. sales tax) . . .

**\$1.80**



**NOW . . . A NEW 8" CO-AXIAL SPEAKER WITH UNIQUE PERFORMANCE AND SIX POWERFUL MAGNETS . . . ONLY \$34.50!**

Can any 8" speaker be worth \$34.50? Easily . . . when you see and hear the remarkable CX-20D. Here at last is a total-performance 8" co-axial speaker with six magnets, a horn type tweeter, an electrical crossover, high compliance and unusually robust ribbed construction. Total weight is almost 8 lbs. and frequency response is 35-20,000 Hz. The response curve is substantially flat; from an engineering viewpoint the CX-20D is superb in design and construction. The matching enclosure is easy to make and any handyman can make it from readily available materials. We want you to hear the CX-20D and make your own appraisal. It's tremendous value for money! Inc sales tax . . .

**\$34.50**

**FROM THE UNITED STATES . . . JANSZEN SPEAKER SYSTEMS WITH ELECTROSTATIC ELEMENTS**

The Janszen Z600 speaker system is revolutionary in design and construction and provides a magnificent "transparent" sound. Response is 30 to beyond 30,000 Hz. The natural treble response results from the use of Series 130 Janszen mid/high range radiators—electrostatic units with 176 push-pull sheathed conductors. The bass reproducer is the Janszen Model 350B dynamic. Impedance is 8 ohms only. Encel price is \$178 for the Z600 . . . and a variety of finishes is available. Truly an audiophile's delight. Ask for copies of related reviews. Encel price (including Sales Tax) . . .

**\$178**

**FIVE LOW COST, HIGH PERFORMANCE SPEAKER SYSTEMS FROM ENCEL ELECTRONICS!**

Separate speaker systems are essential if you wish to exploit the full potential of your amplifier, tape recorder or radio. Sonics speaker systems are beautifully finished in selected walnut/teak veneers, are styled to blend with period or modern decor and are extremely effective from an audio point of view. The following five models are the most popular.

**MODEL AS-57** Bookshelf type — Measuring 15 1/2 in. x 5 1/2 in. x 8 1/2 in., this enclosure is compact and most effective. The speaker unit is an oval wide range loudspeaker. Priced at only . . . **\$22.50**

**MODEL AS-60E** Slim Line 2 Speaker System — Although only 18 in. x 12 in. x 5 1/2 in. the AS-60E houses a bass/mid-range speaker and a high frequency reproducer. Impedance: 8 ohms. . . . **\$27.50**

**MODEL AS-61** 5 Speaker Slim Line System — Four bass/mid-range speakers and 2 1/2 in. tweeter unit are housed in this attractive teak/walnut enclosure. Impedance: 8 ohms. 2 1/2 in. x 17 1/2 in. x 4 1/2 in. **\$38.50**

**MODEL AS-202** 3 Speaker System — This dramatically effective 3 way system measures 20 1/2 in. x 11 1/2 in. x 11 1/2 in. and features an 8 in. bass speaker, a 6 1/2 in. mid-range reproducer with a sealed back with a 2 1/2 in. tweeter. Power handling capacity is 20 watts music power . . . **\$46.50**

**MODEL AS-330.** A 3-way speaker system with 5 speakers housed in a magnificent, hand finished, oiled teak enclosure. Frequency response is 30-20,000 Hz. Size: 15 1/2 in. x 11 1/2 in. x 26 in. Speaker complement includes a 12 in. bass reproducer, two 6 1/2 in. mid-range speakers, two horn type tweeters. **\$98.50**

**IMPORTANT:** All Sonics enclosures have 8 ohm. impedances. Sales tax is included in all Encel prices.

**LOW PRICED CERAMIC CARTRIDGE FOR BUDGET CONSCIOUS MUSIC LOVERS!**

The popular Micro SC-301 cartridge has now been superseded by the new, improved Model SC303D. Only the price remains the same! Frequency response is 20-15,000 Hz. and tracking angle is 15°. With diamond stylus . . . inc. sales tax . . . **\$6.90**

**SEE A COMPLETE AUDIO RANGE AT ENCEL STEREO CENTRES!**

Apart from the many exclusive Encel lines, you'll find a vast range of high quality equipment at Encel stores in both Sydney and Melbourne. Here are a few of the manufacturers represented: Trio-Kenwood, KEF, Sony, ADC, Wharfedale, Ortofon, National, Toshiba, Shure, Akai, Sansui, Philips, Nivico, BSR, Garrard, and many, many more. Be sure to get an Encel EMQ (Encel Mail Quote) . . . you'll save much more at Encel Electronics!

**SONICS STEREO HEADPHONES — FROM \$9.50**

The popular Model HS-304 offers fatigue free listening on a personal basis . . . the headset is very comfortable even over lengthy periods. Price? Just \$12.50. The Models HS-303 and HE-303H (High impedance) are also available . . . frequency response is 20-15,000 Hz. and the price only \$9.50. All models have foam rubber earpads. From . . . **\$9.50**

**JUNCTION BOXES FOR STEREO HEADPHONES**

Add a headset to your amplifier even if it's not fitted with a headphone jack. Model JB3 junction boxes may be fitted in the speaker leads. Twin outlets. Inc. sales tax . . . **\$4.50**

**MICRO DUST PICKUPS—\$3.50**

An effective automatic record cleaner which removes dust as the record plays. An ideal gift. \$3.50 inc. sales tax.

**TAPE SPLICERS . . . ONLY \$2.50!**

We've just made a special purchase of tape splicers . . . and while the stock lasts this easy-to-use unit is priced at only \$2.50. Save time and fidgeting — and frayed nerves; order now!

**CANBERRA ENQUIRIES FOR ENCEL EQUIPMENT**

If you live in Canberra and you want further information on Encel equipment, please phone Canberra 81 1667.

**ENCEL ELECTRONICS (STEREO) PTY. LTD.**

**Head Office:**

431 Bridge Rd., Richmond, Victoria 3121. Tel. 42 3762.

Sydney Store: Ground Floor, 2SM Building,

257 Clarence Street, Sydney, N.S.W. 2000. Tel. 29 4563, 29 4564.

Australia's Greatest Hi-Fi Centre \*Wholesalers \*Trade-ins accepted





# PIONEER

the first family of stereo



## PIONEER MODEL SA900 200 WATT SILICON SOLID STATE PRE-MAIN STEREO AMPLIFIER

One of Pioneer's most advanced amplifiers. Professional features neatly compacted into an all solid state set. Presenting a Powerful, flexible 200 watt integrated amplifier. Finest, most expensive materials have been used, from the low noise silicon transistors to the special Brazilian rosewood front panel. The control amplifier has FET and advanced 3-stage E-S (Emitter.Source) feedback circuitry. The pre and main amplifiers can be used independently.

## PIONEER MODEL SA500 44 WATT SOLID STATE STEREO INTERGRATED AMPLIFIER

This is an efficient medium-range pre/main amplifier built to very high specifications for this size of unit. It has a set of controls, inputs and outputs for versatile operation of speakers and tape recorders. Main amplifier total power is strong at 44 watts (at 4 ohms). Circuitry is all solid state and includes low-noise silicon transistors. For those who want to enjoy full stereophonic realism the SA500 is the set.



## PIONEER MODEL SA700 120 WATT INTEGRATED AMPLIFIER SOLID STATE

Designed to more than meet all demands of modern stereo. First, there's power, a full 120 watts of non-clip music power (at 4 ohms). Secondly, Pioneer uses the finest, most expensive material, such as selected low noise transistors and FET in the control amplifier section. Third, the most advanced circuitry, a 3 stage E-S (emitter-source) feedback circuit control amplifier is typical.



ALL PIONEER AMPLIFIERS ARE TAILORED TO SUIT A RANGE OF MATCHING SPEAKERS OF ALL SIZES FOR MAXIMUM STEREO PERFORMANCE.



# PIONEER

THE QUALITY NAME IN HI-FI MUSIC EQUIPMENT

WRITE FOR THE NAME OF YOUR NEAREST PIONEER DEALER.

SOLE AUSTRALIAN REPRESENTATIVES —

**ASTRONICS AUSTRALASIA PTY. LTD. (ALL STATES)**

DIVISION OF ELECTRONIC INDUSTRIES LIMITED.



# EQUIPMENT PODS FOR RADAR MAPS

Airborne reconnaissance, which not long ago relied entirely on photography, has now developed into a highly specialised art employing specially developed airborne radar and other electronic and optical devices.

By John Marriott

The main requirement for airborne reconnaissance over the land is to obtain an accurate record of the ground and to bring it safely back to base so that it can be scrutinised by trained observers and interpreters.

Over the sea, the problem is not quite the same. All that is required here is for the aircraft to be able to detect ships and submarines and to report their positions so that the necessary action can be taken. Consequently, for maritime work, at present conventional radar is used in conjunction with cameras to identify the ships. Perhaps in the future low-light television may be used, with radar.

For ground reconnaissance there are three main types of modern airborne equipment. These are (a) sideways looking radar, (b) special reconnaissance cameras, (c) line scan. Since all three are relatively new, they merit a brief description.

The standard radar for ground reconnaissance nowadays is one that projects a fixed beam from either side of the aircraft which "looks" sideways and downwards. As the aircraft flies along, this beam is "dragged" across the ground and everything that it detects is recorded in the aircraft.

The military advantage of sideways looking radar is that, as no transmissions are directed ahead of the aircraft, the enemy cannot intercept them until the aircraft passes over their positions. With modern high speed aircraft this is probably too late to do much about it.

The lateral range of the radar is, of course, a function of the aircraft's height; the greater the height, the longer the range—but the less the definition. In order to avoid the enemy's ground radar most aircraft fly as low as possible to get under its beam, so that, in these circumstances, the area scanned with sideways looking radar is limited, probably no more than a few miles on either side of the aircraft.

Britain originally developed a sideways looking radar for a tactical strike reconnaissance aircraft but when development of the aircraft was cancelled, the radar was modified to fit into a pod which could be attached below the belly of the replacement aircraft, when used in the reconnaissance role.

Developed and manufactured by E.M.I. Electronics Ltd., the equipment consists of a transmitter/receiver working at very short wavelengths, a mapping recorder and slotted waveguide aerials fitted into the side walls of the pod.

The radar returns are fed into the recorder, which, by an ingenious arrangement, records them on film, together with data from the navigational equipment in the aircraft (height, position and so on).

Arrangements can also be made whereby all the radar returns, with the exception of those from moving targets, are cancelled out. Thus a record can be obtained of only those targets that are moving. This can be extremely valuable when looking for, say, the movements of heavy armour, tanks, lorries or guns. The device is known as Moving Target Indication. (M.T.I.)

Navigational data are obtained in analog form from the Ferranti Inertial Navigation System and from the altimeter. These data are fed into a data converter and buffer store, where they are digitised and fed to the records made by all the sensors in the pod, upon receipt of a suitable signal demand pulse. The annotation on to the recording media is made in binary code by solid state light sources.

The data converter also computes elapsed distance by integrating ground speed with respect to time and thus generates the signal demand pulse. This is so arranged that the navigational information is placed on the records at set distance intervals which, on the radar record, is every one nautical mile.

Sideways looking radar produces a high definition radar map at both high and low levels. At high level the picture is fundamentally two-dimensional and portrays the

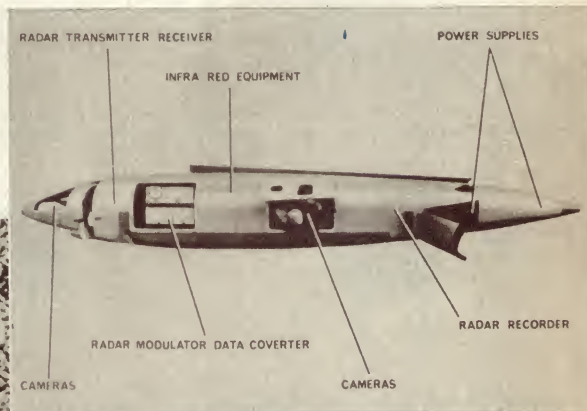

ABOVE: A model of E.M.I.'s reconnaissance pod, showing the disposition of the equipment.

LEFT: This radar map picture shows the detail which can be obtained from the type of airborne equipment described in the article. Although this picture is from an American source, presumably the techniques used are similar. Note the three-dimensional effect, referred to in the article.

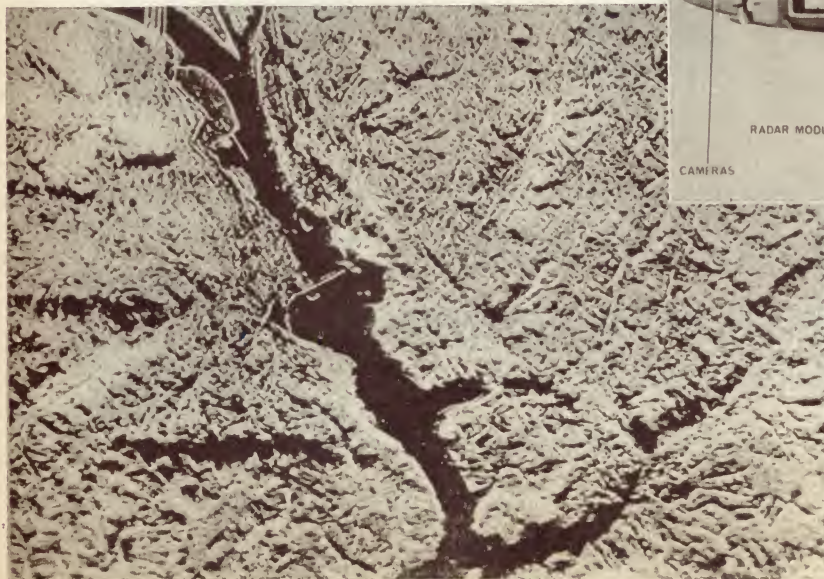



**Sony replaced IFT in this  
4-band transistor radio**

**with the new Murata  
ceramic filter SF-455D.**



BF-455A L SF-455D



Throughout the world electronic design engineers have begun to realise the many benefits offered by Murata Ceramic Filters. These include high gain, low spurious response, negligible ageing characteristics (0.4% over 10 years) and, since no alignment is necessary, considerable cost saving in production. Sony engineers have taken advantage of these benefits and have incorporated two Murata Ceramic Filters

SF-455D and BF-455A in the quality model TR-1000 4-band transistor radio.

Combining excellent overall response and selectivity characteristics with space saving and production economy, the Murata Ceramic Filters are proving superior to conventional IF transformers.

Include Murata Ceramic Filters in your next design.



**MODEL BF-455A** improves the selectivity of transistor radios when used as an emitter by-pass in transistor IF Stages.



**SERIES TYPE (Model SF-455)** is a resonance type filter of 455 KHz. It replaces the transistor radio's IFT or can be used in combination with IFT's.



**LADDER TYPE** Ceramic Filters CF-455 and CF-455P (Popular Type) are ideal for IF stages of high quality communication receivers.

**IRH COMPONENTS PTY. LIMITED**

A subsidiary of International Resistance Holdings Limited

THE CRESCENT, KINGSGROVE, N.S.W. 2208. TEL. 50 0111

**muRata**

MAKES THE MOST OF CERAMICS

IRH. M.I.



Many interesting electronic devices will be world premiered at Melbourne's Expo Electric '69, to be staged in the city's Exhibition Buildings from October 5 to 15.

terrain in a form which is easy to interpret. At low level (say 500ft and below) the picture effectively becomes three-dimensional, as the strong signal returned by a vertical surface is further emphasised by the shadow immediately behind it. The effect is exaggerated when the aircraft is flown low over undulating territory, because of the increased incidence of hill shadowing. Similarly it is more noticeable in urban and industrial areas because of the large number of vertical surfaces. Over the sea the responses from surface vessels are produced in sharp contrast to the background sea return, but the latter can produce a very characteristic pattern which indicates wind direction and the presence of currents and tidal rips.

There are four main types of camera configurations:

(a) Vertical. In this configuration the camera's axis is perpendicular to the terrain, although in fact cameras can be inclined up to 10 degrees either side without materially affecting the picture. Vertical cameras are primarily used for mapping or surveying purposes.

(b) Oblique. Here the camera axis is between the horizontal and the vertical, either in a lateral or in a fore and aft direction.

(c) Fan. This is a combination of the vertical and the oblique. It is possible also to have split pairs of two cameras, each with a tilt of up to ten degrees from the vertical, to provide a small amount of lateral overlap.

(d) Panoramic. Panoramic cameras have only recently come into general use. The camera sweeps from one side to the other over an arc of up to 180 degrees. They have the advantage that the aircraft does not have to be flown with such a degree of accuracy as is necessary to cover a particular target with vertical and oblique cameras.

Cameras automatically take a number of photographs (frames) in a given time; thus it follows that in low level flight, because of the aircraft's very rapid relative speed over the ground very quick cycling cameras are required and, while such cameras have been produced, the ever increasing speed of aircraft presents a problem in low level photography.

Cameras can also produce stereoscopic pictures which are a great help to the interpreters.

Night photography requires external illumination, either by flares or an electronic flash in the aircraft. In either case the aircraft's position is given away to an observer on the ground.

In the British-designed reconnaissance pod, a number of different combinations of cameras are supplied for both low and high altitude use.

Line Scan can take three forms: passive optical, when no artificial illumination is provided; active optical, when the aircraft provides illumination in the shape of a scanning pool of light; and infra-red. All three forms work on the same principle. A detector scans the ground underneath the aircraft at an extremely rapid rate and records what it sees on tape or film, which is kept moving at a speed proportionate to the aircraft's speed and height. In the optical mode the detector is a photo-electric cell and in the infra-red mode it is an IR detector. The area of ground scanned is small, but the resultant record is of very high definition.

The exhibition is being sponsored by the State Electricity Commission of Victoria to mark the SECV's Golden Jubilee, which falls this year. Expo Electric is under the patronage of the State Premier, Sir Henry Bolte, and has been endorsed by the Electrical Manufacturers Association and the Electricity Development Association of Victoria. Space has already been taken by 30 companies, including some from Britain, Continental Europe, North America and Japan, and many more are expected to participate. More than 100,000 visitors are expected to attend to inspect the multi-million dollar displays.

The exhibition will be open from 11 a.m. to 10 p.m. on weekdays and Saturdays, and from 1.30 p.m. to 6 p.m. on Sundays. The exterior of the Exhibition Buildings will be floodlit in gold coloured light to mark the SECV's 50th anniversary. This will provide a city landmark which will be visible from vantage points up to 20 miles from Melbourne.

The theme of the exhibition will be "Tomorrow is Electric." In addition to showing the many current uses for electricity, Expo Electric will demonstrate the technological advances of recent years and some of the likely developments in the foreseeable future.

The main exhibit will be the SECV's own display, covering more than 10,000 sq. ft. This will have a futuristic theme, and will feature a home of the future, plentifully equipped with electronic aids to housekeeping, education and leisure time. Featured on the stands of other exhibitors will be closed circuit television, models of nuclear power generators and the winners of appliance design awards. Novelty items will be a silent discotheque, where dancers are equipped with small ear-piece receivers and pick up music from a nearby transmitter; a "light wall" which has a continually changing kaleidoscope of abstract colour designs; microwave ovens which double as refrigerators to keep the food fresh until required, and then cook it in seconds; videophones; "wristwatch" television receivers and radios; and electric vehicles.

Further information about Expo Electric can be obtained from the organisers, Thomson Exhibition Promotions Pty. Ltd., 415 Bourke Street, Melbourne, Victoria 3000, and 47 Chippen Street, Chippendale, N.S.W. 2008.

Infra-red line scan detects temperature differences on the ground and can be very useful for detecting objects which cannot be seen by cameras or optical line scan due to camouflage. Aircraft or tanks, for example, left out in the sun will rise to a much higher temperature than the surrounding terrain and will be clearly discernible even if camouflaged. It requires no illumination by night, but any meteorological conditions (such as heavy rain) which will reduce everything on the ground to a uniform temperature will adversely affect its performance.

One great advantage of line scan is that its output can be recorded on magnetic tape in a form suitable for radio transmission to the ground. Alternatively, if the aircraft is in radio touch with the ground during its actual reconnaissance, the line scan pictures can be transmitted in real time.

Optical line scan is rapidly being overtaken by the infra-red system and Britain is developing very advanced systems with high resolution. They are primarily intended for fitting in a small attachable pod, suitable for the lighter type of aircraft, such as the Harrier or Jaguar.

One example of such equipment, nicknamed Talisman, consists of two main units, the scanner and the recorder. A third unit houses the signal processing electronics.

Inside the scanner is a simple rotating 45-degree inclined mirror, which scans the ground and directs the radiation it picks up on to an array of

infra-red detectors. This enables many lines to be scanned simultaneously. The mirror is rotated by a turbine driven by air from the engine supply. The IR cells can be cooled by open cycle Joule Thomson coolers supplied with air or nitrogen from a pressure vessel, or, alternatively, cooling can be achieved by use of a liquid nitrogen transfer system.

The output from the infra-red detectors is fed to the recorder where it is converted into electrical signals, which in turn are converted into light. This light is made to impinge upon a film which moves across a recording head at a speed proportionate to that of the aircraft.

A simple control panel is provided in the cockpit and the whole equipment weighs no more than 120lb.

Another device which is rapidly coming to the fore is low-light closed-circuit television. The system makes use of an image intensifier tube which intensifies light reaching the camera by up to a million times. As a result the camera can "see" in near dark conditions.

A monitor screen is fitted in the cockpit of the aircraft to enable the crew to identify objects on the ground which they would otherwise have been unable to see. If required, the pictures can be recorded on video tape and a complete record taken.

A number of British companies are working on the system and although it is still in its infancy, it would appear to have a bright future. ■



# PLESSEY Dry Reed Inserts

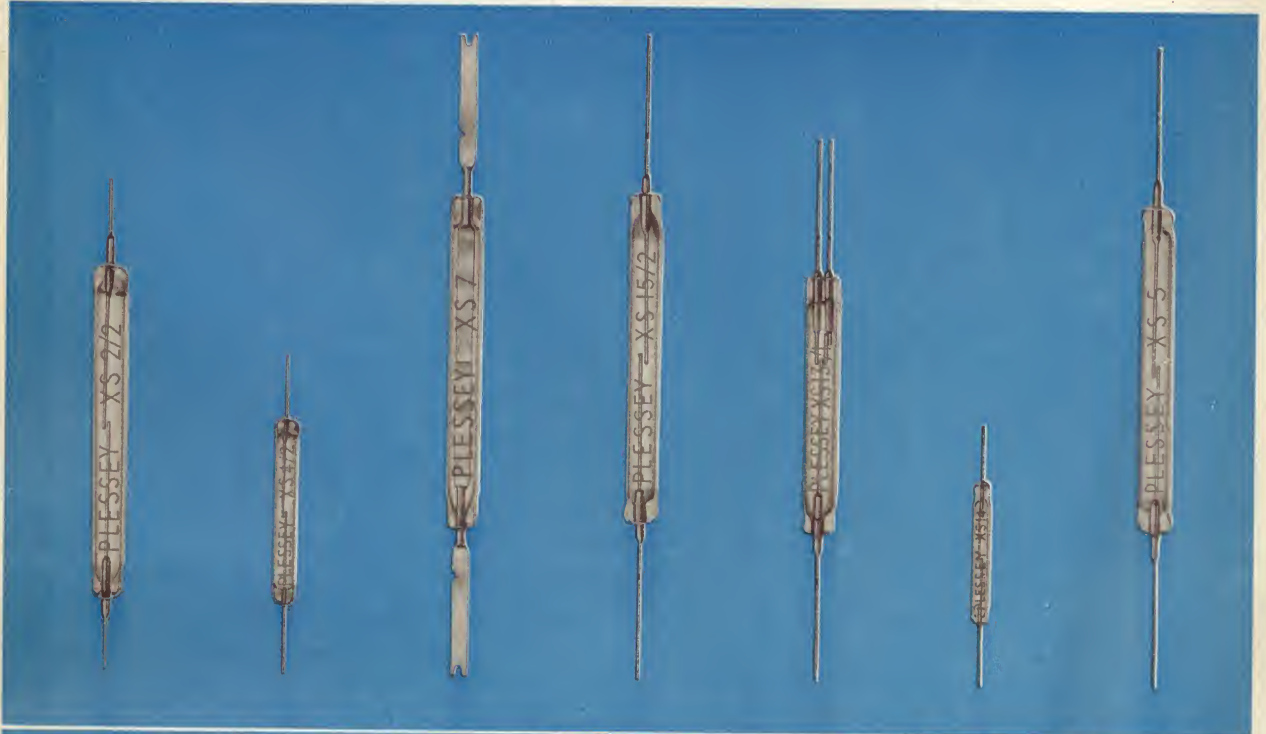

Preferred Types	Glass Length (inches)	Max. Glass Diameter (inches)	Overall Length (inches)	Max. D.C. Switched Current	Max. D.C. Switched Voltage	Max. Switched Load Watts	Min. D.C. Breakdown Voltage
XS2	2.0	0.217	2.75	0.5	250	15	750
XS4	1.1	0.156	1.815	0.15	250	5	500
XS5	2.0	0.217	3.6	0.5	250	15	750
XS7	2.0	0.217	3.6	0.5	250	15	750
XS13	1.375	0.25	3.1	0.25	250	10	300
XS14	0.83	0.125	1.5	0.1	250	3	400
XS15	2.0	0.217	3.6	1.5	250	100	750

Plessey Dry Reed Inserts offer extreme life and reliability since their contacts are totally sealed within an inert gas-filled glass envelope. A range of standard, miniature and subminiature types is available which includes both single pole "normally open" and single pole changeover configurations. Associated bobbins, coils and suitable biasing magnets are also available.

The bobbins employ a unique patented method for retaining the insert in position, providing secure anchorage and facilitating replacement when necessary.

#### Operation

Operation of dry reed inserts is by a magnetic field which can be generated by a coil or permanent magnet. The combination of a coil and reed insert offers a relay of the highest professional standard. In this form dry reed inserts are used by the million in telephone systems and similar applications.

#### Application

Plessey Dry Reed Inserts are used with alarms, control systems and fail-safe devices of every kind. The high speed

of operation permits their use in monitoring movement of fast reciprocating and rotating parts. Furthermore their low contact resistance enables them to handle signal level currents, while types are available handling several amps. This versatility is far greater than that provided by any other single type of switch or relay.

Full technical information and application data available on request from Professional Components Department, Villawood, N.S.W. or Ducon Interstate Offices.

**PLESSEY**  
**Components**



Ducon Division  
Plessey Components  
Box 2 PO Villawood NSW 2163  
Telephone 72 0133

Melbourne 42 3921  
Brisbane 2 3287  
Adelaide 76 3434  
Perth 21 4821/21 7867



# FLEXIBLE LAMINATES IN MASS PRODUCTION

Flexible printed wiring laminates which can be used three dimensionally have been introduced in U.K. by Formica Ltd., and are already being used in a variety of widely differing situations.

by J. R. C. Pearson, A.F.R.Ae.S. and E. Donnelly, B.Sc., A.P.I.



Flexible printed wiring laminates are now being incorporated in products as diverse as electric shavers and computer card readers, hearing aids and missile systems, the wiring harness behind motor car dashboards as well as those in supersonic aircraft. These laminates have the advantage of being flexible to the degree that hinged or moving component assemblies can be reliably connected by printed wiring methods, instead of laborious (and fallible) colour-coded point-to-point wiring. They add a third dimension to the traditional printed wiring board in that they can be designed and produced in the flat state to meet a 3-dimensional problem.

Like the majority of rigid printed wiring materials, the flexible variety is made up of a base insulant film and a thin lamina of conductor or resistor foil. After the unwanted metal has been etched away to form the required wiring pattern, an overlay of plastic film is applied to insulate the otherwise ex-

posed surface. But whereas the overall thickness of a rigid printed wiring board is normally greater than 0.04in. we are here considering a laminate of 0.001 to 0.014in. The thin and flexible nature of the component materials allows the manufacturing process to be radically different from the conventional method of curing in a press to make laminated boards in individual batches.

Both the nature of the materials and the market requirements lead to the product being manufactured continuously; the raw material is taken off from rolls, coated and laminated, and then taken up into rolled form once more. Hence, it is necessary to develop an adhesive which is fast-acting at the point of lamination in order to bond the base insulant to the metal foil. However, the adhesive thus developed requires a cure cycle lasting for several days subsequent to the initial bond being established; therefore the process requires the laminate to be held in tension during a curing

period in the final rolled form.

A further requirement of this class of laminate is that it should be manufactured in a dust-free environment. In order that the properties of the laminate should in no way be impaired when the final etching process has been carried out, dust particles greater than 5 microns are filtered and the room is pressurised to prevent ingress of matter from other sources.

Basically, there are two kinds of flexible printed wiring. One is the multi-strand ribbon of flat cable normally produced to a standard format and fitted with standard terminal plugs. It can be used in any circumstances requiring the inter-connection of separate, hinged or remote component assemblies. The other major application is the printed circuit, individually designed by the electronic manufacturer in order to meet the wiring requirement of a particular component package. Such circuits are required to be reproduced time and again with considerable accuracy, and can be built up to form a complicated compound wiring package in the form of a stack.

The particular flexible copper clad laminate developed by Formica Limited uses polyethylene terephthalate as a base material, of which a typical example is more commonly known by its trade name of Melinex. Copper foil with a purity better than 99.8 per cent, produced by electro-deposition, is then bonded in a laminating 'nip' to this base using an adhesive specially developed. The cross-linked structure of the adhesive after curing is resistant to process chemicals used in the circuit printing industry. It also maintains the electrical properties of the base insulant film, for which a permittivity value of 3.3-3.8 and power factor of 0.02-0.03 at 1MHz are claimed. The resulting laminate forms the basis of Formica CPF 51 Grade of "standard" flexible laminate. The overlay, by which the printed circuit is encapsulated, consists either of a layer of Melinex coated with a heat-reactivated adhesive or Melinex bonded to a layer of thermo-plastic film.

In the manufacturing process, the Melinex, in 50in wide strips, is un-

(Continued on page 189)

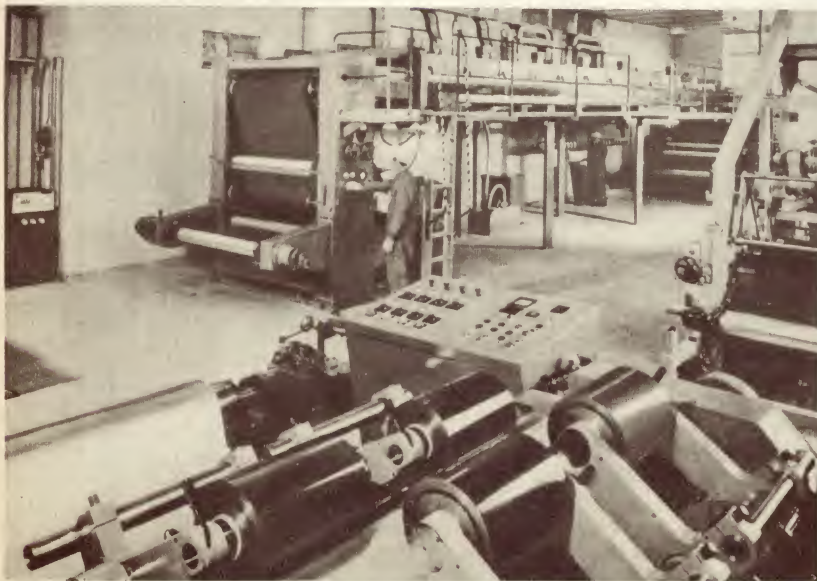

Flexible laminate is in full production in this Tynemouth, U.K. factory. In the background is the flexible laminate plant, and in the foreground is the slitting machine.



STOP RUST OUTDOORS 2 YEARS -- OR MORE!

# Lubricates Penetrates Stops Rust

DRY YOUR ELECTRICAL SYSTEMS  
with LPS — the NON-GREASY ONE

**STOPS  
Squeaks!**



LPS is NOT a paint, lacquer or a varnish, and will NOT damage paint, rubber, fabrics, plastics, or finishes.

**Displaces Moisture Fast!**

## TECHNICAL INFORMATION

### Physical Properties:

#### LPS 1

Less than .0001 inch non-greasy molecular film with capillary action that spreads evenly and easily to seal out moisture at very low cost. **Rust Inhibitor:** Protects all metals from rust and corrosion.

**Water Displacing Compound:** Dries out mechanical and electrical systems fast.

**Lubricant:** Lubricates even the most delicate mechanisms; non-gummy, non-sticky; does not pick up dust or dirt.

**Penetrant:** Penetrates to loosen frozen parts in seconds.

**Volume Resistivity per ASTM D-257:** Room temperature,  $3\text{hm/cm}$ ;  $1.04 \times 10^{12}$

**Dielectric Constant per ASTM-877:**

**Dielectric Constant 2.11 Dissipation Factor: 0.02**

**Dielectric Strength per ASTM D-150:**

**Breakdown Voltage 0.1 inch gap, 32,000 volts**

**Dielectric Strength volts/inch 320,000 volts**

**Flash Point (Dried Film)**

**Fire Point (Dried Film) 900 degrees F**

**TESTS AND RESULTS: 950 degrees F**

**Lawrence Hydrogen Embrittlement Test for Safety on High Tensile Strength Steels: Passed.**

**Certified safe within limits of Douglas Service Bulletin 13-1 and Boeing D6 17487.**

**Mil Spec. C-16173D-Grade 3**

Passed

**Mil Spec. C-23411**

Passed

**Swiss Federal Government Testing Authority for Industry: Passed 7 Day Rust Test for acid and salt water. Passed Weiland Machine Test for Lubricity as being superior to mineral oil plus additives.**

LPS PRODUCTS CONFORM TO  
FEDERAL MIL SPECS  
C-23411 and/or C 16173D



LPS RESEARCH LABORATORIES, INC.  
2050 COTNER AVE • LOS ANGELES, CALIF 90025

(SOLE AGENT)



**ZEPHYR PRODUCTS PTY. LTD.**

70 BATESFORD ROAD, CHADSTONE, VICTORIA — PHONE 56-7231

MANUFACTURERS OF RADIO & ELECTRICAL EQUIPMENT & COMPONENTS

## HOW LPS SAVES YOU TIME AND MONEY

1. LPS PROTECTS all metals from Rust & Corrosion.
2. LPS PENETRATES existing rust — stops it from spreading.
3. LPS DISPLACES moisture on metal—forms fine protective film
4. LPS LUBRICATES even the most delicate mechanisms at extreme temperatures.
5. LPS PENETRATES to free rust frozen parts, nuts, bolts, etc.
6. LPS PREVENTS equipment failures due to moisture (drives it out).
7. LPS LENGTHENS LIFE of electrical & electronic equipment—improves performance.
8. LPS RESTORES equipment damaged by water contamination & corrosion.
9. LPS PENETRATES AND PROTECTS plated and painted metal surfaces.
10. LPS PROTECTS metals from salt atmosphere, acid & caustic vapours.
11. LPS LOOSENS dirt, scale, minor rust spots & cleans metal surfaces.
12. LPS ELIMINATES squeaks where most everything else fails.





# TECHNICAL DIGEST

## Tubeless Television Cameras on the way?

Photoconductor devices now under development in the U.S.A. may lead to tubeless TV cameras in the not too distant future.

When RCA and Westinghouse Electric began working on solid state image sensors they took different tacks toward developing a tubeless television camera. RCA, under an Air Force contract, chose a thin-film course, using cadmium sulphide-cadmium selenide photo-conductors over a glass substrate. Under a NASA program, Westinghouse charted less complicated silicon photoconductors in a mosaic sensor array. Their initial sensors successfully proved the concept, but the devices gave crude pictures of low resolution and sensitivity. Resolution was about 300 lines at best, compared with 525 lines in U.S. commercial television. It looked as though tubeless TV cameras would be a long time coming.

Now, however, the two companies have crossed each other's tracks in their respective efforts to produce a fleet of promising camera ideas. RCA's Princeton Laboratories is working on both thin-film arrays for the Air Force and silicon photoconductors with its own

money. Westinghouse delivered a 200-by-256-element array for NASA and expects to complete a 400-by-512-element array for the space agency by November. The latter would achieve TV-quality resolution, says E. L. Irwin, a research engineer with the company's Defence and Space Centre, Baltimore.

Also in the act is RCA's Avionics Laboratories, Burlington, Mass., which has built a 64-by-64 structure and plans to complete a 128-by-128 structure this year, according to Dave B. Williams, technical staff senior scientist. For switching, this approach uses chemically deposited thin-film lead sulphide, with photoconductor and standard silicon technologies.

Although sensitivity of these arrays is still many times below that of commercial vidicon tubes, these efforts are so promising that researchers predict compact tubeless TV cameras within a few years. Says Paul K. Weimer of the Princeton Labs: "The major problems right now are those of uniformity of (video) lines, cost, and sensitivity; once those are solved, the arrays will be good for a variety of uses."

He listed among these optical reading, surveillance, and monitoring. The compactness problem is already licked. The heaviest part of Westinghouse's 200-by-256 unit is the lens, and Irwin says the camera could be built in less than 2 cubic inches, including circuitry

*An experimental tubeless TV camera developed by RCA. Although this model has proved the feasibility of the design, resolution and sensitivity are poor.*

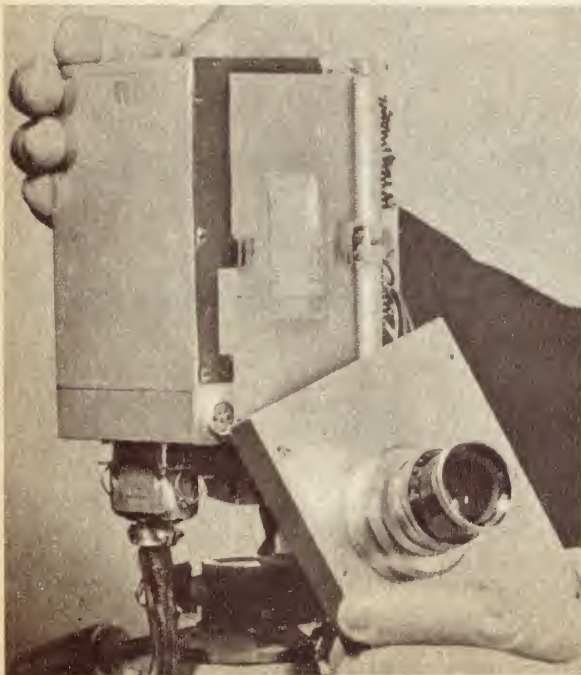

but without lens.

Solid state sensors are a newer way to do what camera tubes do: regularly and sequentially measure the differences in light falling in specific minute areas. The amount of light corresponds to a charge in the sensors. By regularly scanning at TV rates the differences in charges in the sensors—the 200-by-256 array has 51,200 sensors—the array can produce TV-like pictures. The more sensors, and the closer together they are in a matrix, the better the resolution.

Westinghouse chooses silicon planar-process, large-scale integration technology, using aluminium interconnections for its arrays because the process is well-proved, says Irwin. The major problem here is that the photo-etching must be precise because a 0.0025in error will invalidate the whole wafer. And since a whole wafer is used for each array, breakage and handling are also problems.

The logic circuitry is made up basically of junction MOSFET switches for the emitters and the collectors of the photoconductors. Ring counters sequentially switch the pulses to an output video amplifier.

Irwin says he doesn't know how NASA will use the large camera, but he's sure it's not for the moon. For the larger camera, the circuitry will be incorporated on printed circuit boards around the sensing array instead of separately from the array as with the smaller ones. The array is less than an inch square.

With its dual efforts, the Princeton labs is assessing the respective strength of the two approaches. Weimer says that while silicon technology offers greater charge storage in the photoconductor for better sensitivity, thin-film technology has the advantages of longer wavelengths—into the deep infrared. With thin film it is possible to build higher gain into the arrays to activate more electrons per photon encountered. Conversely, thin film can be unstable because it's hard to control thickness.

Weimer hints that the next step may be 360-by-360 units on 1-mil centres (typically, the sensors on all cameras are from 2 to 4 mils apart). These should have sharp resolution. With that one, and the Westinghouse larger one, can a tubeless TV camera be far behind? ("Electronics," 17/2/69.) ■



# MINISCOPE

THE ONLY IRON OF ITS TYPE IN THE WORLD

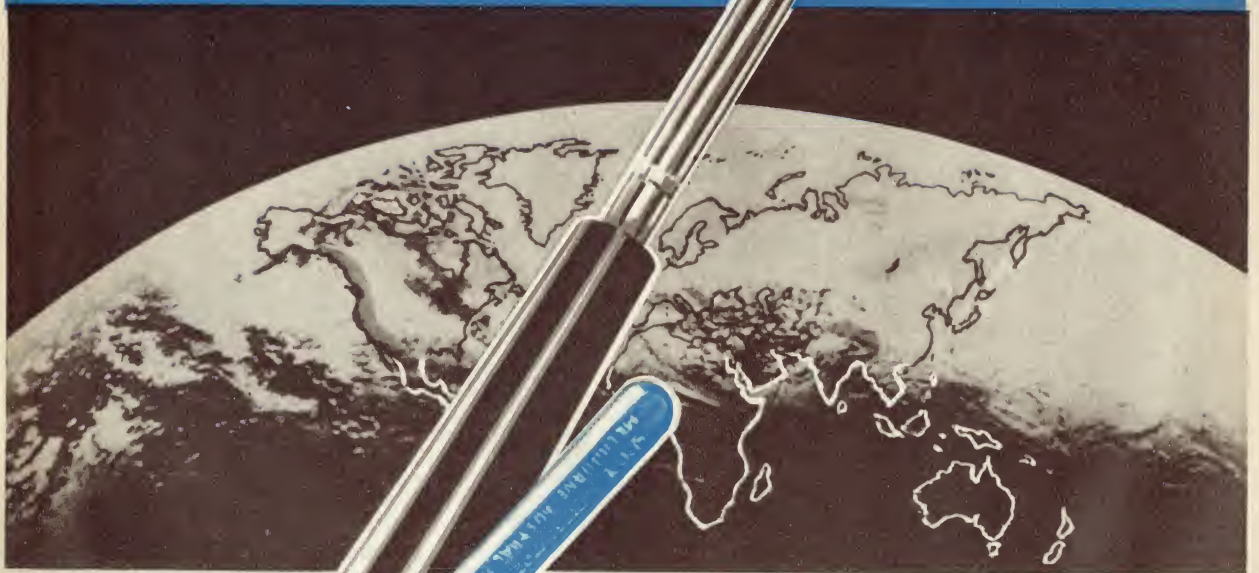

This unique soldering iron has a big heart for hard work. Small but sturdy, it performs all the work usually requiring a conventional iron of up to 75 watts. Check these features before you buy just any soldering iron.

**SPEED** Only 5 seconds initial heating up time from cold, then practically instantaneous.

**CONTROL** Temperature control at your finger tips. Heat only where, when, and as much as needed.

**VERSATILITY** Copes with all soldering jobs — from miniature components to large solder lugs. Can even be operated from a 6 volt car battery.

**MINI WEIGHT** Only 1¾ oz. complete, and its comfortably designed handle reduces operators fatigue, on the longest jobs.

**ECONOMY** Consumes current only whilst in use. Performs all the functions of other irons up to 75W.

**GUARANTEED** Time tested dependability, backed by full guarantee.

**LESS MAINTENANCE** Longer tip life. NO expensive heating element to replace. Spare tips and carbon elements readily available from your Scope distributor.

**LABOUR SAVING** Fast warm-up—always ready, cuts wiping, re-tinning and filing of tips to a MINIMUM.

**TRANSFORMER by NATRONICS**

A Miniscope operates on voltages from 2.5V to 6.3V A.C. or D.C. or from 240V A.C. mains through a "Natronic" Scope Transformer fitted with 6 ft. 3-core flex and 3 pins mains plug. \$7.65.

MINISCOPE, beautifully presented in a handy re-usable plastic pouch-pack, ideal for neat storage and easy portability. MINISCOPE \$5.28

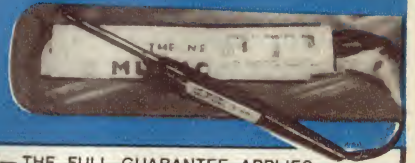

AVAILABLE FROM ALL MAJOR ELECTRICAL WHOLESALEERS AND HARDWARE STORES — THE FULL GUARANTEE APPLIES ONLY WHEN THE IRON IS USED WITH THE APPROVED 'SCOPE' TRANSFORMER. MANUFACTURED BY NATRONICS PTY. LTD.

AUSTRALIAN & OVERSEAS AGENTS:

**IRH COMPONENTS PTY. LIMITED**

(a subsidiary of International Resistance Holdings Ltd.)

THE CRESCENT, KINGSGROVE, 2208. N.S.W. 50 0111

VICTORIAN OFFICE:  
143 Christmas Street, Fairfield.

TASMANIA: W. P. MARTIN PTY. LTD.  
202 Argyle Street, HOBART.

S. AUSTRALIA: COLLETT & CANT PTY. LTD.  
103 Halifax Street, ADELAIDE.

N.Z.: H. W. CLARKE (N.Z.) LIMITED  
42-46 Cable Street, WELLINGTON, C.3

N.Z.: H. W. CLARKE (N.Z.) LIMITED  
10 Teed St., New Market, AUCKLAND, S.E.1

W. AUSTRALIA: I. W. HOLMAN & CO.  
854 Beaufort St., Inglewood, PERTH

QUEENSLAND: K. H. DORE & SONS  
505-507 Boundary Street, BRISBANE

ALSO TOWNSVILLE AND ROCKHAMPTON



VOTED FIRST BY A HOST  
OF SATISFIED USERS.

Please post — free illustrated literature and specifications

My Name \_\_\_\_\_

My Address \_\_\_\_\_

City \_\_\_\_\_ Postcode \_\_\_\_\_



# PLANNING FOR 150mph TRAINS IN BRITAIN

British Railways plan to have in operation within five years a prototype passenger train capable of speeds up to 150 miles per hour.

The evaluation project, which was recently given financial backing, involves the development of gas-turbine or electric-powered traction units, hydraulic brakes, and hydraulic actuating mechanisms which tilt the light-alloy passenger shell for high-speed cornering.

But equally vital will be a new generation of signalling equipment, for if high-speed trains come into service they will be operating on a railways system that handles 18,000 train journeys daily and which caters for expresses, slow-speed freight trains and commuting trains.

The responsibility of developing a signalling system which will allow a high-speed service to be threaded safely into the existing timetable rests with British Rail's Electrical Research Department at Derby. Its director is Mr L. L. Alston. However, he is quick to point out that in developing the hardware for future signalling projects his department has to take into account the needs not only of the glamorous high-speed train but also those of commuting trains. A comprehensive scheme has resulted which caters for all of these requirements, but the emphasis on different aspects of this scheme will be different for each of British Rail's needs.

The commuting train service may be radically improved as a result of continuous voice communication between trains and a control centre, at which on-line computers re-schedule timetables to cater for delays.

Mr Alston's department has already proved computer software programs which could be further developed for on-line re-scheduling of train services. Experience has shown that the maximum number of trains can be squeezed through a junction when high- and low-speed trains are well mixed, and the program incorporates algorithms which achieve this. When this was applied to a Southern Region junction handling 98 trains an hour, the computer generated the existing timetable. In fact the computer had arrived at a sequence in 2½ minutes which had been optimised by British Rail over several years.

Such programs applied to train docking at large terminals and using up-to-the-minute information on train positions derived over speech links, could greatly minimise the effects of dislocations in the timetable.

By contrast, the signalling emphasis for the high-speed train would rest with a train-borne computer. This is made necessary by the greatly in-

creased speeds which would tax the driver's judgment to the limit of safety.

Driving a train using existing signalling methods calls for the continuous use of observation and judgment. With the existing four-light system, amber causes the driver to slow the train to a speed at which he can stop by the next

signal, if this is red. If it is green he can accelerate to the maximum safe speed for that section.

Consequently he is continually assessing braking distances, and also he must take account of gradient, of the train's laden weight and of its braking characteristics. In addition he must hold to a time schedule using a knowledge of future track conditions.

So to simplify his driving task and to provide monitoring back-up at these greatly increased speeds, data is fed to him on track and signal conditions through an interfacing computer. In

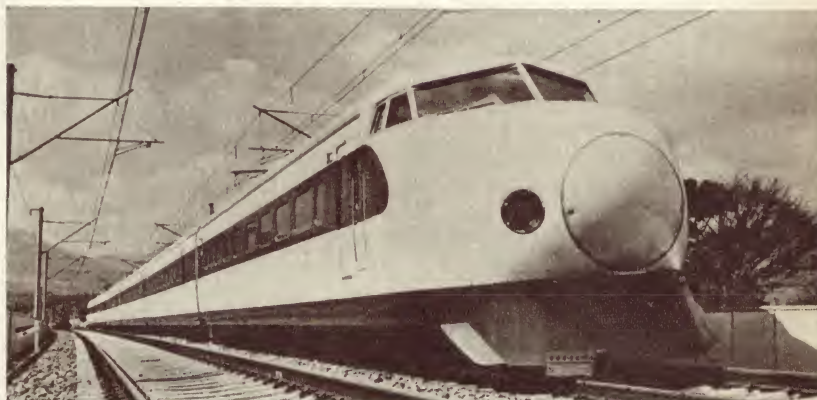

*The only trains now in service capable of the speeds envisaged for Britain's planned high speed expresses are Japan's "Hikari" which travel up to 160mph between Tokyo and Osaka. They complete the 320-mile run in 190 minutes.*

## STC Microwave Equipment for N.S.W. Railways

**Standard Telephones and Cables Pty. Ltd., has gained a contract to supply N.S.W. Railways with a microwave radio link system between Sydney and Orange.**

The contract covers the supply and installation of the radio relay system, complete with carrier telephone multiplexing equipment, supervisory equipment, batteries, mains operated battery charging plant, aerial systems and towers. The electronic equipment is all-solid-state, and will be fully duplicated so that a standby system will automatically take over in the event of a failure. Complete metering facilities are built into the equipment.

The 150-mile radio telephone link is due to be fully commissioned and handed over to the Railways Department by April, 1970. The main terminals will be at Sydney and Orange, with four intermediate repeater stations at Razorback, Explorer's Tree Hill, Owen's Range and Totten's Hill. The Sydney-Razorback section has been designed to allow the addition of

a Sydney-Goulburn 24-channel system at a later date.

This system will provide 24 telephone channels between the Sydney Terminal Railway Station and Orange Railway Station. The equipment will form part of the railway telephone network being provided in connection with the standardisation of Australian railway gauges program. Later, it may extend to railway subscribers throughout the inter-connected railway systems on the mainland of Australia. The radio relay equipment may be called upon to provide bearer circuits also for data transmission and railway centralised train control systems.

Commenting on the order, a spokesman for N.S.W. Railways said that the new link was only part of a telecommunications explosion facing Australia's railways system. More microwave links, more, bigger and faster telephone exchanges, and improved inter-system communications were being planned. Australian Railways would spend about \$500,000 a year on routine work, he said. ■



# CD2300 DTL Family

direct replacements for 830 and 930 series

**45 types / 3 package styles /  
2 Temperature Ranges/Gates  
/ Expanders / Flip-Flops /  
Inverters / 2K  $\Omega$  and 6K  $\Omega$   
Output Pull-Up Options**

**• For your Military Applications:**

CD2300 Series — 15 circuits in  
RCA's Unique Ceramic Flat Package.  
CD2300D Series — 15 circuits in  
RCA's Unique Ceramic Dual In-Line  
Package.

**• For Industrial and Commercial  
Applications:**

CD2300E Series — 15 circuits in  
RCA's Dual In-Line Silicone Pack-  
age.



Circuit and Pull-up Option	-55°C to +125°C Operation		0°C to +75°C Operation
	14-Lead Ceramic Flat Pack	14-Lead Ceramic Dual In-Line Package	14-Lead Dual In-Line Silicone Package
<b>NAND Gates</b>			
Dual-4 Expandable (6K $\Omega$ )	CD2300/930	CD2300D/930	CD2300E/830
Dual-4 Expandable (2K $\Omega$ )	CD2301/961	CD2301D/961	CD2301E/861
Dual-4 High Fanout, Expandable (transistor output pull-up)	CD2306/932	CD2306D/932	CD2306E/832
Dual-4 High Fanout Expandable (no output pull-up)	CD2307/944	CD2307D/944	CD2307E/844
Triple-3 Input (6K $\Omega$ )	CD2308/962	CD2308D/962	CD2308E/862
Triple-3 Input (2K $\Omega$ )	CD2309/963	CD2309D/963	CD2309E/863
Quadruple-2 Input (6K $\Omega$ )	CD2302/946	CD2302D/946	CD2302E/846
Quadruple-2 Input (2K $\Omega$ )	CD2303/949	CD2303D/949	CD2303E/849
<b>Hex Inverters</b>			
Diode Input (6K $\Omega$ )	CD2310/936	CD2310D/936	CD2310E/836
Diode Input (2K $\Omega$ )	CD2311/937	CD2311D/937	CD2311E/837
Expandable Input (6K $\Omega$ )	CD2312	CD2312D	CD2312E
Expandable Input (2K $\Omega$ )	CD2313	CD2313D	CD2313E
<b>Flip-Flops</b>			
Clocked RS with JK Capability (6K $\Omega$ )	CD2304/945	CD2304D/945	CD2304E/845
Clocked RS with JK Capability (2K $\Omega$ )	CD2305/948	CD2305D/948	CD2305E/848
<b>Input Expander</b>			
Dual 4-diode	CD2314/933	CD2314D/933	CD2314E/833

Complete information on the range of RCA integrated circuits available from A.W.V. is covered in the Integrated Circuit Product Guide which is available post free on request.



**AMALGAMATED WIRELESS VALVE CO. PTY. LTD.**

PRIVATE MAIL BAG, P.O. ERMINGTON 2115 OR INTERSTATE OFFICES.



addition he is kept in continuous voice communication with control. The vital link in this system is two parallel wires laid 30cm apart in the track and energised by a multi-tone signal system, the absence of which will cause the train to brake. Different signal tones indicate different signal states, and are fed through to the monitoring computer. The wires themselves are transposed at 100 metre intervals, and this is detected as a phase change on board the train and is used as a distance count.

Other track information is stored in regular groupings of 32 coils, each coil being sleeper mounted. Coils can be wound in opposite directions to produce a 32-digit binary coded word. The first eight coils indicate the nature of the next target, which may be a speed restriction, a signal or a target. The next 16 bits give the gradient and distance to the target, and for a speed restriction, its value. These are fed to the computer, where they are checked for validity and the address switches numerical information to appropriate stores. Train data, including its braking characteristic and maximum permitted speed, are fed into the computer from a punched card.

This, together with information on the next four signal states, which is received as a tone from the line and converted into a register state, completes the information used by the computer. The distance to the next signal is continuously monitored and is derived by subtracting each 100-metre transposition from the target figure, received from the track telegraph.

Similar updating techniques are used to calculate the maximum safe speed. A braking curve of speed against distance for the train is held in the computer memory, and is derived from the train length, its braking performance and maximum speed for its class. Using this and the distance to the next speed restriction or stop, the computer can read off the maximum speed which will allow the train to comply with the restriction or stop.

The computer displays this target speed together with the actual speed to the driver. Many other parameters could be displayed but this will be settled by an ergonomic study.

Also to be determined will be the data transmitted over the train/control centre link, but it is unlikely to consist of more than an interrogation from the control centre made up of its identity, and instruction regarding any responses from the train including identity, speed and position.

The signal state is provided by frequency modulation of a 29KHz carrier. Speech and non-safety data will be transmitted to the train through the track conductors on a 41KHz carrier and train control speech on a 135KHz carrier. Train pickup aerials consist of a ferrite rod surrounded by an aluminium case.

Carrier currents are fed into the conductors by direct connection to line-side transmitters. An AGC circuit compensates for changes in attenuation in the quad cable, and this itself has been minimised by a system of sheath cross-connections. In this way variations due to rain etc. are minimised. ("Electronics Weekly," 5/2/69.)

## SONY FIRST WITH ELECTRET MIC.

Bell Telephone Laboratories, in the U.S.A. and Sony Corporation, of Japan, have both recently announced the development of a new type of condenser microphone which requires no external DC polarising voltage.

Features claimed for the new microphones are: very good frequency response (20-20,000Hz); low electrical impedance, thus permitting good low frequency response without special circuitry; and that different directional characteristics can be easily obtained.

In their announcement, Sony claim to be the first company in the world to develop a production technique for the new microphones. Both companies have based their design on the thin film electret. This is a metalised plastic film which is prepared in such a way that it retains a semi-permanent electrostatic charge — the name "electret" being applied because of the analogy to the more familiar "magnet."

An electret microphone requires no power source at the condenser capsule, since the diaphragm is already electrically charged due to the electret phenomenon. This phenomenon was first discovered about 50 years ago, but no practical applications were found for it. When a material is subjected to a strong electrical field under certain conditions, an electrostatic charge remains in the material after the field is removed. However, retaining a high static electric density constant for a

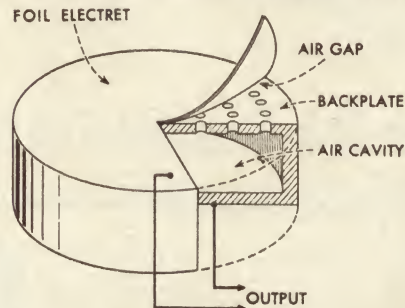

The basic principles of Bell Telephone's electret microphone are illustrated in this diagram. The electret diaphragm touches a metal backplate in several places, and due to surface irregularities, air pockets are formed between the electret and the backplate. The backplate is perforated so that the air layer can communicate with the larger cavity, thus increasing the vibration amplitude and consequently the sensitivity of the system.

period of time has been regarded as extremely difficult. Sony's solution is a special high polymer plastic film, capable of holding a high static electricity charge, which remains stable over a long period. Bell Telephone's design uses a "foil electret" — a thinly metalised sheet of either fluorocarbon or polycarbonate.

As shown in figure 1, ordinary condenser microphones require two power sources for condenser and am-

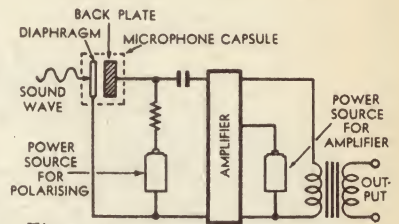

Figure 1:

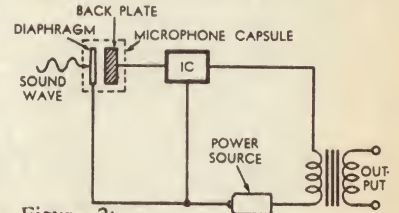

Figure 2:

Simplified schematics comparing the conventional type of condenser microphone (top) with the electret type.

plifier. When sound waves reach the diaphragm of the condenser microphone capsule, the diaphragm vibrations cause changes in the static capacitance in the space between the diaphragm and the back plate, developing an output voltage, which varies according to the pressure strength of the sound waves. The output voltage is then fed to an amplifier.

Just as in previous designs, electret microphones depend on varying capacitance, produced as sound vibrations impinge on one flexible plate of the capacitor. But here the moving plate is the electret itself, with its permanent static charge. As the electret moves, it varies the electrostatic field across the air gap (figure 2), and this again produces a varying output voltage.

In any capacitor, the thinner the dielectric, the greater the capacitor. Dielectric films as used in the electret can be as thin as 0.00012in to 0.001in. As a result of this, the capacitance of the electret microphone is about three times as high as that of conventional condenser microphones, and the impedance is comparably lower. This simplifies the accompanying circuitry.

Electret microphones are inexpensive, exceptionally rugged, immune to wide temperature fluctuations and very small. The Sony type is only 7mm diameter. This compactness has been achieved by using as the preamp a specially designed monolithic IC, which contains a FET and all other necessary electronic circuitry on a 0.5mm square silicon pellet.

Sony expects the new microphones to find applications in fully professional situations such as broadcast studios, as well in consumer goods like tape recorders. The company has already introduced a cassette tape recorder with a built-in electret condenser microphone for the Japanese domestic market.



# The New Tandberg

# 1241X



## The High Fidelity Stereo Tape Recorder With Every Desirable Feature

The versatile Tandberg 1241X is the successor to the proven and popular "Series 12", which enjoyed an international sales volume of well over 40,000 units. This recorder is not a "face lift" — it is completely new . . . and the new Tandberg bias head has made frequency response figures possible which, up till now, have been an audio engineer's dream. For example, frequency range even at 3¾ i.p.s. is 40-14,000 Hz.  $\pm 2$  dB.; signal to noise figures are considerably improved at all speeds.

When you step up to Tandberg you are investing in the Tandberg tradition of "Sound reproduction indistinguishable from the original". When you buy Tandberg you automatically purchase reliability and performance — and advanced features only available to Tandberg users. Listen to the Tandberg 1241X at selected dealers in all States.

Features of the 1241X include:

- Twin 10 watt amplifiers with double volume controls for both inputs and outputs •
- Three speeds, 7½ — 3¾ — 1⅞ i.p.s. • Twin internal loudspeakers
- Bass and treble controls continuously variable  $\pm 12$  dB.
- Inputs for radio tuner, microphone or magnetic pickup — no other amplifier required
- Frequency response at 7½ i.p.s. 20-25,000 Hz. • Signal to noise at 7½ i.p.s. (4 track versions) — 58 dB. • New twin VU meters • Ideal for language study.

### And the new Tandberg Cross Field Bias Head!

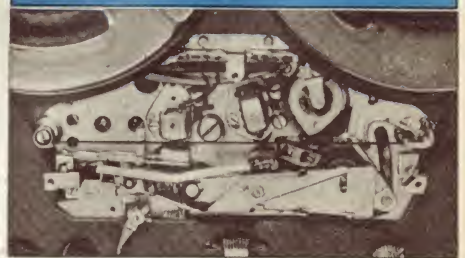

# Tandberg



Australian National Distributors:

**Simon Gray Pty. Ltd.**

Head Office: 28 Elizabeth St., Melbourne, Vic. Tel. 63 8101\*

Sydney Office: 22 Ridge St., North Sydney, N.S.W. Tel. 929 6816

Canberra Office: 31-33 London Circuit, Canberra City, A.C.T. Tel. 49 6050

INTERSTATE REPRESENTATIVES:

SG1241/1

N.T.: Pfitzner's Music House, Smith Street, Darwin. Tel. 3801

Q'land: Sydney G. Hughes, 154-158 Arthur St., New Farm, Brisbane. Tel. 58 1422

S.A.: Eilco Sales Pty. Ltd., 7-9 Osmond Terrace, Norwood, S.A. Tel. 63 4844

Tas.: K. W. McCulloch Pty. Ltd., 57 George Street, Launceston. Tel. 2 5322

W.A.: Athol M. Hill, 613-615 Wellington Street, Perth. Tel. 21 7861



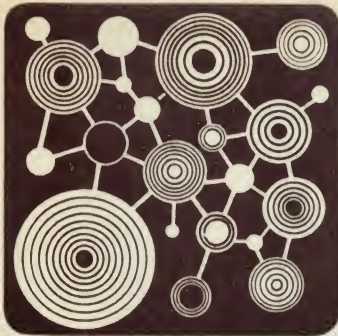

# SCIENTIFIC AND INDUSTRIAL NEWS

## English definitions for SI units

New English language definitions for the base units of the International System of Units (abbreviated SI, for *Système International*) are now available as a result of recent actions by the Advisory Committee on Units (Comité Consultatif des Unités, or C.C.U.) of the International Committee of Weights and Measures. The International Committee of Weights and Measures makes technical proposals that are acted on by the General Conference of Weights and Measures, established under the Treaty of the Metre in 1875. These proposals originate in seven advisory committees, one of which is the C.C.U.

At a meeting in 1967, the C.C.U. modified some of the definitions of the units on which the International System of Units are based. At a recent C.C.U. meeting it was agreed that authorised English translations of the official French definitions of the base units should be made available. The spellings "base unit," "metre," "kilogramme," "caesium," and "black body" have been used, but "basic unit," "meter," "kilogram," "cesium," and "blackbody" are also used in some English speaking countries and are equally recognised.

## Improved speech over lines

Normal telephone lines may have a frequency range limited to 300 to 3200Hz, which eliminates the lower frequencies that provide naturalness and add to the effectiveness of voice transmissions. The Voice-Line, announced by Kahn Research Laboratories of the U.S.A., is said to substantially improve speech quality from 100 to 3200Hz over any available telephone line. The transmitter separates frequencies below 300Hz from the rest of the voice frequency spectrum, and relocates them in a prepared "notch" at 2000Hz for transmission. The receiver returns them to their correct position.

According to Kahn, the notch at 2000Hz in the sound received is undetectable to the ear. Because much background noise in noisy lines is below 300Hz, the elimination of any transmitted intelligence below 300Hz reduces hum and other low frequency noise and results in an improvement in quality.

The Voice-Line is completely transistorised for ease of maintenance and reliability, and is easily installed and operated. Voice-Line is for speech only. For superior transmission of music or voice with a range of 50Hz to 5000Hz or better, Kahn has developed the Proline, which uses two low-quality lines. Kahn is exclusively represented in the export market by Singer Products Co. Inc., 95 Broad Street, New York, New York 10004, U.S.A.

## Piezoelectric elastomers

Some elastomeric materials used for damping vibratory motion are also capable of weak piezoelectric response. Studies of this property were recently conducted at the Institute for Applied Technology, U.S. National Bureau of Standards, by physicist Seymour Edelman with the assistance of Steven Roth and Larry Grisham. The studies show that the effect is greatly enhanced in some rubber-like materials by a process similar to that used to form electrets, and by the presence of a strong electric field.

Following the reasoning that the piezoelectric response resulted in part from electret properties — electrical polarisation analogous to permanent magnetisation — the scientists experi-

mentally treated their samples to maximise electret formation. They did this by reducing the viscosity of sheets of the material by heating it almost to melting point, and allowing it to resolidify while an intense electrical field was placed across it by two electrodes connected to an adjustable DC power unit. The usefulness of the piezo effect in damping vibration was demonstrated in a test fixture using three test elements to support a triangular plastic plate.

## Lens development

A family of high-resolution, large field lenses specially designed for preparation of masks and projection of masks onto silicon wafers during fabrication of microcircuits has been developed by the Research Division of International Business Machines Corporation (IBM), Yorktown Heights, New York, U.S.A. The lenses, which project masks at reductions of 10 or 20 to 1, are said to have diffraction-limited resolution over fields as wide as 100mm, off-axis resolution as good as axial resolution, and to exhibit very low field curvature.

Their contrast ratio is quite high at all spatial frequencies for good edge definition of lines of different widths. Although designed for specific wavelengths, the lenses are corrected for chromatic aberration so that they can be used with light of an extended frequency range centred on the mean frequency. These lenses are specifically fabricated experimental units and are not off-the-shelf production items.

## Microfilm document service

A new subscription service for obtaining microfiche (sheet microfilm) copies of scientific and technical documents grouped by field of interest has been introduced by the U.S. Commerce Department's Clearinghouse for Federal Scientific and Technical Information. The service, Selective Dissemination of Microfiche (S.D.M.), allows customers to order, from any of several hundred categories, unclassified reports and translations

## Antenna location tests

Engineers at Lockheed-California Company are carrying out studies to verify optimum locations for communication, navigation, identification, and special systems antennae for the L-1011 TriStar jetliner. The team uses models of the jet ranging in size from 1/60 up to 1/10 scale to conduct tests with impedance bridges, wide range receivers and power handling test equipment. The test model seen here is sprayed with a coat of copper and fixed to a 25-foot antenna tower on tracks at the Rye Canyon antenna testing system. The model and tower rotate 360° so that different reception angles can be tested.





you've never heard it so good



122-AR1

## new Rola 65MX wide range and 65M woofer hi-fi speakers give exceptional performance - way down low, below 35 Hz\*

\* Measured in accordance with RETMA standards

Hi-Fi enthusiasts never had it so good. In their new series 65M speakers Rola has packed in more performance, more quality in less space for less cost. Now you can range from 30Hz to 14,000Hz in one compact, 6½" diameter speaker with the high fidelity you could normally expect only from a much larger unit. Truly, these speakers sound great:

High compliance suspension, with large diameter spider and synthetic rubber pneumatic rim for large linear excursions. Specially treated cone to give sharp cut-off at crossover frequency; aluminium voice coil former for long-term stability and increased power handling.

Power handling: 65MX — 7 watts RMS

65M — 10 watts RMS

Frequency: 65MX — 30Hz to 14,000Hz

65M — 30Hz to 5,000Hz

ROLA 65MX — a twin-cone, medium-throw loudspeaker designed to provide a compact, single unit, wide-range sound system.

ROLA 65M — a medium-throw loudspeaker designed for use as a woofer in two-speaker enclosures. The new Rola 3DX speaker is an ideal tweeter to use with the 65M for extended upper frequency response.

Enclosure plans specially prepared by Rola are available on request for both speakers.



# PLESSEY Components



For additional information please contact:

Rola Division  
The Boulevard Richmond Victoria 3121  
Telephone 42 3921 Telex 30383  
NSW Plessey Components Rola Division  
PO Box 2 Villawood 2163 Telephone 72 0133



of foreign technical literature sponsored by U.S. Federal agencies and other organisations. Orders can be placed by subject category, by originating agency, or by subject category within an agency collection.

The service will require less effort for the user to get the information he needs since it will eliminate individual orders for documents. The automatic distribution feature of S.D.M. permits the Clearinghouse to offer the service at a price substantially lower than the standard microfiche price 65c (U.S.) per title. Distribution will be made twice each month at the same time as documents are announced for public sale. Detailed information on the categories, cost and the method of ordering S.D.M. are available upon request from the Clearinghouse (152.12), U.S. Department of Commerce, Springfield, Virginia 22151, U.S.A.

## Plan for miners' TV network

Nine major Australian mining companies are considering setting up their own network of from seven to 14 low-power television stations to serve isolated mining townships. Tenders for equipment or complete transmitting stations were called recently by the Australian Mining Industry Council on behalf of interested member companies. The companies involved have been considering the proposal for about a year. They have not yet committed themselves to the scheme and the go-ahead depends on three factors.

The first is the price of the stations. The companies are aware of the cost of a complete station, but are hoping for a better tender price for the number of stations involved. The second factor is the Broadcasting Control Act, which would need to be modified to allow the companies to operate the stations. The third factor is the question of how the stations will be operated. Under one proposed scheme the stations would be serviced from a central program unit with video-taped programs being flown out to the stations, the intention being to use locally prepared material. The alternatives are to operate through commercial interests or through the Australian Broadcasting Commission. Should all the factors resolve themselves favourably, the companies hope to have the scheme operating by the end of the year.

## Coaxial cable link

A 603-mile coaxial cable system was recently completed between Perth, Geraldton and Carnarvon. The \$7 million link is part of the planned development of an Australia-wide broadband telecommunications trunk network. Special equipment was used to bury the coaxial cable directly at a depth of four feet without the use of trench excavating machines. Major repeater and boosting stations, with drop-off facilities from the main cable, have been provided at 10 places. Another 220 small unattended repeaters have been sited underground every 2.8 miles.

The largest stage of the Australian network, a microwave radio link of 1440 miles skirting the Nullarbor Plain from

## Engine development testing

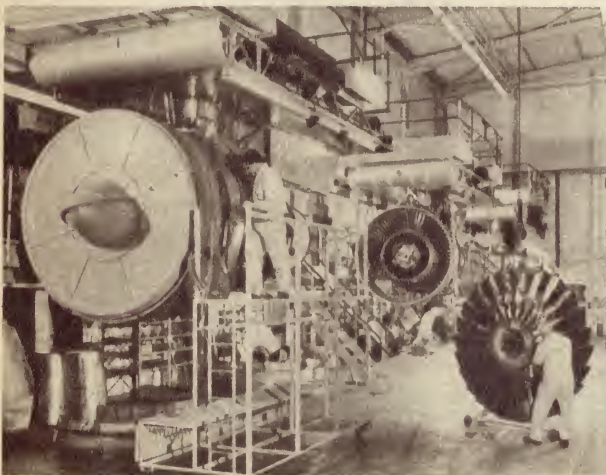

The large test preparation area recently completed at the Rolls-Royce Aero Engine Division, Derby, England, enables RB.211 engines (to be used to power the Lockheed L.1011 TriStar) to be prepared for development testing. Five RB.211 engines can be prepared simultaneously on cantilever supports, three of which are seen in the photograph. Provision has also been made for the test preparation of other engines in the Rolls-Royce range.

## Windows for lunar module



One of the two triangular ascent stage windows in the Apollo lunar module features a reticle system for use by the astronauts in visually aligning the spacecraft in the proper attitude for various manoeuvres. The markings, which appear in fluorescent green and orange colours in the dark, are on the inner pane of the two pane window. Each of the lunar module windows has an inner pane of chemically strengthened glass and an outer pane of 96 per cent silica glass. The strong inner panel is an integral structural element of the module, while the outer panel acts primarily as a micrometeorite shield and a barrier to thermal shock.

Port Pirie to Northam, is still under construction. When this link is completed later this year, a broadband network will run from Cairns through all mainland capitals to Carnarvon with spurs to Tasmania and many provincial centres. The broadband network will enable the Post Office to provide subscriber trunk dialling (S.T.D.) facilities between many centres in Western Australia and the eastern States.

## Computerised design

The Marconi Company recently demonstrated the ease with which a gearbox can be designed using a Myriad II computer and an X2000 electronic graphical/tabular display system. The time-consuming calculations of gear ratios, wheel sizes, numbers of teeth, and the resultant stresses on the shaft bearings are easily calculated using computer aided design techniques.

The computer store contains a library of gears, each fully described in all parameters. The operator enters a specification of a required component through a keyboard, whereupon the computer selects the appropriate gear and displays it on the X2000 screen. The gear is moved into the required position, using a tracker ball controller, onto a previously drawn drive shaft. Any number of gears may be called in this way and their positions modified until a suitable configuration is reached. A Fortran application program is used to calculate the stresses on the bearings. The stress values are displayed next to the relevant bearings on the display screen.

## UK-4 satellite project

The prime contractor and co-ordinating authority for the UK-4 scientific satellite project is to be British Aircraft Corporation's Space and Instrumentation Group at Bristol, England. B.A.C. will be responsible for spacecraft design, manufacture, integration and test, handling equipment, ground check-out equipment, launch support, systems engineering, project co-ordination and management. The Royal Aircraft Establishment, Farnborough, will be the research and development authority, and the space research management unit of the British Science Research Council will be responsible for overall management.

The UK-4 satellite is due to be launched into orbit in 1971 by a NASA Scout vehicle. The main body of the UK-4 will be in the form of a polygonal cylinder with a conical top. Four large booms around the base of the satellite will provide mountings for some of the experimental sensors well away from the main body (to reduce the risk of reflection hazards and interferences) and also to provide a convenient platform for mounting some of the solar cells. During launch, the booms will be wrapped around the fourth stage motor of the Scout rocket. After injection into orbit, the booms will be deployed to an angle of 65 degrees relative to the spin axis of the satellite.



# Proposition: Advance=**MORE MHz/\$**

## Resolution:

(0.1 to 1 Hz)

buy one or all three of these  
**NEW Timer Counters**



### 15 MHz : TC 11, TC 12

Designed to measure frequencies up to at least 15 MHz. TC11 offers a 4-digit display with a max. gate time of 1 sec. (1 Hz resolution). TC12 offers a 5-digit display with a max. gate time of 10 sec. (0.1 Hz resolution). Both instruments may be used for counting and timing. **Freq. Measurement:** 2Hz to at least 15MHz. Gate times. TC11 0.1 mS to 1S. TC12. 0.1 mS to 10 S. **Time Measurements:** Time Units TC11 10 $\mu$ S to 1 S, TC12 10  $\mu$ S to 10 S. **Multiple Period:** 10 to 10<sup>6</sup> periods. **Count Mode:** 2Hz to at least 15 mHz. **Freq. Standard:** Internal 100 kHz crystal oscillator set to 1 part in 10<sup>5</sup> at room temp. Stability  $\pm$  6 parts in 10<sup>5</sup> over the temp. range 0 + 50°C. **Sensitivity:** 10 mV, 100 mV and 1 V RMS. **Display Time:** cont. variable from less than 0.1 S to at least 4 S. **Data Output:** Display data avail. Format 8421 BCD pos. going, negative true. **Power Supply Req.:** 100 to 125 V or 200 to 250 V, 45 to 65 Hz. Consumption 25 VA. **Temp. Range:** 0 to + 50°C.

TC11: \$360.

TC12: \$450 (plus Sales Tax)



### 32MHz : TC9

A 6-digit instrument capable of measuring frequencies up to at least 32 MHz with a resolution of 0.1 Hz. Measures time intervals with a resolution of down to 1  $\mu$ S. Integrated circuits are widely used for max. reliability. **Display:** 6-in-line numerical indicators with dec. points for freq. and multiple period. **Freq. Measurement:** 2 Hz to 32 MHz. Dec. point auto. positioned. **Time Measurement:** Timing units from 1  $\mu$ S to 10 S in decade steps. **Multiple Period:** 10 to 10<sup>6</sup> periods. **Count:** 2 Hz to 32 MHz. **Sensitivity:** 3 position attenuator providing 10 mV, 100 mV and 1 V RMS sensitivities. **Freq. Standard:** Internal 1 MHz crystal oscillator, oven controlled at + 65°C. Set to 1 in 10<sup>6</sup> at + 25°C. Stability  $\pm$  5 in 10<sup>6</sup> from 0°C to + 50°C. **Display Time:** Cont. adjustable from 0.1 S to 4 S, or infinite. **Data Output:** Display data avail. Format 8421 BCD positive going, negative true. **Power Supply:** 100 to 125 V, 200 to 250 V, 45 to 65 Hz, 30 VA. **Operating Temp. Range:** 0 to + 50°C.

TC9: \$578 (plus Sales Tax)



Distributed by—

## jacoby, mitchell & co. pty. ltd.

469-475 Kent Street, Sydney. 26-2651

MELBOURNE  
30-2491/2

ADELAIDE  
53-6117

BRISBANE  
2-6467

PERTH  
28-1102

LAUNCESTON  
2-5322

JM/27-69



## Monolithic memory

Buffer memories which use monolithic memory chips 112mils square have been developed by the Components Division, International Business Machines Corporation, Essex Junction, Vermont, U.S.A. Each chip contains 664 components (transistors, diodes and resistors) making up 64 distinct interconnected memory storage cells. A pair of these chips is mounted on a half-inch square ceramic module to form an 8 x 8 x 2 organised memory building block.

A 7 x 9in multi-layered pluggable card carries 72 memory modules, together with drive and sense circuit modules, with a capacity of 512 memory words of 18 bits each. A larger multi-layered printed circuit board, containing 16 storage and four logic and terminating cards, makes up the basic storage unit. Two storage units form the complete buffer memory with a quarter megabit capability.

## SSB radio telephone



The Redifon PC2 is a battery-operated portable SSB HF radio-telephone designed by Redifon Ltd., Broomhill Road, Wandsworth, London, SW18, England, as a small, inexpensive and lightweight communications set. Only three controls are needed to operate the set which provides 2-channel operation in the 2 to 8MHz frequency band. Tests in Africa gave communication at ranges over 10 miles using whip aerials at both stations.

## High strength carbon

Researchers at Lockheed Missiles and Space Company's Material Sciences Laboratory have developed glassy carbon, a material which shows promise of finding a variety of aerospace and industrial applications. Like glass, the new material has high tensile and compressive strength and low permeability. But unlike glass, it can withstand temperatures as high as 3000 degrees C. It is said to have two to three times the strength of commercially available carbon, and to resist oxidation better than any form of pure carbon or graphite.

## Colour TV committee

The Australian Broadcasting Control Board has circulated draft PAL colour television system standards to the industry, and has held a meeting in Melbourne with industry representatives to discuss the standards. The meeting, attended by 48 representatives from 32 organisations, decided to set up a committee to make recommendations on standards for radiated signals, required transmission tests, and (later) detailed equipment standards. Mr

S. F. Brownless, Director Technical Services of the Australian Broadcasting Control Board, was elected Chairman of the committee.

The committee initially will comprise a small "steering committee" and four sub-committees dealing with transmitters, receivers, relays, and studio equipment respectively. It is intended that the membership of these sub-committees be flexible, with experts being co-opted as required, to utilise the services of all sections of industry with a contribution to make.

## Sabah road project

Radio telephone sets and base stations, manufactured by Standard Telephones and Cables Pty. Ltd., are being used to maintain constant contact with vehicles and men working on a joint Australian/Malaysian multi-million dollar highway project in Sabah. The Australian Government has allocated \$4.2 million toward the construction of the highway, which will link Sandakan in the east of Sabah with Ranau in the west. The design and supervision work is being carried out by the Snowy Mountains Hydro-Electric Authority.

## Electronic poker machine

A special-purpose digital computer, designed and built by Standard Telephones and Cables Pty. Ltd., has been used as the "brain" of a five-reel poker machine (to be marketed by Nutt and Muddle & Sons Pty. Ltd.) which cannot pay out through wrongful manipulation. Normal three and four-reel machines have a limited number of paying combinations because of the mechanical complexity involved in increasing them. With the five-reel machine designed to pay out on recognised poker hands (and not fruit or other symbols) a million combinations are possible, although that number is unlikely to be used in practice.

The computer dictates to the paying mechanism the value of the combination showing in the viewing window, in the form of an electrical code actuated by metallic patterns on each of the five wheels.

## Resilient variable resistor

A new mechanically variable resistance element was shown at a recent exhibition of new inventions in London. The resilient variable resistor (RVR) is a two-terminal device whose resistance falls when pressure is applied. When the pressure is released, the device reverts to its original shape and resistance—hence the description resilient. The inventor, J. H. A. Lewis of 14 Ashdown Close, Maidstone, Kent, U.K., developed the RVR in his spare time.

The RVR is made from a foamed mass of porous elastic material (such as rubber, polyurethane or polystyrene) with conduc-



## Singapore workshop

At the British naval base in Singapore, the chairman of Philips Industries Ltd., Australia, Mr A. J. W. van Agt (second left), inspects equipment in the electronic and engineering workshops. This is to be operated by Singapore Electronics and Engineering (Private) Ltd., under Phillips Australia management, following the British withdrawal in 1971. Also in the party are Lt.-Commander C. C. Holmes, electrical engineer (left), Captain J. C. G. Field,

## Infra-red telescope



An infra-red image-converting telescope, little larger than a revolver and fitted with a pistol grip, has been developed by the Royal Aircraft Establishment, Farnborough, England. A unique feature of the instrument is its trigger-operated power supply built into the butt of the telescope. The device is operated simply by squeezing the trigger and looking into a miniature screen at the viewing end. An infra-red beam illuminates the survey area, and relays the scene in detail to the display screen. The device was originally developed as a method of viewing the output of a laser, but is expected to find applications such as night security surveillance and the study of nocturnal animals.



tive particles (such as powdered carbon) introduced into the cells or added to the mix before foaming. Compressing the material increases the contact between particles and hence lowers the resistance. The ratio of maximum to minimum resistance is more than 10 to 1 when a uniform body is used, but can be greatly increased by introducing non-linearities.

## Mercury ion engine

Early next year the second mission in a program called SERT (Space Electric Rocket Test) will send two experimental mercury ion engines into an earth orbit for six months of testing. The electron bombardment ion engine was invented and is being developed at the National Aeronautics and Space Administration's Lewis Research Centre in Cleveland, Ohio, U.S.A.

The principle by which the new engine delivers thrust involves the use of electrically charged grids to focus and accelerate ions of mercury to high speed. Each mercury atom is changed to a positively charged ion, and is drawn at high speed toward the negative grids. The ion then shoots through a hole in the grid and out through the end of the engine into space providing thrust. NASA estimates that 30 pounds of mercury could power a small spacecraft for a year.



superintendent electrical engineer, and Mr H. J. Brown, technical director of Philips Industries (right).



# Eveready re-chargeable Nickel Cadmium batteries can do hundreds of cycles.



'Eveready' Nickel-Cadmium cells have an incredibly long life: they can be stored charged or uncharged, they are completely sealed, they can be trickle charged, and their charge discharge cycle life extends into hundreds.

Cell sizes range from 20mah to 23ah in button, cylindrical and rectangular forms.

Contact your nearest Union Carbide Sales Office or write to Union Carbide Australia Limited, 167 Kent Street, Sydney, 2000. Please ask for technical literature.

**EVEREADY** BATTERIES Products of **UNION CARBIDE**  
'Eveready' and 'Union Carbide' are registered trade marks.



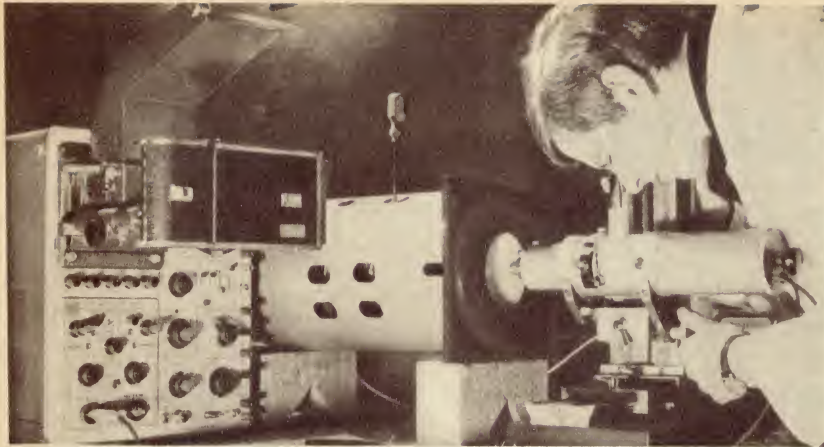

Measurement of the resolution of cathode ray tubes with either long or short persistence phosphors at any scanning rate and without any special deflection waveforms is possible with this Microspot Analyser introduced by Ferranti Ltd., Oldham, Lancs, England. The instrument consists of a measuring head mounted on a heavy travelling microscope-type carriage to provide accurate XY positioning. The head contains a microscope objective, an interchangeable function unit, a photomultiplier tube, and a secondary microscope for viewing the primary image. The magnified image of the CRT trace is focused in the plane of the function unit. Spot sizes can be accurately measured over a range of 7.5 microns to 2.5mm.

### Television service

The Australian Broadcasting Control Board recently made recommendations to the Postmaster-General regarding the extension of television services to other centres in addition to those already approved (Kalgoorlie, Geraldton, Renmark, Mount Isa and Darwin). The centres covered by these new recommendations include Alice Springs, which is one of the larger of the centres at present not provided with television services. The Postmaster-General has announced that the plan will be adopted as far as it affects Alice Springs and certain other areas.

### Radio relay link

The Postmaster-General's Department has awarded contracts for the construction of a radio relay link between Townsville and Mount Isa in Queensland. The contract for the radio relay and

associated equipment, valued at over \$1.5 million, was let to the Nippon Electric Co., of Tokyo, Japan. The contract to supply and erect antennae towers for the repeater stations, worth about \$400,000, has been let to Ascum Pty. Ltd., 63 Queens Bridge Street, South Melbourne. Ascum will build 24 self-supporting towers, some over 200 feet high, along the 600-mile route.

The Post Office has completed survey work along the route and erection of the towers is scheduled for completion early in 1970. The whole system is scheduled to be in operation by the middle of 1971. When completed, the system will be capable of carrying hundreds of telephone and telegraph circuits, and could be used for television relays.

### Weather radar

The Communications and Navigation Division of Electronic Industries Ltd. is to supply 12 marine radar equipments of an advanced type, worth nearly \$2 million, to the Commonwealth Bureau of Meteorology. Manufacture of the equipment is to be carried out by Radio Corporation Ltd., a subsidiary of E.I.L., under licence to Plessey Radar Ltd. of England. The equipments are designed to operate in both wind-finding and weather-watching roles. They lock on to a balloon-carried target, follow it throughout its ascent to heights exceeding 100,000 feet, and supply the data to a computer for calculation of wind speed and direction.

### Standards conference

The first open international conference on the International System of Units (SI) will be held in Brussels on June 24 and 25, 1969. Organised by the Production Engineering Research Association (PERA) of the U.K., it is expected that it will be attended by over 1,000 delegates from countries throughout the world. Some 25 countries, including the U.K., have passed or are preparing legislation to make SI units the only official system of measurement. The conference will consider the application of SI units to the operations of all types of industrial, commercial, scientific and educational organisations. Details may be obtained from the Conference and Education Department, PERA, Melton Mowbray, Leicestershire, England.

### Telemetry commutator



A new high-speed miniature telemetry commutator, which provides for sampling of 64 high level channels at rates to 100,000 samples/second, has been announced by Fifth Dimension Inc., P.O. Box 483, Princeton, New Jersey 08540, U.S.A. The trapezoidal unit has a volume of less than 3 cubic inches and weighs less than 8 ounces. The manufacturer specifies overall transfer accuracy to be within 2 per cent and claims low back current, low noise and linear data transfer to be better than 0.1 per cent. Additional features include internally generated voltages for frame synchronisation and calibration, and fail safe input gate circuits.

**ANY NEW MODEL  
BY FERROGRAPH  
IS ALWAYS  
NEWS WORTHY . . .**

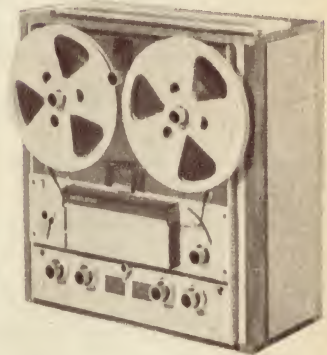

**This new model  
heralds a  
completely  
new era . . .**

**SECOND GENERATION**

**Ferrograph**

**SERIES SEVEN**

The Ferrograph Series 7 heralds a new era in tape recording . . . a completely new concept, but based on the reliability and rugged engineering that have established Ferrograph firmly in the position of Great Britain's leading quality Tape Recorder manufacturer. You are invited to see and hear the Ferrograph Series 7 at our showroom, or write for fully descriptive brochure, free and post free.

**URD**

**UNITED RADIO  
DISTRIBUTORS PTY. LTD.**

SHOP 32, ASH STREET,  
ANGEL ARCADE, SYDNEY.

**Telephone: 28-3718 28-3926**

(Ferrograph sales and service  
since 1948.)

Please forward details of Ferrograph Series 7.

NAME .....

ADDRESS .....

..... State .....



# The measurement of "Q" — and an Economy Q-Meter

Used in conjunction with a familiar RF signal generator or modulated oscillator, this solid-state instrument will facilitate measurement of RF coils and transformers for Q-factor, inductance, inductive reactance and self-capacitance. It will also permit measurement of the value of small capacitors.

by Jamieson Rowe

The need to make measurements of coils (inductors), transformers and capacitors arises frequently in any experimental activity and development work concerning RF (radio frequency) circuits and equipment. Of the types of instrument available to perform such measurements, perhaps the most convenient is the so-called Q-meter. A modest but very useful instrument of this type is described in the present article.

Basically, the Q-meter permits measurements on inductors and capacitors by indicating their behaviour at and near electrical resonance, and this being the case some fundamental knowledge of the phenomenon of resonance is essential both in order to understand instrument operation and in order to use it efficiently and effectively. Before introducing the instrument itself, it may therefore be worthwhile to review briefly the basic concepts associated with resonance.

When inductance and capacitance are associated together in a circuit, there is natural tendency for a portion of any energy present in the circuit to be stored alternately in, and transferred periodically between, a magnetic field associated with the inductance and an electric field associated with the capacitance. The frequency at which this energy oscillation tends to take place is known as the **natural resonant frequency** of the circuit, and is determined by the values of the circuit inductance and capacitance.

The resonant frequency of such a circuit can be found to an accuracy quite sufficient for most practical purposes using the expression

$$F_0 = \frac{1}{2\pi\sqrt{LC}} \dots (1)$$

where  $F_0$  is the resonant frequency in Hertz,  $L$  is the inductance in Henries, and  $C$  is the capacitance in Farads.

The way in which such a resonance may influence the operation of a circuit as a whole depends upon the effective position of the inductance and capacitance components, with respect both to each other and to the remainder of the circuit. This is most clearly illustrated in circuits where the inductance and capacitance are "lumped," or for practical purposes present solely as distinct inductor and capacitor elements.

In cases where an inductor and a capacitor are effectively connected in series with each other relative to the "input" or "output" of the circuit, or both, there is an effective reduction in their combined AC impedance in the vicinity of resonance, and this is usually taken as a characteristic of **series resonance**. On the other hand, if an inductor and capacitor are effectively in parallel relative to the circuit "input" or "output," or both, there is an effective magnification of their combined AC impedance in the vicinity of resonance, and this is usually described as **parallel resonance** or **antiresonance**.

It is important to realise that series and parallel resonance are, in fact, only complementary manifestations of the same basic effect. Because of this, and despite certain second-order differences between the two, both may be described for practical purposes quite accurately by the expression of figure (1) and those which follow.

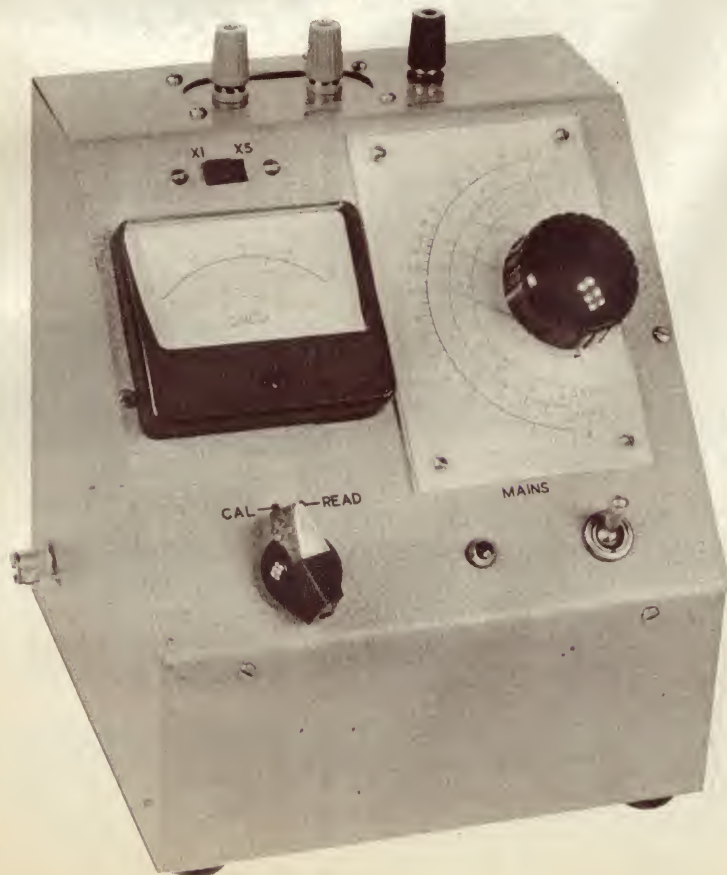

## SPECIFICATIONS

An economy solid state instrument designed to be used in conjunction with a modulated RF signal generator or test oscillator for the convenient measurement of Q-factor, inductance and self-capacitance of inductors, and the value of small capacitors, at frequencies between approximately 200KHz and 30MHz.

The instrument requires approximately 80-100mV of RF input, modulated at approximately 30 per cent at a modulating frequency of between 400Hz and 1KHz. Input impedance is approximately 600 ohms.

The internal resonating capacitor is variable between 25-415pF, and is calibrated in terms of  $C$ ,  $(X.f)$  and  $(L.f^2)$ . The Q-factor measuring range of the instrument is from below 20 to above 500.



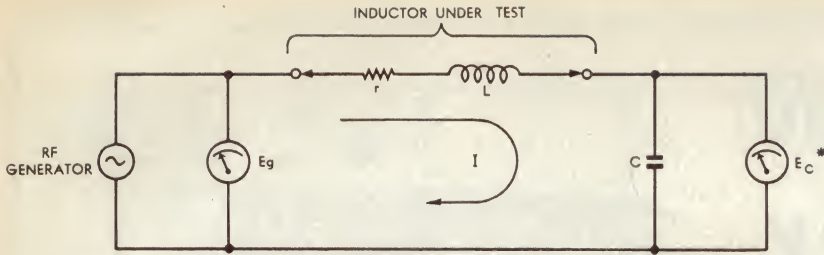

AT RESONANCE  $X_L + (-X_C) = 0$

SO  $I = I_0 = \frac{E_g}{r}$

I.E.,  $E_g = r \cdot I_0$

BUT  $|E_C| = |X_C| \cdot I_0$

$= X_0 \cdot I_0$

$\therefore \frac{|E_C|}{E_g} = \frac{X_0 \cdot X_0}{r \cdot X_0} = \frac{X_0}{r} = Q$

\* ASSUMED INFINITELY HIGH IMPEDANCE METER

Figure 1: BASIC PRINCIPLE OF THE Q-METER

In both cases resonance takes place at a frequency where the AC impedance of the inductor, a positive reactance, is equal in magnitude to that of the capacitor — which is a negative reactance. In other words, there is cancelling of the two reactances  $X_L$  and  $X_C$ , where  $X_L$  is the inductive reactance, given by

$$X_L = \omega L \quad \dots (2)$$

and  $X_C$  is the capacitive reactance, given by

$$X_C = -\frac{1}{\omega C} \quad \dots (3)$$

Here  $X_L$  and  $X_C$  are in ohms (reactive),  $L$  and  $C$  are in Henries and Farads as before, and  $\omega$  is "angular frequency" — equal to  $2\pi \cdot F$ , where  $F$  is the frequency in Hertz.

From (2) and (3) it may be seen that inductive reactance is zero at zero frequency (DC), and rises directly proportional to frequency, while capacitive reactance is infinitely high but negative at zero frequency, and falls inversely proportional to frequency. For any combination of an inductor and a capacitor there will thus be a frequency at which the reactances of the two will be equal and opposite, and this in fact is the resonant frequency given by expression (1).

Because of the mutual reactance cancellation, the impedance of a "perfect" inductor and capacitor combination connected effectively in series would fall at resonance to zero — a short circuit. However practical inductors and capacitors are not perfect but have losses; inductors have a finite resistance, and capacitors a finite leakage and series resistance. Thus the impedance of practical series inductor-capacitor "tuned circuits" does not fall at resonance to zero, but rather to a finite low value "dip" determined by losses.

Similarly the impedance of a "perfect" parallel tuned circuit would at resonance rise to infinity, whereas with practical inductors and capacitors it rises to a peak which is again determined by the circuit losses.

In both series and parallel resonant circuits the effective circuit losses determine not only the extent of the impedance dip or peak, but also—and

often equally, if not more importantly — the "sharpness" of these effects. Hence in a twofold manner the performance of a resonant circuit is very much determined by the effective losses.

A very useful measure of the general "performance" of a resonant circuit, and one which takes the circuit losses into account is the Q-factor, otherwise called the "quality factor" or simply the "Q" of the circuit. Probably the expressions most often used to find Q-factor are

$$Q = \frac{X_0}{r} \quad \dots (4)$$

$$\text{and } Q = \frac{R}{X_0} \quad \dots (5)$$

Here  $X_0$  is the magnitude of the circuit reactances at resonance (equal to either  $X_L$  or  $X_C$ , as both are equal), and  $r$  and  $R$  are alternative representations of the circuit losses. The former,  $r$ , represents the losses considered as lumped into a hypothetical series resistance, while  $R$  alternatively represents the losses considered as lumped into a hypothetical parallel resistance. As this might suggest, expression (4) is usually most appropriate for series resonance, and expression (5) for parallel resonance.

At the present state of the electronic art it is not difficult to produce capacitors with leakage and series resistance losses kept to an extremely low level; however the best inductors which can be produced, while having low losses, are still relatively lossy in comparison. As a result the losses in most practical resonant circuits are almost completely associated with the inductor.

Because of this, it is common practice to assume that the capacitor of a resonant circuit is "perfect," and that the Q-factor of the circuit is determined solely by the inductor. The Q-factor of the circuit thus becomes identified with the inductor, and in fact it is quite common to speak of the "Q-factor of the inductor." The effective Q-factor of an inductor tends to vary with frequency, as in practice many of the losses are frequency dependent.

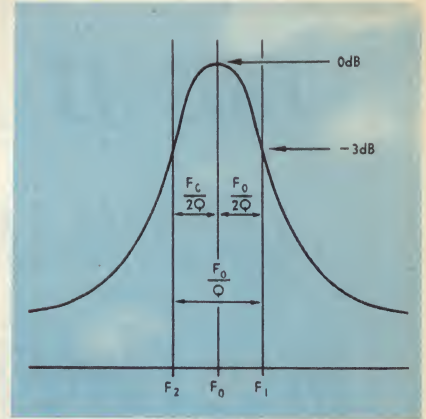

Figure 2: INCREMENTAL FREQUENCY METHOD

The Q-meter is used to measure the effective Q-factor of an inductor at any particular frequency by arranging for it to form part of a series resonant circuit at that frequency, the behaviour of the circuit being arranged to directly indicate the inductor Q-factor. The basic circuit and relationships used are shown in figure 1.

It may be seen that when capacitor  $C$  is adjusted for resonance at the particular frequency of interest,  $X_L$  and  $X_C$  effectively cancel so that the current  $I_0$  is determined only by  $E_g$  and the losses represented by  $r$ . Thus we can write that  $I_0 = E_g/r$ , or by rearrangement  $E_g = I_0 \cdot r$ .

While the reactances of the circuit do not determine the current  $I_0$ , this current nevertheless flows through them, and voltages are developed across both  $L$  and  $C$ . The voltages across each can be many times higher than the generator voltage  $E_g$ , but the two are opposite in polarity because of the opposite types of reactance. A very high impedance voltmeter connected across  $C$  will at resonance indicate  $E_C$ , whose magnitude will be equal to  $(X_0 \cdot I_0)$ , the product of the reactance and the current.

From the foregoing  $E_g$  is at resonance proportional to  $(I_0 \cdot r)$ , while  $E_C$  is at the same time proportional to  $(I_0 \cdot X_0)$ ; hence by taking the ratio between the two ( $E_C/E_g$ ), the common factor  $I_0$  can be cancelled to leave  $X_0/r$ . This may be seen from expression (4) to be equivalent to the Q-factor of the circuit. In other words the Q-factor may be found simply by taking the ratio between the capacitor voltage and the generator voltage, at resonance.

Although it may be seen to be basically quite simple and straightforward, Q-factor measurement is in practice subject to two quite significant sources of error. One arises because the idealised test circuit of figure 1 cannot be realised in a practical instrument: it is in general not possible to achieve an RF generator with zero source impedance, as assumed in figure 1, or to provide an infinitely high impedance metering circuit for the measurement of  $E_C$ .

The second source of error is perhaps more subtle, arising because all practical inductors have inherent self-



# THIS IS NO ORDINARY MULTIMETER!



The Fluke 853A has proved itself a most versatile general purpose instrument or laboratory sub-standard.

In the direct mode this instrument is used like any other multimeter. It has the added convenience of one linear scale for all measurements including ohms. Accuracy is 2 per cent DC and ohms 2 per cent AC.

In the differential mode accuracy is increased up to 10 times, resolution 100 times. The instrument then has an incredibly wide range of measuring capabilities as follows:

The instrument operates from inbuilt batteries or 240 volts 50Hz and is well protected from overload.

VOLTS: 1 mv to 1110 volts AC and DC

AMPS: .1 microamp to 11.10 amps AC and DC

OHMS: .1 ohm to 111.0 megohms

ACCURACY: .2 per cent DC and ohms .5 per cent AC (for a minimum of 12 months)  
PRICE \$465.00 EX-STOCK

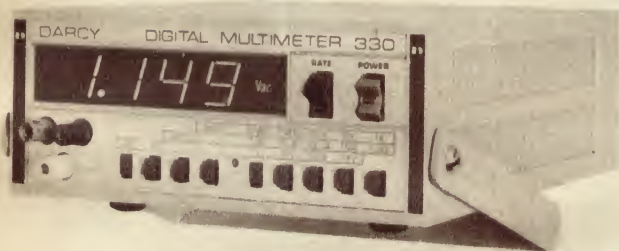

## The New Darcy DM330 Digital Multimeter

### DM330 Basic Specifications

**Display:** 3 full digits, reads 1500 at full scale. Polarity, range, and units. With AC option — AC volts.

**Ranges:** DC Volts:  $\pm 1$  mv/digit to  $\pm 1000$ V full scale. DC input resistance, 10 meg $\Omega$  constant. DC current:  $\pm 1$   $\mu$ a/digit to  $\pm 10$ ma full scale (higher ranges optional).

Absolute maximum input current, 25ma on any range, or 30 times range, whichever is less.

AC volts (optional): 50 Hz to 10 KHz with 10 megohm input resistance shunted by 110 pF.

Resistance: 1 $\Omega$ /digit to 10 megohms, full scale.

Maximum voltage across unknown resistor is 10v DC at full scale.

**Ranging:** Pushbutton selected.

**Accuracy (all ranges):**  $\pm 0.1\%$  of reading  $\pm 1$  digit on DC, K $\Omega$  and current functions. 1%  $\pm 1$  digit on AC Volts.\*

**Settling Time:** .1 sec to within .1% of full scale on DC, K $\Omega$  and current functions.

**Normal Mode Rejection:** Infinite at 50 Hz and multiples thereof.

**Common Mode Rejection:**  $> 100$  dB up to 1 KHz with 1 K $\Omega$  source imbalance.  $> 120$  dB at DC.

**Operating Temperature:** 0°C to +55°C.

**Power Requirements:** 115 or 230 Vrms (specify at time of order), 47-440 Hz, 15 watts.

**Input Isolation From Earth Ground:** 500V DC or peak AC.

**Weight:** 7 $\frac{1}{2}$ lb.

**Dimensions:** 8 $\frac{1}{2}$ " wide x 3 $\frac{1}{2}$ " high (3 $\frac{1}{2}$ " with rubber feet) x 12" long.

\* Over the temperature range of 15°C to 35°C.

Current through unknown resistor	Resistance range
1 $\mu$ a	10 meg
10 $\mu$ a	1 meg
100 $\mu$ a	100K
1ma	10K
10ma	1K

Price without AC option \$369.00

Price with AC option \$409.00  
ex-stock

For more information contact:

**ELMEASCO**

**Instruments Pty. Ltd.**

P.O. Box 334, BROOKVALE, N.S.W. 2100. Tel. 93-7944

P.O. Box 213, MT. WAVERLEY, VIC. 3149. Tel. 82-6159



capacitance. The effect of such self-capacitance is to provide, in "hidden" form, part of the capacitance necessary to resonate with the inductor at the measurement frequency. Hence the external capacitor  $C$  will no longer represent the total capacitance of the resonant circuit, and the validity of the measurement will suffer because  $E_c$  will no longer represent an accurate indication of  $(X_o, I_o)$ .

As will be explained shortly, the errors due to instrument limitations can be fairly accurately calculated and where they are significant corrections can be made. However, due to the distributed nature of inductor self-capacitance it is not really feasible to make valid corrections for the second source of error. As a result Q-factor measurements, even when performed on the most pretentious instruments, can only be relied upon to have an accuracy of between  $\pm 5\%$  and  $\pm 10\%$ . Q-factor is therefore best regarded in practice as a useful parameter indicating the relative "performance" of inductors and resonant circuits, rather than as an absolute figure.

Although the Q-meter cannot really make a valid correction for the effect of inductor self-capacitance upon the indicated Q-factor reading, it does permit a useful measurement to be made of the self-capacitance if this is considered as a hypothetical lumped shunt capacitor. To determine the value of this equivalent capacitor, measurements are made at two different frequencies, and the values of the external capacitor  $C$  required to achieve resonance in each case noted. The equivalent shunt capacitance is then calculated by comparing the ratio of the actual capacitance values to the theoretical ratio corresponding to the frequency ratio between the two frequencies used.

Hence if  $C_s$  represents the equivalent shunt capacitance of the inductor self-capacitance, and  $C_1$  and  $C_2$  the external capacitor values required to resonate at frequencies  $F_1$  and  $F_2$ , the value of  $C_s$  may be found by the expression

$$C_s = \frac{C_2 - (F_1/F_2)^2 C_1}{(F_1/F_2)^2 - 1} \dots (6)$$

If frequency  $F_1$  is chosen to be exactly twice  $F_2$ , the calculation is considerably reduced, as expression (6) then simplifies to

$$C_s = \frac{C_1 - 4C_2}{3} \dots (7)$$

There are a number of ways of measuring Q-factor which are alternatives to that shown in figure 1, and these are sometimes used. However, the two most commonly used of these alternative methods pose in many cases rather severe calibration requirements. One, the so-called Incremental Frequency method, requires an RF generator having high resolution and accuracy in frequency calibration; the other or Incremental Capacitance method requires high resolution and accuracy in the calibration of the resonating capacitor. The only exceptions to these requirements is in the case of measurement of very low-Q inductors.

The Incremental Frequency method of Q-factor measurement is based upon the relationship between Q-factor and

the "sharpness" of the dip or peak of impedance in the vicinity of resonance. It happens that for resonant circuits with a Q greater than 10 the frequency difference by which one may detune—in either direction—from resonance, before the depth of the impedance dip or peak has fallen by 3dB, is equal to a fraction  $1/2Q$  of the resonant frequency. This is illustrated in figure 2.

It may be seen that if the two frequencies at which the dip or peak has fallen by 3dB are designated  $F_1$  and  $F_2$ , then the difference between them—often called the "3dB bandwidth"—is equal to the simple ratio  $F_o/Q$ . The Q-factor can therefore be found by noting  $F_o$ ,  $F_1$  and  $F_2$ , and using the expression

$$Q = \frac{F_o}{F_1 - F_2} \dots (8)$$

With high-Q circuits all three of these frequencies will be very close

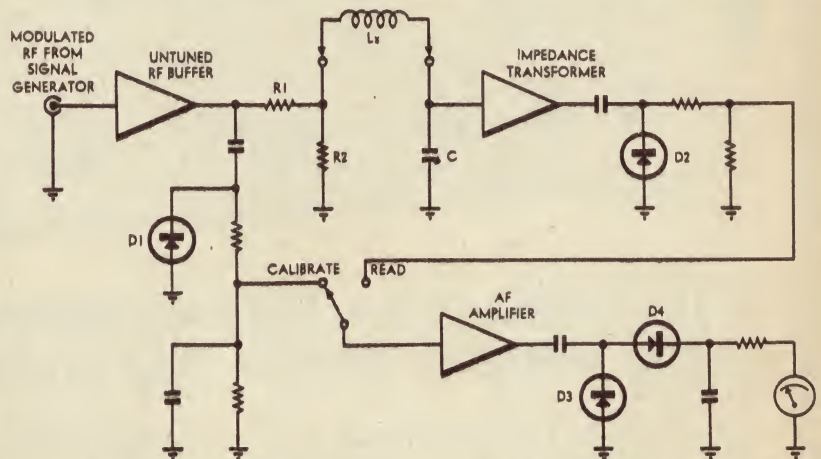

Figure 3: BLOCK DIAGRAM OF THE LOW-BUDGET Q-METER

together, and this explains why an RF generator with high frequency resolution is required.

The Incremental Capacitance method of Q-factor measurement is also based upon the relationship between Q-factor and the "sharpness" of resonance, but in this case the RF generator frequency is kept constant while the resonating capacitor is used to detune the resonant circuit itself to the points where the depth of the dip or peak has fallen by 3dB. Here if  $C_o$  is the value of the capacitor at resonance, and  $C_1$  and  $C_2$  the values for the 3dB down points, then Q is given by

$$Q = \frac{C_o}{C_1 - C_2} \dots (9)$$

Here again as the Q to be measured increases, the three capacitance values become closer together, explaining why this method generally requires the resonating capacitor to be calibrated with high resolution and accuracy. In this case there is also the complication that the self-capacitance of the inductor should strictly be taken into account; for this reason the Incremental Capacitance method tends to be less accurate than the Incremental Frequency method.

The block diagram of the practical Q-meter to be described in this article is shown in figure 3, and it may be

seen to differ in a number of ways from the basic arrangement of figure 1.

Perhaps the most obvious difference is that the instrument contains no RF signal generator of its own. Rather, it is designed to accept the RF output of an external generator or oscillator. This has been done purely for reasons of economy, and is based on the quite reasonable assumption that a conventional RF signal generator or oscillator will normally be available in any situation in which a Q-meter will be required. It may be noticed that the input RF to the instrument must be modulated, again a very reasonable requirement, and the reason for this will be explained shortly.

The modulated RF input to the instrument is amplified by an untuned wideband RF buffer, and then introduced to the Q-factor resonant measuring circuit by means of a resistive voltage divider formed by  $R_1$  and  $R_2$ . The purpose of the divider is to provide a reasonable AC loading imped-

ance to the buffer amplifier, while at the same time providing the Q-factor circuit with an effective generator source impedance which is as low as possible.

It may be remembered that in figure 1 it is assumed that the generator feeding the resonant circuit has zero source impedance, so that the only impedances involved are  $L$ ,  $C$  and the hypothetical loss resistance  $r$ . This is, of course, an idealised situation, as in practice any normal generator will have a finite source impedance, even though the value can be made extremely low.

The error arising from this practical requirement can be calculated, and it transpires that to correct for the effect of generator source impedance (considered as a pure resistance), the following expression may be used:

$$Q = \frac{X_o \cdot Q_{ind}}{X_o - R_s \cdot Q_{ind}} \dots (10)$$

Here  $Q$  represents the corrected Q-factor,  $Q_{ind}$  the indicated Q-factor (the  $Q$  actually measured), and  $R_s$  the effective generator resistance.  $X_o$ , as before, is the resonant reactance of the circuit.

From this expression it may be seen that the error caused by finite generator resistance depends upon the relative magnitude of  $X_o$  and  $(R_s \cdot Q_{ind})$ , increasing as these two quan-



# VALUE ENGINEERED!

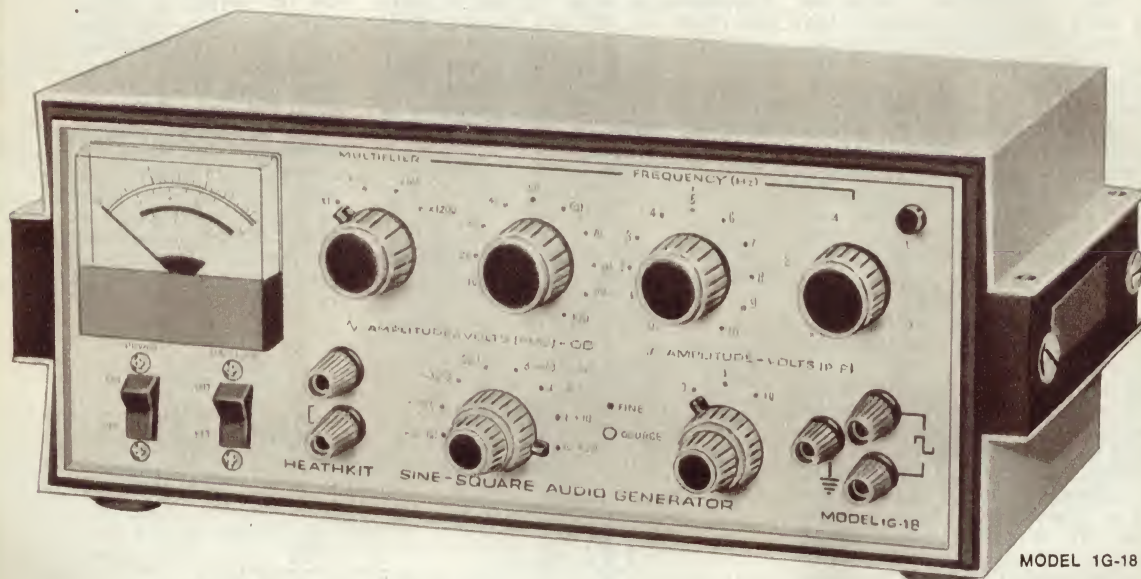

**This completely new Heath sine-square wave generator gives solid-state reliability, high accuracy at low cost!**

#### CHECK THESE SPECIFICATIONS

- Output available from 1 Hz to 100 kHz, using repeatable switch-selection
- Sine and square wave output available simultaneously
- Metered sine wave output
- Less than 0.1% sine wave distortion
- Less than 50 ns square wave rise time
- Floating outputs
- 8-position output attenuator for sine waves
- 3-position output attenuator for square waves
- New Heath instrumentation styling
- Kit or assembly form.

#### A PRECISION SOURCE OF SINE-SQUARE WAVES

The all solid-state circuitry delivers 5% accuracy through the wide range of 1 Hz to 100 kHz. The sine wave section features less than 0.1% distortion, through the audio range, 8 output voltage ranges from .003 to 10V, switch-selected internal 600 ohm load or external load and metered output of both voltage and dB. The square wave output has an excellent rise time of 50 ns, and three output voltage ranges from 0.1 to 10 volt P-P. Both sine and square waves are available simultaneously and switch selection of the frequency makes for fast operation and constant repeatability. New Heathkit styling makes the 1G-18 easy to use, easy to service, and the circuit board construction gives long, trouble-free life.

FOR FULL DETAILS CONTACT THE INSTRUMENTATION SPECIALISTS



**WARBURTON FRANKI**

ADELAIDE: 56-7333. BRISBANE: 51-5121. HOBART: 2-1841. LAUNCESTON: 2-1218. MELBOURNE: 69-0151. MOUNT GAMBIER: 2-3841. NEWCASTLE WEST: 61-4077. PERTH: 8-4131. SYDNEY: 29-1111. WOLLONGONG: 2-5444.







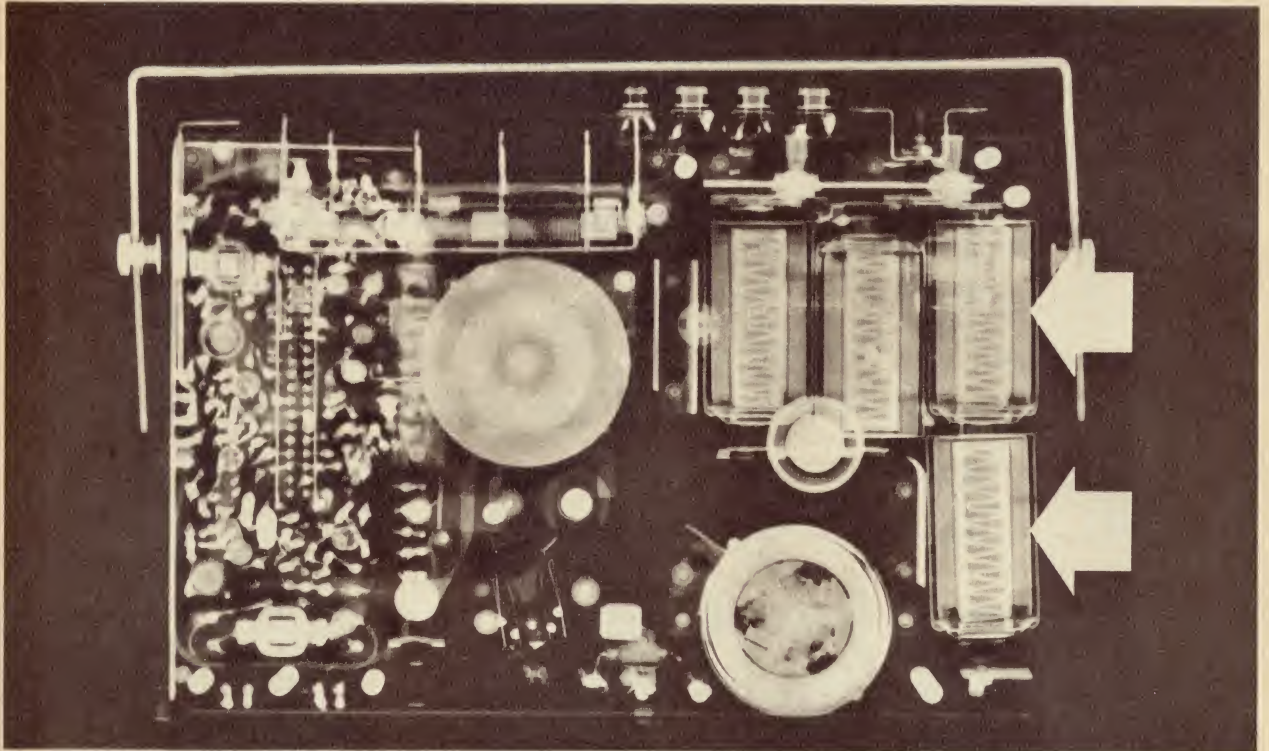

**The more they put into tape recorders**

**the more you need Duracell®**

They put in interlocks to give you sound-on-sound. Automatic shut-offs to save you tape. VU meters, reset counters, automatic level controls—all built-in. Today's portable tape recorders have everything. But it takes heavy-duty batteries to run them. Many manufacturers now recommend Duracell. Duracell, the long distance power cells, pack a maximum of power in a minimum of space.

Inside its steel-jacketed body are almost a dozen patented advances — power cores, special seals and electrolytes. And they all work to stand up to the heavy drains of tape-drive motors. Keep voltage levels high for precise amplifier operation. Hold their power for years. Ask for Duracell—the long distance power cells — wherever batteries are sold.

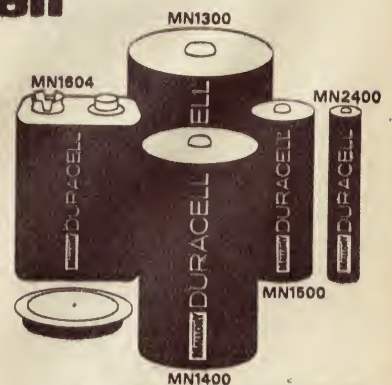

**DURACELL. THE LONG DISTANCE POWER CELL  
STILL GOING STRONG LONG AFTER ORDINARY BATTERIES ARE DEAD.**

Trade enquiries to Mallory Batteries (Australasia) Pty. Ltd., marketers of Duracell 439 2544

**MALLORY**

Registered trademark of  
P. R. Mallory & Co. Inc.

MB2998/68



times, providing the higher or "X5" measuring range.

The effective generator resistance seen by the resonant circuit for the two measuring ranges is 4.6 ohms and 0.92 ohms for the X1 and X5 ranges respectively, and these figures may be used for  $R_s$  if the measurements made by the instrument are to be corrected using expression (10). In general such corrections will normally only be necessary when measuring low-value inductors at medium-to-low frequencies on the X1 range.

The resonating capacitor used in the instrument is a standard miniature single-gang 10-415pF variable unit. The connections between the capacitor, the inductor connection terminals and the injection divider resistors are kept as short as possible, and where feasible are made using 5/16in brass strip for rigidity and low inductance.

An earthed third test terminal is provided on the instrument to permit measurement of small capacitors by the method of substitution. This simply involves the use of a convenient inductor resonating at a convenient frequency with the adjustable resonating capacitor when the latter is set near to its maximum value of 400pF. The capacitor dial reading is noted, and then the unknown capacitor connected in parallel with the internal capacitor via the appropriate terminals. The new, lower, setting of the adjustable capacitor to restore resonance then indicates the value of the unknown capacitor, by subtraction from the first reading. Capacitors up to approximately 375pF may be measured in this way.

The impedance transformer stage employs a type 2N5459 (MPF105) N-channel JFET, which is connected as a source-follower. The gate biasing network is bootstrapped back to the source, ensuring that the stage has a very high input impedance for low loading of the tuning capacitor. The response of the stage is within about 1dB to approximately 30MHz, so that it introduces negligible error.

The diode detector used to measure  $E_g$  for the "cal" function of the instrument is a standard shunt circuit using an OA91 or similar germanium diode. Series and shunt 33K resistors are used for isolation and DC return, and a 2.5mH RFC and .047uF capacitor for RF filtering.

The detector used to measure  $E_c$  for the "read" function is identical to the first with the exception that the DC return resistance is used to form a calibration divider. The divider can be adjusted in a simple manner to compensate for the less-than-unity gain of the impedance transformer stage and for detector differences, and this operation will be described later.

The AF amplifier employs two BC108, 2N3565 or similar NPN planar silicon transistors. The first is connected as a standard common-emitter amplifier stage, and the second as an emitter-follower providing impedance matching to the meter rectifier circuit. The meter used is a modest-cost 3-inch rectangular type of Japanese manufacture, designated type VP-2A and having a sensitivity of 50uA with 2K internal resistance.

Power supply for the instrument is derived from the AC mains via a simple half-wave rectifier using a silicon diode type BY126/50 or similar,

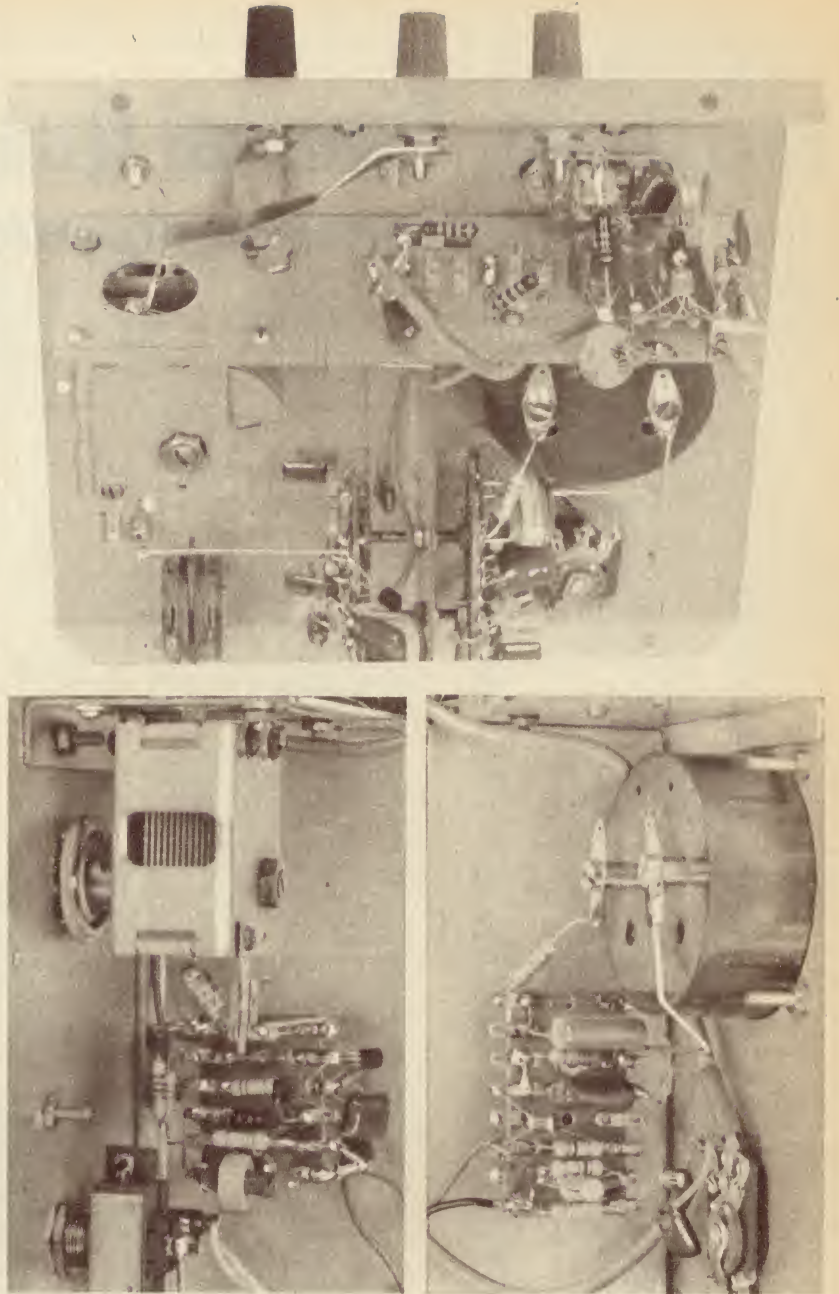

Three views of the rear of the front panel of the instrument, showing respectively the RF buffer and generator detector (top), the JFET impedance transformer and resonating capacitor (lower left), and the AF circuitry.

and a miniature 12.6V/150mA step-down transformer. A small 6V 40mA incandescent bezel lamp is connected in series with the rectifier output, serving as both pilot lamp and dropping resistor.

As may be seen from the photographs, the Q-meter is constructed in a standard 6½in x 7in x 7½in sloping-front utility box. The box is used with the wrap-over part of the front panel at the top of the case, this allowing all of the functional circuitry of the instrument to be mounted compactly and rigidly on the rear of the panel.

The three test terminals are mounted on the wrap-over section itself, with the two active terminals mounted on a small acrylic plate for low capacitance to chassis. Side by side on the upper portion of the front panel are

the Q-factor meter and the resonating capacitor tuning dial, with the X1-X5 slider switch immediately above the meter. Beneath the meter is the "Cal-Read" function switch, while the pilot bezel and mains switch are mounted adjacent to this and beneath the capacitor dial.

The capacitor dial is provided with three scales, the outer and principal of which is calibrated directly in terms of capacitance: 25-400pF. The remaining scales are calculated from this scale, and are provided to enable rapid and convenient determination of resonant reactance and the inductance of unknown coils.

The innermost scale is calibrated in terms of "X.f," and may be used to find resonant reactance (in ohms) simply by dividing by the resonant frequency in Hertz. The scale was pro-



# Mullard Special Quality Valves

## for Industrial Applications

This chart enables you to identify at a glance the Mullard Special Quality Valve equivalents of C.V. Services Types, American Types and Mullard Standard Types. In addition abridged

data is provided to assist in the selection of the Special Quality Valve most suited to your specific circuit requirements. Further information is available on request.

SPECIAL QUALITY PRODUCTION			DESCRIPTION	STANDARD PRODUCTION		
Mullard Type Number	Services Type Number	American Type Number		Mullard Type Number	Services Type Number	American Type Number
E55L	CV5808	8233	High slope wideband output pentode .. ..	—	—	—
E80CC	CV5989	6085	Double triode for industrial use .. ..	—	—	—
E80CF	—	7643	Triode pentode with separate cathodes .. ..	E80CF	CV5215	6BL8
E80F	CV2729	6084	Voltage amplifying pentode .. ..	—	—	—
E80L	—	6227	Output pentode .. ..	—	—	—
E81L	—	6686	Output pentode .. ..	—	—	—
E83F	—	6689	Voltage amplifying pentode .. ..	—	—	—
E86C	—	—	U.H.F. triode .. ..	EC86	—	6CM4
E88C	—	—	U.H.F. grounded grid triode .. ..	EC88	—	6DL4
E88CC	CV2492	6922	Double triode for use in computers and cascode circuits .. ..	ECC88	CV5358	6DJ8
E88CC/01	CV2493	—	Double triode for use in computers and cascode circuits .. ..	—	—	—
E90CC	CV5214	5920	Double triode for use in computers .. ..	—	—	—
E91H	—	6687	Dual control heptode for use as a gating valve .. ..	—	—	—
E92CC	—	—	Double triode for use in computers .. ..	—	—	—
E180CC	CV8431	7062	Double triode for use in computers .. ..	—	—	—
E180F	CV3998	6688	High slope wideband amplifying R.F. pentode .. ..	—	—	—
E182CC	CV5766	7119	Double triode for use in computers .. ..	—	—	—
E186F	—	7737	High slope wideband amplifying R.F. pentode .. ..	—	—	—
E188CC	CV5354	7308	Double triode for use as cascode amplifier .. ..	—	—	—
E280F	—	7722	High slope wideband amplifying R.F. pentode .. ..	—	—	—
E288CC	—	—	Double triode .. ..	—	—	—
E810F	CV5809	7788	High slope wideband amplifying pentode .. ..	—	—	—
EC1000	—	8254	Subminiature triode for use in measurement probes .. ..	—	—	—
ECC2000	—	—	Double triode for use as V.H.F. cascode amplifier .. ..	—	—	—
M8079	CV4025	‡6058	Double diode with separate cathodes .. ..	EB91	CV140	—
M8080	CV4058	‡6100, 6C4WA	R.F. power triode .. ..	EC90	CV133	6C4
M8081	CV4031	‡6101, 6J6WA	V.H.F. double triode with common cathode .. ..	ECC91	CV858	6J6
M8082	CV4063	‡6516	Output pentode .. ..	EL91	CV136	—
M8083	CV4014	‡6064	R.F. pentode with separate g3 .. ..	EF91	CV138	—
M8091	CV4044	‡6443	Half-wave rectifier designed for operation at high altitudes .. ..	EY84	CV2235	—
M8096	CV4039	‡6062	V.H.F. power tetrode .. ..	QV03-12	CV2129	5763
M8097	CV4059	—	Low impedance diode with medium $\mu$ triode .. ..	EAC91	CV137	—
M8099	CV4070	—	Triode for use as grounded grid amplifier .. ..	EC91	CV417	—
M8100	CV4010	‡5654/6AK5W/6096	Low noise, R.F. pentode .. ..	EF95	CV850	6AK5
M8136	CV4003	‡6189/12AU7WA	Low $\mu$ double triode .. ..	ECC82	CV491	12AU7
M8137	CV4004	‡6057	High $\mu$ double triode .. ..	ECC83	CV492	12AX7
M8161	CV4015	‡6065	Variable $\mu$ R.F. pentode .. ..	EF92	CV131	—
M8162	CV4024	‡12AT7WA	Medium $\mu$ double triode .. ..	ECC81	CV455	12AT7
M8195	CV4085	—	Low microphony, low hum A.F. voltage amplifying pentode .. ..	EF86	CV2901	—
M8196	CV4011	‡5725/6AS6W	Dual control pentode .. ..	6AS6	CV2522	6AS6
M8212	CV4007	‡5726/6AL5W/6097	Double diode with separate cathodes .. ..	6AL5	CV283	6AL5
M8248	CV5311	‡6J4WA	U.H.F. grounded grid triode .. ..	EC98	—	‡6J4

‡The American types shown in this chart have the same electrical characteristics as the appropriate Mullard Special Quality type and they may, in general, be regarded as interchangeable. In the case of those types marked ‡ there are, however, certain differences in the test specifications.



### Mullard-Australia Pty. Ltd.

35-43 CLARENCE STREET, SYDNEY, N.S.W. 2000. PHONE: 29 2006  
 123 VICTORIA PARADE, COLLINGWOOD, VIC. 3066. PHONE: 41 6644  
 ST. PAUL'S TCE. AND LIGHT ST., BOWEN HILLS, QLD. 4066. PHONE: 51 5151

Associated with MULLARD LIMITED, LONDON

M220



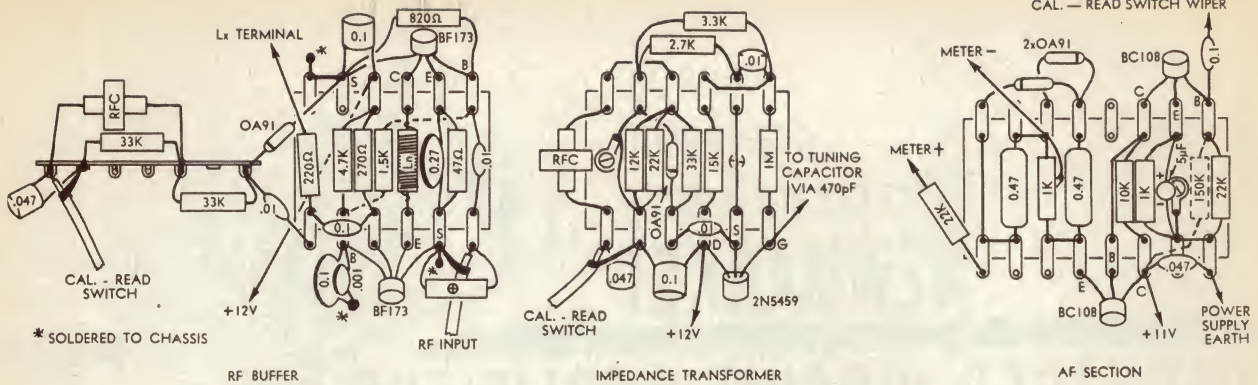

Above are three diagrams showing the wiring of the main sections of the instrument, to aid constructors in duplicating the layout of the prototype.

duced by calculation from the relationship

$$X.f = \frac{1}{2\pi C} \dots (11)$$

and is calibrated in units of ( $\Omega \cdot \text{Hz} \times 10^9$ ).

The central scale is calibrated in terms of "L.f<sup>2</sup>," and may be used to find the value of an unknown inductor (in Henries) by dividing by the square of the resonant frequency in Hertz. This scale was also produced by calculation, in this case using the relationship

$$L.Fo^2 = \frac{1}{4\pi^2 C} \dots (12)$$

and is accordingly calibrated in units of ( $\text{H} \cdot \text{Hz}^2 \times 10^9$ ).

Because of stray capacitance and wiring inductance variations, the capacitor scales of each instrument should ideally be calibrated individually. However, the scales produced for the prototype will probably be sufficiently close for many practical purposes, providing constructors use the same type of variable capacitor (Roblan type RMG-1, 10-415pF) and copy the prototype layout. Photographic copies of the original dial scales will be made available via the Information Service.

Also available will be copies of the meter face, which has a non-linear Q-factor scale reading 20-100 with a reference —3dB mark (for bandwidth and Incremental Frequency Q-factor measurements, if desired), together with a calibration scale showing "Cal" and "Cal X2" settings. (The last-named setting allows the effective generator input  $E_g$  to be set to half its normal value, thus effectively doubling the range of each of the normal Q-factor ranges.)

Inside the instrument, most of the RF circuitry is supported by a horizontal metal shield plate mounted behind the front panel between the slider switch and the meter. The RF buffer amplifier components are supported on a 6-lug section of miniature resistor panel mounted on the plate immediately behind the slider switch, keeping the injection divider resistor wiring as short as would be feasible. Adjacent to the output end of the buffer is the calibration detector circuitry, supported by a miniature 7-lug tagstrip.

The resonating capacitor is suspended beneath the shield plate, with the brass strip connection between the stator and the centre test terminal passing through a 7/8in clearance hole. The earthed test terminal is bonded to the shield plate via a second

brass strip, to ensure low series inductance.

The JFET impedance transformer and "read" detector, and the AF amplifier and rectifier are mounted on sections of miniature resistor panel supported on either side of a second vertical shield plate which is bolted to both the front panel and the horizontal shield, adjacent to the meter. This layout was chosen to ensure that unwanted coupling between the RF and AF circuitry was kept to a very low level.

Most of the wiring details of the impedance transformer and AF circuitry should be visible from the photographs, and from the wiring diagrams. It may be seen that the only component of the JFET section not mounted on the 6-lug section of miniature resistor panel is the 470pF input coupling capacitor, which is supported by a miniature 2-lug tagstrip mounted on the resonating capacitor frame.

The section of miniature resistor panel used to support the AF amplifier and meter rectifier circuitry is 8 lugs long, and the only components not wholly supported by the panel are the 0.1μF input coupling capa-

tor and the 22K meter series resistor. In each case these components are supported at one end by the panel, and at the other by the function switch and meter lug respectively.

We have prepared and present on these pages wiring diagrams of the three main circuit sections of the Q-meter, and using these in conjunction with the photographs constructors should have little difficulty in virtually duplicating the prototype instrument. The usual precautions apply when soldering in the components; particular care should be taken to avoid overheating those in the RF wiring, where the pigtailed are kept short to reduce circuit losses.

Two critical points should be noted. One is that the base of the second RF buffer transistor is bypassed as directly as possible to the horizontal shield plate, using two ceramic capacitors as shown, and with their pigtailed cut as short as possible. The second point is that the leads from the two detectors to the function switch must be run in shielded cable, with the shield braids earthed at the detector ends only.

As shown in one of the photographs, the power supply circuitry is mounted in the lower rear of the case. The

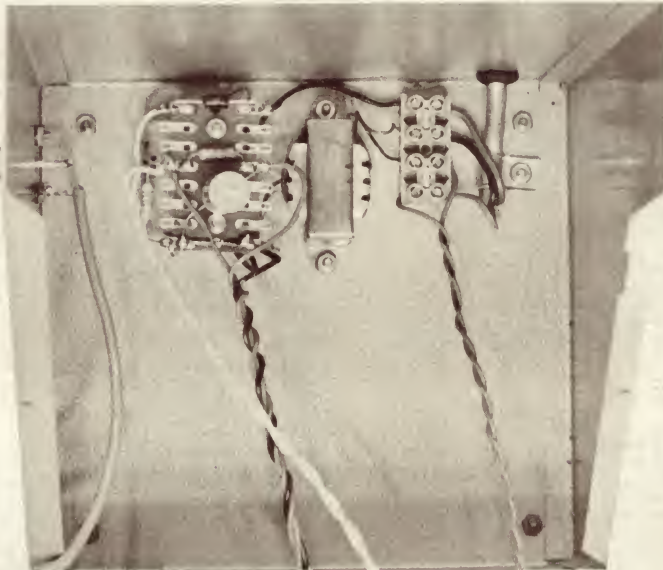

A view of the interior of the rear of the case. Constructors should take special care to fit a grommet on the mains cord entry and to clamp the cord after entry to prevent strain on the connections.



reliable  
pre-tested  
tight performance  
**NEWMARKET**

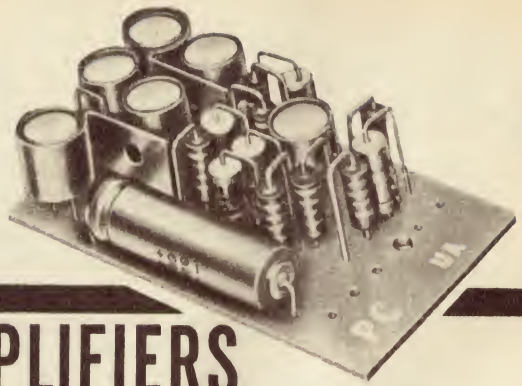

## PACKAGED CIRCUIT AMPLIFIERS

The Newmarket PC range provides *Development Engineers* with reliable pre-tested units of tight performance specifications to incorporate in any equipment at minimum cost. Use of such units not only obviates the need to develop purpose-made amplifiers for every job, but cuts down the number of small

components that company *Buyers* have to buy and maintain in stock. Each unit is guaranteed for 12 months and replacement units are supplied if any fault develops. Our guarantee also enables the manufacturer to guarantee his product to the ultimate user.

### some applications

#### MODEL No. PC 1

Stethoscope Amplifier.  
General Purpose Audio Amplifiers and Drivers.  
Intercomm Amplifier.  
Telephone Amplifiers.  
Laboratory Instrument Amplifiers.  
Back Projector Audio Amplifiers.  
Loudspeaker Amplifier.  
Hospital Board Control Units Intercomm Amplifiers.

#### MODEL No. PC 2

Modulator Driver Stage.  
Intercomm.  
Church Hearing Aid Amplifier.  
Office Dictating Machines.  
Door-Caller Monitor Amplifier.  
Inter-Office Communication Amplifier.  
Tape Replay Amplifier.  
General Purpose Audio Amplifiers and Drivers.  
Telemetry Audio Amplifier.  
Radio Receiver Audio Amplifier.  
Telephone Amplifiers.  
Educational Equipment Audio Amplifiers.  
Laboratory Instrument Amplifiers.  
Language Laboratory Amplifiers.  
Tape Recording Amplifiers.  
TV Aerial Riggers Intercomm Amplifier.  
Loudspeaker Amplifier.  
Radio Concentrator.  
Mine Communication Amplifier.

#### MODEL No. PC 3

Disc Talking Book.  
DC Relay Driver.  
Telecommunications Conference Monitor Amplifier.  
Sound-level Meter Amplifier.  
Close Background Music Amplifier.

Sound Reinforcement Amplifier.  
General Purpose Audio Amplifiers and Drivers.  
Low Power Battery Stereo.  
VHF Communications Receiver Audio Amplifier.  
Radio Receiver Audio Amplifier.  
Telephone Amplifiers.  
Heating and Ventilating Control Amplifier.  
Laboratory Instrument Amplifiers.  
Museum Portable Commentary Equipment System.  
Radio Relay System Amplifier.  
Loudspeaker Amplifier.

#### MODEL No. PC 4

Battery Record Player.  
General Purpose Amplifiers and Drivers.  
Office Dictating Machines.  
Telephone Amplifiers.  
Pay TV Control Circuits Amplifier.  
Stereo Listening Booth Amplifiers.  
Laboratory Instruments Amplifiers.  
Loudspeaker Amplifier.  
Radio Relay System Amplifier.

#### MODEL No. PC 5 Plus

Salesman's Portable Cine Projector Audio Amp.  
Meter Type Galvanometer Amplifier.  
Helmet Intercomms: (a) Diving Suits,  
(b) Crash Helmets, (c) Pilots' Helmets.  
Car Radio Audio Amplifier.  
Communications Receiver Audio Amplifier.  
Lecturer Non-interruption Monitor.  
Erotogetic Amplifier.  
Small Public Address Portable Amplifier.  
Servo Amplifier (Hydraulic Valve Control).  
General Purpose Amplifier.  
Fault Finding Tone Detector Amplifier.  
Tape Replay Amplifier (Aircraft Ground Equipment).  
Automation Drive Amplifiers.  
Colour Television Receiver Audio Amplifier.  
Tape Recorder Replay Amplifier.  
Hi-Fi Amplifier.

Vibration Test Amplifiers.  
Telephone Intercomm System.  
Office Dictating Machines.  
Telephone Amplifiers.  
Fire Detection Equipment Amplifier.  
Mines Telephones Amplifiers.  
Cigarette Manufacturer Production Test  
Equipment Amp.  
Instrument Audio Amplifier.  
Sound Reinforcement Intercomm Amplifier.  
Null Detector Instrument Amplifier.  
Public Address Amplifier.  
Mobile and Fixed Transmitter Modulators.  
Telephone System Audio Amplifier.  
High Power P.A. Driver Amplifier.  
TV Camera Channel Talk Back Amplifier.  
Sound Intercomm Amplifier.  
Industrial Test Instrument Amplifier.  
Burglar Alarm Audio Amplifiers.  
Transceiver Audio Amplifiers.  
Laboratory Instrument Amplifiers.  
Airport Loudspeaking System Amplifier.  
Pocket Paging System Amplifier.  
Carrier System Mains Intercomm (Portaphone).  
Loudspeaker Amplifiers.  
Electronic Organ Power Amplifier.

#### MODEL No. PC 7 Plus

Tape Language Laboratory.  
Telephone Dictating Machine Amplifier.  
Automation Drive Amplifiers.  
Control Amplifier for Textile Machinery.  
Radio Receiver Audio Amplifier.  
TV Receiver Audio Amp.  
General Purpose Amplifier.  
Telephone Amplifier.  
Laboratory Instrument Amplifiers.  
Tape Language Laboratory Amplifier.  
Loudspeaker Amplifier.

### specification details

*Circuits are of transformerless, complementary symmetry type, operating off Standard Voltages. Can be wire-in or plug-in as required.*

PERFORMANCE DATA	PC1	PC2	PC3	PC4	PC5	PC7	PC9
Power Output mW	150	400	400	400	3W	800	Pre-amp
Input Sensitivity mV	50	1	5	150	5	5	1V
Input Impedance ohms	1.5K	1K	2.5K	220K	1.5K	1.5K	1M
Output Impedance ohms	40	15	15	15	3	8	600
Supply Voltage—volts	9	9	9	9	12	9	9
Typical Distortion %	2	3	3	3	3	3	1
Frequency Response	300-15K	200-12K	200-12K	200-12K	50-12K	50-12K	20-20K
Overall Dimensions	2 x 1	2½ x 1½	2½ x 1½	2½ x 1½	5½ x 1¾	3 x 1¾	2 x 1
All ¼ In. high							

**tecnic** **ELECTRONICS PTY. LTD.**

53 Carrington Road, Marrickville, N.S.W.  
18 Normanby St., South Melbourne, Vic.

**SYDNEY:** General Accessories Limited, 443 Concord Road, Rhodes 2138. **NEWCASTLE:** Martin de Launay Pty. Limited, King and Derby Streets, Newcastle 2300. **WOLLONGONG:** Electronic Parts Pty. Limited, Keira Street, Wollongong 2500. **MELBOURNE:** Radio Parts Pty. Limited, 562 Spencer Street; Warburton, Franki Limited, 220 Park Street 3000. **BRISBANE:** General Accessories Pty. Limited, 50 Little Edward Street 4000. **ADELAIDE:** General Accessories Pty. Limited, 81 Flinders Street 5000. **PERTH:** General Accessories Pty. Limited, 46 Milligan Street 6000.



## OPERATING THE Q-METER

Operation of the instrument is quite straightforward. The external RF generator is used to set the test frequency and to produce a full-scale reading in the "Cal" position of the function switch. With the inductor to be measured connected between the appropriate terminals, the function switch is then turned to the "Read" position and the resonating capacitor adjusted until the meter reading indicates a peak in response. The peak meter reading is then read directly in terms of the Q-factor of the inductor. Note that if the frequency must be changed in order to obtain resonance, it is necessary to return to the "Cal" position and check that the RF input has not been altered, before taking the reading.

If the reading obviously exceeds full-scale on the "X1" range, the slider switch may be moved to the "X5" position. Alternatively the function switch may be returned to the "Cal" position and the RF input reduced to the "Cal X2" setting, in which case the new reading obtained in the "Read" mode will need to be multiplied by 2. Obviously the latter alternative is only appropriate for inductors having a Q-factor between 100 and 200.

Generator source resistance error may be corrected using the values of  $R_s$  given earlier in the article, and substituting the appropriate value and that of  $X_o$  (obtained from the capacitor X.f scale) in expression (10). Similarly inductor self-capacitance may be found using expressions (6) or (7).

The lowest Q-factor reading which may be obtained on the instrument using the technique of figure 1 is 20, and this should be adequately low for most purposes. However, in situations where measurements must be made on inductors having a lower Q-factor than this, this can be done using the -3dB point provided on the meter face, and either the Incremental Frequency or Incremental Capacitance methods. But it should be noted that for inductors having a Q-factor below about 10, all of the normal methods of measurement are subject to considerable error, and have very little significance.

When the Incremental Frequency or Incremental Capacitance methods are used, the "Cal" mode and setting-up procedure are not required. The technique is simply one of switching to the "Read" mode, obtaining the resonant peak and then adjusting the RF input level for a full scale reading (100). The frequency or resonating capacitance are then altered up and down to find the -3dB points, after which the Q-factor may be calculated using expressions (8) or (9) as appropriate.

Measurement of small capacitors may be performed using a test inductor which resonates at a convenient frequency with the inbuilt resonating capacitor when the latter is set for near-maximum capacitance. Using the inductor and internal capacitor alone, the resonating capacitor is adjusted accurately for resonance and its capacitance noted. Then the capacitor to be measured is connected to the appropriate terminals, whereupon the internal capacitor will have to be reset to a lower value to restore the resonant condition. The amount by which it has to be reduced will be equal to the value of the external capacitor.

*The table printed above gives brief operating instructions for the instrument, and would be suitable for mounting on the rear of the case for convenient reference. If this is done it would be wise to employ a sheet of clear acrylic for protection.*

mains cable is clamped upon entry and terminated in a small section of "B-B" connector, with the miniature step-down transformer adjacent. On the far side of the latter is an 8-lug section of miniature resistor panel supporting most of the minor supply components. The RF input connector is mounted at the lower rear of the left-hand side of the box as viewed from the front.

When the instrument is completed, it should be calibrated in terms of Q-factor reading. This is done in the following quite simple manner, using a modulated RF signal generator or oscillator set for 30% modulation and an output frequency of around 300-400KHz.

Using ordinary hookup wire connect a temporary link between the output of the RF buffer amplifier (point "X" on the circuit) and the centre test terminal. Then set the resonating capacitor for minimum capacitance, and turn the function switch to the "Cal" position. With the RF generator connected it should then be possible to

adjust the RF input to produce a full scale reading on the meter; typically this will require something in the order of 80-100mV.

If the function switch is now turned to the "Read" position, the meter indication should drop to a value equivalent to "48" on the Q-factor scale. If the reading does not drop to this figure, the value of the calibrating resistor in the second detector circuit (marked with an asterisk on the main circuit diagram) should be altered to correct matters. Increasing the resistor value will increase the reading, while reducing the resistor value will have the opposite effect. When the correct reading is produced the temporary link should be removed.

The instrument can now be considered ready for use, unless of course it is desired to individually calibrate the resonating capacitor. In most cases this will probably not be possible, although constructors may be able to check the capacitance at individual points using one or more inductors of known value.

## up to ten times longer life



MAXELL Alkaline Dry Cell - this unique new design concept features high capacity and durability that surpasses the performance of the world's top dry cell batteries. The construction of the Maxell Alkaline Dry Cell differs greatly from conventional types of carbon ZINC cells. However, the Maxell Alkaline cells can be used where you normally use a carbon ZINC cell. MAXELL ALKALINE CELLS are especially suitable where there is a demand for increased current, combined with durability and little voltage drop. Even near the end of the cell life the discharge capacity is large and stabilized.

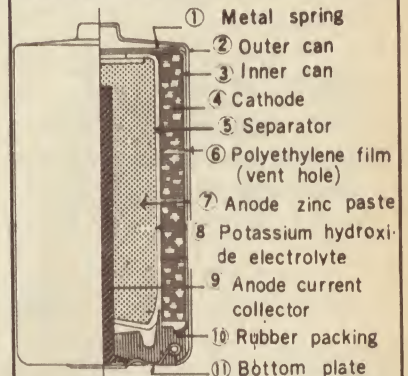

Exclusive new construction minimises leakage. Double cans are used and rubber sealing with the unique spring safety device. (see diagram)

Interior drying is prevented by hermetic sealing, therefore long storage periods are possible (over two years). Even then Maxell Alkaline cells are in the same condition as when they left the production line. These cells will withstand severe temperature changes. Rigid tests have shown extremely stabilized capacities from the low temperature of -4F to the high temperature of 150F at which temperatures dry cells would fail to operate satisfactorily.

### Prices:

AM1 .....	75c
AM2 .....	50c
AM3 .....	40c

Trade enquiries to

TASMANEX PTY. LTD.  
17 Parker Street SYDNEY 2000



# TRADE UP TO AKAI!



**AKAI X 360** —New Release—4 track; stereo-mono. Magnetic brake. Cross-field head. Automatic volume control (COMPUT-O-MATIC). Automatic dust minder. Automatic continuous reverse (REVERS-O-MATIC). 4 speeds, 3 motors. 4 heads. 50 W solid state amplifier. Tape lifter in fast forward and rewind operation. Sound on sound. Sound with sound. Sound over sound. ECHO.

## CHECK OUR AMAZINGLY LOW PRICES

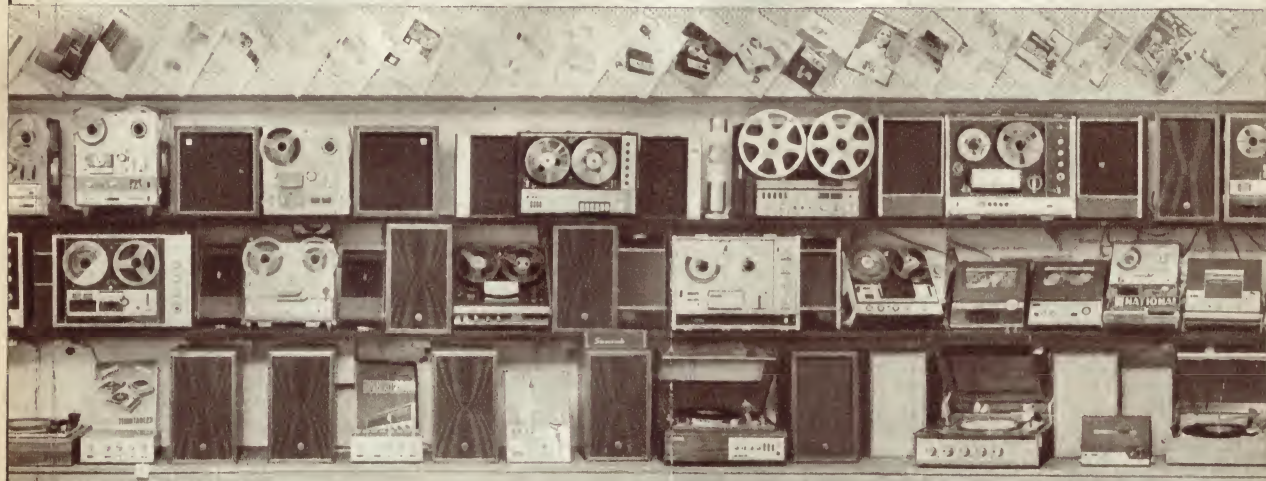

# DOUGLAS TRADING P/L

Inc. City Hi Fi — Tape Recorders (Vic.) — BJD Electronics  
191 BOURKE STREET, MELBOURNE 3000—PHONE 63-9321



# TRADE UP TO REVOX!



**REVOX A77** —New Release—Deck only or full recorder. 8 Watts RMS per channel. 30 CPS-20 KC $\pm$ 3 DB at 7 $\frac{1}{2}$  IPS. 3 motors-10 $\frac{1}{2}$ " spools. Plug in circuit cards. Silicon transistors. Electronically governed capstan motor. Remote control. 54 transistors. 34 diodes. Sound on sound. Multiplay-Echo. On/off Tape monitoring. N A B & I E C Equalization (Switchable).

## ON THE ENTIRE RANGE OF AKAI AND REVOX



# DOUGLAS TRADING P/L

Inc. City Hi Fi — Tape Recorders (Vic.) — BJD Electronics  
191 BOURKE STREET, MELBOURNE 3000—PHONE 63-9321



# Fundamentals of SOLID STATE



## Chapter 2

by Jamieson Rowe

Atoms in combination — energy interaction — crystalline solids and energy bands—the valence band—conductors and electrical conduction—insulators and semiconductors —the effect of excitation—electrons and holes—crystal conductivity and resistivity.

Having looked at the modern concept of atomic structure, and at what might be called the "internal" behaviour of individual atoms, let us now examine what happens when atoms link together to form molecules and "solid" matter. It should become apparent as we progress that knowledge of this "external" behaviour is essential for a clear understanding of electrical conduction.

We have seen that in an individual atom, the electrons surrounding the central nucleus can only occupy certain "allowed" orbits, each of which correspond to a particular value or level of total electron energy, and that in the unexcited or "ground" state the electrons of an atom are found occupying the orbits nearer the nucleus in numbers determined by the orbit capacities. We have also seen that in a practical situation involving light, heat and other forms of radiant energy, electrons are constantly transferred back and forth between allowed orbits as the atom absorbs and emits "lumps" or quanta of energy whose sizes correspond to the energy differences between the various levels.

Two individual and separate atoms of the same element will possess the same allowed orbit structure, or in other words the energy levels of their allowed orbits will be identical. Note that in saying this we make no reference to the electrons occupying the levels, but refer only to the allowed levels themselves. Hence it is not implied that at every instant of time each atom will have exactly the same excitation energy, with identical numbers of electrons at each level. In fact this would not be so even if their situations were equivalent, because the random nature of energy absorption and emission would produce instantaneous differences such that all we could say is that they had the same average excitation energy.

A most interesting thing happens if two such atoms are brought near to one another: the electric fields around the two nuclei interact in such a way that each of the allowed electron energy levels of both atoms progressively "splits" into a pair of levels (orbits), whose energy difference increases as the two atoms are brought closer together. At first sight, this may seem quite inexplicable; however a moment's

thought should show that it is no more so than many other similar effects with which the reader is likely to be familiar.

Recall, for example, that when two resonant circuits tuned separately to the same frequency are coupled together, they interact such that in the coupled state neither is resonant at the original frequency, but both are effectively resonant at two new adjacent frequencies whose separation depends upon the degree of coupling. It is this effect which produces the familiar "double humping" associated with large coupling factors.

Another example occurs in the case of loudspeakers fitted into tuned enclosures. Here a loudspeaker cone system and an enclosure, having the same resonant frequency when separated,

As one might expect, it is the highest or least negative electron energy levels of two atoms which first split as they are brought nearer, because these correspond to the largest allowed orbits. For the same reason it will be the level pairs produced by these levels which will be found most widely separated for any given distance or spacing between the two atomic nuclei. This is illustrated in figure 2.1, which shows the splitting of the various energy levels as a function of the nucleus spacing.

Note particularly that this diagram applies equally to either atom, and that in the interests of clarity only the first four levels are shown. It may be seen that for large spacing, the levels are unaltered from their "individual atom" values, but as the spacing decreases they split progressively from the higher levels. At a spacing distance  $D_1$ , for example, only the  $N=4$  level has split, while at a smaller spacing  $D_2$  both the  $N=3$  and  $N=2$  levels have split also but by smaller amounts. At a still smaller spacing  $D_3$ , the lower of the pair of levels corresponding to the  $N=4$  level has moved below the higher of the  $N=3$  pair. Such "overlapping"

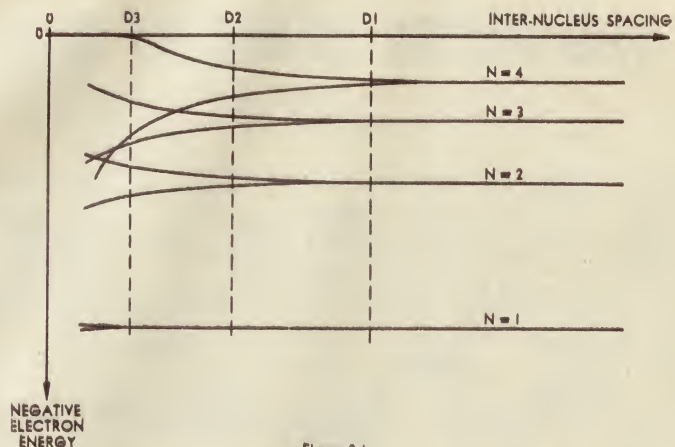

interact when together to produce the same sort of double resonance — which in this case is used to smooth the low-frequency response.

In fact, it is found that this sort of interaction effect is quite universal where oscillatory systems are concerned. Therefore it should not be surprising that it occurs between the allowed electron energy levels of "coupled" atoms, particularly as we have seen that each energy level corresponds to an orbit which represents a particular mode of "oscillation" associated with the wavelike aspect of electron behaviour.

occurs more and more as the spacing is reduced.

What does this mean? Simply that when two similar atoms are placed relatively near one another, their interaction effectively alters and increases the number of "allowed" orbits for the electrons surrounding each. Hence when the atoms, whose behaviour is represented by figure 2.1 are spaced at a distance  $D_2$  apart, each has two new allowed orbits in place of each of the orbits corresponding to its previous  $N=4$ ,  $N=3$  and  $N=2$  energy levels. As splitting occurs progressively from the highest levels down, this will also mean



that all of the higher levels not shown will also have split into two, so that each atom will have very many more allowed orbits than it would have had alone. (In fact the number of allowed orbits will have almost doubled, as in this example only the  $N=1$  level has remained unaltered at a spacing of  $D2$ .)

It so happens that, in the same way that the energy levels of two atoms split into pairs when they are brought together, the energy levels of larger numbers of relatively close atoms are found to split into a corresponding number of new levels. With three atoms, the levels each tend to split into triplets; with four atoms, into quadruplets, and so on.

Accordingly, if we have a lump of an element comprising a large number "M" of atoms regularly spaced at a particular distance, certain of the "individual" energy levels will be found to have split into the same large number of M new energy levels, forming bands. The number of levels which will have split into such bands, and the energy width of the bands, will depend upon the atomic spacing, with the higher levels splitting before the lower and to a greater extent.

An example may help in picturing this situation. A cube of metal measuring one centimetre on each side typically consists of something like  $10^{23}$  atoms — one-hundred-thousand-million-million-million. This means that in place of certain of the higher energy levels of an individual isolated atom of the metal concerned, each of the atoms of the metal cube will have bands each containing no less than  $10^{23}$  extremely closely spaced individual levels. A cube one-hundred-thousand times smaller in volume will similarly have  $10^{23}$  levels in each of the atomic bands—still a very large number!

In both cases the number of bands present, and their "width" in terms of energy levels, will depend as before only upon the inter-atomic spacing. In fact the number of bands and their width is exactly the same as the number of "paired" levels and the separation widths produced for the simple case of only two atoms, illustrated in figure 2.1. Hence, although the size of a lump of material determines the number of discrete levels making up each of the energy bands, it does not affect either the number or the width of the bands.

The type of atomic interaction which we have been considering occurs almost only in the "solid" state of matter, as opposed to the "liquid" and "gaseous" states, because it is only in the solid state that the spacing between atoms is sufficiently small and relatively fixed. And as one might expect, the solid materials whose behaviour most closely conforms to this picture are those in which the atoms are arranged in very regular 3-dimensional "lattice" patterns—the **crystalline solids**.

The electron energy relationships inside a typical crystal structure are illustrated in figure 2.2, which is a two-dimensional energy/distance representation of the same type as that for a single atom given previously in figure 1.3.

It may be noted that in this example the lattice spacing or distance between the atomic nuclei is such that the  $N=1$  and  $N=2$  energy levels have

remained unaltered, while the  $N=3$  and higher levels have split into the expected bands each comprising M closely spaced new levels. In fact overlapping of the  $N=5$  and higher bands has produced virtually a single "higher band," extending right up to the zero energy level. Such overlapping tends to occur with the higher levels in crystalline solids, both because the splitting is greater for these levels, and also because as we have seen previously the energy differences between the original atomic orbit levels decrease with increasing distance from the nucleus.

In this example the  $N=3$  band is shown as the valence band, which corresponds to the valence electron energy

energy levels represented in figure 2.2 by the  $N=1$  and  $N=2$  levels.

On the other hand, electrons having higher or less negative energy can occupy any of the many levels comprising the valence and higher bands, in which they are no longer the "property" of individual atoms but belong only to the crystal as a whole. Those whose energy places them within the valence band are thus "shared" equally by all the atoms of the crystal, and it is in fact these electrons which effectively bind the crystal together. Any electrons in the higher bands are even less restrained than these, having at the same time less negative potential energy and more kinetic energy, and

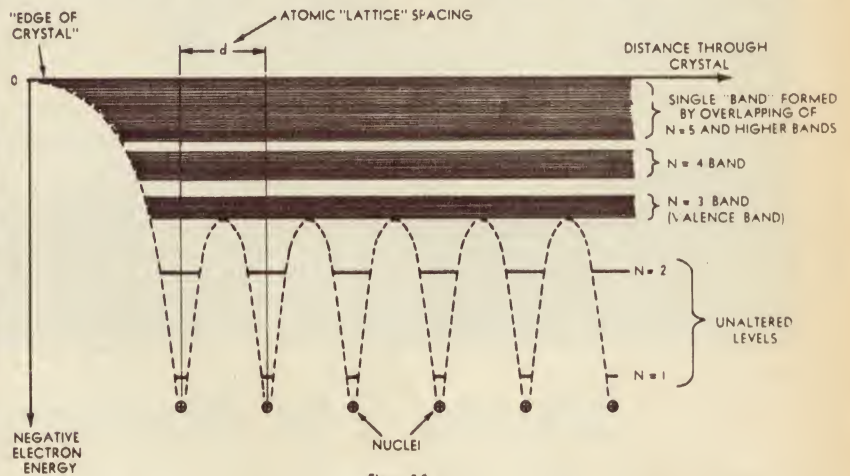

Figure 2.2

level of the individual atoms concerned. Although shown here as an isolated band, not overlapped by higher bands, the valence band is not necessarily so isolated, and is in fact overlapped in certain crystals.

As a result of the interactions between the atoms of the crystal lattice, only the walls of the electron energy wells (dashed lines) surrounding the nuclei at the edge of the crystal rise fully to the zero energy level, as they do with an isolated atom. For the nuclei inside the crystal, the well "walls" fuse and cancel at a somewhat lower level, as shown. The level at which they fuse is in fact very close to the valence band, and this has considerable importance.

It may be noted that below the fusion level, the original electron energy levels are unaltered, and that they are shown as before separately for each nucleus. Conversely above the fusion level, all levels have become bands, and are shown extending continuously throughout the lattice. The significance of these distinctions is that electrons occupying energy levels below the fusion level are influenced almost solely by the individual atomic nuclei, whereas electrons occupying the energy bands above the fusion level are virtually uninfluenced by single individual nuclei, and are effectively "common property."

In other words, this means firstly that electrons having low or more negative energy can exist in the crystal lattice only in orbits closely surrounding the individual nuclei. These are the highly bound "core electrons," and they will be those occupying orbits corresponding to the unaltered

these can accordingly move with increasing freedom anywhere inside the crystal.

It is those electrons in the "common property" valence and higher energy bands of a crystalline solid which are responsible for its electrical behaviour, and the part played in this regard by such electrons is very largely determined both by the relative positions of these bands, and by the distribution of electrons in them. Hence in order to gain an insight into electrical conduction in a crystal, we must look closely at both the bands themselves and the ways in which electrons can occupy them.

There are a number of different ways in which atoms can link or "bind" together to form crystal structures. Depending upon the type of atomic bond involved, and the size of the atoms, a particular crystal lattice will have a definite inter-atomic spacing, and thus an appropriate number of the atomic electron energy levels will be split into bands of appropriate width. The disposition of electrons in the allowed levels and bands will depend, as before, upon both their disposition in the ground state of an individual atom, and on the excitation energy of the atom concerned.

From this it may be appreciated that each crystal structure formed by the various elements will tend to have a different and unique overall energy pattern, with different energy band widths and spacing, and each different with respect to the number of electrons occupying the various levels and bands at a given temperature.

Despite this, it happens that most crystalline solids fall into only two



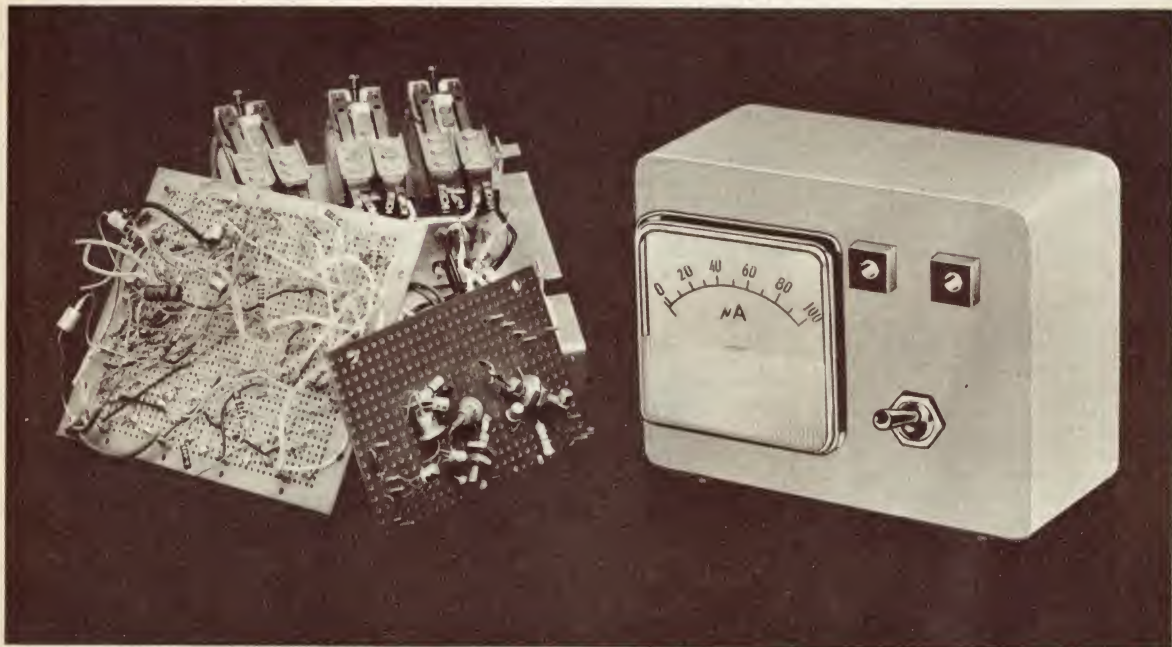

## Mess.... or Masterpiece

The difference is a \$3 Die-Cast Box

Sure it works, and it works well . . . mostly. But it looks messy. For just three dollars you can turn that mess into a masterpiece. These natty little aluminium STC Die-cast Boxes will house the most conventional or zany electronic gadgetry.

The five boxes in the STC 46R range can be used as rigid chassis for mounting in instrument cases, conveniently shaped junction boxes, compact test sets and other complete equipments. They feature

internal slots, for sliding in screens and printed circuit boards. Make your mess into a masterpiece with STC Die-Cast Boxes.

Available in five sizes selected to cater for most circuit sizes and compatible with ISEP Racking system (from 4¾ x 3¾ x 1 to 10¾ x 6¾ x 2").

For further information contact: Components Division, **Standard Telephones & Cables Pty. Limited**, Moorebank Ave., Liverpool, N.S.W. 2170. Phone Sydney 602 0333 or Phone Melbourne 480 1255, Brisbane 47 4311, Adelaide 51 3731, Perth 21 6461, Newcastle 61 5172, Wollongong 2 7974.



AN **ITT** worldwide telecommunications and electronics  
ASSOCIATE





broad categories when one considers the electron energy situation associated with the valence and higher energy bands. One of these situations applies in the case of metal crystals which are excellent electrical conductors; the other applies in the case of crystalline solids which are basically either semiconductors or insulators.

The first type of situation is basically that in which the valence electrons of the various atoms of the crystal do not completely fill the valence band in the ground state, as illustrated in figure 2.3.

This situation can arise if the electrons of an individual atom of the ele-

implies loss in kinetic energy, and falling of the electrons concerned to lower levels; yet the lower levels are filled. However, the converse process of electron acceleration is quite easy, because this involves the transfer of electrons to higher energy levels, and such levels are in this case readily available in the form of the remaining empty upper levels of the partly filled valence band.

Acceleration of electrons thus occurs readily under the influence of the field, and there is the "nett flow of charge from one end of the crystal to the other" which we define as an electric current. In moving through the crystal the electrons exchange negative potential energy for kinetic energy, jumping

energy level which is completely filled with electrons, and in this case all the levels of the valence band are so filled.

The reason why a nett electron flow cannot occur in a completely filled energy level is that, for a nett flow to occur, there must be set up either an electron density or an electron velocity unbalance between one "end" of the level and the other. In a completely filled level a density unbalance is fairly obviously impossible; but so too is a velocity unbalance, because by definition all electrons in a given level have the same kinetic energy.

It may help in understanding this point if one imagines a filled level as something like a highway capable of carrying only a single lane of cars in each direction, and on which all the

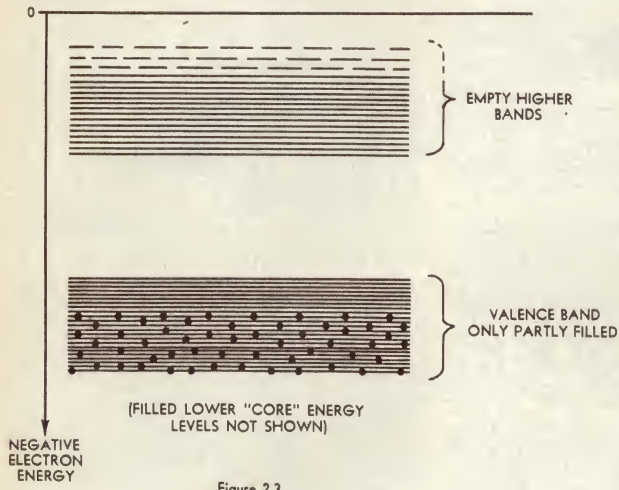

Figure 2.3

ment concerned do not fill the original valence level; it can equally be caused by a crystal lattice spacing which results in overlapping of the "true" valence band by a higher order band or bands, to produce a much wider effective valence band. For our purposes it does not matter which factor is responsible, the essential point being that the valence band is not completely filled.

In order to understand how this situation allows the crystal concerned to act as a good electrical conductor, consider for a moment what happens when an external source of EMF is connected across the crystal. Due to the applied EMF, an electric field is set up through the crystal; as a result one end of the lattice has an effective potential energy with respect to the other, so that the various electron energy levels and bands no longer remain horizontal but have a slope which corresponds to the electric field gradient. This is illustrated in figure 2.4, which shows the same valence and higher energy bands which were shown in equilibrium in figure 2.3.

Electrons are always in motion, and those in the valence band of a crystal are continually "sharing themselves around" among all the atoms of the lattice. The effect of the applied electric field, as one might expect, is to produce a tendency for the electrons to be accelerated in the "downhill" direction of the field, and slowed down or decelerated in the "uphill" direction.

Now deceleration of electrons by the field is in fact difficult, because this

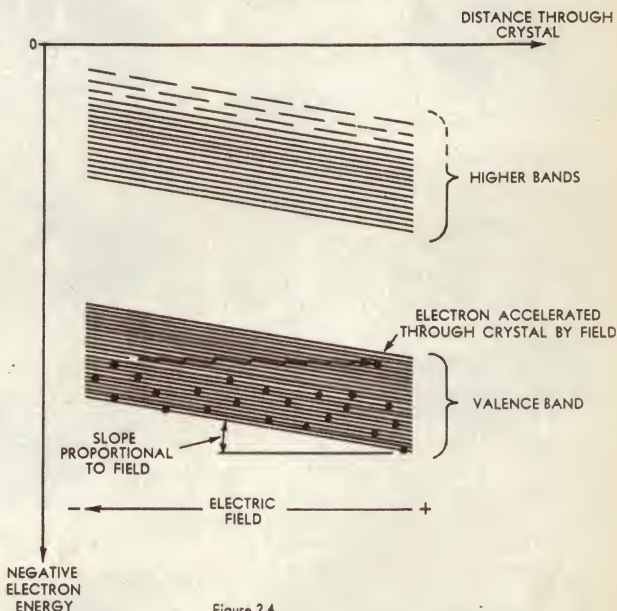

Figure 2.4

from level to level and effectively moving along the crystal energy diagram along paths such as that shown in figure 2.4.

A solid material can thus be defined as an electrical **conductor** if its energy band situation in the vicinity of the valence band corresponds to that shown in figure 2.3. In other words, it is one in which the valence band is only partly filled with electrons. This is the situation which applies in the case of metallic conductors such as copper, gold, silver and aluminium.

The second type of energy band situation which can occur in the vicinity of the valence band of crystals in the ground state is that illustrated in figure 2.5. It may be seen that the only essential difference between this situation and that for a good conductor shown in figure 2.3 is that the valence band is here **completely filled**. The only energy levels of the crystal unoccupied in the ground state are thus those in the higher bands, separated from those of the valence band by a relatively wide "forbidden energy gap."

It may seem surprising, but a crystalline solid in which this energy band situation occurs is completely unable to conduct electricity when in the ground state. This is because a nett electron flow from one region of the crystal to another is impossible in any

cars must travel at a fixed speed (corresponding to the particular energy level). If the highway is "filled" with both lanes carrying cars moving "bumper to bumper," there is no way in which more cars can travel in one direction than in the other; in other words, there can be no "nett car flow" in either direction.

The only ways in which a nett flow could occur would be either if the lanes of the highway were not filled, so that more cars could conceivably travel in one direction than in the other (a density unbalance), or if cars could travel at different speeds (a velocity unbalance), the latter implying the availability of additional "energy level" lanes.

From the foregoing it may be seen that if the valence band of a crystalline solid is completely filled, the crystal concerned will be an electrical **insulator**. ALL crystals whose energy band situation in the vicinity of the valence band corresponds to that shown in figure 2.5 in the ground state are thus strictly insulators in that (hypothetical) state.

Into this category fall both those materials normally known as "insulators" and those which have relatively recently become known as "semiconductors," as noted earlier. In fact, there is **no essential difference** between these



# components with a purpose \*

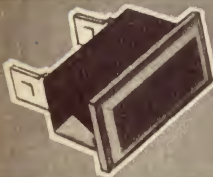

Neon  
Indicator Lamps  
**Telite**



Cordless  
Programming  
Boards

*Sealco*



Magnetic  
Reed Switches  
**HAMLIN**

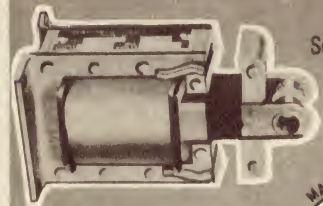

Solenoids



Potentiometers



Toggle Switches

**NKK**



Micro Switches

**Mulon**



Relays



Precision Film Resistors



Type 650

Type 500

Trimming Potentiometers

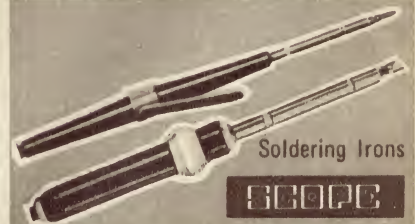

Soldering Irons

**SCOPE**



Wirewound Resistors



Power Rheostats

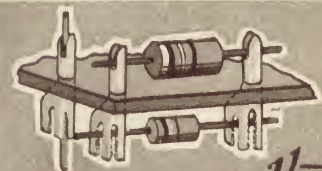

Matrix Boards and Kit-sets

**Vector**

## \* your complete satisfaction

INTERSTATE AGENTS & REPRESENTATIVES

MELBOURNE  
IRH Components Pty. Ltd.,  
Phone 489-1088

BRISBANE  
K.H. Dore & Sons  
Phone 2-1391 (except Magnetic Devices)

PERTH  
Simon Holman & Co.  
Phone 8-2271

HOBART & LAUNCESTON  
W.P. Martin Pty. Ltd.,  
Phone 34-2811 22-844

ALSO  
Underhill Day & Co.  
Phone 70-2141 (Magnetic Devices only)

ADELAIDE  
Collett & Cant Pty. Ltd.  
Phone 23-1971

**IRH**  
**COMPONENTS**  
**PTY. LIMITED**

THE CRESCENT  
KINGSGROVE  
N S W 2208.  
TEL 50 0111



two groups of materials, only a difference in the degree to which their behaviour changes with excitation level. To clarify this point, let us now look at the effect of excitation on the basic situation shown in figure 2.5.

We have seen previously that an individual atom would only be in its ground state if it could be maintained at a temperature of absolute zero ( $-273$  deg. C), shielded against all forms of radiant energy such as heat and light; whereas in actual fact, an atom in a practical environment is taking part in a continual process of energy absorption and emission, involving the transfer of electrons between its various allowed energy levels. As one might expect, the same argument applies to a crystal lattice composed of a large number of such atoms.

A crystalline solid in a practical environment involving heat, light and other radiant energy is therefore

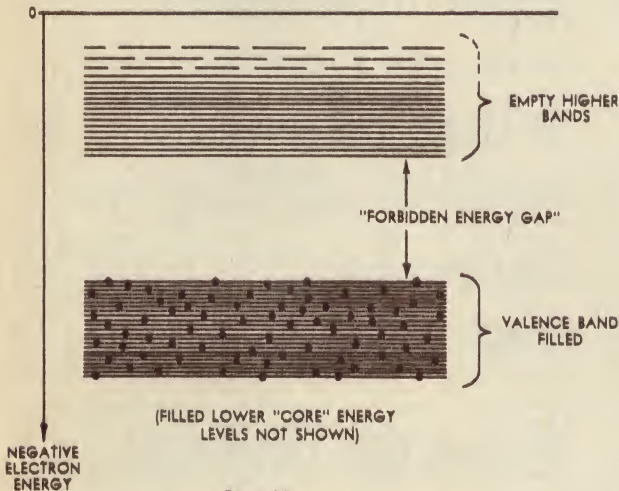

Figure 2.5

similarly involved in a continuous process of absorption and emission, with electrons now transferring both between levels within the crystalline energy bands, and also between the bands. The latter naturally involves absorption or emission of larger energy quanta than the former, as it involves transfer across the relatively large forbidden energy gaps between bands.

Under such conditions the "insulator" energy band situation shown in figure 2.5 will change. Absorption and emission of energy by the crystal lattice will reach a dynamic balance or equilibrium at an excitation level above the ground state, in which a small proportion of ever-changing electrons from the valence band have been transferred to higher energy bands. This is illustrated in figure 2.6.

The extent to which this will occur depends both upon the energy level of the environment in which the crystal finds itself, and also upon the width of the forbidden energy gap between the valence and next higher energy band. Naturally enough, the higher the temperature of the heat energy present in the crystal, the "bluer" the light incident on its surface, and so on, the greater will be the tendency of valence band electrons to acquire the energy necessary for them to be transferred to higher bands; but this granted, the proportion which do actually transfer

will depend upon the energy width of the forbidden gap.

The width of the forbidden energy gap varies widely among the crystalline solids whose valence band situation is represented by figures 2.5 and 2.6. Accordingly, such materials also vary widely in the degree to which electrons are transferred from the valence to higher bands under the influence of excitation. And as we shall see shortly, this behaviour determines directly their electrical characteristics.

In a crystal of diamond, the binding between the constituent carbon atoms is such that the forbidden energy gap is very wide. It amounts to some 6 electron-volts (eV), where an electron-volt is a convenient unit of energy used in atomic physics and other fields;

tion shown in figure 2.5, and both types of material behave as shown in figure 2.6 with excitation. The only difference is one of degree.

Hence by raising the temperature of an "insulator" crystal, for example, one could obtain a semiconductor, while conversely by cooling a "semiconductor" one produces an insulator.

From our earlier look at conduction in metallic crystals, the reader may by now have deduced that a semiconductor crystal in the excited state shown in figure 2.6 will become quite a good conductor, by virtue of the electrons which have transferred from the originally full valence band into the originally empty higher bands. And this is quite so, although it is only half the story.

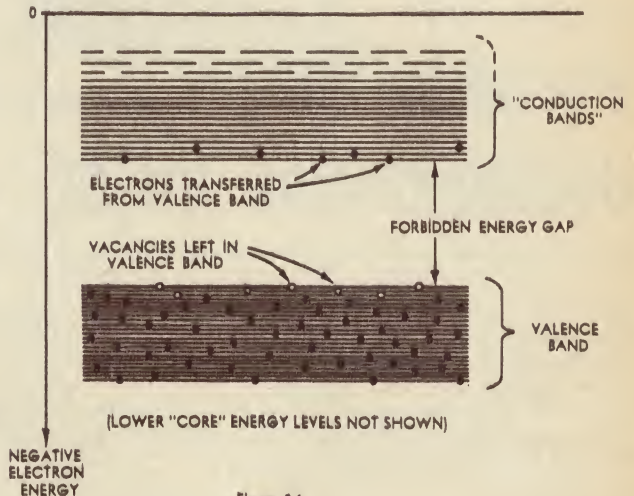

Figure 2.6

The electrons which have transferred into the higher bands, because these bands are largely empty, are certainly capable of forming a net carrier flow through the crystal under the influence of an applied electric field. In fact because of this, the higher bands are usually called the conduction bands, as shown in figure 2.6. However, as it happens, the "vacancies" which are left by transferred electrons in the valence band are also able to contribute to conduction.

In order to understand this, consider that when an electron is transferred from the valence band to a conduction band, this is actually equivalent to the weakening of a valence electron bond between two adjacent nuclei of the crystal lattice. Instead of the usual two-electron "covalent" bond which each nucleus shares with each of its four adjacent nuclei, there is left in the place concerned a weakened bond having only a single electron. This is illustrated in the two-dimensional picture of figure 2.7, where the weakened bond is shown consisting of the single remaining electron together with a hole or vacancy in place of the missing electron.

Because of the missing valence electron, the electrical charge balance of the crystal lattice is upset in the vicinity of the weakened bond. The positive charges of the relatively fixed atomic nuclei are no longer exactly balanced by the negative charges of the surrounding electron population, so that a localised net positive charge is produced.

one electron volt is the potential energy acquired by an electron when it is moved through an electric field for a distance corresponding to an increase of one volt.

In comparison, the forbidden energy gap of pure germanium crystal is only 0.72eV, while that of pure silicon is only a little larger at 1.11eV. It may be seen from this that in such materials the proportion of electrons which have transferred from the valence band to higher bands will be much greater, at a given degree of excitation, than for a material such as diamond.

Because under "normal" practical conditions crystals of materials like germanium and silicon have significant numbers of electrons which have transferred from the valence band to higher bands, whereas crystals of materials like diamond have not, and because this results in significant differences in the normal-conditions electrical behaviour of the two groups of materials, it has become convenient to distinguish between them. Crystals of germanium and silicon are thus known as semiconductors, while those of materials such as diamond are known as insulators.

It should perhaps be stressed again that there is no distinct division between the two groups of materials; as we have seen, in the ground state both have the "insulator" energy band situa-



# University

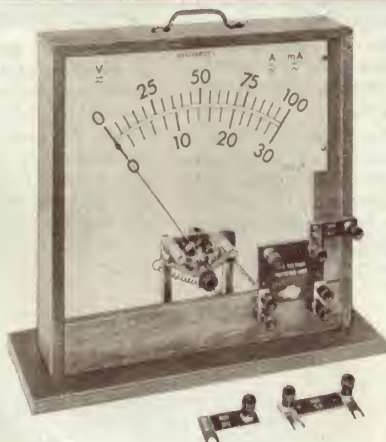

Model B27

## Portable demonstration meter

Teaching aid for use in schools, colleges and universities. As supplied to education departments in all States.

### Scale:

Large white scale approximately 8in long with bold black figures, easily read from a distance of 40 feet.

### Rear Viewing:

The scale is printed on both sides and the meter is fitted with perspex front and back. This enables the instructor to read the meter without obscuring the front scale.

### Movement:

A core magnet moving coil movement, well damped, with a very high torque/weight ratio is used.

The components of the movement are of various coloured finishes for easy identification.

The suspension is by means of spring loaded sapphire jewels combined with niva-point corrosion-proof removable steel pivots. This type of suspension is considered superior for demonstration type meters.

### Overload Protection:

Diode overload protection is available if required.

### Instrument Case:

A sturdy, polished maple wooden case, glued and screwed for additional strength.

The meter case size is 13 inches square, and this is fitted on a base 15in x 5½in.

### Ranges Available:

The unit can be made self-contained, to the following limits.

DC Current	0/100uA up to 0/50 Amp DC
AC Current	0/200uA up to 0/10 Amp (Rectified)
DC Voltage	0/50 mV up to 0/500 Volt DC
AC Voltage	0/3V up to 0/500 Volt AC (Rectified)
Resistance	as required, but using external cell.
Other ranges	on application.

Multirange units, self-contained, can be manufactured with range changing by either terminal selection or switching.

### External Accessories Available:

"Plug-in" voltage multipliers. (Range as required.)

"Plug-in" current shunts. (Range as required.)

"Plug-in" rectifier units. (Range as required.)

Multirange current transformer (12 switched ranges, 1mA to 10A).

### Prices:

Prices on application, dependent on quantity and ranges required.



Model VP65-BSP

## Bench type meter

Price and ranges on application.

A large range of electrical indicating and test equipment is available from

## University Graham Instruments Pty. Ltd.

106 Belmore Road, Riverwood, N.S.W., 2210.

Telephones: 53-8758, 53-0644 (5 lines).

Telegrams and Cables. Raquip, Sydney.

Victoria: Eastern Instrument and

Electronic Service Pty. Ltd.,

3 Carroll Crec., Glen Iris, Melb., Vic. 3164.

Phone: 20-6953.

### Representatives:

W.A.: Atkins (W.A.) Ltd.  
894 Hay Street,  
PERTH, W.A. 6000

QLD.: Keith Percy & Co.  
Pty. Ltd.

Waterloo Street,  
NEWSTEAD, Bris. Qld.  
4006

TAS.: W. P. Martin and  
Company,  
202 Argyle Street,

N.Z.: Allum Electrical  
Co. Ltd.,

21 Liverpool Street,  
AUCKLAND, N.Z.

HOBART, Tas. 7000.  
And 150 Wellington St.,  
LAUNCESTON, Tas.  
7250.

NEWCASTLE DIS.:  
Hunter Engineering  
Sales Pty. Ltd.,

Cnr. Gordon Avenue and  
Parry Street, Hamilton,  
NEWCASTLE, N.S.W.  
2303. Phone 61-4321.



In fact this positive charge is localised right in the "hole" originally occupied by the missing electron, and it has a value of charge equal and opposite to the negative charge of an electron. Neither of these facts are really surprising in view of the way in which the charge is produced.

The interesting thing is that such a hole is capable of moving through the crystal lattice, and as a moving positive charge it can thus effectively make a contribution to a current flow which is almost equal (but opposite) to that of an electron.

A hole tends to move through the crystal lattice because electrons in neighbouring valence bonds are attracted by its positive charge; when such an adjacent electron jumps across to "fill" the hole, it in turn leaves a hole in its own original bond to be filled by another electron, and so on. This "leapfrog" effect results in the effective movement of the hole through the lattice. Under the influence of an applied electric field, the hole movement will tend to take place in the direction opposite to that taken by a conduction band electron.

It may perhaps seem from this description that the concept of a hole is a redundant one, for the reason that "hole movement" in a particular direction through a crystal might seem to be "really nothing more" than a series of small jumps by electrons in the opposite direction; but this is not so. The fact is that the localised positive charge present in a crystal lattice at a weakened valence bond is no more and no less a reality than the "localised negative charge" which we are pleased to call an electron. It even has an effective mass, which is approximately equal to that of an electron.

To use an analogy, a hole in a crystal lattice valence band is rather like an air bubble in a test-tube almost filled with water. Both might be interpreted merely as "vacancies" whose effective movement takes place purely by means of movement in the opposite direction of something which superficially seems more "real" — like electrons, or water. Yet like the air bubble, a hole makes its existence apparent by means of its behaviour, in this case its electrical behaviour.

In a semiconductor crystal of the type whose valence band situation is shown in figures 2.5 and 2.6, then, for every electron which is transferred to the conduction bands and accordingly becomes available as a "negative current carrier," there is also produced a hole which remains in the valence band but is equally available as a "positive current carrier."

Because of this, it is usual to say that excitation of a semiconductor crystal lattice results in the production of electron-hole carrier pairs. Similarly the emission of energy by the lattice is visualised as a process whereby a wandering electron in the conduction band "accidentally" meets a hole wandering in the valence band, the two permanently cancelling or "annihilating" one another and producing a photon of appropriate energy. The latter process is usually termed recombination.

A pure or intrinsic semiconductor material such as we have been considering thus contains, in the excited state, equal numbers of conduction

band electrons and valence band holes available for electrical conduction. However, the two types of carrier do not contribute to current flow in an exactly equal manner, because holes are in the valence band and cannot move through the material at the same rate as conduction band electrons. In effect, whereas the electrons in the conduction band can move speedily through the lattice without having to conform to any orbit requirements, the holes in the valence band must "weave" their way through the crystal binding orbit system, and therefore travel at a lower rate.

This means that while the numbers of free electrons and holes present in an excited intrinsic semiconductor at any one time are equal, any nett cur-

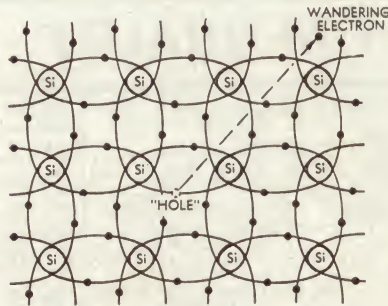

Figure 2.7

rent flowing through the material is carried more by the faster-moving conduction band electrons moving from negative to positive than by the slower-moving holes moving from positive to negative.

To use the analogy of a highway introduced earlier, but in a slightly different sense, the situation is now like a two-lane highway in which both lanes are packed with cars travelling in opposite directions, bumper to bumper but in this case at different speeds (corresponding to the two different energy bands). Although any given length of highway will contain equal numbers of cars in the two lanes, there will still be a greater car "flow" in the faster lane than in the slower lane.

Because the generation of electron-hole carrier pairs depends upon the excitation level of the crystal lattice, the number of such carriers available for conduction varies directly with the excitation level. Hence the conductivity of an intrinsic semiconductor crystal similarly varies directly with excitation. In the ground state, as we have seen, it will be zero; in more practical circumstances it will rise to a value which will depend directly upon both the temperature and the frequency/

intensity characteristics of any incident at its surface.

At this point it is perhaps worthwhile to pause briefly and note the contrast between the current picture of semiconductor-insulator conduction, which we have been examining, and earlier ones which held that these materials were merely those wherein the valence electrons were "harder for the electric field to pull free." It may be seen that the latter idea was quite wrong, because in fact such materials cannot conduct at all under the influence of an electric field alone; they become capable of conduction only when excited. Neither this fact nor the

TABLE 2.1

Material	Resistivity, Ohm-cM
Copper	$1 \times 10^{-6}$
Bismuth	$1 \times 10^{-4}$
Germanium	47
Silicon	200,000
Mica	$1 \times 10^{10}$
Diamond*	$3 \times 10^{12}$

\*Theoretical resistivity. In fact unmeasurable.

existence of holes as additional current carriers in these materials could be explained by the earlier theories.

In talking about the electrical behaviour of a semiconductor at a particular excitation level, reference is often made to the resistivity, which is simply the reciprocal of the conductivity. Resistivity is usually defined as the resistance in ohms between opposite faces of a cube of material measuring one centimetre on each side; this gives units of ohms/cm<sup>2</sup> or ohm-cM, or ohm-cM.

As the conductivity of an intrinsic semiconductor rises from zero with excitation, this means that the resistivity effectively falls from a value of infinity. Table 2.1 gives the approximate resistivity figures for pure silicon and germanium under "normal" conditions, and also gives the equivalent figures for typical metallic conductors and insulators.

The fact that the resistivity of intrinsic semiconductors falls sharply with excitation is exploited by using them in thermistors, or temperature-dependent resistors which have a negative coefficient. This is in fact the main use of intrinsic semiconductors as such, their resistivity being rather too high and too temperature-dependent for direct use in most other semiconductor devices.

## SUGGESTED FURTHER READING

- BURFORD, W. B., and VERNER, H. G., *Semiconductor Junctions and Devices*, 1965. McGraw-Hill Book Company, New York.
- MORANT, M. J., *Introduction to Semiconductor Devices*, 1964. George G. Harrap and Company, London.
- SCROGGIE, M. G., *Fundamentals of Semiconductors*, 1960. Gernsback Library Inc., New York.
- SHIVE, J. N., *Physics of Solid State Electronics*, 1966. Charles E. Merrill Books Inc., Columbus, Ohio.
- SMITH, R. A., *Semiconductors*, 1959. Cambridge University Press.



AMPLIFIERS — PREAMPLIFIERS — TUNERS — CONTROL UNITS —  
GUITAR UNITS — INSTRUMENTS — INVERTERS — CONVERTERS —  
RECEIVERS — TRANSMITTERS — REGULATED POWER SUPPLY —  
TRANSISTOR AND VALVE TYPES.

1967  
ALL WAVE  
3-4-5-6-7



ANY PART FROM A  
SINGLE RESISTOR  
TO THE FULL KIT

**POPULAR KITS - TOP QUALITY - LOWEST PRICES**

- |   |  |  |   |   |
|---|--|--|---|---|
| <p><b>INSTRUMENTS C.R.O.</b></p> <ol style="list-style-type: none"> <li>1. 5in wide range.</li> <li>2. 1963. 3in cal.</li> <li>3. Audio.</li> <li>4. 1965. 3in.</li> <li>5. 1968—Audio.</li> <li>6. Electronic SW.</li> <li>7. W/band Preamp.</li> </ol> <p><b>MULTIMETERS and V.T.V.M.'s</b></p> <ol style="list-style-type: none"> <li>8. 20K ohm/Volt protected M/M.</li> <li>9. Probe for above.</li> <li>10. Protected D.C. M/M.</li> <li>11. Meterless V/meter.</li> <li>12. A.C. Millivoltmeter.</li> <li>13. A.C. Solid State Millivoltmeter.</li> <li>14. Solid State A.F. Millivoltmeter.</li> <li>15. Noise Distortion Millivoltmeter.</li> <li>16. Standard V.T.V.M.</li> <li>17. 1966—V.T.V.M.</li> <li>18. 1968—V.T.V.M.</li> </ol> <p><b>BRIDGES</b></p> <ol style="list-style-type: none"> <li>19. Standard R/C.</li> <li>20. 1966. R/C.</li> <li>21. 1968 R/C and Signal Injector.</li> </ol> <p><b>TV INST.'s.</b></p> <ol style="list-style-type: none"> <li>22. Sweep and marker Generator.</li> <li>23. Dual sweep Gen.</li> <li>24. Silicon diode sweep Gen.</li> <li>25. Silicon diode noise Gen.</li> <li>26. Pattern Gen.</li> <li>27. Trans. pattern Gen.</li> <li>28. Wide range pulse gen.</li> </ol> <p><b>AUDIO INST.'S</b></p> <ol style="list-style-type: none"> <li>29. 1960 Audio Osc.</li> <li>30. 1962 High perf. audio Gen.</li> <li>31. Crystal locked std. Electronic tuning standard.</li> <li>33. 1965. Solid State audio osc.</li> <li>34. Direct reading A.F. meter.</li> <li>35. Sq. wave Gen.</li> <li>36. 1967 transistor audio Gen.</li> <li>37. Additive frequency meter.</li> <li>38. A.F. tone burst gen.</li> <li>38A. 1968. Solid state A.F. Generator.</li> </ol> <p><b>R.F. INST.'s.</b></p> <ol style="list-style-type: none"> <li>39. 6-band service oscillator.</li> <li>40. Trans. wave meter.</li> </ol> | <ol style="list-style-type: none"> <li>40A. 1969 Dip Osc. Solid state.</li> <li>41. G.D.O. wide range.</li> <li>42. G.D.O. adaptor.</li> <li>43. Trans. service osc.</li> <li>44. Simple signal injector.</li> <li>45. Transistorised signal tracer.</li> <li>46. Transistorised osc.</li> <li>47. Basic test osc.</li> <li>48. Transistor test oscillator.</li> </ol> <p><b>MISCELLANEOUS INST., ETC., KITS</b></p> <ol style="list-style-type: none"> <li>49. 1960 Trans. Tester.</li> <li>50. 1968 Transistor test set.</li> <li>51. Valve and Transistor tester.</li> <li>52. Electronic Stethoscope.</li> <li>53. Moisture alarm.</li> <li>54. Electronic Pistol range.</li> <li>55. Transistor Geiger Counter.</li> <li>56. Light beam alarm.</li> <li>57. Burglar alarm.</li> <li>58. Flasher unit.</li> <li>59. Transistor alarm.</li> <li>60. Electronic switch.</li> <li>61. Photo Timer.</li> <li>62. Direct reading impedance meter.</li> <li>63. Electronic anemometer.</li> <li>64. S.W.R. Indicator.</li> <li>65. Simple proximity alarm unit.</li> <li>66. Pipe and wiring locator.</li> <li>67. Electronic metronome.</li> <li>68. Monophonic organ.</li> <li>68A Keyless organ.</li> </ol> <p><b>BATTERY CHARGERS</b></p> <ol style="list-style-type: none"> <li>69. Universal unit.</li> <li>70. 1 amp unit.</li> </ol> <p><b>REGULATED POWER SUPPLIES</b></p> <ol style="list-style-type: none"> <li>71. Transistor. 9v.</li> <li>72. Transistor. fully protected supply.</li> <li>73. 1966 H.T. unit.</li> <li>74. 1968 lab. type. D-30v. supply</li> <li>74A Simple Pwr. supply.</li> </ol> <p><b>VOLTAGE/CURRENT CONTROL UNITS</b></p> <ol style="list-style-type: none"> <li>75. Vari-watt unit.</li> <li>76. Vari-tach. motor speed control.</li> <li>77. 2KW auto-light dimmer.</li> <li>78. 4KW auto. light dimmer.</li> <li>79. Model train control unit.</li> </ol> | <ol style="list-style-type: none"> <li>80. Model train control unit with simulated inertia.</li> <li>81. Above-hi-power.</li> <li>82. No. 81 with simulated inertia.</li> </ol> <p><b>TACHOMETER UNITS</b></p> <ol style="list-style-type: none"> <li>83. 6 or 12v Std.</li> <li>84. 6 or 12v Mullard.</li> <li>85. 6 or 12v with dwell angle.</li> <li>86. Tachometer and dwell angle unit for service stations.</li> </ol> <p><b>TRANSISTOR IGNITION</b></p> <ol style="list-style-type: none"> <li>87. Re-Fl. 6 or 12v.</li> <li>88. Hi-Fire 6 or 12v. (transformer).</li> </ol> <p><b>POWER CONVERTERS</b></p> <ol style="list-style-type: none"> <li>89. D.C.-D.C. 60w.</li> <li>90. D.C.-D.C. 40w.</li> <li>91. D.C.-D.C. 40w. 12v—input.</li> <li>92. D.C.-D.C. 70w 12v—input.</li> <li>93. D.C.-D.C. 100w 12v—input.</li> <li>94. D.C.-D.C. 140w. 24v—input.</li> <li>95. D.C.-D.C. 225w. 24v—input.</li> </ol> <p><b>HIGH FIDELITY AMPLIFIERS MONO UNITS</b></p> <ol style="list-style-type: none"> <li>96. Hi-Fi 3.</li> <li>97. Mullard 3.3.</li> <li>98. Mullard 5-10.</li> <li>99. Mullard 5-10 transistor.</li> <li>100. Transistor 20w.</li> <li>101. Transistor 60w.</li> </ol> <p><b>STEREO UNITS</b></p> <ol style="list-style-type: none"> <li>102. Mullard 2-2.</li> <li>103. Mullard (v) 3-3.</li> <li>104. Mullard (t) 5-5.</li> <li>105. Mullard (t) 5-5.</li> <li>106. Mullard (v) 10-10.</li> <li>107. Mullard (t) 10-10.</li> <li>108. Philips Twin 10.</li> <li>109. S.T.C. 10-10.</li> <li>110. Wireless world transistor 20-20.</li> <li>111. Hi-Fi 60-60.</li> <li>112. Playmaster 2-2.</li> <li>113. Playmaster 3 plus 3.</li> <li>114. Playmaster unit 3.</li> <li>115. Playmaster unit 4.</li> <li>116. Playmaster 10 plus 10</li> <li>117. Playmaster 101.</li> <li>118. Playmaster (t) 105.</li> <li>119. Playmaster (t) 113.</li> <li>120. Playmaster (t) 115.</li> <li>121. Playmaster (v) 116.</li> </ol> <p><b>P.A. UNITS</b></p> <ol style="list-style-type: none"> <li>122. 10 watt std.</li> </ol> | <ol style="list-style-type: none"> <li>123. 25 watt std.</li> <li>124. 35 watt std.</li> <li>125. 30 watt (t).</li> <li>126. 100 watt std.</li> <li>127. stereo P.A.</li> </ol> <p><b>GUITAR UNITS</b></p> <ol style="list-style-type: none"> <li>128. 10 watt std.</li> <li>129. 25 watt std.</li> <li>130. 35 watt std.</li> <li>131. 50 watt std.</li> <li>132. 70 watt (t).</li> <li>133. Playmaster 102.</li> <li>134. Playmaster 103.</li> <li>135. Playmaster 40w. 116.</li> <li>136. Playmaster 60w 117.</li> <li>137. Guitar fuzz box.</li> <li>138. Guitar Waa-Waa.</li> <li>139. Reverb unit.</li> <li>140. Guitar preamp.</li> </ol> <p><b>STEREOGRAMS</b></p> <ol style="list-style-type: none"> <li>141. Playmaster 105.</li> <li>142. Playmaster 106.</li> <li>143. Playmaster 107.</li> </ol> <p><b>CONTROL UNITS</b></p> <ol style="list-style-type: none"> <li>144. Playmaster No. 9.</li> <li>145. Playmaster No. 10.</li> <li>146. Playmaster No. 104.</li> <li>147. Playmaster No. 112.</li> <li>148. Playmaster No. 120.</li> <li>149. Mullard 2v.</li> <li>150. Mullard 3v.</li> <li>151. Philips Miniwatt.</li> <li>152. Wireless world stereo system unit.</li> </ol> <p><b>PREAMP UNITS</b></p> <ol style="list-style-type: none"> <li>153. Transistor—Mono.</li> <li>154. Transistor—Stereo.</li> <li>155. Transistor—Silicon.</li> <li>156. Transistor F.E.T. mono.</li> <li>157. Transistor dyn. mic. mono.</li> <li>158. Above-Stereo.</li> <li>159. Playmaster 115 F.E.T. Stereo.</li> <li>160. Playmaster 118 mag.</li> <li>161. Sound projector.</li> </ol> <p><b>MIXER UNITS</b></p> <ol style="list-style-type: none"> <li>162. Trans. 4 ch. (1966).</li> <li>163. Trans—4 ch. (1967).</li> <li>164. Valve—4 ch.</li> </ol> <p><b>TUNER UNITS</b></p> <ol style="list-style-type: none"> <li>165. Playmaster u/style.</li> <li>166. Playmaster No. 11.</li> <li>167. Playmaster No. 114.</li> <li>168. Playmaster No. 122.</li> <li>169. Playmaster No. 123.</li> <li>170. Philips Miniwatt.</li> <li>180. Trans.—Long range.</li> </ol> | <p><b>TAPE UNITS</b></p> <ol style="list-style-type: none"> <li>181. Trans. Preamp.</li> <li>182. Playmaster 110 (M).</li> <li>182. Playmaster 110 (S).</li> <li>183. Power Unit 110.</li> <li>184. Adaptor 110.</li> <li>185. Playmaster 119 Adaptor.</li> <li>186. Transistor V.O.X.</li> <li>187. Tape Actuated relay.</li> <li>188. Mullard Trans Tape Amp.</li> </ol> <p><b>RECEIVERS</b></p> <ol style="list-style-type: none"> <li>189. Fremodyne 4.</li> <li>190. Fremodyne 4 R.F. Sec only.</li> <li>191. Synchrodyne.</li> <li>192. Communications RX.</li> <li>193. Deltahet RX.</li> <li>194. 3 Band Double Change 5/het RX.</li> <li>195. Explorer VHF Transistor RX.</li> <li>196. Interceptor 5 Semi-Comm. RX.</li> <li>197. 1967 All-Wave 2</li> <li>198. 1967 All-Wave 3</li> <li>199. 1967 All-Wave 5</li> <li>200. 1967 All-Wave 6</li> <li>201. 1967 All-Wave 7</li> <li>202. Transporta 7</li> <li>203. Transistor 3 Band.</li> <li>204. 3 Band 2V RX.</li> <li>205. 3 Band 3V RX.</li> <li>206. Interstate 5</li> <li>207. Versatile Mantel Set.</li> <li>208. All-Wave Transistor 3</li> <li>209. A.B.C. 3</li> <li>210. 1966 F.E.T. 3</li> </ol> <p><b>TRANSMITTERS</b></p> <ol style="list-style-type: none"> <li>211. 144 MHz 50W. Linear Final.</li> <li>212. 144 MHz 20W.</li> <li>213. 144 MHz 75W.</li> <li>214. 144 MHz 18W.</li> <li>215. 144 MHz 5.5B.</li> <li>216. 3 Band A.M.</li> <li>217. Basic 3 Band.</li> <li>218. 5 Band. 5.5B.</li> <li>219. 1967 5.5B.</li> </ol> <p><b>CONVERTERS</b></p> <ol style="list-style-type: none"> <li>220. 80 MHz.</li> <li>221. 144. MHz.</li> <li>222. 50 and 144 MHz Crystal Locked.</li> <li>223. 1965 5/W.</li> <li>224. 1965 S/W 2 Band.</li> <li>225. 1966 3 Band.</li> <li>226. Basic S/W.</li> </ol> <p><b>V.F.O. UNITS</b></p> <ol style="list-style-type: none"> <li>227. Remote Unit.</li> <li>228. 7, 8 and 9 H.F. and V.H.F.</li> <li>229. All transistor.</li> </ol> |
|---|--|--|---|---|

Phone 63-3596

**E. D. & E. (SALES) PTY. LTD.**

Phone 63-3596

232 FLINDERS LANE, MELBOURNE, VICTORIA 3000



Public Address Units — Geiger Counters — Metal Locators — Decade Boxes — Mixers — Battery Chargers — Oscillators — Bridges — Parts Supplied for Projects in Electronics (Aust.), Wireless World, Practical Wireless, Electronics World, Electronics Illustrated, Practical Electronics, etc.

**MULLARD STEREO 3-3**

Full kit . . . . .

(As per Mullard leaflet).

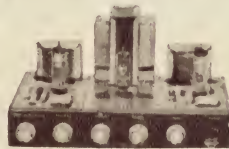

1968 Solid State. V.T.V.M. ELECTRONICS (Aust.), Dec., 1968.

**BATTERY CHARGER 1A**  
ELECTRONICS (Aust.), Feb., 1966

**PLAYMASTER 116 and 117**  
GUITAR AMP.

Electronics Australia  
June 1967 — 40 watt  
July 1967 — 60 watt



**3-BAND SHORT-WAVE CONVERTER**  
ELECTRONICS (Aust.), May, 1966.

LAB QUALITY

Regulated Power Supply (0-30v)  
ELECTRONICS (Aust.), Sep-  
tember, 1968.

1966 R/C Bridge  
May, 1966.



**PUBLIC ADDRESS and**  
**GUITAR AMPLIFIERS**

10, 25, 50 and 100 watt  
units



**3-BAND DOUBLE-CHANGE RECEIVER**  
ELECTRONICS (Aust.), April, 1966.

1966 3m CRO  
ELECTRONICS (Aust.), May, 1966.

Playmaster 122  
Program Source.  
Electronics (Aust.),  
August, 1968.

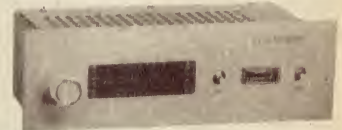

**FOUR-CHANNEL AUDIO MIXER**  
ELECTRONICS (Aust.) Feb., 1966 & 1967

**3-BAND 3-RECEIVER**  
ELECTRONICS (Aust.), Nov., 1966.

**TRANSISTOR MILLIVOLT**  
METER

Electronics (Aust.),  
May, 1968.



**MAJOR STOCKISTS OF ALL GENERAL RADIO & ELECTRONIC COMPONENT PARTS -- YOU NAME IT -- WE WILL QUOTE**

VALVES — TRANSISTORS — ZENER & POWER DIODES — SEMI-CONDUCTORS — DIACS — TRIACS — S.C.R.'S. — I/C'S. SPEAKERS — MICROPHONES — COILS — IFT'S. TRANSFORMERS — INST CASES — METALWORK. PLAYERS & CHANGERS — METERS — RELAYS — CONDENSERS — RESISTORS — BEZELS — STYL II — CARTRIDGES — RECORDING TAPE — PROBES — INSTRUMENTS — POTENTIOMETERS — CRYSTALS — FERRITE BEADS — CORES — BALUNS — TERMINALS — CO-AXIAL PLUGS & SOCKETS — MULTI CONNECTORS — PRINTED CIRCUIT BOARDS — COPPER WINDING WIRE — ETC. — ETC. —

Excellent frequency response. Low distortion figure. High input sensitivity. All controls self-contained. 10 watts per channel.

**PLAYMASTER STEREO 10 PLUS 10**  
COMPLETE KIT \$93.60



**Enjoy your leisure time and build**

**PLAYMASTER STEREO 3 PLUS 3**  
COMPLETE KIT \$52.65

Phone 63-3596

**E. D. & E. (SALES) PTY. LTD.**

Phone 63-3596

232 FLINDERS LANE, MELBOURNE, VICTORIA





# FORUM

## Strong call for "novice" type licences

The Wireless Institute of Australia appears to be sitting on the fence on the issue of novice type amateur licences, though observation would suggest that its legs are hanging on the side of conservatism! Support continues, however, for the new licence classification — partly from those directly affected and partly from those who see it as a means of attracting much needed recruits to the amateur ranks.

### Conducted by the Editor

The following excerpts are from letters which have been addressed to this column:

**15-YEAR-OLD:** "I am most interested in the suggestion that a novice amateur licence should be introduced. One reads a lot in American radio magazines about the novice licence holders and it seems unreasonable that a similar grade is not issued here.

"I am sure that many young people — school radio club members, Scouts, Guides and other youth groups — would be encouraged to take up amateur radio as a hobby.

"In my own case, I would be pleased to start as a novice operator and would certainly continue to improve my radio knowledge and operating skill to the A.O.C.P. standard, Morse Code and all.

"I read T.L.'s letter in the February issue and, while I admire his determination to gain his licence through the W.I.A. correspondence course, I do not feel that his opposition to a novice licence is backed up by any really valid arguments."

J. T. (Westmead, N.S.W.)

**ADULT VIEWPOINT:** "I feel that the young people have done very well in expressing themselves in favour of a novice licence.

"I feel that such a licence would also be a big help to older people as a stepping-stone to the full A.O.C.P. grade.

"In saying this, I want to add that it is not easy for everyone to sit down and write under examination conditions. I have found it very hard myself in examinations where there is a lot of writing to do. It is not that I have not known the work but simply that I find it hard to get brain and pen working together.

"I am an electrical fitter by trade and passed the four years of technical college with an average mark of 88p.c.

I managed this because of the type of multiple answer question used in the examinations. The A.O.C.P. examination is different and favours those who can re-write what they have read.

"I have been studying radio for some years but the only way I can really learn and remember is by doing. I would like to be able to pass a simpler examination and get on the air so that I can learn some of the more advanced material in a practical way.

"I am opposed to the stipulation of Morse code as an essential. It does not seem to occur to some that others find it particularly hard to learn the code. I would have no objection to the novice licence being restricted to 52 or 144MHz, provided voice was allowed, with VFO and crystal to 5 or 10 watts of power. P.M.G. regulations would obviously have to be known and observed.

"Good luck to the people who can learn from books and pass examinations easily. But I can assure you that there would be a lot more amateurs in the ranks if conditions were more favourable to those who — like me — learn best by doing."

R. C. (Cooanbong, N.S.W.)

**FROM AN AMATEUR:** "In most countries which grant novice licences a limit is placed on bands in use, types of emission, whom one may contact and maximum duration of licence. In U.S.S.R. and some associated countries it is necessary to belong to a 'KLUB' and to prove contacts made by QSL cards; a minimum number of contacts having to be made over a given period.

"I would like to see a novice type licence introduced here but with limitations of the following type:—

- a. segments of 160 and 80M bands only to be allocated for novice use, this not to prejudice use of the

frequencies by other amateurs, rather to discourage novices working only novices.

- b. contacts to be limited to VK call area only.
- c. input power not to exceed 25W, mode being AM/CW only.
- d. a limit of one year maximum duration for licence.

"The idea behind 'a' to 'c' would be to minimise possible interference with other services in countries outside Australia, and that of 'd' to encourage progress to A.O.C.P. or at least A.O.L.C.P.

"It should be noted that some countries still insist on one year of CW only for new licensees. Whether or not we regard this as 'horse and buggy' communication it is still an international requirement that A.O.C.P. amateurs demonstrate their CW capability before operating on the HF bands.

"I believe that a novice system, not necessarily under the wing of any organisation, but policed by local amateurs would go far to reduce piracy and meet arguments for easier initial entry to our ranks."

A.F. (Elizabeth Downs, S.A.)

### CHRISTMAS ISLAND, Indian Ocean:

"Starting from tors, with no radio and electrical experience just how many married men with families can find time enough to pass their A.O.C.P. and get on the air as radio amateurs?"

"As an old timer, VK9DR would consider that the bulk of the VK hams have either been, or are in the radio or electronic game and have secured their A.O.C.P. prior to wedding bells, or alternatively have had in their occupations sufficient technical education to grasp the fundamentals with ease, thus enabling them to complete the radio and electrical study without too much effort.

"Another line of thought is just how many of us are there in the radio and electronic professions who gained first interest in the art per medium of ham radio?"

"The demand for technical personnel in Australia is increasing enormously and our incoming technicians and engineers will be drawn from the youth of Australia. How are we going to create the interest to get started in radio and electronics?"

"As the best efforts can be obtained from a person whose work is his hobby it is logical thinking that we must encourage the youth of the country to be interested in these fields.

"The Youth Radio Club organisation is fine, but everyone connected with such clubs knows that interest must be maintained if such clubs are to succeed and expand. Although some



very fine work has been done in this direction in the past, more operating interest is necessary.

"Our Christmas Island Amateur Radio Youth Club received its 'shot in the arm' per medium of the Scouts Jamboree of the Air.

"On this day scouts and guides on the island of all races go on the air and enthusiasm is boundless. As a result our Youth Club membership numbers 26. Our members are mainly boys and girls of Chinese, Malayan, and Indian nationality. Interest is maintained as far as possible by the youth club's close association with the Amateur Radio Club station VK9XI, with its DX hunting, 'rag chewing,' Morse classes, and fox hunts.

"This is fair enough, but the girls and boys want to get going themselves outside of their closed circuit Morse practice stations at the club. The weekly theory instruction papers are not enough to hold interest.

"Then what is the answer?"

"The answer is obvious to all of us hams here on Christmas Island — ask the authorities to approve a novice or trainee amateur licence.

"But let us not get off our bikes about this licence. Have an elementary examination for sure. Keep the minimum Morse speed at 12 w.p.m. Keep the regulations as per existing A.O.P.C. exam. Limit the trainee licence to low power with crystal control and CW only, and let the trainee loose on 160 down to 20 metres.

"I will bet you anything that many of our top full licence phone boys will be delighted to hear a bit of slow Morse on the CW end of the bands so they can have a CW QSO once in a while!

"Well, how about it?"

"Maybe it is of interest that all the personnel associated with the commercial communication stations and with the electronic servicing facilities here at Christmas Island, together with the technical personnel of our broadcasting station, are members of the Christmas Island Amateur Radio Club and Youth Club."

Signed VK9MV, VK9RA, VK9FC, VK9DR, VK9XL.

**FROM REX BLACK:** "I must thank you for the opportunity offered for expressions of opinions on the subject — both for and against and for the editorial commentaries. I must admit a certain bias towards the Youth Radio Scheme as an avenue for implementing a lower-level type of licence but this largely because the scheme is already geared to handle such a situation. In addition, I can envisage a training type of licence being made available to other approved instructional agencies — adult radio clubs which can demonstrate qualified instructors and adequate supervision of their 'novices,' Boy Scout groups, Boys' Brigade Companies, evening college classes, technical college and teachers' colleges and other organisations which can offer adequate training and supervisory functions.

"With regard to your comment that the Morse operating proposal for a novice type of licence is out of date in view of current techniques, it is, I understand, mandatory for licensing authorities to require Morse competence because of I.T.U. agreements.

## MOVE FOR FM STATION IN N.Z.

Dear Sir,

Appended hereto is a brief news item regarding a proposed FM broadcasting station, which may be of interest to "Electronics Australia" and its readers.

As you will appreciate from my article in the January issue, it has always been left to individual effort in this country to introduce innovations in broadcasting, so this project is merely following a well established local custom!

**B. S. Furby.**

(Mr Furby is convener of the Newlands Broadcasting Society, c/- 19 Cotswold Crescent, Newlands, Wellington 4, N.Z.)

### HI-FI FM/STEREO

With private broadcasting in prospect for New Zealand once more, with an authority having been set up to licence private stations, one group is proposing an FM stereo station. This is a society in the Wellington suburb of Newlands, and the station has been inspired by two former N.Z.B.C. technicians, Messrs V. M. Stagpoole and B. S. Furby.

The station has been suggested to operate about two or three hours on three evenings a week, playing high fidelity recordings for enthusiasts and also to provide time for a local broadcasting service to the suburb. Some advertising would be encouraged to help finance running costs, but the station is proposed to be operated as

a hobby or interest to give local entertainers, speakers, hobbyists and other residents with local interests the chance to practice broadcasting and, if they wish, use the experience with the N.Z.B.C. service.

New Zealand still has a band between 90 and 94Mhz reserved for FM broadcasting, although no transmissions other than N.Z.B.C. "roving reporter" communications have been licensed. Publicity given to the project in Newlands has uncovered quite a few FM receivers in the district (either domestic sets brought in by immigrants, tuners imported by high-fidelity enthusiasts, or Japanese portables).

The N.Z. Radio and Television Manufacturers' Association has pressed for an FM service for some years, although the N.Z.B.C. has stated it has no intention at present of introducing a service. Apart from the possibility FM offers of being capable of a hi-fi service, FM has the other advantages of not interfering outside its immediate service area ("capture effect") and economies in transmitter and in building an efficient radiator.

Residents in Newlands have appointed a committee to plan the project, which the proposers hope may be copied in other centres, and lead to an interest in broadcasting as a modern medium of communication among people who would otherwise never have the opportunity to develop such an interest.

"Mr David Rankin has prepared a schedule of conditions detailing overseas 'novice' requirements and the following Morse tests are specified:— U.S.A. (5 w.p.m.); Korea (7 w.p.m.); Japan (5 w.p.m.); Israel (5 w.p.m.); India (5 w.p.m.); Faroes Islands (not specified); Finland (8 w.p.m.); Czechoslovakia (7 w.p.m.).

"I suggest that there should be provisions whereby Australian novices should start with CW operation only after written examination at the level of telegraphy transmitters. As training proceeded into the realms of telephony (AM) provision might be made for extension of transmitting privileges to include telephony. This further stage might include a further written examination and constructional and practical components of the training course."

**IDEAS AT VARIANCE:** "Recent issues have seen opinions both for and against novice type licences. For me to express my views at length would be repetitious, since my ideas have already been expressed by previous correspondents.

"I feel sure that the majority of amateurs are in favour of some form of learner's licence. The apparent opposition to the scheme is due to the fact that the few against are very vocal, whereas those who favour the idea have many and varied views. They will not in general strongly support any scheme other than their own, so that anyone proposing any particular scheme finds it hard to rally others to the cause.

"An excellent example of the above is your own comment in the April

### CHAN NEL LOCK

Like having a "THIRD HAND"



Self-Gripping Heat Sink

### No. 46 Heat Sink Clamp

A specially designed "heat sink" that prevents heat damage to electronic components during soldering. Also a handy, self-gripping "third hand" that holds and retrieves small parts in close work.

Available from wholesalers all States.

SC/10/2/69

## Selectronic Components

29 MARTIN PLACE,  
GLEN WAVERLEY, VIC.  
Phone 232-4883



AY8116 AY8111  
 AY8115  
 AY8109 AY8115  
 AY8108 AY8110  
 AY8111 AY8116  
 AY8109  
 AY8110 AY8108

# POWER UNLIMITED

A proud boast. Now for the first time we offer the Australian Electronics Industry six Silicon Power Transistors, made in Australia to suit Australian conditions. With stocks on the shelf and an Australian production line backing those stocks, can you wonder we boast "Power Unlimited".

All six devices have a simplified circuitry design for high frequency, high temperature applications with built in safeguards against secondary breakdown.

The emitter area is divided into many small discrete emitter sites connected in parallel. This greatly increases the emitter-base peripheral area, thereby improving the  $h_{FE}$  linearity characteristic of the device.

A deposited thin film nickel-chromium resistor ( $R_E$ ) is integrated into each emitter site.

$R_E$  limits the value to which  $I_C$  can increase, and current "sharing" to adjacent sites occurs until equilibrium is established, preventing current concentration and increasing secondary breakdown capability.

Here are the six Silicon Power Devices ready for immediate delivery;

PRICES 100 to 999			
20 WATT — AY8108 — \$1.60	& AY8109 — \$1.35		
25 WATT — AY8110 — \$2.75	& AY8111 — \$3.00		
6 WATT — AY8115 — \$1.00	& AY8116 — \$0.80		

If, there is still someone not entirely satisfied here's good news, already we have plans to increase this range in the very near future.

**FAIRCHILD**  
 AUSTRALIA PTY. LTD.

420 Mt. Dandenong Rd., CROYDON, VIC. 3136. P.O. Box 151, Croydon. Cables: Fairchild Melbourne. Telephone: 723 4131. Fairchild Representatives: Phil Cohen, Melbourne. 723 4131.  David Finch, Sydney. 929 7511.  Wayne Fitzsimmons, Adelaide. 23 1356.  Ray Crutcher, AUCKLAND, N.Z. 57 9307. New Zealand Distributing Agents: John Gilbert and Co. Ltd., Tasman Buildings, Anzac Avenue, AUCKLAND, N.Z. Fairchild Devices Now Available in Distributor Quantities from: George Brown & Co., 267 Clarence Street, SYDNEY, N.S.W., 2000.  General Accessories, 81 Flinders Street, Adelaide, S.A., 5000.  J. H. Magrath & Co. Pty. Ltd., 208 Lit. Lonsdale Street, Melbourne, Vic., 3000.  Radio Parts Pty. Ltd., Spencer Street, Melbourne, Vic., 3000.  Purvisonic Sound and Distributing Co., 44 McCoy Street, Myaree, Perth, W.A., 6154.  Douglas Electronics, 7 Gralunga Street, Mansfield, Qld., 4122.



## Please gentlemen, a little tolerance . . .

Dear Sir,

It is not very often that any serious criticism can be levelled at your publication but this letter is prompted by a recent editorial and subsequent correspondence, which presents only one side of the case. I refer to the indignant statements about the presence of control tones superimposed on the 240V AC power mains.

It is all very well for the hi-fi buff to complain, sitting in the quiet comfort of his home, but spare a thought for the poor supply engineer trying to provide adequate power to consumers who persist in wanting to use most of their electricity in perhaps two hours out of the full twenty-four.

These are the facts in the case for the defence. All over the world, the cost of electric power is largely determined by the capital cost of the generators and transmission equipment, which must be built to supply the peak load. If not limited, peak load problems could effectively double the cost of power, when ultimately passed on to the consumer.

If any readers have any practical ideas on how to overcome this problem, I'm sure that their local supply authorities would be interested to hear them!

In any case, I venture to suggest that control tones should present no problems in equipment of good design. The high frequencies involved should not penetrate the power supply filter and we are therefore forced to the conclusion that the signal is either present at the input or picked up by magnetic or capacitive coupling between the power supply and the input circuitry.

It is therefore probable that the amplifier is already subject to hum but, due to the lower audibility of a 50Hz signal, it is unnoticed. So, please, gentlemen, a little tolerance!

D.C. (Auckland, N.Z.)

issue — you oppose the proposal by Rex Black, because you do not think it should be administered by the Wireless Institute, apparently you feel the proposal worthwhile otherwise. It is surely time that we stopped knocking each other's efforts because they are not identical to what we want, and instead support any reasonable scheme. Once the thin edge is established, then is the time to modify and improve conditions."

VK3ZCA.

**COMMENT:** When something is in the formative stages it is almost inevitable that people will express differing views in regard to the details. However, I doubt that the people expressing these views are so rigid in their outlook that they would be unprepared to support any scheme but their own. One purpose of providing this space is to allow an exchange of views so that the authorities and those who may ultimately become spokesman for amateurs may be better able to gauge the weight of feeling and the direction in which it tends to lean.

It may transpire that certain provisions will be obligatory by international convention. Some suggestions may be totally unacceptable to the licensing authorities. Others may interlock or be mutually exclusive. Things like this will emerge from discussion but now is the time to consider all the suggestions that interested parties may be anxious to bring forward.

The same correspondent attaches another letter on a different subject, but still of interest to up-and-coming amateurs:

**CORRESPONDENCE COURSE:** "Recent correspondents to 'Forum' have indicated that there are young people who wish to study toward A.O.C.P., but are students, and find adult course fees prohibitive. Unable

to find a local radio club, they presume that they are left to fend for themselves.

"I wish to point out that the Youth Radio Clubs Scheme has foreseen this problem, and operates a correspondence section for such cases. Using a system of notes and assignment, the section follows the same certificate levels and syllabi as clubs. In fact, the section can be likened to a correspondence club.

"Costs are met by a modest membership fee, which covers all notes, etc., as a member progresses through the course. I will be pleased to answer any questions about the correspondence section."

W. Tremewen (Supervisor,  
Correspondence Section, Y.R.C.S.A.,  
34 Flower Street,  
Ferntree Gully, 3156).

**CONTROL TONES:** Readers will doubtless recall that we have had something to say, in recent months, about the practice of some electricity supply authorities of superimposing tones on the mains to effect certain switching functions in their area. These tones can penetrate audio systems and be reproduced at a level which is disturbing enough in the home, but which can be quite embarrassing in churches and other public areas.

The correspondent above is obviously trying to be helpful and courteous but I'm afraid that what he says serves only to add fuel to the fire.

Granted, the supply authorities have a problem which, in the ultimate, is reflected in the cost of power to the consumer. This information isn't new; the grouch is with the steps taken by certain supply authorities to deal with the problem.

To save running additional control

(Continued on page 190)

# JEMCO

## NEW MODEL

### US-100 MULTIMETER

combines high quality and wide measuring ranges of expensive instruments with reasonable price.



- Overload Protection.
- Shockproof Movement.
- 10 Amp D.C. and A.C. Current Range.
- D.C. Polarity Reversing Switch.
- 50 MEGOHM Res. Range.
- Large Clear View 4-inch Face.
- Carrying handle can be used as a stand.
- Excellent Frequency Characteristics.

#### SPECIFICATIONS:

D.C. VOLTAGES: 0.25/1/2.5/10/50/250/1000 V (20,000 O/V)

A.C. VOLTAGES: 2.5/10/50/250/1000 V (5,000 O/V)

D.C. CURRENT: 50uA, 1/25/500 mA 10 A

A.C. CURRENT 10 A

RESISTANCE: 0-50 MEG  
RX1/X10/X100/XK/X10K

SIZE: 5½ x 4½ x 1½ inches.

WARRANTY:— SPARE PARTS STOCKED LOCALLY.

PRICE: \$25 plus S.T.

Leather Case: \$4 plus Sales Tax.

Available ex-stock from leading Merchants or Sole Australian distributors:

## INDEVA PTY. LTD.

24 Bellevue Road, Bellevue Hill,  
Sydney 2023

Telephone: Sydney, 36-4401.  
Melbourne, 81-2908. Adelaide, 87-2246.  
Brisbane, 27-3356. Perth, 8-2364.

Tick and Mail this Coupon today for information on:

- MULTIMETERS
- PANELMETERS
- SIGNAL and AUDIO OSCILLATORS
- SIGNAL INJECTORS and TRACERS
- HEADPHONES (MONO and STEREO)
- MICROPHONES and INTERCOMS
- RADIO PARTS and COMPONENTS

Please Print

NAME .....

FIRM .....

ADDRESS .....



# FACTORY FINISH FOR LABELS AND

A problem which besets the home builder, the factory pre-production department, or the small manufacturer making a "one off" product, is to produce a unit which looks as well finished and attractive as its mass produced counterpart. This article discusses some of the materials and processes available to assist in solving this problem.

By LEO SIMPSON

Second only to its ability to perform as specified, the appearance of a piece of electronic equipment is its most important feature. In fact, on the consumer market, appliances are sold far more often on eye appeal than on technical performance. And, while the home constructor may have a greater appreciation of technical performance than the average person he should, if he has any pride in his workmanship, be just as conscious of the need for his projects to look attractive as to perform well.

The large-scale manufacturer has available a whole host of materials and processes to provide the appearance and finish he requires. He can use die-castings, engraved panels, extruded aluminium strip, plated metals, plastics and so on. However, the person who is making equipment on a small scale, such as the manufacturer with small production runs, the designer of prototype equipment or, again, the home constructor, cannot always use these because of the cost involved. One cannot specify an engraved aluminium panel for a "one-off" product unless cost is no object. This, then, is the problem that faces the latter group; how to obtain an acceptable appearance, particularly on control panels, with materials and processes that are available economically.

Fortunately the problem is not nearly as serious as it may appear at first or, indeed, as it really was a few years ago. Today the home constructor has available a variety of processes for finishing and labelling which are economical, reasonably simple to use, and capable of producing a really professional finish.

Paint has always been one of the most popular and widely used decorative finishes and is even more so today by reason of the wide variety of colours, surface, textures, drying characteristics etc., which are available. In addition, the advent of the aerosol paint can means that anyone can enjoy the benefits of spray painting without the need for expensive equipment.

In addition to the more conventional paint surfaces, such as matt, semi-gloss, full gloss, etc., there are various "textured" surfaces, such as "crackle," "wrinkle," "brocade," and so on. Some of these are still more suitable for mass production than single units, but others are now available which are ideally suited to the home constructor.

Crackle finish is a surface of randomly oriented fine lines that are produced in the paint base by a special

overspray which contracts during drying. In general, this process is not very suitable for the home workshop but, in any case, is not a very popular finish even on a commercial basis.

Wrinkle is produced when the paint expands while drying. The increasing area of the paint film causes it to wrinkle, hence the name. These finishes are produced by baking in an oven although there are now available aerosol can paints which give a satisfactory wrinkle finish without baking. Brocade is similar to wrinkle, but the term is usually used to indicate a finer texture.

Hammertone is a high-gloss finish which appears as a hammered or "peened" effect. As produced commercially, it involves a baking process, although some attempts have been made to produce a non-baking version for home use. Unfortunately, these appear difficult to locate.

Clear lacquer is merely an overspray designed to protect the surface underneath, which may be polished, etched, brushed, or some similar finish which might otherwise tarnish.

All metal finishing processes require a scrupulously clean surface to begin with. Dirt, finger-marks and other grease-marks must be removed. This is best done with a detergent mixture, or a degreasing agent such as carbon tetrachloride, trichlorethylene, or other solvent. (Warning: These degreasing agents are toxic and should only be used in a well ventilated area.) If the surface is not free from all greases paint will not adhere properly.

When the surface is thoroughly clean it should be primed to ensure that the paint will adhere properly to the metal. Aluminium, in particular, should be prime coated, and one of the self etching type primers is recommended. Some paints packaged in aerosol cans can be applied to bare metal surfaces, but results are improved if a primer is used.

The best way to apply paint is in the form of a spray. A brushed surface is usually unacceptable. Paint may be sprayed using a simple hand spray similar to an insecticide spray, the rather more elaborate type of gun designed for use with a vacuum cleaner, or the professional type operating from a compressor. In addition, there are the aerosol cans which provide both the paint and the means to spray it for a moderate cost. All these methods are capable of good results.

It should be noted that paints are highly inflammable when in the atomised form, and that spraying should be

conducted only in well-ventilated areas away from possible sparks or flames.

The ready availability of aluminium sheet has popularised the many textured metal finishes which are easily obtained on this metal. These include etching, brushing and anodising. Here is a brief outline of each of these processes.

Etched aluminium gives an attractive, fine-grained silvery finish, and is obtained by the action of caustic soda (sodium hydroxide). Four shallow containers which could typically be plastic wash bowls, are required for this process. The first contains a degreasing solution, or a detergent solution such as one would use for greasy dishes. The purpose is to remove the surface grease which would otherwise give uneven etching. Once the grease has been removed the metal should not be touched by hand. It should be suspended from a piece of string to facilitate handling or rubber gloves should be used.

Note that scratches must be removed before cleaning and etching. The scratches should be polished off with fine steel wool.

The etching solution consists, typically, of four ounces of caustic soda crystals to a half gallon of water. This will work satisfactorily at any temperature but for best results it should be hot — around 140°F. The third container contains water which is being continuously replenished by a hose connected to a tap. The aluminium is rinsed in this after being etched. It is essential to keep the rinse water clean, otherwise the aluminium may become streaky.

The fourth tray contains an acid solution and this part of the process can be varied to suit the particular case. During etching in the caustic solution the aluminium will become blackened to a degree, depending on the alloy used. This residue is removed by washing in an acid solution. If the blackening is mild a weak vinegar solution may suffice or, in more severe cases, a stronger solution of 50 per cent (by weight) nitric or chromic acid may be needed. The aluminium is finally rinsed in water and dried.

A special note is required on the use of acid. Use commonsense. Use rubber gloves and do not work in a confined space. Considerable heat is evolved when mixing acids with water. Water should never be added to strong acid solutions. Always add the acid to water, slowly. If water is added to a concentrated acid so much heat will be produced that steam may be generated, causing the solution to erupt violently, with disastrous results. To repeat, always add the acid slowly to the water.

It is important to have clean running water immediately available for flooding over the hands, face, etc., in case any of the caustic or acid solutions are accidentally spilled.

The etched finish is susceptible to fingermarks and should be given a coat of clear lacquer so that it can be



# PANELS

handled. The above procedure is not rigid and can be varied to suit the requirements of the user.

Anodising is a more complex process than etching but it gives a more durable surface and it can also be coloured. Anodising is an electrochemical process in which the aluminium has a very thick oxide coating developed on the surface. The first steps of the procedure are the same as for etching.

After the aluminium has been etched and rinsed it is placed in a solution of 12-20 per cent (by weight) of sulphuric acid in distilled water. Any acid-resistant container such as a Pyrex dish or plastic wash bowl may be used for the acid. The aluminium is connected to the positive terminal of a variable DC power supply and a lead plate is connected to the negative terminal.

Care must be taken to ensure that the connections to either the aluminium workpiece or the lead plate do not introduce contaminating metals into the bath. The lead plate is best extended beyond the bath before connection is made to it. The workpiece may be suspended from an aluminium wire hook, or held in an improvised aluminium clamp. Alternatively, stainless steel photographic film clips may be used. However, lesser grades of stainless steel may not be suitable.

To enable the work to be done as quickly as possible the power supply should have a capacity of around 12 amps per square foot of the workpiece. Note that both sides of the work must be allowed for. If a piece of aluminium 4 x 10 inches was to be anodised, for example, the current would be adjusted for an overall surface area of 80 square inches, i.e., 6½ amps.

The current passing from the lead cathode through the acid electrolyte and the aluminium workpiece causes large amounts of oxygen to be evolved on the surface of the aluminium and this causes controlled oxidation to take place. The treatment time will take about 20 to 30 minutes depending on the thickness of the oxide coating required. This time is also dependent on the current flow. For values less than the 12A per square foot quoted longer times will be needed.

The oxide coating so formed is transparent and so the resulting finish is a velvety silver. Alternatively, advantage can be taken of the porosity of the oxide film to colour it with one of the many aniline dyes available. The anodised part is immersed in the dye solution for about 20 minutes. The temperature of the dye solution should be between 125 and 150°F. The porous oxide surface must then be sealed by boiling the part in distilled or demineralised water. If the natural aluminium colour is desired the part should be boiled immediately after anodising.

Brushed aluminium is perhaps the most easily achieved finish. No chemicals are called for and the only equipment required is a standard wire brush

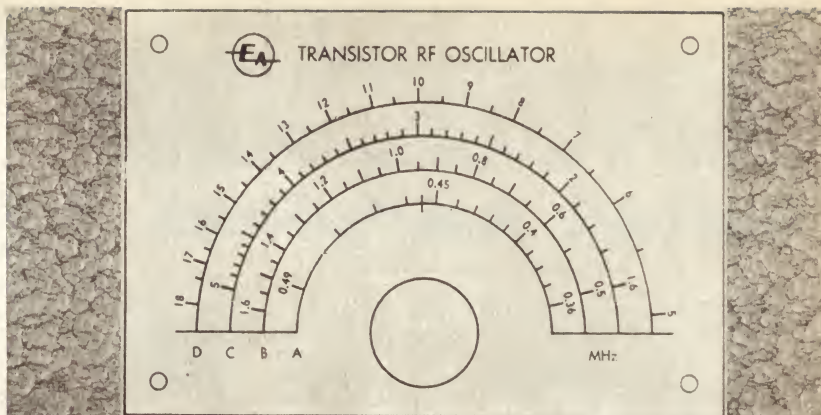

*This label was made on Aluminex, in our workshop, using one of our own transparencies. It is mounted on a Hammertone finished panel with double sided adhesive film.*

which can be obtained from any hardware store. Again, the aluminium must be scrupulously clean before brushing begins. The brushing process is merely a matter of making long parallel strokes with the brush in the direction required. Holding the aluminium can be a problem and this is best done by placing it on a horizontal wooden surface and securing it with a few panel pins to stop it from sliding around.

The "grain" of the resulting scratched surface can be varied by using fine or coarse wire brushes. Alternatively, a similar finish can be obtained with steel wool. The resulting finish is susceptible to finger stains and should be given a coat of clear lacquer before being handled.

While the above information will be useful in producing an acceptable finish on cases, front panels, and so on, there is still the problem of providing labels for the front panels.

One of the easiest approaches for the average constructor is to use "rub-on" lettering as sold under the brand names of Letraset and Instantype. This gives professional results and comes in a wide variety of lettering styles and colours. It is available from most stores specialising in drafting supplies and is supplied in sheets of individual letters or titles relevant to one particular subject, such as audio, amateur radio equipment, test equipment, etc.

Alternatively, one can use lettering guides and a pen of the Rapidograph type. This yields good results but the range of lettering styles is limited. In both cases the label must be given a coating of clear lacquer to protect the print.

A third approach to the problem of producing front panels and labels in small quantities has recently become possible with the introduction of new processes using photo-sensitised aluminium. One process has been developed by Graptex Incorporated, 1 Dell Glen Avenue, Lodi, New Jersey, U.S.A. and represented in Australia by Luna Agencies and Distributing Company, 259 Jasper Road, McKinnon, Victoria.

The process uses Aluminex, a coloured, anodised aluminium from .003 to .125 inches thick which has a photosensitive etch resist on one side. This is exposed to light through a negative transparency. The opaque sec-

tions of the negative are reproduced as silvery aluminium and the clear sections in whatever colours the aluminium is supplied, such as black, red, blue, green or gold, in matt or gloss finish.

The process does not require the use of a darkroom, apart from the preparation of a suitable negative transparency, but the sheet should not be exposed to fluorescent lights or sunlight until final processing.

The three steps of the process are exposure, developing, and etching. The exposure is not critical, the important point being to ensure that it is adequate. Too little will give a washed-out result, but it is difficult to give too much. The light source can be sunlight, a No. 1 or No. 2 photoflood lamp, or the lights on a plan (blueprint or dyeline) copying machine, which are usually banks of fluorescent lamps or an arc lamp. It is essential that the transparency is in optical contact with the Aluminex and, ideally, has been so made that it is the right way round when the emulsion side is nearest the Aluminex. The label should be right way round, i.e., readable, as it is laid on the Aluminex.

After exposure the Aluminex must be developed. The developing is done with trichlorethylene or Graptex developer. This softens the unexposed portions of the sheet so that it can be rinsed off with water. The developing is best done in a vertical tank to prevent contaminants from resting on the Aluminex coating. The tanks may be plain steel, stainless steel or aluminium, pyrex, or similar, or polyethylene. Rubber or those plastics based on

(Continued on page 72)

## VALRADIO

### TRANSISTOR INVERTERS

Inputs 12v—110v D.C.  
Outputs 115v—250v A.C.  
Ratings 30 watts to 2,000 watts.

Sole Australian Distributors

**Leroya Industries Pty. Ltd.**

266 Hay Street,  
SUBIACO, W.A.



# EVERYTHING FOR THE HOBBYIST and

## 40 Watt & 60 Watt Instrol-Playmaster GUITAR AMPLIFIERS

All parts now available

Like all Instrol-Playmaster kits, the 116 and 117 Guitar Amplifier Kits are complete in every detail, down to the last nut and bolt, and precisely to "Electronics Australia" specifications. Chassis is ready drilled, cadmium plated and finally passivated to avoid fingermarking. The front label is beautifully finished with black lettering on silver-white background. Kits for both the 116 and 117 include extras such as 3 inputs (circuit included), vibrato and extra treble pull switches, and foot switch complete with chrome housing.

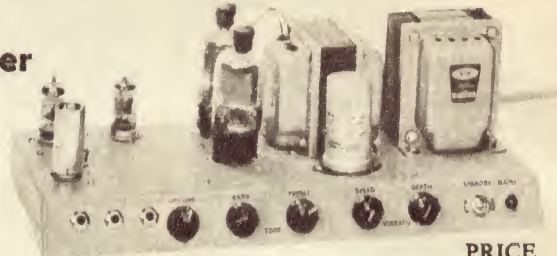

	PRICE
40 Watt complete kit of parts . . . . .	\$84.36
40 Watt built and tested . . . . .	\$91.49
60 Watt complete kit of parts . . . . .	\$92.31
60 Watt built and tested . . . . .	\$98.83
(Freight extra)	

All parts available separately if required.  
 Chassis only . . . . . \$4.70 (plus 85c postage)  
 Front Label . . . . . \$2.80 (plus 20c postage)  
 Fuzz Box Kit . . . \$12.95 (plus 75c postage).



**KEYLESS ORGAN**  
 (Electronics Aust. January 1969)

A useful novelty instrument which can be used successfully by a single entertainer or in conjunction with a group. Includes sharps and flats, built-in vibrato and has a high level of acoustic output.

Kit of Parts . . \$35.10. Postage extra.



**INSTROL-PLAYMASTER 106 AMP/TUNER** ("RTV and H," Dec., 1963).  
 A high-quality amplifier/tuner with all stations clearly marked on dial. Amplifier 10 watts per channel.  
 Kit of Parts . . . . . \$106.15  
 Postage Extra.



The new **INSTROL-PLAYMASTER 115 SOLID STATE STEREO AMPLIFIER** ("Electronics Aust.," April-May, 1967).  
 A fully transistorised 10 Watt Stereo Amplifier using the latest F.E.T. high-efficiency transistors.  
 Crystal/Ceramic Kit . . . . . \$96.80  
 Magnetic kit extra . . . . . \$10.50  
 Postage extra.

### INSTROL-PLAYMASTER 123 PROGRAM SOURCE

("ELECTRONICS AUSTRALIA" Oct. 68)



A high quality wide band solid state unit, fitted in free-standing metal case, featuring meter tuning and large illuminated dial.

Kit of Parts — with Ceramic Filter . . . . . \$91.20

Kit of Parts—without Ceramic Filter . . . . . \$77.50  
 (Postage extra)



**THE 10-PLUS-10 STEREO AMPLIFIER**  
 ("Electronics Australia," November, 1968)

A high quality solid-state 10 watt amplifier. Suitable for crystal or ceramic cartridges.  
 KIT OF PARTS . . . . . \$62.74  
 (Postage Extra.)



**THE 3-PLUS-3-STEREO AMPLIFIER,**  
 ("Electronics Australia," August, 1968).  
 A small, modern, 3-watt solid-state audio amplifier.  
 Kit of parts . . . . . \$43.50  
 (Postage extra.)

Tick catalogue required, and please include stamps for postage.

- |  |  |
|--|--|
| <input type="checkbox"/> Playmaster        | <input type="checkbox"/> Test Equip Kits       |
| <input type="checkbox"/> Toolkit           | <input type="checkbox"/> Tape Recorder Instrol |
| <input type="checkbox"/> Cannon Connectors | <input type="checkbox"/> Microphone            |

Name . . . . .

Address . . . . .

Post Coupon for Free Catalogue.



These robust and attractive meters are available in the following sizes:  
 VP4A 1 1/2" x 1 1/2"  
 VP3A 2 1/4" x 2"  
 VP2A 3" x 2 1/4"  
 VP45 2" x 2"



EW5 1 1/2" x 1" AND EW2 3" x 1/4"

VP4A 0-500 microamps . . . . .	\$4.81
VP4A 0-1 milliamp . . . . .	\$4.81
VP3A 0-500 microamp . . . . .	\$5.27
VP3A 0-1 milliamp . . . . .	\$5.16
VP2A 0-50 microamp . . . . .	\$7.11
VP2A 0-500 microamp . . . . .	\$5.96
VP2A 0-1 milliamp . . . . .	\$5.86
VP45 0-500uA V.U. scale . . . . .	\$4.81
EW5 0-200 microamp V.U. . . . .	\$3.43
EW5 0-200 microamp . . . . .	\$3.43
EW2 0-150 microamp . . . . .	\$2.51

(Including Sales Tax and Postage)

# BROADWAY ELECTRONICS



# TECHNICIAN...

## INSTROL EDUCATIONAL ELECTRONIC KIT

In this Electronic Age, every person should have some knowledge, however elementary, of "how it works." The new Instrol 20 in 1 electronic kit will enable you to understand in an absorbing, simple manner the basic principles underlying computers, satellite communications, industrial electronic devices, etc., etc. You make 20 different experimental circuits, including 10 working radio transistor operated radio circuits. Audio Amplifier circuits, home intercom, testing circuits including Audio Frequency Oscillator and Signal Tracer, Morse Code practice set and telegraph transmitter, etc. You use and learn about the amazing SOLAR CELL.



**NO TOOLS OR SOLDERING IRON REQUIRED**

All components pre-wired, ready for clip-on assembly. 50 page Instruction Manual supplied.

ONLY . . . **\$16.90**

(Plus 85c for Registered Post)



To allow others to hear the results you achieve, why not obtain the Instrol SPI Speaker box. Completely assembled, includes transistorised audio frequency amplifier, dynamic speaker and leads, housed in an attractive plastic box, and ready to plug-in at any appropriate stage of your experiments with the Instrol 20 in 1 Electronic Kit.

**INSTROL SPEAKER BOX. PRICE \$6 plus 10 cents Postage.**



## ELECTRONIC TOOL KIT

**For Hobbyists Students and Servicemen**

An inexpensive, yet most comprehensive, pocket-sized tool kit. Ideal for the Student, Hobbyist and Practising Service Technician. The Soldering Iron is an Australian made high efficiency 30 Watt 240 Volt type. All the other hand tools are imported, high grade steel. The complete kit fits snugly into a strong attractive zip-fastening carrying satchet.

### COMPONENTS

- 1—Soldering Iron with 3-pin plug 30 Watts 240V
- 1—Set 3 Spanners.
- 1—Coil Resin Cored Solder
- 1—Pair Pliers standard
- 1—Pair Long Nose Pliers
- 1—Pair Side Cutters
- 1—Pair Tweezers
- 1—Screwdriver Set complete with handle and chuck, comprising
  - 2—Screwdriver bits
  - 1—Philips driver bit
  - 1—Pointed awl
  - 1—Spintite for 1/4 in nuts

PRICE \$12.50. Plus Regd. Postage \$1.00



**SOLID STATE V.O.M.**  
(Dec., '68)

**V.T.V.M. (Feb., '66)**

**SOLID STATE AUDIO MILLIVOLTMETER**  
(May, '68)

**TRANSISTORISED AUDIO OSCILLATOR**  
(Dec., '67)

**AF TONE BURST GATE**  
(April, '68)

**R.C. BRIDGE**  
(MAY, '66)

**TEST EQUIPMENT KITS**

	PRICE
Solid State V.O.M. . . . Dec. 68	\$57.00
V.T.V.M. Feb., 66 . . . . .	\$57.51
Solid State Audio Millivoltmeter, May, 68 . . . . .	\$60.63
Audio Oscillator . . . Dec., 67	\$44.30
AF Tone Burst Gate, April 68	\$61.00
R.C. Bridge . . . . May, 66	\$40.99

Postage extra on all kits.

# PTY. LTD.

**E. S. & A. BANK BUILDING**  
**CNR. BROADWAY & CITY ROAD, SYDNEY**  
(OPP. GRACE BROS.) Phone: 211-4224, 211-4244, 211-4213



polyvinyl chloride must not be used.

The processing steps are as follows:

(a) Immerse in developer for about 15 seconds.

(b) Immediately wash exposed side of sheet under the hardest stream of cold water available. This, before the developer evaporates from the sheet.

(c) Immerse in developer for 15 seconds again.

(d) Wash again as above.

These times are not critical provided the sheet has been exposed sufficiently. Care should be taken to see that the

coated surface does not become scratched or scuffed. Once developed, the sheet may be exposed to any kind of light prior to etching.

After developing, an image should be visible. If the entire coating washes off during developing then the wrong side was exposed. With gloss Aluminex it is difficult for the inexperienced to determine which is the coated side; run a few drops of water on both sides of the sheet — the water will "wet" the uncoated side, but will run off the coated side as if it were an oily surface.

The etching can be done with a solution of caustic soda or Graphtext etchant. The solution is about 4oz of caustic soda crystals to a half-gallon of water. The etching time is not critical and may be varied within wide limits. The procedure is as follows:

(a) Immerse sheet in solution and wait until small flakes start to lift from the surface.

(b) Wait a further 10 seconds and then rinse front and back under running water as described above for the etching of ordinary aluminium.

(c) Wipe the front and rear to avoid water spots.

The thinner Aluminex material may be stuck to a clean metal surface using Graphtext double-sided adhesive film. An illustration in this article shows a sample label made from artwork for one of our projects.

A similar process to that by Graphtext is marketed by Minnesota Mining and Manufacturing (Australia) Pty. Ltd. under the trade-name "Scotchcal" photosensitive products. This is available in plastic or aluminium in red or black for the aluminium and red, blue, green and black for the plastic. Both materials are available in one thickness only and are supplied with a pressure-sensitive adhesive backing. Prices and other information regarding the process can be obtained from Ozapaper Sensitizers Pty. Ltd., 64-66 Chapel Street, Marrickville, N.S.W. or other distributors of Scotchcal products.

Basically, the Scotchcal process for making a label consists of exposure, developing and spray-finishing. The film is exposed with a negative transparency using a plan copying machine or photoflood lamps. The label is then developed with Scotchcal developer, which can be done in a normally lit room. Final step is to spray the label with a protective clear film. Fifteen minutes later the label can be pressed into position.

The negative transparency for these processes must be of high contrast, as must the artwork form which it is made, i.e., the artwork must have dense black lettering on a white background. Watercolour board makes a suitable background for the artwork. The lettering can be obtained in sheets in various styles and sizes or one can use print from glossy magazines or calendars or, as another alternative, use pens and lettering guides. Sheets of lettering and watercolour board can be obtained from all drafting supply stores.

Unless one has access to darkroom facilities the best way of obtaining a negative transparency is to have it made by a professional photographer. Alternatively one can make suitable transparencies without a camera using Scotchcal photosensitive film exposed in a plan copying machine or to photoflood lamps.

Finally, a transparency can be obtained without resorting to photographic methods by using pens and letterguides on clear plastic film. This will result in silvery letters on a coloured background on the label.

So there it is — an outline of some of the processes available for obtaining a good finish on electronic equipment, whether home built or made in small quantities by equipment manufacturers.

## "FIRST FOR QUALITY IN HI-FIDELITY"

Try our economical and rapid Mail Order Service. We guarantee you the best for less! All enquiries given prompt attention. Popular brands stocked include—**Leak, K.E.F., Beocord, ADC, Wharfedale, Toshiba, Teac, Goodmans, Shure-SME, Peak, Goldring, Kenwood, Sansui, Labcraft, Thorens, Sony, Revox, J.H. Tandberg, Lux, Dynaco, Jorgen, Celestion, B & O, Rapar, etc.**

COMPLETE SYSTEMS FROM \$129

**S**TEREO  
OUND  
YSTEMS  
PTY. LTD.

51-3998

304 CHAPEL ST.,  
PRAHRAN, VIC.  
3181

## BUY RECORDING TAPE AT WHOLESALE PRICE

### WILCOX BROS. & BARCLAY

are now offering their line of recording tape direct to the Public at wholesale prices. This is a leading American manufacturer's first-grade line especially packed for us in a plain box. We are not allowed to reveal the maker's name.



TYPE	CODE	LIST PRICE	YOUR Wholesale PRICE
5" 900ft Acetate PVC .....	5R9	\$2.75	\$1.80
5" 1200ft Tensilized Polyester .....	5P12	\$4.45	\$2.95
7" 1800ft Acetate/PVC .....	7R18	\$5.10	\$3.35
7" 2400ft Tensilized Polyester .....	7P24	\$8.35	\$5.50

Wholesale prices allow for 33 1/3 per cent trade discount and cash settlement discount an include sales-tax. Freight free throughout Australia.

### MONEY BACK GUARANTEE

WILCOX BROS. & BARCLAY tape is guaranteed to be first-grade splice free recording tape made in the U.S.A. Your money will be refunded in full on return of goods within fourteen (14) days if you are not fully satisfied with your purchase.

### ORDER FORM (capital letters please)

FROM:  
NAME:  
STREET AND NO.  
CITY OR SUBURB:

POSTCODE:

PLEASE SHIP:

..... rolls 5R9 at \$1.80. Total \$ .....

..... rolls 5P12 at \$2.95. Total \$ .....

..... rolls 7R18 at \$3.35. Total \$ .....

..... rolls 7P24 at \$5.50. Total \$ .....

I enclose cheque/postal note/ Money Order for Total \$ .....

Return this order to:

**Wilcox Bros. & Barclay**

WHOLESALE MERCHANTS

Mail Order Office:

Room 7, 3rd Fl., 323 Bourke St., Melbourne

**W**  
**B & B**



# Test Set-up For Digital Circuits

BY  
C. P. TROEMEL

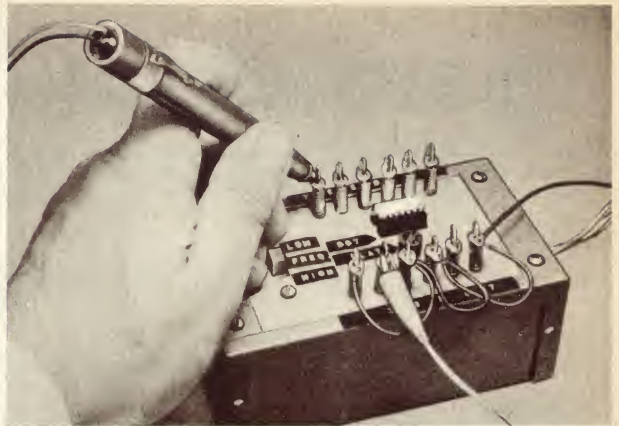

This article is published by arrangement with "Popular Electronics," U.S.A., presented more or less as it appeared in their April, 1969 issue, but with some suggested part substitutions. It describes a simple test set-up for checking digital ICs, using a simple probe and pulse generator which may be used separately or in combination.

The increasing use of digital ICs in many experimenters' projects has created a need for a low-cost in- or out-of-circuit tester for these complex semiconductor devices. Up to now experimenters have done their best using a conventional voltmeter to trace the on-off signal on a circuit board. This is a difficult process at best. Making contact with a narrow foil strip and looking at a meter at the same time is trouble enough, but most of the time the pulses are so short that they don't even register on the meter. It is even more difficult to test ICs that are not connected into known operating circuits.

The "IC Telltale" described here was designed to solve many of these testing problems. It will test, in or out of the circuit, the RTL (resistor-transistor-logic) ICs such as the Motorola MC700P series and the Fairchild uL900 series that are used in a number of "Popular Electronics" projects.

The IC Telltale consists of two assemblies: a 10,000-ohm input-impedance probe for checking ICs mounted on a circuit board; and a test set with a built-in 2Hz and 10Hz trigger pulse generator with 14-pin in-line and 8-pin round IC sockets for out-of-circuit tests. The oscillator circuit in the test set can also be used as a trigger source for finished IC boards, if desired.

The readout is built in the probe and consists of a small pilot lamp that is on when the logic is at, or near, ground level and goes "off" when the logic is at, or near, +3.6 volts. The probe can be used to trace a digital signal through foil patterns and integrated circuit connections.

Probe: The electronic part of the probe (figure 1) is assembled to fit inside a plastic tube whose inside diameter is just large enough to hold the pilot lamp, I1. The author used the empty plastic case of a large cheap felt-tip marking pen.

If you use a similar case, take out the inside and clean it thoroughly. Use a No. 27 drill to enlarge the hole at the pen tip so that it will pass a 6-32 screw. Place a nut on a 1/4in 6-32 brass screw about three-quarters of the way down its length. Using a file, make a sharp point of the end of the screw.

The nut, which will secure the finished probe within the pen, will clean the threads as it is removed.

Lay all the probe components beside the pen case as shown in figure 2. Trim the component leads and assemble the circuit, making sure that you don't exceed the inside diameter of the plastic case. Use insulating tubing on leads where required to prevent accidental shorts. Note that the indicating lamp does not require a socket and the leads are soldered directly to its base.

When you have the components assembled, slide them into the case from the rear until the pointed end of the screw comes out as far as possible. Use a lockwasher and the 6-32 nut to secure the screw to the case. Be sure that you do not rotate the

screw as this may break the solder connection to it. The lamp should be slightly recessed within the pen case so that it is protected and yet can still be seen. Two flexible leads (red for positive and black for ground) are bought out of the probe beside the lamp. These leads can be a couple of feet long if desired (18in is about ideal) and should be terminated with small alligator clips.

The operation of the probe is as follows. Transistors Q1 and Q2 form a high-gain current amplifier using R1 to limit the input base current to Q1 and prevent loading of the IC being tested. When Q1 is cut off, with the input either grounded or left floating, current through R2 saturates Q2. Resistor R3 reduces the voltage supplied to lamp I1 when Q2 saturates.

Figure 1. The probe is a simple two-transistor lamp driver arrangement. With no signal applied, the lamp is lit. When a positive voltage is applied to the tip, the lamp goes out.

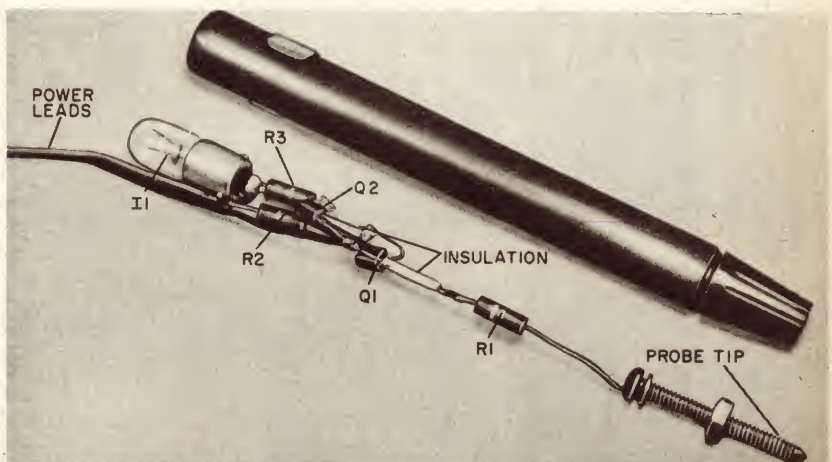
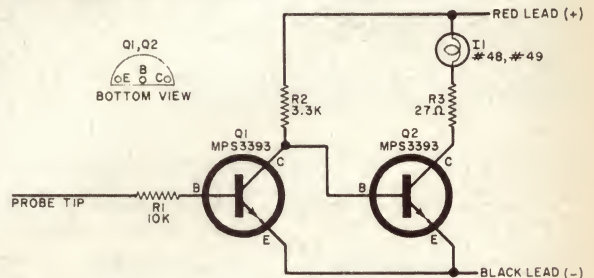

Figure 2. The complete probe is housed in a plastic tube, in this case an old felt-tip marker pen. Assemble the components with care, and gently fit into the housing.





# HITACHI

## TAPE RECORDERS AND TAPE PLAYERS . . .

- are quality engineered
- have tasteful styling
- give superb reproduction



**TRQ 717**  
4 track, 3 speed stereo recorder with built-in speakers.

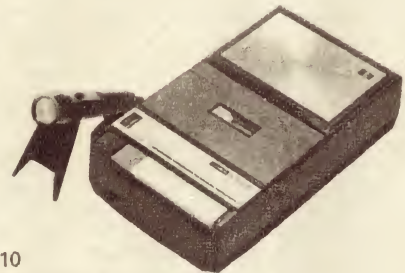

**TRQ 210**  
Compact, battery cassette portable tape recorder.

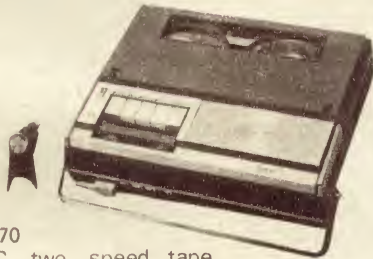

**TRQ 570**  
AC/DC two speed tape recorder.



**TRQ 222**  
Compact, portable AC/DC stereo cassette tape recorder.



**INSPECT** this wide and varied range of **HITACHI** reel and cassette stereo and mono recorders **NOW** at your State Branch Showroom of General Accessories.



Melbourne people take advantage of the special Hi Fi Stereo Showroom General Accessories have built.

Products are eagerly displayed. There is a complete range of HITACHI domestic tape recorders and tape players on display.

Why don't you go now to 153 Sturt Street, South Melbourne and inspect the range for yourself.

## GENERAL ACCESSORIES

(A DIVISION OF ELECTRONIC INDUSTRIES LIMITED)

VIC. 153 Sturt Street, South Melbourne. 69 0300  
QLD. 50 Lt. Edward Street, Brisbane. 23093.  
TAS. Homecrafts, 199 Collins St., Hobart. 22711.

S.A. 81 Flinders Street, Adelaide. 23 4022.  
N.S.W. 443 Concord Road, Concord West. 73 0211.  
W.A. 46 Milligan Street, Perth. 21 2501.



When the input to Q1 exceeds about +0.6 volt, Q1 conducts and removes the base drive from Q2, cutting off this stage and extinguishing I1. Since most RTL (resistor-transistor-logic) ICs require more than 0.8 volt to guarantee turn on and less than 0.46 volt to turn off, the 0.6-volt threshold of the IC Telltale falls in the correct place to indicate the state of the input or output.

To test the probe, connect the black lead to ground and the red lead to a source of 3.6 volts (the same voltage used for the IC circuit). The lamp should glow and be plainly visible at the top of the probe. Touch the probe tip to the +3.6-volt source and note that the lamp goes off. If the lamp either doesn't light or doesn't go off when it is supposed to, remove the circuit from the probe and check for accidental shorts that may have occurred during assembly.

**Test Set:** There are two circuit boards in the test set: an oscillator and a socket-contact board. The oscillator section, whose schematic is shown in figure 3, is assembled on the PC board with the foil pattern shown in figure 4. Mount the components on the board as shown in figure 5.

To test this circuit, connect the board to ground and +3.6 volts at the indicated places and connect an oscilloscope across the TRIGGER OUTPUT terminals. Depending on the position of S1, you should see either a 2Hz or 10Hz pulse train.

Make the socket-contact board using the foil pattern shown in figure 6. Solder the 12 spring-contact terminals and the two IC sockets in place as shown in figure 7. Looking at the top (non-foil) side of the socket-contact board, orient the 8-pin round socket so that pin 8 (identified by a small projection on the socket) is in the position shown in figure 7. Make some sort of marks on the board to identify pin 8 and to identify the dot and notch end of the in-line socket. At the same time, mark the LOW and HIGH frequency positions for switch S1. The hole for this switch can be cut to fit the switch used.

The oscillator board is mounted on the socket-contact board using three pieces of stiff wire about 1/8 in long. Insert the three wires in the indicated holes on the smaller board (figure 5) and solder them in place. Insert the other ends of these wires in the appropriate holes in the larger board and solder them in place. Clip any excess

Right: Figure 3. The trigger generator is a conventional multivibrator whose frequency is changed by resistor variation. Output stage is an emitter follower.

Below: Figure 4. Actual size foil pattern for the emitter follower multivibrator and circuit.

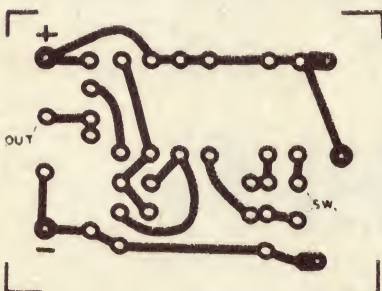
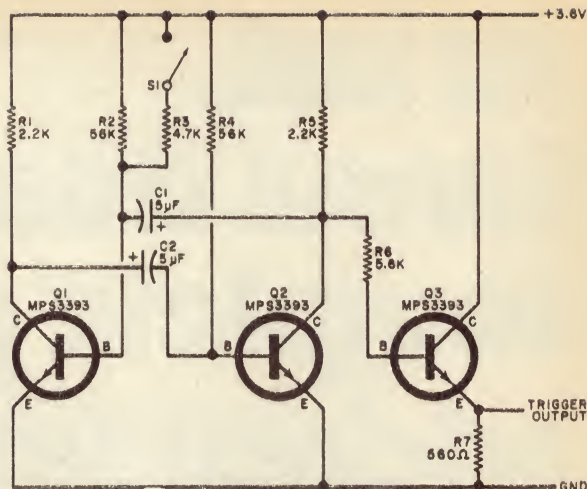

wire from the top of the board. Connect S1 to its leads.

On the upper surface of the metal chassis, cut out a rectangle 4 in by 2 in so that the larger board can be mounted within the chassis and secured with appropriate hardware at each corner. Drill a hole in one end of the chassis to accept a small rubber grommet. After tying them in a knot to provide a strain relief, pass the three test leads from the smaller board through this grommet. Attach a small alligator clip to the end of each lead. Use a black lead for ground, red for + and another colour for trigger.

Assemble the cover on the metal chassis. Using some type of marker, identify each spring clip on the metal lip adjacent to it, as shown in the photograph. Note that pins 4 and 11 are missing since they are connected internally.

**In-Circuit Tests:** To check ICs on a finished board, apply the required DC power to the board (usually +3.6 volts) and introduce a trigger signal. If no trigger source is available in the

## PARTS LIST

### PROBE

2 volt, 50-60mA pilot lamp (No. 48, No. 49, or similar).

Q1, Q2 — Transistors MPS3393.

R1—10,000-ohm, 1/2-watt

R2—3300-ohm, 1/2-watt

R3—27-ohm, 1/2-watt

Misc.—Plastic tube or felt-tip marker pen 1/8 in inside diameter; 1 1/2-in-long brass screw with lockwasher and nut; flexible test leads 18 in long (one red, one black); small alligator clips; insulation.

### TEST SET

C1, C2—5µF, low-voltage electrolytic capacitor.

Q1, Q2, Q3—Transistors MPS3393.

R1, R5—2200-ohm, 1/2-watt

R2, R4—56,000-ohm, 1/2-watt

R3—4700-ohm, 1/2-watt

R6—5600-ohm, 1/2-watt

R7—560-ohm, 1/2-watt

S1—S.p.s.t. switch

Misc.—5 1/2 in x 3 in x 2 1/8 in enclosed metal box (Bud CU2106-A or similar); 8-pin IC socket (Cinch-Jones 8-ICS, Allied No. 47FO155 or similar); 14-pin in-line IC socket (Augat 314-AG5D-2, Allied No. 47F6225 or similar); spring-clip terminals (Vector T30N2, 12 needed); three lengths of colour coded flexible test leads; three small alligator clips; small rubber grommet; 2 in bare stiff wire; mounting hardware, etc.

Note: The Motorola transistor MPS3393 is not available in Australia. It can be replaced by low power audio types, such as the BC108, 2N3565, TT3565.

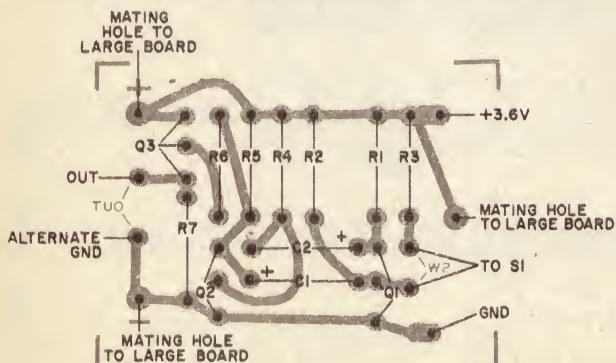

Figure 5. Component installation on the oscillator board. This board is supported from the large board by three stiff wire leads whose locations are also shown here. Two of these leads carry the power supply.

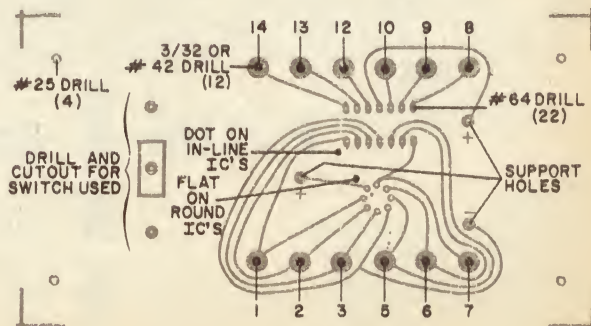

Figure 7. Parts layout for the socket-contact board. Note the three support holes for oscillator board.



# At last. Sansui create the first complete public address unit.

## And in Hi-Fi

Enter the Sansui PA100: world's most versatile Hi-Fi public address mixer/amplifier incorporating more features than any other comparable solid state model made.

These are the Sansui features that make the PA100 ideal for clubs, hotels, schools, conference halls, offices, factories, dance studios—anywhere a versatile address system is needed:

- 6 dual inputs, both front and rear.
  - 6-channel Hi-Fi mixer.  
Recording pre-amps 20-20,000 Hz.
  - 60 watt main amp.
  - Multiple outputs—5 impedances.
  - Indicator lamps for each channel.
  - Voltage stabilisation to 20% power deviation.
  - Provision for independent use of pre and main amps
- PLUS** many other features.



SANSUI SOLID STATE **PA100**

*For immediate interstate enquiries contact:  
Melbourne: Maurice Chapman, Magnecord;  
Adelaide: Neil Muller Pty. Ltd.;  
Brisbane: Chandlers Pty. Ltd.*

For further information return this coupon today.

**MAGNECORD SALES AND SERVICE**

P.O. BOX 882, G.P.O., SYDNEY.

Please forward me your free information and price list  
on the Sansui PA100  Other models  (Tick box.)

NAME:.....

ADDRESS:..... POSTCODE:.....

OCCUPATION:.....



equipment itself, use the oscillator in the test set. Connect the black lead of the test set to the PC board ground and the red lead to +3.6 volts. Connect the test set TRIGGER OUTPUT terminals to the PC board's input terminal. Switch S1 can be in either the LOW or HIGH frequency position.

Connect the black lead from the probe to the PC board ground and the red lead to +3.6 volts. The probe lamp should be on. Check for the presence of +3.6 volts at the IC (usually pin 11 of the in-line type and pin 8 of the TO-5 can). When the probe makes contact with +3.6 volts, the lamp should go out. If it doesn't, check back along the foil pattern and locate any break.

Note that, when using the probe, it isn't necessary to watch the lamp directly as it is in your line of vision when your attention is on the probe tip. Since the lamp stays on when the probe tip is grounded, it is also possible to check the ground pattern of the foil.

Once it has been determined that the positive DC and ground are correct, place the probe tip on the signal input terminal and observe that the lamp blinks on and off in step with the applied trigger signal. It is easier to see the lamp blinking if S1 is in the LOW frequency position. You can now trace the trigger signal directly to the IC terminal.

When checking flip-flops, observe that the signal at the output (1 or Q, 0 or  $\bar{Q}$ ) is usually at a slower rate than the applied trigger. Using the probe and a schematic of the circuit board, it is possible to trace the path of the signal and note where the signal stops (if the board is faulty). If a number of flip-flops are involved (as in a countdown circuit), the probe lamp will blink more slowly as you move down the chain. In this case, place S1 in the HIGH frequency position to speed up the counting. You can trace the signal through gates or inverters by observing the presence of signals at the inputs and output.

**Out-of-circuit Tests:** To test unmounted (loose) ICs, remove the power from the test set and insert the IC in its socket, observing the notch and dot code on in-lines and the flat, tab, or colour dot on round ICs.

The only direct connections to the ICs are +3.6 volts to pin 11 of the in-line and pin 8 of the round socket and ground to pin 4 of both types.

The rest of the contacts to the IC are made through the 12 spring clips.

Apply power to the test set by connecting the black test lead to ground and the red test lead to a source of +3.6 volts. Test the IC using the ac-

companying table as a guide. Use small lengths of insulated wire with bare ends to make any necessary interconnections. The two-speed oscillator built into the test set serves as the signal source.

TEST TABLE FOR ICs* OUT OF CIRCUIT						
Function	Input				Output †	
Inverter	signal				blinks	
Gate	all gnd				off	
	any +				on	
	one to signal, others to gnd				blinks	
Flip-flop	Reset	S	T	C	1 or Q	0 or $\bar{Q}$
	gnd	gnd	signal	gnd	blinks	blinks
	gnd	+	signal	gnd	off	on
	gnd	gnd	signal	+	on	off
	gnd	+	signal	+	on or off	
	+ then gnd	gnd	gnd	gnd	on	off

\*For Motorola MC700P and Fairchild  $\mu$ L900 series ICs.

† As indicated by probe lamp.

+ Indicates +3.6 volts.

Figure 6. Actual-size foil pattern for the socket-contact board. Switch S1 cutout and mounting holes are dependent on the particular switch you are using.

Interior of a completed test set. The three leads (one for positive, one for ground, and one for trigger output) are knotted to provide a strain relief.

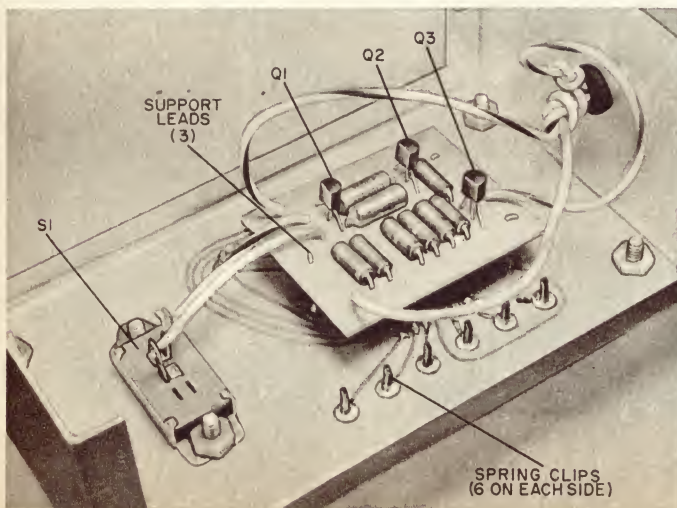
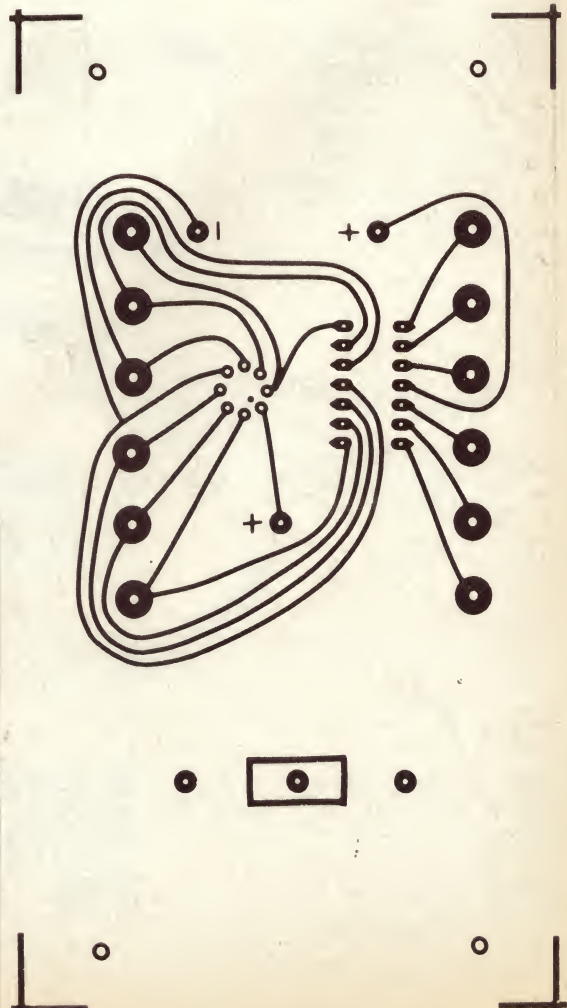



# Meet the Redette gang!

Let us introduce you to five boys with but a single thought – to provide you with the finest miniaturised connector range. The Redette range, moulded in D.A.P. with 16, 26, 38 and 52 ways, designed by these fellers to give greater reliability with no hold ups!

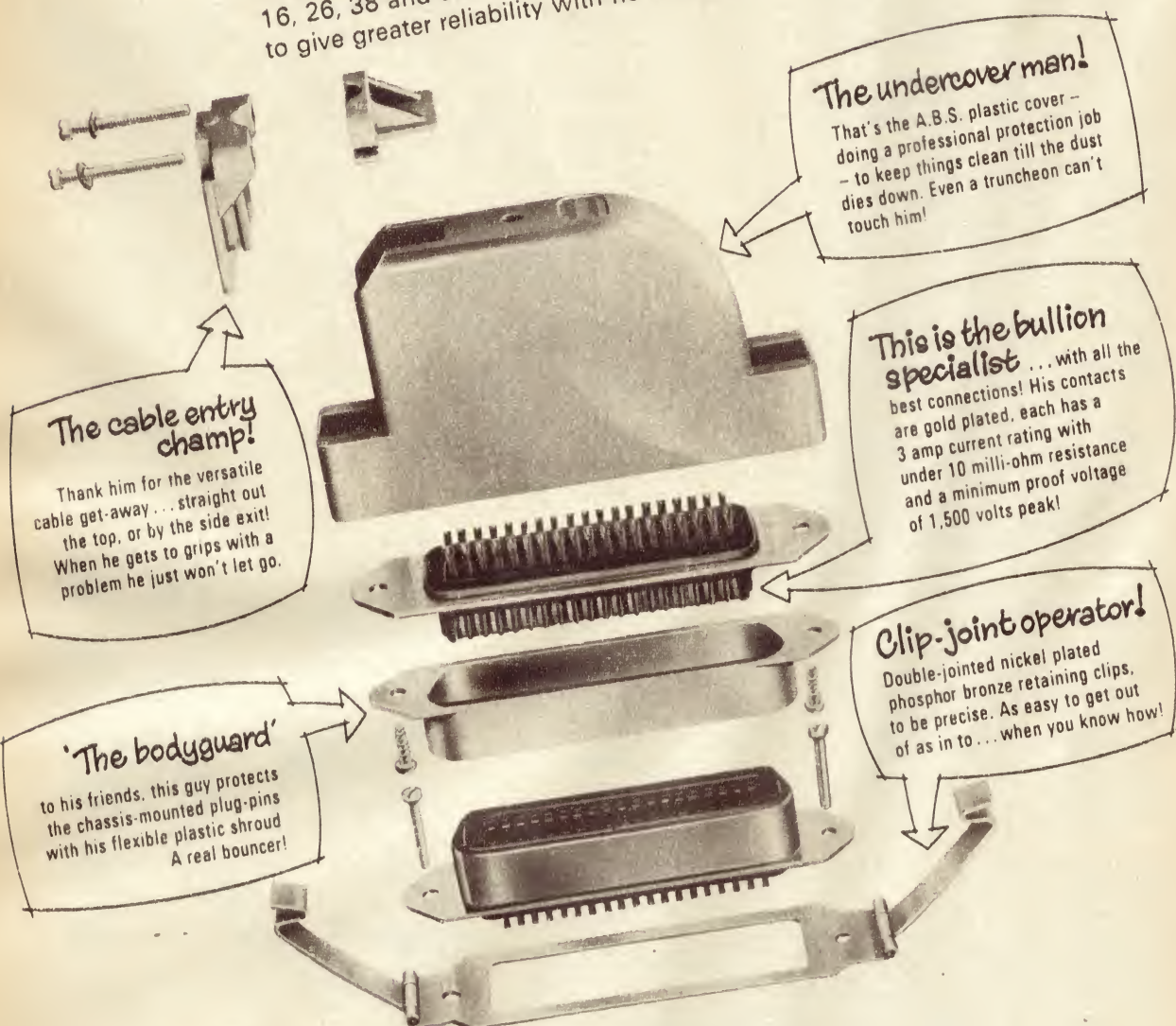

**The cable entry champ!**

Thank him for the versatile cable get-away... straight out the top, or by the side exit! When he gets to grips with a problem he just won't let go.

**The undercover man!**

That's the A.B.S. plastic cover – doing a professional protection job – to keep things clean till the dust dies down. Even a truncheon can't touch him!

**This is the bullion specialist...**

...with all the best connections! His contacts are gold plated, each has a 3 amp current rating with under 10 milli-ohm resistance and a minimum proof voltage of 1,500 volts peak!

**Clip-joint operator!**

Double-jointed nickel plated phosphor bronze retaining clips, to be precise. As easy to get out of as in to... when you know how!

**'The bodyguard'**

to his friends, this guy protects the chassis-mounted plug-pins with his flexible plastic shroud. A real bouncer!

If you're daring enough to let the Redette boys have your name and address, they'd like to fill you in... on the details of the Redette range. Write or 'phone them now care of this address...

**MCM** ELECTRONIC COMPONENTS  
**MURDO**

15 Edinburgh St., Huntingdale, Victoria, 3166. Tel.: 544-3033  
N.S.W. Sales Office: 56 Berry St., North Sydney, N.S.W. 2060. Tel.: 92-7675.



# HINTS ON READING CAPACITOR CODES

Readers who have occasion to handle imported electronic equipment should appreciate the tabulated information given in this article. It is reproduced from "Service Scope," a publication issued by Tektronix Inc., for their customers and service agents.

As far as possible, Australian capacitor manufacturers tend to favour the practice of making capacitor values and ratings directly on the body of the component. Where a color or letter code is used, it is normally no great problem to verify it by reference to local manufacturer's literature.

The real problem arises with capacitors found in imported equipment and marked only with a series of letters, numbers or colour dots, for which there is no related literature. One may guess at the significance of some of the markings but there is always the possibility that the guess may be wrong. And there are often other markings, the meaning of which is unknown.

The problem with the marking of capacitors arises largely from the fact that there is so much information which needs to be encoded, the capacitance value being only one of the things a customer needs to know. Almost certainly, he will need to be informed about other para-

meters such as tolerance, temperature coefficient and voltage rating. What is more, the need for such data varies with the type of capacitor involved.

With electrolytic capacitors, tolerance and temperature coefficient are seldom important, but peak and working voltage ratings are, even related in some cases to temperature.

Voltage rating and tolerance are important for ceramic capacitors intended for bypass functions; temperature coefficient is less so. For coupling and trimming functions, involving ceramic capacitors of a different type, the emphasis shifts away from voltage rating towards the details of tolerance and temperature coefficient. Thus, temperature coefficient will seldom, if ever, be found on electrolytic capacitors but will almost invariably appear on ceramic fixed capacitors and trimmers intended for coupling, alignment and compensation circuits.

Faced with coding problems, manufacturers have often resorted to improvised methods which may cause no great problem to themselves or their immediate customers. The problem arises later when the same capacitors turn up in isolation or in equipment being serviced, with no readily available key to the coding.

It would be a mammoth task to discover and list the coding methods which have been adopted from time to time by individual manufacturers but what follows is a summary of accepted present-day practice.

## CERAMIC DISC CAPACITORS

Often called "discs" (that's the trademark of one manufacturer), ceramic disc capacitors are available in two categories: temperature compensating or class I, and "high-K" or class II. Temperature compensation (Tc) types usually carry the capacitance in pF's directly. Tolerance may be shown in per cent or by letter:

M = ± 20%

K = ± 10%

J = ± 5%

G = ± 2%

F = ± 1%

Temperature coefficient is indicated as the number of parts per million per

degree centigrade by which capacitance will increase with temperature (+) or decrease (-). Thus P100 stands for +100 P/M/° C, N750 for -750 P/M/° C, NPO for 0 P/M/° C, N030 for -30 P/M/° C, etc. All these Tcs have a tolerance, too. NPO is usually ±30 P/M/° C, with looser tolerance on larger Tcs. Tc tolerance is also looser on very low capacitance parts.

"High-K" types list capacitance the same way (or in µF), and in addition sometimes use a multiplier scheme as follows: 102 for 1000 pF, 473 for 47,000 pF, etc. Capacitance tolerance is shown as above, with the addition of P for GMV ("guaranteed minimum

value" or -0, +100%), and Z for -20, +80%. The temperature coefficient of these units is usually not linear, so only the maximum capacitance change due to temperature from the 25° C value is given. This is called the "temperature characteristic," a typical case being "Z5U." This table explains the meaning of the more common temperature characteristic designations. Temperature range over which characteristic is effective:

Z5: +10° C to +85° C

Y5: -30° C to +85° C

X5: -55° C to +85° C

W5: -55° C to +125° C

Limits of capacitance change from the room temperature value:

D: ±3.3%

E: ±4.7%

F: ±7.5%

S: ±22%

U: +22, -56%

V: +22, -82%

Thus "Z5U" means that temperature can cause the capacitance to increase a maximum of 22%, or decrease a maximum of 56% from the room temperature value, within the limits of +10° C and +85° C.

Whether voltage rating appears on a disc depends on the manufacturer's practice. Most do not include it on their "standard" voltage rating, which is 1000V for Sprague and RMC, and 500V for Erie. Other voltage ratings, however, are printed on the capacitor.

High-voltage ceramic discs and plates used at Tektronix are of class II dielectric material, and carry labels similar to the class II discs.

## CERAMIC TUBULAR CAPACITORS

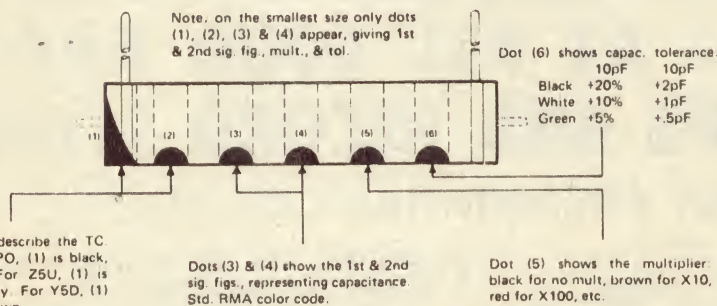

These units are usually white enamel coated and have parallel radial leads. "Dog bones" come in both class I and class II dielectrics and in several sizes, at least one being too small for a complete code of any kind. The code consists of colour dots which show tem-

perature coefficient (Tc), capacitance, and tolerance (Tol.). The smallest style shows only capacitance and tolerance, and none can show the capacitance of a close-tolerance part to greater than two significant figures. The more common examples are illustrated above.





The best  
buy at any  
price!

# PROFESSIONAL TAPE AT WHOLESALE PRICES

"BRAND 5"—unconditionally guaranteed and manufactured to highest U.S.A. professional standards and sensationally priced at half that of comparable tapes.

"BRAND 5" has high remanence iron oxide

emulsion coated to highest grade Acetate or Mylar base material.

"BRAND 5" ensures unmatched results in high fidelity mono and stereo recordings, with certain protection against head wear, squeal and gumming of heads.

## FINEST QUALITY! HALF THE PRICE!

LENGTH	TYPE No.	DESCRIPTION & MIL. THICKNESS	NORMAL PRICE	OUR PRICE	LENGTH	TYPE No.	DESCRIPTION & MIL. THICKNESS	NORMAL PRICE	OUR PRICE
<b>7" REELS</b>					<b>CORRESPONDENCE TAPES</b>				
1200'	15D7	1.5 ACETATE	6.60	3.00	<b>3 1/2" REELS</b>				
1800'	10D7	1.0 ACETATE	7.25	3.25	900'	3D32MS	.33 MYLAR	3.90	1.95
1800'	10D7M	1.0 MYLAR	9.15	3.99	<b>3" REELS</b>				
2400'	5D7M	.5 MYLAR	10.40	4.75	150'	15D3	1.5 ACETATE	.95	.50
2400'	5D7MT	.5 TENSIL MYLAR	11.90	5.25	225'	10D3	1.0 ACETATE	1.20	.65
3600'	5D7MS	.33 MYLAR	13.20	6.75	225'	10D3M	1.0 MYLAR	1.65	.70
<b>5 1/2" REELS</b>					300'	5D3M	.5 MYLAR	1.95	.85
1200'	10D57	1.0 ACETATE	5.50	2.55	600'	3D3MS	.33 MYLAR	3.30	1.60
1200'	10D57M	1.0 MYLAR	6.00	2.95	<b>CASSETTES</b>				
1800'	5D57M	.5 MYLAR	8.90	3.75	C30	3.10	1.55		
<b>5" REELS</b>					C60	3.50	1.65		
600'	15D5	1.5 ACETATE	3.40	1.80	C90	4.75	2.65		
900'	10D5	1.0 ACETATE	4.15	1.98	C120	6.50	3.30		
900'	10D5M	1.0 MYLAR	5.32	2.25					
1200'	5D5M	.5 MYLAR	6.95	2.50					
1200'	5D5MT	.5 TENSIL MYLAR	8.70	2.75					
1800'	5D5MS	.33 MYLAR	9.60	3.75					

\* AVAILABLE AT ALL GOOD RADIO,  
TAPE AND RECORD STORES

GREEN CORPORATION LTD. 88 KING STREET  
SYDNEY. TEL.: 25-1989



**GREEN CORPORATION LTD.**

88 KING STREET, SYDNEY, N.S.W. 2000

Please send me FREE 24-page booklet "TAPE EDITING AND SPLICING".

NAME.....

ADDRESS.....



# BUTTON MICA CAPACITORS

The most difficult aspect of understanding the code on these parts is "where do you begin?" The sketch shows that the first dot is keyed to a centre terminal lug.

Dot Meaning

1. Identifier: Black, except omitted where capacitance must be specified to 3 significant figures.
2. Capacitance; 1st significant figure in pF.
3. Capacitance; 2nd significant figure in pF.
4. Multiplier of Capacitance: black = X1, brown = X10, red = X100, etc.
5. Capacitance Tolerance: black =  $\pm 20\%$ , silver =  $\pm 10\%$ , gold =  $\pm 5\%$ .
6. "Characteristic": black means a

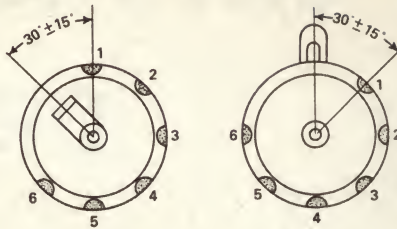

temperature coefficient falling somewhere between  $-20$  and  $+100\text{P}/\text{M}/^\circ\text{C}$ .

Note: The dots always read in a clockwise direction.

If the button has no centre lug terminals, the manufacturer tries to put the dots more on one side than out on the very edge; thus the code can be seen from one side only.

# MOULDED MICA CAPACITORS

Colour codes on this type vary, causing much confusion. There are two basically different code schemes, one being "OLD," the other being the EIA/MIL scheme currently in use. The sketch shows the difference.

OLD

Dot Meaning

1. Capacitance: 1st significant figure in pF.
2. Capacitance: 2nd significant figure in pF.
3. Capacitance: 3rd significant figure in pF.
4. Multiplier of capacitance.
5. Tolerance:
  - Black =  $\pm 20\%$
  - Silver =  $\pm 10\%$
  - Green =  $\pm 5\%$
  - Brown =  $\pm 1\%$
6. "Characteristic":
  - Brown = B
  - Yellow = E
  - Green = F

EIA/MIL

Dot Meaning

1. Identifier: White if per commercial specification, black if per mil specification.
  2. Capacitance: 1st significant figure in pF.
  3. Capacitance; 2nd significant figure in pF.
  4. Multiplier of capacitance.
  5. Tolerance: same as "OLD."
  6. "Characteristic": same as "OLD."
- Note: "Characteristic" in mica capacitors refers to the temperature coefficient and capacitance drift.

Char.	T <sub>c</sub> (P/M/°C)	Drift
B	$\pm 500$	$\pm 3\% + 1 \text{ pF}$
C	$\pm 200$	$\pm (0.5\% + 0.5 \text{ pF})$
D	$\pm 100$	$\pm (0.3\% + 0.1 \text{ pF})$
E	$-20$ to $+100$	$\pm (0.1\% + 0.1 \text{ pF})$
F	$0$ to $+70$	$\pm (0.05\% + 0.1 \text{ pF})$

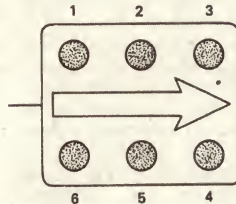

EIA STANDARD  
COLOR CODE

Black	0
Brown	1
Red	2
Orange	3
Yellow	4
Green	5
Blue	6
Violet	7
Grey	8
White	9

# OTHER TYPES

**DIPPED MICA CAPACITORS:** These parts carry a printed label much like that on ceramic discs. They may include the characteristic letter explained in the table above.

**PAPER AND FILM CAPACITORS, ALUMINIUM AND TANTALUM ELECTROLYTIC CAPACITORS:** In almost all cases they carry printed or stamped labels consisting of capacitance, tolerance, and voltage rating. Other characteristics are either unimportant or are reasonably consistent in all capacitors of the same kind.

**CERAMIC TRIMMERS:** The printed on labels usually show capacitance range and temperature characteristic. T<sub>c</sub> reads the same as on ceramic discs. The tolerance on T<sub>c</sub> of ceramic trimmer rotors is much looser than on fixed capacitors, for mechanical reasons.

**AIR TRIMMERS:** The same principle applies as in the case of paper and film capacitors. Only capacitance range need be indicated as T<sub>c</sub> is essentially uniform in this type.

(NOTE: Readers may wish to be reminded of the article "Fixed Capacitors—a guide to types and characteristics" which appeared in the May, 1965 issue of "Electronics Australia." Among the subjects discussed in this article are included tolerance, stability, operating frequency, leakage, losses and physical construction. Copies of this article can still be obtained from the Information Service for 20c post free.)

# COMPUTER BOARDS

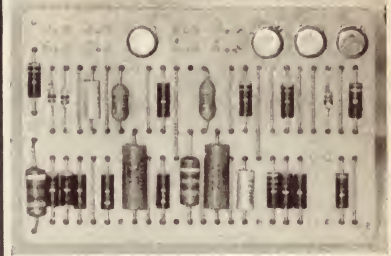

TRANSISTORS 15c Each.  
Resistors, Diodes, Capacitors Free.

8 BOARDS WITH A MINIMUM OF 30 TRANSISTORS Pack and post 25c \$4.00  
25 BOARDS WITH A MINIMUM OF 100 TRANS. Pack and post 50c \$12.00  
Technical Information supplied with goods. Minimum order \$1.50. Please add Postage.

COLSTOK ELECTRONICS  
Box 178, KELLERBERRIN. 6410

# L.P. RECORDS WANTED

Any quantity. Highest prices paid. Will call with cash within 30 minutes.

CASTLES RECORDS  
323 Church Street, Parramatta  
635-8621 after hours 86-1422

# NOW AVAILABLE FROM ELECTRO-PAK...!

A range of ARCO polyester-metal foil capacitors of the highest quality for all audio and RF applications.

These capacitors feature very high dielectric resistance (50,000 meg., low loss factor and high stability in temperatures from  $-40\text{c}$  to plus  $100\text{C}$ .

They are in 160-volt D.C. rating, 10 per cent capacitance tolerance on all values and are very well constructed with axial leads suitable for printed circuits or conventional wiring and have a tough epoxy encapsulation.

Also available, MIFLEX miniature styroflex capacitors in 400-volt D.C., 10 per cent tolerance, very stable capacitors for all RF applications.

160V 10 per cent Polyester—each			
1,000 pf ..	7c	.033 mf ..	10c
1,500 pf ..	7c	.047 mf ..	12c
2,200 pf ..	7c	.068 mf ..	12c
3,300 pf ..	7c	.082 mf ..	12c
4,700 pf ..	7c	.1 mf ..	14c
6,800 pf ..	7c	.15 mf ..	14c
8,200 pf ..	7c	.22 mf ..	16c
.01 mf ..	7c	.33 mf ..	20c
.015 mf ..	8c	.47 mf ..	24c
.022 mf ..	8c		
400V 10 p.c. Styroflex—each			
56 pf, 68 pf, 82 pf, 100 pf, 150 pf, 220 pf, 330 pf, 470 pf, 560 pf, 680 pf, all	5c.		

Note: All orders to include sales-tax at 25 per cent and post and pack 15c.

ELECTRO-PAK COMPONENT  
SUPPLIES CO.  
P.O. Box 731, Canberra City,  
A.C.T. 2601.



# A CRYSTAL CLOCK DRIVE UNIT



Years ago, the pendulum reigned supreme as a timekeeper. More recently it has reluctantly given way to the quartz crystal oscillator and other devices. Here is a simple approach to the design of a crystal clock which can be duplicated at a relatively modest cost.

by Ian Pogson

A few months ago, in December, 1968, to be exact, we presented "Some Thoughts On Crystal Controlled Clocks." This was in response to a large number of requests and inquiries relating to crystal clocks generally. When the foregoing article was written, we had a prototype clock running and undergoing tests, with the view to proving the system before we came up with a project for home construction.

During this time, the fortunes of our clock have risen and fallen, with various obstacles dogging its path. On some occasions, the problems which we had to meet could be put down to "teething" troubles, with all the ramifications that this involves. On other occasions, the problems could be put down to nothing else but bad luck. The unfortunate point about all this is the fact that the unit only had to stop functioning for any reason and for any short period, and the time of the test thus far is virtually wasted. The only choice under these conditions, was to start the checks all over again.

Perhaps readers may have more than a passing interest in the problems which we have had to meet and overcome. They are not necessarily in chronological order, but the following is briefly the story.

About last October, using the setup as shown in the photograph in the article on page 67 for December, all was going quite nicely. The writer went on annual leave and left the unit in the tender care of another member of the staff. For three weeks, all went well, with a reasonably constant losing rate which amounted to four seconds during this period. Although the losing rate may be considered as one which could be improved upon, the important point was the fact that the rate was virtually constant.

Suddenly, on the Monday morning following this run, the clock was four minutes slow! This was indeed a major setback. Checks showed that the clock was in fact, still running at just about the same rate as previously. Inquiries of the engineers responsible for the building revealed that, once a month, the Diesel-operated emergency power supply was tested. The changeover from mains to emergency supply and

back again, we were told, took four minutes. So this was the answer.

For convenience, we were running the clock from a regulated and adjustable power supply from the mains. In order to avoid a repetition of this failure, we set up a 12-volt emergency supply made up of eight 1.5-volt flashlight cells. These were connected in parallel with the mains operated power supply. So that there would be no drain on the batteries until the mains failed, we introduced an ordinary power silicon diode in series with the batteries. The mains-operated supply voltage was then set a little higher so that the batteries would not take even a small share of the load.

In the event of a power failure, the silicon diode would allow the batteries to take over. As the drain is only 250 milliamps, the batteries could cope with this for short periods, without any ill-effects on the time-keeping of the clock. This has worked out successfully and readers who may find a standby supply necessary could use this method.

Following solution of this problem the clock appeared to be erratic in its time-keeping, for no obvious reason. By monitoring the 50Hz from the last divider, against the 1000Hz from the previous stage, on a twin beam CRO, we finally traced the trouble to interference from a nearby transmitter. This transmitter is not on continuously but is keyed remotely as required. When keyed, we found that sometimes the last divider came out of lock and then dropped in again. Although the unit was still left generally unshielded, shielding of the output lead was sufficient to cure this one.

Another fault involving the last divider occurred on a couple of occasions, when the last divider came out of lock and stayed out, necessitating readjustment. This could only be put down to aging of components and the answer appears to be to use the very best and most stable components around this stage.

The next fault was a much more subtle one, and requires a fairly detailed explanation. It is a most interesting and informative exercise, to feed the 50Hz output from the clock

on one beam of a CRO and the 50Hz from the mains on the other beam. One only of these two components can, of course, lock the CRO time base. From subsequent experience, it is reasonable to assume that the 50Hz from the clock is, for all practical purposes, constant.

Let us assume, therefore, that we lock the time base with the 50Hz from the clock. This allows the 50Hz from the mains to drift with respect to the 50Hz from the clock. Many readers will be under the impression that the mains frequency is substantially stable. However, one only has to observe the setup just described, to find that this is not so. Although the mains frequency averages out to exactly 50Hz over a long period of time, the short term stability is quite a different matter.

A few minutes observation will allow one to observe a gentle drift of the mains frequency in one direction, a pause for a while, and then a drift back in the opposite direction. The point about all this is that the drift between the two very close but slightly dissimilar frequencies leads to some intermittent reaction.

It was found that when the mains drifted in one direction, there was no trouble. However, when drifting in the other direction and when a certain phase relationship was reached, the 50Hz frequency divider would momentarily jump into lock with the mains. This caused an erratic losing tendency and presumably the locking took place as the mains frequency was running slightly slow.

The cure for this problem was the addition of more filtering on the supply line and some slight changes to the triggering circuit component values.

At somewhere about this point, we decided that it would be a good idea to house the unit in the die-cast metal box set aside for it. This was done and all was neat and tidy, with the clock set up again and sent merrily on its way.

As if we had not had enough troubles to iron out, it appeared that the end was not in sight and the writer was beginning to wish that there was no such thing as a crystal clock!



Although all appeared on the surface to the well, after a few days the readout movement would stop and the current consumption would drop to somewhat less than half the normal value. To investigate the trouble, the assembly now had to be removed from the case. During the process, the clock movement started again and everything resumed normality. Much looking, tapping, twisting, voltage measurements and investigations with the CRO revealed nothing. We had no alternative but to put it back and set it up again.

These antics were repeated a number of times and it looked as though there was an intermittent fault in the audio amplifier system somewhere. Finally, the fault persisted for long enough to establish that the crystal oscillator and dividers were all functioning normally. However, after a short while, the fault vanished, leaving the problem still unsolved.

At last, a complete breakdown occurred and it was traced to the second stage of the audio amplifier. Replacement of the transistor and its collector load cured this nasty one. As can be appreciated, these troubles spread themselves over quite a long period and this is a major contributing factor to the delay in publishing details of the completed unit.

At the time of writing this paragraph, the clock has been running for four days and the rate has been established to be a gaining one, with somewhat less than 0.1 second per day. It will take the next few weeks to establish just what the rate is, and we hope to give more details along these lines later on.

From the foregoing it appears that the system as a whole is capable of quite good performance, in spite of the initial problems. In any case, not all units will need to be operated in close proximity to a radio transmitter and not all will be operated from the mains, thus eliminating even the risk of at least two of our problems. Also, our experience will allow readers to be forewarned against these and other problems, some at least of which have been "designed out" anyway.

On the other hand, our unit operated in a more favourable environment in some respects. It was installed on a bench, making it virtually a fixed installation, as opposed to a mobile installation, with its attendant vibrations etc. Also, although the laboratory is not air conditioned, the changes in weather conditions are not severe. This all adds up to what may be considered quite good environmental conditions. Just how vibration or extreme changes in temperature and humidity would affect the time-keeping qualities, we are not able to say.

Provided the unit is constructed properly and the crystal used is one which will stand up to vibration, then we can

The upper portion of the circuit shows the crystal oscillator and the three frequency divider stages. Note the "Advance" and "Retard" buttons associated with the third divider. The lower portion shows the 50Hz amplifier which drives the synchronous movement.

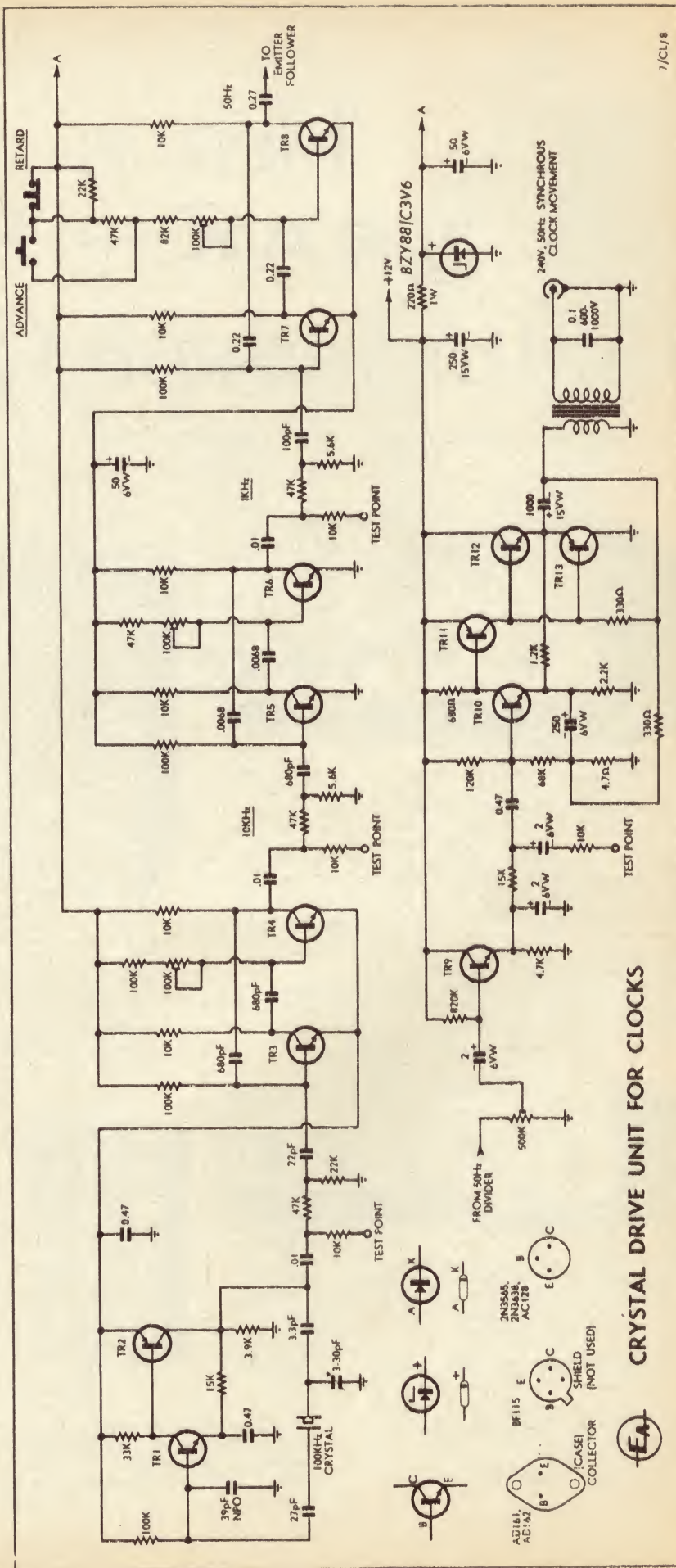

CRYSTAL DRIVE UNIT FOR CLOCKS



# Here is

## LEAK HIFI

# Craftmanship & Quality

A COMBINATION OF TALENTED DESIGNERS  
AND THE FINEST TECHNICAL MINDS.



**LEAK 'STEREO  
70' AMPLIFIER**

**\$298.00**

The 'Stereo 70' is full of latent power — up to 35 watts r.m.s. per channel. Distortion is a mere 0.1% at 1,000 Hz for all power outputs up to 25 watts r.m.s. per channel. In addition, this extra output enables a pair of loudspeakers to be connected apart from the two in the main listening room. Elegantly finished in black and silver, or an attractive teak case is also available for shelf mounting. Other brand new features are a head-phone socket for those who prefer to listen to stereo that way, and a DIN record/replay socket on the front panel for a portable tape recorder together with the standard inputs at the back of the amplifier.

All this, backed by the famous LEAK craftsmanship and reliability, makes the Stereo 70 the most technically advanced amplifier available.

**LEAK 'STEREO 30' AMPLIFIER**



**\$198.00**

The 'Stereo 30' solid-state amplifier offers the discriminating music lover studio-quality sound reproduction, advanced audio engineering and pleasing aesthetic design. The performance of the LEAK 'Stereo 30' represents the highest standards available. Each LEAK instrument is individually crafted and has the same high quality performance as LEAK instruments supplied to broadcasting and television companies throughout the world.



**LEAK  
SANDWICH MK. II  
SPEAKER SYSTEM**

**\$139.00**

The Sandwich cones comprise stiff aluminium skins for the outer surfaces where stresses are greatest, bonded to a thick core of featherweight, expanded plastic where stresses are lowest.

Use of this material provides immense stiffness and rigid piston action over more than six octaves and results in a remarkably smooth response free from violent peaks and troughs over a very wide frequency range. Available in mahogany, teak and walnut, this beautifully finished enclosure is still the only compact speaker system offering substantially linear frequency response. Size: 26" x 15" x 12".



**LEAK MINI-SANDWICH  
SPEAKER SYSTEM**

**\$99.00**

For music lovers who cannot spare space for a full-size LEAK Sandwich, the new Mini-Sandwich provides almost identical performance, with the exception of the very lowest octave. This superlative small speaker system is designed and made exactly as its larger companion. Size: 18½" x 11" x 7". Available in mahogany, teak and walnut.

## LEAK HIFI

H. J. LEAK (AUST.) PTY. LTD.

P.O. BOX 14, FRENCH'S FOREST, N.S.W. 2086.

FACTORY: 1 CAMPBELL PARADE, MANLY VALE, N.S.W. TELEPHONE: 94,4902.

CABLES: LECTRON, SYDNEY.

Professional equipment enquiries to Simon Gray offices or Representatives in all states



see no reason why the performance should not be satisfactory from this point of view. With regard to weather conditions, it remains to be seen just how much these factors affect the performance. The only approach to this one would be to try it out and when conclusions are reached, the appropriate action, if any, would suggest itself.

All things considered up to this point, it is the opinion of the writer that this crystal clock unit is still somewhat in the experimental stages. As was pointed out earlier, the design is one which has economy as a high priority factor. This naturally leads to some compromises. One, which is important, is the use of free-running multivibrators as frequency dividers. While they are very good when adjusted properly, they are not foolproof and so not 100 per cent reliable. This point should be considered where a unit is required and where reference is not available against one or preferably two more units.

Although it is not essential, it is highly desirable to have a double beam CRO for setting up and adjusting. In point of fact, we would have been in unenviable trouble had we not been equipped with a double beam CRO, when we had the aforementioned faults to track down.

The last few paragraphs may seem to paint a rather dark picture of the whole project. This is not the intention, but, we on the other hand, do not wish to convey an over-optimistic picture. We feel sure that, in spite of the earlier remarks, there will be readers who will want to "have a go," and this is a good thing. Perhaps the unit may not be sufficient on its own for navigational purposes in a small boat on a long sea voyage. On the other hand, there are many other applications, with less exacting requirements, where this clock could do a very commendable job.

There are probably many readers who, like the writer, delight in the pursuit of the elusive ultimate in time and frequency measurement. This leads us on to an alternative application for the clock. Even if you are not interested in its time-keeping as such, more than likely you will have a use for it as a frequency standard. Without alteration, the oscillator and frequency dividers will give accurately, 100KHz, 10KHz, 1KHz and 50Hz. Changes or additions could be made so that more and lower frequencies are made available.

So much for the preliminaries. Let us turn to the circuit diagram. The first stage is the 100KHz crystal oscillator which many readers will recognise as the 100KHz crystal oscillator we have used for a number of recent projects. There is nothing pretentious about this oscillator but it has already proved its worth. Two transistors are used and it should be noted that the second one is of the PNP type and is used "upside down." Circuit constants have been modified for this particular application, to meet the special needs. Emitter currents have been considerably reduced, to reduce temperature effects in the transistors and to keep the crystal oscillation amplitude to a minimum, both in the interests of frequency stability.

A 39pF NPO ceramic capacitor has been placed across the first transistor

emitter junction, with the object of swamping, to a degree, any input capacitance variations due to temperature, etc. This, in turn, has necessitated the addition of a 27pF NPO ceramic capacitor in series with the crystal loop. Otherwise it would be difficult to set the crystal precisely on the frequency using a reasonable value for the rate-setting trimmer capacitor. The latter is a high grade Philips 3-30pF trimmer. The transistors which

we used are types 2N3565 for the NPN and a 2N3638 for the PNP type.

The output from the crystal oscillator is taken via an attenuator network, which also modifies the pulse shape, to the base of the first of two transistors in a 10KHz multivibrator circuit. This functions as a ten to one frequency divider. The time constant of the frequency divider is adjustable by the 100K potentiometer in the base

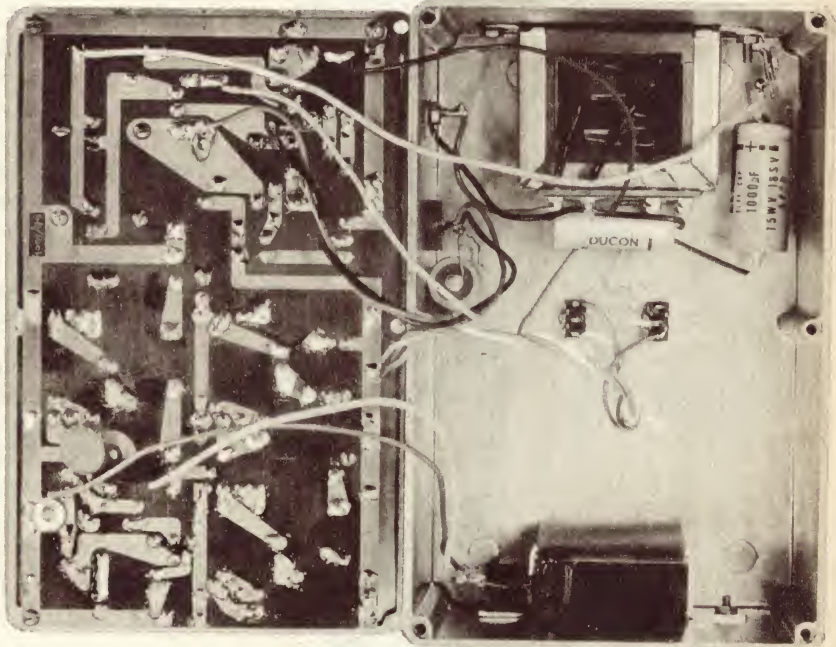

A general view of the complete unit assembled in the two sections of a die cast box. The printed wiring board (left) is mounted on the lid, with the power supply, "Advance" and "Retard" buttons, and the crystal in the box proper. The crystal is shown at the bottom of the picture wrapped in foam plastic.

## PARTS LIST

- 1 Die-cast box, 7 3/8in x 4 1/2in x 3 1/2in (Eddystone type 903)
- 1 Printed board, type 68/10cl
- 1 Output transformer, type 2155 (see text)
- 1 Coaxial socket (Belling and Lee)
- 1 2-Pin miniature speaker socket
- 1 Push-button switch, normally open (see text)
- 1 Push-button switch, normally closed (see text)
- 1 2-Tag strip
- 5 Stand-off pillars, 1in x 1/2in brass, tapped 1/8in Whitworth each end
- 1 100KHz crystal (see text)
- 1 Socket to suit crystal
- 1 3-30pF Philips trimmer
- 9 Transistors, 2N3565, BF115, etc. (see text)
- 1 Transistor, 2N3638
- 1 Transistor, AC128 (with heat sink)
- 1 Transistor, AD161
- 1 Transistor, AD162 } matched pair
- 1 Zener diode, BZY88/C3V6
- 3 100K potentiometers (see text)
- 1 500K tab potentiometer
- Screws, nuts, hookup wire, solder lugs, etc.

### RESISTORS

- (1/2 watt unless stated otherwise)
- 1 220 ohms 1W
- 2 330 ohms
- 1 680 ohms
- 1 1.2K
- 1 2.2K
- 1 3.9K
- 2 4.7K
- 2 5.6K
- 10 10K
- 2 15 K
- 2 22K
- 1 33K
- 5 47K
- 1 68K
- 1 82K
- 5 100K
- 1 120K
- 1 820K

### CAPACITORS

- 1 3.3 pF NPO ceramic
- 1 22pF NPO ceramic
- 1 27pF NPO ceramic
- 1 39pF NPO ceramic
- 1 100pF Styroseal
- 3 680pF Styroseal
- 2 .0068 uF low voltage plastic
- 3 .01uF low voltage plastic
- 1 0.1uF 600-1000VW polyester (see text)
- 2 0.22uF low voltage plastic
- 1 0.27uF low voltage ceramic or plastic
- 3 0.47 uF low voltage plastic
- 3 2uF 6VW electrolytics
- 2 50uF 6VW electrolytics
- 1 250uF 6VW electrolytic
- 1 250uF 15VW electrolytic.
- 1 1000uF 15VW electrolytic

Note: This list does not include power supply components or clock movement.



# MSP 'DIMINUETTE'

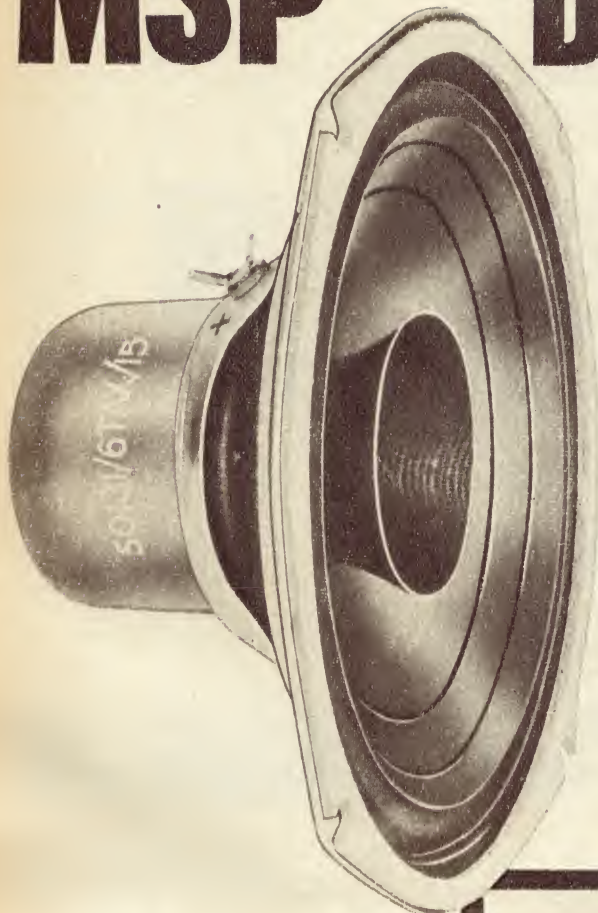

Designed for big performance where styling requirements, or sheer necessity, determine size limits, the Diminnette sound system is the engineered solution to the problem of small enclosure operation. It incorporates a six-inch wide-range speaker and a three-inch tweeter specifically intended for small enclosure application. The tweeter uses the proven curvilinear principle producing crisp brilliance and bringing modern recordings to life. Both units are coupled in a petite, aesthetically appealing enclosure and provide exciting high-fidelity sound.

The enclosure may be constructed as either an 8 or 15 ohm system to suit popular valve or solid-state amplifier requirements. The response is smooth and essentially flat from 80 Hz to 16 kHz but greater bass response can be obtained with a small amount of boost. Rapid transients, and an absence of boom, are ensured by solid timber construction and by liberally lining the enclosure with "innerbond".

15Ω Speaker System { 1-6" wide-range twin-cone speaker, 50131/6TAX/15.  
1-3" high-frequency curvilinear tweeter, 53418/31B.

8Ω Speaker System { 1-6" wide-range twin-cone speaker, 53406/6TAX/8.  
1-3" high-frequency curvilinear tweeter, 53418/31B.

Capacitor: 1-1μF 200V, AEE type W48/A303.

Innerbond: ¼ yard (36" wide x 1" thick), Wender Wool Pty. Ltd.

Sundries: 2 terminals, hookup wire, screws and glue, fret and trim.

Timber: ½ sheet ½" x 3' x 3' ply or pineboard, 7' of ¾" timber (cleats).

## SPECIFICATION

### Standard Stock Speakers

50131/6TAX/15	53406/6TAX/8	53418/31B
Frequency Response 60-12000 Hz	60-12000 Hz	5000-16000 Hz
Voice Coil Impedance 15 ohms	8 ohms	8 or 15 ohms
Nominal Power Handling 7 watts	7 watts	*
Minimum Total Flux 38000 lines	38000 lines	12000 lines
Mounting Hole Centres 6¾" P.C.D.	6¾" P.C.D.	3½" P.C.D.

\*Fed through suitable coupling capacitor the tweeter may be used in conjunction with a 7 watt amplifier providing speech or music programme material.

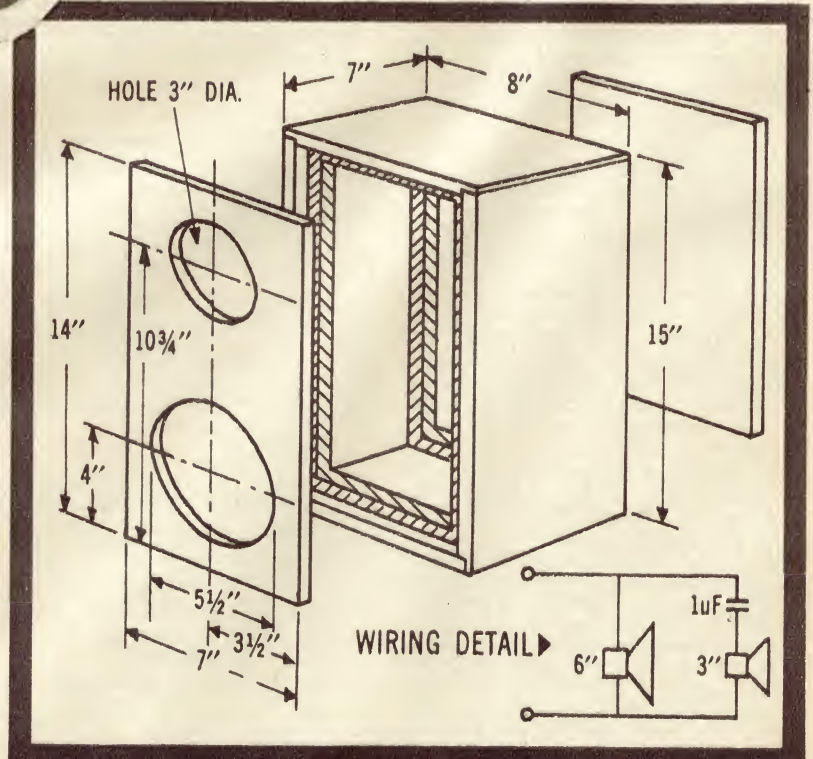

Recommended Enclosure Design by:

## MANUFACTURERS SPECIAL PRODUCTS PTY. LTD.

47 York Street, Sydney. Telephone 2 0233



circuit of the second transistor. Between the two stages, a test point is brought out, with a measure of isolation afforded by the 10K resistor.

The crystal oscillator and the 10KHz multivibrator are "stacked" with respect to the DC supply voltage. The current consumption of the two stages is virtually equal and so they share the supply voltage equally. This practice was adopted early in the development stages, with the object of obtaining maximum economy of operation. Compared with the final figure of 250 milliamps, for the complete unit, this saving is of little significance. However, for any future efforts to produce a clock where current economy is paramount, this approach would be valuable.

The 10KHz output from the first divider is fed, via a network similar to the one just described, to trigger the next divider to 1KHz. This circuit is similar to that of the previous frequency divider, with only the time constant values changed.

The 1KHz output from the second frequency divider, is fed via a similar network to those before, to trigger a 20-to-one frequency divider delivering 50Hz. Again, the circuit constants only are changed, to suit the lower frequency, but with one important addition. In order to advance or retard the time indicated by the second hand on the readout, provision is made to switch resistance in or out of circuit, so that the divider will divide by 21 or 19, instead of 20. This will slow down or speed up the output frequency and will advance or retard the second hand accordingly. The amount of change amounts to approximately 3 seconds for each minute the appropriate push button is held down.

The 50Hz output from the third frequency divider is fed via a level control, to an isolating emitter follower, the output of which is filtered to get rid of any spikes which may have persisted on the waveform and to make it a little more like a sine wave. A test point is also provided here and the signal is then fed into the first stage of the main audio amplifier.

The complete amplifier is a very much diluted version of a 10 watt amplifier originally designed by Philips. At first sight, this may seem to be a strange approach, when only 2 watts or less are required. The original amplifier was designed to give 10 watts with a supply rail of about 30 volts. We wanted 2 watts or so but were limited to a supply rail of a nominal 12 volts, and this is where the problem arose.

Many ways of obtaining 2 watts of audio at 50Hz, were investigated. This was found not to be an easy matter, when the supply was limited to 12 volts and complete reliability and good economy of power consumption were basic requirements. Finally, we found that the 10 watt amplifier would deliver about 1.5 watts or so, when fed from the 12 volt supply. Also, the current drain at this level of output was about 250 milliamps, which was better than other schemes which were investigated.

However, it is quite unnecessary to use a high quality amplifier such as this one, just to amplify 50Hz to operate a clock movement. Distortion, including crossover distortion, is of little consequence for such an application and so we set out to reduce the number

of components to a bare minimum, without prejudicing reliability. The circuit herewith is what we have found to meet the need of the particular application.

The output impedance of the amplifier is such that it should work into something between 8 and 16 ohms. As the impedance of the clock movement is much higher than this, it is necessary to use a transformer to step up the impedance to the optimum value, such that the maximum power transfer is available.

It was found that a transformer with a step-up ratio of about 32 was required and this could be met by a number of transformers which were available over the counter. An ordinary heater type power transformer designed to operate from 240 volts and deliver 7.5 volts from the secondary was found to be very satisfactory. In this application, the primary and secondary functions are reversed.

Some medium fidelity audio transformers are also satisfactory, provided they meet the ratio requirement. If the ratio deviates from the optimum by

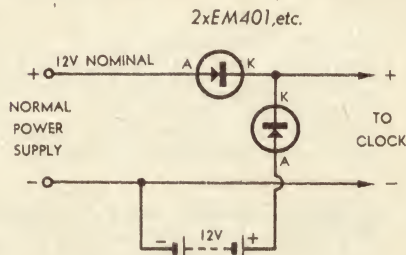

*A simple diode configuration permitting automatic change-over from mains supply to battery in the event of a mains failure.*

*Suggested circuit for a power supply to drive the clock unit. The resistor value will have to be determined experimentally to provide the recommended output voltage.*

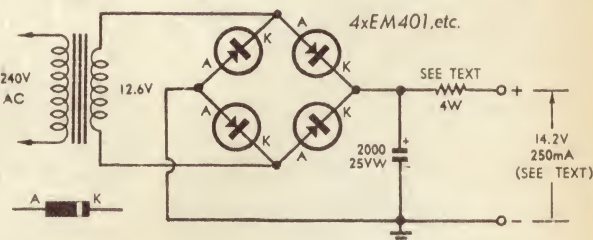

more than a restricted amount, the efficiency falls off rapidly and there is not enough power to operate the clock movement reliably. Also, the smaller and cheaper audio transformers have poor efficiency and are not satisfactory.

Apart from a few components, such as the output transformer, some electrolytics, etc., the unit is built on a printed board, measuring 7in x 4in. While on the subject of the printed board, our normal practice is to make available the necessary information to manufacturers so that they can make boards for the market. We are also making available full size glossy prints of the board, through the Information Service, at 50c each.

The location of the crystal is up to the individual and will depend upon the type of crystal used and other considerations. One important consideration is the leads from the crystal to the board, particularly where vibration is involved. The leads, if loose, may move about and the slight change

in capacitance would be sufficient to change the rate significantly. Where possible, it would be wise to fix the crystal to the back of the board, insulated and shock-proofed with a piece of foam plastic wrapped around it.

During our tests, we have used two different types of crystal. One was an old disposals unit in a relatively large "box" and having three pins at one end. This was made by Bliley and similar units made by RCA have been available from time to time. We were not able to find many technical details of this crystal but suffice to say that it was the one used when the tests were made last October.

The second crystal is of similar vintage, made by English Marconi and housed in a holder similar to the old familiar DC11. Again, no specific details of its characteristics are available but it is reasonable to assume that it is a square plate, plated on opposite faces and with thin electrodes attached at opposite centres, similar to some types available at present. This is the crystal which we have used for subsequent tests, and more will be said about it later on.

The types of transistors used throughout the unit are not critical with one exception. This applies to TR2, where a PNP type must be used. We used a 2N3638 as this is a type which is readily available, at a reasonable price. The other oscillator transistor, TR1, may be a 2N3563, 2N3565, or similar types. Although we have not tried them on this occasion, types BF115 or even BC108 are possibilities. For the three dividers, TR3, TR4, TR5, TR6, TR7 and TR8 may be the same as TR1. In the audio amplifier, TR9 and TR10 could be BC108 in each case. For TR11, it would be wise to stick with the AC128. Similarly, for the output, TR12 and TR13, a

matched pair consisting of AD161 and AD162 should be used.

The zener diode, BZY88/C3V6, is nominally rated at 3.6 volts. However, at these low voltages, zener diodes have a rather rounded knee, rather than a sharp one which is obtained at around 9 volts and above. As a result, the voltage at the C3V6 zener diode will vary according to the amount of current flowing through it. In short, the voltage which we have on this line is of the order of 4.2 volts and although regulation is achieved, it is limited by the characteristics of the diode.

The output transformer which we used just fits into the space available. It is the A&R type 2155. This is a step-down transformer with taps giving a range between 5 and 15 volts. We found that best results were obtained by using the 7.5 and 15 volts terminals as the primary. The secondary is the 240 volt terminals.

The 0.1uF capacitor across the



# EMPIRE — World's most perfect stereo/mono cartridges

Designed to meet the optimum-performance requirements of your record-playing equipment.



Professional 999VE Cartridge

**EMPIRE PROFESSIONAL 999VE SUPER QUALITY STEREO ELLIPTICAL CARTRIDGE** — for high performance record playback systems only. Will track 30 cm/sec. at less than 1 gram. Patented 4-pole, 4-coil, 3-magnet design. Frequency Response: 6 to 35,000 Hz. Output voltage: 5.0 millivolt per-channel. Channel separation: more than 30 dB. Tracking force  $\frac{1}{2}$  to 1 $\frac{1}{2}$  grams. Tracking angle 15 degree. Stylus: .2 x .7 mil elliptical hand polished diamond.



888 Series Cartridge

**888 SERIES.** Deluxe stereo cartridges with patented "Magnetic Cone-Stylus" Frequency response 888 — 12 to 25,000 Hz 888E — 10 to 30,000 Hz, 888TE — 8 to 32,000 Hz, 888VE — 6 to 32,000 Hz, Channel separation for each cartridge exceeds 30 dB. Tracking force: 888 —  $\frac{1}{2}$  to 4 grams, 888E —  $\frac{1}{2}$  to 3 grams, 888TE —  $\frac{1}{2}$  to 2 grams, 888VE —  $\frac{1}{2}$  to 2 grams. Tracking angle 15 degrees on all cartridges. Stylus: 888 — .7 mil conical diamond, 888E — .4 x .9 mil elliptical diamond, 888TE — 883VE .2 x .7 mil elliptical hand polished diamond. Output Voltage: 8.0 millivolt per channel for each cartridge.

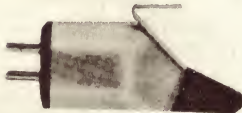

808 Cartridge

**EMPIRE 808 SERIES.** Recommended for use with automatic turntables Tracking force: 1 to 4 grams. Channel separation more than 30 dB. Output voltage: 8.0 millivolts per channel. Frequency response 808E — 10 to 25,000 Hz, 808 — 10 to 20,000 Hz. Tracking angle for both cartridges 15 degrees. Stylus: 808E — .4 x .9 mil elliptical diamond, 808 — .7 mil conical diamond.



**EMPIRE MODEL 8200 IMPERIAL GRENADIER BOOKSHELF SPEAKER.** Frequency response: 30 — 20,000 cps. Power Handling Capacity: Music Power: 100 watts, Sine Wave Power:

25-450 cps	60 watts.
450-5,000 cps	40 watts.
5,000-20,000 cps	20 watts.

Components: Woofer 12in High Compliance with 4-inch voice coil. Min-range-Direct Radiator. Tweeter-Ultra Sonic Domed Tweeter. Both coupled to Di-cast Acoustic Lenses. Total Magnetic Power—more than one million lines of force. Controls: Three position electronic treble adjustment. Finish: Satin walnut finish—hand rubbed.

## FAMOUS EMPIRE TROUBADOR 398

Perfectly engineered. Not even a whisper of distortion. A completely integrated 3-speed "Silent" record playback system. More Empire Playback equipment is used by FM stereo stations than any other brand. Equipment reviewers, professionals and audiophiles the world over acclaim the Troubadors as the best money can buy.

- (1) Audio Magazine. "Precise performance... an excellent buy for those who want the quality."
- (2) American Record Guide (Larry Zide) "I found speed variations — that is, flutter and wow — to be inaudible... vibration extremely low... Total rumble figures have not been bettered by any turntable I have tested."

Its massive turntable is driven by a heavy duty hysteresis synchronous motor that provides a constant speed regardless of current fluctuation. Only two moving parts, resilient nylon "seat" support and cushions the rest of the main bearings. A continuous flexible belt (perfectly ground to a  $\pm 0.001$  inch thickness) also contributes to its flawless performance.



## HARMAN KARDON NOCTURNE 210 TUNER/AMPLIFIER

Advanced Styling and engineering, plus added convenience and pleasure of hearing AM through your High-fidelity system.

Power Output: 50 watts IFH.

Frequency Response  $\pm 1$  dB : 8. to 25,000 Hz at 1 watt (normal listening level); 10 to 23,000Hz at full rated power.

Harmonic Distortion: less than 1%.

Hum and Noise Suppression: 90 dB.



**RECORDED MUSIC SALON**  
23 Collins Street,  
MELBOURNE 3000

**TRUE FIDELITY**  
C. PINCZEWSKI  
Tel. 63-6257



secondary winding has quite a severe stress to withstand and we suggest that a voltage rating of a minimum of 600 should be used. This could preferably be raised to 1000 volts. The old paper type could be suitable but it would be wiser to fit one of the modern polyester types. We do not advise the use of a polystyrene capacitor for this service.

The two push-button switches used to advance and retard the indicated time, are imported by Ducon. These units have a micro-switch action and are excellent for this function. There are also other suitable switches available through IRH Components Pty. Ltd.

The potentiometers used to adjust the three multivibrators for correct division are most important, in that they are directly in the time-constant circuits. As such, they must be very reliable both mechanically and electrically. Just how seriously this will be taken, will depend upon the needs of each particular case. We started out by using the ordinary miniature tab potentiometers, which are available under the Philips or IRC brands. The board is actually made to accommodate either of these.

Although these items have an exacting task to perform, and although we had troubles as we have already discussed, at no time were we able to definitely point a finger at them. In other words, they are worth using unless you have other ideas.

After the troubles of last October, and when we were fitting the unit into its case, we took the opportunity to install some very high grade potentiometers in the three positions in question. These potentiometers are made to very exacting specifications by Morganite in England. They are designated as type 81E, 100K rotary Cermet Trim-pots and they should be available from Morganite Australia Pty. Ltd., 65-67 Bourke Road, Alexandria, N.S.W. As these potentiometers are precision pieces, the price is rather high, as one would imagine. Although quite different physically from the ordinary tab potentiometers, they can be fitted to the board without difficulty.

The fourth potentiometer, used to control the drive from the 50Hz divider to the input of the emitter follower and the audio amplifier, is not critical and one of the usual tab potentiometers will be suitable.

So that this project could be made as physically versatile as possible, we have divided it into three sections. The frequency generator, dividers and power amplifier are in one section. We have housed this in an Eddystone die-cast metal box, type No. 903, which measures 7-3/8in x 4 1/2in x 3 1/2in. This makes a neat unit and affords protection and shielding to the vital parts and functions.

The readout device is an ordinary 50Hz, 240 volt, synchronous clock movement. The one we used for most of our investigations was a small unit made originally for clock radios. It has switching and alarm facilities, which are not needed for our purpose. It is made by Telechron and it proved very suitable for the job. Unfortunately, stocks of these movements have dried up in the past few months and the possibility of this type being available again and particularly at the attractive price, seem to be remote.

Alternatively, there are many synchronous clock movements available today and the price, although covering a wide range, is not really high. Movements with different characteristics are available. Some are self-starting, moving forward almost immediately power is applied. Others are also self-starting, but they do not always start in the forward direction. If the movement starts in the reverse direction, there is a mechanism which comes into play after a couple of seconds, and the movement is reversed into the forward direction. A third type has to be started with a small knob or other device.

The method of starting can lead to



Another view of the complete unit, showing the DC power input socket (two-pin) and the 50Hz output socket (coaxial).

problems in getting the second hand to read exactly to the correct time. Fortunately, the correction facility we have developed makes it possible to bring the second hand to the correct position.

The type of movement to be used is up the individual to decide, so that it meets his tastes and requirements. The method of housing the movement will also be dictated by local conditions.

The method of powering the clock is again up to individual requirements. However, here are some suggestions which may be helpful. The basic need is for 12 volts DC, well filtered, at about 250 milliamps. This could be supplied by a 12-volt car or similar battery, either charged periodically, or permanently "float charged" or, in the case of mobile use, the 12-volt vehicle battery could be used.

Where AC mains are available for fixed installation, then a simple supply can be made up quite cheaply. A

suggested circuit appears on these pages. A small transformer with a secondary rating of 12.6 volts at 1 amp would be satisfactory. A bridge rectifier consisting of four low voltage silicon power diodes, is followed by a 2000uF 25VW electrolytic.

If it is decided to use a mains operated power supply, the possibility of a power failure must be considered. To avoid interruption, it is wise to provide some sort of emergency supply. This can be done easily, with a set of dry batteries having a nominal voltage of 12. They can be connected in parallel with the power supply, with precautions to keep them from sharing the load at normal times. This is done with a silicon power diode in series with the positive lead of the battery supply, as shown in the diagram.

This arrangement has to be adjusted so that, in spite of the diode, the batteries will not share even a little of the load. This is achieved by operating the main power supply at a slightly higher voltage than that of the batteries. There is a further problem to be met with this set-up. Should the power fail, there are circumstances where the power supply itself can present an additional load to the batteries. This can be easily overcome by adding a silicon power diode in series with the main power supply lead. This is also shown in the diagram.

During our current test run with the clock, we are feeding it from the Transistor Power Supply, described in January, 1969. With the emergency battery supply and the protective diodes as shown in the circuit, it is necessary to set the main power supply voltage to just under 14.2 volts. This setting was determined by placing a milliammeter in series with the battery supply and raising the main power supply voltage to the point where no current flowed from the batteries.

To meet this requirement with the suggested power supply, a series resistor must be placed between the 200uF electrolytic and the clock. The value of this resistor will depend upon the output voltage from the rectifier and this could be between about 17 and 19 volts. The value of the resistor can best be determined experimentally. However, a starting point of 15 ohms, rated at 4 watts is suggested.

Next month, we will continue this article, with details how to construct the unit together with all the information for adjustment and putting it into operation. ■

## STUDYING SOLAR WINDS

(Continued from page 11)

the interplanetary magnetic field and solar wind far out beyond the orbit of Mars. This region of space, like that close to the sun, is also not accessible to direct exploration at the present time. The cosmic ray detector used in HEOS depends on the emission of Cerenkov light (emitted by the charged particles moving through the material) in a Perspex cylinder by cosmic ray protons which travel faster than light in this material, which has a refractive index of 1.5. (They do not, of course, travel faster than light in free space.) The Cerenkov light is emitted more or less in the direction in which the

particle is travelling and by making use of this property it is possible to build detectors which have directional properties like the solar proton experiment so that the directional distribution of cosmic rays can be measured and related to the magnetic field.

These three closely related experiments will provide new information about the behaviour of the interplanetary magnetic field during the period of maximum sunspot activity and should lead to an improved understanding of the propagation of both solar flare particles and cosmic rays through the field. ■



# Telite

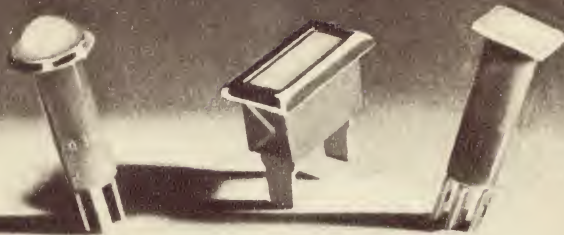

## The Light Fantastic

TELITE NEON INDICATORS ARE TRULY A "FANTASTIC" LIGHT

- NO FILAMENT TO BURN OUT!
- UNAFFECTED BY VIBRATION!
- NOR BY POWER SURGES!
- NOR BY FREQUENT SWITCHING!

TELITE NEON INDICATORS are available in voltages from 60V. A/C to 415V. A/C and in a variety of attractively styled mouldings in materials to suit your purpose — for example, Nylon, for high temperature operation — or indelibly impressed with letters or figures in permanent colours. Your new project is worthy of these advantages — ask for technical literature.

**IRH**  
**COMPONENTS**  
**PTY. LIMITED**

A Subsidiary of International Resistance Holdings Limited

THE CRESCENT,  
KINGSGROVE,  
N.S.W. 2208.  
TEL. 50 0111

### INTERSTATE AGENTS & REPRESENTATIVES

MELBOURNE I R H Components Pty. Ltd. Phone 489-1088	LAUNCESTON W.P. Martin Pty. Ltd., Phone 22-844	PERTH Simon Holman & Co. Phone 8-2271
BRISBANE K.H. Dore & Sons Phone 2-1391	HOBART W.P. Martin Pty. Ltd., Phone 34-2811	ADELAIDE Collett & Cant Pty. Ltd. Phone 23-1971





## Acoustic feedback problem that wasn't

Any good detective story will confuse the trail to the culprit by one or more false leads. The format isn't quite as rigid with serviceman stories but they do occasionally turn out that way.

This particular story concerns a former client who moved into another suburb, rather off my usual beaten track. Over the years, I had looked after his radio and later his television problems but, some time ago, he retired and bought another, smaller, home more suited to his declining years. In the normal way, I imagine that I'd have forgotten all about him.

Recently, however, he rang and re-introduced himself—complete with a new problem.

I gather that, when he moved into the new house, he indulged a long-standing ambition and bought a quite expensive stereo amplifier system with, he explained, "a special cabinet for the amplifier and radio and two separate loudspeakers."

The equipment had performed well for two or three years but now it was giving trouble.

"What kind of trouble?"

The conversation that followed was fairly typical of the efforts one has to make to piece together a story that makes technical sense from the observations of a strictly non-technical person. Sparing you the details, however, it appeared that the amplifier would be playing along quite normally when, all of a sudden, the music would get louder and the whole thing would break into a violent rumble.

He had to race over and turn down the volume and lift the pickup off the record. He could then start it playing again and everything would be normal—until next time!

At first, the equipment misbehaved only on isolated occasions but now the trouble was recurring more frequently, so that he could count on it happening at least once during an evening's listening.

"Can you possibly come over and have a look at it for me?"

Frankly, I wasn't keen to get involved. To trace and fix a fault is one thing but to wait around somebody's place until a fault showed up was quite another. And there certainly wouldn't be much point in taking the whole thing into my shop for listening tests.

From the description, the trouble sounded very much as if it had something to do with acoustic feedback:

Sound waves from the loudspeaker agitate the air in the room and may also vibrate the floor. Some of this energy may reach the pickup stylus, causing it to vibrate and generate a spurious signal which drives the amplifier. This drives the loudspeaker harder, which vibrates the pickup stylus and so on, in a vicious circle. The end result, as often as not, is a rumble which builds in violence till it threatens the eardrums, if not the equipment itself.

Most hi-fi equipment in ordinary home situations suffers from the effect to some degree, some energy from the loudspeaker making its presence felt at the pickup.

The effect may be so slight as to be unnoticeable. It may, on the other hand, tend to make the bass sound a little "drummy" or cause the system to emit a dull "bong" when equipment is bumped or somebody walks too heavily across the floor. Turning up the volume or the bass control tends to make it worse.

And, of course, there are the cases where the equipment will break into active oscillation, even before the volume and/or bass controls have been advanced to a desired playing level. This is where the situation really gets sticky.

Being basically an acoustic problem, there isn't much point in diving in with a soldering iron and multimeter. One may have to start moving the furniture round, or looking for a too-springy floor, or experimenting with the suspension of the record playing deck. It can be a fiddling, time-consuming business in which one seldom comes up with a complete cure. As often as not, one succeeds only in reducing the magnitude of the trouble.

If the problem is going to show up, it normally does so at the time the equipment is installed. There is no special reason to expect it to show up later or to be intermittent and, in this respect, the present complaint didn't quite add up to expectations.

However, a few things can happen which might turn a potential trouble into a real one. For example, the rubber or spring cushioning below the playing deck may gradually subside or distort, allowing the deck to rest against

the cabinet work; this may be all that is necessary to transmit vibrations to the pickup and stylus, or the stylus suspension may change its characteristics slightly.

Quite differently, a pier beneath the house may subside enough in a dry spell to allow the floor to vibrate!

Inside the amplifier, gradual loss of capacitance in the filter and decoupling components may aggravate potential oscillatory condition involving acoustic feedback.

As for the allegedly intermittent nature of the trouble, I was inclined to put it down to the possibility that the equipment was on the verge of instability, requiring only a sustained loud passage or a heavy footfall to start it going. This would be aggravated if the nature of an individual recording required the volume or bass controls to be advanced slightly beyond their accustomed settings.

With these rather speculative thoughts in mind, I said that I'd call in some time, if I was over that way, and at least see if I could pick out any tendency, even if I didn't get to hearing the actual "performance."

About a week later, another telephone call advised me that the amplifier had now become so unreliable that it would only run for a few minutes without misbehaving. Couldn't I please call in today, tomorrow or at least before the weekend?

There was nothing for it but to go!

When I duly made the call, I had only listened to the system for about three minutes when it "took off" quite violently. Immediately it did, I turned the volume control down, perhaps rather more hurriedly than the owner had been used to doing. The volume went down, then jumped up again, complete with rumbling, as the potentiometer hit the stop.

What was this? A faulty control?

I left the control where it was and hurriedly lifted the pickup off the record. In the comparative silence that followed, I could hear a gentle hiss and hum. Walking across, I ascertained that it was coming from one channel only, just as if the volume were turned right up on that channel. Yet I had turned the volume right off.

Gently working the control and listening to the hum confirmed the observation. There was an intermittent, presumably between the volume control resistance element and the earthy side of the circuit. When the intermittent opened, the channel was turned virtually full on, irrespective of where the control happened to be set.



# Introducing: Sony's non-stop stereo

It automatically reverses the tape within 10 seconds after it's through playing in one direction, and starts playing in the other



## SPECIFICATIONS

**Recording system:** 4-track stereo/mono recording and play-back. **Power requirement:** AC 100, 110, 117, 125, 220 or 240 volts, 50/60 Hz 50 watts, DC 12 volts; it uses 240 volts AC (at home) or 12 volts DC (in car or boat). **Tape speed:** 7½ ips, 3¾ ips, 1½ ips. **Reel capacity:** 7". **Frequency response:** 20-21,000 Hz at 7½ ips; 50-17,000 Hz  $\pm$  3 dB at 7½ ips. **Signal-to-noise ratio:** Overall, better than 50 dB; amplifier (aux., tuner, phono), better than 60 dB; amplifier (mic.), better than 53 dB. **Flutter and wow:** Less than 0.15% at 7½ ips; less than 0.2% at 3¾ ips; less than 0.35% at 1½ ips. **Harmonic distortion:** Overall, less than 2.0%; amplifier, less than 0.5%. **Level indication:** Dual VU meter. **Power output:** 5 watts RMS per channel. **Recording time:** 4-track stereo, 6 hours at 1½ ips; (1,800' tape) 4-track mono, 12 hours at 1½ ips. **Inputs:** Microphone input—sensitivity, — 72 dB (0.2 mV); impedance, 250 ohms. Auxiliary input—sensitivity, — 30 dB (25 mV); impedance, approx. 100 K ohms. Tuner input—sensitivity, 30 dB (120 mV); impedance, 100 K ohms. Phono input—sensitivity, — 52 dB (2 mV); impedance, 50 K ohms. **Outputs:** Line output—output level, — 2 dB (0.6 V); impedance, approx. 7 K ohms. **Dimensions:** 20¾"  $\times$  11¼"  $\times$  17½". **Weight:** 50 lb. **Accessories:** 2 microphones F-98 (MTL); 2 microphone stands; 1 empty reel R-7A; 1 demonstration tape; 1 connecting cord RK-56; 1 power cord; 1 head-cleaning ribbon; 2 reel caps.

To: Jacoby, Mitchell & Co. Pty. Ltd., 469-475 Kent St., Sydney, N.S.W.  
Please send, without obligation, information on Sony Tape Recorders.

NAME .....

ADDRESS .....

P'CODE .....

EAB

If you're the kind of person who hates to be interrupted, you're really going to go for the uninterrupted enjoyment of owning a Sony TC560. Even when it reaches the end of a track, it doesn't interrupt you. Because the Sony TC560 has ESP (Electronic Sensory Perceptor) — an electronic brain that automatically reverses the tape within 10 seconds after the end of the recording. Better still, Sony's exclusive 4-way loudspeaker system (incorporating two self-contained high compliance woofers and two lid mounted tweeters) faithfully reproduces the entire audible range.

Sony's TC560 non-stop stereo operates on 240 v. AC (at home) and 12 v. DC (in car or boat)

# SONY®

DISTRIBUTOR: JACOBY MITCHELL & CO. PTY. LTD.  
SYDNEY MELBOURNE BRISBANE ADELAIDE

JM001



No wonder the system—or at least that particular channel—took off in acoustic oscillation. In the confusion that followed, the owner could hardly have been expected to notice that one channel only was involved.

Sliding the amplifier out, I removed the top cover and felt the lugs of the potentiometer. I can't say that I was impressed by the rigidity of any of them and it seemed highly likely that faulty assembly was to blame. Short of completely disassembling the control, however, there was no way of attempting any kind of a repair and I certainly didn't have a suitable replacement with me. So I wobbled the lugs, re-soldered the connections to them and sprayed them with degreasing fluid, all with the idea that the fouling would be dispelled that had apparently built up between the earthy end of the element and the connecting lug.

Fortunately, luck was with me and, when the equipment was switched on again, I couldn't make it misbehave. I didn't regard the fault as being genuinely fixed and I arranged to drop in some time later when I had obtained a suitable replacement component. But, in the meantime, the old couple would be able to listen to their stereo music without having to jump and down like Jack (and Jill) in the box.

This story reminds me of another one about an amplifier which I had to cope with a couple of weeks back and which I roughed out at the time. It seems appropriate to include it here, just as I wrote it.

"Listen mate, would you have a look at this (adjectival) amplifier. It'd fair drive you up the wall."

In this uninhibited and distinctly Australian fashion, I was invited to service a small P.A. amplifier which was dumped on the shop counter.

I knew, without being told, that the amplifier belonged to a local social group. The man who delivered it went on to explain that it couldn't be relied upon. Sometimes it was "strong"; sometimes it was "weak."

"Sometimes it varies all over the flamin' shop!"

I gathered from this that the amplifier varied considerably in terms of gain and it was my job to find out why.

Lifting off the top and bottom covers, next morning, revealed it as a fairly typical small public address amplifier: An EF86 microphone preamp. stage, feeding a volume control/mixer arrangement; then came a 6BL8 wired as a pentode amplifier and triode phase-splitter, feeding a couple of EL84 output valves.

As I normally do with equipment suffering an intermittent condition, I left everything severely alone, until I had connected it up and switched it on. The proper time to push and prod amongst the components in such a case is when you're able to observe any effects of such pushing and probing.

Having connected the amplifier to a test loudspeaker and switched it on, I turned up the microphone gain control and, as I had expected, was greeted with enough hum and hiss to know that everything was working, apparently normally.

Then with an ear cocked to the sound in the loudspeaker, I clipped the earthy probe of the VTVM to the chassis, set the instrument to the 300V DC range and read off the HT supply voltages, then the plate and screen voltages of the EF86 mic. preamplifier; this followed by the cathode, on the 3V range. The HT voltage read around 260, the decoupled supply around 230, the plate and screen voltages around 70 and the cathode about 1.5. They all seemed normal enough but one thing I did notice: clicks through the amplifier, caused by the meter prod, seemed to disturb the gain slightly, as evidenced by the level of hiss and hum from the loudspeaker.

Next step was to measure around the 6BL8 pentode. Touching the meter prod on the grid produced the kind of buzz one expects from so doing, but showed no sign of any voltage which one might have expected if the preceding coupling capacitor had been leaky. The plate voltage was normal, likewise the screen . . .

Oops!

As I broke the connection between test prod and screen, there was a sudden silence, as hum and hiss disappeared. Very obviously, the gain had dropped by lots of decibels. By touching the prod on to the screen pin again, I found that I could induce a change of gain more or less randomly. What was no less significant, when the amplifier was in the low gain condition, touching the test prod on to the grid produced very little hum. The change was occurring from the 6BL8 onwards.

Another significant point was that the change in gain was apparently not reflected anywhere in a change of operating voltage. It seemed rather unlikely, therefore, that it was being caused either by a resistor or a valve.

The obvious component to suspect was the 6BL8 screen bypass, mounted rigidly on a tagboard and remote from the socket. A bit of prodding here produced the low-gain condition as an apparently permanent one. It seemed as though I had struck oil.

With hot iron and pointed pliers, I very carefully eased the suspect capacitor off the tagboard and clipped it on to the R/C bridge. More or less



"How about that: Four dollars for one home service call!"  
("PF Reporter").

as I had suspected, it read open-circuit. In position, and while undisturbed, it had been alternatively bypassing the screen and leaving it float, partially or completely unbypassed. No wonder the gain had been "all over the flamin' shop."

Needless to say, it didn't take long to install a new capacitor and put the amplifier aside as "fixed." I had every reason to hope that the members of the club could henceforth come down from their positions "up the wall."

Here is another story demonstrating the value of the "canned cold" technique. This was one of those "off the record" jobs undertaken out of working hours to assist a friend. However, it is none the less interesting technically for that.

My friend is a keen and fairly experienced electronics enthusiast. In the early days of TV he constructed his own TV receiver—a 17in type—which served him faithfully for many years. Then he took the opportunity to update it to a 21in type, using as a guide the circuit of the 1964 23in Television Receiver described in this magazine.

This had worked out quite well initially but, over the last few months he had become aware of a temperature sensitive defect. This involved the vertical deflection system. If, when the set was first switched on, the picture height and linearity were correctly adjusted, the gradual warming up of the set would, after about an hour, result in the bottom of the picture shrinking by up to an inch. This produced marked cramping in this part of the picture so that all the cowboys and their horses were running around on dachshund-like legs.

The problem was, where to look. My friend had tried to reason out which component would most likely cause this effect, but without much success. He wasn't even sure whether the trouble was in the oscillator or the output stage.

In fact, it was on this point that he approached me, hoping that I could at least narrow down the number of likely components. Otherwise he felt that he might have to change all the components in this section before he found the culprit. Since there was a considerable number involved, some of them fairly expensive, and a considerable amount of work involved in changing them, he wasn't particularly keen on this idea.

Unfortunately, I didn't feel much more confident about such a prediction than he did. For one thing the circuit was a fairly complex one employing, among other features, a feedback loop around the output stage to control height and linearity. And, while this is an excellent idea and produces very good results, it just isn't the kind of circuit which lends itself to speculation when something goes wrong.

As far as that goes, such circuits are not the easiest to service even when one has them on the bench. Even assuming that one can check the performance, i.e., waveform, with a CRO and recognises that it is not as it should be, it is another thing again to nominate the cause. Because of the feedback network the faulty waveform is likely to appear anywhere inside the feedback loop, making it almost im-



**DECCA  
SPECIAL  
PRODUCTS**

# DECCA the world's leading manufacturer of records and the means of playing them

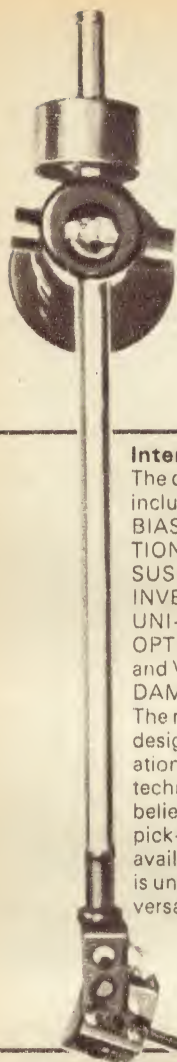

### International Arm

The design features include, MAGNETIC BIAS COMPENSATION, MAGNETIC SUSPENSION, INVERTED JEWELLED UNI-PIVOT, OPTIONAL LATERAL and VERTICAL DAMPING PIVOT. The result of painstaking design and the incorporation of the very latest techniques has, we believe produced a pick-up far ahead of any available and one which is unsurpassed in its versatility and precision.

Other outstanding pick-ups include



### Anti-Rumble Integrated pick-up arm

### The Decca ffss Mk.4 cartridge

Cartridge with elliptical stylus for use in head shells fitted to arms other than the Decca ffss range



### Magnetic Bias

An ingenious method of applying an anti-skating force to all current Decca pick-ups i.e. *Professional, Mk. 1, ARI* arms.



### Stylus Cleaner

A soft-hair wheel cleans the stylus when the pick-up is in its rest position. Adjustable height for most pick-up arms. A must for all conscientious record collectors.



### Microlift

Protect your records with this simple operation microlift which positions at any point. Easy to fit and adjust for most pick-up arms, not suitable for auto-changers.



**DECCA**

Sole Australian Agent:

**BRITISH MERCHANDISING PTY. LTD.**

Shaw House, 49-51 York St., Sydney. Telephone 29.1571 (3 lines)

possible to determine at what point it is originating.

Of course, one can always disconnect the feedback loop. But where, as in this case, the loop contributes a significant amount to the final waveform, it may be difficult to predict how the circuit should behave without it. And if, as is quite likely, the fault is in the loop itself, how is one to find it, short of replacing each component in the loop. Which is more or less where we came in.

By the time I had discussed all these points with my friend he was feeling — and looking — pretty discouraged. Little did he realise that I was setting the scene for a dramatic revelation.

"It just so happens," I explained, when he had just about reached his lowest ebb, "That I have here the very thing to solve this otherwise insurmountable problem." (Well, perhaps "insurmountable" was going a bit far, but I couldn't resist a little dramatic licence.) At the same time I picked up my little aerosol freezer can and swept it on to the counter in front of him with a dramatic gesture.

"What is it?" he asked.

"I call it canned cold," I replied, "and it has already solved some otherwise very sticky problems for me." Then I went on to explain how it was used.

"Quite seriously," I concluded, "I think this is by far the simplest approach. We could try swapping likely components, or we could try to work out which component is most likely to cause the precise symptoms you describe, but I think this will do the job in a fraction of the time, with a minimum of effort."

As it happened Mrs Serviceman and I were due to pay a social call on my friend in a few days time, so we decided that this would present a good opportunity to put my theory to the test. I advised my friend how to set things up in advance, and we left it at that.

Thus it was that, accompanied by Mrs Serviceman, I arrived at my friend's place a couple of days later, armed with my can of cold and a lot of confidence. Acting on my suggestion my friend had switched the set on about two hours previously, carefully adjusted the vertical controls to just fill the screen, then let it run. By the time I arrived the bottom of the picture had shrunk exactly as he had described it. So, while Mrs Serviceman and my friend's wife went off prattling about such trivia as "pearl," "plain," "basques," and other incomprehensible things, my friend and I got down to the important business of the evening.

Fortunately, the underside of the chassis was easy to get at. The chassis was mounted vertically on one side of the cabinet, its flanges running in grooves cut in wooden strips mounted inside the top and bottom of the cabinet. It was thus possible to gain access to the underside of the chassis by removing the knobs and sliding the chassis backwards until it was about half out of the cabinet. The leads to the picture tube were long enough to permit this while the set was running.

This done my friend pointed to a moderate size resistor strip and explained that it supported most of the vertical oscillator and output stage



components. I noticed with satisfaction that the layout was a good deal more open than most of the previous devices on which I had used the freezer making it relatively easy to treat each component separately.

So, without more ado, and without bothering to identify the individual components, I started at the top and squirted each component in turn. At the same time my friend watched the screen, although we had also rigged a mirror so that I could watch it as well.

The first half dozen components I sprayed produced some unexpected side effects, and there were also a couple of false alarms. One side effect, caused by spraying a particular resistor, produced shrinkage at the top of the picture. Perhaps this wasn't surprising, seeing that the resistor had a crop of frost on it which would have done justice to a Christmas tree.

The false alarm was caused by the fact that most vertical scanning systems vary their scan slightly with changes in picture brightness. And, while this circuit is remarkably stable in this regard, there is still enough shift to be noticeable when one is concentrating on a visible edge. Thus it was that, at the precise moment I sprayed a particular component, there was a change from a very dark picture to a very light one. My friend's immediate reaction was that we had found something, but a more critical look soon revealed the mistake.

To avoid this kind of confusion, it would be better to conduct such a test while a test pattern was available, although it is not a serious problem once the possibility is appreciated.

Finally, I had sprayed all the components on the panel, with one exception, without any real indication that any of them were faulty. The exception was a paper capacitor located behind the panel and not very easy to get at. So I twisted the spout of the freezer can as best I could to reach it, pressed the button, and gave it a good squirt.

I glanced at the mirror. The picture was the same as before. My friend looked at me and we shrugged our shoulders. It seemed my idea hadn't worked out. Then we both looked back at the screen and, lo and behold, the picture now filled the screen with something to spare. Nor was there any doubt about it, even the darkest picture filled the screen.

To make quite sure we let the set run while we had a cup of tea, by which time the picture had started to shrink again. We left it a little while longer until we were quite sure, then I gave the capacitor another squirt. Once again nothing happened for a few seconds, presumably the time needed for the cold to penetrate to the "innards" of the capacitor, then the picture expanded to normal size.

This seemed to put the matter beyond doubt. The capacitor was the .012uF sawtooth capacitor in the oscillator circuit, and was one of the old paper type. We found and fitted a modern plastic type, and reset the height and linearity controls. The picture remained stable for the rest of the evening and subsequent reports from my friend indicate that the trouble has been completely cured.

Another victory for the "canned cold" technique! ■

# THE

# TANNOY

# Monitor

# GOLD



## Full range world famous dual concentric loudspeakers

The Monitor Gold is a further refinement in the almost legendary range of Tannoy Dual Concentric Loudspeakers. An entirely new crossover network not only provides facilities for adjusting treble energy to suit prevailing acoustic conditions, and treble roll-off to accommodate variations in programme material, but also gives a smoother frequency response in the middle treble register together with a more constant impedance characteristic; thus ensuring the highest performance from modern transistor amplifiers. The impedance is nominally 8 ohms but never falls below 5 ohms.



Distributed through the Consumer Products Division of

**AMALGAMATED WIRELESS (AUSTRALASIA) LIMITED**

554 PARRAMATTA ROAD, ASHFIELD. 71 0791

167 Queen Street, Melbourne. 67 9161 • 70 Merivale Street, Brisbane. 4 1631  
• Cnr. Darby and King Streets, Newcastle. 2 5166 • 231-233 Bulwer Street,  
Perth. 28 6400 • 48 King William Road, Goodwood, Adelaide. 72 2366 • 42  
Frederick Street, Launceston. 2 1804 • 123 Murray Street, Hobart. 3 3836-7



# 180 WATT SOLID STATE STEREO AMPLIFIER KA-60

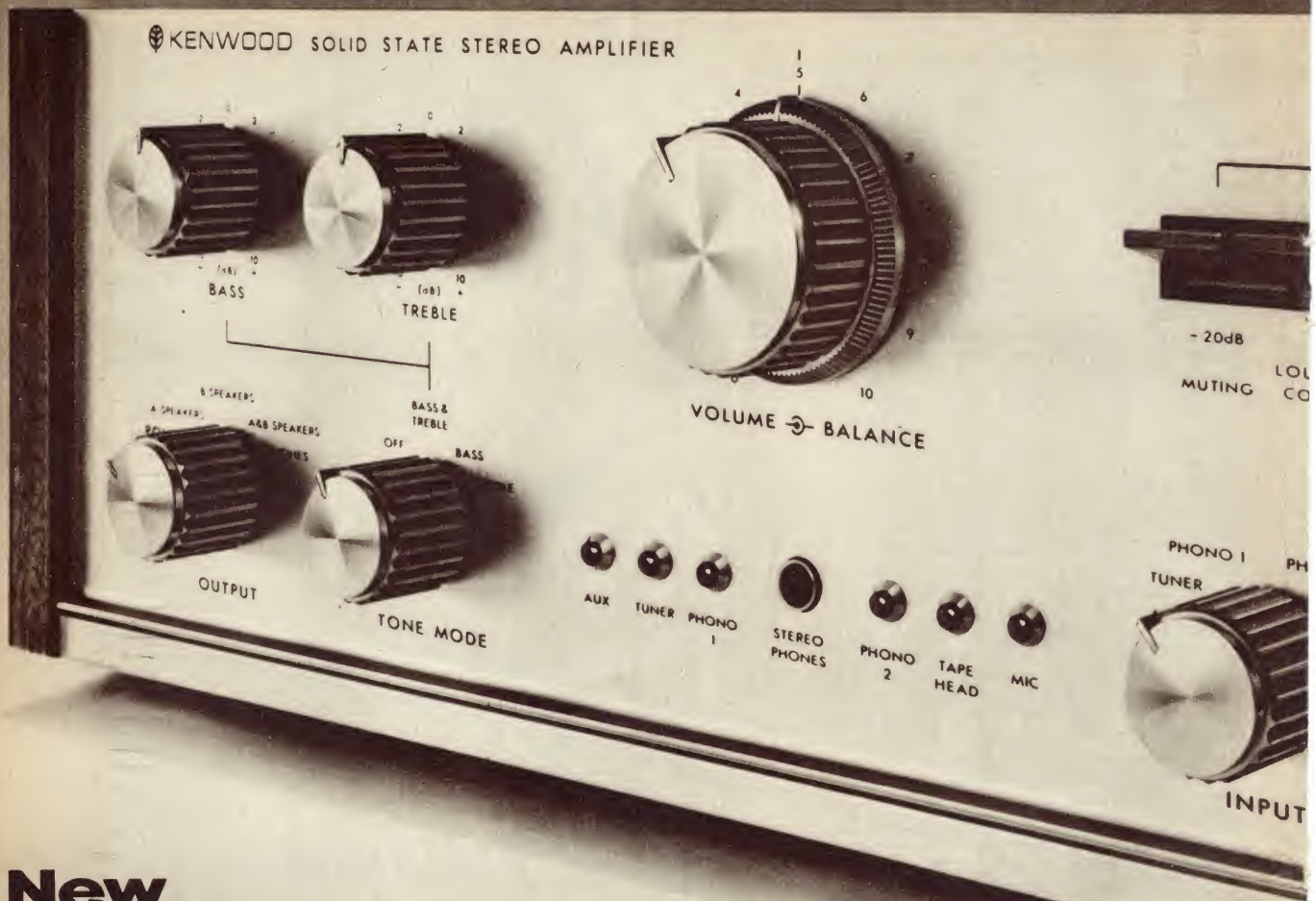

## New KENWOOD's KA-6000 The Musical Powerhouse For Maximum Perfection

You don't have to look elsewhere—KENWOOD's KA-6000 180-watt solid state stereo amplifier has all the power you need for maximum perfection. It has more than enough power to drive even Hi-Fi speakers of low efficiency. With its wide power bandwidth of 10Hz to 50,000Hz there is low-low IM distortion. The KENWOOD exclusive low level phono inputs for low level output phono cartridges. There are many other outstanding features in the KA-6000—all the results of high performance. The final test is in performance. Stop in at your KENWOOD dealer for a KA-6000. Remember, KENWOOD also has other amplifiers with less power. There's a KENWOOD for every stereo need.

SOLE AGENT: Jacoby, Mitchell & Co., Pty., Ltd: Head Office: 469-475 Kent Street, Sydney Tel: 26-2651 Melbourne: 15 Abbotsford Street, Electronics, 64 Hindmarsh Square Tel: 23-3024 Perth: United Australia Co., Pty., Ltd., 435 Hay Street, Subiaco Tel: 8-4665 Tasmania: 100-1000



### BOOKSHELF TYPE 4-WAY 5 SPEAKER SYSTEM KL-660

- \* Mounted speakers: 12-inch, free-edge woofer × 1 (Bass)
- 6 1/2 inch cone squawker × 1 (lower midrange)
- 4 inch cone squawker × 1 (higher midrange)
- Horn-type tweeter × 2 (Treble)
- \* Dimensions: 15" (W), 25 1/2" (H), 11 1/2" (D)



### 40 WATT SOLID STATE STEREO AMPLIFIER TK-150U

- \* 5 pairs of input terminals for MAG, AUX 1, AUX 2, TAPE REC and TAPE PLAY.
- \* Damping factor: 40 (at 16ohms), 20 (at 8ohms)
- \* Dimensions: 10 1/4" (W), 4 1/4" (H), 9 1/2" (D).



### 60 WATT SOLID STATE STEREO AMPLIFIER TK-250

- \* 2 sets of stereo speaker terminal selector switch.
- \* Dimensions: 13" (W), 4 1/4" (H), 9 1/2" (D).



MODEL KA-6000

NORMAL



ON  
IDNESS  
NTOUR

40Hz — 80Hz — 8KHz

LOW FILTER HIGH FILTER

ONO 2  
TAPE HD  
C

MODE TAPE

STEREO STEREO  
REV LEFT  
MIX RIGHT  
MIX

MODE/TAPE MONITOR

eo amplifier

on.  
dges of 2mV, 0.5mV or 0.05mV.  
h quality engineering—but  
demonstration.

et Tel: 30-2491 Brisbane: 56 Edward Street Tel: 2-6467 Adelaide: Truscott  
mania: K.W. McCulloch Pty., Ltd., 57 George Street, Lounceston Tel: 25-322

*the sound approach to quality*



**KENWOOD**

**TRIO ELECTRONICS, INC.**

6-5, 1-CHOME, SHIBUYA, SHIBUYA-KU, TOKYO, JAPAN



EO  
U  
and front panel  
3/8" (D).



**30 WATT  
FET SOLID STATE AM/FM  
STEREO RECEIVER TK-20U**

- \* F.E.T. (Field Effect Transistor) 3 Gang Tuning Condenser frontend for superior sensitivity, image rejection and cross modulation ratio.
- \* Dimensions: 14 3/16" (W), 4 3/8" (H), 11 3/4" (D)

Ask for a catalogue or demonstration by your nearest dealer.

To: Jacoby Mitchell & Co., Pty., Ltd. EA  
469-475 Kent St., Sydney.

Send me information on KENWOOD RECEI-  
VER, AMPLIFIERS, SPEAKERS & name of  
nearest KENWOOD retailer,

NAME: \_\_\_\_\_ AGE: \_\_\_\_\_

ADDRESS: \_\_\_\_\_

\_\_\_\_\_



# A SOLID-STATE THEREMIN

Here is a project for which we have had many requests over the past years. It is the Theremin, an instrument with a reputation bordering on the mythical. Most people know that it can be used to produce weird sound effects for science fiction films and the like, but few have seen one and fewer still have been close enough to try one. In this article, construction of a Theremin is described in detail.

By Leo Simpson

Invented by a Russian named Leon Theremin, in the early days of radio, the instrument is very simple in its principle of operation. Its sound output is controlled in pitch and loudness by the effects of hand capacitance. The player merely waves his hands near two "antennas" to produce the weird sound effects—and music!

The control functions of the instrument consist of two fairly distinct sections: (1) one of the player's hands, one antenna or capacitance plate and the associated circuitry to produce the desired note or audio frequency; (2) the player's other hand, a second capacitance plate and more circuitry to control the loudness of the sound produced. Over and above these sections, there is the amplifier system, the loudspeaker and the power supply, of which more will be said later.

Basically, the audio tone or musical note is produced by heterodyning two radio frequency oscillators to produce an audible "beat" or difference frequency. Most readers will have heard a similar kind of whistle, produced when an oscillating radio receiver is turned across the carrier frequency of an incoming station. By

carefully manipulating the receiver dial, it is possible to produce a beat ranging from a high frequency whistle to a low frequency growl.

As might be expected, the two oscillators in a Theremin, used to produce the audible beat, must be set up so that they can operate very close together in frequency, without too obvious a tendency to "pull" one another or to lock together.

One oscillator must be designed so that its frequency will change readily when a hand is brought close to a capacitance plate which is part of its circuitry. The other oscillator should not exhibit this effect and, in practice, is pre-set so that it oscillates on the same frequency as the "variable" oscillator when the latter's natural frequency is not being disturbed. With both oscillators on the same frequency, there is "zero beat" and no audible note is heard from the loudspeaker system.

When a hand is brought near the capacitance plate, the frequency of the variable oscillator changes and a beat note is produced. With suitable design, the beat note can be changed from near zero frequency to the limit of

audibility. In part the art of playing a Theremin is in being able to move the hand with sufficient control and subtlety to produce a desired sequence of musical notes. Moving the hand from one position to the next must inevitably produce a gliding tone, or glissando effect, while a slight tremble — intentional or otherwise — will produce vibrato.

For the instrument to have any potential appeal at all, it is essential that the player have adequate control over loudness, not only to give the required emphasis to the melody notes but also to control the glissando effect first mentioned. Control could be obtained with a foot—or hand-operated potentiometer but this would be completely out of keeping with the Theremin idea. Hence the need to adapt hand capacity effects to control loudness as well as pitch and, later in the article, we shall see how this can be done.

Ideally, both the pitch and volume control effects should be as progressive as possible, with pitch and loudness changing smoothly and linearly with movement of the hands within a fairly large "active" distance from the respective plates.

Unfortunately for the present requirement, capacitance varies inversely with the distance between hand and plate, so that the closer the hand is to the plate, the greater is the capacitance change for a given small change in distance. It is quite difficult to counter this effect in a practical kind of instrument and, as a result, the player must be able to position his hands quite accurately and often quite close to the surface of the respective plates to obtain just the right pitch and the right volume level.

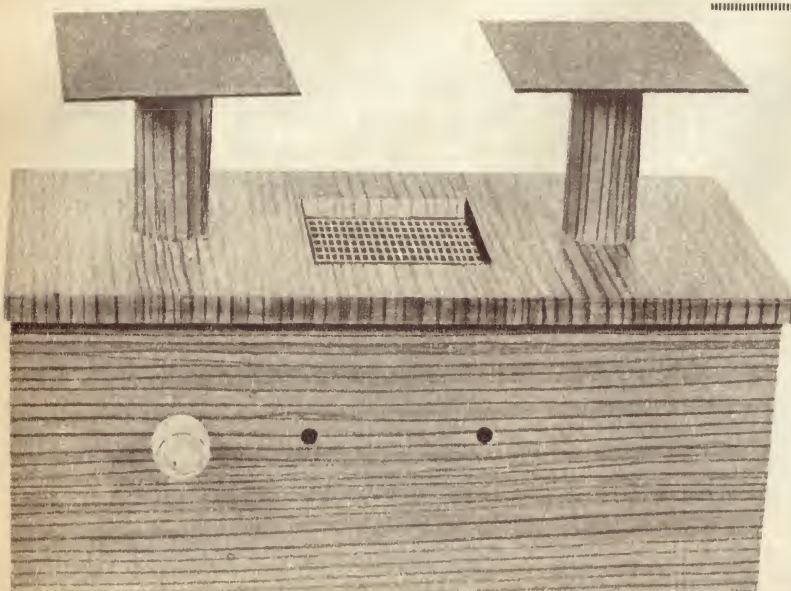

At left is a player's eye view of the prototype Theremin. It is played by waving the hands near the two raised plates. The plate on the left controls the pitch while that on the right controls the loudness. The two holes in the panel are screwdriver access holes for initial setting of pitch and loudness. The loudspeaker is installed under the lid but could be fitted in a separate cabinet if desired. The volume control knob is used to set the overall loudness to a suitable listening level. At right is the circuit diagram of the complete instrument. The numbers in brackets after the semiconductor type numbers are the key to their lead connection diagrams.







# THE MAGNIFICENT WORLD



## Model 4000D

### 4 TRACK STEREO TAPE DECK ————— 4000D

\*4 track stereo/monaural recording and playback \*2 speeds, 3 heads \*All silicon transistor pre-amplifier \*Automatic shut off, Instant stop control \*Tape cleaner \*ONE MICRON GAP HEAD \*Magnificent oil-finished wooden cabinet

For increased stereo enjoyment, use the matching amplifier AA-5000S and the matching speaker SW-120A.

Prove it by the sound!  
..... prove it with

**AKAI**<sup>®</sup>  
CROSS-FIELD HEAD

MAGNECORD SALES & SERVICE: 210 Clarence St., Sydney, N.S.W. 146 Burwood Rd., Hawthorn, VICTORIA 399 Montague Rd., West End, Brisbane, QUEENSLAND 8 Arthur St., Unlev. S.A. 579 Murray St., Perth, W.A. HOMECRAFTS: Petrie St., Canberra, A.C.T. J.B. YOUNG: Giles St., Kingston, A.C.T.



tance of the volume antenna (plate). A portion of the signal across the tuned circuit is coupled to a diode via another 4.7pF capacitor. The DC voltage so derived is amplified by a PNP transistor, T5, and applied to the gate of the FET.

The level of the audio tone being reproduced should increase when a hand is brought near the volume antenna. Initially, the volume oscillator is adjusted, by means of a 100pF rotary ceramic trimmer capacitor, to give a minimum loudness of the audio tone. This involves tuning the oscillator so that its frequency coincides with the resonant frequency of the tuned circuit. As a result, the voltage derived from the diode will be at a maximum so that T5 is forward biased and, consequently, turned on. The gate of the FET is taken toward the positive supply rail and the drain-source resistance held to a low value,

*A view of the layout inside the cabinet. The mains cord should be clamped to the chassis (this has been obscured) and knotted as shown, to reduce strain.*

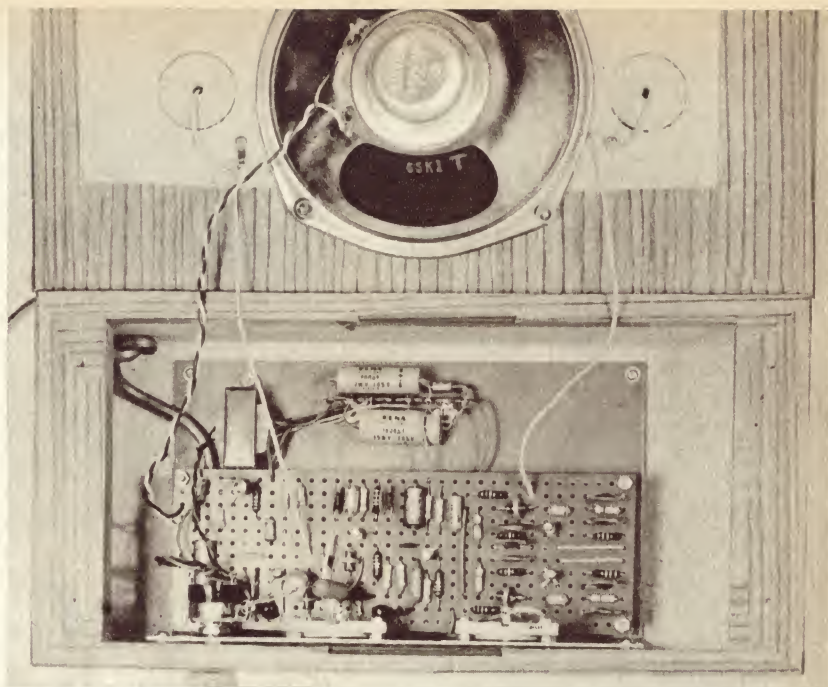

shunting a large portion of the beat note signal to the positive supply.

When a hand is brought near the volume antenna the hand capacitance in the tuned circuit changes the resonant frequency so that the DC derived from the diode decreases. This progressively carries T5 toward cut-off so that the drain source resistance of the FET increases, and thus more of the audio tone signal is fed to the following amplifier. At this point, a particular characteristic of the FET becomes apparent.

For small voltages of either polarity (or AC) applied between drain and source electrodes, the FET behaves as a resistor which can be varied in linear fashion by a voltage applied between source and gate. From zero to about minus 4 volts between source and gate, the relationship between gate-source voltage and drain-source resistance may be relatively linear but this is no longer true as the gate-source voltage approaches the "pinch-off" voltage of the FET. In this region the relationship becomes very non-linear, a small increase in gate-source voltage resulting in very large change of drain-source resistance; i.e., the FET is turned off over a small voltage range.

The above means that, in a certain region near the volume antenna, a small hand movement will result in a large change in loudness so that it tends to act almost as a switch. To reduce this effect, a 33K resistor is connected between collector and emitter of T5. When the transistor is turned off, the 33K and the 10K collector load resistor form a voltage divider which limits the FET gate-source voltage to about minus 6 volts. This has the effect of making the volume control action more progressive but it does reduce the available range of the control.

Note that it is not possible for the volume control circuitry to give zero sound output, since the minimum resistance of the FET is typically 300 ohms and it cannot shunt all the signal to the positive supply.

To sum up, then, we see that the pitch of the Theremin is controlled by beating two RF oscillators together, one of which is sensitive to hand capacitance. The resulting beat note can be varied over the whole of the audible range. The loudness of the beat note is controlled by a third oscillator feeding a tuned circuit which has its reso-

nant frequency shifted by hand capacitance. A DC voltage, derived from the tuned circuit, is used to vary the drain-source resistance of a FET, which is part of a voltage divider to which the beat note signal is applied. Having grasped this, the rest of the Theremin is straightforward.

The signal from the generator and

## PHOTOMULTIPLIER TUBES HAMAMATSU TV CO. LTD.

**HIGH PERFORMANCE — LOW COST**

### PM TUBE

### RESPONSE

HTV-R106	1,600 to 6,500°A	Critical Applications
HTV-R136	1,600 to 8,000°A	Wide range spectral response
HTV-R166	1,600 to 3,200°A	U.V. Range
HTV-R196	4,000 to 12,000°A	Vis. and infrared range
HTV-R213	1,850 to 8,000°A	U.V. to near IR Range

**OTHER TUBES AVAILABLE R212, 913A, IP21, IP22, IP28  
9 Stage, side-on types, 11 pin base**

**FOR FULL DETAILS PLEASE CONTACT**

Sole Australian Agents

## VARIAN TECHTRON PTY. LTD.

Springvale Road, North Springvale, Victoria

Phone: 560 7133



DESPITE the initial reservations felt by many people, particularly with reference to servicing, the printed circuit is now firmly established in most types of electronic equipment, ranging from the incredibly cheap pocket radios that have flooded the country in recent years, to some of the most sophisticated professional equipment available. Its origins lie in weaponry — a heritage unfortunately common to many good "electronic" ideas, but printed circuitry is, and indeed has been for some time, an attractive system for the amateur who constructs his own equipment, for it solves the mechanical problems of component mounting and eliminates the chores of wiring — as well as facilitating a neat and workmanlike job. For the amateur who has so far shied away from etching his own boards, a new system is now available, which is both economical and easy to use, yet with care, is capable of excellent results. Known as **Cir-kit**, the system utilises bakelite boards, similar to those used commercially, in conjunction with self-adhesive copper strip. This is 1/16in or 1/8in wide — easily cut with scissors or a model knife — and attaches to the boards rather like a piece of Sellotape. The adhesive is very efficient, although the bond is not quite as good as that on pre-laminated boards — which means that care is needed when soldering not to overheat the copper. However, anyone who is competent to solder a transistor or capacitor without causing damage should have no trouble, and the adhesive improves with aging, so that long-term stability is satisfactory. Layouts can normally be planned using the theoretical circuit diagram as a guide, and boards may be pre-punched or drilled according to requirements. With the pre-punched board, the strip can either be laid over the holes, and then punched through with a small drill or a watchmaker's screwdriver, or it can be laid alongside the holes and component leads are inserted through the board, folded over and soldered (see photo). The former method permits a more compact layout.

A few tips on planning layouts. Always be sure that the component spaces you allocate are adequate — it is preferable to purchase the bits before embarking on this task, although capacitors are available in literally dozens of shapes for board mounting and resistors are more or less of standard size, dependent on ratings. Avoid siting adjacently on to your layout components which are in different stages — as this can lead to instability. If instability does occur, of course, **Cir-kit** does permit alterations to be made, although it is as well to investigate the problem before redesigning sections of the board for it may not prove necessary.

The excellence of the system, however, lies in its versatility, for it enables the home constructor to produce a wiring board on a one-off basis for most of the circuits described in this and other journals, and while it will no doubt encourage many to "try their hand," it will also enable many who already build their own equipment to achieve neater, more reliable results with a minimum of fuss.

**AVAILABLE ALL LEADING  
RADIO HOUSES.**

(SOLE AGENT)



**ZEPHYR PRODUCTS PTY. LTD.**

70 BATESFORD ROAD, CHADSTONE, VICTORIA—PHONE 56-7231

**MANUFACTURERS OF RADIO & ELECTRICAL EQUIPMENT & COMPONENTS**

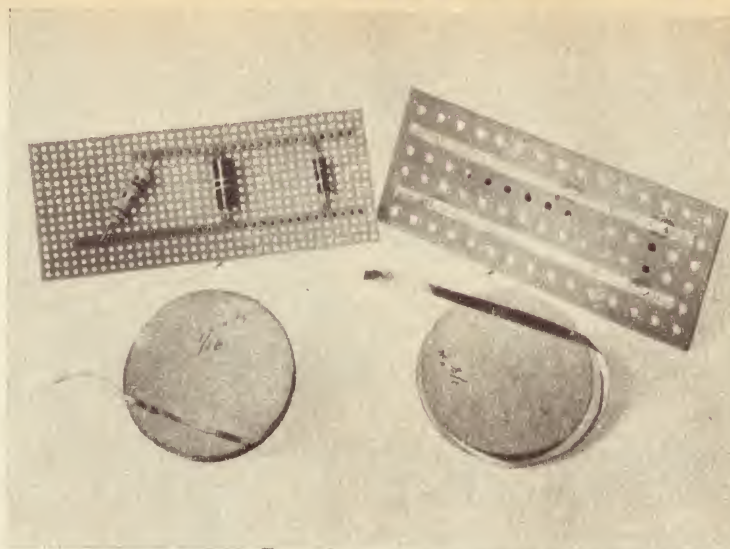

## INSTANT CIRCUITS

**A new method of making component boards  
using self-adhesive copper strip.**

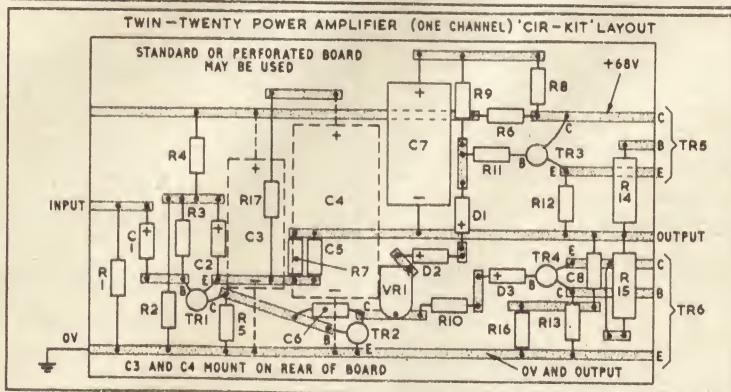
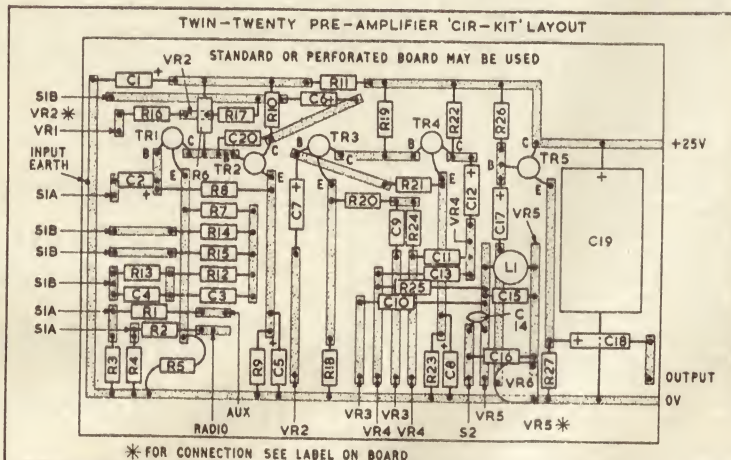



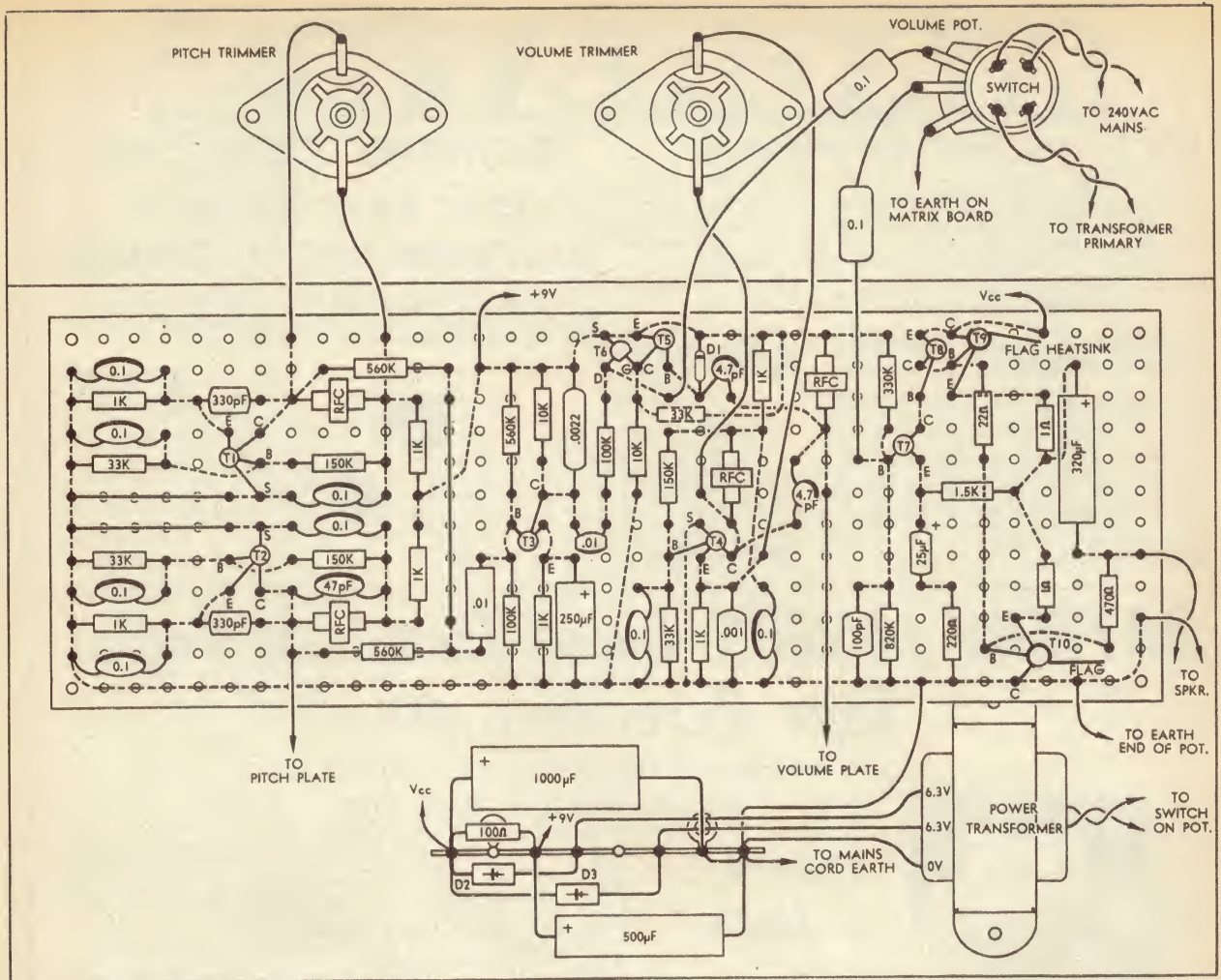

The above wiring diagram shows all the necessary details so that construction will be straightforward. Note that flag heat sinks should be fitted to the output transistors and the chassis must be earthed via the mains cord.

volume control system is fed to a 100K potentiometer and then to an audio amplifier and loudspeaker. The amplifier used in the prototype is the same as featured in the Keyless Organ in the January, 1969 issue, except that it does not incorporate vibrato.

Four transistors make up the amplifier, with the output transistors connected in the complementary-symmetry mode. The amplifier has low current drain of 10mA at no signal and a maximum power output of 400mW into a 15-ohm speaker with a 9-volt power supply. Sensitivity of the amplifier is approximately 300mV for full output, with an input impedance of 200K. We used a particular 15-ohm speaker but any speaker with an impedance from 15 to about 47 ohms could be pressed into service, provided it is not one of the miniature variety which have low sensitivity and a poor bass response. A voice coil impedance of greater than 15 ohms will reduce the available output power and lower the current drain.

Some readers may wish to incorporate the facility of vibrato and this is simply a matter of using the amplifier and phase-shift oscillator featured in the Keyless Organ. However, this would be "cheating." Vibrato should be achieved manually, not electrically!

Instead of using the amplifier featured in the prototype, an existing amplifier may be used, provided it has sufficient sensitivity and an input impedance of 100K or greater. The signal may be fed to the amplifier via the 0.1µF capacitor connected to the drain of the FET.

Mention was made earlier of the use of battery supply for the instrument. There is, however, a possible drawback in the use of batteries in that the whole unit could be left "floating," electrically. If the circuitry is not tied to earth, the hand capacitance affecting the volume control may also affect the pitch oscillator, giving considerable interaction between volume and pitch controls. Clearly, this is undesirable. The theremin may be battery-powered but it must be connected to earth or to some other large metal mass otherwise its operation may be completely unsatisfactory.

In the face of this requirement, there is little advantage in battery operation and we used a mains power supply in the prototype which enables the theremin to be automatically tied to earth. Any small power transformer with a 6.3 volt or centre-tapped 12.6 volt secondary winding will suffice. At the voltage available, maximum signal current drain is of the order of 90mA.

A full-wave rectifier is used, feeding a 1000µF electrolytic filter capacitor. This supplies the current requirements of the audio amplifier. The bias resistors for the input stage of the amplifier and the remaining circuitry are run from a supply decoupled from the 1000µF capacitor via a 100 ohm resistor and 500µF capacitor. This is to ensure low hum and minimise risk of instability.

If, in spite of what we have stated above, readers wish to use a 9-volt supply battery, the decoupling network consisting of the 100 ohm resistor and 500µF capacitor should be retained. Ideally, the 1000µF capacitor should also be retained across the battery to minimise distortion as the battery nears the end of its service life.

**CONSTRUCTION:** The prototype theremin was installed in a cabinet made of 3/8-inch particle-board covered with a plastic adhesive contact material with a simulated wood grain. If particle board is used, ensure that the surface is free of dust and wood chips before applying the covering material. Do not use a metal case as it will render the instrument less sensitive to hand capacitance.

All the circuitry, apart from the power supply, is accommodated on a piece of matrix board, 9 x 3 inches. The actual wiring uses no tags or eyelets, the component leads being pushed through the board, bent over and soldered point to point. The details of wiring underneath the board can be obtained from the wiring diagram.



# MAGRATH'S

## SCOPE The fastest heating IRON money can buy!

SCOPE DELUXE. Complete with pouch pack, stainless barrel, only 6 secs. Initial heat-up time. **\$5.95**  
 SCOPE STANDARD 6 secs. INITIAL warm-up. Performs work of irons requiring up to 150 watts. **\$5.50**  
 MINISCOPE Light, only 1oz 5 secs. to INITIAL heat-up time. Ideal for hard to reach spots. **\$5.28**  
 VIBROSCOPE. Protects your property. Etch any metal ferrous or non-ferrous or annealed, dull or polished. Produces deep penetration. **\$3.50**  
 Matching 3.3V transformer for these Scope products. **\$7.65**  
 POST FREE Anywhere in Australia and its territories.

## PANBRAKE Bench Mounting METAL FOLDER

**\$19.50**

Invaluable for design prototypes, model shops and hobbyists in every field where light sheet metal work is used.

FOLDS — angles from 175 deg. to 85 deg. 18in long. FORMS — pans (chassis) from 1/2in x 3/8in to 16 1/2in. Maximum depth of pan — 1 1/8in. Makes Channels from 1/2in upward by 18in long. Z-section, decorative trims, etc. CAPACITY: Aluminium to 13-gauge. Mild steel to 21 gauge. 1/2in bedplate adjustable by cams — multiple slots permit a range of 14 pan sizes from 3/8in to approx. 16 1/2in. SIZE: 20in x 4in x 4in. WEIGHT: 17lb. Mounts with 4, 5 1/16 bolts.

PLUS

SALES

TAX

POSTAGE EXTRA

## "PIONEER" MODEL P-382B

### 15 in. BASS GUITAR or ELECTRONIC ORGAN SPEAKER

This superb 15-inch unit is available in 8 ohm or 15 ohm Voice Coil. Power handling 30 watts R.M.S., 60 watts (peak). Frequency response to 500 cycles. Resonant frequency 60 plus or minus 12 cycles. Sensitivity 103 plus or minus 2 db/watt. Total flux 11,600 MAXWELL. Flux density 9,360 gauss.



**\$30**

Including Sales Tax

POSTAGE FREE

Anywhere in Australia

# BATTERY SAVERS - for all Transistor Radios Tape Recorders, etc.



## A & R Battery Saver-A/C Adaptor

Permits A/C mains operation of 6-9V battery powered equipment.

APPROVED BY ELECTRICAL SUPPLY AUTHORITIES

PS 64 Specially for tape recorders **\$14.00**

PS 82 Specially for transistor radios **\$9.00**

- 6 or 9 Volt (Nominal Voltage) selected by external switch.
- Double insulated for absolute safety.
- Handsome cabinet complete with 3-pin power point plug, and radio lead with plug.
- Measures a compact 3 1/2in x 2 1/2in x 2in.
- Suitable for any 6 or 9 Volt Battery Operated Transistor Equipment.

ALL SALES TAX AND POSTAGE PAID.

## RADAR REGULATED BATTERY ADAPTER

Input 11-15 Volts D.C. Model 912. Output 9 Volts plus-minus 5 per cent D.C. Model 712. Output 7.5 Volts plus-minus 5 per cent D.C. Ideal for Cassette Tape Recorders. Model 612. Output 6 Volts plus-minus 5 p.c. D.C. Save your batteries while motoring. Size 2 1/4in x 1 1/2in x 7/8in. **\$8.75.**

## Radars Solid State INVERTER

Ideally suitable for use in your car, boat or caravan. With it you can use your Electric Shaver, Tape Recorder, Record Player, Radio, Small P.A. System, Personal Fan or any other A.C. powered unit up to 40watts consumption. Simply connect the Unit to any 12V car battery. The inverter will draw 4 amps, a full load equivalent to the consumption of one headlamp. With a fully charged battery the unit can operate for many hours without danger of battery damage. **\$26.**

## RADAR 05X POWER SUPPLY UNIT

Designed to operate the majority of ELECTRONIC APPLIANCES — Transistorised Tape Recorder, radios, record-players, small amplifiers, Radiograms, Battery Shavers, and all Battery-operated units of 6 volts, 9 volts and 12 volts at a maximum current of 0.5 amps. The only unit available incorporating these three power outputs. This unit features full wave bridge rectification with capacitor and choke filtering. Select your voltage by adjusting the Selector Switch then plug into any power point. 220 to 250 Volt A.C. Costs 1c per 100 hours — Saves dollars on Battery purchases. Can be used also for car batteries as a trickle charger. **\$15.**

## REGULATED BATTERY ELIMINATOR

240 Volt AC Regulated out-put of 4.5 Volts, 6.5 Volts, 7.5 Volts, and 9 Volts D.C., also an unregulated 12 Volt supply. MODEL 05XR 1/2 amp. input **\$20.70.** MODEL 1XR 1 amp. input **\$27.00.** ALL SALES TAX AND POSTAGE PAID.

# 'STENTORIAN' SPEAKERS

## H.F. 1016 STENTORIAN MAJOR SPEAKER

Designed to achieve full range response when mounted in a "compact" cabinet. Cone diam. 10in. Pole diam. 1in. Flux density 15,000 gauss. Total flux 64,000 Maxwells. Impedance coil at 15 ohms. Frequency response 50 c.p.s. to 16,000 c.p.s. In suggested cabinet. 30 c.p.s. to 16,000 c.p.s. in larger cabinet. Capacity 10 watts **\$28.50** (Including Sales Tax).

## Model H.F. 1016 STENTORIAN SPEAKER

10in P.M. Unit and 16,000 gauss magnet. Universal impedance speech coil at 3, 7.5 and 15 ohms. Capacity 10 watts. Frequency response 30 c.p.s. to 15,000 c.p.s. Bass resonance 35 c.p.s. **\$21** (Including Sales Tax).

## Model H.F. 1012 STENTORIAN SPEAKER

10in Unit 12,000 gauss magnet. Universal impedance speech coil at 3, 7.5 and 15 ohms. Capacity 10 watts. Frequency response 30 c.p.s. to 14,000 c.p.s. Bass resonance 35 c.p.s. **\$14.00** (Including Sales Tax).

## Model T.10 STENTORIAN TWEETER

Speech Coil is aluminium wire wound on an aluminium former rigidly fixed to an aluminium diaphragm, giving high standard of reproduction when used with Stentorian H.F. 1016 speakers. Speech coil Impedance 15 ohms. Response: 200/15,000 c.p.s. flux density: 14,000 gauss. Capacity: 5 watts. **\$16.00** (Including Sales Tax).

## CX 3000 CROSSOVER NETWORK

W./B. Crossover is of the filter type and is fitted to all the Duplex Loudspeakers. It is available for use separately, the 3,000 c./s. type is half section series connected having an attenuation of 12dB per octave. C.X. 3000, **\$6.50** (Including Sales Tax).

## T359 TWEETER

3,000-15,000 c.p.s. Size overall 3 1/2in diam. x 2in deep Voice coil Impedance 15 ohms. **POST FREE ANYWHERE IN AUST.**

COME TO MAGRATH'S—WE'VE GOT IT!

**J. H. MAGRATH & CO. PTY. LTD.**  
 208 LT. LONSDALE STREET, MELBOURNE, VICTORIA, PHONE 663 3731



## PARTS LIST

- 1 chassis (see text).
- 1 miniature power transformer, with centre-tapped 12.6 volt secondary.
- 1 piece of matrix board, 9 x 3 inches.
- 1 8-terminal tagstrip.
- 4 330uH RF chokes.
- 1 100K(log) potentiometer (mains switch optional).
- 2 100pF Ducon TDB rotary ceramic trimmers.
- 1 15-ohm loudspeaker.
- 1 knob.

### SEMICONDUCTORS

- 3 BF115 or similar silicon NPN RF transistor.
- 2 BC108, 2N3565 or similar silicon NPN transistor.
- 1 2N3638 or similar silicon PNP transistor.
- 1 BC178, 2N3638A, AY1110 or similar high gain PNP transistor.
- 1 AC127/128 complementary germanium pairs (with flag heat-sinks).
- 1 2N5459 N-channel FET.
- 1 OA91 or similar diode.
- 2 EM401, AD4001, 1N3193 or similar power diode.

The layout is not really critical but the wiring diagram should be followed fairly closely for best results.

All the RF chokes are 330uH, honeycomb wound on a ferrite former by Aegis Manufacturing Co. Pty. Ltd., and available from most component suppliers. All the 0.1uF capacitors in the RF portion of the circuit are low voltage ceramic discs rated at 25 volts working; a lower rating may be used, if available. Mica or polystyrene capacitors may be substituted, if they are on hand.

Electrolytic capacitors shown on the circuit diagram and in the parts list are specified with the minimum suitable voltage rating currently available. As always, higher voltage units may be used if size is not a problem. old electrolytics should not be used, as their capacitance may have decreased and leakage and power factor will be increased.

The AC127/128 output transistor pair should be fitted flag heatsinks, (Miniwatt part No. 56200) which are normally supplied with each complementary pair. Under normal conditions the transistors will be cold to the touch.

A simple chassis was used in the prototype, made from a piece of 22 gauge aluminium 9½ x 8½ inches bent so that it has a 3 inch flange to accommodate the volume potentiometer and two trimmer capacitors. The matrix board is mounted on the chassis so that it is spaced above it by a distance of one inch, by 1/8-inch screws and nuts. The chassis reduced the tendency of the two pitch oscillators to lock.

The rotary ceramic trimmers are type TDB, made by Ducon division

### RESISTORS

- (½ or ¼ watt unless specified)
- 1 x 820K, 3 x 560K, 1 x 330K, 3 x 150K, 2 x 100K, 4 x 33K, 2 x 10K, 1 x 1.5K, 7 x 1K, 1 x 470 ohms, 1 x 220 ohms, 1 x 100 ohms, 1 x 22 ohms, 2 x 1 ohm/¼ watt.

### CAPACITORS

- 1 x 1000uF/12VW electrolytic.
- 1 x 500uF/10VW electrolytic.
- 1 x 320uF/6VW electrolytic.
- 1 x 250uF/6VW electrolytic.
- 1 x 25uF/6VW electrolytic.
- 8 x 0.1uF/25VW ceramic disc (see text).
- 2 x 0.1uF polyester or ceramic.
- 2 x 0.01uF polyester or ceramic.
- 1 x .0022uF polyester or ceramic.
- 1 x .001uF polystyrene or ceramic.
- 2 x 330pF polystyrene or ceramic.
- 1 x 100pF polystyrene or ceramic.
- 1 x 47pF polystyrene or ceramic.
- 2 x 4.7pF ceramic.

### MISCELLANEOUS

Timber for cabinet, contact covering, sheet metal for pitch and volume plates, 3-core mains flex and power plug, hook-up wire, mains cord clamp, screws, nuts, solder, etc.

of the Plessey Components Group and are available from most component suppliers. These trimmers were used since they are fully adjustable and do not lose their ability to be adjusted, as do compression trimmers. The trimmers are adjusted by a screwdriver, through an access hole in the chassis and cabinet. They are spaced off the chassis by the thickness of one nut to ensure that the rotor has sufficient clearance. When wiring the trimmer for the pitch oscillator, connect the rotor terminal (terminal going to centre of ceramic former) to the positive supply rail, as in the circuit diagram. If it is connected in contrary fashion, it will be impossible to "zero" the pitch oscillator because of the capacitance of the screwdriver blade.

To take advantage of the wide frequency range available, a speaker with a good frequency response should ideally be used. If an economy speaker is used it should have as large a diameter as is practical. For this reason we used a 6-inch diameter speaker which enables a conveniently sized cabinet to be obtained.

An exploded diagram illustrates the method of assembly of the cabinet and gives the major dimensions of a cabinet suitable for a six-inch diameter speaker. If desired, the output of the amplifier can be fed to an external speaker system. If this is done, be sure to connect the speaker with a two-pin plug and socket to reduce the possibility of shorting the output of the amplifier which would almost certainly be damaged.

Antennas or plates associated with the pitch and volume controls may be any reasonable size and shape. We made two rectangular plates 6 x 4½in.

# ELECTRONIC DESPATCH

16 SHERIDEN ST., GRANVILLE,

9-1 Daily and Sat.

MAIL ORDERS WELCOME  
(but add for delivery).

P.O. BOX 149, AUBURN, 2144, N.S.W.

Re. April Ad.: Sorry all High Voltage Electros and QQVO3/10 sold out.

### COMPUTER BOARDS

10c per TRANSISTOR

5c per DIODE

Resistors, capacitors, tantalum electrolytics, chokes which may also be on board are free. Order by value. Boards have from 2 to 9 Ts and up to 10 diodes.

### TRANSFORMERS

200, 215, 230, 240V. input 50 Hz.  
25V 3A, 10V.1A, 110V.6A output ... \$ 4.00  
240V.-115V. 8.7A ... \$20.00  
230/240-52V. 1KVA ... \$ 8.00  
3-phase auto 15KVA 415V.-380V.  
22.8A ... \$40.00

### VLF RECEIVER

15-560KHz

Ex P.M.G. ... \$25.00

### INVERTERS

250V. 50Hz at 250 watts (1/3 h.p.)  
from 12 volt battery ... \$25.00

### BELL WIRE

Hook-up, etc., 1/036 Copper PVC Fortisan  
Lapped coil 440 yds. twisted pair or  
880 yds. single \$10 or 1.5c yd. single.

### THERMISTORS

STC bead type for temp measurement or  
compensation, G54, 10c.  
Rod type CZ12A, 10c.

### ZENER DIODES

Large range up to 8W to select.

9V, 1W, 10c.  
RD16C 13.5-18V. 3W, \$1.00.

### POWER DIODES etc

1N539 ... 50c 1N1342 ... \$1.00  
1N540 ... 60c 1N1599 ... \$1.50  
1N604 ... 50c CA152AA ... \$1.50  
1N606 ... 50c 1A800VW ... 65c

### DIODES

GD5 ... 5c 1N277 ... 10c  
1N23 ... 10c  
GD12 ... 5c PE 501 ... 20c

### TRANSISTORS

SE 3030 ... \$3.00 2N511A ... \$2.00  
2N456A ... \$2.50 \*2N442 ... \$2.00  
ADY 22 ... \$1.25  
2 SC 139 400 MH3 RF amplifier ... 60c  
BFY 22, 23, 30, Pinhead hearing  
aid type ... 50c  
BC 107 ... 70c BC 109 ... 75c  
BC 108 ... 60c BC 148 ... 50c  
AC 126 Equiva. (OC308, 25B110, 11,  
12, TS13) ... 50c  
AF 116 ... 65c OC 445 ... 50c  
BSY 28 ... 50c (BCY30) ... 30c  
OC 440K ... OC 469 ... 50c  
(BCY33) ... (BCY34) ... 50c  
OC 440 ... TS3 (AF185) ... 25c  
(BCY430) ... 50c 25C92 ... 50c  
OC 470 ... 2G526 ... 50c  
(BCY34) ... 50c 2N 1613 ... 50c  
OC 71 equals ... 50c 2N 396 ... 50c  
2N291 ... 50c 2N 526 (AC128) ... 40c  
OC 440 ... 50c

\*Available in matched pairs.

### RESISTORS

5% ¼W Phillips full range ... 6c  
High stab. IRC most values ... 10c

### ELECTROLYTICS

Added since April Ad.  
15000/55VW ... \$5.00 70,000/13 ... \$5.00  
250/85 ... \$2.00 500/50 ... \$2.50  
1000/200 ... \$3.00 400/80 ... \$4.00  
1500/150 ... \$3.00

All new professional quality.

240V MAINS STABILISER CLAUDE  
LYONS NEW 10A 192-264V INPUT 240V  
OUTPUT plus / minus 5 per cent.



# EVERY BLACK BOX SHOULD HAVE A DJINNI.



The reed switch is the greatest thing that's happened to electronic control devices since the Arabian Nights. It's encased in a little glass bottle you don't even have to rub. A coil turns it into a relay. A bar magnet makes it the most versatile electro-mechanical switch yet invented.

The reed switch is isolated in its glass container with a controlled atmosphere. It stays free of dust, damp and corrosion. There are no armatures, springs or pivots to wear. Life can easily exceed 100

million operations. Sensitivity is readily controlled. Speed is the next best thing to transistorized logic at a mere wisp of the circuit cost. Even RF switching is practical.

If this isn't magic, what is?

If you are not as familiar with magnetic reed switches as you should be, ask for technical literature. With this information at your fingertips you may devise machine, flow or control uses no other engineer has conjured up yet.

## IRH COMPONENTS PTY. LIMITED

A Subsidiary of International Resistance Holdings Limited

THE CRESCENT, KINGSGROVE, N.S.W. 2208. PHONE 50 0111

### INTERSTATE TELEPHONES

MELB. VIC.	489 1088	BRIS. QLD.	70 2141
HOB. TAS.	34 2811	PERTH W.A.	8 2271
LAUN. TAS.	22 844	ADEL. S.A.	23 1971

## HAMLIN

MAGNETIC REED SWITCHES.  
THE FIRST AND FINEST IN THE FIELD.

2119



## MAIN DIMENSIONS OF CABINET

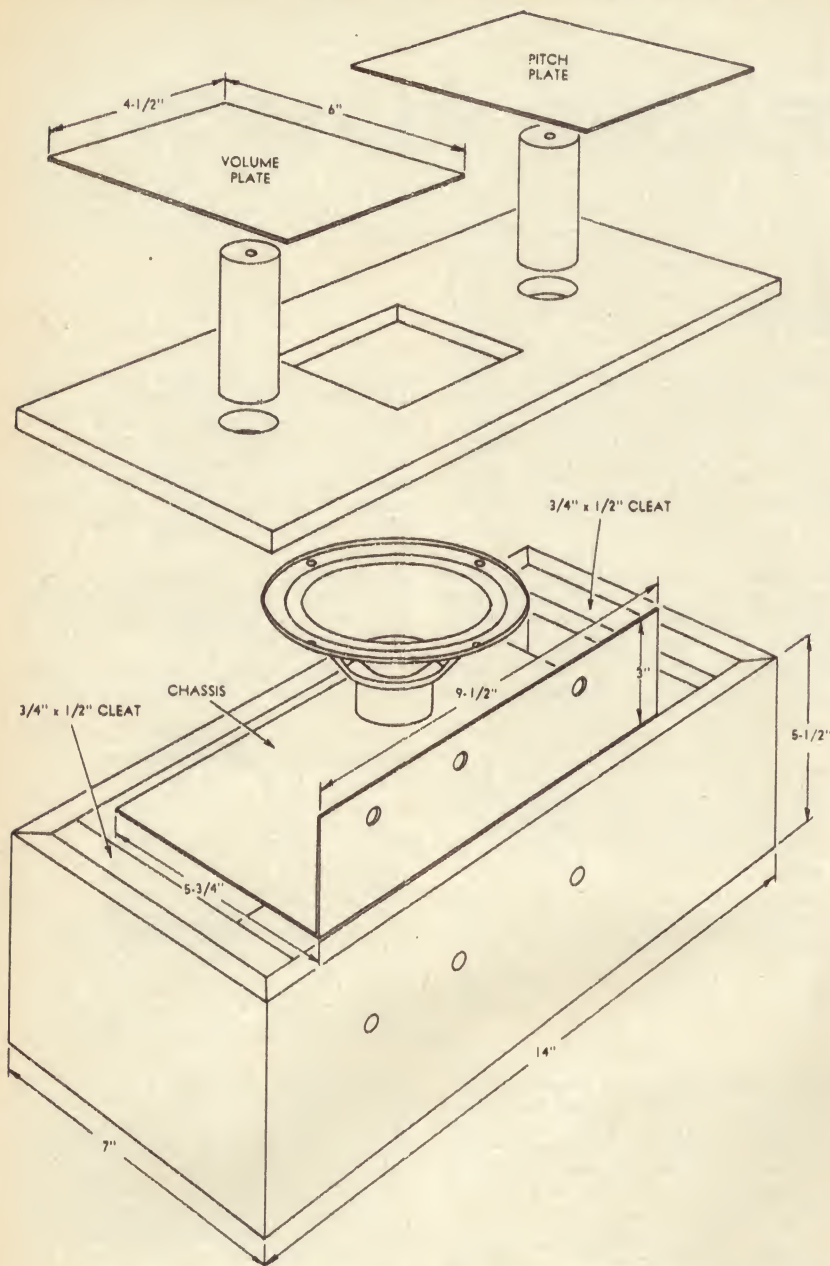

The above diagram shows the major details of a cabinet suitable for a six-inch diameter speaker.

and these were mounted above the lid by two 1-3/8-inch dowels. These were drilled right through to take a piece of hookup wire for connection in the circuit. The method of mounting the plates, however, is non-critical and readers may use whatever method is convenient. Note that the plates should not be too close together, otherwise the controls will interact.

Finally, we covered the plates with black vynex to contrast with the simulated wood of the cabinet. Contact adhesive is suitable for sticking the material to the plates.

**SETTING UP:** First, adjust the pitch control trimmer for an audible note. Set the volume control potentiometer for a suitable level. Then adjust the volume control trimmer for minimum loudness. Note that it is not possible for the volume trimmer to

completely turn off the sound, for the reason already explained. Finally, with your hand close the volume plate, adjust the pitch trimmer for zero pitch. These adjustments will have to be repeated each time the unit is set up in a different position.

You will find the theremin capable of an endless variety of sounds. Low grunts and growls can be produced by a quick, sweeping motion of the hands. Similarly, one can obtain wails and squeaks in the high range. To produce a vibrato effect, hold the "volume hand" in a fixed position and flutter the "pitch hand" at the desired rate. Similarly, to create a "tremolo" effect, hold the "pitch hand" in a fixed position and flutter the "volume hand." Do not practice these effects in the vicinity of someone with a headache!

Go to it. □

## TECHNOCENTRE TOPICS

At our Technocentre you receive friendly advice and guidance from our highly qualified consultants. An invaluable service to those building or altering a home. The equipment you buy at Convoy will serve you well for many years and have a good resale value. This is your real cost! Make sure you visit the Technocentre before you buy any item of Hi-Fi equipment.



- ★ The Electronics review of Revox 77A Tape Recorder has brought a slight blush to our cheeks. We have confidently said, "the best ever," after appraising this machine. It is good to know our opinion is now supported by the unbiased technical experts of Electronics. Call, see, hear, then own the best, A Revox Tape Deck or Full Recorder with 20 watt amps and Speakers.
- ★ At its price, the Kenwood KA6000X Amplifier, 100 watt RMS, is the outstanding buy of the moment for connoisseurs, P.U. input to .05 Mv., In Tuner Amplifiers, the Pioneer SX440 rated 30 watts RMS is a smooth machine with luminescent tuning scale and black finish — FM and Multiplex, too!
- ★ Stereo Headsets by A.K.G. make private Hi-Fi listening a totally new experience. The A.K.G. series of microphones are of professional standards, but we can choose them to suit your requirement and budget.
- ★ The Peerless of Denmark, Sherwood 15" three-way Speaker System in new enclosures is an experience to hear. Compare it with other speaker systems. We have imported Peerless speakers in teak enclosures from \$100.00 pair. Also Poly-Planar Speakers less than one inch deep, 20Hz 20KHz—Speaker Cloth and innerbond stocked.
- ★ **STOCKTAKE SPECIALS.** June is the month to pick up a real bargain at the Technocentre—Amps., Speakers, Turntables, Tape Decks, Cartridges — You'll be surprised at the low prices.

### SERVICE AND MAINTENANCE

—Let the Technocentre specialists care for your sound equipment. We service all brands—Sony—Akal—National — Pioneer — Trio—Phillips — Sharpe, etc.

# Convoy

FOR SOUND SATISFACTION

TECHNOCENTRE  
449 KENT STREET,  
SYDNEY 29-6475





# A READER BUILT IT!

## Enlarging Exposure Calculator

Amateur photographers are constantly seeking ways to measure the light projected on to the enlarger baseboard, in an effort to avoid the time wasting chore of making test strips. This design has the advantage that it requires no expensive meter and is cheap and simple to construct.

In photographic enlarging it is very helpful to have some means of determining the time of exposure to give a proper gradation of tones from shadow to highlight. It is also necessary to know which paper grade is best suited to the type of negative being printed.

The unit to be described is run from a low voltage transformer, is easy and cheap to construct with parts relatively easy to obtain, and provides an extremely accurate means of measuring the actual "light value" being projected on to the enlarging easel. The circuit was evolved from the "Tape Actuated Relay" described in *Electronics Australia* for September, 1967.

It can be constructed in a small metal box housing both the transformer and circuit board, with the LDR on a probe, or the transformer can be located in a place out of reach and the small circuit board, lamp and LDR build up as a probe with only the 6.3 volt leads attached.

Operation of the device is based on adjustment of the lens stop until a point is found where the indicator lamp is extinguished. Based on this broad principle, there are two methods which may be employed to determine exposure.

In the first method, the probe can be placed in the path of the light corresponding to what would be a black in the print, or shadow area, and the exposure needed for a satisfactory print determined experimentally. Once this is done, the time used for this print will be the same for all prints, whatever the degree of enlargement, simply by adjusting the lens stop until the globe goes out. A very small movement of the stop will light or extinguish the globe.

When setting up the unit, focus up for a print about postcard size and adjust the 30K pot. control so that the lamp will operate using a small stop (f11). It will then be found that as the print size is increased so also will the size of the stop, without changing the exposure time.

The grade of paper can be determined by first taking a reading of the brightest part of the negative in the same manner as above. Then move

the probe to the darkest part, open the lens until the globe just lights, then close it until it just goes out. The number of stops difference will indicate the contrast of the negative.

The best practice, of course, is to

*The circuit is simple and uses only a few low-cost components. A small lamp serves in place of a meter.*

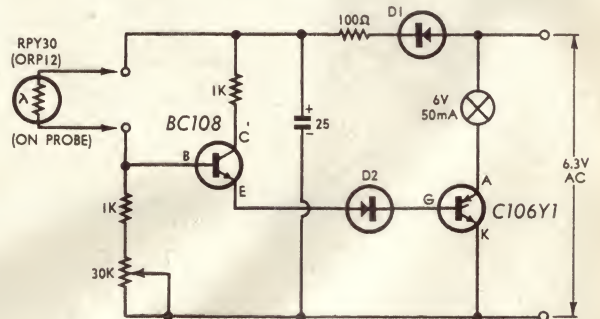

expose and develop all negatives to a consistent contrast, thus minimising the need to use more than one grade of paper. However, allowance must still be made for the wide differences in contrast which occur between different subjects.

In the second method the light is measured after diffusion. A swing around holder is mounted under the lens and fitted with some diffusing material such as grained astrofoil and

accommodate the LDR and lead out wires to keep them flush with the surface. A thin piece of white plastic or formica is then cut to the shape of the base and a small hole  $\frac{3}{16}$ " to  $\frac{1}{4}$ " is drilled to coincide with the LDR. This is affixed to the base with plastic cement. The lead may be plastic covered shielded cable or small twin flex.

(Submitted by: Mr A. R. Coates, 36 St. Lawrence Avenue, Edwardstown, S.A. 5039.)

## Boxes for Tapes and Films

Finding boxes in which to store or post audio tapes or 8mm film can be one of those annoying practical problems for which there seems to be no simple answer. This article describes how one reader tackles the problem.

Once upon a time the whole family became involved in turning the house upside down in search of suitable boxes for my tape recordings. But not any more, I've found a quick and easy way to make my own.

Quite by accident I discovered that the local supermarket discards hundreds of empty bulk cigarette cartons each week. Their size set me thinking. Could they be adapted successfully for

my use? I asked for a couple out of which come five packets of 20s. I was surprised by the simplicity of the operation. Now the manager gives me as many as I want.

Those with short tuck-in ends, usually about  $3\frac{1}{2}$  inches wide, are ideal for message tapes. Ones with a single long tuck-in flap on one side are excellent for storing 3-inch tapes. They need scissors treatment but in a matter



of minutes you can make them into suitable boxes. Real money savers because 3-inch empty spools cost at least 10c extra if boxed. And boxes are usually too battered for a second trip through the post.

Take one of these empty cigarette packet containers with short tuck-in ends, measure  $3\frac{1}{4}$  inches along the carton lengthwise, and draw a straight line at right angles. Undo both ends and press the whole carton flat. Cut along the straight line you drew at the  $3\frac{1}{4}$  inch mark. Now spring the smaller cut section back into its original shape and tuck-in the end flap. From the remainder of the cut carton measure

tuck-in opening and measure  $3\frac{1}{4}$  inches back from one of the short ends. Draw a line across at right angles and cut straight along this line. Glue down the flap and cut out a "V" from one of the sides of the open top making it easy to slip-in and pull-out a tape reel.

Using the remainder of the carton, measure  $3\frac{1}{4}$  inches along from the other cut and as before cut it straight across. When you open it out it will have two narrow folding pieces at each end. Cut off these two pieces along the folds. The large piece you'll be left with should be about  $7\frac{1}{2}$  inches long by  $3\frac{1}{4}$  inches wide with a narrow folding part in the centre.



Two types of cigarette cartons and two tape boxes made from them.

and mark it  $3\frac{1}{4}$  inches from your first cut. Then cut it straight across as before and spring it back into shape. It should be relatively square with two open ends. Into one of these open ends insert the section you have already made, keeping the tuck-in end at the bottom, open end along the top. You'll find you've made a totally enclosed slide-in tape box. Of course, you'll need to wrap the box in brown paper for posting because of the printed matter still showing on the outside.

For storing 3-inch tapes or reels of 8mm film, use a carton with the long

Turn it inside out and glue one side of it as far as the first fold to the other section you have already completed making sure that the open end where you cut out the "V" corresponds with the folding part in the centre. And presto! It's become a wrap-around storage box suitable for either 3-inch tapes or reels of 8mm film with a plain spine and plain sides on which to list the contents.

(Submitted by: Mr K. Lovett, 5 Glover Street, Willoughby, N.S.W. 2068)

## Picture Tube Tester, Rejuvenator

Since picture tubes are expensive, no one wants to discard one until its failure is beyond doubt and all restoration techniques have been tried. This combined tester and rejuvenator can be made from a minimum of low cost components, yet provides similar functions to a commercial instrument costing a good deal more.

Where a faulty picture tube is suspected, this tester will give a definite answer. It may be constructed mainly from oddment parts. Although the power transformer voltages are unusual they may be obtained by using two old radio transformers with the secondaries connected in series.

The circuit is similar to commercial instruments but, to avoid using a complicated and expensive switching system, connections are made via four 9 pin sockets mounted on the main panel, each socket being wired to provide a particular function. These are

used in conjunction with a wandering lead consisting of two (or more) picture tube sockets connected to a 9 pin plug. This is wired as shown. When the tester is completed, appropriate pins in the picture tube socket should be deliberately shorted and the results checked against the testing table.

The NE2 neon lamps should be mounted in such a way as to be visually shielded from each other. They should also be wired exactly as shown in the circuit in order that the left and right hand elements (as referred to

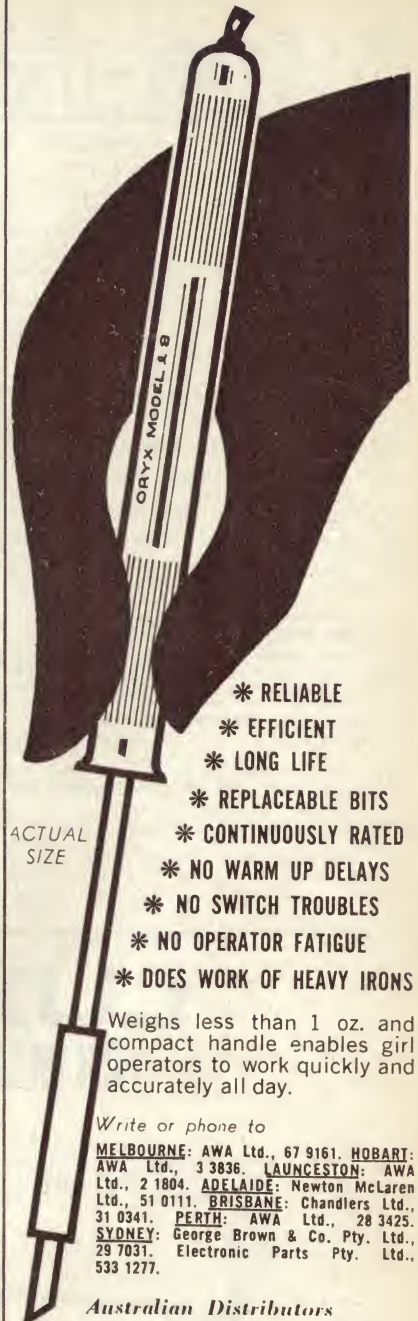

ACTUAL SIZE

- \* RELIABLE
- \* EFFICIENT
- \* LONG LIFE
- \* REPLACEABLE BITS
- \* CONTINUOUSLY RATED
- \* NO WARM UP DELAYS
- \* NO SWITCH TROUBLES
- \* NO OPERATOR FATIGUE
- \* DOES WORK OF HEAVY IRONS

Weighs less than 1 oz. and compact handle enables girl operators to work quickly and accurately all day.

Write or phone to

MELBOURNE: AWA Ltd., 67 9161. HOBART: AWA Ltd., 3 3836. LAUNCESTON: AWA Ltd., 2 1804. ADELAIDE: Newton McLaren Ltd., 51 0111. BRISBANE: Chandlers Ltd., 31 0341. PERTH: AWA Ltd., 28 3425. SYDNEY: George Brown & Co. Pty. Ltd., 29 7031. Electronic Parts Pty. Ltd., 533 1277.

Australian Distributors

**MANUFACTURERS SPECIAL PRODUCTS PTY. LTD.**

47 York Street, Sydney. 2 0233, Ext. 284

# WANTED

BY ALL  
PRODUCTION ENGINEERS

# ORYX

miniature  
soldering instruments



# Homecrafts FOR RADIO PARTS

## 289 Elizabeth St. Melbourne. Phone 60 1442

### PIEZO PICK-UP AND CARTRIDGES

PU-86 Pickup LP/78 T/O Crystal cartridge. Length 240mm . . . . . Ea. **\$2.95**  
 Y700 Ceramic Cartridge. Mon. LP/78 **\$2.50**  
 PU-86 Pick-up Ster-LP/78. T/O Cartridge. Length 204mm . . . . . Ea. **\$4.00**  
 Y200 Ceramic Cartridge. ST LP/78 **\$3.40**  
 Y400 Crystal Cartridge. LP/45 **\$1.90**  
 Y130 Crystal Cartridge. T/O Type Ster/LP **\$2.70**  
 Sapphire Replacement Styl. Each Ster/LP **60c**  
 Plus postage 15c.

### PIEZO MICROPHONE INSERTS

MC-3 Crystal, 50-7K, 35 x 25 x 8mm. -57 DB **\$1.00 ea.**  
 MC-7 Crystal, 100-7K. 39mm Round x 11mm. -56 DB **\$1.00 ea.**  
 MC-8 Crystal, 50-8K. 48mm Round x 9mm. -50 DB **\$1.00 ea.**  
 MC-9 Crystal, 50-8K. 25mm Round x 9mm. -68 DB **\$1.80 ea.**  
 MC-33 Crystal, 50-10K. 33mm Round x 9mm. -60 DB **\$1.30 ea.**  
 MD-5 Dynamic, 100-15K. 33mm Round x 14mm. -55 DB **\$1.80 ea.**  
 Plus postage 20c.

### TRANSISTOR SET ACCESSORIES

Magnetic Earpiece with 3.5mm Plug **75c**  
 Crystal Earpiece with 2.5mm Plug **75c**  
 Crystal Earpiece with 3.5mm Plug **75c**

### LAPEL TYPE CRYSTAL MICROPHONE

With 3.5mm Plug **\$1.00 ea.**  
 Plus postage 15c.  
 Fuses for Japanese equipment 1A, 3A, 5A 3c ea. OR \$2.00 per 100. Plus postage 10c.

Michigan/Collard—Twin Heads	Track	Rec/Play	<b>\$8.50</b>
Michigan/Collard—Twin Heads	Track	Erase	<b>\$3.00</b>
Michigan/Collard—Four Heads	Track	Erase	<b>\$8.50</b>

12-Pin Wafer Sockets. **20c ea.** | 12-Pin Plum . **25c ea.**  
 Plus postage 10c.

### OCTAL PLUG AND CORD

Ext. Socket.  
**45c pr.** Plus postage 10c.

### ALL TYPES AMPHENOL PLUGS AND SOCKETS

Carried in stock.  
 Plus 27c ea. Sockets 30c ea. Meall Covers for same 27c ea.  
 Plus postage 10c.

### HALF-INCH MINIATURE PLUGS AND SOCKETS

2, 3, 4 and 5-Pin Plugs 10c ea.  
 Sockets 10c ea. Plus postage 10c.

### ELECTROLYTIC CAPACITORS IN METAL CANS

16 + 16	450 VW	<b>95c ea.</b>
32 + 32	450 VW	<b>\$1.30 ea.</b>
50 + 50	450 VW	<b>\$1.85 ea.</b>
50 + 50 + 50	350 VW	<b>\$1.90 ea.</b>
100 MFD	P.V.C. Cover	<b>\$1.15 ea.</b>
Jacks, 2.5 and 3.5mm		<b>20c</b>
3.5mm Plug and Cord Ext. Jack Pair		<b>50c</b>
Metal Co-axial Plugs and Line Sockets		<b>65c</b>
Pr.		<b>65c</b>
"Din" and "Hirschmann," 2, 3, 4 and 5-pin Plugs, Chassis and Line Sockets.		carried ex stock.

Prices on application.

P.M.G. type Plugs from **50c**  
 P.M.G. type Jacks from **35c**  
 P.M.G. Line Jacks from **85c**  
 Plus postage 15c.

### 5 CORE CABLE

7/0076. P.V.C. insulated, P.V.C. covered.  
**25c yd.**

### 6 CORE CABLE

same spec. as above  
**30c yd.**

Capacitor Substitution Box. 1,000 VW **\$5.00**  
 Resistor Substitution Box. 1 Watt. **\$4.90**  
 Plus Post. 20c.

### TRANSISTOR AERIALS

5in extends to 39in	<b>\$1.70</b>
5in extends to 39in	<b>\$1.70</b>
6in extends to 43in	<b>\$1.70</b>
6in extends to 32in	<b>\$1.00</b>
6in extends to 28in	<b>\$1.20</b>
7in extends to 39in	<b>95c</b>
9in extends to 39in	<b>\$1.90</b>
5in extends to 4ft 6in	<b>\$3.70</b>
7in extends to 5ft 8in	<b>\$3.70</b>

Plus Post 15c.

### CRYSTAL SET BUILDERS

Coils	<b>80c</b>	Tuning Conds.	<b>\$2.00</b>
Diodes	<b>35c</b>	Terms	<b>Ea. 12c</b>
Headphones	<b>\$2.80</b>		Plus Postage.

### TAPE RECORDER ACCESSORIES

2 1/4in Spools	<b>30c</b>	3in x 600ft	<b>\$2.35</b>
1in Spools	<b>35c</b>	Tape	<b>60c</b>
5in Spools	<b>40c</b>	5 1/4in x 1,200ft	<b>\$3.10</b>
5 1/4in Spools	<b>70c</b>	Tape	<b>60c</b>
7in Spools	<b>80c</b>	7in x 1,800ft	<b>\$5.10</b>
2 1/4in x 100ft	<b>60c</b>	Tape	<b>60c</b>
2 1/4in x 300ft	<b>\$1.40</b>	5in Plastic Tape, boxes	<b>60c</b>
Tape	<b>60c</b>	7in Plastic Tape, boxes	<b>90c</b>

Plus postage 20c.  
 See us for Tape Recorder Patch Cords, Adaptors, etc.

### STEREO PLUGS AND JACKS

Metal Plugs	<b>95c</b>	Bakelite ext. sockets	<b>70c</b>
Bakelite	<b>70c</b>	Chassis Jacks	<b>65c</b>

Plus postage 10c.

## MAIL ORDER SPECIALISTS

# LUX AMPLIFIERS ARE UNEQUALLED FOR VALUE, QUALITY AND PERFORMANCE



### THE NEW LUX SQ-1220 SOLID STATE STEREO AMPLIFIER OVER 100 WATTS R.M.S. TOTAL OUTPUT!

The new and outstanding Lux SQ-1220 is rated at over 50 watts R.M.S. into an 8 ohm speaker load. Distortion is so minute it is difficult to measure even at high outputs. 40 transistors and diodes. Frequency response is 10-50,000 Hz.  $\pm 1$  dB. Provision is made for separate bass and treble controls in each channel, low and high filters, frequency selectors and tape monitoring. Ask for complete and unabridged specifications for this sophisticated Lux amplifier. Performance can only be described as superlative. Encel price (including Sales Tax) **\$350**

### EXTRACTS FROM REVIEW OF LUX SQ1220 INTEGRATED AMPLIFIER APPEARING IN "HI FI NEWS" JANUARY, 1969.

"Here, then, is an amplifier of Japanese origin which conforms very closely (on some counts, better!) to the published specifications" . . . "The amplifier was run for several weeks under domestic conditions with a wide range of programme sources, pickup cartridges and speakers and at all times it performed perfectly and without flaw." . . . "Nice to look at, nice to use and very well made and designed. I vote the Lux SQ1220 a top-of-the-class amplifier which, I am sure, will hold its own with the best of the other Class-B designs now available."

### LUX SOLID STATE STEREO AMPLIFIER — THE MODEL SQ-77TW — \$169

Using silicon power transistors the SQ-77TW is rated at 30 watts R.M.S. in each channel with a 4-6 ohm speaker load. Frequency response is 10-50,000 Hz, plus 0, minus 3dB. Input sensitivity is 1.8mV for magnetic pickup or tape head, aux. inputs being rated at 200 mV and 800 mV. Controls include stereo volume, stereo balance, mode switch, treble and bass (separate controls for each channel), input selector, head-phone jack and switch, tape monitor switch, rumble and scratch filter switches, etc. (including Sales Tax) **\$169**

### EXTRACTS FROM REVIEW OF LUX SQ77 AMPLIFIER APPEARING IN "HI FI SOUND" FEBRUARY, 1969.

"Both design and construction reach very high standards of electronic engineering. Some idea of the excellence of the design of the amplifier can be gleaned from the illustrations. It is also note-worthy that the components employed are of good quality and reasonably rated, especially the mains transformer, so normal servicing should not cost much from one year to the next." . . . "After running the amplifier for several weeks in a typical domestic environment with all sorts of signals and sources, and not encountering any troubles or even mere shortcomings on my ordinary dynamic speaker systems of various kinds, I have no hesitation at all in voting this one of the most worthy of amplifiers I have had the pleasure of testing for a long time. For the power that it delivers and the way it is made it is well worth its price."

### LUX MODEL SQ-606 SOLID STATE STEREO AMPLIFIER

Rated at over 20 watts R.M.S. per channel, the handsome new Lux Model SQ-606 is an all-silicon unit with 27 silicon transistors. Power transistors are designed to withstand temporary short circuits and overloading. Overall frequency response is 10-50,000 Hz.  $\pm 1$  dB. Acoustic performance is quite outstanding. Controls and features include volume, balance, mode selector, treble/bass controls, filters, tape monitor, headphone jack, etc. All in all the SQ-606 is a very fine amplifier, attractively priced. **\$219** Inc. sales tax

# ENCCEL

**ELECTRONICS (STEREO) PTY. LTD.**

Head Office:  
 431 Bridge Rd., Richmond, Victoria 3121. Tel. 42 3762.  
 Sydney Store: Ground Floor, 2SM Building,  
 257 Clarence Street, Sydney, N.S.W. 2000. Tel. 29 4563, 29 4564.  
 Australia's Greatest Hi-Fi Centre \*Wholesalers \*Trade-ins accepted







# WHY THROW YOUR MONEY DOWN THE DRAIN! . . . YOU DON'T?

YOU DO IF YOU ARE NOT BUYING ALL YOUR HI-FI AND AUDIO EQUIPMENT AT THE RIGHT PRICES FROM TRUSCOTT ELECTRONICS, WHERE ALL THE LEADING BRAND EQUIPMENT IS AVAILABLE. LISTED BELOW IS SOME OF OUR HUGE STOCK.



Kenwood TK20U

## AMPLIFIERS

Akai — Sound — Monarch — Lux — Fisher — Compax — Kenwood — Pioneer — Trio — Sony — Tempo — Sansui — Leak — Grundig.

## TURNTABLES

Dual — JH — Neat — BSR — PE — Compax — Labcraft — Pioneer — Goldring.



Dual 1009F



Neat G30—Tone Arm

Neat V70—Cartridge

## tone ARMS & CARTRIDGES

Neat — ADC — Ortofon — All Balance — Goldring — Decca — Audio Technica — Dual — Shure — Micro.

## SPEAKERS

Soundmaster — Wharfedale — Tesla — Philips — Rola — Kenwood — Pioneer — Sansui — Akai — Leak.

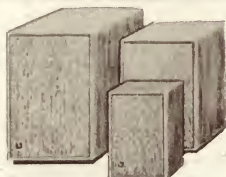

Soundmaster Speaker Systems



Tesla B46

## TAPE RECORDERS & DECKS

Tesla—Akai—Sony — National—Thorn Atlas — Julicorder—BSR—Toshiba—Sanyo—Aiwa — Philips —Grundig — Tandberg — Geloso

## ACCESSORIES

Microphones and Stands — Tape and Spools — Splicing Kits — Record care accessories — Speaker enclosure acoustic cloth and inner baffling — Headphones — Pre-packed leads — Plugs and Connectors — Head cleaning kits — Pillow Phones — Bases and covers, and many others.



## SPEEDY MAIL ORDER SERVICE

When ordering please give your full address printed in BLOCK LETTERS. All Truscott equipment is brand new and fully guaranteed. Sales tax is included in all quoted prices. All orders are despatched promptly. AVAILABLE CASH, TERMS OR LAY-BY. All prices quoted are Net. Postage and freight extra.

### NOTE:

T.M.Q. = Truscott Mail Order Quote.

## COMPONENT PARTS AND ACCESSORIES

Truscotts are stockists of all general electronic components, including resistors, capacitors, plugs and sockets, solder, scope irons and spares, hook-up cables, valves, terminals, tag strips, matrix board, cambric spaghetti, fuses, chassis, grommets, solder lugs, alligator clips, valve sockets, D.I.N. connectors, T.V. Connectors, battery savers, and also a large range of semi conductors for all Japanese makes.

## SPEAKER ENCLOSURE PADDING

Truscotts are the leading South Australian stockists of Innerbond, and Bonded Courtelle. Ensure dust free padding for your speaker enclosure. Send for a T.M.Q.

## STEREO HEADPHONES

Truscotts carry all the leading brand top quality stereo headphones, including Elega, Akai, Sony, Pioneer, Sansui, Ashidavox, Foster, etc. Send for details and a T.M.Q.

## TAPE RECORDER AND HI-FI SERVICE CENTRE

For service on all leading brand Tape Recorders and Hi-Fi equipment—come to the experts. Truscotts modern service centre uses only the finest servicing aids, backed up by fully trained professional technicians.

## SLEEP LEARNING EQUIPMENT

All requirements for sleep learning equipment available, including Pillow Phones at \$4.50—Endless Tapes at \$8.86, and Time Clocks at \$25.00.

## ACOUSTIC SPEAKER CLOTH

Truscotts now carry over 50 top grade cloths to select from. Send now for samples and a T.M.Q.

## SAVE YOUR RECORDS . . . USE THE UNIVERSAL LUSTRE TONE ARM LIFT

This beautifully finished and functional universal tone arm lift will fit all tone arms . . . the lowering action is pneumatically dampened and extremely smooth. Risk of record damage may now be eliminated. Truscotts price only \$8.50.

## TAPE RECORDER BELTS

Belts available to suit most models of Telefunken, Uher, Philips, Cossor, Stella, Grundig, B.S.R., Ferguson, Walter and Korting recorders. When ordering, it is most essential to state the correct make and model of recorder.

## NEAT MAN—THAT'S THE WAY TO ENJOY HI-FI MUSIC

Truscott Electronics are the sole Australian Agents for Neat Hi-Fi Equipment. Available from your local Hi-Fi store or direct from agents.

Listed below are just two of the Neat range of products. Send for specifications, prices and reviews.

Neat G30. Professional Static Balance Tone Arm. A precision built unit, outstanding in appearance and simple to mount and use in any installation. The results obtained are far beyond those usually expected at such an extremely moderate price.

It will accommodate all standard cartridges and the tracking weight is easily adjusted to the particular one in use.

Review from the "Gramophone".

"Notwithstanding the very modest price, the conception, construction and finish of this tone arm are first class, and equal to many arms selling at considerably higher prices."

Neat V70. Moving Magnet Cartridge. The V70 is a top performance, high quality magnetic cartridge, that out performs many more expensive cartridges. When used with the Neat G30 tone arm, an excellent low priced combination can be obtained. Send now for reviews of the G30 and V70, and ask for a T.M.Q.

## SENNHEISER STUDIO MICROPHONES

A full range of these famous Sennheiser Studio Microphones for amateur or professional use are now available. Send now for specifications and a T.M.Q.

## 220S MULTIMETERS

D.C. Volts 5, 25, 125, 500, 2,500.  
A.C. Volts 10, 50, 250, 1,000.  
Current: 250mA, 250mA.  
Resistance: 0-10K, 0.1 Meg.  
Truscotts Price only \$7.95.

## CAR RADIO SPECIAL "SOUNDMASTER 8"

The new super sensitive push button all transistor car radio, featuring 8 trans—3W. output—push button tuning—built-in noise suppression—high quality speaker—suit any car—Truscott price only \$55.00. If aerial required add \$4.00.



# TRUSCOTT ELECTRONICS

AUSTRALIA'S GREATEST TAPE RECORDER & HI-FI CENTRE

62-64 HINDMARSH SQ. ADELAIDE, 5000 Phone: 233024 233278



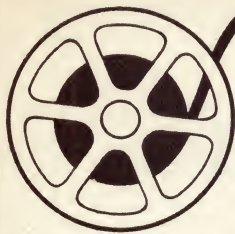

# AUDIO TOPICS



## 7-INCH LABORATORY TEST RECORD

An interesting 7-inch 45rpm test record has just been released by an Australian company. Intended mainly for laboratory use, it will facilitate measurement of distortion, noise, wow and flutter, and transient performance with square waves.

Produced by a company interested primarily in high quality transcription work, it is a mono recording and the figures quoted relate to the mono mode.

However, the record could well find application for stereo testing, representing an accurate and a balanced source of lateral drive for the respective 45-degree generator systems.

For distortion measurement, a 1KHz sine wave is provided, recorded at a velocity of 7cm/S. It is suggested on the jacket that the measurements be done with a 500Hz high-pass filter in circuit to minimise the contribution to "distortion" readings from unrelated sources, notably hum and rumble. This provision will be more of a necessity than an option in many situations, particularly where building rumble is present to add to that from the turntable motor.

Another problem which distortion testing rapidly uncovers is that of wow and flutter. The speed (and pitch) variation from typical players may be considered small enough to be of no consequence with program material but it can be a very different thing, for distortion tests, when the fundamental has to be accurately nulled, leaving only the noise and distortion content to be measured. The more precise the measurement attempted, the more difficult it becomes to achieve a meaningful null in the presence of wow and flutter, which change the frequency of the fundamental.

Where conditions are favourable for the measurement of small orders of distortion, the jacket notes point out that the inherent distortion in the record is low enough to warrant measurement being taken under constant velocity replay conditions, i.e. with the treble de-emphasis and bass boost rendered inoperative. Under these conditions, which will exaggerate greatly distortion and noise content, the manufacturers claim that a good pickup will yield an RMS figure of less than 2% T.H.D. (Total Harmonic Distortion).

For actual measurement of speed variation or frequency modulation effects in the reproducing system, a 3KHz track is provided, to be used in conjunction with a wow and flutter

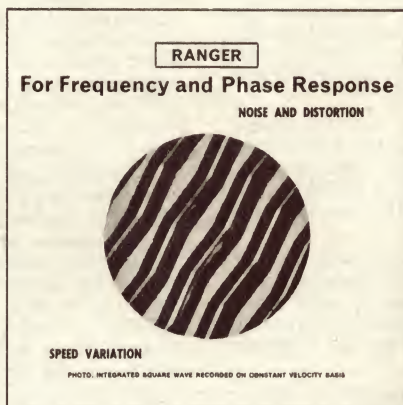

*Traced from the oscilloscope screen, these are transient patterns obtained with a typical high quality magnetic cartridge. At the top is the intended square wave produced by normal replay conditions with RIAA equalisation. Below it is the pattern produced under constant velocity conditions, and no equalisation.*

meter. The makers claim that, when played on a high quality turntable, the record can—and should—yield a figure for wow and flutter not exceeding 0.15%—the specification laid down for professional equipment by the Australian Broadcasting Control Board.

An unmodulated track is provided for noise measurement from all sources. Where it is desired to assess

noise due to stylus/groove contact, it is suggested that the disc be played with a 500Hz high-pass filter in circuit, under which conditions it is claimed that meaningful readings of signal/noise ratio can be obtained in excess of 50dB. For high frequency noise tests, it is again possible to replay under constant velocity conditions and make appropriate allowance for the degree to which noise content, under these conditions, will be exaggerated.

For transient testing, two 1-minute tracks are provided, each of 1KHz square-wave, with an amplitude which corresponds to the 7cm/S velocity used for the sine wave track. The manufacturers claim that the recorded tilt on the square wave is less than 1%, with negligible overshoot. On this basis, any deformation of the square-wave discernible on an oscilloscope, and particularly ringing, is a product of the playback cartridge and the amplifier which follows it.

The manufacturers state that this is one of a very small number of records in which the square wave has been recorded with a true RIAA recording characteristic in operation. It is therefore possible to replay with a pickup and RIAA compensated preamplifier and to observe the reproduced square wave directly on an oscilloscope.

If the track is played with a magnetic pickup without RIAA characteristics and responding on a constant velocity basis, ringing effects are grossly exaggerated and the horizontal portion of the wave is steeply inclined. Such an exaggerated pattern may be useful in comparing the ringing and symmetry characteristics of different cartridges. Effects can show up which would be much less apparent with a square wave of normal configuration.

Designated as Test Record number RRM-002, it is a product of Ranger Recordings, 82 Chelmsford Avenue, Epping, N.S.W., 2121. It is available directly from the above company but can alternatively be obtained from Messrs. George Brown and Co. Pty. Ltd., 267 Clarence Street, Sydney, 2000. The price quoted is \$4.50 plus \$1.13 sales tax. Packing and postage is free within Australia but the second class airmail rate should be added to remittances when delivery outside Australia is required.

According to the manufacturers, the record has created interest among broadcasting authorities throughout the world and many copies have already been sold overseas. ■



## SOUND AND VOICE MAGNIFIERS

BY

RAYMOND EVANS

The magnification of weak signals of a wireless receiver is now well understood. However, the various methods employed all make use of the "valve" as a magnifying medium. The method discussed in this article should prove of interest to experimenters as it utilises methods other than that of the valve in order to effect the necessary magnification.

The terms, sound-magnifier, voice-magnifier, note-magnifier and tone-magnifier, merely apply to the instrument or combination used to magnify or amplify the received audible notes or tones as heard in the telephones, not to amplify the high-frequency currents or oscillations which are above audibility; in simple terms, they are sound magnifiers, or loud speakers. In order that the "valve" may be made to function as a tone-magnifier, it must be connected inductively to the "plate" circuit of the preceding valve receiver, or in place of the phones in a crystal receiver per medium of an audio-frequency or iron-core transformer, as shown in figure 1.

It can readily be seen that this circuit will not magnify the high-frequency currents on account of the high impedance of the iron-core transformer windings, through which these currents would require to pass, but the low-frequency or note currents will pass through readily to the valve, where magnification will take place.

The first type of note-magnifier which will be dealt with in this article is that known as the microphonic relay. In its elementary form, which by the way is quite practicable, it consists of an electro-magnet introduced into the receiver in the position usually occupied by the telephone receivers.

The electro-magnet is arranged so that one or both of its poles are in close proximity to a diaphragm of thin sheet-iron to which is secured on its reverse side, a small button of hard carbon. From this it is obvious that any variation of the field of the electro-magnet due to received currents will have the effect of causing the diaphragm to vibrate. An adjustable screw with a contact-point of steel or hard carbon makes very light contact upon the carbon button on the diaphragm. An auxiliary circuit, including a four to 10 volt battery and telephones, is connected in series across the terminals of the microphonic contacts as shown in figure 2. These microphonic relays certainly do magnify the signals, but, unfortunately, weak signals are not magnified in nearly the same ratio as strong ones, while very weak signals will not magnify at all. The arrangement is so susceptible to ordinary mechanical vibrations that permanent sensitive adjustment is out of the question.

An improved type of microphonic relay developed by S. G. Brown has been used both singly and in cascade with good results. These relays have been so successfully used in the past by many of the Marconi high-power stations, using balanced crystal and Fleming valve receivers, that three or four relays in cascade produced such magnification that signals emanating from distances of from 3,000 to 4,000 miles could frequently be heard at a considerable distance from the telephone receivers.

In construction, the "Brown" relay consists fundamentally of a soft iron core whereon is wound two windings, a fine and a heavy winding, the finer one being wound upon

the ends of the magnet as shown and connected to the receiving circuit in place of the usual telephone receivers. This forms the input circuit of the relay. The heavier winding is connected at one end to a steel reed or vibrating tongue, on which is mounted a contact button of hard carbon. An adjustment screw is provided and fitted with a contact-point of an alloy of iridium and osmium and is poised in such a position by means of the micrometer adjustment, that very delicate contact can be made with the carbon button on the reed. The opposite end of the heavy winding is connected to the telephones, a battery of dry cells and thence to the contact-screw, as shown in figure 4.

This is the output circuit, and, in the case where several relays are used in cascade, the telephones are omitted and in their place the input terminals of the second relay are substituted and so on. The aforementioned micrometer adjustment is obtained by a movement of the knurled nut shown let into the base in figure 3. The "Brown" relay will also magnify voice currents without any appreciable harshness or distortion and considerable use has been made of it in this direction.

Another and perhaps more universally known instrument developed by the same engineer is the "Brown" telephone receiver, a diagram of which is shown in figure 7. This cannot be truthfully classed as a magnifier, but a telephone of considerably higher efficiency than the average, merely on account of its producing a greater volume of sound for a given value of current input. It consists essentially of an ebonite case in which is mounted a horse-shoe magnet (M) of hard steel, with pole-pieces of soft iron, upon which are the bobbins and windings. The resistance of the magnet windings varies, an average value being 750 ohms per receiver, but on account of the more universal use of telephone transformers, low resistances of about 75 ohms are now being used. A small steel reed (R) is placed with one end, as shown, immediately over the ends of the pole-pieces so as to obtain the maximum magnetic influence. This end of the reed is also secured to the centre of a diaphragm (D) of very thin aluminium, which, instead of being flat, is of a conical shape and unlike most receivers does not rest upon the receiver case but a short distance from it, a ring of tissue being cemented around the gap.

Another magnifier of considerable merit, the product of an American engineer, for use both as a magnifier of wireless signals and voice currents, is known commercially as the "Magnavox." This magnifier, which operates upon an electro-dynamic principle, gives out sound in exact proportion to the current put into it; of course, allowing for the efficiency of the electrical design of its windings. Figure 5 will give the reader an idea of the general arrangement of the parts, while figure 6 illustrates the electrical connections necessary for the magnification of weak wireless signals. A magnetic circuit (NS) which is almost closed, is energised by means of current from a local battery (b) passing through its windings. A coil of fine wire is placed centrally in the gap as shown in the magnetic circuit, and is connected to the terminals of the secondary of a small step-down transformer. The coil is secured by means of wax, cement, or shellac, to a diaphragm of mica about 0.002 inch in thickness. A large horn or megaphone is usual-

This article, which appeared originally in "Sea, Land and Air" in 1921, has been reproduced in the "Audio Topics" section of our magazine to give high-fidelity enthusiasts some idea of amplification methods in 1921. When the article was written, audio techniques were still in their infancy, and even the terminology was in some cases not firmly established. For example, the author refers to audio amplifiers

loosely as "loudspeakers," while the various transducers used for converting electrical energy to acoustic energy do not appear to have any generic term. The idea of using valve amplifiers to raise the output from detectors to a high enough level for normal listening was still new, but nevertheless well enough advanced to have laid the foundations for public address systems.



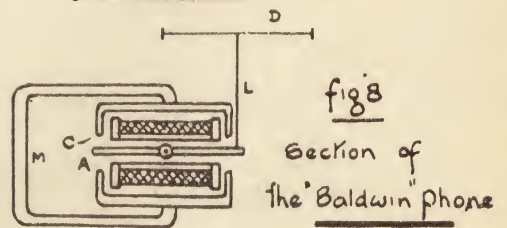
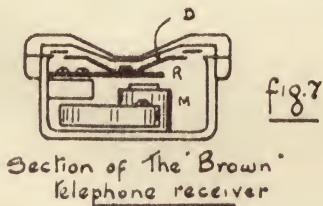
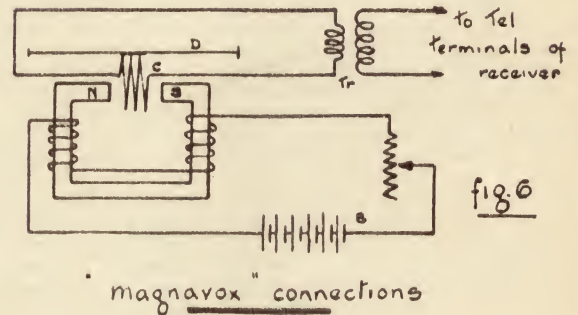
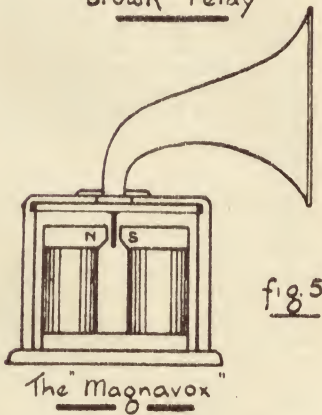
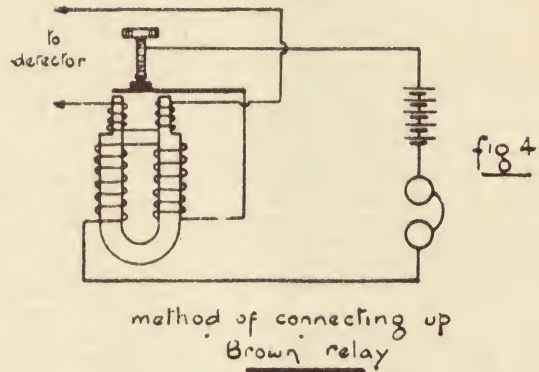
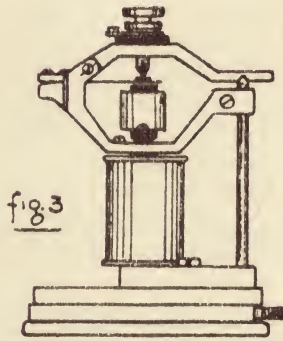
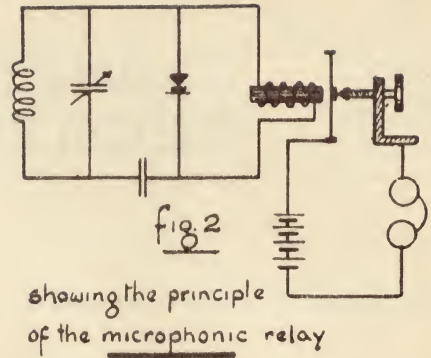
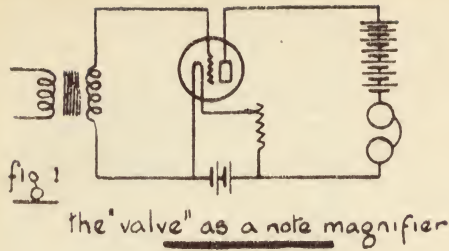

ly placed over the diaphragm and takes the place of the usual uncomfortable ear-pieces.

The "Magnavox" works on the principle that the magnetic field across the gap being constant, whenever a received current from the transformer passes through the windings of the small coil it is either attracted or repelled, depending upon the direction of the pulsating current. The movements of this coil are therefore transferred to the mica diaphragm and in turn converted to sound waves in the horn.

During the development of this apparatus an experimental instrument was placed on the chimney of the laboratory and connected with microphones and a phonograph. On clear evenings, songs and phonograph music, sung and played before the microphones within the building, could be heard by the whole population of the town, approximately 6,000, and on one of these occasions it is claimed

the voice and music were heard eight miles away. The slender tones of a single violin could be distinctly heard a mile away, while a piano solo resembled the chimes of Westminster Abbey played by the Colossus of Rhodes, truly a wonderful achievement. It is claimed, also, in connection with its use as a radio-signal magnifier used in conjunction with a valve amplifier, signals which are just audible can be eventually heard over a mile away, while wireless telephone conversations can be heard by assemblages of thousands of people and wireless music made loud enough to provide dance music for a hall full of dancers.

Added interest will also be given to this piece of apparatus when it is recalled how, last year, H.R.H. the Prince of Wales delivered an address at San Diego, Cal., U.S.A., to an audience of over 10,000 people during which his

(Continued on page 189)



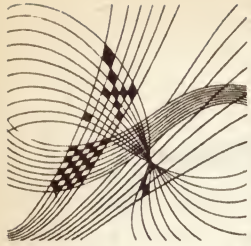

## CLASSICAL RECORDINGS

Reviewed by Julian Russell

**BRITTEN** — Billy Budd (Complete Opera). Peter Glossop (Billy Budd); Peter Pears (Vere); Michael Langdon (Claggart); John Shirley-Quirk (Redburn); Bryan Drake (Flint); David Kelly (Ratcliffe); Gregory Dempsey (Red Whiskers); David Bowman (Donald); Owen Brannigan (Dansker); and others with the Boys from Wandsworth School, the Ambrosian Opera Chorus, and the London Symphony Orchestra conducted by Benjamin Britten. Decca Stereo SET 379/81

I think time will prove "Billy Budd" with "Peter Grimes" to be the most enduring of Britten's operas. The first provides a well nigh perfect example of what Wagner meant when he wrote of "the fertilisation of poetry by music." But let me hasten to add that there, all resemblance between Britten's and Wagner's music ceases. Some great operas have been composed to absurd and sometimes almost incomprehensible librettos but Britten went to E. M. Forster and Eric Crozier, a wise choice, for Budd. "This means that he starts off with a cohesive story condensed out of Hermann Melville's novel and one which, together with Britten's music, makes quite clear the motives of characters which might charitably be described as elusive in the novel."

Basically the story tells of a conflict between good and evil in the Royal Navy during the period of the French Revolution, a navy into which reluctant civilians were impressed into service to exist in appalling conditions on wretched food and in which floggings and executions were common. The Forster-Crozier libretto is truly operatic, offering the composer countless opportunities for sailors' choruses, aria-like soliloquies, and a continuous line of expressive recitative, developed out of the methods of Wagner and the later Verdi works. Indeed Britten's personification of evil, Claggart, even has some moments reminiscent of Iago in Verdi's "Otello."

The original version seems to have proved a little too long for the operatic stage and was condensed for a TV version telecast in England which not only made the work more readily assimilable for the average listener but had the additional merit of restoring its somewhat waning popularity. After a brief comet-like flash through the operatic sky the original work had been put aside for some years after its first performances. And it is the abridged but by no means disfigured version that is used by

Decca in the admirable set under review. And when I add that the recording was produced by the incomparable John Culshaw—it was, I think, his last work in the medium before he joined the B.B.C. last year—you can see that the set had many virtues going for it before even its first bars were recorded.

The cast is an all-male one, which presented serious problems of finding voices of contrasting timbres to avoid monotony—problems brilliantly solved by Decca. Boys singing the parts of midshipmen add treble notes to the men's voices. Britten, too, of course, played an important role in the opera's production as well as conducting the performance. And nothing less than the highest praise is due to both producer and composer for the skill with which they handled so complicated an assignment. The result presents to the mind's ear a perfect picture of this strong, sometimes even repellent drama with its constantly changing moods of lyricism and brutality.

But I had better add here that all the beauties of the score will not be apparent at first hearing, nor perhaps until after many repetitions. But they are there all right, in far too generous a number to be enumerated in the space at my disposal. So I shall content myself by saying that the singing is consistently excellent with great performances contributed by Glossop, Langdon and Pears, mainly by virtue of the importance of their roles, for all the other, minor, parts are admirably filled, too. And to this can be added the superlatively good playing by the London Symphony Orchestra and the sensitive choruses supplied by the Ambrosian singers.

A final word of warning. If your ideal of an opera is "Tosca," "Butterfly" or "Aida" Britten's work is unlikely to appeal to you—at any rate until you have done a great deal of homework on it. But if you are able to appreciate a work at once resilient and finely tensed, full of dramatic conflicts, and with a shattering climax, this will certainly be for you.

★ ★ ★

**BRITTEN** — Les Illuminations (Song Cycle). Peter Pears (tenor) with the English Chamber Orchestra conducted by Benjamin Britten. Variations on a Theme by Frank Bridge. English Chamber Orchestra conducted by Britten. Decca Stereo SXL6316.

The Variations on a Theme of Frank Bridge (like A Young Person's

Guide to the Orchestra) has won for itself firm favouritism with the general public. The Variations were Britten's first important work — it was commissioned by Boyd Neel and achieved almost instant popularity. This is well deserved because even in his early years Britten had shown extraordinary precocity in both composing and scoring. In it Britten transforms Bridge's attractive tune into a March, Romance, Italian Aria, a Bourre, a Viennese Waltz, a Moto Perpetuo, a Funeral March, a Chant, and a Fugue and Finale of impressive dimensions and ingenuity.

The recent work of the English Chamber Orchestra both on records and in the concert hall — they made a tour of Australia under Daniel Barenboim only last April — should by now be well enough known to most of my readers to need little in the way of praise from me. I can write with complete confidence that their playing of the Variations under the composer is far and away the best of the many recordings that have been made of the work dating back even to the days of 78s.

"Les Illuminations" might not be quite so well known to the average record buyer and concert goer. The only other recording I know — and I still have it — was issued many years ago, before stereo, with Peter Pears singing the tenor part with the strings of the New Symphony Orchestra under the late Eugene Goossens on a Decca mono. It was a good performance but the sound is now showing signs of its age. The new issue is in every way superior.

In it you have again the English Chamber Orchestra playing like angels under the direction of the composer's finest interpreter — himself. It is a setting of a string of pearl-like evocative poems by the French poet Rimbaud, which open with a brilliant fanfare and move from one exquisite mood to another through nine separate but conjoined short songs. While I share almost everyone's respect for Pears' technique and musicianship, I am not particularly enamoured of the timbre of his voice, but I found him as attractive in this cycle as in anything he has ever recorded. And, I might add, that his identification with Britten's music has already had time to become legendary. At any rate I enjoyed the whole cycle enormously—Pears included.

★ ★ ★

**PUCCINI** — La Boheme. Complete Opera. Jan Peerce (Rudolfo); Licia Albanese (Mimi); Francesco Valent'no (Marcello); Anne Mc-Knight (Musetta); Nicola Moscona (Colline); George Cehanovsky (Schaunard); Salvatore Baccolini (Benoit and Alcindoro). N.B.C. Symphony Orchestra and Chorus conducted by Arturo Toscanini. RCA Victrola Stereo VICS6019.

This set, now re-issued by RCA on the low-priced Victrola label, was originally recorded at a concert performance in New York in 1946. In its re-issued form it has been recut to simulate stereo and a few extra noises have been put in to give the illusion of an



opera house performance. In addition to these you have Toscanini's own contributions in the form of duplicating the singers' parts from time to time with, to me, irritating results. But if you close your ears to these (admittedly a difficult feat) you will have a typical Toscanini reading, full of forceful drive, tempos a deal faster than is fashionable nowadays, but the whole carried off with the élan that made the Italian conductor so famous. Indeed there are some passages in which he achieves an intensity not achieved since in any subsequent recording I have ever heard — and I include Beecham's superb account with the others. But Puccini does not require such intensity except occasionally and I must confess to a preference for the relaxation that can be enjoyed throughout the famous Beecham set of 1957. However, if, to you, Toscanini is still the unchallenged master in his field I think you will enjoy this recreated version of what must have been a fine performance, vocally and orchestrally.

★ ★ ★

**BONONCINI — Griselda.** Excerpts from the opera edited and prepared for performance by Richard Bonyngé, Lauris Elms (Griselda); Joan Sutherland (Ernesto); Monica Sinclair (Gualtiero); Margréta Elkins (Almirena); Spiro Malas (Rambaldo) with the Ambrosian Singers and the London Philharmonic Orchestra conducted by Richard Bonyngé. Valda Aveling and Geoffrey Parsons (harpsichords) and Jeanne and Marguerite Dolmetsch (recorders). Decca Stereo SET352.

Back in the early and middle 1700s the music of Giovanni Bononcini was thought to be as fine as that of Handel. There was even bitter rivalry between their respective supporters, rivalry that occasionally erupted into something closely resembling violence. Today Handel's immortality is secure while Bononcini's music is for the most part known only to scholars interested in his period. "Griselda" was first performed in 1722 and was warmly acclaimed, mostly, one suspects, by non-Handelians. But that is no reason for it to be dismissed out of hand today as a weak imitation of Handel. Only excerpts of the complete work are offered here, but there is enough good music, and by that I mean melodious as well as efficiently constructed sound, to make it worthy of the attention of all students of early 18th century opera. For instance, some of the vocal numbers are really fine, others quite unpardonably banal. Comparison between the two composers will be inevitable throughout much of the disc but this need not always be to the disparagement of Bononcini.

The outstanding performance comes from Australian contralto Lauris Elms. Her production is immaculately steady and her sense of musicianship finely perceptive. Joan Sutherland, another Australian I have no need to add, offers what has now come to be regarded as a typical performance — rich toned, agile in coloratura, but a little slovenly in phrasing that relies too much on portamentos, and diction

## Even greater trackability with Shures' new series 2 cartridges

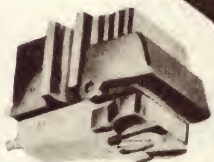

### NEW

#### M75 TYPE 2 HI-TRACK SERIES

Model M75E Type 2. Elliptical stylus. Optimised design parameters for trackability second only to the incomparable V-15 Type II. \$45 (R.R.P.).

**NEW M75G Type 2 Spherical Stylus.** A high trackability cartridge for those people who desire to have a spherical diamond stylus and prefer  $\frac{3}{4}$  to  $1\frac{1}{2}$  grams tracking. \$35 (R.R.P.).

**NEW M75EJ Type 2 Elliptical Stylus.** Ideal for use in upgrading systems with older turntables that track at heavier forces ( $1\frac{1}{2}$  to 3 grams). \$38 (R.R.P.\*).

**NEW M75-6 Type 2 Spherical Stylus.** Specifications and trackability same as M75EJ Type 2 except that M75-6 Type 2 has a spherical diamond stylus. \$29.50 (R.R.P.\*).

### High trackability in a GARD-A-MATIC (R)

The newest members of both the High Trackability and the Gard-A-Matic series. These units combine the advantages of the M75E Type 2 Hi-Track cartridge with the Gard-A-Matic floating cartridge head assembly which prevents the stylus from jumping out of the groove in installations where floor vibration is a problem. All are pre-mounted in shells for ease of installation.



### NEW

FOR DUAL TURNTABLES. Model M75E-D19 Type 2. \$50.00 Model M80E-D19. \$38.00



FOR GARRARD TURNTABLES. Model M75E-95G. Type 2. \$50.00

### Pre-Mounted Cartridges Featuring High Trackability

M75E Type 2 cartridges pre-mounted in slides for instant installation without need for any tools or mechanical aptitude. Take it home, plug it in, and you're in business.

### NEW

FOR DUAL TURNTABLES. Model DU10-M75E Type 2. \$48.00



For more information on Shure products contact:

N.S.W.: Audio Engineers, 342 Kent St., Sydney.

Qld.: Ron Jones Pty. Ltd., 7-9 Merton Rd., Woolloongabba, Brisbane.

W.A.: Athol M. Hill Pty. Ltd., 613-615 Wellington St., Perth.

Vic.: Audio Engineers (Vic.) 2a Hill St., Thornbury. Phone No. 44-3295.

\* RECOMMENDED RESALE PRICE.



# JH A PROMISE

# ADC NEWS ITEM

## Insist on the ORIGINAL J. H. SYNCHRONOUS TURNTABLE



**NOW ONLY \$36.00**

We sincerely assure all dedicated enthusiasts that the original J.H. turntable was brought to a state of elegant perfection only after years of research and development and has not been equalled.

Its apparent simplicity conceals many complexities which our imitators have failed to observe. Consequently the performance of the J.H. turntable is unmatched by any other, regardless of price.

It is compatible with the finest stereo components and we are indeed 'soft pedalling' in promising you that this equipment represents **OUTSTANDING VALUE FOR MONEY!**

Peter Pritchard, President of A.D.C., is the world's foremost designer of pick-up cartridges. He is **always first** and is **first again** with this revolutionary new and imaginative design concept:—



What is it? Three magnetically attached styli are supplied to provide optimum stylus/groove compatibility. It will be no longer necessary to own three cartridges. The price will be \$127.50. **Watch for further news.**

### **MORE GOOD NEWS**

The following reduced retail prices now apply to A.D.C. cartridges:—

A.D.C. 10 E Mk. 2	\$70.00
A.D.C. Point 4E	\$61.50
A.D.C. 550E	\$43.50
A.D.C. 770	\$35.00
A.D.C. 660	\$22.50
A.D.C. 220	\$15.50

Musically gifted people always choose A.D.C. Also A.D.C. cartridges represent the best value per ounce of performance — **NOW MORE THAN EVER!**

## **J. H. REPRODUCERS PTY. LTD.**

**293 HUNTINGDALE ROAD, CHADSTONE, VICTORIA. 3148**  
**TELEPHONE: 277-3066**



which has come under constant adverse criticism for many years and about which Miss Sutherland seems to take no trouble to adjust. One might have hoped that a year taken out to study under any one of many famous coaches would have rectified this fault but there is no news of her taking this step. It is seldom that I have to write that I am disappointed with one of Monica Sinclair's performances but I must do so here. I never imagined so good a singer could turn in so insensitive a performance as you hear in these excerpts. On the other hand, contributions from Margreta Elkins and Spiro Malas, though small, are significantly good.

Richard Bonyng's stature as a conductor of eighteenth century and early nineteenth century music grows with every recording of his one hears. He is at the very top of his form here, keeping his orchestra alert, spirited and unflinching musical throughout.

★ ★ ★

**PROKOFIEFF** — Classical Symphony in D Major, Op. 25.

**BIZET** — Symphony No. 1 in C Major. New York Philharmonic Orchestra conducted by Leonard Bernstein. CBS Stereo 235292.

It is difficult to fault the well-drilled playing of both these symphonies except on the grounds of slightly heavy-handed treatment of works presented just a shade too seriously. The Prokofieff is essentially a miniature work, its neo-classicism responding gratefully to its good-natured mood of parody. Bernstein, despite a second movement outstanding for the delicacy of its pianissimos and a Finale that fairly rushes along with exhilarating accuracy, tends to take most of the work with deadpan seriousness.

The same might be said of the Bizet, which has all the same virtues and minor faults. The very best performance of this work I have heard recorded was the Beecham, which had a relaxed elegance I found altogether enchanting. Bernstein's is magnificently disciplined and full of vitality, but also suffers, ever so slightly, from a too serious-minded approach.

★ ★ ★

**DREYFUS** — Symphony No. 1. Melbourne Symphony Orchestra conducted by Ladislav Slovak.

**SCULTHORPE** — Sun Music III (Anniversary Music). Sydney Symphony Orchestra conducted by Sir Bernard Heinze.

**CUGLEY**—Prelude for Orchestra. Pan the Lake, Sydney Symphony Orchestra conducted by Joseph Post. EMI Stereo OASD7547.

Among the many Australian composers nowadays receiving a fair share of public attention, at any rate in Australia, George Dreyfus stands out as far and away the wittiest and most easily digested. True his music always displays without embarrassment his allegiances particularly to the French school of the years between the two world wars. His First Symphony is nearly always beguilingly tuneful and his characteristic references to styles other than his own are frequent enough to be enjoyed as parodies. His

scoring is unremittingly colourful. One feels that, unlike many of his contemporary Australian colleagues, Dreyfus knows exactly what every note will sound like when he sets it down. But it is in the second movement that Dreyfus shows that he is capable of writing what is probably the most moving slow movement to ever come from an Australian pen. Its falling cadences carry eloquent messages of despair, try to establish renewed hope but finish by achieving only resignation. The music speaks directly to both mind and heart. The Finale is a set of variations on what one would have thought to be an almost impossible theme to be treated in this form. True it diverges widely from the original, so widely that many might find it difficult to recognise any relationship. But further examination will reveal a deftly constructed set of variations much more closely related than they might have sounded at first hearing. I found the whole a most attractive work. It is played with reasonable efficiency by the Melbourne Symphony Orchestra under Ladislav Slovak.

The Sculthorpe piece should also offer immediate enjoyment even to those who are not necessarily avant garde enthusiasts. Its melodic structure and instrumentation are strongly influenced by Indonesian gamelan music, are decorated sometimes with chinoiserie reminiscent of Ravel's "Laidronette" in the "Mother Goose" Suite, and realised with a sensitive appreciation of the work's dreamlike qualities by Sir Bernard Heinze and the Sydney Symphony Orchestra.

Ian Cugley's two brief pieces show the influence of Sculthorpe, under whom Cugley studied for some time. But they were composed before the composer had reached the age of 20, and his more recent works, none of which I have heard, might have a more personal statement to make. They are ably conducted by Joseph Post directing the Sydney Symphony.

The items played by the Sydney Symphony, which were recorded in the Sydney studios of the A.B.C., are very much better engineered than the Melbourne Orchestra's performance for which the A.B.C.'s Melbourne studio was used.

★ ★ ★

**SCHUBERT** — Piano Quintet in A major, Op. 114. ("The Trout"). Ingrid Haebler (piano); Arthur Grumiaux (violin); Georges Janzer (viola) Eva Czako (cello); Jacques Cazauran (double-bass). Philips Stereo SAL 3621.

There have been many fine recordings of the "Trout" among which my favourite for some time has been the Curzon-Vienna Octet for Decca. But this new version has made me change my allegiance and I am of the opinion that it is now the best available. True it has not the Viennese genialty of the Decca, but it scores in two major features—the blending of the piano with the strings, always a tricky engineering enterprise, and in the modesty of the leader who makes way without fuss for important contributions by his colleagues. Mind you, I don't think the margin is as great as you might infer from my remarks. And it is

possible that you might even find the gemutlichkeit of the Viennese performance more to your taste than the slightly more classical playing on the new Philips. There is, however, one final comment I think it only fair to make. The Philips is issued on a top price label. The Decca is now available on that company's lower priced Ace of Clubs and this might make your ultimate preference a matter of economy.

★ ★ ★

**TCHAIKOVSKY**—Piano Concerto in B Flat Minor, Op. 23.

**GRIEG**—Piano Concerto in A Minor, Op. 16. Nelson Freire (piano) with the Munich Philharmonic Orchestra conducted by Rudolf Kempe. CBS Stereo SBE235299.

Here are performances of two old war horses that frankly dazzled me by their spontaneity and freshness. When this is coupled with a flawless technique displayed here by this young, and to me new, pianist, the disc makes a very attractive issue indeed. I particularly liked his "big" reading of the Grieg which reminded me of the late Julius Katchen's with Charles Mackeras in Sydney a few years ago. By the way, Katchen, whom I not only admired, but liked very much personally, died in Paris at the end of April at the ridiculously wasteful age of 42. Like Katchen, Friere avoids mimmatisation of the music of the kind that must have prompted Debussy to describe it pejoratively as "snow wrapped in pink paper." Friere's reading, though

## EKCO-STYLUS

### DIAMOND and SAPPHIRE

### RADIOGRAM NEEDLES

- Of all the Needles you will be offered,
- EKCO - STYLUS is the only needle which will give paramount satisfaction from your 'gram.'
- The best 'gram is only as good as the needle you use.
- Why not bring your existing needle to our Needle Clinic for FREE and honest examination?

EKCO - STYLUS available all good stores.

Enquiries:

**ERNEST KUENZLI**  
PTY. LTD.

60 HUNTER ST., SYDNEY  
N.S.W. 2000  
Phone 221-2899



## ARROW ANNOUNCES

# 3 NEW SPEAKER SYSTEMS FROM **W** ENGLAND

WHARFEDALE

The most respected and sought-after speakers in the world. Illustrated are the all-new "ROSEDALE," "DOVEDALE III" and "MELTON" systems.



The "DOVEDALE III" . . . a 3-way system with 12in. Woofer, very smooth performance over the range, 40 to 20,000Hz. Modern cabinet style in Teak or Walnut finish. 25w Power Handling. Size 24in. x 14in. x 12in.  
List Price (tentative) \$175.30 each.

The "ROSEDALE," a 3-way system with 15in. Woofer second only to the mighty "AIREDALE". Beautiful period style cabinet, 35Hz to 20,000Hz without colouration, 25w power handling capacity, size 24in. x 23in. x 13½in.

List price \$284.00 each  
Walnut or Teak finish.

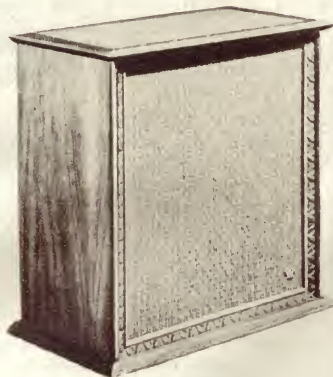

THE "MELTON" . . . a 2-way system with 12in. Woofer and power handling of 20 Watts. Handsome styled in oiled Teak, or Walnut veneers, extremely smooth response from 45Hz to 17,000-Hz. Small but with big sound. Size 21in. x 13in. x 10½in.

List Price \$130.50 each  
Completing the "WHARFEDALE" range is the famous "AIREDALE" 3-way system, the "SUPER LINTON" and "DENTON" 2-way systems. If you want the best in speakers you can't go past the tried, tested and proven "WHARFEDALE" range. Phone, write, or call NOW for details and your special "ARROW QUOTE" on any model mentioned above.



**AE** **ARROW ELECTRONICS** **342 Kent St.**  
**SYDNEY**  
**NOW AT 29-6731**

Opposite 2UW between KING & MARKET Sts.

big in structure, is always lyrical, his touch poetic, his runs unflatteringly fluent.

Altogether a memorable performance with a notable contribution from the Munich Philharmonic — an orchestra which, on the evidence provided here, might profitably receive more attention from the recording companies.

I found the Tchaikovsky equally attractive in a different way. In this Friere's style is much more extroverted in a display of blazing virtuosity and the kind of elan that I thought was displayed in this work only on the old recording made many years ago by Cherkassy. Needless to say, the new CBS improves vastly on the sound of its earlier rival. Indeed there is only one qualification I can make about the new issue. The surface of my pressing was not as clean as it might be — a most unusual shortcoming in anything coming from CBS.

★ ★ ★

**RODRIGO** — Fantasia Para un Gentilhombre.

**DODGSON** — Concerto for Guitar and Chamber Orchestra. John Williams (guitar) and the English Chamber Orchestra conducted by Charles Grove. CBS Stereo SBR235285.

The classical guitar, which has grown enormously in popularity during recent years, still suffers from the lack of a distinguished literature. How many recitals on the instrument finish their second half with transcriptions of Bach and other composers for keyboard instruments simply from lack of anything more suitable to include? However, Williams offers here a new work by Stephen Dodgson which, while very light-weight, has at least the merit of novelty. The Rodrigo, though better-known, is also on the flimsy side. But Williams' playing of both should make this disc attractive not only to guitar buffs, but even to those somewhat less fanatical about the instrument. Charles Grove's handling of the accompaniments to both works is very impressive indeed, and he has the benefit of so responsive an instrument as the English Chamber Orchestra under his direction to supply them.

★ ★ ★

**MAHLER** — Des Knaben Wunderhorn (Song Cycle). Christa Ludwig (mezzo-soprano); Walter Berry (bass-baritone); Leonard Bernstein (piano). CBS Stereo SBR235300.

This beautiful song cycle is usually heard with an orchestral accompaniment and I find it inexplicable that Bernstein substitutes a piano instead. His playing of the accompaniments hasn't even the benefit of spectacular merit and understanding of the music in this form. To put it bluntly, I found Bernstein's contribution very disappointing indeed. Both Ludwig and Berry, while they have their fine moments, do not offer on the whole a completely satisfactory account of the songs, though they admittedly reach true perfection in many. Another shortcoming of the production is in the engineering. The recital was recorded live in the Vienna Konzerthaus, a reverberant hall whose acoustics sometimes obscures some important quiet detail.



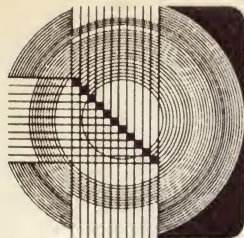

## DOCUMENTARY RECORDINGS

Reviewed by Glen Menzies

**WILFRED OWEN (1893-1918).** Poems and Letters. Read by Richard Johnson, Tony Church and Frank Duncan. Edited by Frederick Woods and directed by Harley J. Usill. Argo Mono LP RG593.

Before commenting on this album I should like to quote these words from the preface to the collected poems of Wilfred Owen by his fellow poet Edmund Blunden: "He was, apart from Siegfried Sassoon, the greatest of the English war poets. But the term "war poets" is rather convenient than accurate. Wilfred Owen was a poet without classifications of war and peace. Had he lived, his humanity would have continued to encounter great and moving themes, the painful sometimes, sometimes the beautiful, and his art would have matched his vision"

Those words were written in 1931 and they are more than ever confirmed by the high esteem that Wilfred Owen's poetry enjoys today. Not a little of this must stem from the genius shown by Benjamin Britten in selecting several of Owen's finest poems for use in his moving "War Requiem," first performed at Coventry in 1962.

The finest poems, written in the trenches during the first world war, have transcended this original time and place and speak out just as eloquently to today's audiences. His death at 25, only seven days before the 1918 Armistice, during the course of a futile action, was a tragedy not only because it symbolised the deaths of so many young men at the Western Front, but also because he would have undoubtedly gone on to greater things.

This album pays eloquent tribute to the young poet with excerpts from letters written to his mother which contained subject matter later developed into magnificent poetry.

The life and writings of Wilfred Owen are pointed up further with passages from Harold Owen's biography of his brother. These are read by Tony Church, and Frank Duncan reads from a letter written by Siegfried Sassoon. The main burden of the reading; however falls on Richard Johnson, and his is indeed a wonderful performance, capturing every nuance of the poems and letters. It culminates at the end of side 2 with what must be the definitive reading of "Strange Meeting" capturing to perfection the nobility, tenderness and compassion of this most moving of all Wilfred Owens' poems.

By now we have come to expect outstanding productions of the spoken word from Argo, but in this album even they have excelled themselves.

**WALT DISNEY'S STORY OF LITTLE HIAWATHA.** Disneyland 33-1/3 7inch LP LLP330.

**WALT DISNEY'S STORY OF BABES IN TOYLAND.** Disneyland 33-1/3 7inch LP LLP329.

**THE STORY AND SONGS FROM BABES IN TOYLAND.** Featuring the Hanky Pank Players, Cricketone Chorus and Orchestra. Cricket (Pickwick Records, New York) 12inch LP CR42.

**STOP! LOOK! LISTEN! A Road Safety Story for Children.** Ailsa Martin, Merv. Smith as "Fortescue Frog" and The Little Folksingers of Mt. Roskill. Children's Record Guild, released through The World Record Club. 45 EP JD29.

The Disneyland records for the younger children are most attractively presented with 24-page books in large print with illustration on every page. As the cover suggests; see the pictures, hear the record, read the book. The young listeners can see and read every word, altogether an entertaining way for new readers to improve their reading ability.

These are just 2 out of 33 stories available in this format with the story on side 1 and songs on the reverse. I question the latter as it seems to be a rather lazy way out. Far better that the songs be integrated with the story where they make more sense.

Knowing the kind of treatment these little records may get around nursery and rumpus room floors I think that a stouter sleeve should have been provided to protect them. At present the

books are sold with the record inserted in a loose pocket inside the rather flimsy back cover.

The two "Babes in Toyland" albums have one peculiarity in common — neither gives any credit to the composer, Victor Herbert, who, in 1903, had one of his greatest successes with this unique musical.

The 12inch LP album on the Cricket label is a sumptuous presentation with an excellent narrator and lots of dialogue. So much so in fact that it makes one wonder why someone doesn't do a full scale revival of the musical with its journey through the Giant Spider Forest and eventual arrival at Toytown, peopled with fairy tale characters and toys that come to life. There's a science fiction angle too with the wonderful Thinking Machine which makes toys at the press of a switch. In this part of the musical the lines have been suitably updated to include references to TV, transistors, etc.

This is by no means a new release but the whole production is so polished that it is well worth seeking out. It is certainly a firm favourite with my own children. The recorded sound has warmth and clarity and the whole company act and sing with obvious enthusiasm.

"Stop! Look! Listen!", with its road safety message, originated in Auckland, New Zealand. Its main aim is to teach some of the fundamentals of road safety in a simple but enjoyable way with just a little gentle persuasion; some humour and a catchy song in which the listeners are encouraged to sing-along. Fortescue Frog is created by the Auckland radio personality Merv. Smith, who makes some of his main points about road safety by taking a group of children for a walk. Sound effects of traffic in the streets help to add to the atmosphere.

The idea for a record of this kind was a good one, and in this production the vital subject of road safety is well presented without being too obvious. ■

## WANTED

STATE DISTRIBUTORS  
FOR COLTON STYLI  
AND ACCESSORIES  
MOST STATES AVAILABLE

Contact:—

**Leroya Industries PTY. LTD.**

266 HAY STREET, SUBIACO. W.A. 6008



# TUDOR RADIO

L. E. CHAPMAN  
ESTABLISHED 1940

103 ENMORE ROAD, ENMORE, N.S.W.

PHONE 51-1011

PHONE 51-1011

Knobs long shaft, push on. Dozen \$1.20  
Knobs for concentric shaft. Dozen \$1.20  
250 mixed screws. BA, Whit., self-tapper  
bolts, nuts, etc. \$1 bag plus 25c post.  
Crystal microphones, good quality, ideal  
tape recorders, etc. \$2.80.  
Transistor speaker transformers, single  
ended, 5 watt. \$1.50.  
Pick up shielded Wire—15 cents yard.

## SPEAKERS

MSP 8-inch dual cone . . . . . \$6.50  
MSP 12-inch dual cone . . . . . \$7.50  
MSP 7 x 5 15 ohm . . . . . \$3.50  
MSP 3½-inch 3 ohm . . . . . \$2.00  
Rola 6 x 4 15 ohm . . . . . \$3.00  
Rola 5 x 3 15 or 27 ohm . . . . . \$2.00  
Rola 5B 3 ohm . . . . . \$2.00  
MSP 6 x 9 15 ohm . . . . . \$5.00  
3-inch single cone 15 ohm . . . . . \$4.20  
6 x 4 33 ohm . . . . . \$3.00  
MSP 20 Watt . . . . . \$19.75  
MSP 12-inch 8 ohm . . . . . \$8.50  
MSP 2-inch 15 ohm . . . . . \$2.00  
MSP 8-inch dual cone, 8 ohm . . . . . \$6.50  
MSP 12-inch 3.5 ohm . . . . . \$6.00  
MSP 4-inch large magnet 8 ohm . . . . . \$2.50  
MSP 3-inch 150 ohm . . . . . \$3.00  
National 8-inch built-in tweeter  
and crossover network . . . . . \$14.75  
MSP Electro Dynamic, 8in, \$4, or 6 x 9.  
MSP 6 x 2 15 ohm, \$3.  
MSP 6 x 4 15 ohm \$3.50.  
Peak 607 16cm Hi-Fi  
Dual Tone 6in . . . . . \$7.50  
MSP 20watt radial beam 12pqb \$21.50  
Magnavox 8 ohm 4in tweeter . . . . . \$2.50  
2 gang tuning condenser . . . . . \$1.00



**RADIOGRAM CHASSIS** 4 valve including valves and speaker, \$15.50. Size 10½ x 3 x 5.



## SMALL 2-GANG TUNING CONDENSERS

Complete with direct drive scale. \$1.75

TV IF STRIPS . . . . . \$5 each.

ENGLISH PANEL LAMP with toggle switch 75 cents.

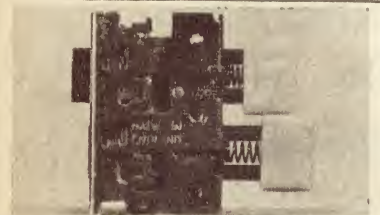

English push-button on/off switches, 75c each. Pack and post 10c.

Vinyl insulating tubing, 13MM wall thickness .030, 25 yards . . \$1  
Mini cable, 4 strand shielded, lots of uses, including microphone cable, extension speakers etc. . . . . 10c yard  
Radio knobs, push on . . . . . 50c doz.

Miniature valve sockets 7 and 9 pin 15 cents each.  
Speaker Crossover net work Condensers 2 MFD — 60 cents.  
Philips IFT's 455KC . . . . . 75c each  
Aerial and oscillator coils . . . . . 50c each  
Scope soldering iron, standard; mini scope. Scope De Luxe. Vibra scope; National scope transformer.

Transistor IFs, medium size, 75c each  
Record Changers, Garrard 3000. \$35

RECORD CHANGERS, B.S.R. UA70. \$45.00.

PORTABLE RADIOGRAM CASES. NEW, SHOPSOILED . . . . . \$4  
Pack and Post, 50 cents.

Transistor speaker and drive transformers, large and midget type . . \$1.00  
Speaker transformers 15,000 and 25,000 to 3 ohms 6 watts . . . \$1.50 each  
5,000 to 3 and 15 ohms . . \$1.25 each  
Transistor speaker chokes . . \$1.50 each  
Here's value in pots.

Pots, single log and linear:  
3K, 7½K, 10K, W.W., 20K, 25K, 50K, 100K, 200K, 250K, 500K, 1 Meg, 2 Meg. Dual Concentric Switch Pot \$1.25

Pots 25,000 dual gauged switch pots, 1.5 Meg. Dual Concentric . . \$1.00

Pots dual ganged 10K, 50c. 1 Meg. \$1.25

Pots concentric. 100K + 50K, 100K + 2½K, 100K + 10K, 250K + 250K, 500K + 500K, 1 Meg + 1 Meg., 1 Meg. + 500K. Various others 2 Meg . . . . . 50c each

TV power Transformers 300 mill 225v a side, suit amplifiers up to 50 watts voltage doublers available, \$8.00 each

TV safety glass per sheet . . \$3.50

Garrard plug in stereo heads . . \$4.00

TV masks, 17, 21, 23in . . . \$1.50 each

Tuning condensers 2 and 3 gang, \$1.00



## STEREO AMPLIFIER KIT SETS

TU 10, 3.5 watt per channel . . \$19

TU 11, 3.5 watt per channel, has facilities for tape and microphone channels . . . . . \$23

TU 12, 5 watt per channel . . . \$22.00

TU 13, 5 watt per channel, with TU 11 facilities . . . . . \$27

Each kit set includes valves and all components. Front face plate, if required, \$1 extra.

Single stage amplifier kit set:

5 watt per channel . . . . . \$22.00

Transistor ear plugs . . . 3 for \$1.00

Tag strips, mixed types . . Dozen, 60c

Switches, oak 4 position . . 50c each

2 position . . . . . 40c each

½ and ¼ AMP. FUSES \$3.50 100.

Din Plugs, 3 or 5 pin . . . . . 50c each.

Ceiling Speaker Baffle, suit 5in or 6in Speaker . . . . . \$2.50

Utilux H168 Double contact Holders . . . . . 20c each

Elip Sal. 2-pin, 10 amp, 240 volt plug sockets . . . . . 25c each

## ELECTROS:

3 in one  
50 250 415  
8 350 415  
10 350 415  
75 cents each.

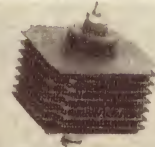

Metal Rectifier . . . . . \$1 each

## TV AERIALS

Famous Make

All types \$3.50 to \$20.00 plus post.  
TV aerial lead in . . . . . 10c yard  
Tuning Condensers, 2 gang or 3 gang —\$1 each.

2 amp fuses . . . . . \$3.50 per 100  
Special, 12in speaker, 2 ohm Rola, \$6.00 pack and post, 75c.

Transistor plastic outer case, 50c each

Transistor carrying straps . . 20c each

Stereo pick-up arms, with Xtal, \$6.00 ea.

Metal rectifiers for battery and electric portables . . . . . 50c each, post. 10c

Pilot lamp holders . . . . . 60c per doz.

TV or cabinet castors . . . . 4 for \$1.00

100 Mixed Knobs including TV channel changers . . . . . \$10.00

240v AC Record Changers, stereo \$21.50, Mono \$20.00. Pack and post, N.S.W. \$1.50, interstate \$2.50.

Gramophone motor and pick-up, 240v AC \$11.50. Pack and post, N.S.W. \$1.00, interstate \$1.50.

OA 70 diodes . . . . . 40c each

Morganite and IRC resistors. At least 33 values. Suit transistors, radios, TV, etc., \$2.00 per 100. Pack and post, 25c.

3, 5, and 10 Watt IRC wire wound resistors. Many values.

20c each, 12 for \$2.00

100 mixed condensers, micas, ceramics, tubular. Fresh stock.

50 + 24, 350 vw + 100 mf 25vw, 75c each

30, 30mf 300 vw 350vp . . 75c each

Many others. Invaluable for service.

SHEPHERD CASTORS, \$3.00 set of 4.

SMALL AMPLIFIER OR TUNER CHASSIS, \$1.50 each. Pack and post 25c.

ALPHA 200VAC ¼ amp push-on switches, 30c each. Ideal for fridges.

90 deg. PICTURE TUBE SOCKETS 25c each. 152 valve sockets, 25c each.

Transistors AC127, 2N384, 2N217, 2N218, OC71, OC75.

\$1.00 each. Post and pack 5c.

THREE WATT AMPLIFIERS, complete with speaker.

NEW. \$10.00

Electron 1.8 x 0 9 MF — 20c each

AUDIO TRANSFORMERS

18-4294, 28-4536 . . . . . 75 cents each.

PILOT LIGHTS, Plug in . . 10 cents

SWITCH WAFERS

20 Cents each.

R.C.A. plastic Tape Reels, 7 inch type EPR-7 — 85 cents each.

NEW GRAMOPHONE MOTORS, For 4-speed Turntables . . \$2.50 each.

NEW VALVES

12AU7 . . \$1.25

6SA7 . . . \$1.25

6BU8 . . . \$1.25

6M5 . . . . \$1.25

6BM8 . . . \$1.50

1S5 . . . . \$1.00

1T4 . . . . .50

6CJ6 . . . \$1.50

6L8 . . . . \$1.00

ECL85 . . . \$1.25

SP61 . . . . \$1.00

UU9 . . . . \$1.00

12BE6 . . . \$1.00

6AU4 . . . \$1.25

6U9 . . . . \$1.25

6Y9 . . . . \$1.25

6X9 . . . . \$1.25

6BM8 . . . \$1.50

6AQ5 . . . \$1.25

1B3 . . . . \$1.50

1T4 . . . . .50

1S2 . . . . \$1.50

5AS4 . . . \$1.25

6DQ6 . . . \$1.50

12AT7 . . \$1.25

12AX7 . . \$1.75

6B8 . . . . \$1.25





TV IF Coils, ideal for Coil Formers  
..... \$1 dozen.



**SPEAKER CABINETS**

- 13 x 6 1/2 ..... \$5.00
- 10 x 6 1/2 x 4 1/2 ..... \$3.50
- 12 1/2 x 8 1/2 x 6 ..... \$5.00

Dial drums 5 inch, 3 1/2, 3 3/4 .. 50c each

National speakers 8 inch built-in  
Tweeter, Crossover net work. \$14.75  
10 inch Bass, mid range  
Tweeter combined. \$32

Fuse holders ..... 50 cents doz.  
Octal valve sockets ..... 50 cents dozen  
Chokes 18 Henry 30 mil. .... \$1.50

ELECTROS 20 MFD 200 PV — 20c

RESIN CORE SOLDER 5 yards 75c

M.S.P. 6in SPEAKERS, 3 or  
15ohm ..... \$4.00

6 VOLT PILOT LIGHT, screw-  
in ..... ea. 10c

TRANSISTOR speaker and Case Plastic  
5-inch speaker with plug and lead, \$4  
each, Pack and Post 25 cents.



Stereo Head Phones, good quality —  
\$9.75.



TV Portable voltage doubler power  
trans. C. Core. 240 volt 77V 1 amp. 6.3  
Volts 8 amps, \$6.



TV POWER TRANSFORMER, \$8.  
300 mil. Two 6.3 windings. 200 volt sec-  
ondary for Bridge Type Rectifier.



AMPLIFIER, 3-watt, complete with  
speaker. Size 10 1/2 x 3 x 5. \$11.  
Pack and post, 75c.



VOLTAGE DOUBLER POWER  
TRANSFORMER. 200 mil 240 volt x  
105-110 secondary 6. 3V 15 amp. \$8.



BATTERY SAVER. 6 or 9 volt DC  
100MA, \$8.50; 300 MA, \$100.



SPEAKER ENCLOSURE, complete  
with 8in M.S.P. dual-cone speaker,  
8 or 15 ohm, \$15.80.  
Cabinet without speaker, \$10.  
Cabinet size 16 x 10 x 8.



TRANSISTOR IN EXTENSION  
SPEAKER. 5in cabinet, \$3.50.

Tape Spools and Cassettes, American  
Tapes, 7/1800 — \$4.40.  
R.C.C. 5 1/2 1800 — \$5.60.  
R.C.A. 5 1/2 1200 — \$5.25.  
R.C.A. 5 1/2 900J — \$2.80.  
HANIMEX 3/225 — \$1.20.  
HANIMEX C60 Cassettes — \$3.40.  
HANIMEX C90 Cassettes — \$4.75.

BASF 5/900 — \$6.14.  
SONY 7/1200 — \$3.25.  
BASF 5 1/2 2400 — \$12.45.

NEW RADIOGRAM, chassis, mono,  
complete, valves, speaker .. \$13.50

**POTS**

- 1 meg. Dual Ganged Log. . . . \$1.25
- 1 meg. Dual Ganged Lin. . . . \$1.25
- 1/2 meg. Switch Pot double pole  
log . . . . . 75c
- 2 meg. Lin. Pots . . . . . 50c



Stereo radiogram chassis, new .. \$25.00

STEREO SPEAKER LEAD, 8 Cents yd.

GARRARD MAGAZINE TAPE DECK  
1/2 Per Second, 2 Track, Left to Right  
\$25.



Speaker box unpolished suit 8 inch  
speaker \$3.75. Pack and post 50 cents.

2N 1108, 2N 1110, 2N 1111, Transistors  
50 Cents each.



RCA VIBRATING CAPACITOR.  
98601 .. 2c

Dial scales, 5in 1 1/2 x 6, 10 1/2, 3 1/2,  
9 1/2 x 1/4 .. 50c

Pots 50 ohm switch, .... 50 cents each.

American or Japanese 2 pin power plugs  
rubber complete with 2 1/2 yards flex 50  
cents, Pack and post 10 cents.

Microphones magnetic or crystal \$1.75.  
Pack and post 10 cents.

Speaker Cabinet, 16 x 10 x 8, complete  
with 6 inch MSP dual cone Speaker  
tweeter, 3 inch and Crossover net  
work — \$18.75.

Magnavox 8 WR, 10 WR,  
12 WR. Tweeter 3, 4 or 5 inch

Speaker Plugs, 4 pin ..... 15 cents  
Speaker Sockets ..... 15 cents

PUSH PULL AUDIO TRANSFORM-  
ERS 10,000 CT 3.5 ohm .. \$3.00 each

STEREO HEADPHONES, \$10 pair.  
Pack and post 25 cents.

TRANSISTOR DRIVE and OUTPUT  
TRANSFORMER 23 to 15 ohm. 75  
cents a pair.

MSP 6 inch dual  
cone — \$5.50 each.  
M.P.S. 3 inch.  
tweeter — \$3.75.

Mullard Bookshelf Speaker Cabinets  
\$10 each.

STEREOGRAM CHASSIS, 5 watt per  
channel, complete except speakers.  
\$35

NEW POSTAGE RATES  
PLEASE ADD EXTRA



# Quality Components from Danish Hi-Fi Pty. Ltd.



## PEERLESS SPEAKERS

Outstanding clarity of reproduction with low distortion is assured if you fit the Peerless special High Fidelity model speakers. We have the following models in stock

MODEL	SIZE	FREQUENCY RANGE	WATTS RMS	IMPEDANCE	PRICE
DUAL CONE					
610 FM	6½ X 10½	30-15000	5	4, 8	\$ 12.05
O 825 FM	8½	50-16000	5	8	11.67
P 825 FM	8½	45-16000	10	4, 8	19.70
P 100 FM	10	40-16000	10	4, 8	22.03
D 100 FM	10	40-14000	12	4, 8	30.34
P 120 FM	12	40-16000	10	4, 8	23.37
D 120 FM	12	35-14000	12	8	30.96
COAXIAL					
825-20	8½	30-18000	12	4, 8	35.09
100-20	10	30-18000	12	4, 8	36.29
D 100-25	10	25-18000	15	4, 8	43.32
120-50	12	40-15000	8	4, 8	33.61
120-2-	12	25-18000	12	8	47.00
BASS GUITAR					
D 120 WL	12	3000	25	8, 16	36.23
WOOFERS					
L 825 WG	8½	2500	50	4, 8	19.48
L 100 WG	10	2500	50	4, 8	20.83
O 525 WL	5½	5000	10	8	14.68
B 65 W	6½	4000	8	4, 8	10.00
610 W	6½ X 10½	4000	8	4, 8	10.69
P 825 W	8½	4000	12	8	17.81
D 825 WL	8½	4000	20	8	33.45
D 100 W	10	3000	15	8, 16	29.31
CM 120 W	12	4000	12	4, 8, 16	21.43
A 120 W	12	3000	15	8	75.82
D 150 WL	15	2000	50	4, 8	56.02
C 150 W	15	2000	25	8	159.19
MID-RANGE					
GT 50 MRC	5	800-7000	3	8	6.88
G 50 MRC	5	750-6000	5	4, 8	10.69
B 65 MRC	6½	650-6000	5	8, 16	11.06
O 570 MRC	5 X 7	250-4500	20	4, 8	19.13
O 825 MRC	8½	550-4500	8	8	12.42
TWEETERS					
MT 20 HFC	2 X 2	3000-18000	1	4, 8, 16	6.39
MT 225 HFC	2½ X 2½	1500-20000	5	4, 8	6.49
MT 25 HFC	2½ X 2½	2000-18000	1½	4, 8, 16	6.43
KITS					
2-8		50-18000	8	8	21.72
2-10		50-18000	10	8	32.43
2-20		40-20000	20	4	37.82
2-40		30-20000	40	4	39.64
3-25		40-18000	25	8, 16	61.53
4-50		40-20000	50	4	122.15

Mail orders dealt with promptly. We pay freight. Speakers mounted in teak or palisander enclosures are also available.



We carry a complete range of the famous Labcraft belt drive turntables (manufactured in Copenhagen by SRT - a subsidiary of Bang and Olufsen). All models have 3 speeds and adjustment of ± 10% on all speeds.



Lowest in price are the models with 9 inch turntable! 643 for ceramic cartridge, 605 for magnetic \$56.40. 605L with grey mat \$63.75. 655 black mat \$68.25. Automatic turntable 665 now available with grey or black mat from \$103.55. Acoustical 3100 transcription turntable with special Papst motor and belt drive, built in strobe and speed adjustment \$133.70.

SP 8  
with elliptical stylus



Magnetic stereo cartridges from Europe's largest manufacturer (B&O) are best value by far and a listening test will prove it. SP 8 now \$36.30, SP 6 \$20.70, SP 1 \$18.03. Arms to suit the above turntables are fitted with anti skate (oil damped lifts from \$12.90). B&O models STL 25° or STA (includes SP 1/2 cart.) \$25.90, STL 15° arm with SP 7 cartridge \$36.75 or with SP 9 \$51.85. All Balance Mark II \$25.79 (includes anti skate).

## DYNACO AMPLIFIER KITS

SCA 35 control amplifier 35 watts rms. "Unmeasurable distortion at normal listening levels". Pre-amplifiers PAS 3 X (valve) or PAT 4 (transistor). Power amplifiers Stereo 35, 70 or 120 (ie. watts rms). Factory assembled units also available. Write for leaflets, prices, reviews of these top ranking U. S. amplifiers.

Australia's largest range of High Grade Danish stereo equipment now on display in our showroom, including the most outstanding amplifier and speaker system ever produced for domestic use: Beolab 5000 amplifier and Beovox 5000 speakers.



BEOMASTER 1400 amplifier 30 Watts RMS

# Danish Hi-Fi Pty. Ltd.

941 BURKE ROAD, CAMBERWELL 3124, PHONE 82 4839





# VARIETY FARE

## Devotional recordings

**SACRED VOCAL MUSIC.** Henry Purcell. (1658-1695). The Deller Consort, London; "Stour Music Festival" Choirs and Orchestra. Stereo, World Record Club S/4506.

Interest: As per title.  
Performance: Capable.  
Quality: Very good  
Stereo: Normal.

As the detailed jacket notes point out, Henry Purcell and his music belong to the Restoration period surrounding the return of Charles II to the Throne of England in 1661. It was a period when composers had to pick up again the threads of sacred music, eclipsed during the Cromwellian era.

Side 1 is devoted to two items "Te Deum" and "Jubilate Deo In D Major" (for St. Cecilia's Day)—works which were published by Purcell's widow two years after his death. With choir, organ, strings and trumpets, the works are sung in English and are expressions of worship on a larger scale.

"In Guilty Night," which begins side 2, is quite different in character and is more in the nature of a miniature oratorio. With Honor Shepherd (the witch), Alfred Deller (Saul) and Maurice Bevan (Samuel) it is based on the famous Biblical incident when a rejected King Saul enlists the aid of the Witch of Endor to summon the spirit of his former mentor, the prophet Samuel.

The final item "Man That Is Born Of Woman" is an anthem, expressive of apprehension at the brevity of life and the inevitability of death to follow. As with the previous item, the words are in English and printed on the jacket. The same three singers are featured, with Neil Jenkins (tenor) and the "Stour Music Festival" choirs.

Recorded in Boughton Aluph All Saints Church, Ashford, Kent, the sound has just the right atmosphere for works of this kind and is virtually above criticism. Released in England by Deller-Recordings, the album is available in Australia only through the World Record Club. For those with an interest in the history of sacred music, recommended. (W.N.W.).

★ ★ ★

**FOR PETE'S SAKE.** Songs from Billy Graham Films. With Ralph Carmichael and The Young People. Stereo, Sacred LPS-74049. (Available from Sacred Productions in all capital cities.)

Interest: Gospel film music.  
Performance: Top professional standard.  
Quality: Very good indeed.  
Stereo: Also very good.

Reviewing devotional records, as I have, for a decade or more, I have

been acutely aware of the emergence of a new breed of Christian composers, vocalists, musicians and conductors: people motivated by a strong sense of dedication but also people trained to full professional standards. Teamed with film makers and technicians, they are producing a constant stream of devotional musical literature, records and films which can take their place, any day, alongside the secular product.

Typical of the "new breed" is Ralph Carmichael, songwriter, musician and conductor and the man responsible for much of the music in the Billy Graham feature films.

Conducting here a very capable vocal and instrumental group, he pre-

tronic sounds — back-to-front envelopes and, in one instance at least, a mouth used to shape an electronic sound into words.

It's somewhat gimmicky, sentimental, Gospel-platform type entertainment, but interesting and capably presented. The titles: Look Down That Lonesome Road — Lord It's Me Again — Nobody Knows — If I Could Hear My Mother Pray Again—Anytime, Anywhere — Near To The Heart Of God — I Am A Pilgrim — Steal Way — Keep Walking — Wait Heaven Means To Me — Lord I'm Coming Home — Ole Time Religion.

A certain conversation piece. (W.N.W.).

★ ★ ★

**HYMNS EVERLASTING.** The Pete King Chorale. Stereo, Universal Record Club SU-957.

Interest: Long-esteemed hymns.  
Performance: With feeling.  
Quality: Some surface noise.  
Stereo: Normal.

Contrasted with the Gospel songs in the album "For Pete's Sake" reviewed elsewhere on this page, the hymns on this album have been sung for many decades in churches throughout the world — and translated into many languages. Universal, ecumenical and familiar, they express the hopes and convictions of many creeds: Holy,

## VARIETY FARE reviews by

Harry Tyrer, Forbes Cameron, Neville Williams

sents eleven of his own compositions: He's Everything To Me — There Is More To Life — Beyond All Time — The Numbers Song — All My Life — The Restless Ones — Hear My Prayer — Seek Me With All Your Heart — Miracle Of Grace — The Man.

The songs have the modern touch intended to communicate with today's young people but unless you're a lot squarer than I think, you'll enjoy every minute of this album. For young people its appeal is a foregone conclusion. (W.N.W.).

★ ★ ★

**J. D. SUMNER, BASS.** Stereo, Sky-lite SSLP-6033. (Available from Southwell Supplies, 176 Geelong Rd., Footscray, Vic. 3011).

Interest: Low, low bass voice.  
Performance: Unusual.  
Quality: Good.  
Stereo: Normal.

From the first few bars, I was certain that I had heard J.D. Sumner before; it transpired that I almost certainly had—as a member of the Blackwood Brothers Gospel Group.

With a good bass voice, both as a singer and for interspersed monologue, additionally he has the ability to push it way down below the normal bass register. Used close-up on mic, it results in a floor-shaking vocal sound that, I fear, may be too much for low compliance pickups. I have never heard any other artist produce sound quite like it.

Backing J. D. Sumner is a vocal group and instrumentalists using unobtrusive but nevertheless novel elec-

Holy, Holy — Rock Of Ages — All Hail The Power Of Jesus' Name — I Love To Tell The Story — Whispering Hope — Onward Christian Soldiers — Stand Up For Jesus — Just As I Am — What A Friend We Have In Jesus — Come Thou Almighty King — Faith Of Our Fathers — Now The Day Is Over.

With very little in the way of instrumental support, Pete King's Chorale produces some very well balanced, well rounded vocal sound, with plenty of vitality in the more vigorous passages. Starting with four-part harmonies that will have a familiar sound to those who know the hymns, Pete King introduces modest but effective variations to distinguish the performance. Playing time is 35 minutes.

An album that will bring pleasure to those who treasure these old Sankey hymns. (W.N.W.)

## FERROGRAPH

### Matching Transformers

Low to High Impedance, or  
Low to Line Impedance  
\$18.75 ea.

Available from all Ferrograph  
Dealers.

Leroya Industries Pty. Ltd.  
266 Hay Street,  
SUBIACO, W.A.



Peter Clark invites you  
to visit his two floor  
Hi-Fi and Tape  
Recorder sound centre



Discover the thrill of

## HI-FI STEREO SOUND

from **\$179.95**

Three piece set includes S.A.  
616 20 watt amplifier Garrard  
3000 record player 2 M.S.I.  
G.T. 100 speakers

\$2.50 weekly

The best sound in the world comes only from Hi-Fi Stereo. From our Junior Executive 3-piece 20-watt system priced at \$179.95 or \$2.50 weekly—to the Senior Executive system at \$2,000. Match up your own system with exciting imported names such as Fisher, Leak, Lansing, Sansui, Sony, Sanyo, Trio and Titan. Over 2,000 different combinations to explore.

**OUR TAPE RECORDER AND HI-FI PRICES  
ARE LOWER THAN ANY DISCOUNT STORE**



Only Australia's Top Recorder  
Specialist can offer you these out-  
standing buys.

NATIONAL RS 780 automatic reverse tape  
recorder, 16 watts, list price \$495, our  
price \$335.95.

NATIONAL RQ 706 twin speaker mono  
machine, list price \$176.95, our price  
\$133.95.

NATIONAL 205 cassette machine, list price  
\$69.75, our price \$52.95.

PHILIPS 4408 stereo, list price \$450, our  
price \$338.95.

SANYO stereo, list \$499, our price  
\$335.95.

SANYO 915 stereo, list \$275, our price  
\$199.95.

**ALL AKAIS AT  
WHOLESALE PRICES**

# Magnetic Sound

**INDUSTRIES**

**387 GEORGE ST., SYDNEY** I door **29-3371**  
from Kodak  
Parramatta Branch, 20 Macquarie St., 635-0830 opp. Astra Theatre.

## Instrumental,

**CAN-CAN** (Cole Porter) Nelson Riddle  
Orchestra and chorus, with Frank  
Sinatra, Shirley Maclaine, Maurice  
Chevalier and Louis Jourdan.  
Stereo. Capitol Encore SENC-  
9449.

Interest: Cole Porter musical, film.  
Performance: Spirited.  
Quality: Good.  
Stereo: Normal.

This economy Encore release is  
identical with the original full-priced  
Capital stereo originally reviewed in  
December, 1960. On that occasion we  
reported the orchestra as being well  
recorded and well spread by the stereo,  
such as to provide good hi-fi listening.  
At the same time, we expressed some  
reservation about certain of the vocals,  
on the basis that their amplitude had  
pushed the system to the edge of dis-  
tortion. As much as anything, this  
probably had to do with the type of  
cartridge then available, for present  
listening would certainly not have  
evoked this comment.

The track titles: Entr'acte (orchestra)  
— It's All Right With Me — Come  
Along With Me — Live And Let Live  
— You Do Something To Me — Let's  
Do It — Main Title (orchestra), I Love  
Paris (chorus), Montmart' — C'est  
Magnifique — Maidens Typical Of  
France — Just One Of Those Things  
— I Love Paris — Can-Can (orchestra).

With a top-line cast, this album of  
a French-scented Cole Porter musical  
makes very good value at the Encore  
price. Recommended (W.N.W.)

★ ★ ★

**AUSTRALIAN SUITE**, Sven Libaek  
and his orchestra. Festival Stereo  
SFL-933,151. Available in Mono.

Interest: Large-scale Australian  
work.

Performance: Satisfactory.

Quality: Good standard.

Stereo: Well spread.

Sven Libaek has been steadily mak-  
ing a name for himself both as a per-  
former on piano in the jazz field and  
as a composer of both jazz and more  
serious music. His "Australian Suite" is  
a major effort in which all these skills  
are combined. As a large-scale work  
taking nearly an hour to perform, it  
must obviously be regarded as serious  
music, but it has jazz influences —  
in fact, part of the orchestra is a jazz  
group.

The work has six movements en-  
titled: The Isa — Riverina Sunrise —  
Australia Square — The Snowfields —  
Nullarbor — The Kimberleys. In his  
sleeve note, Libaek mentions the order  
in which he worked the pieces, and  
says the suite finishes with the Riverina  
and Kimberley movements. The order  
in which they are presented here differs  
from that given by the composer but  
still finishes with "The Kimberleys" for  
a satisfying climax to the work.

The sections are skilfully scored,  
and have some movements of real  
melodic beauty, while the jazz sections  
are restrained and smoothly flowing,  
in the modern manner. However, I did  
find some movements rather overlong  
at the first few hearings but this may  
wear off with repeated listenings. Even  
on first hearing, certain influences are



# Vocal and Humour . . .

obvious on the composer's work, notably Grieg (perhaps this is not surprising, as Libaek is Norwegian) and Smetana.

It is too early to say yet whether this work will become an established standard in the same way as Eric Coates' "London Suite" and Grofe's "Grand Canyon Suite." It is certainly encouraging to see a work of this kind setting a precedent for Australian light music, and if the suite does become established, this first recording could well become a collector's item.

Congratulations are due to Festival Records for undertaking the expensive business of recording the work (it required a 24-piece orchestra, including Libaek at the piano). However, the Festival art department should enter a black mark for the dull cover, showing a ship in full sail, in a dull shade of grey. The disc screams out for a brightly coloured landscape picture of one of the scenes depicted in the music. (H.A.T.)

★ ★ ★

**MELODIES WE KNOW AND LOVE.** Well-known orchestras and artists. Stereo, World Record Club S/4468.

Interest: Classical bits and pieces.  
Performances: Consistently good.  
Quality: Very clean, slightly lacking in sparkle.  
Stereo: Normal

This could best be described as "Soft lights and sweet music—classical style." Not that the performances are in any way lacking in character — it's just that the items are well known, melodic and calculated to caress the ears. Let's list the sources:

William Tell Overture, Rossini (Hollywood Bowl Orch., Slatkin) — Valse Triste, Sibelius (Capitol Symphony Orch., Dragon) — Flight Of The Bumble-Bee, Rimsky-Korsakov (Hollywood Bowl Orch., Rabin, Slatkin) — Clair De Lune, Debussy (Pennario) — Serenade, Toselli (Hollywood Bowl Orch., Dragon) On The Trail, Grofe (Capitol Symphony Orch., Dragon) — Ich Liebe Dich, Grieg (Fox, organ) — Serenade, Drigo (Zither, Ruth Welcome) — Prayer from "Hansel and Gretel," Humperdinck (Hollywood Bowl Orch., Dragon) — March from "The Love Of Three Oranges," Prokofiev (Hollywood Bowl Orch., Newman) — Funiculi-Funicula, Denza (Hollywood Bowl Orch., Dragon) — Lullaby, Brahms (Hollywood Bowl Orch., Dragon) — Les Preludes, Liszt (Hollywood Bowl Orch., Rossa).

For those to whom the music appeals, good value at the club price. (W.N.W.)

★ ★ ★

**THE BEST OF ERIC COATES.** The Liverpool Philharmonic Orchestra conducted by Charles Groves. Columbia (E.M.I.) Stereo SCXO-7889.

Interest: English light music.  
Performance: Relaxed and lyrical.  
Quality: Excellent.  
Stereo: Normal.

Eric Coates devoted his life to composing light music and, as I believe he was a modest unassuming person-

ality, I imagine he would have been very surprised to find the Liverpool Philharmonic Orchestra playing a whole program devoted to his works. I suppose most people will know "By the Sleepy Lagoon" which begins the selection, also the famous "Knightsbridge March" from his "London Suite" and the "Dam Busters" march. But I wonder how many will know the other pieces included in the selection: Wood Nymphs—at the Dance from "Summer Days Suite" — Music Everywhere — Saxo Rhapsody — Suite "From Meadows to Mayfair"—Elizabeth of Glamis from "The Three Elizabeths" Suit. These are all charming pieces in the typical light music style, with the "Elizabeth" piece outstanding in melodic inspiration and fine scoring.

One of Britain's finest provincial orchestras, the Liverpool Philharmonic sounds very relaxed in this performance, presumably because they are playing well within themselves in these uncomplicated pieces. The sound quality is excellent (H.A.T.)

★ ★ ★

**NASHVILLE SAXOPHONES.** Billy Vaughn. Stereo, Dot (Festival) SZL-933,167.

Interest: Swinging saxes.  
Performance: Melodic.  
Quality: Good.  
Stereo: Normal.

I couldn't guess how many albums Billy Vaughn has made in recent years, which must surely be an indication that a lot of listeners find pleasure in his basic formula—melodic, gently swinging sound, with an emphasis on saxophones. On this album, he moves a little out of the plush, soft-light atmosphere into Nashville country — percussion a-plenty, a touch of hick and a looser fabric than the usual silky smooth sound.

There are eleven tracks in all: No One Will Ever Know—Last Date—Always Late—A Mansion On The Hill—I Really Don't Want to Know—You Win Again — A Nashville Sunday Morning—I've Got You On My Mind Again—Mama Tried—Then You Can Tell Me Goodbye—Moon On My Pillow.

Not a record to get excited about, it is nevertheless well recorded and should please those with a soft spot for Billy Vaughn. (W.N.W.)

★ ★ ★

**DANCES OF OLD VIENNA.** The Boskowsky Ensemble directed by Will Boskowsky. Decca (E.M.I.) Stereo SXL 6344.

Interest: Viennese Bon-bons.  
Performance: Authentic.  
Quality: High standard.  
Stereo: Well spread.

The work of this group has been receiving warm praise in the classical columns of this magazine, for their series of discs devoted to the Marches and Dances of Mozart. This latest disc, featuring a collection of lighthearted works by the two Johann Strausses, Josef Lanner and Franz Schubert, is equally deserving of high praise. These people are specialists in Viennese music, and know exactly how to treat it. This delightful selection comprises:

## "INNERBOND"

(Regd.)

# BONDED ACETATE FIBRES

FOR PACKING IN

## SPEAKER ENCLOSURES

A new resilient Bonded Wadding made from ultra fine Cellulose Acetate Fibres that gives high efficiency for Sound Absorption.

"INNERBOND" is light, clean, dust-free and easy to handle. Because all the fibres are bonded "INNERBOND" will hang as a "curtain" and will not fracture or break down due to vibration.

"INNERBOND" is odourless, highly resistant to attack by bacteria or fungus and is vermin repellent; "INNERBOND" at 16oz sq. yd. has a normal thickness of 1" and at this density is recommended as a packing in Speaker Enclosures for Sound Absorption.

### STOCKISTS:

**SYDNEY:** Arrow Electronics Pty. Ltd., 342 Kent St.; Broadway Electronics (Sales) Pty. Ltd., 52 Glebe Point Rd.; GLEBE: Convoy International Pty. Ltd., 449 Kent St.; Ence Electronics Pty. Ltd., 257 Clarence St.; Kent Hi-Fi, 432 Kent St.; Mastersound Sales Pty. Ltd., 400 Kent St.; Radio Despatch Service, 869 George St.; Stereo Music Systems, 193 Clarence St.; Circuit Components (A/sia) Pty. Ltd., 460 Bexley Rd., BEXLEY; Classic Radio, 245 Parramatta Rd., HABERFIELD; Dyna Stereo Pty. Ltd., 331 Prince's Hwy., ST. PETERS; Albert Wright Radio Service, 795 New Canterbury Road, HURLSTONE PARK; H. B. Radio Products, 103-105 Catherine St., LEICHHARDT.

**NEWCASTLE:** Martin de Launay Pty. Ltd., King and Darby Streets; Dynamic Sound, 587 Hunter Street.

**WOLLONGONG:** Electricon Parts Pty. Ltd., 82 Keira Street; Martin de Launay Pty. Ltd., 270 Keira Street.

**MELBOURNE:** J. H. McGrath and Co. Pty. Ltd., 208 Little Lonsdale Street.

**BRISBANE:** A. E. Harrold Pty. Ltd., 123 Charlotte Street; Brisbane Agencies, 78 Wickham Street, Fortitude Valley.

**ADELAIDE:** Duncan Agencies, 57 Woodville Road, Woodville; General Accessories, 81 Flinders Street; Trustcott Electronics, 62-64 Hindmarsh Square.

**PERTH:** Atkins (W.A.) Ltd., 894 Hay Street; Carlyle and Co. Pty. Ltd., Milligan Street; General Accessories, 46 Milligan Street.

**HOBART:** Homecrafts-Tasmania, 199 Collins Street.

If unobtainable

For 1 sq. yd. as above send \$2.00  
For 2 sq. yds. as above send \$3.75  
For 4 sq. yds. as above send \$6.50

Postage paid in Australia and Territories to the manufacturers.

## WONDER WOOL PTY. LTD.

87 JAMES STREET, LEICHHARDT, N.S.W., 2040.  
Box 548 — G.P.O., Sydney, 2001.  
Phone: 56-2780.





# 3 OF A KIND WITH A DIFFERENCE



## PE31

**(PE31R & PE31K) Long Play Tape**  
A hard wearing Long Play Polyester base tape that stands up to rough treatment, PE31 is especially designed for professional and semi-professional uses. PE31 is unaffected by changes in temperature or humidity because it's tropicalised.



## PE41

**(PE41R & PE41K) Double Play Tape**  
The universal tape for all fields of application. A tape with great flexibility on a pre-stressed polyester base. This is the all purpose tape for the amateur. As with all Agfa polyester tapes, it is unaffected by changes in temperature and humidity. Recommended for 4-track and 2-track recordings on home recording equipment.



## PE65

**(PE65R & PE65K) Triple Record Tape**  
Because PE65 is so thin any spool of PE65 WILL HOLD twice the length of longplay tape. This doubles the playing time. Like all Agfa polyester tapes, it has high resistance to wear and tear in spite of its thinness. The outstanding flexibility of Agfa PE65 ensures close contact with the recording head. Recommended especially for four-track recorders.

PE31PE31RPE31KPE41PE41RPE41KPE65PE65RPE65K?



### PE31-PE41-PE65

(in Cardboard Archive Box)  
Agfa PE (POLYESTER) tapes are available in the famous cardboard swivel box. This pack allows you to file your tapes in a library fashion.



### PE31R-PE41R-PE65R

(in transparent economy pack)  
The transparent economy packs are easy to store, and are very reasonably priced.



### PE31K-PE41K-PE65K

(in attractive Novodur Plastic Swivel Type Box)  
Perfect for the enthusiasts. This pack allows you to store your tapes in a neat compact library. The Novodur pack is attractive, and also permanently dust-proof and unbreakable.



### Agfa Magnetophon Universal Mailing Cassette

3" Agfa tapes are available in this attractive, unbreakable mailing cassette. This cassette is ideal for mailing to friends interstate or overseas.



### Compact Cassette

Also available are compact cassette C60 supplied with PE65 Triple-Play tape and C90 with PE85 unrecorded.

Write for FREE leaflet on Agfa Recording tapes and accessories.

**AGFA-GEVAERT LIMITED**

P.O. Box 48, Nunawading, Victoria. 3131

NAME..... (PLEASE PRINT)

ADDRESS.....

STATE..... POSTCODE.....

\*Registered trademark AGFA-GEVAERT Antwerp/Leverkusen.



Jugendfeuer Galop, Die Guten Alten Zeiten Walz, Indianer Galop, Tivoli Rutsch Walzer, and Exeter Polka, all by Johann Strauß the Elder; Liebeslieder Walzer by Johann Strauss the Younger; Eight Waltzes and Six Ecosais by Franz Schubert; Pesther Walzer and Lust Galop by Josef Lanner.

Willi Boskowsky has conducted much research into the music of this period, and the arrangements are based on old copies and editions. The small orchestra is also typical of those which played this music in nineteenth-century Vienna. We may therefore regard this as an authentic account, which will delight musical scholars and casual listeners alike. (H.A.T.)

★ ★ ★

**AFRICAN BLUE.** Les Baxter with Orchestra and Chorus. Crescendo (Festival) Stereo SGNPL-933,170. Available in Mono.

Interest: Mood music.  
Performance: Relaxed style.  
Quality: Very good.  
Stereo: Normal.

Nowadays it is accounted a good thing to have some kind of a gimmick in the world of popular music. Herb Alpert has his bullring sound, Martin Denny has the Hawaiian touch, and so on. Les Baxter's gimmick is apparently Africa. The recipe is a pattern of percussion, plenty of flute (always sounds exotic), a touch of vibraphone, and a few weird sounds (bugaloo). I hope the above does not sound derogatory, since in fact Mr Baxter is very pleasant to listen to. The mood is one of relaxation, and if one does not succumb too deeply to the mood, it is possible to distinguish the excellent work of the sidemen. The chorus contributes some pleasing sounds without becoming intrusive, and the arrangements are very well done indeed. Just the disc for an hour's quiet relaxation.

The rather exotic flavour of the disc is sustained by the tune titles: Yellow Sun — Flame Tree — Zebra — Dark River — Topaz — Tree Of Life — Girl From Uganda — Magenta Mountain — Johannesburg Blues — Jalaba — Azure Sands — Kalahari. Unfamiliar fare, but it will please most tastes. (H.A.T.)

★ ★ ★

**CARMEN AND OTHER HITS.** The Living Brass. RCA Camden Stereo CAS2238.

Interest: Popular tunes.  
Performance: Virtuoso.  
Quality: Excellent.  
Stereo: Well spread.

The Living Brass make a welcome return on their second Camden disc. The individual players are all anonymous, and I suspect that they are all symphony orchestra players who do these discs for a lighthearted change from the rigours of symphonic playing, and also to earn a little more pocket money. This would account for the high standard of playing, and individual virtuosity. Here they swing their way through ten well-known numbers (ten tracks being virtually a standard on Camden discs). Titles are: Lady of Spain — Fowl Play — Medley; The Other Man's Grass, Funny Bone — Las Chiapenacas — Carmen selection — There's a Kind Of Hush — Fiesta In Acapulco — Windy — Medley;

Adoro and Segundo Carino — Zabadak. The playing time is on the short side, at around 15 minutes a side, but at the new low Camden price of \$1.99 this disc is still good value. Technically, the disc is of excellent standard. (H.A.T.)

★ ★ ★

**THE LONDON BALALAIKA ENSEMBLE.** Deram (E.M.I.) Stereo SMLA 712.

Interest: Russian folk tunes.  
Performance: Sparkling.  
Quality: First rate.  
Stereo: Well spread.

If you have any liking for the balalaika, or the slightly melancholy minor mode tunes of Russian folk music, you should certainly make a point of hearing this disc. The balalaika's various forms (including the domras) are the only instruments used, and in the hands of an expert group such as is featured here they make very pleasant listening.

Wisely, the group has elected to restrict their repertoire to the folk songs of Russia and, while some of these will not be familiar to most Australians, they will certainly recognise the better known ones, such as "Kalinka" and "At the Gates." Also included are: Pedlar's Dance — Remember, Remember — In the Garden — Beyond the Fast Running River — Little Apple — Russian Dance (Barynya) — There is More Than One Path — Brightly Shone the Silver Moon — Oh, You My Snowball Tree — Under the Apple Tree — My Meadows — Oh, You the Night. Excellently recorded in Deram high quality sound, this is first-class entertainment (H.A.T.)

★ ★ ★

**GOLDEN INSTRUMENTALS OF HAWAII.** Duke Kamoku and his Islanders. Stereo, Crescendo (Festival) SGNPL-933,057. Also in mono.

Interest: Island sound.  
Performance: Smooth, romantic.  
Quality: Completely clean.  
Stereo: Two-channel variety.

I don't think there is anything quite as relaxing as the sound of native musicians, heard in the dimly lit, balmy atmosphere of an island resort. The atmosphere seems all-pervading, whether the tempo is dreamy or exhilarating, the instruments traditional or as up-to-date as the 50-watt solid-state amplifiers.

In this album, recorded in Hawaii, Duke Kamoku and his Islanders string together a dozen island favourites calculated to put you in an island mood — favourites like "Song of the Islands," "Moon of Manakoora," "Sweet Leilani," "Blue Hawaii" and "Pagan Love Song."

In a sense routine but a sample of one of the most pleasant "routines" I've ever experienced! (W.N.W.)

★ ★ ★

**HAWAII.** Arranged by George Cates in collaboration with George Wyle. Stereo SFL-933,157. Available in Mono.

Interest: Popular Hawaiian tunes.  
Performance: Skilful.  
Quality: Excellent.  
Stereo: Good spread.

This is the Hawaiian music of the tourist, with the steel guitar prominent

If you want to sell or buy the best sound equipment ever made — TEAC is for you.



### TEAC MODEL A 4010S STEREO TAPE DECK

A precision recording and playback machine.

- ★ automatic reverse play and monitoring while recording.
- ★ separate reel and capstan motors — smooth stable performance.
- ★ 100 KHZ bias oscillator — eliminates stereo beat and minimises distortion.



### TEAC MODEL AS 200 INTEGRATED AMPLIFIER

Powerful differential-type amp and pre-amp, with superb equalisation and precision tone control. Latest release.

- ★ push-button source selector.
- ★ large variety of input connectors.
- ★ overload protection.
- ★ hidden panel controls.
- ★ 100 Watts R.M.S. total output.

Retail Enquiries: 63 6701

*Brashs*

108 Elizabeth St. Melbourne.

Wholesale Enquiries: 63 2601  
AUSTRALIA MUSICAL INDUSTRIES  
155 Gladstone St. Sth. Melb.

WB471



# TEST WITH THE BEST

New from Sanwa  
**A-303TR<sub>D</sub>**—a medium-size  
 circuit tester with a 44-micro-  
 ampere meter movement.



- Zener effect via silicon diode automatically safeguards the moving coil from burn-out. Also functions against pulse voltage in television circuit checking.
- Solid-state diode rectifier obtains stability measurement extending frequency coverage up to 100kHz for lower ranges.
- High voltage probe is available extra to align television circuits.
- As a Sanwa TR Series multimeter, the specific LI and LV scales provided serve to check characteristics of semiconductors by reading current and voltage applied simultaneously with resistance.
- For better insulation and ruggedness, the front panel and rear case are moulded from plastics.

#### Measurement Ranges

DC voltage: 0.3V 1.2V 3V 12V 30V 120V 300V 1.2kV 6kV (20k $\Omega$ /V) 25kV (with probe)  
 AC voltage: 6V 30V 120V 300V 1.2kV (8k $\Omega$ /V)  
 DC current: 60 $\mu$ A 3mA 30mA 300mA 12A (300mV)  
 Resistance: Range  $\times 1$   $\times 100$   $\times 1K$   $\times 10K$   
 Midscale - 25 $\Omega$  2.5k $\Omega$  25k $\Omega$  250k $\Omega$   
 Maximum - 5k $\Omega$  500k $\Omega$  5M $\Omega$  50M $\Omega$   
 Load current (LI): 60mA 500 $\mu$ A 60 $\mu$ A  
 Load voltage (LV): 1.5V 1.5V 1.5V  
 Volume level: -10~+17~+63dB

**Accuracy.** Within  $\pm 2.5\%$  for DC range up to 1.2kV.  
 Within  $\pm 4\%$  for DC 6kV range.  
 Within  $\pm 3\%$  for AC ranges.  
 Within  $\pm 2.5\%$  for ohm ranges.

**Batteries.** 1.5V $\times 1$  and 22.5V $\times 1$   
**Size.** 170 $\times 116 \times 59$ mm

## 430-ES Multitester



- Meter movement of 10 microamperes, doubly protected by silicon diode circuit and spring-backed jewel bearings.
- Common terminals for DC and AC current measurements. Two AC current ranges read on single scale because of equalized characteristics.
- Solid-state germanium diode rectifier.
- Flat frequency response up to 100kHz.

#### Measurement Range.

DC voltage: 0.3V 3V 12V 30V 120V 300V (100k $\Omega$ /V)  
 1.2kV 6kV 30kV (with probe) - (16.6k $\Omega$ /V)  
 DC current: 12 $\mu$ A 0.3mA 3mA 30mA 300mA 1.2A 12A (300mV)  
 AC voltage: 3V 12V 30V 120V 300V 1.2kV - 5k $\Omega$ /V  
 AC current: 1.2A 12A  
 Resistance: Range  $\times 1$   $\times 10$   $\times 100$   $\times 10K$   
 Midscale - 40 $\Omega$  400 $\Omega$  4k $\Omega$  400k $\Omega$   
 Maximum - 5k $\Omega$  50k $\Omega$  500k $\Omega$  50M $\Omega$   
 Volume level: -17~+63dB

**Accuracy.** Within  $\pm 2\%$  (10% for 6kV and above) fsd for DC voltage.  
 Within  $\pm 2\%$  fsd for DC current.  
 Within  $\pm 3\%$  fsd for AC voltage.  
 Within  $\pm 2\%$  of scale length for resistance.

#### Frequency coverage.

50Hz-100kHz for AC 30V and below ( $\pm 3\%$ )  
 10kHz for other AC voltage ranges.

**Batteries.** Four 1.5V (UM-3) and one 1.5V (UM-2) dry cells.

**Size & weight.** 179 $\times 133 \times 85$ mm & 1400 gr

## SH-63TR<sub>D</sub> Multitester



- Protected by silicon diode circuit.
- Stabilized AC voltage reading by solid-state rectifier and frequency coverage extended up to 100kHz.
- Current loss minimized by high input impedance (20k ohms/volt for DC and 8k ohms/volt for AC).
- Standard HV probe of sealed-in 480-megohm resistor

#### Measurement ranges.

DC voltage: 0.25V 1V 2.5V 10V 50V 250V 1000V (20k $\Omega$ /V)  
 AC voltage: 1.5V 10V 50V 250V 1000V (8k $\Omega$ /V)  
 DC current: 50 $\mu$ A 2.5mA 25mA 250mA (250mV)  
 Resistance: Range  $\times 1$   $\times 100$   $\times 1000$   $\times 10000$   
 Midscale - 25 $\Omega$  2.5k $\Omega$  25k $\Omega$  250k $\Omega$   
 Maximum - 3k $\Omega$  300k $\Omega$  3M $\Omega$  30M $\Omega$   
 Minimum - 0.5 $\Omega$  50 $\Omega$  500 $\Omega$  5k $\Omega$   
 Load voltage: 1.5V 1.5V 1.5V  
 Load current: 60mA 600 $\mu$ A 60 $\mu$ A  
 Volume level: -15~+5dB for AC 1.5V range  
 0~+22dB for AC 10 volt range and up to +62dB

**Accuracy.**  $\pm 3\%$  fsd for DC voltage & current  
 $\pm 4\%$  fsd for AC voltage ( $\pm 6\%$  for 1.5V range)  
 $\pm 3\%$  of scale length for resistance

**Batteries.** One each 1.5V (UM-3) and 22.5V (BL-015) dry cells.

**Size & weight.** 160 $\times 103 \times 64$  mm & 730 gr approx.

## U-50<sub>D</sub> Multitester



- Meter movement of 35 microamperes safeguarded by a protection circuit.
- Reading error eliminated by battery sheaths.
- Shunt adapter separately available.

#### Measurement Ranges:

DC voltage: 0.1V 0.5V 5V 50V 250V 1000V (20k $\Omega$ /V)  
 AC voltage: 2.5V 10V 50V 250V 1000V (8k $\Omega$ /V)  
 DC current: 50 $\mu$ A 0.5mA 5mA 50mA 250mA  
 Resistance: Range  $\times 1$   $\times 10$   $\times 100$   $\times 1K$   
 Midscale - 50 $\Omega$  500 $\Omega$  5k $\Omega$  50k $\Omega$   
 Maximum - 5k $\Omega$  50k $\Omega$  500k $\Omega$  5M $\Omega$   
 Volume level: -20~+62dB

**Accuracy.**  $\pm 3\%$  for DC and ohm ranges  
 $\pm 4\%$  for AC ranges

**Batteries.** Two 1.5V dry cells (UM-3 or equivalent)

**Size & weight.** 131 $\times 89 \times 41$ mm & 445 gr

#### Accessories available.

Shunt adapter High voltage probe  
 Clip adapter Carrying case

For full details contact the Exclusive Sanwa Specialists...



**WARBURTON FRANKI**



**SANWA ELECTRIC  
 INSTRUMENT CO., LTD.**

Dempa Bldg., 2-chome, Sotokanda, Chiyoda-ku, Tokyo, Japan. Cable: "SANWAMETER TOKYO"



in the instrumental line-up, which is otherwise fairly standard. In this category, I have no hesitation in giving this disc high marks. Comprising mainly very well-known melodies, it is very pleasing to hear. The work of the band is of a high standard and the arrangements have been very skilfully done to give the exotic touch which gives this type of music atmosphere. The very familiar tunes comprise: Now is the Hour — Moon of Manakoor — Hawaiian Wedding Song — Beyond the Reef — Pagan Love Song — Drifting and Dreaming — Bali Ha'i — Ka-Lu-A — Hawaiian War Chant — Song of the Islands — Aloha Oe. The recording is of high quality, with good stereo spread. (H.A.T.)

★ ★ ★

**IN MOTION.** Earl Grant. Decca Records, U.S.A. (Festival — Stereo SDL-933,131. Available in Mono. Interest: Popular entertainer. Performance: Very professional. Quality: Excellent. Stereo: Normal.

To appreciate to the full the superb artistry of Earl Grant it is necessary to see him in action, seated between the V formed by the keyboards of his grand piano and electronic organ; switching from one to the other, or with one hand on each keyboard, with never a falter in the flow of music. And, of course, he also dances and sings in his live performances. Despite the loss of visual impact, his playing is of sufficiently high standard to stand on its own. The program here comprises: The Look of Love — In Motion — Two Different Worlds — King of the Road — A Message to Michael — What the World Needs Now — It was a Very Good Year — Saints — Ode to Billy Joe — Green Eyes — Black Coffee. A good blend of new and old, presented with great artistry, and well supported by a small backing group. An effective contribution is also provided in places by a female choir. Well worth a try. (H.A.T.)

★ ★ ★

**THE BEST OF KING CURTIS—** King Curtis. Atlantic Records (Festival) Stereo SAL 933,116. (Also in Mono.)

Interest: Alto and tenor saxophonist. Performance: Competent, if limited music. Quality: Bright recording. Stereo: Generally well spread.

As I pointed out in my review of his last LP, "Sweet Soul," in the February issue, King Curtis has somewhat modest talents as a saxophone soloist. His main attribute, indeed, is a tough, gutty tone particularly on tenor. In addition, run-of-the-mill instrumental versions of R. & B. hits tend, in my experience, to become rather monotonous over two sides of an LP.

Nevertheless, King Curtis presumably commands some kind of following in Australia and this album features 12 of his best-known recordings from previous Atlantic albums. The tracks include "I Was Made To Love Her," "Spanish Harlem," "Ode To Billy Joe," "Soul Serenade" (one of his biggest hits) and "Dock Of The Bay."

I would imagine that the 36 minutes of this album would make good party

music or background listening but, for the rest, potential buyers would be wise to hear a few tracks. (T.F.C.)

★ ★ ★

**ORGAN FAVOURITES FROM BLENHEIM PALACE.** Nicholas Danby, organist. Studio 2 Stereo (E.M.I.) SCXO 7882.

Interest: As per title. Performance: Outstanding skill. Quality: Excellent sound. Stereo: Normal.

I can recommend this disc unreservedly to those just starting an organ disc collection. The selection comprises the pieces which have become organ standards (and will therefore most likely be in the collections of those who already have a number of organ discs) but these are played with wonderful skill and virtuosity by Nicholas Danby, who must now be reckoned one of the outstanding young organists of today. The recording too is of high standard, and has captured extremely well the beautiful mellow tone of this fine organ. The instrument was built by the famous "Father" Willis, being completed in 1891, and although it has not been modified in any way it is still in perfect condition.

The program commences with a

piece which must be regarded as inevitable in a recital of this type, Bach's famous "Toccate and Fugue in D Minor." Clarke's popular "Trumpet Voluntary" follows, then side one ends with the stately four movement "Suite Gothique" of Leon Boellmann. Side two has: Toccata from Symphony No. 5 (Widor) — Nimrod from "Enigma Variations" (Elgar) — Scherzo from "Dix Pieces" (Gigout) — Chorale No. 3 in A Minor (Franck). A disc which is hard to fault. (H.A.T.)

★ ★ ★

**FOR LOVERS ONLY.** Various artists. World Record Club Stereo S4469

Interest: Sentimental ballade. Performance: Excellent all through. Quality: Varies. Stereo: Normal.

Selected from earlier World Record Club releases, the tracks on this album are all of high standard, featuring top-ranking artists. Besides this, there is pleasing variety, with frequent changes of style and tempo, and the use of French and Italian in some tracks.

Outstanding in this very good selection are Emile Becaud singing "Eh Maintenant" (the original French version of "What Now My Love") who brings a dimension to this song which

**PLAY  
IT  
SAFE**



Before you outlay \$500.00 or more on a tape recorder, play it safe and spend \$2.50 on the 75 page, hard-bound, Ferrograph Series Seven Operators Handbook. You get the \$2.50 back when you buy a Ferrograph so that's as safe as we can make it.

See for yourself what makes Ferrograph Australia's Most Coveted Recorder.

Compare performance, versatility, construction and finish. You'll agree that there's no substitute for Honest Engineering and Ferrograph Skill.

Send for  
"Why Ferrograph"  
It's Free

Sole Australian Distributors

**LEROYA INDUSTRIES PTY. LTD.**  
266 Hay Street, SUBIACO, W.A.



# Check all systems -

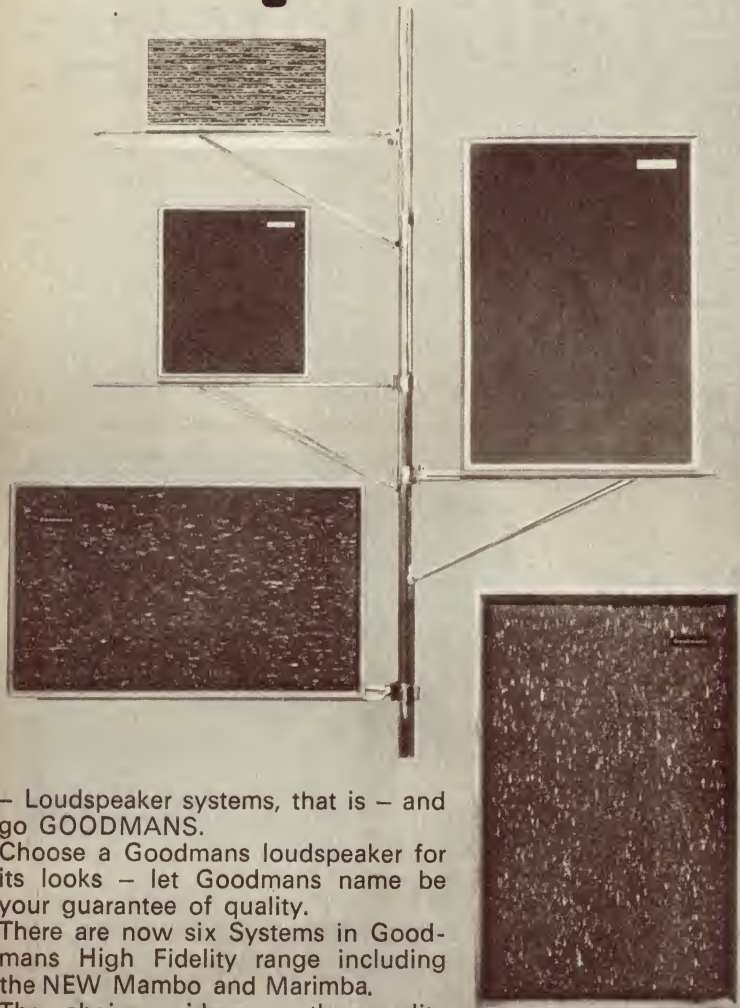

- Loudspeaker systems, that is - and go GOODMANS.

Choose a Goodmans loudspeaker for its looks - let Goodmans name be your guarantee of quality.

There are now six Systems in Goodmans High Fidelity range including the NEW Mambo and Marimba.

The choice widens - the quality remains the same. All offer the finest High Fidelity reproduction anywhere. Check for yourself - at your Goodmans dealer.

- 1 NEW! MAMBO\* 10 $\frac{1}{2}$ " x 8 $\frac{1}{2}$ " x 8" deep.
- 2 MAXIM Mini-system. 10 $\frac{1}{2}$ " x 5 $\frac{1}{2}$ " x 7 $\frac{1}{2}$ " deep.
- 3 NEW! MARIMBA\* For wall mounting. 19" x 13" x 5 $\frac{1}{2}$ " deep.
- 4 MEZZO 11 Flush fitted attenuator. 19 $\frac{1}{2}$ " x 12" x 9" deep.
- 5 MAGNUM-K. 3 speakers. 2 attenuators. 24" x 15" x 11 $\frac{1}{2}$ " deep.

All finished in Teak or Walnut to order.

\*Sold in ready matched pairs.

## Goodmans for High Fidelity

For full particulars, write to the Sole Australian Agent:

**BRITISH MERCHANDISING PTY. LTD.**

Shaw House, 49-51 York St., Sydney. Telephone 29.1571 (3 lines)

most English language versions miss completely; and Lorie Mann, with her version of the Cole Porter number "Let's Do It." There are two songs by that fine Italian singer Roberto Cardinale, "Quando Quando" and "Romantica," while Janie Marden shows her versatility by singing in French and Italian - "Je Ne Regrette Rien" and "Non Ho L'Eta per Amarti." The accomplished Mike Sammes Singers contribute five tracks: Till There was You - She Didn't Say Yes - Tonight from "West Side Story" - Getting to Know You - As Long as He Needs Me. The selection is completed by Ray Ellington's version of Jerome Kern's "Just the Way You Look Tonight."

On the technical side, the disc does not get full marks, since a few tracks have a level of distortion which may worry those with high-quality equipment. (H.A.T.)

★ ★ ★

**HITS OF THE 20's.** Raymonde's Magic Organ. Stereo, Deram (E.M.I.) SMLA-714.

Interest: Organ and percussion.

Performance: Capable but routine.

Quality: Good.

Stereo: Good.

The singularly uninformative jacket generates no interest in the artist, his instrument or even in the numbers he plays. The music itself is well known but sounds much like any other group of numbers when churned out on electronic organ with percussion backing. The dozen titles include Caroline In The Morning - I'll See You In My Dreams - My Blue Heaven - Let The Rest Of The World Go By, and others less well known.

Individually, the tracks are well played and well recorded but scarcely commend themselves for listening to twelve in a row. Be that as it may, a member of my family grabbed the disc as just right for their morning calisthenics! (W.N.W.)

★ ★ ★

**COLOURS** - Claudine Longet. A and M Records (Festival). Stereo SAML 933138 (also in Mono).

Interest: Young French singer/actress.

Performance: Pleasant listening.

Quality: Beautifully recorded.

Stereo: Well balanced.

Claudine Longet is a young French actress/dancer who first worked professionally in America in 1961. Shortly afterwards, she married Andy Williams and her own career as a singer dates from 1966, when she signed a contract with Herb Alpert's A & M label. Since then, she has made a number of successful recordings for A & M, including a cover version of Paul Mauriat's "Love Is Blue."

Her fragile and wistful voice is rather attractive and appealing and, thankfully, she sings beautifully in tune.

The tunes are well chosen for Miss Longet's limited vocal range and they include Paul Simon's very beautiful "Scarborough Fair," "Let It Be Me," Randy Newman's "I Think It's Gonna Rain Today" and two of Donovan's compositions, "Catch The Wind" and "Colours."

This album, which plays for 33 minutes, is at best pleasant and very easy



## Reader's Digest Release

**BE MY LOVE.** The Golden Voice of Mario Lanza. Stereo, Reader's Digest 6-record boxed set "Collector's Edition."

Interest: Lanza, opera to schmaltz. Performance: In the ears of the listener!

Quality: Good job of re-mastering. Stereo: Mainly doctored mono.

It's no use meaning one thing and trying to say another. I didn't enjoy listening to Mario Lanza; I seldom have and the chances are diminishing that I ever will!

Granted that he made a rather good job of "The Great Caruso"; granted he can emote vocally at the slightest provocation; granted he can sing louder and longer than most. But the big trouble is that, every time I hear him sing, my mind races ahead to the next big climax where he is likely to shout sharp—and all too frequently he does!

But, despite such views, in which I am certainly not alone, Mario Lanza still has the kind of following which makes it worthwhile for albums to be issued and re-issued. Or for an organisation with the acumen of "Reader's Digest" to offer a 6-record boxed set. "Out there" — among our readers — there must surely be quite a few prepared to tell me that I wouldn't know a good tenor if I heard one.

Well, if you're numbered in this group, you'll certainly get your usual money's worth from this set. Record 1 is devoted to Lanza's "Greatest Hits" — some popular love ballads, follow-

ing. But I would be surprised if many readers consider it to be worth \$5.75. (T.F.C.)

★ ★ ★

**THE BOARD OF DIRECTORS' ANNUAL REPORT** — The Mills Brothers and Count Basie. Dot Records (Festival Stereo SZZL 933040 (also in Mono).

Interest: Sentimental, nostalgic. Performance: Even better than their 1st L.P.

Quality: Superb recording. Stereo: Well balanced.

When I reviewed the first album by the Mills Brothers and the Count Basie Band in these pages last year, I concluded that this was "nostalgia of the most satisfying kind." This, their second L.P. together, is even better than the first, due largely to stronger material.

On this occasion, four of the Mills Brothers' biggest hits are featured — "You Never Miss The Water," "Glow Worm," "I'll Be Around" and "Cielito Lindo." After 30 years at the top, the Mills Brothers still manage to sound wonderfully fresh, enthusiastic and, most of all, polished.

The Basie Band, too, was in cracking form when these tracks were recorded. Three of their classic recordings from the late 1930's are given the Mills Brothers' treatment — "Sent For You Yesterday," "Blue and Sentimental" (featuring Eric Dixon's tenor) and "Every Day." The other main soloists

ed by "Beguine," "Bolero," "Lady of Spain" and others.

Side 1 of record 2 is "Lanza in the Movies" — a climate in which, to my ear, a tighter rein appears to be held on his vocal meanderings. "Neapolitan Serenade" is the theme of side 2.

Two operettas dominate record 3, "The Student Prince" and "The Desert Song," with numbers which are familiar and predictable.

Record 4 features songs from "The Great Caruso" and, on side 2, "Songs of Faith and Inspiration." "For the First Time" on record 5 features performances mastered from tapes of U.S. radio network performances. "Lanza on Broadway" on side 2 is based on the curious theme of how Lanza would have sounded had he ever starred in a Broadway musical!

And finally, on record 6, more love songs, "The Romantic Lanza" and "The Vagabond King."

Technically, the engineers have done a good job in re-mastering the selections from a variety of sources. They have disguised the difference between older and newer material and avoided glaring comparison between older, "doctored" mono tracks and newer, purely orchestral interludes included here and there by way of relief. Most important, they have avoided the use of any material having the tell-tale crackle of old pressings.

If you're a Lanza fan, go ahead. If not, buy one of the other Reader's Digest albums. Goodness knows, there's a wide enough choice! (W.N.W.)

are Bill Basie himself, Al Aarons on trumpet and Eddie Davis on tenor.

The remaining three tracks on the album — "Sunny," "Cherry" and "Gentle On My Mind" — are almost as good as the classic songs and obviously the atmosphere at these sessions was very happy and relaxed.

The 31 minutes of this thoroughly enjoyable album should appeal to the great majority of readers. (T.F.C.)

★ ★ ★

**SONGS FOR SWINGIN' LOVERS** — Frank Sinatra. Capitol (E.M.I.) Encore Series. Stereo, SENC 9455.

Interest: Sinatra at his peak. Performance: A classic album.

Quality: Well recorded. Stereo: Evenly spread.

This is one album that almost defies review in the normally accepted terms. It features Frank Sinatra, the greatest interpreter of the popular song for the past three decades, at the very height of his creative talents.

The fifteen tracks, all but one of which were made in January, 1956, have been widely regarded as classic Sinatra recordings ever since their original release and most readers will probably be familiar enough with the majority of them.

My particular favourites are "You Make Me Feel So Young," "Pennies From Heaven," "Love Is Here To Stay" and "We'll Be Together Again." But there is not a sub-standard track in the album and the immaculate ar-

# BAKER Loudspeakers

★  
Price Reduction  
AND  
Design  
Improvement!

★

The very popular Group 25 and Group 35 loudspeakers for Electric Guitar, Bass, Organ and P.A. now have Ceramic Magnets for Increased Efficiency, Better Bass.

Group 25 (25 watts RMS)

**\$25.76**

Group 35 (35 watts RMS)

**\$36.80**

Trade Enquiries Invited

Sole Australian Distributors

**LEROYA INDUSTRIES  
PTY. LTD.**

**266 Hay Street,  
SUBIACO, W.A.**



# THE ROYAL GRENADE

## PREMIER SPEAKER SYSTEMS FOR THE DISCERNING MUSIC-LOVER

In the Royal Grenadier, Empire's total stereo design is coupled with the ultimate in electronic engineering for truly matchless sound reproduction. Facing downwards within the stereo cylinder is a 15-inch high-compliance woofer built around an 18-pound ceramic magnetic structure. Unparalleled in power and precise response, this magnet controls a 4-inch voice coil that remains within the magnetic gap during even the widest-excursion bass notes. Non-linear motion is eliminated, and with it the low bass distortion that less powerful drivers create. At 450 cycles, this woofer is cut out of the system electrically, by the crossover network, and also acoustically by its impedance-matched horn. Speaker-cone break-up, a prime cause of distortion in woofers allowed to reproduce higher frequencies, is totally blocked by this extraordinary double cut-off.

The powerful mid-range radiator that reproduces the 'heart' of the musical spectrum utilizes the same engineering combination of magnetic power, precise voice-coil control and perfect compliance for unsurpassed linear response and clean, clear, distortion-free sound. At 5,000 cycles, the same double cut-off takes place via the crossover network and the acoustic impedance of the Grenadier's divergent lens.

And, like the other components of this premier speaker system, Empire's ultrasonic domed tweeter is precision-engineered to give you nothing but pure, undistorted, perfectly-balanced music. The Royal Grenadier has a power-handling capacity of 100 watts — the ultimate protection against distortion, burn-out and uneven-response.

### TECHNICAL SPECIFICATIONS: MODEL 9000M.

Frequency response: 20 to 20,000 Hz.

Impedance: 8 ohms.

Components: 15-inch high-compliance woofer.

Mid-range radiator and ultrasonic domed tweeter, both coupled to Empire's wide-angle acoustic lens.

Crossovers: 450 and 5,000 Hz.

Controls: 3-position treble response switch.

Sound dispersion: 360 deg. below 450 Hz. 160 deg. up to 20,000 Hz.

Minimum Power Requirement: 20 watts.

Maximum Power Handling Capacity: 100 watts, undistorted.

Diameter: 22". Height: 29".

Finish: Hand-rubbed satin walnut.

Top: Imported marble or walnut.



**Recorded Music Salon are sole agents for Australia for world's most perfect record playing equipment — Empire, made in U.S.A.**

**RECORDED MUSIC SALON  
23 Collins Street,  
MELBOURNE. 3000.**

**TRUE FIDELITY  
C. PINCZEWSKI  
TEL. 63-6257.**



rangements, by Nelson Riddle, have rarely been surpassed in this field.

At the re-issue price of \$2.50, this album is exceptional value for collectors, like myself, who have worn their original copies grey; or, indeed, for any reader who would like to possess two sides of vintage Sinatra.—(T.F.C.)

★ ★ ★

**THE FAIR MAID OF THE MILL** (Schubert). Fritz Wunderlich, tenor, with Heinrich Stolze, piano. World Record Club Stereo S/4462.

Interest: German lieder.  
Performance: Fine interpretation.  
Quality: Very good.  
Stereo: Normal.

Members of World Record Club who are also lovers of German lieder should certainly not miss the opportunity to obtain this fine disc. The artist was killed in a road accident last year, when approaching the peak of his career, and lamentably left only a small heritage of recorded music for posterity. He made two attempts at this song cycle, the second having been released as three sides of a two-disc set on the DGG label, shortly before his death. I have not heard the DGG version, but I do know that it received very high praise from record critics overseas.

This disc has the advantage of low price (\$3.25) compared with the \$12 for the DGG, but with this goes the disadvantage that four songs have been omitted, to get the work on one disc. The nearest competitor is the Fischer-Dieskau/Gerald Moore version, on the H.M.V. label, which is complete on one disc, and costs \$5.75. Therefore if price is the main consideration, the Wunderlich disc is a very good choice. If he does not scale the same heights

## Popular Jazz

**THE JAZZ COMPOSITIONS OF DEE BARTON**—Stan Kenton and His Orchestra. Capitol (E.M.I.) Stereo ST 2932.

Interest: Contemporary big band jazz.  
Performance: Surprisingly, an excellent L.P.  
Quality: Dull flat recording.  
Stereo: Normal separation.

I must confess that I approached this album with some apprehension, for I cannot be numbered among Stan Kenton's hardy and dedicated followers. However, I regard this L.P. not only as the first genuine jazz album to come from Kenton for several years, but also as one of the finest that he has recorded in his musically eccentric and varied career.

The principal reason for the album's success is undoubtedly the sophisticated and highly accomplished standard of writing and arranging by Kenton's drummer, Dee Barton. All seven tracks were composed by Barton and they are much closer to the jazz idiom than the normal run of Kenton's recorded output.

At the same time, some of the usual Kenton trade-marks are still very much in evidence — the powerful, brassy ensembles, the use — sometimes to excess — of dissonance, the pseudo-classical touches but, above all, the impeccable musicianship.

as in his second attempt, this is still very fine singing. The piano accompaniment is perhaps not as sensitive as one could wish, but is not obtrusive or in any way objectionable. The sound quality is of very good standard, and the pressing is of the usual World Record Club high standard. (H.A.T.)

★ ★ ★

**AUSTRALIA'S COUNTRY MUSIC MAN.** Reg Lindsay. Festival Stereo SFL-933,119. Available in Mono.

Interest: C. & W.  
Performance: Good standard.  
Quality: Satisfactory.  
Stereo: Normal.

Reg Lindsay is so well known to Australian C. & W. fans that little needs to be said about the disc. However, it is perhaps worth pointing out that four of the 12 tracks were made in Nashville, the Mecca of C. & W. performers in the U.S.A. In these tracks, Reg is supported by a group of the famous Nashville musicians, including David Brigg, Bobby Dyson, Kerl Himmel and Weldon Myrick.

The four Nashville tracks are: Something to Drink About—Play me a Song I Can Cry To—When it Come to Going—Hey, Good Looking. The other tracks are: I've Only Loved Three Women—Blackboard of My Heart—Every Boy Has Been Some Mother's Darling—A Place for Girls Like You—Sing Me a Song of the Mountains—There's No Place Like Home—Mother the Queen of My Heart—It's a Weary World Without Blue Eyes.

Reg is obviously aware of the honour of his Nashville performance, and puts everything he has into the four tracks made there. However, the locally made tracks are not too obviously inferior. (H.A.T.)

Kenton has always displayed a remarkable flair for unearthing outstanding young musicians and this orchestra is no exception. Apart from Don Bagley on bass, all are new names to me but they play quite superbly. Most of the solos are taken by Jay Daversa (trumpet) and Ray Reed (alto and flute) and in them, Kenton has discovered musicians of unusual qualities.

There is neither a weak track nor an uninteresting composition on the album, which plays for 37 minutes. Even if you are not a dedicated admirer of Stan Kenton, this album is worthy of your serious attention. (T.F.C.)

★ ★ ★

**REUNION JAZZ BAND—2.** Harmony (CBS). Stereo HAS 137 (also in Mono).

Interest: Re-creation of Dutch Swing College Band 1955-60.  
Performance: Spirited.  
Quality: Average recording.  
Stereo: Adds little.

The world-famous Dutch Swing College Band has been an important part of the European jazz scene for more than 20 years. During this time, it has carefully acquired and maintained a reputation for first-rate traditional jazz.

Over the years, the personnel of the DSC Band has undergone many changes. The idea behind this re-

# If you want STEREO EQUIPMENT

You'll deal better with  
**H. B. RADIO SALES**  
**JUNE SPECIALS**

**KENWOOD TK250 AMPLIFIER/** 2 Wharfedale Golden 10 speakers in R2 teak cabinets—Dual 1019 player with Shure magnetic cartridge on platform. \$410.

With Sansui 555 amp, \$20.00 extra. **KENWOOD 150 AMP,** 2 Magnavox 10in speaker systems in Teak. Garrard AT60 with Shure M44G on Platform, \$275.00.

**TOKAI AMP.** 2 Magnavox 8in speakers, Garrard 1000 Players on Platform, \$98.50.

**MAGNAVOX or ROLA design** slimline cabinet with 8 W.R. (V.C. 15, 8 or 3 ohms) or 8 CMX speaker fitted . . . . . \$30.00  
Cabinet Kit only . . . . . \$11.00

**MAGNAVOX 10 W.R.** and 3 T.C. Tweeter with Crossover network in 2 C.F. cabinet 4" material \$43.00  
12 W.R. in 3 cubic ft. cabinets \$43.00

**GOODMANS design 3 CF Cabinet** and Twin-axiom 10 speaker, 4in material . . . . . \$57.50  
Cabinet Kit and Speaker . . . \$44.20

**WHARFEDALE design,** 3 CF cabinet (R3) 4in material and Golden 10 speaker . . . . . \$62.00  
Cabinet Kit and Golden 10 Speaker . . . . . \$48.00

Special quotes for other Wharfedale or Goodmans speakers.

Available in Maple, Walnut or Rosewood colours. Teak veneer \$1 extra for Slimline and Bookshelf models. \$2.00 extra for others.

**PLAYMASTER Bookshelf Speaker System.** Complete, \$31.00  
Cabinet kit only \$7.40

All other parts, including speakers, innerbond, etc., \$16.00.

**POINT 4. BOOKSHELF UNIT,** complete kit of parts, cabinet, speaker, innerbond, etc., \$25.00.  
Complete. Price \$35.00.

**PLAYMASTER Super Bookshelf System.** Complete \$41.00  
Cabinet kit only \$10.50.

All other parts, including speakers, innerbond, etc., \$25.00.

**Wharfedale Unit 3.** Complete kit of parts, cabinet size, 14in x 9in, 8 1/2in (4in)—\$41.25 (made \$49).  
Cabinet size 11 1/2, 21in 9 1/2in (4in)—\$45.50 (made \$54).

Packing charge \$1 per order.  
Postage, N.S.W. \$1.00; Qld., Vic., Tas., \$1.40; other States, \$2.00.

Send for Stereo Catalogue

**H. B. RADIO SALES**  
Manufacturers of Quality Radio and Radio Furniture for 36 years  
103-105 Catherine Street,  
**LEICHHARDT, SYDNEY**  
Telephone 56-5580



some TV sets aren't marketed now  
...but their components are...

# Rola supply them!



Rola does more than manufacture a wide range of T.V. components for the production of new television sets. They supply components for the older T.V. sets as well — regardless of year, make or model. In fact, since 1956, when television was first introduced into Australia, Rola has supplied more than 2,500,000 electronic components to original equipment

manufacturers and service companies of Australia's television industry. From the earliest Admiral television receivers to the latest Astor, Thorn and General Electric, T.V. manufacturers and suppliers have depended on the reliability and availability of Rola products. These are the reasons why Rola components are an integral part of nearly every brand name

television set made in this country today. Components manufactured by Rola include vertical output and horizontal output transformers, deflection yokes, blocking oscillators, power chokes and many other electronic systems. And, apart from the wide range of standard products available, Rola can tailor make T.V. components to suit your own specifications.

## PLESSEY

---

## Components



For additional information please contact:

Rola Division  
The Boulevard Richmond Victoria 3121  
Telephone 42 3921 Telex 30383  
NSW Plessey Components Rola Division  
PO Box 2 Villawood 2163 Telephone 72 0133

124-A R13



cently-recorded L.P. was to reunite the musicians who comprised the band in the second half of the 1950s, when the group operated on a semi-professional basis.

On the whole, the results are very satisfactory. The music is robust, virile and enthusiastic and these attributes more than offset a lack of individuality in the group sound. The front-line, in particular, is impressive although it is dominated to an unusual extent by the two clarinetists, Dim Kesber (who also plays fine soprano saxophone) and Jan Morks. Wybe Buma's trumpet lead is quiet but accomplished, while Wim Kolstee produces a solid, brassy tone from his trombone.

As one often finds with European jazz rhythms, the rhythm section is a bit lumpy and plodding but they do manage to maintain a good steady beat.

Most of the material is well-known but worthwhile and the tracks include "Frog-I-More Rag," "Big Butter and Egg Man," "Kansas City Stomp" and "Buddy's Habits."

Dutch Swing College enthusiasts (of whom there are many in Australia) will no doubt agree that the 43 minutes of this album represent excellent value at \$2.50. Other traditional jazz collectors would perhaps be advised to hear a few tracks first. (T.F.C.).

★ ★ ★

**MERCY, MERCY—The Buddy Rich Big Band. Liberty (Festival). Stereo SLYL 933191 (also in mono)**

Interest: Contemporary big band jazz.

Performance: Exciting—but shallow.

Quality: Well recorded for "live" performance.

Stereo: Evenly spread.

For several years, optimistic observers of the American jazz scene have

## Two from Louis Armstrong

**I WILL WAIT FOR YOU — Louis Armstrong. Coral (Festival). Stereo SCL 933129 (Also in Mono).**

**WHAT A WONDERFUL WORLD —Louis Armstrong. E.M.I. State-side. Stereo SOSL 10247.**

Interest: Mainly Louis' vocals.

Performance: Delightful.

Quality: Both L.P.'s brightly recorded.

Stereo: Well balanced.

Despite some recent illness, Louis Armstrong, who will be 69 this year, is still producing warm-hearted and uniquely appealing albums. In the past few years he has naturally had to limit considerably his trumpet-playing but, happily, quite a few of these tracks contain at least a few bars of trumpet. However, these two albums (both of which were recorded last year) mainly feature the inimitable magic of his singing.

The Coral L.P. includes superb songs like "I Will Wait For You" (listen to his trumpet introduction) and "The Gypsy In My Soul," together with two very touching ballads, "I Believe" and "You'll Never Walk Alone."

The best track on the album is, with-

been predicting a "return of the big bands." Despite the continued existence of the Ellington, Basie and Herman Orchestras, however, the economics of maintaining regular big bands are far from attractive. Nevertheless, one recent addition to the ranks—the Buddy Rich Big Band—seems to have hit on a successful formula.

This 52-year-old drummer, a veteran of the Artie Shaw, Tommy Dorsey and Harry James Orchestras, has recruited a band of enthusiastic young musicians and adopted a policy of contemporary big band material.

The band is tight and disciplined and the music brassy and, on the surface, exciting. In addition, Rich is fortunate in having several first-class soloists with him, including the great alto player Art Pepper, Don Menza (tenor) and Walter Namuth (guitar). His own spectacular (and, I believe, heavily over-rated) drumming is still immensely popular with audiences all over the world.

This album was recorded last year "live" at Caesars Palace in Las Vegas. The best track is "Channel 1 Suite" written and arranged by Bill Reddie with solos by Menza, Pepper and Rich, while Art Pepper is featured on an excellent arrangement of "Alfie" by Don Piestrup.

For the rest, the material is rocky ("Mercy, Mercy," "Ode to Billy Joe," etc.) and, to my mind, the arrangements tend toward the monotonous.

While the Buddy Rich Band will never approach the status and importance of Duke Ellington, Count Basie or (a fairer comparison) Woody Herman, it is very encouraging to have it on the scene today. If you enjoy the contemporary sounds of the Rich Band, you will not be disappointed with the 46 minutes of this album. (T.F.C.).

out doubt, "That's My Desire," an old favourite of Louis', on which he is joined for the vocal by his trombonist Tyree Glenn.

The backing is provided by his current All-Stars with the addition of some well-known session men like Al Caiola and Clark Terry and a vocal chorus, which unfortunately grates a little at times. The playing-time is 31 minutes.

The E.M.I. album is very similar. The backing is again one provided by his All Stars (with Marty Napoleon on piano and Tyree Glenn on trombone outstanding), augmented on many of the tracks by a large string orchestra.

The album includes some of his recent hits like "What a Wonderful World" and "Cabaret" together with a nice blend of old favourites (like "Dream a Little Dream Of Me" and "There Must Be A Way") and some new songs written specially for him. The playing time of the E.M.I. L.P. is a shade longer at 33 minutes.

If I had to express a preference, I think I would probably choose the Coral L.P. But readers who enjoy Louis' wonderful singing will probably be happy to add both L.P.'s to their record shelves. (T.F.C.)

## COMPLETE HI-FI RADIOGRAM-TAPE RECORDER ALL IN ONE

MODEL TR9



### AS AN AMPLIFIER . . .

- Frequency response, 20-20000 cps.
- 7 Watts RMS. output per channel.
- Distortion less than .25%
- Separate treble and bass controls.

### AS A RADIO . . .

- Being fully transistorised, can be switched on all day at full output without heat problems. Program can be recorded on tape without any external connections.

### AS A TAPE RECORDER . . .

- Freq. response 30-18000 cps.
- 3 speeds. Meter level indicator.
- Push button operation.
- Superimposing.

### PRICES:

- 2 track mono, \$159.00
- 4 track mono, \$169.00
- 4 track stereo, \$230.00

RADIO TUNER CAN BE FITTED TO ANY OF THE ABOVE MODELS FOR \$28 EXTRA.

### TAPE DECKS

for the home constructor. COLLARO (Magnavox) tape decks complete with record/play and speed change switch wafers fitted . . .

2 tracks, \$48. 4 tracks, \$55. SPECIAL LOW IMPEDANCE HEADS for transistorised tape amplifier circuits (Mullard) available).

## CLASSIC TAPE RECORDERS

93B LIVERPOOL ROAD, SUMMER HILL, N.S.W. Telephone 79-2618



# Chosen by the BBC... GOLDRING '800' SERIES

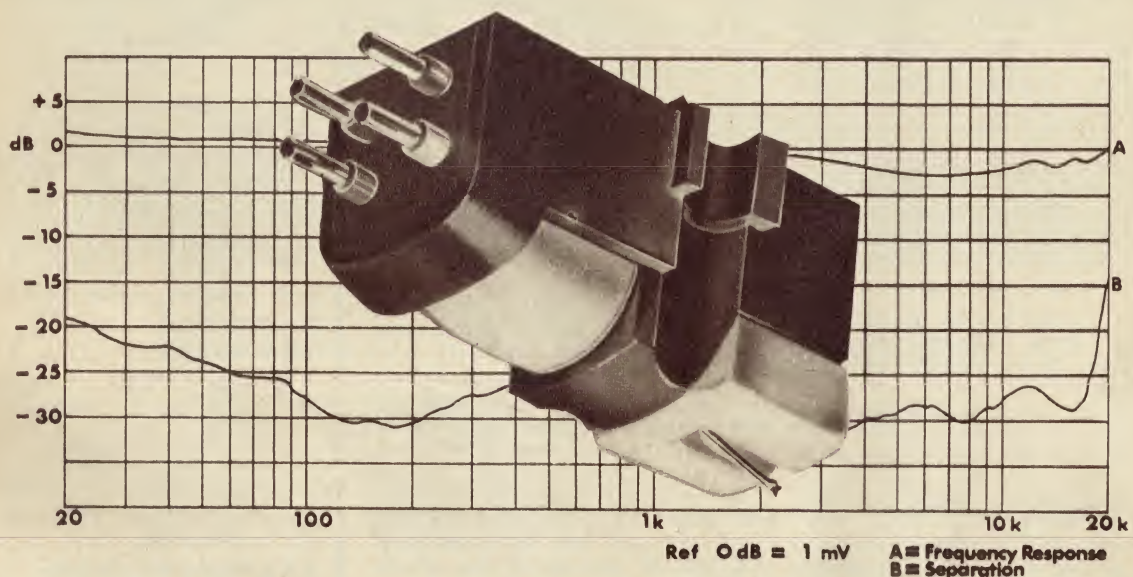

## Goldring '800' and '800E' free field stereo cartridges

With a choice of the finest cartridges anywhere in the world, BBC engineers chose the Goldring '800' series. They recognised the unparalleled advantages of the 'free field' system in re-creating the finer shades of original sound. Read the specifications and you'll agree. In these cartridges a very lightweight tube of magnetic material lies in a 'free field' generated by a fixed source coupled to a low mass diamond point. They feature low mechanical impedance, tracking at 1 to 3 grams (800) and 0.75 to 2 grams (800E), screening from external hum fields, gold-plated contacts. Stylus is replaceable.

Specifications:	'800'	'800E'
Type	Magnetic	stereo & mono
Frequency Response	20Hz-20kHz	10Hz-25kHz
Sensitivity	5.5 mV at 5 cm/sec	
Separation	25dB at 1kHz and nowhere less than 15 dB	
Load	100k-47k/ohms	
Compliance	20 x 10 <sup>-6</sup>	30 x 10 <sup>-6</sup>
Static	cm/dyne	
Effective Point		
Mass	1 mg	less than 1 mg
Stylus Point	Conical 0.0005" diamond	Elliptical .0008" x 0.0003" diamond
Tracking Weight	1-3 gm	0.75-2 gm
Head Weight		8 gm
Connections		4 pins
Fixing		Standard 1/2" centres
Vertical Tracking Angle	15°	
Mu-Metal Shield for hum protection		
Removable Stylus		

### GOLDRING ENGINEERING (A'ASIA) PTY. LTD.

N.S.W.: 443 Kent St., Sydney, 2000. Phone 29-5802  
VIC: 162 Pelham St., Carlton, 3053. Phone 34-5105.  
QLD.: 415 Adelaide St., Brisbane, 4000. Phone 23247.

S.A.: Farley & Fahy Pty. Ltd., 75-77 Wright St., Adelaide, 5000. Phone 51-5117.

W.A.: 32 Northwood St., Leederville, 6007. Phone 84988

FROM THE EVER-WIDENING RANGE OF HI-FI EQUIPMENT AVAILABLE FROM GOLDRING.



# There's an AIWA microphone to solve your recording problem.

**AIWA DM.57 DYNAMIC MICROPHONE**—Impedance: 60 and 50K. Frequency Response: 100-13,000 cps. Sensitivity: 75 db's. Dimensions: 7½" x 1½". Weight: 14 ozs. **\$15.50**

**AIWA DM.17 OMNI-DIRECTIONAL DYNAMIC BOOM MICROPHONE**—Impedance: 50K or 50Ω. Frequency Response: 70-14,000 cps. Sensitivity: 75 db's. Dimensions: 5½" x 1½". Weight: 10½ ozs. **\$18.50**

**AIWA DM.51 DYNAMIC MICROPHONE**. Impedance 50Ω or 50KΩ. Frequency Response: 50-15,000 cps. Sensitivity: 55 db's. Dimensions: 10" x 1½". Weight: 29 ozs. **\$27.00**

**AIWA DYNAMIC NON-DIRECTIONAL MICROPHONE DM.13**—Impedance: 50K or 50Ω. Frequency Response: 60 c's-14,000 cps. Sensitivity: 75 db's. Dimensions: Length 10½". Weight: 18½ ozs. **\$29.00**

**AIWA UNI-DIRECTIONAL DYNAMIC MICROPHONE DM.47**—Impedance: 50Ω or 50K. Frequency Response: 40-18,000 cps. Sensitivity: 75 db's. Dimensions: 5½" x 1½". Weight: 18 ozs. with cord. **\$36.00**

**AIWA DM.10 DYNAMIC DESK MICROPHONE**—Impedance: 50Ω or 50K. Frequency Response: 60-13 Kc's. Sensitivity: 75 db's. Dimensions: 7½" x 1½". Weight: 11 ozs. without stand. **\$16.50**

**AIWA DM.14 DYNAMIC MICROPHONE**—Impedance: 50Ω or 50K. Frequency Response: 90 c's-14,000 cps. Sensitivity: 75 db's. Dimensions: 3½" x 1½". Wt. 10 ozs. **\$12.50**

**AIWA DM.67 CARDIOD DYNAMIC MICROPHONE** — Impedance 50Ω or 50 KΩ. Frequency response 100 > 12000 CPS with 15 dB. Front to rear separation. Sensitivity: 74 dB. Dimensions: 5½" x 2" max. Weight: 8 ozs. **\$33.00**



**DM 57**



**DM 17**



**DM 51**



**DM 13**



**DM 10**



**DM 47**



**DM 67**



**DM 14**



*Distributed by:*  
**GOLDRING**  
**ENGINEERING (A'ASIA) PTY. LTD.**

N.S.W.: 443 Kent St., Sydney, 2000. 29-1275.  
VIC.: 162 Pelham St., Carlton, Vic. 3053. 67-1197.  
QLD.: 415 Adelaide St., Brisbane, Qld. 4000. 23247.  
W.A.: 32 Northwood St., Perth, W.A. 6007. 84988.  
S.A.: 77 Wright St., Adelaide. 5000. 51-5117.

GE:P345



# TRADE REVIEWS AND RELEASES

## DIGITAL VOLT-OHMMETER USES ICs

The TR-6334 is a compact digital DC voltmeter-ohmmeter, part of the range of high quality instruments made in Japan by Takeda Riken Industry Co. Ltd. It offers nominal 0.2% accuracy at moderate cost, plus the reliability provided by integrated microcircuits.

cent  $\pm 2$  digits between 0 and 45 degrees C. Accuracy on the resistance ranges is  $\pm 0.2$  per cent  $\pm 1$  digit for the Kiloohm ranges and  $\pm 0.5$  per cent  $\pm 1$  digit for the Megohm ranges between 10 and 40 degrees C; these figures increase to  $\pm 0.3$   $\pm 2$  digits and  $\pm 0.6$  per cent  $\pm 2$  digits respectively for the 0-45 degrees temperature range. Measurements are normally taken by the instrument at a sampling rate of 12/second, but any reading may

be held indefinitely by means of a front-panel switch.

The instrument is fully solid-state apart from the display tubes, and uses integrated microcircuits (mainly RTL) for most of the functional circuitry. The internal reference source is provided by a temperature-compensated zener diode circuit, while the clock pulses used by the counter section are derived from the 50Hz (or 60Hz) power mains.

Tested in our laboratory the sample TR-6334 sent for review performed impressively, its performance matching closely the maker's specification. Readout display was bright and stable, the controls straightforward and convenient to operate, and accuracy substantially as claimed. The construction gave every evidence of careful design and fabrication, and suggested that the instrument should prove reliable and maintenance-free.

Price of the TR-6334 is quoted as \$501 duty paid, plus sales-tax where applicable. Inquiries should be directed to the Australian representatives for Takeda Riken, who are N.E.T. Pty. Ltd., 6-8 Clarke Street, Crows Nest, 2065. (J.R.)



Externally the instrument measures a compact 4in x 7in x 12½in overall, and is fitted in an attractive blue hammertone case with rugged extruded aluminium alloy front panel. The case is fitted with a retracting carrying handle, buffet feet, a tilting bail and four rear posts which would serve both as mains-cord coiling guides and supplementary feet if the instrument is to be used front-up on a floor or platform. The readout display window is fitted with an orange filter for improved readability in high ambient light conditions.

The TR-6334 is a three-full-decades plus single digit over-range instrument, with a full-scale capacity of 1,800. It uses three side-view neon indicator tubes for the main decade display, and neon lamps for indication of the over-range digit, polarity indication and overflow alarm. The display tubes provide numerals approximately 9/16in high, for convenient reading at almost any normal viewing distance.

A single-function switch on the front panel selects from the nine ranges provided by the instrument. The four DC voltage ranges have F.S. values of 1.8V, 18V, 180V and 1000V respectively, while the five resistance ranges have F.S. values of 1.8K, 18K, 180K, 1.8M and 18M. Rated accuracy on the DC voltage ranges is  $\pm 0.1$  per cent  $\pm 1$  digit between 10 and 40 degrees C, and  $\pm 0.2$  per

The 888VE is the most recent of the 888 series and the third in the Empire range of cartridges which we have tested over the past few years. It uses the same mechanical principle as those before it, in that it uses a very light stylus assembly integral with a moving cone in a multi-magnet arrangement, operating on a variation of the moving-iron principle. All this is enclosed in a metal shield which gives a high immunity to induced hum from the magnetic field commonly encountered around turntable motors.

The stylus assembly, complete with guard and suspension tube, can be withdrawn with the fingers, so that stylus replacement is a very simple matter.

The 888VE stylus assembly is colour-coded black for identification, the metal



shell of the cartridge itself having a gold-coloured finish. A plastic mounting bracket allows it to be used with all head-shells having the standard half-inch mounting centres. A packet of mounting screws and lead terminals is provided with each cartridge.

To gain some initial impressions, we set the cartridge up in a good tone arm and connected to a high-power amplifier and a pair of bookshelf loudspeakers. Playing a selection of discs, we were impressed with the wide stereo separation, and the overall "very easy-on-the-ear" sound of the cartridge. Indeed, we were reluctant to put away the music and get down to measurements.

We found that a playing weight of 1½ grams was desirable to ensure proper tracking of some of the more heavily modulated records although, for most records, 1 gram would probably be sufficient with, of course, reduced stylus wear. The recommended range of playing weights is ½ to 2 grams. We found that, at

2 grams, the cartridge tracked the plus 12dB band of the W & G 25/2434 test record quite comfortably, but would not handle the plus 16dB band. For subsequent frequency response and other measurements, we used a playing weight of 2 grams.

Frequency response and channel separation was checked using the CBS STR-100 test record and the Hewlett Packard HP331A distortion analyser as an AC voltmeter. With the cartridge loaded with 47K frequency response was within plus 2dB and minus 3dB from 30Hz to 18KHz, with a system resonance at 16KHz of 2dB above reference and a minus 3dB trough centred around 7KHz. The bass response showed a slight rise at the extreme low end. Channel balance was within 2dB over most of the range.

Sensitivity at 1KHz was 5.2mV in one channel and 4.5mV in the other for 5cm/sec.

Channel separation was excellent at 35dB at 1KHz in one direction and 36dB in the other. Minimum separation was 15dB at 20KHz, which explains the impression of a wide stereo separation on listening tests. These figures are considerably better than we were able to measure with the more expensive 999VE cartridge reviewed in the December, 1967, issue, but the present facilities were better than were available for the earlier tests.

Waveform was good, apart from some irregularities in the range from 5 to 10KHz. As we have remarked in the past, distortion in this region is fortunately not readily apparent, since it consists of harmonics high up in the frequency range where the ear is least sensitive. Square wave response was good, with minimum over-shoot and negligible ringing.

To sum up, this cartridge has performance characteristics which add up to give a very good overall picture. It has smooth frequency response, wide separation between channels and can be used on most records at a playing weight of 1.0 to 1.5 grams. A most pleasant-to-listen-to cartridge.

Advertised retail price is \$60 from Recorded Music Salon. This compares with the price in the U.S.A. of \$59.95. Price of a new stylus assembly is \$35. The cartridge is available from most hi-fi equipment retailers. (L.D.S.)



# MANUAL, PEDAL CLAVIER FROM A.C.E. RADIO

A.C.E. Radio have submitted for review a 49-note keyboard and 13-note pedal clavier. These will be of interest to electronic organ constructions in view of the relative scarcity of such components on the Australian market.



The keyboard incorporates a switching system which is completely enclosed to exclude dust. All contact surfaces are gold-plated. The switching system involves a pair of gold-plated bus-bars for each of the four octaves; two pairs of gold-plated wires for each key switch the pre-mixed signal for each note to the pair of bus-bars. General standard of construction is good, the metal chassis being cadmium plated and passivated.



The keys are made of plastic and are attached by means of one countersunk screw each, making repairs easy. The front edge is cut away underneath, making the unit eminently suitable for use in a 2-manual console. The finish on the keys themselves is quite satisfactory and the spring "action" is good.

The pedal clavier is a self-contained free-standing unit, complete with cable and multi-pin connector and socket. It can be used with a normal organ and be easily moveable for cleaning or it could be used with portable instruments. The unit

is housed in a plywood cabinet covered with simulated wood-grain material. Just how this will stand up to being kicked, etc., only time will tell. Apart from reservations about the covering material the unit is quite well constructed and should stand normal use quite well.

Switching for each note is accomplished by a fully-enclosed micro-switch which should make for good reliability. The unit is easily dismantled for repairs, if necessary.

Retail prices are \$72 for the keyboard and \$39.50 for the pedal clavier. All enquiries regarding these units should be directed to A.C.E. Radio, 136 Victoria Road, Marrickville, N.S.W. (L.D.S.)

## AWA Announces New Counter-Timer

A new counter-timer, TF2414, produced by Marconi Instruments, England, is being marketed in Australia by Amalgamated

Wireless (Australasia) Ltd. The counter is intended for general purpose use in industry and research, and provides a 6-digit readout with decimal point, by means of neon tubes. A printer output is available as an optional extra.



For those requiring an instrument with still more ambitious specifications, including a memory facility, counter-timer type TF2415 is available. Information about both instruments can be had from the Engineering Products Division of AWA, P.O. Box 96, North Ryde, N.S.W. 2113.

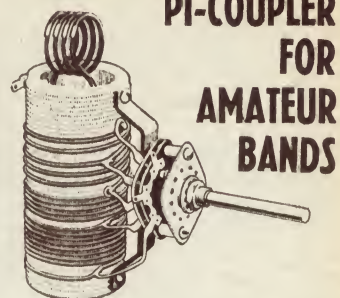

## PI-COUPLER FOR AMATEUR BANDS

### Willis Medium Power Type

For use up to 600 watts p.e.p. Match plate loads of 2,000 to 3,500 ohms (Z) and higher into co-axial cable. Operating Q increases at higher frequencies to increase harmonic suppression, enabling practical values of tuning capacity to be used on 10 and 15 metres and allowing for wiring inductance (L). Incorporates extra switch section for shunting additional capacity (C) if required, or switching other circuits. Switch rated for 10 amps at 2,000 volts with contact resistant (R) of 0.8 milliohms. Price \$8.85.

**WILLIAM WILLIS & CO. PTY. LTD.**

ELECTRONIC AND RADIO EQUIPMENT SUPPLIES

430 Elizabeth Street, Melbourne, Vic., 3000

Telephone 34-6539

ALWAYS RELY ON R.D.S.

## SPECIALS FOR JUNE

**R  
D  
S**

ALL KIT SETS FOR ELECTRONICS AUSTRALIA AVAILABLE.

2-stage intercom., \$7.94

3-stage intercom., \$12.88

CT 500 Meter with mirror scale . . . . . \$14.38

200H Meter . . . . . \$11.50

ST.708 Stereo Amp. 3½ watts per channel . . . . . \$41.25 nett



The Independent Wholesaler

**RADIO DESPATCH SERVICE**

Radio and Electrical Distributors

**869 GEORGE STREET, SYDNEY.**

Corner George and Harris Streets Telephone 211-0816, 211-0191

Open Saturday mornings



## WHY DOESN'T YOUR TURNTABLE LOOK LIKE THIS!

- The ERA arm outperforms even the most recent cartridge; it can track at 1/10 gram.
- By principle its pivot eliminates all friction. The pivot is in fact the intersection of four counter-balanced spring blades. They form two Xs which do not touch each other.
- The tracking weight is applied directly to the pivot by changing the angle of the blades. In this way the inertia of the arm is not increased with the tracking force as in all other arms. The pickup sounds better.
- The arm itself is made of a light alloy H beam which eliminates the resonant frequencies of the tubes.



**UNIT 1: Armstrong Model 521 amplifier, power output, continuous sine wave: 25 watts per channel, 8 ohms, power bandwidth: 20-25,000 Hz, frequency response from 20-20,000 plus or minus 1dB. Harmonic distortion: less than 0.5% at 1 kHz measured at 25 watts output plus or minus 1 dB; with P.E. 34 belt driven Hi-Fi turntable, Empire 808E cartridge, frequency response from 10 to 25,000 Hz, 2 Goodmans 10in Twinaxiette loudspeakers. Total Price \$364.**



**UNIT 2: Ampex Model 2163 tape recorder, automatic threading, automatic reverse and bi-directional recording plus outstanding reliability, magnificent sound reproduction and beautiful styling, 2 Ampex Model 830 loudspeakers complete in boxes. Total Price \$775.**  
Plus P.E. 2020 turntable with Empire 888TE cartridge. Add \$146.

**UNIT 3: Telefunken Model Magnetophon 204E stereo tape recorder, built-in synchronous play and multiplex circuit, selector switch for 6 functions: mono 1, mono 2, transcription from 1 to 2, transcription from 2 to 1, stereo recording and reproduction 2 input selector switches, mechanical rapid stop three-digit tape counter, tape-end stop by switching foil, volume indication by 2 instruments. Can also be used as an amplifier in public address systems.**

Our Special Price \$340.  
Plus P.E. 34 turntable belt driven hydraulic controlled lowering device and fully balanced arm. Add \$62.

**UNIT 4: Akai Model 3000D all Silicon Stereo Deck with 3 heads, recording and playback pre-amplifier, 2 speeds, Automatic shut off, tape cleaner, DIN Jack, stereo headphone jack, frequency response: 30 to 22,000 cps plus or minus 3 db at 7 1/2 ips. Armstrong Model 127 tuner-amplifier, frequency response from 40-20,000 cycles complete with 2 Goodmans 8in Twinaxiette loudspeakers. Total Price \$390.**



**UNIT 5: Armstrong Model 426 fully transistorised tuner-amplifier, 15-watt RMS per channel, 20-20,000 cycles frequency response from plus or minus 1 db less than 1% distortion on the full 15 watt RMS. 2 Wharfedale 10in Golden RSDD loudspeakers. Total Price \$386.**

Plus Dual 1019 turntable and Empire 808 cartridge, frequency response from 10-20,000 Hz. Add \$150.

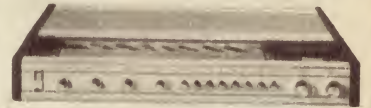

**UNIT 7: Schaub-Lorenz Model 4000 tuner/amplifier made in Germany, 25 watt per channel. The most beautiful looking tuner-amplifier available on the world market. The sound reproduction is excellent, broadcast short wave, long wave, ultra short wave, FM, magnetic input, provision for tape recording and tape playback, 2 Schaub-Lorenz Model STL201 speakers complete in cabinets. Total Price \$440.**  
Plus P.E. 34 turntable and Empire 888 cartridge, frequency response from 12 to 25,000 Hz. Add \$92.



**EMPIRE 888VE CARTRIDGE:**  
Technical Specifications:  
Frequency response: 6-32,000 cycles.

Output Voltage: 8.0 mV per channel.  
Channel Separation: more than 30 db.  
Compliance: 30 x 10<sup>-6</sup> cm/dyne.  
Tracking Force: 1/2 to 2 grams.  
Stylus: 2 x 7 mil bi-radial elliptical hand polished diamond.  
Terminating Impedance: 47000 ohms.

# RECORDED MUSIC SALON

C. PINCZEWSKI

TRUE FIDELITY

23 COLLINS STREET,  
MELBOURNE 3000.

Telephone 63-6257

## BATTERY ELIMINATOR REGULATED POWER SUPPLY

Specially for Larger Battery  
Operated Tape Recorders.

### SPECIFICATIONS

Input Voltage	240 Volts, 50 Hz.
Output Voltage	4.5V 6V, 7.5V 9V or 12V D.C. by Selector plug. Max. Current 0.5A.
Protection	Electronic Overload Protection.
Regulation	Approx. 10% on 12V Range Approx. 5% on all other Ranges
Ripple	Less than 100 mV R.M.S. under all conditions.
Circuitry	All silicon solid state.
Size	4 ins. wide by 2 1/2 ins. high x 5 1/2 ins. deep
Weight	2 lbs. 7 ozs.
Approval	Approved by Electric Supply Authorities



### TYPE PS104

Designed primarily for Tape Recorders where a regulated voltage supply is necessary to prevent speed variation with load changes. A versatile power supply with a range of output voltages making it ideal for design, testing and repair of Transistor Radios, Amplifiers, Record Players, Test Equipments, etc. It is also eminently suitable for use in Schools, Universities, Government Departments and Industry.

Manufactured by

**A & R ELECTRONIC EQUIPMENT  
COMPANY PTY. LTD.**

42-46 Lexton Rd., Box Hill, Vic., 3128

Phones 89 0238 89 0239.

### AGENTS IN ALL STATES

N.S.W. SOANAR ELECTRONICS P/L., 82 Carlton Cres., Summer Hill  
Phone 798 6999

Q'LAND R. A. VENN P/L., 71-73 Doggett St., Valley, Brisbane  
Phone 51 5421

S.A. SCOTT THOMPSON P/L., 93 Gilles St., Adelaide  
Phone 23 2261

W.A. EVERETT AGENCY P/L., 17 Northwood St., West Leederville  
Phone 8 4137



## NEW IMPORTS FROM SAMPLE ELECTRONICS

Sample Electronics are Australian representatives for Krohn-Hite Corporation and Keithley Instruments Inc., both of the U.S.A., and have sent details of the following instruments made by their principals.

**Krohn-Hite Model 3550 solid state variable filter.** This is one of the Series 3500 solid state variable filters designed to replace the company's Series 310 valve type filters. Model 3550 is tunable from 2Hz to 200KHz. Functions include low-pass, high-pass, band-pass and band reject with 24dB/octave attenuation slopes extending greater than 60dB. Operation mode is selected by a front panel switch. The circuit consists of two cascaded four-pole filters, one for high-pass, the other for low pass. Each has been designed specifically for Butterworth response (maximum flatness) for frequency domain measurements.

For time domain operation, a switch modifies the response and prevents overshoot when fast rise inputs are used. A FET amplifier is used as the input stage for high impedance and zero dB insertion loss. Buffer stages are used between each RC tuning network. Low output impedance is achieved by the use of an output amplifier. Hum and noise is less than 200uV.

Also included in the series is Model 3500, a band-pass filter similar in performance to the Model 3550. It features high and low cutoff, tunable over the band 20Hz to 200KHz.

**Keithley Model 604 Differential Electrometer Amplifier.** Features of this instrument are a high input impedance of one hundred million megohms; low input

noise, 20uV; excellent stability; immunity to AC pickup. Although designed primarily as a differential electrometer amplifier, the Model 604 can be readily used as a millivoltmeter and, when coupled with the Keithley Model 6041 Differential Current Shunt, as a picoammeter.

As an amplifier, the Model 604 will operate over a bandwidth of DC to 75KHz with six selectable 3dB points from 30KHz to 100Hz. Two outputs are provided, one being a plus or minus 10V at each recorder output, the other being a unity gain output (one for each input) with plus or minus 50ppm accuracy. The unity gain outputs allow the instrument to be used as a preamplifier with digital or differential voltmeters for precise measurements. These outputs can also be fed into an X-Y recorder.

As an electrometer voltmeter, the unit will measure high impedance sources from 80uV to 1V. It can be used in a differential or single ended mode. High common rejection of greater than 90dB reduces the effects of stray AC pickup. Excellent zero stability (4mV/week) allows monitoring of small signals for days without constant re-zeroing. Variations as small as 1mV in a 1V signal can be displayed full scale. Overloads up to plus or minus 400V will not damage the unit, and recovery is immediate.

As an ammeter it can measure currents from 1uA to .01picoampere, in combination with the Model 6041. Noise is as low as .001picoampere, using a one hundred thousand megohm shunt resistor. Offset current is less than .01picoampere.

Further details on either of the above instruments may be obtained from Sample Electronics (Aust.) Pty. Ltd., 100 Chandos Street, Crows Nest, N.S.W. 2065.

*Keithley Model 604 Differential Electrometer Amplifier.*



*Krohn-Hite Model 3550 Filter.*

## NEW EQUIPMENT CABINETS



**MODEL 154**

With lift-up lid over player. Sliding door in front of amplifier compartment. Large storage space with four separators. Size: 36in wide, 17 1/2in deep, 31in high.

Price

Made and polished (maple, walnut or teak) ..	\$63.50
Packing ..	\$2.20
Kit of Parts (maple) ..	\$36.00
Teak extra (Kits only) ..	\$6.50
Packing ..	\$1.40

New Player Platform model 175 is 16in x 14in x 3 1/2in. Price \$7.50 for maple or walnut. Kit of parts \$4.00, Teak, 50c extra. Perspex cover, 3 1/2in or 5 1/2in high, \$8.20 and \$1.50 extra if required hinged.

Please specify cutout required.



**MODEL 186**

New Player Cabinet model 186 is 9 1/2in high, 16in wide, 16 1/2in deep and 5 1/2in above shelf. Finished with attractive hinged, tinted perspex top. Price: \$21.00 for maple or walnut or teak.

**Kit of Parts: \$14.00**

Teak: \$1.00 extra (Kits only).

Height of this model can be increased to take various amplifiers. Tailored cut out. Ask for quotation.

Free on rail.

Packing charge \$1 per order.

Write for Catalogue and Player Guide

## H. B. RADIO SALES

Manufacturers of Quality Radio and Radio Furniture for 37 years  
103-105 CATHERINE STREET,  
LEICHHARDT, SYDNEY.  
TELEPHONE 56-5580.



## New All Balance Arm

G.R.D. INSTRUMENTS PTY. LTD., who are Australian distributors for the All Balance tone arm, advise that a new model is now available fitted with an adjustable anti-skating device.

The new model is also fitted with a new type of precision ball race of Swiss make. Earlier improvements such as rubber-mounted balance weight, alternative light and heavy mounting plates, and adjustable head shell, have been retained. It is claimed that the arm has high performance with low tracking error, low resonance, low friction, and corrected

anti-skate for a wide range of high grade cartridges. An arm-lifting device is available as an optional extra. Price of the arm is \$25.79 retail, or with lift \$44.10 retail.

We have not received for review a sample of the new arm, but we have previously commented on the excellent performance of All Balance arms. The present modifications appear to be in line with a process of improvement designed to keep abreast with improvements in other components of high fidelity equipment, notably those which apply to cartridges.





# AVAILABLE LOCALLY



WORLDWIDE EXPANSION WITH SINCERITY & DEVELOPMENT

# PALACE

ITOKA PRODUCTS CORPORATION

No. 1-4, 3-chome, Mita, Minato-ku, Tokyo, Japan.

A comprehensive range of products from the ITOKA CORPORATION

- Amplifiers
- Bookshelf speaker systems
- Tape decks.
- Microphones
- Preamplifiers
- Stereo and mono microphone mixers
- Stereo headphones
- Tuners
- Solid state modules
- Phono preamplifiers
- Tape preamplifiers
- Audio power amplifiers
- Code oscillators
- Guitar amplifiers



## GENERAL ACCESSORIES

(A DIVISION OF ELECTRONICS INDUSTRIES)

116-118 CLARENCE STREET, SYDNEY 443 CONCORD ROAD, RHODES — 73-0211

BOTH STORES OPEN SATURDAY MORNING

### R.C.S. SPECIALS



**NEW IMPROVED  
30 WATT**  
NOMINAL  
54w MAX.

**12v All Transistor  
P. A. AMPLIFIER**

**WIRED READY TO OPERATE**  
15 ohm output No. 591D ..... \$62  
125, 250, 500 ohm 592D ..... \$62  
Dimensions: 6 1/2 in. w. X 3 1/2 in. h X  
8 1/2 in. d. For 240V op. \$33 extra.

**10 WATT P.A.**  
Inputs 5 MV and 100 MV, 10w R.M.S. at 1%. Frequency 40cy.—30kc. For use with 1 4 ohm, 2 8 ohm or 4 16 ohm speakers in parallel. Same cabinet and dimensions as 30w above.  
Wired and tested, No. 485, \$40.  
Freight extra in both cases.



**R.C.S. COMPLETE  
DO-IT-YOURSELF  
KITS**

Peak reception, low price. No expensive test equipment. Everything fits. 1964 R.F. Transports 7.

Complete kit—No. 640 ..... \$43.50  
Portable car radio, identical to 640 above, plus extra switch and car coil etc. No. 642 ..... \$46.00  
(Write for booklet on 640 and 642)  
Postage \$1.

#### NEW TRANSISTOR PREAMP KIT

SIZE 3 x 2 x 1 1/2 in 2 req. for Stereo.  
LOW IMP. Input 2 trans. 672C ..... \$6.50  
Wired ready for use. 672D ..... \$8  
HIGH IMP. 2 tran. 680C ..... \$6.50  
Wired ready for use 680D ..... \$8  
HIGH IMP. silicon 3 tran. 682C ..... \$8  
Wired ready for use. 682D ..... \$9.50  
Postage 10c each. Write for data.

#### HI-FI BROADCAST TUNER UNIT 4 TRANSISTORS — HI SENSITIVITY.



R. F. mixer, I.F., pwr., dectr. stages, adjustable aerial coupling. Complete as illust., wired and tested with 461 dial. Knobs and switch pot. No. 474D, \$31. Postage \$1.  
**WHISTLE FILTER** for above set for 8Kc band width (can be altered to 9, 10, or 11Kc). No. 128, \$4. Post 10c.

### PRINTED CIRCUITS

For all R. and H., E.A., Mullard, Philips and other designs. Clearly coded, White letters and numbers, easy assembly and service, polished and resined for easy soldering. With blueprint parts list.  
**SPECIALS:** To your drawing—write for particulars and Drafting aids.

New Printed Circuits	Number.	Recent Designs
726 3 x 3 or 10 x 10 w stereo 68/A8	722 Mullard pre-amp	\$3.00
736 B/C tuner EA	725 Protected supply	\$2.50
	734 E.A. 69 01 gold p. organ	\$5.00
727 E & A wide band. tuner 68/8T	731 E.A. 68 M 12	\$2.50
728 Audio osc. E.A.	709 Pre-amp 67-P5	\$2.50
	684 Pre-amp 65-P10	\$2.50
718 Mullard main amp.	685 Pre-amp. 65-P12A	\$2.50
	686 Pre-amp. 65-P12B	\$2.50
		\$2.50

Write for full list. Immediate despatch. Postage 10c.



### 10W STEREO

**MULLARD 10 x 10  
watts R.M.S.**

With output transistor **PROTECTION**. Frequency response 40cy. to 30Kc. Distortion 0.5%. Treble, bass. boost 20dB. Complete kit of parts No. 480C ..... \$74.00.  
Wired and tested No. 480D ..... \$79.00.  
With hi-fi tuner and whistle filter, \$35 extra. Freight extra. Write for details. For special Saturday demo. ring 59-6550.

#### MAGNETIC STEREO PRE-AMP

In 5mV out 250mV. Bass and treble 20dB. No. 724C \$29.  
Wired ready for use \$31.  
Postage 30c each.  
For crystal ceramic. No. 722D —\$27.00.



#### TRANSFORMER

Tap 4.6v and 9v D.C. at 100 millamps.

Filter, condensers, rectifier, resistor, case, etc. \$6.50. Post 10c.

#### PERSONAL PORTABLES 2 TRANSISTORS

Range 30 miles, 200 with short aerial and earth. Earpiece only, no speaker. Wired ready to use. No 666D, \$10.  
Postage 20c.  
Do-it-yourself kit, No. 666C, \$9.00.



**1 TRANSISTOR — 1 DIODE**  
593C Do-it-yourself kit, \$5, post 10c.  
593D Wired ready to operate, \$6 post 10c.

#### DIAL KITS SCALE GOLD WITH WHITE LETTERS.

Size 6 3/8 x 2 3/8 in.  
● No. 459 to match 300 pf gang. Price ..... \$4.50  
● No. 461 to match 200 pf gang. Price ..... \$4.50  
Post 20c.

#### NEW AUDIO AMPLIFIER



4 transistors. 1/2 or 1 watt. Small size, cabinet 3in x 2in x 1in plastic. Suitable crystal P./up. inter com., microphone, radio, etc. (9 volt).  
**DO-IT-YOURSELF KIT 665, \$10 (Post 10c). Wired ready for use 665D \$11.50**

#### COILS & IF's 455 Kc

Aer. R.F. OSC. and IF's .. \$1.80 ea.  
Ferrite Aer. .... \$2  
No. 265 Universal tape OSC Coil. \$6  
Postage 10c. Write for details and price.

**R.C.S.** Order by Mail Order, Postal Note or Money Order (add post.), direct to—  
**RADIO PTY. LTD., 651 FOREST ROAD, BEXLEY, N.S.W., 58-3491, 58-5385**



# NEW "EVEREADY" RELEASES

Union Carbide Australia Ltd. has introduced on the market a portable fluorescent lantern and a range of alkaline batteries.

The fluorescent hand lantern (No. 360 Fluorolite) is a compact unit, measuring approximately 11 x 6 x 2½ in overall. It is powered by two No. 509 lantern batteries, and light is provided by a 6W fluorescent tube. The unit costs \$27.50 plus batteries. The makers say that up to 18 hours operation can be obtained from the two batteries.

The metal and plastic case is of pleasing design, as can be seen from the photograph at right. The top and bottom caps and handle are of high impact plastic mouldings, and the transparent front cover is also plastic. The rest of the casing is sheet metal, the external surfaces being covered with a decorative plastic sheet material of the self-adhesive type. An ON/OFF switch is conveniently situated high up on one side so that it can be operated by the hand holding the lantern. Standard miniature fluorescent fittings are used, and the transistorised converter is mounted in a normally inaccessible position inside the case, thereby forestalling the unwelcome attentions of young fingers. The lid is hinged and held in position by a knurled thumbscrew. We feel it would be an advantage if this thumbscrew was made captive, since it is the type of thing which could easily go astray.

We tested the unit in typical locations,

and found it to be a convenient source of reasonably bright light, very useful in areas where mains power is not available. However, we believe it is not markedly better than a normal incandescent hand lantern in most domestic situations. The unit will justify its rather high price much more readily in more specialised applications, such as: camping sites and caravans and similar outdoor situations, where it would be more convenient and presumably safer than alternative lighting using gas or kerosene; in the home during power blackouts, since one lantern will provide a reasonable level of lighting in a medium sized room; for the use of service and maintenance personnel in unlighted locations, particularly where flame-type lights would be undesirable; in the home where tasks have to be carried out in dark corners, such as in attics or unlighted sheds.

We understand that quantities of the "Fluorolite" have been supplied to the armed services, public utilities, fire brigades and ambulance services. The unit should be made available through normal trade channels by the time this review appears.

The "Eveready" alkaline batteries, made by Union Carbide in the U.S.A., are recommended for appliances requiring a heavy current drain, such as in tape recorders and record players. In fact, the greater the current drain, the greater the service superiority of the alkaline type battery over the conventional carbon/zinc type. Initially, eight sizes of alkaline cells have been introduced, including those equivalent to the three most popular sizes of carbon/zinc cells. These three sizes, which are expected to be the

*This counter display will be made available to retail and trade establishments for Eveready alkaline batteries.*



Eveready "Fluorolite" lantern.

major sellers in the new range, will be marketed in twin blister-packs, as illustrated at left. Among the other types available are some multi-cell batteries delivering 3V or 4V and fitted with snap fasteners for portable radio use.

Literature on the batteries quotes typical situations where the alkaline types will give from three times to 10 times the life of carbon/zinc types of comparable size. Other advantages listed are: exceptional current handling capabilities; consistent performance over a wide temperature range, down to as low as minus 40 deg. C; extended shelf life due to hermetic sealing; sealed construction prevents leakage and salting.

Prices of the alkaline cells are generally three to four times higher than equivalent size carbon/zinc types, so economic advantages would only be apparent in situations where more than three to four times the life can be expected. However, there are other advantages which apply in some cases. In the case of transistor radios, for example, the lower internal resistance results in improved performance, and the longer periods between battery changes gives added convenience, although life performance is only three times that of equivalent carbon/zinc types. In motorised devices such as tape recorders, record players and toys, and in some devices using light bulbs, the advantages are more obvious. (H.A.T.)



## NCR to market electronic calculators

NATIONAL CASH REGISTER CO. PTY. LTD. has entered the calculator field with an electronic model using integrated circuits and removable circuit boards. Designated the NCR 18, the calculator features two magnetic core memories, working register, 16 digits of display, automatic floating decimal point, decimal point selector and automatic square root computation. It also offers fully automatic addition, subtraction, multiplication and division with automatic round-off under switch control.

It provides constant multipliers or divisors, credit balance indication and overflow warning lights. The core memories retain data even if power is removed. Calculations are performed in less than half a second. It is not necessary to clear

the display before commencing new calculations. The NCR 18 is compact and lightweight, so that it can be moved easily around the office. Further details can be obtained from the company's head office at 14-16 York Street, Sydney, 2000.



## TRADE RELEASES—in brief

**STANDARD TELEPHONES AND CABLES PTY. LTD.** Mr J. B. Scott has taken up a new post in Canberra, having been appointed as the company's resident director in the A.C.T. with offices in Moresby House, London Circuit, Civic. Mr Scott graduated as a Bachelor of Engineering at Sydney University in 1933. He was manager of the Line Transmission Division at Alexandria when in 1965 he was appointed divisional manager of the company's Liverpool plant. He was made assistant managing director in charge of Liverpool operations in 1966. In 1967, he was transferred to Alexandria as assistant managing director in charge of Alexandria operations.





### A NEW MODEL GRACE ARM NOW AVAILABLE!

Although available only a few months, Grace tone arms are already prized by the audio enthusiast. The new Model G-545 is a winner . . . it features a gimbal type gyroscopic bearing and will track down to 1/4 gram with suitable stereo cartridges. A super light-weight head shell is supplied; the new arm shape reduces tracking error to the point where it may be disregarded. Ask for prices or write for an EMQ.



### GRACE LIFTS REMOVE THE RISKS!

Handling delicate cartridges and arms requires some dexterity and the softer touch. The new Grace lift matches all Grace arms, is velvet-smooth and may be regarded as a precision instrument. Ask for prices.

### NEW GRACE STEREO CARTRIDGE

The Model F-8M has an output of 7 mV, and a frequency response of 5-35,000 Hz. Cross talk is less than -30 dB. at 1 kHz. An elliptical diamond stylus (0.2 x 0.8 mil.) is standard equipment and tracking force is 1/2-2 1/2 grams. Weight of the cartridge is 6 1/2 grams. Performance equals many cartridges selling at twice the Encel price. Write for full details and prices.

## Encel ELECTRONICS (STEREO) PTY. LTD.

Head Office:

431 Bridge Rd., Richmond, Victoria 3121.

Tel. 42 3762.

Sydney Store:

Ground Floor, 25M Building,

257 Clarence Street, Sydney, N.S.W. 2000.

Tel. 29 4563, 29 4564.

\*Wholesalers

\*Trade-ins accepted

Australia's Greatest Hi-Fi Centre

**FAIRCHILD AUSTRALIA PTY. LTD.**, 420 Mount Dandenong Road, Croydon, Vic. 3136.

**Silicon Power Transistors AY8108-11, AY8115, AY8116.** Features: AY8108 and AY8109 20W, AY8110 and AY8111 25W, AY8115 and AY8116 6W: discrete emitter geometry with integrated feedback resistors; higher safe area power dissipation; increased secondary breakdown capability; high frequency, 50-60MHz; high voltage, 60V. Cost (for small quantities AY8108 \$2.50, AY8109 \$2.00, AY8110 \$4.15, AY8111 \$4.50, AY8115 \$1.50, AY8116 \$1.20 each.

**AUSTRALIAN GENERAL ELECTRIC PTY. LTD.**, 103 York Street, Sydney. 2000.

**SC141, SC146 Plastic Power Pac Trlacs.** Feature: SC141 6 amps, SC146 10 amps; moulded in silicone resin; copper mounting tab is extension of heatsink at bottom of the case; with leads bent at right angles, package is interchangeable with TO-66 metal can; designed for switching functions in consumer and industrial applications. For further information regarding price and availability, contact: A.G.E. reps., Bryan E. Catt — Sydney 29-7553 — or Alan Powell — Melbourne 67-8221.

**ALLIED CAPACITORS PTY. LTD.**, 752 Pittwater Road, Brookvale. N.S.W. 2100. Agents for U.S. Capacitor Corporation, U.S.A.

**Ceramic Chip Capacitors.** Features: high reliability; various temperature coefficients available; physical size .075 x .035 x .04in thick; range from 10pF to 3.3uF at either 50V or 100V; self levelling noble-metal mounting pads; each capacitor marked for capacitance, tolerance and voltage.

**KIT-SETS AUST.**, Box 176, P.O., Dee Why, N.S.W. 2099. The price of 1/2W resistors has been reduced to 4c each or \$3.00 per 100. The prices of polyester capacitors have also been reduced, as have the prices of quantity buying discounts. A new price list is available on application.

## Computer Counter

**HEWLETT - PACKARD CO.**, Palo Alto, California, U.S.A. has released details of the new model 5360A computer counter, first shown at the recent IEEE Show in New York. The basic frequency measuring range is 0.01HZ to 320MHz, extendable to 18GHz with plug-ins. Time intervals are measured with an accuracy of 1nS or better with 100pS resolution. The significance of the  $\pm 1$  count ambiguity is reduced 1,000 times through interpolation, compared with earlier instruments. In most ranges the counter measures frequency a 100 times more accurately within any customary time interval, or measures with commonly-desired levels of accuracy in 1/100 of the time formerly required. Results are shown on an 11-digit display.

The instrument, which incorporates its own computing circuitry, can automatically measure a single short burst of RF carrier, and read out the frequency directly; it can deliver phase information directly, calculated from time interval measure-

## Amateur Transceiver

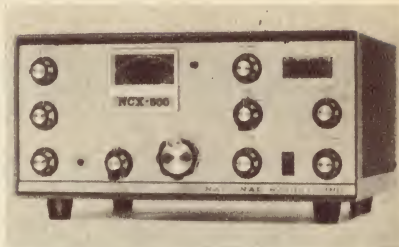

**AURIEMA (A'SIA PTY. LTD.)**, 443 Kent Street, Sydney, N.S.W. 2000. Agents for National Radio Co. Inc., U.S.A.

**National Radio NCX-500** transceiver for the amateur radio field. Features: 500W peak envelope power on SSB; grid block keying on CW; compatible AM operation; receive vernier has tuning range greater than  $\pm 3$ KHz; has separate product and AM detection, sidetone monitor and built-in oscillator for code practice; fast attack, slow release AGC in all modes; uses heavy duty 6LG6 valves; crystal controlled pre-mixing with single VFO for effective frequency stability; identical calibration rate on all bands; crystal lattice filter for high sideband suppression on transmit also rejects adjacent channel QRM on receive; has solid state balanced modulator for "set and forget" carrier suppression. Price on application to the agents.

**RUTHERFORD ELECTRONICS PTY. LTD.**, 833 Doncaster Road, Doncaster, Victoria 3108. Distributors for National Semiconductor Corporation, U.S.A.

**Operational Amplifier LM107.** A high performance operational amplifier with built-in frequency compensation. Features: Guaranteed bias current of 100nA and offset current of 20nA over the full military temperature range; offset voltages of 3mV and offset voltage drifts of 15uV/deg. C also guaranteed over the military temperature range. The LM107 serves as a plug-in replacement for the 709, LM101, LM101A and the 741. Low input currents make it suitable for long interval integrators or timers, sample and hold circuits and low frequency waveform generators.



ments; it can directly read  $Df/f$ ; it can average values over chosen time periods, and convert units. On command from an accessory keyboard, it will go far beyond all the usual calculation functions; it will, for example, make differential measurements, take square roots, or give standard deviations. With the accessory keyboard, the 5360A can automatically process its own measurements and external data. Programming can be performed with simple plug-in program modules. Inquiries to the Australian associate company, Hewlett-Packard Australia Pty. Ltd., 22-26 Weir Street, Glen Iris, Vic. 3146.





### Variable Mains Transformers

Recently to hand from the Miniwatt Electronics Division of Philips Electrical Pty. Ltd., is a sample from the comprehensive range of variable mains transformers manufactured by the company.

As with most of the units in the range the sample is an autotransformer. It has a single layer, toroidally wound core with a sliding carbon contact, and is moulded in reinforced polyester resin to obtain a very compact package for a unit with this power rating.

The unit has the type number, 2242-530-01407 and is designed to deliver voltages from 0-180V with an input of 220 or 240 volts. Nominal output current over the whole range is 0.7A with a frequency range of 50 to 400Hz. Operating temperature range without derating is from minus 15 to plus 40 degrees centigrade.

Overall diameter is 3½ inches, not including the terminal block and the required depth behind the mounting panel is 2½ inches. The spindle which can be of any length, can protrude from either side of the unit and is locked to the slider by means of an expanding collar.

The price of the unit in small quantities is \$9 including tax. Further information regarding this and other units in the range of variable transformers can be obtained from the Miniwatt Electronics Division of Philips Electrical Pty. Ltd., 20 Herbert St, Artarmon, N.S.W. or interstate offices.

**NARDA MICROWAVE CORPORATION**, Commercial Street, Plainview, N.Y. 11803, U.S.A.

**Microwave Coaxial Attenuators 757C Series.** These moderately priced type N precision coaxial attenuators are said to represent an improvement in performance in major parameters over other attenuators in the same price range. They cover the frequency range from DC to 12.4GHz and are available in attenuation values of 3, 6, 10 and 20dB. The maximum VSWR is 1.20 up to 6GHz and 1.25 from 6 to 12GHz. The power rating is 2W average, with a peak rating of 500W (3 and 6dB values) or 300W (10 and 20dB values).

**SOLARTRON AUSTRALIA**, 112 High Street, Kew, Vic. 3101.

**LM.1604 Digital DC Voltmeter and LM.1605 DC/AC Plug-in Unit.** These were seen for the first time in Australia at the recent I.R.E.E. and I.E.A. Exhibitions in Sydney and Melbourne. The LM.1604 has 0.01 per cent accuracy and uses modular construction. It achieves 1uV DC resolution without needing precautions normally necessary at such high sensitivity. The mains-locked integration, coupled with excellent isolation, gives outstanding noise rejection without filters. Other features are scale length 19999, remote auto ranging, and the instrument is programable.

# Compact, rugged easy-to-read

# JAYEM

## MULTIMETERS



### Model MT220

This volt/ohmmeter is diode-protected against accidental misuse. Sensitivity is 20,000 o.p.v. on DC and 10,000 o.p.v. on AC. Measures DC voltages 0-5000V (6 ranges) and DC current 0-50mA (4 ranges); AC volts 0-1000V (5 ranges); Resistance 0-12 megohms (4 ranges); Level -20db to +62db.

£13.50 plus Sales Tax



### Model HB-100

This rugged pocket size unit has mirror-scale and high sensitivity —100,000 o.p.v. DC and 10,000 o.p.v. AC. Particularly useful for semiconductor measurements. Measures DC voltages 0-3000V (7 ranges) and DC current 0-300mA (4 ranges); AC volts 0-600V (5 ranges); Resistance 0-200 megohms (4 ranges).

£30 plus Sales Tax

For further information contact:

**jacoby, mitchell**  
& co. pty. ltd. 26-2651  
469-475 kent street, sydney

MELBOURNE 30-2491  
ADELAIDE 53-6117  
BRISBANE 2-6467  
PERTH 28-1102  
LAUNCESTON 2-5322



JM/30-69





**NEW SHIPMENT OF HIGH QUALITY, LOW PRICED COSMOS STEREO AMPLIFIERS**

Once more the popular Cosmos Model SW-30C stereo amplifiers are in stock. Output is 8 watts R.M.S. or 15 watts I.H.F.M. in each channel, all necessary control facilities are included and the price is only \$79.50. (IMPORTANT: The sensitivity of the Cosmos suits magnetic cartridges at 5 mV.) Provision is made for use of stereo headphones and a DIN socket permits connection of tape recorders. The pre-amplifier is fully transistorised. Speaker outputs allow for use of 4, 8 and 16 ohm. speakers or speaker systems. The Cosmos is ideal for use with tape recorders and tape decks. When used with high quality stereo pick-ups and wide range speaker systems, results are very satisfying. Encel price, inc. sales tax ..... **\$79.50**

**A NEW ENCEL STEREO SYSTEM FEATURING THE COSMOS STEREO AMPLIFIER—ONLY \$239!** We supply the Cosmos Model SW-30C stereo amplifier, the popular Compax III belt driven turntable, the Lustre Model CP-3 tone arm, your choice of a Shure or Micro stereo magnetic cartridge with a diamond stylus, an oiled teak base for the turntable and a matched pair of Sonics Model AS-61 speaker systems. Each enclosure houses four bass/mid-range speakers and a tweeter. Total Encel price inc. sales tax is only ..... **\$239**

**SAVE ON SANSUI AMPS & SPEAKERS**  
All popular Sansui models are in stock . . . amplifiers and speaker systems. Write for your EMQ or call at your nearest Encel Stereo Centre.

**CONNOISSEUR STEREO CARTRIDGE — ONLY \$12.50**  
Designed to effectively load any amplifier or tape recorder, the Connoisseur Model SCU-1 ceramic stereo cartridge has an extremely wide frequency response and is fitted with a diamond stylus. Ask for copies of reviews ..... **\$12.50**

**SAVE MORE ON ALL LEADING MAKES OF TAPE RECORDER**  
Encel Stereo Centres stock all the best makes . . . Akai, Sony, National, Toshiba, Philips, Revox, Tandberg, Nivico and many more. You'll be wise to secure an Encel price before you commit yourself elsewhere. Save at Encel's!

**KENWOOD AMPLIFIERS NOW AVAILABLE!**  
Save more at Encel's . . . write or call for your Kenwood price. Ask for a trade-in valuation on your old equipment; often the allowance made for working units will reduce your outlay considerably. All Kenwood models available.

**POPULAR LOWTHER SPEAKERS AVAILABLE**  
Stocks of the Lowther Model PM7 have just arrived and are available at Encel Stereo Centres in Melbourne and Sydney. Cabinet specifications are available to suit this particular model. Encel low prices cannot be advertised. Write for an EMQ or call for your personal Lowther quote.

**TRADE-IN AND TRADE-UP!**  
When purchasing equipment from Encel Electronics, be sure to ask for a trade-in valuation on your old equipment. If your old equipment is in good working order, the cost of your current purchase can be reduced considerably. Bring in your amplifier, tape recorder, tone arm, etc. . . . and save more than ever at Encel Stereo Centres!

**Celestion**



**THE NEW MODEL HF 1300 MK. II TWEETER**  
A further development of the popular HF 1300 tweeter, which was patterned on the well-known GEC BSC 1853 tweeter. Frequency response is 2 kHz. to 15 kHz. plus or minus 2 dB. and extends well beyond the latter frequency. Impedance is 15 ohms at 10 kHz. Recommended cross-over frequency is 3 kHz. This tweeter adds "sparkle" to any speaker system. Including Sales Tax ..... **\$17.50**

**BUY YOUR NEW PHILIPS STEREO RECORDER FROM ENCEL ELECTRONICS**  
You'll save more when you buy your new Philips recorder from Encel's. Models currently in stock include EL3302, EL3312, N4308 and the new model N4408. The latter is one of the most effective stereo recorders ever available, and extremely good value at the low Encel price. It features 3 speeds, 4 tracks, 2 VU meters, stereo speakers and it is completely solid state. It takes 7" reels, frequency response at 7 1/2 i.p.s. is 40-18,000 Hz. ± 3 dB. The fast forward and fast rewind rate is 1800' within 200 seconds. An automatic selector enables the operator to find sections of the tape accurately and quickly. Encel's prices cannot be advertised because of agreements with manufacturers. Write or call for your trade-in valuation or an EMQ (Encel Mail Quote).

**ENCEL ELECTRONICS (STEREO) PTY. LTD.**

**Head Office:**  
431 Bridge Rd., Richmond, Victoria 3121. Tel. 42 3762.  
**Sydney Store:** Ground Floor, 2SM Building  
257 Clarence Street, Sydney, N.S.W. 2000. Tel. 29 4563, 29 4564.  
**Australia's Greatest Hi-Fi Centre** \*Wholesalers \*Trade-ins accepted

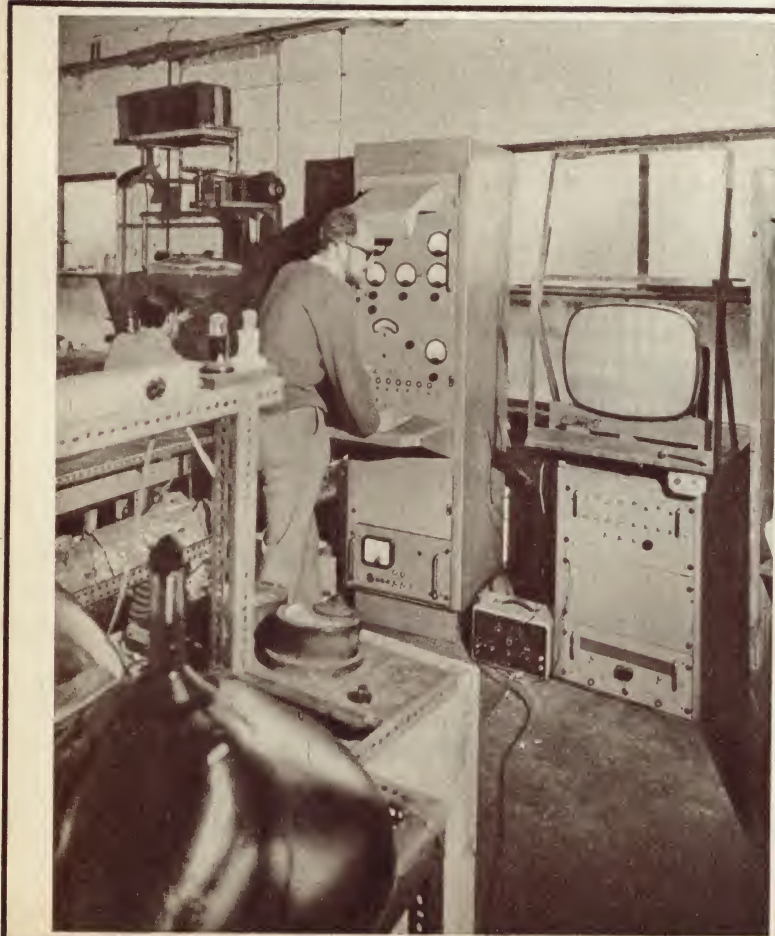

**TEL-LEIGH-TUBES PTY. LTD. (Sydney and Melbourne)**

Manufacturer of Premium Quality TV Picture Tubes with

**TWO YEARS GUARANTEE**

Once a tube is manufactured by Tel-Leigh-Tubes Pty. Ltd. it is subject to a series of rigid tests and quality inspections before leaving our factory. This photograph shows a tube undergoing inspection on one of our eight modern electronic testers during the tenth of sixteen checks.

**N.S.W.:**  
**Tel-Leigh-Tubes Pty. Ltd.**  
51 Reuss Street, LEICHHARDT, Sydney, N.S.W. 2040.  
Ph.: 56-8498

**VIC.:**  
**Tel-Leigh-Tubes Pty. Ltd.**  
32-34 Graham Road, HIGHETT, Melbourne, Vic. 3190.  
Ph.: 95-4086.



**WARBURTON FRANKI INDUSTRIES (MELBOURNE) PTY. LTD.**, 220 Park Street, South Melbourne, Vic. 3205. Agents for Sanwa Electric Instruments Co. Ltd., Japan.

**Sanwa 501-ZTRD Multimeter.** A high sensitivity circuit tester with a wide selection of measurement ranges, it has an internal resistance of 20K/V on the DC voltage ranges. The circuit includes a silicon diode to protect the meter movement. A standard high voltage probe has a sealed-in 480M multiplier resistor and allows measurements up to 25KV. A polarity switch permits the reversal of connections on DC measurements. The ranges are: DC voltage, 0.25V to 5KV in nine ranges, 25KV with probe; AC voltage, 2.5V to 1KV in five ranges; DC current, 0.5mA to 10A in six ranges; resistance, to 50M in five ranges.

**TECNICO ELECTRONICS**, 53 Carrington Road, Marrickville, N.S.W. 2204. Agents for Princeton Applied Research Corporation, U.S.A.

**Princeton Multiplier Research Instrument Module Model 230.** This module performs analog algebraic computations which can be read out directly or can be averaged and amplified in a variable time-constant internal RC integrator. It operates over a frequency range from DC to 500KHz; provides a dynamic range of 1000:1; includes automatic overload indication; calculates products, squares, ratios, and square roots; can be operated as a free-standing instrument when powered by a standard  $\pm 24V$  power system. Two of the many uses of the model 230 are the determination of the  $\tau = 0$  auto-correlation (mean square value) of a signal, and measurement of average cross-correlation between two randomly varying signals.

**WARBURTON FRANKI INDUSTRIES (MELBOURNE) PTY. LTD.**, 220 Park Street, South Melbourne, Vic. 3205. Agents for International Rectifier, U.S.A.

**IR Subminiature 1W Zener Diodes.** These are now available in a plastic package similar to the glass type, DO-7. They are made in standard voltages from 3.3V to 100V, with a 5 per cent tolerance, at a cost of 97c each in small quantities.

**Plastic Encapsulated 2A Thyristor.** Available with voltage ratings from 30 to 300V at 66c each for lots of 1,000. **Heat Exchangers.** A range of heat exchangers to suit semiconductors in a wide range of Jedec case styles.

**VARIAN PTY. LTD.**, 38 Oxley Street, Crows Nest, N.S.W. 2065. Australian associated company of Varian Associates, U.S.A.

**VSA-9010 Gunn Effect Oscillator.** This offers 10mW minimum power output over any selected 1000MHz tuning range in the 26.5 to 40GHz region. Maximum operating bias requirements are 6V and 500mA. It is conduction cooled and capable of operating in ambient temperatures up to 100deg C. FM and AM noise characteristics are said to be superior to most reflex klystrons. The output connector mates with a UG-599 micro-flange.

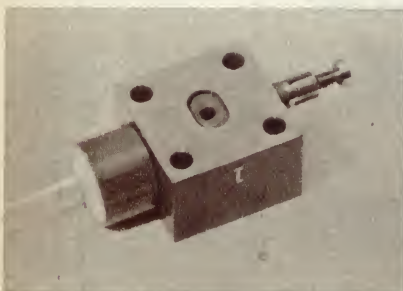

VSA-9010 Gunn Effect oscillator, approximately full-size.

## Monolithic Luneberg Lens



Lightweight, spherical microwave lenses and reflectors of the Luneberg type are now manufactured in monolithic form by Emerson and Cuming Inc., U.S.A. Made in one piece with continuously varying dielectric properties, the units are available in diameters ranging from 6 to 44 inches. Although weighing only 3lb/cub. ft., microwave performance is said to be comparable with standard stepped-index units, weighing 20lb/cub. ft. Inquiries to the Australian agents, I.R.H. Components Pty. Ltd., The Crescent, Kingsgrove, New South Wales, 2208.

**IRH COMPONENTS PTY. LTD.**, The Crescent, Kingsgrove, N.S.W. 2208. Agents for Emerson and Cuming Inc., U.S.A.

**Eccobond Solder 72-C.** This two-component electrically conductive adhesive costs about a quarter the price of silver filled plastic solders, yet effectively replaces hot solders. It has a volume resistivity of 0.01ohm-cm, a value adequate for most applications. A room temperature cure is possible with Eccobond Solder 72-C making it applicable to soldering where high temperatures must be avoided, such as waveguide joints and delicate electronic components. It is a two-part epoxy, with a pot life of one hour, and may be applied with a plastic syringe.

**WARBURTON FRANKI INDUSTRIES (MELBOURNE) PTY. LTD.**, 220 Park Street, South Melbourne, Vic. 3205. Agents for Weston Instruments Inc., U.S.A.

**Weston Model 1270 Digital Panel Meter.** Designed to operate as a basic 10uA device, readout is by three Nixie tubes, easily replaceable from the front of the panel. The standard instrument is available in a choice of 10 voltage and current ranges with 0.1 per cent  $\pm 1$  digit accuracy. **Model 1272 Bipolar Digital Panel Meter.** Engineered and styled in the same size electronic package as the 1270, this meter also displays plus and minus readings. It is available in nine voltage and current ranges. **Model 1280 Digital Panel Meter.** This is similar to the 1270, but is a four-digit digital panel meter. All these instruments include an out-range indicator.

**R. H. CUNNINGHAM PTY. LTD.**, 608 Collins Street, Melbourne, Vic. 3000.

**Q Max Sheet Metal Punch.** To cut holes in steel and aluminium up to 16 gauge, this punch is available in a range of sizes for hole diameters from 3/8in to 1 1/4in, for squares 11/16in and 1in, and for rectangles 21/32in x 15/16in. They cut cleanly and leave no jagged edges, and should be suitable for hobbyists and amateurs not equipped with a machine shop.

## HI-FI STEREO SPECIALISTS

STA ELECTRONICS

MANUFACTURE-SALES-SERVICE

(Props. C. & B. Rener)

731 Centre Road, East Bentleigh, Vic. 3165.

Telephone 579-1519 A.H. 97-5539



KA 600 Stereo amplifier with 8-track cartridge player incorporating X'TAL MAG. AUX. TUNER MIC and HEADPHONE facilities also TAPE OUTPUT. Tape speed 3 3/4 ips. Wow and flutter 0.3 per cent RMS. Music power 15W per channel. 30-20,000 Hz S/N Ratio: 45 dB min. High performance hysteresis motor. Width 16 3/4in. Height 4 1/2in. Depth 12in.

Postage 51.

Price Sp. \$199



### SUPER SPECIAL

Cartridge Tape Recorder. Takes Philips-type Cassette C.30 to C.120 700m Watt Power Output. 150-6000Hz. Wow and flutter 0.35 per cent. Remote control mic.

ONLY \$55

(including leather case)

Postage 80c.



Stereo-Headphones with Volume Controls and Stereo/Mono Chanscover Control. Matched Impedance. 8-16 ohm. Power handling 0.5 Watt attenuator 40 ohms.

Best Value at \$16.75

Post 40c



SPECIAL ONE ONLY AS NEW FISHER STEREO AMPLIFIER TO CLEAR AT \$390. 100 WATT (IHF) 16 INPUTS, 10 OUTPUTS. 21 CONTROLS.

Mail Orders, send postal note, cheque or money order. Please add postage. Inquiries send self-addressed stamped envelope. Our lay-by is at your service. Hire-purchase can also be arranged.



## A vast range of SATO Parts

- For manufacturers
- For TV
- For radio
- For instruments
- For amplifiers
- For kitset builders
- For sound equipment
- For industry
- For stereo equipment
- For educational purposes
- For electronics
- For tape recorders

Distributed by



## GENERAL ACCESSORIES

(A DIVISION OF ELECTRONICS INDUSTRIES)

116-118 CLARENCE STREET, SYDNEY 443 CONCORD ROAD, RHODES — 73-0211  
BOTH STORES OPEN SATURDAY MORNING

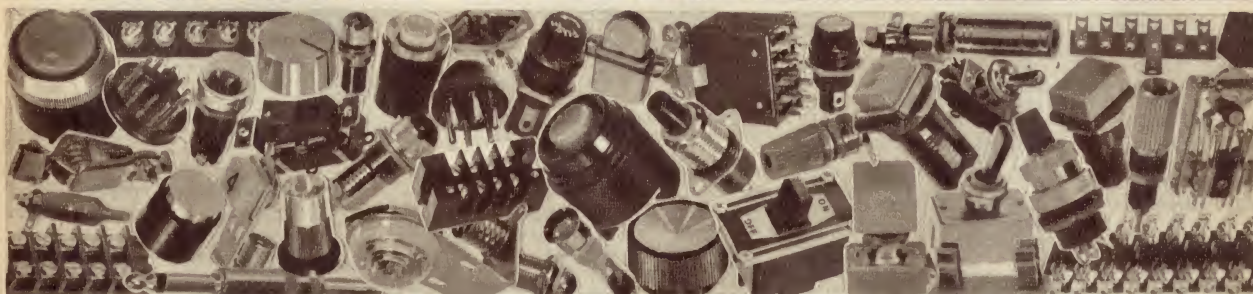

Like being proud of their Kangaroo, Sato's large variety of electrical parts is the favorite choice by Australians. Your inquiries are welcome.

# SATO PARTS

**SATO PARTS CO., LTD.**

HEAD OFFICE: EBISU, SHIBUYA-KU, TOKYO, JAPAN TEL: (442) 8506~8  
BANK ACCOUNT: MITSUBISHI BANK

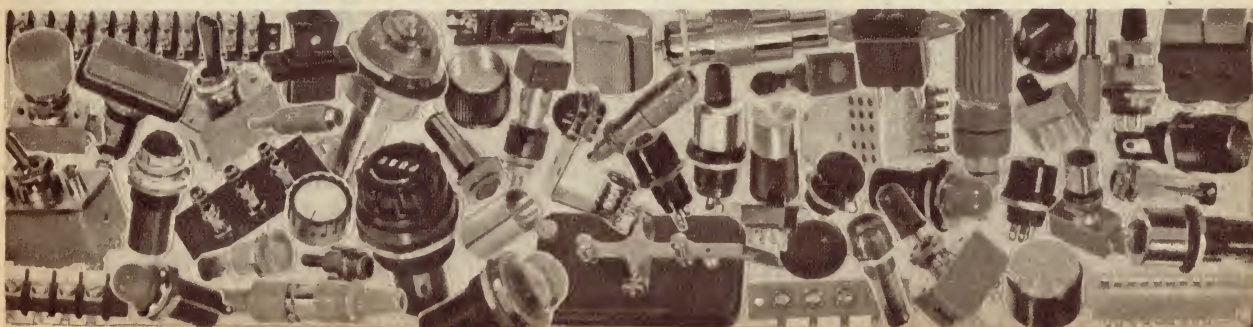



**AUSTRALIAN GENERAL ELECTRIC PTY. LTD.**, 103 York Street, Sydney, 2000.

**High Performance Fluidic Units.** A comprehensive range, designed for aerospace and advanced industrial applications, is now available. They can operate in the most severe environment and are constructed entirely of metal with stainless steel laminations to form the basic amplifiers and logic circuits. Data sheets on the full range of component elements, modular circuits, operational amplifiers, and an analog fluidic portable laboratory kit are available.

**FAIRCHILD AUSTRALIA PTY. LTD.**, 420 Mount Dandenong Road, Croydon, Vic. 3136. A broad range of Fairchild instruments is to be made available in Australia, comprising digital multimeters, panel meters, electronic time and frequency measurement instruments, and a fully programmable curve tracer. After-sales service will be provided. Information regarding availability, specifications, etc. can be obtained either from the Fairchild production plant at Croydon, or from any Fairchild representative.

**AURIEMA (AUSTRALASIA) PTY. LTD.**, 433 Kent Street, Sydney 2000. The Auriema International Group was recently selected to market the electronic measurement and control products of the International Instruments Division of Sigma Instruments Inc., U.S.A. The agreement calls for Auriema to distribute the products on a worldwide basis, excluding the U.S. and Canada. International Instruments products include a complete line of edgewise panel meters, miniature 1in and 1½in diameter panel meters, aircraft instruments and mechanisms, pocket-size VOM multimeters, meter relays, and electronic controllers.

**FAIRCHILD AUSTRALIA PTY. LTD.**, 420 Mount Dandenong Road, Croydon, Vic. 3136. Mr Chris Reardon has been appointed engineering manager of the Fairchild Facility, Seoul, South Korea. He previously held the position of manufacturing manager of the Fairchild Australia plant for the past five years. His successor in Melbourne is Mr John McCluskey, who formerly held the position of production superintendent. Mr Peter J. Walker has joined the company as sales engineer for the Adelaide/South Australian territory in succession to Mr Wayne Fitzsimmons, who has moved to Melbourne, where he operates directly from the Croydon plant.

**A. E. E. CAPACITORS PTY. LTD.**, 202 Bell Street, Preston, Vic. 3072, has been appointed sole Australian agents for Electro Motive Manufacturing Co. Inc., U.S.A. Electro Motive, manufacturer of El-Menco capacitors, has been a pioneer

## New Australian Company

**HY-Q ELECTRONICS PTY. LTD.**, P.O. Box 256, Frankston, Vic. 3199. This recently formed company is fully Australian owned, and is an advanced technological manufacturing company with laboratories and production facilities in Frankston. The company will specialise in the manufacture of quartz crystals, quartz crystal devices, and other related products. The directors are: Mr Peter Cooper, chairman; Mr R. C. Richards, A.M.I.E.E., S.M.I.R.E., S.M.I.E.E., managing director; Mr T. A. Dineen, B.E.M. Mil, marketing director; and Mr G. S. Penglis, director and secretary.



Mr R. C. Richards

in the development and manufacture of higher quality mica dielectric capacitors and the full range will be available from A. E. E. Capacitors.

**PHILIPS INDUSTRIES LTD.**, 69-79 Clarence Street, Sydney, 2000. Mr H. H. Gyles, the company secretary of Philips Industries Holdings Ltd., has retired after 22½ years' service. Mr Gyles was instrumental in the leasing and acquisition of most of the company's premises and a supervisor to the construction of its many buildings. Mr Gyles was also company secretary of most of Philips' subsidiaries, and held these portfolios until the last few years when he was appointed secretary to the personal bureau of the chairman. Mr A. J. W. van Agt. He is succeeded as company secretary by Mr R. Wellings.

**INFORMATION ELECTRONICS LTD.**, 19 London Circuit, Canberra, A.C.T. 2601. Mr S. A. Westwood has been appointed assistant to the chairman, Mr Malcolm Macaulay. Mr Westwood is a communications engineer, who prior to his retirement was associated with STC Australia and ITT South America.

**AUSTRAL ENGINEERING SUPPLIES PTY. LTD.** Mr W. A. Greacen, general manager, and Mr J. McPhee, Newcastle branch manager, left in mid-April on an extensive overseas trip, to include the Hanover Trade Fair. After this they will visit the company's principals in Europe, the U.K. and the U.S.A. before returning to Australia at the end of June.

**THOMSON-CSF (A'ASIA) PTY. LTD.** has announced that the professional electronic activities of Thomson-Houston-Hotchkiss-Brandt group were recently brought together with those of CSF (Compagnie Generale de Telegraphie Sans Fil) under the new name of Thomson-CSF Societe Anonyme. The new company, designing and manufacturing all professional equipments formerly produced under the French trade marks CSF and CFTH, now covers every aspect of modern elec-

tronics in the military and civilian fields. Details of the range of products may be obtained from the Australian subsidiary company, Thomson-CSF (A'asia) Pty. Ltd., 171 Flinders Street, Melbourne, Vic. 3000.

**R. H. CUNNINGHAM PTY. LTD.** has opened a branch office in Western Australia under the management of Bob McGrath. The address is 34 Wolya Way, Balga, Perth, 6061; telephone 49-4919.

**RUTHERFORD ELECTRONICS PTY. LTD.**, 833 Doncaster Road, Doncaster, Vic. 3108, has appointed Peter Moon and Merv White as the company's direct representatives in New South Wales and South Australia respectively. The phone numbers are Sydney 61-2118 (after hours 476-1586) and Adelaide 23-2703.

**TELEVISION ENGINEERING**, a division of Radio Corporation Pty. Ltd., has been converted into two separate divisions to cover the expansion of Astor products to include modern automation systems. The Engineering Products (Sales) Division (manager Mr Paul Long) will handle the expanded Astor range together with agencies such as Pye and Central Dynamics. The Systems Engineering Division, manager Mr John Hart, will carry on the technical services provided by Television Engineering, and specialise in automation and electronic control systems in association with Central Dynamics and other agencies. The former manager of Television Engineering, Mr C. L. Faudell, has been appointed executive consulting engineer with Electronic Industries Ltd. Inquiries should be addressed to Radio Corporation Pty. Ltd., 161 Sturt Street, South Melbourne, Vic. 3205.

**STANDARD TELEPHONES AND CABLES PTY. LTD.** has appointed Mr Dennis Harbour as marketing director. Mr Harbour comes to STC from International Resistance Holdings Ltd., where he was a divisional general manager. He is a graduate of London University and an Associate Fellow of the Australian Institute of Management.

## JINDIVIK . . . continued from page 18

The pictorial record thus obtained is used in conjunction with data recorded by other sources (kinetheodolite and radar trackers) to determine the miss distance to a high degree of accuracy.

One of the attractive features of the Jindivik is its reliability and safety. All electronic sub-units in the command and control system have been built with an inherent high degree of reliability. All air and ground systems are duplicated as far as is practicable. Jindiviks are not normally intended to be the target in weaponry tests, but it sometimes happens that they suffer damage. This possibility

was realised when the aircraft was designed, and as a safeguard against the loss of an aircraft from missile damage, the duplicated systems are as widely spaced as possible within the airframe. It is unlikely that a missile will damage both systems simultaneously, unless the damage to the airframe is so severe that the aircraft would crash anyway.

Should these measures fail to prevent loss of control, there are other safety devices built into the aircraft. The aircraft will not fly erratically if command signals are not properly re-

ceived and decoded. They are normally operated well out to sea or in isolated areas and there is very little risk of an aircraft deprived of control signals crashing into an inhabited area. Instead, it will orbit at a safe height until it again comes under the control of the ground station. Should this prove to be impossible, duplicate command destroy systems can be used to put the aircraft down in the sea or an uninhabited area.

Apart from its many other excellent features, the Jindivik has proved to be a very economical aircraft to operate, and it seems certain that as long as a subsonic target aircraft is still required, the Jindivik will fill the part admirably.



# Electronic Technicians Earn Big Money!

## Why not YOU?

With training through T.T.I., you could qualify for a start in the Electronics Industry as a:

- Radio-television technician • Telecommunications technician • Instrumentation technician • Business machine technician • Automatic control technician • Industrial electronic technician—and many other skilled positions.

### WILL YOU FILL THE BILL WHEN THE TIME COMES?

The "good job" you hold down today may offer less and less opportunity for advancement as Electronics increase their impact on all branches of industry.

**TECHNICAL TRAINING INTERNATIONAL**, a world-wide company with 30 years' experience in the field of specialised technical training, offers the latest Electronics training programmes available in Australia.

**GAIN FULL PRACTICAL EXPERIENCE BY BUILDING YOUR OWN LABORATORY AT HOME.** With T.T.I. training you build over 100 circuit-proving projects. In addition, you actually construct the professional test equipment illustrated here.

IF YOU ARE BETWEEN 18 AND 45 YEARS, AND EARNING LESS THAN \$80 PER WEEK . . . IF YOU ARE SERIOUSLY INTERESTED IN TRAINING FOR A CAREER IN ELECTRONICS, FILL IN THIS COUPON FOR FURTHER INFORMATION, WITHOUT OBLIGATION.



To: Technical Training International Pty. Ltd.  
P.O. Box 328 Chatswood, N.S.W. 2067.

Please tell me more about T.T.I. Electronics Training, without obligation to me.

Name \_\_\_\_\_

Address \_\_\_\_\_

Age \_\_\_\_\_ Present occupation \_\_\_\_\_

T.T.I.—The industry-approved Technical Training Organisation

EA/K

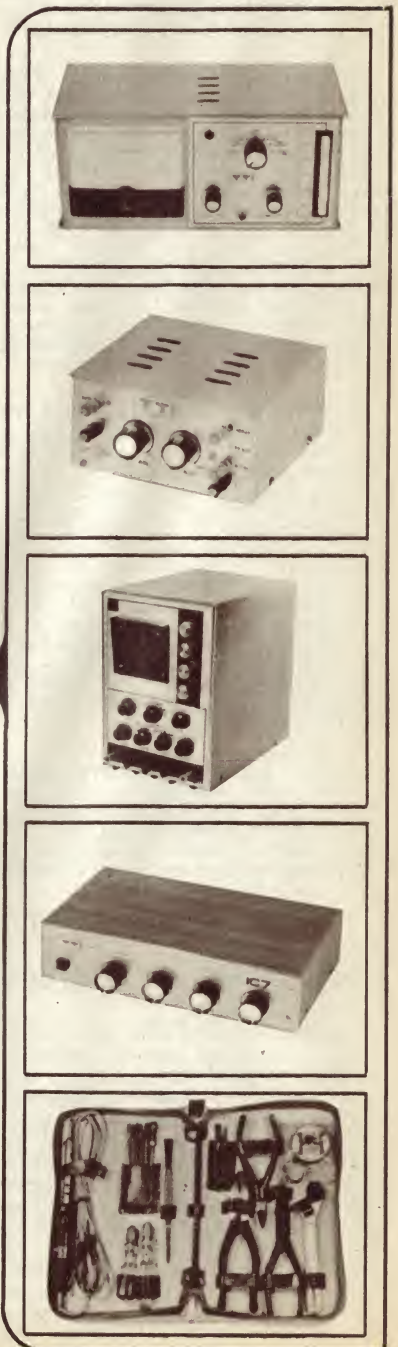



# TECHNICAL BOOKS AND PUBLICATIONS

## Operating a broadcast radio station

**BROADCAST STATION OPERATING GUIDE**, by Sol Robinson. First edition January, 1969, published by TAB Book. Hard covers, 256 pages 8½ x 5½ inches, mainly text. Price in Australia \$16.20.

At first glance, this would seem to be a most unpromising book to release on the Australian market — a book dealing with the radio broadcast situation in the United States and carrying a price tag of no less than \$16.20. However, it didn't take more than a few minutes of browsing to establish that it has quite a lot to say to the intended reader, in or outside the U.S.A.

Written by a man who has had an extensive background in radio broadcasting, it is intended primarily as a guidebook for anyone who may be contemplating the establishment of a radio station or buying into one. Over and above this, it would provide excellent basic reading for anyone involved in — or about to become involved in — the management, commercial or programming side of the business.

Chapter 1 "Market Studies" explains how a would-be broadcaster can assess the ability and inclination of a potential audience to support a commercial radio station — something affected not only by numbers, but by the nature of the audience, the kind of commercial activity in the area, other media available and so on.

Chapter 2 "Programming and the FCC" has special relevance to the U.S. but one gains the impression that the controls and restrictions are not all that different from those which apply to commercial stations in Australia.

"Programming Concepts and Formats" is the subject of chapter 3 and

here the picture is uncannily similar to the local one. It is intriguing to read, for example, that despite listener and management "ideals," stations which have specialised in a classical, semi-classical and show music formula, have almost invariably ended up in financial difficulties. The formula is being abandoned by FM as well as AM stations.

Succeeding chapters cover: "Developing a Program Schedule," "Staffing a Station," "The Sales Department," "Special Sales Considerations" and "Internal Operations." This last-named chapter explains the office routines and the paper work that is necessary in an efficiently run station — sales order, FCC (or other such body) reports, accounting and auditing, attorneys, travel and entertainment, contributions and so on.

Chapter 9 deals with the problems and procedures of "Establishing a Radio Station" while chapter 10 covers "Application to Operation" — keyed to U.S. requirements but typical enough of practice elsewhere.

Books of this general type seldom pass through our hands for review in these columns and we are therefore not informed as to the availability of comparable texts. However, this one appealed to us as being very well written, right up to date and packed with good commonsense in the field of marketing. It left us with the intention of reading it right through — some day, if and when the opportunity occurs! It is certainly well worth examination by anyone actively interested in the field.

Our copy came from Grenville Publishing Company Pty. Ltd., 401 Pitt Street, Sydney, 2000. Copies should be available on order through local bookstores. (W.N.W.).

## Servicing Citizen Band equipment

**PRACTICAL CB RADIO SERVICING** by R. R. Freeland, edited by Leo G. Sands. Rider series, copyright 1968, published by Hayden Book Co. Inc. Stiff paper covers, 175 pages, 9 x 6 inches, illustrated by photographs and diagrams. Price in Australia \$5.90.

In the preface, the author states that there are (or were) some 800,000 C.B. (Citizens Band) licensees in the U.S.A., using 3,000,000 C.B. transceivers — a number which is being added to at the rate of 35,000 per month! Legally, servicing of this equipment must be undertaken only by licensed personnel — adding up to a very large-scale activity.

Examination of the book indicates, furthermore, that American C.B. operation goes far beyond the con-

cept of hand-held walkie-talkies licensed in the Australian 27MHz "commercial" band. With base stations and mobiles, operation has more in common with our VHF radio-telephones plus, of course, a high proportion of irregular DX-ing and inter-station chit-chat.

Because of this difference (one that I imagine the local authorities will strive to maintain) the book has little relevance to the Australian scene. Naturally enough, it contains a fair amount of general information which would apply to any two-way radio system but the material is so directed to a particular end that it would scarcely provide economical study for any other purpose.

There are twelve chapters in all dealing, among other things, with

Base and Mobile station checks, measurement of frequency, modulation, and power output. There is a discussion of sensitivity, selectivity and noise interference, plus chapters on receiver and transmitter troubleshooting.

The book could be read easily by a serviceman or anyone with a modest technical background but its specialised nature will limit its appeal in this country.

Our copy came from Grenville Publishing Company Pty. Ltd., 401 Pitt Street, Sydney, 2000. Copies should be available on order through local bookshops. (W.N.W.).

★ ★ ★

**POPULAR TUBE/TRANSISTOR SUBSTITUTION GUIDE**, by the TAB editorial staff. Published by TAB Books, Blue Ridge Summit, Pa. 17214, U.S.A., January, 1969. Size 8½ x 5½ inches, 157 pages, including 16 pages of valve base connections and three pages of transistor base diagrams. Price in Australia \$3.70 paperback, \$6.15 leatherette bound.

Substitution data for both valves and transistors is included in this quick-reference guide. It is divided into eight sections — four devoted to valves and

## RADIO ENTHUSIASTS

Learn amateur radio in your spare time.

Whatever your interests are in amateur radio, there's a Stott Radio course for you. Easy to follow. Practical. Modern. Guidance all the way by top-flight radio engineers.

### Radio for amateurs

Learn the exciting skills of building modern radio receivers. Learn about the latest advances in electronics, design, construction and operation. Let Stott's show you how.

**Amateur Operator's Certificate Course:** Broadcasting is fascinating. Stott's offer an entirely new course that enables you to sit for the Amateur Operator's Certificate of Proficiency Examinations with complete confidence.

Get full details now on Stott's Radio Courses.

POST THIS COUPON TODAY

**Stotts** 

TECHNICAL CORRESPONDENCE COLLEGE

159 Flinders La, Melbourne. 383 George St, Sydney  
290 Adelaide St, Brisbane. 45 Gilles St, Adelaide.  
1130 Hay St, Perth.

Please send me, free and without obligation, full particulars of your courses in Radio for Amateurs.

Mr Mrs Miss.....

Address.....

Age.....

No sales representative will call



# MASTERSOUND

## THE LEADING SOUND CONSULTANTS

At Mastersound we have a long-standing reputation for selling only top quality equipment. Come in, look around, listen to any of our fine equipment and if you're completely satisfied buy with the confidence that you have bought the best.

### NEW LEAK STEREO 70



The NEW LEAK STEREO 70 will thrill you with the clearest, most exciting sound ever reproduced by an amplifier — 35 watts P.M.S. per channel — distortion a mere 0.1 per cent at 1,000 Hz for all power outputs up to 25 watts R.M.S. per channel. Brand new features of the Stereo 70 include — extra output, enabling a pair of loudspeakers to be connected apart from the two in the main listening room — a head-phone socket for private listening — a DIN record-replay socket on the front panel for a portable tape recorder.

### THE QUAD 33/303

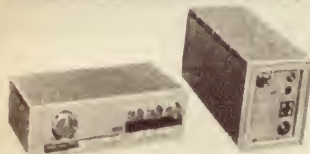

At last, QUAD has gone solid state — Phenomenal specifications — Distortion no greater than 0.03 per cent up to 45 watts per channel — Stability: stable under all conditions with any load. New switching facilities and plug-in printed circuit boards for pick-up matching. Hum and Noise: 100db below full output. Comprehensive controls on pre-amplifier. The most carefully built and designed amplifier of our time.

### SANSUI 777



All silicon Solid State Pre-main Amplifier with a power output of 30 watts R.M.S. per channel. Distortion less than 0.5 per cent. Frequency Response of 20-100,000 Hz. Professional designed fascia panel and switched bass and treble controls. Filters. Loudness: A masterpiece of electronic design.

### SANSUI AU70



If it's a valve amplifier you prefer, then this is the one for you. Exquisite quality and a performance that will surprise you—25/25 W RMS.

Looking for a speaker to match or improve your present equipment?



### THE FAMOUS AIREDALE SYSTEM

The 3-way speaker system by WHARFEDALE in sand-filled cabinet using 15in woofer, 8in midrange and 3in treble unit. Concert Hall performance at your fingertips.



### WHARFEDALE SUPER 10"

The performance of this speaker will amaze you as will its low price.



### KEF/WHARFEDALE

If you like the expensive sound of KEF at \$450 a pair. Listen to Mastersound's KEF/WHARFEDALE at only \$250 a pair.



### FISHER XP33

THE LITTLE GIANT. If space is your problem but you don't want to sacrifice quality then this speaker is the answer to your dreams. Incredible performance from a small but highly efficient speaker system.

Tone arms, cartridges, styli, "Dust Bugs," all the accessories to make your listening a real pleasure are always available at  
**MASTERSOUND**

## MASTERSOUND SALES PTY. LIMITED

400 KENT STREET,  
SYDNEY. 29-1527

four to transistors. Sections 1 and 5 list popular American valves and transistors respectively with substitutes most readily available. Section 2 is similar, listing substitutes for American valves found in industrial and commercial equipments. Sections 3 and 6 list American substitutes for foreign valves and transistors respectively. Sections 4 and 8 list base diagrams for valves and transistors, while section 7 is a listing of general-purpose transistor substitutes.

In valve sections 1 and 3, substitutes are classed as "preferred" or "good." The latter are said to work in most cases, although in certain applications they may not work as well as the original. In the industrial and commercial list, substitutes are classed as "equal or superior" or as "non-ruggedised equivalent." The latter are equivalent electrically, but may not last as well in industrial equipment. In these sections, the only other information presented is a reference to the base diagrams in section 4.

In the transistor substitution sections, substitute types are listed with no preference being indicated. Additional information presented is limited to type (PNP or NPN, germanium or silicon), application (e.g. AF, RF), and reference to base diagrams in section 8.

Constructors wishing to build overseas-designed projects may find this guide useful where a valve or transistor originally specified is not readily available. Again, this guide could be of assistance when repairing imported equipment to find replacement types for faulty valves or transistors.

However, the listing can be of only partial value to Australian users, as many of our familiar valve and transistor types are not listed—not even to be found under foreign types. At best, therefore, this guide can only suggest an American equivalent for an American or foreign valve or transistor, which may still leave the problem of finding an Australian equivalent.

Our review copy was supplied by Grenville Publishing Co., 401 Pitt Street, Sydney, 2000. Copies should be available from most booksellers. (J.H.)

★ ★ ★

**ON THE COLOUR TV SERVICE BENCH**, by Jay Shane. Published by TAB Books, Blue Ridge Summit, Pa. 17214, U.S.A., 1968. Size 8½ x 5½ inches, 192 pages, illustrated by circuits and diagrams. Australian price \$8.70 hard covers, \$6.15 paper covers.

This book was reviewed in our April, 1969, issue, page 141. We have been informed that copies are available from Grenville Publishing Co., 401 Pitt Street, Sydney, 2000.

★ ★ ★

**TV SERVICING GUIDEBOOK, Problems and Solutions**, by Art Margolls. Published by TAB Books, Blue Ridge Summit, Pa. 17214, U.S.A., 1968. Size 8½ x 5½ inches, 176 pages, illustrated by circuits and photographs. Price in Australia \$8.70 hardbound, \$4.95 paperback.

This book was reviewed in our May, 1969, issue, page 155. We have been informed that copies are available from Grenville Publishing Co., 401 Pitt Street, Sydney, 2000.



# A.R.R.L. handbook

**THE RADIO AMATEUR'S HANDBOOK**, 46th Edition, edited by Doug. DeMaw, W1CER. Stiff paper covers, 700 approx. pages 9 1/2 x 6 1/2 inches with over 1,300 illustrations, including pictures, circuits, diagrams, tables, etc., published by the American Radio Relay League, Newington, Conn. Price in Australia \$5.85 plus 60c postage (or more depending on postal distance).

Just 12 months ago, we reviewed the 1968 issue of this book and, as we remarked then, it has been published regularly since 1926. Intended primarily to serve the amateur fraternity, it nevertheless contains a lot of material that is of potential value to electronic engineers, technicians and students.

After introducing and explaining amateur radio as an activity, the book devotes three chapters to a comprehensive but necessarily concise survey of electrical laws and circuits, valves and semiconductors. Then follow four chapters on receiving principles and receivers, and transmitting principles and transmitters. Chapter 11 deals with specialised communication systems, followed by one on testing and monitoring transmissions, and another on power supplies.

## NOTES and ERRATA

**PLAYMASTER 122 and 123 WIDE BAND TUNERS:** There have been a few instances where instability has been experienced when these tuners have been aligned. The cure in each case has been the addition of a 200uF capacitor from the 8.2 volt line to earth. An alternate approach could be to change the 400uF capacitor on the output of the filter, with a 1000uF unit. It may be considered wise by dealers to supply a 1000uF electrolytic in place of the 400uF unit as specified in the articles. This could reasonably lead to an increase in cost of something like 50c or so. Also, in the coded photograph for the Playmaster 123 Tuner, the link shown between the 470 ohm resistor and the .0039uF capacitor should be deleted.

### "DIGITAL ELECTRONICS"

In chapter 2, expression (22) on p. 14 should contain a complementation bar over the second "A" term. Also in figure 10 on p. 17 the sample Transistor-Transistor Logic circuit on the lower left is a NAND circuit in positive logic, and not a NOR circuit as shown; the accompanying logic expression should thus read

$$Z = A.B.C$$

In chapter 3, p. 25, fifth paragraph from the top of the first column, three binary bits are claimed to provide only seven code combinations; this is of course wrong, there being eight possible combinations. Also overleaf on p. 27 expression (6) for redundancy should involve the base-2 logarithms of M and N, not these terms themselves:

$$r = \frac{\log_2 M - \log_2 N}{\log_2 M} \dots (6)$$

Transmission lines, antennas and wave propagation form the subject of chapters 13, 14 and 15 for the most part related to the HF bands below 30MHz. VHF and UHF receivers, transmitters, antennas and techniques are covered in chapters 16, 17 and 18.

A following section deals with mobile operation, others with constructional methods, measurements, interference problems and station operation. The book rounds off with valve and semiconductor data, a general index and a catalogue section indicating the kind of equipment which is available to American amateurs from their home market.

The new edition has about the same number of pages as the previous one; it has a similarly styled cover but is readily distinguished by its deep yellow colour.

An examination of the contents reveals that a lot of the earlier material has been retained but there is also ample evidence of change and rearrangement with the individual chapters. This is in keeping with the Editor's policy of constantly updating the text so that, while all A.R.R.L. handbooks have about them a certain sameness, each succeeding edition contains a range of material which is typi-

cal of then-current amateur practice.

In the earlier theory chapters, updating has given rather more emphasis to solid-state techniques and IF filters. On the constructional side, a number of new projects displace older ones and a check of the page numbers suggests that receivers, SSB transmitters and RTT equipment have gained at the expense of conventional AM projects.

One could go on in this strain to the end of the book.

If you have a copy of the last edition, you may be disinclined to spend money on this one. However, it will certainly represent good value to those amateurs who may not have purchased an edition for some years.

Our review copy came from the Technical Book and Magazine Company Pty. Ltd., 288-299 Swanston Street, Melbourne, 3000. (W.N.W.)

### OPPORTUNITY KNOCKS!

Don't be fooled. There are no short cuts to an honest, profitable, dependable business. Build a substantial business or spare-time enterprise you can depend upon. Full free details of wide variety of money-making plans, sent without obligation. Any one could mean lots of extra money and independence. If serious-minded, send stamp for postage NOW. If not, forget it.

DEPT. RH 46,  
BOX 5070, G.P.O., SYDNEY, 2001.

## Be Paid What You are REALLY WORTH!



Develop your aptitudes at your own pace, for recognition that brings HIGHER PAY. Begin YOUR Progress Today! Select the course you want and which will benefit you most. ICS will send YOU promptly—a FREE illustrated BOOK, giving FULL DETAILS.

### GENERAL

Journalism — Short Stories  
Writing for Radio & TV  
Interior Decorating  
Etiquette & Entertaining  
Textiles  
Photography  
Mathematics  
General Education  
Dressmaking

### DRAUGHTSMANSHIP

Architectural  
Builders' Plan Drawing  
Mechanical Structural  
Surveying & Mapping

### ILLUSTRATING

Still Life—Landscape  
Caricature & Cartoons  
Oil & Water Colour.  
Fashion Drawing  
Showcards & Tickets  
Signwriting

### COMMERCIAL

Accountancy  
Cost Accountancy  
General Bookkeeping  
Salesmanship  
Shorthand Typing

Retail Management  
Commercial Management  
Small Business Owners  
Hotel-Motel Management  
Club Administration  
Window Dressing  
Business Letters

### BUILDING

Architecture  
Building Contracting  
Carpentry, Joinery  
Structural Engineering  
Concrete Engineering  
Estimate & Quantities  
Roofing, Steel Square  
Timber Home Building

### INDUSTRIAL

All Mechanical Eng.  
Fitting & Turning  
Soft Drink Manufacture  
Air Conditioning  
Gas or Elect. Welding  
Chemistry, Plastics  
Electronics  
Electrical Mechanics  
Radio Eng. or Service  
Television  
Refrigeration  
Diesel Engines

Auto Mechanics  
Civil Engineer  
Production Management  
Industrial Management  
Executive Training  
Modern Supervision

### SPECIAL EXAMINATION COACHING COURSES

Account'cy: All Exams  
Institute of Secretaries  
Inst. Cost Accountants  
Inst. Sales & Marketing  
Metric, or Leav. Cert.  
Intermediate Certificate  
Senior or Junior Public  
C'wealth Clerical Exams  
Police Entrance Exam  
Nurses' Entrance Exam  
Steam Certificate  
Refrigeration Certificate  
Radio Examinations  
Inst. Auto. Mech. Engrs.  
Inst. Diesel Engineers  
Shire Overseers' Exam  
Engineers' Institutions.

### ADVERTISING

Copywriting  
Commercial Art  
Advertis'g Inst. Aust.

## TO INTERNATIONAL CORRESPONDENCE

Dept. 526 **SCHOOLS.**

SYDNEY: 400 Pacific H'way, Crow's Nest, Tele.: 43-2121.

MELBOURNE: 234 Collins Street, Tele.: 63-7327.

BRISBANE: Heindorf House, 171 Queen St., Brisbane, Tele.: 2-6125.

ADELAIDE: T. & G. Building, King William St. Tele.: W-4140.

PERTH: C'wealth Bank Building, 55 William St. Tele.: 21-7268.

NEW ZEALAND: Wellington, 182 Wakefield St. Tele.: 53-109.

Please send Free Book on .....

NAME (Mr, Mrs, Miss) ..... AGE .....

ADDRESS .....

..... STATE ..... Dept. 526

OCCUPATION ..... PHONE .....

EA 6. 69.



# THE CHOICE IS YOURS at *Southern Sound*

963 Nepean Highway, MOORABBIN VIC. 3189  
Phone 97-7245

## 12 NEW STEREO SYSTEMS available with new exclusive Basic Turntable Module.

Basic Turntable Module consists of famous Belt Drive turntable (wow and flutter less than 0.4 per cent), World renowned B. and O. Tone Arm with built-in anti skate. Magnetic cartridge with diamond stylus. Attractively styled, slim line oiled timber cabinet with plexi-glass lid. Add to this exclusive module any of the following amplifiers and speaker systems.



Your TOTAL cost is shown in the table (Prices include sales tax, fitting and guarantee)

### SPEAKER SYSTEMS

Amps	Peerless	Peak 8A7	Rola C8MX	Sonics AS60
Sound 203 . . . . .	\$209.00	\$209.00	\$215.00	\$217.00
Cosmos SW30 . . . . .	\$214.00	\$214.00	\$219.00	\$222.00
Peak KST200 . . . . .	\$223.00	\$223.00	\$229.00	\$231.00

All speakers supplied in oiled timber enclosures. Individual prices available on request. Write for quotation if you do not require cabinets. Quotations given for any make and model of Hi-Fi gear.

Address enquiries to: SOUTHERN SOUND P.O. Box 204  
MOORABBIN VIC. 3189

## BERNARDS FAMOUS RADIO AND TELEVISION BOOKS

### HI-FI, TUBES, RADIO VALVES, TRANSISTORS, ELECTRONICS

No.	TITLE	PRICE	No.	TITLE	PRICE
56	Radio Aerial Handbook . . . . .	.45	172	International Radio Stations List	.45
57	Ultra-Shortwave Handbook . . . . .	.45	173	Practical Transistor Audio	.60
58	Radio Hints Manual . . . . .	.45		Amplifiers	.60
64	Sound Equipment Manual . . . . .	.45	174	Practical Subminiature Receivers	.85
68	Freq. Modulation Receivers Manual	.45	175	Transistor Test Equipment and	
83	Radio Instruments & Construction	.45		Servicing Manual	.80
96	Crystal Set Construction . . . . .	.18	176	Manual of Transistor Audio	1.00
100	Comprehensive Radio Valve			Amplifiers	1.00
	Book No. 1 . . . . .	.85	177	Modern Transistor Circuits for	
103	Master Colour Code Index for			Beginners	1.30
	Radio & Television . . . . .	.25	178	Comp. Radio Valve Guide Book	
104	Three Valve Receivers . . . . .	.25		No. 5 . . . . .	1.00
121	Comprehensive Radio Valve		179	Transistor Circuits Manual 5 . . . . .	.85
	Book No. 2 . . . . .	.85	180	British Semiconductor Survey . . . . .	2.50
123	Beginners' Push-Pull Amplifier		181	22 Tested Circuits Using MAT's	.85
	Leaflet . . . . .	.25	183	How to Receive Foreign TV Pro-	
126	The Boys' Book of Crystal Sets			grammes by Simple Modifications	.85
	& Simple Circuits . . . . .	.55	184	Tested Transistor Circuits	
129	Universal Gram-motor Speed			Handbook Using Professional	
	Indicator . . . . .	.18		Printed Circuit Modules . . . . .	.60
135	All Dry Portable Battery Port-		185	Tested Shortwave Receiver Cir-	
	able Construction . . . . .	.45		cuits Using Micro Alloy	
138	How to Make F.M. and TV			Transistors . . . . .	.85
	Aerials Bands, 1, 2 and 3 . . . . .	.50	185	Tested Superhet Circuits for Short-	
141	Radio Servicing for Amateurs . . . . .	.60		wave & Communication Receivers	
143	Comp. Radio Valve Guide Book			using MAT's . . . . .	1.00
	No. 3 . . . . .	.85	187	The TSL Mark-4 Valved F.M.	
146	Hi-Fi Loud Speaker Enclosures			Tuner and its Construction . . . . .	.60
	. . . . .	.85	188	Construction of the B.H. Hi-Fi 14-	
147	Practical Tape-Recording			Watt Audio Amplifier . . . . .	.25
	Handbook . . . . .	.85	190	How to Build The World's	
148	Practical Transistor Receivers . . . . .	.85		Smallest Hi-Fi Amplifier (4	
149	Practical Stereo Handbook . . . . .	.60		Transistors) . . . . .	.25
150	Practical Radio Inside Out . . . . .	.80	191	Practical Car Radio Handbook . . . . .	1.00
151	Transistor Superhet Receivers . . . . .	1.30	193	'At a Glance' Radio Valve &	
152	Transistor Circuits Manual No. 1			TV Tube Equivalents and	
157	Comp. Radio Valve Guide Bk. 4 . . . . .	.85		Substitution Manual . . . . .	1.00
158	Radio, TV, Industrial Tubes,		194	How to Build 11 Tested Circuits	
	Semi-Conductors and Diodes			using specially designed TSL	
	Equivalent Handbook . . . . .	1.80		Relays and Light Cells practical	
160	Coll Design & Constn. Manual . . . . .	.85		working wonder gadgets for use	
161	Radio, TV, & Electronics Data Bk.			in Car, Home, Nursery, Kit-	
162	Hi-Fi Stereo Gramophone for			chen and Workshop, Burglar	
	Home Constructor . . . . .	.85		Alarms, Rain Detectors, Life	
163	Transistor Circuits Manual No. 2			Savers, Car and Engine Alarm,	
165	Radio Tuners—Hartley on Hi-Fi,			etc., etc. . . . .	.25
	etc. . . . .	.85	501	ABCs of Magnetism . . . . .	.85
168	Transistor Circuits Manual No. 4		502	ABCs of Missile Guidance . . . . .	.85
170	Transistor Circuits for Radio-		503	ABCs of Ultrasonics . . . . .	.85
	Controlled Models . . . . .	1.30		Resistor Colour Code Disc Calcu-	
171	Super-Sensitive Transistor Pocket			lators . . . . .	.25
	Radio . . . . .	.60		Engineer's Reference Tables . . . . .	.25

### ADDITIONAL BOOKS RECOMMENDED FOR BEGINNERS, STUDENTS AND HOBBYISTS.

**BASIC ELECTRONICS** by van Valkenburgh, Nooger & Neville, Inc. Expanded Course. Volumes 1 through 6, bound in one large volume. Published by Rider. Price \$17.00.

**INTERNATIONAL TUBE & TRANSISTOR HANDBOOK** by De Mulderkerk, 2 volumes (10 languages). Vol. 1 Valves and Tubes, Vol 2 Semi-Conductors . . . . . \$9.00

An authoritative and most outstanding work, 2 vols. bound in plastic covers.

**YOUNG PEOPLE'S SCIENCE ENCYCLOPEDIA**, 20 vols. with two complementary volumes entitled Science Dictionary and New Frontiers in Science, 22 volumes for only \$70.00

This outstanding work is strongly recommended by leading Educational authorities, and has been approved for subsidy to State schools and is an inspiring work for young students and adults.

POSTAGE TO BE ADDED TO ABOVE PRICES. TERMS AVAILABLE BY NEGOTIATION.  
SPECIAL DISCOUNTS TO BOOKSELLERS AND INSTITUTIONS.  
DESCRIPTIVE CATALOGUE AVAILABLE UPON REQUEST.  
Sole Australian Distributors

## BERNARDS RADIO BOOKS AND SUPPLIES

3 Kerferd Street, East Malvern, Vic. 3145. Telephone 50-5225.  
Also Branch Office: 51 Station Street, Malvern, Vic. (opp. Malvern Station)

## LITERATURE—in brief

**STANDARDS ASSOCIATION OF AUSTRALIA**, Standards House, 80 Arthur Street, North Sydney, N.S.W. 2060. The Standards Association is seeking comment on proposals to endorse as Australian Standards ten recommendations of the International Organisation for Standardisation (ISO) relating to cinematography. Copies of the documents setting out the proposals, issued under one cover, may be obtained without charge from the various offices of the Standards Association in all capital cities and Newcastle. Comment on these proposed endorsements is invited from persons or organisations experienced in the manufacture, sale or use of motion picture film and should reach the headquarters of the Association or any branch office not later than June 30, 1969.

**STANDARDS ASSOCIATION OF AUSTRALIA**. A specialist acoustics committee has completed two Australian standards intended for use in acoustics work, and many other standards are in course of preparation. The new standards are: AS Z41, Octave, Half Octave and One-third Octave Band-pass Filters Intended for the Analysis of Sound and Vibrations; AS Z44, Expression of the Power and Intensity Levels of Sound or Noise. The purpose of AS Z41 is to establish minimum performance requirements for filters forming part of equipment used in establishing the characteristics of sound, AS Z44 will assist in explaining and interpreting noise levels. Copies of the standards may be obtained from any office of the Standards Association for \$1 (AS Z 41) and 40c (AS Z44).

**VARIAN PTY. LTD.**, 38 Oxley Street Cross Nest, N.S.W. 2065. A 12-page brochure describes Varian's new E-line electron paramagnetic resonance (EPR) spectrometer systems is available. The E-line is an entire family of EPR systems, comprising easy to use instruments which provide increased flexibility and performance, and featuring an improved microwave bridge. The brochure describes control console modules, the microwave bridge, magnet systems, cavities, a wide range of available accessories, and performance and physical specifications.

**TRIBOS**. Published monthly by the British Hydromechanics Research Association, Cranfield, Bedford, England. Abstracts of papers on tribology which appear in about 340 periodicals from the world's technical literature are grouped under nine main headings which cover lubrication, friction, wear, materials, and sliding contact and rolling contact devices. It is intended that the time delay between the publication of the original article and notification in Tribos will not be more than one or two months.

**MEASUREMENT OF CARRIER LIFETIME IN SEMICONDUCTORS — AN ANNOTATED BIBLIOGRAPHY COVERING THE PERIOD 1949-1967**, by W. Murray Bullis, National Bureau of Standards Technical Note 465, issued November, 1968, 62 pages, 60c U.S. About 300 papers concerned with the measurement and interpretation of carrier lifetime in semiconductors are listed together with key words and a brief comment for each. Eight types of entry are included: Description of Methods; Analysis of results; Standard methods; Experimental results; Theoretical models; Auxiliary procedures and data; Reviews; Books. Order from the Superintendent of Documents, U.S. Government Printing Office, Washington, D.C. 20402, U.S.A.

**TECHNICAL NEWS BULLETIN**, Vol 53, No. 1, January 1969. Published by the National Bureau of Standards, Washington, D.C. 20234, U.S.A. Contents: N.B.S. installs synchrotron; Improved accuracy in neutron activation analysis; Fabric flammability section established; Computer model simulates



north-east corridor; N.S.R.D.S. news; International Committee of Weights and Measures; Brief history and use of the English and metric systems of measurement; Conference briefs; Standards and calibration; Post-doctoral associates begin advanced studies; Standard reference materials; Publications of the National Bureau of Standards.

**NATIONAL BUREAU OF STANDARDS** provides a monthly listing of its latest publications, and recent articles by its staff in non-N.B.S. publications, as a quick reference aid to editors, book reviewers, and others. Short write-ups on N.B.S. non-periodicals are also available. Inquiries to the Office of Technical Information and Publications, National Bureau of Standards, Washington, D.C. 20234, U.S.A.

**SPECTROSYSTEM 100/200 FOR LABORATORY AUTOMATION.** This 20-page booklet, published by Varian Data Systems, U.S.A., provides a clear, concise description of the Spectrosystem 100/200 family of laboratory data processing systems. Supported by 21 illustrations, graphs, and diagrams, the text outlines the equipment capabilities and operation. Sections of the booklet discuss major advantages, system hardware, software, ease of operation, and applications. Inquiries to the Australian associated company, Varian Pty. Ltd., 38 Oxley Street, Crow's Nest, N.S.W. 2065.

**RAYTHEON COMPANY,** Micro State Electronics Operation, Murray Hill, New Jersey, U.S.A. A four-page colour pamphlet describes in detail the dimensions, characteristics, and capabilities of Raytheon's Micro State microwave insert switches, insert limiters, integrated switches and limiters, integrated limiters, mixers, and custom RF assemblies. Diagrams, charts and photographs of the integrated components are included in the booklet. Inquiries to the Australian agent, Auriema (Australasia) Pty. Ltd., 443 Kent Street, Sydney, 2000.

**PRECISION MEASUREMENT AND CALIBRATION; ELECTRICITY—LOW FREQUENCY;** editors F. L. Hermach and R. F. Dziuba, National Bureau of Standards Special Publication 300, Vol. 3 (supersedes in part Handbook 77, Vol. II), December, 1968, 489 pages, price \$4.50 (U.S.). Order from Superintendent of Documents, U.S. Government Printing Office, Washington, D.C. 20402, U.S.A. Each volume in the series, N.B.S. Special Publication 300, will present selected papers, monographs, abstracts, and bibliographies dealing with precision measurement of specific physical quantities and the calibration of the related equipment. Vol. 2 on temperature measurements has already appeared, and Vol. 1 on statistical concepts and procedures is in publication. According to present plans there will be 12 volumes in all.

The material in Vol. 3 is arranged in eight parts: General papers on electrical measurements; Standard cells and zener diodes; Resistors and resistance apparatus; Capacitors and inductors; Instruments and AC-DC transfer standards; Transformers and inductive voltage dividers; High-voltage and surge measurements; Dielectric and magnetic measurements. The bulk of each part consists of the text of previous publications, in some cases revised to bring them up-to-date. These are followed by abstracts of related longer publications. The publication also includes a general bibliography and many references.

**MICROPHONES FOR STUDIOS.** Published by Akustische u. Kino-Geräte (AKG), Vienna, Austria. Contents: condenser stereo microphone, condenser studio microphone, dynamic two-way microphone, dynamic studio microphones, mechanical and electrical accessories. This catalogue lists essential data, design and operation and gives suggested application for each type.



**EMERSON AND CUMING INC.,** Canton, Massachusetts, U.S.A. Australian agents: I.R.H. Components Pty. Ltd., The Crescent, Kingsgrove, N.S.W. 2208.

**Eccocoat Surface Coatings.** A folder describing the company's line surface coatings, including epoxies, urethanes, and low electrical loss hydrocarbons, covering a wide range of applications. Applications and physical properties are both tabulated.

**Eccoshield EMI/RFI Gaskets.** A folder describing Eccoshield gaskets for controlling electromagnetic interference (EMI) and radio frequency interference (RFI). Nine different materials are described, illustrated and presented in comparative property chart form. Applications are shown in sketches.

Inquiries to the Australian agents, Amalgamated Wireless (Australasia) Ltd., Engineering Products Division, 422 Lane Cove Road, North Ryde, N.S.W. 2113.

**TELECOMMUNICATION JOURNAL,** Vol. 36, No. 4, April, 1969. Published by the Publications Service, International Telecommunication Union, Place des Nations, 1211 Geneva 20, Switzerland. Contents: A PCM-PDMA demand assigned multiple access experiment, by J. G. Puente; The "Fonotelex" service, by P. F. Erikson; Simplified method for calculating auroral absorption for distances of over 4000KM, by V. Vladimirov. In addition to giving news about the activities of the ITU, the journal carries information, under the heading "Ideas and Achievements," on: Solar observatory OSO-V; International satellite for ionospheric studies—ISIS-1; Large colour television pictures produced by laser system.

**B.B.C. ENGINEERING MONOGRAPHS.** Published by the British Broadcasting Corporation, and available from B.B.C. Publications, 35 Marylebone High Street, London W.1, England.

**No. 75, December, 1968. Pulse-code Modulation for High-quality Sound-signal Distribution.** Contents: Introduction; Basic Concept of Pulse-code Modulation; Coding and Decoding; Techniques for Improving the Signal-to-quantizing Noise Ratio of the Basic PCM System; Incorporation of the PCM Sound Signal in a Video Waveform; Conclusions; References.

**No. 76, December, 1968. The Variable Inductance Frequency Modulator.** Contents: Introduction; Essential Design Considerations; The Principle of Variable Inductance; Deviation Produced by an Inductance Change; Application to a Practical Circuit; Practical Design of a Broadcast Modulator; Application to a Band II Transmitter; Conclusions; Acknowledgments; Bibliography.

**MULLARD OUTLOOK,** Vol. 12, No. 1, January-February, 1969. Published by Mullard-Australia Pty. Ltd., 35-43 Clarence Street, Sydney, 2000. Contents: Viewpoint with Mullard; Colour Television—Part 3, Colour and Colour Reproduction; TAA300 Integrated One-Watt Class B AF Amplifier; Noise Problems and Interfacing Techniques with Integrated Circuits; Low Cost "Light-Beam" Infrared Communications System; Snap-On Heat-sinks; A Three-Channel Stereo Mixer. Also included with this issue is the Table of Contents and Product Type Number Index for Volume II, 1968.

# PLAN YOUR FUTURE

CHOOSE a career in the field of **ELECTRONICS\*** — the Nation's most progressive and fastest expanding industry.

✳ Advancement in this modern science demands technical ability, a sound knowledge of basic principles and applications.

YOU can master the subject by training at the **MARCONI SCHOOL** and be ready to grasp the opportunities that occur in the three fundamental branches of Radio-technology.

# KNOW WHERE YOU'RE GOING

**A = APPLIED SERVICING**  
Comprehensive training in the maintenance and repair of radio and television receivers offers substantial rewards to competent technicians. Marconi School training covers all aspects of radio and television receiver circuit applications, practical exercises in fault finding and alignment procedures.

**B = BROADCASTING**  
A thorough and practical grounding is available to students in broadcasting transmitter performance standards and maintenance techniques, with individual instruction in station operation and studio control and testing.

**C = COMMUNICATIONS**  
Combines all the foregoing, together with radio aids to navigation, mobile telephony, marine service application and international wireless telegraph regulations, qualifying the successful student for the Commonwealth Government Certificate of Proficiency and the Marconi School Diploma in Radiotechnology. Classes are conducted at 21 Pier Street, Sydney (at the foot of Goulburn Street).

Daily: 9.30 a.m. to 4.30 p.m.  
Evenings: 6 p.m. to 8.30 p.m.  
or by Home-Study Courses (except practical instruction on equipment).

# STUDY NOW

Send for training syllabus. There is no obligation.

NAME.....  
ADDRESS.....

the **MARCONI SCHOOL** of  
wireless  
G.P.O. Box 2516, Sydney  
A Service of Amalgamated Wireless (Australasia) Ltd



# NEW Releases!

## IN HI-FI STEREO EQUIPMENT BY CLASSIC BASED ON THE PLAYMASTER 118 AMPLIFIER



### MODEL C200V. BASED ON THE PLAYMASTER 118 WITH TUNER

Dimensions 16½in x 5½in x 11in.

CABINET IN OILED WALNUT OR TEAK WITH METAL TRIM.

**\$118.00**

FREIGHT EXTRA

This amplifier is based on the Playmaster 118 circuit as featured in "Electronics Australia" to which has been added the following features.

- Inbuilt high gain A.M. tuner with a coverage of 530 to 1,600 K.C.
- Loudness control giving bass boost at low volume.
- Provision for tape, record and play-back, with din connector.
- Calibrated dial available for all States.
- EM84 tuning indicator giving accurate tuning with ease.

POWER OUTPUT: 9 watts per channel R.M.S. FREQUENCY RESPONSE: 20 to 20,000 cycles incorporating Ferguson O.P.412 grain oriented output transformers. VALVES USED: 4-6GW8, 12AX7 or 12AU7, 6AN7, 6N8, EM84 and 2 silicon diodes.

## NEW AMPLIFIER AND TUNER BASED ON THE 107 AMPLIFIER AND TUNER

**\$85.00**

FREIGHT EXTRA

### 107 AMPLIFIER

● Output 5 watts per channel (10 watts). Ferguson output transformers with a response of 30 to 20,000 cycles.

● Valves used: 6AN7, 6N8, 2-12AT7, 2-6BQ5, and 6CA4 rectifier.

### PLAYMASTER 107



#### SPECIFICATIONS

- Inbuilt high-gain tuner with a frequency coverage of 530 to 1,600K.C.
- Two-channel tone control stage with separate bass and treble controls.
- Switching facilities for pick-up and stereo or mono tape recorder for record or play-back.
- Loudness control giving bass boost at low volume.
- Chassis plated and mounted in attractive metal case finished in grey with control panel in silver and black with matching knobs and switches.
- Dimensions: 13½in x 5¼in x 11in.
- Fully guaranteed.

The above amplifier supplied with the new Garrard 40 Mk II Changer with Sonatone ceramic cartridge and diamond stylus and two Magnavox 8WR or Rola 8CMX Hi-Fi speakers.

**\$132.00**

FREIGHT EXTRA

### MULLARD MAGNAVOX MINI SPEAKERS

These units designed by Mullard and Magnavox engineers compare favourably with imported B/S Speakers costing more than twice the amount and are ideal where space is limited. Incorporates the Magnavox 6WR 6-inch Speaker and the new 3TC Mk. II tweeter frequency response, 50 to 18,000 cycles. Power rating max. 8 watts. Available in 7½ or 15-ohm impedance.

**\$27.00**

Post and Packing:  
N.S.W. \$1.50.  
Interstate, \$2.00.



Dimensions: 14in x 8½in x 8½in.

## NEW BOOKSHELF SPEAKER SYSTEMS

### PLAYMASTER .4

Incorporates the new 6in Philips Speaker and Magnavox 3TC tweeter. Frequency response 45 to 18,000 cycles. Power rating 10 watts. Dimensions. 14in x 8in x 8in.

Available in 8 ohms only.

**\$36.00**

Post and Packing: N.S.W. \$1.50.  
Interstate, \$2.00.

### PLAYMASTER SUPER BOOKSHELF

Using two of the new Magnavox 6WR Speakers and one 3TC tweeter. Dimensions: 19½in x 10in x 8in.

Available in 15 ohms or 8 ohms.

**\$40.00**

Post and Packing: N.S.W. \$2.00  
Interstate: \$3.00.

ALL SPEAKER UNITS FINISHED IN OILED WALNUT  
OR TEAK WITH SILVER TRIM

# CLASSIC RADIO

245 PARRAMATTA ROAD, HABERFIELD, N.S.W. PHONE 798-7145



# NEW ALL TRANSISTOR STEREO AMPLIFIER ULTIMATE IN DESIGN-LONG DEPENDABILITY

## USING ALL SILICON TRANSISTORS

### 40 WATTS – RMS

#### SPECIFICATIONS:

**POWER OUTPUT:** 20 watts per channel  
R.M.S. Total output 40 watts R.M.S.

**FREQUENCY RESPONSE:** From 20 cycles to  
20,000  $\pm$  1db.

**HARMONIC DISTORTION:** Less than 1% at  
rated output.

**HUM & NOISE:** Aux. 70db, Mag. 50db.

**INPUT SENSITIVITY.** Mag. 3mv. Aux. and  
tuner 150 mv.

**SPEAKER IMPEDENCE.** 8 ohms.

**EQUALIZED:** Mag. RIAA.

**TONE CONTROLS:** Bass 50 c/s  $\pm$  12db. Treble 10kc/s  $\pm$  12db.

**LOUDNESS CONTROL:** 50 c/s 10db.

**SCRATCH FILTER:** (High filter) at 10 kc/s 9db.

**RUMBLE FILTER:** (Low filter) at 50 c/s 5db.

**PROVISION FOR TAPE RECORDER.** RECORD OR PLAY-BACK WITH DIN PLUG CONNECTION.

**PROVISION FOR HEADPHONES WITH HEADPHONE/SPEAKER SWITCH ON FRONT PANEL.**

**THE CIRCUIT INCORPORATES REGULATED POWER SUPPLY WITH TRANSISTOR SWITCHING PROTECTION FOR OUTPUT TRANSISTORS. 26 SILICON TRANSISTORS PLUS 5 DIODES ARE USED.**



MODEL C300/20

**\$119.00** FREIGHT EXTRA

DIMENSIONS: 16½in x 5½in x 11 in deep  
MOUNTED IN OILED WALNUT OR TEAK  
VENEERED CABINET WITH METAL  
TRIM AND MATCHING KNOBS.



MODEL C300/20/T

**ABOVE AMPLIFIER  
WITH INBUILT A.M.  
TUNER**

**\$144.00** FREIGHT  
EXTRA

12 WATT RMS PER CHANNEL VERSION OF ABOVE AMPLIFIERS AS PREVIOUSLY  
ADVERTISED ALSO AVAILABLE.

## CLASSIC RADIO

245 PARRAMATTA ROAD, HABERFIELD, N.S.W. PHONE 798-7145



# PETER SHALLEY Electronics

Pty. Ltd.

127 YORK STREET (just near Town Hall)  
29-7021 29-3767

## New 5-WATT Base Station

Just Released

### FEATURES:

- Delivers a full 5-Watt Input Power to the Final Amplifier.
- Operates on any of the 6 Citizen's Band Channels.
- Tone Call System for more effective communication.
- Stable Crystal-controlled Receiver with RF Stage.
- For short distance communication, Battery Saver slide installed.
- Variable Squelch and full series of Jacks for PA, Mic, External Speaker, External Antenna and External Power connecting.
- All Die-cast Cabinet and Leather Case.

Price \$179.00 each

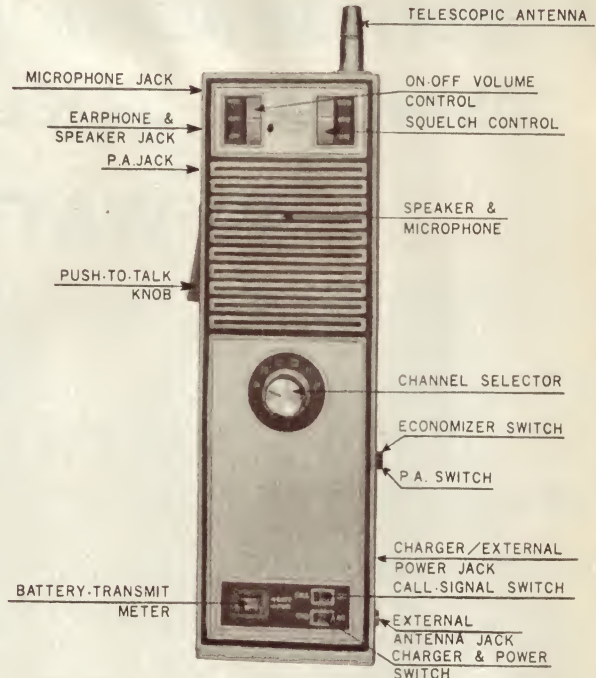

## YAESU-MUSEN AMATEUR TRANSCEIVERS

### SIDEBAND ELECTRONICS ENGINEERING

continues to offer you the largest stock and selection of imported amateur equipment in Australia. All units advertised below are in stock in quantity except the FT-200. I cannot yet satisfy the large demand for it as the factory is swamped with orders and applies rationing to all parts of the world! However, my agent in Japan is working hard to get dozens of them sailing soon, so in June, 1969 the situation may have cleared.

YAESU-MUSEN FT-DX-400 transceiver, \$550. FT-DX-100 transceiver, \$525. FV-400 external second VFO, \$100. FT-200 transceiver, \$375. FL-DX-2000 linear amplifier, \$250. FL-DX-400 transmitter, \$375. FR-DX-400 receiver, \$375. All Yaesu-Musen sets including all the necessary plugs and as a premium a P.T.T. ceramic microphone! SWAN SW350C transceiver, \$550. 14-230 AC/DC Swan power supply, \$150. GALAXY latest GT-550 transceiver, \$575. HY-GAIN TH6DXX master beam, \$200. TH3JR junior beam, \$110. BN-86 Balun, \$17.50. 18AVQ all-band vertical, \$90. 14 AVQ 10 to 40M vertical, \$50. MOSLEY TA33JR beam, \$98. MP-33 senior beam, \$125. HAM-M CDR heavy duty antenna rotator, \$180. AR-22 rotator, \$60, both with 230 volt indicator-control units. WEBSTER Bandspanner all-band mobile whip with swivel-mount and base, \$55. NEWTRONICS 4-BTV 10-40 M vertical, \$55, with 80 M top-loading coil, \$70. A.C.I. 12 volt heavy duty DC supply, fits all transceivers, \$105. Used SWAN SW350 transceiver with AC power supply, \$400.

### SIDEBAND ELECTRONICS ENGINEERING

33 PLATEAU ROAD, P.O. BOX 23, SPRINGWOOD, N.S.W. 2777.

TELEPHONE (STD 047) 511-394

City Office & Showroom, Mondays to Fridays, 9 a.m. to 5 p.m. by appointment with Clive Hutchison  
145 George Street, near Circular Quay, Sydney. Tel. 27-5885/6.





# AMATEUR BAND NEWS AND NOTES

## VHF-UHF-ATV 1969 Mid-winter Contest

Several new and interesting features have been incorporated into the 1969 Mid-winter Contest by the contest committee of the VHF and TV Group of the W.I.A. New South Wales Division.

by Pierce Healy, VK2APQ\*

The 1969 VHF/UHF Mid-winter Contest has been planned to cater for all conceivable aspects of operation within the VHF/UHF frequency spectrum allocated to the Australian amateur service. In addition, VHF operators in all Australian States and New Zealand as well as shortwave listeners are invited to participate.

In an endeavour to encourage participation between operators on the various VHF/UHF amateur frequency allocations and modes of transmission, an incentive scoring table has been carefully formulated.

Participation by amateur television (ATV) operators has been provided for. This, it is believed, is the first time in Australia that ATV has been included in any contest.

The incentive scoring table has been prepared to encourage cross-band and cross-mode operation between portable, mobile and home stations. It provides an increasing incentive to make the more difficult types of contacts, using more complex equipment, yet allowing equal opportunity for those who go further afield to score points for distance contacts by the simpler modes over known paths.

Of course, the success of any contest depends on the participants and to a very large degree on those who participate for participation's sake. A good participant exemplifies the true spirit of amateur radio.

The contest committee also hopes that, from reports received, a lot of useful data on VHF/UHF propagation will result. Also that new Australian records will be set for some bands.

Full details of the contest and the rules to apply are given on page 168 of this issue.

### VHF Band Opening

During the period April 23 to 25, several long-distance contacts were made in the south-eastern portion of Australia on the 144-148MHz band. This was probably due to a large high-pressure system which persisted over the area for several days.

A number of contacts were recorded between Victorian and South Australian stations over paths exceeding 200 miles.

In New South Wales, between 1700 hours and 2000 hours on April 25, direct contacts were made on the 146MHz channel "B" net frequency, by VK2AKC and VK2ACT at Dubbo and most of the net frequency operators in Canberra. A.C.T., the distance being over 200 miles. It was also reported that a contact was made between VK3AJM, at Wangarratta in Victoria, and VK2ATO in Sydney. N.S.W., via the experimental repeater station of the Orange Radio Club at Mount Canobolas, a distance of approximately 400 miles.

More details of the openings are being sought and it is hoped to record them next month.

### Amateur Television

In the month's notes mention was made of an amateur television (ATV) record being made in South Australia. Further information received from Mait Lane, VK5AO/T on the event gives the date as February 16, and the actual distance, as measured on an Adelaide Lands Department map, was 93 miles.

From Willunga Hill, Ray Foxwell, VK5ZEF/T used a 16 element collinear array with 30 watt average video power into a QQE06/40. The receiver was a transistor UHF converter, valve tuner and an 8 inch monitor. The camera used a one inch vidicon. The camera receiver and monitor was built and operated by Allan Nation.

The South Hummocks station operated by Mait Lane, VK5AO/T consisted of 20 watt sync. power into a QQE03/20 and a 16 element collinear antenna. Audio power was 5 watts into a QQE02/5 and a 5 element yagi. A nuvistor UHF converter was used with a home constructed RTV&H 17-inch television receiver. A vidicon camera was used for live pictures.

Both transmitters used 5.5MHz inter-carrier sound and operated on 432MHz.

At the present time, four stations are carrying out ATV experiments in Adelaide. These are VK5ZEF/T; VK5GG/T; VK5ZHD/T and VK5AO/T.

The accompanying photograph gives an indication of the quality of the picture received over the 93-mile path.

### Japan Amateur Radio League

The following awards are offered by the JARL, recognising proficiency and achievement of any amateur operator or shortwave listener in the world.

The applicant must submit QSLs fulfilling the conditions of the award with a

list of them showing the date and time of the QSO, type of emission and frequency used, signal report, and location of the stations contacted.

All claims for these awards must be made by the submission of the QSLs, together with the list as mentioned above and the IRCs as listed below, direct to Awards Manager, JARL, P.O. Box 377, Tokyo, Japan.

Number of IRCs to be sent are:—

AJD — All Japan Districts: 10.

WAJA— Worked All Japan Prefectures: 10.

JCC —Japan Century Cities: 10.

HAC — Heard All Continents: 5.

All contacts between amateurs or reported by shortwave listeners must have been made on or after July 30, 1952. Any authorised amateur band and type of emission may be used, but no cross band contacts will be allowed.

Requirements:

AJD: QSO with 10 JA/JH stations in 10 different call areas, 1 to 0 inclusive. SWL-AJD for SWLs.

WAJA: QSO with 46 JA/JH stations in 46 different Japanese Prefectures shown below. SWL-WAJA for SWLs.

JCC: QSO with over 100 JA/JH stations in different cities in Japan. JCC-200, -300, -400, -500 are also issued as separate awards. The list of cities is available on request, (3 IRCs required). SWL-JCC for SWLs.

HAC: This award is issued to any SWL who gets 6QSLs for his reception reports of amateur stations in 6 different continents.

### WAJA LIST

Districts	Prefectures
JA1	Tokyo, Kanagawa, Chiba, Saitama, Ibaraki, Tochigi, Gumma, Yamanashi.
JA2	Shizuoka, Gifu, Aichi, Mie.
JA3	Kyoto, Shiga, Nara, Osaka, Wakayama, Hyogo.
JA4	Okayama, Shimane, Yamaguchi, Tottori, Hiroshima.
JA5	Kagawa, Tokushima, Ehime, Kochi.
JA6	Fukuoka, Saga, Nagasaki, Kumamoto, Oita, Miyazaki, Kagoshima.
JA7	Aomori, Iwate, Akita, Yamagata, Miyagi, Fukushima.
JA8	Hokkaido.
JA9	Toyama, Fukui, Ishikawa.
JA0	Nugata, Nafiamo.

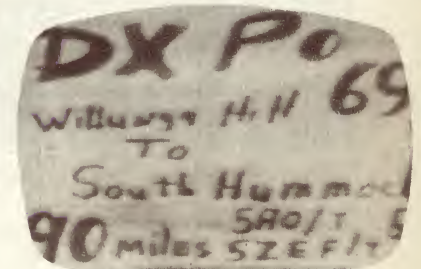

Picture received at South Hummocks. For the distance and power involved, it is a very significant achievement.

\* News and notes of Divisional and Club activities submitted for inclusion in these columns should be forwarded direct to Pierce Healy, 69 Taylor St., Bankstown, N.S.W. 2200.



# METRA

## MEASURES UP TO A TRADITION

Behind every Metra electrical measuring instrument stands the Metra tradition of excellence. This tradition began more than 50 years ago, and today is represented by 56 factories employing over 12,500 scientists and 75,000 workers supplying equipment to 30 countries throughout the world.

To cover the application and range of Metra electrical measuring instruments in this advertisement is impossible. The developments of science and technology are continuously extending the possibilities of application. However, some of the more significant areas are listed here.



**Switchboard Instruments:** Voltmeters, Ammeters, Wattmeters, Phase Meters, Frequency Meters, Ammeters with built-in electricity meter, Rated Voltage, and Electrical Revolution Indicators.

**Panel Instruments**

**Recording Instruments:** Line Recorders, Rated Voltage, Recording Voltmeters, Portable Recording Voltmeters and Wattmeters, and Compensating Amplifiers.

**Installation and Routine Service Instruments:** Ampere Voltmeters, Universal Measuring Instruments, Insulation Resistance Meters, Battery Testers.

**Laboratory Instruments, School and Demonstration Instruments, Digital Instruments and Data Loggers, Bimetallic Thermometers and Thermostats.**



### CHARMAC PTY. LTD.

Representatives for METRA Czechoslovakia

VICTORIA: 33 Bridge Road, Eltham 3095. Telephone: 439 9517

S. AUST.: TRUSCOTT ELECTRONICS

64 Hindmarsh Sq., Adelaide 5000. Telephone: 23 3024

Please send me further information including technical specifications on.....

NAME.....

ADDRESS.....

### CONTEST RESULTS 1968-1969 ROSS HULL MEMORIAL CONTEST

**Trophy Winner:**

C. M. Hutchesson VK5ZKR 2103 points.

**Award Winners:**

E. Penikis VK1VP 213 points.  
R. C. F. Norman VK2ZCF 1302 points.  
R. W. Wilkinson VK3AKC 2015 points.  
J. N. Thornton VK4ZJT 782 points.  
C. M. Hutchesson VK5ZKR 2103 points.  
M. J. McDonald VK6MM 99 points.  
K. J. Henricks VK7ZAH 884 points.

**Receiving Section:**

VK3 M. Batt 529 points.  
VK5 S. Ruediger 682 points.

## W.I.A. ACTIVITIES

The 33rd Federal Convention of the Wireless Institute of Australia was held over the Easter weekend April 4 to April 9, 1969. For the first time, the Convention was held in Canberra, A.C.T. The venue was the Hotel Canberra and the arrangements for the convention were very ably handled by the Canberra Radio Society.

The proceedings commenced at 11.30 a.m. on Friday morning with the following representatives in attendance.

John Battrick, VK3OR, Federal president.

Peter Williams, VK3IZ, Federal Secretary.

Michael Owen, VK3KI, Federal Vice-president.

George Pither, VK3VX, I.T.U. Liaison Officer.

David Rankin, VK3QV, Federal Activities Officer.

Alf Seedsman, VK3IE, Federal Executive Officer.

David Wardlaw, VK3ADW, Federal In-truder Watch Co-ordinator.

Pierce Healy, VK2APQ, Federal Councillor VK2 Division.

Eddie Penikis, VK1VP, Observer VK2 Division.

Dean Blackman, VK3TX, Federal Councillor VK3 Division.

Ken Pincott, VK3AFJ, Observer VK3 Division.

David Portley, VK4DP, Federal Councillor VK4 Division.

Geoff Taylor, VK5TY, Federal Councillor VK5 Division.

Roger Pullem, VK5ZKK, Observer VK5 Division.

Neil Penfold, VK6ZDK, Federal Councillor VK6 Division.

Ted Cruise, VK7EJ, Federal Councillor VK7 Division.

Charlie Rann, VK1CR, President Canberra Radio Society.

Also members of the Canberra Radio Society recording the proceedings.

In addition to the reports on various institute activities, 61 motions were dealt with during the discussions. Prior to the commencement of discussions on agenda items, John Battrick, VK3OR, Federal President, announced his retirement as president and member of Federal Executive. However, during the proceedings of the convention John accepted the appointment as W.I.A. Director on the Region III organisation.

Among the subjects relating to W.I.A. administration policies, proposals by the New South Wales Division suggesting changes in relation to the location of Federal Executive, were rejected by all other Divisions. It was resolved that the W.I.A. Solicitor and the Honorary Solicitor of the New South Wales Division investigate certain aspects relating to the incorporation of the proposed new Federal Constitution of the Institute.

It was resolved that the New South Wales Division continue to provide the secretariat to deal with all W.I.A. proposals relating to the repeaters and translators recently allowed by the Postmaster-General's Department in the regulations governing the Australian amateur service.



The term is to be for a period of three years. In addition it was agreed that all proposals relating to gentlemen's agreements on the use of portions of the 144MHz and 432MHz bands as well as repeater and net frequencies, be submitted to the Repeater Secretariat for correlation and subsequent report to Federal Council.

Federal Council approved the Interim Constitution drawn up by the Region III Secretariat and circulated to other members of the Region III Association. The formal approval of the Interim Constitution by other societies attending the inaugural Congress in Sydney in 1968, will allow the organisation to commence to function as a part of the International Amateur Radio Union.

Due to rising costs, an increase in the price to Divisions for the Institute Magazine "Amateur Radio" was agreed to.

It was also agreed that the arrival of Captain James Cook to the eastern shores of Australia in 1770 will be commemorated in 1970 as will also the Diamond Jubilee of the Wireless Institute of Australia.

Changes to the rules of the Remembrance Day Contest will be made. The changes will allow full participation of stations in the VK1, VK8, VK9 and VK0 call areas and the scores of these stations being included with the score of the Divisions with which they are associated.

A new scoring table to include the above changes and taking into account other aspects was also agreed to.

Subject to agreement that it will be economically possible the 1970 Federal Convention will be held in Perth, Western Australia. If otherwise, the venue will be Adelaide.

During the official convention dinner on Easter Saturday night, Life Membership Badge of the W.I.A. was presented to Arch Cox, VK1GU. Arch has been a Life Member of the New South Wales Division for many years, but the badges had only been struck within the last 12 months. The presentation was made on behalf of the N.S.W. Division by Pierce Healy VK2APQ.

When replying to the presentation, Arch recalled some of his experiences of the past years, his pleasure in receiving the badge and offered some very sound views on the status of amateur radio and points to be kept in mind when promoting the advancement of amateur radio.

#### Federal Executive

The appointments to Federal Executive, ratified by Federal Council were:

Federal President Michael Owen, VK3K1.

Federal Vice-president David Rankin, VK3QV.

Federal Secretary Peter Williams, VK3IZ.

I.T.U. Liaison Officer George Pither, VK3VX; Alf Seedman, VK3IE; Kevin Connelly, VK3ARD; David Wardlaw, VK3ADW.

### NEW SOUTH WALES

On March 22 the Council of the New South Wales Division called a meeting of Area Officers in the division. During the meeting a number of proposals were made with a view to improving the Institute's service to country members. Such subjects as library service, QSL card distribution, WICEN co-ordinators, subsidies to branches, technical information service and several other matters affecting individual branches and clubs were discussed.

Following a review of the discussions, council decided to put several of the proposals into operation. These include the despatch of QSL cards, the setting up of a technical information committee and subsidising of branches on a membership basis. This later decision will overcome the financial problems branches have in providing meeting places and other facilities for their members.

#### Central Coast Branch

At the April meeting of the Central Coast Branch, a very good number of members was in attendance to hear a most interesting and enlightening lecture on microcircuits.

The guest lecturer for the evening was Peter Finch, of Fairchild Aust. Pty. Ltd., who described current techniques using these devices. A demonstration of a digital voltmeter captured the interest of all present.

Dick Maitland, the branch secretary, has passed the recent A.O.C.P. examination and is preparing to take his place among the active members on the air.

The branch meets on the third Friday of each month at the Kariong Progress Hall. Visitors are always welcome.

Full details of meetings and other activities may be obtained from the secretary, R. A. Maitland, 3 Albany Road, Gosford, or from Jack Jeffrey, VK2AJY, 291 Hargraves Street, Toukley.

### VICTORIA

#### Eastern and Mountain District Radio Club.

This large and active club not only caters for amateur operators in the area but its membership extends to Japan, New Zealand, Western Australia and New South Wales. In all the membership is very near to 200.

Each month all members receive the club bulletin which contains information on the forthcoming activities, technical

articles, and lists of items for sale. This publication is available to non-members at 10c per copy.

The club meets on the last Friday in each month at the Mooroolbark Technical College, Reay Road, Mooroolbark. The club call sign is VK3ER, but unfortunately at the present time, due to problems with antennas, activity on the air is restricted.

Many types of activities are available to club members, in addition to lectures and building nights. These include barbecues, outings to place of interest, disposals sales and "white elephant" nights.

Members are at present actively engaged in the construction of a receiver featuring the Waddley Loop principle. This is a transistorised version of the well-known Ralac or Deltahet receiver.

Members of the committee are:

President: Ken Nisbett, VK3AKK, 25 Thames Avenue, Springvale.

Vice-president: John Boyce, VK3AXF, 182 Huntingdale Road, Mount Waverley.

Secretary: Reg Durrant, VK3AJV, Grosvenor Street, North Blackburn.

Treasurer: Keith Nicholls, VK3ANI, Lot 57, Chalmers Avenue, Upper Ferntree Gully.

Publicity Officer: Tony King VK3IO, 97 Campbell Street, Heathmont.

Membership of the club is open to any person anywhere. The annual subscription is \$2, and there is a 50c joining fee.

### CALLING ALL PROSPECTIVE AMATEURS

The Wireless Institute of Australia was established in 1910 to further the interest of Amateur Radio. With over 45 years experience, who could be more experienced in the teaching of this subject?

We are a non-profit making Organisation. Correspondence Courses are available at any time. Personal Classes commence in February of each year.

For further information write to:  
**THE COURSE SUPERVISOR, W.I.A.,**  
14 Atchison Street,  
CROWS NEST, N.S.W.

Registered Trade Mark

# ELECTROLUBE 2A-X

**IMPROVES ELECTRICAL CONTACTS  
INCREASES RELIABILITY AND  
LOWERS MAINTENANCE COSTS**

**SAFE ON**

POLYSTYRENE, P.V.C. MAKROLON,  
PAINTS, NATURAL AND SYNTHETIC  
RUBBER NON-HAZARDOUS VAPOUR

Write for free Products Summary on the range of electrical and mechanical oils and greases



**RICHARD FOOT (Australia) PTY. LTD.**  
63 Hume St., Crows Nest, N.S.W. Tel. 43-0326.

Available from leading electrical wholesalers.





Already established as the most popular basic radio text book the **BASIC RADIO COURSE** has now been reprinted as

# BASIC ELECTRONICS

with new and up-dated information.

**Out now, only \$2.00**

This 128-page text book is packed with diagrams and useful information about radio, hi-fi and electronics.

An ideal gift for either student or enthusiast.

An invaluable source of information for those who are curious to know **HOW** and **WHY** the many electronically based devices of today's world work.

It is written so you can understand it.

For a comprehensive review please see page 137 of the March '69 issue.

You can buy your copy of **BASIC ELECTRONICS** by calling personally at any of the offices of John Fairfax & Sons — **Sydney:** Sun-Herald Building, 235-243 Jones Street, or 26 Hunter Street; **Melbourne:** 392 Little Collins Street; **Newcastle:** 22 Bolton Street; **Adelaide:** 104 Currie Street; **Perth:** 847 Hay Street and **Brisbane:** 78 Elizabeth Street.



**To: ELECTRONICS AUSTRALIA:  
Box 2728, G.P.O., Sydney, N.S.W. 2001.**

Please send me ..... copies of **BASIC ELECTRONICS** at \$2.20 posted within Australia. \$2.00 plus postage to overseas buyers (plus estimated for 11 oz. posted weight). Please enclose only a cheque, money order, Australian Postal Order, etc., NOT CASH.

NAME .....

ADDRESS .....

STATE .....

**A SPECIAL 10% DISCOUNT** is available on single-copy rate for bulk buyers of not less than 25 copies to radio clubs, youth groups. Please enclose remittance with order including estimated parcel postage or freight.



# VK-ZL OCEANIA DX CONTEST

## 1968 Results Band leaders VK Call Areas

Multi-band:		Phone	
CW		VK2KM 23140 points	
VK2APK 17860 points		VK1GD 22315 points	
VK3QK 13330 points		VK2APK 18930 points	
VK2GW 13260 points		28MHz:	
VK4XJ 5220 points		VK4VX 7685 points	
VK2APK 3230 points		VK1GD 6375 points	
VK2GW 2190 points		VK2KM 5635 points	
21MHz:		VK2KM 6340 points	
VK3AXK 8185 points		VK3AXK 5695 points	
VK4VX 7745 points		VK1GD 5575 points	
VK5FM 6035 points		14MHz:	
VK5FH 6720 points		VK1GD 9995 points	
VK2APK 6555 points		VK7GK 9480 points	
VK3QK 6465 points		VK6UT 9445 points	
7MHz:		VK2KM 2240 points	
VK3APN 3305 points		VK2APK 1590 points	
VK3QK 2690 points		VK7GK 480 points	
VK3OP 2655 points		3.5MHz:	
VK3APN 1085 points		NIL	
VK7GK 940 points		NIL	
VK2VN 745 points		NIL	

## Band Leaders ZL Call Areas

Multi-band:		Phone	
ZL1AJU 22925 points		ZL1AMN 16275 points	
ZL4BO 17880 points		ZL4BO 16235 points	
ZL1AMO 16520 points		ZL1HW 8115 points	
28MHz:		ZL3IS 5130 points	
ZL1AJU 5810 points		ZL1DS 5050 points	
ZL1DS 5485 points		ZL1AMN 2505 points	
ZL3IS 3020 points		21MHz:	
ZL1AMO 8610 points		ZL1HW 8115 points	
ZL1AJU 8270 points		ZL1AMN 6615 points	
ZL4BO 6140 points		ZL4BO 4420 points	
14MHz:		ZL4BO 8930 points	
ZL2FA 9525 points		ZL1AMN 7000 points	
ZL2ANX 9485 points		ZL2AFZ 6655 points	
ZL3GQ 8060 points		7MHz:	
ZL3GQ 2740 points		ZL1AGO 3090 points	
ZL4BO 2570 points		ZL4BO 800 points	
ZL2ANX 1815 points		ZL1AMN 155 points	
3.5MHz:		ZL4BO 135 points	
ZL4BO 165 points			
ZL1DV 100 points			

### 1969 VK -ZL - Oceania DX Contest:

This is a part of New Zealand's Cook Bi-Centennial Celebration.

Phone — 1000 Hrs. GMT Saturday 4 October to 1000 Hrs. GMT Sunday 5 October.

CW — 1000 Hrs. GMT Saturday 11 October to 1000 Hrs GMT Sunday 12 October.

Trophies: Silver mounted plaques; Colourful certificates; Cook Bi-Centennial medallions, in all sections.

Full details in a later issue of these notes.

## QUEENSLAND

This year the State Convention of the Queensland Division W.I.A. will be held at Bribie Island on the weekend of June 7 and 8.

The convention will have as its main interest a Saturday evening function along the lines of an Hawaiian Night—casual dress, help yourself dishes, music, laughing, talking—good fun consisting of a buffet meal followed by a full evening's entertainment which should cater for all.

It is hoped to make this function a most memorable occasion and its success will be ensured by a good attendance. Transport will be available for those not wishing to stay the night at Bribie Island. Saturday morning will be set aside to visit places of interest.

On Saturday afternoon a series of technical sessions have been arranged. Subjects, such as printed circuits, interference problems, modern circuitry, RTTY equipment will be discussed. There will be displays of equipment and opportunities to ask questions. Technical literature will also be available. Of course, those who wish may surf, play bowls or swim.

On Sunday morning, VK4WI will be operating from the convention. HF and VHF contests will be conducted. It is

hoped to have a RTTY station operating from the site and a display of equipment by members of the various radio clubs.

The general meeting will be held during Sunday afternoon followed by the presentation of prizes, and an auction of disposal equipment.

Accommodation will be available to everyone—camping, stationary caravans, motels, flats, luxury hotels. Men's single accommodation will also be provided.

For bookings contact: Ross Cuttle, Cummings Street, Bribie Island, Phone STD 075, 53-1070.

There will be a large central hall with facilities for all. Children will be catered for, with competitions, organised games and entertainment.

Consideration is being given to subsidising transport for large groups from clubs. Interested clubs are requested to contact the organisers.

Members of the organising committee are:

Ross Cuttle.  
Bob Campbell, VK4XV.  
Peter Brown, VK4PJ.  
Reg Vickary, VK4VX.  
Bill Flannery, VK4XO.

The annual report on the activities of

## ON TELEX



from



*Cunninghams*

Call—  
Melbourne:  
31447

Sydney:  
21707  
for service.

Bob Cunningham

To beat the slow communications in this modern era, we have installed full TELEX facilities for customer service. This is your means of obtaining rapid answers and deliveries from our extensive range of BULGIN, EDDY-STONE, GELOSO, SENNHEISER, VITAVOX, DOW-KEY, etc., components available from our Melbourne, Sydney, Brisbane and Perth offices.

## WHAT'S NEW

**SONNENSCHNEIDER** is a new agency. This trademark covers a range of unspillable, sealed lead-acid batteries for portable electronic apparatus as used in many high-quality imported tape-recorders and camera equipments. Send for literature.

**SENNHEISER** now offers a "Foam-type" wind-shield for MD 21, MD 421 as well as MKH series of condenser microphones. Wind-noises attenuated 20 dB. From stock at \$6.00 plus S.T.

**STOLLE** Automatic Aerial Rotor permits rotation of the largest TV aerial with full control at the operating table. Only 40 volts are transmitted via the 5-core control cable to the rotor motor at the mast-head. This rotor will also be popular with radio hams. Well priced at \$45.00 plus S.T.

**SENNHEISER** HD 414 Stereo Headphones have been developed and are now available possessing a frequency range of 20 to 20,000 Hzs. Completely newly designed to avoid hermetically sealed ears. HD 414 rely on rubber foam pads to exclude outside noises. Price only \$14.00 plus S.T. ex stock.

*R.H. Cunningham*  
PTY. LTD.

608 Collins St., Melbourne, Vic.

64 Alfred St., Milsons Point, N.S.W.

34 Wolya Way, Balga W.A.

L. E. Boughen & Co.,  
95 Central Ave, Sherwood, Qld.



# For effective testing

## ADVANCE

### AUDIO SIGNAL GENERATORS

#### ← ADVANCE MODEL J2C

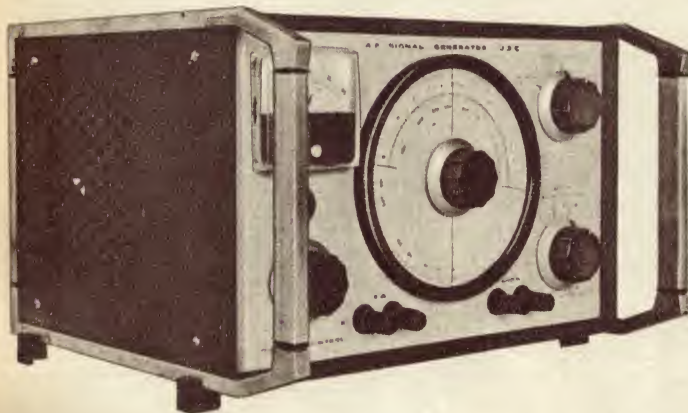

##### 1 Watt Output

The Advance J2C has been designed for the requirements of telephone and service engineers. It has specifications and features which are ideal for the testing of low noise audio systems and other specialised equipments now becoming commonplace in today's electronic industry.

**Output:** Continuously variable 0.1 mW to 1 Watt.  
**Frequency:** 15 Hz to 50 kHz, 3 ranges.  
**Metered:** Output to 25V.  
**Impedance:** 600 ohms or 5 ohms by selection.  
**Distortion:** At 1 Watt better than—35dB; at 0.1 Watt better than—40dB.  
**Dimensions:** 11 $\frac{1}{8}$ " x 7 $\frac{5}{8}$ " x 9 $\frac{5}{8}$ ".  
**Weight:** 20 lb.  
**Power:** 105 to 125V and 210 to 250V—40 to 100 Hz—40 Watts.

Price: **\$140** plus Sales Tax as applicable.

#### ADVANCE MODEL H1B →

The Advance Model H1B has provision for square-wave output to assist in the quick testing of low-frequency amplifier response, recovery and phase distortion. Testing or alignment of most networks may be carried out quickly.

**Frequency:** 15 Hz to 50 kHz.  
**Accuracy:** Sine wave  $\pm 1\%$  to 1 Hz. Square wave  $\pm 3\%$  to 1 Hz.  
**Rise Time:** Less than 3  $\mu$  s. (10% to 90% of peak).  
**Output:** Sine wave: 200  $\mu$  V to 20V r.m.s.  $\pm 2$ dB. Impedance: Maximum 13 k $\Omega$ . Square wave: 1.4 mV to 140V P-P (approx.).  
**Distortion:** Less than 1% at 1 kHz at a level of 20V— $\pm 2$ dB.  
**Dimensions:** 7 $\frac{5}{8}$ " x 11 $\frac{1}{8}$ " x 9 $\frac{5}{8}$ ".  
**Weight:** 12 $\frac{3}{4}$  lb.  
**Power:** 105 to 125V and 210 to 250V—40 to 100 Hz—30 W (approx.).

Price: **\$100** plus Sales Tax as applicable.

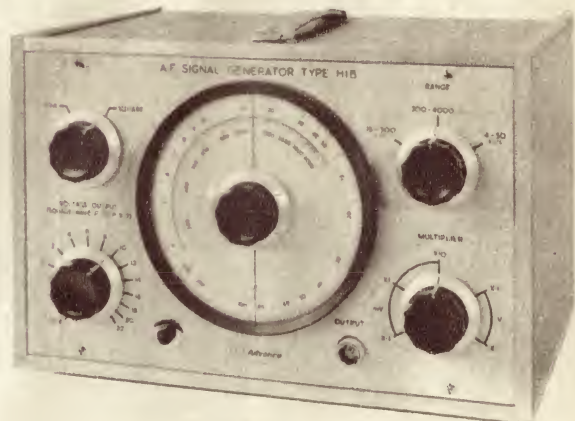

MELBOURNE  
30-2491/2

ADELAIDE  
53-6117

BRISBANE  
2-6467

PERTH  
28-1102

LAUNCESTON  
2-5322

Manufactured in  
Australia by:

**jacoby, mitchell & co. pty. ltd.**

469-475 Kent Street, Sydney. 26-2651



the Queensland Division, by the retiring president, Les Brennan, VK4XJ, recorded several notable events in the affairs of the division. The most important being the incorporation of the division under the Companies Act. For some years the division had been the only one not a corporate body under the Act and had posed a difficulty in the adoption of the proposed new Federal Constitution.

In addition to the A.O.C.P. class provided for those wishing to study for their licence, Morse code practice sessions have been transmitted four nights a week. The frequency is 3580KHz and transmissions commence at 1930 hours E.S.T.

During the year, Vince Jeffs, VK4VJ, was elected Life Member of the division in recognition for his services over many years.

## WIRELESS INSTITUTE OF AUSTRALIA

### Divisional Addresses.

#### New South Wales:

W.I.A. New South Wales Division, Wireless Institute Centre, 14 Atchison Street, Crow's Nest, N.S.W. 2065 (phone 43-5795).

#### Victoria:

W.I.A. Victorian Division, 478 Victoria Parade, East Melbourne; Postal Address: P.O. Box 36, East Melbourne, Vic. 3002 (phone 41-3535).

#### Queensland:

W.I.A. Queensland Division, Box 638, G.P.O., Brisbane, Qld. 4001.

#### South Australia:

W.I.A. South Australian Division, Box 1234K, G.P.O., Adelaide, S.A. 5001.

#### Western Australia:

W.I.A. Western Australian Division, Box N002, G.P.O., Perth, W.A. 6001.

#### Tasmania:

W.I.A. Tasmanian Division, Box 851, G.P.O., Hobart, Tas. 7001.

### VHF Report

The VHF section of the annual report recorded the completion of the VK4 VHF beacon transmitter installation. Thanks were expressed to the assistance given by the Chairman and Board of Directors for their assistance in making available an excellent location for the unit. The frequency used and the exact location were not given in the report.

It was recorded that the conditions for 52MHz DX were the poorest for many years. However, a new Australian distance record for 1296MHz was established over a distance of 112 miles.

The operators who made this contact were H. N. Sandford, VK4ZT and T. J. Fishpool, VK4KE.

Office Bearers for 1969 are:  
President: Mick Pettiford, VK4ZAA.  
Treasurer: Royce Hazlett, VK4ZRH.  
Secretary: Ron Everingham, VK4ZRE.

There were insufficient nominations to require an election for the Divisional Council for 1969-1970. Following the Annual General Meeting the following officers were appointed:

President: N. F. Wilson, VK4NP.  
Honorary Secretary: A. E. W. Williams, VK4AI.

Honorary Treasurer: D. R. Watson, VK4DZ.

Federal Councillor: D. M. Portley, VK4DP.

Disposals Officer: T. A. Lane, VK4ZAL.

Library Officer: R. L. Guttormsen, VK4RL.

Station Manager: H. F. Bremerman, VK4HB.

Y.R.S. Supervisor: W. Cockburn, VK4ZWC.

Q.T.C. Editor: L. J. Brennan, VK4XJ.

Business Manager: K. P. O'Farrell, VK4OF.

Country Representative: A. E. Carter, VK4LT.

Inwards QSL Officer: H. Scholz, VK4HR.  
Outwards QSL Officer: W. Jehn, WIA-14001.

## SOUTH AUSTRALIA

### VHF Convention

A VHF convention, catering for VHF operators in easy travelling distance from Mount Gambier, will be held over the Queen's Birthday holiday weekend, June 14, 15 and 16. Activities will commence with a barbeque at 6 p.m. E.S.T. on Saturday 14.

Accommodation has been reserved at a motel in Mount Gambier for those interested in attending the function.

Registration fee will be \$3 and will include the whole family. A deposit should be sent with the registration should accommodation be required. Registration forms may be obtained from Carl Hutcheson, VK5ZKR, Yahl, via Mount Gambier, 5290.

This has been a very popular event in the past and a good program of events is being arranged.

## WESTERN AUSTRALIA

### Ockley Radio Club VK6OR

An enthusiastic group in the Wickiepin — Narrogin — Ockley area, about 90 miles south-east of Perth, have formed the Ockley Radio Club. At the inaugural meeting the following officers were elected:

Patron, George Justin; President, Aub Keightley, VK6XY; Vice-president, Max Shooter, VK6ZER; Secretary-Treasurer, John Ellis; Program Organiser, Pat Haywood, VK6PH; Property Officer, Karl Henning, VK6XW; HF Officer, Aub Keightley, VK6XY; VHF Officer, Don Benck, VK6DB.

Club meetings will be held on the second Friday in each month at the QTH of VK6PH, until the club building at Ockley is completed.

No doubt members will be pleased to welcome those in the district interested in amateur radio.

## YOUTH RADIO SCHEME

### NEW SOUTH WALES

#### Kyeemagh Sea Scouts Radio Club VK2BXX

This active club meets every Wednesday night in the 1st Kyeemagh Sea Scouts Hall, Bestic Street, Brighton Le Sands, (adjacent to the Fishermans Club). The classes are open to anyone interested in becoming a radio amateur operator and are not restricted to Scouts. Fees are payable at ten cents a night. The 1969 classes are under way but there is plenty of room for additional students.

The instructors are John Scougall, VK2ASC and Noel Ericsson, VK2MF. The club has its own transmitting station operating under the call sign VK2BXX, and in addition is equipped with various educational aids required to assist students to progressively gain the various certificates at a pace suited to their individual ability.

Morse code instruction is given, and Y.R.C.S. notes are used in the form of lesson papers. Classes commencing at 7.30 p.m.

In the 1968 Y.R.S. Elementary Certificate examination, Michael Cook gained a Credit Pass, while Patrick Cook and Eric Brown obtained Pass marks. All three are in the young teenage group.

Some of the former students of the Kyeemagh Club are now employed in the P.M.G.'s Department, Overseas Telecommunication Commission, the Department of Civil Aviation and one is a cadet radiologist in a hospital.

(Continued on page 172)

# BRIGHT STAR CRYSTALS

PREFERRED BY LEADING MANUFACTURERS THROUGHOUT THE COUNTRY FOR —

**ACCURACY - STABILITY - ACTIVITY - OUTPUT**



All types of Crystals Available  
Such as DC11, FT 243 HC6U CRA  
B7G, HC18U, ETC.  
TOLERANCES: .0015%, .002%,  
.003%, .005% ETC.

Consult us for Crystals for any Mobile Radio. Prices depend on tolerance and frequency required.

**DISCOUNT FOR QUANTITY ORDERS**

Established 36 Years



**AMATEUR AIRCRAFT and ULTRASONIC CRYSTALS also AVAILABLE**

**Our new Factory employing the most modern equipment allows us to offer you PROMPT DELIVERY for all your CRYSTAL requirements.**

**DEVOTED EXCLUSIVELY TO THE MANUFACTURE OF**

## PIEZO ELECTRIC CRYSTALS

Contractors to Federal and State Government Departments

REPRESENTATIVES AUSTRALIA AND NEW ZEALAND: Messrs. CARREL & CARREL  
BOX 2102, AUCKLAND.

MESSRS ATKINS (W.A.) LTD.,

894 Hay Street, PERTH.

MESSRS. A. E. HAROLD PTY. LTD.,

123-125 Charlotte Street, BRISBANE.

MESSRS LAWRENCE & HANSEN

ELECTRICAL (VIC.) PTY. LTD.,

34 Brisbane Street, HOBART.

and 29 St. John Street,  
LAUNCESTON, TASMANIA.

## BRIGHT STAR RADIO

546-5076

LOT 6 EILEEN ROAD, CLAYTON, VICTORIA

546-5076



# MIDWINTER VHF-

The Contest Committee of the N.S.W. Division W.I.A., VHF and TV Group invites all amateurs and shortwave listeners with VHF and/or UHF equipment to participate in the 1969 Midwinter Contest. This contest will be held during the Queen's Birthday holiday weekend in June. Copies of these rules have been sent to VHF groups in all Australian States and New Zealand, inviting participation.

Awards will be made as stated in Rule 5, and scores from all accepted entries will count towards the Annual Chairman's Trophy of the N.S.W. VHF and TV Group, on a pro-rata basis.

**OBJECTS:** Amateur operators in the VK2 and VK1 call areas will endeavour to contact as many other amateur stations as possible and over as great a distance as possible. Contacts may be made on any one or more of the authorised Australian amateur bands from 52MHz and above.

The "Incentive Rating" tables introduced this year, give a scoring advantage increasing with the use of the tunable VHF bands, the UHF and SHF bands and Amateur television.

**DATE/DURATION:** Contest commences Saturday 14/6/69 1400 hours E.S.T. and ends Monday 16/6/69 1200 hours E.S.T. with rest periods.

The operating times are:  
Saturday 14/6/69, 1400 hours to 2200 hours (8-hour period).

Sunday 15/6/69, 0600 hours to 1100 hours (5-hour period).  
1200 hours to 2200 hours (10-hour period).

Monday 16/6/69, 0600 hours to 1200 hours (6-hour period).

The rest period on Sunday between 1100 and 1200 hours is for the VK2W1 broadcast. **RULES:**

1. There are two time divisions, for which entries may be submitted, Division "T" for the total, or overall, contest duration and Division "S" for the best scoring six consecutive contest hours. These may, if desired, be broken by one of the rest periods, e.g. from 2000 hours to 2200 hours Saturday 14th, then 0900 hours to 1000 hours Sunday 15th. Similar periods are acceptable as six consecutive hours.

2. Entries may be submitted for either Division "T" (total) or Division "S" (six hours), or both. But, the winner of Division "T" will not be eligible to also win Division "S."

3. The various classes in which participants may enter are:

- Class "H" Home station.
- Class "M" Mobile station.
- Class "P" Portable (field) station.
- Class "SWL" Listener, home station.

A station may enter in more than one class if satisfying the conditions; e.g. he could work from home, then go mobile and then portable.

4. Combining the divisions and classes, gives the following different sections available to contestants:

- Section HT Home station total period.
- Section HS Home station six-hour period.
- Section MS Mobile station six-hour period.
- Section PT Portable station total period.
- Section PS Portable station six-hour period.
- Section SWL Listener home total period.

5. **AWARDS:** Will be made to the winners of the above sections for each of the following four bands: 52MHz; 144MHz; 420/576MHz; 1215MHz and above.

Entry forms should be clearly marked in the block provided, showing bands used in each section. A special prize will be awarded to the outright highest scorer in the whole contest in addition to any other awards the same entrant may win.

As well as the awards mentioned, a MERIT Award will be made for the best entry submitted by an operator who has held a call sign for 12 months or less.

6. A **PORTABLE STATION** is defined as being one at a field location, not using normal car antennae and at least one mile from the home QTH of any operator of that station. Use of AC mains is permitted but the station must not be at the home of another amateur operator.

7. A **MOBILE STATION** is defined as one whose equipment, power source and antenna are wholly mounted in or on the vehicle, which is capable of being driven while the equipment operating. The vehicle need not be moving and it may be at any location. Maritime and airborne mobiles score the same as normal mobiles.

8. **CROSSBAND OPERATION** is permitted as is the arranging, during contest hours only, of contest contacts. For this contest, the use of HF bands is not permitted for the arranging of contest contacts.

9. **NET FREQUENCY CONTACTS** score as part of the band containing them and not on an individual net basis. That is, six metre nets



# TRIO

## 2 METRE TRANSCEIVER

# TR-2E



### FEATURES:

#### SEPARATE V.F.O. FOR TRANSMITTER AND RECEIVER

- CRYSTAL CONTROL
- SQUELCH
- NUVISTOR FRONT END
- TRIPLE CONVERSION RECEIVER
- NOISE LIMITER
- A.C.-D.C. OPERATION
- INBUILT POWER SUPPLY

### SPECIFICATIONS:

**RECEIVER**  
Frequency Range: 144-148 Mc AM  
Sensitivity: 1 microvolt for 10dB  
S/N at 145.5 Mc  
(0.05 W Audio Output)  
Image Ratio: 50 dB at 145.5 Mc  
IF Frequency: 1st IF 44-45 Mc  
2nd IF 10.7 Mc  
3rd IF 455 Kc  
Noise Limiting: Automatic  
Squelch: 1 microV-300 microV.  
Selectivity: 20 dB down at 10Kc  
Audio Output: 3W 8 ohms  
Input Impedance: 50 ohms (Unbalanced)

**TRANSMITTER**  
Frequency Range: 144-148 Mc AM  
Power Input to Final: 22 to 26 Watts  
RF Output Power: 10W 144-146 Mc  
AC 240V Operation  
9W 144-146 Mc  
DC 12.8V Operation  
FT-243  
Crystal Type: FT-243  
Crystal Frequency: 8-8.222 Mc

VFO Frequency: 8-8.222 Mc  
Microphone Input: High Impedance w/Push to Talk  
Frequency Response: -3 dB at 300 and 3,000 c/s  
Output Impedance: 50-100 ohms w/Coaxial Connector  
**POWER SUPPLY**  
AC Operation: 117/230V 60/50 c/s  
Receive Power Drain 106 VA  
Transmit Power Drain 146 VA  
DC Operation: DC 12.8V (12/14V)  
Receive Power Drain 90 VA  
Transmit Power Drain 120 VA

Tubes and Transistors used: 16 Tubes  
1 Nuvistor, 8 Diodes, 4 Power Transistors  
Dimensions: H: 6 5/8"; W: 11 7/8"; D: 12 3/4"  
Weight: 22.2 lb  
F.O.R./F.O.A. SYDNEY \$282.00

CONSULT YOUR LOCAL RADIO DEALER, OR

MAIL THIS COUPON *today*

Please forward free illustrated literature and specifications on Trio equipment.

Name.....

Address.....



(A unit of Jacoby Mitchell Holdings Ltd.)  
376 EASTERN VALLEY WAY, ROSEVILLE, N.S.W.  
Cables and Telegraphic Address: 'WESTELEC',  
Sydney. Phone: 40 1212



# UHF CONTEST

score as part of the six metre band score and the two metre nets as part of the two metre band score.

10. Contacts via repeaters and translators can NOT score in this contest but such contacts may be used for arranging, during contest hours only, of contest contacts. As with direct net operation, operators should have due regard for the etiquette and importance of net operation.

11. One scoring contact per station is allowed in every one "clock hour" for each band a station can work. One contact per "clock hour" means one QSO between say, 1300 hours and 1400 hours. It is not necessary to wait a full hour to have a second scoring QSO with the same station on the same band. E.g. "A" works "B" at 1259 hours; they may then work again any time from 1300 hours to 1359 hours, with their following QSO between 1400 hours and 1459 hours, and so on.

12. If two stations have a scoring contact on one band then, in the same "clock hour," have a contact on another band, both these contacts are allowed to score. If only one station can transmit on the other band and they have a cross-band contact this is allowed to score, but, where both stations can transmit on the band, cross-band contacts do NOT score. Any two stations may therefore have several scoring contacts in each "clock hour" if they use several bands.

13. In Section SWL all scoring contacts heard can be logged; the hour rule does not apply in this section of the contest.

14. SERIAL NUMBERS must be exchanged as usual before points may be claimed for a contact. The five or six digit serial number to be the R/S report for phone or R/S/T for telegraphy followed by three digits commencing as shown below and increasing by one for each successive scoring contact.

For all 52MHz band contacts commence at 601.

For all 144MHz band contacts — commence at 201.

For all 420MHz band contacts — commence at 401.

For all other including ATV — commence at 001.

Note: — Serial numbers for contacts on net frequencies are to be in the same sequence as for the band they are in.

15. ATV STATIONS. The same serial number is to be sent over the video transmission as is sent over the audio transmission.

16. LOGS are not required but may be sent in with the entry. In any case they should be made available to the contest committee if requested. Entries are to be set out in the form shown in Figure 1. This will enable the contest committee to finalise the results and compile the statistics quickly. Please check entries for completeness and accuracy before submission. For cross band contacts, record contact number under the band transmission was made.

17. ENTRIES should be sent in so as to reach the Secretary, VHF/TV Group, Wireless Institute Centre, 14 Atchison Street, Crow's Nest, N.S.W. 2065 by Friday night 4/7/69. The committee wish to release the major results on July 19 and full results and statistics on 1/8/69.

If requested and as time permits, the Contest Committee will assist with the preparation of an entry. In this way it is hoped to ensure a large return of entries.

18. INCENTIVE RATING and MULTIPLIER: The various bands and operating possibilities have been broken up into categories for the application of an "Incentive Rating," from which an operator can derive the multiplier for each contest contact.

To obtain the multiplier for a contact, take the rating for your station from the rating table given — and add to the rating of the station worked. This sum is called the multiplier. The same multiplier therefore applies to both stations in any one contact.

19. DISTANCE POINTS are based on the airline separation of the two stations in contact and accrue at one point for each ten miles or part thereof, on any frequency. The minimum distance for scoring is one mile, e.g. 1 to 10 miles — one point; 50 miles — 5 points; 51 miles — 6 points, etc.

20. SCORE CALCULATION for each contact is made by multiplying the distance in miles by the multiplier, derived from rule 18. Example: A home station operating on a 52MHz net frequency, rating of one from table, has a cross-band contact over a 50-mile path with a 432MHz ATV portable station, rating of 10 x 2 eq. 20. The multiplier for each of these stations is the sum of their ratings — 1 plus 20 eq. 21. Applying this multiplier of 21 to the distance points gives 5 x 21. A score of 105 is therefore earned by both of these stations for the contact.

The total score for a division is the total of all the individual scores in that division.

21. SECTION SWL. The distance points are based on the airline distance from the station heard to the listeners location, and the multiplier is the straight out rating of the station from the table.

22. ATV STATIONS. The audio channel may be on any band 144MHz or higher, the rating being based only on the band used for the video channel.

23. IMPORTANT NOTE. Only one call sign may be used from any one station.

24. Each participant must operate within the terms of his/her licence, abide by the rules of the contest and sign the declaration at the foot of the entry form.

TABLE OF INCENTIVE RATINGS AND MULTIPLIERS

Category	Rating																																																																																																																																																																																					
	52MHz and 144MHz Nets Home/Port/Mob.	52MHz and 144MHz Bands Tunable Home	52MHz and 144MHz Bands Tunable Port/Mob.	70cm (438MHz) Net Home	70cm (438MHz) Net Port/Mob.	420MHz and 576MHz Bands Home	420MHz and 576MHz Bands Port/Mob.	1215MHz Band Home	1215MHz Band Port/Mob.	2300MHz to 10GHz Bands Home	2300MHz to 10GHz Bands Port/Mob.	21GHz Band Home	21GHz Band Port/Mob.	52MHz and 144MHz Nets Home/Port/Mob.	52MHz and 144MHz Bands Tunable Home	52MHz and 144MHz Bands Tunable Port/Mob.	70cm (438MHz) Net Home	70cm (438MHz) Net Port/Mob.	420MHz and 576MHz Bands Home	420MHz and 576MHz Bands Port/Mob.	1215MHz Band Home	1215MHz Band Port/Mob.	2300MHz to 10GHz Bands Home	2300MHz to 10GHz Bands Port/Mob.	21GHz Band Home	21GHz Band Port/Mob.																																																																																																																																																												
52MHz and 144MHz Nets Home/Port/Mob.	1	2	4	5	4	5	10	11	16	17	20	21	23	24	3	4	6	7	6	7	12	13	18	19	22	23	25	26	4	5	7	8	7	8	13	14	19	20	23	24	26	27	3	4	6	7	6	7	12	13	18	19	22	23	25	26	4	5	7	8	7	8	13	14	19	20	23	24	26	27	9	10	12	13	12	13	18	19	24	25	28	29	31	32	10	11	13	14	13	14	19	20	25	26	29	30	32	33	15	16	18	19	18	19	24	25	30	31	34	35	37	38	16	17	19	20	19	20	25	26	31	32	35	36	38	39	19	20	22	23	22	23	28	29	34	35	38	39	41	42	20	21	23	24	23	24	29	30	35	36	39	40	42	43	22	23	25	26	25	26	31	32	37	38	41	42	44	45	23	24	26	27	26	27	32	33	38	39	42	43	45	56

Rating for amateur TV (black and white): The rating of the band used for the video channel multiplied by two.

To find the multiplier for a contact, ADD the ratings of the two stations -- OR -- on the above chart select the horizontal row corresponding to the category of one station. Then select the vertical column for the category of the other station. The multiplier for that two stations is the number shown at the intersection of the two lines.

## Specimen Entry Form

Midwinter VHF - UHF Contest June 14 - 16, 1969

Call Sign Used .....

Location .....

Operators Names and Call Signs .....

.....

.....

If in Division "S" - 6 hours: From ..... hrs on ../6/69

To ..... hrs on ../6/69

Place Band Name in Sections Entered  
52MHz; 144MHz;  
432MHz; etc.

Division	"T"	"S"
Class		
H		
M		
P		
SWL		

Category	Mark "X" for Categories		Est. RF Pwr. Out. Mode	Antenna Type-Size-Height.	Division "T"		Division "S"	
	Transm'd	Rec'd			Number Contacts	Score Claim	Number Contacts	Score Claim
52MHz Net								
52MHz Tunable								
144MHz Net								
144MHz Tunable								
70cm (438MHz) Net								
420MHz to 576MHz								
1215MHz								
2300MHz to 10GHz								
21GHz								
420MHz ATV								

Comments and suggestions:

Declaration: I hereby certify that I have operated in this contest in accordance with the conditions of my licence and abided by the rules of the contest.

Signed ..... Call Sign ..... Date .....



# NEW RANGE OF RESISTORS, CONDENSERS AND POTENTIOMETERS

WE HAVE JUST PURCHASED THE COMPLETE STOCK OF RESISTORS, CONDENSERS AND POTS. OF A LARGE MANUFACTURER AND CAN OFFER SAME AT LESS THAN 25 PER CENT OF LIST PRICE.

The resistors are mainly I.R.C. and Morganite and are in a wide range of values from 200 ohm. to 3meg. in  $\frac{1}{2}$ , 1 & 2watt also included are I.R.C. 3watt wire wound 2,200 ohm. 3,300 ohm 4,700 ohm. etc.

List price \$9.00 per 100 our price \$2.00 per 100 post & packing 25c extra.

The condensers are in most popular makes and include Polyester, Paper, Mica, Ceramic & Electrolytic in standard values including 4mfd, 8mfd, 16mfd 300V etc.

List price \$11.00 per 100 our price \$2.00 per 100 post & packing 50c extra.

The potentiometers are all current types and include switch pots, dual concentric, 1meg. tandem,  $\frac{1}{2}$  meg switch, tab pots etc.

List price \$12.00 per dozen our price \$2.50 per dozen post & packing 50c extra.

With each lot of resistors, condensers or pots, we will supply free one new valve type **FREE** 6U7G, 6X5GT, 1T4, 6K7G, or 12AT7. Resistors, condensers and pots are in packs of 100 or 12 and we regret we cannot supply to individual Lists of values or types.



## LEADER SIGNAL GENERATOR LS611

240V A.C. operated, 6 band 120KC to 390 Mcs. Provision for crystal. Post N.S.W., 75c; Interstate, \$1.25. **\$32.00**

## USED HIGH-SPEED 240V. AC/DC MOTORS

These 240 v. a.c. or d.c. motors are 1/8 H.P. with a speed of 7,000 R.P.M. and are ideal for small drills, grinders, etc. Dimensions,  $5\frac{1}{2}$ in x  $3\frac{1}{2}$ in, with 5/16in spindle . . . . . \$3.75.

Post, N.S.W., 50c; Interstate, 85c.

## NEW VALVES AT BARGAIN PRICES

7193 . . . . . 25c	1T4 . . . . . 45c	6H6G . . . . . 35c	6SS7 equiv. 6SK7 . . . . . 85c	JA7GT . . . . . 75c
807 . . . . . \$1.75	3Q4 . . . . . 75c	6K7G . . . . . 45c	6U7G . . . . . 45c	1L5G . . . . . 85c
1C7G . . . . . 30c	3S4 . . . . . \$1.00	6K8G . . . . . 68c	6X5GT . . . . . 75c	12SK7 . . . . . 80c
1D8GT . . . . . 95c	5V4G . . . . . \$1.00	6SA7GT . . . . . 95c	7C7 . . . . . 35c	12A6 . . . . . 80c
1K8G . . . . . 40c	6C8G . . . . . 80c	6SJ7 . . . . . 95c	12AT7 . . . . . \$1.00	12K8 . . . . . 50c
1K7G . . . . . 49c				12SH7 . . . . . 84c
1M5G . . . . . 40c				866 . . . . . 1.80
1P8G . . . . . 28c				954 . . . . . 25c
1Q8G . . . . . 25c				955 . . . . . 28c
				EK32 . . . . . 68c

Please add postage on all valves.

## NEW ENGLISH and AMERICAN TRANSISTORS AT 1/4 LIST PRICE

Ideal for the experimenter or service man. Each package of 12 contains 3 of each of the following types.

Mazda XA101.	Equivalent:	OC45 R.F. Transistor.
Texas 2N1108.	"	OC44 OSC. Transistor.
Texas 2N1111.	"	OC75 General purpose
Texas 2N1110.	"	OC45 R.F. Transistor.

## PACKET OF 12 FOR \$3.00

THESE TRANSISTORS CAN BE SUBSTITUTED FOR MANY OTHER TYPES.

Post and Packaging 20c extra.

## New Electrolytic Condensers

These condensers are miniature pigtail type insulated new stock in packets of 12, each packet containing: 3 16mfd 300 V.W., 2.32 mfd. 300 V.W., 1 25 mfd. 450 V.W. and 6 low voltage electrolytics. \$2.50.

Post and packing 20c extra.

## NEW IMPORTED 4" P.M. SPEAKERS

Available with a 4 or 16 ohm voice coil. \$2.00. Post and packing 30c extra.

## NEW 240V ELECTRIC MOTORS

3300 R.P.M. can be supplied with or without 4-speed reduction mechanism. Size  $3\frac{1}{4}$ " x  $2\frac{1}{2}$ " x  $3\frac{1}{2}$ ", including spindle.

**\$2.75**

plus 60c. postage.



## NEW MINIATURE MOTORS

Ideal for models, toys, etc.  $1\frac{1}{2}$  to 3 volts. 6,000 r.p.m. 39c each or \$3.50 per doz. Post 10c.



## NEW MIDGET POWER TRANS. \$3.25

40mA prim., 240v. Sec 225 x 225 with 6.3v Fil. Winding. 30mA 240v Prim. Fil. Winding. Postage: N.S.W. 25c; Interstate 45c.

150 x 150v. Sec. with 6.3v. Postage: N.S.W., 35c; Interstate 60c. **\$3.25**

## NEW AMERICAN TWIN TELESCOPE TV AERIAL

Extends to 36in, each section can be used singly for car or portable . . . . . \$1.50. Post 20c.

SINGLE TELESCOPIC Aerial 12in extends to 33in. 60 cents. Post 10 cents.

## NEW B.S.R. TAPE DECKS

These new 3-speed B.S.R. Decks are fitted with a digital counter and will take 7in spools, 2 Track, \$35, 4 Track \$40.



## A PREAMP FOR MAGNETIC PICK-UP OR TAPE HEADS

SUITABLE FOR USE WITH THE COLLARO OR B.S.R. TAPE DECKS

Using 3 silicon transistors as featured in October Electronics Australia complete with kit of parts including transistors mono \$7.50, stereo \$13.00, 240 power supply for above \$7.00. Please specify if required for pick-up or tape heads.

# NATIONAL RADIO SUPPLIES

332 PARRAMATTA ROAD, STANMORE, N.S.W. PHONE 56-7398



# NEW TRANSISTOR 8 KIT SET

SPECIAL PURCHASE ENABLES US TO OFFER THIS KIT SET AT \$24.00

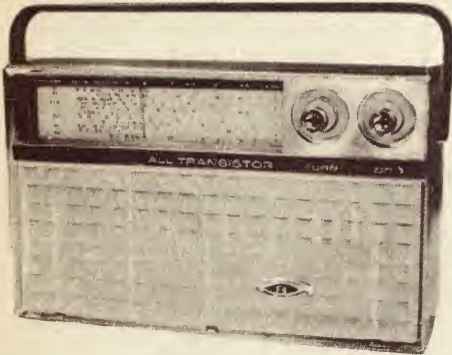

**DIMENSIONS**  
9" x 5" x 3" DEEP

(WIRED AND TESTED \$6.00 EXTRA)

- Complete kit of parts with circuit and full instructions
  - Eight transistors.
  - Magnavox 5X3 speaker gives excellent fidelity.
  - High sensitivity, suitable for city or country use.
  - Heavy duty battery for economical operation.
  - Modern design, plastic cabinet with gold trim.
  - Dial calibrated for all States.
  - Available in colours of off-white, red, black or light green.
- Post & Packing extra. N.S.W. \$1.25, interstate \$1.75.

## NEW TRANSISTOR CAR RADIO

New transistor six car radios with R.F. stage, of Aust. manufacture using A.W.A. components and transistors. Available in manual or push-button models with dial calibrated for all Australian States. Supplied with speaker (5", 6", 5" x 7" OR 6" x 9") and lock-down aerial.



MANUAL MODEL ..... \$43.00  
PUSH-BUTTON MODEL ..... \$48.00  
Post and Packing N.S.W. \$1.50, Interstate \$2.50.

Suitable for 6 or 12 volts for positive or negative earth. Please state type required.

## NEW TRANSISTOR STEREO RECORD PLAYER

This Stereo Record Player is fitted in a durable and attractive vinyl covered case with silver trim and incorporates an 8-transistor Stereo amplifier with two Magnavox 5in x 3in speakers and B.S.R. record player (4-speed) with crystal pick-up. For 240 volt A.C. operation only.

**\$38.00**



DIMENSIONS:— 21" x 10" x 3½" WEIGHT 12lbs  
Post and Packing extra N.S.W. .... \$1.50 Interstate ..... \$2.50

## NEW 25 AND 35 WATT. P. A. AMPLIFIERS

These amplifiers are suitable for installation in clubs, schools, restaurants, factories, etc. Wherever the amplification of speech or music is required.

25W \$61.00 SPECIFICATIONS 35W \$71.00.

Nominal power 25 or 35 watts.  
● Inputs two microphone and pick-up or radio with separate controls and mixing facilities.  
● Tone control. ● Microphone sensitivity 6MV. pick-up or radio 150MV. ● Frequency response 30 to 18,000 CPS. ● Output impedance Line output (100, 166, 250, 500 ohms) or can be supplied with V.C. output (2, 3, 7, 8, 15 ohms). ● Dimensions 11in x 6in x 8in. Weight 25W 23lb, 35W 26lb.



Freight Extra

## THE 10 PLUS 10 STEREO AMPLIFIER

(WITH OUTPUT STAGE PROTECTION)  
ELECTRONICS AUSTRALIA, APRIL, 1969.



A high quality 10 watt amplifier suitable for crystal or ceramic pick-up. Complete kit of parts

**\$65.00.**

# NATIONAL RADIO SUPPLIES

332 PARRAMATTA ROAD, STANMORE, N.S.W. PHONE 56-7398



# LAFAYETTE *Solid State*

## 5-Watt 27 MHz Two-Way Radio



**Model** \$169.50 (Crystals Extra)  
**HE-20T** P.M.G. Type Approved (Licence Required)

### Cool Instantaneous Operation

- Crystal Controlled Transmit and Receive.
- 13 Transistors, 10 Diodes.
- 117 VAC and 12 VDC Negative or Positive Battery Ground.
- 455 KHz Mechanical Filter.
- TVI Trap.
- Pi-Network Output.
- May also be used as P.A. Amplifier with External Speaker.

This solid state transceiver is ideal for 27MHz communications. Solid state circuitry features low battery drain and provides instant operation; 5-watt transmitter input with efficient push-pull audio modulator; a Pi-network for matching the output to 30-100 ohm antennas; an extra-sensitive superhetrodyne receiver. Fine selectivity and adjacent channel rejection is obtained through a 455 KHz mechanical filter. Sensitivity: .7 uV for 10 db signal to noise ratio. Receiver also incorporates automatic floating series-gate noise limiter and variable squelch control resulting in virtually no background noise between calls. A rear mounted low-loss antenna jack accepts SO-239 type connector used with ground plane and direct mounting antennas. Complete with fused DC line cord for negative ground battery and push-to-talk mike. Size: 8 1/2 in D. x 4 1/2 in H. x 11 1/2 in W.

## .5-Watt 3 Channel Walkie Talkie



- Sturdy Metal Case.
- Battery Condition Indicator.
- Built-in Call Alert.
- Switchable 3 Channel Operation.
- Range Boost for Extended Talk Power.
- Adjustable Squelch. Noise limiter.
- Superhet Receiver with 1 uV Sensitivity.
- Large, Efficient Speaker/Mike.

Lightweight 2-way transceiver includes three switchable channels. Call alert system sends or receives a pleasant alerting tone for convenient calling. 14 transistors, 1 diode, 1 varistor superhet circuit with noise limiter and variable squelch, .5 watt transmitter with range boost. Supplied with telescopic antenna, batteries, carrying strap, and crystals for 27.240 MHz.

**MODEL**  
**HA-305 \$57.25**  
**P.M.G. Type**  
**Approved**  
**(Licence Required)**

SEND REMITTANCE WITH ORDER FOR IMMEDIATE DELIVERY ANYWHERE. WRITE, PHONE OR CALL FOR DETAILED INFORMATION.

# LAFAYETTE

## ELECTRONICS

Division of Electron Tube Distributors Pty. Ltd.

VICTORIAN SALES  
 CENTRE AND HEAD OFFICE,  
 94 HIGH STREET,  
 ST. KILDA, 3182, VIC.  
 94-6036.

## Y.R.S. Notes — contd.

Prospective students are invited to obtain further information about the club activities by telephoning, Noel Ericsson, 59-1658. or John Scougall, 59-1796.

### Westlakes Radio Club

At the annual meeting of the Club the following members were elected to office for the coming year:

President Keith Howard VK2AKX  
 Vice-president Joe Waugh VK3IQ  
 Secretary Bruce Morley VK2ZNB  
 Treasurer Max McLachlan  
 Communications Officers David Russell VK2BSC; Brian Jones VK2ZKF; Allen Legge  
 Morse Training Officers Bob Blyth VK2BOB; Joe Waugh VK2IQ  
 Stores Officer Ray McCook —; Brian Jones VK2ZKF  
 Canteen Officer Henry Schroeder VK2ZGK  
 Transport Co-ordinator Ray McCook

Committee Colin Mackie —; Patrick Maloney VK2AXU; Wal Lean —; Keith Adams —; Eric Brockbank —; Joe Corrigan —; Kevin Scully —; Edward Rozario —; Roy Bennett —

The Club completed the year with a total of 124 members. Already twelve new members have enrolled for 1969. By secret ballot at the annual meeting it was decided to change the method of paying fees. Now, instead of paying a door charge for attending the club, a yearly membership fee has been introduced. This is \$4.50 per year for senior members and \$2.50 for junior members. For those who wish to receive the newsletter only, without any other benefits of Club membership the charge will be 75c per year.

The committee is making plans to raise sufficient money to purchase the property where the club is located. Information received from the owners indicates that the property will soon be available for sale. Not wishing to lose this excellent location for the club, at Teralba on the shores of Lake Macquarie, every effort is being made to raise sufficient funds to make the purchase possible. A target of \$3000 has been set.

## VICTORIA

### Camberwell Grammar School Radio Club

The club has received quite a large amount of radio equipment from Mr Leman which has enabled members to convert a 522 transmitter for operation on 144MHz. Two Club members, Chris Holiday, VK3ZYF and Michael Goode, VK3ZYY are the operators. Running a power input of 20 watts, many contacts have been made.

Students studying for the various Y.R.S. Certificates are making good progress and all are aiming to set a very high standard at the examinations.

### Correspondence Section

This section was established for the benefit of young people who are unable to join a Youth Radio Club. Certificate levels are identical to those issued by Y.R.C.S. Clubs, theory being studied from notes and assignments provided.

On joining the Correspondence Section, members become part of a group, each group being rather like a radio club operated by correspondence. Fees are kept to a minimum, currently being \$4.00 per year for student members. This charge covers the cost of notes and postage.

Applications for the Correspondence Section membership or further inquiries about the Section should be made to the Secretary:— Marian Tremewen, 34 Flower Street, Ferntree Gully, Victoria 3156.



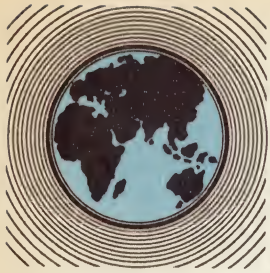

# LISTENING AROUND THE WORLD

## Survey of European transmissions.

Our six-monthly survey of reception of European signals shows a tendency towards better reception during the daylight hours, because of the diminishing sunspot count. For the same reason, broadcasters are moving to lower frequencies in the short-wave bands.

by Arthur Cushen

**ALBANIA:** Radio Tirana has increased its English services in recent months, and has many which provide good reception in the Pacific area. In our winter months we would suggest best reception as:

GMT	KHz
0630-0700	9495
0700-0730	9495
2200-2230	7090

On the first and second Sunday of each month, in the 0700GMT service, a special program for New Zealand is broadcast, which includes a New Zealand newsletter from a New Zealander now living in Tirana.

**AUSTRIA:** Radio Vienna in Austria has extended its service with new transmitters recently installed. English is being introduced into the broadcasts on a regular basis, and one transmission is on the air for the Australasian area at 1000-1200GMT, on 17885KHz.

**BELGIUM:** Radio ORU in Brussels has introduced an English period in its daily transmissions. This can be heard on 6125, 9615, 6010KHz at 2205-2215 and is repeated 0050-0100GMT. A second program is heard 2315-0100GMT using the same frequencies.

**BULGARIA:** Radio Sofia has English services to North America, which gives good reception in our afternoons as follows:

GMT	KHz
0000-0100	9700, 9660, 9560
0400-0430	9700, 9660, 9560

The service to Europe is received also at fair level. This is broadcast 1930-2000GMT on 6070, 9700, 9660, 9560KHz.

**CZECHOSLOVAKIA:** Radio Prague has its transmission to the Pacific on the air at 0700-0800GMT, on 6055, 9575, 21450KHz. This is a repeat of the program first carried to North America. Further transmissions are 0100-0200 and 0300-0400, on 5930, 7345 and 11990KHz.

**DENMARK:** Radio Denmark, at Copenhagen, is on the air with English programs to the Pacific and Asian area at 0800GMT on 15165KHz. This program includes a DX session at 0815-0835GMT each Monday. The full transmission time to Australasia is 0815-0845GMT. The service to Africa at 1915-1945GMT is also

received at good strength on 15165KHz and the DX program on Monday is also carried in this service.

**FINLAND:** Radio Helsinki has a service to Europe which has an opening and closing announcement in English. Best reception from Helsinki should be:

GMT	KHz
0600-0630 weekdays	9550, 11805
0630-0650 Sunday	9550, 11805

**FRANCE:** ORTF in Paris has several transmissions in English of 15 minutes' duration. The best received programs are:

GMT	KHz
0515-0530	9700, 11975
1100-1115	15160, 21650
1915-1930	15380, 21680

**GERMANY (EAST):** Radio Berlin International has several English programs for the Pacific area. They have a DX Club program on the second and fourth Tuesday of each month, which is heard in the last 15 minutes of each transmission.

GMT	KHz
0645-0730	21465
1115-1200	21540
1200-1245	17880, 21540
1330-1415	21540
1430-1515	21540
1515-1600	21540

On Wednesday, Thursday, Saturday and Sunday at 1115 and 1430GMT transmissions are in Hindi and Indonesian.

**GERMANY (WEST):** Radio Deutsche Welle, Cologne, has two transmissions in English each day for Australia and New Zealand, as well as two programs in the German language.

ENGLISH	
GMT	KHz
0920-1030	11795, 17740, 17845, 21560
2100-2200	7290, 9765, 15275.

GERMAN	
GMT	KHz
0700-0910	9650, 11785, 15205, 21585
0900-1110	15275, 17705, 21585.

**GREAT BRITAIN:** The B.B.C. World Service is on the air 24 hours a day with specific periods beamed to the Pacific area. Reception of the World Service throughout the day in winter is excellent, even of programs not beamed to this area, whether from the B.B.C. transmitters in the United Kingdom or from the relay base at Ascension. The transmission periods are:

ENGLISH	
GMT	KHz
0600-0915	7150, 9640, 11955
0900-1115	11750, 15070, 21550
2000-2245	7120, 9410, 11750, 15070

**GREECE:** Athens is received on Sunday with a church relay on 11720KHz, and is best at 0600GMT. Radio Athens

has recently introduced short periods of news in English and some other European languages.

GMT	KHz
0709	9605, 11720
1344	7295, 11720

**HOLLAND:** Radio Nederlands, Hilversum, has announced that the use of the Bonaire relay station will mean an increase in English programs to Australia and New Zealand. The present 50 minutes of program will be increased to 80 minutes each day. The service at present is:

GMT	KHz
0600-0720 (Sun)	6020, 9525 (Happy Stn.)
0730-0820	9715, 11730 (English)
0600-0720	9715, 11730 (Dutch)
0830-0950	9715, 11730 (Dutch)

It is planned to introduce a daily service 0600-0720 GMT, using one frequency for English and another for Dutch transmissions, with the new relay facilities.

**HUNGARY:** Radio Budapest has several transmissions in English. Although intended to service North America and Europe, they give good reception in this area.

GMT	KHz
0030-0130	6234, 9755, 9833, 11910, 15160
0300-0400	6234, 9833, 11910
0430-0500	6234, 9833, 11910

**ITALY:** Rome Radio has only one transmission in English which gives good reception in the Pacific area, and this is actually beamed to Japan. Services to North America, in our afternoon, provide alternative listening.

GMT	KHz
2200-2225	9710, 11905, 1530 (English)
0100-0120	9575, 11810 (English)
0600-0645	21560, 17800, 17795 (Italian)

**NORWAY:** Radio Norway in Oslo has a daily service to this area, and on Sunday the last 30 minutes of each transmission is in English.

GMT	KHz
0700-0830	15175, 21730, 25730
1100-1230	21730, 25900, 21655

**POLAND:** Radio Warsaw in its service to Britain also provides good reception in the Pacific in an English transmission 0700-0730GMT, using 7125KHz. Warsaw is also broadcasting to Europe as follows in English:

GMT	KHz
1930-1955	6135, 7145
2030-2100	6135, 7145
2100-2130	5995, 7125, 9540

**PORTUGAL:** Radio Portugal in Lisbon, which uses the slogan "The Voice of the West," is heard in a transmission to the Pacific at 0730GMT, in English. Programs for reception in North America also provide excellent reception here.

GMT	KHz
0730-0900	21495, 17880
0200-0245	9680, 11935
0345-0430	6025, 9680, 11935

**ROMANIA:** Radio Bucharest has a service to the Pacific at 0645GMT. English services beamed to other areas of the world are also heard. The following transmissions are the best received:

GMT	KHz
0645-0715	15380, 17850
0130-0230	9590, 11810, 11885
0300-0330	9570, 11940, 15250
0430-0500	9590, 11940, 15380

Notes from readers should be sent to Arthur Cushen, 212 Earn Street, Invercargill, N.Z. All times are GMT. Add 8 hours for Perth, 10 hours for Sydney and 12 hours for Wellington. All frequencies in KHz.



## NEW RH (Radio House) RANGE OF MULTIMETERS

### NEW POCKET SIZE MULTITESTER LIMITED STOCKS



Latest model multitester YT67 now costs only \$8, measures up to 100,000 ohms and continuity.

DC volts 0-15, 0-150, 0-1000.  
AC volts 0-15, 0-150, 0-1000.  
DC current 150 MA.  
1,000 ohms per volt, sensitive and clear scale for accuracy. Posted \$8.50 anywhere, with test leads and internal battery complete, ready to use. Size 3½ in x 2½ in.

### Model RH-80 \$18.00 Postage 50c



20,000 Ohms per Volt DC  
10,000 Ohms per Volt AC

**Specifications:**  
DC Volts. 0.5, 2.5, 10, 50, 250, 500, 1000 V  
AC Volts. 10, 50, 250, 500, 1000 V  
DC Current: 50µA, 5mA, 50 mA, 500 mA  
Resistance. 5 kΩ, 50kΩ, 500kΩ, 5 MegΩ  
Decibels. -10 + 62 db  
Accuracy. DC ±3%, AC ±4% (of full scale)  
Batteries. Two 1.5V dry cells. Size AA, "Eveready" 915  
● Overload-protected by dual silicon diodes. ● Mirror scale.  
● Double-jewelled ±2% meter. ● ±1% temperature-stabilized film resistors.

### Model RH-70 \$22.50 Postage 50c



30,000 Ohms per Volt DC  
10,000 Ohms per Volt AC

**Specifications:**  
DC Volts: 0.5, 2.5, 10, 50, 250, 500, 1000 V  
AC Volts: 10, 50, 250, 500, 1000 V  
DC Current. 50 µA, 5 mA, 50 mA, 500mA  
Resistance: 7 kΩ, 70 kΩ, 700 kΩ, 7 MegΩ  
Decibels. -10 +62 db  
Accuracy. DC ±3%, AC ±4% (of full scale)  
Batteries. Two 1.5 V dry cells. Size AA, "Eveready" 915  
● Overload-protected by dual silicon diodes. ● Mirror scale.  
● Double-jewelled ±2% meter. ● ±1% temperature-stabilized film resistors.

### Model RH-20 \$15.00 Postage 50c



20,000 Ohms per Volt DC  
10,000 Ohms per Volt AC

**Specifications:**  
DC Volts: 0.25, 2.5, 10, 50, 250, 1000 (20,000/V)  
AC Volts: 10, 50, 250, 500, 1000 (10,000/V)  
DC Current. 50 µA, 25mA, 250mA  
Resistance. 7kΩ, 700kΩ, 7MΩ  
Decibels. -10 +22 (at AC/10V) +20 +36 (at AC/50V). Upper frequency limit 7kc.  
Accuracy. DC ±3%, AC ±4% (of full scale)  
Batteries: Two 1.5V dry cells. Size AA, "Eveready" 915  
● Overload-protected by dual silicon diodes.  
● Double - jewelled ±2% meter. ● ±1% temperature-stabilized film resistors.

### Model RH-55 \$20.00 Postage 50c



30,000 Ohms per Volt DC  
14,000 Ohms per Volt AC

**SPECIFICATIONS:**  
\*DC Volts: 0.6, 3V, 12V, 60V, 300V, 1200V (30,000 ohms/V)  
\*AC Volts: 12V, 60V, 300V, 1200V (14,000 ohms/V)  
\*DC Current: 60 A, 12mA, 300mA.  
\*Resistance: 10K ohm, 1Meg ohm, 10Meg ohm.  
\*Decibels: -10 db +23 db.  
\*Meter Sensitivity: 23 A.  
● Overload-protected by dual silicon diodes. ● Mirror scale.  
● Double-jewelled ±2% meter. ● ±1% temperature-stabilized film resistors.

### Model RH-60 \$25.00 Postage 50c



50,000 Ohms per Volt DC  
10,000 Ohms per Volt AC

**Specifications:**  
DC Volts: 0.25, 2.5, 10, 50, 250, 500, 1000 V  
AC Volts. 10, 50, 250, 500, 1000 V  
DC Current. 25 µA, 5 mA, 50 mA, 500 mA  
Resistance: 10 kΩ, 100 kΩ, 1 MegΩ, 10 MegΩ  
Decibels. -10 +62 db  
Accuracy: DC ±3%, AC ±4% (of full scale)  
Batteries. Two 1.5 V dry cells. Size AA, "Eveready" 915  
● Overload-protected by dual silicon diodes. ● Mirror scale.  
● Double-jewelled ±2% meter. ● ±1% temperature-stabilized film resistors.

#### NOTICE

From June 30th, 1969, the Royal Arcade shop will be closed on account of rebuilding on the site.

Enquiries at head office  
306 - 308 PITT ST., 26-2817

# RADIO HOUSE PTY. LTD.

306-308 PITT STREET: 6 ROYAL ARCADE & 760 GEORGE STREET, SYDNEY



**SPAIN:** Radio Madrid is best received in various Spanish transmissions. A service in English to North America 0100-0145-GMT is carried on 6130 and 9765KHz. Further programs at 0200-0245, 0300-0345GMT are on the same frequencies.

**SWEDEN:** Radio Sweden, in Stockholm, has several English program transmissions, each of 30 minutes' duration.

GMT	KHz
1230-1300	9760
1900-1930	15240, 11865
0330-0400	11705

**SWITZERLAND:** S.B.C., in Berne, has a daily service to New Zealand and Australia. Signal level and program content are excellent. Other services are also well received.

GMT	KHz
0700-0830	9590, 11775
0845-0945	11775, 15135
0445-0615	6120, 9720.

**U.S.S.R.:** Radio Moscow, with relays via its Siberian stations, provides excellent signals on short wave, and on medium wave after dark, to this area of the world.

GMT	KHz
1100-1130	7280, 9540
1130-1200	7280, 9540
1330-1400	7280, 9540

**VATICAN:** Radio Vatican has two transmissions in English for the Pacific areas.

GMT	KHz
2200-2215	9645, 11705
1130-1145	17700, 21690

**YUGOSLAVIA:** Radio Belgrade has its English service at times not convenient for listening in this area, but the signals on the transmissions listed are generally of fair quality.

GMT	KHz
1530-1600	7200, 1524
1830-1900	6100, 7200
2000-2030	6100, 7200

#### VH9RA RABAUL

A new shortwave station is now operating from Rabaul in Papua, New Guinea. This station, operated by the Australian Broadcasting Commission, has the call sign VH9RA and is using 5985KHz. It is on the air 2230-0530GMT, and relays the medium wave program of the A.B.C. over 9RB on 810KHz. It is presumed that 9RB is being supplemented for its daytime coverage by this new short-wave station. The present schedule of 9RB is 2000-1300GMT weekdays and to 1400GMT on Saturday. Rabaul is at present also being served by the Australian Administration Station VL9RB on 3385KHz, using 10KW.

#### DZYV VERIFIES

The reception of DZYV, in the Philippines, was reported recently when we heard their signals on their second harmonic of 2640KHz when closing at 1400GMT. We have since received a letter of verification from the station, which expressed surprise at its reception in New Zealand. The letterhead shows the operating frequency as 1320KHz. The station was so impressed with our reception that greetings were broadcast during its evening program at 1300 and 1400GMT.

Radio DZYV is operated by the "Y" Broadcasting System, and has its offices at 2212 Marconi Street, Makati, Rizal. The studios are located at Rosario Gumaca, Quezon.

#### LATEST KUWAIT SCHEDULE

GMT	KHz	KW
0400-0700	1133	1
0400-0700	4967	10
0400-0700	17750	250
01600-1900	1133	1
1900-1900	11920	250
0900-1100	15150	250

#### RADIO NACIONAL NICARAGUA

A new station with the slogan "Radio Nacional Nicaragua," broadcasting from Managua, has been reported using its new 100KW transmitter on several frequencies. The station was received on 11875KHz,

#### SCHEDULE CHANGE FOR RSA

Radio South Africa in Johannesburg has retimed its schedules to Australia and New Zealand and now uses two frequencies instead of the three formerly used. The earlier broadcast time should enable better reception throughout the year, as in the past good reception has only been possible in the summer months. The new schedule for New Zealand is from 0800GMT and to Australia from 1000GMT:

GMT	KHz
0080-0900	17825, 21535
1000-1100	17825, 21535

opening at 1545GMT. It had an announcement in English stating that the power was 100KW, and that the station was also on the frequency of 5935KHz. The transmission on 5935KHz has been heard in the United States to sign off at 0400GMT, and should provide good reception in Australia and New Zealand in our winter months. The station is operated by the Government and carries no commercials. A further report states that the frequency of 5935KHz has been running as late as 0500GMT.

#### ENGLISH FROM COSTA RICA

A special transmission intended for listeners in North America but giving good reception in New Zealand is broadcast from station TIQ, Port Limon, which has the slogan Radio Casino. The station is heard on 5954KHz and is broadcasting in English 0400-0600GMT. The program consists mainly of popular music and commercials and has frequent calls to listeners in the United States. The frequency is blocked by WNYW New York, which is using 5955KHz to 0500 and again from 0555GMT by Radio Canada also on 5955KHz.

#### WNYW ON 5955HKz

A new frequency for Radio New York World Wide, station WNYW, is 5955 KHz, which carries a program in Spanish to sign off at 0500GMT. The signal level in New Zealand is excellent. The station has news in Spanish at 0400GMT and the balance of the program is popular music. WNYW is broadcast to Latin America as follows:

GMT	KHz
0000-0150	15215
0000-0145	15130
0200-0500	15130
0000-0150	17835
0000-0400	11855
0200-0350	9615
0345-0500	5955
0425-0500	11865
0200-0500	15130

#### FOUR STATIONS FOR UGANDA

A contract was recently announced between The Marconi Company, of U.K. and the Uganda Government, covering the construction and installation of a number of transmitting stations as an extension to the National Radio Network of Uganda. The contract, worth nearly £700,000, is for four medium-wave transmitting stations to be built in the Northern, Eastern, Western and Midland regions of the country. This will bring the total number of Marconi transmitters in Uganda to 17.

Each station will employ two 50KW transmitters operating in parallel to give a total output of 100KW. The contract also includes the equipping of each station with masts and aerials and a small studio for broadcasting regional programs in conjunction with the national network. These stations will extend Radio Uganda's coverage on the medium-wave band to practically the whole country, and will enable the programs to be received on small inexpensive receivers. Uganda is roughly equal in area to the U.K. but has very difficult terrain, with mountains reaching over 16,000 feet, adding to the problems of radio propagation.

The new transmitters will incorporate up-to-date design features, which will ensure high reliability and efficiency. Such is the inherent reliability of the transmitters that it is proposed to staff each station with only two engineers.

The construction is due to start immediately once the final site selections have been made. The installation program provides for all four stations to be commissioned during 1970.

#### ETLF ADDIS ABABA

The present schedule from the Voice of the Gospel ETLF at Addis Ababa, Ethiopia is as follows:

GMT	KHz	Language
1900-1945	15425	French
1930-2015	11895	English
0300-0330	11855	French
0400-0425	9600	English
0400-0425	11855	French
0445-0525	15170	French
0530-0555	11890	English

#### BETTER LATE THAN NEVER

The fact that stations do not verify promptly at times concerns the listener, but it has been found that some stations have confirmed reception after two or three years. Patience in waiting for a verification from these stations is essential as it seems that they answer mail only spasmodically. In a recent issue of "Contact" a review of these stations was published, and this will enable readers to get some idea of the present policy of the stations in this group.

#### EUROPE

All European stations which have an overseas service will QSL correct reports by card or letter, and, in most cases, return postage is not needed. Many small stations on MW only, or with a domestic service, will also QSL, and return postage may be needed. As a general rule, the language used in the report should be English, though in the case of smaller stations the local language may be preferable.

**AZORES:** Emissor Regional dos Azores, up to recently, has not verified reports. **PORTUGAL:** All Portuguese stations will verify reports, but it may take 7 or 8 months.

**U.S.S.R.:** Radio Moscow does not now verify reports on regional stations as it does not have the information to do so, and reports should be sent directly to the stations concerned.

#### AFRICA

As with all other areas, it is recommended that reports be sent air mail, since if this is done reports will stand a substantially greater chance of being verified. This may seem an expensive way to get QSLs, but with the more difficult stations it is definitely worthwhile. Except in the case of the largest stations, return postage should be sent and the reports should be in the local languages. Stations in Portuguese Africa may take up to 12 months to reply. Here are the stations which reply irregularly:

**ANGOLA:** Radio Clube Benguela; erratic. **CAMEROUN:** Radio Buea; irregular. **CHAD:** Radio Chad; erratic, but if they are going to send you a card it should arrive after about a month.

**CONGO:** (Kinshasa) R. TV National and Radio Bukavu now appear to verify reports.

**DAHOMY:** Radio Cotonou; fairly good reports in French get a quicker reply than those in English.

**GABON:** Libreville will QSL reports in French if an IRC is enclosed. Franceville; occasionally verifies.

**GUINEA (Republic):** Radiodiffusion Nationale; will verify reports in English.

**GUINEA (Spanish):** Radio Ecuatorial; irregular.

**IVORY COAST:** Radio Abidjan; irregular, reports must be in French.

**MALI:** Radio Mali; may take as long as 14 months to hear from them. Reports must be in French and return postage sent.





# WARBURTON FRANKI

## NEW! METREX AUTOMATIC SOLDERING GUN

- The Metrex Automatic contains everything you need — solder, flux, heat.
- Simple one-hand operation — trigger action feeds the right amount of solder at the right temperature.
- Weighs only one pound.
- Magazine holds 10ft of solder (refills available).
- Works directly from 240v mains.



**\$9.95**

Plus 25c pack and post.

## NEW! 2.5 WATT AMPLIFIER MODULES

- Built-in Volume and Tone Controls
- 5 Transistors
- High (1 megohm) Input impedance
- Output impedance 8 ohms. Less than 100 M.V. for full output
- Distortion — .5 per cent at 1 WATT
- Frequency response — FLAT from 50 to 20 K.H.Z.
- Power requirements — 18 volts at 300 M.A.
- Size of Board — 2in x 4in.



**\$16.95**

Including pack and post.

## POWER SUPPLY TO SUIT

240v A.C. to tapped outputs of 9v to 21v D.C. at 1 amp.

Size of Board — 3½in x 2½in.

**\$14.50**

Including pack and post.

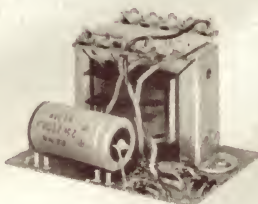

## A NEW INSTRUMENT CASE

- Modern up to the minute styling.
- Tough A-B-S plastic case.
- Long life anodised aluminium panel.
- Battery compartment.
- Ribbed for easy hand carrying.
- Dimensions — 7.5" x 4.5" x 4.5" approx.
- Dozens of uses — Multimeter, Test Instruments, Intercom, Extension Speakers, etc., etc. etc.
- Grey, but other colours by arrangement.



**\*LOW PRICE \$3.75**

Including pack and post.

## POLYPAC No. 20

Contains 25 assorted condensers, including ceramic, electrolytic, metal pack, mica, paper tubular.

**\$1 plus postage 10c (or five for \$5, post free)**

## PHILIPS RE2 RADIO ENGINEER KITS

Everything supplied to build a 3 transistor mantel radio including cabinet. The radio may also be used as an amplifier for a record player or microphone.

**\$17.95**

Including batteries and freight.

## "CADET" SPEED CONTROLLER FOR ELECTRIC HAND TOOLS

Varies speed from stop to full speed with no loss of torque. Rated capacity 2 amps. Complete with flex and plug.

**\$11.50**

FREIGHT FREE.

## POWER SUPPLY BASIC KIT

Consists of:

One Transformer tapped for 9v and 12v at 500 ma.

One full-wave contact-cooled rectifier.

One 1,000 mfd 15 V.W. capacitor.

Make your own 9 or 12-volt power pack to supply transistor radios, record-players, slot cars, toys, etc.

Supplied with wiring diagrams.

**\$3.85**

Post free.

## TRANSFORMERS

Let us quote for your special power or stepdown transformers. Lowest prices and speediest delivery.



# WARBURTON FRANKI

220 PARK ST., STH. MELB., VIC. Ph. 69-0151 (30 lines)

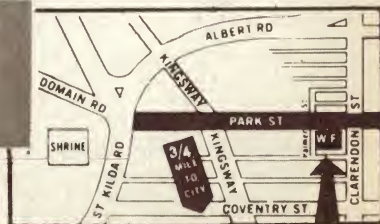



MOROCCO: RTV Marocaine; does have a QSL card, but very few people have managed to get one.

**ASIA**

Reports in English are acceptable by most stations in this area. Return postage is necessary for the smaller stations. CEYLON: Radio Ceylon; QSLs are rare. The commercial service can sometimes be verified from Radio Advertising Services, P.O. Box 10013, Bombay, 1, India. IRAN: Radio Teheran needs an IRC. MONGOLIA: An alternative address for Radio Ulan Bator is via the Head of the Foreign Relations Service, Montsame News Agency, Ulan Bator, Mongolian People's Republic. PAKISTAN: Now verifies reports. SAUDI ARABIA: QSL may take a long time to arrive, one of these reasons being the irregular postal service.

**AMERICAS.**

Reports should be in Portuguese to Brazil, and in Spanish to most other countries. Most stations will verify a report if you take enough time and trouble over it. To North America, all reports should be in English. Below are listed stations which have persistently not verified reports:

- ARGENTINE: LRA 33.
- BRAZIL: Radio Sociedad da Bahia, Radio Cultura da Bahia (intermittent), Radio Jornal do Comercio, Radio Dif Sao Paulo, Radio Cultura Caruaru, Radio Timbira, Radio Pionera do Teresina.
- CHILE: Radio Nuevo Mundo.
- PERU: Radio America OAX-4V and Radio Nacional del Peru.
- URUGUAY: Radio Sarandi.
- VENEZUELA: Radio Universal Marida, Radio Dif Venezuela.
- DOMINICAN REPUBLIC: Radio Santo Domingo TV, Radio Commercial.
- GUATEMALA: TGWB (intermittent).
- MEXICO: XESE.
- WINDWARD ISLANDS: WIBS is very slow, but will reply if a personal letter is sent to the station manager. Reports answered more quickly when on special transmissions.

**COUNTRY LISTS BEING ADOPTED.**

This month, at the meeting of the European DX Council at Halmstad, Sweden, a new country list is expected to be adopted. This, it is hoped, will be the basis of the universal counting of countries by medium and short wave listeners. Already some extensive work has been done in Europe, and by the North American Association of Radio Clubs.

The major fields in which the work has been done is to designate a country in the following categories.

1. Sovereign states.
2. Remote territories, colonies and far away islands separate from the parent territory.
3. Different in Governmental administration.
4. Countries separate from the parent body by intervening land under other control.
5. Broadcasting activities.

Contrary to other lists no autonomous departments and republics of Unions are included such as U.S.A., U.S.S.R., China or India. A further problem with newly emerging countries is to wait and see if they become established. Some countries may not be adopted into the official list until they have become firmly established.

Countries which are absorbed into new countries are counted and are listed in a footnote. These are counted by old DXers if logged when they were independent and under the old name or Government.

The major points of disagreement include the way to count: Malaysia, West Berlin, Netherlands Antilles; the question of rented territories such as Guantanamo Bay, in Cuba; new federations of Arab States; Biafra; South West Africa; and the Commonwealth Islands in the West Indian Federation.

**FLASHES FROM EVERYWHERE**

**AFRICA**

CONGO: The Radio Bukava station in the Congo Democratic Republic is on 4839KHz reports "World Bulletin". On Sunday the station operates 0400-2100-GMT. Radio Lubumbashi is back on 4750KHz, a move from 3285KHz. Radio Kinshasa has been heard signing on at 0400GMT on the new MW frequency 1448KHz, and is also using 1331 and 836-KHz.

IVORY COAST: Radio Abidjan has moved from 6015KHz and now uses 11920KHz for all transmissions 0600-0800 (Sunday to 1200), 1200-1400, (Sunday to 1800), 1800-2400GMT. The new sign-on time is now 0600GMT, 30 minutes earlier than previously.

RHODESIA: The Rhodesian Broadcasting Corporation has dropped 3306 and 3396KHz and now uses 4828KHz for the African program 0330-0530, 1530-2010-GMT. On Saturday, English is carried to 2200GMT. English is on 5012KHz at 0355-0545, 1600-2100GMT weekdays, and Saturday to 2200, Sunday 2205GMT.

REUNION: According to a recent verification from Radio Saint Denis, they now use 8KW on 602KHz and 4KW on each of 665, 2446 and 4807KHz. The station is now on the air 0230 to 1800GMT in French.

GABON: Radiodiffusion Television Gabonaise also identifies as "La Voix de la Revolution", and is now reported to open its service at 0430GMT on 4777KHz. The power on this frequency is 25KW. The address is B.P.150, Libreville.

SUDAN: Radio Omdurman, P.O. Box 572, Omdurman, is testing a new transmitter of 100KW on 11835KHz. The station has been heard 0400 to 2200GMT. Programs are entirely in Arabic. The same programs are carried on 4995KHz.

**ASIA**

INDONESIA: Radio Republik Indonesia, Jogjakarta, is now received with an English program, according to "World Bulletin". The signal has been received on 5047KHz at 1144GMT, and opens with the chirps of native birds, and then full identification in English. The station then has news at 1146GMT and sign off in English is at 1159GMT. The station also has a similar program in its

**WEARITE DEFLUXERS**

*Guard your Tapes*

Magnetised Tape Heads Can Partially Erase Recorded Tapes.

Available from all Ferrograph Dealers.

**LEROY INDUSTRIES PTY. LTD.,**  
266 Hay Street,  
SUBIACO, W.A.



**BARGAIN PACKS!**

**SEMI-CONDUCTOR PACKS, BRAND NEW AND TESTED! SILICON AND GERMANIUM TYPES**

- 10—RF Type Similar BF115 AT325. \$2.95
- AY1101
- 10—AUDIO Type Similar AT326, BC108 \$2.95
- 10—AUDIO Out put Matched Pairs \$3.25
- 1—NPN HI Power Output. 2N3055 \$2.00
- 5—Pair Complementary Output \$3.25
- 1—PNP RF IF Type SIM AF116 or .60
- 10—SIM AF116 \$5.00
- 1—PNP Power Output 2N2148 - 2N301. \$1.00
- 1—PNP Audio Similar OC70 .50
- FET's MPF 102 ... \$1.10
- MPF 105 ... \$1.10
- MPF 106 ... \$1.10
- 2N 3819 ... \$1.00

**SILICON RECTIFIERS**

- 50V, 100V, 200V, 400V at 36c each.
- 800V, \$1 ea; 1000V, \$1.30 ea
- GERMANIUM DIODES**
- OA90 Type 27c ea or 10 for \$2.50
- OA91 Type 27c ea or 10 for \$2.50
- AN1102, BA100, 27c ea or 10 for .. \$2.50

**RECORDING TAPE, POPULAR MAKE AT WHOLESALE PRICES**

- 3in 150ft ... .60
- 3in 225ft ... .72
- 3in 300ft ... .99
- 5in 600ft ... \$1.80
- 5in 900ft ... \$2.35
- 5in 1200ft ... \$2.90
- 5 1/2in 900ft ... \$2.65
- 5 1/2in 1200ft ... \$3.00
- 7in 1200ft ... \$3.00
- 7in 1800ft ... \$4.10
- 7in 2400ft ... \$4.97
- 7in 3600ft ... \$6.65

**PHILIPS TYPE CASSETTES**

- C60, 60min ... \$1.95
- C90, 90min ... \$2.75
- C120, 120min ... \$3.50

**NEW WIDE BAND TUNER**

Based on Playmaster design. Ceramic filters. Tuning meter, whistle filter, etc. \$52, plus tax. Teak cabinet, \$6 extra.

**TRANSISTORISED TUNERS**

New, low-priced model, wood grain finish. Without power supply.

ONLY \$19.50, plus tax. UNIT 10—with RF stage and power supply 8 Kcs bandwidth—\$31, plus tax.



Peak 7W Stereo Amplifier. 50,20,000 Hz, in oiled timber cabinet. \$34.50, complete.



**AMPLIFIER KIT**  
STC 20W RMS STEREO AMPLIFIER

Complete to last nut and bolt. Plus full instructions. \$72 plus 25 p.c. sales tax.

Unit 4. Pre-amp tone Control Stage.  
Unit 11. 65W HI-FI Amplifier.  
**TRANSISTORS AND DIODES AT SPECIAL PRICES. ALSO ALL COMPONENTS, TAPE, FILM, etc.**  
SEND S.A.E. FOR DETAILS AND LIST.

**SPECIAL IIII 1st RELEASE!**

8 TRANSISTOR RADIO KIT! USES SILICON TRANSISTORS AND DIODES. Complete with instructions and earphone \$21. Wired and Tested \$23.50.

**NEW 1969 TRANSISTOR RADIO KIT**



6 Silicon Transistors and complete with Instruction Book, carrying case and earphone. Special price, \$11.25  
Wired, \$13.50  
Post and Pack, 75c.



**BOYS' CRYSTAL SET KIT**  
Complete with plastic cabinet, earphone and instructions. \$2.20

Transistor Modules—  
Unit 1. 25W RMS Amplifier.  
Unit 2. 10W Amplifier.  
Unit 3. 10W RMS Amplifier.

**S. E. WILLIS TRADING CO.**

38 Riversdale Road, Camberwell Junction, Vic., 3124.  
Phone 82-5767. Please Include Freight. Sorry No C.O.D.



# A. C. E.

AMPLIFICATION

COMMUNICATION

ELECTRONICS



# RADIO

WEEKENDS & AFTER HOURS 98-5956.

## 136 VICTORIA ROAD MARRICKVILLE — 51-3845

**K 20 CT330**  **K 20 CT500**

**C.T.330 20K. OPV**  
D.C. Volts 6, 6, 30, 120, 600, 1,200, 3,000, 6,000. A.C. Volts 6, 30, 120, 600, 1,200. D.C. Current .06-6, 60, 600mA. Resistance, 6K, 600K, 6meg., 60meg., D.B. minus 20 to plus 62. 5 Ranges. Specially suitable for transistor use.  
**\$16.45**

**C.T.500 20K.OPV**  
D.C. Volts, 2.5, 10, 50, 250, 500, 1,000. A.C. Volts, 10, 50, 250, 500, 1,000. D.C. Current, .05, 5.50, 500mA. Resistance, 12K, 120K, 1.2meg., 12meg. D.B. minus 20 to plus 62.  
**\$13.25**

**KAMODEN—100B**  
100,000 O.P.V.  
D.C. Volts, .5, 2.5, 10.50, 250, 500, 1,000.  
A.C. Volts, .25, 10.50, 250, 500, 1,000.  
Mils., .01, .25, 2.5, 25, 250, ID.A. Res., 20K, 200K, 2M, 20M:OHM. DB minus 20 to plus 62. 5 Ranges  
**\$29.75 POST \$1.00**

**P.T.34 1000.OPV**  
D.C. Volts, 0, 10, 50, 250, 500, 1,000.  
A.C. Volts, 0, 10, 50, 250, 500, 1,000.  
M.A. 1-100-500 RESISTANCE.  
**\$5.50 Post 50c**

**200H 20K.OPV**  
D.C. Volts, 5, 25, 50, 250, 500, 2,500. A.C. Volts, 10, 50, 100, 500, 1,000. D.C. Current, 50uA, 2.5, 250mA. Resistance, 6K, 600K, Capacitance, 2 D.B. Ranges.  
**\$10.95 Post 50c**  
Full range of Kaise-S.K. brand at Special Prices.  
Send for details.  
ALL PRICES NET. INC. S-TAX

### PANEL METERS



EDGE METERS, 1mA. Scaled V. U.S. Tuning Stereo Bal. **\$2.50.**  
A FULL RANGE OF UNITS.  
85 Types, 1/4in to 3/4in. FROM **\$3.25.**  
Send for full list.

### HI-FIDELITY TWIN CONE SPEAKERS

Aust. made, 8 or 16 ohms.  
6in .. **\$9.00** 12in .. **\$11.75**  
8in .. **\$7.50** Postage: ..  
8in .. **\$9.00** N.S.W. 50c.  
10in .. **\$10.75** Interstate 80c.

### AMPLIFIERS Public Address Range 240V-AC



#### MINIATURE P.A. AMPLIFIER. 15 WATTS OUTPUT.

Multi Match Ferguson O.P. transformer input for crystal mike and pick-up with electronic mixing  
P.P. EL.84 output .. **\$42.50**  
30 Watt. As above, EL.34 P.P. .... **\$57.50**  
40 Watt. As above, EL.34 P.P. .... **\$85.50**  
60 Watt. As above, 6DQ6 P.P. .... **\$105.50**  
LINE OR VOICE COIL.

#### SOLID STATE

240V. A.C. 50 Watt Output .. **\$85.00**

240 V. A.C. plus 12 V. D.C. and charges own battery. **\$95.00.**

Inputs for 2 Dynamic Mikes or Pickups with Electronic Mixing.

### P. A. SPEAKERS

8 WATT.  
8in Units in Waterproof Projection Horns.  
15 Ohm Voice Coils.  
**\$15.25**  
Line Output Transformers to suit. **\$1.75** extra.

### DYNAMIC MICROPHONES



#### Model UDM-105 CARDIOID (uni-directional)

Impedance: High 50K ohms/Low 600 ohms. Sensitivity: -60db/1,000 cps. Frequency Response: 150-10,000 cps.

**\$16.95**



#### Model DM-108 (non-directional)

Impedance 50K ohms. Sensitivity: 57db/1,000 cps. Frequency Response: 100-10,000 cps.

**\$11.95**

### CARDIOID. HI. IMP DYNAMIC

DX-129 Hi Imp Dynamic. DM 401 **\$12.75**  
Hi Imp Dynamic DM 203 **\$8.75**  
Hi Imp Dynamic DMS-3 **\$5.50**  
Crystal Pencil BM-3 **\$7.50**  
Crystal Lapel **\$1.75**

**KEYLESS ORGAN**  
Complete Kit, Set. **\$42.50.**  
Wired, Tested, Tuned, **\$49.50.**  
Post **\$1.00.**

**CO-AXIAL SPEAKER**  
12in 2ohms, 20 Watts. Cross over, 3,000 cycle. Frequency range 40 to 20,000 cycles.  
**\$27.75**

### REVERBERATION UNITS

Latest design to suit organs, stereo, guitar, any hi-fi equipment.  
**\$5.75**  
Post 35c.

### TACHOMETERS



Mullard ACE, scaled for 5.7 or 9K .. **\$20.75**  
With Dwell Angle .. **\$23.75**

**OHNAR**  
240-degree Circular Movement. Scaled 6K or 8K .. **\$24.75**  
Standard Scale 6 or 8K .. **\$19.75**  
Postage N.S.W. 50c. Interstate 75c

### MICROPHONE

Low Loss Mic. Cable 15c per yard or \$10.00 per 100yds  
**GOOSE NECKS. SATIN**  
9in .. **\$2.75** MIC. STAND.  
12in .. **\$3.50** Floor Model.  
18in .. **\$4.35** **\$11.75.**  
24in .. **\$5.00** Table model **\$3.65.**

### STEREO RECORD CHANGERS

Latest Model, 4-speed.  
**\$28.75**  
De Luxe Model. Fully machined and balanced. Heavyweight turntable. Ceramic cartridge.  
**\$34.00**  
Post N.S.W. \$1.25. Interstate \$1.75.  
De Luxe Model with mechanical cueing device. Calibrated stylus. Pressure control. Adjustable counter balance. Two spindles.  
**\$46.50**  
**ELAC 190**  
4-Speed Changers. Ceramic pick-up **\$27.50**



### HI-FI STEREO HEADPHONES

8-OHM. Range 25c to 17K.c.  
**\$9.75**  
Post 35c.

**240V VARIABLE POWER**  
Units. 0 to 20 V. 1 Amp. Fully Transistorised. **\$21.50.**

**VOLT-AC VARIABLE TRANSFORMERS**  
0 to 260V. 10 Amp. 2400 Watts. **\$49.50**

### 4 CHANNEL TRANSISTORISED MICROPHONE MIXER

Specs. High imp. input. Gain, Approx. 3DB. Max. input sig. 1 volt max. output sig. 1-3-volt noise ratio —60DB, 9-volt operation.  
**\$9.95**

### V.T.V.M. MODEL TE-40 MILLIVOLTER

Spec. AC.V. Imv.—300 Vrms. 10 ranges, Accuracy 5 cps—1 2mc, plus-minus 1db. 10 cps-1 mc, plus-minus 1db. 20 cps-250 KC.. plus-minus 0.2db.  
dB. Scale: 40-30-20-10.0, 10.20, 30.40, 50 dBm, 240 V.A.C.  
**\$48.75**

### MODEL TE-65 V.T.V.M.

DC. V. 0-1, 5-5-15-50-150-500-1,500 V. Rms. AC.V. 0-1.5-5-5-15-50-150-500-1,500 V. Rms. 0-1-4-4-14-40-140-400-1,400-4,000 V. P.P. Resistance RX10,100, 1K, 10K, 100K, 1M, 10M. Decibel—100db, minus-plus 65dB.  
240 V.A.C.  
**\$43.75**  
TECH. P.V. 58 **\$40.50.**

### ORGAN KEYBOARDS

49 Note. Complete with Switching System. **\$72.00**  
13 Note Pedal Claviers, complete with Switches. **\$39.95**  
Special: Semi-finished Stromberg Organ Cabinets to suit above. **\$19.50**  
Organ Stools .. **\$14.50**

### NEW SPEAKER SPECIALS

8 or 15 ohms,  
2in .. **\$2.75** 4in x 2in **\$3.30**  
2 1/4in .. **\$2.75** 5in x 3in **\$3.30**  
2 3/4in .. **\$2.85** 6in x 4in **\$3.50**  
80mm .. **\$2.85** 7in x 4in **\$4.25**  
3 1/2in .. **\$2.95** 9in x 6in **\$5.95**  
4in .. **\$2.5** Postage: ..  
5 1/4in .. **\$3.20** N.S.W. 25c.  
6in .. **\$4.00** Interstate 40c

### NEW RECORDING TAPE

Most popular brand 50c  
3in Correspondence .. **\$1.05**  
3in Mylar, L.P. 300ft .. **\$1.05**  
3 1/4in Mylar, D.P. 600ft .. **\$1.25**  
5in Mylar, L.P. 900ft .. **\$2.50**  
5in Mylar D.P. 1,200ft .. **\$3.15**  
5 1/4in Mylar L.P. 1,200ft .. **\$3.15**  
5 1/4in Mylar D.P. 1,800ft .. **\$4.70**  
7in Mylar L.P. 1,800ft .. **\$4.70**  
7in Mylar D.P. 2,400ft .. **\$6.25**  
7in Mylar T.P. 3,600ft .. **\$7.00**  
7in P.V.C. 1,200ft .. **\$2.50**  
Postage N.S.W. 15c.  
Postage Interstate, 25c.





## GUITAR AMPLIFIERS

10-Watt, Two-Channel, with Twin Cone Speaker . . . . . \$53.55  
 14-Watt, 4 Inputs, Bass and Treble Boost, 2 Twin-Cone Speakers, \$63  
 17-Watt, Four-Channel, Bass and Treble Boost, Two Twin-cone Speakers . . . . . \$76.25

### 35 WATT

4-Channel, Bass and Treble Boost 4 Twin-Cone Speakers — \$109.05  
 Vibrato with foot control and 2 preset controls for frequency and intensity, \$10.50 extra on above models.

### ELECTRIC GUITAR

Pickup Units . . . . . \$8.75  
 Accordion Pickup Units . . . \$8.75  
 Harmonica Pickup Units . . . \$1.95  
 Post. N.S.W., 40c; Interstate, 75c.

### FUZZ BOX

FUZZ BOX E. AND A. AUG. WIRED AND TESTED. \$15.  
 Post. 75c.

### REVERB UNIT

COMPLETE with AMPLIFIER E.A. October Issue. Kitset \$39.95. Wired and tested, \$41.95.



## MULLARD MAGNAVOX

### BOOKSHELF ENCLOSURE

Maple, Teak or Walnut Complete \$24.75  
**SUPER BOOKSHELF \$36.75.**

Post: N.S.W. 50c. Interstate \$1.00. CABINETS ONLY

R. H. BOOKSHELVES \$11.50  
 MULLARD \$10.95

### BOOKSHELF UNITS

6in 8in 10in 12in  
 \$27.75 \$33.50 \$35.50 \$36.50

### PLAYMASTER 106 AND 107



Feb. and March Elect. Aust. 106

WIRED AND TESTED \$94.75

107

WIRED AND TESTED \$83.75

### SOLID STATE VTVM

E.A. Dec. Wired. Tested. \$49.50

## PIGGY BACK GUITAR AMPLIFIER

Excluding Speakers

30 Watt . . . . . \$79.75  
 45 Watt . . . . . \$99.75  
 60 Watt . . . . . \$119.75  
 4 Inputs, Bass and Treble Boost Vibrato if required, \$10.50 extra.

## PIGGY BACK GUITAR AMPLIFIER

Complete with Speakers, Cabinet  
 30 Watt Lead . . . . . \$138.75  
 30 Watt Bass . . . . . \$146.75  
 45 Watt Lead . . . . . \$158.75  
 45 Watt Bass . . . . . \$166.75  
 50 Watt Lead . . . . . \$218.00  
 60 Watt Bass . . . . . \$234.00  
 Vibrato if required . . . . . \$10.50

### 14 plus 14 WATT

With Reverberation. May be used as 28 Watt or as 14 Watt plus 14 Watt Reverb. Two 9 x 6 Woofer Speakers, Two 9 x 6 Twin-Cone Speakers, 4 Channels, Bass and Treble Boost. Foot Vibrato control included.

\$163.50

### UA 41A - 20-20

SOLID STATE STEREO 20 watts per channel. Inputs for tape, magnetic and ceramic P.U. Tuner and aux. Teak cabinet.

\$88.00



### 240v A.C. POWERED SOLID STATE STEREO

T.S.135  
 18 Transistor, 15-watt per channel. Inputs for Tape, Mag. P.U. Ger. P.U. Radio Aux. Freq. Range 30c to 20KC. Max Sensitivity 3 MV. Speaker matching 4 to 15 ohms.

\$78.00

### RECORD PLAYERS

Latest Model, 8in Turntable, Crystal Cartridge, 4-speed, 240 V-AC  
 Mono . . . . . \$17.50  
 Stereo . . . . . \$19.50  
 Post \$1.00.



### A.Z.C. STEREO AMPLIFIER

5 WATTS PER CHANNEL. Valve Unit, 240V A.C. Input for Crystal and Ceramic P.U. Radio and Auxiliary. Output for 4, 8, 15 ohms. Cross talk better than -40db. Sensitivity 50 MV.

\$47.50

### TAPE DECKS B.S.R.

2 Tracks, 3 1/4 i.p.s. \$25.50  
 4 Track, 3 Speed Stereo, \$41.50



### 11 1/2" FULLY BALANCED PICK-UP ARM.

COMPLETE WITH MAGNETIC Stereo Cartridge . . . \$19.50  
 Arm less cartridge . . . \$11.50  
 Mag. cartridge only . . . \$9.50

## WIDE BAND OSCILLOSCOPES

### SPECIFICATIONS

#### VERTICAL AXIS

Deflection Sensitivity (at 1 kc) 0.1 V p-p/cm.  
 Frequency Characteristics 1.5 cps—1.5 MC.  
 Input Impedance 2 M ohms 25 pF.  
 Calibration Voltage IV pp-cm.

#### HORIZONTAL AXIS

Deflection Sensitivity 0.9 V p-p cm.  
 Frequency Characteristics 1.5 cps—800 KC.  
 Input Impedance 2 M ohms 20 pF.  
 Sweep Oscillator (5 Range) 10 cps—300 KC.  
 Synchronization Devices Internal (Positive and Negative, External). Power 240V AC 50/60 cps. Cathode Ray Tube 3KFIF.



5 Meg Bandwidth Push-Pull vertical and horizontal Amplifiers, 8 positions, high sensitivity vertical Amplifier Frequency Compensated on all positions. Calibrated .02 to 600 volt. Hard time base, 20 cycles to 75K. Latest American R.C.A. circuitry. Complete with probe.

**3-inch \$102.75; 5-inch \$118.75**



### PLAYMASTER 115

The new solid state Stereo-Amplifier. April Issue. Wired and tested . . . \$104.00  
 Kit Set . . . . . \$90.00  
 Pre-amp to suit magnetic Cartridge . . . . . \$12.00

### 10 + 10 STEREO AMPLIFIER

With Overload Protection Circuit Kit Set. \$62.75.  
 Wired and Tested . . . . . \$72.75



### AUDIO GENERATOR

De Luxe Model TE-22D. Freq. range, Sine 20 cps—200 KC. SQ. 20 cps—25KC. Output voltage, Sine 7V, SQ. TV P.-P. Output impedance 1000 ohms, Acc. 5 per cent. Distortion less than 2 per cent. 4-range attenuation, 1/1, 1/10, 1/100, 1/1K. Printed circuit. 240V A.C. \$42.95

### SIGNAL INJECTOR

Transistorised, Fountain pen-sized Unit for Signal Tracer in Radio, TV and Amplifier Service. \$5.75. Post. 25c

### TRANSISTOR AND DIODE TESTER

E.A. August '68. Wired and Tested. \$57.00  
 KIT SET \$48.00

### G.D.O. UNITS

Post. N.S.W., 50c; Interstate, 75c. T.E. 15 Transistorised, 7 Band, 360 Kc to 270 Megs. \$35.75

### T.V. BOOSTER

240VAL. Especially designed for fringe area reception. Also up to 3 TV sets can be operated off common aerial for improved signal strength. \$15.95 Post Free.

### NEW GRAMMO MOTORS

240V A.C. 3 Speeds. \$2.75. Post. 40c.  
 INTER. COM. UNITS  
 2 Station Transistorised. \$11.95  
 4 Station, including Master. \$20.95

### 3" VERNIER DIAL.

8:1 Ratio. \$2.95. Post 25c.

### TRANSISTORISED CRADLE TYPE TELEPHONE AMPLIFIER.

Have Conversation with both Hands Free . . . . . \$12.95  
 Post \$1.25.

### T.O. 2" Oscilloscope

IDEAL TV AID  
 240 V-AC 2 BPI CRO Tube  
 Vert. Sen. 10V P-P/CM. 50V P-P/CM.  
 Vert. Input imp. 2 Megs. 25pF.  
 Vert. Freq. 2 cps/1 Meg.-3DB.  
 Sweep Freq. 2 Ranges, 60cps-75KC. \$64.50.

### SIGNAL GENERATOR

Deluxe Mod 1 TE-20D. Freq. range 120 KC—500 Mcs. 7 Bands. Accuracy 2 per cent. Output 8V. Provision for Xtal. Suitable for self calibration Marker generator. Printed circuit. 240 T.E.20. \$25.50. \$28.50 V.A.C.

### 15-INCH HI-POWER SPEAKER

Imported 30 Watts R.M.S. \$30.00  
 Local 50 Watts R.M.S. \$50.00

### L.S.G. 11

SIGNAL GENERATOR  
 FREQ. RANGE IN 6 BANDS  
 120KC—130MCS . 02  
 Calibrated Harmonics  
 120MCS—390MCS.  
 RF output over 100,000UV.  
 120KC-38MC.  
 Mod. Freq. 400 and 1000CPS.  
 Crystal Osc. 1-15MCS.  
 AF Output, 3 to 4 Volts.  
 AF Input, 4V approx.  
 240V AC Operation.  
 \$31.75. Post 75c.

### T. E. 46 RESISTANCE-CAPACITANCE

Bridge and Analyser. Capacity 20 pF to 2,000 mfd. Resistance 2 ohm to 200 meg. Also tests power factor, leakage, impedance, transformer ratio, insulation resistance to 200 meg. at 600V. Indications by eye and meter. \$49.75

### TRIO W.O.I. SWEEP GENERATOR

TV and F.M. 2 to 260 Mcs. Sweep 0 to 20 Mcg. Ideal for TV Sound and Picture Aligning. \$99.00



# Choose from the *Taylor* range of **Multimeters**

- for • HIGH SENSITIVITY  
• ACCURACY  
• FOOLPROOF OPERATION

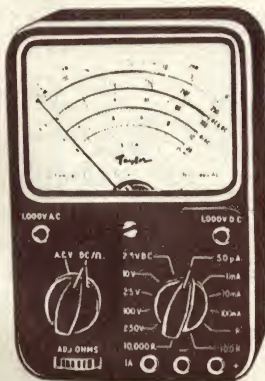

(Left) Model 127A: SENSITIVITY: 20,000  $\Omega/V$  d.c., 1,000  $\Omega/V$  a.c. RANGES: d.c. current—50 $\mu$ A to 100mA. d.c. volts—0.15 to 1,000 a.c. current—100 $\mu$ A. a.c. volts—10 to 1,000. Resistance—0 ohms to 20 megohms (3 ranges). Decibels — 10 to + 62 db. ACCURACY: D.C. ranges— $\pm$  3%. A.C. ranges— $\pm$  4%.

(Right) Model 88B: SENSITIVITY: 20,000  $\Omega/V$  d.c., 2,000  $\Omega/V$  a.c. RANGES: d.c. volts—0.1 to 2,500. 25 kv with adaptor Model 488. a.c. volts—1 to 2,500. d.c. current—0.05 to 10A. a.c. current—1 to 10A. Resistance—1 ohm to 50 megohms (5 ranges). Decibels — 10 to + 68 db (8 ranges). Capacitance — 1,000 pF to 100 $\mu$ F (4 ranges). Inductance—0.2 to 20H (2 ranges). ACCURACY: D.C. ranges— $\pm$  2%. A.C. voltage ranges— $\pm$  3%. METER: 5" mirror scale. OVERLOAD PROTECTION: automatic mechanical cutout.



(Left) Model 100A: SENSITIVITY: 100,000  $\Omega/V$  d.c., 5,000  $\Omega/V$  a.c. RANGES: d.c. voltage—5 to 2,500. High voltage probe for 25 kv a.c. voltage—10 to 2,500. d.c. current—10 $\mu$ A to 10A. Resistance—0 ohms to 200 megohms (4 ranges). Decibels — 10dB to + 62db (5 ranges). ACCURACY: D.C. ranges— $\pm$  2%. A.C. ranges— $\pm$  3%. METER: 8 $\mu$ A M/C with mirror. OVERLOAD PROTECTION: automatic mechanical cutout. REVERSE POLARITY. Also available: Model 101. A simplified version of the 100A, without the 2,500 V measuring ranges, the Overload Protection Switch and Polarity Reversal Switch.



Send now for further information to:

**JACOBY, MITCHELL & CO. PTY. LTD.**

469-475 Kent Street, Sydney. 26-2651

MELBOURNE  
30-2491/2

ADELAIDE  
93-8117

BRISBANE  
2-6467

PERTH  
26-1102

LAUNCESTON  
5-8322

JM/21-69

morning service, according to the sign off announcement.

**IRAN:** The first two 250KW transmitters for Radio Iran's short-wave centre at Kamalabad have been ordered. A medium-wave station of 2000KW is already under construction.

## THE AMERICAS

**BRAZIL:** Radio Nacional de Brazil, from Rio de Janeiro, has daily programs to North, Central and South America. The frequencies of 6145, 11795, 15295 and 17850KHz are used. The programs at 0030GMT are in Spanish-English, French and Portuguese.

**VENEZUELA:** Ondas Portenas, using 4790KHz, is now devoting a special program to listeners who send in reception reports. The broadcast is at 0500GMT on Saturday.

**ECUADOR:** Radio Nacional de Ecuador, Casilla 1316, Quito, using 4940-KHz, is offering a station pennant to listeners who report on the program "Asi es el Ecuador" broadcast from 0400 to 0430GMT daily.

**ARGENTINA:** Radio Argentina Exterior, LRA32, is now heard on 9683KHz, and has English to North America 0300-0400 and 0600-0700GMT.

**DOMINICAN REPUBLIC:** Radio Mil, Santo Domingo, is using 4930KHz and has a program for foreign listeners at 0345 to 0400GMT. The station offers to answer questions about the Dominican Republic. It acknowledges receipt of correspondence and plays popular music.

**CANADA:** Radio Canada is now acknowledging reception reports with a new QSL card. The card represents Canada's most popular sport, ice hockey, and it features four hockey players in an action packed scene on a red and blue background. The verification is issued on reports on the C.B.C. International Service sent to Box 6000, Montreal Canada.

**CUBA:** Radio Havana is using a new service to North and South America, from 2300GMT on 11760, 15155, 15265, 15365-KHz, also on 17715, 17750 and 17885KHz in the 16M band. At 0555 they use 6060, 9550, 11930, 15270, 17885KHz.

## BROADCAST BAND NEWS

**MASIRAH ISLAND:** A new B.B.C. relay station is under construction on this small island in the Indian Ocean. It will operate on medium wave with two 750KW transmitters. The station replaces Berbera, in Somalia. This was closed when the Somalia Republic was formed and the station transferred to Perim Island, outside Aden. This station also was closed, when Aden became independent. It is presumed that the frequency of 701KHz will be used by the new station and the programs will be mainly in Arabic.

**MACAU:** Emissor Vila Verde is now in Chinese 2300-1600GMT on 735KHz, using 10KW. The frequency of 1200KHz is no longer in use.

**INDIA:** A new transmitter for All India Radio is now in operation on 570KHz. The possibilities of reception here are restricted to each second Monday morning when 2YA Wellington is silent for the period 1120-1700GMT Sunday.

**PHILIPPINES:** A new station is on the air with the call sign DXJO on 1460KHz using 1KW. The station is located at Jolo, an island of Mindanao, and the station's service area is the Southern Philippines and Sabah.



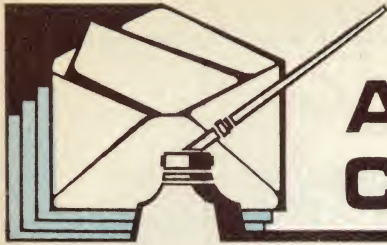

# ANSWERS TO CORRESPONDENTS

**MICROPHONY PUZZLE:** A 1T4 valve in a small battery radio I have built is quite markedly microphonic. What I can't quite understand is how the valve elements can receive the sound waves from outside, when the valve interior is a vacuum and therefore should not be able to sustain sound waves. Can you please explain? (J.M., Lakes Entrance, Vic.)

● Although the interior of the valve is largely a near-vacuum, J.M., there are still the element electrodes to act as a "link" with the outside world. Vibration can thus quite easily reach the valve elements, in effect, by travelling up the valve pins and support structure. There are often also mica spacer washers in contact with both the inside surface of the glass envelope and the outer surface of the plate cylinder or shield. In general, a valve becomes markedly sensitive to sound and other vibration only if its interior support structure alters such that one or more of the elements can move or vibrate relative to the others. When this occurs, the vibration can produce a variation in the transconductance, plate resistance and other characteristics, and by this means make the vibration evident in an electrical sense. But if the valve elements are all rigidly held relative to one another, they can vibrate as a whole without any noticeable effect upon their electrical performance. We hope this brief explanation clears up the puzzle. Incidentally, your subscription to the magazine has been registered, and we are glad to hear that you find it of interest and value.

**COLOUR TELEVISION:** Now that the colour TV system to be used in Australia has been announced, are you bringing out a course, or can you recommend a book that we could study to bring us up to date with this system? (R.P., Soldiers' Point, N.S.W., and D.S., Geelong, Vic.)

● Thank you for the suggestion, R.P. and D.S., but, unfortunately, we cannot produce a course on colour television out of the air. To prepare such a course would involve taking an experienced staff member off other more urgent work. Although we have predicted a start to colour television in mid-1972, it could, in fact, be much later than this and a course presented now could be premature. We will certainly consider the possibility of such a course at a later date, possibly starting about the time of the P.M.G.'s 18-month notice. In the meanwhile, the following publications may be of some assistance:

"PAL Colour TV . . . The PAL System and Mullard Circuits Described." Published by Mullard Ltd. Reviewed in our January, 1968, issue.

"Colour Television, with Particular Reference to the PAL System," by G. N. Patchett. Published by Norman Price Ltd. Reviewed in June, 1968.

"Colour Television Explained," by W. A. Holm. Published by Philips Technical Library. Reviewed in July, 1965.

"Beginner's Guide to Colour Television," by T. L. Squires. Published by George Newnes Ltd. Reviewed in July, 1965.

"Introduction to Colour TV," by M. Kaufman and H. Thomas. Published by John F. Rider, 1956. Copies should still be available.

"Proceedings of the Institution of Radio

and Electronics Engineers Australia," Vol. 29, No. 12, December, 1968, which contains an article on PAL colour television.

**AUDIO BOOK:** Have you considered publishing an audio book made up from selected features, "Know Your Gramophone," "Audio Topics," etc? What are earth loops? How do recording companies produce re-channelled stereo? Not all teenagers have as their criterion "the need to recognise the tune." I have collected equipment which gives me very acceptable reproduction. I would like to congratulate you on the magazine. The material is well balanced in presentation and in the fields of interest covered. (G.N., Bayview, N.S.W.)

● We have thought quite a lot about such a book and plan to do one as soon as we can cope with it, over and above our monthly production effort on the magazine. To be successful, however, a book needs to have written into it a continuity and a uniformity which cannot be secured by pushing together articles not expressly intended for the purpose. The subject of earth loops is too large for explanation here; we will have to cover it again sometime in the body of the journal. The simplest type of re-channelling may involve nothing more than frequency division, with treble dominating the left channel and bass the right. You can pick it immediately by swinging the balance control between its limits. More ambitious re-channelling backs this up with use of a musical score and manipulation of the panel controls to swing the more prominent instruments or instrument groups to appropriate apparent positions. Your comments about teenagers are noted. Unfortunately, a great deal of teenage material, particularly the 45rpm "quickies" owe more to immediacy than to quality. Thanks for the kind

remarks about the journal. We try to make it that way!

**PERCUSSION RECORD:** You have helped me quite a deal towards enjoyment of my hi-fi system. You should hear "Provocative Percussion" by Enoch Light on "Calendar," Stereo SR66-9515. I picked it up at \$1.99. I have heard nothing quite as good. (A. S., Lane Cove, N.S.W.)

● Glad to know that we have been of assistance. We are not quite certain whether we have heard the particular disc but we have listened to several of Enoch Light's "Percussion" series. This type of material can sound very impressive, even on modest equipment. In fact, we tend not to judge equipment performance on percussive records for this very reason. For evaluation, we prefer material less likely to flatten and more likely to reveal faults and texture: orchestra, voice and grand organ.

**MORE SELECTIVITY:** Like many teenagers I am interested in simple constructional projects. I have built a crystal receiver but it has very poor selectivity. Could it be improved? Would you have on hand any circuits for a small portable transistor receiver? (R. D., Maryborough, Qld.)

● Crystal sets are, by their nature, limited in selectivity. The most practical circuit we can suggest appears on page 49 of "Basic Electronics," a book which supersedes our original "Basic Radio Course." It is available from this office for \$2 plus 20c postage. Circuits for small receivers are given in chapters 20 and 21 of this same book and we suggest, if you have not already studied the contents, that you do so. We do not encourage constructors to attempt miniature transistor portables of the type commonly used by teenagers. They use special min-

## "ELECTRONICS Australia" Information Service

As a service to readers "ELECTRONICS Australia" is able to offer: (1) Photographs, dye-line prints and other filed material to do with constructional projects and (2) A strictly limited degree of personalised assistance by mail or by reply through the columns of the magazine. Details are set out below:

**PROJECT REPRINTS:** For a 20c fee, we will supply data, as available from our files. The amount of data available varies but in no case does it include material additional to that already published in the magazine. For complicated projects involving material extracted from more than one issue, an extra fee may be requested. As a rule, requests for project data will be answered more speedily if the projects are positively identified and the request is not complicated by questions requiring the attention of technical personnel. Where articles are not on file, we can usually provide a photostat copy at 20c PER PAGE.

**PHOTOGRAPHS, DYE-LINE PRINTS:** Original photographs are available for most of our projects, from 50c plus 8c postage for a 6in x 8in glossy print. In addition, metalwork dye-line prints are available for most projects for 50c each; these show dimensions and the positions of holes and cut-outs but give no details of wiring.

**BACK NUMBERS:** A fairly good selection is available. On issues up to six months old the cost is the face value, plus 5c surcharge. From seven to 12 months, 10c surcharge; over 12 months, 20c surcharge. Package and postage is 10c extra per issue. Please indicate whether a PROJECT REPRINT may be substituted if the complete issue is not available.

**REPLIES BY POST:** This provision is made primarily to assist readers in matters relating directly to articles and projects published in "ELECTRONICS Australia" within the last 12 months. Note, however, that we cannot provide lengthy answers, undertake special research or modifications to basic designs. A 20c query fee must be enclosed with letters to which a postal reply is required; the inclusion of an extra fee does not entitle correspondents to special consideration.

**OTHER QUERIES:** Technical queries which fall outside the scope of "Replies by Post" may be submitted without fee and may be answered through the columns of the magazine at the discretion of the Editor. Technical queries will not be answered by interview or telephone.

**COMMERCIAL EQUIPMENT:** "ELECTRONICS Australia" does not maintain a directory of commercial equipment, or circuit files of commercial or ex-disposal receivers, amplifiers, etc. We are therefore not in a position to comment on proposed adaptation of such equipment, or on its general design. "ELECTRONICS Australia" does not deal in electronic components. Prices, specifications or other assistance must be sought from the appropriate advertiser or agent.

**REMITTANCES:** These must be in a form negotiable in Australia. Where the charge may be in doubt, an open cheque, endorsed with a limitation, is recommended.

**ADDRESS:** All requests for data and information, as set out above, should be directed to The Assistant Editor, "ELECTRONICS Australia," Box 2728 G.P.O., Sydney, N.S.W. 2001: 5/69



# MULTIDRAWER

A TRANSPARENT MULTI-COMPARTMENT DRAWER  
AND OUTER CASE MADE OF STRONG CLEAR PLASTIC

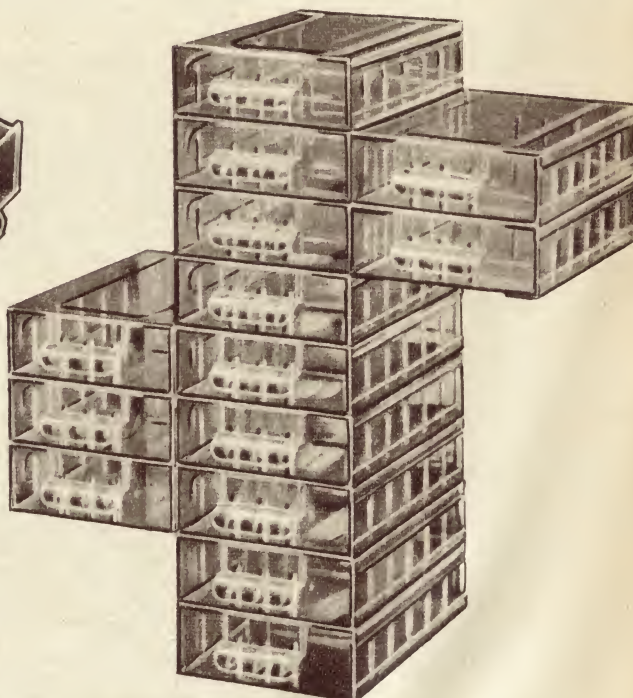

IT CAN BE USED AS:

- a self contained STORAGE BOX UNIT
- or a MULTIDRAWER CABINET by joining the individual units IMMEDIATE ASSEMBLY by sliding action  
**NO GLUE — NO TOOLS NECESSARY!**

Each drawer can be partitioned into 12 varieties of compartment arrangements by removable dividers.

The Multidrawer consists of a drawer sliding into an outer case. Both parts are made of strong clear plastic to ensure immediate visual location of stored articles (opaque outer case also available). The outer case has built-in integral dovetails and grooves for vertical and horizontal assembly by means of sliding the corresponding sides. This assembly is achieved instantaneously without using any tools or cement.

The drawer has built-in grooved side ribs, which allow its partitioning into 13 possible combinations of compartments by simply dropping into the grooves standard dividers, available in 4 lengths. The longest of the dividers is provided with the same ribs as the drawer in corresponding positions, to firmly hold the smaller dividers.

The dividers can be left as removable for any future rearrangement, or could be cemented in by using TRICHLOROETHYLENE.

The assembled cabinet will firmly stand on any flat surface and will not require additional reinforcement.

**AT HOME:** as a box for sewing, jewellery, haberdashery, hair accessories, cosmetics, medicaments, fishing accessories, writing utensils, small hardware, cigarettes and cigars, photographs, colour slides and many others.

**AND IN:** SHOPS, OFFICES, WORKSHOPS, LABORATORIES, STORES and FACTORIES.  
for visible storage of small parts and also as production assembly aid.

## THE MULTIDRAWER — THE STORAGE BOX OF 101 USES

**SPECIFICATIONS:** Drawer — transparent. Outer case — opaque (steel grey). Dimensions—Identical for both models are: Outer Case: Length: 9 5/16", width: 6 7/16", Height: 2 3/8". Drawer: Length, 9 3/8", Width: 6", Depth: 2". Protrusions of the handle — 3/4". Weight of the unit — 12 ozs.

Also available from General Accessories Interstate Branches.

Trade Enquiries Invited

Write to General Accessories for further information and Price List.

## GENERAL ACCESSORIES

(A DIVISION OF ELECTRONICS INDUSTRIES)

116-118 CLARENCE STREET, SYDNEY 443 CONCORD ROAD, RHODES — 73-0211



## ANSWERS – continued

ature components which would be difficult to obtain and for a beginner difficult to handle. Over and above this, the parts would almost certainly cost a good deal more than a completed receiver!

**METAL DETECTORS AGAIN:** Looking back through past issues of "Electronics Australia," I have seen hundreds of circuits but have not found one for a transistorised metal detector. I should have thought that this would fall inside the scope of your magazine. I think many people would benefit from one, including plumbers, electricians, police, veterinary surgeons and those looking for buried treasure. (M.B., Hampton, Vic.)

● We have had many requests for metal detectors but we regret we cannot oblige. We have carried out many tests with metal detectors designs and have concluded that they have such limited range (a few inches) that the average potential user would be disappointed. However, we did describe a pipe and wiring tracer in our September, 1965, issue which works very satisfactorily.

**DELTAHET RECEIVER:** I read with great interest a description of your Deltahet Front End in Amateur Radio Techniques, by Pat Hawker. As there is not much constructional detail given, I wonder if you could help me with enough information to build and align the unit. I have a receiver which tunes 2-3MHz and I could feed the Deltahet Front End into it. As I enjoy listening in between the amateur bands, I feel that this unit is what I need. (D.W., Baltimore, Md. 21212 U.S.A.)

● We are pleased to learn that you saw the reference to the Deltahet Front End in Pat Hawker's Amateur Radio Techniques. We can supply full details for the construction and alignment of this unit. In addition, there were two introductory articles on general communications receiver designed, later, two articles (which should be read with the articles on the Deltahet Front End) describing the construction of the complete Deltahet Communications Receiver. More recently, there was a short article, "Observations on the Deltahet." This deals with some slight modifications, together with some problems which had been encountered by a few readers. Back issues of the magazine are no longer available and due to the popularity of this project, tear sheets are also exhausted for most articles. However, we are able to supply dyeline copies in such instances, although these are somewhat heavier than tear sheets. The price of each article is 20c (Australian). Here is a list of the articles:

Prelude to a Communications Receiver Part 1, May, 1963.

Prelude to a Communications Receiver Part 2, June, 1963.

### Transistor ignition:

I should like to ask a number of questions about your articles on transistor ignition, from you January to April, 1964, issues. 1. Is the Hi-Fire coil still available? 2. With the change in cost of NPN transistors, are they now an economic possibility for positive earth systems; if so, can you suggest a suitable type? 3. Is there any possibility of an article on this subject in the near future? (I.T., St. Lucia, Qld.)

● Circuits for transistor ignition systems were in strong demand a few years ago, largely because of outlandish claims in regard to improved engine performance at all speeds and greater fuel economy. Because of the pressure of demand we ran articles on the subject but with a much more matter-of-fact evaluation of advantages and disadvantages. In recent years, interest in the subject has diminished and current opinion seems to be that transistor ignition adds cost and complication, without contributing much to ordinary motoring. This being so, we have no immediate plans to up-date the original articles or spend more laboratory time investigating or re-assessing the subject. We are really not in a position, therefore, to advise about the suitability of more recent transistor types or the degree to which they may have influenced the wisdom or economy of particular techniques. We have not had occasion, either, to check the present market situation for transistorised ignition components but we gather that the Hi-Fire coil is no longer in ready supply.

Deltahet Front End Part 1 July, 1963.  
Deltahet Front End Part 2 August, 1963.  
Deltahet Communications Receiver Part 1 September, 1964.

Deltahet Communications Receiver Part 2 October, 1964.

Observations on the Deltahet January, 1966.

To assist calculation of postage, either by air or surface mail, here are the weights of the most likely combinations of the series.

The complete set of 7 articles; 8oz. July, August, 1963 and January, 1966; 4oz.

September, October, 1964, and January, 1966; 4oz.

**ALTERNATIVE TRANSISTOR:** Will you please tell me if there is an equivalent to the NPN power transistor, 40250, which has been used in several of your projects? I am unable to obtain them. (J.K., Light Pass, S.A.)

● An alternative to the 40250 is the 2N3054 which has slightly higher ratings. If this is not available you can use the BDY10 or 2N3055 which have considerably higher ratings, a larger encapsulation, and consequently would require differently spaced mounting holes. 40250s are in short supply from time to time but kit suppliers can usually supply one of the above types.

**WIRELESS INSTITUTE:** Can you tell me how I can join the W.I.A.? (L.E.M., South Oakleigh, Vic.)

● Details of how to join the Wireless Institute of Australia can be obtained either from the Federal Secretary, Box 2611W, G.P.O. Melbourne 3001, or from the Division of the W.I.A. in your State. The addresses of the Divisions are: N.S.W. Division — 14 Atchison Street, Crow's Nest, N.S.W. 2065; Victorian Division — P.O. Box 36 East Melbourne, Vic. 3002; Queensland Division — Box 638J, G.P.O. Brisbane 4001; South Aust. Division — Box 1234K, G.P.O. Adelaide 5001; Western Aust. Division — Box N1002, G.P.O. Perth 6001; Tasmanian Division — Box 851J, G.P.O. Hobart 7001.

**TUNNEL DIODES:** Can you tell where I can obtain technical information on tunnel diodes available in this country. I am interested in their applications, and I require the characteristics of the various types. (P.M.McC, Hobart, Tasmania.)

● We suggest a good place to start is with the manufacturers of transistors, who publish data sheets and other technical matter. For example, Amalgamated Wireless Valve Company, Victoria Road, Rydalmere, N.S.W. 2116 (distributors for RCA semiconductors in Australia) or Australian General Electric Pty. Ltd., 103 York Street, Sydney 2000.

# "OXFORD"



## RADIO CHASSIS



## INSTRUMENT CASES



## MINI BOXES "ALUMINIUM"



All printed and engraved panels for "Electronics Aust.", Mullard "Outlook," Philips "Digest."



Any special metalwork and panel engraving to specification.



All stock cases and chassis from our distributors in Brisbane, Melbourne, Adelaide.

## HEATING SYSTEMS PTY. LTD.

24 O'Riordan St.,  
ALEXANDRIA, N.S.W.  
2015.  
69-3764 - 69-7616





# SAVES CIRCUIT DESIGN TIME!

## SAVE SET-UP TIME ON EXPERIMENTAL CIRCUITRY

The Vector EXPERIMENTER'S CHASSIS provides quick set-up of electronic circuitry with simple hand tools. Intended mainly for mock-ups, the structure is also suitable for more permanent use and may be mounted on racks or in cabinets with added adaptor plates. The construction is highly flexible and parts can be readily cut to make other sizes than those supplied.

Kit 22X is for quick set-up of transistor and similar circuitry. It has combination transistor sockets with pig-tail wires. These fit transistor pins "in-line" or in the triangular "JETEC" configuration. Sockets are on saddles which mount above the punched board. Transistor leads may also be clipped into the unique SPRINGCLIP terminals provided. Sockets for power transistors are also supplied.

## UNIQUE SOLDERLESS TERMINAL

The heart of the system is the Vector SOLDERLESS SPRINGCLIP Terminal, T30N. SPRINGCLIPS hold as many as six component leads without soldering or crimping wires. This allows re-use and prevents heat damage to expensive components. Contact resistance is less than .01 ohms.

- EASY TO USE ● ECONOMICAL
- SAVES DAMAGE TO EXPENSIVE COMPONENTS ● PERMITS RE-USE

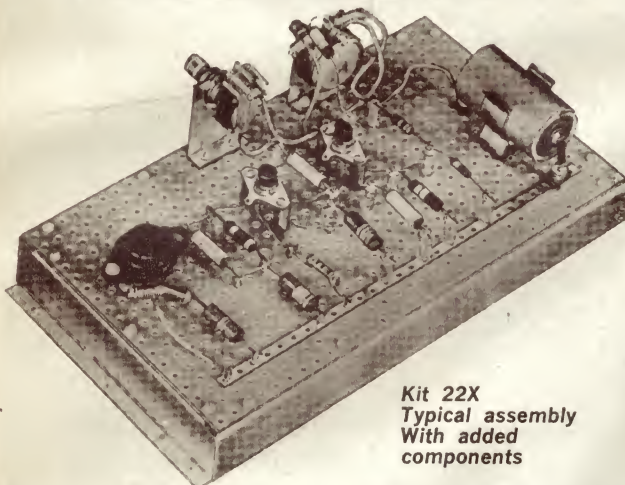

Kit 22X  
Typical assembly  
With added  
components

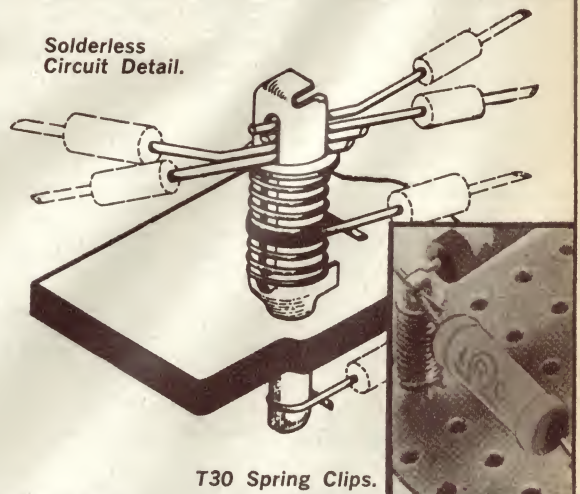

## IRH COMPONENTS PTY. LIMITED

A Subsidiary of International Resistance Holdings Limited

THE CRESCENT, KINGSGROVE, N.S.W. 2208. PHONE 50 0111

## POST COUPON NOW

Please forward details of VECTOR kit

NAME .....

ADDRESS .....

STATE .....

V/67.1



# ANSWERS – continued

If you are on the lookout for circuits to use up oddment parts and valves, this may interest you. It was described in our December, 1957 issue and then, as now, was intended purely as a project to use second-hand or ex-disposal components. It would not warrant expenditure on new components except, perhaps, for a few small capacitors and resistors. In terms of performance, it would not be as good as a comparable superhet but it does present fewer alignment problems. Tuning requires a 3-gang tuning capacitor, an aerial coil and two RF coils. The circuit could be made to work, however, with oddment aerial coils in the RF positions. Semi-conductor diodes could also be used in place of the two halves of the 6H6. A limited number of copies of the original article

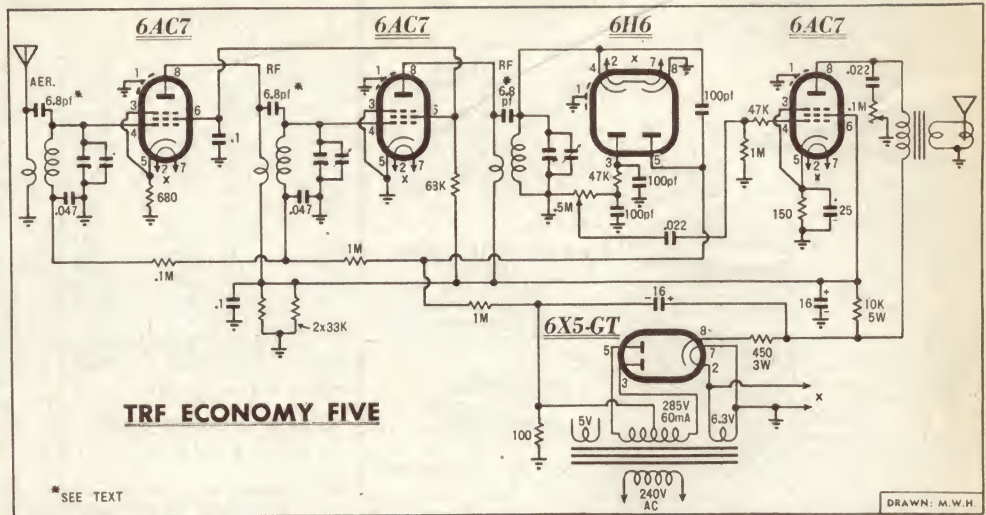

TRF ECONOMY FIVE

\* SEE TEXT

DRAWN: M.W.H.

are available for 20c.

Requests for copies should be addressed to: The Assistant Editor, "Electronics Australia," Box 2728, G.P.O., Sydney, N.S.W. 2001.

**PLAYMASTER 107:** In the March, 1961 issue of "Radio, Television and Hobbies," there was an article on the Playmaster 107 Amplifier-Tuner. At the moment I am interested in obtaining the chassis, amplifier case, dial plate and dial plate assembly. Are these parts readily available, and from whom? (G.K., Brisbane, Qld.)

● Several of our regular advertisers offer kits of parts for our projects. By examining their advertisements, you should be able to find a source for the parts you require.

**TEST EQUIPMENT:** Have you ever published a one or two valve oscilloscope and a simple audio signal generator with all parts readily available. Your magazine is very good but there is not a lot for the beginner. (D.H., Gympie Bay, N.S.W.)

● We have not published an oscilloscope using only one or two valves. Typical of our smaller designs is the latest (published in April, 1968) which uses four valves in addition to the cathode-ray tube. We published a simple transistorised audio oscillator in September, 1965. Parts for both these projects should be readily available, and copies of the articles may be obtained through the Information Service.

**HALLICRAFTERS AGENTS?** Can you please tell me the name and address of the Australian agents for Hallicrafters communications equipment? I would also like to know how to add an S-meter and RF gain control to my communications receiver. (R.J.E., Balgowlah, N.S.W.)

● Sorry, R.J.E., but we have had neither contact with, nor advertisements from, any local agents for Hallicrafters for as long as we can remember. If an agent does exist, he may perhaps contact us in response to this reference and, if so, we may be able to let you know the details in a later issue. We regret that we cannot help with details regarding the addition of an S-meter or RF gain control to a commercial communications receiver, for

this is outside the scope of our Information Service; we can only suggest that you refer to a reference such as the RSGB's Radio Communication Handbook or the ARRL Radio Amateurs Handbook.

**WHY NPN?** I have been reading "Electronics Australia" for nearly three years and have found the contents to be of a high standard. However, I have noted that NPN transistors are used, mainly BC108, in nearly all the transistor projects. Is this because NPN types are superior to PNP types? Can one PNP transistor be substituted for the BC108 with minimum change in design (such as polarity changes)? Can you tell me where to get the details of a simple low-pass filter with a cut-off of 10KHz. Also, can you supply details of a type of receiver called the Synchronyne which I saw in block diagram form in a book? To finish,

what effect, numerically, does the addition of a ferrite iron core have on the inductance formula? (A.M., Nyah West, Vic.)

● NPN type transistors are neither superior nor inferior to PNP types, in general, and the reason they are preferred in our projects is that they are cheaper than equivalent PNP types and are readily available. The BC108, in particular, is a good example of the type of saving achieved. This sells for around 70c, whereas an equivalent PNP type costs around \$1. A PNP type transistor could be substituted in some cases, but there is no general rule. Each case would have to be considered on its merits. A Synchronyne circuit was published in our September, 1963, issue. A copy of the article can be obtained through the Information Service for 20c. Please note that this is a tuner, not a full receiver. The other questions you ask are not of a type which can be answered in these columns. We suggest you look up these matters in a comprehensive textbook dealing with tuned circuits and inductance. The article "Receiver Front Ends" from our February, 1965, issue may be of assistance, as it deals with the formulas involved in calculating coil resonances, and component values.

## ACOS

### REPLACEMENT LONG LIFE CARTRIDGES

Acos 90 Series — a family of pick-up cartridges covering all the main types needed today, each fitted with Diamond Stylus at no extra cost.

- GP91-1 MONO CRYSTAL Stereo Compatible .. \$5.95
- GP91-2 HIGH OUTPUT MONO CRYSTAL Stereo Compatible .. \$5.95
- GP92 MONO CERAMIC Stereo Compatible .. \$6.55
- GP93 STEREO CRYSTAL .. \$7.55
- GP94-1 STEREO CERAMIC .. \$7.95
- GP94-5 STEREO CERAMIC FOR TRANSISTOR AMPLIFIERS .. \$8.95



fitted with  
**DIAMOND**  
Stylus at no extra cost.

TECHNICAL DATA SHEETS SENT FREE ON REQUEST

Sole Australian Agents:

**AMPLION (A'SIA) PTY. LTD.**

29 Majors Bay Rd., Concord,  
Sydney, N.S.W. Phone 73 1227



### SOUND PROJECTORS

Cinevox Perfect and Harbour and Heath 16mm in good working order. 240v operated, complete with speaker and amplifier. **from \$90.00**

### CIRCULAR SLIDE RULE

3 3/4 in diameter. Will do the same work as the conventional slide rule. Instruction book included.

**\$1.25 each**  
Post 10 cents.

### REFLECTOR GUNSHOT

Contains these lenses:

- 1 Lens 1 in Focus. 1 1/2 in diam.
- 1 Lens 1 11/16 in Focus. 1 1/4 in diam.
- 1 Air-spaced Lens. 1 1/4 in diam.
- 1 Filter Lens. 1 Graticule.
- 1 Lampholder. **\$1.85**

Post.: N.S.W. 30c; Interstate: 40c.

### P.M.G. TYPE TELEPHONES

Standard desk type with magneto bell calling device. Range 30 miles. Uses standard batteries at each phone. Any number can be connected together on single line.

**\$23.00**

### (2 TELEPHONE SETS)

30c cartage to rail. Freight payable at nearest attended railway station.

Please note we are now able to include 1/2 mile of telephone cable FREE with each set of Phones.

### BATTERY CHARGERS

240 volt A.C. Input. Each battery charger will charge either 6 or 12 volt batteries. 2 amp. without meter. **\$13.75**  
2 amp. with meter. **\$15.75**  
Post N.S.W. 70c; Interstate 95c.

### MINIATURE ELECTRIC MOTORS

1 1/2 to 3 volts D.C. Ideal for model boats, cars, planes, etc. Strong torque. Only **\$15.75** 65 cents each or 10 for **\$4.00**. (Post 7c).

### TRANSCEIVER

(2-way radio) R.C.A. America RT 68, 24 volt, operated 10 watt output 38-54 megacycles F.M. crystal locked. Transmitter and receiver using frequency synthesiser in 100 K/c/s; step 10 channel per meg/cycle with power supply. Leads, mike and headphones **\$45**, 60c cartage to rail. Freight payable at nearest attended railway station.

### TRANSCEIVER

(2-way radio) 62 set ideal small ships, Hams, etc. 1.6 to 10 megs. Crystal locked or V.F.O. controlled 5 watt output. Complete with antenna, headphones and mike **\$60**. 60c cartage to rail. Freight payable at nearest attended Railway Station.

### HEAD PHONES

Low impedance moving coil fitted with rubber muffler to reduce external noise, fitted with press to talk, dynamic hand microphones. Ideal for use with all types of transceivers. **\$3.50** pair. Same with black felt muffler. **\$4.50** pair. Post N.S.W. 25c; Interstate 30c.

### 12 VOLT D.C.

DESYNN INDICATOR AND TRANSMITTER UNIT. Suitable for aerial rotation indicator, etc. 0-360 deg., weatherproof mountings. **\$5.00** per set. Postage: N.S.W., 95c; Interstate **\$1.67**.

### 16'6" WHIP AERIALS

6-Piece, brand new, **\$5.75**. 60c cartage to rail. Freight payable at nearest attended railway station.

### AVO MULTI METER

Type CT 38 **\$75.00**

### A.W.A. AUSTRALPHONE

Transceivers 12 V New Complete Station. 1.6 to 10 megs on transmit. 0.54 to 16 megs on receive. **\$150.00**

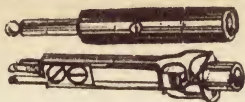

P.M.G. Phone Jack and plugs, 25c each. 45c the pair. Post 7c.

### NIFE CELLS

1.2 Volt fully charged. 4in x 3in x 1in 4 AH. **\$1.00** each

Post. N.S.W., 25c; interstate 35c. 1.2 volts 15 AH. 8in x 4in x 2in. **\$3.95**

2.4 volt 10 AH. 6in x 2 1/2 in x 2in. **\$2.50**.

Post. N.S.W., 30c; interstate, 40c.

### WALKIE TALKIE TWO-WAY RADIOS

P.M.G. Approved Citizen Band. 9 Transistor, **\$79.00** per set of 2. Post. N.S.W. 50c; interstate, 60c.



P.M.G. TYPE KEY SWITCHES. 45c each. Post, 15c.

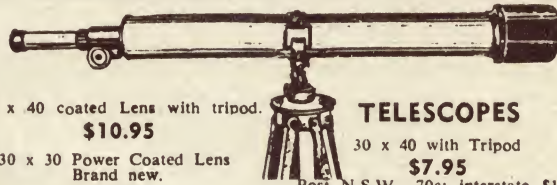

45 x 40 coated Lens with tripod. **\$10.95**

30 x 30 Power Coated Lens Brand new. **\$3.75**

60 magnification with a 60mm coated objective lens. With tripod. **\$23.00**

As illustrated.

Postage, 95c; Interstate **\$1.20**.

### HIGH STABILITY RESISTORS

I.R.C. brand new, usually 80c ea. 50 assorted values for only **\$3.75**

Post 15c.

### RECEIVER 8C A.W.A.

With ABC and D Coils. Complete with all spares. **\$90.00**

### 522 TRANSCEIVERS

100 to 150 m/cs. **\$35.00**

### TYPE S POWER SUPPLY

(240 Vac supply for AT 5-ARB) suit most types of Disposal transmitters and receivers outputs 250 volt, 10ma 550 volt 200ma, 300 volt 100ma, **\$30.00**

### TELEPHONE WIRE

21 gauge copper, plastic covered. Ideal telephone or bell wire. 1,320ft coil of twin (equal 1/2 mile) **\$7** per coil. Post. N.S.W. 70c; Interstate **\$1.20**.

### SCOOP PURCHASE

Gramo Motors. New. Made in U.S.A. 4-speed 240 volt A.C. 50 c/c. Only **\$2.75** each. Post. N.S.W. 30c; interstate, 40c.

### CO-AXIAL SWITCH

70 ohms 4 positions, can be motor driven completely waterproof 70 ohms type connectors. Housed in metal case 9in x 8in x 8in **\$5.00** each. Post N.S.W. 70c. Interstate **\$1.20**.

### MOBILE

### 2 WAY RADIOS

PYE 70 to 85 M/CS. 6 Volt Operated. 3 mobiles, 1 base station 240 VAC **\$80 THE LOT**

### BC 221

Frequency Metres **\$55.00**

## VALVES BRAND NEW IN CARTONS

Special discount for quantity

807	75c	X61M	\$2.20
6SN7GT	95c	CV850	\$1.50
8989	\$1.00	1H6G	30c
12SA7	\$1.25	832	\$5.00
5U4G	95c	6F13	75c
77	\$1.00	6AK5	\$1.50
EF50	35c	6X4	\$1.00
6U7	75c	6F3	75c
VH120	\$1.00	12SK7	50c
1L4	\$1.00	VR1120	50c
5Y3	\$1.75	VR118	75c
6C4	50c	VR65	25c
2 x 2	75c	VT4C	75c
6AG5	80c	AU5	\$1.00
12AU7	\$1.00	80	\$1.25
		6AK5W	\$1.50

### CATHODE RAY TUBES

3FP7	\$2.95	5BP1	\$3.50
3JP1	\$2.95		
V1669 4/1	\$2.95	CY2184	\$2.95

PLEASE ADD POSTAGE ON ALL ARTICLES

### MINE DETECTORS

Ex A.M.F. with Instruction Book. Complete in wooden case. Ideal for plumbers, councils for locating buried pipes, etc. Freight payable at nearest attended railway station. **\$39.00**

### 4 DIGIT RELAY COUNTERS

50-volt D.C., suit slot car. Lap counters, etc. **\$1.25** each. Post 13c.

### ALTEC STUDIO MICROPHONES

639B Western Electric, top grade. original cost **\$250**. Ideal Broadcast Studio, music recording, Church and play recording, etc. Fraction of original cost. Price on Application.

### 240 VOLT

### 522 POWER SUPPLY

Supplies all necessary voltages to operate 522 transceiver from 240 V A.C. Complete and ready to plug in **\$30.00**.

SPECIAL lucky dip valve offer, 15 new valves in cartons for only **\$2.00**. We haven't got time to sort them, so you reap the benefit. Post 60c.

### SOLENOIDS

Plunger Type 12V 300M.A. Suit electric camera control, miniature trains, radio, etc. **\$1.25**. Post, 10c.

200 Mill. amp., 24 volt, 1/8in push movement. **\$1.25**. Post 10c.

### LENSES

TOP GRADE ACHROMATIC 2in DIAMETER, 20in FL. Ideal as telephoto lens, telescope objectives. **\$13**. Postage 46c.

### CONDENSER LENS

2 1/2 in DIAM. 2in FL. **\$1.50** each or **\$2.50** per pair. Post 21c.

### CONDENSER LENS

1 1/2 in diam. 1 1/2 FL. **50c** each. Postage, 17c.

### FOUR CHANNEL

### BRANCHING AMPLIFIER

With 4in Vu, meter GLORAD. Complete with Portable Power Converter. 600 ohm balanced input and output. Ideal for outside broadcasting, etc. **\$39.50**

### MONITOR SPEAKER UNIT

Ex-A.B.C., consisting of low resistance 8in speaker in Acoustic Labyrinth Baffle Box, complete with 10-watt amplifier, 600 ohms plus 8dbm input, 240 volt A.C. operated. **\$37.50**

### TEN CHANNELS VHF TRANSCEIVER

Types TR1934 100-125 meg/cys. and TR1935 125-150 meg/cycles. 28 volt DC operated AM single crystal locks both TX and RX on same channel complete with generator. **\$33.00**

### RECORDING TAPE

EX-GOVERNMENT SURPLUS STOCK. Topgrade, 1200ft on 7in spool, **\$2.25**, post 21c. 600ft on 5in spool, **\$1.45**, post 13c. 150ft on 3in spool, **65c**, post 9c.

### TELEPRINTER PAPER TAPE

8 1/4 in x 6 5/8 in Full Page **\$1.50** per roll.

### WHEATSTONE BRIDGE

Top grade In Multiples up to 1000 **\$65.00**

# Deitch Bros.

70 OXFORD STREET, SYDNEY, 2010

SORRY, NO C.O.D.



# ANSWERS - continued

**COLOUR TV RECEIVER?** Now that a decision has been made in favour of the PAL colour system, I wonder whether you plan to run a course on colour television and also whether you plan to describe the construction of a colour television receiver. (L.H., Sandgate, Qld.)

● We have no immediate plans to run a full course on colour television, as much as anything because the job of preparing a course would impose a greater load on our staff than we could at present accommodate. It is necessary to remember also that 18 months will elapse after notice has been given before a colour service will begin. That notice has not yet been given. The economics of monochrome TV receiver construction have fallen out strongly against the idea of building your own and, unless the position changes drastically and unexpectedly, it will probably remain so for colour receivers. Added to this is the extra complication of getting things adjusted properly. We are keeping an open mind on the subject. If it seems worthwhile, when the time arrives, we may describe a project along these lines. If it doesn't, then we'd rather say "no" and disappoint a few readers than encourage others to embark on a costly project which might turn out to be a dead loss.

**PEN-FRIEND WANTED:** I am only 14 years old, but I read the magazine every month and think that it is very fine. I particularly like reading "The Serviceman." Would you please publish my name and address, because I would like to hear from any readers of my own age who are also interested in radio. Also can you tell me if and when you described a low-cost five or six transistor radio, and also if a rod aerial can be fitted to a transistor radio which does not have one already. (Malcolm Miller, "Stranraen," Noonga via Jackson, Qld.)

● Thanks for your compliments, M.M., and as you can see we have published your name and address as you asked. We described a 5-transistor mantel-type radio in October 1961 and a 6-transistor portable in August 1958, but neither could really be described as low cost unless you have access to a reasonable stock of salvaged components. Actually home construction of transistor radios, particularly the more elaborate superhet types, is quite uneconomic these days, as complete imported receivers are available at a cost considerably lower than for a kit of parts. Adding an external aerial rod to a

transistor portable can be done by winding two or three turns of hookup wire around one end of the internal ferrite rod, earthing one end to the receiver ground (usually battery positive), and connecting the other to the new aerial rod. For improved sensitivity, the receiver ground may be connected to "real" earth via a water pipe.

**MICROCIRCUIT RECEIVER:** I intend to build your "Micro-One" receiver, described in the April, 1969, issue, using another microcircuit as an audio amplifier. I shall have plenty of power to spare and would like to use a higher quality tuned circuit with two or more bands. Would it be possible for you to publish some tuned circuits suitable for this? (J.H., Tarragindi, Qld.)

● Very briefly, no. We cannot supply information additional to that already published concerning any of our designs. Also, we have no immediate plans for describing a two-IC receiver.

**VHF RECEIVER:** I would like to comment on a letter in your "Answers to Correspondents" section for March, referring to a fire brigade receiver. I also have a need for such a receiver, but instead of an old television receiver, I was thinking more along the lines of a transistorised converter or a transistorised version of the Fremodyne Four, perhaps a crystal locked device. It would have to be capable of operating with a car radio. I feel sure that there must be many people who have a need to monitor a certain frequency within the VHF FM communication band while travelling in their private vehicle. (B.P., Cribpoint, Vic.)

● We have considered the possibility of a transistorised version of the "Fremodyne Four" but have nothing concrete to offer as yet. We cannot see ourselves developing a series of single-frequency converters to meet the needs of the few who require a "bush-fire brigade converter." If you are prepared to think in terms of a crystal locked converter, perhaps you might care to consider modifying one of our amateur band crystal locked converters to the frequency bands you require. Our latest designs of this type were the "Four Band Crystal Locked Converter" of February, 1961 and the "50 and 144MHz Crystal Locked Converter" of March, 1965. Copies of both articles are available through the Information Service for the usual 20c each. However, we should also draw your attention to a letter on page 189 of the May issue. ■

## Reader's problem - 1926

The following reader's query is reprinted from our "ancestor" publication "Wireless Weekly," August 13, 1926. To be a listener in those days, you didn't have to be a wireless technician, but it certainly helped!

**W.G.R. (Bundarra):** I have wired up a superhet, but cannot get more than faint carrier waves on the second audio. My wavemeter says the set is oscillating at various wavelengths. As I alter the first oscillator condenser dial, also, there is a shrill whistle all the time heard on loudspeaker. What is the cause of this? After tuning for an hour, I gave the oscillator condenser a spin around, and the moveable plates struck the fixed ones and burned out my nine valves. This occurred twice. What can I do to avoid a recurrence?

A: To avoid burning out valves, place a .006 m.f.d. fixed condenser in series with the oscillator condenser and be careful to see that the negative A and the negative B are linked together.

If a short circuit then takes place, you still have an open circuit for the high tension due to the presence of the fixed condenser. The shrill whistle of which you speak may be due to an audio howl which may be caused by using valves with too large an amplification factor. The second audio may be too close to the intermediate frequency transformer or one or more of the intermediate frequency valves may be oscillating.

Only one stage of audio should be necessary with a receiver of this type and we would advise you to remove one stage. You will then have more room to spread out the other components.

## UNITED TRADE SALES

PTY. LTD.

### SPECIAL

6 only Marconi Video osc. spec. in Jan. 69 Electronics. \$90 ea. plus freight.

### MILLER TRANSISTORISED IF STRIPS

455 Kc Selectivity 5 Kc at 6db down. Power 6 Volts 2mA gain 50db. Price: \$9.70.

### TRIO TR2E 2-METRE TRANSCEIVER

- Triple conversion receiver with crystal locked second and third oscillators for maximum selectivity and sensitivity.
  - Separate VFO tuning for both receiver and transmitter.
  - Nuvistor RF amplifier.
  - Provision for crystal locking of the transmitter.
  - 12 volts DC (internal transistor power supply) and 230-240 volts AC operation.
  - Noise limiter and squelch.
  - 17 tubes, 4 transistors and 7 diodes.
  - 1 microvolt sensitivity for 10 db. S/N ratio at 14 6Mc.  $\frac{1}{2}$
  - "S" meter, RF output meter and "netting" control.
- Price: \$282.  
3,000 TYPE RELAYS.  
Large range.  
Only 50c each.

### NEW PIANO KEY SWITCHES

5 KEY, Special at \$1.00 each.

### CAPACITORS

80 for \$2 in Poly Packed Bags. Mixed values only.

### VALVES

6JC 30c ea. 815 70c ea. 807 70c ea.  
6AC7 20c ea. or 12 for \$2; 6C4 50c ea.  
1K7 20c ea. or 3 for \$2. 6AM6, 50c each.  
QS150/15 50c ea. VR150/30 75c ea. or 3 for \$2.  
QB2/250 Philips (813). New in sealed cartons.  
Current manufacture, \$7 ea.

### COMPLETE RANGE OF METERS.

P25's 24sq  
100uA .. \$6.95 1mA .. \$4.50  
500uA .. \$5.25 50mA .. \$4.50  
10mA .. \$4.50 S'meter .. \$5.25

**MULTIMETERS, 200H, 20K ohms per volt. \$11.25, inc. tax. CT 500 20K ohms per volt, \$15 inc. tax. CT 330 20,000 ohms per volt, \$17.25.**

**RESISTORS. Mixed Values only in Bags: \$2 per 100, or 50 for \$1. 3,000 Type Relays. New stocks. 50c each. Plus postage.**

### TRANSISTOR V.H.F. CONVERTER

Tunable 108-136 Mhz Aircraft Band 1F-600Kc to 1,000Kc. No connecting wires needed, 9V Battery, self-contained, just place alongside broadcast radio. Price only \$14.40 plus 45c postage.

### WANTED BUY:

RECEIVERS, TRANSMITTERS, TEST EQUIPMENT.  
All prices subject to alteration without notice.  
All items PLUS POSTAGE.

## UNITED TRADE SALES

PTY. LTD.

280 LONSDALE STREET,  
Melbourne. Phone 663-3815  
Opposite Myers



# HAM

## RADIO SUPPLIERS Mail Order Specialists

323 ELIZABETH STREET,  
(2 Doors from Little Lonsdale Street)  
MELBOURNE, VIC. 3000  
TELEPHONES: 677329, 674286

1B3GT (DY30)	\$1.45
1C7	.50
1D4	.75
1F5	\$1.00
1H5	.75
1K5	.50
1K7	.50
1L4	.50
1L5	5 for \$2.00
1LN5	.50
1M5	.50
1P5	.50
1Q5	.50
1R5	\$1.50
1S2(DL86)	\$1.45
1S4	\$1.00
1S5	\$1.70
1T4	\$1.00
1X2 A/B	\$1.20
2D21	.20
3S4	\$1.00
3V4	\$1.70
5AR4 GZ34	\$2.45
5AS4	\$1.30
5R4GY	\$2.00
5T4	\$1.75
5U4GB	\$1.30
5V4(GZ32)	\$1.50
5Y3GT	\$1.20
5Z3	\$1.50
6A8G	\$2.00
6AB7	\$1.00
6AC7 ea.	.50
6AD8 or 5 for	\$2.00
6AE8 (X79)	\$3.50
6AG5	.20
6AG7 or 12 for	\$2.00
6AJ5	\$1.25
6AK5(EF95)	\$2.55
6AL3	\$1.75
6AL5	.75
6AM5 or 3 for	\$2.00
6AM6 or 3 for	\$2.00
6AN7/A	\$1.30
6AQ5	\$1.80
6AR7GT	\$1.80
6AU4GT/A	\$1.50
6AU6	\$1.30
6AV6	\$1.20
6AX4	\$1.50
6B6	\$2.00
6B8	\$3.00
6BA6	\$1.40
6BE6	\$1.40
6BH5	\$1.35
6BK8 (EF86)	\$1.50
6BL8	\$1.50
6BM8	\$1.60
6BQ5 (EL84)	\$1.50
6BQ6GTB/	\$2.50
6CUG	\$2.50
6BQ7A	\$2.50
6BV7	\$1.35
6BX6	\$1.35
6BY7	\$1.95
6C4 or 5 for	\$2.00
6C8	\$1.00
6CA4	\$1.10
6CA7/EL34	\$3.00
6CB6	\$1.40
6CD6G/A	\$4.50
6CG7	\$1.50
6CH6	\$2.40
6CK5	\$2.00
6CK6	\$1.40
6CM5	\$2.20
6CQ6	\$2.20
6CQ8	\$1.40
6C56	\$1.30
6CW4 (NUVISTA)	\$2.75
6DC6	\$2.40
6DC8	\$1.90
6DQ6A	\$2.20
6DQ6B	\$2.65
6D58	\$1.80
6DT6	\$1.40
6DX8	\$1.65
6EA8	\$1.55
6E56	\$1.80
6E58	\$1.80
6E6G	\$1.25
6G8G	\$2.50
6GV8	\$1.70
6GW8	\$1.70
6H6GT	.20
6HG5 or 12 for	\$2.00
6HS8	\$1.50
6J5GT	\$1.00
6J6 or 3 for	\$2.00
6J7G or 5 for	\$2.00
6J8G	\$3.00
6K6	\$1.00
6K7	.50
6K8GT	\$1.50
6K8 Metal	\$2.00
6KV8	\$1.75
6L6G	\$2.90
6L7	.50
6M5	\$1.35
6N3	\$1.20
6N7 or 10 for	\$2.00
6N8	\$1.40
6O7G	\$2.50
6R3	\$1.55
6S2	\$1.85
6S7GT	\$2.20
6S7	.75

6SF5	.75
6SF7	.75
6SH7	.50
6SJ7 or 5 for	\$2.00
6SL7GT or 3 for	\$2.00
6SN7GT	\$1.25
6SQ7GT	\$1.00
6SS7	\$2.10
6U4GT	\$2.00
6U7G	.75
6U8/A or 3 for	\$2.00
6V4	\$1.55
6V4	\$1.05
6V6GT	\$1.05
6X2	\$1.75
6X2	\$1.95
6X4	\$1.00
6X5GT	\$1.50
6Y9	\$1.90
7A8	\$3.50
7C5	8 for \$2
7E6	.50 or
7H7	5 for \$2
7W7	.50 or
9A8	5 for \$2
9U8	\$1.90
12A6	\$1.75
12A6	.50 or
12AH7	5 for \$2
12AT7	.50 or
12AU6	5 for \$2
12AU7	\$1.50
12AV6	\$1.45
12AX7/ECL83	.75
12BE6	\$1.60
12BY7/A	.75
12C8	.75
12D5	.50
12SA7GT	\$1.00
12SC7	.50
12SH7	.50
12SK7	.50
12SN7GT	\$1.00
12SR7	.50 or
16A8	5 for \$2
35L6	\$2.00
3L6	\$1.00
30	.50
42	\$2.50
47	.50
57	.50
58	.50
58	.50
80	\$1.50
100TH	\$3.00
717A	\$1.25
807	\$1.00
808	\$1.00
832A	\$7.00
866A	\$1.00
954	50c or
955	5 for \$2
956	.50
958A	.50 or
1625	5 for \$2
1629	50c or
5636	5 for \$2
9006	.75
25c or	for \$2
10c or	for \$2
10c or	for \$1
12 for \$1	
ECC35	\$2.00
ECH35	\$2.80
EF86/6BK8	\$2.00
EL34 (6CA7)	\$3.00
EM84	\$1.50
EY91	.50
KT61	\$3.90
KT66	\$4.75
KT88	\$5.30
RL18	.75 or
UL141	3 for \$2
VR150	\$1.00
(Volt Reg.)	\$1.25
2D21	\$1.20
2E26	\$4.60
2X2/879	.75
6CW4	\$2.75
NUVISTA	\$2.75
6DQ5	\$4.75
75C1	Reg. \$2.25
100TH	Reg. \$3.00
90C1	Reg. \$2.50
108C1/OB2	\$2.50
150C4/OA2	Reg. \$1.65
832A	\$7.00
866A Reg.	\$1.00
807	\$1.20
884	\$2.85
885	\$2.85
2051	\$2.50
5743	\$2.50
6146A	\$6.25
6146B	\$6.25
OA2/150C4	\$1.65
OB2/108C1	\$2.50
OEO3/10	\$2.55
OEO3/12	\$2.55
OEO3/20	\$2.00
OEO6/40	\$12.95
QVO4/7	\$1.50 or
3 for \$3.75	

ALSO OTHER  
TYPES AVAILABLE,  
P.O.A.



**MODEL OL-64D MULTIMETER.** 20,000/OPV, DC Volts: 0-0.25/1/10/50/250/500/1000V at 20K/OPV, 5000 volts at 10K/OPV, AC Volts: 0-10/50/250/1000V at 8K/OPV, DC/A: 50uA/1mA/50mA/500mA/10 amps. RESISTANCE: 0-4K/400K/4M/40Megohm, DB Scale: -20 to plus 36db. Capacitance: 250pF to .02uF, Induct. 0-5000H, size: 5 3/4 x 4 1/8 x 1 3/4 in.  
**PRICE: \$19.50 post 30c.**



**MODEL 200H MULTIMETER,** 20,000 opv, DC Volts: 0-5/25/50/250/500/2500V (20,000 opv) AC Volts: 0-15/50/100/500/1000V (10,000 opv) DC/Amps: 50uA/2.5mA/250mA, Resistance: 0-60K/6M ohm (scale centre 300 ohm—30K ohm. Capacitance: 10uuf to .001uF/.001uF — .1uF, D3 scale 20 db to plus 22 db. Size 4 1/2 x 3 1/4 x 1 1/8.  
**PRICE: \$11.25 post 30c.**



**NEW MODEL US-100,** Overload protection, Shockproof Movement, polarity switch DC volts: 0.25/1/25/10/50/250/1000V (20K/OPV) AC Volts: 0-2.5, 10/50/250/1000V (5K/OPV), DC/Amps: 1mA/25mA/500mA and 10A, AC/Amps 10A, RESISTANCE: 0-50M/ohms (centre scale 50) R X 1/10/100/1K/10K, db scale -20 to plus 10 plus 22/plus 35/plus 50db.  
**PRICE: \$28.75 post 40c.**  
**Mirror Scale**



**MODEL C-1000 POCKET MULTIMETER.** 1000 ohms/per Volt, AC Volts: 0-10/50/250/1000 (1000 opv) DC Volts: 0-10/50/250/1000 (1000 opv), DC Current: 0-100mA, Resistance: 0-150K ohms (3K centre), 2 colour scale, Range Selector Switch, Dimens: 3 1/2 x 2 1/4 x 1 in.  
**PRICE: \$6.50 post free**



**MODEL CT500 MULTIMETER,** 20,000/Opv, DC Volts: 0-2.5/10/50/250/500 (20K/OPV) AC Volts: 0-10/50/250/1000V (10K/OPV) DC/Amps: 5uA/5mA/50mA/500mA, RESISTANCE: 0-12K/120K/1.2Meg/12Megohms, (scale centre: 60/600/6K/60K, DB scale: -20db to plus 62db (5 ranges). Size: 5 1/2 x 3 5/8 x 1 3/4 in.  
**PRICE: \$14.95 post 30c.**



**MODEL CT330 MULTIMETER,** 20,000/OPV, DC Volts. 0-6/6/30/120/600/1.2K Volts (10K/OPV), DC/Amps: (0-0.06/6mA/60mA/600mA, RESISTANCE: 0-6K/600K/6M/60M/600Megohm. (30/3K/30K/300Kohms) centre scale: Capacitance: 50 uf to .01 uf .001 to 0.2 uf. Decibels: -20 to plus 63db size approx: 5 1/2 x 3 5/8 x 1 3/4.  
**PRICE: \$16.75 post 30c.**



**NEW LAFAYETTE SOLID STATE HA600 RECEIVER**  
5 BAND AM/CW/SSB AMATEUR AND SHORT WAVE, 150 Kc/s—400 Kc/s and 550 Kc/c—30 Mc/s, F.E.T. front end • 2 mechanical filters • Huge dial • Product detector • Crystal calibrator • Variable BFO • Noise limiter • S Meter • 24in Bandspread • 230V A.C./12V DC, neg. earth operation • RF gain control. Size 15in x 9 3/4in. 8 1/2in. Wt. 18lb. S.A.E. for full details.  
**PRICE \$199.50**



**"KEW" KYORITSU MO 65 METERS, NEW**  
Size: 3 3/4 inch, mounting hole 2 1/2 inch, 1 1/2 inch deep.  
All plus Postage 20c.  
1 mA, 5 mA, 10 mA, 25 mA, 50 mA, 100 mA, 150 mA, 250 mA, 500 mA.  
**\$4.50**  
1 amp DC . . . . . \$4.50  
5 amp DC . . . . . \$4.50  
10 amp DC . . . . . \$4.50  
30-0-30 amp DC . . . . . \$5.25  
15v DC, 30v DC, 300v DC . . . . . \$4.50  
300 volts AC . . . . . \$5.50



**STEREO HEADPHONES**  
Large rubber earpiece, full audible frequency, 100-15,000 cycles.  
**\$9.00 inc. Tax.**



P25 2 1/4 inch square, clear plastic face, 2 1/8 inch mounting hole, 3/4 inch deep.  
50 uA . . . . . \$5.75 15 volts d.c. . . . \$5.50  
100 uA . . . . . \$5.75 25 volts d.c. . . . \$5.50  
500 uA . . . . . \$5.25 500 volts a.c. . . . \$5.50  
1, 5, 10, 20, 50 "S" Meter . . . \$5.75  
250 and 500 mA . . . . . \$5.00 "VU" Meter . . \$6.50



MR3P 3 3/8 inch square, clear plastic face, 2 3/4 inch round mounting hole, 1 1/2 inch deep.  
50 uA . . . . . \$7.00 50-0-50 uA . . . \$5.75  
100 uA . . . . . \$6.75 15 volts d.c. . . . \$5.75  
500 uA . . . . . \$6.50 25 volts d.c. . . . \$5.75  
1, 5, 10, 25, 50 25 volts d.c. . . . \$5.75  
100, 250 and 30 volts a.c. . . . \$5.75  
500 mA . . . . . \$5.75 "VU" Meter . . \$8.25

**S.W.R. METERS, MODEL KSW-10**  
Specifications.—Standing Wave Ratio: 1:1 to 1:10, Accuracies: Plus or minus 3 per cent, scale length, impedance: 52 ohms and 75 ohms, Meter: 0-100 DC microamperes.  
**Price \$19 inc. tax.**



# FLEXIBLE LAMINATES

(Continued from page 25)

wound from a shaft adjacent to the adhesive coating station. This shaft is equipped with a multi-disc clutch and airbrake system, so that the unwind tension can be set and maintained throughout the process.

At the coating station a three-roller coater applies the required film thickness of adhesive to the web, which then continues upwards to the first of the horizontal drying ovens where the solvent is driven off. The ovens are arranged in series, initially both above and below the path of the web, but in the latter stages above the web only. Each of the six oven zones can be individually temperature-controlled and, in addition, the air bleed, air circulation and air velocity on to the web can be varied.

If increased production from the plant is necessary, it is a relatively simple matter to increase the oven length by adding further sections.

Each oven has a counter-balanced lid, which provides simple access to the web when threading the machine and has a further function as a safety panel in the unlikely event of explosion in the oven. The flow of fresh air through the oven is maintained at a rate greatly in excess of the amount that would produce an explosive combination of solvent and air. Inside the top, or lid, of each oven, a radial fan draws in air through mushroom inlets and ejects it through a heat exchanger into a plenum chamber. The air is filtered once more, and passes through nozzles on to the moving web.

Throughout its traverse in the drying ovens the web is supported by rollers which are individually driven. No tension is required to pull the web through the ovens.

At the end of the 36ft long oven, the copper foil is unwound in the same manner as the Melinex web, and the tension mechanism is also identical. The two webs, comprising the coated and dried Melinex film and the copper foil, then pass around an 18in diam. oil-heated laminating roller, which has a highly polished surface. At the end of their passage over the rollers, the two webs are subjected to pressure from a rubber-faced roller that "nips" the surfaces together to form a laminate. The thrust for this "nip" roller is supplied by pneumatic rams.

The action of the laminating nip produces an initial adhesion between the two surfaces that is only a small fraction of the fully cured laminate. The final stage, namely re-reeling the partially bonded laminate, is critical if deformation of the laminate, after the printed circuit pattern has been etched, is to be held to the required tolerances of 0.3 per cent when compared with the original laminate dimensions before etching. The bond strength specification is expressed as 2-5lb., this being the tensile force required to peel off a 1-inch wide strip of copper at 90 deg. to the laminate at a strain rate of 2 inch/min.

To control these re-reel conditions as accurately as possible, the copper surface of the laminate, after leaving the nip roller, is passed around a water-cooled roller similar in construction to the hot-oil laminating roller. Sub-

sequently the cooled laminate web passes around a tension sensing roller which signals its requirements to the re-reel squirrel-cage motor. The tension required during the long curing process that takes place in the final roll form, is pre-set on the control console.

The manufacturing cycle has been designed to produce the maximum advantage from the cost-saving inherent in continuous processing methods. A further process of slitting the roll of laminate down to width size is therefore carried out, so that individual customer requirements can be met. In effect this means that small batches of material can be made available to the customer virtually from stock, while incorporating the price advantage of a mass production method.

And, of course, the story does not end here, because the printed circuit manufacturers are themselves rapidly adopting in-line processing methods, such that the flexible laminate passes continuously via machines which punch the locating holes, screen print the circuit, apply etching fluid, wash the surface, remove the solvent-arrest covering the tracks, apply the insulant overlay, shear the material to the required component shape . . . and so on. ■

\*\*\*\*\*

## VOICE MAGNIFIERS

(Continued from page 115)

voice was distinctly heard in every corner of the vast auditorium, the "Magnavox" supplying the necessary voice magnification.

This article would be incomplete without reference to the "Baldwin" amplifying telephones. These receivers have come into considerable use since their inception, particularly for wireless purposes, as it is claimed that the incoming signal is magnified eight or nine times. A glance at the diagram, figure 8, will give an idea of the principle of its working, though for the sake of clearness the shape shown in the drawing has deviated somewhat from the actual instrument, mainly due to constructional details necessary in order to adapt such an arrangement into the size of an ordinary telephone receiver case.

As shown, it comprises a steel permanent magnet (M) with soft iron pole-pieces (C) of the shape illustrated, between which is placed the receiver winding, generally of high resistance, and a light soft-iron armature (A) pivoted at its centre. One end of this armature is left free, while to the other is secured a piece of stiff wire (L), the opposite end of which is secured to the centre of a diaphragm of selected mica.

The extreme sensitiveness of the receiver is mainly due to the fact that until signals are being received the armature (A) is under no magnetic strain, thus producing a greater diaphragm movement, and again, the armature is acted upon at both ends on account of the divided flux due to the design of the pole-pieces.

Thus, the deflection for a given current is correspondingly increased. ■

## SECRETS ENTRUSTED TO A FEW



## The Unpublished Facts of Life

THERE are some things that cannot be generally told — things you ought to know. Great truths are dangerous to some — but factors for personal power and accomplishment in the hands of those who understand them. Behind the tales of the miracles and mysteries of the ancients, lie centuries of their secret probing into nature's laws — their amazing discoveries of the hidden processes of man's mind, and the mastery of life's problems. Once shrouded in mystery to avoid their destruction by mass fear and ignorance, these facts remain a useful heritage for the thousands of men and women who privately use them in their homes today.

### THIS FREE BOOK

The Rosicrucians (not a religious organisation), an age-old brotherhood of learning, have preserved this secret wisdom in their archives for centuries. They now invite you to share the practical helpfulness of their teachings. Write today for a free copy of the book, "The Mastery of Life." Within its pages may lie a new life of opportunity for you. Address Scribe Y.J.N.

## The ROSICRUCIANS (AMORC)

Box 2451, G.P.O. Melbourne,  
Victoria, 3001, Australia.

Scribe Y.J.N.

The Rosicrucians (AMORC)  
Box 2451, G.P.O. Melbourne.  
Vic., 3001, Australia.

Please send me the free book, "The Mastery of Life", which explains how I may learn to use my faculties and powers of mind.

NAME .....

ADDRESS .....



# LEADER TEST INSTRUMENTS

## SINE-WAVE / SQUARE WAVE AND COMPLEX



Budget priced unit indispensable for any serious audio measurements.

**Specifications:**

Frequency Range	20-200,000Hz in four 10 : 1 bands
Calibration Accuracy	Within $\pm 2\%$ $\pm 2$ Hz
Sine Wave Output	20-200,000Hz; level constant within $\pm 0.5$ dB below 100kHz; Output 5 V rms below 100kHz
Square Wave Output	20-20,000Hz; Output 10 Vp-p
Complex Wave Output	Above 5,000Hz combined with line frequency Amplitude ratio 4 : 1 (low to high); Output 10Vp-p

## AUDIO SIGNAL GENERATOR WITH METERED OUTPUT AND FREQUENCY METER



Top quality Leader Unit.

**Specifications:**

<u>Generator</u>		<u>Frequency Meter</u>	
Frequency Range	11 to 110,000Hz in 4 bands	Range	10 to 110,000Hz in 4 ranges
Output Voltage	600 Ohms: 0-1V in 6 ranges 10k Ohms: 0-10V in 2 ranges	Input Impedance	200,000 Ohms, approx.
Distortion	Less than 0.3%, 20 to 20,000Hz	Accuracy	$\pm 1.5\%$ , full scale: 10 to 11,000Hz

### FROM ALL GOOD TRADE HOUSES

WHOLESALE ENQUIRIES ONLY TO  
SOLE AUSTRALIAN REPRESENTATIVES:  
ASTRONICS AUSTRALASIA PTY. LTD.,  
ALL STATES.

## FORUM

(Continued from page 67)

lines, they have opted for coded control signals on the supply mains themselves. And because reliability problems arise from keeping the amplitude of the control tones to a very low figure, some authorities have pushed the amplitude up to a point where it minimises their worries but transfers them to the consumer in another form.

I wonder whether the implications were really analysed by these authorities before they made the decision to use the method. Undoubtedly, they would have been assured that the tones would not affect motors, heater elements and the like. Undoubtedly they would have been most careful about ratings and safety factors involved in superimposing tones on the lines and detecting them elsewhere. But did they look into the implications for hundreds of thousands of audio systems connected to their mains, ranging from domestic radiograms and TV sets to large scale organs and public address systems?

We've had complaints from readers relative to a wide range of such items as well as in regard to more technical electronic equipment which contains sensing circuits to react to variations in mains voltage.

In the face of this, our correspondent's exhortation to exhibit a little more tolerance is simply provocative. It isn't too easy for a public speaker to be tolerant, or a minister of religion, or a performer, or an organist when their efforts before an audience are suddenly punctuated by a series of long drawn out whistles.

Is a private individual supposed to be tolerant when he has been involved in abortive service calls — brought about by tones on the mains?

If the cure was simple, it wouldn't be so bad — a line filter of some extra microfarads hung on the high tension line. In practice, neither of these measures seems to help, nor can it be fairly charged that amplifiers which suffer from the trouble also suffer from hum, which is significant in the design or user sense.

My own observations would suggest that the mode of injection may take a number of more subtle forms but notably earth loops and modulation effects in the RF fields.

Whatever the mode, one can hardly level the charge of poor design against equipment which is not proof against a purely artificial hazard, which has been introduced subsequent to installation; a hazard which was probably not considered, by those who introduced it, at anything like enough depth in relation to the electronics implications.

It is perhaps significant that our references to the subject have triggered quite a lot of responses from "victims," but, to the time of writing, we have not heard from a single person who has analysed or quantified the problem and who is prepared to state how it occurs and what can be done to offset it.

I have a horrible suspicion that it has been relegated to the same vague and capacious "bottom drawer" which holds other noise interference problems. ■



# CLASSIFIED ADVERTISING

## FOR SALE

**RECORDING TAPE**, Best U.S.A., all tensilised. 5 x 900, \$1.95; 7 x 1200, \$2.50; 7 x 1800, \$3.25; 7 x 2400, \$4.95. Australian made 3.7, 225, 50c; 5 x 1800, \$2.80; 7 x 1200, \$2.25. Full list of 12 brands and accessories, free. Recorder bargains 2-speed, 2-track, \$43.50 (retail \$73). Hi-Fi stereo, \$395 (retail \$664). Stereo record player, satellite speakers, \$54. All new and top quality makes. A.1. Mail Orders, Box 15, Footscray, Vic. 3011. Phone 68-4436.

**SHURE**, two magnetic stereo cartridges type M44C. Brand new. Half price \$30 each. Bill Byrnes, 27 Badham Street, Merrylands. 2160.

**COLLINS KWM2-A** transceiver plus power supply and Kyoritsu SWR meter. 120 xtals supplied with Collins. Perfect condition, full coverage 3.5MHz to 30MHz. \$650. R. J. McCosker, Box 1887-P, G.P.O., Adelaide.

**PHILIPS** cassette portable recorder, \$70. I.L. Beard, 34 Wylie Avenue, Greenslopes, 4120. Phone 97-2860.

**DECCA** head SH4E, as new. \$50 guarantee. J. Spivey, 37 Berry St., Nowra, N.S.W. Phone Nowra 2-4444.

**NEW OC71**, 5 for \$2 or 50c ea. OC44, 45, BC108, 109, 60c ea. 2N3638, 3643, OC171, 2N370, 371, AF116N, 117N, 70c ea. OC72, 84, AC128, 75c ea. BF115, AC127, 90c ea. power types 2N176, \$1 ea. 2N301, \$1.20 ea. OC28, 29, 35, 36, \$1.50 ea. 2N3055, \$2 ea. OA210, EM404, 50c ea. OA211, EM410, 80c ea. UJT 2N2160, \$1.20 ea. FET 2N4360, \$1.20 ea. 2N5459, 90c ea. BA100, 40c ea. OA81, 85, 91, 95, 25c ea. No. S.A. Sales Post and pack 15c. Custom Electronics, Box 1452, G.P.O., Adelaide, S.A. 5001.

**SWAN 240** 12 volt power supply, 20, 40, 80 metre Neutronics antennas manual, \$265. ONO, W. Middleton, 22 Belmont Road, Croydon, Vic. 3136. Phone Croydon 3-4673.

**HEATHKIT SB-101** transceiver as new with HP-23E 230 volt and HP-13 12 volt power supply \$565. CW filter \$20. E. Penikis, 8 11 Northbourne Flats, Canberra City, A.C.T. 2601.

**COLLINS 7553B** receiver. Used less than 24 hours. Immaculate as new condition. Best offer over \$625. Roth Jones, 51 Albert Road, Melbourne, 3004. Phone 26-5911.

**BASS REFLEX** corner enclosure, nine cubic ft. Phillips 12-inch bass. Peerless 8-inch middle with tweeter. \$50. Phone 36-4336 (Sydney).

**TV PICTURE TUBES** Sure Brite Pty. Ltd. now at 642 King St., Newtown, N.S.W. Now the largest factory of its kind in N.S.W. Daily delivery Sydney suburbs, and to railway station. Lowest prices in Sydney to the trade. Duds bought. Send all duds to Sydneyham station, freight paid. Customer sales rear of building. Phones 519-3403, 51-5928. Brisbane area: 1120 Oxley Road, Oxley, 79-6828.

**STEREO PHONES**, 20-20000Hz. Including tweeter volume control. \$16.50 direct from importer. Arbor Pty. Ltd., 33 Queens Road, Melbourne. 26-1815.

**EV-PATRICIAN** 800 speakers, one pair. In teakwood cabinets. 16 ohms. 100 watts handling power. Giant 30in woofer, 12in midbass, horn-type midrange, and ultra hi-fi tweeter. \$3000. C. Keyland, 21 Harbour Road, Kingsford, Sydney. Phone 663-5233.

**ELECTRONIC ORGAN** built from harmonics kits. Suit amateur, need slight attention, transistorised. \$200. 48-3097, Melbourne.

**MAGNETIC** optical 8 and 16mm projectors. Mag. comedy sound films, stripe r/p heads, test films, pre-amps. Exchange, Halpin, 12 Swinburne Ave., Hawthorne. 3122. Phone 81-4724.

**BURGLAR ALARMS**, 12V 150mA. Transistor control units, \$12 plus 12/2 p.c. s.t. Unit on 4 x 2 plate and case, \$16 plus s.t. 41-V rotary sirens, \$10.50. All above plus 60c p. and post. Foli tape terminals, mats, key switches, bells, reed switches, infra-red ray unit. Complete quote and installation service to insure your requirements. **EDORE ENTERPRISES**, 802 Doncaster Road, Doncaster, Vic.

**RECONDITIONED** Channel Master "Telstar" transistorised aerial booster amplifiers, \$25 each. Also Channel Master automatic antenna rotators \$40 ea. Freight free. J. Yalden, 21 Oxford St., Glen Innes, N.S.W., 2370.

**R.C.S. hi-fi tuner unit No. 474D**, complete with whistle filter No. 128. Condition as new. \$20. B. Saville, 61 Ada Ave. Wahroonga, N.S.W. 48-1198.

**BC108-109 60c**; AD161, \$1.45; AD162, \$1.40; AD161-162 match pair, \$2.85; MPP105, \$1.10; silicon diodes 6 amp 400 p.i.v., 65c; 1 amp x 800 p.i.v. miniature type 1N4006, 75c. Post Free. T. & M. Electronics, Box 75, P.O. Haberfield, N.S.W., 2045.

## FOR SALE

**SELL** all back issues "ELECTRONICS Australia." In stock at all for ones. 1939-64, 50c; 64 to date, 60c. Post free. T. Weir, 56 O'Connor St., Haberfield, Sydney, N.S.W., 2045. 798-7569. Wanted to buy copies also.

**POLYESTER CAPACITORS** Clients please note our new reduced prices. Same new, high grade types. 0.001 0.0022, 0.0033, 0.0047, 0.0068 all 7c ea. 0.01, 7c, 0.022, 8c, 0.033, 9c, 0.047, 10c, 0.068, 11c, 0.08, 11c, 0.1, 12c, 0.22, 16c, 0.47, 25c. All up 10c pack/post any order. Kit-Set Aust., Box 176, P.O. Dee Why, N.S.W. 2099.

**RESISTORS**. Due to our increased buying power, we can now offer our top grade 1/2W, 5 p.c. tolerance resistors at 4c each or \$3 per 100. Range 1 ohm to 10M, 1/4W types also 4c each or \$3 per 100. We supply to your list. 10c pack/post any order. Kit-Set Aust., Box 176, P.O. Dee Why, 2099, N.S.W.

**BARGAINS**. Limited quantity avail. at these prices. SC-40D Triacs, \$4.00; C106F1 SCR 50V 2A, \$1.20; BZY88 zeners 22v, 80c and 3.6v, 65c; 1N914 sil. diodes, 25c; 10 OA91, \$2.00 or 26c ea; 10 25mf 25V, \$1.80 or 22c ea; Ducon linear pots 10 for \$3.50 or 40c ea; relays 12v 185 ohm miniature Siemens type \$3.50, magnetic earphones 50c; 10 sil. rect. 100 PIV 1A \$2.50 or 28c ea; 400 PIV 1A \$3.20 or 36c ea; All new and above untested. Send 9 x 4" SAE for free catalogue. Pack and Post 10c any order. Pre-Pak Electronics, P.O. Box 131, Kingsgrove, 2208.

**TRANSISTOR** radio parts. We stock a large range of parts for building or repairing transistor radios etc. and carry a full range of semiconductor at unbeatable prices. Send 9 x 4" SAE for free catalogue. Pre-Pak Electronics, P.O. Box 131, Kingsgrove 2208.

**MAGNETIC PRE-AMP E.A.** Oct. 65. Easy to assemble kit-set supplied with all parts. Specify pick-up or tape-head use. Mono \$4.90, Stereo \$9.00, Stabilized mains power supply, \$5.00. Built and tested \$1.00 ea. Pre-Pak Electronics, P.O. Box 131, Kingsgrove, 2208.

**10 PLUS 10 Stereo Amplifiers** with overload protection, E.A. April 69. Easily assembled kit-set supplied with all parts. Excellent finish and appearance. \$58.00 ea. Built and tested \$68.00 ea. Also 3 plus 3 and 3 plus 3 above \$42.00. Built and tested, \$52.00. Pre-pak Electronics, P.O. Box 131, Kingsgrove 2208.

**VALVES**, 6BQ5 \$1.20, 6GW8 \$1.35, 6V4 90c, 15Z \$1.00, 12AX7 \$1.25, 6BL8 \$1.15. Send 9 x 4" SAE for complete range of valves at best prices. Pack and post 10c any order. All new and guaranteed. Pre-Pak Electronics, P.O. Box 131, Kingsgrove 2208.

**TRANSISTORS**: 3 2N3638A \$1.80 or 75c ea.; 3 2N3546 \$2.20 or 80c ea; 5 2N4121 \$1.50 or 40c ea; 2N2160 \$1.40; OC74N, AC125, AC126 80c ea; AD161 16Z \$3.30; AF116N, AF117N 77c ea; BC108, BC109, BF115 60c ea. Send 9 x 4" SAE for free catalogue. Pack and Post 10c any order. Pre-Pak Electronics, P.O. Box 131, Kingsgrove, 2208.

## READER SERVICE

**TOP QUALITY** discs from your tapes. Any quantity, all sizes and speeds. We guarantee our work because we take every precaution to ensure satisfaction. Write for details A.A.V.R., 87A Mullens Street, Balmain, 2041.

**ELECTRONIC ORGANS**. Do not build yourself an organ without first finding out about the superb Schober (U.S.A.) Assemble-It-Yourself Kits. Inquiries to Schober Organs (Australia), 124 Livingstone Ave., Pymble, N.S.W., 2073. (Mail only, please.)

**PRE-RECORDED TAPES** hired to members of Australian Tape Recording Society. Bimonthly releases. The Microphone news-papers, round robins sales, service, tape-splicing. Send 5c, 9in x 4in SAE to ATRS, Box 9, P.O., Crow's Nest, N.S.W., 2065, or phone (2) 43-6681, after hours.

**DUPICATING**: James E. Smith Duplicating Service for photostats, photo copies, electronic stencils, addressing service, extensive duplicating coverage. Customers wanted, P.O. Box 48, Albion, Qld., 4010. Phone 57-6612.

**TAPE** copying, editing. Four-track stereo or mono. John Cain, 17 Powell St., Reservoir, Melb., Vic. 3073. Phone 47-6680.

**FREE** stereo pre-recorded tape, cartridge or cassette, when you join the Rondo Reef Pre-recorded Tape service. Est. 5 yrs. Save 20 p.c. on all your pre-recorded tape, etc. over 25 labels to choose from. Interstate, N.G. and Fiji Inquiries welcome, regular new releases posted to all members. Details, Rondo Reef, Box 162, Rockdale, N.S.W. 2216, Aust.

**TRANSFORMERS** wound. Output or mains and specials to order. Paris Radio Electronics, 7a Burton St. Darlinghurst, N.S.W., 31-3273.

## READER SERVICE

**TAPE** to disc service. Take advantage of W and G. Records' professional experience when next needing a tape to disc service. W and G. Record Processing Co., 185 A'Beckett Street, Melbourne. Tel. 329-7255.

**REPAIRS** to receivers, transmitters, construction testing, TV alignments; Xtal conv., specialised electronic equip. Eccleston Electronics 146a Cotham Road, Kew, Vic. 80-3777.

**ACCURATE WORK** and low cost secure you any meter repair.

El. Instr. Maker W. Peterson, 151 Keele St. Collingwood, Vic., 3066. Japanese meter specialist. Mail orders.

**COILS, CHOKES, RFS, IFS, etc.** wound to your own specifications or on contract basis. Reply with S.A.E. Paris Radio Electronics, 7a Burton St. Darlinghurst, N.S.W. 31-3273.

**MODELS**. Marine engine blue prints, also steamer designs. Bolton, 70 King Street, Sydney. Catalogue \$1.50.

**RADIO TV TAPE** service, all spares available, trade discounts on parts. Amplifiers, microphones, Nichols Radio, 91 Wellington Street, Launceston, Tas.

**CUSTOM BUILT TRANSFORMERS**. Power, audio, etc. Single or quantity production. Amplifiers, P.A. systems, battery chargers, Rectifiers, electric motors, transistor radios. General engineering, fitting and turning, sheet metal work, etc. Parkinson Transformers, P.O., Box 523, South Brisbane. Telephone 872-033.

## WANTED

**PHILIPS**, pair 800-ohm speakers, preferably 12-inch twin cone. Phone Tiche, 59-4480 (Sydney) A.H.

**PHILIPS** PB1700/01 40,000ohm/V multimeter. Please state condition price. Wardell, 78 Denison St., Hamilton, N.S.W.

**ELECTRONIC ORGAN**. Wishing to contact amateur organ builders especially in North Queensland, also suppliers of organ keyboards parts, etc. P. J. Pietila, P.O. Box 22, Collinsville, Qld. 4804.

**TEST EQUIPMENT** and Transistor sets, Any condition. Collier, 84 Orange Parade, Wyoming, Gosford, 2251.

**AMPEX** 2100 series secondhand, but must be in good condition. Reply write 249 Eastern Valley Way, Middle Cove, Sydney, 2068.

**ELECTROLYTIC CAPACITORS**

Miniature Type		Top Grade	
Type	Price	Type	Price
25VW	1-9	10VW	1-9
5mf	16c	5mf	12c
10mf	18c	10mf	13c
25mf	20c	25mf	14c
50mf	21c	30mf	15c
100mf	25c	50mf	17c
200mf	29c	100mf	19c
500mf	40c	200mf	25c
1000mf	60c	500mf	33c
2000mf	95c	1000mf	49c

100 off prices on application. For resistor and polyester capacitors prices see classified section. Prompt service. Pack, and post 10c any order.

**KITSETS AUST.**  
Box 176, P.O., Dee Why, 2099, N.S.W.

## COLTON GRIPEX

Anti-Slip Solution for Idler  
Wheels and Drive Belts \$1.10  
per one ounce bottle.

Trade and Wholesale enquiries  
invited.

**Leroya Industries Pty. Ltd.**  
266 Hay Street,  
SUBIACO, W.A.







# I'm alright, Jack.



I've happily settled for  
**SANSUI**

All over Australia discriminating music lovers are settling for nothing less than Sansui. Sansui is Japan's top quality brand . . . and costs a little more than lesser makes. And with Sansui you get what you're paying for — the priceless ingredient that is *quality*. Two new solid state stereo amplifiers have now been

released in Australia — both offer *real* value for money. The new Model AU555 costs \$217 and the Model AU222 is priced at \$180. Examine the specifications; then see your nearest Sansui supplier and *listen* to these fine amplifiers. We know you'll agree with us, and *invest* in Sansui.

**IMPORTANT:** Ask for complete unabridged specifications. Then you can see how much more you get when you buy Sansui. See your local Sansui agent!



MODEL AU555 PRICE: \$217 inc. sales tax



MODEL AU222 PRICE: \$180 inc. sales tax

**OUTPUT:** 60 watts music power at 4 ohms  
**FREQUENCY RESPONSE:** 20-80,000 Hz. + 1 dB.  
**SENSITIVITY:** Mag. p.u. 2mV.  
 Tape head 1.5mV. Aux. 1 200mV.  
 Mic. 3.8mV. Plus other inputs.

**OUTPUT:** 46 watts music power at 4 ohms  
**FREQUENCY RESPONSE:** 20-30,000 Hz. + 1 dB.  
**SENSITIVITY:** Mag. p.u. 2mV.  
 Tape head 1.5mV. Aux. 1 150mV.  
 Aux. 2 150mV. Plus other inputs.

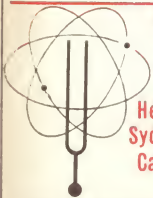

Australian National Distributors:

**Simon Gray Pty. Ltd.**

Head Office: 28 Elizabeth St., Melbourne, Vic. Tel. 63 8101\*  
 Sydney Office: 22 Ridge St., North Sydney, N.S.W. Tel. 929 6816  
 Canberra Office: 31-33 London Circuit, Canberra City, A.C.T.  
 Tel. 49 6050

INTERSTATE REPRESENTATIVES:

N.T.: Pfltzner's Music House, Smith Street, Darwin. Tel. 3801  
 Q'land: Sydney G. Hughes, 154-158 Arthur St., New Farm, Brisbane. Tel. 58 1422  
 S.A.: Eilco Sales Pty. Ltd., 7-9 Osmond Terrace, Norwood, S.A. Tel. 63 4844  
 Tas.: K. W. McCulloch Pty. Ltd., 57 George Street, Launceston. Tel. 2 5322  
 W.A.: Athol M. Hill, 613-615 Wellington Street, Perth. Tel. 21 7861

S.G. S11/68



# This A.R.T.C. Success Story Can Be Yours!

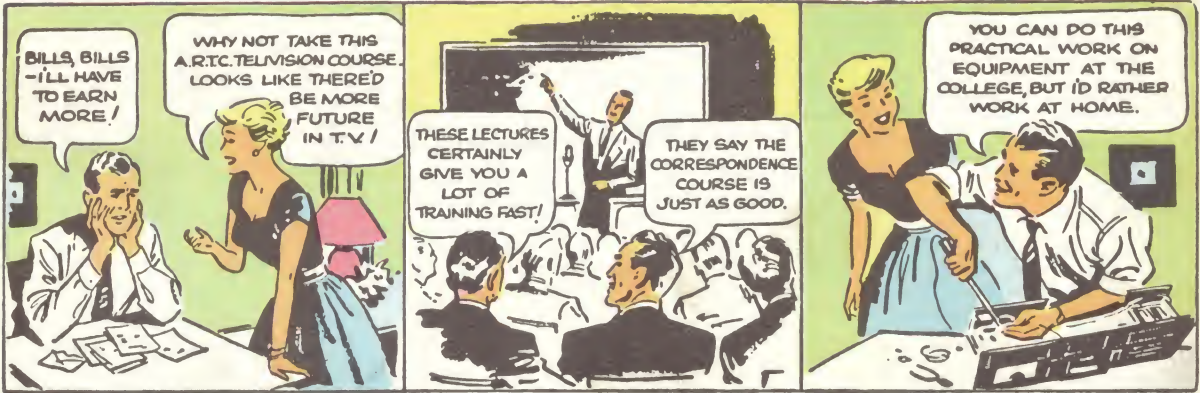

## GET INTO ONE OF THESE PROFITABLE CAREERS IN RADIO AND TELEVISION

There is a profitable career for you in the many phases of radio television including manufacturing, radio servicing, television servicing, research, sales broadcasting and television executive, armed forces. A.R.T.C. can help you gain one of these much sought-after positions. But remember, it is only the trained man who succeeds and A.R.T.C. can give you the complete training which is necessary.

### TRAIN AT HOME OR AT THE COLLEGE

With A.R.T.C. you can obtain the training you need. At the benches and in the lecture halls of Australian Radio and TV college or in your own home by correspondence . . . you can be taught every important aspect of radio, television, details of every application of the fundamental principles. The course is intensely practical and individual.

### MAKE SPARE-TIME MONEY

If you wish you can make your spare time earn money for you. Many students make extra money at spare time work after only the first few weeks. Think of all those things extra money can bring you, home of your own, car, time for relaxation, etc. Safeguard your future . . . mail the coupon today.

### MAIL COUPON NOW

You are invited to mail the coupon below which can be your first step towards securing a job or business of your own with good prospects, security and big money. A.R.T.C. will mail to you by return, at no obligation to you the big free booklet: "Careers in Radio and Television." This booklet will show you definite steps you can take for a better job, how you can succeed in life. Post the coupon, phone or call NOW.

## AUSTRALIAN RADIO AND TELEVISION COLLEGE

PTY. LTD.  
E. S. & A. BANK BUILDING,  
Cnr. Broadway and City Road, Sydney.  
(Opp. Grace Bros.) Phone 211-4244 (3 lines.)



### AUSTRALIAN RADIO & TELEVISION COLLEGE PTY. LTD.,

206 Broadway, Sydney, N.S.W.

Dear Sir,

Please send me, without obligation, your free booklet, "Careers in Radio, TV and Electronics."

NAME .....

ADDRESS .....