

# ELECTRONICS

## Australia

May, 1969

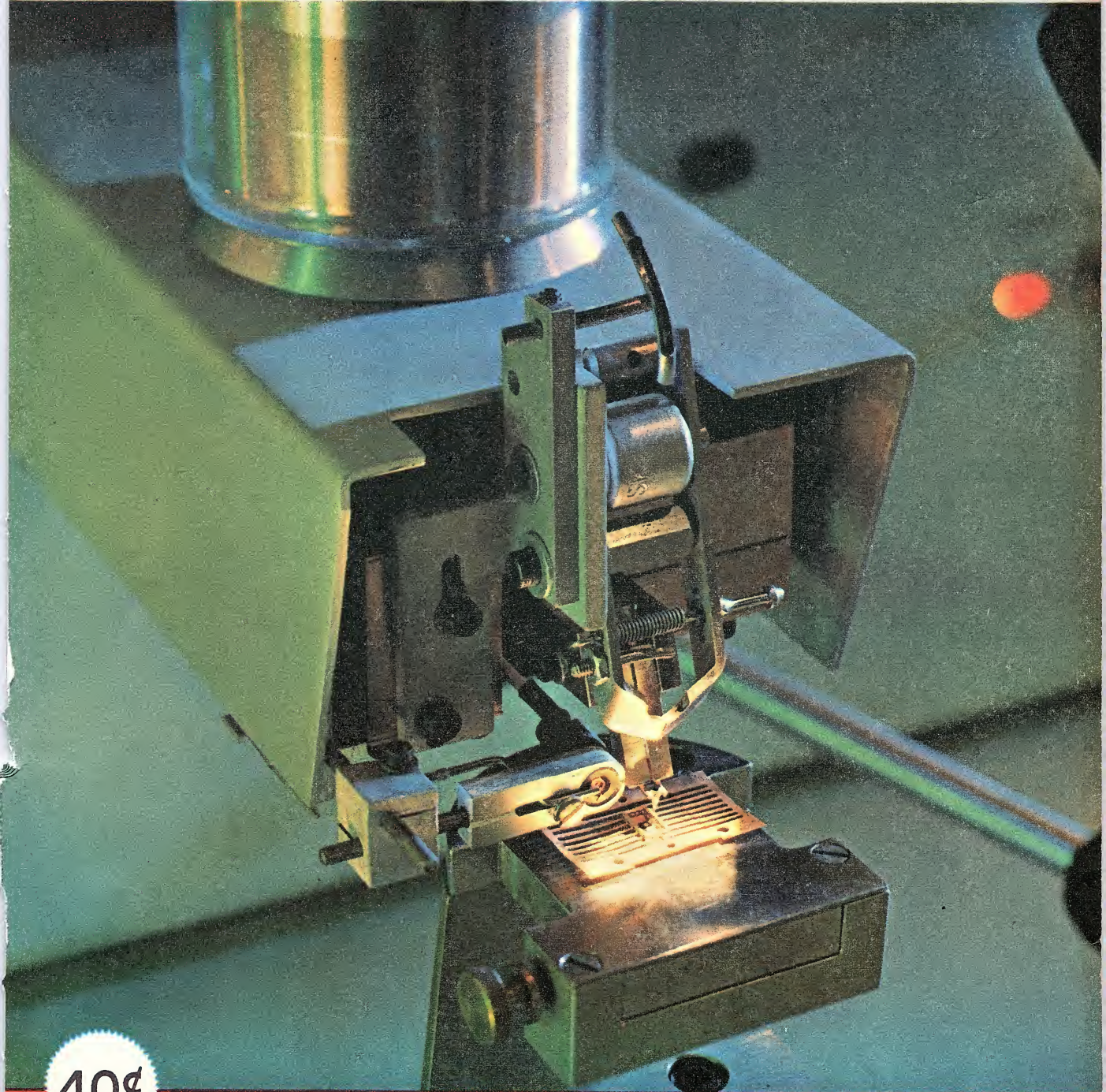

40¢

Thermo-bonding leads to silicon chips

COMMENCING IN THIS ISSUE: A COURSE IN SEMICONDUCTORS  
PICKUP CARTRIDGE CHART • HOW PEN RECORDERS WORK



# NATIONAL

## NEW SOLID-STATE CAR STEREO TAPE PLAYERS

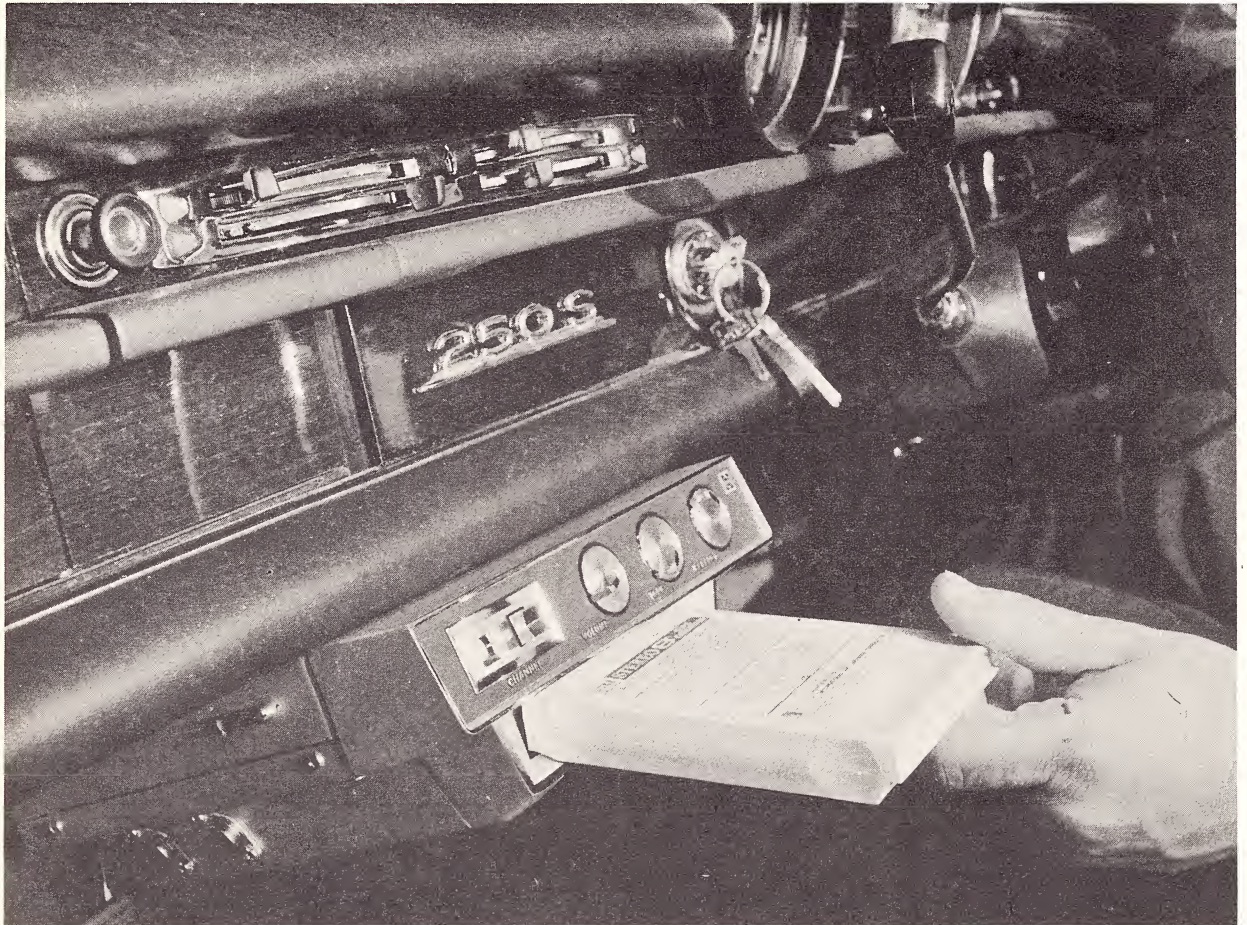

### Now you can choose the entertainment you want in your car!

National's brilliant new solid-state car stereo tape players give you uninterrupted home entertainment quality at a touch! No aerial, no radio required. Just push in a cartridge of your favourite pre-recorded music. It plays instantly without warm up. Gives an unbelievably rich and full sound. It's an 8-track, 4 channel system with big 2 x 4 watt output.

And if you want radio as well, all you need do is plug in our National C190U radio pack in place of a cassette, and you've a long-range car radio playing through both the speakers.

CX807U Stereo tape player with two speakers ..... \$165.00

C190U Long distance radio pack for CX807U ..... \$76.80

**SEND COUPON FOR FREE DETAILS!**



To HACO DISTRIBUTING AGENCIES PTY. LIMITED,  
57-69 Anzac Parade, Kensington, N.S.W. 2033.

Please send me further information on National car stereo tape players.

Name.....

Address.....

Post code.....

Y756B

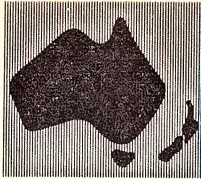

# ELECTRONICS Australia

incorporating RADIO, TELEVISION & HOBBIES

ABC certified circulation in excess of 47,000

volume 31, number 2

## CONTENTS — MAY, 1969

### features

- 3 Editorial
- 10 Photographs from space
- 12 Battery—fuel cell combinations
- 15 I.R.E.E. 1969 convention
- 16 U.K. to continent phone system
- 18 IBM time-shared computer, Sydney
- 21 New words by the thousand
- 25 I.E.A.C.C. exhibition, Melbourne

### technical digest

- 27 Instant warm-up TV picture tube
- 29 British plan for tidal electricity
- 31 Converting U.K. TV to 625-line colour

### technical articles

- 40 Playmaster 124 stereogram
- 53 Fundamentals of solid state—chapter 1
- 62 Graphic recorder writing systems
- 70 Transistorised RF preamplifier
- 81 Loudspeaker cabinets from scrap
- 82 New SW system—E. H. Armstrong (historical)
- 95 Combating interference with a wavetrap
- 96 Stereo cartridge connections

### regular features

- 33 Scientific and industrial news
- 76 Forum
- 88 Serviceman
- 99 Reader built it
- 106 Audio topics—Recordings—then and now
- 116 Record reviews—classical
- 121 Record reviews—documentary
- 125 Record reviews—devotional, popular, jazz
- 140 Trade reviews and releases
- 153 Technical books and publications
- 161 Amateur band news and notes
- 173 Listening around the world
- 181 Answers to correspondents
- 191 Classified advertising
- 192 Index to advertisers
- 189 Notes and errata

#### Editorial Office:

12th Floor, 235-243 Jones Street,  
Broadway, Sydney, Australia.  
Phone 2-0944.

#### Postal Address:

Box 2728, G.P.O., Sydney, 2001, Australia.

#### Advertising:

Selwyn Sayers, Manager.

Bill Summons, Rep. Sydney.

Office: 8th Floor, 235-243 Jones Street,  
Broadway, Sydney. Phone 2-0944.

Clarrie Levy, Rep. Melbourne.

Office: 392 Little Collins Street,  
Melbourne, 3000. Phone 67-8131.

#### Circulation:

Alan Parker, Manager.

Office: 9th Floor, 235-243 Jones Street,  
Broadway, Sydney. Phone 2-0944.

#### Subscription Rates:

See back page.

#### Representation:

Melbourne—John Fairfax and Sons Ltd.,  
392 Little Collins St., 3000. Ph. 67-8131.

Brisbane—Sungravure Pty. Ltd., 78 Eliza-  
beth Street, 4000. Ph. 2-6688.

Adelaide—John Fairfax and Sons Ltd., 104  
Currie Street, 5000. Ph. 51-3502.

Perth—Sungravure Pty. Ltd., 847 Hay  
Street, 6000. Phone 23-4513.

Newcastle, N.S.W.—Associated Newspapers  
Ltd., 22 Bolton Street, 2300. Ph. 2-3696.

London—John Fairfax and Sons (Aust.)  
Ltd., Reuter Building, 85 Fleet Street.

New York—"The Sydney Morning Herald"  
Ltd., "Times Annex," 229 West 43rd Street.

#### Distribution:

Distributed in N.S.W. by Sungravure Pty.  
Ltd., Jones St., Broadway, Sydney, N.S.W.;  
In Victoria by Sungravure Pty. Ltd., 392  
Little Collins Street, Melbourne; In South  
Australia by Sungravure Pty. Ltd., 104  
Currie Street, Adelaide; In Western Aus-  
tralia by Western Press; In Queensland by  
Gordon and Gotch (A'sia) Ltd.; In New  
Zealand by Truth (N.Z.) Ltd.; In Tasmania  
by Davies Bros. Ltd., "Mercury," Hobart.

# Three examples from the Mullard range of advanced microwave devices

## Gunn diodes 5 to 15mW, 8 to 12GHz

High production rates have brought down prices to very low levels. The CXY11 series are gallium arsenide, bulk-effect devices. They are encapsulated in varactor-type pill packages suitable for most types of cavity. Depending on the cavity, they will operate at any frequency in X-band.

Here's some quick reference data—

	CXY11A	CXY11B	CXY11C
Operating voltage	7.0V	7.0V	7.0V
$P_{tot,max}$ ( $T_{amb} = 25^{\circ}C$ )	1.0W	1.0W	1.0W
Operating frequency	X-band	X-band	X-band
$P_{out,min}$	5.0mW	10mW	15mW

## Planar varactors

These varactors are efficient, rugged, reliable and inexpensive too. After all, they're made by Mullard, Britain's largest suppliers of planar semiconductors. Check these brief details of the comprehensive planar varactor diode range.

Type	Min. $P_{out}(W)$	Frequency (GHz)	Multiplication Factor
BAY96	22.0	0.5	X3
BAY66	10.0	1.0	X2
BXY27	5.0	2.0	X2
BXY28	3.5	4.0	X2
BXY29	0.3	9.0	X4
BXY32	15mW	9.0	X10
CXY12	50mW	36.0	X4

## New solid-state X-band oscillators

Three new series, all electronically tuned—compact solid-state alternatives to the reflex klystron, needing only a 7V negative stabilised supply. Prices compare very favourably with klystrons and their associated power supplies.

### CL8420 Series

General purpose 9.2-9.5 GHz oscillators.

50MHz electronic tuning.

Power output to 10mW.

For local oscillators in X-band radar.

Coaxial or waveguide output.

### CL8300 Series

For local oscillators in radars with automatic frequency control.

Frequency range 9.2-9.5GHz.

200MHz electronic tuning.

Power output to 3mW.

Coaxial or waveguide output.

### CL8400 Series

Precision oscillators for laboratory use.

50MHz electronic tuning with up to 3GHz mechanical tuning range.

Power output to 10mW.

Coaxial output.

Further details are available from Mullard offices throughout the Commonwealth.

N.S.W.: 35-43 Clarence St., Sydney 2000. Phone: 29 2006

VIC.: 123-129 Victoria Pde., Collingwood 3066. Phone: 41 6644

QLD.: Cnr. Light St. & St. Paul's Terrace, Bowen Hills 4006. Phone: 51 5151

S.A.: 176 Wright St., Adelaide 5000. Phone: 51 3123

W.A.: 579 Murray St., Perth 6000. Phone: 21 2561

TAS.: MEDHURSTS LTD., 163 Collins St., Hobart 7000. Phone: 2 2911

# Mullard

Microwave tubes, semiconductors  
paramps, components and  
solid-state sources



## EDITORIAL VIEWPOINT

by Neville Williams

### Servicing. What do you think?

When they were very young, the managers of our radio TV service organisations probably asked their parents where babies came from. Nowadays, they are much more likely to ask where servicemen come from — a question to which the answer is no less elusive.

Superficially, it would seem that an ever-increasing number of recruits should be available from the blossoming technical colleges — young men who have just completed a broadly based and up-to-date course of study. In actual fact, and perhaps not surprisingly, only a few of them seem to end up as radio/TV servicemen. Already employed in 5-day week laboratory or industrial situations, with time off for study, they simply move up the ladder in their accustomed environment, with scarcely a glance towards servicing as a career.

No less to the point, the average technical college electronics course is not designed to produce radio/TV servicemen, as such. The syllabus, the textbooks, the lecturers are biased towards basic theory. The students emerge well enough qualified to occupy a technical strata adjacent to engineering graduates but they are a long way removed in aptitude and inclination from the servicing industry.

It would seem that there is urgent need for a whole new emphasis on courses deliberately aimed at turning out properly oriented consumer-product servicemen, NOT back-up designers and engineering assistants; courses with the strongest possible emphasis on how devices work and the logic of trouble-shooting when they fail; courses with a commercial and public relations content, so that embryo servicemen will have some appreciation of the commercial side of their career.

It is one thing to say this, but quite another to provide such courses. They demand theory training quite different from the usual near academic variety and an emphasis on practical work in simulated servicing situations. If it is to be relevant, this practical work has to be constantly up-dated to keep step with commercial practice.

A problem which service-orientated courses will not solve is how trainees will provide for themselves while they are attending college. One of the problems of the servicing industry is that, while it desperately needs trained recruits, it cannot readily employ them while they are being trained.

As if this were not enough, there is the question of remuneration. More and better trained people would be attracted to the industry — despite odd hours — despite cranky customers — if the financial inducement were stronger. But I fear that the cut-rate complex which has plagued appliance marketing for so long, has spilled over into the servicing of these same appliances.

No wonder service managers are looking with apprehension to the coming of colour television — with Australia as the first country in the world to launch into colour television solely with all-transistor receivers.

Forget the babies; they turn up automatically. The real problem is: Where do TV servicemen come from? Especially the solid-state three-colour variety?

### On the cover

*A close-up view of the work area in a Hughes Model HPB-360, a "state of the art" pulse-heated thermo-compression wire bonder. Thermo-compression bonders are used in semiconductor manufacture to make connections from chip to leadouts and to make circuit interconnections in hybrid circuits. Gold wire ranging in size between .0007in and .005in is used. The Hughes Aircraft Company is represented in Australia by Royston Electronics Pty. Ltd., 12 Churchill Street, Mont Albert, Victoria.*

#### EDITOR

Neville Williams  
M.I.R.E.E. (Aust.)  
(VK2XV)

#### ASSISTANT EDITOR

Philip Watson  
A.M.I.R.E.E. (Aust.)  
(VK2ZPW)

#### TECHNICAL EDITOR

Jamieson Rowe  
B.A. (Syd.),  
B.Sc. (Tech., N.S.W.)  
A.M.I.R.E.E. (Aust.)

#### TECHNICAL STAFF

Ian Pogson (VK2AZN)  
Harry Tyrer (VK2ZHH)  
Anthony Leo (VK2ZHK)  
John Horsfield  
Robert Flynn  
Leo Simpson

# INSTROL *hi-fi systems . . .*

There's a custom built Instrol hi-fi System to suit every possible purpose. For example, this prestige system, based on the magnificent new Instrol Cabinets "Series One Thousand." We suggest the Kenwood TK250 Amplifier, and Dual 1019 Player (with Shure M75G magnetic cartridge), plus two Wharfedale Super 12 RSDD Speakers all fitted in Instrol Teak Cabinets one Model 1002 and two of enclosure 1001. Built and tested for \$717.00. Many fine combinations can be produced to suit your requirements, with and without tape recorders, in any of the craftsman-made cabinets from the Instrol range. Let us quote you for your choice. You can save more money if you prefer to assemble your own from Instrol Cabinet Kits.

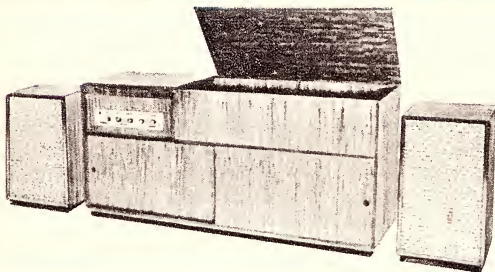
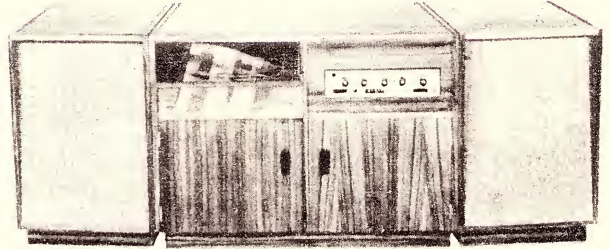

Here's another splendid selection. Take Instrol Model 375 R.S. Cabinet, with two Wharfedale Super 10 Speakers fitted into Instrol Vented Enclosures. The cabinet work may be Queensland Maple, Teak or Walnut. For your amplifier, what better than Instrol, solid state Model 20-20, or Kenwood TK150 or Instrol Model AT1 Amp-Tuner, Add Sony TC255 Tape Deck, and Dual 1015 (with Shure M44MG magnetic cartridge). Cost, within the range of \$690.00 and \$731.00. The same systems, but without tape deck and fitted in Instrol Model 250 R.S. Cabinet, between \$453.00 and \$494.00.

## SPECIAL

Two compact, shelf or table mounting systems — quality at very low cost.

- (A) Instrol 20-20 Solid State Amplifier, plus BSR MA70 Player, fitted to Instrol Model 75 Cabinet (Teak) which features hinged perspex top. Add two Instrol-Mullard mini speaker systems. \$229.00
- (B) Instrol 20-20 Solid State Amplifier, plus Dual 1010F or Garrard AT60/2 Player, in Model 50 Cabinet, plus two Instrol-Playmaster Bookshelf speaker Systems (all Teak). \$249.00.

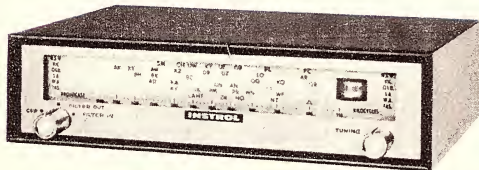
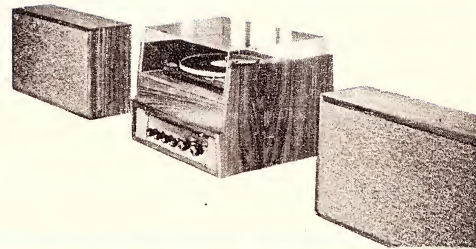

## INSTROL WIDE BAND TUNER Solid State Model T-101

A high quality hi-fi tuner designed to operate with all makes of valve and solid state amplifiers.

- Wide band 530 to 1600KHz
  - Tuning Meter. ● Efficient Noise filter.
  - R.F. Stage.
  - Built-in AC. Power Supply.
  - Major Stations, all States clearly marked on large illuminated scale.
- Housed in smart metal box. Available as Amp/Tuner in combination, with the Instrol 20-20 Amplifier, in attractive Teak cabinet (as illustrated) or less cabinet for panel mounting.



### PRICE DETAILS:

T101 TUNER (in Metal Case) . . . . .	\$72.00
T101 TUNER (without case) . . . . .	\$69.80
20-20 AMP. (in Teak Case) . . . . .	\$99.00
Combined 20-20-T101 in Teak Case . . . . .	\$176.00

Yes, we carry a range of imported Loudspeakers, Players, Amplifiers and Tape Recorders. Please state your requirements and we will gladly quote. All well-known brands stocked.

- |              |               |            |
|--------------|---------------|------------|
| ● INSTROL    | ● A.D.C.      | ● GARRARD  |
| ● FISHER     | ● DECCA       | ● SONY     |
| ● KENWOOD    | ● QUAD        | ● BRENNELL |
| ● SANSUI     | ● LABCRAFT    | ● AKAI     |
| ● WHARFEDALE | ● ALL BALANCE | ● TEMPO    |
| ● GOODMANS   | ● DUAL        | ● LEAK     |
| ● SHURE      | ● ELAC        |            |

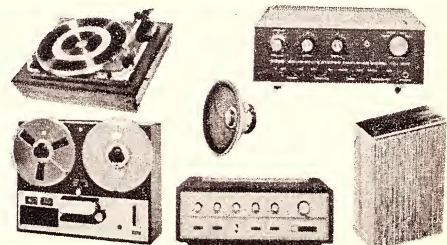

# INSTROL cabinet kits . . .

## And Now INSTROL PERIOD STYLE Hi-fi furniture . . .

We are in the process of adding period styling to some of the models from our standard range of Instrol hi-fi furniture. The photograph shows Model 600 equipment cabinet with Instrol Wharfedale speaker enclosures rendered in Queen Anne period styling. This styling is equally attractive for other models from the Instrol range. Soon, some Instrol models will be available in Spanish-Mediterranean styling.

### PRE CUT KITS OR BUILT & FINISHED

All Period Styles are available as pre-cut kits to assemble yourself or as built and finished furniture. By assembling yours from an Instrol pre-cut kit, you can make your own period style furniture for little more than half cost. Ideal for finishing to an almost exact replica of cedar, mahogany, rosewood, etc., and really magnificent when finished in any of the new Estapol Antique colours.

Each kit is complete with all necessary pre-cut timber parts, legs, antique handles, moulding, carvings, nails, screws, etc., plus fully illustrated easy-to follow instruction manual.

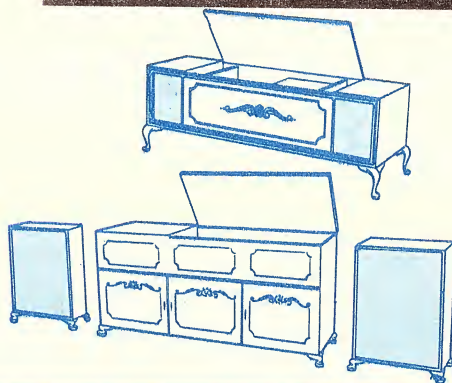
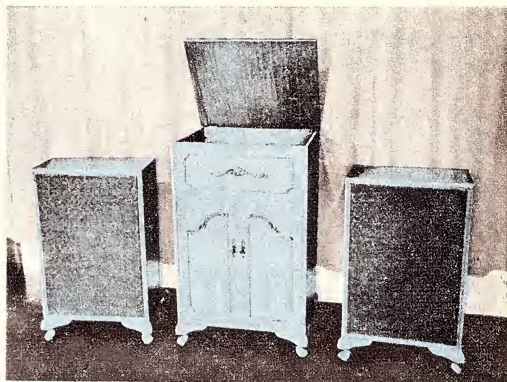

### EQUIPMENT CABINETS

There are more than sixteen Instrol equipment cabinet designs, all available built and polished or as kits of parts to assemble yourself. They range from massive floor units to compact table models, and include cabinets for record storage and wall shelf units.

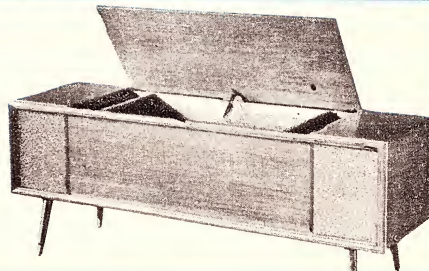

### SPEAKER ENCLOSURES AND SYSTEMS

Name your speaker and Instrol can supply an enclosure to suit. If it's not in the standard range we can quickly produce enclosures to suit speaker manufacturers' specifications. Enclosures only or complete speaker systems are all available built and polished or as kits.

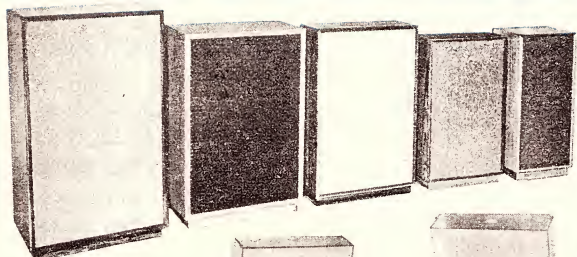

Post coupon, call, or phone for free fully illustrated Instrol hi-fi cabinet brochure. It includes full specifications and down to earth price details of all Instrol cabinet designs. (If writing please include postage stamp.)

### PLAYER STANDS

The Instrol range includes a wide variety of player stands and combination amplifier-player cabinets. High quality perspex covers (clear and tinted) are also available, some hinged, others separate.



**FREE**  
**INSTROL**  
**CABINET**  
**CATALOGUE**

## BROADWAY ELECTRONICS (SALES)

PTY. LTD.

32 GLEBE PT. ROAD, GLEBE, N.S.W.

Telephone 660-1171. Only 100 yards from Broadway.

OPEN SATURDAY MORNINGS.

Send Coupon for **FREE CATALOGUE**.  
(Please enclose postage stamp.)

NAME .....

ADDRESS .....

.....

.....

Instrol Hi-Fi  Instrol Cabinets

**With a BSR X3M  
'compatible' cartridge,  
almost any mono  
record playing  
equipment can take  
stereo records  
(without damaging  
them)**

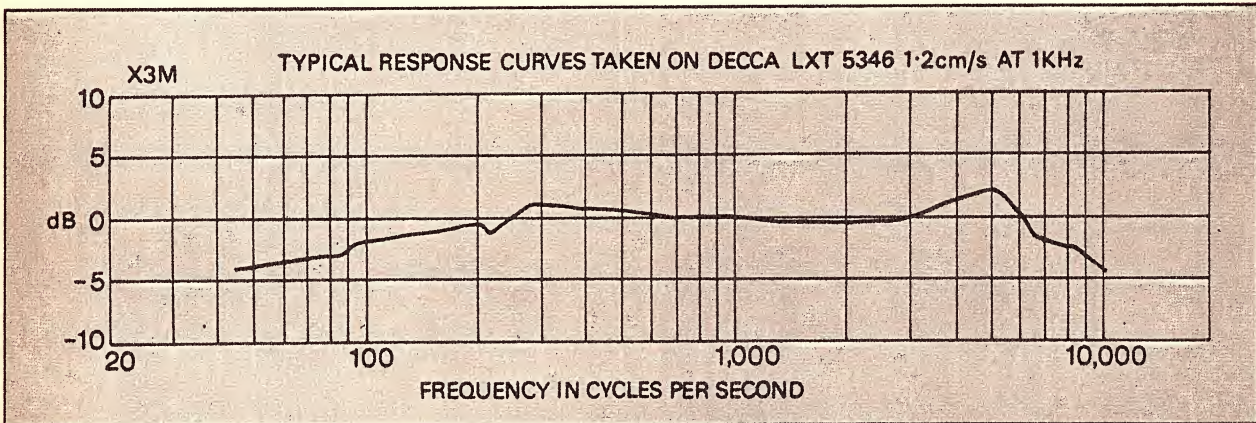
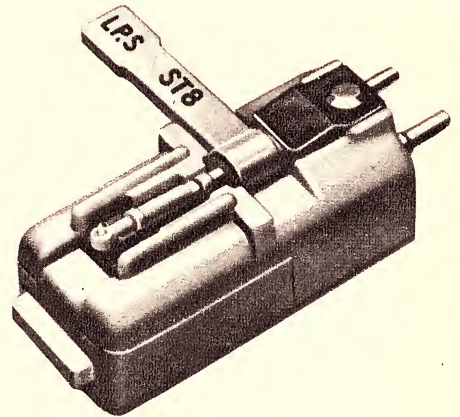

### Why compatible cartridges?

An increasing number of record companies are now making stereo LP records only.

Until now these records could not be played on a mono player without distortion and damage to the records.

When playing stereo records the stylus tip moves vertically and horizontally following groove contours. Mono records have grooves which only move the stylus horizontally so old mono cartridges will not allow vertical movement of the stylus. Playing stereo records with old mono cartridges will damage the vertical component of the groove irrevocably.

The X3M 'compatible' cartridge, designed and perfected by BSR, is the answer to this problem. For a small outlay it allows you to play both stereo and mono records without harming either. Retail price, \$6.00.

### TECHNICAL DATA X3M

Output: 350 mV  $\pm$  2 dB

1 KHz test record Decca  
LXT 5346 at 1.2 cm/s

Frequency Response: See typical curves above

Dynamic Compliance:

Horizontal  $3.0 \times 10^{-6}$  cm/dyne ( $\pm 20\%$ )  
Vertical  $1.0 \times 10^{-6}$  cm/dyne ( $\pm 20\%$ )

Equivalent Capacity: 800 pF

Nominal

Recommended Loading: 2 M. ohm 100 pF

Stylus Pressure: 4-6 grammes  
depending on pick-up arm

Measuring Temperature: 20° C 68° F

Colour: Beige



BSR (A/ASIA) PTY. LTD.  
SOUTHERN SECTION INDUSTRIAL ESTATE  
ST. MARY'S, N.S.W.  
PHONE: 623-0375, 623-0376



DISTRIBUTORS:  
GOLDRING ENGINEERING (A/ASIA) PTY. LTD.  
443 KENT STREET, SYDNEY, N.S.W.  
OFFICES IN ALL CAPITAL CITIES.

BSR:P100



# Better sound reproduction begins with the new BSR MA75...

The MA75 is an expression of the craftsmanship and engineering know-how that have made BSR the world leader. Check the features. It gives you a die-cast turntable, switch 'pop' filter, changer muting switch and many other sophisticated ideas usually found only on much more expensive units. BSR have done it again—and it's their best ever.

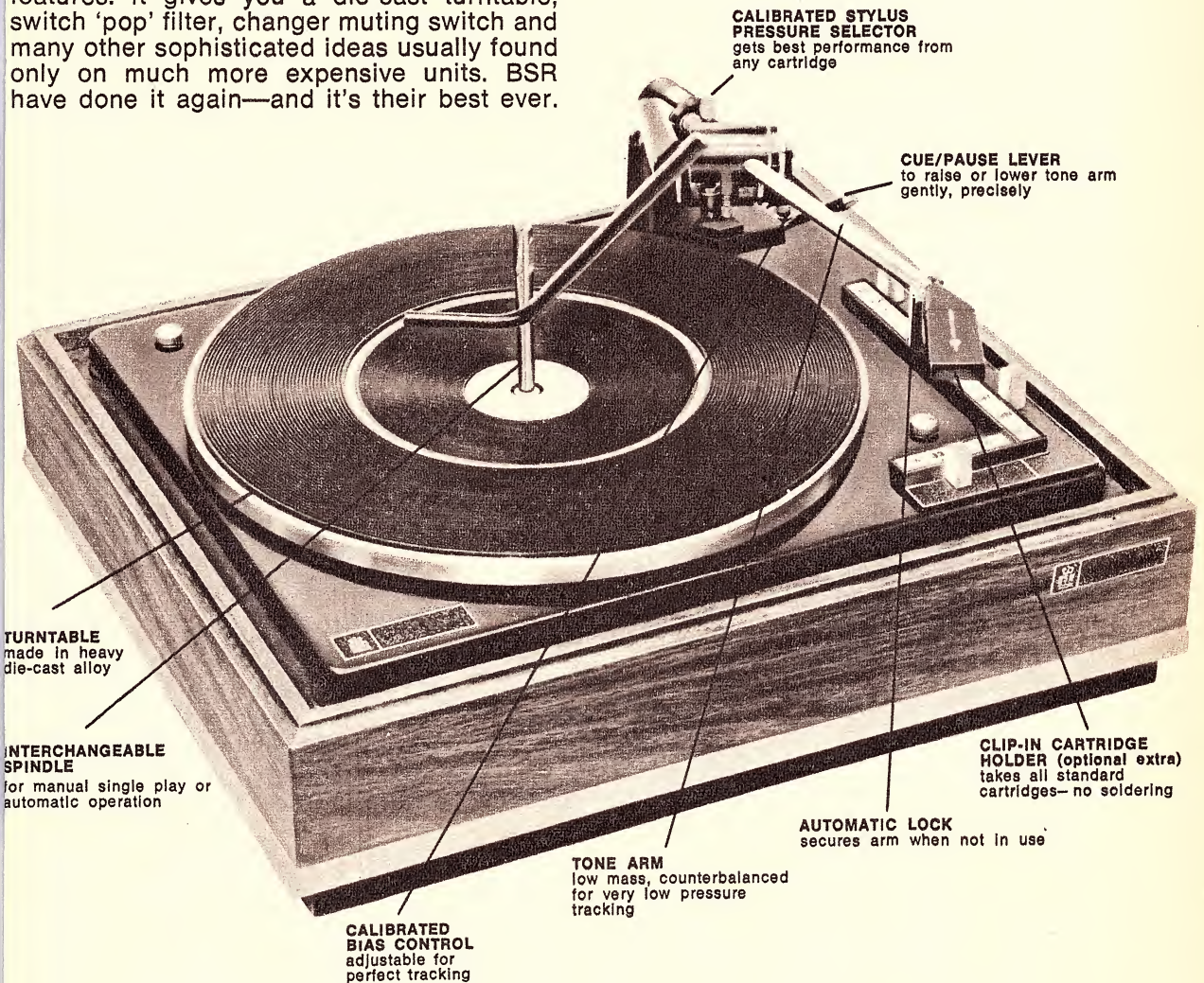

**CALIBRATED STYLUS PRESSURE SELECTOR**  
gets best performance from any cartridge

**CUE/PAUSE LEVER**  
to raise or lower tone arm gently, precisely

**TURNTABLE**  
made in heavy die-cast alloy

**INTERCHANGEABLE SPINDLE**  
for manual single play or automatic operation

**CLIP-IN CARTRIDGE HOLDER (optional extra)**  
takes all standard cartridges—no soldering

**AUTOMATIC LOCK**  
secures arm when not in use

**TONE ARM**  
low mass, counterbalanced for very low pressure tracking

**CALIBRATED BIAS CONTROL**  
adjustable for perfect tracking

## BSR (A'ASIA) PTY. LTD.

Southern Section Industrial Estate,  
St. Marys, N.S.W.  
Phones: 623-0375, 623-0376

**WHOLESALE DISTRIBUTORS**  
**GOLDRING ENGINEERING (A'ASIA) PTY. LTD.**  
N.S.W.: 443 Kent St., Sydney, 29-1275  
VIC.: 368 Little Bourke St., Melbourne, 67-1197  
QLD.: 235 Edward St., Brisbane, 2-7010  
W.A.: 91 Hay St., Subiaco, Perth, 8-4988  
S.A.: 77 Wright St., Adelaide, 51-5117





# BANG!

**Yes! STC makes them also.**

The BC 107,108,109 (Gain specified to your requirement or design)

AN **ITT**

ASSOCIATE worldwide telecommunications and electronics



— From the world wide technical resources of ITT semiconductor laboratories STC now release to the Australian electronic market the real BC 107, 108 & 109.

You can purchase these general purpose beauties at a price which places real profit in your pocket. Available ex stock.

Free detailed technical data available from:  
Components Division, Standard  
**Telephones & Cables Pty.Limited**,  
Moorebank Avenue, Liverpool,  
N.S.W. 2170. Phone Sydney  
602 0333, or Melbourne 480 1255,  
Brisbane 47 4311, Adelaide  
51 3731, Perth 21 6461,  
Newcastle 61 5172, Wollongong  
2 7974.



Actual size



# PHOTOGRAPHS

We are indebted to Victor Hasselblad Aktiebolaget, of Sweden, for this remarkable series of photographs, taken by American astronauts with Hasselblad cameras over a five-year period. The company has provided much specialised camera equipment for NASA projects.

Walter Schirra was the first astronaut to use a Hasselblad camera in space, when he took a series of pictures from a Mercury spacecraft in 1962. In the last flight in the Mercury series, in 1963, Gordon Cooper took a large number of photographs during his 34-hour flight, in which he made 22 earth orbits. Until that time, NASA had not made any special arrangements for space photographs, but when NASA officials saw Cooper's photographs they began to realise the significance of such photographs, not only for their publicity value, but also because of their scientific interest. They immediately set about forming a photography department, which among other things, was responsible for providing suitable cameras and processing film.

Other sections of the department prepared plans of what the astronauts were to photograph before each

## PICTURES THIS PAGE

*TOP: Photograph taken by Gemini 4 commander James A. McDivitt, of Edward H. White's historic first walk in space, in June, 1965.*

*CENTRE: The first rendezvous in space, carried out on December 15, 1965, is recorded in this photograph. The spacecraft taking part were Gemini 6 and Gemini 7.*

*BELOW: This magnificent photograph was taken from Gemini 11 during the flight of September 12-15, 1966, when astronauts Richard F. Gordon and Charles Conrad jun. set a new altitude record of 845 miles. The shot was taken when the spacecraft was almost over India.*

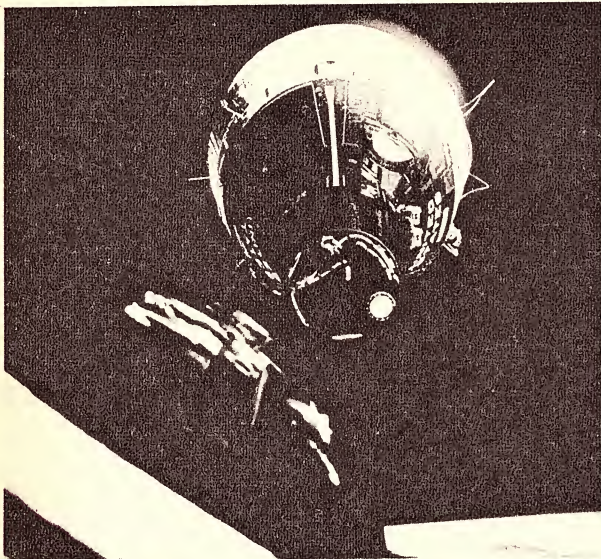

# FROM SPACE

## ... an historical record

mission. A number of experts, photo-technicians, laboratory workers and photo-analysers were added to the department. Contact was made with various institutions likely to be interested in space photographs, notably meteorology departments. As a result of all this activity, all Gemini crews, starting with Gemini IV, were given detailed instructions on what they were to photograph. The cameras used were modified Hasselblad 500C cameras, with mirror and auxiliary shutter removed, and the outer case completely anodised in black to prevent reflections.

Over 2,400 photographs were taken during the 10 Gemini space missions. Besides being extremely beautiful, these are of great scientific value. They show how important space photography is to such fields as geology, geography, oceanography, agriculture, hydrology, city planning, meteorology and space technology.

With the important Apollo program in view, NASA contacted the Hasselblad company regarding specialised photographic equipment, which would be needed. A special department was set up at the Hasselblad plant, with the sole purpose of satisfying NASA specifications. Specialised cameras designed for NASA will be carried to the moon when the first manned landing takes place as the culmination of the Apollo series.

One such camera is the Lunar Surface Hasselblad SWC, with a magazine for 70mm film, a large winding crank and a large, direct vision viewfinder, so that the astronauts will be able to handle the camera in their cumbersome spacesuits.

One specially designed camera, a modified version of the Hasselblad 500EL, has already been used in the Apollo VIII (manned flight around the moon) mission. Two of these were carried, each with seven magazines (one of the features of Hasselblad cameras, which makes them suitable for space work, is the facility for changing magazines.)

The fourth and ninth orbits of the moon were taken up almost entirely in taking photographs, and while they were shooting, the astronauts recorded their comments on tape to simplify identification of the shots after landing. A series of stereo pictures of the moon's surface was probably the most important assignment undertaken during the mission. In this work, the nose cone of the spacecraft was pointed directly at the moon's surface, and a shot was taken every 10 seconds with the aid of a timer.

From this series of shots, experts are able to determine the heights of the moon's mountains and analyse other topographical details. ■

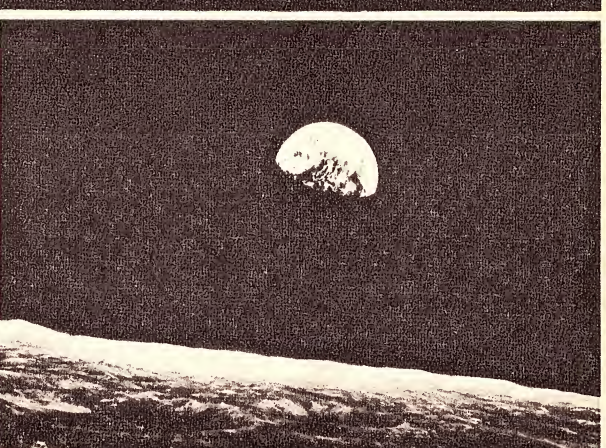
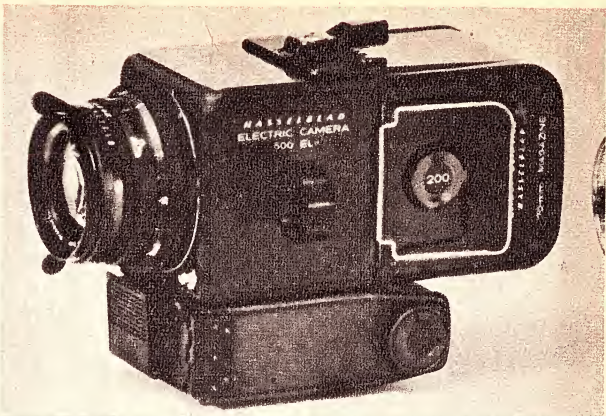

**TOP:** A modified Hasselblad 500EL camera of the type carried by Apollo 8 during its orbits of the moon. Modifications include removal of the mirror and auxiliary shutter and replacement of the release button by a large square release key.

**SECOND PICTURE:** Taken directly over Cape Kennedy during the launching of the first manned Apollo flight, this picture shows the third stage of the giant rocket just after detachment.

**THIRD PICTURE:** A shot of the earth taken from Apollo 8 during one of its orbits of the moon, showing the southern hemisphere. The South American continent can be seen through the cloud formations, as well as the Caribbean Islands and the West Coast of Africa.

**BOTTOM:** "The world looks like a jewel on black velvet," said Frank Borman as Apollo 8 was on its return journey to earth. This photograph taken while the spacecraft was still orbiting the moon shows what he meant.

# FUEL CELL-BATTERY COMBINATIONS

Fuel cells and secondary batteries have both been used in electrically propelled vehicles and, separately, have both proved to have limitations. Since the disadvantages and advantages of each type are mutually opposite, experiments are now being conducted which use them in combination, with apparently promising results.

by Ron Brown

Up to now, most of the talk about new forms of battery and fuel cell has concentrated on making comparisons between particular types on their own. It now looks as though hybrid forms, using fuel cells and secondary (that is, storage) batteries, or diesel engines and secondary batteries, may be the best bet. What is more, this may apply at both ends of the power range. At the recent Sixth International Power Sources Symposium in Brighton, U.K., two American engineers described low-power fuel-cell/secondary-battery hybrids for powering such things as battlefield radio sets; and a British Rail engineer discussed how fuel-cell/secondary-battery and diesel-engine/secondary-battery hybrids might eventually replace the diesel engines at present used on most of the world's railways.

Hybrid arrangements are attractive because they can combine the advantages of particular types of power source, the respective disadvantages being compensated for by the advantages of the other. For example, secondary batteries have a very high power density: they can provide (for limited periods) large amounts of power per pound of weight. Against this must be placed the fact that they have a low energy density — they cannot store a great deal of energy in each pound of weight and so quickly become discharged and need recharging. Fuel cells on the other hand have very great energy densities, but low power densities. Another disadvantage of fuel cells is that they cannot provide power instantaneously, the way a secondary battery can, because they take time to reach their normal operating conditions (temperature, for instance) starting from those of the surrounding environment.

A type of hybrid power source that is already beginning to appear was described by Galen R. Frysinger and a co-worker from the United States Army Electronics Command, Fort Monmouth, New Jersey. They have developed hybrid systems to power a wide range of portable communications and surveillance equipment such as radios (figure 1), radars and night vision devices. A secondary battery provides the required instant power, while the fuel cell provides the high energy density needed for long missions, efficiently converting primary fuel to electrical power to recharge the battery.

A comparison between this new power source and traditional batteries shows how attractive it is. At the

present time the bulk of electrical power consumed in forward-area tactical military communications and surveillance equipment comes from the discharge of primary zinc-carbon batteries of the Leclanche type. At drain rates of approximately 10W or less, that is, at low power densities, these batteries give very trouble-free service for periods of the order of 10 to 20 hours. At the end of this period the battery is discarded and a fresh supply of chemical energy in the form of new cells is inserted into the equipment.

It now looks as if the low power density of these batteries will become a serious problem in the near future because of the introduction of micro-electronic circuits, which is having two seemingly contradictory effects upon the power requirement of communications equipment. Much less power is needed for the receiver, perhaps only two to three watts, while much more power is needed for the transmitter—120 to 150W — because designers can now incorporate much more complex circuits in small portable transmitters. The periodic high peaks of power needed for the new transmitters cannot be provided by primary batteries, and so secondary batteries must be used.

These can supply the large pulses of energy, but their energy densities are only about 10WH per pound which means that, if a lightweight package is specified, they very quickly become discharged. Some convenient means of recharging the battery is needed, and it would be very useful if the energy for this could be provided in chemical form in a disposable container. Here the attractions of the fuel cell becomes apparent.

Large quantities of fuel are not required: the total amount consumed in an 8 to 12-hour period by a small fuel cell is only a fraction of a pound. The cost of the fuel is therefore not an important factor, particularly as the cost of electrical power from zinc-carbon batteries is very high anyway. Most fuel cells use hydrogen as the active material, and a solid chemical form of hydrogen such as lithium hydride or sodium aluminium hydride was selected as the fuel for a 30W cell for manpack applications. Hydrazine, which has a somewhat more complicated operating system, was selected for a higher power (60 to 100W) fuel cell designed to power vehicle-mounted equipments. Approximately one kilowatt-hour per pound is obtained from the hydrides at a cost of about \$US-10 per KWH. About 350WH per pound is obtained from the hydrazine at a cost of about \$US3 per KWH. This compares very well with standard military zinc-carbon cells, which provide approximately 30WH per pound at a cost of about \$US44 per KWH.

Hybrid power sources for the other end of the power range are at a much earlier stage of development. If they are ever to be used for rail traction—an application described by I. Dugdale and a co-worker, of British Rail Re-



Experimental battery-operated electric buses with seating for 29 passengers, developed in the U.K. by Austin Crompton Parkinson. Powered by a fuel cell/battery combination, these vehicles would have longer range and could compare favourably with diesel powered vehicles in running costs.

search Department, Derby—they must compete against diesel engines, whose chief advantage at the present time is their ability to burn a low-cost liquid fuel. The chief disadvantages of diesels are their high maintenance costs and their limited power density, which restricts the rate at which trains can accelerate away from stations.

Fuel cells, even on their own, would appear to have advantages over diesel engines, in that maintenance requirements would be very low and power densities would be higher. Secondary batteries on their own would also have low, or even zero, maintenance costs, while power densities would be much higher than those of diesel engines. Overall efficiency is equally high, but the limited energy density of secondary batteries would severely restrict the range of a battery-powered prime mover.

At the present time fuel cells have not reached the stage of development where a really fair comparison can be made, but Mr Dugdale and his colleague have made an analysis which while speculative in some respects is nevertheless very informative and interesting. They based their comparisons on the 500HP diesel-electric multiple-unit fleet used on the Southern Region of British Rail. The cost of diesel fuel they took as 9.5d (approx. 9c) per gallon. With diesel fuel available at this low price, expensive fuels such as hydrogen, methanol and hydrazine, which can be used directly in low-temperature fuel cells, are all too expensive to be considered for rail traction. If fuel cells are to be used they must employ low-cost fuels such as naphtha or methane, which are cheaper than diesel oil.

In a detailed comparison of fuel cell systems currently available, or at various states of development, Mr Dugdale said that the low-temperature alkaline types which are in the most advanced state of development use the sort of fuels that would make them too expensive to compete against diesel engines. Acid electrolyte systems might be better, but unacceptably high-cost materials would be necessary because

of the corrosive nature of the electrolyte. The "internal reforming" fuel cell, which uses hydrogen which it derives from a hydrocarbon, has an alkaline electrolyte and operates at around 200°C. It can use cheap fuels, but a very expensive palladium alloy membrane is needed, and this makes the initial cost very high. The type of fuel cell which uses a molten metal carbonate as electrolyte (for immunity to attack by carbon dioxide) also runs on cheap hydrocarbon fuels. Constructed from materials that are not unduly expensive, it seems to be very attractive. Unfortunately, fused-carbonate cells have a life of only a few months, and it seems to be generally accepted that this must be extended to a few years before they can compete with diesel engines.

The most attractive type, according to Mr Dugdale's analysis, is the solid

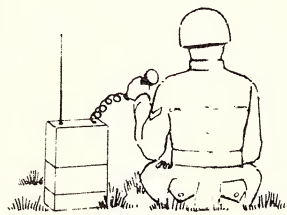
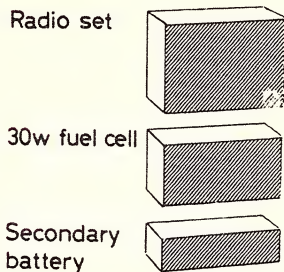

Figure 2. The basic elements of a sodium-sulphur storage battery developed in the U.S.A. by the Ford Company.

Figure 1. Showing the relative sizes of a hybrid powered field radio its storage battery and its fuel cells.

oxide fuel cell, whose electrolyte is a solid-solution of oxides, such as zirconia-calcia, and operates at temperatures around 800 to 1,000°C. The oxide can be made in the form of ceramic membranes with metal electrodes deposited on each side. Nickel, chromium and other metals and alloys can be used, and the cells can run on low-cost hydrocarbon fuels such as kerosene or natural gas. The chief problems at the present time are associated with the materials and the high operating temperatures. A significant step forward, according to Mr Dug-

dale, would come with the development of a solid oxide electrolyte with a reasonably high conductivity at temperatures below 700°C. Recent design studies have shown that units larger than 100KW can be expected to have costs as low as \$US30 per KW. This type of cell appears to have the best chance of replacing the diesel engine in the long run. It would be on equal terms with the diesel engine if it cost \$30 per kilowatt, and used methane at 4c a therm at an efficiency of 30 per cent—even if its life was only two years instead of the 15 years of a diesel engine.

Turning to secondary batteries, Mr Dugdale said that lead-acid batteries which are readily available have, as Mr Frysinger had earlier pointed out, a low energy density. The same applies to zinc-air batteries. Lithium-nickel fluoride batteries also have similar characteristics; their power density is lower again, which makes them look very unattractive; but their energy density is higher and they are sealed and therefore maintenance-free.

The most attractive-looking battery of all is the sodium-sulphur type (figure 2). This is still at an early stage of development, but it is already clear that it will eventually be suitable for most traction applications, although the need to maintain a temperature of 300°C will limit its use to medium and large sized power sources. In these batteries, liquid sodium is separated from liquid sulphur by a ceramic membrane which conducts sodium ions. The most promising separator is a form of alumina. A table presented by Mr Dugdale showed that a sodium-sulphur battery capable of storing 12MWH of energy, which is the amount a diesel engine can store, would provide 14,000KW of power during maximum acceleration, against the 1,860 of the diesel engine. It would weigh 36 tons

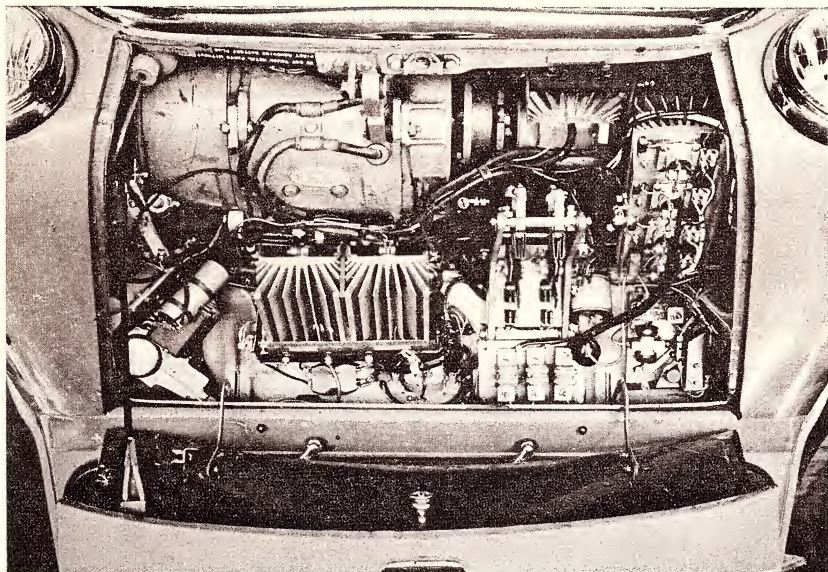

View under the bonnet of an electric powered Mini Traveller. The electric drive mechanism was developed in the U.K. by A.E.I. for the Electricity Council. The single 10HP motor (right front) is supplied by a thyristor control system.

**di/dt capability 10 times industry's best  
EVEN WITH LOW POWER GATE DRIVE**

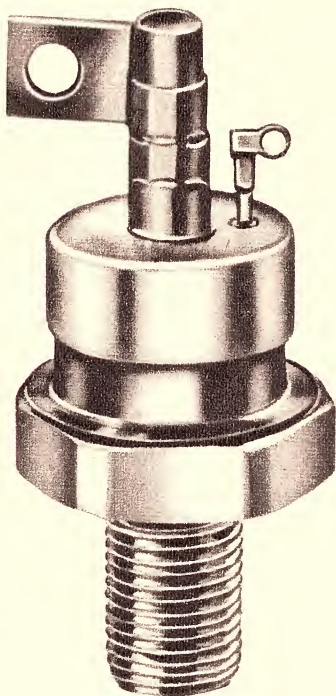

## **varian-national invents the regenerative gate\* S.C.R.**

\* (Patent pending)

The Varian-National regenerative gate SCR is the only SCR that will give 600 A/usec when tested according to JEDEC SUGGESTED STANDARD No. 7 Section 5.1.2.4. This is a di/dt rating at 3 times the peak on-state current and half the switching loss of any SCR presently available. No sacrifice is required in gate drive, turn-on time, turn-off time or any other characteristic. 55A and 110A SCRs are currently available.

Varian-National SCRs are manufactured with ratings from 16A to 470A.



**varian PTY LTD**

electron tube and device group

38 oxley street/crows nest/nsw 2065 tel: 43 0673

springvale road/north springvale/vic 3170 tel: 560 7133

Distributors

Perth, Western Australia: Henderson Instrument Co. Pty. Ltd. Subiaco.

New Zealand: Geo. W. Willon & Co. Ltd. Wellington and Auckland.

ETD3368



## I.R.E.E. 1969 CONVENTION

and would occupy a volume of only 850 cu. ft., as against 33 tons and 2,000 cu. ft. for the diesel engine. It, too, would be economic even if its life was only two years.

One problem with secondary batteries is the fact that to charge a 12MWH battery in four hours requires a power input of 3MW. This means that charging points would have to be close to electricity substations, which would impair operating flexibility. This is what makes the hybrid type of solution look attractive. For example, the high power density of the sodium sulphur battery could be combined with the high energy density of the diesel engine. A 2,750-h.p. diesel engine could be replaced by one of 2,100-h.p. engine plus a 3.5MWH sodium-sulphur battery. Such a hybrid would have a power output considerably greater than either the diesel or the battery alone



*Mr Francis Bacon, the British inventor of the fuel cell, is seen here after receiving a gold plated model of the fuel cell used in the U.S.A.'s Apollo 8 spacecraft. It was presented at a special dinner given recently in his honour by the National Research Development Corporation, at which scientists from Britain and representatives of the American space program paid tribute to his pioneering work on fuel cells.*

and would give much better acceleration. A fuel-cell/battery hybrid, using a solid oxide fuel cell burning hydrocarbon fuel at greater than 30 per cent efficiency would have lower fuel costs than even the diesel/battery hybrid system. The power weight ratio would also be superior.

All this is, of course, still rather speculative, and firm comparisons will have to await further developments of both the solid oxide fuel cell and the sodium-sulphur battery. Nevertheless, it is now becoming clear that batteries or fuel cells may eventually replace the diesel engine, and that a hybrid system, possibly one using a diesel engine and a sodium-sulphur battery, may be a very attractive short-term solution. Certainly the work on fuel-cell/battery hybrids for low-power applications shows that the fuel cell is at last becoming sufficiently simple and reliable to be used as a portable power source in the field. ■

The Institution of Radio and Electronics Engineers will hold its 12th National Radio and Electronics Engineering Convention in Sydney from May 19 to 23. As in the case of the 11th Convention, the venue is the Wentworth Hotel.

The convention incorporates the presentation of a widely ranging program of technical papers to be given each day during morning, afternoon and evening technical sessions. As well as contributed papers, many others have been especially invited from overseas authors and from leading Australian scientists and engineers.

Some 70 manufacturers and distributors of professional electronic components, equipment and systems will display their products in an enlarged exhibition area adjacent to the lecture rooms. More than 10,000 visitors are expected to inspect the wide variety of equipment on display and to see new items released for the first time in this country.

For the 1,500 delegates who are expected to attend the formal technical sessions, there will be a program of visits to interesting technical establishments and for their ladies a separate program of entertainments.

Highlighting the 1969 technical program will be papers to be given by:—

Dr F. E. Jones, M.B.E., F.R.S. managing director of Mullard Limited, London, who will present the guest address following the official opening declaration by Mr J. L. Knott, C.B.E., Director-General of Posts and Telegraphs.

Dr Henri Busignies, general technical director, International Telephone and Telegraph Corporation, New York.

Dr C. Lester Hogan, president, chief executive officer and a director of Fairchild Camera and Instrument Corporation, Mountain View, California.

Dr Thomas E. Charlton, director of engineering, Andrew Corporation, Orland Park, Illinois.

Messrs J. A. Greefkes and F. W. de Vrijer, Philips Research Laboratories, Eindhoven, Holland.

Mr G. Fugging, Wandel und Goltermann, Reutlingen, Western Germany.

Mr B. M. (John) Poole, Ampex International, Redwood City, California.

Professor J. D. Wilson, Royal Military College of Canada, Kingston, Ontario, Canada.

Mr A. Allen, M.B.E., Cossor Electronics Limited, Harlow, Essex, England, U.K.

Mr E. Wolfendale, deputy managing director, Racal Research Limited, Tewkesbury, England.

Mr P. L. Mothersole, Mullard Limited, Central Application Laboratory, Mitcham, England.

Mr D. A. Pay, The Marconi Company, Chelmsford, England.

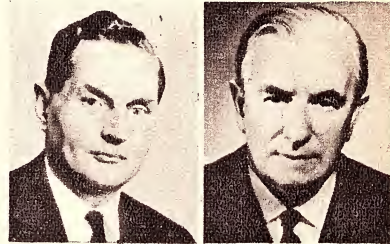

*Dr F. E. Jones (left) and Mr J. L. Knott.*

These overseas visitors will deal in their papers with subjects ranging from an assessment of the industry and the profession in the 1970s to the latest developments in propagation and communication, instrumentation and navigational aids, integrated circuits and computer applications. Particular emphasis will be focused on colour television topics.

Colour television will also be discussed by local authors headed by several from the Australian Broadcasting Control Board. Papers invited from Australian engineers and scientists include a group on electronics in mineralogy with speakers led by Professor G. H. Newstead and another group on satellite utilisation.

The sources of papers are widely varied and include representation from main industrial organisations eight universities, five divisions of C.S.I.R.O. and several divisions of the P.M.G.'s Department and the Weapons Research Establishment, the A.B.C., O.T.C., Department of Civil Aviation, the Commonwealth Acoustic Laboratories and the Department of Meteorology.

Persons wishing to attend as delegates to the convention and participate in the lectures and discussions who are not members of the institution may register on arrival at the convention, or may obtain registration forms from the head office or divisional offices of the Institution or by telephoning 27-1039 in Sydney. Upon registration delegates will receive a 220-page book containing substantial abstracts of all papers to be presented, as well as a directory containing descriptions of the products and equipment on display.

Entrance to the equipment displays will be by invitation card available from, all major organisations or direct from the Institution, 157 Gloucester Street, Sydney. The displays will be open to ticket-holders from 10 a.m. to 10 p.m. from Monday, May 19, through Thursday, May 22, and from 10 a.m. to 6 p.m. on Friday, May 23.

# U.K. TO CONTINENT CALLS IN

The private telephone exchange installed by Plessey in U.K. for British Petroleum's new 35-storey London headquarters building uses as many handsets as the City of Wollongong's public telephone network. The advanced features of the system include push-button dialling, direct connection to extension from outside, international dialling using only four digits and multi-phone conference facilities.

Basically, what was required was a 6,500 line private automatic branch exchange (PABX) and, as with any business firm installing new equipment, thought was given from the start to ways of reducing labour costs and overheads. It was felt that the most effective way of doing this was to reduce the number of operators to a minimum, and it was decided that this could be done in two ways:

1. By making the operation of the manual console as efficient and labour saving as possible.
2. By the use of automatic devices and push button handsets to transfer some of the operators' functions to the extension telephone users.

Since extension users would be dialling out directly, instead of going through the PABX operators, consideration was given as to how they could be assisted, in view of the fairly complex multi-digit numbers now in use in Britain's subscriber trunk dialling (STD) system. This has been achieved by using a memory device which stores information on a magnetic drum. Up to 3,000 of BP's most frequently required telephone numbers — local, national and international — are stored on the drum, and each of these numbers is allotted a combination in a four-digit code. A limited library of local, national and international numbers is also available to selected handsets on a two-digit code.

To make the system even more attractive for extension users, all handsets are of the push button type. This has resulted in a system which is fast and convenient. The extension user has only to punch out the code corresponding to the required number on his handset, and the drum recorder will carry out the full dialling routine rapidly and efficiently. The information required to dial the full number is read off from the magnetic drum by read-out heads. Provided the caller has not made an error in his four-digit code, the chances of obtaining a wrong number are virtually non-existent. This alone is expected to lead to a considerable economy through reduced wastage of abortive calls.

To assist an answering extension to give service to the caller, "operator re-call," "inquiry" and "transfer" facilities are provided. An extension can call in an operator while holding a call, and the operator can take over the call or retire from it after giving assistance. The "inquiry" facility allows an extension to make an inquiry call to another extension and then return to the original caller. If required, the call can then be transferred to another extension. The circuits are so designed that if

any mis-operation occurs during transfer and inquiry operations, the operator-recall conditions are automatically established.

Direct-dialling-in (DDI) facilities also lift a large part of the normal work load from the operators. DDI allows calls from the public telephone network to be routed direct to the desk telephone without the need for operator assistance. With DDI, a speedier flow of incoming traffic results and callers do not have to pay for time otherwise taken by operators to effect a connection, which can be a lengthy period if the required extension is busy. With the introduction of subscriber trunk dialling, this aspect of the system is an important one.

Extension handsets have direct access to exchange line, private wire, and inter-switchboard circuits. If a call is attempted when all the lines in a private wire group are busy, provision is made for the call to be automatically re-routed via the public network to the distant PABX.

The result of this "do it yourself" approach has meant that only nine ordinary operators and three inquiry operators are required to handle the 6,500-line system.

Each operator has a cordless type of console which is modern in style and pleasing to the eye, as well as being easier and speedier to operate than the cord type previously used. Operating keys are so positioned on the switchboard that two-handed operation is the normal pattern. Where practicable, push-button controls are employed. Lamp display units indicate lines which are busy and the number of calls waiting. There are special facilities to indicate the calls of specified senior executives.

Another facility available to operators is the so-called "trunk offer" key. This can be used if an operator finds an extension busy when routing a call, to advise the extension user that a caller is waiting. After announcing an incoming call, the operator sets a final selector to a "ring when free" condition, and is then free to deal with other calls. When the called extension's line becomes free, it is automatically acquired, and ringing is applied. The call is connected, without further assistance from the operator, when the extension answers. During the period that the operator is offering a call, a "warning" or "intrusion" tone is connected to the speech paths to ensure privacy. During the period between the time the operator retires from the connection and the called party answers the call, supervisory lamp indications are given to the operators so that the progress of the call can be followed.

On the more technical side a number of factors had



*General view of the telephone room in British Petroleum's new London headquarters, showing the nine console operators, the three inquiry operators and the supervisor's console.*

# FOUR SECONDS

## BP's unique 6,500-line PABX with a memory

to be considered in the design and also in the selection of equipment. It was decided to install "Strowger" type step-by-step switching equipment. Cost was one factor, and speed of installation and availability of the gear another. Generally however, the British phone network is "Strowger" in character, so using another switching medium would have meant the inclusion of signal conversion equipment at the PABX/public network interface.

A system employing crossbar or reed relay switching would have had a faster switching time on internal calls only.

The decision to include push-button hand sets was vital to the ultimate success of the operation. Firstly, they have made the "short code dialling" system through the memory drum a fast operation. Even for numbers not recorded on the drum they have achieved greater simplicity and ease of operation for the hand set user. National STD numbers carry ten digits, while international STD numbers up to an incredible 17 digits. Since such an increased work load has been transferred to the extension user, it is of great importance that the desk units provide minimal time consumption.

Other facilities along these lines included a system whereby incoming calls can be automatically re-routed if the extension user is absent.

For key executives there have been installed loud speaker/key call units, which provide for push-button connection of calls on up to 20 sets at the one time. This allows impromptu conferences to be held at any time, without prior organising.

The magnetic memory drum system is the first in use on a private exchange in Britain, although the British Post Office has had a similar system in its STD network for some time. There are actually two in the BP system and they share traffic on a random basis. The drums were supplied by the Sperry Gyroscope Company and use Plessey recording heads. There are 400 tracks on the 12in diameter recording surface of each drum. Each track is capable of storing 4,000 "bits" of information. Their operational speed is nominally 1,500rpm, which provides a "bit rate" or systems frequency of 100KHz.

The major parts of the drums are taken up with the permanent storing of selected numbers, as outlined earlier. Provision is also made to record details of all calls originating in the system for connection with the public network. Complete information on each call, ranging from the extension number, the type of call (STD, etc.), to the called number is recorded. This is known as Automatic Message Accounting. This information is only stored on the drum until the call is complete, when it is transferred to punched tape. This facility produces a fully documented record of all metred calls, simplifying departmental accounting and providing a simple analysis of frequently called numbers for updating the memory code.

The electronic equipment associated with the magnetic drums use bistable devices and diode logic for data processing. A range of some 50 standard circuit modules, each mounted on individual printed-wiring boards, caters for all systems requirements.

In the unlikely event of both drums failing, there is provision for switch over to 32 electro-mechanical registers to maintain a limited service.

In all, the Plessey designed and installed facility has produced some of the most significant advances in PABX since large-scale switchboard systems came into existence. By use of advanced electronic equipment and a careful study of private exchange requirements, a system has been developed that could become standard within a few years. ■



*The operators' consoles have push-button controls, arranged to allow two-handed operation. The keys in the bottom row are those most commonly used.*

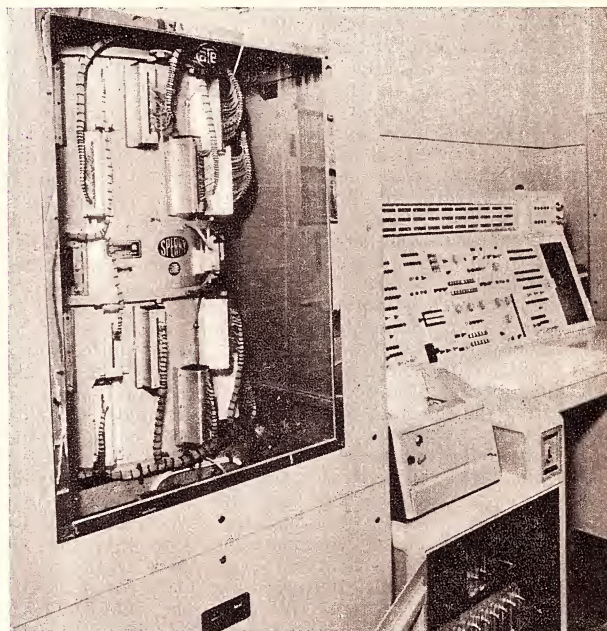

*The magnetic drum memory equipment (left) and the control console for the electronic equipment.*



*One of the push-button dialing handsets. Adjacent to the hand-piece are four auxiliary service push buttons offering additional facilities.*

# IBM's Sydney-based Shared Computer System

A new general purpose on-line shared computer service said to have been designed specifically for Australian data processing needs, has been opened in Sydney by IBM Australia Ltd.



An IBM 2741 communications terminal for System 360.

The system, which has been named Call/360, can accommodate 300 terminals from remote locations via telephone lines, to an IBM System/360 Model 50 located in the new IBM Data Centre in Rosebery, a Sydney suburb. The company says it marks a major step forward in the ease of operation and range of applications of typewriter-like terminals linked to a remote computer and its data banks.

The communications terminals which are used at the subscriber's premises (offices, factories, laboratories, hospitals, or even private homes) are virtually indistinguishable in appearance and operation from the IBM "golf ball" electric typewriters (so called because the type is contained entirely on the surface of a small metal ball). Learning to use Call/360 takes only about four hours.

At the other end of the line in Rosebery, five IBM systems analysts and operators maintain a round-the-clock supervision of the computer installations. However, customers can use the terminals only between the hours of 8 a.m. and 5 p.m., five days a week.

"Software" for the Call/360 system involves two quite different programs or program packages: MATH and DATATEXT.

MATH is a new and powerful pro-

blem-solving language, easy to learn, user-oriented and completely conversational. In its simplest form, it is a highly efficient desk calculator for day to day calculating requirements. Because of the concise nature of the language, MATH is also used extensively for one-time or infrequent problems requiring a larger degree of on-line computing. As programs can be stored indefinitely, MATH will also handle problems of a more repetitive nature by processing changing data against a previously stored program.

DATATEXT is an application package which has the ability to enter, to inquire into and to maintain a stored file of data. This data file can be in many differing forms: for example, technical specifications which are being constantly amended; a file of names and addresses which require updating on a continuing basis; standard letters or proposals which require changes from draft form until finalised for distribution; inventory files requiring updating; any other data for subsequent computer processing. DATATEXT can thus be used to add to, to delete from, or to change information stored on a remote computer under the control of a typewriter terminal in the user's office. At the same time, such a file of data can be printed on the typewriter terminal

or on a remote high-speed printer; or it may be used to update a file purely for continuing inquiry purposes or to enter data for subsequent processing on the computer.

The security aspects of the system have been fully considered. A terminal can be operated and access gained to confidential information stored in the computer's data banks only by authorised personnel with the right code. Additional security precautions can be incorporated into the code whenever required. The customer's code may appear on documents around the office. But just to type the code will not activate the computer, unless, when originally storing the code with the computer, the operator inserts a number of back-spacings on the typewriter.

At a recent function to introduce the new facility, Mr P. Holmes a Court, manager of IBM Data Services, said two aspects make Call/360 different from IBM time-sharing services operating overseas. "Firstly, it is a truly general purpose service," he said. "Secretaries, executives, programmers, engineers, architects, and clerks can use the typewriter to communicate with the computer. Wholesalers can use it for inventory and bookkeeping, statisticians to establish correlation factors, journalists and public relations consultants for correcting and automatical-

(Continued on page 189)

The System/360 Model 50 at the IBM Data Centre, Rosebery.

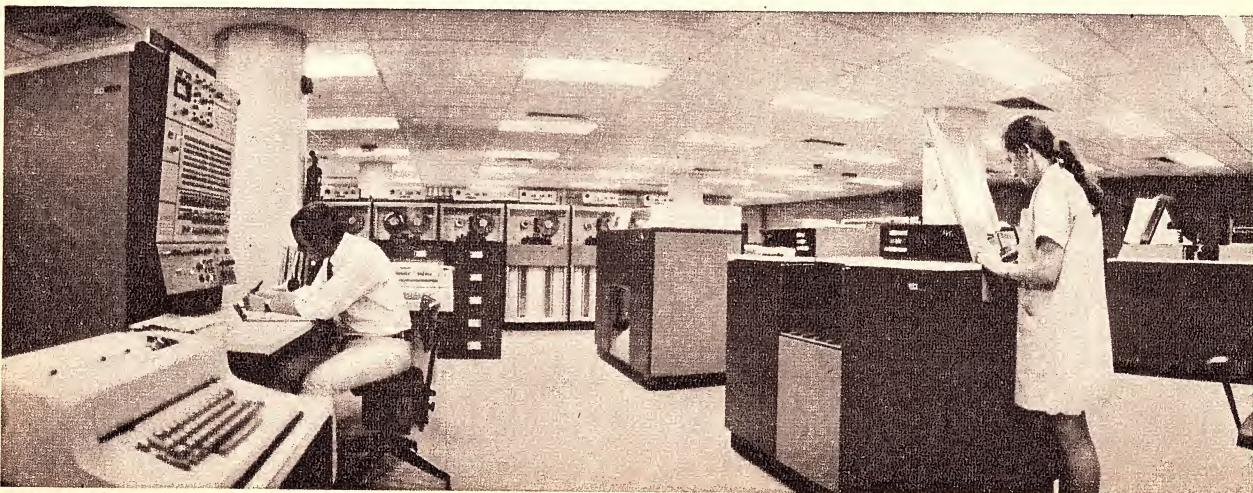

**CANBERRA ENQUIRIES FOR ENCEL EQUIPMENT**  
If you live in Canberra and you want further information on Encel equipment, please phone Canberra 81 1667.

**LOW PRICED CERAMIC CARTRIDGE FOR BUDGET CONSCIOUS MUSIC LOVERS!**

The popular Micro SC-301 cartridge has now been superseded by the new, improved Model SC303D. Only the price remains the same! Frequency response is 20-15,000 Hz. and tracking angle is 15°. With diamond stylus . . . inc. sales tax . . .

**\$6.90**

**WORN STYLII**

Worn stylus wreck records. A worn stylus in your cartridge can ruin your favourite records quite quickly. Regular inspection is a must. Encel's now have a stock of stylus inspectors which are priced at only (Incl. sales tax) . . .

**\$1.80**

**DEMAGNETISE YOUR TAPE HEADS AND IMPROVE TAPE PERFORMANCE!**

Simply plug the "Sonics" tape head demagnetiser into any AC power point and pass over the heads. Takes only five seconds and can make a world of difference. Single probe. Inc. sales tax . . .

**\$3.90**

**AKAI RECORDERS**

All AKAI models are now in stock . . . M9, XV, 4000D, X150D, X360, X300, 1710W and the X1800SD. Ask for your Encel price or a trade-in valuation. Sorry . . . we cannot advertise the low Encel prices!

**JUNCTION BOXES FOR HEADPHONES**

Add a headset to your amplifier even if it's not fitted with a headphone jack. Model JB3 junction boxes may be fitted in the speaker leads. Twin outlets. Inc. sales tax . . .

**\$4.50**

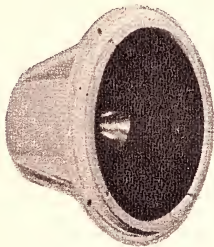

**NOW . . . A NEW 8" CO-AXIAL SPEAKER WITH UNIQUE PERFORMANCE AND SIX POWERFUL MAGNETS . . . ONLY \$34.50!**

Can any 8" speaker be worth \$34.50? Easily . . . when you see and hear the remarkable CX-20D. Here at last is a total-performance 8" co-axial speaker with six magnets, a horn type tweeter, an electrical crossover, high compliance and unusually robust ribbed construction. Total weight is almost 8 lbs. and frequency response is 35-20,000 Hz. The response curve is substantially flat; from an engineering viewpoint the CX-20D is superb in design and construction. The matching enclosure is easy to make and any handyman can make it from readily available materials. We want you to hear the CX-20D and make your own appraisal. It's tremendous value for money! Inc sales tax . . .

**\$34.50**

**FROM THE UNITED STATES . . . JANSZEN SPEAKER SYSTEMS WITH ELECTROSTATIC ELEMENTS**

The Janszen 2600 speaker system is revolutionary in design and construction and provides a magnificent "transparent" sound. Response is 30 to beyond 30,000 Hz. The natural treble response results from the use of Series 130 Janszen mid/high range radiators — electrostatic units with 176 push-pull sheathed conductors. The bass reproducer is the Janszen Model 350B dynamic. Impedance is 8 ohms only. Encel price is \$178 for the 2600 . . . and a variety of finishes is available. Truly an audiophile's delight. Ask for copies of elated reviews. Encel price (Including Sales Tax) . . .

**\$178**



**NEW SHIPMENT OF HIGH QUALITY, LOW PRICED COSMOS STEREO AMPLIFIERS**

Once more the popular Cosmos Model SW-300C stereo amplifiers are in stock. Output is 8 watts R.M.S. or 15 watts I.H.F.M. in each channel, all necessary control facilities are included and the price is only \$79.50. (IMPORTANT: The sensitivity of the Cosmos suits magnetic cartridges at 5 mV.) Provision is made for use of stereo headphones and a DIN socket permits connection of tape recorders. The pre-amplifier is fully transistorised. Speaker outputs allow for use of 4, 8 and 16 ohm. speakers or speaker systems. The Cosmos is ideal for use with tape recorders and tape decks. When used with high quality stereo pick-ups and wide range speaker systems, results are very satisfying. Encel price, inc.

**\$79.50**

**A NEW ENCEL STEREO SYSTEM FEATURING THE COSMOS STEREO AMPLIFIER—ONLY \$239!**  
We supply the Cosmos Model SW-300C stereo amplifier, the popular Compac III belt driven turntable, the Lustre Model CP-3 tone arm, your choice of a Shure or Micro stereo magnetic cartridge with a diamond stylus, an oiled teak base for the turntable and a matched pair of Sonics Model AS-61 speaker systems. Each enclosure houses four bass/mid-range speakers and a tweeter. Total Encel price inc. sales tax is only . . .

**\$239**



**MICRO DUST PICKUPS—\$3.50**

An effective automatic record cleaner which removes dust as the record plays. An ideal gift. \$3.50 inc. sales tax.



**SONICS STEREO 'PHONES—\$12.50**

Model HS-304 Sonics stereo headphones are very comfortable and offer fatigue free listening on a personal basis. Wide frequency response and remarkable stereo presence . . .

**\$12.50**

**SEE THE CELESTION RANGE!**

Both models of the Celestion 12" co-axial loudspeakers (the CX-1512 at \$44.50 and the CX-2012 at \$64.50) are very popular with audio enthusiasts. If you're looking for a compact speaker system be sure to hear the Celestion "Ditton 10" (\$59) and the "Ditton 15" (\$89). All Encel prices include sales tax.



**THE NEW LUSTRE MODEL ST-510 TONE ARM . . . TRACKS AT LESS THAN 1/2 GRAM . . . AND COSTS ONLY \$19!**

Orders for the new Nikka-Lustre Model ST-510 tone arm can now be filled immediately. Miniature ball races are used throughout, the head shell accepts all standard 1" mounting cartridges, finish is satin chrome and anodised aluminium. An outrigger bias adjustment is fitted and stylus pressure is adjusted with the counter balance weight. The Model ST-510D is fitted with a lifting/lowering device and costs \$24.50. The Model ST-510 (without lift), inc. sales tax is priced at . . .

**\$19**

**TRADE-IN AND TRADE-UP!**

When purchasing equipment from Encel Electronics, be sure to ask for a trade-in valuation on your old equipment. If your old equipment is in good working order, the cost of your current purchase can be reduced considerably. Bring in your amplifier, tape recorder, tone arm, etc. . . and save more than ever at Encel Stereo Centres!

**TAPE SPlicERS . . . ONLY \$2.50!**

We've just made a special purchase of tape splicers . . . and while the stock lasts this easy-to-use unit is priced at only \$2.50. Save time and fidgeting — and frayed nerves; order now!

**SEE A COMPLETE AUDIO RANGE AT ENCEL STEREO CENTRES!**

Apart from the many exclusive Encel lines, you'll find a vast range of high quality equipment at Encel stores in both Sydney and Melbourne. Here are a few of the manufacturers represented: Trio-Kenwood, KEF, Sony, ADC, Wharfedale, Ortofon, National, Toshiba, Shure, Akai, Sansui, Philips, Nivlco, BSR, Garrard, and many, many more. Be sure to get an Encel EMQ (Encel Mail Quote) . . . you'll save much more at Encel Electronics!

**LOOKING FOR LOWTHER LOUDSPEAKERS?**

Models PM6 and PM7 are now in stock at Encel Electronics. Both are fine performers — and cabinet specifications are available to suit both speakers. Encel's low prices cannot be advertised — call for your personal Lowther price!



**CP3 TONE ARMS IN STOCK AGAIN**

Because of the popularity of the CP3 arm, we've been obliged to re-order. Price has been reduced to only \$17.50, or \$22.50 with the lifting/lowering device. Order now! Limited stocks. Inc. sales tax . . .

**\$17.50**

**SPECIAL SLASHED PRICES ON SHURE CARTRIDGES**

If you're waiting to buy a new Shure cartridge be sure to get Encel's bargain basement price before you make your purchase. We are not at liberty to advertise our new low prices.



**SOUND MODEL SAQ-203 SOLID STATE STEREO AMPLIFIER**

Frequency response is 30-20,000 Hz. and input sensitivity suits magnetic cartridges at 3 mV. Output is 12 watts R.M.S. or 30 watts E.I.A. peak power. 18 low noise transistors. Headphone jack, all necessary controls, attractive front control panel. Speaker matching for 4, 8 and 16 ohm. speakers or speaker systems. An ideal compact amplifier for use with tape recorders or for building into cabinets and bookshelves. Inc. sales tax . . .

**\$74.50**



**SOUND MODEL SAQ-505X SOLID STATE STEREO AMPLIFIER**

With an output of 25 watts R.M.S. into 8 ohm. speaker systems, the 505X represents outstanding value for money. Frequency response is 20-20,000 Hz. plus or minus 1 dB, and extends well beyond this range. Sensitivity is 3 mV. for magnetic cartridges and all desirable control facilities are incorporated. This powerful amplifier is bargain priced by Encel Electronics at only . . .

**\$119.50**

**ENCCEL**  
**ELECTRONICS (STEREO)**  
**PTY. LTD.**

Head Office:

431 Bridge Rd., Richmond, Victoria 3121. Tel. 42 3762.

Sydney Store: Ground Floor, 2SM Building,

257 Clarence Street, Sydney, N.S.W. 2000. Tel. 29 4563, 29 4564.

Australia's Greatest Hi-Fi Centre \*Wholesalers \*Trade-ins accepted

a new approach to  
 low cost, high  
 performance power  
 control for domestic  
 electrical equipment

Although widely used in professional and industrial equipment to provide reliable, efficient and silent control of power, cost considerations have prevented the general use of thyristors for domestic applications.

Now as the result of a breakthrough in thyristor design the Miniwatt BT100A with its outstanding performance and reliability makes 240

volt mains control for household and light industrial appliances a practical and economic proposition. The BT100A is sturdily constructed, easily mounted and is designed for a hard life in such applications as:

- motor speed controls
- light level controls
- temperature controls
- voltage conversion
- alarm systems

**Quick Reference Data**

Repetitive peak reverse voltage . . . . .	max. 500 V.
Average forward current . . . . .	max. 2 A.
Storage temperature . . . . .	-40 . . . + 100°C
Voltage: to trigger all devices . . . . .	> 2 V
Current: to trigger all devices . . . . .	> 10 mA

# new low cost Thyristor BT100A

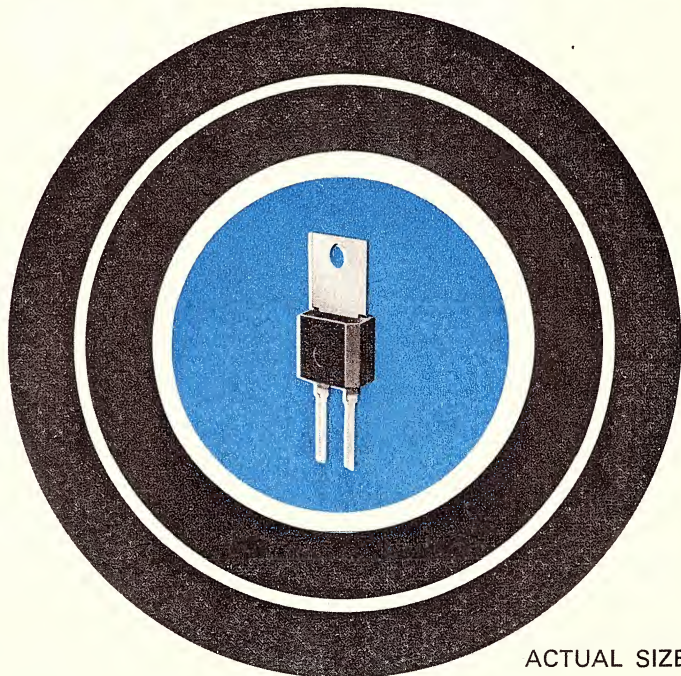

ACTUAL SIZE

For detailed data and Application Information contact

*"Miniwatt"*

ELECTRONICS DIVISION OF PHILIPS  
 ELECTRICAL PTY. LIMITED



Sydney • Melbourne • Adelaide  
 • Perth • Canberra • Brisbane.

# NEW WORDS BY THE THOUSAND

It is said that more new words have entered the vocabulary of the English language in the past 50 years than in the preceding 900 years. Of the hundreds of new words which come into being each year, a large majority are of technical origin.

by Thomas E. Long

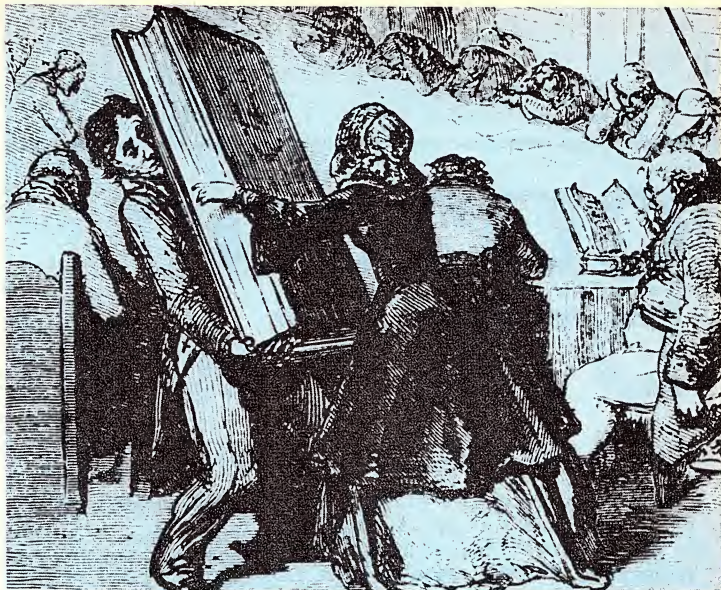

This etching, dating from the mid-nineteenth century, shows an outsize dictionary in a Paris library as a result of the "word explosion" brought about by the Industrial Revolution.

The combination of advances in technology and the communications media has wrought a greater change in the lexicon of the English language in the past 25 years than in any similar period in its past history. However, the influence of science on language is not new. As early as the sixteenth century, scientific words that are now part of the common vocabulary, such as **skeleton** and **smallpox**, were being introduced. The process has continued since, at an accelerated pace. What distinguishes the present century is not only the enormous number of technical terms being created but also the rapidity with which these terms are made available to the average speaker as part of the general vocabulary. **Antihistamine**, **LSD**, **laser**, **digital computer**, **cryogenics**, **phenacetin**, **Rh factor**, **ICBM**, and **stereophonic** are good examples.

Although the average person might not be able to define all of these words precisely, each term is probably known to him. With the possible exception of **phenacetin** (also known as **acetophenetidin**—one or the other appeared until recently on almost every bottle of patent aspirin combinations), none of these words existed 25 years ago.

Though linguists still do not fully understand the means by which new words are brought into a language, the major role that technological culture is now performing in this process is unmistakable. It is difficult to predict which of the newly created technical words will become as assimilated by the general vocabulary as have **skeleton** and **oxygen**. But it is certain that a large number of them are already on the way "in."

There are, however, indications as to the acceptance of words. For example, if the hypothetical average person were challenged on his use of certain words, his response would give an indication of what degrees, from the basic to the very specialised, exist in the English vocabulary, and how the central core of the language is being changed and increased. If accused of misusing **tree** or **hat**, he would probably not take it seriously at all. He is absolutely confident of the meaning of these words that have been in general use since Anglo-Saxon times. If he were accused of misusing **stereophonic** or **LSD**, he might be a little more hesitant but still ready to argue. If his use of **cryogenics** were questioned, he might admit, right away, that he was open to correction. His feeling of confidence and familiarity with such words is a clue as to where they lie in respect to the core vocabulary.

None of the words such as **antihistamine**, **LSD**, **laser**, and others cited at the beginning of this article is ever likely to be a part of the general vocabulary in the same way as **tree** or **hat**. But it is still too early to say how far some of them will advance along the road of popularisa-

tion. Widely used terms like **eliminate**, **acid test**, **potential**, and **ultimate analysis** were originally technical and limited to the vocabulary of chemistry and physics. And **by** and **under way** came into general use from the specialised language of sailors. It is safe to assume that many of the new words will undergo a similar development and become what Fowler's "Modern English Usage" labels "popularised technicalities." It is also probable that they will be popularised quickly, since many are creations of the typically modern fields of nuclear physics, space science, and electronics — highly publicised disciplines that have a pervasive influence on modern life.

Though the student of language cannot accurately predict which of the new terms will prove to have staying power in the vocabulary, he does know the methods by which they will be created. There are three general possibilities for creating technical terms: extend the meaning of existing words; borrow words from other languages; and coin new words from resources already existing in the language.

The first possibility — old words whose meanings are being extended or changed — is the most difficult to analyse. As cultural and social contexts change, so do the associations of old words. Certain meanings become dominant, sometimes to the extent of cancelling other meanings. A list of these words might include: **jet**, **missile**, **film**, **cart-ridge**, **probe**, **program** (verb), **bug**, **tape**, **space**, and **channel**.

The pressure of the technological associations has not completely changed the older meanings of any of these words, but it is easy to see what influences are at work. It is doubtful that even a young schoolboy, if asked to give an example of the word **missile**, would write "snowball." Similarly with **jet** — which in its most frequent current use has been boiled down from **jet-propelled** — it is evident from the readiness with which it combines with other words in certain phrases (**jetport**, **jet set**) that its aeronautical meaning is highly active. The verb **program** has been around for a long time, but the context in which it is now used — in popular journalism, for instance — seems always to be that of computer technology. As for **space**, it is most unlikely that the average person, if asked to write down his first association, would ever write "roominess." In the unlikely event he had never heard of an astronaut, the spaceships of the comics and science fiction have been around too long not to exert a powerful influence on his choice. These shifts in meaning suggest the lively relationship that exists between technical usage and established words.

The second method, borrowing whole words from foreign languages, is characteristic of earlier periods of science, not of twentieth-century technology. This is true primarily because the linguistic orientation of the technology of today is definitely English.

In the past, Latin and Greek have always been the

# CD2300 DTL Family

direct replacements for 830 and 930 series

45 types / 3 package styles /  
2 Temperature Ranges/Gates  
/ Expanders / Flip-Flops /  
Inverters / 2K  $\Omega$  and 6K  $\Omega$   
Output Pull-Up Options

• For your Military Applications:

CD2300 Series — 15 circuits in  
RCA's Unique Ceramic Flat Package.  
CD2300D Series — 15 circuits in  
RCA's Unique Ceramic Dual In-Line  
Package.

• For Industrial and Commercial  
Applications:

CD2300E Series — 15 circuits in  
RCA's Dual In-Line Silicone Pack-  
age.

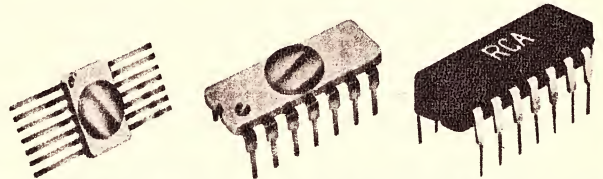

Circuit and Pull-up Option	-55°C to +125°C Operation		0°C to +75°C Operation
	14-Lead Ceramic Flat Pack	14-Lead Ceramic Dual In-Line Package	14-Lead Dual In-Line Silicone Package
<b>NAND Gates</b>			
Dual-4 Expandable (6K $\Omega$ )	CD2300/930	CD2300D/930	CD2300E/830
Dual-4 Expandable (2K $\Omega$ )	CD2301/961	CD2301D/961	CD2301E/861
Dual-4 High Fanout, Expandable (transistor output pull-up)	CD2306/932	CD2306D/932	CD2306E/832
Dual-4 High Fanout Expandable (no output pull-up)	CD2307/944	CD2307D/944	CD2307E/844
Triple-3 Input (6K $\Omega$ )	CD2308/962	CD2308D/962	CD2308E/862
Triple-3 Input (2K $\Omega$ )	CD2309/963	CD2309D/963	CD2309E/863
Quadruple-2 Input (6K $\Omega$ )	CD2302/946	CD2302D/946	CD2302E/846
Quadruple-2 Input (2K $\Omega$ )	CD2303/949	CD2303D/949	CD2303E/849
<b>Hex Inverters</b>			
Diode Input (6K $\Omega$ )	CD2310/936	CD2310D/936	CD2310E/836
Diode Input (2K $\Omega$ )	CD2311/937	CD2311D/937	CD2311E/837
Expandable Input (6K $\Omega$ )	CD2312	CD2312D	CD2312E
Expandable Input (2K $\Omega$ )	CD2313	CD2313D	CD2313E
<b>Flip-Flops</b>			
Clocked RS with JK Capability (6K $\Omega$ )	CD2304/945	CD2304D/945	CD2304E/845
Clocked RS with JK Capability (2K $\Omega$ )	CD2305/948	CD2305D/948	CD2305E/848
<b>Input Expander</b>			
Dual 4-diode	CD2314/933	CD2314D/833	CD2314E/833

Complete information on the range of RCA integrated circuits available from A.W.V. is covered in the Integrated Circuit Product Guide which is available post free on request.



**AMALGAMATED WIRELESS VALVE CO. PTY. LTD.**

PRIVATE MAIL BAG, P.O. ERMINGTON 2115 OR INTERSTATE OFFICES.



primary sources for borrowings, as, for example, in the eighteenth century, the age of Linnaeus and of the great descriptive systems and classifications in botany and zoology. However, few of these learned borrowings have ever moved into any kind of general use. Because their meanings are not self-evident to the average English speaker, they have on the whole maintained the technical senses for which they were originally needed, and their meanings have not undergone the adulteration typical of "popularised technicalities."

A few of the more familiar classical borrowings are *genus*, *habitat*, *saliva*, *bacillus*, and *quantum*, all from Latin, and *cotyledon*, *thorax*, *pneumonia*, *iris*, and *psyche*, from Greek. If a complete list of such borrowings were drawn up, there would, of course, be a huge number of words with which any educated layman would be perfectly familiar. However, very few of these are of recent technological vintage; most are older terms from such fields as medicine, biology, and mathematics. Moreover, in words that English has borrowed from modern foreign languages, it is often found that, like the French "helicoptere," it is a coinage involving elements that could have as easily been put together in English. It is only in the narrowest sense that these words could be called French or German. Thus *vitamin* was, strictly speaking, borrowed from German, but was initially coined from classical elements — Latin *vita* ("life") plus *amine*—that have nothing peculiarly German about them.

**Thermometer** was coined originally as a seventeenth-century French word, "thermometre." But only a few years later, it had gained the status of a technical word in English, with its Greek elements intact, but with no traces of its French origin. This stateless, cosmopolitan quality is characteristic of so many technical words that it is superficial to consider them merely as foreign borrowings. Rather, they occupy a middle position between true foreign borrowings, like *chassis* or *coupe*, and words coined in English from elements originally non-English, like *cyclotron*.

**Cyclotron** is an example of the final heading — the creation of new words from resources already existing in the language. *Cyclo* and *tron* are what linguists call combining forms. Though they are learned and foreign in origin, they are illustrative of the elements that the English language freely adapts in compounding, one of its most characteristic methods of forming words. At present, vast numbers of technical terms are entering the language as compounds. The most common of these may be roughly divided into two types: those like *cyclotron* or *television*, which are composed of combining forms that are available or well-established in English though not of English origin, and those like *feedback* or *fibreglass*, made by joining words that, in isolation, do not have technical meanings. Some examples of the first type are: *automobile*, *astronaut*, *insecticide*, *osophone*, *telephone*, *antibiotic*, *television*, *supersonic*, and *vinyl*.

With the exception of *osophone*, all of these are familiar to the layman. *Automobile*, surprisingly, is a word, like *helicopter*, originally compounded in French. It also illustrates a type of compound that purists once referred to as "barbaric" — the kind having elements from two or more languages. From this extreme point of view, *telephone* (Greek *tele-* plus Greek *phone*) is acceptable but *television* (*tele* plus Latin *visio*) is not. (A satisfactory all-Greek compound for a television set could be made up — *teleopticon* would do — but would probably lose the adaptability that *television* has shown in producing other forms like *televise*.)

Of the three terms *aquaplane*, *seaplane*, and *hydroplane*, the purist is willing to admit only the last, a Greek-plus-Greek compound. This view is, of course, pedantic and leads to absurdities. But it is less in evidence nowadays than it formerly was, perhaps because a knowledge of Latin and Greek is no longer considered the basic requirement of a good education.

The second type of compounding is deceptive because it involves technical and sometimes highly specialised terms that are produced by juxtaposing non-technical words with obvious meanings. Examples are: *waterproof*, *airtight*, *take-off*, *throughway*, *underpass*, *fibreglass*, *countdown*, *input*, *output*, and *feedback*. These terms offer a convenient shorthand in naming processes, states, structures, and so forth that are often highly complex. The simple juxtaposition of the elements, which obscures the usual indications that English gives as to part of speech, number, and modifiers, is perhaps a sign that the language is becoming more analy-



One of the earliest surviving books linking science and language—a hand-written botanical dictionary in Latin dating from the fifteenth century.

tical and less inflectional. In short, it is becoming more like Chinese which does not indicate grammatical relationships by declensions, conjugations and singular and plural endings, and less like German, which makes heavy use of these inflectional endings.

A number of technical terms are being created as acronyms, blends, and portmanteau words. An acronym—itsself a technical term coined in 1944—is literally a "peak-name," a word that is pronounced as a word and composed of the initial letters or syllables (the "peaks") of other words. Acronyms were first popular as names for governmental and military agencies and offices during World War II. They have also been used by commercial organisations, a widely known one being Nabisco (National Biscuit Company).

Strictly speaking, acronyms should be pronounceable, like NATO and not merely abbreviations, like WPA, or some sort of in-between creature like STOL or VTOL in both of which the first letter is pronounced as a letter and the rest as a word. They have proved of use in technical vocabularies for the obvious reason that they conveniently condense often unwieldy phrases, as *radar* (radio detecting and ranging), *sonar* (sound navigation ranging), *scuba* (self-contained underwater breathing apparatus), and *napalm* (naphthene palmitate).

Closely related to acronyms are blends and portmanteau words that combine two or more words into a new whole, as *smog* from *smoke* and *fog*. Like puns, these words have been favourite devices of humourists, a famous instance being Lewis Carroll's blending of suggestive sounds in the verses of "Jabberwocky" ("Twas brillig, and the slithy toves/Did gyre and gimble in the wabe . . .). Carroll's poem, in fact, gives a clue to one requirement for a blend; whatever emerges, it must sound to English-conditioned ears the way a word ought to sound, and the sounds must occur in an order normal to the language. *Quasar* (quasi-stellar radio source), *transceiver* (transmitter

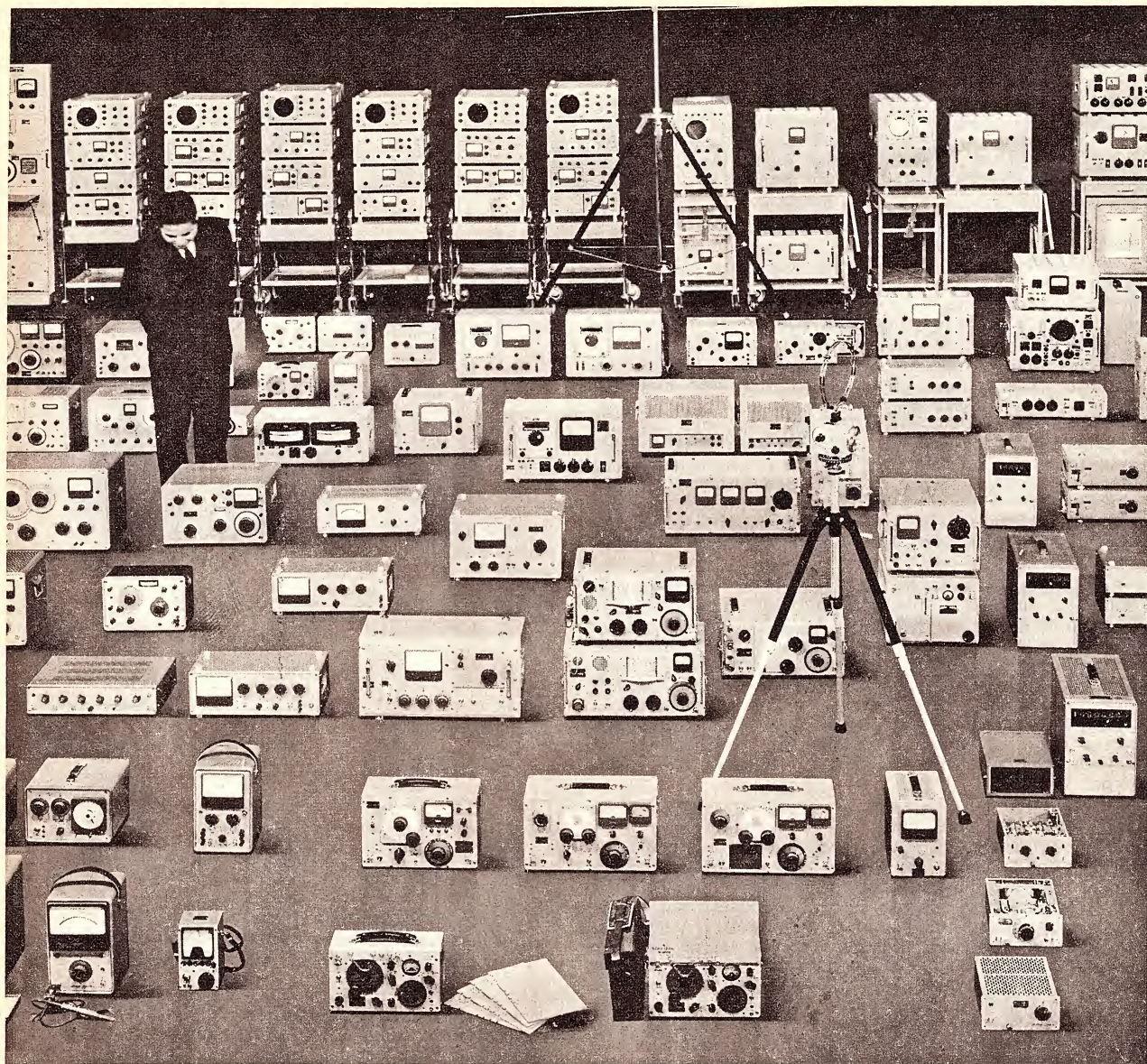

# Now locally available: Whole Varieties of Proven-Quality Measuring Instruments from Anritsu Electric

Anritsu Electric, Tokyo, Japan have appointed Watson Victor Ltd. an exclusive agent for Australia and Territory of Papua and New Guinea.

For full details and servicing on Anritsu Measuring Instruments, please contact your nearest Watson Victor office.

⑥ Watson Victor Ltd.  
155 Tynte Street,  
North Adelaide, S.A.,  
5006, Australia.

⑦ Watson Victor Ltd.  
893 Stanley Street,  
East Brisbane, QLD.  
4169, Australia.  
Phone: 91-4441

⑧ Watson Victor Ltd.  
201 Victoria Parade,  
Collingwood, Victoria  
3066, Australia.  
Phone: 419-1588

① Postal Address:  
P.O. Box 8 North  
Adelaide, S.A., 5006  
Phone: 67-3011

④ Watson Victor Ltd.  
1122 Hay Street, West  
Perth, W.A. 6005, Australia.  
Phone: 21-8021



② Postal Address:  
P.O. Box 100, North  
Ryde N.S.W. 2113  
Phone: 88-6188

③ Watson Victor Ltd.  
261 Elizabeth Street,  
Hobart, Tasmania,  
7000 Phone: 34-2255

⑤ Watson Victor Ltd.  
95-99 Epping Road, North  
Ryde, N.S.W., 2113, Australia

 **Anritsu Electric Co., Ltd.**  
12-20, Minami-Azabu, 4-chome, Minato-ku, Tokyo, Japan



**WATSON VICTOR LTD.**

# 1969 I.E.A.C.C. SHOW—MELBOURNE

receiver, and bit (binary digit are three examples of useful technical blends.

Occasionally, blending causes confusion in the etymological elements of the word. Thus, **triphibious** (tri-plus **amphibious**) obscures the fact that in the model word, **amphibious**, the correct division is **amphi-** (Greek for "both") and **-bious** ("life"), not **amplu-** **phibious**. Looked at in this way, **triphibious** is related to a number of words that have been formed on the basis of false analogy. The derivatives of hamburger — cheeseburger, beefburger, and chilliburger—are perhaps the most famous examples. They became possible because of the mistaken analysis of hamburger as ham plus burger instead of (as is correct) Hamburg (the city) plus -er, the same suffix as in New Yorker.

Some technical words often take the form of shortenings of longer words (**stereo**, **audio**, **strobe**, **intercom**, **Moho**) or back formations (**televise**, **destruct**). Sometimes they are onomatopoeic (**tweeter**, **woofer**, **growler**, **flip-flop**), though these seem to be fewer of late. They can be based on proper names (**hertz**, **mach**, **tesla**, and **baud**, which is actually a shortening of the proper name Baudot). They may be arbitrary or seemingly arbitrary coinages (**Kodak**, **nylon**, **chad**). All of these examples are representative of the ordinary means by which English increases its stock of words.

However, there is a need for even more new words to keep pace with the advances in modern technology. This need is shown by the abundance and variety of words created by analogy. An analogical formation is a word created on the model of another word. From the model **automat** — a shortening of **automaton** — a number of analogical formulations are constructed, such as **laundromat**, **dialomat**, **gasomat**, **vendomat**, and **sodamat**. In science **electron** has served as the model for one series of **-on** words, the end of which is not in sight. Some of these are **proton**, **neutron**, **meson**, **baryon**, **lepton**, **fermion**, and **boson**. In another set of **-on** words, most likely modelled on **rayon**, the ending has come to denote "synthetic fabric" (**nylon**, **Dacron**, **Orlon**). And there are other groups in which the value of **-on** changes to indicate gases (**neon**) or vacuum tubes (**klystron**). Similar series have developed for **-tron** words (**cyclotron**, **bevatron**, **betatron**). Often, it is difficult to say precisely which word is the model for these long series of technical terms formed by analogy.

Whatever the model, however, certain words that have been developed by this means often seem to be monstrosities, as far as normal English prose style is concerned. Thus, **fadeometer**, **densitometer**, **intensitometer**, **absorptiometer**, and **optical interferometer** are derived from the highly fertile **-meter** model. With **resistance** as the probable technical model, there are such creations as **absorptance**, **capacitance**, **elastance**, **inertance**, **reactance**, and **leakance**.

The danger here is that such words easily become true barbarisms if they are generally adopted and their technical meanings distorted or lost, as is often the case. A student of the future, for instance, may use **leakance** for **leakage** because he thinks it gives his

The 1969 International Instruments, Electronics, Automation, Control Equipment and Communications Show will be held at the Exhibition Buildings, Melbourne, from May 26 to 30, 1969.

More than 240 companies will be exhibiting in conjunction with nominated exhibiting firms. A conference entitled "Electronics in Industry" is to be held at the Southern Cross Hotel on the 28th and 29th May, and has been designed for senior, non-technical executives in industry. The subjects to be covered include instrumentation, fluidics, computerisation, and communications.

One of the interesting items on display in the exhibition will be the Unitutor, described as a "universal adaptive teaching machine." This teaches by sight and sound, by means of 35mm film strip and pre-recorded four-track magnetic sound tape. The sound tape provides up to two hours of audio, and the 35mm film can have as many as 1,200 frames.

The visual information is presented on a ground glass screen by back projection. In front of the screen is a keyboard which the student uses to punch out his selection from a series of preset questions, or his own answers.

For free choice responses, the tests are designed so that the first two or three symbols punched into the keyboard will indicate whether the answer is correct or not.

The keyboard has "A" to "Z" and "1" to "9" keys, and in addition there is a row of unmarked keys above the others. The inputs from these keys vary from frame to frame, and their functions are shown by symbols carried on the lesson segment frame. In a driving lesson, for

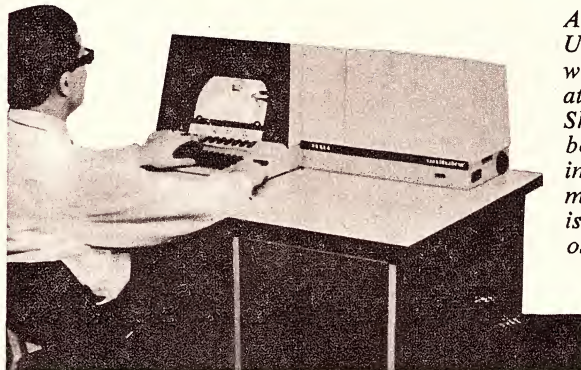

*A model of the Unitutor, which will be displayed at the I.E.A.C.C. Show, in Melbourne, by the importers, Charmac Pty. Ltd., It is made in Czechoslovakia by Tesla.*

example, these keys might indicate trucks, buses or cars. For mathematical instruction, they could stand for such operations as taking integrals, squaring or multiplying.

For particularly slow learners, there is a key marked "?". When this is pressed, the machine backtracks to a spot where basics are introduced and takes the student through the lesson again.

The Prague School of Economics has prepared a number of programs for the Unitutor, including mathematics, bookkeeping, automobile driving, mechanics and foreign languages. Programs can be worked out for virtually all fields of learning, in schools, universities, industry, commerce, military, and so on.

Lessons are presented in segments (frames). After each lesson segment, the student punches into a keyboard his answers to a series of questions on the matter he has just learned. The inputs are then compared to signals generated by the optical code for the frame. Co-incidence circuits determine whether the answer and check inputs match, and develop logic zero or logic one outputs. These logic outputs are the source of command signals which step the film and tape either forward to the next segment or backwards to the beginning of the previous segment for repetition. When a student makes an incorrect response, a red light flashes on the front panel to advise the student that he has to repeat the segment.

Branching — backtracking when a student has not understood, or moving ahead when he has — is provided in both the audio and visual channels. A 30-bit optical code is used to signal the film frame information to the control circuitry. For audio, two of the tracks on the tape are assigned to control markings, with one track for each direction.

writing a more authoritative or "scientific" ring. To cite actual classroom instances, freshmen sometimes use the "scientific" word **analyzation** when all they mean is **analysis**.

The need for new technical terms will multiply in a world in which man's store of knowledge doubles every de-

cade or less. Even now, the rapid advance of technology is being reflected in the English language. As a result, both the professional and layman, who also is bound to encounter many of the new terms, may be helped by knowing the variety of ways that English has for enlarging itself. ■

**D**ESPITE the initial reservations felt by many people, particularly with reference to servicing, the printed circuit is now firmly established in most types of electronic equipment, ranging from the incredibly cheap pocket radios that have flooded the country in recent years, to some of the most sophisticated professional equipment available. Its origins lie in weaponry — a heritage unfortunately common to many good "electronic" ideas, but printed circuitry is, and indeed has been for some time, an attractive system for the amateur who constructs his own equipment, for it solves the mechanical problems of component mounting and eliminates the chores of wiring — as well as facilitating a neat and workmanlike job. For the amateur who has so far shied away from etching his own boards, a new system is now available, which is both economical and easy to use, yet with care, is capable of excellent results. Known as Cir-kit, the system utilises bakelite boards, similar to those used commercially, in conjunction with self-adhesive copper strip. This is 1/16in or 1/8in wide — easily cut with scissors or a model knife — and attaches to the boards rather like a piece of Sellotape. The adhesive is very efficient, although the bond is not quite as good as that on pre-laminated boards — which means that care is needed when soldering not to overheat the copper. However, anyone who is competent to solder a transistor or capacitor without causing damage should have no trouble, and the adhesive improves with aging, so that long-term stability is satisfactory. Layouts can normally be planned using the theoretical circuit diagram as a guide, and boards may be pre-punched or drilled according to requirements. With the pre-punched board, the strip can either be laid over the holes, and then punched through with a small drill or a watchmaker's screwdriver, or it can be laid alongside the holes and component leads are inserted through the board, folded over and soldered (see photo). The former method permits a more compact layout.

A few tips on planning layouts. Always be sure that the component spaces you allocate are adequate — it is preferable to purchase the bits before embarking on this task, although capacitors are available in literally dozens of shapes for board mounting and resistors are more or less of standard size, dependent on ratings. Avoid siting adjacently on to your layout components which are in different stages — as this can lead to instability. If instability does occur, of course, Cir-kit does permit alterations to be made, although it is as well to investigate the problem before redesigning sections of the board for it may not prove necessary.

The excellence of the system, however, lies in its versatility, for it enables the home constructor to produce a wiring board on a one-off basis for most of the circuits described in this and other journals, and while it will no doubt encourage many to "try their hand," it will also enable many who already build their own equipment to achieve neater, more reliable results with a minimum of fuss.

**AVAILABLE ALL LEADING  
RADIO HOUSES.**

(SOLE AGENT)



**ZEPHYR PRODUCTS PTY. LTD.**  
70 BATESFORD ROAD, CHADSTONE, VICTORIA—PHONE 56-7231  
MANUFACTURERS OF RADIO & ELECTRICAL EQUIPMENT & COMPONENTS

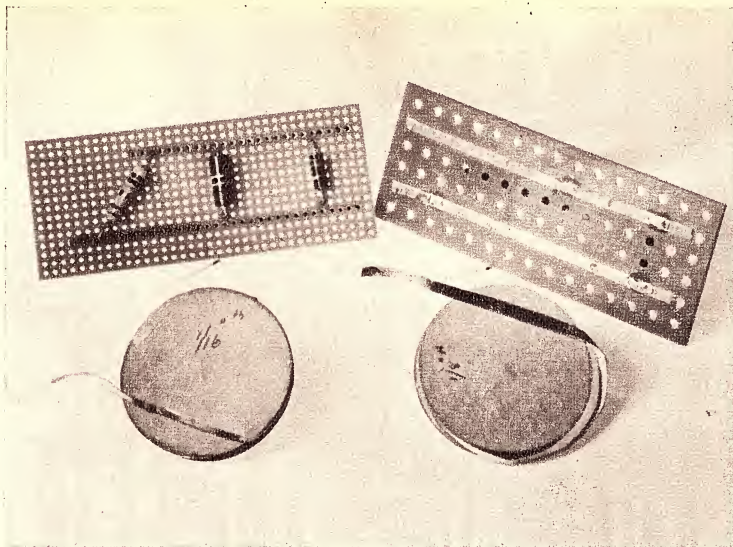

# INSTANT CIRCUITS

**A new method of making component boards  
using self-adhesive copper strip.**

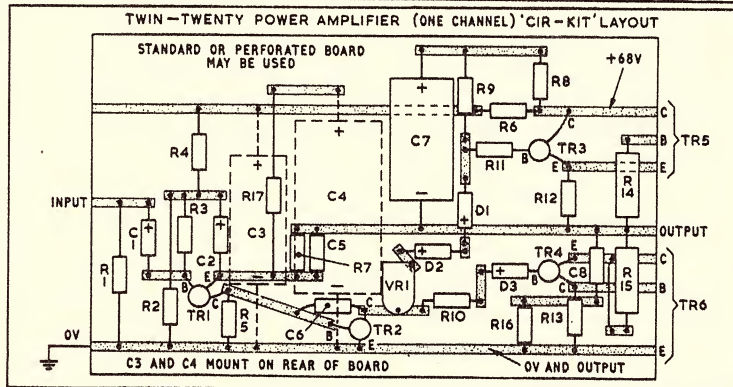
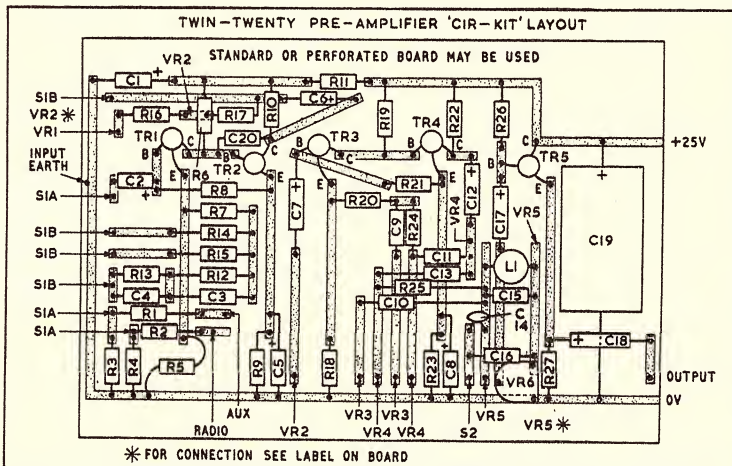

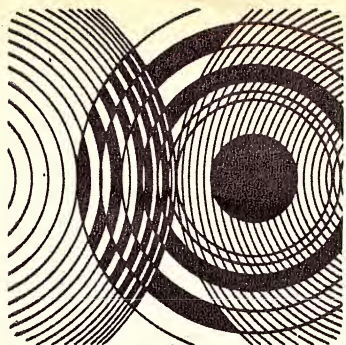

# TECHNICAL DIGEST

## Instant Warm-up TV Picture Tube

Sylvania Electronic Products Inc., of U.S.A., has designed a new directly heated cathode for TV tubes that approaches the "instant warm-up" characteristics of modern solid state receivers.

The cathode requires so little power that it can be driven by a simple link to the horizontal yoke current. The construction of the cathode is shown in figure 1. The mounting is designed to give maximum thermal isolation from the cathode. The ceramic support is also carefully designed to act as a thermal sink for the cathode support structure. This maintains a relatively uniform thermal gradient along the length of the cathode ribbon. This is very important for long mechanical life of the cathode.

The cathode itself is a ribbon with an oxide coated button at its centre. Since power input requirements are proportional to the mass of the button, the button area is kept to a minimum. Sylvania evaluated the instant warm-up cathode in a monochrome tube and

came up with some remarkable results. Warm-up time, measured in terms of a visible raster, was as little as 1½ to 2 seconds. The test tubes did not show any microphonic properties, nor did severe shock appear to change electrical characteristics. Emission levels were satisfactory with maximum currents in the region of 1mA.

The low power requirements (0.5V at 0.8A) enabled the designers to experiment with unusual sources of power. In a conventional arrangement a portion of the DC power supply load current could provide the necessary heater current. But this approach would rule out use of the heater as the element by which the video signals are applied to the picture tube. This important feature can be retained if the heater is driven by means

of a transformer in the yoke circuit, as shown in figure 2.

In this circuit, a half-inch diameter ferrite toroid is used as a one-turn transformer. The primary is the ground return lead. The secondary is formed by passing the heater lead from the picture-tube socket through the core and connecting it to the other heater contact.

The result is a very low impedance source for powering the heater.

The toroidal transformer adds a minimum of capacitance to the video circuit, thus requiring no modification of the output stage peaking components. The low-impedance source is capable of supplying the higher-than-rated current needed when the cathode is cold. Measured warm-up time of the picture tube using this circuit was less than two seconds.

Although it is not available as an "off the shelf" item, the new instant warm-up cathode is definitely out of the experimental stage, and Sylvania engineers are ready to discuss designing it into picture tubes. (Sylvania "Ideas" feature in "Electronics," 6/1/69.)

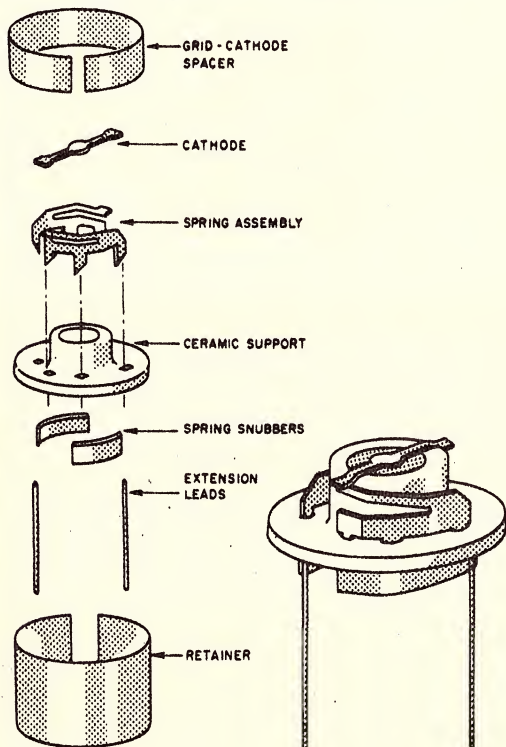

Figure 1

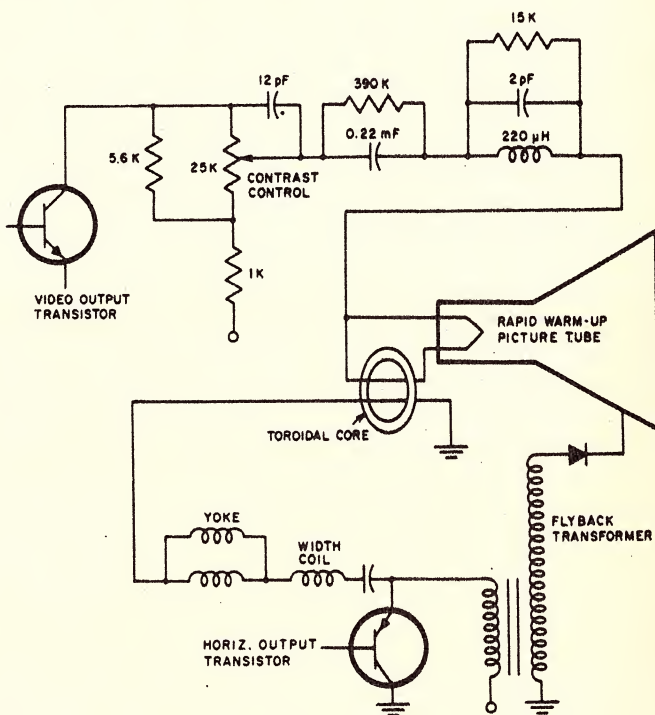
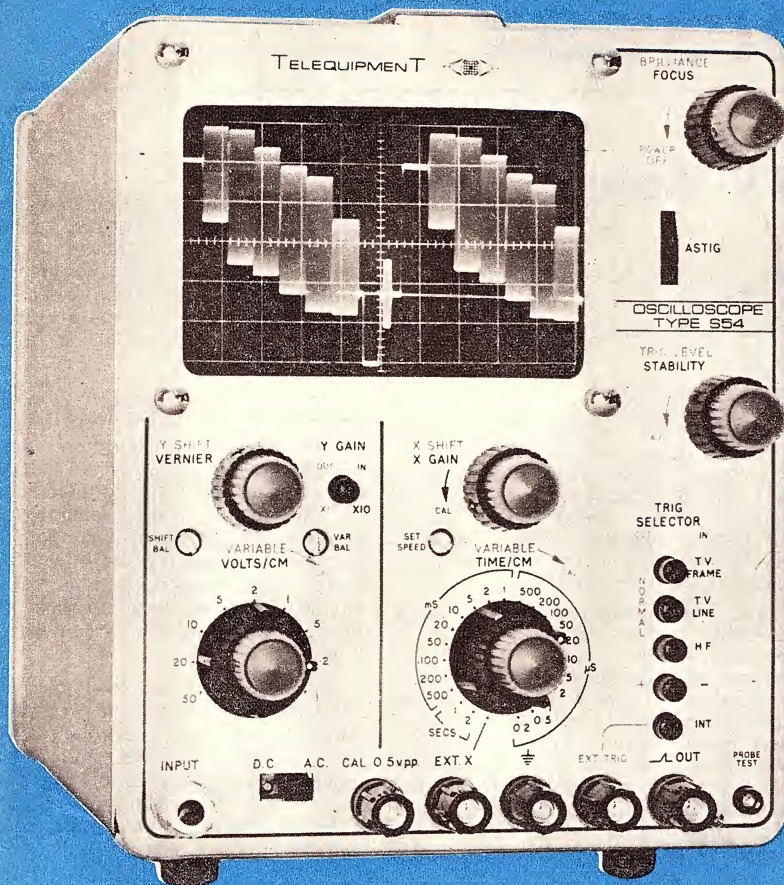

Figure 2

# TELEQUIPMENT



Look at the features:

- Low power consumption
- Large display area 6 x 10 cm
- Wide bandwidth DC-10 MHz
- 22 Calibrated sweep speeds
- Small size—low weight

Send for full details NOW!!!

You'll find that no other oscilloscope of this type offers such a combination of features at such low cost.

# NEW S54

## SOLID STATE SINGLE BEAM OSCILLOSCOPE

### TEKTRONIX



Distributed by Tektronix Australia Pty. Limited  
N.S.W. 80 Waterloo Road, North Ryde 2113. 88 7066  
VIC. Suite 20, 67 Queens Rd., Melbourne 3004. Phone 51 1592  
S.A. 128 Gilles Street, Adelaide 5000. 23 2811

# NEW BRITISH PLAN FOR TIDAL ELECTRICITY

British engineers have proposed a scheme for tidal power generation which has some unusual and attractive features. The scheme is outlined in this article by Allan Jack, assistant editor of "Electrical Times."

later stages, provide for reclamation of some 250 square miles of land. The consultants envisage most of this land reclamation would take place in a third construction phase in which the complete tidal scheme would move further out into the estuary, the site of the original, or phase 2, scheme being reclaimed. These two phases could include, as well as the tidal generation

(Continued on page 190)

The almost unlimited potential of tidal power for the generation of electrical energy has challenged engineers the world over, but few schemes have proved to be economically attractive. Probably the best known and the most recent is the French La Rance tidal scheme which uses the energy available during ebb and flow of the tides to drive low-head reversible water turbines, which in turn drive the electrical generators.

However, such a scheme is not able to give continuous generation, nor can the output be completely controlled. In the British Isles, several sites for tidal generation schemes have been considered from time to time but as yet none has been built. Recently two firms of consulting engineers, E. N. Underwood and Partners of Bristol and Sir Frederick Snow and Partners of London have outlined a scheme to harness the tidal potential of the Severn estuary in south-west England.

This is one of the most promising sites for tidal generation because of the wide variation between high and low tides of up to 50ft.

Essentially the scheme entails the construction of two vast basins in the river estuary, one of which would be filled at high tide and the other held at low level by draining at low tide. Between the two basins there would be a dam containing 175 or more specially designed turbo-electric generators.

The two basin scheme has the advantages that generation can be continuous over 24 hours and that the energy can be produced at a constant level by pumping into the upper basin, and from the lower basin, during periods of high and low tide, so overcoming lunar variations of tidal range.

Water pumped at these times against a small head would be used over a much larger head and so there would be an appreciable gain in electrical energy generated. (Editor's Note: The concept of pumping against a small head and using the stored water over a larger head does appear to be an attractive proposition at first glance, but a closer examination of the situation outlined here throws doubt on the claim of a net gain in power from this process.)

The estimated generation from such a scheme would amount to some 50 million MWH a year (50 thousand million KWH) — an enormous quantity even in these days of 2,000 MW thermal power stations — and produced at a cost which would be very much less than that of nuclear generation.

Cheap electricity is not the only advantage of the scheme however. The British Isles is densely populated and so any addition to land area would be

welcome. The proposals include, as phase 1, a flood control scheme for the river Severn lower reaches, enabling a considerable local problem to be solved. It would also, in the

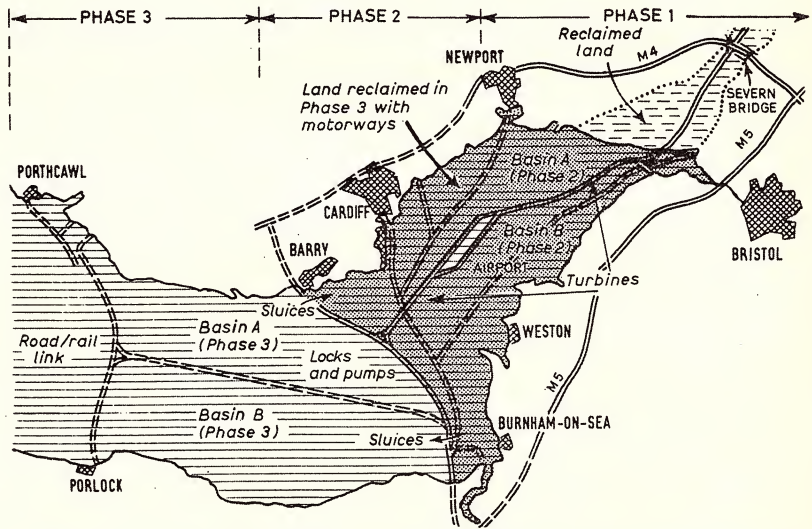

The suggested three phases of development for the Severn Estuary tidal generating scheme. In phase 1, flood control of the lower region of the estuary would include the formation of a large freshwater storage reservoir; phase 2 entails construction of two basins for tidal generation, motorways and airport; phase 3 would move the generation scheme further out into the estuary to allow land to be reclaimed in the phase 2 area.

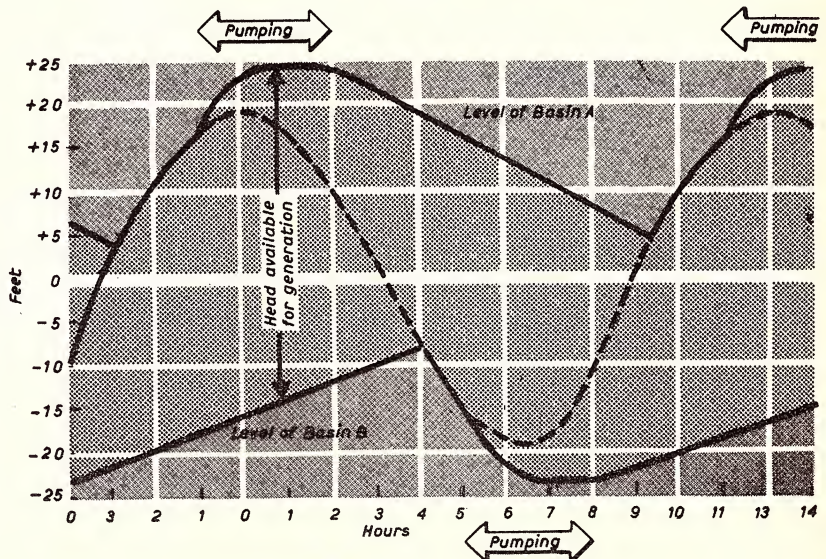

How the basin scheme can give a substantial head at all states of the tides by using pumping power at high and low tides.

# components with a purpose \*

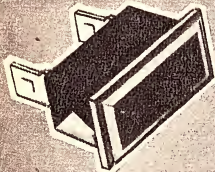

Neon  
Indicator Lamps  
**Telite**

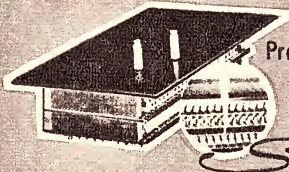

Cordless  
Programming  
Boards

*Seabro*

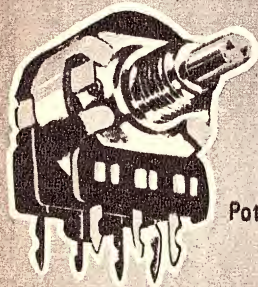

Potentiometers

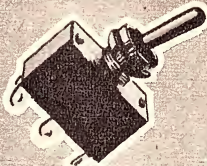

Toggle Switches

**NKK**



Micro Switches

**Mulon**



Precision Film Resistors

Type 650

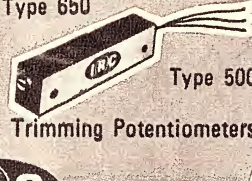

Type 500

Trimming Potentiometers



Wirewound Resistors



Power Rheostats

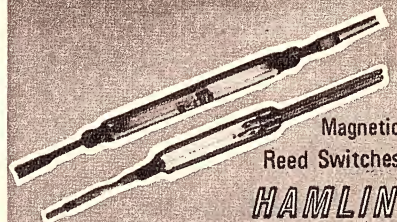

Magnetic  
Reed Switches

**HAMLIN**

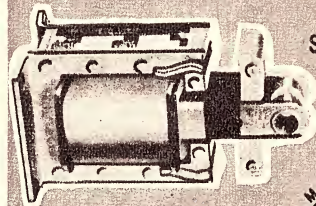

Solenoids

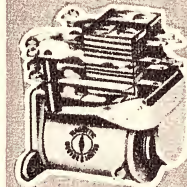

Relays



Soldering Irons

**SCOPE**

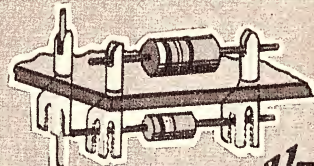

Matrix Boards and Kit-sets

*Vector*

## \* your complete satisfaction

INTERSTATE AGENTS & REPRESENTATIVES

MELBOURNE  
I R H Components Pty. Ltd.,  
Phone 489-1088

BRISBANE  
K.H. Dore & Sons  
Phone 2-1391 (except Magnetic Devices)

PERTH  
Simon Holman & Co.  
Phone 8-2271

HOBART & LAUNCESTON  
W.P. Martin Pty. Ltd.,  
Phone 34-2811 22-844

ALSO  
Underhill Day & Co.  
Phone 70-2141 (Magnetic Devices only)

ADELAIDE  
Collett & Cant Pty. Ltd.  
Phone 23-1971

**IRH  
COMPONENTS  
PTY. LIMITED**

THE CRESCENT  
KINGSGROVE  
N S W 2208  
TEL 50 0111





# CONVERTING U.K. TELEVISION TO 625-LINE AND COLOUR

The main stages of the establishment of Britain's 625-line UHF and colour television networks are expected to be completed by the end of the year. This involves a massive engineering effort and the expenditure of millions of pounds.

The situation at present is that the B.B.C. has one channel operating in the UHF band to 625-line standards, and capable of transmitting colour (BBC2), and another channel still operating on VHF to the 405-line standards with black-and-white transmissions only (BBC1); while commercial television is still operating on VHF to 405-line standards without colour. The present plans provide for all programs on all three networks to be originated on 625-line equipment, but for the existing 405-line services to continue to operate for an unspecified number of years. Thus two completely new transmitting networks will be required to be in operation for the new 625-line services.

When the new 625-line services are operating, many U.K. viewers should have available over 100 hours a week of colour TV programs to choose from—opening the way to a receiver market worth a potential £5,000 million, before saturation point is approached.

From the start of three-service colour—the unofficial engineering target date is November 15—Britain will have colour programs on a scale unknown outside the United States; almost certainly to technical standards which will not be matched anywhere in the world.

Yet relatively few outside the broadcast industry have realised the magnitude and complexity of the current engineering projects involved in putting the Independent Television (I.T.V.) and BBC1 programs into "beautiful 625-line PAL."

The Independent Television Authority (I.T.A.) is currently spending more than £10-million on the change of line standards and the construction of the first 26 main UHF stations, together with all the associated control and monitoring systems. The I.T.A. owns and operates the transmitters used for commercial television in U.K. The program companies, who rent transmitter time from the I.T.A., are currently spending a roughly equal sum in converting their studios, their telecines, their video tape machines, their caption scanners, master controls, and outside broadcast units and other facilities to 625-line operation and, in most cases to colour as well.

The initial phase of I.T.V. colour is thus costing well over £20-million with many more millions to be spent in the broadcast industry before the network is finally complete. For the transmitters alone, substantial contracts have been placed with Pye and Marconi for main stations, and with

Plessey for low-power relays. A number of aerial contracts have been placed also with E.M.I. and Marconi, and many other firms are supplying equipment and instrumentation.

The I.T.A. building program for its first UHF stations, and the program companies plans for colour facilities are reaching a critical stage. By July 6, all the program companies should be originating pictures in 625-lines, and on night of the official changeover, the final moves will be made to bring electronics standards converters from studio centres to the I.T.A.'s VHF transmitters, where they will allow the 405-line service to continue unchanged for an indefinite number of years.

I.T.A. has building works currently in progress at over two dozen sites, including 14 entirely new regional colour control rooms. These new control and monitoring rooms will play a vital role in the operation of the UHF network which looks like growing eventually to some 60 main stations and 450 or more relay stations.

There can be little doubt that national UHF coverage could never have been contemplated had it not been for the development in recent years, by broadcasters, of new techniques for the remote control and supervision of unattended transmitters.

For the new UHF network, it is planned that all stations at new sites will operate on an unattended basis, controlled from a series of new master control rooms. For example, in the London area, the new UHF transmitter will be co-sited with the BBC1 and BBC2 transmitters at the B.B.C. Crystal Palace site, but all the I.T.A. equipment will be entirely controlled from the long-established I.T.A. VHF station at Croydon, in S. London, which is currently being completely re-equipped.

New control and monitoring rooms are being installed also in 12 provincial stations. These new facilities are being based on an extensive program of research directed at new methods of remote monitoring, supervision and data-transmission systems.

Under the U.K.'s Television Act, the I.T.A. is responsible for maintenance of high technical standards on its network—with all the subtle problems involved in good colour performance. Since I.T.A. staff have direct control only over the transmitting stations, a technical quality control section has been established to help in the supervision of the whole chain of

transmission. In consultation with the program companies, standards of performance are being established and the section will have to ensure that these are being maintained in practice. But the coming of 625-line colour has equally placed a massive work load on the shoulders of the program companies' engineering staffs.

In some cases the new colour facilities will be achieved by extensive conversion of existing studio centres, but in addition a large number of completely new studio centres, designed specifically for colour operation often in both PAL and N.T.S.C. (for export programs) systems, are planned to come into operation over the next few months and years.

From its start last year, Yorkshire Television has been originating entirely in 625 lines from the centre at Leeds built specifically for colour, and this centre is still being expanded. Major new centres are also being planned or built for Independent Television News in London; Southern Independent Television at Southampton; ATV Network as part of the new Paradise Centre in Birmingham; Thames Television at the Euston Centre in London; Ulster Television in Belfast; Scottish Television in Glasgow; and, later, for London Weekend Television on the Southbank of the Thames.

Extensive conversion programs are being undertaken by a number of the program companies, and some of these projects are already operational.

By around the end of 1969, there are expected to be almost 40 colour studios, over 60 colour-capable video tape recorders, some 70 colour telecines, and around 15 colour outside-broadcast mobile control rooms engaged on commercial TV colour operations—with many others coming into use during 1970 and 1971.

This lavish provision of colour facilities is required for commercial television with its unique necessity of splitting down into separate regional programs.

Already many unexpected difficulties have had to be overcome and some of the time margins involved are "perilously thin." And it will not be possible to start the colour programs on the target date unless the B.B.C. and the G.P.O. links are also ready. It is the policy of the U.K. Government that the duplicated services of the BBC1 and I.T.A. networks should start—and as far as possible be developed—together.

It is a massive undertaking that the electronics industry has every reason to support—for even if only one million colour sets are in use by 1971, they represent a retail value of some £300,000,000 plus, for the engineering industry, the many millions now being spent on capital equipment. ("Electronics Weekly," 19-3-69.)



Presents a completely revised range of transformers

**OUTPUT TRANSFORMERS**

Type No.	Nom. Watts	Primary Impedance (ohms)	Secondary Imp. (ohms)
Medium fidelity 40-30,000 cps minus/plus 2db.			
OPM 1A	5	7000, 5000	S.E. 15. 8 3.7, 2
OPM19A	5	7000, 5000	S.E. 500, 250, 166, 100
OPM 2A	7	10000	P.P. 15. 8 3.7, 2
OPM 7A	15	(10000) 8000, 7000	P.P. 15. 8 3.7, 2
OPM 8A	15	(10000) 8000, 7000	P.P. 500, 250, 166 100
OPM10A	25	(8000) 6600	P.P. 15. 8 3.7, 2
OPM 9A	25	(8000) 6600	P.P. 500, 250, 166 100
OPM14A	35	(8000) 6600	P.P. 15. 8 3.7, 2
OPM13A	55	3500	P.P. 15. 8 3.7, 2

Impedance in brackets indicate screen taps available.

**OUTPUT TRANSFORMERS**

Type No.	Nom. Watts	Primary Ohms	Secondary ohms
HI-FI Using Oriented Grain Steel for Mullard 5-Stereo-7 Playmaster 2 & 4			
OP412	7	9000 + Screen Taps	PP. 15 7.5 3.7 2

**HI-FI for Mullard 5-10 Amplifier**

OP308/15	12	8000, 6000	P.P. 15 3.75*
----------	----	------------	---------------

**Ultra-Linear**

OP301/15	12	8000 + Screen Taps	P.P. 15 3.75*
OP312/15	25	6600 + Screen Taps	P.P. 15 3.75*

**For 6GW8's (ECL86's)**

OP447/15	12	8000 + Screen Taps	P.P. 15 3.75*
----------	----	--------------------	---------------

**Ultra-Linear Oriented Grain Steel For 6BQ5's (EL84's)**

OP387/15	12	8000 + Screen Taps	P.P. 15 3.75*
----------	----	--------------------	---------------

\*Also available in 8.4 and 2.1 ohms.

**POWER TRANSFORMER General Purpose—Valve Rectifier**

Type No.	Primary Volts	H.T. Volts	H.T. mA	Low-Tension Secondaries
PF619	240	150/150	30	6.3V—1.8A
PF299	240	285/285	40	6.3V—2A 6.3V—tap5V—2A
PF201	240	225/225	50	6.3V—2A
PF151	230, 240	285/285	60	6.3V—2A C.T. 6.3V—tap 5V—2A
PF1460	230, 240, 250	250/250	80	6.3V—2A C.T. 6.3V—2A 6.3V—tap5V—2A
PF130	230, 240	285/285	100	6.3V—2A C.T. 6.3V—2A 6.3V—tap5V—2A
PF174	230, 240	285/285	150	6.3V—3A 6.3V—3A C.T. 6.3V—tap5V—3A

**POWER TRANSFORMER General Purpose—Voltage Doubling**

Type No.	Primary Volts	H. T. Volt (R.M.S.)	DC Output After Doublers mA	Low Tension Secondaries
PVD100	250	120	310	80 6.3V—3A CT
	240	110	285	
	230	100	260	
PVD102*	250	120	310	100 6.3V—4A CT
	240	110	285	
	230	100	260	
PVD103	250	50	380	100 6.3V—5A CT
	240	140	355	
	230	130	330	
PVD104	250	120	310	125 6.3V—3A CT 6.3V—3A
	240	110	285	
	230	100	260	
PVD105	250	146	380	125 6.3V—3A CT 6.3V—3A
	240	136	355	
	230	126	330	
PVD108	250	173	450	150 6.3V—3A CT 6.3V—3A
	240	163	425	
	230	153	400	
PVD109	250	146	380	180 6.3V—3A CT 6.3V—4A
	240	136	355	
	230	126	330	
PVD110	250	193	500	200 6.3V—3A CT 6.3V—4A
	240	183	475	
	230	173	450	
PVD111*	250	124	310	150 6.3V—3A CT 6.3V—3A CT
	240	114	285	
	230	104	260	

\*Also available in flat mounting;

**LOW VOLTAGE EQUIPMENT TRANSFORMER**

Type No.	Primary Volts	Secondary Rating
PF537	240	17V tapped 11.5V—0.4A
PF1848	240	17V—1.25A
PF265	240	17V tapped at 11.5V, 10V, 8.5V at 4.2A
PF2344	240	18V, 0, 18V, 2.5A
PF2114	24	20V, 0, 20V, —2A DC
PF2440	240	19.4V, 0, 19.4V, —1.5A DC
PF2228	240	30V—0.6A
PF1763	240	30V tapped at 25V, 20V—2A
PF2876	240	32V at 1A 32V at 1A
PF2004	240	35V, 0 35V,—750mA
PF114	240	50V—2.3A tapped at 24V—4.8A tapped 12V—9.6A
PF115	240	50V tapped at 30V, 25V, 15V—5A
PF2235	240	150V, 125V, 100V, 75V, 50V, 25V, or 75V 0 75V at 30mA 6.3—1.2A

**FILAMENT TRANSFORMERS**

Type No.	Prim.	Secondary Rating
PF1290	240	6.3V—0.6A insulated for 2500V working
PF2315	240	6.3V—1.2A
PF1728	240	6.3V—1.1A, 6.3V—1.1A or 12.6V—1.1A C.T. if series connected or 6.3V—2.2A parallel windings.
PF1630	240	5.3V—2.25A C.T.
PF476	240	6.3V—3A C.T.
PF162	240	6.3V—3A, 6.3V—3A C.T. or 12.6A—3A C.T. if series connected.
PF2565	240	12.6V—0.5A 12.6V—0.5A or 25V—0.5A if series connected or 12.6V—1A parallel windings.
PF2851	240	12.6V C.T. at 0.15A.

# FERGUSON TRANSFORMERS PTY. LTD.

331 HIGH STREET, CHATSWOOD, N.S.W. ● POST OFFICE BOX 301, CHATSWOOD. TELEPHONE: 40-0261 (8 LINES).  
● TELEGRAMS: "FERTRAN."

178 BOUVERIE ST., CARLTON, VICTORIA. TELEPHONE 34-5814.

**INTERSTATE AGENTS:**

**TASMANIA:**  
Associated Agencies Pty. Ltd.,  
25 Barrack Street,  
Hobart, 7000.  
Phone: 2-1843.

**A.C.T.:**  
Erroll Nazer Pty. Ltd.,  
84 Barrier Street,  
Fyshwick, 2600.  
Phone: 9-0325.

**QUEENSLAND:**  
Keith Percy and Co. Pty. Ltd.,  
Waterloo Street,  
Newstead, 4006.  
Phone: 51-5461.

**WESTERN AUSTRALIA:**  
Athol M. Hill,  
613 Wellington Street,  
Perth, 6000.  
Phone 21-7861.

**SOUTH AUSTRALIA:**  
Wm. M. Matthew Pty. Ltd.,  
12 French Street,  
Adelaide, 5000.  
Phone: 23-6202.

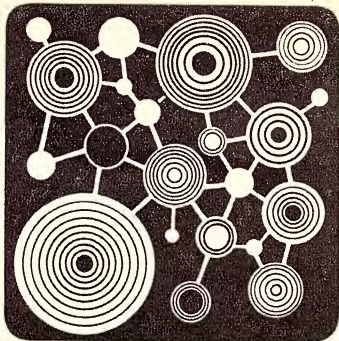

# SCIENTIFIC AND INDUSTRIAL NEWS

## Radio university courses

New courses over Radio University VL2UV, to begin in June, have been arranged by the Division of Postgraduate Extension Studies of the University of New South Wales. "Audio Signals in Communication" is a course of 10 one-hour lectures plus a number of attended seminars and lectures over Television University VITU. "Linguistics" is a course of 12 one-hour lectures and three attended seminars. Both are designed to train people in the compilation of information for transmission by any method. Enrolment by May 19 will facilitate the posting of notes before the courses begin. Tape recordings of the lectures are available where a group wishes to enrol, or for people beyond the range of the radio broadcasts. Further information on these and other courses can be obtained from the Division at P.O. Box 1, Kensington, 2033.

## Pakistan telecommunications.

The expansion of telecommunications services in Pakistan will be assisted by a credit of \$16 million from the International Development Association (IDA) for a term of 50 years, including 10 years grace. The IDA credit will finance the foreign exchange costs of specific works to be undertaken in the early part of a program costing a total of \$42 million. The Telegraph and Telephone Department of Pakistan will finance the local costs from internal cash generations and the remaining foreign exchange from bilateral loans and credits.

The principal items included in the program are: the addition of 175,000 telephones to the present 172,000; provision of 550 public call offices in rural areas; provision of 2,700 miles of open trunk lines with 607 carrier trunk circuits; extensions to the microwave and coaxial cable systems in the main towns; direct dialling between 13 towns in East and 21 towns in West Pakistan; extension of the interworking and international network by two satellite earth stations working via the Intelsat III satellite over the Indian Ocean; the improvement of existing HF radio systems; and the extension and improvement of telegraph and telex networks.

## Unusual metals in largest plane.

The U.S. Air Force C-5 Galaxy, now in production at Lockheed-Georgia Co., uses not only a lot of aluminium, steel and titanium, but also beryllium, magnesium and uranium in various alloys. Aluminium, the natural choice for structure and exterior skins of the huge jet transport, accounts for about 225,000lb. Very high strength steels are used for key landing gear, fasteners and castings, up to about 50,000lb per aircraft. Each C-5 has about 8,300lb of titanium (lighter than steel

and stronger than aluminium) which trimmed more than 13,000lb from the total aircraft weight.

Beryllium is used as lining material for the Galaxy's disc brakes, the first such application on any production aircraft. By specifying 1,400lb of beryllium instead of steel for the brakes, Lockheed-Georgia saved another 1,800lb of aircraft weight, got a better heat sink and a material that holds its strength up to 800 degrees. Castings of magnesium, lightest of all aircraft structural materials, go into about 25 different parts. Because of its very high density, depleted uranium alloy serves as counterweights in some of the transport's control systems. More than 1,000lb of the metal is used in the C-5.

## Fiji airport communications.

The Marconi Company, of the U.K., has won an order worth about \$500,000 to provide remote-controlled RF radio communications equipment at Nadi airport in Fiji to increase the handling capacity of the aeronautical fixed telecommunications network in the South Pacific. The new equipment will link Nadi airport with Tontouta airport at Noumea in New Caledonia, with Pago Pago in American Samoa, with Papeete in Tahiti, and with Sydney, N.S.W. An extension to the scheme will also provide a link to Rarotonga in the Cook Islands at a later date.

The equipment will include four ISB 7.5KW transmitter systems and four receiver systems, all from the Marconi self-tuning range. A number of additional transmitter drive units will be supplied to modernise existing transmitters at Nadi. Full remote facilities will enable a transmission and reception facilities, including frequency changes and aerial switching, to be controlled from the airport operations building. The work is expected to be completed by mid-1970.

## STC as ITT lead-house.

International Telephone and Telegraph Corporation (ITT) of U.S.A., has appointed Standard Telephones and Cables Pty. Ltd. (STC), Alexandria, N.S.W., as "lead-house" for a range of Private Automatic Branch Exchange (PABX) equipments. The ITT decision means that the parent company has recognised STC as being at least as advanced in the design and manufacture of PABX systems as any other associate company in the world group. A "lead-house" virtually designs a product which is suitable for markets in different countries. Most of the basic development is done at the "lead-house" and the developmental information passed to other countries. One major advantage is that some of the top electronic engineers will come to Australia to form an international team to co-operate in the design and development of the product.

## Countdown for title fight

A specially designed visual countdown was used for the Lionel Rose—Alan Rudkin world bantamweight title fight in Melbourne on March 8. The system, installed by the C.S.A. Division of Plessey Telecommunications, consisted of two large illuminated digital timers for the stadium spectators, and an on-screen digital timer for television viewers. The complete system was synchronised with the dual set of stopwatches used by the official timekeeper. At the beginning of each round a crystal chronometer in the system was set in motion by the timekeeper, simultaneously sounding the starting bell and triggering the digital timers. The finishing bell at the end of each round was also synchronised with the completion of each countdown by the digital timers.

C.S.A. engineer Kurt Filla (right) conducts a test run of the timing system. On the left of the picture is the Plessey control panel next to the timekeeper's master control unit.

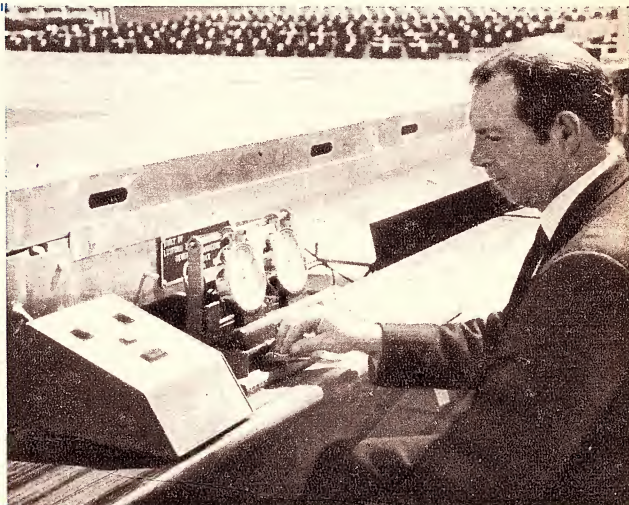

**PA246 . . . the industry's first 5 watt monolithic power amplifier**

PA246 is a monolithic power amplifier designed to deliver 5 watts of continuous power to a 16-ohm load. This integrated circuit will operate from a wide range of supply voltages, up to 37 volts, and can drive a wide range of loads with up to 1.25 amp peaks. This new package contains two heat sink tabs and eight leads in a staggered arrangement.

Primarily designed for use in audio equipment, the PA246 can be used as a voltage supply regulator, servo motor drive, relay and lamp driver, operational amplifier booster and in many more applications.

**For 2 watt applications, take advantage of the versatile PA237.**

PA237 is a complete audio amplifier capable of delivering up to 2 watts of continuous low distortion output power to

a speaker load. This monolithic IC is ideal for tape recording equipment, radio and television sound systems, and sound cinema projectors.

There are provisions for application of external feedback, and adjustment for gain and distortion. The PA237 will operate over a supply range of 9-27V, with a frequency response well beyond normal audio frequencies.

**For 1 watt applications, use the PA234 IC which operates with a minimum of external components.**

PA234 audio amplifier delivers one watt of continuous power to a speaker load from a 22-volt supply. Low cost and simplification of design afforded by the reduced number of external components make the PA234 a most economical one-watt audio amplifier. In addition, a 1.5 to 2.0 watts power capability version of this type is also available. Applications range from phonographs and radio receivers to television sound systems.

"Power Tab" transistors for easy mounting, top versatility, and high density packaging. D27C (NPN) and D27D (PNP) planar complementary power transistors feature the "Power Tab" plastic package, designed for output stages of stereo amplifiers, automobile stereo, standard audio stages and other consumer applications. Both feature  $\pm 40V$   $V_{ce0}$ ,  $\pm 3$  amp IC and have lead capability with the TO-66 package.

D28C, a power Darlington Amplifier with very high gain (10K) is designed for medium power applications in oscillators, amplifier buffers, audio output stages, and as a driver for very high power amplifiers.

For more information write *Australian General Electric Pty. Ltd.*

Dept. 40-21  
103 York Street,  
Sydney, N.S.W. 2000  
Telephone 29 8711;  
or 552 Lonsdale Street,  
Melbourne, Victoria 3000  
Telephone 67 8221

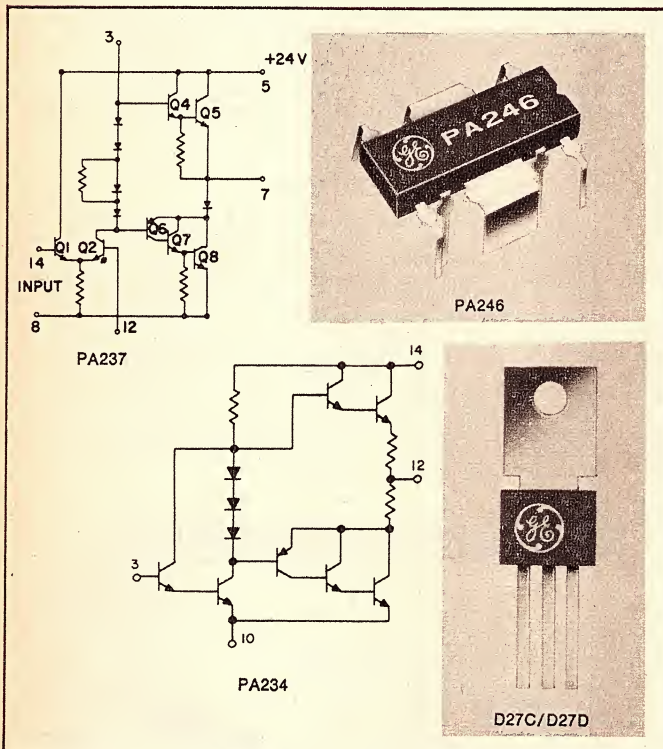

General Electric solves customer problems with new integrated circuit developments.

**GENERAL ELECTRIC**  
U. S. A. Reg. Trademark

## Satellite communications

A new system designed to make more efficient use of communication satellites was demonstrated recently between the U.K. earth terminal at Goonhilly and the earth station at Etam, U.S.A. The system, known as SPADE, was developed for the International Telecommunications Satellite Consortium (Intelsat) by its managing company, Comsat. It uses a technique called demand assignment which allows unoccupied circuits to be allocated to any route where they are needed. The existing system used by Intelsat allocates a fixed block of circuits to each route. The economics of the new system are still under study.

SPADE is a frequency-division multiple access demand assignment system. Each channel of the system has a separate RF carrier. The additional equipment required at each earth station includes a Demand Assigned Signalling and Switching Sub-system (DASSS) which is in constant communication with corresponding equipment at other earth stations via a Common Routing Channel (CRC). When a request for a call is received at an earth station, the DASSS equipment automatically selects available carriers for the call.

## Computerised radar sharing

A radar system designed to make information originated by individual ships sensors available to the whole of a naval force is under development in the U.K., according to a report in "Wireless World." Ferranti Ltd., with Decca Radar as principal sub-contractors, are to produce the system, called Computer Action Information System. Each ship in a naval force will have equipment which stores information from "own ship" sensors. This information is entered automatically and manually and can originate from radar, sonar, or other navigational equipment. A computer which forms part of the equipment operates on this information and allows it to be superimposed, on request, on a radar display in alphanumeric form.

The information stored in each ship's computer is transmitted by radio to all other ships in the force. This ensures that information available to any one ship is also available to all its consorts. Under the terms of the contract, worth about \$2 million, Ferranti will supply the computing equipment, and Decca the combined alphanumeric and radar displays.

## Group technology seminar.

Leading specialist from the U.S.S.R., the U.S.A., and 12 other countries will meet in Turin, Italy, in September to exchange ideas on group technology, a new approach to batch production developed in Europe over the past 10 years. The seminar, which runs from 8th to 13th September, 1969, will

brief top managers and Government representatives on group technology, and will examine the managerial, technological and economic implications of the new approach. Working languages will be English, French and Russian with simultaneous interpretation. Further information may be obtained from the host organisation, the International Centre for Advanced Technical and Vocational Training, 140 Corso Unita d'Italia, 10127 Torino, Italy.

## Philippines police radio

The police force in Davao City, Philippines, has been equipped with two-way radio communications supplied by Standard Telephones and Cables Pty. Ltd. The system includes base stations, control equipment, mobile radio equipment, and a series of talk-through repeater stations on the crests of hills to provide complete communications for all vehicles and base stations within a 50-mile radius of the city. A feature of the system is the direct access into the network for the chief of police, the head of the fire department, and the city mayor, from either their offices or homes. In any emergency, these officials have instant contact with the mobile fleet of vehicles in any part of the city or surrounding country.

## Electrostatic recorder

An electrostatic read-out recording instrument for high-speed scientific computers has been introduced by Varian Associates, of Palo Alto, California, U.S.A. The instrument accepts digitised data signals and records the information as pictorials, charts, graphs, or alphanumeric characters. Designated Status V, the recorder functions as a digital printer/plotter and has no moving parts except for its paper transport. A multi-stylus fixed recording head places electrostatic charges on dielectrically coated paper. An electronic switching scheme (discrete or sequential) energises the stylus array to permit extremely fast writing. As the paper passes through a toner, a permanent black image is immediately formed on the electrostatically charged areas.

## Pressurised cables

The Australian Post Office is carrying out a program to pressurise all long distance, trunk and junction cables, most trunk entrance cables, and main subscribers' distribution cables. The cable pressurising equipment consists of a compressor which dries air and pumps it into the cable from an exchange, instruments to indicate the pressure, consumption and flow of air within the cable system, and an alarm system. Within the cable sheath a minimum pressure of 3psi above atmospheric pressure is maintained—sufficient to keep out moisture if a fault develops in the sheath.

## Microelectronics design school

The first microelectronics design school held in Australia was conducted recently by the microelectronics facility of Amalgamated Wireless (Australasia) Ltd., in conjunction with the Department of Supply, at Rydalmere, N.S.W. Four similar schools are to be held annually, each with a maximum enrolment of eight engineers. The course, which totalled 60 hours of lectures and 30 hours in the laboratory over a four-week period, included instruction in the fabrication, modelling, analysis and design of silicon integrated circuits for digital and analog applications.

The co-ordinator of the school is Dr. Graham Rigby,

senior engineer, design and planning, of the AWA facility. The design school committee comprised Professor L. W. Davies, chief physicist of the AWA physical laboratory and professor of electrical engineering at the University of N.S.W.; Mr J. H. Brodie, staff engineer, design and planning, and senior lecturer in electrical engineering at the University of Tasmania; and Mr P. S. Smith, staff engineer, design and planning, of the facility. The instructors were Mr D. M. Sutherland, manager of AWA advanced devices development laboratory, Mr D. K. Money, senior engineer, operations, Mr R. L. A. Walton, staff engineer, design and planning, and Mr H. S. Banks, senior lecturer in electrical engineering, University of N.S.W.

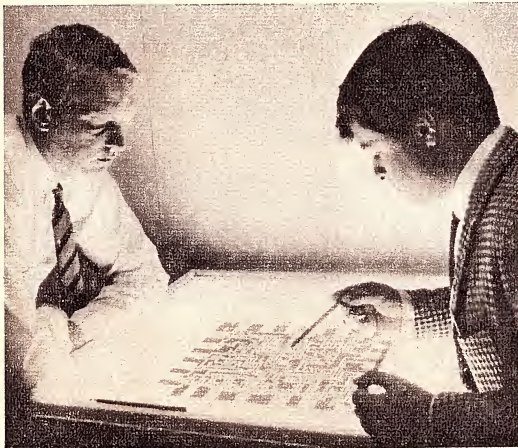

The co-ordinator of the school, Dr. G. A. Rigby (left), and one of the students, Mr R. Cearns of the Weapons Research Establishment, examine a mask for an IC.

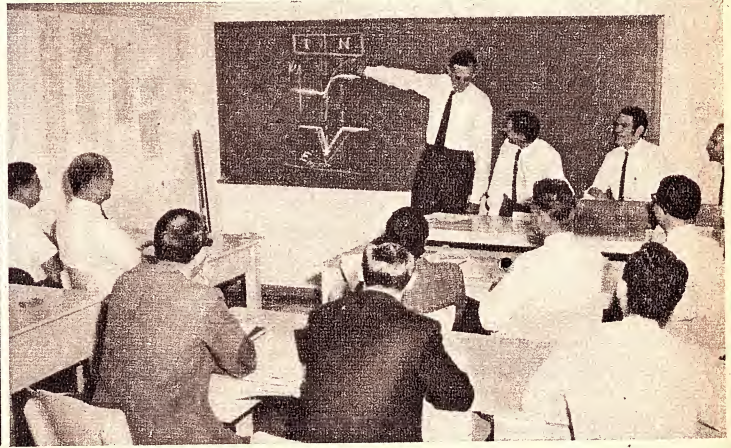

The microelectronic design school in session at Rydalmere. At the blackboard is Professor L. M. Davies, chief physicist of AWA. Alongside are (left to right) D. K. Money, P. S. Smith, and R. W. Walton, instructors at the school.

# New Rola C8MX deluxe brings you right down to 30Hz...



**for great sound and great value!**

What a choice—more bass, more top, more value. C8MX deluxe gives you the widest-range speaker at the lowest cost. Only 8" in diameter, yet with a frequency response of 30Hz-16,000Hz, C8MX deluxe gives an outstanding performance within compact enclosure dimensions. Highly efficient C8MX deluxe is the answer for budget conscious hi-fi enthusiasts. Look for it in the attractive new Blue and Gold carton. Build your own enclosure from plans specially prepared by Rola. Ask for technical publication 54.

**PLESSEY**  
**Components**



For additional information please contact:  
Rola Division  
The Boulevard Richmond Victoria 3121  
Telephone 42 3921 Telex 30383  
NSW Plessey Components Rola Division  
PO Box 2 Willawood 2163 Telephone 72 0133

123 A R 12

## Industrial espionage.

In Britain commercial spying has become so serious that the problem is engaging the attention of Parliament. At present there is virtually no effective law against it. New penalties have been suggested to make industrial spies subject to a fine of up to £1,000 or two years in gaol. However, in the opinion of the managing director of a counter-espionage firm, the penalty would discourage only the amateur spy, the opportunist employee, who takes some of his firm's secrets to sell to a competitor.

The professional spy does not bother about legislation, but is merely concerned with whether he can complete a job of espionage and get paid for it. He is prepared to use all the devices of modern technology including radio microphones, bugging, telephone-tapping, etc. He might even welcome new legislation, because with the greater risk he could charge a higher fee.

## Telegraph transmitter.

A self-contained transmitting unit for use with fully-punched-tape in telegraph networks has been designed and developed by Standard Telephones and Cables Pty. Ltd. Alexandria, N.S.W. The equipment can also be used in torn-tape telegraph message centres and automatic switching systems. Known as the II-SU-4, its principle features are: dual tape readers having almost noiseless operation; inbuilt electronics and controls; electronic distributors and line switching unit; IC digital elements; base for optional table or rack mounting. The system, which contains no moving parts, is said to be a robust flexible item of equipment requiring the minimum of servicing.

## Pneumatic film scanner.

A 16mm colour film scanner using a novel method of film transport was demonstrated in London recently by Fernseh GmbH., a member of the Bosch Group. The conventional method of moving the film by a sprocket engaging in holes at the edge of the film has been replaced by a pneumatic method. A cup shape is constructed just below the lens unit so that when the film is lying across the cup it becomes an airtight chamber. This chamber is repeatedly evacuated of air at 25 times per second thus pulling down the film intermittently at a speed of 25 frames per second. The frame remains stationary during scanning.

## Arabian Gulf television.

An order for more than \$100,000 of equipment for the first television service in the Arabian Gulf has been placed with The Marconi Company of the U.K. by the Kuwait Government. Kuwait is to make a gift of the equipment to Dubai, the largest of the seven Trucial States on the southern slopes of the Arabian Gulf. The equipment will include two black and white cameras, a teletext channel and a variety of associated studio and test equipment for installation in the first studio of the projected Dubai Television Service.

## Automated draughtmanship

The Drafter Numericon (right) combines a draughting machine and a numerical control device to produce drawings by automatic methods. Developed by Muto Industry Co. of Tokyo, Japan, it was shown at the recent Japan Machine Tool Fair. The bridge moves in accordance with instructions from a Fujitsu FANUC 250 numerical control system which is suitably programmed. The drawing section of the device is shown above in close-up.

## Testing under space conditions

The Siemens research and development centre at Munich, West Germany, includes a high-altitude chamber using a new principle to attain the resistance to compression in a chamber of its size. The 700 cub. ft. of working space is sealed off from outside by a hydraulic actuated side wall and an air lock. The interior can be reached via the air lock even during tests of extreme climatic conditions. A temperature range of  $-80$  to plus  $150$  deg C can be attained, and 100 p.c. humidity generated up to plus 60 deg. The lowest pressure, .01 Torr, corresponds to that encountered 44 miles above the surface of the earth.

It is also possible to introduce a vibration table (right) into the chamber to unit climatic and mechanical influences in the test programs. Units or components can be vibrated up to 10,000 times per second on this oil-cooled table. In this way forces up to 100 times g can be obtained. Operators have to wear earmuffs to protect themselves against the resultant noise.

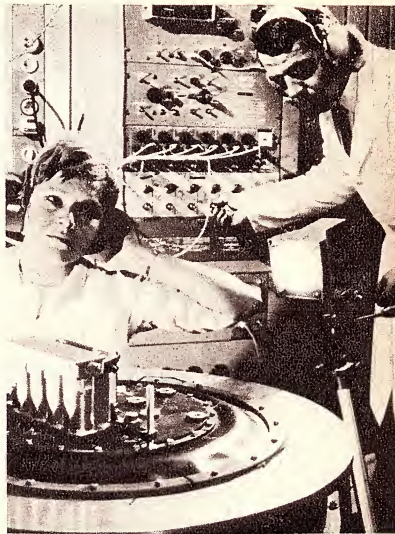

## R/T to Indonesia

The Sydney to Bandung (Indonesia) radio-telephone service has been extended to operate from 11 a.m. to 2.30 p.m. (Australian Eastern Standard Time), Monday to Friday. The service does not operate at weekends.

## Ceduna radio station

A National medium wave broadcasting station is to be established in the Ceduna/Streaky Bay area of South Australia. The station should serve about 8,000 people at Ceduna, Streaky Bay, Penong, Wirrula, Minnipa, Poochera and Elliston. The day-time service should extend even further along the Eyre Highway to Eucla. The station, which will operate on a frequency of 690KHz with a power output of 2KW, will take its

programs on relay from the ABC station 5CK in Adelaide. The station should be operating in two to three years' time.

## Tribology exhibition.

An Industrial Lubrication and Tribology Exhibition (ILTEX) will be held in London from 25-28 November, 1969. It is sponsored by the journal "Industrial Lubrication and Tribology." Tribology is the science and technology of interaction between relatively moving surfaces, of which lubrication is only one aspect. Concurrent with the exhibition, a symposium will be held to consider and discuss latest advancements in the subject. Further information is available from the organisers, UTP Exhibitions Ltd., Racquet Court, Fleet Street, London E.C.4, England.

## Distress beacon.

A crash and waterproof radio transmitter, invented in the U.S.A., has a range of about 70 miles and is actuated by a very fragile electrical conductor, breaking under stress. The conductor can be mounted either inside or outside the unit, and is fractured by only slight abnormal stress. The inventors, Harold R. Hine and Edward Dawson, say that in the past, search operations have been difficult if an aircraft crashed with no survivors to turn on a distress beacon.

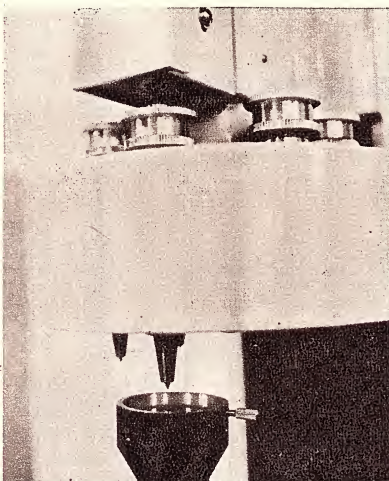

# ADCOLA

## "M" SERIES

AUSTRALIA'S LEADER IN MODERN PRECISION SOLDERING TOOLS

SELECTED AS

**Good Design**

FOR AUSTRALIAN DESIGN INDEX

INDUSTRIAL DESIGN COUNCIL OF AUSTRALIA

### LONG LIFE TOOLS, TESTED AND PROVED IN WORLD-WIDE SERVICE.

Adcola "M" Series soldering tools are long-life precision-made tools, the result of 20 years' development to meet the particular needs of the Communications and Electronics industries throughout the world. They are standard equipment in all Australian Armed Services, Space Tracking establishments, P.M.G.'s Department; major computer firms and numerous other organisations with the resources to carry out stringent comparative pre-selection tests on soldering equipment.

### GREATER THERMAL EFFICIENCY

The advanced design reduces heat losses to a minimum and provides a work capacity in each model normally associated with conventionally designed tools of twice the rated power. Initial heat-up time (60 seconds for M70, 100 seconds for M64) and heat recovery are extremely rapid. Elements are calibrated to provide optimum tip temperatures for swift and sound soldering of terminations in each type of circuit.

### DESIGNED FOR ACCURATE SOLDERING

The lightness and balance of the "M" Series tool; the flared handle, ribbed for a positive precision finger grip; the slim heater unit allowing the best possible visibility and penetration; the combination of these design features allows easy, precise manipulation and therefore better soldering.

### INSTANT CONTROLLED HEAT

A constant heat tool operating at the correct soldering temperature ensures the swiftest and most efficient soldering. Poor quality soldered joints caused by too high or too low a soldering temperature are avoided. Fitted with a hook for suspension while idling, Adcola soldering tools will operate continuously without risk of overheating or loss of tip tinning. Heat sinks, idling or cut-off switches are NOT required.

### EASY REMOVAL OF TIP

The tip is held firmly by a stainless steel collet, and is easily removed for cleaning and replacement and to allow quick fitting of special-purpose tips.

### SAFETY FIRST

Safety was a primary consideration in the design of the "M" Series, which embodies a fully insulated element and a double-earthed helical wire outer casing to the heater unit. Every heater unit must pass an insulation test of 2,000 volts before release from the factory.

### NO TRANSFORMER REQUIRED

Adcola tools conform to S.A.A. approval and test specifications and are approved in all States for mains voltage operation.

All models are available for 230-250V, 200-220V, 100-120V, 50-55V, 32V, 24V, 12V and 6V.



**M70** Tip Shaft Dia: 1/8" Rating: 19 watts Weight: 3 ozs. Application: Transistor, miniature and micro-miniature electronics and instrument work.

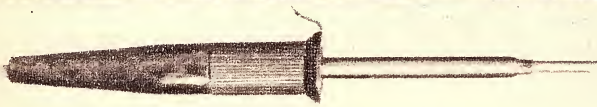

**M64** Tip Shaft Dia: 3/16" Rating: 23 watts Weight: 3 1/2 ozs. Application: Standard tool for radio and television assembly and servicing.



**M107** Tip Shaft Dia: 1/4" Rating: 27 watts Weight: 4 ozs. Application: Servicing in telecommunication centres and similar heavier tagging.

\*Weight of tool only, without cord set.



**M150** Tip Shaft Dia: 5/16" Rating: 45 watts Weight: 6 ozs. Application: General Purpose Solder Tool, sheet metal, earthing strips and other heavy duty work. Tip incorporates unique anti-seizing ferrule

# ADCOLA PRODUCTS PTY. LIMITED

22 FIRTH STREET, DONCASTER, VICTORIA 3108. Telephone: 848-3777

N.S.W.: ADCOLA PRODUCTS PTY. LTD., 17 BURWOOD ROAD, BURWOOD, N.S.W. 747-1606.

S.A.: F. R. MAYFIELD PTY. LTD., 11 HALIFAX STREET, ADELAIDE, TEL.: 8-4131.

QLD.: T. H. MARTIN PTY. LTD., 56-74 EDWARD STREET, BRISBANE, TEL.: 2-0555.

W.A.: EVERETT AGENCY PTY. LTD., 17 NORTHWOOD STREET, WEST LEEDERVILLE, 6007, TEL.: 8-4137.

N.S.W.: H. ROWE & CO. PTY. LTD., 512 PUNCHBOWL ROAD, LAKEMBA, 750-0333. GEORGE BROWN & CO. PTY. LTD., 29-5877; BROADWAY ELECTRONICS PTY. LTD., 211-4224; ELECTRONICS PARTS PTY. LTD., 533-1277; GENERAL ACCESSORIES PTY. LTD., 73-0211; GEORGE KENT (AUSTRALIA) PTY. LTD., 525-2811; MARTIN DE LAUNAY PTY. LTD., 29-5834; NEWCASTLE, 84741; WAGGA, 4644; WOLLONGONG, 86020; LAWRENCE & HANSON ELECTRICAL PTY. LTD., 69-4041; NEWCASTLE, 61-5573; WAGGA, 4224; PAUL'S (MERCHANTS) PTY. LTD., 61-6392; RADIO DESPATCH SERVICE, 211-0191; REG ROSE & CO. PTY. LTD., 29-1851; W. G. WATSON & CO. PTY. LTD., 29-5631; NEWCASTLE, 61-6961. VIC.: A.E.I. PTY. LTD., 34-0471; ELECTRONICS DEVELOPMENTS PTY. LTD., 63-3596; GENERAL ACCESSORIES PTY. LTD., 69-0300; HOMECRAFTS PTY. LTD., 32-3711; J. H. MAGRATH CO., 32-3731; RADIO PARTS PTY. LTD., 30-1251, 211-5921; WARBURTON FRANKI (MELB.) PTY. LTD., 69-0151. QLD.: BATTEN'S ELECTRICAL PTY. LTD., 5-3936; SOUTHPORT,

2-1685; CHANDLERS PTY. LTD., 31-0341; JAMES CROKER & SONS, MACKAY; A. E. HARROLD PTY. LTD., 31-3081; LAW-CAIRNS, 3739; TOOWOOMBA, T.VILLE; GENERAL ACCESSORIES PTY. LTD., 2-3093; B. MARTIN PTY. LTD., CAIRNS, INNISFAIL; C.A. PEARCE & CO. PTY. LTD., 2-3201; TRACKSON BROTHERS PTY. LTD., 2-2804; WYPER BROTHERS LTD., 5-3219, BUNDA-BERG; WARBURTON FRANKI (BRISBANE) PTY. LTD., 51-5121. S.A.: GENERAL ACCESSORIES PTY. LTD., 23-4022; GERARD & GOODMAN PTY. LTD., 23-2222; HEALING (SALES) PTY. LTD., 8-0171. T.A.S.: CHARLES DAVIS (WHOLESALE) PTY. LTD., HOBART, 3-3121; W. & G. GENDERS PTY. LTD., LAUN., 2-2231; HOMECRAFTS PTY. LTD., HOBART, 2-2711; LAWRENCE & HANSON ELECTRICAL PTY. LTD., HOBART, 2-7464; LAUN., 2-2683. W.A.: ATKINS (W.A.) LTD., 21-0101; GENERAL ACCESSORIES PTY. LTD., 21-2501; CARLYLE & CO. (1959) PTY. LTD., 21-9331. N.T.: LAWRENCE & HANSON ELECTRICAL (N.T.) PTY. LTD., DARWIN, 3732.



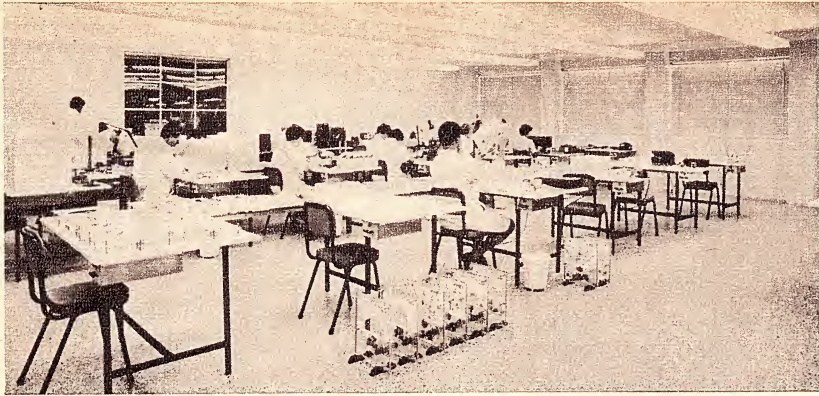

The clean room of Master Instruments Pty. Ltd., Marrickville, N.S.W., is fitted with a single sheet of Evathene covering the 50ft x 44ft floor and 1½in up three walls. The fourth wall, a partition, has the edge covered by a beading strip. The floor consists of an epoxy resin base spread with a trowel, then suitably coloured, and finished with three coats of polyurethane. It was supplied by A. C. Hatrick Chemicals Pty. Ltd. Since the floor was installed, the rejection rate of instruments has fallen by 70pc.

### Superconducting motor.

A superconducting electric motor, producing 3250HP at 200rpm, has been developed by International Research and Development Co. Ltd. (IRD) of Newcastle-upon-Tyne, England. It will be used in a new oil-fired power station to drive a cooling-water pump. The IRD motor is basically a simple homopolar machine, but new principles permit higher voltages to be used than with previous motors of this type. The field winding uses 5½ tons of niobium/tantalum/copper composite superconductor and is coupled with a closed-circuit helium refrigerator. (See also "Superconductivity," in the November, 1968 issue of "Electronics Australia.")

### Character display

The British company, Ferranti Ltd. of Oldham, Lancs., has introduced a terminal display equipment with a repertoire of 64 characters from its own in-built magnetic store. The desk-top package, which comes complete with keyboard, operates independently of any other ancillary equipment. A message of up to 2048 characters (32 rows of 64 characters 3mm high) can be composed and displayed on a slim-line CRT with a 24 x 18cm screen, edited as required, and then transmitted rapidly over a data line. Alternatively, the unit may be coupled to an ordinary telephone line and used remotely to interrogate a computer.

The characters are displayed by the sub-raster method (using low-intensity raster) from a 15 x 11 bit matrix. This high-definition display produces a much better legibility than a conventional 7 x 5 bit matrix. An alternative version of the equipment uses a full-raster television scan with broadcast standards, in place of the sub-raster system, to produce television caption fields.

### Low-temperature probe

A cryosurgical probe which can be cooled to the temperature of liquid nitrogen for cataract and retinal-detachment surgery and other surgical applications has been developed by International Research and Development Co. Ltd. (IRD) of Newcastle-upon-Tyne, England. The temperature of the probe tip is indicated by means of a thermocouple, and can be varied rapidly in a controlled and safe manner by passing either gaseous or liquid nitrogen through the probe, or by switching on a small heater. Several types of probe tip can be attached to the instrument to suit the surgery required.

### Flight test systems

Three I.L.S. (instrument landing system) flight test telemetry systems have been ordered by the Canadian Department of Transport from Amalgamated Wireless (Australasia) Ltd. The usual method of checking an airport's I.L.S. is to have a ground party on a runway tracking the flight of a test aircraft with a theodolite. The theodolite readings are radioed to the aircraft for comparison by a technician with the aircraft I.L.S. receiver indication. In the A.W.A. system, the angular readings of the theodolite are converted to electrical signals and transmitted over the same channel as that used for voice communication between the aircraft and the ground party. ■

### Navigation beacon

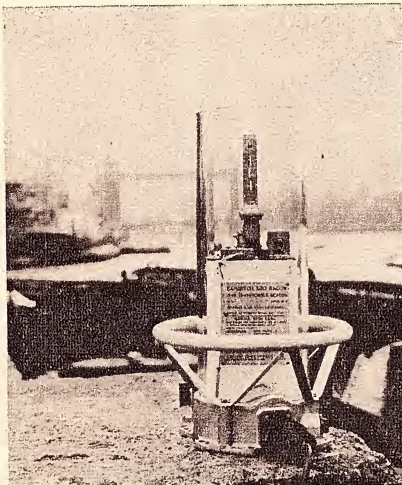

A new type of radar beacon (racon) which mounts on a buoy and operates for up to 12 months from a single battery has been developed in U.K. by GEC-AEI (Electronics) Ltd. Known as Seawatch 300, the new racon transmits information on its position when triggered by pulses from a ship's radar system, to provide a clear indication of areas to be avoided by shipping. Its signals may be coded, thus enabling a ship's radar to indicate the identity of the site, as well as range and bearing. Detection range is increased from the normal 2-3 miles of unassisted marine radars to 7-10 miles or 12 miles with high aerials. Seawatch 300 can operate in rough seas and in extremes of heat and cold.

## TRADE ENQUIRIES INVITED!

- ✧ COMPAX III TURNTABLES
- ✧ LUSTRE TONE ARMS
- ✧ MICRO CARTRIDGES  
See review on Page 119 of February, 1969 issue, "Electronics Australia".
- ✧ COMPAX AMPLIFIERS
- ✧ LUX AMPLIFIERS
- ✧ PML MICROPHONES
- ✧ LONDON MICROPHONES
- ✧ GRACE TONE ARMS AND CARTRIDGES
- ✧ CELESTION GUITAR SPEAKERS
- ✧ PRL TANGENTIAL FANS
- ✧ MICRO DUST PICKUPS
- ✧ PLANET P.A. AMPLIFIERS
- ✧ SOUND AMPLIFIERS
- ✧ RAPIER TUNERS
- ✧ PIEZO MICROPHONES
- ✧ SONICS SPEAKER SYSTEMS

Trade supplies only available from:

**INTERNATIONAL DYNAMICS (AGENCIES) PTY. LTD.**

361 Bridge Rd., Richmond,  
Vic. 3121  
Tel. 42 4403

# THE PLAYMASTER 124 STEREOGRAM

By LEO SIMPSON

Here is a project that is based on well proven circuitry; a combination of the Transistor Broadcast Tuner and the 3-PLUS-3 Stereo Amplifier, described in Electronics Australia for May 1968 and August 1968 respectively.

The design is intended to fill the demand for a simple, moderate-powered tuner-cum-stereo amplifier. The tuner has adequate sensitivity for most localities and the amplifier can be driven to full power by the popular ceramic or crystal cartridges. It will produce adequate sound level in a domestic lounge room for ordinary family listening.

The unit can typically be used with 8, 10 or 12-inch loudspeakers of 8 or 15 ohms impedance and preferably of high sensitivity.

Used in this way the power available can make a lot of noise; far more than is likely to be needed for a domestic situation. With some reservations, it may also be used successfully with the smaller speaker systems, such as a pair of Playmaster "Bookshelf" or "Point-Four" systems, a pair of Mullard

dealer for a test run before committing yourself to a purchase.

The tuner section uses four silicon RF transistors. The first functions as a self-oscillating mixer, with an aerial coil feeding the base circuit. The aerial is connected to the aerial coil via a 4-60pF variable capacitor which can be adjusted to protect the first stage from overload in strong signal areas.

The oscillator coil has three windings. The main winding is tuned and controls the oscillator frequency; the other two windings are connected in the emitter and collector circuits respectively. Also in the collector circuit of the mixer is the tuned primary of the intermediate frequency transformer, the secondary of which feeds into the base of the first IF amplifier. The collector load of this stage is resistive

## SPECIFICATIONS

**Power:** 3 watts music power per channel into 8-ohm loads; 2.5 watts music power per channel into 16-ohm loads, 2 watts (continuous tone) into 8 or 16-ohm loads with either channel driven singly.

**Distortion:** 1.5% THD at 2KHz at 2.5 watts into 16-ohm load; 2% THD at 1 KHz at 2.5 watts into 8-ohm load.

**Signal-to-noise ratio:** 54dB with respect to 2.5 watts.

**Crosstalk:** -38dB at 1KHz with respect to 2.5 watts; -30dB at 10 KHz with respect to 2.5 watts.

**Frequency response at 1 watt:** -3dB points at 25Hz and 15KHz.

**Tone Control:** -17dB cut at 10KHz.

**Input Sensitivity:** 420mV for full power for all inputs; input impedance 1 megohm. (See text).

**Tuner Coverage:** 520KHz to 1630-KHz.

**IF:** 455KHz.

**Bandpass:** 5KHz at -3dB points.

**AGC:** 60dB input increase (100uV to 100mV) gives 10dB output increase.



*The complete stereogram, housed in a metal case. Alternatively, it may be built into a cabinet with the turntable. The circuit diagram is shown on the opposite page.*

"Mini" systems, or one or other of the commercial equivalents.

The reservation is that all sealed enclosure speaker systems are significantly less sensitive than larger speakers mounted in an open-back cabinet. Nevertheless, this amplifier would have enough power to drive the units mentioned above, at least for ordinary domestic listening in an average flat or living room. Be aware, however, that some commercial sealed enclosure systems, while excellent performers, have even lower sensitivity and would not be suitable.

If in doubt on any of these points you should try to arrange with your

and couples straight into the SF455D ceramic IF filter. This, in turn, feeds into the base of the second IF amplifier.

The SF455D consists of two sections which are coupled together with a 150pF capacitor. This value gives an acceptable compromise between selectivity and audio frequency response. The BF455A filter, connected across the emitter of the first IF transistor, improves the skirt selectivity to minimise adjacent channel interference.

The output of the second IF transistor is capacitively coupled into the base of the fourth transistor, which functions as a class B detector.

The AGC system is relatively simple, but it is also very effective. Referring again to the circuit, the first IF amplifier obtains its bias from the collector of the class B detector, through a voltage divider consisting of a 100K and a 33K resistor. This is set up so that the IF amplifier is normally biased with no signal present. Bias for the second IF amplifier is obtained from a voltage divider, with a 220K and a 22K resistor, the latter being referred to the emitter of the first IF amplifier. Finally, a germanium diode is connected between the junction of a 1K and a 3.3K resistor in the collector of the

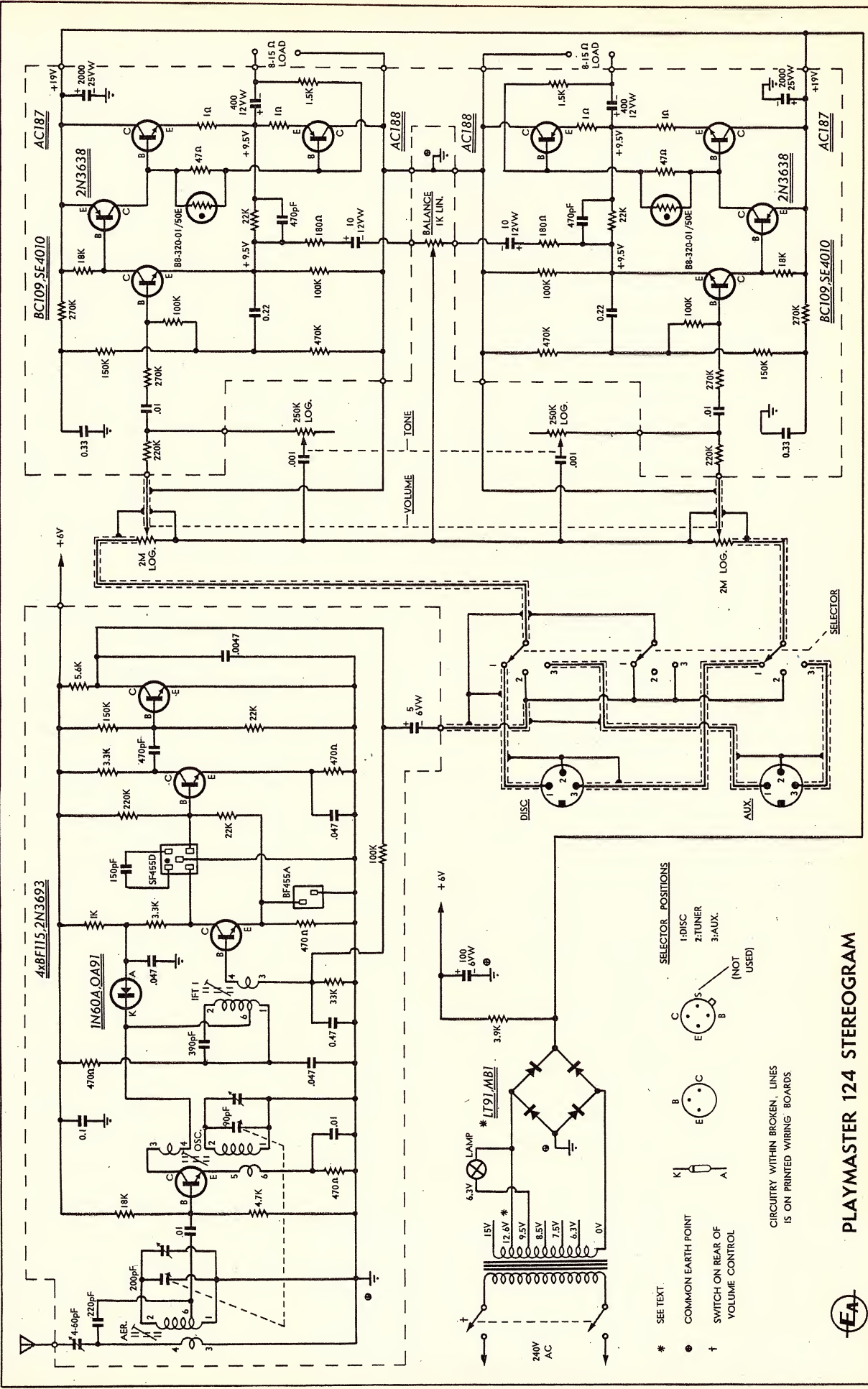

SEE TEXT.

COMMON EARTH POINT

SWITCH ON REAR OF VOLUME CONTROL

CIRCUITRY WITHIN BROKEN LINES IS ON PRINTED WIRING BOARDS

SELECTOR POSITIONS

1-DISC  
2-TUNER  
3-AUX.

(NOT USED)

SELECTOR POSITIONS

1-DISC  
2-TUNER  
3-AUX.

(NOT USED)

PLAYMASTER 124 STEREOGRAM



# arrow electronics

over 20 years  
experience  
in the Hi-Fi-business

When you've been selling and talking Hi-Fi and sound equipment for over 20 years you learn a lot. You learn it pays to sell only equipment that has proven reputation for quality and performance. Equipment that won't let you down but continues to sound great for many happy Hi-Fi years to come.

All this, plus the best value for money in town, is what Arrow can offer you.

An amazing budget system we would like you to have a look at the . . . **CRITERION MODULE.**

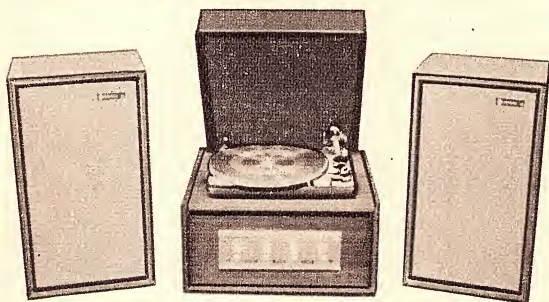

- A superb DUAL 1015 record player (manual or automatic).
- A SHURE magnetic cartridge.
- LAFAYETTE solid state amplifier with all silicon transistorised circuitry (12 watts per channel).
- Plus 2 CRITERION 50 2-way speaker systems, with separate woofer, tweeter and electronic crossover network.

## Unbeatable Value at \$300

With the hundreds of different Hi-Fi equipment combinations available at Arrow why not spend a few minutes to experiment with just a few from this impressive range  
**LEAK . . . THORENS . . . KENWOOD . . . WHARFEDALE  
DUAL . . . SANSUI . . . TANBERG . . . GOODMAN'S  
ORTOFON . . . and many more.**

Open 8.30 to 5 Mon. to Fri. 9 to 12 Sat.

**AE** **ARROW ELECTRONICS** **342 Kent St.**  
**SYDNEY**  
**NOW AT 29-6731**

Opposite 2UW between KING & MARKET Sts.

first IF amplifier, and part of the primary winding of the IF transformer.

Large incoming signals to the base of the first IF amplifier reduce its collector current because of the biasing system referred to above. This reduction in collector current causes the diode to be forward biased and it assumes a low value of resistance which shunts the tuned winding of the IF transformer.

The resulting AGC characteristic is as follows: With aerial input capacitor set to avoid overload at 100mV, a 60dB increase in signal input, from 100 microvolts to 100 millivolts, gives an increase in audio output of 10dB.

The tuning range is from 520 to 1630KHz with an intermediate frequency of 455KHz. The nominal IF bandwidth is 5KHz at 3dB. The sensitivity is such that it will give good reception of all local stations with about a foot of wire connected to the aerial terminal. A more elaborate aerial will allow reception of country and interstate stations. Note that the aerial coupling capacitor should be adjusted to avoid overload of the mixer stage. Overload will be indicated by audible distortion, by strong stations being received at several spots on the dial, or by cross-modulation—the audio signal of one station superimposed on that of another.

The tuner is powered from a 6-volt supply derived from the main supply line of the amplifier via a 3.9K resistor and 100uF capacitor. The current drain varies between about 4 milliamps at no signal to 3 milliamps on strong signals. The supply should not rise above 7 volts, as the performance will deteriorate.

Power output of the amplifier on music signal is approximately 3 watts per channel, being of a similar order to ordinary commercial stereograms and mains-operated stereo players. This order of power, together with the necessary high input impedance and overall gain is obtained with only four transistors per channel.

Of the four transistors, two are silicon types used for the voltage amplifier and driver stages, and two are germanium types serving as the output pair.

The input transistor is a low-noise silicon NPN type functioning as a common emitter amplifier. Positive current feedback applied from the emitter to base (bootstrapping) increases the effective input impedance of the stage.

Negative AC feedback and negative DC feedback is applied from the junction of the two output transistor emitter resistors to the emitter of the input transistor. The capacitor across the 22K feedback resistor rolls off the extreme high frequency response in the interests of stability. Low frequency response is determined mainly by the 10uF capacitor completing the feedback loop to earth and the 400uF output coupling capacitor to the loudspeaker.

Because all stages in the amplifier are direct coupled, the voltage at the junction of the output transistor emitter resistors is determined by the ratio of the 470K to the sum of the 150K and 270K resistors—the bias network for the input base. Normally, there should be no need to adjust this network, but the optimum setting, for those with a signal source and oscillo-

Looking down on the complete assembly. The tuner board is at top right, the amplifier at lower left. Power transformer and rectifier are at lower right. Selector switch, volume, tone, and balance controls are at top left.

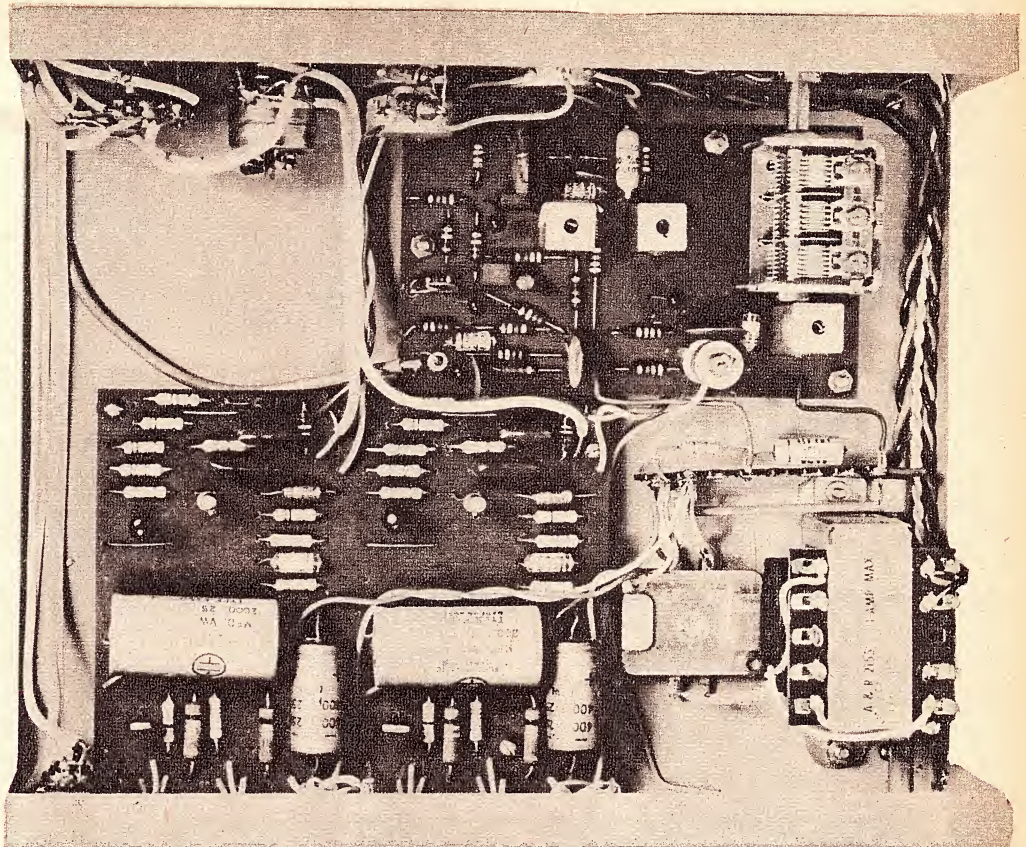

scope to hand, is for symmetrical clipping at the onset of overload.

Following the input transistor is a silicon PNP transistor which performs further voltage amplification and also acts as the driver for the output transistors. The output transistors are a complementary germanium pair, AC187/AC188 in a push-pull complementary-symmetry mode. Complementary-symmetry operation has the advantage of achieving the phase-splitting necessary for class-B push-pull operation in the output pair itself. For those not familiar with this principle a short explanation follows:

Suppose, initially, that the signal from the collector of the driver transistor is positive-going, so that both output transistor bases are driven positive. This will cause the upper (NPN) transistor to conduct and to "charge up" the output coupling capacitor via the loudspeaker load, the lower (PNP) transistor meanwhile being turned off. During the following half-cycle, as the signal becomes negative with respect to the junction of the two emitters, the upper transistor turns off while the lower one conducts and discharges the output coupling capacitor through the loudspeaker load.

Class-B operation is thus achieved, with positive half-cycles being supplied to the loudspeaker from the positive supply rail, the negative half-cycle being supplied by the subsequent discharge of the coupling capacitor.

A frequent type of distortion encountered in a class-B amplifier is "cross-over," i.e., distortion introduced at the cross-over point where one transistor turns off and the other begins conducting. This distortion can be reduced to negligible proportions by a suitable choice of "quiescent" current

for the output pair—the current under "no-signal" conditions. A suitable choice of quiescent current ensures a small overlap and a smooth transition between the state of conduction and non-conduction in each transistor.

In this case, the lower transistor is slightly forward-biased by the divider formed by the 1.5K and 47 ohm resistors. The quiescent current should be 8 to 10mA and can be set by varying the 47 ohm resistor. Adding a small resistor in series will increase the quiescent current; shunting the 47-ohm resistor will decrease the current.

Note that the quiescent current cannot be checked unless a load is connected to the output. This is because the load forms part of the biasing network for the output transistors. The load should be between 8 and 16 ohms.

Temperature stabilisation, i.e. stabilisation of the quiescent current to prevent thermal runaway and possible destruction of the output transistors is provided, firstly, by the 1 ohm emitter resistors. These provide negative current feedback and also tend to "swamp" internal resistances of the transistors, which are temperature-sensitive. A thermistor provides further stabilisation; an increase in the base current of the lower transistor (AC188) will cause the thermistor to decrease its resistance and thus bias the transistor back into a lower state of conduction.

Referring now to the control circuitry it can be seen that each channel input is connected across a 2-megohm volume control. The volume control wiper is connected to the input base via 220K and 270K resistors, with their junction connecting to a treble-cut control. Besides increasing the input impedance the resistors satisfy

another basic requirement. In a direct coupled configuration of this kind, connecting the input transistor base to earth, via a capacitor, may cause low frequency instability. These two resistors inhibit any such tendency.

The balance control takes the form of a 1K (linear curve) potentiometer which varies the feedback of each amplifier. In this form it avoids shunting of the input circuit, but it does have the somewhat academic disadvantage that it will not completely "cut-off" either channel. However, it has a range of about 5dB either way, which is ample to cope with any likely degree of imbalance. The balance control can most easily be set by playing a mono record and setting the control for equal output from the channels.

The power supply uses a multi-tapped transformer with, among others, taps at 12.6 and 15 volts, 1 amp. One of these two taps feeds a full wave bridge rectifier which feeds a 2000uF/25VW electrolytic capacitor in each channel. The quiescent power supply voltage must not exceed 19 volts if the amplifier is to be used with 8-ohm loads and 21 volts if it is to be used with 16-ohm loads.

#### DETAILS OF PERFORMANCE:

The performance of this little unit is well on a par with the amplifiers used in commercial "stereograms" and in some respects is well above them.

With a 21-volt supply the amplifier will deliver 2.5 watts music power into 16-ohm loads. Harmonic distortion was measured at 1.5% at 1KHz. With a 19-volt supply the power delivered to 8-ohm loads is 2.5 watts music power at 2% harmonic distortion, and 3 watts at 3.5% harmonic distortion at 1KHz. These music power ratings are obtain-

# WHY THROW YOUR MONEY DOWN THE DRAIN! . . . YOU DON'T?

YOU DO IF YOU ARE NOT BUYING ALL YOUR HI-FI AND AUDIO EQUIPMENT AT THE RIGHT PRICES FROM TRUSCOTT ELECTRONICS, WHERE ALL THE LEADING BRAND EQUIPMENT IS AVAILABLE. LISTED BELOW IS SOME OF OUR HUGE STOCK.

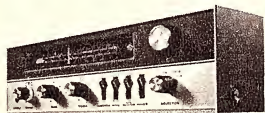

Kenwood TK20U

## AMPLIFIERS

Akai — Sound — Monarch — Lux — Fisher — Compax — Kenwood — Pioneer — Trio — Sony — Tempo — Sansui — Leak — Grundig.

## TURNTABLES

Dual — JH — Neat — BSR — PE — Compax — Labcraft — Pioneer — Goldring.

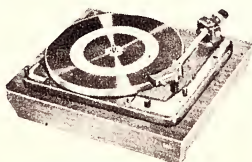

Dual 1009F



Neat G30 — Tone Arm



Neat V70 — Cartridge

## STONE ARMS & CARTRIDGES

Neat — ADC — Ortofon — All Balance — Goldring — Decca — Audio Technica — Dual — Shure — Micro.

## SPEAKERS

Soundmaster — Wharfedale — Tesla — Philips — Rola — Kenwood — Pioneer — Sansui — Akai — Leak.

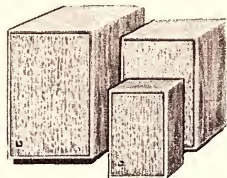

Soundmaster Speaker Systems



Tesla B46

## TAPE RECORDERS & DECKS

Tesla — Akai — Sony — National — Thorn Atlas — Julicorder — BSR — Toshiba — Sanyo — AIWA — Philips — Grundig — Tandberg — Geloso.

## ACCESSORIES

Microphones and Stands — Tape and Spools — Splicing Kits — Record care accessories — Speaker enclosure acoustic cloth and inner baffling — Headphones — Pre-packed leads — Plugs and Connectors — Head cleaning kits — Pillow Phones — Bases and covers, and many others.



## SPEEDY MAIL ORDER SERVICE

When ordering please give your full address printed in BLOCK LETTERS. All Truscott equipment is brand new and fully guaranteed. Sales tax is included in all quoted prices. All orders are despatched promptly. AVAILABLE CASH, TERMS OR LAY-BY. All prices quoted are Net. Postage and freight extra.

### NOTE:

T.M.Q. = Truscott Mail Order Quote.

## COMPONENT PARTS AND ACCESSORIES

Truscotts are stockists of all general electronic components, including resistors, capacitors, plugs and sockets, solder, scope irons and spares, hook-up cables, valves, terminals, tag strips, matrix board, cambric spaghetti, fuses, chassis, grommets, solder lugs, alligator clips, valve sockets, D.I.N. connectors, T.V. Connectors, battery savers, and also a large range of semi conductors for all Japanese makes.

## SPEAKER ENCLOSURE PADDING

Truscotts are the leading South Australian stockists of Innerbond, and Bonded Courtelle. Ensure dust free padding for your speaker enclosure. Send for a T.M.Q.

## STEREO HEADPHONES

Truscotts carry all the leading brand top quality stereo headphones, including Elegia, Akai, Sony, Pioneer, Sansui, Ashidavox, Foster, etc. Send for details and a T.M.Q.

## TAPE RECORDER AND HI-FI SERVICE CENTRE

For service on all leading brand Tape Recorders and Hi-Fi equipment—come to the experts. Truscotts modern service centre uses only the finest servicing aids, backed up by fully trained professional technicians.

## SLEEP LEARNING EQUIPMENT

All requirements for sleep learning equipment available, including Pillow Phones at \$4.50—Endless Tapes at \$8.86, and Time Clocks at \$25.00.

## ACOUSTIC SPEAKER CLOTH

Truscotts now carry over 50 top grade cloths to select from. Send now for samples and a T.M.Q.

## SAVE YOUR RECORDS . . . USE THE UNIVERSAL LUSTRE TONE ARM LIFT

This beautifully finished and functional universal tone arm lift will fit all tone arms . . . the lowering action is pneumatically dampened and extremely smooth. Risk of record damage may now be eliminated. Truscotts price only \$8.50.

## TAPE RECORDER BELTS

Belts available to suit most models of Telefunken, Uher, Philips, Cossor, Stella, Grundig, B.S.R., Ferguson, Walter and Korting recorders. When ordering, it is most essential to state the correct make and model of recorder.

## NEAT MAN—THAT'S THE WAY TO ENJOY HI-FI MUSIC

Truscott Electronics are the sole Australian Agents for Neat Hi-Fi Equipment. Available from your local Hi-Fi store or direct from agents.

Listed below are just two of the Neat range of products. Send for specifications, prices and reviews.

Neat G30. Professional Static Balance Tone Arm. A precision built unit, outstanding in appearance and simple to mount and use in any installation. The results obtained are far beyond those usually expected at such an extremely moderate price.

It will accommodate all standard cartridges and the tracking weight is easily adjusted to the particular one in use.

Review from the "Gramophone". "Notwithstanding the very modest price, the conception, construction and finish of this tone arm are first class, and equal to many arms selling at considerably higher prices."

Neat V70. Moving Magnet Cartridge.

The V70 is a top performance, high quality magnetic cartridge, that out performs many more expensive cartridges. When used with the Neat G30 tone arm, an excellent low cut continuation can be obtained. Send now for reviews of the G30 and V70, and ask for a T.M.Q.

## SENNHEISER STUDIO MICROPHONES

A full range of these famous Sennheiser Studio Microphones for amateur or professional use are now available. Send now for specifications and a T.M.Q.

## 220S MULTIMETERS

D.C. Volts 5, 25, 125, 500, 2,500.

A.C. Volts 10, 50, 250, 1,000.

Current: 250mA, 250mA.

Resistance: 0-10K, 0.1 Meg.

Truscotts Price only \$7.95.

## CAR RADIO SPECIAL-SOUNDMASTER 8

The new super sensitive push button all transistor car radio, featuring 8 trans—3W. output—push button tuning—built-in noise suppression—high quality speaker—suit any car—Truscott price only \$55.00. If aerial required add \$4.00.

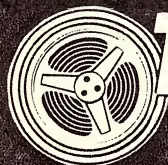

# TRUSCOTT ELECTRONICS

AUSTRALIA'S GREATEST TAPE RECORDER & HI-FI CENTRE

62-64 HINDMARSH SQ. ADELAIDE, 5000 Phone:

233024 233278

able only with an external regulated power supply or with a tone burst tester as described in "Electronics Australia" for April, 1968.

Signal-to-noise ratio was measured as -54dB with respect to 2.5 watts. This is the ratio of residual noise to 2.5 watts, obtained with volume and tone controls at full gain (fully clockwise) and the balance control centred (for equal gain in both channels) and with open-circuit input. The residual noise consisted mainly of low frequency transistor noise and was reduced at lower settings of the volume control. The amplifier is very quiet, and at full gain one has to listen close to the speakers to detect any noise even with high-sensitivity speakers.

Separation between channels was measured as -38dB with respect to 2.5 watts at 1KHz and as -30dB with respect to 2.5 watts at 10KHz. This was measured with one channel driven to full power at the same control settings as above and with open-circuit input for the idle channel.

Measured at an output of 1 watt, the response is level over the major portion of the audible range, tapering to -3dB points at 25Hz and 15KHz.

Input required for full output is about 420mV. To ensure adequate level from lightly recorded tracks, it is best to use the amplifier with a stereo crystal cartridge or one of the ceramic cartridges having reasonably high signal output.

In the near future we may publish details of an add-on preamplifier, possibly using field-effect transistors, which will enable lower output cartridges such as the Decca Deram and Connoisseur to drive the amplifier to full power.

Apart from being used with loudspeakers, the amplifier is suitable for use with low impedance stereo headphones. High impedance headphones may also be used but the amplifier should be terminated with a suitable resistive load in parallel with the headphones, e.g., 33 ohms. Disconnecting the load while power is applied to the amplifier will not cause any damage but short-circuiting the outputs may ruin the output transistors.

This raises the question of incorporating circuitry to protect the output transistors from possible damage. This was considered in the development of this unit and the original 3-Plus-3 Stereo amplifier on which it is based. We decided that the extra cost and complication of the protection circuitry was not justified for several reasons. Firstly, the output transistors sell at quite a low price. Secondly, the necessary sensing resistors would reduce the available power output. Provided normal caution is taken when using the amplifier there is little risk of transistor damage.

Normal caution involves ensuring that the speaker leads are properly terminated, with no loose strands to cause short circuits, avoiding experiments which might result in a very low resistance across the speaker terminals, and switching off the amplifier before changing connections to it.

If readers care to experiment with output protection circuitry a suitable circuit was published in the "Reader Built It" feature in the March 1969 issue of Electronics Australia. This uses a sensing resistor in the negative supply line of the amplifier. If the current drain exceeds a certain pre-

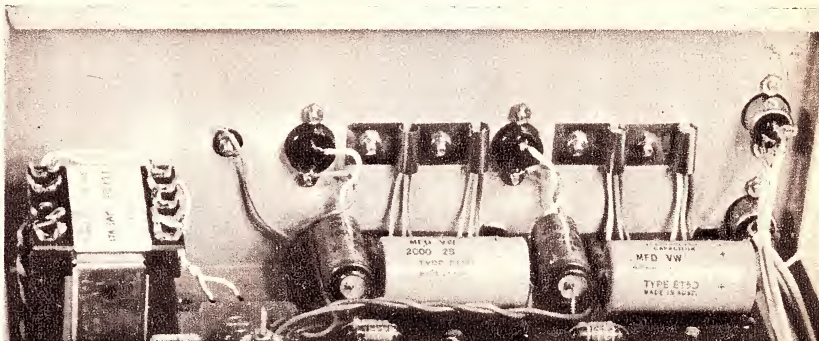
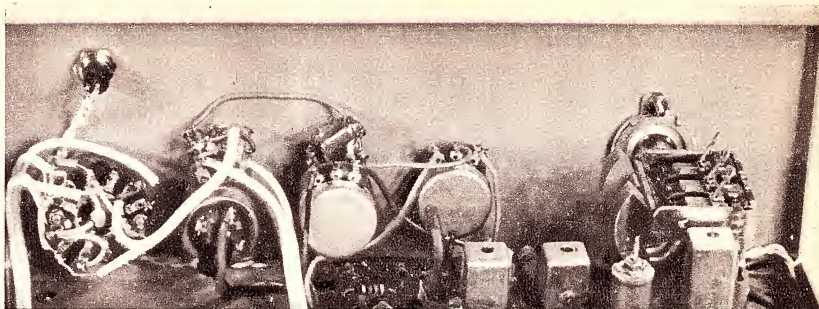

Upper picture shows the rear of the front panel. The selector switch is on the left, then come the volume, tone, and balance pots. The tuning capacitor is at right. The lower picture shows an inside view of the rear panel. Note particularly the four heat sinks belonging to the four output transistors.

## PARTS LIST

- 1 Chassis with overall dimensions, 10½ x 8½ x 3¼in.
- 1 Metal cover with dimensions to suit chassis (optional).
- 1 Front panel.
- 1 Label dial movement with 6:1 reduction ratio.
- 1 Power transformer, with secondary tapped at 6.3, 7.5, 8.5, 9.5, 12.6 and 15 volts AC at 1 amp DC (A and R 2155 or equivalent).
- 2 3-pin DIN sockets.
- 2 2-pin polarised sockets, plus plugs.
- 2 Printed boards, 68/a8 and 69/5t.
- 1 3-gang padderless tuning capacitor, with trimmers (Roblan 200pF-90pF-200pF).
- 1 Philips trimmer, 4-60pF.
- 1 Aerial coil, Aegis or similar.
- 1 Oscillator coil, Aegis or similar.
- 1 I.F. Transformer, Aegis ST45C or similar.
- 2 Ceramic filters, SF455D and BF455A.
- 1 3-position, 3-pole rotary switch.
- 1 Spring-loaded terminal (Aerial).

### CAPACITORS (Higher voltage ratings may be used)

- 2 x 2000uF/25VW electrolytic (pig-tail type).
- 2 x 400uF/12VW electrolytic.
- 1 x 100uF/6VW electrolytic.
- 2 x 10uF/12VW electrolytic.
- 1 x 5uF/6VW electrolytic.
- 1 x 0.47uF/25VW ceramic or metalised polyester.
- 2 x 0.33uF/25VW ceramic or metalised polyester.
- 2 x 0.22uF/25VW ceramic or metalised polyester.
- 1 x 0.1uF/25VW ceramic or metalised polyester.
- 3 x 0.047uF/25VW ceramic or polyester.
- 1 x 0.01uF ceramic.
- 3 x 0.01uF ceramic or polyester.
- 1 x .0047 ceramic.
- 2 x .001uF ceramic or polyester.
- 3 x 470pF polyester or polystyrene.
- 1 x 390pF polystyrene.
- 1 x 220pF polystyrene.
- 1 x 150F polystyrene.

### SUNDRIES

- 4 turned aluminium knobs, 4 ¼in. fibre rod spacers (tapped ¼in. Whit.), 3 ½in. spacers (to mount tuner board), 4 rubber feet, 1 8-terminal tagstrip with two mounting feet, mains cord and plug, mains cord clamp, grommet, miniature bezel and lamp, dual shielded cable, spaghetti sleeving, hook-up wire, screws, nuts, solder, etc.

### POTENTIOMETERS

- 1 x 2M (log) dual ganged, with rotary power switch.
- 1 x 250K (log) dual ganged.
- 1 x 1K (lin.).

### RESISTORS

(¼ or ½ watt unless specified)

# SONY TC-230 *Not just a tape recorder...*



*... a compact, portable stereo music control centre*

## SPECIFICATIONS

**Recording system:** 4-track stereo/mono recording and playback. **Power requirements:** 240V, 50, 60 Hz, AC 60W. **Tape speed:** 7½ ips, 3¾ ips, 1½ ips. **Frequency response:** 40-18,000 Hz at 7½ ips • 40-12,000 Hz at 3¾ ips • 40-6,000 Hz at 1½ ips. **Signal-to-noise ratio:** Better than 46 dB. **Flutter and wow:** less than 0.17% at 7½ ips • less than 0.3% at 3¾ ips • less than 0.4% at 1½ ips. **Harmonic distortion:** less than 3% at OdB line output. **Recording time (1,800' tape):** 4-track stereo 1.5 hrs. at 7½ ips • 3 hrs. at 3¾ ips • 6 hrs. at 1½ ips. **Power output:** 4Wx2. **Inputs:** Rec/PB connector—impedance approx. 10K ohms • Microphone inputs—sensitivity—75dB (0.14mV) impedance 600 ohms • Phono inputs—sensitivity—52.5dB (2mV) • Tuner (auxiliary) inputs—sensitivity—25dB (44mV) impedance approx. 100K ohms. **Outputs:** Line outputs—output level PB 3dB (1.1V) Rec. 1dB (0.87V) • Load impedance 10K ohms • External speaker outputs—11.3dB (2.83V) impedance 8 ohms • Headphone outputs—impedance 8 ohms or more • Rec/PB connector—impedance approx. 3.5K ohms.

## FEATURES

Call the TC-230 an integrated stereo amplifier with a built-in tape recorder, or a tape recorder with a built-in stereo amplifier—either way you have the most advanced, compact, solid state stereo tape and music system to ever come along. In addition to a complete 4-track stereo monophonic tape recording and playback system, this versatile TC-230 features the exclusive stereo control center consisting of a multiple input stereo preamplifier and 4Wx2 stereo power amplifier. Just connect your stereo tuner, stereo changer or turntable to the TC-230, and you are free to choose instantly, with just a flick of the selector switch on the front panel, either listening or recording source from any of the connected components. The TC-230 literally gives you convenience and versatility—designed also for travel use, its two high-compliance speakers are installed in the two split-lids which can be separated up to fifteen feet for optimum stereo effect. Features include • 3 speeds • 7" reel capacity • dual VU meters • automatic shut-off switch • digital tape counter • contemporary style, pale grey heavy-duty vinyl-finished case with aluminium trim • handsome front panel in gleaming chrome and black.

# SONY®

Distributed by:

**jacoby, mitchell & co.pty. ltd.**

SYDNEY • MELBOURNE • BRISBANE • ADELAIDE

To: Jacoby, Mitchell & Co. Pty. Ltd., 469-475 Kent St., Sydney, 2000  
Please send me information on Sony Tape Recorders

Name.....

Address.....

JMS/4-69/EA569







# You build the boxes . . . Pioneer supply the speaker kits . . . for only \$140

FOR ONLY \$70 EACH YOU CAN OWN TWO PIONEER TOP QUALITY SPEAKERS -

PIONEER'S AS-303A custom speaker kit makes up to the equivalent of the famous Pioneer CS-77 bookshelf speaker. It comprises 12" woofer, 5" cone type squawker, and a rectangular bell horn type tweeter, and all other components for a speaker system including crossover networks, level controls, padding and all necessary nuts and bolts.

All that need be done is assembling an enclosure with available materials, and then installing the components of the AS-303A into your 2 boxes, and a superb speaker system is completed.

Also available is model AS-305A 'do-it-yourself' kit for a custom 12-inch 3-way 5-speaker system for use in high fidelity sound systems. **PRICE \$105 EACH**

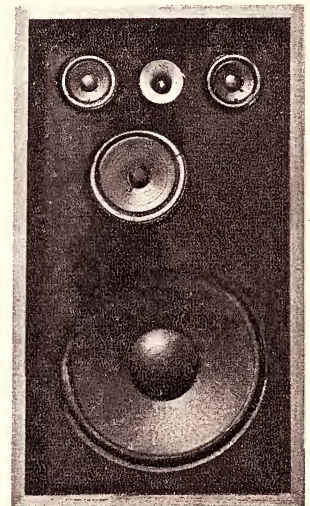

**PIONEER**  
THE QUALITY NAME IN HI-FI EQUIPMENT.

ASK YOUR NEAREST OFFICE OF ASTRONICS AUSTRALASIA FOR YOUR LOCAL AUTHORISED PIONEER DEALER.

when the Disc or Auxiliary input is in use.

An important point concerns the connections between, and "earthing" of, the various sections of cable shielding making up the input wiring. As indicated by both the circuit and the wiring diagram, the various sections of shielding are connected together, but are "earthed" at only one point. This is to minimise any possibility of earth loops.

Two 3-pin DIN sockets are provided for the Disc and Auxiliary inputs and these are connected to the selector switch via shielded cables. We used "figure 8" twin shielded cable which facilitates neat wiring. The shield for each channel input is connected to the centre pin (pin 2) of each socket but no connection is made to the outer case of the socket.

The only connection to chassis from each amplifier channel is from the board to an 8-terminal tagstrip which also terminates the output from the bridge rectifier and accommodates the 3.9K resistor and 100uF capacitor for the tuner supply.

The power transformer used in the prototype was made by A&R, type 2155. The voltage from the 12.6 volt tap at no load is normally just over 13 volts with 240 volts mains input, which gives a good margin for mains supply variations.

Readers who want the maximum power available for 16-ohm loudspeakers may use the 15-volt winding but only with due attention to the DC output. If the DC supply voltage exceeds the required values of 19 or 21 volts (dependent on loudspeaker load to be used) a bleeder resistor of suitable power rating must be connected across the output of the rectifier to reduce the voltage to the stated value under quiescent conditions.

The bridge rectifier we used was a selenium type, Westinghouse LT91, which sells at a very economical price. As an alternative, an encapsulated silicon bridge rectifier, type MB1, is marketed by STC; it is more compact than the LT91, but there is a price difference of almost one dollar. The LT91 is mounted on the chassis, underneath the volume control/power switch, by means of two 1/8in Whitworth screws and nuts. The MB1 bridge may be mounted similarly by means of one screw.

A 6.3 volt pilot lamp is used, running at reduced voltage to extend its life and to lessen the possibility of hum being induced into the control wiring. It is connected between the 12.6 and 9.5 volt taps on the transformer via a pair of twisted wires.

For the dial we discarded the usual dial cord/drum arrangement in favour of a "hand-span" rotary dial with a six-to-one reduction movement. It is made by Jackson Brothers and available from most trade houses. This dial kit also includes an adhesive dial scale which we discarded. In our units the dial scale is incorporated with the front dress panel. Ours was marked in Kilo-hertz and also carried the major N.S.W. broadcast station call-signs. Kit suppliers will probably have available panels which show the major call-signs for most of the States.

The use of a handspan dial eliminates the need for expensive cut-outs in the chassis and greatly simplifies the assembly. The result is a silky-smooth tuning movement.

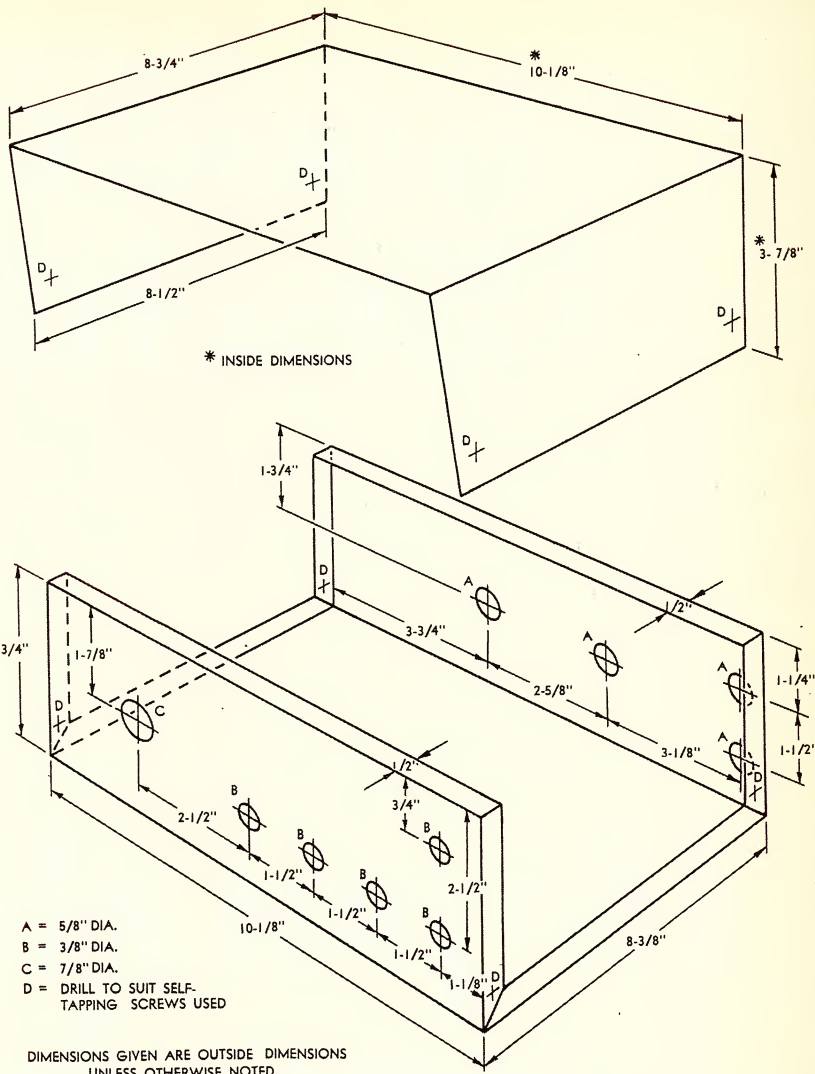

*This drawing gives all necessary dimensions and instructions for the metal chassis and cover. Ready-made versions should be available.*

A suitable order of assembly would be as follows:

First, wire all the components and hook-up wires into the boards, making sure that the hook-up wires are of sufficient length. Do not bend the pig-tails too close to the bodies of the components otherwise they may fracture.

Having wired the boards attention can be turned to the chassis. The rubber feet are retained with a screw and nut, the nut being held in the foot itself. The potentiometer and selector switch shafts should be cut to suit the knobs. Having installed the controls and input sockets, transformer and rectifier, etc., the appropriate wiring can be installed. The mains cord should be passed through a grommetted hole in the rear of the chassis, then between the chassis side flange and the transformer stack and finally terminated at the switch/pot. It is anchored by a clamp, which is held by the same screw which retains one of the transformer lugs and the tagstrip for the rectifier and earth terminations.

The reduction movement for the dial is mounted behind the front panel by means of two countersunk 1/8in Whitworth screws and nuts. To ensure that

the dial mounts as close as possible to the front panel, the reduction drive is spaced away from the rear of the panel by the thickness of one nut. The hole in the front panel to accommodate the drive is 7/8in diameter.

The tuner board can now be mounted on the chassis by means of three 1in long 1/8in Whitworth screws and nuts. It is spaced off the chassis by 5/8in by means of rod spacers. Careful attention must be paid to the correct positioning of the board, otherwise the reduction movement may bind in some parts of its travel.

Next, the amplifier board may be installed. It is mounted on four half-inch insulated spacers. The flag heat-sinks should be secured firmly to the chassis as detailed earlier. Connection between the board and other components can then be made.

Finally, the front panel and knobs can be fitted. The perspex dial is attached to the reduction movement by means of two small screws, and a suitable knot fitted to the tuning shaft. Those readers who find the selector switch difficult to operate with the small diameter knob may improve the "action" by lessening the spring tension on the ball-bearing in the clicker

# Good old Hirschfeld.

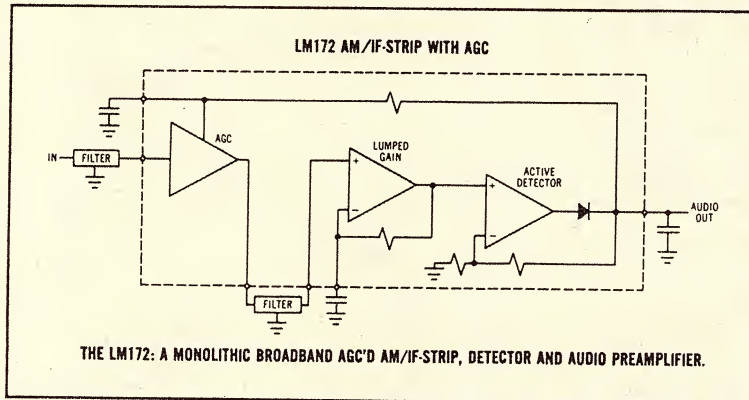

# He put all this on a chip.

## National Semiconductor

When Bob Hirschfeld came up with a monolithic IC that replaced a lot of transistors, coils and other things, we werewhelmed. It's an AGC'd AM/IF-strip at any center frequency up to 2 MHz. Or, if you prefer, it's a complete TRF receiver for the AM broadcast band or for getting a fix on any of the aeronautical/navigational frequencies below 2 MHz. Its full mil temperature range and extremely low power dissipation make today's conglomerations of cans and gadgetry look pretty old fashioned.

Now that it's on all our distributors' shelves at \$12.95 for the mil temperature range LM172 and \$4.95 for the commercial communications LM272 (100 quantities), we're a bit more blase. But still impressed. Call or write for the full impression. Bob will like that.

**Rutherford Electronics Pty Ltd,**

833 DONCASTER ROAD, DONCASTER. TELEPHONE 848 3033  
P.O. BOX 30, NORTH BALWYN, VICTORIA, AUSTRALIA. 3104  
Sydney 61-2148. Adelaide 23-2703.

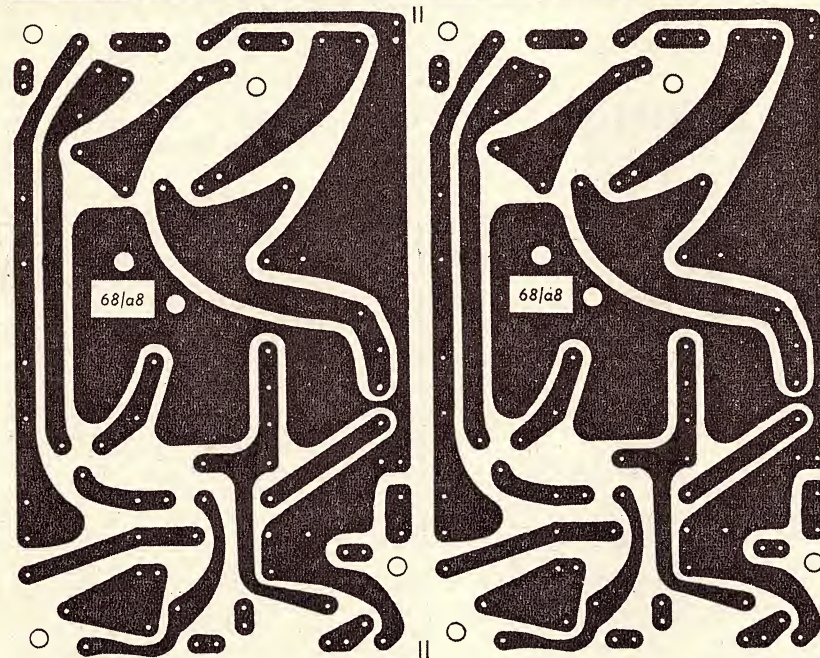
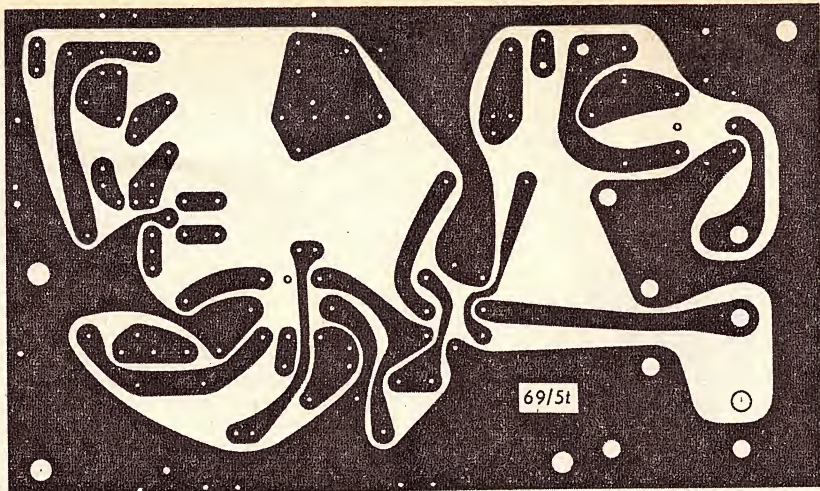

Printed wiring board patterns for the tuner (upper) and the amplifier (lower). These are slightly under full size. The tuner board measures 5in x 3in, the amplifier 5½in x 4½in.

plate. This is easily done with a screw-driver.

**ALIGNMENT:** First, see that the gang is fully meshed and set the dial so that the diametrical mark lies along the horizontal line on the dial scale. Tighten the two grub screws which secure the shaft of the gang to the reduction movement.

A rough alignment can be made using only one's ear to judge the setting of various adjustments, but much better results can be achieved by using a meter to indicate signal strength. If you have a multimeter available, connect it in series with the positive line from the tuner to the power supply. The total drain is between three and four milliamps and so the multimeter will be set to, say, the 10 milliamp range.

One precaution that must be taken if the current monitoring method is used is that the meter must not be connected after the amplifier has been turned on, otherwise the full supply voltage of about 18 volts will be applied to the tuner with the possibility of damage to the transistors.

Switch on, connect a suitable length

of wire to the aerial terminal and tune in a station. Adjust the aerial coupling capacitor so that the tuner is not overloaded, as detailed earlier. Adjust the slug in the IF transformer for maximum audio output. This will automatically tune the IF transformer to 455KHz as the ceramic filters are centred on this frequency. This is the only adjustment required within the IF system.

Now tune to a station around 600KHz. Adjust the slug in the oscillator coil until the station occupies the correct position on the dial. Then adjust the slug in the aerial coil for maximum signal strength. Tune another station around 1300KHz and adjust the oscillator trimmer (on the centre section of the gang) so that the station occupies the correct position on the dial. Adjust the aerial trimmer (the section of the gang nearest the aerial coil) for maximum signal strength. These adjustments should then be repeated. Frequency coverage is 520KHz to 1630KHz.

So there it is. An economical little tuner-amplifier which is easy to build and will give years of pleasure.

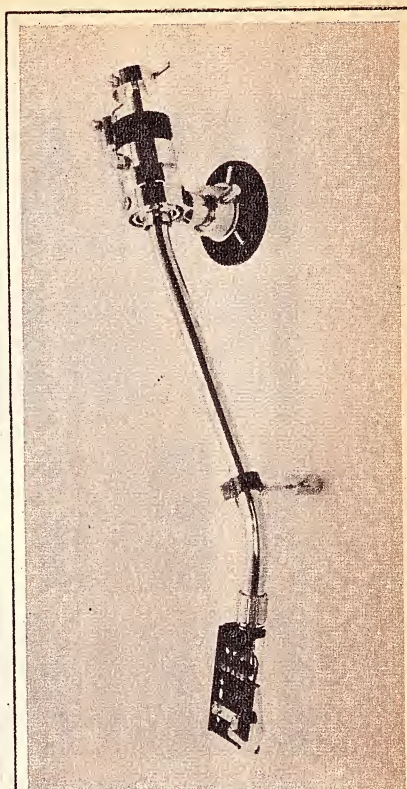

### A NEW MODEL GRACE ARM NOW AVAILABLE!

Although available only a few months, Grace tone arms are already prized by the audio enthusiast. The new Model G-545 is a winner . . . it features a gimbal type gyroscopic bearing and will track down to ¼ gram with suitable stereo cartridges. A super light-weight head shell is supplied; the new arm shape reduces tracking error to the point where it may be disregarded. Ask for prices or write for an EMQ.



### GRACE LIFTS REMOVE THE RISKS!

Handling delicate cartridges and arms requires some dexterity and the softer touch. The new Grace lift matches all Grace arms, is velvet-smooth and may be regarded as a precision instrument. Ask for prices.

### NEW GRACE STEREO CARTRIDGE

The Model F-8M has an output of 7 mV, and a frequency response of 5-35,000 Hz. Cross talk is less than -30 dB. at 1 kHz. An elliptical diamond stylus (0.2 x 0.8 mil.) is standard equipment and tracking force is ½-2½ grams. Weight of the cartridge is 6½ grams. Performance equals many cartridges selling at twice the Encel price. Write for full details and prices.

# Encel

**ELECTRONICS  
(STEREO) PTY. LTD.**

Head Office:  
431 Bridge Rd., Richmond, Victoria 3121.  
Tel. 42 3762.

Sydney Store: Ground Floor, 2SM Building,  
257 Clarence Street, Sydney, N.S.W. 2000.

Tel. 29 4563, 29 4564.

\*Wholesalers \*Trade-ins accepted

Australia's Greatest Hi-Fi Centre

# TESLA IS MAKING A BIG EXHIBITION OF ITSELF!



## DON'T MISS IT!

This month from May 26th-30th you can see the greatest show of Czechoslovakian Electronic Equipment ever assembled in Australia. It's at the Exhibition Buildings Melbourne. See some of the world's most advanced equipment including tape recorders, hi-fi amplifiers, loud speakers, 2 way radio control equipment, telephones, electronic components, meters, X-ray equipment and the Unitutor.

**Computerized teaching machine on display** This is something that has to be seen to be believed so we'll just say there's virtually nothing the Unitutor can't teach you. It is a computerised machine which can be programmed to teach by sight and sound. See it in operation at the show.

## FREE PASSES

Write to Charmac Pty. Ltd., stating the name of your company or institution for your free Trade Pass to the 1969 International Instruments, Electronics, Automation, Control Equipment and Communication Show. Early requests will receive priority.



## CHARMAC PTY. LTD.

Representatives for Tesla Czechoslovakia  
33 BRIDGE STREET, ELTHAM 3095. 439 9517

CH/443

## STARTING: a new series

Commencing opposite is the first of a brand-new series of articles which we are presenting under the title **Fundamentals of Solid State**. Written by Technical Editor Jamieson Rowe, who also wrote our popular book "An Introduction to Digital Electronics," the new series is designed to present for readers a detailed, thorough, up-to-date and — especially — a **readable** explanation of both the operation and applications of diodes, transistors, unijunctions, FETs and the many other exciting solid state devices which have revolutionised modern electronics.

Because a useful and satisfying knowledge of solid state devices and their operation must be based upon a clear understanding of electrical conduction and its relationship to the atomic structure of matter, as these are currently understood, **Fundamentals of Solid State** takes no risks that the reader might be misled, frustrated or hampered by an out-of-date conception of this important basic knowledge. It starts right from the beginning, carefully developing a "foundation" of basic concepts which are then expanded and built upon logically and progressively.

It may perhaps seem surprising that we are presenting **Fundamentals of Solid State** in 1969, when transistors and other semiconductor devices are now around 20 years old and have become established — even dominant — in almost every field of electronics. Fact is, however, that there is still a very significant proportion of experimenters, amateurs, technicians and even engineers whose knowledge of these devices is embarrassingly weak. And it would seem that a major reason for this is that there has been a severe shortage of really helpful literature.

**Fundamentals of Solid State** will, we hope, correct this situation. While thorough and businesslike, with the aim of providing the reader with a really useful and satisfying knowledge of the subject, it will be basically a non-mathematical treatment with the emphasis first and foremost on clarity and understanding.

Those who intend to progress to a full, detailed mathematical knowledge of solid state device physics and circuit analysis may well find the treatment useful as an introduction; we certainly hope that this is the case. However the main aim, and we think it an important one, is to assist the many people who have hitherto found only frustration in their efforts to gain at least a clear and satisfying insight into the subject at basically "qualitative" level. To these people we say: Read on, and stay with us, for this series is being written for YOU!

# Fundamentals of SOLID STATE

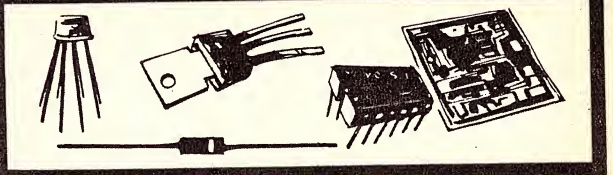

## Chapter 1

by Jamieson Rowe

Introduction — modern concept of the atom — electrons as both particles and waves — "allowed" orbits — electron energy and energy levels—energy level capacities—valence —excitation and energy "quanta"—radiant energy as both waves and particles.

The concept of an atom as a micro-miniature "solar system" is a familiar one to most people in electronics. According to this picture, atoms consist of a central and relatively heavy nucleus having a positive electrical charge, around which orbit smaller, lighter and negatively charged electrons whose number is such that in the "normal" state the atom carries zero net charge. For each of the chemical elements, the atomic nucleus has particular values of mass and positive charge, and is accompanied in the "normal" state by the appropriate number of orbiting electrons.

Consistent with this picture is the idea that electrical conduction is a mechanism in which an applied electric field causes outer orbiting electrons to be freed from their atoms, whereupon they can wander through the material to form the traditional "current flow." Conducting materials such as metals are thus understood as materials in which the outer electrons are "loosely bound" to the atomic nuclei, while insulating materials are in contrast those in which the electrons are "tightly" bound, and unable to wander.

For many years, this simple and quite easily grasped concept of atomic structure and its relationship to electrical conduction proved quite satisfactory for most purposes. It was generally adequate, for example, for an understanding of the operation of thermionic valves and the circuits in which they were used. However as science, and consequently technology, progressed it was found increasingly that the simple picture could not adequately explain many of the new discoveries. It became necessary, as with so many scientific concepts, to both revise and expand our conception of atomic structure, and with it our understanding of electrical conduction.

Hence it is that, in order to gain a clear knowledge not only of the mechanisms of electrical conduction as it is currently understood, but also and in particular of the operation of the many different semiconductor devices which are used in — and have virtually revolutionised — modern electronics, one must begin by becoming acquainted with the atom as it is now pictured.

Unfortunately, perhaps, a full understanding of modern atomic theory and the physics of electrical conduction requires a thorough grasp of the abstract and highly mathematical science of Quantum Mechanics; and this is beyond many professional en-

gineers. However a full understanding in this sense is really only necessary to the scientist, research student and device development engineer. A somewhat more limited understanding at a basically "qualitative" level is usually found both adequate and satisfying for most other purposes, including that of preparation for further detailed study. It is at this level that the following treatment is pitched.

Perhaps the first thing to be noted about the modern view of the atom is that it is somewhat more "fuzzy" than before, and in consequence it tends to be less satisfying. Although disconcerting, this must unfortunately be accepted as a fact of life. The fact is that the apparent clarity of the simple "solar system" picture was an illusion, with no real justification on the basis of our actual knowledge.

We are unlikely to know for some considerable time, if indeed we will ever know, the "real" nature of electrons and other sub-atomic "particles," or of such fundamental things as mass, energy, time, electric and magnetic fields, and electrical charge.

The modern picture of the atom and its behaviour tries to take this lack of knowledge into account. In producing a theory which "works," in the sense that it can satisfactorily explain most of the little we do actually know, it aims at the same time at preventing us from kidding ourselves that we know more than this!

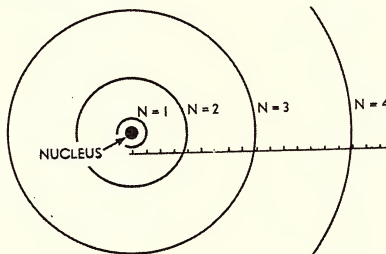

ALLOWED ELECTRON ORBITS  
(N = QUANTUM NUMBER)

Figure 1.1

At this stage the reader may well be wondering if the modern picture of the atom bears any resemblance at all to the simpler one. The truth is that there is a resemblance, although only a general one.

In broad terms, the atom may still be pictured as consisting of a central positively charged nucleus, surrounded by a number of negatively charged electrons. As the nucleus plays no

more than a nominal part in electrical behaviour, we need not concern ourselves here with its structure. Suffice to say that it is just as well that this is the case, because the closer physicists examine the nucleus, the more complex does it seem to become!

The electrons are still held to be the components of the atom which are responsible for its electrical and chemical behaviour. However, they can no longer be regarded simply as tiny physical particles orbiting around the nucleus, nor can the part which they play in electrical conduction be pictured as a straightforward one where-by an electric field "loosens" those in the outermost orbits and whisks them along to form a current flow. As with the nucleus, the closer the electron and its behaviour are examined the more complex—and in this case, the more elusive—does it become.

It has been found that, in some circumstances, the behaviour of electrons can indeed only be explained by visualising them as small particles. Yet, equally, there are other situations in which their behaviour can only be explained as consistent with that of small bursts of oscillations or "waves" of a type similar to, but different from, those responsible for sound, heat and light. In other words, an electron must now be regarded as a somewhat vague thing which sometimes behaves as a physical particle, and at other times alternatively behaves as a "packet" of some sort of waves.

As it happens, it is the wave aspect of their "personality" which seems to play the major part in determining the behaviour of electrons as they surround the nucleus of an atom. So that in place of the simple picture of a number of electron "planets" orbiting around the nucleus, we must now try to visualise a system of spherical and elliptical "surfaces" at various distances from the nucleus, and each somewhat fuzzy and indistinct because of wavelike variations over the perimeter.

Whereas it would appear that, at the more familiar macroscopic level, planets may orbit around a sun at virtually any radius providing they have the appropriate orbital velocity, this does not occur in the microscopic level of the atom. Electrons are only able to "orbit" (the term is still used, for convenience) around the nucleus at certain definite radii. In terms of the wavelike aspect of the electron these radii can be interpreted broadly as those whose perimeter corresponds to an integral (or whole-number) multiple of a compatible electron "wavelength."

Although this concept may seem strange and rather hard to accept, the full reasoning behind it is quite abstract and involves mathematical "gymnastics" which we cannot deal

# SANWA

SANWA ELECTRIC  
INSTRUMENT CO. LTD.

## Top value, protected MULTI-TESTERS

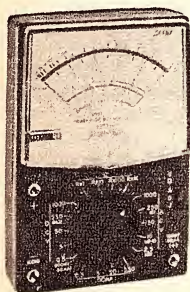

MODEL  
U-50D  
**\$19.00**  
INCL. S.T.

The Model U-50D is a pocket-size, high performance circuit tester equipped with a meter movement of 35 microamperes in sensitivity.

The high internal resistance of 20k ohms per volt for DC and 8k ohms per volt of AC ranges accurately measures voltages of high impedance circuits. A protection circuit safeguards the meter movement. Shunt adaptors are available to give ranges up to 25 amperes DC.

#### Measurement ranges available

DC voltage: 0.1v, 0.5v, 5v, 50v, 250v, 1000v (20k  $\Omega/v$ )

AC voltage: 2.5v, 10v, 50v, 250v, 1000v (8k  $\Omega/v$ )

DC current: 50 $\mu$ a, 0.5ma, 5ma, 50ma, 250ma

Resistance: From 50 ohms to 50k ohms in four ranges

Volume level: — 20~ + 62db

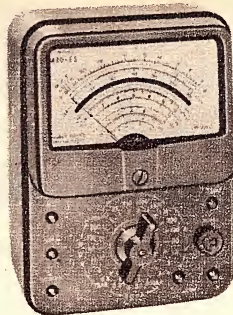

MODEL  
430 ES  
**\$53.50**  
INCL. S.T.

This unit has a 10 micro-ampere movement giving sensitivity of 100k ohms/volt for all DC ranges to 300 volts. The movement is supported by spring backed jewels and is protected by a parallel diode. Frequency response is to 100 KHZ.

#### Measurement ranges available

DC Voltage: 0.3v-3v-12v-30v-120v-300v (100k $\Omega/v$ )

1.2kv-6kv-30kv (with probe) (16.6k $\Omega/v$ )

DC Current: 12ma-0.3ma-3ma-30ma-300ma-1.2a-12a-300mv

AC Voltage: 3v-12v-30v-120v-300v-1.2kv (5k $\Omega/v$ )

AC Current: 1.2a-12a

Resistance: Up to 50 megohms (40 ohms to 400k ohms midscale)—decibel scale is provided

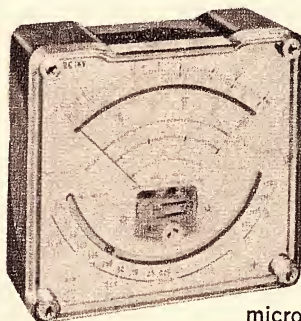

MODEL  
F80 TRD  
**\$33.40**  
INCL. S.T.

The high-sensitivity suspension band movement of 34.5 microampere is frictionless and accurate. Structurally, the moving part is shock-proof, withstanding impact and vibration. Ranges are smoothly changed over by a unique designed rotary-ring switch. The meter movement is automatically protected from accidental impression of high current. The LI and LV scales provided check all types of semi-conductors. The germanium diode rectifier extends frequency response of the low AC voltage ranges up to 100k cycles. Even the AC 250 volt range checks voltages of 20k cycles.

#### Measurement ranges available

DC voltage: 0.25v, 2.5v, 10v, 50v, 250v, 500v, 1000v (25k  $\Omega/v$ )

AC voltage: 2.5v, 10v, 50v, 250v, 500v, 1000v (5k  $\Omega/v$ )

DC current: 40 $\mu$ a, 0.5ma, 5ma, 50ma, 500ma

Resistance: From 100 ohms to 250k ohms Midscale in four ranges. Load current: LI — 15ma, 1.5ma, 150 $\mu$ a

Load voltage: LV — 1.5v

Volume level: — 10~ + 10db, + 5~ + 36db

AVAILABLE EX STOCK FROM



**WARBURTON FRANKI**

ADELAIDE: 56-7333. BRISBANE: 51-5121.  
HOBART: 2-1841. LAUNCESTON: 2-1318.  
MELBOURNE: 69-0151. MT. GAMBIER: 2-3841.  
NEWCASTLE WEST: 61-4077. PERTH: 8-4131.  
SYDNEY: 29-1111. WOLLONGONG: 2-5444.



with here. However, for the present it may help to compare the situation with the more familiar one involving the production of standing waves in a stretched string: waves can only occur at frequencies at which the string length corresponds to a single wavelength, two wavelengths, three wavelengths, and so on.

The electrons of an individual atom, then, can only occupy orbits corresponding to certain "allowed" effective radii. This is illustrated by the diagram of figure 1.1. As may be seen, the various possible orbits are each assigned a so-called **quantum number**, commencing at "1" for the innermost. The effective radius of the orbits increases with the square of the quantum number, i.e., 1 unit, 4 units, 9 units, and so on.

Some idea of the size of the orbits may be gained from the fact that the innermost or  $N=1$  orbit corresponds to an effective radius of approximately  $5 \times 10^{-11}$  metre, or about 50 million-millionths of a metre.

Associated with each possible orbit is a corresponding energy level; i.e., an electron occupying a particular orbit will have a particular amount of energy. This will consist of both the kinetic or "motional" energy associated with its orbiting momentum, together with the potential or "latent" energy which it possesses by virtue of its position in the electric field surrounding the nucleus.

Because of the opposite charges of electrons and nuclei, an electron is attracted to the nucleus with a force which varies inversely with the square of its distance from the nucleus centre. In view of this, an electron at a particular point in the electric field surrounding the nucleus has a positive potential energy with respect to that nucleus, and at the same time a negative potential energy with respect to any point more distant from the latter.

If these polarities seem wrong, remember that positive potential energy corresponds to the ability to perform work or release "internal" energy, while negative potential energy implies a need for energy to be externally supplied.

From the point of view of the electron, therefore, the vicinity of the nucleus represents an area of lower or "more negative" potential energy than elsewhere. In fact the field around the nucleus forms what may be visualised as a potential energy "pocket" or well, with the nucleus at its centre and the "sides" sloping exponentially. Viewed in this light, a free electron wandering near the nucleus and attracted to it effectively "falls into the well." These ideas are illustrated in the diagrams of figure 1.2.

According to this view, an electron which is orbiting around the nucleus does so (rather than "fall") by virtue of its orbital momentum — in effect, it "rolls around" the walls of the potential energy well at a sufficient speed to prevent itself from falling. An orbiting electron thus possesses a positive kinetic energy, and because the required orbital momentum increases with decreasing effective orbit radius, the kinetic energy similarly increases. In fact it turns out that the positive kinetic energy follows the same exponential curve as that of the negative potential energy, but with opposite sign and with an amplitude half as

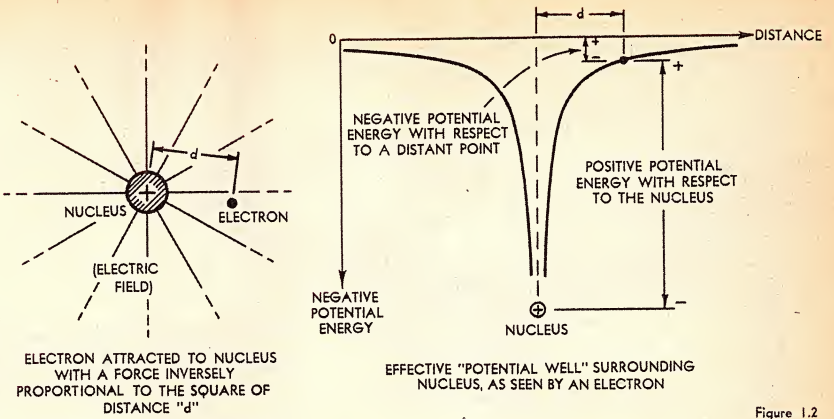

Figure 1.2

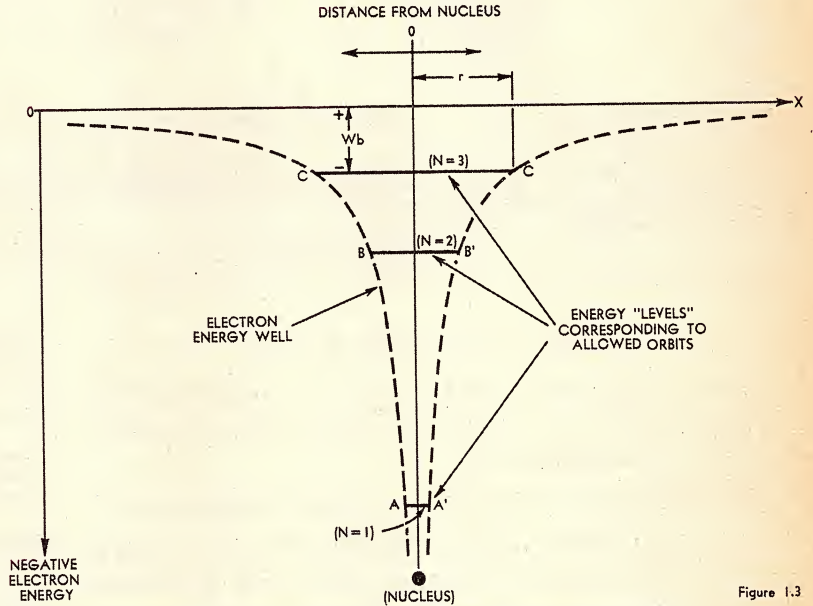

Figure 1.3

great if spherical orbits are considered.

As the total energy of an orbiting electron consists of the algebraic sum of its potential energy (negative) and its kinetic energy (positive), and both these follow exponential laws with the former larger than the latter, the total energy will thus be negative and will also follow an exponential. In short, the vicinity of the nucleus represents for orbiting electrons a **total energy well**, similar to that for potential energy but "less deep." A two-dimensional representation of this well is shown by the dashed curved lines in figure 1.3.

An example may help in clearing up any possible confusion at this point. An electron in an orbit of effective radius " $r$ " is seen to occupy an energy level represented in figure 1.3 by the line C-C', with a total negative energy of  $W_b$ . From the shape of the dashed outline of the energy well, it may be seen that the smaller the effective orbital radius, the greater the negative energy possessed by an electron in that orbit.

It should be fairly evident at this stage that removal of a particular orbiting electron from the influence of the nucleus (i.e., taking it to an effectively distant place) will involve doing positive work, to a degree which corresponds exactly to the negative energy level of the orbit concerned. Hence an electron occupying the energy level C-C' in figure 1.3, in order to be "freed" from the nucleus altogether, must acquire a positive energy equal

and opposite in sign to  $W_b$ .

In short, the negative energy level of an orbit simply corresponds to the degree to which an electron in that orbit is "bound" to the nucleus — the orbital **binding energy**.

As we saw earlier, in an individual atom electrons can only occupy orbits having certain allowed effective radii. Hence, in terms of the energy level diagram of figure 1.3 an orbiting electron must occupy one of the discrete energy levels represented by such lines as A-A', B-B', C-C', and so on. Level A-A' might correspond to the  $N=1$  orbit of figure 1.1, for example, and level B-B' to the  $N=2$  orbit.

Although only three of the permitted energy levels are shown in figure 1.3, there is in fact a very large number, corresponding to allowed orbits with effective radii increasing rapidly with the squares of successive quantum numbers. Because of the exponential shape of the energy well around the nucleus the energy differences between successive orbits actually decreases, however, so that if further levels were shown in figure 1.3 they would be seen to form a series of horizontal lines with decreasing vertical spacing, above level C-C' and approaching the zero energy level represented by O-X.

One might perhaps imagine, from the foregoing, that in an individual atom of an element all of the electrons surrounding the nucleus would be found occupying the lowest (most negative) energy level, at least when the atom is in the ground state with no



Already established as the most popular basic radio text book the **BASIC RADIO COURSE** has now been reprinted as

# BASIC ELECTRONICS

with new and up-dated information.



**Out now, only \$2.00**

This 128-page text book is packed with diagrams and useful information about radio, hi-fi and electronics.

An ideal gift for either student or enthusiast.

An invaluable source of information for those who are curious to know **HOW** and **WHY** the many electronically based devices of today's world work.

It is written so you can understand it.

For a comprehensive review please see page 137 of the March '69 issue.

You can buy your copy of **BASIC ELECTRONICS** by calling personally at any of the offices of John Fairfax & Sons — **Sydney:** Sun-Herald Building, 235-243 Jones Street, or 26 Hunter Street; **Melbourne:** 392 Little Collins Street; **Newcastle:** 22 Bolton Street; **Adelaide:** 104 Currie Street; **Perth:** 847 Hay Street and **Brisbane:** 78 Elizabeth Street.



**To: ELECTRONICS AUSTRALIA:  
Box 2728, G.P.O., Sydney, N.S.W. 2001.**

Please send me ..... copies of **BASIC ELECTRONICS** at \$2.20 posted within Australia. \$2.00 plus postage to overseas buyers (plus estimated for 11 oz. posted weight). Please enclose only a cheque, money order, Australian Postal Order, etc., **NOT CASH.**

NAME .....

ADDRESS .....

STATE .....

**A SPECIAL 10% DISCOUNT** is available on single-copy rate for bulk buyers of not less than 25 copies to radio clubs, youth groups. Please enclose remittance with order including estimated parcel postage or freight.

additional energy or "excitation" received from external sources. However, this is not so.

In fact it is found that, in effect, each energy level has a definite electron "capacity"; only two electrons can occupy the N=1 level, only eight can occupy N=2 level and so on.

The maximum number of electrons which may occupy the first five allowed energy levels are 2, 8, 18, 32 and 50 respectively.

Although quantum mechanical theory provides an adequate explanation of the electron capacities of the various energy levels, the detailed arguments involved are beyond the scope of the present treatment. For the present it should be sufficient to note that in addition to their energy level, electrons in orbit have other important characteristics such as degree of orbit ellipticity, magnetic moment, and spin polarity. It is believed that only certain combinations of these characteristics are permitted at each energy level, and further that no two electrons at the same energy level can have the same combination. The latter "law" is held to apply to any unified system involving electrons, and is known as **Pauli's exclusion principle**.

In an individual atom in the ground state, then, the electrons occupy the lowest permitted energy levels to a degree determined by the various energy level capacities. For example in a boron atom, with five electrons, two occupy the N=1 level, which is thus "filled," while the remaining three occupy but only partly fill the N=2 level; the remaining levels are empty. Similarly the fourteen electrons of the silicon atom are disposed with two

filling the N=1 level, eight filling the N=2 level, and the remaining four partly filling the N=3 level.

Table 1.1 gives the electron dispositions of the first 20 elements of the "periodic table," illustrating the way in which the various energy levels are progressively "filled."

It is those electrons in the outermost of the **occupied** energy levels of an atom which almost completely determine its external behaviour, both chemical and electrical. The electrons which may be present in any filled lower energy levels play little part in external behaviour, because they are relatively strongly bound to the nucleus. Accordingly the latter are usually called the "core" electrons, and can often be considered as "lumped together" with the nucleus, whereas the former are called the **valence electrons** (from the Latin "valere," meaning strength; an allusion to the part played in chemical bonding), and are almost always considered separately and in detail.

The energy level occupied by the valence electrons of an atom of a particular element is consequently known as the **valence level** for that element. Each of the allowed energy levels is the valence level for atoms of certain elements; for example the N=2 level is the valence level for atoms of elements such as boron, while the N=3 level is the valence level for elements such as silicon.

In the foregoing description of the structure of the atom as it is currently pictured, we have considered the atom in the so-called ground state. Actually, this state is a purely hypothetical one; it would only occur if an atom could be placed in a light-tight and radiation-

TABLE 1.1

Element	Number of Electrons (Atomic Number)	Occupation of Orbits/Energy Levels					
		N=1	N=2	N=3	N=4	N=5	N=6
Hydrogen	1	1					
Helium	2	2					
Lithium	3	2	1				
Beryllium	4	2	2				
Boron	5	2	3				
Carbon	6	2	4				
Nitrogen	7	2	5				
Oxygen	8	2	6				
Fluorine	9	2	7				
Neon	10	2	8				
Sodium	11	2	8	1			
Magnesium	12	2	8	2			
Aluminium	13	2	8	3			
Silicon	14	2	8	4			
Phosphorus	15	2	8	5			
Sulphur	16	2	8	6			
Chlorine	17	2	8	7			
Argon	18	2	8	8			
Potassium	19	2	8	8	1		
Calcium	20	2	8	8	2		

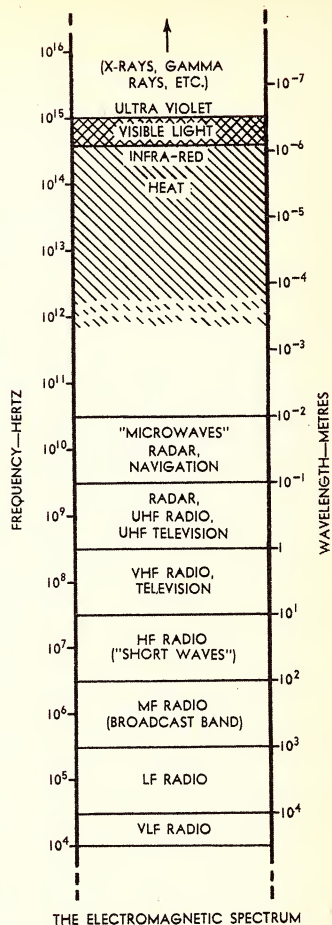

Figure 1.4

proof container maintained at a temperature of absolute zero (-273°C). Let us therefore look briefly at the more usual situation, where an atom is at a somewhat more comfortable temperature and is accessible to light and possibly other forms of radiation.

Most readers will probably be aware that light, heat and other forms of radiation such as X-rays are essentially energy, in the form of electromagnetic waves. As such, they are related to the familiar waves used for communication and for sound and television broadcasting. They differ from the latter almost solely in terms of frequency, or wavelength; in fact heat radiation corresponds virtually to "super-super-high frequency" radiation, or "ultra-ultra-short waves," while light and X-rays correspond to even higher frequencies and shorter waves again. These relationships are illustrated in figure 1.4, which shows the relevant portion of the electromagnetic spectrum.

In view of this, it should not be hard to understand that an atom which is in any practical situation involving light, heat and the other forms of radiation is virtually subjected to a constant bombardment of energy. And it should be no surprise that in such a situation the atom will tend to be found not in its ground state, but in one of many possible "excited" states which correspond to its having absorbed—at least temporarily — additional energy.

As one might perhaps guess, the mechanism by which an atom "absorbs" energy to become excited is a rather complex and obscure one; so too is the converse mechanism whereby the atom "ejects" energy to return to

# MULTIDRAWER

A TRANSPARENT MULTI-COMPARTMENT DRAWER  
AND OUTER CASE MADE OF STRONG CLEAR PLASTIC

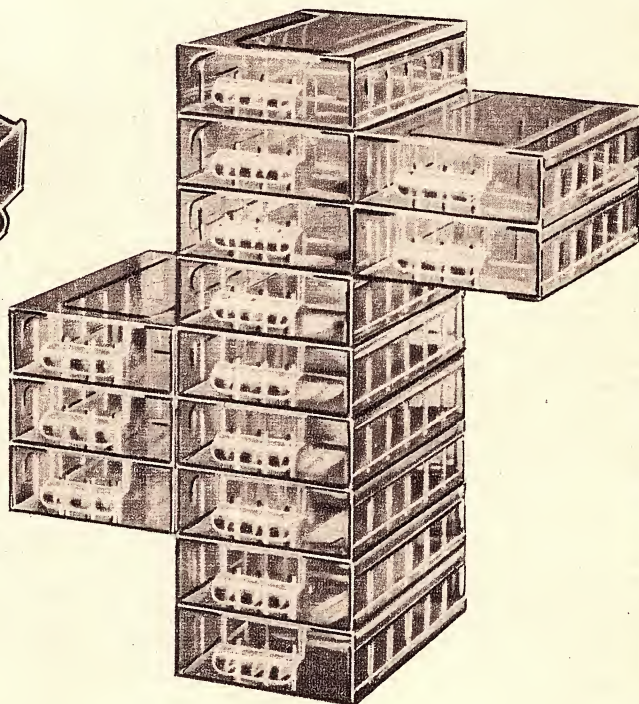
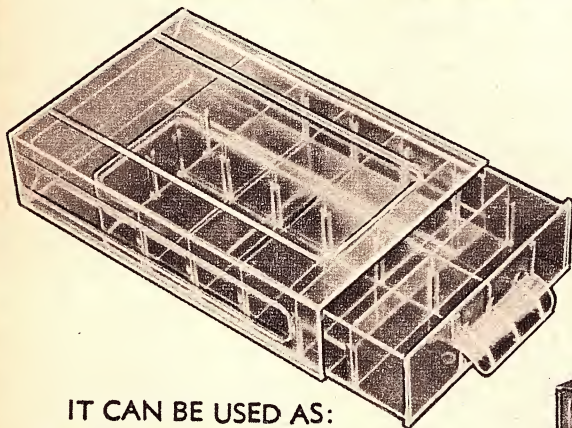

IT CAN BE USED AS:

- a self contained STORAGE BOX UNIT
- or a MULTIDRAWER CABINET by joining the individual units IMMEDIATE ASSEMBLY by sliding action  
**NO GLUE — NO TOOLS NECESSARY!**

Each drawer can be partitioned into 12 varieties of compartment arrangements by removable dividers.

The Multidrawer consists of a drawer sliding into an outer case. Both parts are made of strong clear plastic to ensure immediate visual location of stored articles (opaque outer case also available). The outer case has built-in integral dovetails and grooves for vertical and horizontal assembly by means of sliding the corresponding sides. This assembly is achieved instantaneously without using any tools or cement.

The drawer has built-in grooved side ribs, which allow its partitioning into 13 possible combinations of compartments by simply dropping into the grooves standard dividers, available in 4 lengths. The longest of the dividers is provided with the same ribs as the drawer in corresponding positions, to firmly hold the smaller dividers.

The dividers can be left as removable for any future rearrangement, or could be cemented in by using TRICHLOROETHYLENE.

The assembled cabinet will firmly stand on any flat surface and will not require additional reinforcement.

**AT HOME:** as a box for sewing, jewellery, haberdashery, hair accessories, cosmetics, medicaments, fishing accessories, writing utensils, small hardware, cigarettes and cigars, photographs, colour slides and many others.

**AND IN:** SHOPS, OFFICES, WORKSHOPS, LABORATORIES, STORES and FACTORIES.  
for visible storage of small parts and also as production assembly aid.

## THE MULTIDRAWER — THE STORAGE BOX OF 101 USES

**SPECIFICATIONS:** Drawer — transparent, Outer case — opaque (steel grey). Dimensions—Identical for both models are: Outer Case: Length: 9 5/16", width: 6 7/16", Height: 2 3/8". Drawer: Length, 9 3/8", Width: 6", Depth: 2". Protrusions of the handle — 3/4". Weight of the unit — 12 ozs.

Also available from General Accessories interstate Branches.

Trade Enquiries Invited

Write to General Accessories for further information and Price List.

# GENERAL ACCESSORIES

(A DIVISION OF ELECTRONICS INDUSTRIES)

116-118 CLARENCE STREET, SYDNEY 443 CONCORD ROAD, RHODES — 73-0211

either the ground state or a lower excited state. For a full explanation, as before, one must delve quite deeply into quantum mechanics. However, there is a basic and important principle involved, and one which we can consider here briefly.

Stated simply, the principle is as follows: The absorption of energy by an atom corresponds to the transfer of electrons to higher energy levels. Because there are only certain allowed energy levels in an atom, as we have seen, this means that energy can only be absorbed in "lumps" or quanta of definite sizes. The sizes of the quanta correspond to the energy differences between the various allowed levels.

Hence an atom can absorb an amount of energy corresponding to the transfer of an electron from the  $N=1$  level to the  $N=3$  level, for example, or to the transfer of perhaps three electrons at the  $N=2$  level to the  $N=4$  level. But, whatever the quantum of energy absorbed, it must correspond to the transfer of a whole number of electrons from one of the allowed energy levels to other, higher levels.

And the same principle holds for emission of energy, which as one would expect involves transfer of electrons from higher to lower allowed energy levels. An atom can only emit energy in quanta of fixed sizes, corresponding to the transfer of whole numbers of electrons from higher to lower allowed energy levels.

At this point the reader may well be asking how it is possible for atoms to be able to absorb and emit energy in discrete quanta, when the energy absorbed and emitted is in the form of supposedly continuous radiation such as light or heat.

The answer to this is that in fact electromagnetic energy, like the electron, behaves in many ways as if it too has a "split personality." In contrast with its continuous wavelike nature, it can equally readily behave as if it consists of small particles or quanta of energy. These particles have been named photons.

It happens that the amount of energy represented by a photon is independent of the intensity or "strength" of the radiation concerned; this only determines the number of photons present. Rather, the energy of a photon is directly proportional to its frequency. This is a very important relationship which was discovered by the physicist Max Planck in 1900 and developed by Albert Einstein in 1905.

According to this relationship, photons of "blue" visible light represent larger energy quanta than photons of lower frequency such as "red" light, and the latter in turn represent larger quanta than photons of heat radiation. Also, and very importantly for our present purposes, heat photons corresponding to higher temperatures represent larger energy quanta than those corresponding to lower temperatures. This arises because temperature is a direct function of frequency.

From the foregoing it may be seen that, because it is only capable of absorbing energy quanta of certain fixed sizes corresponding to electron transfers between allowed energy levels, an atom can effectively only be excited by radiation of particular frequencies (wavelengths). Each frequency will correspond to an electron transfer between a particular combination of

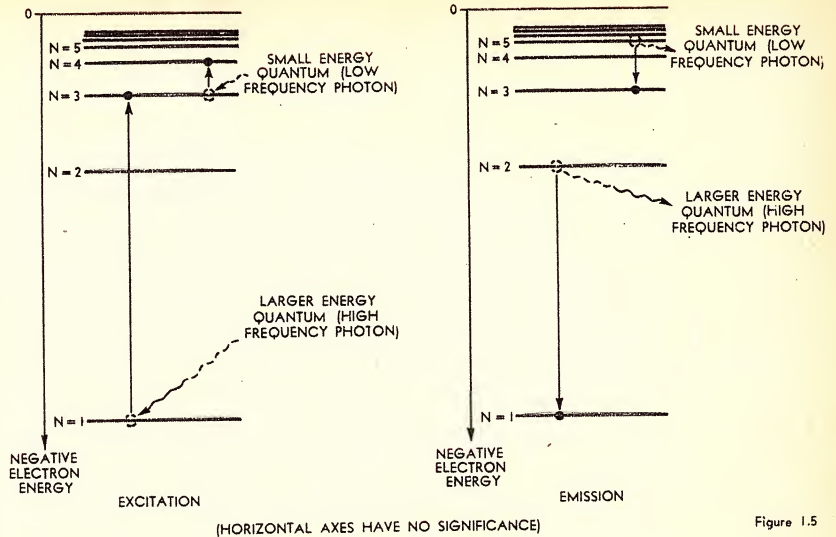

levels; hence a transfer from the  $N=1$  level to the  $N=3$  level might result from absorption of a photon of frequency  $f_1$ , while a photon of another frequency  $f_2$  might produce a transfer of an electron from the  $N=3$  to the  $N=4$  level.

Similarly the ejection of energy by an atom dropping to the ground state or to a lower excitation state results in the emission of radiation only at particular frequencies. An electron transfer from the  $N=2$  level to the  $N=1$  level might result in the emission of a photon of frequency  $f_3$ , for example, while a transfer from the  $N=5$  to the  $N=3$  level would result in the emission of a photon at a different frequency.

These concepts are illustrated in the diagrams of figure 1.5.

In practical situations atoms can thus be found tending to continuously absorb and emit radiation at a number of specific frequencies, each of which corresponds to one of the possible energy level transitions. It is this behaviour which accounts for the so-called "line spectra" obtained by analysis of the wavelengths of light and heat absorbed and emitted by atoms of the various elements under suitable conditions.

As one might expect, the number of specific photon frequencies involved in atom energy absorption and emission tends to be quite large, as there are many possible energy level transitions. This is particularly so with elements having many electrons surrounding the nucleus. However due to differences between levels concerning the allowed "secondary" electron characteristics of orbit ellipticity, magnetic moment and spin, some level transitions tend to be more prevalent than others, in a fashion which varies from element to element. As a result each element tends to have a characteristic

pattern of "dominant" absorption and emission frequencies.

An atom in the excited state contains, as we have seen, electrons which are occupying higher energy levels than they would occupy in the ground state. It is interesting to consider whether we can make any inferences regarding which of the electrons will be more likely to be found at such higher levels.

As it happens, we can. Earlier, we saw that the energy differences between the allowed energy levels decrease with increasing orbit radius and quantum number. Hence somewhat greater energy would be required to transfer an electron from the innermost  $N=1$  level to the next or  $N=2$  level for example, than to transfer an electron from the  $N=3$  level to the adjacent  $N=4$  level. Thus even for transfer between adjacent levels, the electrons at the lower levels require larger energy quanta.

There is also the electron capacity of the various levels to be considered, i.e., Pauli's exclusion principle. As the capacity of the various levels does not alter with excitation, this means that a transfer of an electron to a particular energy level can only take place if there is a "vacancy" at that level. From this it can be seen that transfer of electrons from the higher levels is more likely to occur than from the lower levels, both because the lower levels are more likely to be "full" and also because the capacity of the levels increases with increasing energy.

We can say, then, that for a given degree of excitation, the "excited level" electrons will tend to be those which already occupy the higher levels in the ground state, rather than those from the lower levels. In particular, there will tend to be a high proportion of the electrons from the valence level of the atom concerned.

## SUGGESTED FURTHER READING

- BURFORD, W. B., and VERNER, H. G., *Semiconductor Junctions and Devices*, 1965. McGraw-Hill Book Company, New York.
- MORANT, M. J., *Introduction to Semiconductor Devices*, 1964. George G. Harrap and Company, London.
- SCROGGIE, M. G., *Fundamentals of Semiconductors*, 1960. Gernsback Library Inc., New York.
- SHIVE, J. N., *Physics of Solid State Electronics*, 1966. Charles E. Merrill Books Inc., Columbus, Ohio.
- SMITH, R. A., *Semiconductors*, 1959. Cambridge University Press.



*Which is the most popular imported speaker?*

## The Wharfedale Super 8.

More Wharfedale Super 8 high-fidelity speakers are sold in Australia than any other imported single speaker unit — because the Super 8 *sounds* like a much larger wide-range loudspeaker.

Frequency response is from 20 Hz. to 20,000 Hz. when used in a suitable enclosure, the massive magnet structure provides extremely high sensitivity and the audio quality is unequalled when comparisons are made with similarly sized speaker chassis. In addition to these attributes the transient performance of the Super 8 is quite remarkable.

It's easy for the handyman/music lover to

build a matching enclosure for his new Super 8 from detailed specifications which are included in the box containing your purchase. Where space is a problem enclosures for the Super 8 can be as small as 1 cubic foot!

Addition of the Super 8 makes a world of difference to your hi-fi system, radio, TV set or your tape recorder . . . and many Super 8's have been successfully added to car radios. Whatever the

application, the Wharfedale Super 8 will add a new dimension of Wharfedale superior sound. The comprehensive Wharfedale range is available at all good audio stores.



WS8-1

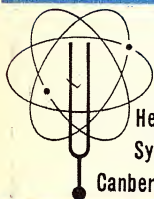

Australian National Distributors:

***Simon Gray Pty. Ltd.***

Head Office: 28 Elizabeth St., Melbourne, Vic. Tel. 63 8101\*

Sydney Office: 22 Ridge St., North Sydney, N.S.W. Tel. 929 6816

Canberra Office: 31-33 London Circuit, Canberra City, A.C.T. Tel. 49 6050

INTERSTATE REPRESENTATIVES:

N.T.: Pfitzner's Music House, Smith Street, Darwin. Tel. 3801

Q'land: Sydney G. Hughes, 154-158 Arthur St., New Farm, Brisbane. Tel. 58 1422

S.A.: Eilco Sales Pty. Ltd., 7-9 Osmond Terrace, Norwood, S.A. Tel. 63 4844

Tas.: K. W. McCulloch Pty. Ltd., 57 George Street, Launceston. Tel. 2 5322

W.A.: Athol M. Hill, 613-615 Wellington Street, Perth. Tel. 21 7861

# Just what was in one of the largest containers on the "Encounter Bay"?

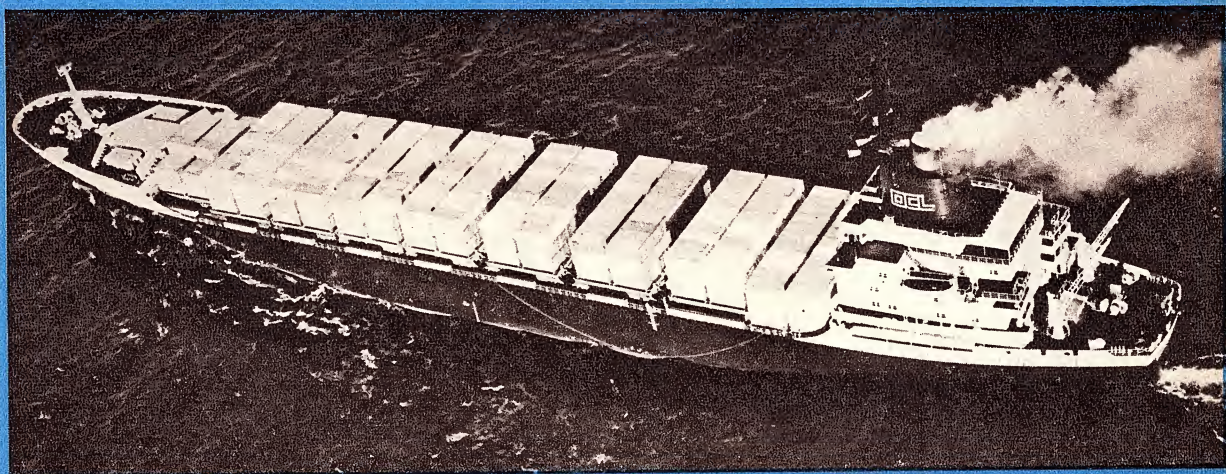

## *It was loaded to capacity with Wharfedale speakers and speaker systems.*

Discriminating music lovers all over the world have created an unprecedented demand for Wharfedale equipment . . . in Australia, too, more and more enthusiasts are specifying Wharfedale speakers and speaker systems.

Production has been increased — and the advent of modern container shipping methods has considerably reduced delays caused in transportation. One of the largest containers on the "Encounter Bay" was packed with Wharfedale high-fidelity speakers and speaker systems.

Use of containerisation speeds deliveries and assures arrival of Wharfedale units in perfect condition.

The "Encounter Bay" shipment contained a quantity of the popular Wharfedale "Denton"

and "Super Linton" compact speaker systems. These competitively priced units are now available at selected audio stores in all states. If you've been waiting for either of these speaker systems, see your Wharfedale dealer now!

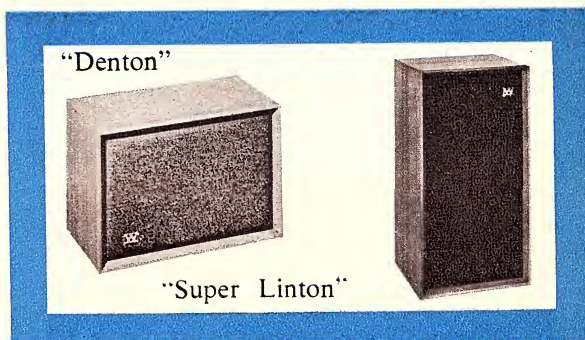

SG EB/5

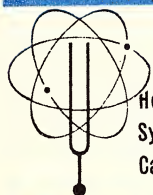

Australian National Distributors:

***Simon Gray Pty. Ltd.***

Head Office: 28 Elizabeth St., Melbourne, Vic. Tel. 63 8101\*

Sydney Office: 22 Ridge St., North Sydney, N.S.W. Tel. 929 6816

Canberra Office: 31-33 London Circuit, Canberra City, A.C.T.  
Tel. 49 6050

INTERSTATE REPRESENTATIVES:

N.T.: Pfitzner's Music House, Smith Street, Darwin. Tel. 3801

Q'land: Sydney G. Hughes, 154-158 Arthur St., New Farm, Brisbane. Tel. 68 1422

S.A.: Eilco Sales Pty. Ltd., 7-9 Osmond Terrace, Norwood, S.A. Tel. 63 4844

Tas.: K. W. McCulloch Pty. Ltd., 57 George Street, Launceston. Tel. 2 5322

W.A.: Athol M. Hill, 613-615 Wellington Street, Perth. Tel. 21 7861

# Graphic recorder writing systems

The pen recorder, one of the oldest methods of recording measurable phenomena, is still supreme in many applications. This story, describing the range of systems in use today, and their particular advantages, is taken from the Hewlett-Packard Journal, October, 1968

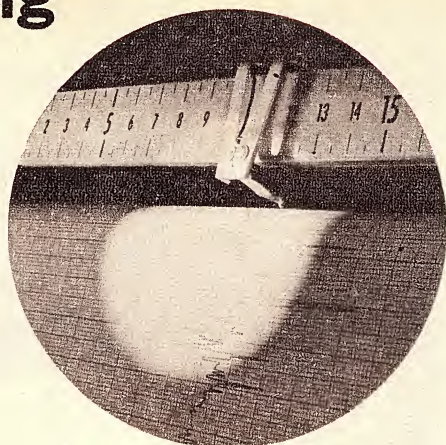

By Dale R. Davis and Charles K. Michener

Choice of the proper writing technique for graphic recording is largely a function of the content of the record and how the record is to be used. Since no single recording method can claim all of the advantages of all writing methods and none of their disadvantages, the choice of a writing technique becomes a compromise.

Some basic questions to be answered when selecting a system are: Is maintenance of the system simple? How often is it necessary to maintain the system? Is the system designed so that the line is uniform at the highest and lowest writing rates? Is the system reliable enough to do the job the way it needs to be done? Is the record permanent, clean, high contrast, and smudge free? Will the record be marked by casual handling? Can the recorder be idled for long periods without a great deal of pre-start-up maintenance? Does the writing technique

might be successful for a given application.

Among the many schemes for marking chart paper, the ink system has been most widely used. Its principal advantage is its ability to write in a variety of colours with high contrast. Several parameters may be recorded on the same chart, each in a different colour, making identification easy. The chart paper is relatively inexpensive. An operator may become familiar with its operation and care without a great deal of special training.

**Capillary System:** A capillary system, figure 1 (left), consists of an ink reservoir, a piece of tubing leading from the reservoir to a metal pen tip and the paper on which the recording is made. Ink is pumped through the tubing to the pen tip prior to starting a record. After this initial "priming" the ink continues to feed itself to the pen tip on demand by capillary action.

It is not uncommon to find water-based inks still in use in capillary pen systems. A coffee spill on a record of this type can destroy the record. Further, a noisy signal (one involving wide and very rapid sweeps of the pen) can flood the chart paper with ink so that the paper becomes soggy and finally torn by the action of the stylus. A record made with a water-based ink can be smudged by moisture even months after the record is made.

It is necessary to choose the proper diameter pen tip for the speed range desired. A typical range is from 10 inches per hour to 50 inches per second. A fine-tip pen can be used at speeds as low as  $\frac{1}{4}$  inch per hour, but then its upper limit is reduced.

A non-pressure system is subject to vapour lock caused by high temperatures, altitude or vibration. The ink used in these systems freezes at 0°C and starts to bubble at 40°C, and eventually results in vapour lock. Vibration causes the ink to foam, forming bubbles that cause vapour lock.

In spite of the above problems capillary writing is still a very popular method of recording because of the ease of identifying traces and the high contrast. Newer recorders have simplified inking, pen-tip cleaning, and inks that minimise flooding and smudging.

**Pressurised Systems:** In recent years pressurised ink writing systems have been introduced by at least two firms. By modulating the pressure on the ink as the pen speed varies, it is possible to achieve very uniform, good contrast lines.

The writing systems have been engineered to require a minimum of pre-start-up maintenance, and to operate without the mess ordinarily associated with ink. A special coating on the paper used in these systems causes the non-water-based inks to dry on contact and enables the pen to make a liquid seal with the paper to prevent ink drying.

**Ball Point and Fibre Tips:** Other methods of ink recording are also in use. Ball point tips can be used in place of the capillary tip. A compromise between the pressure on the tip and line width is necessary. Very tight mechanical tolerances are required for fine lines, but the pen will have a tendency to skip at higher speeds. Dynamic range is lower than for a capillary ink system.

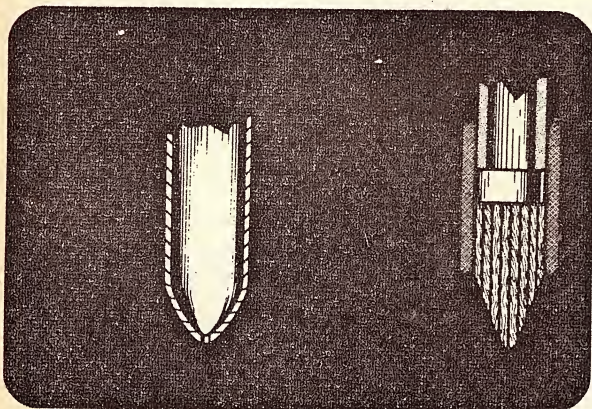

Figure 1. General purpose capillary pen tips (left) are steel tubes with an inside diameter of about .01in. Fibre pen tips (right) consist of parallel bundles of fibres to reduce clogging.

impose any special environmental limitation on the recorder, such as temperature, humidity, radio frequency interference (RFI), altitude, or attitude? Are powders, gases or liquid by-products generated during writing that may interfere with other gear in the area where the recorder is used? Answers to these questions will help determine whether a specific writing method

The surface tension and viscosity of the ink is such that the movement of the pen tip on the graph paper pulls the ink from the pen tip. Since the pulling force is a function of stylus speed, a relatively uniform line can be made over a useful range of writing speeds.

Where a greater dynamic range is necessary, involving both high and low writing speeds, the use of an ink with a low enough viscosity to flow and make a continuous line at high writing rates would not be satisfactory at low writing rates. The ink may run out of the pen and flood the paper. Inks designed to dry fast enough so they do not smudge by the time the user is ready to handle the record generally dry in the pen-tip after being inoperative a few minutes to a few days.

As originally presented, this story was preliminary to a description of specific Hewlett-Packard recorders. However, it appealed to us as an interesting and comprehensive discussion worthy of presentation as an article in its own right. Editor, Electronics Australia.



Fibre tipped pens contain a parallel bundle of fibres which provide many ink passages, figure 1 (right). Thus the pens do not clog as readily as the single-tube capillary tips. But as fibre tips wear they tend to write broader lines and lose resolution. Fibre tips are designed to be disposable and easily replaced.

## Electric Writing Systems

**Electrosensitive Papers:** A relatively new electrosensitive paper is based upon the reduction of zinc oxide to free zinc. Conductive zinc oxide dispersed in an organic binder is coated on to a metal base, such as aluminium foil, that has been laminated to paper. (Figure 2.) The passage of current through this coating reduces the zinc oxide in the layer, thereby forming the mark. The mark is in the coating, unlike other electrosensitive systems where the mark is the result of erupting the coating from its base and exposing a black sheet. To prevent carbonisation of the coating materials, the coating is designed so that its resistance increases when the mark is made. Both very high and very low writing speeds are possible without degradation of the mark. As a consequence, the writing process is clean and dry. (Figure 3.)

Writing rates as high as 200in/s and as low as 1in/hour are practical with some papers of this type. These papers are particularly useful in those applications where a permanent, rugged copy is required, where record cleanliness is important, and in those areas where rapid start-up and reliability are of importance. The paper cannot be marked by pressure, heat, light or moisture. The marks are smudge resistant and reasonably contrasting.

Some RFI is generated during marking, but good instrument design reduces the radiation to a level where interference with other equipment is not a problem. Some odour is generated during marking and is detectable when writing at higher speeds. The vapours given off during writing are non-toxic.

**Carbon-Impregnated Paper:** Perhaps the oldest type of electrosensitive paper, and still the most common, involves the removal of a thin, light-coloured layer from a carbon-impregnated paper by dielectric breakdown and subsequent eruption of the layer from the carbon-filled paper. (Figure 4a.)

These papers have some electrical characteristics that make them less attractive than some of the other methods of recording. The resistance of the marked area is lowered after marking, so that marks made at low writing rates will either broaden out and over-burn (image spreading), or very little marking will take place when the stylus is moving at high speed. Carbon is blown from the

coating during marking, leaving a residue on the paper and in the machine. RFI is a problem and can interfere with nearby equipment if the recorder is not properly shielded.

In addition to the above electrical problem, these papers are generally easy to mark with casual handling, due either to moisture on the users' hands or to the pressure sensitivity of the electrosensitive coating. An odour is generated during writing that increases as the amount of marking increases.

Recent improvements in the conductivity of white pigments have made it possible to mark papers of this type at voltages compatible with current solid state circuitry.

**Electrolytic Papers:** In this system, the stylus material is gradually plated on to the surface of a conductive paper. The paper is saturated with a salt solution to make the paper conductive. (Figure 4b.) Reasonably low voltages (voltages as low as a fraction of a volt to 100 volts depending upon writing rate) are used in plating the paper. Excellent contrast and writing rates can be achieved with the system. The principal disadvantage of this type of writing is the requirement of having to keep the paper wet during use, and then having to dry it before handling.

Problems typical of those of handling corrosive chemicals around electronic equipment must also be considered.

This system has been used for facsimile transmission of news photographs over telephone lines. Because of the short time the paper is in the facsimile recorder, it does not have time to dry out.

**Metallised Papers:** Probably the simplest method of electrical graphic recording is based upon the fusing of a vacuum-deposited metal on a paper or film base. (Figure 4c.) Exposing the paper base through the metal film produces the contrast necessary for viewing the mark. Marks can be made on these papers with as little as 1½ volts.

Problems encountered in this system include low contrast, paper corrosion at high humidities, and possibility of eye fatigue due to the metallic appearance of the paper.

**Electrostatic Writing:** Electrostatic writing involves the use of a conductive

paper with a dielectric coating on it. The dielectric coating is charged electrostatically in the areas to be marked. The charge is then held on the surface of the dielectric until the paper can be dusted with an electroscopic powder (toner) or bathed in dielectric fluid containing charged particles. The toner makes the charged area visible and the mark is made permanent by heating the toner and melting it to the dielectric coating, or by evaporating the dielectric fluid from around the particles and dry setting the particles to the surface of the paper.

Excellent black on white lines can be made by this system over a broad range of marking speeds. The system is particularly suited to those applications where chart speeds in excess of 10in/min are used or where it is not necessary to view the record immediately as it is being made. Signals up to 5KHz may be recorded.

Approximately 2 inches of record is inside the machine being developed before it is viewable. Very low speeds such as a 1in/hour do not seem practical.

## Pressure-sensitive Systems

Pressure-sensitive systems use a stylus that is pressed against a special paper to make a mark. A typical pressure-sensitive paper of this type is made by coating a black paper base with microscopic spherical wax beads. When these beads are pressed they flow and become transparent exposing the black base beneath the wax. Although this system alleviates many problems associated with ink, there are new problems that sometimes make it unsuitable. The paper can be marked by handling. Some of these papers mark not only from pressure but also from moisture. If papers of this type are made so they do not mark easily in handling high mechanical pressure must be used on the stylus, which could result in a less reliable writing mechanism.

Pressure-sensitive papers are best suited to low-speed recording where unattended operation is of prime importance and where the record is not usually handled nor intended to be a permanent record. These recorders are generally inexpensive.

Figure 2 (below).  
Electrosensitive paper. Figure 4 (right). (a) Carbon-impregnated paper. (b) Salt impregnated paper. (c) Vacuum metallised paper.

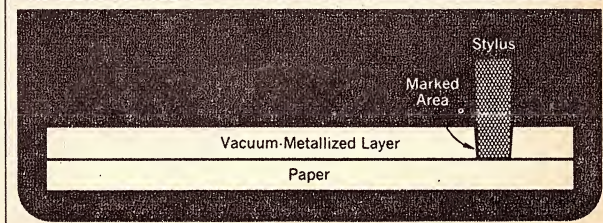
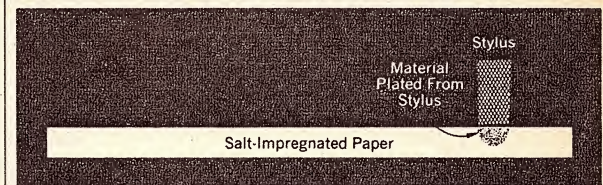
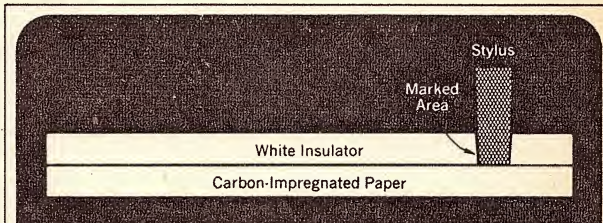
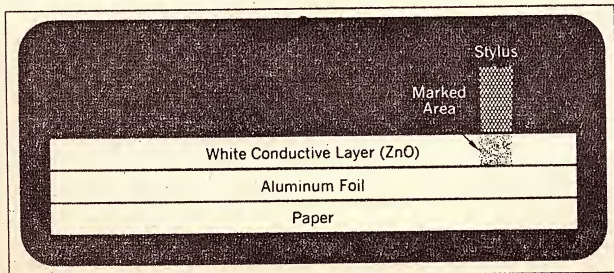

do you wish to own



the world's finest tape recording system?

Consider then the

**REVOX 77A** (Tape Decks & HI FI Systems)

Brief Spec: Tape speed:

7½ i.p.s. and 3¾ i.p.s.

Wow and Flutter:

max. .08% at 7½ i.p.s.

Frequency response:

30Hz-20kHz + 2dB/-3dB at 7½

i.p.s.

30Hz-16kHz + 2dB/-3dB at 3¾

i.p.s.

Signal to noise ratio:

better than 58dB at 7½ i.p.s.

better than 56dB at 3¾ i.p.s.

\* Write or phone for full technical specifications and price details, or contact your local HI FI dealer.



Engineering Products Division

422 LANE COVE ROAD, NORTH RYDE, N.S.W. 88 6666

AMALGAMATED WIRELESS (AUSTRALASIA) LTD

MELBOURNE  
67 9161

BRISBANE  
4 1631

ADELAIDE  
72 2366

PERTH  
28 6400

LAUNCESTON  
2 1304

## Heat-sensitive Papers

Probably the most common heat sensitive writing method used in graphic recording uses a heated stylus which melts a thin white wax-like coating on a black paper base. The preparation of this type of paper is almost identical to the preparation of a waxed pressure-sensitive paper except that the wax-like spheres are made of a harder, less pressure-sensitive material that melts at low temperature.

This type of system circumvents many of the problems inherent with both ink and pressure-sensitive papers. The stylus system is quite reliable and high contrast traces are easily made. The paper is clean to handle and no objectionable by-products are generated during its use. Although some heat-sensitive papers are quite easily marked in casual handling, most papers of this type do not mark easily with pressures normally encountered.

When marking at low speeds, if low stylus temperature is used to prevent image spreading, then no marks or only very light marks are made when marking at high speeds. Some recorder systems compensate for this effect by varying the stylus temperature with stylus speed.

Heat-sensitive papers are commonly used in industrial and medical instruments where environmental conditions

are not severe and where rapid start up is of prime importance.

A less common type of heat-sensitive paper is based upon a chemical reaction between two colourless, heat-sensitive materials in the coating that forms a third coloured material.

This system is not pressure-sensitive but is less efficient (i.e. more energy is required to mark a given area), which limits the writing rate. Some of these papers lack long-term stability, gradually turning dark. Others give off an unpleasant odour when marked.

These papers are particularly suited to those applications where the range of writing speeds is not great, where the writing rate is below 2in/s, where rapid start-up is important, where the record will be handled a great deal, and where the record is not needed longer than about six months.

## Photographic Systems

One of the oldest graphic recording systems uses photographic paper or film written upon by light beams reflected from galvanometer-driven mirrors. These systems are available to record up to 36 channels or more and are capable of very high speeds. Their chief disadvantage is the cost of the paper and the instrumentation, and the inconvenience of processing. Accuracy of a galvanometer without feedback is limited to about 1 p.c.

*Right. The model 7825A is a typical example of recorders using electric writing. It can monitor four channels with a single stylus.*

*Figure 3 (below). Record from a 10-inch electric writing instrument recorded at 1 inch per hour.*

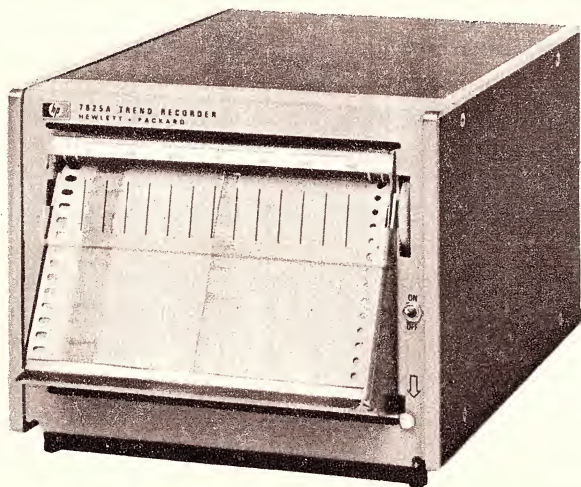

## up to ten times longer life



MAXELL Alkaline Dry Cell — this unique new design concept features high capacity and durability that surpasses the performance of the world's top dry cell batteries. The construction of the Maxell Alkaline Dry Cell differs greatly from conventional types of carbon ZINC cells. However, the Maxell Alkaline cells can be used where you normally use a carbon ZINC cell. MAXELL ALKALINE CELLS are especially suitable where there is a demand for increased current, combined with durability and little voltage drop. Even near the end of the cell life the discharge capacity is large and stabilized.

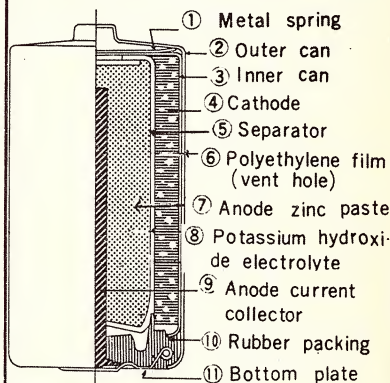

Exclusive new construction minimises leakage. Double cans are used and rubber sealing with the unique spring safety device. (see diagram)

Interior drying is prevented by hermetic sealing, therefore long storage periods are possible (over two years). Even then Maxell Alkaline cells are in the same condition as when they left the production line. These cells will withstand severe temperature changes. Rigid tests have shown extremely stabilized capacities from the low temperature of -4F to the high temperature of 150F at which temperatures dry cells would fail to operate satisfactorily.

### Prices:

AM1 ..... 75c  
AM2 ..... 50c  
AM3 ..... 40c

Trade enquiries to  
TASMANEX PTY. LTD.  
17 Parker Street SYDNEY 2000



## Changes for Mobile Radiotelephone Services

Licensees of V.H.F. land and harbour mobile radiotelephone services, now operating in 30 kc/s channelling areas, are advised that if they have not already installed equipment which meets the Australian Post Office 30 kc/s channelling specification, they must do so before 30 June, 1969.

This requirement has been brought about by the growing demand for V.H.F. mobile radiotelephone services in city areas which is taxing the existing channels available. The change to 30 kc/s channelling will enable more radiotelephone services to be brought into operation as they are required.

However, some changes to existing equipment will be necessary and the following programme for conversion, which is designed to cause the least inconvenience to all concerned, has been adopted:—

As from 30 June, 1969, licensees of V.H.F. mobile radiotelephone services operating in 30 kc/s channelling areas within the frequency bands 70-85 Mc/s and 156-174 Mc/s\* will be required to make necessary changes so that:—

- (i) All base station transmitter/receivers (both amplitude and angle modulated) employed in a base station installation shall be of a type complying with the relative Post Office specification and approved for 30 kc/s operation and shall be operated in accordance with the terms of that specification.
- (ii) All angle modulated mobile transmitters shall be adjusted to function with a maximum deviation of  $\pm 5$  kc/s.

\*This excludes the International Maritime Mobile V.H.F. Radiotelephone and the existing Australian Post Office Subscriber Services.

Early conversion will assist manufacturers in meeting delivery dates for equipment.

**FURTHER DETAILS MAY BE OBTAINED FROM THE SUPERINTENDENT,  
RADIO BRANCH, G.P.O., IN YOUR CAPITAL CITY.**

**AUSTRALIAN POST OFFICE**

PRT 3.84.39

There are, however, some recording applications that can be done by no other technique, such as oscillographic recording up to 30KHz. In one such system, a high intensity ultra-violet beam is focused on the paper. The image is made visible by latensification.

Latensification is the process of producing a stable latent image on silver halide paper by exposure to a high-intensity light. Further exposure to a low-intensity light develops the image to make it visible.

The image formed by latensification will begin to darken in a matter of hours if left in room light. To make

weld itself to the aluminium base, the spring bends, rocking and releasing the ball.

To assure a uniform, high-contrast line on the 10-inch chart of the HP Model 7100 Series Recorders, the stylus voltage is varied in proportion to its speed. Voltage variation is not necessary in the 5-inch Model 680, but the increased excursion and pen speed on a 10-inch chart require this refinement. As the stylus approaches a null and slows, the voltage is lowered; when the stylus is slewing rapidly, its voltage is increased.

A typical application for recor-

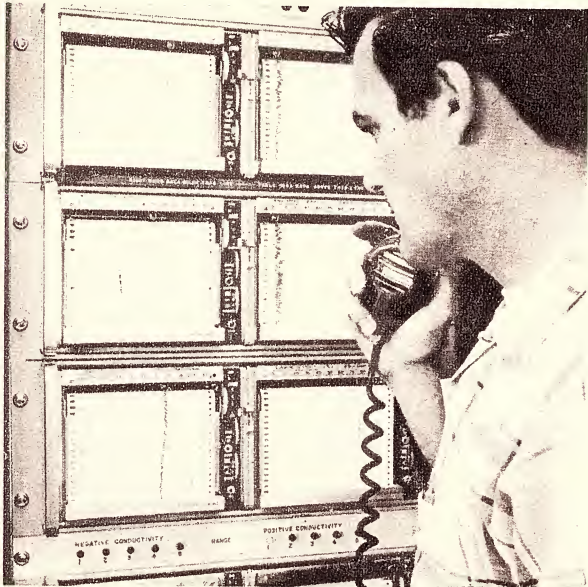

*This bank of recorders, being checked at the National Center for Atmospheric Research, Boulder, Colorado, records meteorological data seven days a week, 24 hours a day.*

the record stable the paper must be "fixed" by wet processing.

Although most oscillographic recording work is black on white, a two-colour paper is available.

All the above systems have their own particular advantages and an example will show how those of one, the electric writing system (figure 2 page 63) are exploited in practice. Typical of instruments using this system are the Hewlett-Packard models 7100, 680, and 7825A. A feature of this latter instrument is its ability to trace up to four curves simultaneously, using only a single stylus and a time sharing system.

Time-sharing is made possible by the use of electric writing which, unlike ink or thermal recording, allows writing to be started or stopped instantly.

Because of the contact pressure required on the fairly abrasive electro-sensitive coating, a wear-resistant tungsten carbide stylus is used. The tungsten carbide ball initially produces a line width of 0.01 inch. It wears until the line broadens to about 0.02 inch after about 10,000 feet of travel. Then it remains fairly constant, requiring about 12 miles of travel to produce a line 0.026 inch wide.

Unless properly designed, the stylus may break through the thin electro-sensitive coating at very slow speeds (about 1 inch per hour), and weld itself to the aluminium backing. It could plough a furrow in the coating.

This condition is avoided by mounting the tungsten carbide ball at the end of a cantilever spring (see picture at head of page 63). Should the stylus

recorders is recording meteorological data. This requires an instrument with the capability of responding to rapid changes over a wide range. Continuous operation over long periods of time at very slow chart speeds is generally desired.

In one such application, the National Centre for Atmospheric Research (NCAR), Boulder, Colorado, records 10 channels of data telemetered from a remote site on the Continental Divide. Data includes wind direction and velocity, positive and negative conductivity of the atmosphere, atmospheric electric field, cloud cover conditions, and temperature.

Wind direction shifts often, by about 20 to 30 degrees, and wind velocities range from zero to 145mph. Gusts up to twice the average velocity occur frequently. Because of the slow 1 inch per hour chart speeds, ink recording would be unsatisfactory. Wide swings of the pen could saturate the paper with ink. The electric writing system, however, produces a clean, readable and dry trace.

Another application is Radiation Monitoring. Long periods of unattended recorder operation at very slow chart speeds are encountered in a radiation monitoring application. Gamma radiation levels from 0.01mR/hr to 100mR/hr are recorded by electric writing instruments operating in field environments. The instruments are subject to line voltage and frequency variations and to temperature ranges from -10°C to +65°C. Chart speed is 1in/hr, making it necessary to replenish paper only about once a month.

## Mk. II "Delica"

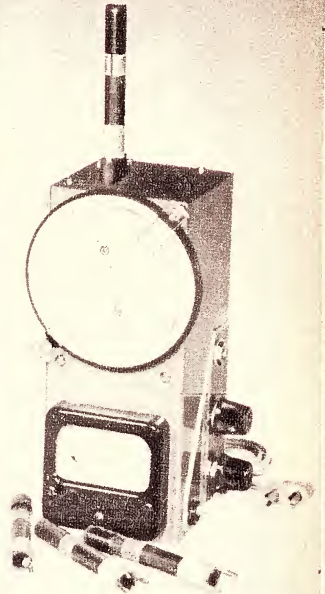

## GRID DIP METER

Incorporating important new features by Japan's Leading Electronic Instrument Manufacturer.

A compact unit (7in x 2½in x 2½in), ideally suited to Amateur or Commercial Servicemen's requirements, the Delica offers these features:—

- ★ **CONTINUOUS COVERAGE** FROM 1.3 Mc/s TO 150 Mc/s In 5 RANGES.
- ★ **INDIVIDUALLY CALIBRATED TO .1 of 1 p.c. ACCURACY.**
- ★ Has dial space for two additional bands.
- ★ 1,000 cycle modulation by switch.
- ★ Jack provided for monitoring.
- ★ 3in dial for easy reading.
- ★ 3½in x 3in coils for access to "hard-to-get" areas.
- ★ Instruction manual (12 foolscap pages) provided, giving valuable data on grid-dipping.
- ★ Self-contained transformer to operate from 240V A.C. current.

(Spare coils available at \$1 each.)

Now Priced,

**\$55.30** Plus Sales Tax



**SMITH SONS AND REES**

LIMITED

30-32 Wentworth Avenue, or  
G.P.O. Box 5038, Sydney,  
NSW. Phone 20 956.



# PROFESSIONAL

Effortless highs, smooth waydown lows, and ample power mean magnificent performance can be yours with:—

- PEAK BD-515 Two speed, belt driven player unit with Auto return. Peak magnetic cartridge.
- PEAK TRM-120 60 Watt/channel, 15-35000 Hz  $\pm$  1 db. Transistorised stereo amplifier.
- PEAK P12/3 Enclosures fitted with 12" woofer 6" mid range and metal diaphragm tweeter.

If preferred your choice of cartridge can be fitted or alternate components arranged.

# AND POPULAR

For full Hi-Fi Enjoyment at moderate cost choose.

- PEAK STP-69 12" three speed player unit with arm lifter. Peak magnetic cartridge.
- PEAK TRM-40B 22 Watt/channel, 20-20,000 Hz  $\pm$  1 db. Transistorised stereo amplifier.
- PEAK 8CX-50 8" co-axial speakers, 8 or 16 ohm impedance.

Mounting base or cabinet for player unit and alternate matched speaker enclosures are also available.

# PEAK STEREO SETS

**H. ROWE**  
& CO. PTY. LTD.

SOLE  
AUSTRALIAN  
AGENTS

ADELAIDE  
HOBART  
PERTH

BRISBANE  
MELBOURNE  
SYDNEY

AVAILABLE FROM YOUR RETAILER.

# RF PREAMPLIFIER FOR SHORT-WAVE RECEIVERS

Here is an RF preamplifier which covers from 1.4MHz to 30MHz, in four switched ranges. It will prove a useful addition to many receivers deficient in the input stage, or it could be the basis for the RF amplifier for any solid state communications receiver.

by Ian Pogson

From time to time we are asked for details of some means of improving the sensitivity, front end selectivity, image response, etc., of receivers which are lacking in one or more of these qualities. Our records show that we have described only one such RF preamplifier previously, in the issue for August, 1962.

If your receiver is reasonably modern and has an RF stage, more than likely it will be adequately designed for good sensitivity and signal to noise ratio, as well as such other considerations as image rejection. Such being the case, you are unlikely to be interested in an outboard RF preamplifier. On the other hand, if your receiver is an old one with an old type valve in the RF stage, or if it does not have an RF stage at all, the unit we are about to describe will be a worthwhile addition.

Before going into the details of this amplifier, perhaps it would be worth while to consider some design aspects. Regardless of whether the amplifier is to be used with valve or transistor receivers, we felt it desirable to use a solid state device, rather than a valve. Admittedly, at the present state of the art, valves still seem to have the advantage when it comes to signal handling ability with freedom from cross-modulation, blocking and AGC characteristics. However, with careful design and the observance of suitable precautions, the solid state counterparts can be made to perform quite well. This is particularly the case when short-wave listening is being considered.

Having decided in favour of the solid state device, the next question is just what this will be. The now familiar bipolar transistors are capable of high gain but there is a problem of impedance matching between the input tuned circuit and the transistor base, normally achieved by tapping down on the coil. Besides having to make the tap, the tuned circuit is somewhat loaded by the transistor input resistance.

On the other hand, junction type field effect transistors have somewhat less intrinsic gain, but they have a much higher input impedance, so much so that the tuned circuit coil does not need to be tapped and the resultant loading by the FET is less than for the bipolar transistor. All other things being equal, the resulting loaded Q of the tuned circuit will be higher and the gain of this part of the circuit will be greater. In short, the field effect transistor advantages cannot be over-

looked. Of the types available, the Motorola type 2N5459 was finally chosen as being best suited to our purpose.

Next, should we use one or two tuned circuits? Two tuned circuits will give a greater degree of selectivity and gain but the extra cost and complexity makes one wonder whether it is worthwhile. If we give enough consideration to the input tuned circuit, and retain a relatively high Q factor, then one tuned circuit should be sufficient. The output (drain) circuit will not be tuned.

In order to preserve maximum gain, we must have a suitable step-down in impedance from the drain to the aerial terminal of the receiver. This can be done quite conveniently with an emitter follower stage.

Although we have just made a case for the FET (or other solid state device) the fact remains that, under strong signal conditions, there is the possibility of cross-modulation. So that a not so strong signal may be received, in the presence of a very strong adjacent one, the FET must be protected from overload. This can be done simply by introducing a 1K potentiometer in the aerial input circuit. By judicious use of this control, the wanted signal can usually be sorted out from possible interference.

With the circuit diagram before us, let us go over it in detail and explain the various parts. We start off with a 1K potentiometer between the aerial input terminal and the primary of the aerial coil. Experience has shown that the value of 1K is about optimum for this function and gives a very smooth control. From the rotor of the potentiometer, the signal passes to the first section of the range selector switch.

In order to restrict the frequency coverage from each coil, using a 415pF tuning capacitor, a fixed capacitor is connected between the tuning capacitor and each coil, individual values being selected to suit the range involved. These capacitors are interposed between each coil and its switch contact.

The signal level across the variable capacitor is limited to the ratio of the variable and fixed capacitor, and is less than the full value as measured across the coil. It is therefore necessary to take the signal from across the coil. This involves using a third switch section on the range selector switch, the rotor feeding directly to the gate of the FET.

To further restrict the frequency coverage of each band, this time at the high frequency end, a 22pF fixed capacitor is located between the gate

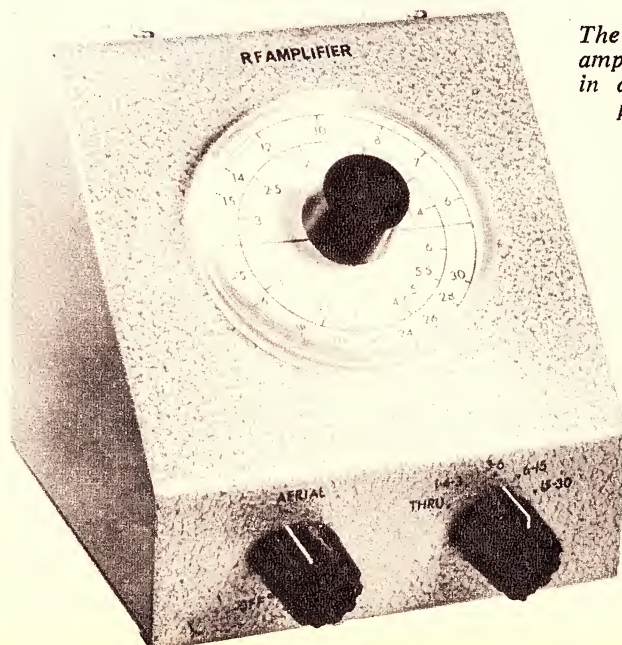

*The complete pre-amplifier is housed in a neat sloping panel box.*



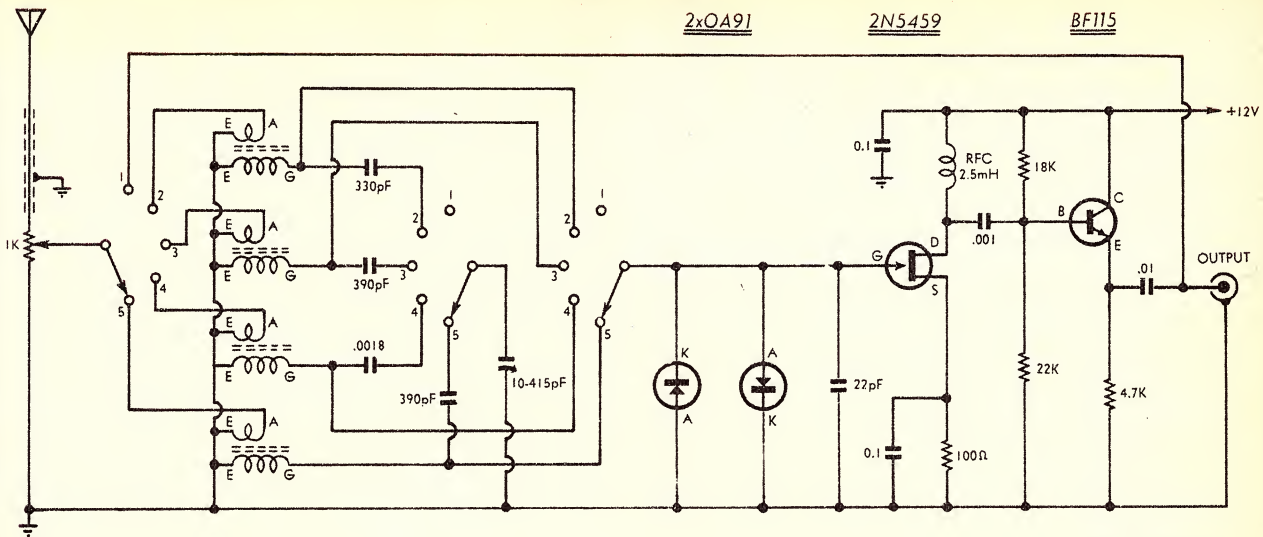

FET RF PREAMPLIFIER



SWITCH POSITIONS

1	- DIRECT TO RECEIVER
2	- 1.5 MHz
3	- 3-6 MHz
4	- 6-15 MHz
5	- 15-30 MHz

and chassis. There are also two OA91 germanium diodes, one in each direction, from the gate to chassis. These are added as a precaution against excessive RF being fed to the gate of the FET, which could cause damage. This applies particularly where the unit is operated very close to a transmitter, as in a two-way system. Although these diodes will limit the signal level into the FET to about 300 millivolts, they do not affect normal signals in any way. If you intend to use this unit only for ordinary listening, you may omit these diodes.

The source resistor and by-pass are the equivalent of the cathode resistor and by-pass capacitor of a valve circuit. The value of 100 ohms is about optimum to accommodate the spread likely to occur with the 2N5459 FET.

As we have elected not to tune the drain circuit, but need to present as high a load to the drain as possible, a 2.5mH RF choke is used. Generally speaking, the impedance of the RF choke will rise with increasing frequency, so holding up the gain where it would otherwise tend to fall.

As this high impedance circuit will need to be connected to a low-impedance aerial terminal of a receiver, we have interposed an emitter follower stage. A BF115 transistor is used and the circuit is so straightforward that no further comment is needed.

The circuit shows position 1 of the range selector switch wired to direct the aerial around the preamplifier to the output terminal. This is most useful if the receiver is to be used on a band not covered by the pre-amplifier, such as the broadcast band. While satisfactory for the broadcast band, it produces a noticeable insertion loss on the short-wave bands, due mainly to the presence of the emitter follower across the output terminal. In practice, the preamplifier is unlikely to be switched out of circuit on those bands where it can function.

While on the subject of the extra switch position, in cases where it is desired to make the preamplifier cover the broadcast band, it is only necessary to add a suitable broadcast aerial

*Use of only a single tuned circuit for each band greatly simplifies the circuit. The FET operates into a fixed load and an emitter follower.*

coil. Such a coil would be one designed for valve use and with a tuning capacitor of 10 to 415pF. No series capacitor is needed for this band and this will simply be omitted and a piece of wire substituted.

As mentioned earlier, the short-wave coils need to be high Q types. To achieve this, we looked at a number of alternatives. A well-designed helix, on a low-loss former, can result in quite a high Q. However, this type is generally somewhat

larger than we had in mind for this application and it has another disadvantage which we will mention later. A promising alternative is to use a ferrite core of some type. Pot cores are excellent, though rather expensive. They also provide for limited adjustment of the inductance, but this is not necessary here.

Ferrite toroids appeared more attractive. After some investigation, we found that unloaded Q values ranged from about 120 at the lowest point,

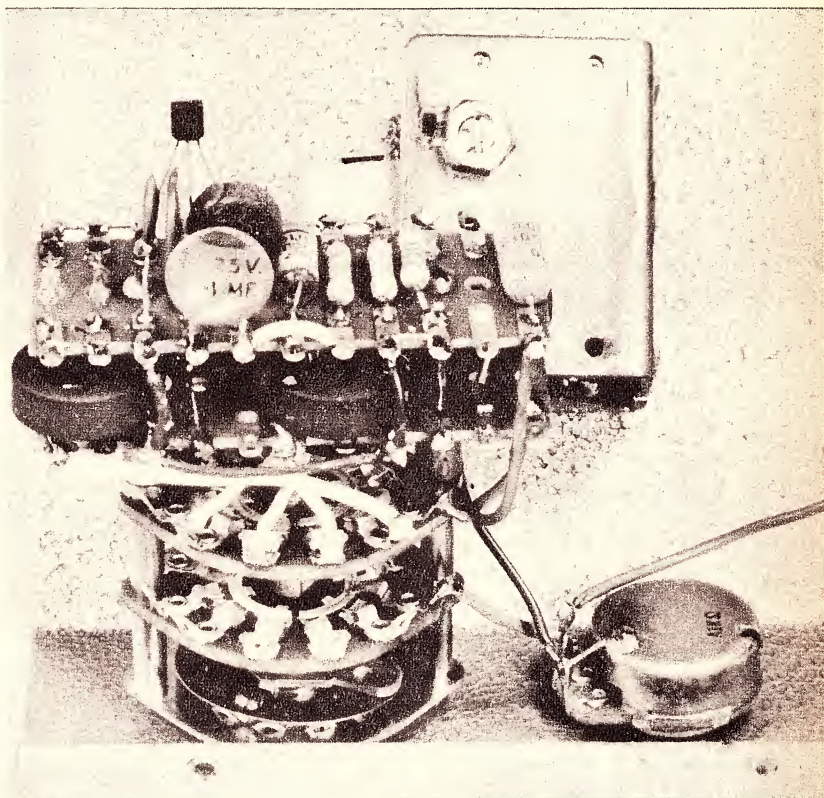

*How the two resistor panels are mounted on the rear of the switch. The toroid on the left is the 15-30MHz winding.*

# MAGRATHS

## MELBOURNE'S ELECTRONIC HOBBIES CENTRE

# THIS POPULAR SPEAKER AGAIN AVAILABLE

## "PIONEER" MODEL P-382B

### 15in. BASS GUITAR or ELECTRONIC ORGAN SPEAKER

This superb 15-inch unit is available in 8 ohm or 15 ohm Voice Coil. Power handling 30 watts R.M.S., 60 watts (peak). Frequency response to 500 cycles. Resonant frequency 60 plus or minus 12 cycles. Sensitivity 103 plus or minus 2 db/watt. Total flux 11,600 MAXWELL. Flux density 9.360 gauss.

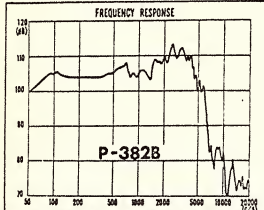

# \$30

Including  
Sales Tax  
POSTAGE FREE  
Anywhere in  
Australia

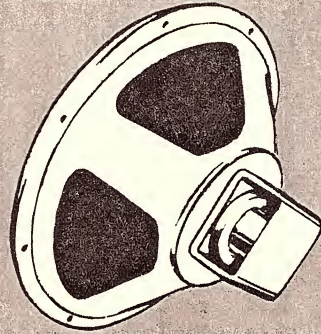

15 ohm unit  
AVAILABLE NOW.

PLACE YOUR  
ORDER FOR 8 ohm  
UNITS AVAILABLE  
LATE MAY

## 'Stentorian' Speakers

### H.F. 1016 STENTORIAN MAJOR SPEAKER

Designed to achieve full range response when mounted in a 'compact' cabinet. Cone diam. 10in. Pole diam. 1in. Flux density 16,000 gauss. Total flux 64,000 Maxwells. Impedance coil at 15 ohms. Frequency response 60 c.p.s. to 16,000 c.p.s. in suggested cabinet. 30 c.p.s. to 16,000 c.p.s. in larger cabinet. Capacity 10 watts \$28.50 (including Sales Tax).

### Model H.F. 1016 STENTORIAN SPEAKER

10in. P.M. Unit and 16,000 gauss magnet. Universal impedance speech coil at 3, 7.5 and 15 ohms. Capacity 10 watts. Frequency response 30 c.p.s. to 15,000 c.p.s. Bass resonance 35 c.p.s. \$21 (including Sales Tax).

### Model H.F. 1012 STENTORIAN SPEAKER

10in. Unit 12,000 gauss magnet. Universal impedance speech coil at 3, 7.5 and 15 ohms. Capacity 10 watts. Frequency response 30 c.p.s. to 14,000 c.p.s. Bass resonance 35 c.p.s. \$14.00 (including Sales Tax).

### Model T.10 STENTORIAN TWEETER

Speech Coil is aluminium wire wound on an aluminium former rigidly fixed to an aluminium diaphragm, giving high standard of reproduction when used with Stentorian H.F. 1016 speakers. Speech coil impedance 15 ohms. Response: 200/15,000 c.p.s. flux density: 14,00 gauss. Capacity: 5 watts. \$16.00 (including Sales Tax)

### CX 3000 CROSSOVER NETWORK

W/B Crossover is of the filter type and is fitted to all the Duplex Loudspeakers. It is available for use separately, the 3,000 c/s type is half section series connected having an attenuation of 12 dB per octave C.X.3000, \$6.50 (including Sales Tax).

### T359 TWEETER.

3,000-15,000 c.p.s. Size overall 3 1/2in diam. x 2in deep. Voice coil impedance 15 ohms, \$6.50 (including Sales Tax, plus Postage).

POST FREE ANYWHERE IN AUST.

## FULLY PIERCED VEROBOARD copper clad strips

Part No.	Between Holes	No. of Strips	Size	Pin Size	Price
2/7003	.1"	16 way	17.9" x 3.4"	.052"	\$1.64 each
4/1001	.1"	21 way	18.9" x 4.8"	.052"	\$2.00 each
6/7006	.1"	24 way	17.9" x 5"	.052"	\$2.25 each
41/1501	.1"	16 way	17" x 2.55"	.052"	\$1.16 each
44/1505	.1"	24 way	17" x 3.75"	.052"	\$1.60 each
101/231	.106"	27 way	17" x 4.371"	.052"	\$2.00 each
122	.075"	34 way	17.9" x 3.75"	.040"	\$1.86 each

## PLUG-IN VEROBOARD copper clad strips

Part No.	Between Holes	No. of Strips	Size	Pin Size	Price
202/7011	.1"	16 way	5.1" x 3.4"	.052"	\$1.04 each
241/2502	.1"	16 way	5" x 2.55"	.052"	\$0.93 each
243/2504	.1"	24 way	8" x 3.75"	.052"	\$1.60 each
245/2506	.1"	24 way	3.75" x 3.75"	.052"	\$1.16 each
281/271	.106"	27 way	3.7" x 3.591"	.052"	\$1.13 each
304	.075"	22 way	3.7" x 2.5"	.040"	\$1.04 each

## DOUBLE SIDED VEROBOARD Copper strips each side

Part No.	Between Holes	No. of Strips	Size	Pin Size	Price
1311	.1"	39 way	8.1" x 8.4"	.052"	\$3.51 each

## VERO-EDGE CONNECTORS

To suit Board(s)	Part No.	Price
41/1501	304	\$1.88
241/2502		\$2.84
44/1505 243/2504, 245/2506		\$2.08
281/271		\$3.25
2/7003, 202/7011		\$2.84
6/7006		\$4.20

## PIN INSERTION TOOL

Tool No. 2150 is for use with terminal pin 2140/3073, and Tool No. 2151 with terminal pin 2142. \$1.55 each, exempt Sales Tax.

## TERMINAL PINS



2140/3073  
To fit a 0.052" (1.32 mm) diam. hole 85c per 100



2142  
To fit a 0.0375 (0.94 mm) diam. hole 45c per 100.



2141  
To fit a 0.052" (1.32 mm) diam. hole 85c per 100.

## PLAIN VEROBOARD

Part No.	Between Holes	No. of Strips	Size	Pin Size	Price
402/7022	.2"	16 way	17.9" x 3.4"	.052"	\$1.16 each
403/4001	.2"	21 way	18.0" x 4.8"	.052"	\$1.34 each
441/4501	.15"	16 way	17" x 2.5"	.052"	\$0.78 each
442/4505	.15"	24 way	17" x 3.75"	.052"	\$1.00 each
522	.1"	34 way	17.9" x 3.75"	.040"	\$1.16 each

**POST FREE 15% Sales Tax Extra**

**J. H. MAGRATH & CO. PTY. LTD.**  
208 LT. LONSDALE STREET, MELBOURNE, VICTORIA, PHONE 663 3731

to about 360 at the other end of the scale. These were obtained with Ducon Q2 toroids, which are only about  $\frac{3}{8}$ in diameter. The price is somewhat less than that for a pot core.

Although there is no real provision for varying the inductance of a coil wound on one of these toroidal formers, it is possible to make small variations under conditions where the full length of the circle is not used for the winding. If the inductance needs to be increased, then the turns should be pushed closer together. On the other hand, the inductance can be reduced by spreading the turns. We mention this as a matter of interest, since there should not be any need to make adjustments in this case, as no ganged circuits are involved.

Another advantage which is to be gained from the use of a magnetically enclosed former, such as the toroid, is the fact that practically all the magnetic field is enclosed, with very little stray. This means that the coils for the various ranges can be grouped together with little mutual coupling to cause "suckout." In the case of the helical coils first mentioned, this problem necessitates an extra section on the switch, to short out the coils not in use.

In short, by using coils wound on toroids, we have been able to achieve a high Q at small cost and with a minimum of space. This leads to an efficient and compact assembly.

The coil winding details are given in the table. The number of turns on each winding and the disposition of the windings should be closely adhered to. However, the gauge of wire specified is simply a guide. If you do not

## COIL DETAILS

1.5MHz-3.0MHz	Secondary, 50 turns 26 SWG enamel, wound to occupy about 90 per cent of former. Primary, 5 turns, interwound at earth end of secondary.
3MHz-6MHz	Secondary, 24 turns 24 SWG enamel, wound to occupy about 60 per cent of former. Primary, 3 turns, interwound at earth end of secondary.
6MHz-15MHz	Secondary, 9 turns 18B&S enamel, wound to occupy about 50 per cent of former. Primary, 2 turns 26 SWG enamel, interwound at earth end of secondary.
15MHz-30MHz	Secondary, 4 turns 18B&S enamel, wound to occupy about 33 per cent of former. Primary, 1 turn 26 SWG enamel, interwound at earth end of secondary.

have the exact gauge specified, then something close to it should suffice. At the same time, particularly for the higher frequency coils, the gauge of wire should be as heavy as practicable. This will reduce the resistance of the coil and so give a higher Q.

With the exception of the 1K aerial attenuator potentiometer and the tuning capacitor, all components are integrated into one assembly. Most of the components are mounted on a strip of tag board, with 11 pairs of tags. The four toroidal coils are mounted on another and similar size tag board. Both of these are shown in the respective sketches.

A logical place to start is winding the four toroidal coil units. This task is straightforward but an odd comment or two may make the job a little easier. The number of turns quoted in the coil table may be considered as

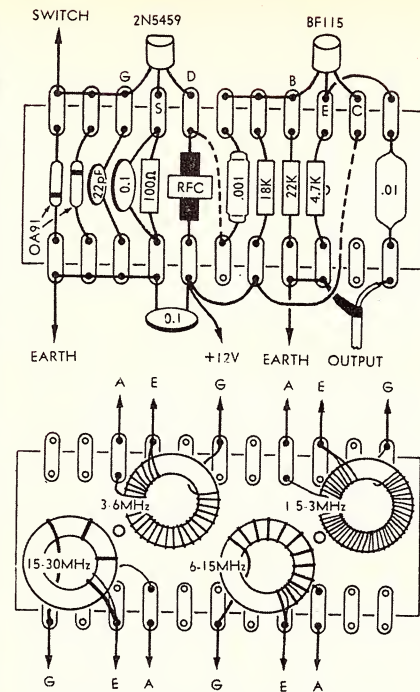

*These two panels are shown correctly orientated, relative to each other. Compare these drawings with the photograph on page 71.*

the number of times the wire passes through the hole of the toroid. It is a good idea to make an estimate of the quantity of wire required for the secondary winding and then locate the centre of the length. Pass one end through the toroid and bring the wire

to the centre point, thus leaving equal amounts to be wound with half the number of turns each way. This means that there is less wire to thread through each time. Care should also be taken not to scrape the enamel from the wire against the edges of the toroid.

At one end of the secondary winding, which will become the earth end, the primary is wound on. The common earth ends of the two windings should be bared, tinned and soldered together.

With the four coils wound, they are mounted on the tag board in the relative positions as shown in the diagram. The respective ends of the windings are terminated at convenient adjacent tags on the board. In the case of the lower frequency coils, which are wound with relatively fine wire, this is not enough to fix the coil securely to the board. This is best done by simply tying the

toroid to the board with a piece of nylon cord. While not so necessary with the coils wound with heavy wire, it is a good idea and ensures that they do not shift about.

The main component board is next and is wired up according to the diagram. The usual care should be taken not to overheat any of the components, in particular the transistors and diodes. Make sure that all the interconnecting wires are complete, before any attempt is made to take the assembly of this board any further. The four capacitors in series with the tuning capacitor are not wired in at this stage.

The two above sub-assemblies are mounted on the end of the range selector switch and separated from each other and the switch with  $\frac{1}{4}$ in long spacers. The first step in assembly involves fitting the first pair of spacers to the rear ends of the two switch retaining screws. Generally, there is about 1/16in of thread protruding beyond the nuts. The screws used in MSP switches are 5BA and the threaded spacers which are readily available are 1/8in Whitworth. These dissimilar threads do not mate very well but, due to the short length of thread, it is possible to screw the spacers on, provided due care is taken. If you can substitute Whitworth screws, so much the better.

Having mounted the spacers, check the centre-to-centre dimension between the spacers with that of the third hole from each end of the two boards. More than likely you will find that the two holes are too close together. A little filing with a slim taper file will put this right.

The board with the coils is mounted against the spacers at the end of the switch, with the coils away from the switch. The second board is spaced away from the coil board with the second pair of  $\frac{1}{4}$ in spacers. Two round-head screws, 1/8in x  $\frac{1}{4}$ in are used to secure the two boards to the spacers on the switch.

The assembly is now ready for the outstanding wiring and components. The various sections of the switch are used as follows. Only one section is used on the wafer nearest the clicker plate, and is employed to switch the

## SERVICE

BILL TURNBULL offers you service on Hi Fidelity equipment tape Recorders, Communication Receivers and Electronic Test Equipment.

25 years experience  
All work guaranteed

BILL TURNBULL  
11 ELLALONG ROAD,  
CREMORNE, N.S.W. 90 4825

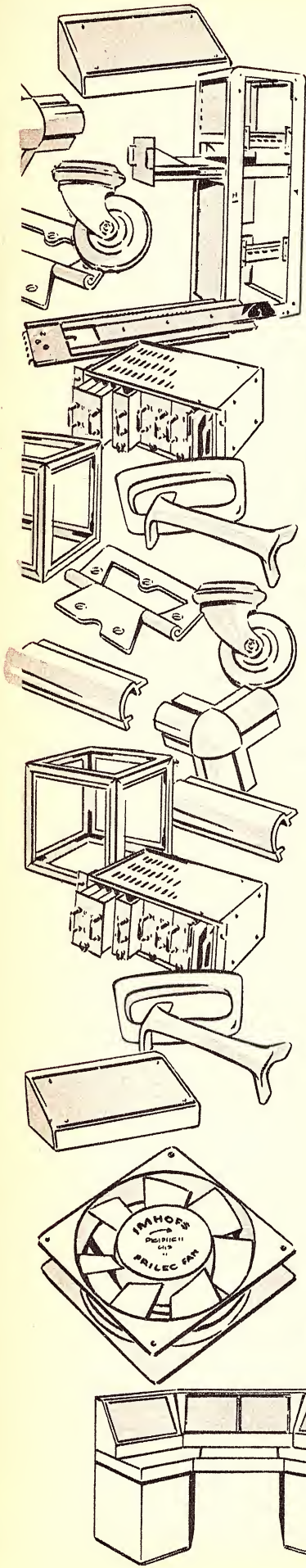

# Got a housing problem?

## LET'S HEAR ABOUT IT

We can house your instruments in any size or shape of cabinet you need. Aladdin can supply a whole range of beautifully modern Imhof racks, cases and consoles in a whole range of standard or custom-built styles. Attractive Imhof handles in a variety of styles and finishes. Imlok framework for cases can be ordered already assembled or delivered ready for easy self-assembly. Next time you've got a housing problem, call us: Aladdin Industries. We'll put you in good shape.

### IMLOK & IMHOF

## Aladdin

INDUSTRIES PTY. LTD.  
43 Bridge Road, Stanmore.  
2048. Phone 51-2826.  
688

aerial into the primaries of the coils. The corresponding section on the other wafer switches the tuning capacitor to the relevant series capacitors. The third section selects the top of the secondary of each coil.

The wiring involves the interconnections between the various contacts on the switch and coils, together with the series capacitors. One connection not mentioned is the one from pin 1 of the aerial section, to the output point at the end of the .01uF capacitor. This is optional.

Now we have three items, the coil-switch assembly, the potentiometer for the aerial attenuation and the tuning capacitor. If your box is ready drilled to take these items, then it is only a matter of screwing them into place. However, if you have a box which you have to drill yourself, there are a couple of points worth watching. The

### PARTS LIST

- 1 Metal case, 5in, with sloping panel.
  - 1 Variable capacitor, 10-415pF, single section.
  - 1 Potentiometer, 1K linear.
  - 2 Coaxial sockets.
  - 1 Switch, 2 wafers, 2-pole 5-position.
  - 2 Tag boards, 11 pairs of tags.
  - 4 Toroidal formers, Ducon type F4040/2, Q2 material.
  - 1 Field effect transistor, Motorola type 2N5459.
  - 1 Transistor, type BF115.
  - 2 Diodes, type OA91.
  - 1 RF choke, 2.5mH.
  - 2 Spacers, 3/8in long, 3/8in diam. brass, tapped 1/8in Whit.
  - 2 Spacers, 3/8in long, 3/8in diam. brass, 1/8in clearance.
  - 1 Dial scale.
  - 1 Knob dial.
  - 2 Knobs.
  - 1 22pF NPO ceramic.
  - 1 330pF Styroseal.
  - 2 390pF Styroseal.
  - 1 .001uF plastic.
  - 1 .0018uF plastic.
  - 1 .01uF low voltage plastic.
  - 2 0.1uF low voltage ceramic or plastic.
  - 1 100 ohms 1/2W.
  - 1 4.7K 1/2W.
  - 1 18K 1/2W.
  - 1 22K 1/2W.
- Hook-up wire, solder, screws, nuts, coaxial cable, etc.

hole for the coil-switch assembly should be carefully placed so that the assembly will not foul any parts of the case when it is slid into position. Having located this hole, the position for the potentiometer is then established.

The placement of the tuning capacitor needs care, so that it does not foul the coil-switch assembly. At the same time it should be as close as possible. This will keep vital leads to a minimum length. There are three untapped holes on the front of the tuning capacitor. These are tapped and used to mount the capacitor to the panel, using countersunk head screws. Spacers must be used to keep the spindle bearing from fouling the panel. We found that four flat washers on





# FORUM

## Radio interference, organs and so on

This is one of those months when we seem to have many letters on many quite different subjects. So, without further ado, let's set them down and comment as we go along. If you have something to add, remember that the Forum columns are provided for that very purpose.

### Conducted by the Editor

**INTERFERENCE:** "As I look at the stuff written in technical journals on the subject of man-made noises, on the air and on the mains, I get a laugh and think: "These fellows have not heard real QRM until they have switched on some form of communications receiver in the Villawood (N.S.W.) area! It goes on from midnight Sunday to midnight Sunday. Name a time and you've still had it!"

"During my 15 years of living in the area, I've tried all kinds of communications receivers, all with the same result — no hope of receiving signals under a good S8. Being an ardent short-wave listener, I am in a position to say this, believe me.

"I called on the services of the P.M.G. Radio Branch on one occasion, only to be told that short-wave reception was not really their concern. I'd go so far as to say that we have no men brainy enough in the Department to tackle the enormous QRM problem. There are plenty of would-be short-wave listeners like myself who would not bother their ears listening to the drivel that is fed into the ether day after day by our local broadcast stations. But that's another point.

"All we ask of the P.M.G. and the brainy staff is a cleaner ether for the sake of the many short-wave listeners." R. B. (Fairfield, N.S.W.)

**COMMENT:** This letter raises points which have been aired in these columns before but it may not do any harm to refer briefly to them again.

Firstly, the proliferation of electrical wiring and electrical equipment is taken as some kind of an index to a modern way of life and a rising standard of living. The almost inevitable price, it would seem, is an increase in the ambient electrical noise level. As it rises, so will weak radio signals tend to be swamped out.

There is plenty of evidence to suggest that it is an extremely difficult and costly business to instal wiring and equipment which does not radiate some interference in some circumstances. The problem might con-

ceivably be diminished greatly if all supply wiring were run in deep underground conduits but it is claimed that the cost of doing this would be prohibitive.

This being so, there is not much point in taking it out on P.M.G. radio inspectors — popular sport though it is. Their authority in the matter of noise interference is very, very limited and, as matters stand at the moment, about the best they can do is to solicit corrective action on noise sources which are upsetting local radio and television reception.

It's tough enough when the noise is traceable to an individual or a company. It's really tough when it concerns another Government or civic body, with all their in-built inertia.

To establish the principle that interference should not prejudice DX radio reception and to give expression to such a principle would require strong co-ordinated action at Federal and State Government level — something that doesn't come about too easily.

To be realistic, one must expect that Villawood will continue to be a poor location for DX listening for many years to come. But not just Villawood — most cities and most suburbs and most country towns!

But, before we dismiss the subject let's look at the next letter:

**INTERFERENCE, AGAIN:** "I would like to add my own little piece on the subject of radio interference, having just witnessed the birth of another source.

"What happened was that an electrician, on his normal rounds of a local school, found that a particular 3 x 40W fluorescent fitting was overheating. Apparently this was due to an insulation breakdown in the capacitor across the mains. He simply cut the lead wires to the capacitor at the mains connector, took out the faulty capacitor, reassembled the fitting without putting in a new one and climbed down the ladder.

"When I asked him about it, he

simply replied: 'We never replace those things, they always fail eventually. And anyway, they don't affect the working of the light — they're only to stop interference getting back into the main.

"No wonder interference is a growing problem with attitudes such as this. I couldn't count the number of times I've heard radio salesmen tell customers (including me) in their fluorescently lit showrooms: 'Don't take any notice of the buzz in the radio (or amplifier), it's only the lights!'

"If this is a problem in newer shops where presumably most of the lights have capacitors fitted, what must the situation be in buildings where the capacitors have simply been snipped out of circuit by the maintenance electrician?

"I understand that manufacturers fit the capacitor in accordance with regulations. Shouldn't it be just as much a transgression of regulations to remove the capacitor during the life of the fitting?

"I realise that it may be extremely hard to police such matters but we should surely be trying to avoid the situation which exists in major cities in the U.S. where, at times, the mains are almost unuseable for radio, due to interference.' G. B. (Chatswood, N.S.W.)

**COMMENT:** There are a number of interesting angles to this letter the first being the electrician's explanation of why capacitors are installed in fluorescent fittings. It would appear that the basic—and only "official"—reason is to correct the power factor of the appliance on the line, the leading power factor of the capacitor offsetting the lagging power factor of the lamp ballast inductor.

At one time manufacturers were more or less obliged to fit capacitors for this reason, but this appears no longer to be the case. A call to a typical supplier indicated that capacitors are provided in domestic style fittings only if they are expressly ordered—the price of the fitting being adjusted upwards accordingly.

A word to the electrical department of our parent company confirmed this.

They are sensitive to the power factor of the total load and have to order fluorescents fitted with capacitors in those specific terms.

As far as interference is concerned, a quick whip around failed to elicit any positive reaction. There were plenty of "coulds," "mights" and "maybes" but the most we got was an opinion from a custom supplier that fluorescent lights will cause trouble in radios and amplifier systems, if mounted too close, with or without capacitors.

## BETTER MAIL ORDER SERVICE?

The vagueness is probably due to the fact that, in urban situations, with strong radio signals and a high level of interference, the contribution of one more fluorescent light could hardly be noticed.

We'd be interested to hear of the experience of country readers, with lower signal levels, lower ambient noise levels and the opportunity to judge the noise characteristic of typical commercial lighting appliances on a more selective basis.

But, of course, right or wrong, the attitude of the electrician is evident: Capacitors don't matter . . . "they're only to stop interference getting back into the mains" . . . and who cares about that?

As for American cities, it would be interesting to know whether the position is really as bad as reported or whether aggrieved listeners there are even more vocal than their Australian counterparts.

**CHORD ORGANS:** "With reference to the problems of R.S. of Condong, N.S.W. (Jan., 69) in providing a chord accompaniment for a monophonic organ, I would recommend the following approach:

"First obtain the bass and chord section from an old accordion. It is often possible to buy an unserviceable instrument quite cheaply but it should be checked to see that the chord mechanism functions cleanly and reliably. The bars operating the reed pallets (or valves) can be used to operate contacts for oscillators.

"Having studied one of these mechanisms, I can state that a minimum of four oscillators will provide all of the 48 chords available on them. However, the switching is complex and an increase to six oscillators (each covering two adjacent semitones) will provide simple switching.

"The bass buttons usually operate through a separate mechanism and this can be connected to a low-pitched monophonic organ. The use of frequency dividers will provide "high," "normal" and "low" bass. Frequency dividers can also be added to the monophonic melody organ and may be blended by switches or pots.

"One of the earliest instruments of this type—the Hammond Solovox—has a three-octave keyboard and four pitches available at octave intervals. This unit also uses a network of filters—inductors, capacitors, resistors and tuned circuits which may be switched into circuit for different tone colouring.

"Quite a good instrument could be built in this way for a minimum outlay. The total requirement would be six oscillators for the chord section and one oscillator each, with dividers if desired, for the melody and bass sections. Various books on electronic musical instruments will provide circuits for the tone filters, variable attack and decay units and many other effects." (G.M. Dover Gardens, S.A.)

**COMMENT:** The suggestions made in this letter should provide food for thought for all those who are keen to build some kind of electronic organ without incurring too much expense. It is quite different in content from the kind of letter which commonly follows the publication of any article

"It has been my experience (confirmed by others) that 'country' project builders are at an extreme disadvantage in Australia. Many letters written to suppliers for prices and information go unanswered. Also very few suppliers offer any form of catalogue, so the process of obtaining an item firstly requires a letter inquiring the price and secondly an order for the item. This process commonly requires from 2-3 months.

"I am unable to offer a simple solution to this problem but there would appear to be a good opening for an efficient mail order firm that provides a simple catalogue. There are some that provide a subscription catalogue, but the prices are prohibitive for the home experimenter. No doubt a lot of your projects are built from kits available, but there are still a large number of builders who only require some items to complete a unit with the aid of their 'junk box.'

"It may be possible to improve the situation somewhat if you could during the development of various projects, compile a list of firms who would be willing to compete for such a trade. Although the cost of even a simple catalogue is considerable, the increased turnover should offset this together with the 'free advertising' that would result in the names of such firms being passed around." (N.S., Toowoomba, Qld.)

on a monophonic (i.e., one note at a time) kind of organ.

Inspired by the relative simplicity of such instruments, would-be constructors commonly begin to reason that, with two oscillators, it should be possible to play two notes at a time. With four to six oscillators, it should be possible to play chords with both hands. What they fail to appreciate is that the design, switching and circuitry would have to be at almost genius level for the half-dozen oscillators to connect themselves appropriately to any half-dozen notes that might be depressed anywhere on the keyboard.

It transpires that provision of a

polyphonic facility necessitates the use of a minimum of at least one oscillator to serve each of three adjacent semitones throughout the keyboard. Even this order of economy, which is greater than many players like, necessitated 16 oscillators for the single manual "Stromberg-Playmaster" organ, described in these pages some years ago.

Again, the kind of non-linear wave-shaping which one can apply to a single oscillator cannot be applied simultaneously to further oscillators, because of the cross-modulation effects which would take place. Simple con-

(Continued on page 81)

# high speed tape duplicator

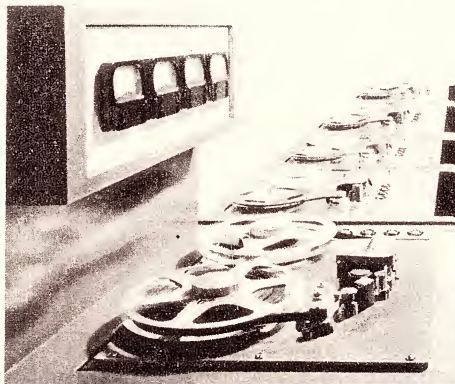

- Otari 4 & 8/2 & 4 track high speed tape duplicator.
- ◆ 120" per sec. ◆ .15" & .25" tape
- ◆ Fully automatic ◆ Stereo or mono
- ◆ Dual capstan ◆ Factory pre-aligned heads don't require adjustment ◆ Plug in heads
- ◆ Up to 20 slaves from 1 master
- ◆ Slaves have separate replay head for monitoring while duplicating ◆ Solid construction and good accessibility for maintenance ◆ 12 month warranty ◆ After sales service

**KLARION ENTERPRISES**  
PROPRIETARY LIMITED  
321 WILLIAM ST. MELBOURNE 3000



See us at Stand No. 4A  
I.R.E.A. 12TH NATIONAL CONVENTION  
WENTWORTH HOTEL SYDNEY  
MAY 19 TO 23 1969

# 180 WATT SOLID STATE STEREO AMPLIFIER

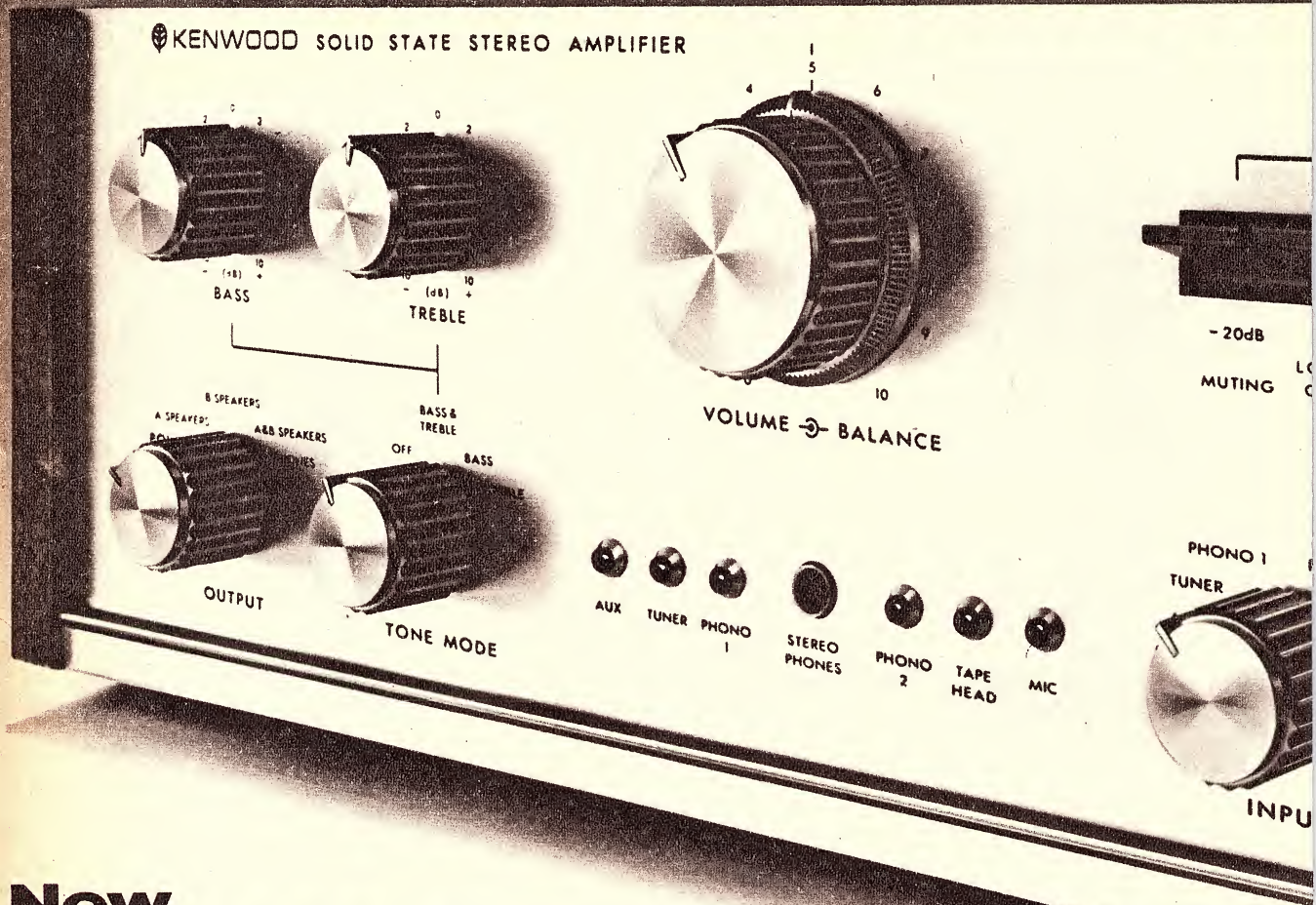

## New KENWOOD's KA-6000 The Musical Powerhouse For Maximum Perfection

You don't have to look elsewhere—KENWOOD's KA-6000 180-watt solid state stereo amplifier has all the power you need for maximum perfection.

It has more than enough power to drive even Hi-Fi speakers of low efficiency.

With its wide power bandwidth of 10Hz to 50,000Hz there is low-low IM distortion.

The KENWOOD exclusive low level phono inputs for low level output phono cartridges of 2mV, 0.5mV or 0.05mV.

There are many other outstanding features in the KA-6000—all the results of high quality engineering—but the final test is in performance. Stop in at your KENWOOD dealer for a KA-6000 demonstration.

Remember, KENWOOD also has other amplifiers with less power.

There's a KENWOOD for every stereo need.

SOLE AGENT: Jacoby, Mitchell & Co., Pty., Ltd: Head Office: 469-475 Kent Street, Sydney Tel: 26-2651 Melbourne: 15 Abbotford Street Tel: 30-2491 Brisbane: 56 Edward Street Tel: 2-6467 Adelaide: Truscott Electronics, 64 Hindmarsh Square Tel: 23-3024 Perth: United Australia Co., Pty., Ltd., 435 Hay Street, Subiaco Tel: 8-4665 Tasmania: K.W. McCulloch Pty., Ltd., 57 George Street, Louceston Tel: 25-322

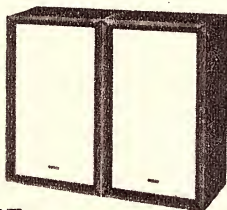

### BOOKSHELF TYPE 4-WAY 5 SPEAKER SYSTEM KL-660

- \* Mounted speakers: 12-inch, free-edge woofer × 1 (Bass)
- 6½ inch cone squawker × 1 (lower midrange)
- 4 inch cone squawker × 1 (higher midrange)
- Horn-type tweeter × 2 (Treble)
- \* Dimensions: 15" (W), 25½" (H), 11½" (D)

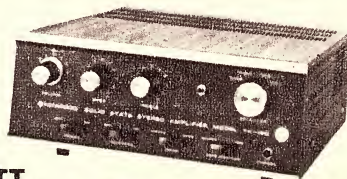

### 40 WATT SOLID STATE STEREO AMPLIFIER TK-150U

- \* 5 pairs of input terminals for MAG, AUX 1, AUX 2, TAPE REC and TAPE PLAY.
- \* Damping factor: 40 (at 16ohms), 20 (at 8ohms)
- \* Dimensions: 10½" (W), 4½" (H), 9¾" (D).

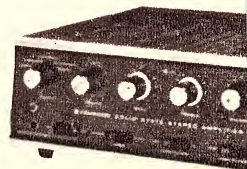

### 60 WATT SOLID STATE STEREO AMPLIFIER TK-250U

- \* 2 sets of stereo speaker terminal and front panel speaker selector switch
- \* Dimensions: 13" (W), 4½" (H), 9½" (D).



# KA-6000

## MODEL KA-6000

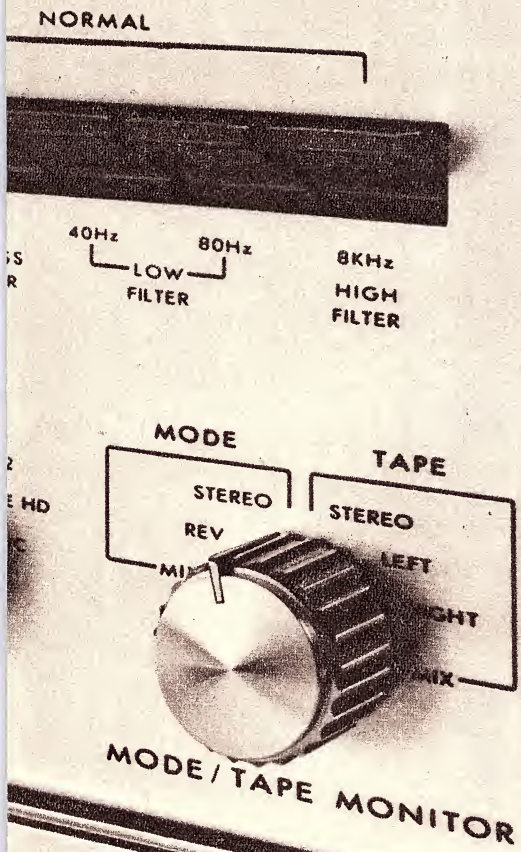

*the sound approach to quality*



# KENWOOD

## TRIO ELECTRONICS, INC.

6-5, 1-CHOME, SHIBUYA, SHIBUYA-KU, TOKYO, JAPAN

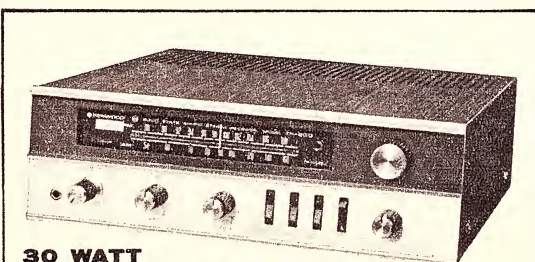

**30 WATT  
FET SOLID STATE AM/FM  
STEREO RECEIVER TK-20U**

\* F.E.T. (Field Effect Transistor) 3 Gang Tuning Condenser front end for superior sensitivity, image rejection and cross modulation ratio.

\* Dimensions: 14 $\frac{3}{16}$ " (W), 4 $\frac{3}{8}$ " (H), 11 $\frac{1}{2}$ " (D).

Ask for a catalogue or demonstration by your nearest dealer.

To: Jacoby Mitchell & Co., Pty., Ltd. EA  
469-475 Kent St., Sydney.

Send me information on KENWOOD RECEIVER, AMPLIFIERS, SPEAKERS & name of nearest KENWOOD retailer,

NAME: \_\_\_\_\_ AGE: \_\_\_\_\_

ADDRESS: \_\_\_\_\_

\_\_\_\_\_

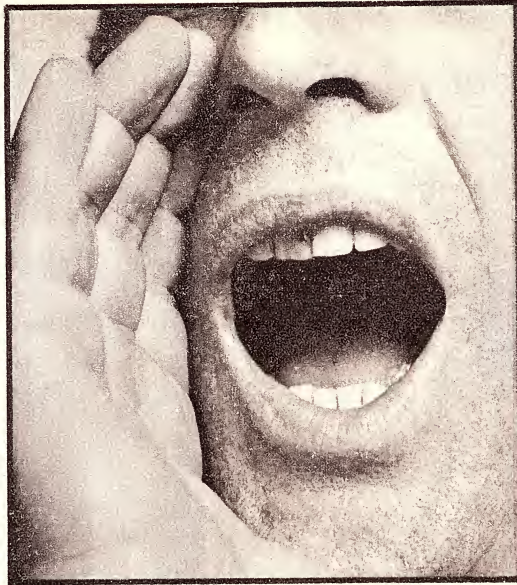

no shouting needed:

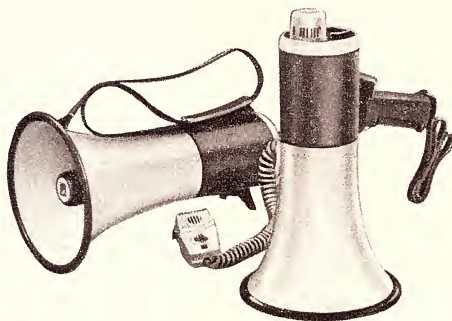

# TOA MEGAPHONES

If you've got something to say, if you direct traffic, train a team, fight a fire, direct construction, start a race, make a movie, or simply sound off.

TOA amplifiers are lightweight, easy to operate, rugged and fully transistorised.

TOA equipment delivers high efficiency, long life and the kind of full colour sound that stretches carrying power even under the most difficult conditions.

ER308 hand-operated pistol type. Fully transistorised, battery operated. Maximum output is 16 watts. Special mic construction makes it

feed-back proof. This enables maximum volume. Projects voice up to 1,000 yds. Weight, 3.5 lb.

ER64 shoulder type. Details as ER308.

ER45 shoulder type as ER64. Plus equipped with emergency alarm. Red all over and covered in reflective red tape which glistens in the dark.

ER65 shoulder type as ER64. Maximum output 20 watts (most powerful in the world). Can be installed as stationary type. Projects voice to 1,500 yds. Weight, 6.5 lb.

All models are leakproof and backed by the unrivalled AWA sales and service organisation.



**AMALGAMATED WIRELESS (AUSTRALASIA) LIMITED**

Australia's National Wireless Organisation



**TOA ELECTRIC CO. LTD.**

Public Address Equipment

**AMALGAMATED WIRELESS (AUSTRALASIA) LIMITED:** Sydney, Newcastle, Canberra, Brisbane, Melbourne, Hobart, Launceston, Adelaide, Perth; and also Chandlers Pty. Ltd., Queensland, and Newton McLaren Ltd., South Australia.

trol circuitry rapidly mushrooms into a major undertaking.

Inseparable from all this is the basic philosophy of an instrument. A small, monophonic instrument is an interest project, a gimmick, a toy, maybe, and no one expects more of it than its appearance would imply.

But give it a longer keyboard and other trappings, so that it begins to look like a musical instrument, and it inherits the obligation to perform as such.

It sounds so obvious and logical that one could build a simple monophonic instrument to start with and gradually add to it until it becomes a full-size organ. Technically and psychologically, however, there is a gulf between the two which is very hard to bridge.

The approach put forward by G.M. is interesting because it aims at something which is neither monophonic nor polyphonic but a simplified chord organ providing a monophonic melody line, a chord system for the left hand and a monophonic pedal bass.

What makes it practical is the system of switching involved in chord buttons which presumably allows a variety of chords to be constructed from a limited number of oscillators. We haven't cross-checked G.M.'s statement but he appears to have looked into the matter fairly carefully.

Whether or not the idea of a chord organ appeals is another matter, but, if it does, G.M.'s suggestion would be worth careful consideration.

**MAIL ORDER:** The letter on page 77 mentions a problem which is not new but which can stand occasional re-statement—the problem which faces country readers in obtaining parts.

In defence of mail order suppliers — and not referring to our present correspondent — it is only fair to point out that the blame for non-service is as often with the customer as with the supplier. Inquiries have turned up in letters which lack signature or address, which are so badly scrawled that it is almost impossible to decipher them or which are so vague, in terms of requirements, that the supplier would need second sight to fill the order accurately.

But, equally, we have heard all too frequently of suppliers who have put aside letters which involve some problem, intending to reply "later on"; or who let days and even weeks drag, waiting to supply something that doesn't turn up when expected. A brief note and a stamp would save so much apprehension and bitterness for a customer who just doesn't know what's happening — other than the fact that his cheque has been paid in!

While advertisers are well satisfied with the amount of business which they attract through the pages of "Electronics Australia," we do often wonder how much extra business goes down the drain through misunderstanding and lost opportunities.

Our present policy is to mention in articles the source of new or unfamiliar components which may be used, both to guide parts suppliers and buyers who cannot arrange supply through normal sources. This is as much as we can undertake at the moment. Maybe a nice slice of business awaits someone who is prepared to offer some kind of a new deal in mail order supply. ■

## LOUDSPEAKER CABINETS FROM SCRAP

Pushed into the racks of "off-cuts" in many hardware stores are oddments from which the handyman can make loudspeaker cabinets at comparatively low cost.

Pictured is a small cabinet which one of our staff members made up privately for a relative needing a simple extension loudspeaker. It looked so much better than a painted box, that we considered it worthy of special mention.

The loudspeaker to be housed was an ordinary 7 x 5 inch unit and the dimensions were selected to accommodate its frontal area, leaving room for small internal cleats. The depth was made as great as could reasonably be justified on the assumption that, in housing a small general-purpose loudspeaker, the bigger the cabinet can be made, the better it will sound.

The finished cabinet was packed loosely with Innerbond (see "Wonder Wool" advert in each issue). The back was closed off with a small piece of ¼-inch thick composition board with a pattern of holes to relieve back pressure on the cone. In no sense can a box like this be regarded as a properly designed enclosure but an oddment extension loudspeaker, so housed, will

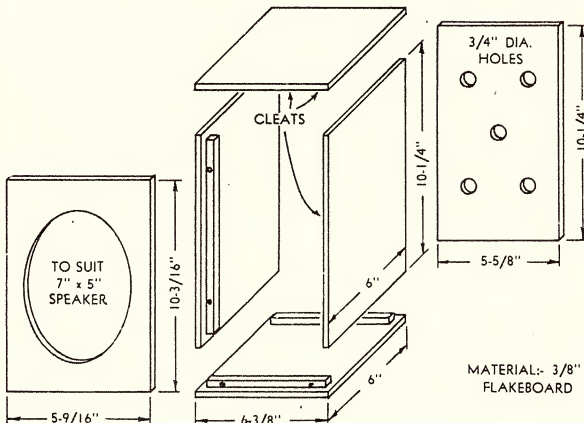
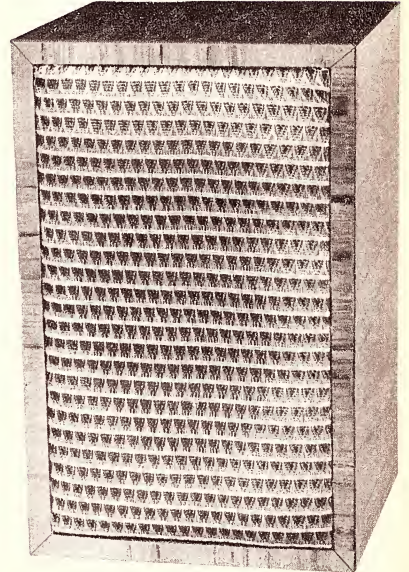

The cabinet illustrated was made up for a small extension loudspeaker. The same methods could be used to produce an enclosure of approved design.

certainly look the part and radiate acceptable sound.

The main panels were cut from 3/8in thick flakeboard, scraps of the same material being used also for the cleats. The cabinet was assembled using a good adhesive (typically Aquadhere) and light pins. After being put aside for the glue to set, the pins were punched below the surface and the cabinet dressed and sanded.

A "Laminex" knife is highly desirable to scribe the plastic laminate (Laminex or similar) slightly oversize for each of the surfaces to be covered. Do the bottom of the cabinet first, then the sides, the top. The front edges go on last, meeting at the corners at 45 degrees.

Working one surface at a time, coat the cabinet and the underside of the laminate with contact type adhesive

and allow to dry for the specified time. Use a couple of thin wooden dowels to keep the surfaces apart and position the laminate accurately over the side to be covered. Press the laminate down at the centre and moving the dowels one at a time, press the laminate into contact over the whole surface. When firm, dress the edges exactly square with a sharp plane set very fine. Always plane inwards to minimise risk of chipping the corners. If desired, the corners can be dressed later to 45 degrees.

To produce a "padded" look, the baffle was covered with a layer of Innerbond but, of course, cut away in front of the loudspeaker. It was over-wrapped with plastic fret cloth, pinned at the back. Pushed in from the front, the baffle was retained by screws passing through the cleats from the rear. ■

# A NEW SYSTEM OF SHORT-WAVE AMPLIFICATION

BY

EDWIN H. ARMSTRONG\*

(Columbia University, New York)

**SUMMARY.** — The various possible known methods of amplifying incoming signals of very short wave length (below 600 metres) are described, and their limitations considered.

The new method then described consists (for continuous wave reception) of the following steps:

- (1) Heterodyning, with the production of a beat frequency which is itself a radio frequency (for example, 100,000 cycles per second).
- (2) Rectification of the beat current.
- (3) Amplification at the beat radio frequency, preferably by a tuned amplifier.
- (4) Audio frequency modulation of the amplified current.
- (5) Rectification of the modulated current.

For reception of damped wave or radiophone signals, step 4 is omitted.

It is shown that in this case the quality (characteristic tone) of the incoming signals is preserved.

**T**HE problem of receiving weak signals of short wave length in a practical manner has become of great importance in recent years. This is especially true in connection with direction finding work where the receiver must respond to a very small fraction of the energy which can be picked up by a loop antenna.

The problem may be summed up in the following words: To construct a receiver for undamped, modulated continuous, and damped oscillations, which is substantially equally sensitive over a range of wave lengths from fifty to six hundred metres, which is capable of rapid adjustment from one wave to another, and which does not distort or lose any characteristic note or tone inherent in the transmitter.

It is, of course, obvious that some form of amplification must be used, but a study of the various known methods soon convinces one that a satisfactory solution cannot be obtained by any direct method. In the interests of completeness, we will consider the three well-known direct means which might possibly be employed, and examine the limitations which apply to each. These three methods are:

- (1) Amplification of the audio frequency current after rectification.
- (2) Amplification of the radio frequency current before rectification; and
- (3) Application of the heterodyne principle to increase the efficiency of rectification.

(NOTE: The heterodyne principle of reception described in (3) should not be confused with the superheterodyne principle as we know it today. In spite of the similarity of terminology, it refers to a method of reception using an oscillator in association with the detector, so adjusted as to produce an audible beat note. Editor, Electronics Australia).

Consider first the method of rectifying the radio frequency current and amplifying the resulting audio frequency current. Two limitations at once present them-

selves, one inherent in audio frequency amplifiers, and the other inherent in all known rectifiers. The limitation in the amplifier is the residual noise which makes it impracticable to use effectively more than two stages of amplification. The second limitation lies in the characteristic of the detector or rectifier. All rectifiers have a characteristic such that the rectified or audio frequency current is roughly proportional to the square of the impressed radio frequency EMF. Hence the efficiency of rectification becomes increasingly poorer the weaker the signal, until a point is reached below which the detector practically ceases to respond.

The second method of attack on the problem is the amplification of the received radio frequency currents before rectification to a point where they can be efficiently dealt with by the detector. This method is ideal on long waves, and various methods of inductance, resistance, and capacity couplings have been successfully used, but when the attempt is made to use the same methods of coupling on wave lengths below six hundred metres, it results in complete failure. This is because the low capacity reactance existing between the various elements of the tubes causes them, in effect, to act as a short circuit around the couplings means and thereby prevents the establishment of a difference of potential in the external plate circuit. It is, of course, possible to eliminate the short-circuiting by tuning with a parallel inductance, but this introduces a complication of adjustment which is highly objectionable, and the tuning of all circuits also leads to difficulty with undesirable internal oscillations.

The third method which might be used is the heterodyne method to increase the efficiency of rectification. Great increase in signal strength is possible by means of this method, particularly where the signal is very weak, but there are certain reasons why it cannot be effectively used in practice at the present time. The chief reason in receiving continuous waves of short wave length is the instability of the beat tone which makes operations below six hundred metres unsatisfactory. This disadvantage does not apply to the reception of spark signals, but here the loss of the clear tone and its individuality offsets much of the gain due to increased signal strength. In the case of telephony the distortion which always results, likewise offsets the gain in strength. It is, of course, undeniable that there are many special cases where the use of the heterodyne on short wave lengths is of the greatest advantage, but the foregoing remarks apply to the broad field of commercial working where the practical aspects of the case greatly reduce the value of the amplification obtained by this method.

In spite of the great difficulties involved in a direct solution, great success was obtained by Round in England and Latour in France, in the production of radio frequency amplifiers to cover effectively a range from three hundred to eight hundred metres. This result was accomplished only by the most painstaking and careful ex-

\* We present this article to give our readers an appreciation of radio engineering at a time when "wireless" communication was still in its infancy. Written in 1921 by Edwin Armstrong (who later achieved fame for his work in developing the frequency modulation system of broadcasting) the article originally appeared in the

Australian publication "Sea, Land and Air." To the best of our knowledge, this magazine has been defunct for many years. We point out that what the author refers to as "short-wave" is in fact our present broadcast band also that some of the engineering difficulties discussed arose from the fact that only triode valves were available.

periment, and it represents some of the very finest radio work carried out during the war. Round secured his solution by constructing tubes having an extremely small capacity without increase in internal resistance above normal values and coupling the tubes by means of transformers wound with very fine wire to keep down the capacity, and very high resistance to prevent oscillation at the resonant frequency of the system. The effect of the high ratio of inductance to capacity and the high resistance of the winding is to flatten the resonance curve of the system and widen the range of response. Latour solved the problem by the use of iron core transformers wound with very fine wire, the iron serving the double purpose of increasing the ratio of inductance to capacity and introducing resistance into the system. Both these factors widen the range of response.

It is the purpose of this paper to describe a method of reception evolved at the Division of Research and Inspection of the Signal Corps, American Expeditionary Force, which solves the problem by means of an expedient. This expedient consists in reducing the frequency of the incoming signal to some predetermined super-audible frequency which can be readily amplified, passing this current through an amplifier, and then detecting or rectifying the amplified current. The transformation of the original radio frequency to the pre-determined value is best accomplished by means of the heterodyne and rectification, and the fundamental phenomena involved will be understood by reference to the diagram of figure 1. Here LC represents the usual tuned receiving circuit, loop or otherwise, H a separate heterodyne, and D1, a rectifier. A is a radio-frequency amplifier designed to operate on some predetermined frequency. This frequency may be any convenient frequency which is substantially above audibility. The amplifier is connected on its input side to the rectifier D1, and on its output side to a second rectifier D2 and a telephone or other receiver.

Suppose now that the frequency to be received is 3,000,000 cycles per second, corresponding to a wavelength of one hundred metres, and, for the sake of simplicity, that the incoming waves are undamped. Also, assume that the amplifier A has been designed for maximum efficiency at 100,000 cycles per second. The circuit LC is tuned to 3,000,000 cycles, and the heterodyne H is adjusted to either 3,100,000 or 2,900,000 cycles, either of which will produce a beat frequency of 100,000 cycles per second. The combined currents of 3,000,000 and 3,100,000 (or 2,900,000)

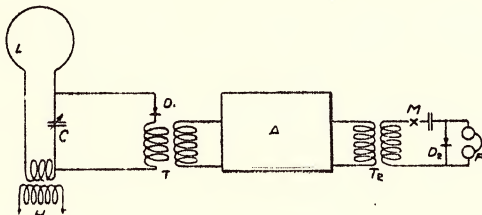

Figure 1.

cycles are then rectified by the rectifier D1 to produce in the primary of the transformer T1 a direct current with a superimposed 100,000-cycle component. This 100,000-cycle current is then amplified to any desired degree by the amplifier A, and detected or rectified by D2. In order to get an audible tone where telephone reception is used some form of modulation or interruption must, of course, be employed in connection with this second rectification, as the current in the output circuit of the amplifier is of a frequency above audibility.

While this frequency is only 100,000 cycles and while it is, therefore, well within the range of practical heterodyning: its steadiness depends on the beats between 3,000,000 and 3,100,000 cycles per second and hence in any attempt to heterodyne it to audibility the same difficulties, due to fluctuation, would be encountered as in heterodyning the original radio frequency to audibility. However, the inability to use the heterodyne on the second rectification is not of great importance because the amplitude of the signal to be rectified is large, and hence the differences (as far as signal strength in the telephone is concerned) between heterodyne and modulated reception is not great.

It is important to note here that the value of the heterodyne current in the first rectifier should always be kept at the optimum value in order to ensure the carry-

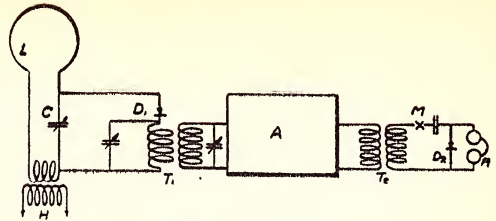

Figure 2.

ing-out of the first rectification at the point of maximum efficiency. This adjustment, however, is not a critical one, and, once made, it is seldom necessary to change it. The amplifier A may be made selective and highly regenerative if so desired, and some very great increases in the selectivity of the system as a whole can be secured. Figure 2 illustrates the principle involved. This arrangement is substantially the same as Figure 1, except that the primary and the secondary coils of the transformer T1 are tuned by means of condensers as shown, and the coupling between them is reduced to the proper value to ensure sharp tuning. This system of connection has all the advantages of tuning to the differential frequency in the manner well known in the art, and an additional one due to the fact that since it is above audibility the musical character of atmospheric disturbances so troublesome in audio-frequency tuning, does not appear.

So far, the reception of undamped waves only has been considered, but this method of amplification is applicable also to the reception of damped-wave telegraphy and to telephony with practically equal efficiency and without distortion of any characteristics of tone. It is somewhat difficult to understand this, particularly in the case of the reception of spark signals, as in all previous experience the heterodyning of a spark signal has resulted in the loss of the note, whereas in the present case the individuality between stations is more marked even than on a crystal rectifier.

This is the most interesting point in the operating of the system and the reason will be understood from the following analysis:

In heterodyning, the efficiency of rectification of the signalling current depends on its phase relation with the local current. If the two currents are either in phase or 180 deg. out of phase the efficiency of rectification is a maximum; if 90 deg. out of phase, a minimum. In ordinary heterodyning, the initial phase difference depends on the time of sparking at the transmitter and hence this initial phase difference will be different for each wave train. As the frequency of the two currents are substantially the same, and as the duration of a wave train is short compared to the time necessary to produce a complete beat at an audible frequency, this initial phase difference is maintained throughout the wave train. Hence, the different wave trains are rectified with varying efficiency, the telephonic current becomes irregular, and a rough or hissing tone results.

In the present method of heterodyning, the beat frequency is high, so that several beats per wave train are produced. As a consequence, the phase angle between the signalling and local current varies through several cycles, and the initial phase difference becomes a matter of minor importance. The number of beats which actually occur in practice depends on the beat frequency, the damping of the incoming wave, and the damping of the receiving circuit. As the damping of the receiving circuit is almost invariably much less than the damping of the incoming wave, it is a determining factor. In any practical case, however, where the beat frequency is kept above 20,000 cycles per second, there is a sufficient number of beats to minimise the initial phase differences and maintain the characteristic tone.

The phenomena which occur in the reception of modu-

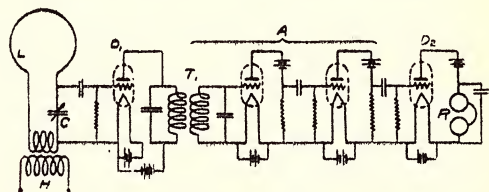

Figure 3.

another achievement in  
fine quality stereo from Tempo...



## the **TEMPO Series 2000** modular stereo system

The new TEMPO 2000 Series, designed and manufactured in Australia, incorporates the latest solid state integrated circuit design. The three separate modular units are attractively finished in oiled walnut, and can be arranged to suit any room. Amplifier and record changer/player unit incorporates the new Garrard 2025 TC automatic changer, and can, for those who prefer manual operation, be used as a player. The Garrard 2025 is fitted with a wide range ceramic cartridge and micro-lift for easy track selection. The two loudspeakers are designed to complement the performance of the amplifier unit, and are perfectly matched, both in quality and appearance, to the TEMPO 2000 amplifier.

**DETAILED SPECIFICATION.** Power Output: 8 watts per channel (8 ohm load) IHFM 16 watts total MUSIC POWER. 5 watts per channel (8 ohm load) RMS. Distortion: Total Harmonic distortion less than 1% measured at 5 watts RMS. Frequency Response: 35 Hz to 50 kHz  $\pm$  2dB. Damping Factor: 10 at 8 ohms. 20 at 16 ohms. Inputs: Pickup. Tape. Tuner. Sensitivity: All inputs 80 mV for full output. Bass control: Continuously variable, plus/minus 10dB at 100Hz. Treble Control: Continuously variable, plus/minus 10dB at 10 kHz. Balance Control: Zero to maximum either channel. **TUNER SECTION.** Sensitivity: 4 Microvolts. Bandwidth: 8 kHz. Tuning Range: 530-1620 kHz. Antenna: Internal ferrite rod. Ext. ant. provision.

Distributed by  
**MAGNECORD SALES & SERVICE**  
210 Clarence Street, Sydney. Phone 29-1704

MC.E10.68

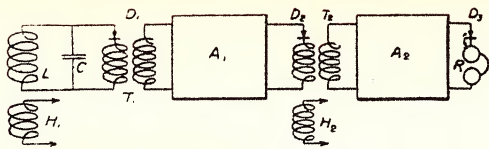

Figure 4.

lated continuous wave telegraphy and telephony are substantially a combination of those explained in the cases of undamped and damped wave reception. The adjustments are made in the same manner as for damped waves and the only precaution necessary in the reception of telephony is to damp the amplifier circuits somewhat to prevent distortion of the speech by excessive resonance.

The general arrangement found most suitable for practical working is shown in figure 3. Both rectifications are carried out by three-element vacuum tubes. The amplifier here shown is resistance coupled, although any form of coupling may be used. The tuned circuits LC and L2C2 are preferably adjusted to some frequency between 50,000 and 100,000 cycles. The circuit LC may be made regenerative, if so desired, by any form of reactive coupling, but the practicability of this depends largely on the amount of time which is available for making adjustments.

In the diagram of figure 3, only two stages of radio frequency amplification are shown, but at least four and preferably six should be used to get the maximum advantage of this method. This is because the transformation of frequency is accomplished only by a certain loss so that something between one and two stages of amplification is required before this is overcome and it is possible to realise a gain. In this figure a separate heterodyne is shown and it will generally be necessary to use it on account of the mistuning which is involved in the use of the self-heterodyne. This mistuning is considerable on six hundred metres, but on the shorter waves it is possible to use the self-heterodyne method with equal efficiency as far as signal strength is concerned, and a great gain in simplicity, as adjustments have been reduced to the minimum of a single one.

It may be observed here that this method is not limited to one transformation of frequency with one subsequent amplification. If the frequency to be received is 5,000,000 cycles this may be stepped down to 500,000 cycles, amplified, stepped down again to 50,000 cycles, re-amplified and detected. The great advantage of this method of amplification is that the tendency to oscillate, due to the reaction between the output of the amplifier and the input is eliminated as the frequencies are widely different. The only reaction which can take place is in each individual amplifier. Hence, the process of extreme amplification is best carried out in stages of several frequencies, the amplification on each frequency being carried as far as possible without loss of stability. As soon as the limit of stable operation is approached, no further amplification should be attempted until the frequency has been changed. (Figure 4.)

The foregoing descriptions and explanations do not pretend to any save a most superficial treatment of the phenomena present in this method of reception. Lack of time has prevented a careful study, and quantitative data only of the roughest sort has been obtained. Sufficient work has been done, however, to demonstrate the value of the method, particularly in the case of modulated continuous wave telegraphy and telephony. In this field neither the amplification nor the selectivity can be equalled by any direct method.

The practical results which have been obtained may perhaps be of interest. With a ten-turn, three-foot (1 metre)

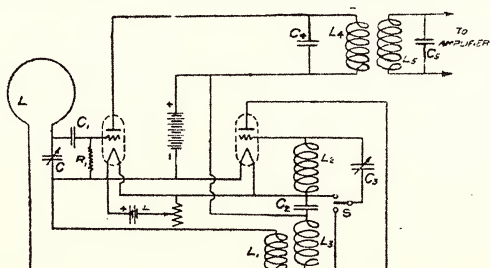

Figure 5.

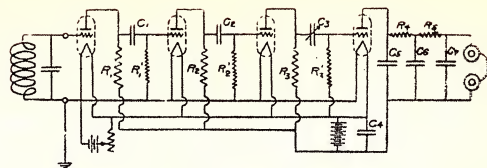

Figure 6.

loop antenna and an amplifier consisting of six stages, resistance coupled, making a total of eight tubes, the night signals of ships working with the Florida and Gulf stations are loudly received. The night signals of amateur stations in the Middle West are regularly received, as are also the signals of the stations in the Gulf States. The general arrangement of the apparatus used is shown in figures 5 and 6, which illustrate the scheme of connections of the frequency transformer and amplifier respectively. Four stages of amplification only are shown, but six were actually used.

It is beyond question much more efficient to use some form of inductive coupling, since the amplifier is intended to operate on only one frequency, and the use of a resistance-coupled amplifier is not recommended where one of the former type is available.

The new practice of this method involves the use of many known inventions, but in connection with the production of a super audible frequency by heterodyning, I wish to make due acknowledgement to the work of Meissner, Round and Levy, which is now on record. The application of the principle to the reception of short waves is, I believe, new, and it is for this reason that this paper is presented.

While the fundamental idea of this method of reception is relatively simple, the production of the present form of the apparatus was a task of the greatest difficulty for reasons known only too well to those familiar with multi-stage amplifiers; and to Lieutenant W. A. MacDonald, Master Signal Electricians J. Pressby and H. W. Lewis, and Sergeant H. Houck, all of the Division of Research and Inspection, Signal Corps, A.E.F., I wish to give full credit for its accomplishment.

Hartley Research Laboratory,  
Columbia University, New York City.

## Biographical Note

Edwin H. Armstrong made major contributions to radio science during his lifetime, and is remembered not only for his work on the superheterodyne and frequency modulation, but also for his development of regenerative and superregenerative circuits. He was born December, 1890, and graduated from Columbia University at the age of 23. He remained with the University until his death, (except for a period of military service during the first world war) and became Professor of Electrical Engineering in 1934. Captain J. H. Round, of Marconi's (U.K.) of whom mention is made in the text, was a close friend of Armstrong. Following Armstrong's death in 1954, Captain Round contributed the following appreciation for publication in "Wireless World":

"The tragic death of Armstrong has given a sincere shock to all his friends, many of whom are on this side of the Atlantic.

"The writer first met him in 1917 during the later stages of the war when he was a Major in the U.S. forces then going into Europe, and the friendship then established has been maintained throughout the years.

"I had the good fortune to be given a very early demonstration of his superheterodyne in the Paris laboratory he had established, and, as the world knows, this basic invention was followed first by super-regeneration and in 1935 by wide-band frequency modulation.

"This, as with some of his other inventions, involved him in very prolonged and expensive litigation, a good deal of which his closest acquaintances thought could have been avoided. However, the intensity with which he attacked technical problems he also applied to his legal problems and there is not much doubt in my mind that this double load clouded his very great intellect in the end."

**Why has the  
biggest name  
in the battery  
business waited  
until now to  
bring out  
alkaline  
batteries?**





*gold*

Alkaline cells have been around for ages. We're the first to admit we're not the first. But because we are the biggest name in the game we had to be sure that our alkaline cell would be significantly better than any other. We believe it is.

The Eveready Alkaline Energiser will outlive carbon-zinc up to ten to one because they are more efficient in heavy-duty use. You'll also find that it will outlive comparable alkaline cells. That's because we're still the biggest name in the battery business.



BATTERIES Products of



'Eveready' and 'Union Carbide' are registered trade marks.

E84

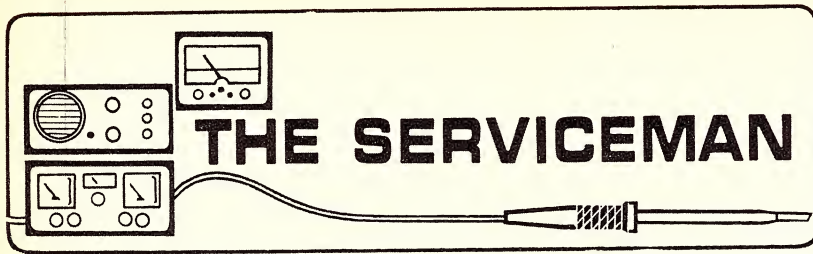

## More on canned cold techniques

Here is another story describing the use of "canned cold" (see October, 1968) to track down elusive intermittents. It is a classic example of how valuable this technique can be where a combination of a stubborn fault and limited history combine to create a particularly difficult problem.

The equipment involved was a rather specialised unit, being part of an amplifier system used by a semi-professional group for the presentation of stage plays, musical items, and similar acts. It was, in fact, a pair of high gain pickup preamplifiers, each having several transistor stages to provide the necessary gain, frequency compensation, and impedance matching to enable the signals to be fed to a switching and mixing unit ahead of a main amplifier.

Although no doubt originally conceived as a stereo pair, and still used in this role when required, it now leads a much more versatile existence. More often than not it accepted signals from two separate pickups and fed them to the switching and mixing complex. Here they could, in turn, be mixed with signals from microphones, tapes, etc., to produce the final combination of sound required.

The complaint was, simply, that one channel had failed. Could I fix it in time for their next rehearsal? It seemed a reasonable enough request, except that the customer had brought only the section concerned, which was a self-contained plug-in unit. Perhaps it was unreasonable to expect the whole set-up, considering that it was such a complex arrangement, but it would have saved me some of the problems associated with providing a power source and sorting out the necessary connections. However, he was able to supply me with a circuit, which helped a lot.

I eventually sorted everything out on the bench to the point where I expected the good channel to work. One advantage of a twin system is that it generally provides a reference against which an unfamiliar piece of equipment may be checked. To simulate a signal I connected an audio generator to the input terminals, with a CRO on the output terminals to observe its behaviour.

It wasn't hard to get the good channel working and I soon had a fair idea of what it was supposed to do and how well it did it. Then I transferred the generator and CRO to the faulty channel and checked its performance. Imagine my feelings when I discovered that the supposedly faulty circuit behaved in exactly the same manner as the good one.

This really put me in a spot. Was

the unit really faulty? If it was, was it intermittent, or was it something too subtle to show up on my bench set-up? On the other hand, was the fault really elsewhere, such as the pickup feeding the channel, or the circuitry immediately following it? As I pondered on these questions I realised that I had been less careful than usual in obtaining the full history of the fault; I had simply taken the customer's word that the fault was in the unit.

Which just goes to show how vital is the full history of a fault if a serviceman is to do a proper job. It also illustrates just how easy it is for misunderstandings and customer dissatisfaction to arise from such situations. Had I not known better I might have treated the job at its face value, given it a complete overhaul, replaced any doubtful components, repaired any doubtful connections, calculated a charge according to the time spent, and returned it to the owner.

The only snag would be that, regardless of where the fault lay, it would inevitably recur, perhaps at a most embarrassing time. Then I could just hear the customer saying, "I paid so many dollars to that so-and-so to fix this thing, and it's just as bad as ever." And, believe me, nothing ruins one's reputation quicker.

Of more immediate importance, however, was what was to be done about the situation. The customer intimated that he would be out of town for the next couple of days, and more or less expected the job to be finished when he returned. If I waited for his return to clarify all these points, it might well be that I would not be able to finish the job by the time it was needed. In addition, I had spent some time setting the thing up on the bench and finding my way around it. It seemed logical to go ahead while all this information was fresh in my mind.

I decided to assume that there was an intermittent in the unit. If there was, I should have a fair chance of finding it. If there wasn't and the fault was elsewhere, at least I would have done my best and could hardly be blamed for any delays which might occur.

First, I made a thorough voltage check of the board. Where intermittents are concerned, there is nothing like having as much performance data as possible, taken when the

equipment is functioning normally. Such a reference can prove invaluable when the fault shows up. In this case I had the advantage of a circuit and a duplicate channel against which to check my findings. By the time I had finished I had compiled a comprehensive list of voltages, and had decided that they all seemed to make sense.

Next, I went right over the board in the mechanical sense. I checked everything visually, then tapped each component hard while watching the output signal on the CRO. The result was completely negative; if there was a fault, it was a good deal more subtle than a simple mechanical defect.

From here, the next logical step seemed to be to introduce temperature changes, using one or other of the approaches discussed in the October story. In this case the construction was fairly open, making it relatively simple to treat each component individually. Mainly for this reason I decided to try the effect of cooling first.

Working on the assumption that the transistors are normally the most reliable components in a circuit, I concentrated on the resistors and capacitors. Although there was a fairly large number of them, I was pleasantly surprised at how quickly I could do the job. Just a few seconds to squirt each one, a quick check on the CRO pattern, then on to the next one. Almost before I realised it I had checked them all.

Which was gratifying in one sense, but a bit disconcerting in another. Like Ginger Meggs, I was running out of places to look, and too scared to look in the last few, in case it wasn't there! In this case the last few places were the transistors, and I found it hard to convince myself that one of these would be at fault.

On the other hand, there was only one way to prove it, so I went ahead and squirted. This had little effect on the first two transistors, but when I squirted the third one the pattern on the CRO suddenly collapsed.

Well, this looked like it, but I had to make sure. For one thing, the technique of cooling transistors could be misleading. If one cools a transistor sufficiently its beta will be reduced to a point where it will virtually cease to function. Nor did I have any doubt that this method of cooling was capable of bringing about this condition. A colleague, to whom I had introduced the freezing technique, had demonstrated the fact quite dramatically by setting up a transistor in his tester, and checking the beta as it was progressively cooled.

It was also possible that, in spite of my previous checks, I was really observing a fault adjacent to the transis-

tor, rather than within it. For example, there could be a hairline crack in the copper pattern connected to one of the transistor leads, or there could be a dry joint at the junction of a transistor lead to the copper pattern.

To assist in checking these possibilities, I hastened to make another voltage check around this stage, before it recovered, for comparison with the previous readings. The stage was an emitter follower, and previous readings had shown about 2.3V from emitter to chassis, and 3V from base to chassis. The collector connected directly to the main 12V supply rail. The latest check showed that the collector voltage was normal, the base voltage was normal, but the emitter voltage had dropped to zero.

The most likely causes of such an effect were a failure of the transistor itself, or the emitter resistor. A quick check confirmed that the resistor was

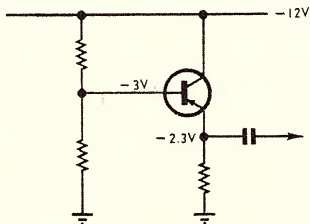

*The suspect emitter follower circuit, with voltages taken when it was behaving normally.*

intact, leaving the transistor as the suspect.

Although I had considered the possibility that I had "overcooled" the transistor, I did not regard this as very likely. The main reason was the suddenness with which the stage had failed, which was akin to a switch being operated. The effect of cooling in all stages I had checked so far was to produce a steady decline in performance. Nevertheless, I waited until the stage came good by returning to normal temperature, then tried again. This time I was particularly careful not to overdo the cooling, taking it down gently by means of several very brief squirts. The result was the same. At a critical temperature, the stage went dead.

Finally, when it had again restored itself to operation, I made a detailed mechanical inspection. I could find no sign of hairline cracks, dry joints, or anything else likely to create the symptoms I had observed. There seemed little doubt now that it was the transistor, and I took the final step of replacing it. After that the trouble vanished, and nothing I could do would induce it to return. As far as I was concerned, the point was proved.

On quite a different theme, there is an old saying about the plumber's tap which persists in dripping — long after he's fixed everyone else's. I'm afraid it finds a parallel in a certain serviceman's television receiver: mine, to be precise.

Months ago, the set started to play up on channel 7; one had to "wiggle" the channel knob a couple of times to get a clear picture. Then the number of wiggles necessary began to increase and the trouble showed up on channel

9, then on 10, then on 2. I explained to the family that it was probably a dirty or faulty contact in the tuner turret and that "I'd have to fix it some time."

One day, I did try squirting some degreasing solution in through the most accessible aperture but with only temporary benefit. It was evident that the tuner would have to come right out and be thoroughly cleaned and checked.

But you know how it is. There was always some reason why I couldn't do it right then. And weeks went by, with the wiggle routine almost becoming a way of life. It even became necessary to give the knob an occasional wiggle during the course of a program.

But, one night, when the need for wiggle after wiggle prevented me from settling down to a program I particularly wanted to watch, patience gave out and I promised myself and everyone else in the room that I would fix it once and for all tomorrow — and I wasn't going to put it off for anybody or anybody's program!

Such is determination born of desperation.

So next day I set to work and, being careful not to disturb things any more than necessary, lifted the tuner right out and took it to the bench where I could work on it properly. Having removed the covers, I clicked the rotor around and watched as each spring contact rode over the studs in the individual biscuits. The movement was obvious and apparently ample on all but a couple of the contacts at one end of the row. Some adjustment might be necessary to ensure slightly more movement.

But before doing anything else, I removed the retaining plates at each end of the tuner and lifted the biscuit rotor right out. It took only a glance to appreciate that the fixed contacts were fairly liberally coated with grime so I set to work to clean them up with a soft rag, moistened with degreasing solution. Likewise the studs on the biscuits.

Two minutes later, everything looked brighter and better though it did not necessarily mean that it would work better!

In fact, not convinced that it would, I reassembled the tuner and clicked the rotor round, this time studying very closely the action of the contacts.

One thing that caught my eye was that the contacts seemed to depress to a maximum as the biscuits moved under them but tended to relax slightly before the rotor clicked into the indexed position. It seemed pretty obvious that the index mechanism was set wrongly and that it was not locking the biscuits in the position of maximum pressure.

Fortunately, it was a simple matter in this particular tuner to correct the situation. It was only necessary to slacken off a couple of screws, ease the index plate along by about 1/16-inch and retighten the screws.

For good measure, I also repositioned slightly the bar holding the fixed contacts so as to increase slightly the travel of the two end springs which had seemed to be making rather lighter contact than the others.

This done, I rubbed over the studs where my fingers had been, gave the "works" a light squirt for good measure and replaced the covers.

The tuner was duly replaced in the receiver and, happy to relate, the nec-



## TECHNOCENTRE TOPICS

At our Technocentre you receive friendly advice and guidance from our highly qualified consultants. An invaluable service to those building or altering a home. The equipment you buy at Convoy will serve you well for many years and have a good resale value. This is your real cost! Make sure you visit the Technocentre before you buy any item of Hi-Fi equipment.

★ New Revox 77A solid state Tape Deck Recorder is now in stock again, as little as \$300 with trade-in. We are looking for trade-in Revox G36. Also Sony, Ampex, Sharp, Tandberg and many others available. Tape Decks are our speciality, including Cassette Players and Recorders.

★ Peerless Speakers are special value. Call in and hear the superb quality of the 12in and 10in three-way systems — used as monitors by Radio, TV stations in Europe. You save money, not quality. Complete speaker systems from \$100 pair, in quality cabinets. Also Goodmans, Wharfedale, Leak, etc. Speaker Cloth and Innerbond stocked.

★ Hear Convoy's wide range of selected amplifiers before you choose a system including the new Kenwood TK600, connected to top quality speakers. Let your ear decide. Quad — Citation — Kenwood — Sansui — Trio and others selected by our experts.

★ Microphones and headsets require specialist advice, we have full range of AKG and other quality lines.

**RUMMAGE SPECIALS. WE HAVE CLEARED OUT OUR CORNERS AND FOUND SOME SPEAKER AND AMPLIFIER BARGAINS, CALL AND SEE THEM, ALSO TRADE-IN BARGAINS AVAILABLE.**

**SERVICE AND MAINTENANCE** of your equipment is essential to satisfactory listening — let our specialist Hi-Fi technicians check your equipment or make any modifications you require. This is a Technocentre special service.

29-6475

**Convoy**  
FOR SOUND SATISFACTION

TECHNOCENTRE

449 KENT STREET, SYDNEY

# For the big outdoors



Nova-Tech's 'Nova 3' is the perfect three band, 11 transistor portable for basic navigation, special weather information, regular broadcast band music and news. Boat owners the world over have proved this one to be the ideal precision instrument—reliability is the key to the success. Rotating antenna up top for accurate reading of radio beacon signals for direction finding and homing.

Frequencies: LF 190-400 KC; AM 550-1600 KC; MF 1.7-5.0 MC. \$109.90.

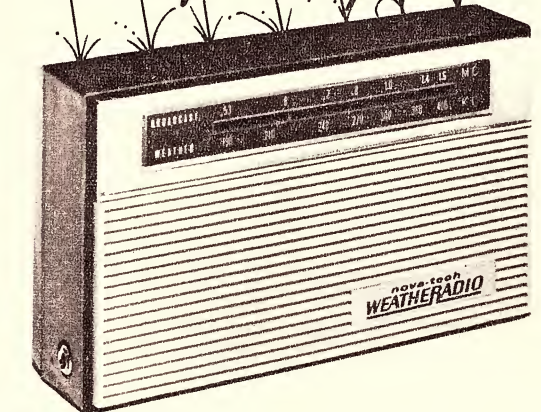
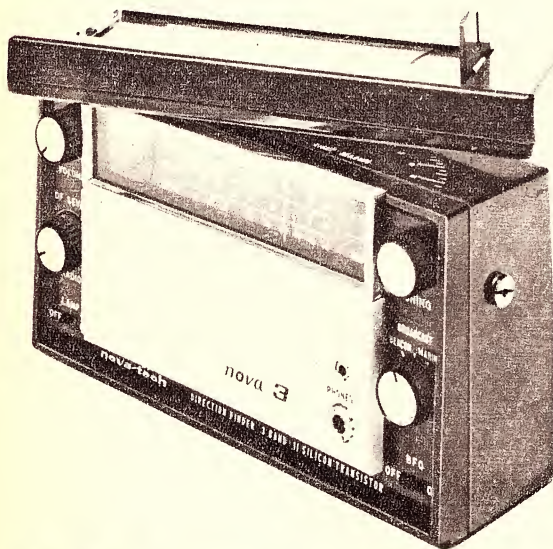

'Weatheradio' takes the guesswork out of planning all your outdoor activities. Find out before just what the weather is up to. This compact piece of engineering is built to the same high standards as all Nova-Tech products and features the aviation weather band of 200-400 KHZ, as well as standard broadcast band AM 550-1600 KC. \$59.90.



**nova-tech, inc.**  
(Inc. in U.S.A.—Ltd. Liability Co.)

212 New South Head Road, Edgecliff, N.S.W. 2027  
Trade Inquiries: Lawrence & Hanson Electrical  
N.S.W., Vic., Qld., S.A., Tas., N.T.  
Transerve Distributors W.A.

essity for the wiggle routine had completely disappeared. A touch of the oscillator slugs and all was well.

In fact, the set behaved just as well as if it had belonged to one of my customers!

So what about it, you plumbers? What about having a go at your leaking taps?

The question of battery polarity markings has come up again. We have been advised by the distributor of yet a third brand (i.e., not in any way connected with the brands involved in the two previous cases) that they have struck a complete batch of batteries with the wrappers—and polarity markings—reversed. The manufacturers have promised to make good damage to equipment suffered by one of their customers.

I find this story of interest for two reasons. In the first place, coming hard on the heels of the two previous cases, which appeared to be isolated examples only, it indicates that this kind of fault can happen on a larger scale. And, secondly, it confirms that, in some circumstances at least, equipment can be damaged. I emphasise this latter point because, in preparing the comments published in the March issue, I was conscious that, while there was an ever-present risk, damage would not be automatic.

In fact, there are a number of factors which may combine to protect equipment in these circumstances, if one's luck happens to be favourable. For example, in a typical portable radio, most of the transistors other than the output stage will be afforded a measure of protection by reason of their associated circuitry. One way or another, there will usually be enough resistance in the circuit, in the form of load resistors, decoupling resistors, etc., to limit the otherwise abnormal currents to something less than a destructive value.

The output transistor (or transistors) are undoubtedly the most vulnerable but, even here, one may be lucky. It is even possible that the internal resistance of the battery may be high enough to limit current to a safe value. Much depends on the ratings of the transistor—across both the emitter-base and the collector-base junctions—the actual circuit configuration, the resistance of the speaker transformer primary, and so on.

In short, one may get away with it,

## A friend in need

While technical failures can sometimes lead to amusing situations, the following story must represent some kind of a record in this field. It is taken from the Australian Post Office journal "Telegen" who credit it, in turn, to the B.B.C. publication, "The Listener."

The unbelievable irritation of wrong numbers, crossed lines, or failing to get through at all, sometimes overwhelms me. Earlier this year, I found that nearly a third of my telephone calls were being thwarted in this way. But, every so often, one gets one's reward.

A little while ago I found myself cut into a conversation between two banks — one here in London the other, from the sound of it, in Scotland. A customer of the Scottish branch was at the London branch hoping to cash a cheque for £20. The Scottish branch, when they heard their customer's name, sounded very dubious, but eventually asked the London clerk to hold on while they checked.

In silence, I too held on, thinking of my compatriot's trip to London — perhaps on honeymoon, or to find a new job and a new life — being abruptly terminated for lack of credit. So it was I who spoke up, saying yes it was all right for the customer to have his £20. I only hope someone will do the same for me, the next time I'm in that position.

or one may not. The important thing for the customer or non-technical person to realise is that, just because they, or someone they know, or have heard about, made such a mistake without causing any ill-effects, this is no justification for a blanket assumption that all sets can be mistreated in this manner with impunity. It is far safer to assume that a set can be damaged and treat it accordingly.

And, finally, remember the story in the January issue about portable radios being wrecked by transmitters in close proximity? Last month I published a letter from a reader whose experience suggested that this was much less a problem than the January story would indicate.

Fair enough. Except that in the U.K. journal "Electronics Weekly" dated February 26, 1969, there is a report, under the heading, "A Shocking Business," which makes interesting reading.

"The next time you leave your car, make sure you don't touch the radio aerial. You could send a 25,000-volt shock surging into the set.

"While you may hardly feel anything, the surge from the static electricity built up on your person could be high enough to blow out some of the transistors.

"A British car radio manufacturer recently found that 63 per cent of all transistorised radios returned for service were inoperative because the first-stage transistor had been blown by a high-voltage overload.

"Further investigations revealed that in some cases these static voltages were caused by driver and passenger static electricity produced by normal friction between clothes and plastic seat materials.

"In the home, these same high voltages can be generated through synthetic-fibre clothes and soft furnishings. Under certain conditions, particularly during the winter when homes are heated, a person touching the aerial of a domestic portable set can produce a similar burnout fault.

"So, the next time you want to adjust the height of the whip aerial on your car, don't forget to discharge yourself first."

This may not do much to settle any argument, but it is an interesting story about another possible source of damage. Perhaps some readers may have encountered sets damaged in this way without realising it. Any comments?

## COMPLETE HI-FI RADIOGRAM-TAPE RECORDER ALL IN ONE

MODEL TR9

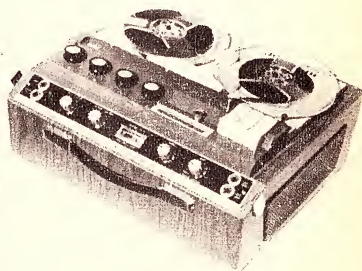

### AS AN AMPLIFIER . . .

- Frequency response, 20-20000 cps.
- 7 Watts RMS. output per channel.
- Distortion less than .25%
- Separate treble and bass controls.

### AS A RADIO . . .

- Being fully transistorised, can be switched on all day at full output without heat problems. Program can be recorded on tape without any external connections.

### AS A TAPE RECORDER . . .

- Freq. response 30-18000 cps.
- 3 speeds. Meter level indicator.
- Push button operation.
- Superimposing.

### PRICES:

- 2 track mono, \$159.00
- 4 track mono, \$169.00
- 4 track stereo, \$230.00

RADIO TUNER CAN BE FITTED TO ANY OF THE ABOVE MODELS FOR \$28 EXTRA.

### TAPE DECKS

for the home constructor. COLLARO (Magnavox) tape decks complete with record/play and speed change switch wafers fitted . . .

2 tracks, \$48. 4 tracks, \$55. SPECIAL LOW IMPEDANCE HEADS for transistorised tape amplifier circuits (Mullard) available).

## CLASSIC TAPE RECORDERS

93B LIVERPOOL ROAD,  
SUMMER HILL, N.S.W.  
Telephone 79-2618

# EVERYTHING FOR THE HOBBYIST and

## 40 Watt & 60 Watt Instrol-Playmaster GUITAR AMPLIFIERS

All parts now available

Like all Instrol-Playmaster kits, the 116 and 117 Guitar Amplifier Kits are complete in every detail, down to the last nut and bolt, and precisely to "Electronics Australia" specifications. Chassis is ready drilled, cadmium plated and finally passivated to avoid fingermarking. The front label is beautifully finished with black lettering on silver-white background. Kits for both the 116 and 117 include extras such as 3 inputs (circuit included), vibrato and extra treble pull switches, and foot switch complete with chrome housing.

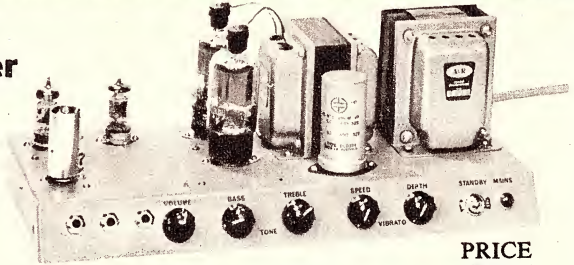

	<b>PRICE</b>
40 Watt complete kit of parts . . . . .	<b>\$84.36</b>
40 Watt built and tested . . . . .	<b>\$91.49</b>
60 Watt complete kit of parts . . . . .	<b>\$92.31</b>
60 Watt built and tested . . . . .	<b>\$98.83</b>
(Freight extra)	

All parts available separately if required.  
 Chassis only . . . . . **\$4.70** (plus 85c postage)  
 Front Label . . . . . **\$2.80** (plus 20c postage)  
 Fuzz Box Kit . . . **\$12.95** (plus 75c postage).



**KEYLESS ORGAN**  
 (Electronics Aust. January 1969)

A useful novelty instrument which can be used successfully by a single entertainer or in conjunction with a group. Includes sharps and flats, built-in vibrato and has a high level of acoustic output.  
 Kits of Parts . . **\$35.10**. Postage extra.



**INSTROL-PLAYMASTER 106 AMP/TUNER** ("RTV and H," Dec., 1963). A high-quality amplifier/tuner with all stations clearly marked on dial. Amplifier 10 watts per channel.  
 Kit of Parts . . . . . **\$96.50**  
 Postage Extra.



The new **INSTROL-PLAYMASTER 115 SOLID STATE STEREO AMPLIFIER** ("Electronics Aust.," April-May, 1967).  
 A fully transistorised 10 Watt Stereo Amplifier using the latest F.E.T. high-efficiency transistors.  
 Crystal/Ceramic Kit . . . . . **\$95.00**  
 Magnetic kit extra . . . . . **\$10.50**  
 Postage Extra.

### INSTROL-PLAYMASTER 123 PROGRAM SOURCE

("ELECTRONICS AUSTRALIA" Oct. 68)



A high quality wide band solid state unit, fitted in free-standing metal case, featuring meter tuning and large illuminated dial.  
 Kit of Parts — with Ceramic Filter . . . . . **\$91.20**  
 Kit of Parts—without Ceramic Filter . . . . . **\$77.50**  
 (Postage extra)



**THE 10-PLUS-10 STEREO AMPLIFIER**  
 ("Electronics Australia," November, 1968)

A high quality solid-state 10 watt amplifier. Suitable for crystal or ceramic cartridges.  
 KIT OF PARTS . . . . . **\$60.50**  
 (Postage Extra.)



**THE 3-PLUS-3-STEREO AMPLIFIER,**  
 ("Electronics Australia," August, 1968).  
 A small, modern, 3-watt solid-state audio amplifier.  
 Kit of parts . . . . . **\$43.50**  
 (Postage extra.)

Tick catalogue required, and please include stamps for postage.

- |  |  |
|--|--|
| <input type="checkbox"/> Playmaster        | <input type="checkbox"/> Test Equip Kits       |
| <input type="checkbox"/> Toolkit           | <input type="checkbox"/> Tape Recorder Instrol |
| <input type="checkbox"/> Cannon Connectors | <input type="checkbox"/> Microphone            |

Name . . . . .  
 Address . . . . .

Post Coupon for Free Catalogue.

### OTHER PLAYMASTER KITS

	Price	Add Post
111 Tuner . . . . .	<b>\$39.00</b>	<b>\$1.20</b>
114 Tuner . . . . .	<b>\$47.00</b>	<b>\$1.20</b>
107 Amp/Tuner . . . . .	<b>\$81.80</b>	<b>\$2.00</b>
108 Amp/Tuner . . . . .	<b>\$69.80</b>	<b>\$2.00</b>
101 Amp . . . . .	<b>\$61.00</b>	<b>\$2.00</b>
No. 3 Amp . . . . .	<b>\$57.80</b>	<b>\$2.00</b>
10W U/L Amp . . . . .	<b>\$85.80</b>	<b>\$2.00</b>
No. 10 Control Unit . . . . .	<b>\$39.00</b>	<b>\$1.20</b>
113 Amp . . . . .	<b>\$64.00</b>	<b>\$2.00</b>
119 Tape Adapter . . . . .	<b>\$86.70</b>	<b>\$1.20</b>
No. 4 Amp . . . . .	<b>\$73.00</b>	<b>\$2.00</b>

Most Playmaster Designs are also available Completely Built and Tested.

### INSTROL PRINTED CIRCUIT BOARDS

High-quality, pre-fluxed boards to suit the 115 Amp. Clearly printed on the reverse side with component location map. Easy to assemble.



**PRICE**  
 Crystal Pre-Amp . . . . . **\$2.00 ea.**  
 Main Amp (2 required) . . **\$1.60 ea.**  
 Magnetic Pre-Amp . . . . . **\$1.60 ea.**  
 (Add 15c for postage)

# BROADWAY ELECTRONICS

# TECHNICIAN...

## INSTROL EDUCATIONAL ELECTRONIC KIT

In this Electronic Age, every person should have some knowledge, however elementary, of "how it works." The new Instrol 20 in 1 electronic kit will enable you to understand in an absorbing, simple manner the basic principles underlying computers, satellite communications, industrial electronic devices, etc., etc. You make 20 different experimental circuits, including 10 working radio transistor operated radio circuits. Audio Amplifier circuits, home intercom, testing circuits including Audio Frequency Oscillator and Signal Tracer, Morse Code practice set and telegraph transmitter, etc. You use and learn about the amazing SOLAR CELL.



**NO TOOLS OR SOLDERING IRON REQUIRED**

All components pre-wired, ready for clip-on assembly. 50 page Instruction Manual supplied.

ONLY . . . **\$16.90**

(Plus 85c for Registered Post)

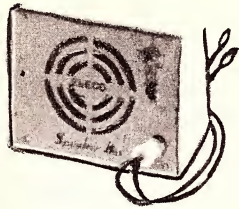
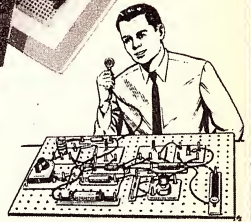

To allow others to hear the results you achieve, why not obtain the Instrol SP1 Speaker box. Completely assembled, includes transistorised audio frequency amplifier, dynamic speaker and leads, housed in an attractive plastic box, and ready to plug-in at any appropriate stage of your experiments with the Instrol 20 in 1 Electronic Kit.

**INSTROL SPEAKER BOX. PRICE \$6 plus 10 cents Postage.**



## ELECTRONIC TOOL KIT

**For Hobbyists Students and Servicemen**

An inexpensive, yet most comprehensive, pocket-sized tool kit. Ideal for the Student, Hobbyist and Practising Service Technician. The Soldering Iron is an Australian made high efficiency 30 Watt 240 Volt type. All the other hand tools are imported, high grade steel. The complete kit fits snugly into a strong attractive zip-fastening carrying satchel.

### COMPONENTS

- 1—Soldering Iron with 3-pin plug 30 Watts 240V
- 1—Set 3 Spanners.
- 1—Coil Resin Cored Solder
- 1—Pair Pliers standard
- 1—Pair Long Nose Pliers
- 1—Pair Side Cutters
- 1—Pair Tweezers
- 1—Screwdriver Set complete with handle and chuck, comprising
- 2—Screwdriver bits
- 1—Philips driver bit
- 1—Pointed awl
- 1—Spintite for 1/4 in nuts

PRICE \$12.50. Plus Regd. Postage \$1.00

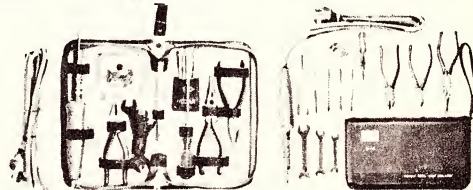

### SOLID STATE V.O.M.

(Dec., '68)

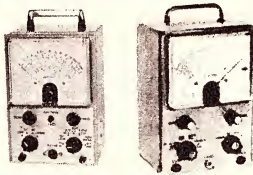

V.T.V.M. (Feb., '66)

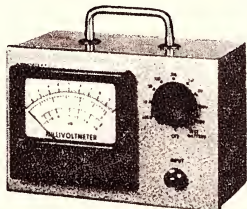

SOLID STATE AUDIO MILLIVOLTMETER

(May, '68)

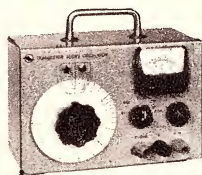

TRANSISTORISED AUDIO OSCILLATOR (Dec., '67)



AF TONE BURST GATE (April, '68)

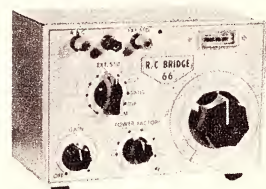

R.C. BRIDGE (MAY, '66)

### TEST EQUIPMENT KITS

	PRICE
Solid State V.O.M. . . . Dec. 68	\$57.00
V.T.V.M. Feb., 66 . . . . .	\$57.51
Solid State Audio Millivoltmeter, May, 68 . . . . .	\$60.63
Audio Oscillator . . . Dec., 67	\$44.30
AF Tone Burst Gate, April 68	\$61.00
R.C. Bridge . . . . May, 66	\$40.99
Postage extra on all kits.	

# PTY. LTD.

E. S. & A. BANK BUILDING  
CNR. BROADWAY & CITY ROAD, SYDNEY  
(OPP. GRACE BROS.) Phone: 211-4224, 211-4244, 211-4213

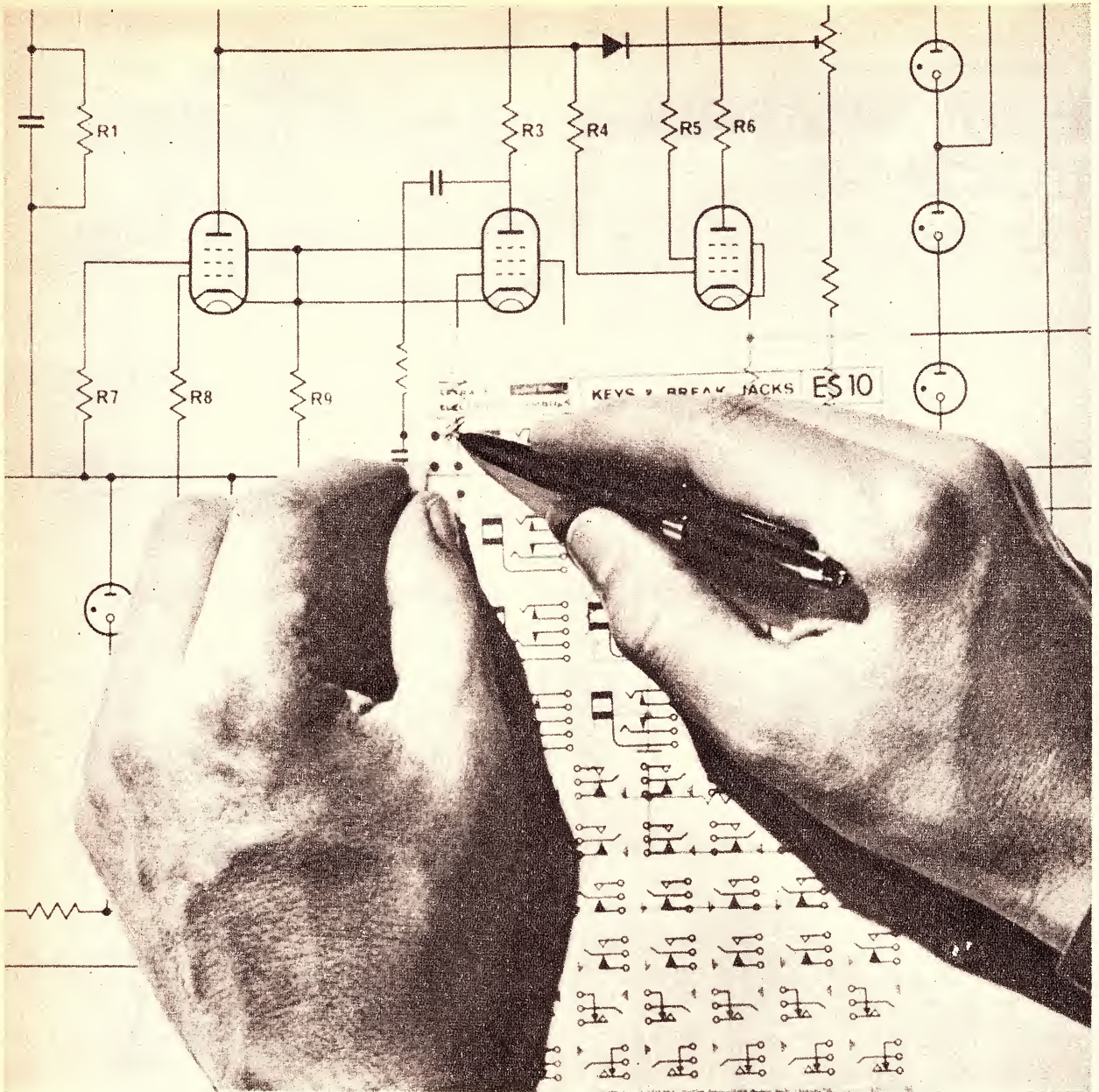

THERE IS A COMPLETE SET OF 65 LETRASET ELECTRONICS SYMBOLS SHEETS. COST: 53c per SHEET.

## From rough to finished diagram

Letraset Electronics Symbols — more comprehensive than any other system—now provide the answer for the over-worked Drawing Office. From rough sketches to high quality finished diagrams in one compact operation, saving valuable time of skilled staff. Letraset dry transfer circuit symbols are a complete and completely new drafting aid for significant reduction of the circuit — planning to diagram production cycle.

A set of 65 sheets is available; these include Capacitors, Rectifier Diodes, Inductor and Transformers, Relay Contacts, Resistors, Uniselectors, Transistors to name but a few. Cost: 53c per sheet. (Print area: 4½" x 6").



Simple to use • Comprehensive symbol range • Designed to B.S.530 • Easy symbol adaptation • Dyeline resistant • Symbols fit a ½" grid.

**Letraset Australia Pty. Ltd.**  
230A Sussex Street, Sydney.  
Phone: 29-5011

### FREE SAMPLES

Please send catalogues and samples of Letraset.

Name .....

Position .....

Company .....

Address .....

.....

LET15

# Letraset



For Our Beginners . . .

# A Wave Trap To Control Strong Signals

Over the years we have received many requests for assistance from readers suffering interference from a strong local station. Usually they are using a simple crystal or regenerative set, but sometimes full size receivers are involved. This article discusses how a wave trap can help in such circumstances.

While it may be possible to marginally improve the selectivity of simple receivers by various tricks, such as winding the coil(s) for maximum Q regardless of physical size, by employing more than one tuned circuit, and by reducing the loading on the coil(s) to a minimum, such processes are, at best, only compromises. There is a limit to the benefit they can bestow if, in fact, this limit has not already been reached in the basic design. From this point on there is little that can be done to the receiver itself to improve performance while retaining the original simple concept of, say, a crystal set. This becomes particularly evident when we realise that many techniques to improve selectivity result in a loss of sensitivity; something we can seldom tolerate in a crystal set.

The next step up in simple receivers, those employing a regenerative detector, can put up a much better all-round performance. Regeneration is one of the few simple devices which improves both sensitivity and selectivity at the same time. As a result, we are in a much better position to trade a little of one for the other to achieve optimum performance. Nevertheless, there are still situations where a powerful local transmitter can swamp weaker signals over a substantial portion of the band.

And even the full superhet receiver, if operated under sufficiently adverse conditions, can suffer interference from a powerful local transmitter. This generally takes the form of cross modulation, the signals from the powerful station being evident behind the wanted signals, though not necessarily in between stations. Though such conditions are relatively rare, compared with the problem of the simple receiver, they are no less important to those facing the situation.

In all these cases, a wave trap connected in the aerial circuit can be a very useful device. The amount of improvement it can offer will vary with the severity of the problem, but even the simplest crystal set, which normally presents the most severe problem, can generally gain some benefit from its use.

The regenerative set, being a better performer anyway, will normally suffer less severe interference than would a crystal set in a similar location. What little interference remains can often be almost completely controlled

by a trap, making this type of receiver, with a trap, a very effective combination.

In the more serious application, that of eliminating cross modulation effects in a full-size receiver, the trap can be expected to provide a very high percentage of cures. Although an unusual approach, it is a perfectly legitimate one, and a handy trick to remember.

A wave trap consists of a coil and capacitor connected in parallel. A parallel tuned circuit offers maximum impedance to signals at its resonant

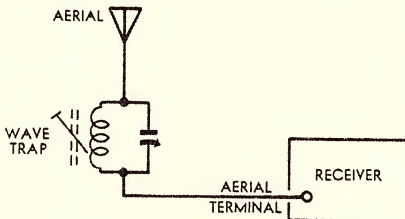

*The trap as it is normally fitted to the receiver.*

frequency, and a lower impedance to all other signals. If such a circuit is connected between a receiver and the aerial from which it is operating, and adjusted to resonate at the frequency of an unwanted station, it will introduce a very considerable loss at this frequency. There will be some loss at adjacent frequencies, too, but becoming less as we move away either side of the trap resonant frequency.

In use, the trap is tuned to give minimum output from the receiver when tuned to the interfering station. The receiver is then tuned to give maximum signal from the desired station. From the foregoing it should be obvious that a wave trap cannot discriminate between a wanted and an unwanted signal if their two frequencies are the same. For the same reasons, it will be least effective when the two frequencies are very close together. In such cases a directional aerial may provide additional discrimination. (See "Reader Built It" section, February 1969).

A trap can control only one interfering station at a time. If there is more than one interfering station the value of the trap will depend a good deal on where they are located on the

dial. If they are well separated, and do not overlap each other, then it may be that each can be controlled, as required, when it is desired to listen to weaker signals in the vicinity of either one. Otherwise it may be that the best that can be done is to control the one causing the most interference.

Also, a wave trap can control only those signals picked up by the aerial. For this reason, the trap should be located as close to the set's aerial terminal as possible, otherwise the lead between the trap and the set may function as a small aerial, with enough pickup to undo some of the discrimination provided by the trap.

In the case of mains operated receivers, there is a very real possibility that the unwanted signal may reach the receiver via the mains rather than the aerial. In fact, the tendency to operate full size sets without the benefit of any real aerial depends very much on the fact that the mains provide good signal pick-up in most cases. While there can be no serious objection to this situation while ever the set performs well, it is one of the first that needs to be corrected when interference is experienced.

The first thing to do is to ensure that the only signals which can reach the set will be via the aerial terminal. This may mean fitting a line filter in the mains lead, or it may be suffi-

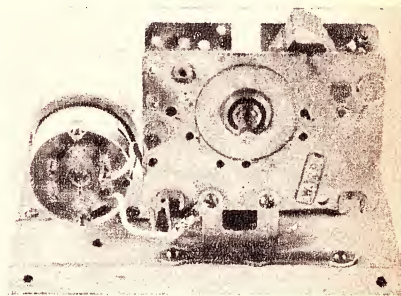

*View of the trap with front panel removed.*

cient to by-pass the mains inside the receiver chassis, using interference suppression capacitors such as described in a previous article ("Beating the Noise Problem" January 1968). In extreme cases it may be necessary to shield the entire set, using a metal or wire mesh screen box, but such a situation would be rare.

With the mains effectively disabled at signal frequencies, the set should be connected to a good local "earth," such as a water pipe or metal stake. If

(Continued on page 190)

# HANDY REFERENCE CHART . . .

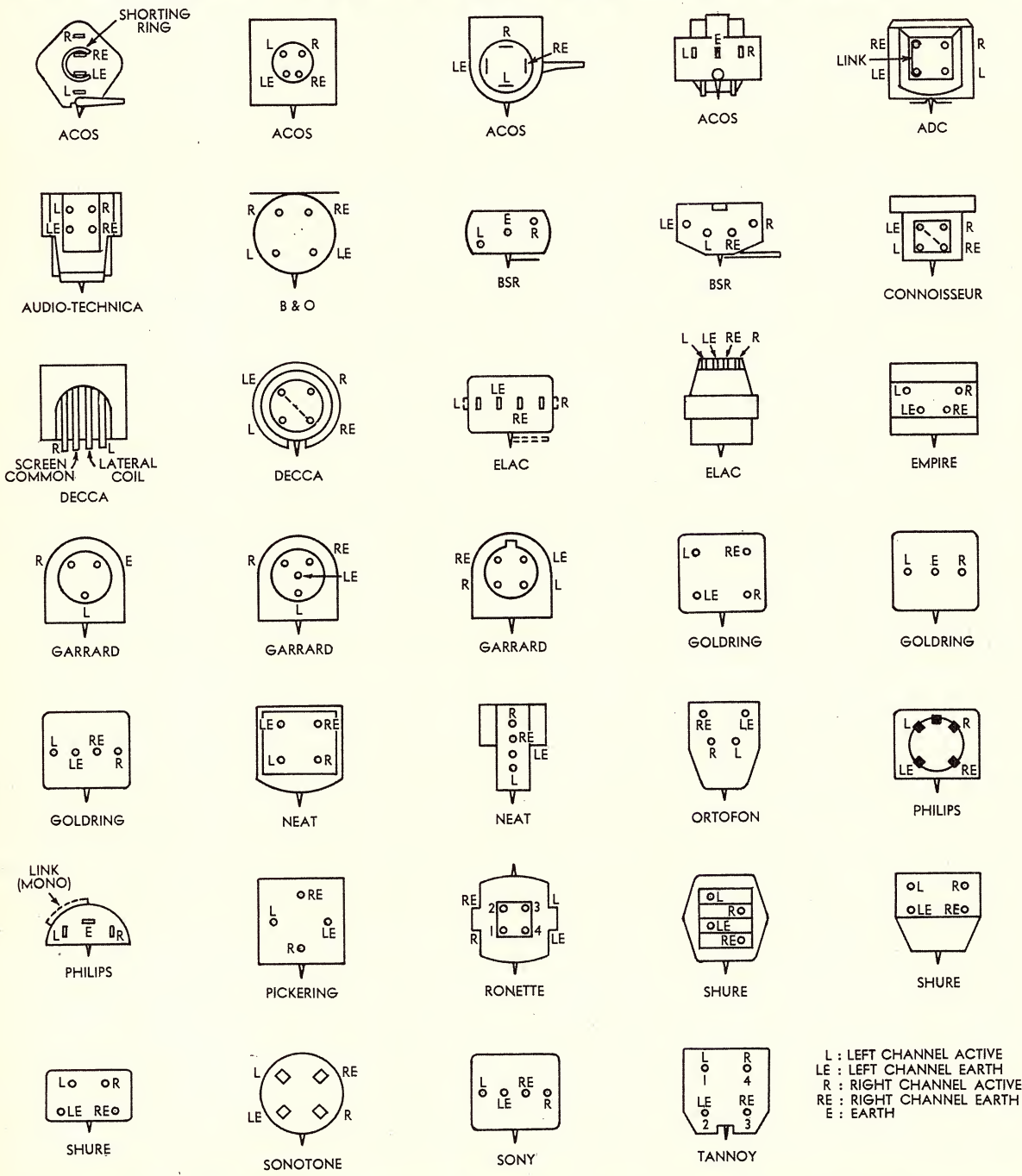

L : LEFT CHANNEL ACTIVE  
 LE : LEFT CHANNEL EARTH  
 R : RIGHT CHANNEL ACTIVE  
 RE : RIGHT CHANNEL EARTH  
 E : EARTH

This handy two page chart gives essential terminal and other data for the more popular brands of pickups. For much of this we acknowledge our indebtedness to "Practical Wireless" November 1968. Above are typical cartridge pin connections. The cartridges are shown from the rear with the stylus in playing position. Dotted lines indicate internal connections or links. In most cases the earth returns of the respective channels are commoned at the amplifier input. Some manufacturers use several forms of cartridge connections which are similar to the types shown. Most

cartridges are colour coded to the following internationally agreed code, also used for the leads in a pickup arm or shell:  
 left channel live — white  
 left channel earth — blue  
 right channel live — red  
 right channel earth — green  
 common or screen — black.  
 Earlier codes produced numerous variations, the most popular being; grey, brown and black for left, right and common respectively.  
 The following notes apply to particular makes:

**Garrard:** Several different heads, but all are colour-coded. Earlier versions are: left live, grey; left earth, blue; right live, brown; right earth or common, black. Later versions to international code.  
**Goldring:** Several different heads. Some have the same pin arrangement but with connections transposed.  
**Ronette:** Some cartridges have three pins in line; left pin for left channel live, right pin for right channel live, and centre for common.  
**Shure:** Pin spacings vary, but the phasing is as shown.

# Pickup and Record Data

Leads in a pickup arm or shell usually follow international practice in their colour coding. (See under cartridge connections.) There are, however, many variations and some typical arrangements are illustrated.

**BSR:** When used with three pin cartridges, the black is not used.

**Ortofon:** Colour coding may be left red, right white, and black for both earths. The two earths may be transposed on some models. Another black lead may be used for connections to the arm.

**SME:** Colour coding is left (L) red, right (R) green, common earth black (B), and mono (M) yellow.

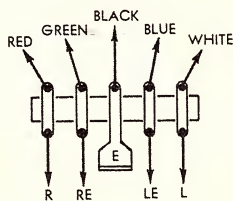

PRESENT CODE

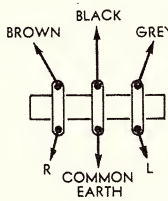

FORMER CODE

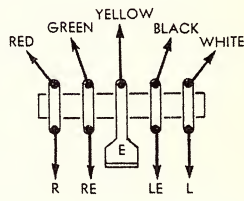

BSR TAG STRIP

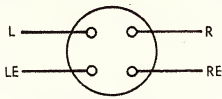

ORTOFON PICKUP ARM

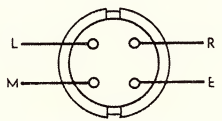

SME SHELL

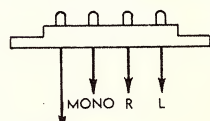
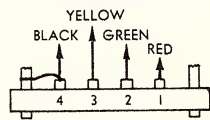

SME PLUG & SOCKET

## DIN connections

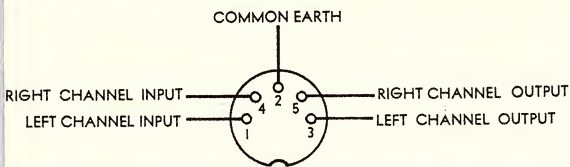

Although DIN connectors will be found using an almost infinite variety of pin connections, the arrangement shown appears to be an emerging convention, and one we have tried to follow at "Electronics Australia."

Whenever a connector performs an output function,

e.g., when mounted on a tuner, preamp, mixer, etc., it uses pins 2, 3, and 5 (stereo) or 2 and 3 (mono). When the connector performs an input function, as when on a main amplifier, it uses pins 1, 2, and 4 (stereo) or 1 and 2 (mono). The mono connections are thus compatible with a three pin plug, which also fits a five pin socket.

The patch cord between the two units performs the cross-over function from output pins to input pins. Where one unit is permanently fitted with a cable, the terminating plug must be wired to suit the opposite piece of equipment into which it plugs. Thus the permanent cable on a microphone must be wired to fit the "input" configuration.

## Record and stylus data

Approximate groove widths:  
Coarse (78rpm) 6 mils.  
Fine (33 and 45rpm) 2 to 3 mils.

Playing speeds:  
78rpm discs 77.92rpm  $\pm$  0.5%  
45rpm discs 45.11rpm  $\pm$  0.5%  
33rpm discs 33.33rpm  $\pm$  0.5%  
Rake angle: 15 degrees.

Stylus radius:  
Mono 78rpm 2 to 3 mil  
Mono microgroove 0.7 to 1 mil.  
Stereo 0.5 to 0.7 mil.  
Bi-radial (elliptical):  
Major axis 0.7 to 0.9 mil.  
Minor axis 0.2 to 0.3 mil.

Disc sizes:  
12in disc 11-7/8  $\pm$  1/32in.  
10in disc 9-7/8  $\pm$  1/32in.  
7in disc 6-7/8  $\pm$  1/32in.

Recorded diameters: Outer  
12in disc 11-1/2  $\pm$  1/64in.  
10in disc 9-1/2  $\pm$  1/64in.  
7in disc 6-19/32  $\pm$  1/64in.

Inner  
12in discs 4 3/4  $\pm$  1/64in.  
10in discs 4 1/4  $\pm$  1/64in.  
7in discs 3 3/4  $\pm$  1/64in.  
Centre hole diameter:  
Normal .285 to .2885in.  
45rpm discs (alternative)  
1.502 to 1.506in.

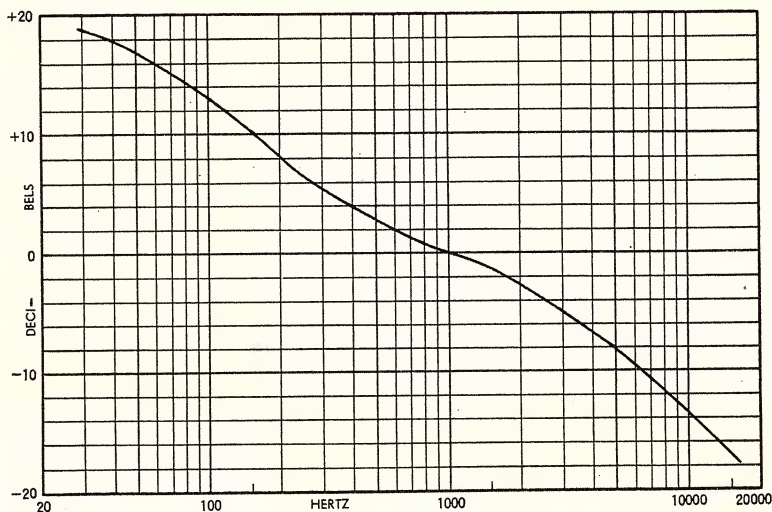

The R.I.A.A. equalisation curve. A magnetic cartridge will normally require that the whole of this compensation be provided in the associated amplifier circuitry. A crystal or ceramic cartridge will deliver a usable approximation of this compensation curve if fed into a high resistance load; not less than .5M for crystal, 2M for ceramic.

# UHER

## TAPERECORDERS

Made in Western Germany

"The World's Most Reliable Name for Precision Taperecorders"

NOW every Amateur and Enthusiast can benefit from this experience because

# ATRAM PTY. LTD.

presents to you

## ACTION and SOUND

with the NEW BREED styled Uher Taperecorders available to you without restrictions!

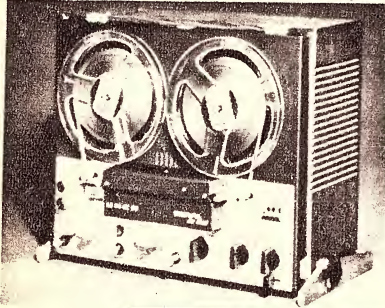

### All New Uher Royal Deluxe Stereo

Stereo Home Studio of the ultimate hi-fi class 20 watts rms push/pull output by separate amplifier—fully transistorised—4 or 2 track operation (stereo)—4 speeds—4 heads—A & B monitoring—4 amplifiers—VOR—11 exclusive recording functions, operated by one control—all new tape comparator—dia pilot-echo sound mixing—frequency response 20-20,000 cps at 7½ ips. Teakwood cabinet, can be hung on wall.

# ATRAM PTY. LTD.

Sole Australian Importer and General Agent.  
5 McLaren Street, North Sydney, Tele.: 92-4177.

N.S.W.: John Border Photographics Pty. Ltd.,  
175 Liverpool Street, Sydney,  
Tel.: 26-1106.  
N.S.W.: Milversons Sound Centre,  
791 Pacific Highway, Chatswood,  
Tel.: 41-4365.  
N.S.W.: Glen Dor Camera Centre,  
43 The Corso, Manly,  
Tel.: 92-2709.  
A.C.T.: Canberra Sound & Recording Service.

109 Malura Avenue, Dickson,  
Tel.: 45980.  
VIC.: Atram Pty. Ltd.,  
1 Corr Street, Moorabbin,  
Tel.: 95-5633.  
VIC.: Klapp Electronics Pty. Ltd.,  
224 Chapel Street, Prahran,  
Tel.: 51-4653.  
S.A.: Kallin Distributors (W./S.) Pty. Ltd.,  
140 Gawler Place, Adelaide.

Tel.: 8-7171 (11 lines).  
W.A.: Alberts TV and Hi-Fi Centre Pty. Ltd.,  
282 Hay Street, Perth,  
Tel.: 21-5004.  
QLD.: A. E. Harrold Pty. Ltd.,  
123-125 Charlotte Street, Brisbane,  
Tel.: 31-3081.  
N.T.: N.T. Musical & Electrical W./S. Pty.,  
Ltd., 54 Cavanagh Street, Darwin,  
Tel.: 3072.

## BATTERY ELIMINATOR REGULATED POWER SUPPLY

Specially for Larger Battery  
Operated Tape Recorders.

### SPECIFICATIONS

Input Voltage 240 Volts, 50 Hz  
Output Voltage 4.5V 6V, 7.5V 9V or 12V D.C. by Selector  
plug. Max. Current 0.5A.  
Protection Electronic Overload Protection.  
Regulation Approx. 10% on 12V Range  
Approx. 5% on all other Ranges  
Less than 100 mV R.M.S. under all  
conditions.  
Ripple All silicon solid state.  
Circuitry 4 ins. wide by 2½ ins. high x 5½ ins. deep  
Size 2 lbs, 7 ozs.  
Weight Approved by Electric Supply Authorities

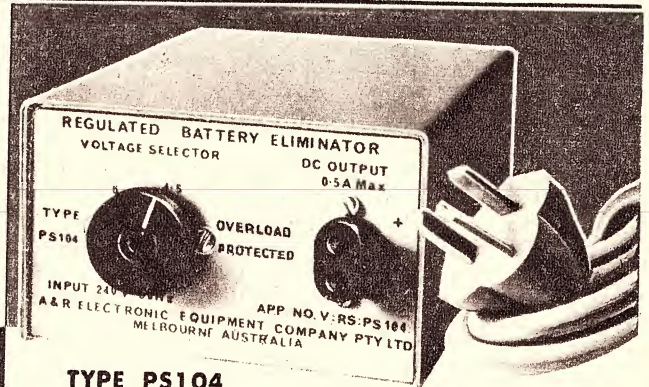

### TYPE PS104

Designed primarily for Tape Recorders where a regulated voltage supply is necessary to prevent speed variation with load changes. A versatile power supply with a range of output voltages making it ideal for design, testing and repair of Transistor Radios, Amplifiers, Record Players, Test Equipments, etc. It is also eminently suitable for use in Schools, Universities, Government Departments and Industry.

Manufactured by

## A & R ELECTRONIC EQUIPMENT COMPANY PTY. LTD.

42-46 Lexton Rd., Box Hill, Vic., 3128

Phones 89 0238 89 0239.

### AGENTS IN ALL STATES

N.S.W. SOANAR ELECTRONICS P/L, 82 Carlton Cres., Summer Hill  
Phone 798 6999  
Q'LAND R. A. VENN P/L, 71-73 Doggett St., Valley, Brisbane  
Phone 51 5421  
S.A. SCOTT THOMPSON P/L, 93 Gilles St., Adelaide  
Phone 23 2261  
W.A. EVERETT AGENCY P/L, 17 Northwood St., West Leederville  
Phone 8 4137



# A READER BUILT IT

## Waa-waa Unit for Guitar Amplifiers

This description of a "Waa-waa" or "wow" pedal should interest those readers who have written enquiring about guitar effects. The unit developed from a design published in "Practical Electronics," may be used with any electronic musical instrument which gives a fair output of harmonics, e.g. guitar (not bass), organ, harmonica (with microphone), etc.

The circuit is basically a phase-shift oscillator, except that the feedback is restricted to a value which is just insufficient to maintain self-oscillation. The circuit behaves as a selective amplifier, applying boost to a selected band of frequencies within the audio range while amplifying the remaining frequencies to a lesser degree. The position of the boosted band is shifted up and down in frequency, relative to the rest of the audio frequencies, by the operation of the foot pedal. Decreasing the resistance of the control resistor in the feedback loop raises the frequency of the boosted band, while increasing resistance lowers the band.

The original design used a carbon pot for the variable control resistor, and a press-on switch in parallel with a 220K resistor between the input and output terminals as a "Normal-Waa" switch. However, the carbon pot produced violent crackling within an hour of use, and the "Normal-Waa" switch gave an unwanted click.

To overcome these problems, a lamp-LDR combination is used to control both functions, as indicated in the circuit diagram. A variation from 0 to about 50K in the variable control resistor is necessary to produce the "Waa" effect with a guitar. Little audible difference is noticed with a resistance greater than 50K using a guitar signal. A square wave, however, requires a resistance variation from 0 to about 1M.

The lamp control circuit gives the required variation in the forward half of the pedal movement, thus providing the necessary rotational space between the operation of the "Normal-Waa" switch and the commencement of the "Waa" effect, while also decreasing the required pedal movement to produce the effect.

For maximum sensitivity of the lamp-LDR combination to rapid foot movement, a miniature 6V lamp (about 1.5cm long x 0.5cm diameter) is used. This globe is shorter than the one supplied in the lamp housing and so allows the LDR to fit flush against the front of the housing, while also producing a higher light output. The LDR must be shielded from external light sources. A suitable can, which

should be earthed, can be made from a piece of tinfoil.

The original design specified a 2N2926 (green spot) transistor, but a BC108 or 2N3565 transistor is a suitable equivalent. 160V polyester capacitors should be used, as low-voltage ceramic capacitors may have a high enough leakage current to affect the critical phase-shift circuit.

A steel box, 12 1/4 in x 4 in x 2 1/4 in, with a removable base, will house the circuit and batteries if the layout is carefully planned. A suitable pedal is a piece of wood 11 in x 3 1/2 in x 1/2 in. A piece of ribbed rubber sheeting (from a garage service department) can be glued to the top side of the pedal to give a professional look and a non-slip finish. Some of the rubber should also be glued under each end of the pedal to deaden the impact at the ends of travel of the pedal. The pedal is hinged to the top of the box with a block of wood, triangular in cross-

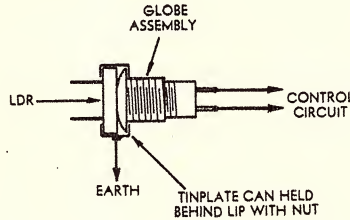

A section through one of the lamp-LDR combinations.

A sketch of the physical arrangement of the device showing the crank mechanism to operate the "Waa-waa" control potentiometer.

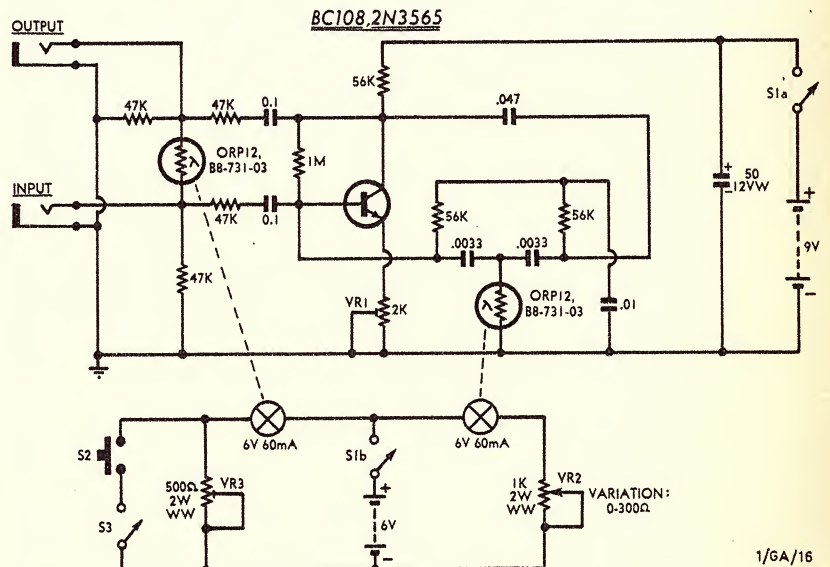
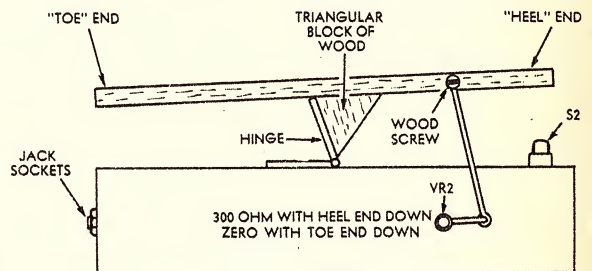

The main feature of this simple circuit is the use of the lamp-LDR combinations to obviate possible noise from conventional controls and switches.

# PIONEER

## SOUND EQUIPMENT

has  
**NO BOUNDARY**  
at...



## General Accessories

Come and see this exciting range of Pioneer sound equipment for a no obligation free inspection at General Accessories new stereo showroom.

at- 153 Sturt Street, South Melbourne.

### LATEST

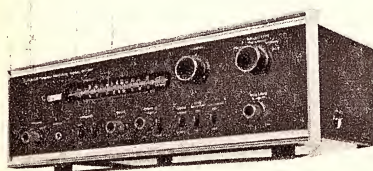

#### MODEL SX 440

The newly developed stereo receiver designed with meticulous attention to looks as well as to sound quality. It uses an FET in the FM front end to provide excellent selectivity and sensitivity as high as 2.5 mV (IHF). The AM tuner section is equipped for ideal reception with a ferrite loop antenna. The audio-frequency at a dynamic 40 watts (IHF/4 ohms).  
Dimensions: 15-15/16"(W) x 5-7/16"(H) x 15"(D).



#### MODEL PL 11

The perfect addition to quality stereo systems, with 2-speed, 4-pole synchronous motor, 12" aluminium die-cast turntable. It is an idler driven system and has a static balance type pipe arm.  
Dimensions: 16-9/16"(W) x 13"(D) x 6-5/16"(H).

### RELEASES



#### MODEL SA 500

An efficient medium-range pre/main amplifier built to very high specifications for size of unit. It has a set of controls, inputs and outputs for versatile operation of speakers and tape recorders. Main amplifier total power is 44 watts (at 4 ohms). All solid state circuitry includes low-noise silicon transistors.  
Dimensions: 13"(W) x 4-5/8"(H) x 12-5/16"(D)

## GENERAL ACCESSORIES

SERVING THE RADIO AND ELECTRICAL INDUSTRY THROUGHOUT AUSTRALIA.

Division of Electronic Industries Ltd.

N.S.W. 443 Concord Road, Concord West. Phone: 73 0211.  
S.A. 46 Milligan Street, Perth. Phone: 21 2501.  
TAS. 199 Collins Street Hobart. Phone: 2 2711.

QLD. 50 Little Edward Street, Brisbane. Phone: 2 3093.  
S.A. 81 Flinders Street, Adelaide. Phone: 23 4022.  
VIC. 153 Sturt Street, South Melbourne. Phone: 69 0300.

# READER BUILT IT — continued

section, to raise the pedal about 7/8in above the top of the box.

The linkage from the pedal to the shaft of the control pot is a simple crank mechanism constructed from heavy wire. The hinged movement and crank mechanism can be made in many ways—the only necessary requirement being the variation in lamp control resistance (VR2). Using a 1000-ohm wire-wound pot, a rotation of about 80 degrees (the total pedal movement) is required to change VR2 from 0 to 300 ohms.

VR1 should ideally be mounted internally, and a hole drilled in the case to allow access to it with a screwdriver, as the setting may need to be altered if the unit is used with other equipments (instrument or amplifier).

The "Normal-Waa" LDR has a 500-ohm wire-wound pot (VR3) as its lamp control resistance in parallel with two switches in series. One is a press-on, release off, push-button switch situated under the heel of the pedal to short-circuit the lamp control resistance. The other is to negate the action of the first, as the "Normal-Waa" facility is not always desirable.

The resistance of the LDR can be measured at low illumination levels but NOT when the LDR is fully illuminated as the power dissipation of the device will be exceeded. (The resistance of an LDR decreases with increasing illumination).

Setting up: As adjustment of VR1 will vary the gain of the unit, first set VR3 to maximum resistance, then adjust VR1, and lastly set VR3.

To set the position of VR1, connect the unit to the instrument and amplifier with which it will normally be used. Slowly decrease VR1 from its maximum value of 2K until a howl is heard from the loudspeaker. Then slowly increase it until the howl just

ceases when the pedal is rocked over its full range. A slight "waa-waa" sound imposed on the background hiss should be heard, but no howl. VR1 may need to be increased a little more if distortion is heard for a certain pedal position when the instrument is played.

VR3 should be adjusted to give a minimum change in overall volume when the "Normal-Waa" switch is operated (about 200 ohms for VR3 or 220K for the LDR out of circuit).

(Submitted by: Mr E. Reimer, 9 Denman Street, Eastwood, N.S.W. 2122).

## Parts List

- 1 case and pedal (see text).
  - 1 9-lug miniature resistor panel.
  - 2 jack sockets.
  - 1 9-volt battery (type 216 or similar) and connector.
  - 1 6-volt battery (type 509 or similar).
  - 2 miniature 6V lamp assemblies.
  - 2 miniature lamps VTY 6V 0.36W.
  - 1 single-pole, press-on release-off, push-button switch.
  - 1 SPST toggle or slider switch.
  - 1 DPST toggle or slider switch.
- SEMICONDUCTORS**
- 1 BC108, 2N3565 or similar transistor.
  - 2 ORP12, B8-731-03 or similar LDRs.

## POTENTIOMETERS

- 1 2K pre-set.
- 1 500-ohm, 2W wire-wound.
- 1 1K 2W wire-wound.

## RESISTORS

- (All 1/2-watt, 5 p.c. tolerance)
- 4 x 47K, 3 x 56K, 1 x 1M.

## CAPACITORS

- 2 x .0033uF, 1 x .01uF, 1 x .047uF,
- 2 x 0.1uF (all 160VW plastic).
- 1 x 50uF, 12VW electro.

## A SIMPLE TRANSISTOR AMPLIFIER

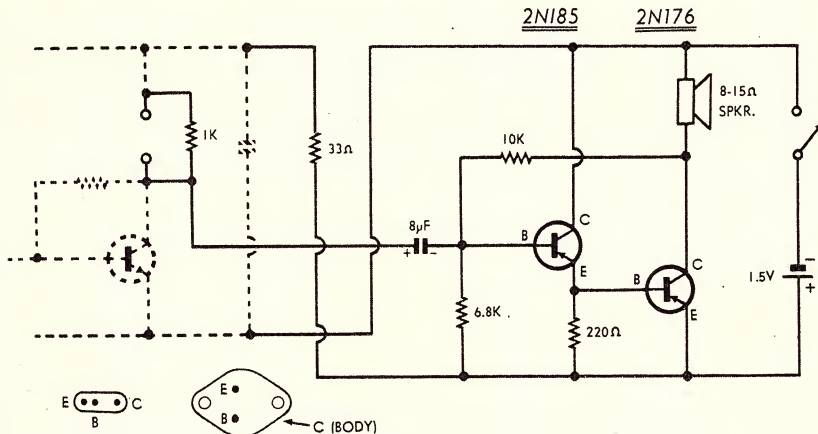

This simple amplifier, for use with beginners' receivers was built using a 2N176 mounted on a small angle-bracket, rather than a proper heat sink. A 2N301, 2N256 or 2N250 would be satisfactory alternatives. The driver transistor is a 2N185 but a 2N217 or OC72 could be used.

The loudspeaker can be of 8 or 15

ohms and the voltage raised to 3.0 or 4.5, but lower impedance loudspeakers and higher voltage should not be used or the output transistor may be destroyed. I used a 15-ohm loudspeaker and a 1.5V Eveready No. 6 cell with screw terminals, so that a very long life can be expected. (Submitted by Mr P. Collen, 15 Narrawong Rd., Caulfield, Vic. 3162.)

## TAKEDA RIKEN TR-6334 Digital Volt-Ohmmeter



**Data:** 1.8V-1000V full scale in 4 ranges, maximum resolution 1mV, 1.8K $\Omega$ -18M $\Omega$  full scale in 5 ranges, automatic polarity and decimal point indication, fully transistorised, including I.C.'s.

**Price \$501.**

**Plus S.T. and Postage.**

## N.E.T. SK-100-3 Volt-Ohm-Milliammeter

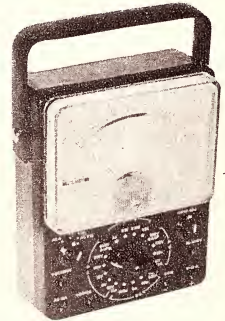

**Data:** 100K/V DC 10K/V AC  
0.6-1200V DC  $\pm$  3%  
6-1200V AC  $\pm$  4%  
12uA-12A DC 12A AC in  
one range 20K $\Omega$ -20M $\Omega$   
-20dB-63dB.

**Price \$29.84**

**Plus S.T. and Postage.**

**N.E.T.**

**NUCLEONICS ELECTRONICS &  
TELECOMMUNICATIONS PTY. LTD.**

**6-8 CLARKE STREET,  
CROWS NEST, N.S.W. 2065  
Telephone 439-2657**

# Homecrafts FOR RADIO PARTS

## 289 Elizabeth St. Melbourne. Phone 60 1442

### PIZZO PICK-UP AND CARTRIDGES

PU-86 Pickup LP/78 T/O Crystal cartridge. Length 240mm ... Ea. \$2.95  
 Y700 Ceramic Cartridge. Mon. LP/78 .. \$2.50  
 PU-86 Pick-up Ster-LP/78. T/O Cartridge. Length 204mm ... Ea. \$4.00  
 Y200 Ceramic Cartridge. ST LP/78 .. \$3.40  
 Y400 Crystal Cartridge. LP/45 .. \$1.90  
 Y130 Crystal Cartridge. T/O Type Ster/LP .. Ea. \$2.70  
 Sapphire Replacement Styl. Each Ster/LP .. 60c  
 Plus postage 15c.

### PIZZO MICROPHONE INSERTS

MC-3 Crystal, 50-7K, 35 x 25 x 8mm. -57 DB .. \$1.00 ea.  
 MC-7 Crystal, 100-7K. 39mm Round x 11mm. -56 DB .. \$1.00 ea.  
 MC-8 Crystal, 50-8K. 48mm Round x 17mm. -50 DB .. \$1.00 ea.  
 MC-9 Crystal, 50-8K. 25mm Round x 9mm. -68 DB .. \$1.80 ea.  
 MC-33 Crystal, 50-10K, 33mm Round x 9mm. -60 DB .. \$1.30 ea.  
 MD-5 Dynamic, 100-15K. 33mm Round x 14mm. -55 DB .. \$1.80 ea.  
 Plus postage 20c.

### TRANSISTOR SET ACCESSORIES

Magnetic Earpiece with 3.5mm Plug .. 75c  
 Crystal Earpiece with 2.5mm Plug .. 75c  
 Crystal Earpiece with 3.5mm Plug .. 75c

### LAPEL TYPE CRYSTAL MICROPHONE

With 3.5mm Plug .. \$1.00 ea.  
 Plus postage 15c.  
 Fuses for Japanese equipment 1A, 3A, 5A 3c ea. OR \$2.00 per 100. Plus postage 10c.

Michigan/Collard—Twin Track Rec/Play Heads .. \$8.50  
 Michigan/Collard—Twin Track Erase Heads \$3.00  
 Michigan/Collard—Four Track Erase Heads \$8.50

12-Pin Wafer Sockets. 20c ea.  
 12-Pin Plugs . 25c ea.  
 Plus postage 10c.

### OCTAL PLUG AND CORD

Ext. Socket.  
 45c pr. Plus postage 10c.

### ALL TYPES AMPHENOL PLUGS AND SOCKETS

Carried in stock.  
 Plugs 27c ea. Sockets 30c ea. Meall Covers for same 27c ea.  
 Plus postage 10c.

### HALF-INCH MINIATURE PLUGS AND SOCKETS

2, 3, 4 and 5-Pin Plugs 10c ea.  
 Sockets 10c ea. Plus postage 10c.

### ELECTROLYTIC CAPACITORS IN METAL CANS

16 + 16 450 VW .. 95c ea.  
 32 + 32 450 VW .. \$1.30 ea.  
 50 + 50 450 VW .. \$1.85 ea.  
 50 + 50 + 50 350 VW .. \$1.90 ea.  
 100 MFD P.V.C. Cover .. \$1.15 ea.  
 Jacks, 2.5 and 3.5mm .. 20c  
 3.5mm Plug and Cord Ext. Jack Pair .. 50c  
 Metal Co-axial Plugs and Line Sockets Pr. .. 65c  
 "Din" and "Hirschmann," 2, 3, 4 and 5-pin Plugs, Chassis and Line Sockets, carried ex stock.

### Prices on application.

P.M.G. type Plugs from .. 50c  
 P.M.G. type Jacks from .. 35c  
 P.M.G. Line Jacks from .. 55c  
 Plus postage 15c.

### 5 CORE CABLE

7/0076. P.V.C. insulated, P.V.C. covered. 25c yd.

### 6 CORE CABLE

same spec. as above 30c yd.

Capacitor Substitution Box, 1,000 VW .. \$5.00  
 Resistor Substitution Box, 1 Watt. Plus Post, 20c. .. \$4.50

### TRANSISTOR AERIALS

5in extends to 39in .. \$1.70  
 5in extends to 39in .. \$1.70  
 6in extends to 43in .. \$1.70  
 5in extends to 32in .. \$1.00  
 6in extends to 28in .. \$1.00  
 7in extends to 39in .. \$1.20  
 9in extends to 39in .. 95c  
 5in extends to 4ft 6in .. \$1.80  
 7in extends to 5ft 8in .. \$3.70  
 Plus Post 15c.

### CRYSTAL SET BUILDERS

Coils .. 80c | Tuning Conds. .. \$2.00  
 Diodes .. 35c | Terms .. Ea. 12c  
 Headphones .. \$2.50 | Plus Postage.

### TAPE RECORDER ACCESSORIES

2 1/2in Spools .. 30c | 3in x 600ft Tape .. \$2.35  
 3in Spools .. 35c | 5 1/4in x 1,200ft Tape .. \$3.10  
 5in Spools .. 40c | 7in x 1,800ft Tape .. \$5.10  
 5 1/4in Spools .. 70c | 5in Plastic Tape, boxes .. 60c  
 7in Spools .. 50c | 7in Plastic Tape, boxes .. 90c  
 2 1/2in x 100ft Tape .. 60c  
 2 1/2in x 300ft Tape .. \$1.40  
 Plus postage 20c.

See us for Tape Recorder Patch Cords, Adaptors, etc.

### STEREO PLUGS AND JACKS

Metal Plugs .. 95c | Bakelite ext. sockets .. 70c  
 Bakelite .. 70c | Chassis Jacks .. 65c  
 Plus postage 10c.

## MAIL ORDER SPECIALISTS

# JUST ARRIVED FROM OVERSEAS

## LAFAYETTE 10 TRANSISTOR RADIO

Aircraft Band 108 MHZ-136 MHZ, Broadcast Band. 550 KHZ to 1500 KHZ. Size 7" x 4" x 2". Price only \$71.50 inc. tax, postage \$1.00. V.H.F. MONITOR 10 TRANSISTOR RADIO 146 MHZ TO 175 MHZ. Size 5 1/2" x 3" x 1 1/2".

PRICE \$61.50 INC. TAX, Postage \$1.00.

### BELLPHONE



Lift receiver and dial number, \$10.12 per pair plus postage.

### DC 330 MULTIMETER

DC Voltage Ranges 0-0.6, 6.0, 30, 120, 600, 1200, 3000, 6000.  
 AC Voltage Ranges 0-0.6, 30, 120, 600, 1200.  
 DC Current 0-0.06 mA, 6, 60, 600 mA  
 Resistance 0 - 6K, 600K, 6M, 60M.  
 Capacitance 50 pF to 0.01 MFD, 1000 pF to 0.2-MFD.  
 Decibels minus 20 to plus 63db.  
 Sensitivity DC 20,000 ohms per volt. AC 10,000 ohms/volt.  
 \$15.95 inc. tax. Post 50c.



### KEW 142 V.T.V.M.

AC and DC voltages 0 to 1.5, 5, 15, 50, 150, 500, 1500.  
 Decibels (dbm) minus 20 to plus 65db.  
 Resistance 0 to 1K, 10K, 100K, 1M, 10M, 100M, 1000M.  
 Accuracy plus or minus 3 p.c. of scale length.  
 Input impedance 1.4 M ohms AC range 11 M ohms DC range  
 Response (AC volts) 30 Hz to 500 KHz plus or minus 5db, 20 Hz - plus or minus 10db.  
 Price \$59 inc. tax. Postage 70c.



### NEW EVERSHED MEGGER

Range — 0.1 ohm to 200 Megohms in 3 ranges.  
 Has in-built battery tester, stable voltage generator and the famous Evershed and Vignoles cross-coil ohmmeter movement. In attractive leather case with probes.  
 \$62.70 inc. tax. Postage 70c.



### CHEST OF DRAWERS TYPE C.D.4

A 17 1/2in x 6 1/2in x 11 1/2in Galvanised Chest containing 4 full-length drawers each measuring 15 1/2in x 6 1/2in x 2 1/2in. Finished in blue hammertone stoving enamel. \$7.00.

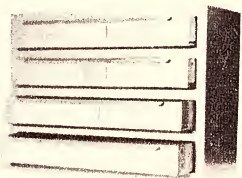

### SOLID STATE AUDIO SIGNAL GENERATOR

Available as battery or AC operation. Ranges—15Hz to 1.5 MHz in 5 ranges. Output—800 mV (2.5V p-p) max. Adjustable in 5 steps with fine control. 100B (Battery) \$50.60 inc. tax. 100A (AC) \$57.50, 80c postage.



### RESISTORS MIXED VALUES

In bags, \$2 per 100 or 50 for \$1 plus postage 40c.  
 3,000 Type relays, new stocks, 50c each, plus postage.

### TRANSISTOR V.H.F. CONVERTER

Tunable 108-136 Mhz Aircraft Band IF-600K to 1000Kc. No connecting wires needed. 9V battery, self contained, just place alongside your broadcast radio. Price only \$14.40, plus 45c postage. Wanted to Buy, Receivers, Test Equipment and Transmitters. All prices subject to alteration without notice.

## UNITED TRADE SALES PTY. LTD.

280 LONSDALE STREET, MELBOURNE, Phone 663-3815, (opposite Myers)



# READER BUILT IT - continued

The circuit board described here would make an excellent instructional toy for a lad who is just becoming interested in electricity.

A lamp, buzzer, relay and Morse key are mounted on a chassis, and leads from these components are taken beneath the chassis to a bank of terminals mounted at the front of the chassis and suitably labelled. A 6-volt lantern battery, as the power supply, may be mounted under or on the chassis as desired, the other components should be chosen bearing this voltage in mind. For convenience, a switch is included in one of the leads from the battery. The diagram shows the general layout and labelling of the set.

A number of short lengths of insulated wire, each about 1ft long, are used to connect the various terminals together. Several different circuits may be built, ranging from the simple lighting of the lamp, through illustrations of parallel and series connections, to various burglar alarms and other circuits using the relay.

The simple circuits, including the use of the Morse key and light or buzzer as a Morse practice set, are quite obvious and will not be described here.

The following circuits show some of the more interesting possibilities. The connections are made between pairs of terminals referred to by number in the diagram.

**CHATTER CIRCUIT.** Connections: 1-10, 2-7, 8-11.

When this circuit is first switched on, current flows through the coil of the relay through the bottom two contacts. The relay operates, which makes the contacts separate and the current stop flowing. As this happens, the contacts drop back together. This process is repeated rapidly, causing the "chatter" after which the circuit is named. A variation of the chatter circuit is to include the lamp in one of the battery leads. The pulsating current then causes the lamp to flicker.

**BURGLAR ALARMS.** Two burglar alarms can be built.

Connections: 1-7, 1 to external contact, 2-5, 2-10, 6-8, 11 to external contact.

The first alarm draws current continually so that the electromagnet in the relay holds the buzzer circuit open. When the pair of contacts are parted, the buzzer circuit closes and raises the alarm. Buzzing stops as soon as the contacts are closed again. A demonstration fire alarm may be made by using a thin piece of low melting point metal as the contacts. When this is heated, it melts and the buzzer will sound.

Connections: 1-9, 1 to external contact, 2-5, 2-10, 6-8, 8-11, 11 to external contact.

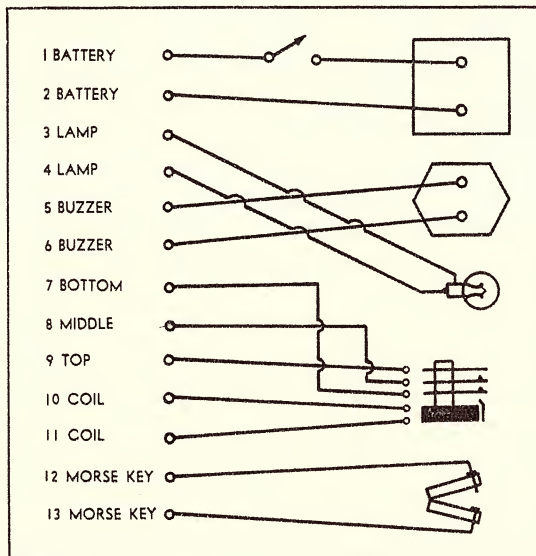

The second burglar alarm uses no current until the contacts are made to touch, then the relay locks the buzzer circuit on so that separating the contacts will have no effect. Buzzing will stop only when the current is switched off at the main switch in the battery

lead. A "chatter" circuit which includes the buzzer may be made by changing the connection 8-11 to 8-10.

**ALTERNATING LIGHT AND BUZZER.** Connections: 1-3, 1-5, 1-11, 2-8, 2-12, 4-7, 6-9, 10-13.

This circuit uses the relay and Morse key to allow either the lamp (key open) or buzzer (key closed) to work. A variation is to add the connection 7-11.

**TWO-STROKE ENGINE.** Connections: 1-8, 1-12, 2-9, 2-11, 7-13, 10-13.

This is another "chatter" circuit, having two chattering speeds controlled by the Morse key. It has been called the "two-stroke engine" because the noise is reminiscent of a two-stroke engine idling and then running at speed.

To save space, diagrams have not been drawn for the individual circuits described. This, however, is not difficult to do and adds to the educational value of the circuit board. Once a boy has become familiar with the circuits described, and can work out the circuit diagram for each, he could then experiment with other possible combinations. (Submitted by Mr M. R. Talbot, 16 Myrtle Avenue, Myrtle Bank, S.A. 5064.)

## L.P. RECORDS WANTED

Any quantity. Highest prices paid. Will call with cash within 30 minutes.

**CASTLES RECORDS**

323 Church Street, Parramatta  
635-8621 after hours 86-1422



## BARGAIN PACKS!

### SEMI-CONDUCTOR PACKS, BRAND NEW AND TESTED! SILICON AND GERMANIUM TYPES

10—RF Type Similar BF115, AT325.	\$2.95
10—AUDIO Type Similar AY1101, AF326, BC108	\$2.95
10—AUDIO Output Matched Pairs	\$3.25
1—NPN Hi-Power Output, 2N3055	\$2.00
5—Pair Complementary Output	\$3.25
1—PNP RF IF Type SIM AF116 or	.60
10—SIM AF116	\$5.00
1—PNP Power Output Sim. 2N301, 2N2148	\$1.80
1—PNP Audio Similar OC70	.50
"Super-Fast" Solder—Special Resin Cored, 2 1/2 lb reels, ONLY	\$2.75

### RECORDING TAPE, POPULAR MAKE AT WHOLESALE PRICES

3in 150ft	.60
3in 225ft	.72
3in 300ft	.99
5in 600ft	\$1.80
5in 900ft	\$2.35
5in 1200ft	\$3.50
5 3/4in 900ft	\$2.65
5 3/4in 1200ft	\$3.00
7in 1200ft	\$3.00
7in 1800ft	\$4.10
7in 2400ft	\$4.97
7in 3600ft	\$6.65

### PHILIPS TYPE CASSETTES

C 60 60 min	\$1.95
C 90 90 min	\$2.75
C120 120 min	\$3.50

### SILICON RECTIFIERS

50V, 100V, 200V, 400V at 56c each.	
800V, \$1 ea; 1000V, \$1.30 ea	

### GERMANIUM DIODES

OA90 Type 27c ea or 10 for	\$2.50
OA91 Type 27c ea or 10 for	\$2.50
AN1102, BA100, 27c ea or 10 for	\$2.50
FET'S MFF 102	\$1.10
MFF 105	\$1.10
MFF 106	\$1.30



**NEW WIDE BAND TUNER**  
Based on Playmaster design. Ceramic filters. Tuning meter, whistle filter, etc. \$52. plus tax. Teak cabinet, \$6 extra.

**TRANSISTORISED TUNERS**  
New, low-priced model, wood grain finish. Without power supply.

ONLY \$19.50, plus tax.  
UNIT 10—with RF stage and power supply, 8 Kcs bandwidth—\$31, plus tax.



Peak 7W Stereo Amplifier. 50-20,000 Hz. In oiled timber cabinet. \$34.50, complete.



**AMPLIFIER KIT**  
STC 20W RMS STEREO AMPLIFIER  
Complete to last nut and bolt. Plus full instructions. \$72 plus 25 p.c. sales tax.

Complete to last nut and bolt. Plus full instructions. \$72 plus 25 p.c. sales tax.

### NEW 1969 TRANSISTOR RADIO KIT



6 Silicon Transistors and complete with Instruction Book, carrying case and earphone. Special price, \$11.25  
Wired \$13.50  
Post and Pack. 75c.



**BOYS' CRYSTAL SET KIT**  
Complete with plastic cabinet, earphone and instructions. \$2.20

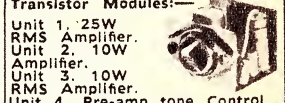

**Transistor Modules:**  
Unit 1. 25W RMS Amplifier.  
Unit 2. 10W Amplifier.  
Unit 3. 10W RMS Amplifier.  
Unit 4. Pre-amp tone Control Stage.  
Unit 11. 65W Hi-Fi Amplifier.  
**TRANSISTORS AND DIODES AT SPECIAL PRICES. ALSO ALL COMPONENTS, TAPE, FILM, etc.**  
SEND S.A.E. FOR DETAILS AND LIST.

## S. E. WILLIS TRADING CO.

38 Riversdale Road, Camberwell Junction, Vic., 3124.  
Phone 82-5787. Please Include Freight Sorry No C.O.D.

# Three great ways to start a customized

Push the power switch of any of these professional performing amplifiers and you're ready to enjoy the results of the world's highest standards of audio engineering.

At 70 watts, the AU-777 is the largest of the three in both power and in diversification. It offers complete stereo control throughout a wide 20 to 50,000Hz bandwidth and holds distortion to a negligible 0.5% or less. It also offers independent pre- and main-amplifier sections and no fewer than four output and seven input circuits.

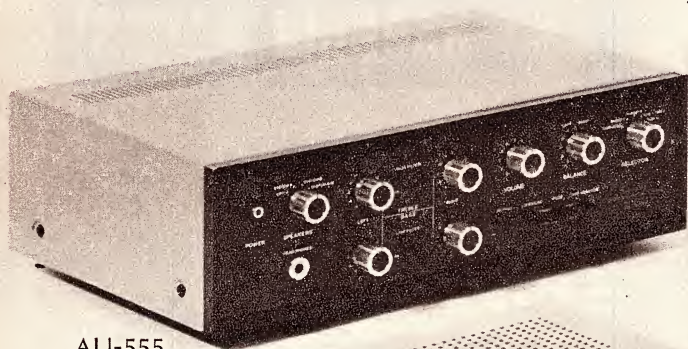

AU-555



AU-222



AU-777

**Sansui®**

# stereo system,

A 60 watt solid state, the AU-555 offers the same number of output and input circuits as the AU-777, and differs only in size, price and power bandwidth rating, 20 to 30,000Hz.

The 46 watt AU-222 is the most compact of all. With a bandwidth from 20 to 20,000Hz and a distortion factor of only 0.8% or less, it brings professional Sansui performance within the budget of everyone.

Depending on the size of the system, any of these three models is an ideal place to start a customized stereo system of your own.

## and two great ways to add to it.

Sansui's SR-3030BC and SR-2020BC 2-speed manual turntables are recognized worldwide for their precision speeds, superior pick-up capabilities and flawless wow and flutter characteristics. Both feature large platters, tubular type tonearms, induced magnetic type cartridges, wide frequency response ranges and high channel separation figures. Either makes an ideal addition to any amplifier in the Sansui AU series.



SR-2020BC



SR-3030BC

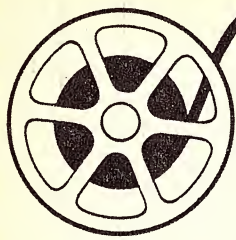

# AUDIO TOPICS



## DISC RECORDINGS — THEN AND NOW

This article relates something of the background of disc recordings as we now know them. In particular, it explains why a so-called "recording characteristic" is necessary and what it involves in terms of frequency response.

The history of "gramophone" or "phonograph" recording makes a fascinating study but it is not our purpose to dwell upon it here. It takes in the work of people like Leon Scott who, well over a hundred years ago, established a connection between sound, and wave patterns capable of being produced and inspected. It would dwell heavily on the work of Thomas Edison, who, in 1877, succeeded in recording sound upon the surface of a cylinder and playing it back.

The technique of recording on flat discs is normally credited to Emil Berliner, from work done just before the turn of the century. Technical arguments aside — and there were many — Berliner's flat discs offered the overwhelming advantage that they were capable of ready duplication by a plating and pressing process. In addition, they were cheaper to market and easier to store. By the 1920s, Berliner style discs, spinning at a standard 78rpm, had virtually ousted Edison cylinders and laid the foundation for what has been a very successful industry ever since.

What we have to say virtually begins at this point.

Inscribed or pressed into the surface of a disc recording is a groove which spirals gradually inwards from the outer edge towards the centre. If this groove is examined under a powerful magnifying glass it will be seen to contain tiny, wave-like deviations, produced when audio signal currents through the cutting head caused the stylus to vibrate (figure 1).

For those with a mathematical turn of mind, it is appropriate to regard the groove as an inscribed graph, in which the instantaneous value of the audio signal (side-to-side deviation) is plotted against elapsed time (along the spiral).

When the groove is subsequently traced by a stylus in an electrical replay head, the replay stylus must substantially duplicate the deviations of the recording stylus. As a result, the replay head will deliver an electrical output signal closely equivalent to that which produced the original recording and this can be amplified to drive a loudspeaker.

While these broad principles are easy enough to grasp, their application requires a decision about many of the working parameters. Most ob-

vious, perhaps, are the diameter of the disc, the pitch of the spiral and the speed of rotation. A large disc, a fine spiral and a slow speed all contribute to a longer playing time but other considerations intervene to set limits on these various quantities.

Then there are details of the groove itself — its shape, depth, width, the nature and extent of the deviation with cutter modulation and the nature of the material which makes up its walls; in short, the material of which the record itself is made.

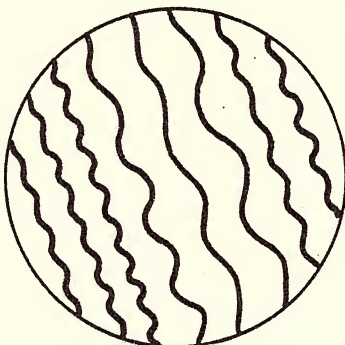

Figure 1: Under a microscope the tracks of a conventional mono disc will be seen to deviate from side to side, giving rise to the term "lateral" recording. The deviations are exaggerated in the drawing for the sake of clarity.

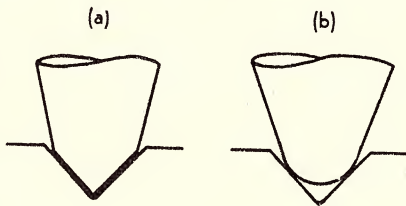

Figure 2: Old-fashioned steel, thorn or fibre needles were intended to wear rapidly and conform to the shape of the groove, as in (a). Jewelled styli were radiused accurately to be gripped between the walls, as in (b).

Closely dependent on groove characteristics is the nature of the replay needle or stylus — the shape and dimensions of its tip, the way in which it is supposed to ride in the groove, the material of which the stylus is made and the weight of the pickup head which it can reasonably be expected to support.

As might be expected, there have been numerous arguments through the years within the record industry regarding appropriate dimensions and conventions but various "standards" have emerged out of the sheer commercial necessity that records from any source be playable on equipment from any other source.

The earliest conventions within the disc recording industry were established to cope with mechano-acoustic methods of recording and playback. In the recording studios, sound waves, collected by a large horn, were concentrated on to a diaphragm directly connected to the recording stylus. Many compromises had to be accepted in order to satisfy the prime requirement that there should be adequate modulation of the groove.

Reproducing sound from a disc was essentially the reverse of the recording process. The modulated groove was traced by a "needle" directly coupled to a thin diaphragm located at the throat of a horn. Air pressure waves created at the surface of the diaphragm were propagated into the listening room. Since the system was devoid of electrical amplification, the listener was entirely dependent for adequate sound on the efforts of recording engineers to secure adequate deviation of the track.

Because the playback needle had to perform significant "work" in driving the linkage, the diaphragm and the air in the horn, its movement was quite stiff. To hold the needle in the groove, the playback head had to bear down heavily upon it, with a playing or tracking weight which was, in fact, measured in ounces.

On the slender needle point, this represented a tremendous pressure per unit area, and very rapid wear had to be expected of the needle point, or the groove walls, or both.

Early practice was to regard the needle as the more logically expendable item. The formulation from which discs were pressed contained a certain amount of abrasive filler, the effect of which was to rapidly grind the steel needle to conform to the shape of the particular groove: in so doing, it distributed the downward thrust over a greater surface area. The granular nature of the shellac-plus-filler formu-

lation added a considerable amount of "crackle and pop" noise to the reproduced sound but this came to be accepted as almost an intrinsic part of reproduction from disc.

It certainly had the designed effect on hard steel needles. Older readers will remember the days when one purchased them by the hundred, each small tin carrying the advice "replace needle after every playing."

Around 1925 microphones, amplifiers and electrical recording heads appeared, giving engineers greater flexibility in the kind of material they could record, more precise control over amplitude, smoother and wider frequency response and lower distortion. Then, in the late twenties, electrical playback heads began to appear in quantity, delivering an electrical output signal which could be passed through an amplifier and loudspeaker system for reproduction.

Since the needle in these new heads did not have to drive a diaphragm directly, they held the promise of a less stiff — or more compliant — needle system, reduced playing weight and therefore reduced needle and record wear.

In fact, designers seemed to be rather slow in exploiting this possibility and the majority of early electrical pickups were cumbersome and used exactly the same needles and the same heavy chuck system as acoustic phonographs of the day. It was well into the thirties before the idea of higher compliance, lighter weight pickups began to catch on.

Conservatism notwithstanding, the thirties saw steady progress in the quality of signal impressed on to discs and subsequently recaptured during playback.

Unfortunately, however, the industry of the day was soundly wedded to the idea of compatibility. Engineers could improve the records if they wanted to but only within the framework of existing practice. Anything they produced still had to be fully compatible with the requirements of acoustic phonographs — even if most of those still in use were in underprivileged countries!

One important development which did come near the end of the 78rpm era was that of truly light-weight, high-compliance pickups fitted with long-wearing (wrongly called "permanent") styli. The sapphire tips were ground and radiused, more or less accurately so that the stylus would ride part way down the V-shaped groove, gripped between the two walls (figure 26). So

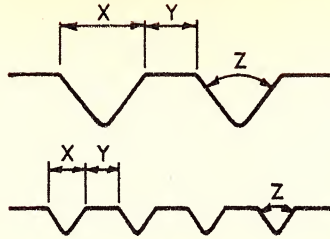
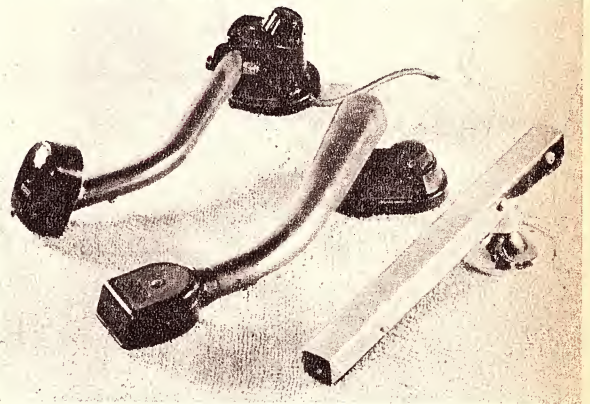

Figure 3: The groove dimensions of 78rpm and microgroove discs. There are 90-120 grooves to the inch on standard 78rpm records (top), the dimensions being X 0.006 inch, Y 0.004 inch. Microgroove records have 200-300 grooves per inch with dimensions X 0.002 inch to 0.003 inch, Y 0.0017 inch. The included angle Z is approximately 90 degrees in each case, and the maximum bottom radii are 0.001 inch and 0.00015 inch respectively.

held, it could be expected to trace the groove more accurately and be more responsive to very fine deviations corresponding to the higher modulation frequencies. Ability to respond to the higher frequencies was further improved by a reduction in the mass of the stylus and elimination of the traditional and cumbersome needle chuck.

On the left, two old magnetic pickups for playing 78 rpm records. And, on the right, the first "crystal" pickup to be marketed in Australia. Distinguished for its modest playing weight, it tracked at 3 ounces — one half to one third the tracking weight of many older magnetics. By contrast, a modern run-of-the mill stereo pickup tracks at 5 to 6 grams, the majority of high performance magnetic cartridges at between 1 and 2.5 grams.



argument and rivalry, a new set of standards emerged soon after the war or, rather, a new set of practices which gradually emerged as standards. They can be summarised as follows:

RECORDS: Shellac and fillers formulation gave place to plastic materials such as vinyl and polyethylene. The substitution of an homogenous material for one which was essentially granular in nature, made possible a dramatic reduction in record surface noise. It became possible to record, and play back successfully from, a

	Coarse groove Mono	Microgroove		
		Mono		Stereo
Nominal Speed (rpm) . . . . .	78	33-1/3	45	33-1/3
Nominal Size (in.) . . . . .	10 12	10 12	7	12
Outer Diameter of recorded surface (in.) . .	9.52 11.52	9.52 11.52	6.625	11.52
Inner Diameter of recorded surface (in.) . .	3 3/4	4 1/4 4 3/4	3 3/4	4 3/4
Centre hole (in.) . . . . .	0.285	0.285 0.285	0.285	0.285
			or 1.5	
Average pitch (grooves per in.) . . . . .	100	250		250
Stylus tip radius (in.) . . . . .	0.002-0.003	0.0007-0.001		0.0005-0.0007
Stylus included angle . . . . .	40 deg.-55 deg.	40 deg.-55 deg.		40 deg.-55 deg.

Figure 4: This table compares the main features of the 78rpm, microgroove mono, and microgroove stereo disc record systems. A few 7-inch mono records have been released, intended for

playing at 33rpm, while a few 7-inch 45rpm records and 10-inch 33rpm records have been released in stereo. Such information is normally given on the jacket and/or label.

# THE MAGNIFICENT WORLD

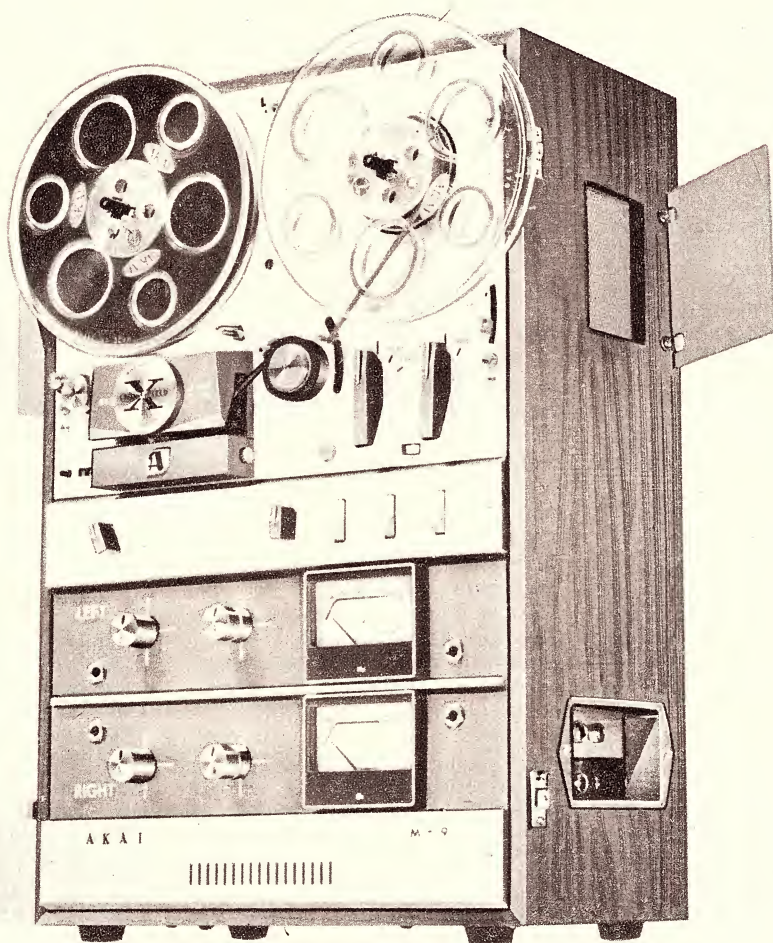

## Model M-9

### **HIGH FIDELITY STEREO TAPE RECORDER-M-9**

The wide frequency CROSS-FIELD HEAD \*4-track stereo/monaural recording and playback \*All solid-state 40 watts music power \*4speed, 3, heads \*Automatic shut off \*Automatic pinch wheel release \*Automatic lever release \*Magnificent oil-finished wooden cabinet \*For increased stereo enjoyment, use the matching Speaker SW-130

Prove it by the sound!  
..... prove it with

**AKAI**<sup>®</sup>  
AKAI ELECTRIC CO., LTD.  
CROSS-FIELD HEAD

MAGNECORD SALES & SERVICE: 210 Clarence St., Sydney, N.S.W./146 Burwood Rd., Hawthorn, VICTORIA/399 Montague Rd., West End, Brisbane, QUEENSLAND/8 Arthur St., Unley, S.A./579 Murray St., Perth, W.A./HOMECRAFTS: Petrie St., Canberra, A.C.T. J.B.YOUNG: Giles St., Kingston, A.C.T.

track exhibiting much smaller deviation.

**PICKUPS:** The use of plastics for commercial record pressings presupposed that they would always be played with lightweight electrical pickups. In fact, the situation posed a fresh challenge to designers to produce pickups which would track successfully at a playing weight of a few grams at the most. This would necessitate using a needle or stylus system exhibiting very high compliance (a minimum of stiffness) and very low effective tip mass (low inertia or a minimum of weight for the groove to accelerate to and fro).

**STYLUS:** While new, very lightweight pickups could conceivably use new, lightweight steel needles (in fact, a few did) it was evident that jewelled styli would be preferred by the public. Needing to be changed only occasionally, they obviated the earlier tedium of changing needles after every side.

**GROOVES:** With the assumption that only lightweight pickups would be used, and a further assumption that the public could be trained to handle less massive equipment, the industry opted for grooves of approximately one third the width and depth of those which had for decades been used with 78rpm records. Furthermore, they were to be recorded much closer together, averaging from 200 to 300 to the inch instead of the earlier figure of 90-120. In fact, it was evident that the groove spacing could be varied in the more refined type of recording lathe, the grooves being packed tightly together during the quiet passages and opened up in anticipation of loud or heavily modulated passages.

The new type of record actually took its name from the new groove dimensions and "microgroove" became the term which distinguished the new generation from the older "coarse groove" 78s.

**SPEED:** With the reduction in groove and therefore stylus tip dimensions, it became possible to record and retrace deviations of much shorter wavelength, equivalent to sounds of much higher frequency. The industry decided to trade some of those potential advantages for longer playing time and, after a great deal of technical and commercial argument, two new speeds emerged: 45rpm, mainly for 7-inch pressings of shorter items and 33rpm for 10-inch or 12-inch longer playing pressings for collections or major works. Both are "microgroove," however, with the same standards for groove and stylus.

**PLAYING TIME:** Lower rotational speed and closer groove spacing provided what the disc record industry desperately needed — a longer playing time per side. The new standards made possible recordings of major works with a playing time of 30 minutes or more on a single 12-inch side.

**MUSIC SOURCE:** In the recording studios, a vitally important development made it possible to take full advantage of the potential of microgroove records — the use of magnetic tape for master recordings. Prior to this, original recordings had to be made directly and without interruption on to a master disc, and the problems of obtaining 30 minutes of flawless

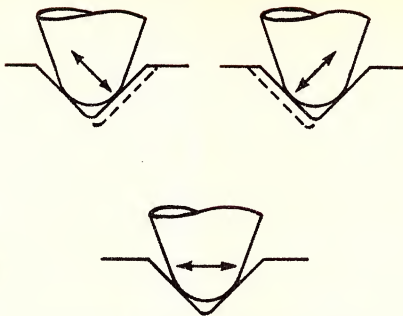

Figure 5: In normal two-channel stereo disc recording, independent modulation on the two 45-degree groove walls produces the respective output signals (upper sketch). By suitable phasing of the drive to the cutter, a centre-image sound will produce a substantially lateral resultant, similar to a mono signal (lower sketch).



Figure 6: A much enlarged photograph of a stereo recording, reproduced by courtesy of Cecil E. Watts. Note the difference between the modulations on the respective groove walls. The average groove width is also seen to vary as signal components resultants have produced vertical modulation and either raised the cutter tip or forced it more deeply into the surface.

recording were very great. When it became possible to make the master recordings on tape, studios had at their disposal the means to re-record faulty passages, to assemble one optimum performance from a number of takes and assemble the material for collections by stringing together individual recordings in appropriate order.

With the new standards and the impetus to re-equip after the war, microgroove recordings and playing equipment found rapid and wide acceptance both by high fidelity fans and at general listener level. Supporters of the older system brought forward a variety of arguments to support its retention but it rapidly lost ground in

the face of obvious advantages of the new: Lighter, "unbreakable" pressings, informative and decorative cover sleeves, longer playing time, lower noise, lower distortion, wider frequency response.

At the same time, however, the new system was threatened by the rising popularity of domestic tape equipment which offered one major advantage over disc. It could present multiple signal tracks, making possible stereophonic reproduction. Instead of having to listen to sound concentrated through a single channel, multi-track recording and playback allowed the sound to be spread across an area fronting the listener, creating a more natural and more pleasing effect of dimension and space.

In fact, the industry already possessed the potential answer to this challenge, dating back to work done around 1930, by A. D. Blumlein.

This involved the use of a special recording head, capable of modulating the stylus tip both horizontally and vertically. One early scheme was, in fact, to record one track in the horizontal mode (lateral recording) and the other in vertical mode (hill and dale recording). This and other such ideas were ultimately put aside in favour of using the respective signals to drive the cutting stylus tip at 45 degrees, as illustrated in figure 5. In effect, the information is modulated into the respective groove walls, one signal into each wall.

For playback a suitably designed pickup is necessary, with a stylus system capable of tracing deviations having vertical as well as horizontal components. Put another way, the stylus has to be capable of moving up and down as well as sideways. In addition, the internal transducer system has to be capable of resolving 45-degree vibrations into separate output signals, equivalent to those which were used originally to drive the cutter.

Investigation of the 45-45 stereo system indicated that a further reduction in the tip radius of the replay stylus would be desirable — and also practicable in view of the dramatic way in which designers had succeeded in reducing the tracking weight of ordinary pickups.

However, the industry faced the problem of introducing a new standard hard on the heels of the microgroove system. Would the listening public take it up?

An obvious prerequisite seemed to be that the system would have to be compatible with the existing monophonic (i.e. single-channel) microgroove, at least to the extent that purchasers of new stereophonic equipment must be able to play their existing microgroove records without prejudice.

Guided by this requirement, the industry nominated 0.5mil (.0005in) as a desirable figure for the tip radius of a stereo stylus but settled upon 0.7mil (.0007in) as an acceptable compromise for playing both stereo and mono discs.

It was reasoned that such a stylus would play stereo discs reasonably well, offering the additional advantage that it would wear less rapidly than the finer tip. At the same time, it could be expected to play the vast majority of mono discs rather better than .001in styli, the sole exception being those

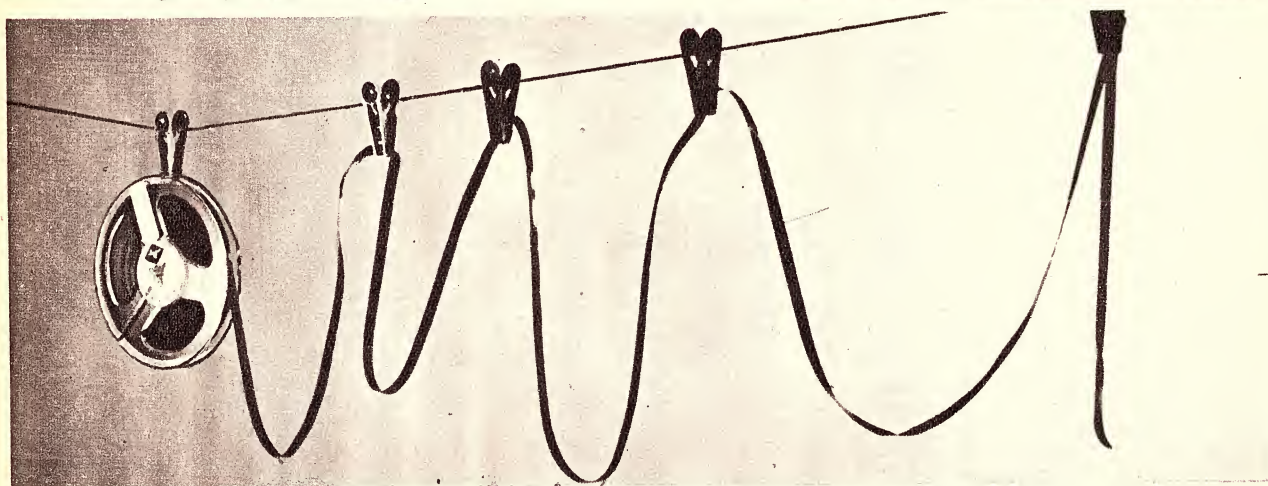

# COOK IT! COOL IT! HANG IT OUT TO DRY!

**Agfa PE tapes came through unharmed! These torture tests show that Agfa PE (Polyester) tapes last longer, wear better!**

**AGFA PE TAPES HAVE BEEN PRE-STRESSED TWICE!**

Stretched until there's no stretch left . . . both ways; length and breadth.

AGFA PE TAPES have distortion free recording and playback. No surface hiss when recording is played back, even at full volume.

All these features add up to the toughest, most perfect magnetic recording tape.



*the toughest*



## PE RECORDING TAPE

**AGFA-GEVAERT LIMITED**  
MELBOURNE • SYDNEY • BRISBANE • ADELAIDE • PERTH

\*Registered trademark AGFA-GEVAERT Antwerp/Leverkusen.

Write for the free leaflet on Agfa recording tapes and accessories.  
To

**AGFA-GEVAERT LIMITED**  
P.O. Box 48, Nunawading, Victoria. 3131

NAME .....

ADDRESS .....

STATE..... POSTCODE.....



mono discs which had been recorded (in many cases inadvertently) with a groove having a heavily radiused bottom. All future mono discs could obviously be recorded with the finer replay styli in mind.

A second measure was to ensure that the cutting system was so arranged that signals arriving in phase at the microphones would interact to produce a substantially lateral modulations of the groove. Thus a performer standing centre-stage would produce a substant-

During the last few years, the stereo system has gained tremendous impetus to the point where stereo equipment completely dominates the quality market and the call for 12-inch mono pressings has fallen to an uneconomic level. This has led to the introduction of so-called "compatible stereo" records, which are supposed to be stereo records capable of being played normally and without damage on existing mono players.

From the purist viewpoint, the con-

1. Re-fit the pickup with a mono cartridge of suitable type, which is known to have adequate vertical compliance. Manufacturers are now offering compatible mono cartridges for this very purpose;

2. Re-fit the pickup with a stereo cartridge, which can be as budget-priced or as expensive as desired, and connect the output terminals to produce a mono signal suitable for a mono amplifier system.

Either course will render a mono

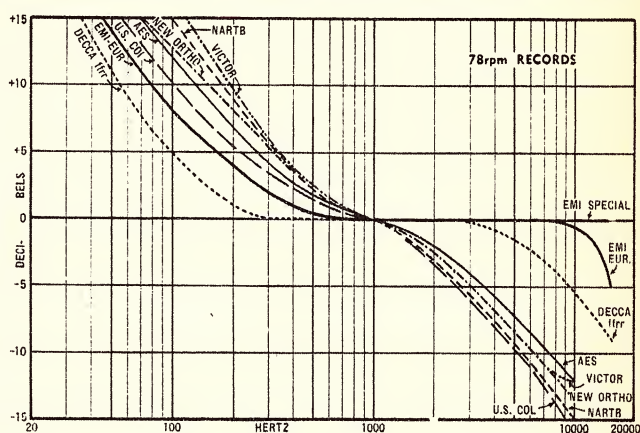
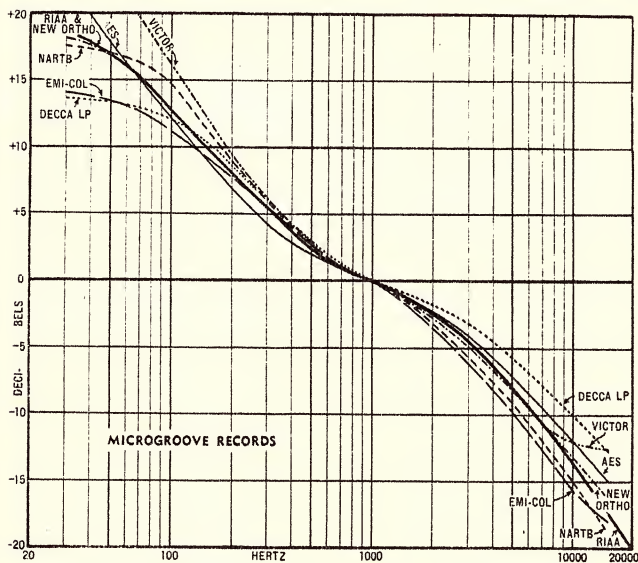

These two diagrams depict the optimum frequency compensation characteristics for playing back various brands of 78rpm record (figure 7, above) and of mono LP records (figure 8, left).

ially laterally modulated groove, similar to a mono recording. The pickups, of course, would be wired to correspond, to produce a centre-image sound from a centre-stage performer.

In these circumstances, a stereo system could be used to reproduce mono records directly, the lateral track producing a centre-image sound just as if, in fact, an actual mono loudspeaker were operating at that point.

As things worked out, purchasers of stereo equipment showed a clear preference for stereo records when adding to their collections and, apart from the odd disc as already mentioned, experienced no difficulty in playing mono records without change to the system. For all practical purposes, stereophonic systems proved to be completely compatible with existing and new mono records.

The reverse is not necessarily true, however and, for many years, listeners were warned against playing stereophonic records on monophonic equipment.

Superficially, stereo records will, in fact, play and sound normal on mono equipment. The speeds are the same and, because of the way the signals on the stereo disc are phased, a mono pickup will derive from it a fairly normal sounding mono signal.

The big problem is that the stylus system in many mono pickups has very little vertical compliance; it will move from side to side quite freely but is resistant to vertical movement. When a stereo record is played with such a pickup, it may damage the groove in respect to vertical components of modulation and therefore ruin it or compromise its quality for subsequent stereo playing. Hence the early warnings.

cept is unacceptable, since a mono pickup which would damage stereo records 10 years ago, will still damage stereo records at the present time. Or again, if a record has a genuine stereo content, then it will have vertical components of modulation and these will be just as vulnerable now as they would have been 10 years ago!

The difference in the situation is more one of degree. Faced with the problem of reverse compatibility, a record manufacturer may choose to control the placements of instruments and/or the stereo mix so as to avoid excessive vertical modulation, not vitally necessary to the stereo effect. His "compatible stereo" record may, therefore, contain less exacting vertical modulation than a stereo record made without this precaution in mind.

At the same time, care may be taken with the microphone placement, the stereo mix and even the musical arrangement itself to ensure that the mono listener obtains a satisfying version of the multi-track sound.

As far as pickups are concerned, the passing years have seen a progressive improvement in the tracing characteristics of mono units and the odds are rather more in favour of stereo records escaping calamitous damage if played thereby. And there are fewer mono pickups to be reckoned with anyway!

Lastly — and rather grimly — if a listener buys compatible stereo records and damages their stereo content by repeated playings with a totally unsuitable pickup, he may not be actively aware of the fact until some time in the vague future.

If a particular listener is wedded to a mono system for any reason, and is dismayed by the diminishing supply of mono discs, two courses are available:

system truly compatible, without relying on the element of luck to avoid damage to stereo discs.

One of the aspects of disc recording which frequently puzzles enthusiasts has to do with talk of frequency response and frequency compensation. What is it all about?

Earlier, it was pointed out that, in the lateral system of recording, the signal is used to vibrate the stylus from side to side. The amount of deviation which can be tolerated depends a good deal on the spacing of the tracks. If the deviation is excessive in relation to track separation, the grooves may intersect on adjacent signal peaks, with rather obvious results.

The deviation of the track is directly related to the amplitude of the signal being recorded and it is the responsibility of the recording engineer to see that permissible limits on amplitude are not exceeded, even momentarily.

There is, however, another factor, less obvious but no less important, namely the frequency of the signals being recorded.

When sound energy of a given loudness is applied to a diaphragm, it causes the diaphragm to accelerate to a proportional velocity. If the sound is of a very high frequency, the diaphragm will not have traversed a very great distance before the sound wave reverses in pressure phase, causing the diaphragm to reverse its direction. At a much lower frequency, the diaphragm will tend to move through a greater distance before it reverses direction. In short, for a given sound energy level, the amplitude of movement of a vibrating body, either producing the sound or responding to it, will increase for diminishing frequency.

A familiar example can be found in

# Labcraft HIGH GRADE RECORD PLAYERS Labcraft

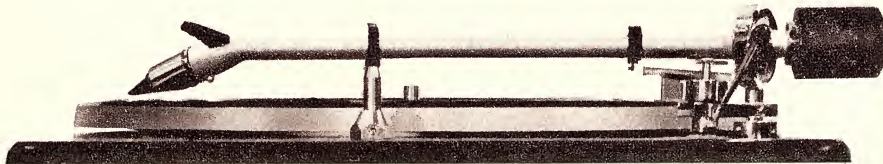

Perfection in a record player is now a reality and is available to you. If utmost clarity of reproduction and freedom from distortion is your main requirement choose a Labcraft Player. Various models and styles are available, all free from rumble, wow or flutter and fitted with magnetic stereo cartridges having extremely low distortion but reproducing the full audible sound spectrum.

Many important features are essential in a high grade record player. Here are some examples:

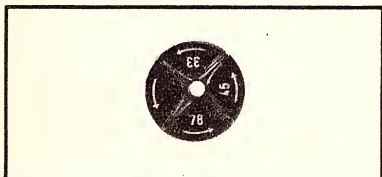

NO! You won't find an ordinary synchronous motor on a Labcraft Player. All Labcraft units have a specially designed SRT motor with variable speed control. Simply turn the central knob to raise or lower the speed by any desired amount; i.e. by up to  $\pm 10\%$  from any of the standard speeds of 33, 45, 78 rpm.

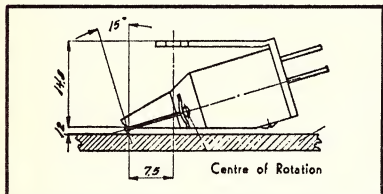

This cartridge should sound perfect!

A magnetic cartridge with elliptical diamond stylus set for  $15^\circ$  with a flat response from 20 Hz to 20 kHz, extremely low distortion and perfect square wave, outstandingly good shielding, the ideal tip mass of 1.5 mg. It does in fact sound perfect — it's the B & O SP 9! (SP 8 when fitted to the All Balance arm).

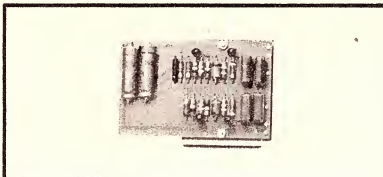

It doesn't matter if your power amplifier hasn't a pre-amplifier input section for magnetic cartridge. The Labcraft player takes the special low distortion, solid state pre-amplifier made by SRT of Copenhagen. Plugs in under the mounting board.

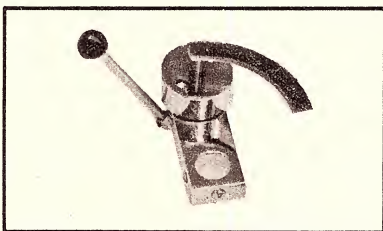

It's child's play (yes literally!) to lower the stylus down gently on the record with the oil damped 'pick up lift'. This is available for All Balance or B & O arms. It is an important contribution to record care besides making

the player very easy to use.

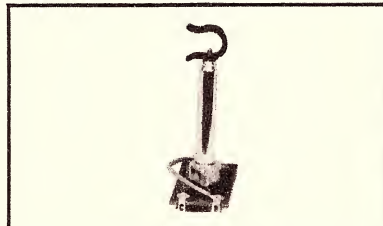

Simple — natural — convenient is the unique SRT arm rest switch fitted to all Labcraft turntables or players. Just lift the arm and the motor starts. The switch has a capacitor to eliminate pops.

The base of the Labcraft Player has mitred corners as in the original Danish design. Choice of selected ash or teak or palisander. The smokey clear plastic cover looks magnificent and completes the picture.

Many details of design contribute to the perfection of Labcraft Players. For example:—lubricated in factory for years of playing, fully shielded motor, anti-vibration motor suspension, rim belt drive of special design, arm with in-built anti-skate, interchangeable cartridges, stylus pressure by special spring tension.

Ask your local Hi Fi dealer to obtain a Labcraft Stereo Record Player for you from the sole Australian Agents, **G.R.D. Instruments Pty. Ltd., of 6 Railway Walk, Camberwell, Victoria.** Telephone 82-1256.



the strings of a piano or, again, by comparing the high-note string of a violin with the low-note string of a double bass. The amplitude of movement of a string producing a very high frequency is quite small; that of a string producing a very low frequency, visibly apparent.

A similar comparison can be made between the diaphragm movement of a high frequency "tweeter" loudspeaker and a low frequency "woofer." Both may be radiating sounds of designedly comparable loudness but, whereas the tweeter loudspeaker cone will not be moving perceptibly, that of the woofer may be oscillating by plus and minus a quarter-inch or so.

In the case of a disc recording cutter, either driven directly or per medium of an amplifier system, the same tendency is evident. If it is allowed to move naturally with a velocity proportional to the loudness of the original signal, and irrespective of the frequency of that signal, it will oscillate through a very large distance for the lower signal frequencies.

And here the recording engineer faces a number of conflicting factors. If the stylus is allowed to follow its natural inclination at very low frequencies, the deviation will be so great as to dictate a very wide groove spacing. This must reduce playing time. In addition, the deviation may be of such an order as to make it difficult for practical pickups subsequently to retrace the groove.

On the other hand, if the low frequency waveforms are restricted to an acceptable amplitude by simply reducing the level of the recorded signal as a whole, this level may turn out to be so far down at middle and high frequencies, that it will be comparable with or below the inherent noise of the disc and reproducing system.

Quite early in the history of recording, and certainly with the introduction of electrical recording, engineers realised that a deliberate compromise had to be arrived at. Clearly enough, they had deliberately to restrict the tendency for groove deviation to increase with diminishing frequency and it seemed logical that matters be arranged so that, below a certain frequency, for a given sound energy level, the recorded groove should remain at constant deviation amplitude.

To introduce here a couple of technical terms, this meant that below a certain frequency (conveniently referred to as the "turnover" or "corner" frequency) the groove should be given a "constant amplitude" characteristic. Above the turnover frequency, it would revert to its natural "constant velocity" or unmodified velocity characteristic.

With electrical components and circuitry, it is not unduly difficult to achieve such an effect. A selected value of coupling capacitor at a strategic point in the circuit can introduce just the right kind of roll-off at the low frequencies to produce a constant amplitude characteristic below a selected turnover region. Inductance can be used in the same way.

The vital point, however, is that, in imposing a constant amplitude characteristic on the bass region, the recording engineer is effectively imposing a bass cut — and a recording characteristic is born.

If the recording is to sound proper-

ly balanced on playback, the bass needs to be restored or boosted by the same amount as it was attenuated earlier — and the need for playback compensation becomes evident. Hence a playback characteristic.

In the twenties and early thirties listeners were dependent on playback devices which gave an output nominally proportional to velocity — acoustic phonographs or magnetic pickups — and the niceties of applying bass compensation were either not widely appreciated or difficult of achievement.

Use was typically made of such things as pickup arm resonance, or magnet/armature spacing but the end

groove records, engineers had to rethink the position. Having no longer to worry about acoustic phonographs and with industry well attuned to the need for playback compensation, they were free to impose any limitation on the bass recording characteristic that seemed appropriate.

There was also fairly common agreement that it should be possible to apply treble boost during recording. This would necessitate playing back with amplifier systems having an equivalent amount of treble cut — a provision that would tend very usefully to reduce any residual surface noise from the disc.

Figure 9: The RIAA recording characteristic (dotted) and the equivalent playback characteristic (solid line). As will be apparent from figure 8, it occupies a position intermediate between the older curves.

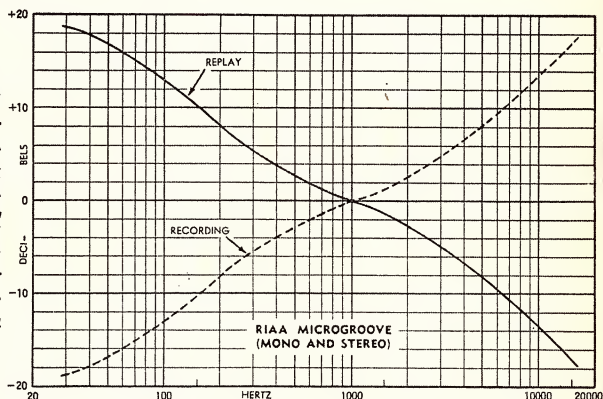

result generally left a good deal to be desired.

If engineers cut the bass too heavily, in the interest of playing time, their products were likely to be criticised as sounding "too thin." If they opted for more bass (and wider track spacing) the playing time was too short! If they sought both, by limiting total recorded amplitude, the records would be "too weak." Later in the 30s, as the quality of playback equipment improved, some reassessment of the position became possible and companies adopted revised practices, which seemed best to suit the current market.

Interestingly enough, the "revised practices" affected more than the bass. Toward the end of the 78rpm era, many of the major companies, particularly American, began to move away from the European convention of a flat treble response to a policy of deliberately boosting the treble. Implicit in this was a desire to meet the needs of electrical rather than mechanical reproduction and to provide recordings which would sound brighter (particularly with crystal type pickups) and in the knowledge that over-bright reproduction could be corrected readily by the ordinary amplifier tone control. In fact, some of the practice established with the last generation of 78rpm records carried over into the microgroove era; this much will be evident from an examination of figures 7 and 8.

Not surprisingly, out of all this change and compromise came many different recording characteristics and, by inference, the same number of complementary replay characteristics. Figure 7 shows a collection of replay characteristics and emphasises the problems of enthusiasts who, for one reason or another, have since sought to play back an assortment of 78rpm records to best advantage.

With the introduction of micro-

Unfortunately, and despite the lessons from the 78rpm era, technical disagreement and commercial rivalry prevented the immediate adoption of an industry standard and early microgroove records were recorded to a variety of nominal standards, as indicated in figure 8. Amplifiers of the day reflected this situation in that many of them were provided with switches allowing particular playback compensation characteristics to be selected.

It took several years for the industry to adopt anything like a common standard but this is now more or less universal. Known as the R.I.A.A. characteristic, it is illustrated in figure 9. The solid curve shows the recording characteristics and the dotted curve the complementary characteristics which should be provided by the playback amplifier.

Fortunately, the R.I.A.A. characteristic represents something of an average of earlier practice and can reasonably be used as a playback characteristic for all microgroove records. The purist may object that there are significant differences between the R.I.A.A. characteristic and certain of the others — but it does not follow that practical pressings were ever as precise as the curves might suggest. There is a lot to be said for being content with the R.I.A.A. characteristic (which is all that is available on modern amplifiers anyway) and nudging the bass and/or treble controls slightly if further correction seems to be desirable.

Fortunately, the R.I.A.A. characteristic was adopted forthwith and almost universally for stereo records and, in fact, has become as universal as the stereo record itself.

This, then, is the background to disc records, the various standards to which they have been recorded and their frequency characteristics. What all this means in terms of playback equipment must be the subject of another chapter.

# Are Ferrographs too durable?

If you think the Honest Engineering and Ferrograph Skills that make Ferrographs last so long sacrifice sound quality and practical features. Think again.

Ferrograph's absolute refusal to skimp or "cut corners" results in performance that is second to none and the combination of 30 USEFUL features is unique. Then there's the 10 years' guarantee of spare parts availability. Very comforting when your recorder's no longer young.

As every professional knows, the true indication of a recorder's fidelity is the combination of three values each of which, without the other is quite meaningless.

Frequency response, S/N ratio, and distortion are all inter-related.

When you find a recorder which is GUARANTEED to give less than 2% distortion for better than 55dB, signal to noise ratio\* with a frequency range of 30 Hz to 17 kHz  $\pm$  2dB at 7½ i.p.s.\*\* . . . BUY IT, because undoubtedly it will be a seven series Ferrograph—Australia's Most Coveted Recorder.

\* (¼ track unweighted inc. hum.)

\*\* (wow and flutter less than 0.08%.)



FERROGRAPH STEREO AMPLIFIER

The F307 is a 20 watts (R.M.S.) per channel, 0.25% Distortion, \$240, integrated stereo amplifier from Ferrograph. For full details and a no obligation demonstration see your Franchised Ferrograph Dealer. You'll agree with him that the F307 is an outstanding amplifier at a reasonable price.

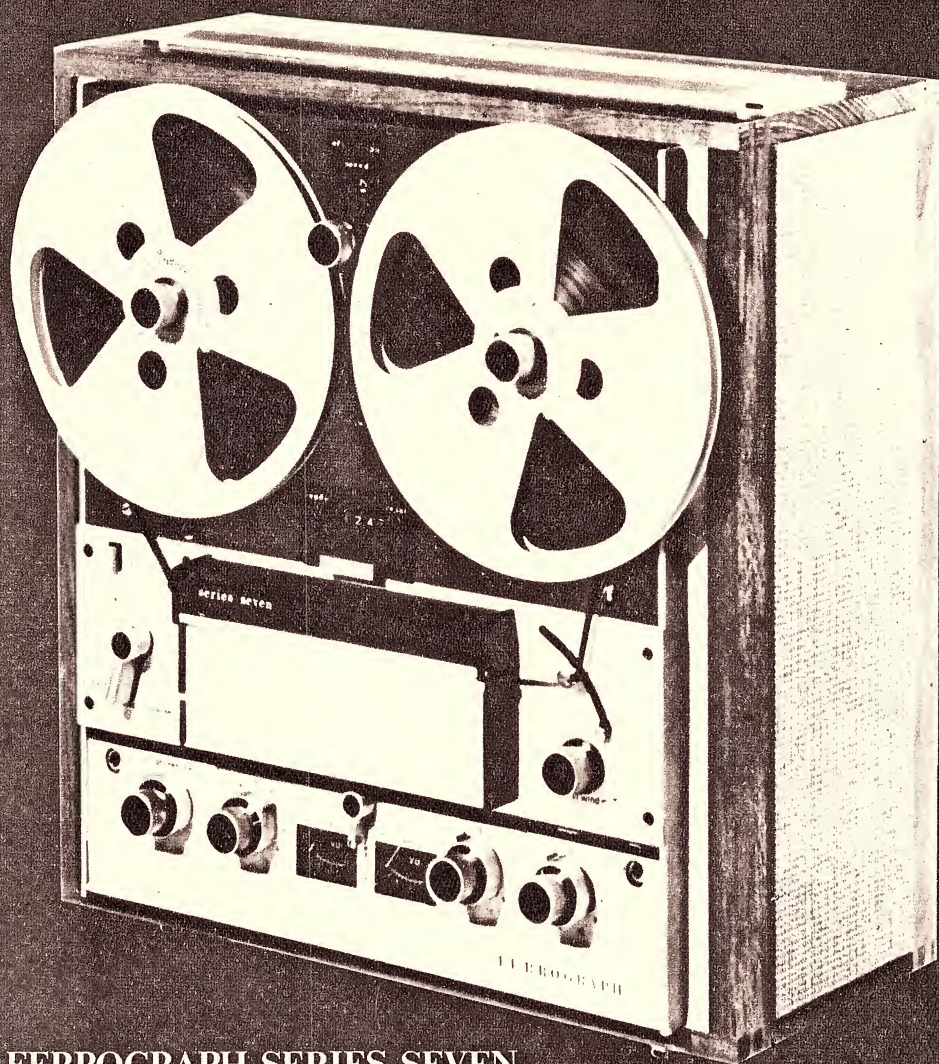

**FERROGRAPH SERIES SEVEN**

## **FRANCHISED FERROGRAPH DEALERS**

### **NEW SOUTH WALES:**

#### **SYDNEY:**

United Radio Distributors,  
32 Angel Arcade, Ash St.  
Kent Hi-Fi, 432 Kent St.  
Tape Recorders Pty. Ltd., 49-51 York St.  
W. C. Wedderspoon Pty. Ltd.  
193 Clarence St.  
Magnetic Sound Industries, 387 George St.  
Glen-Dor Camera Centre,  
43 The Corso, Manly.

#### **NEWCASTLE:**

Dynamic Sound, 587 Hunter St.

#### **WAGGA WAGGA:**

Pitmans Television, 38 Bayliss St.

### **VICTORIA**

#### **MELBOURNE:**

Myer (Melbourne) Ltd., Bourke St.  
Melbourne Tape Recorders Pty. Ltd.,  
242 Elizabeth St.  
Thomas' Pty. Ltd. 92-96 Bourke St.

Recorded Music Salon 23 Collins St.

Stereo Sound Systems, 10 McKay Court.

### **QUEENSLAND**

#### **BRISBANE:**

Brisbane Agencies, 78 Wickham St.

Allan & Stark Ltd., Queen Street.

#### **CANBERRA, A.C.T.**

Homecrafts, Petrie St.

### **WESTERN AUSTRALIA**

#### **PERTH:**

Musgroves Limited, 223 Murray St.

General Accessories, 46 Milligan St.

### **SOUTH AUSTRALIA**

#### **ADELAIDE:**

Ernest Smith and Co. Pty. Ltd.,

52 King William Street.

Eilco Sales Pty. Ltd., 7 Osmond Terrace.

Whyalla Tape Recorders, Playford Ave,  
Whyalla.

## **SOLE AUSTRALIAN DISTRIBUTORS**

***Leroya Industries PTY. LTD.***

266 HAY STREET, SUBIACO, W.A. 6008

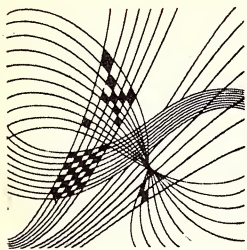

## CLASSICAL RECORDINGS

### Figaro — in the traditional manner

**MOZART—The Marriage of Figaro. Complete Opera. Dietrich Fischer-Dieskau (Count); Gundula Janowitz (Countess); Edith Mathis (Susanna); Hermann Prey (Figaro); Tatiana Troyanos (Cherubino); Patricia Johnson (Marcellina); Erwin Wohlfahrt (Basilio); Peter Lager (Bartolo); Klaus Hirte (Gardener); Barbara Vogel (Barbarina). Orchestra and Choir of the German Opera, Berlin, conducted by Karl Bohm. DGG Stereo 104962/65.**

Some four years ago, at Covent Garden, Australian-born conductor, Charles Mackerras, directed a performance of "Figaro" in which he restored appoggiaturas and other ornaments that, over the years, had disappeared from the score—written or performed. The result must have been gratifying to Mackerras, who received wide acclaim for his enterprise. But in an interview in London late in 1967 Mackerras himself pointed out the difficulties of mounting a similar performance in an opera house where "Figaro" was a fixture in the repertoire and such radical changes as he advocated would lead only to confusion on the part of the singers, and in many cases the orchestra, too.

Tradition plays a big part in such standard works, and a new conductor with new ideas would be less than welcome by the cast of an opera house long used to delivering the opera in a standard style.

It is perhaps for this reason that in the recording of "Figaro" under review Karl Bohm plays it safe in offering what might be described nowadays as a conventional reading of the work. This is not to say that Bohm's version is not stylish in its own right. It is never heavy-handed as some central Europeans tend to make it. And even if it smiles less often than might a Beecham performance, it is nevertheless consistently bright without flippancy. His orchestra, the German Opera Orchestra, is always alert and generous in its response, its playing never less than immaculate.

The performance most likely to raise controversy is that of Fischer-Dieskau as the Count. And to those who might object that his reading is too harsh and forceful, I must remind them the Count Almaviva was a typical aristocrat of the period—haughty, arrogant and wilful. It is along these lines that Fischer-Dieskau plays the part, to my mind with outstanding success. That he sometimes rages immoderately when crossed is, to my thinking, a perfectly

natural thing to do. And even those who question his characterisation will surely find only trivial points to criticise in his magnificent singing of the role.

The Susanna (Edith Mathis) and Cherubino (Tatiana Troyanos) I found enchanting in all they do. They achieve precision of articulation without any sacrifice of warmth and their fast staccato passages float out with dazzling accuracy. Gundula Janowitz (The Countess) is not quite at ease in her first great aria, "Porgi Amor," but soon settles down to a reading that is essentially feminine in character and rewarding musically.

The Figaro (Hermann Prey) goes to some trouble to avoid overloading his role with buffo antics and sings well throughout, though there are times when a lighter approach would have been welcome. The whole performance is beautifully balanced between orchestra and singers and the internal balance of the orchestra is always

---

by JULIAN RUSSELL

---

completely satisfactory. The engineering is admirably clear with a fine presence and while no detail of the famous score escapes the diligent attention of the conductor, he is just as successful in his handling of the big ensembles. This is not a performance with Beecham elan, but it is an extremely fine one in the traditional German manner. And to some that is the only way to present it.

★ ★ ★

**PENDERECKI — St. Luke Passion. Stefania Woytowicz (soprano); Adrezej Hiolski (baritone); Bernard Ladysz (bass); Leszek Herdegen (Evangelist). Boys' Chorus, mixed chorus and orchestra of the Cracow Philharmonia conducted by Henryk Czyz. Philips Stereo SAL3613/4.**

You will find many mid-20th century innovations in this new version of the St. John Passion. Many of its timbres will be new to most listeners, and the way in which some of the instruments are used will be novel to all but students of avant garde music. Yet all these unusual treatments of

chorus, orchestra, and an ancient text do not remove the work from the mainstream of Western devotional music. It is violently dramatic yet lacks nothing of reverence. Indeed I found its first impact quite overwhelming and subsequent repeat playings confirmed my impression that this is the finest piece of church music to be heard since Britten's "War Requiem."

I can find no better words to express the part the chorus plays in this new St. Luke, than those used by David Hogarth in his eloquently perceptive annotations that accompany the set. He writes: "The Chorus participates in, rather than merely represents, the drama, and in its sibilant hissing and jeering one can almost see the distorted facial expressions typical of medieval paintings of the scenes Penderecki portrays in music."

To this I might add that the chorus entrances, which often chase the heels of their predecessors without ever stumbling over them, command much respect for their trainer, and the conductor of the set, Henryk Czyz. (How you pronounce this gifted musician's last name might be anyone's guess).

The complex work of the chorus is made additionally effective by the admirable use of stereo techniques in a hall where a little more than the usual reverberation period adds to the cathedral-like atmosphere. All the vocal soloists are splendid, judged by any prevailing standard, and the whole production is, to me, an example of avant garde music at its best and immediately accessible.

★ ★ ★

**VAUGHAN WILLIAMS — Symphony No. 4 in F Minor. Serenade to Music. New York Philharmonic Orchestra conducted by Leonard Bernstein. CBS Stereo SBR235289.**

Sir Adrian Boult rather than Leonard Bernstein is a name one might associate with the music of Vaughan Williams. Yet the latter seems quite at home in the harsh, agony-ridden climate of the F Minor Symphony. The work was composed some 30 years ago when intellectuals—and non-intellectuals, too, for that matter—were oppressed by anticipation of the coming war. It was for many years taken to reflect the composer's thoughts on these questions. However this theory has now been discarded, especially since Vaughan Williams' widow has stated that the work was conceived some years before and that "whatever it contains in rage and passion was in the man himself."

The only previous recording I can trace after it first appeared on 78s is the version by Boult with the London Philharmonic for Decca which was issued some 15 years ago, in the early days of LP. Not surprisingly the engineering of this disc, which I still have, sounds a little dated nowadays. But I was surprised to find myself enjoying Bernstein's reading as much as I did Boult's. Bernstein is in complete sympathy with the symphony's changing moods of violence, despair, consolation and sardonic humour. And the new engineering is really first rate.

Moreover now, on the CBS disc, there is a bonus in the form of

Vaughan Williams' "Serenade to Music," a much later work written as a tribute to Sir Henry Wood, of Promenade Concert fame, and to the glory of music. Vaughan Williams used as a text some of the dialogue between Lorenzo and Jessica in the love scenes of Shakespeare's "Merchant of Venice." It is a lovely serene work and in it the splendid New York Philharmonic Orchestra is joined by 12 of the most famous singers, men and women, appearing in the United States today. It was recorded live at the concert marking the opening of the Lincoln Centre for the Performing Arts, New York, on September 23, 1962. I recommend the whole disc with great enthusiasm.

★ ★ ★

**KIRSTEN FLAGSTAD MEMORIAL ALBUMS** Nos. 1 and 2. Excerpts from her Farewell Concert at Carnegie Hall, New York, on March 20, 1955, with the Symphony of the Ari conducted by Edwin McArthur. World Record Club 3080/1.

The items in this Wagnerian recital include "Schlafst Du, Gast?" (Valkyrie); Brunnhilde's Immolation Scene (Gotterdammerung); The "Liebestod" (Tristan and Isolde); and the Wesendonck Lieder. To these the orchestra adds the Dawn Music and Siegfried's Rhine Journey from "Gotterdammerung" and the Prelude to "Tristan and Isolde." Flagstad was 60 when she gave this concert which was recorded live in New York, and it is not surprising if her voice lacked some of the exciting qualities of earlier days. But her interpretations remained incomparable. There was all the old grandeur in Gotterdammerung, the touchingly feminine Sieglinde in The Valkyrie, and the noble tragedy of the final scene of Tristan and Isolde. Her reading of the Wesendonck Songs, too, remained peerless.

Edwin McArthur, who was for many years her accompanist — he visited Australia with her for the A.B.C. before the War and I got to know and like him pretty well — conducts the orchestra competently. Two discs to be treasured by all who admired the greatest Wagnerian soprano of her generation. Indeed the finest I, personally, ever heard.

★ ★ ★

**ELGAR—Overture "In the South."**

**VAUGHAN WILLIAMS — Overture "The Wasps."** Fantasia on a Theme of Tallis. Bournemouth Symphony Orchestra conducted by Constantine Silvestri. EMI Stereo OASD2370.

You will find a different kind of Vaughan Williams altogether in one of the works which represent him here. "The Wasps" Overture dates from 1909 and was the composer's first work for the theatre— incidental music to Aristophanes play of the same name. It is for the most part a bustling work, full of exciting march-like tunes alternating with onomatopoeic, sounds descriptive of buzzing insects. If its vigorous humour is English rather than classical Greek it suffers in no way for that reason.

Vaughan Williams' "Fantasia on a



## NEW from QUAD SOLID STATE 303 POWER AMPLIFIER AND 33 CONTROL UNIT



QUAD has introduced two new models, the SOLID STATE Quad 303 and Quad 33. What's new in these models? . . . 30 watts power rating (R.M.S.) per channel with frequency response of—1 db, 20 to 35,000 Hz. Fully silicon transistorised.

Entirely new circuit design provides outstanding high quality reproduction and output circuit protector which cannot be accidentally upset by misuse, overdriving, shorting or disconnecting speakers. Distortion is less than 0.03% at any level up to 45 watts per channel into an 8 ohm load at 700 Hz and is 10 times lower than in the best of valve amplifiers. With the professional look and the professional touch, the price of these two new Quad units is \$486.00.

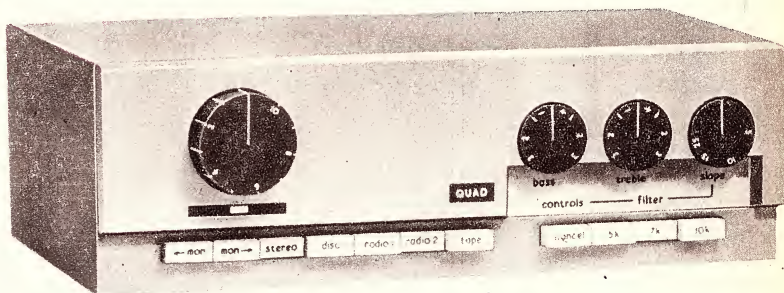

### QUAD ELECTROSTATIC LOUSPEAKER

Using closely coupled moving elements some 200 times lighter than the diaphragms of moving coil loudspeakers, and being entirely free of cabinet resonances and colouration, this loudspeaker overcomes the usual major problems of loudspeaker design and provides remarkably natural reproduction of sound. The real test is to listen to the music it reproduces — a comparative demonstration is strongly recommended.

QUAD for the closest approach to the original sound.

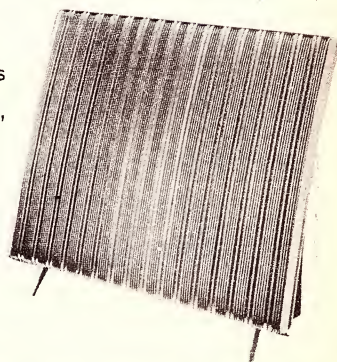

Please send me a copy of the new QUAD leaflet.

NAME .....

ADDRESS .....

**BRITISH MERCHANDISING PTY. LTD.**  
49-51 York St., Sydney. Telephone 29-1571.  
(sole Australian agent.)

**SANSUI** From Melbourne's leading **HI-FI** specialist

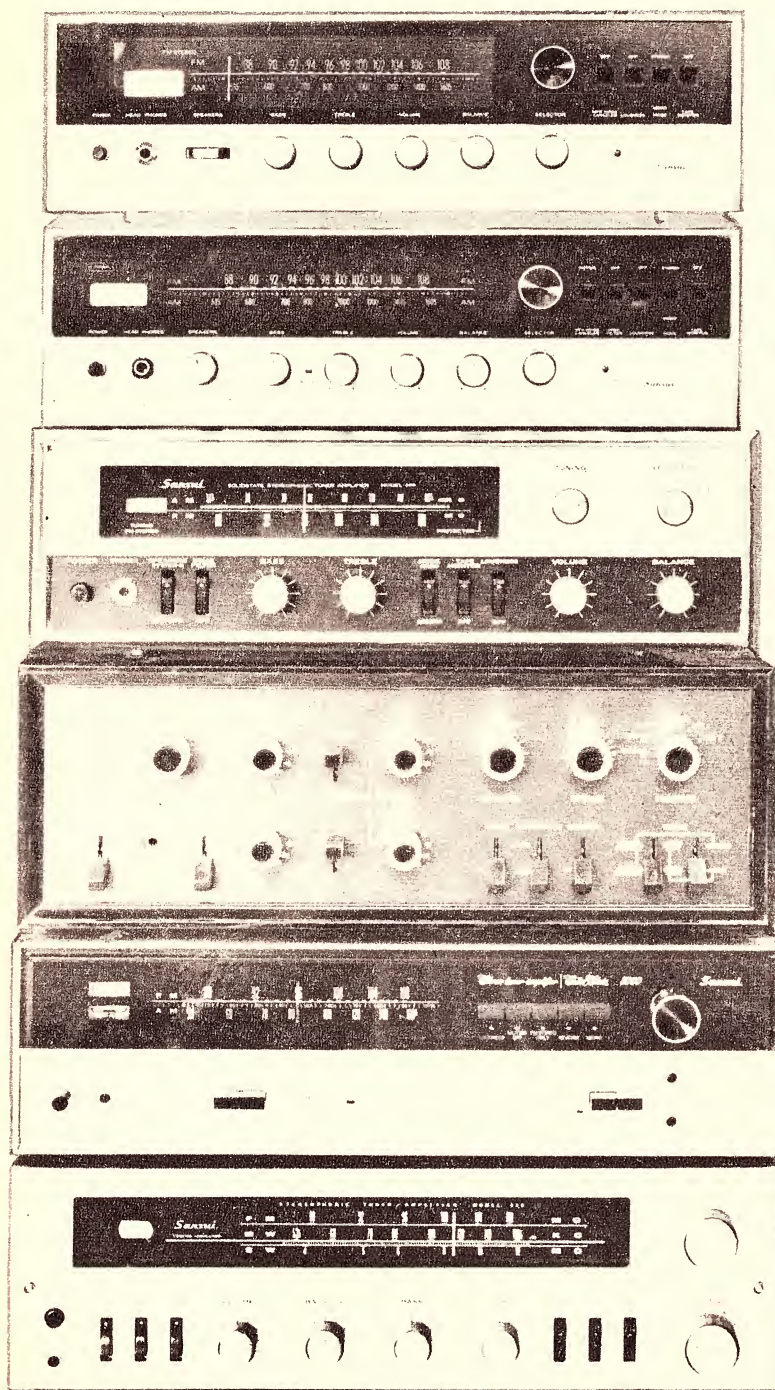

350

800

400

777

5000

220

**SANSUI**

*Check our amazing low discount price on the entire range of Sansui.*

**DOUGLAS TRADING P/L**

Inc. City Hi Fi — Tape Recorders (Vic.) — BJD Electronics

**191 BOURKE STREET, MELBOURNE 3000—PHONE 63-9321**



## CLASSICAL MUSIC ON CASSETTES

Theme of Tallis" will be well-enough known to most readers for me to dispense with the high praise that its beautiful music deserves. This was composed in 1910, by which time the composer had reached the height of his powers in the creation of music of this kind. It is, like most of the composer's music, modal in character the one used on this occasion being the Phrygian. Apart from the lovely melodic content the scoring is of unusual interest — for double string orchestra and solo string quartet. The skilful use of stereo recording techniques efficiently exploits the antiphonal use of these combinations and the fact that it was recorded in Winchester Cathedral, which has a longer than usual reverberation period, lends poetry to rather than detracts from the composer's deeply felt meditation.

Elgar's "In the South" Overture was inspired by a holiday he spent in Italy. It is typical fine Elgar — big in theme and beautifully scored for rich strings and brass pageantry. It used to be a favourite of mine when I was a boy and I listened to it again, after a lapse of many years, with as much enjoyment as ever. Surprisingly the late Constantin Silvestri — he died early this year — is quite at home with all this essentially English music despite the fact that he was Romanian-born and lived in that country till the last few years of his life. Under his direction, the Bournemouth Orchestra plays admirably and Silvestri discarded much of the disfiguring rubatos that earlier used to give his readings a rather too precious character.

The only tiny fault I can find in the whole recital is an occasional slight fogging of some of the fast passages in "The Wasps," which was also recorded in Winchester Cathedral. In this the extra reverberation period is not so happily exploited as in the Tallis "Fantasia."

★ ★ ★

**SWITCHED ON BACH — Electronic realisations and performances by Walter Carlos, with the assistance of Benjamin Volkman. C.B.S. Stereo SBR 235297.**

Bach scholars are in for a shock when they listen to this interesting disc. All the pieces are played on a Moog synthesizer, an electronic instrument which can reproduce very closely the timbres of many different musical instruments separately or in combination. In some ways I suppose it can be called a development of a Hammond type electronic organ. The sleeve notes give only a vague idea on how the instrument works. The editor of this magazine might be better informed on this question than I. All I know for sure — and can appreciate with more enthusiasm than I would have thought possible — is that it can reproduce a very wide range of sounds, some imitative of existing instruments, others unlike any I have ever heard before. It can, moreover, play these at a speed impossible for human hands to copy. And more especially, when the composer is Bach it can give equal and simultaneous significance to the many strands in the composer's often complex polyphonic writing. It can, in short, make audible every line in a Bach fugue, giving each voice its cor-

I propose to review from time to time as they appear music-cassettes of serious music. Since this is the first such review to appear, I feel a few words of introduction will not be out of place.

I take it for granted that most readers will already have heard of these miniaturised pre-recorded tapes, which have the advantage of extreme compactness—one which plays the full length of a two-sided LP disc is little bigger than a packet of cigarettes—and their ease of operation—they need no threading but are ready in their plastic cartridges for instant use.

So far (in Australia, anyway), issues of classical music on cassettes have been infrequent and their quality unreliable, but they are now coming to hand fairly regularly — mostly from Philips and their associated labels, especially DGG — and their quality is improving all the time.

But I must make it clear immediately that at present the quality of reproduction will not please hi-fi fans. They will complain of absence of high frequencies, and the presence of background noise that is not present in hi-fi recordings played on first-class equipment.

Cassettes at their present stage of development will appeal rather to those satisfied with good average radiogram reproduction.

These will find Musicassettes very useful, hooked up to speakers in the interior of a car or played through amplifiers — mono or stereo — in their music rooms.

My own music room is larger than average — 30ft x 23ft — with an acoustic ceiling. The equipment I use is a Lux solid state stereo amplifier, an Orpheus turntable, a Micro MA-77 tone arm with a Micro M-2000 moving magnet stereo cartridge, and two Leak MKII Sandwich Speakers.

To play the cassettes, I plug a Philips Stereo Cassette player-recorder EL3312 into the tape monitor of my amplifier. I find that I obtain the best results by setting the treble control back a little, increasing the volume, and sitting at least 20 feet from the speakers. In this way—for some reason which I cannot explain technically—I find the acoustics of the room tend to blanket most of the tape noise, except when the music is silent while at the same time it makes the music comfortably audible at the increased distance. Here are some brief notes on the latest release by Philips.

**Haydn's C Major Cello Concerto and Boccherini's B Flat Cello Concerto** played by cellist Maurice Gendron with, in the Haydn, the Concertgebouw Orchestra conducted by Raymond Leppard, and, in the Boccherini, the Lamoureux Orchestra of Paris conducted by Pablo Casals. This is my

favourite. Gendron's tone is superb, issuing from what must be one of the noblest instruments ever made, his technique impeccable, and his sense of eighteenth century music style faultless. In both concertos the accompaniments are excellent and the balance between soloist and orchestra faultless. This particular cassette comes very close to good hi-fi disc reproduction.

**Dvorak's "New World" Symphony** also ranks very high among the cassettes under review. It is played by the Radio Symphony Orchestra of Berlin conducted by Lorin Maazel. Maazel's reading is excitingly fresh-complexioned, though an occasional tempo might seem a little fast until one glances at the score and finds that it is the speed indicated by the composer. Indeed, there is only one phrase in which I find myself at odds with the conductor's choice of tempo. The little flute solo second subject in the first movement is slowed down awkwardly whenever it is played. Otherwise, I found this as enjoyable a performance of the "New World" as any I know, and better than most.

In much the same class is **Beethoven's "Eroica" Symphony** played by Montoux and the Concertgebouw. His tempos, too, are a trifle brisker than those to which you are probably accustomed, but the work loses nothing in dignity for that reason. And if you think his tempo in the Funeral March movement is too fast, consider the plight of the poor mourners compelled to march in a procession to the slower tempos used by most other conductors. If you like your "Eroica" free of mock heroics, this is for you. And for a fill there is the seldom-heard Beethoven overture, "Zur Namensfeier" again admirably played by the Concertgebouw, this time under Eugen Jochum.

On another cassette the Concertgebouw is again featured, this time under Van Beinum, in a delightfully varied account of a suite from Tchaikovsky's "Nutcracker" Ballet. This should prove a very popular product on, especially as the second track has a richly emotional account of the same composer's "Romeo and Juliet" Overture, played the Concertgebouw under Bernard Haitink.

And in the fifth and final cassette in this selection, Arrau can be heard in a poetic account of **Beethoven's Fourth Piano Concerto** with the Concertgebouw again under Haitink. I can find no serious fault with either the solo or orchestral performance, but the standard of reproduction on this tape is not up to that on the others I have reviewed above. (J. Russell.)

if you relax  
with records...



... make this winter your  
warmest ever with Hi-Fi  
equipment from  
Mastersound

CHOOSE FROM ANY OF THESE EXCELLENT COMBINATIONS

**1** LAFAYETTE Amplifier 10 watt r.m.s.—GARRARD turntable with SHURE M44-7 Cartridge—2 x 8in MAGNAVOX Speakers in 1 cu. ft. enclosure—turntable base and perspex cover.

**\$265**

**2** SANSUI AU70 Amplifier, 25/25 r.m.s.—THORENS TD 150A Turntable with SHURE M44-7 Cartridge — 2 Goodmans Twin-axiom speakers in 2 cu. ft. enclosure—Base and perspex cover.

**\$494**

**3** KENWOOD TK250 Solid State Amp. 20/20 r.m.s. — LENCO GL75 Turntable with SHURE M32-E Cartridge—2 Wharfedale SUPER LINTON Speakers — Base and perspex cover.

**\$424**

**4** LEAK Stereo 70 Amplifier the cleanest sound ever—LEAK Sandwich speaker system—DUAL 1019 Turntable with SHURE M75 Cartridge—Base and perspex cover.

**\$748.50**



**GRILLE CLOTH:** A big bright new range of patterns ideal for those building or remodelling their speaker enclosures. Upgrade your present Hi-Fi system with a NEW SHURE Cartridge from our comprehensive range. Enjoy your Hi-Fi without disturbing the family with a set of world famous AKG Headphones.

**SPECIAL: 2 Sherwood cabinets shop soiled \$60 the pair.**

*Mastersound where quality at a realistic price is your best guide to Hi-Fi buying.*

**MASTERSOUND SALES PTY. LTD.,**  
400 Kent Street, SYDNEY. 29-1527.

rect dynamic value, a feat impossible to the greatest organists who ever lived. And it does this with effortless accuracy, however many-stranded the writing and whatever the speed at which it is delivered. It is therefore no electronic toy but an instrument to play Bach's music in a way that might well have surprised the composer — or perhaps astounded would be a better word — but which, it is interesting to speculate, he might well have approved. After all Bach was an unrepentant arranger of other composers' music and I can see no reason to doubt that he would have opposed his own being similarly treated — or ill-treated, as some might think.

Now while I feel that this disc might have been put out as something of a stunt — and a very interesting and I believe, profitable one, too — calculated to appeal to the "with it" generation, it should, at least on the evidence provided by the recording, reach a far wider audience. Those lovers of Bach who are not outraged, or even those who conquer their initial outrage, will find much to interest them in hearing music they all know well — and that goes for all the items included on this disc—played in a manner they would not have previously thought possible. I have not the space here to describe all the pieces in detail, but here is a list of the pieces: Sinfonia to Cantata No. 29 — Air on a G String — Two-part Invention in F Major—Two-part Invention in D Minor—Jesu, Joy of Man's Desiring—Prelude and Fugue No. 7 in E-Flat Major—Prelude and Fugue No. 2 in C Minor—Chorale Prelude "Wachet Auf"—Brandenburg Concerto No. 3 in G Major.

Some, I admit, stand up to the treatment better than others. But I strongly recommend anyone interested in any kind of music to hear the record.

I think that most of them who do so will buy — if only "just for kicks," as the kids say today.

(EDITOR'S NOTE: Another review of this interesting disc appears in the "Variety Fare" section, on page 127.)

★ ★ ★

**ELGAR — The Wand of Youth (Suites Nos. 1 and 2), Chanson de Matin; Chanson de Nuit; Three Bavarian Dances, London Philharmonic Orchestra conducted by Sir Adrian Boult, EMI Stereo OASD2356.**

This disc should appeal to those whose musical tastes run to what is generally called "light classical." It is all light weight and cannot be classed as vintage Elgar. But it is consistently tuneful, sometimes in a large Elgarian manner, and all of it is wrought by the hand of a master. Boult, a great Elgarian, and a personal friend of the composer, conducts all the pieces with devotion, despite their minor importance. In only one, the "Minuet, Old Style," would I have appreciated a more dainty treatment. One of the items used as a fill, the third Bavarian Dance, is an example of Elgar at his very fine best. The other two might best be described as restaurant music. An attractive disc for those who seek only relaxation in their music. ■

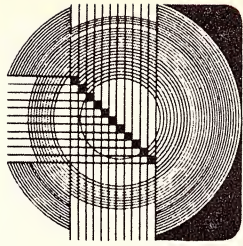

# DOCUMENTARY RECORDINGS

Reviewed by Glen Menzies

**CANTERBURY TALES: Original London Cast Recording of the Musical Play. Adapted from Chaucer by Nevill Coghill and Martin Starkie. Music by Richard Hill and John Hawkins. Lyrics by Nevill Coghill. Decca Stereo SKLA 4956.**

Nevill Coghill's magnificent translation into modern English of Chaucer's celebrated "Canterbury Tales," first published as a Penguin Classic in 1951, virtually gave the stories a new lease of life and introduced them to thousands of new readers. I wonder whether anyone at the time could have foreseen that in 1968 this same translation would be the inspiration for a successful musical.

The basis for it was laid in 1964, when Martin Starkie dramatised some of the tales for a presentation at the Oxford Playhouse, using Coghill's translation. It was so well received that Starkie decided to ask Professor Coghill to work with him on a new venture in which Coghill rewrote some of his original translation, choosing the tales which are centred around the theme of love and marriage and the battle of the sexes.

Quite separately, Richard Hill and John Hawkins were busy writing a musical suite inspired by the characters of the Canterbury Pilgrims. The two teams eventually came together, and Starkie and Coghill decided to incorporate songs and music throughout the play. The rest is now history; the show opened in London's West End a year ago and is still running.

This album provides an exhilarating listening experience, mainly because of the quite unusual musical sounds where the composers have combined modern pop music with medieval rhythms and harmonies. Much use is made of a superb brass choir against the sound of a well balanced pop rhythm section. Ancient instruments are heard in some solo spots, with quite spirited singing by both the company and soloists. The main thing is that it all sounds remarkably apt and in keeping with the fourteenth century background of the tales.

The spoken word excerpts are not particularly long, but are very effective and help to give coherence to the songs. The album begins with Martin Starkie, as Chaucer, in a beautifully spoken prologue.

In equally fine voice are Australians Ken Warren as "The Miller" and Kevin Brennan as "The Merchant." That accomplished English actor Wilfred Brambell is "The Steward" and in the dominant female role is Jessie Evans as "The Wife of Bath."

The spoken parts left me wishing for more, simply because Nevill Coghill's translation is so superb, but this is not to say that he hasn't done just as splendid a job of turning some of Chaucer's verse into song lyrics. The songs, many of them quite short, are delightful and, at times, richly earthy.

The recording has been expertly "staged" by the Decca engineers and full use is made of all the possibilities offered by stereo.

A timely release; the Australian production of the "Canterbury Tales" begins its Australian season in Sydney about the middle of May.

★ ★ ★

**THE SOUNDS OF PAPUA-NEW GUINEA: Its People and the Birds of Paradise. Narrated by Hank Curth and Jim Leigh. Produced by Robert Iredale. Published by The Jacaranda Press Seven-inch LP JPNG-001.**

To add the dimension of sound to a photographic book about the Territory of Papua and New Guinea was a natural thing for someone like Hank Curth to do. Mr Curth, who broadcasts regularly on the A.B.C., is an American photographer/journalist of some note. He is also a broadcaster of long experience who seldom goes anywhere without a tape recorder slung over his shoulder.

His idea for Picture-Sound Books is a very good one; look at the pictures and listen to the sounds. Many of the sounds heard on this record were not won without some effort and Mr Curth roamed far and wide through the Territory to capture them on tape. He travelled thousands of miles, using planes, jeeps, helicopters, native canoes and inter-island freighters, to reach remote places. He spent several weeks on the Ramu and Sepik Rivers with 50ft long native canoes as his only means of transportation.

The record is in two distinct sections: Side one is devoted to the incredible birds of paradise including the bluebird of paradise, which hangs upside down when making its mating calls, and the acquisitive gardener bower bird; Side two is concerned with the sounds of the people, the language of the drums, native chants, children singing in schools, and other human noises.

The first side, after a brief introduction by Hank Curth, is narrated by Jim Leigh. On side two, all the material is narrated by Mr Curth. I would have preferred hearing Mr Curth's pleasantly deep voice on both sides, as the tones of Mr Leigh's voice is rather mundane, and unfortunately

sounds even more colourless alongside the remarkable bird sounds. Apart from this qualification the record offers us many intriguing sounds from one of the world's most interesting places.

This record complements the photographic book "Papua and New Guinea" published by Jacaranda Press and is contained neatly on the inside cover of the book.

I understand that Hank Curth is planning future Picture-Sound books, for which he will be gathering material in such places as Fiji, New Hebrides/New Caledonia, Hawaii, Tonga and the Solomon Islands.

★ ★ ★

**SONGS AND POEMS OF AUSTRALIA: Featuring works of Henry Lawson, C. J. Dennis, John O'Brien, Adam Lindsay Gordon. Sung and spoken by Tex Morton, Chips Rafferty, Leonard Teale, Kevin Brennan and the Bush Music Club. Calendar (Festival) Mono LP AUS.1.**

This album is a reissue on Festival's economy price Calendar label of a disc first released some years ago. Since it was originally compiled from material taken from other releases, representing some of the first LPs devoted to Australian verse and songs, it is not surprising that it comprises very familiar material. While some may find it an attractive proposition at the economy price, others will probably look for new readings which might help to throw new light on this familiar fare. My own reaction was a wish that some imaginative producer could persuade one of our record companies to issue an album of poems by some of the talented Australian poets of our own times.

Accepting the material chosen for this album at its face value I found most enjoyment in listening to Chips Rafferty. He sounds very natural and relaxed in C. J. Dennis' "Digger Smith" and in the two well-known poems by Adam Lindsay Gordon, "The Sick Stockrider" and "How We Beat The Favourite."

Neither Kevin Brennan nor Leonard Teale impress with their readings. Mr Brennan uses "stage" Irish for Mr O'Brien's rather sentimental verses and Mr Teale misses the more subtle qualities of the poetry of Henry Lawson.

Tex Morton is a good country and western stylist who I think is largely out of place here, as are the members of The Bush Music Club.

The quality of the pressing is excellent. ■



# Goldring Trendsetters in sound equipment

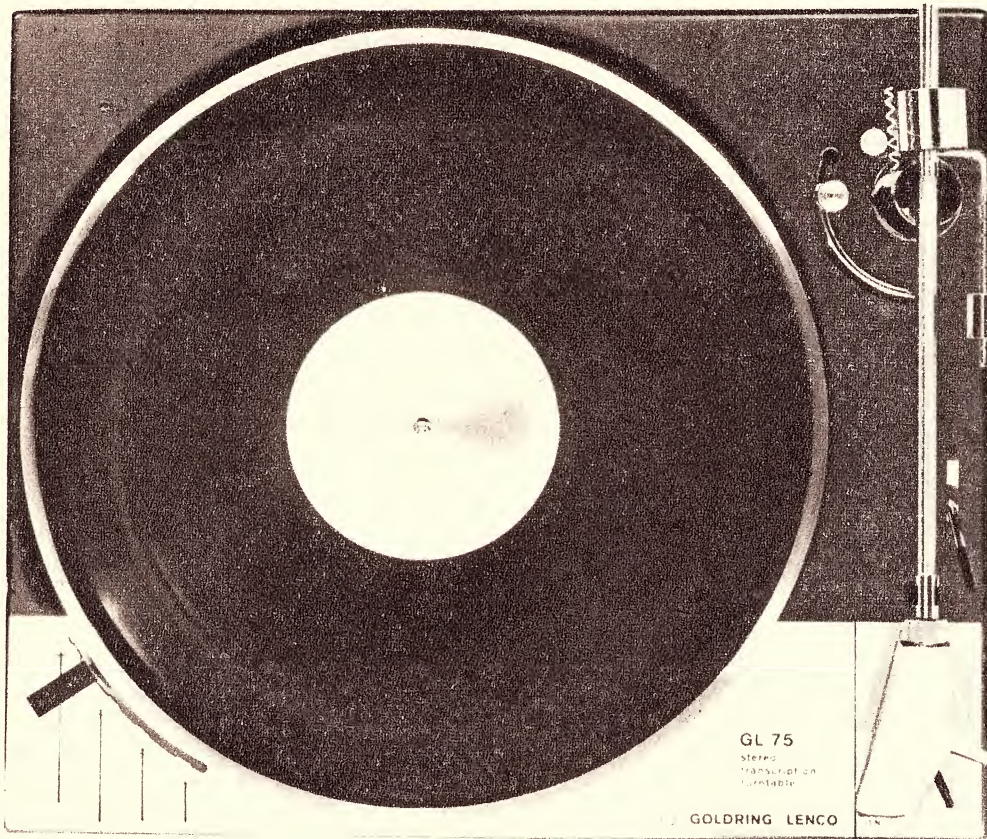

## Latest release, Swiss made precision transcription unit GL75

Integrated transcription motor unit and arm, built to instrument standards of quality and appearance. The drive system is the unique Goldring-Lenco constant velocity 4-pole motor with conical shaft coupled to the underside of the turntable by a knife-edged idler (automatically disengaged by the on/off switch, which is fully click-suppressed and also operates a turntable brake).

The turntable is die-cast from non-ferrous material; weighs 9 lb and is dynamically balanced.

Speed is continuously variable from

86-30 rpm and from 18-15 rpm with adjustable positive stops for the four standard playing speeds. There is only 0.2% change of speed for 10% mains voltage change.

The transcription arm is the Goldring-Lenco L75 with knife-edge bearings, full balancing facilities, calibrated stylus pressure adjustment, and 'anti-skating' bias compensation. It is lowered hydraulically by a lever fitted to the deck plate. Shock-damping mountings are supplied with the unit.



## Goldring '800' series free field stereo cartridge

800: In this cartridge a very lightweight tube of magnetic material lies in a "free field" generated by a fixed source coupled to a low mass diamond point. It features low mechanical impedance (tracks at 1 to 3 grams), screening from external hum fields, gold-plated contacts. Stylus is replaceable. Rivals finest in the world. Frequency response 20-20 kHz, compliance 20 x 10<sup>-6</sup>.

800E: Using the same cartridge body as the standard model, an elliptical diamond stylus is fitted. Compliance is substantially increased resulting in brilliant linear, resonant free, performance. Frequency response 20-20 kHz, compliance 30 x 10<sup>-6</sup>.

## GOLDRING ENGINEERING (AUSTRALASIA) PTY. LTD.

N.S.W.: 443 Kent Street, Sydney. 29 1275. Vic.: 162 Pelham Street, Carlton. 34 5105. Q.L.D.: 235 Edward Street, Brisbane. 2 7010. W.A.: 91 Hay Street, Subiaco, Perth. 8 4988. S.A.: Ernsmith, 52-54 King William St, Adelaide. 51 6351.

**From the ever-widening range of hi-fi equipment available from Goldring.**

# Chosen by the BBC... GOLDRING '800' SERIES

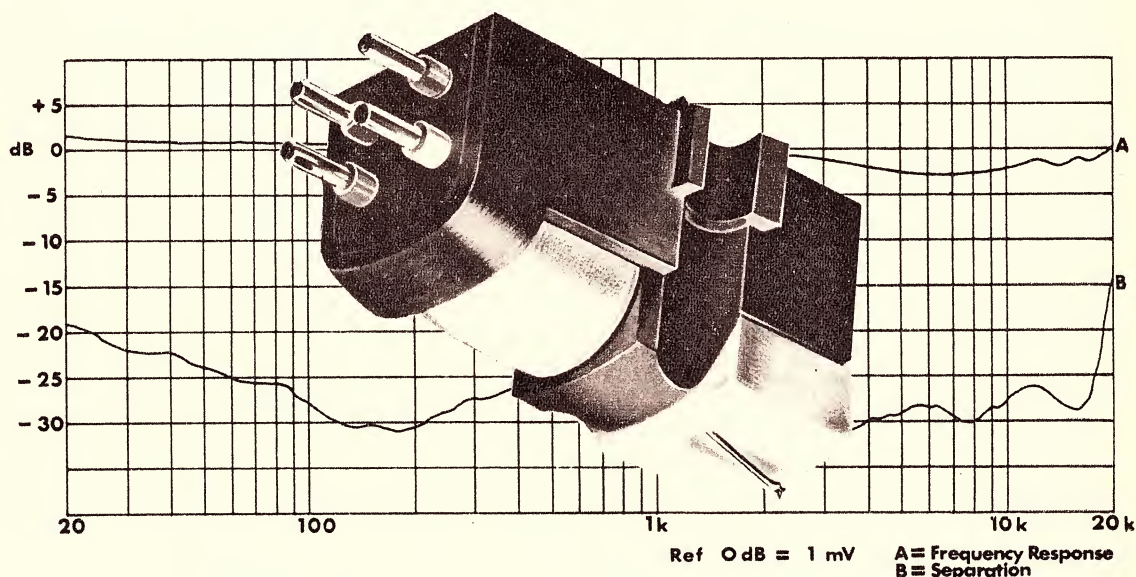

## Goldring '800' and '800E' free field stereo cartridges

With a choice of the finest cartridges anywhere in the world, BBC engineers chose the Goldring '800' series. They recognised the unparalleled advantages of the 'free field' system in re-creating the finer shades of original sound. Read the specifications and you'll agree. In these cartridges a very lightweight tube of magnetic material lies in a 'free field' generated by a fixed source coupled to a low mass diamond point. They feature low mechanical impedance, tracking at 1 to 3 grams (800) and 0.75 to 2 grams (800E), screening from external hum fields, gold-plated contacts. Stylus is replaceable.

### Specifications:

	'800'	'800E'
Type	Magnetic	stereo & mono
Frequency Response	20Hz-20kHz	10Hz-25kHz
Sensitivity	5.5 mV at 5 cm/sec	
Separation	25dB at 1kHz and nowhere less than 15 dB	
Load	100k-47k/ohms	
Compliance	$20 \times 10^{-5}$	$30 \times 10^{-5}$
Static	cm/dyne	cm/dyne
Effective Point		
Mass	1 mg	less than 1 mg
Stylus Point	Conical 0.0005" diamond	Elliptical .0008" x 0.0003" diamond
Tracking Weight	1-3 gm	0.75-2 gm
Head Weight		8 gm
Connections		4 pins
Fixing	Standard 1/2" centres	
Vertical Tracking Angle	15°	
Mu-Metal Shield for hum protection		
Removable Stylus		

## GOLDRING ENGINEERING (A'ASIA) PTY. LTD.

N.S.W. 443 Kent St., Sydney, 2000. Phone 29-5802  
VIC: 162 Pelham St., Carlton, 3053. Phone 34-5105.  
QLD.: 415 Adelaide St., Brisbane, 4000. Phone 23247.

S.A.: Farley & Fahy Pty. Ltd., 75-77 Wright St., Adelaide, 5000. Phone 51-5117.  
W.A.: 32 Northwood St., Leederville, 6007. Phone 84988

FROM THE EVER-WIDENING RANGE OF HI-FI EQUIPMENT AVAILABLE FROM GOLDRING.

# KEF

## Why not paper cones?

New industries begin where old ones leave off and long established skills help to establish many a new invention. When the growing loudspeaker industry demanded large quantities of lightweight moulded cones, it was the felted paper industry which provided an economical solution. That was over forty years ago and even today, the majority of speaker production is nurtured by this ancient craft. But the gentle skills of the specialist papermaker are dwindling in an industry which attracts few youngsters. The number of firms in all the world, which produce paper diaphragms, is very small and very little research is being done to improve the product.

Being a natural substance and hygroscopic at that, paper is scarcely an engineer's material. Its properties vary from batch to batch and the characteristics of diaphragms made from it differ widely and change with time, temperature and humidity. Nevertheless, with care and selection and with perhaps a touch of damping treatment in the right places, it is possible to obtain a very fine performance. But such a technique is scarcely admissible in a field of endeavour, which demands always better standards, tighter tolerances and greater reliability.

It is for all the foregoing reasons that KEF has never designed a paper cone speaker. Every unit made at Tovil is fitted with a scientifically engineered diaphragm of plastic, metal or sandwich construction, specially developed for each purpose and produced to precise limits to ensure a predictable performance. The materials used do not absorb moisture from the atmosphere, nor do they grow brittle with age.

The physical properties of these materials, polystyrene, neoprene, P.V.C., melinex and aluminium, can be specified and controlled quite accurately, so that with precision tools and good quality control it is possible to manufacture loudspeakers which not only give superior performance, but do so CONSISTENTLY.

Paper cones will, of course, be around for a long time to come, especially for cheaper and less critical applications, but wherever precise reproduction is called for, more modern materials will be in growing evidence and KEF already have seven years' experience in this new field of development.

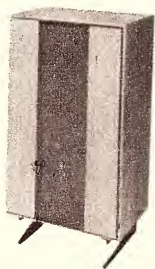

The remarkable KEF "CONCORD" system

# ADC

## Why not moving magnets?

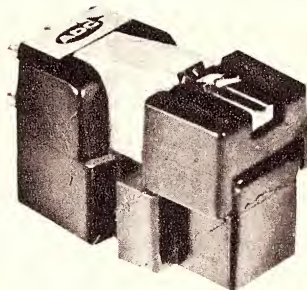

The new ADC 550E cartridge

The popular moving magnet design is a good compromise and was used by ADC in its first series of cartridges. However, it presents three serious problems difficult to overcome.

- (1) The moving magnet is relatively heavy irrespective of its shape, thus increasing the mass at the stylus tip.
- (2) This increased moving mass will and must resonate with the vinyl disc within the audible range. To smooth out the frequency response curve heavy damping is required, which is most undesirable.
- (3) To obtain reasonable efficiency, both poles of the moving magnet must be placed between the pole faces, thus necessitating a fairly long cantilever in order to give sufficient stylus clearance and to maintain the correct tracking angle. This long cantilever is very difficult to make with adequate stiffness to prevent resonance or decoupling without excessive mass.

THAT'S WHY ADC ENGINEERS INVENTED THE PATENTED INDUCED MAGNET PRINCIPLE, which features all the advantages of the moving magnet design, but eliminates the weight of the magnet itself. Almost like having your cake and eating it, as a noted reviewer puts it.

You may be absolutely sure, that ADC cartridges are more advanced than their competitors and that they offer you the finest possible choice of that important first link in your reproducing chain.

# J. H. REPRODUCERS PTY. LTD.

293 HUNTINGDALE ROAD, CHADSTONE, VICTORIA. 3148

TELEPHONE: 277-3066

Exclusive Australian Representatives of ADC, U.S.A., and KEF, U.K., and manufacturers of the popular J. H. SYNCHRONOUS TURNTABLE.

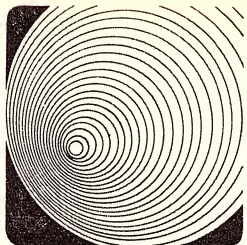

## VARIETY FARE

### Devotional recordings

#### JIM NABORS SINGS THE LORD'S PRAYER and Other Sacred Songs. Stereo, CBS SBP-233602.

Interest: A "new" Jim Nabors.  
Performance: Superb.  
Quality: Very good.  
Stereo: Normal.

To anyone who has known Jim Nabors only as television's quaintly comic Gomer Pyle, the sight of his portrait on the sleeve of a devotional album is most likely to produce a wry smile.

If Gomer Pyle, why not an album from Charlie Brown?

Think that way and you're in for the biggest shock of the season. Jim Nabors has a voice smoother, truer, more powerful and as well trained as almost any voice in the business. What's more, he sounds equally at home with a powerful Panis Angelicus, a sincerely moving "Old Rugged Cross" or a bright up-tempo, "Just A Closer Walk."

The full list of titles is: The Lord's Prayer — What A Friend We Have In Jesus — Amazing Grace — Panis Angelicus—Holy, Holy, Holy—Battle Hymn Of The Republic—The Holy City—Rock Of Ages — Just A Closer Walk With Thee — The Old Rugged Cross—In The Garden—Ave Maria.

Listen to these numbers and you'll realise that Jim Nabors isn't a television comic who happens to be able to sing a bit. He's one of the finest gospel signers I've yet heard — who happens to be a pretty good comedian as well!

Strongly recommended. (W.N.W.)

★ ★ ★

#### THE PRIDE OF WALES. Treorchy Male Choir. Conducted by John Cynan Jones, Tom Jones, piano; Dilys Lloyd, organ. Stereo, EMI OCSD-3653.

Interest: Welsh Choir.  
Performance: Very good.  
Quality: EMI at its best.  
Stereo: Beautifully spread.

With a tradition dating back over 100 years, but reformed in 1946, the Treorchy Male Choir has since gained 22 major awards in 27 contests and eisteddfods. It has performed for Royalty, given concerts in the Royal Albert Hall and the Royal Festival Hall, been featured many times on radio and television and has toured the British Isles and Switzerland. One of their recordings is included in the U.S. time capsule, to remain buried until 2052 A.D.

Their performance here is all that one would expect of such a choir — gentle or robust as the music requires,

cohesive, well balanced, beautifully phrased and with excellent diction. Former miner Tom Jones does a fine job at the piano, as also does Dilys Lloyd at the pipe organ.

The content of devotional music warrants including the review in this section: Fantasia on Famous Welsh Airs—Y pren ary bryn—The Soldiers' Chorus from Faust — Steal Away — Italian Salad—Immortal, Invisible, God Only Wise—Jesu, Lover Of My Soul — Guide Me, O Thou Great Redeemer — Alleluya, Sing To Jesus—Ar Hyd y nos (All Through The Night) — Myfanwy—Mae Hen Wlad fy nhadau (Welsh National Anthem).

An album that can be recommended. (W.N.W.)

### VARIETY FARE reviews by

Harry Tyrer, Forbes Cameron, Neville Williams

#### SINGING WE GO. The Jones Sisters. Arrangements by Tedd Smith. Stereo American Word pressing WST-8396-LP. (Available from Sacred Productions, Aust., in all capital cities.

Interest: Gifted teenage trio.  
Performance: Very listenable.  
Quality: Normal but a little "dry."  
Stereo: 2-channel effect.

Gail, Phyllis and Cheryl are the teenage daughters of Rev. Howard Jones, for some years an evangelist with the Billy Graham Evangelistic Association, resident in Liberia. There, the girls had their own weekly radio session designed for the youth of the African continent.

For this album they are backed by arrangements devised by Billy Graham accompanist Tedd Smith, himself well known in Australia. Using piano, organ and glockenspiel, these add their quota of enjoyment to the album.

The titles: I Got A Robe—Lead me, Guide Me—Joy In Serving—Jesus — Yes, I know—Wayfaring Stranger—Tis So Sweet To Trust In Jesus — Jesus Walked This Lonesome Valley—Singing I Go—Saviour Like A Shepherd Lead Me—There's No Hiding Place — Oh, How I Love Jesus—The Saviour is waiting.

Not surprisingly, perhaps, the girls lack the polished professionalism of the better-known White Sisters, and it is just a pity that the recording engineers didn't provide a touch of reverberation to round out their phrasing. But they are very pleasant and listenable, nevertheless. (W.N.W.)

#### WHISPERING HOPE. George Beverly Shea. Stereo, RCA Victor LSP-4042.

Interest: New Bev. Shea selection.  
Performance: Well produced.  
Quality: Completely clean.  
Stereo: Good spread, separation.

For the most part, Bev. Shea's earlier albums were built around gospel songs and hymns which he had sung consistently at rallies and in films, TV and radio. Very successful at first, the formula later produced albums which, to this reviewer, sounded pretty tired.

More recently, there has been evidence of a new approach removed from the necessarily limited "rally" arrangements. In this album, backed by a vocal group, "The Nashville Sounds," and a gently rhythmic orchestra, Bev. Shea sings a dozen devotional songs, several of them new to me: He Touched Me—The Unclouded Day—What A Day That Will Be—Follow Me—Not My Will—Thank You—Blue Galilee—He's Everywhere — Without Him — Somebody's Knocking At Your Door — Where Could I Go? — Whispering Hope.

A few Bev. Shea mannerisms remain to irk those who may particularly dislike them but, all told, it is a pleasant and successful Gospel album which will appeal especially to Bev. Shea fans. (W.N.W.)

## M.B.H. AUDIO SALES

33 MARLBOROUGH ROAD,  
HOMEBUSH, N.S.W. 2140.



The new "Saraband" player gives you genuine fidelity with compactness, simplicity and reliability.

Completely Australian made and backed by service.

If you want to hear your records at their very best you need M.B.H. quality.

**SEND TODAY FOR YOUR  
'SARABAND' BOOKLET**

# ACOS

## REPLACEMENT CRYSTAL CARTRIDGES

Acos 90 Series — a brand new family of four pick-up cartridges, covering all the main types needed to-day, each fitted with Diamond Stylus at no extra cost.

- GP91-1 Replaces GP67-1G MONO CRYSTAL \$5.95
- GP91-2 Replaces GP67-2G HIGH OUTPUT MONO CRYSTAL \$5.95
- GP92 MONO CERAMIC \$6.55
- GP93 Replaces GP73-2A STEREO CRYSTAL \$7.55
- GP94-1 Replaces GP81 STEREO CERAMIC \$7.95
- GP94-5 STEREO CERAMIC FOR TRANSISTOR AMPLIFIERS \$8.95

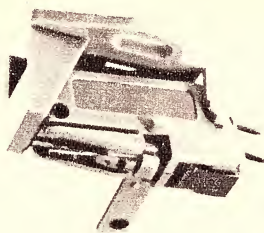

fitted with  
**DIAMOND**  
Stylus at no extra cost.

TECHNICAL DATA SHEETS SENT FREE ON REQUEST

Sole Australian Agents:

**AMPLION (A'SIA) PTY. LTD.**

29 Majors Bay Rd., Concord,  
Sydney, N.S.W. Phone 73 1227

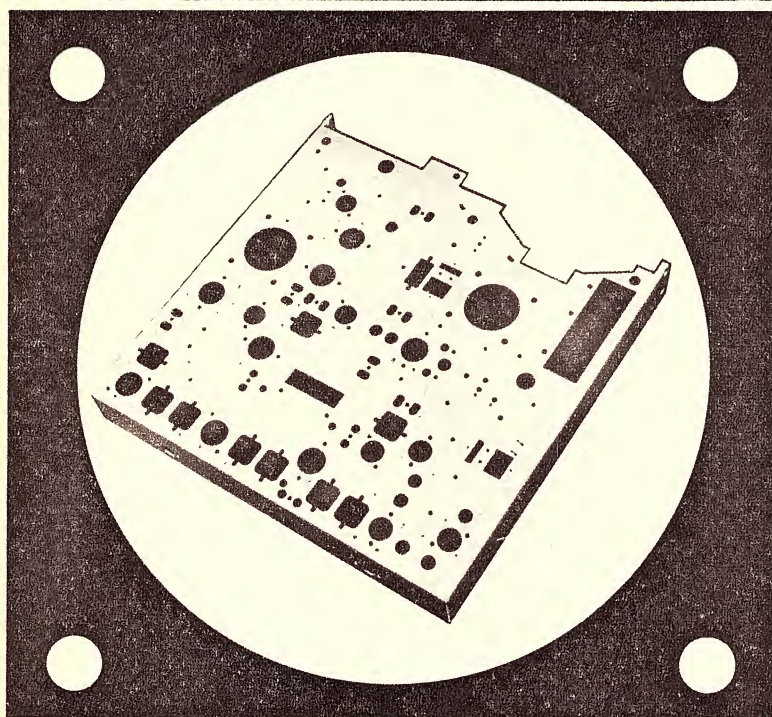

## High precision chassis at under \$4 each can solve your production problem

Plessey manufacture for short and medium runs, cad plated and silk screened chassis that offer distinct price advantages. The example illustrated with folded and welded sides costs under \$4 each for a run of 100.

Accuracy is assured by using a sophisticated fabricator that reproduces the finished part to within .005". Take advantage of this unique service. Consult Plessey now for on-time deliveries that will guarantee profit gains.

# PLESSEY Components



For additional information please contact:  
Rola Division  
The Boulevard Richmond Victoria 3121  
Telephone 42 3921 Telex 30383  
NSW Plessey Components Rola Division  
PO Box 2 Willawood 2163 Telephone 72 0133

AR 16

## Instrumental,

**FRENCH ORCHESTRAL MUSIC.**  
The Boston Symphony Orchestra conducted by Charles Munch, RCA Victorla Stereo VISS-1323.

Interest: French romantics.  
Performance: Fine.  
Quality: Excellent.  
Stereo: Good spread.

The late Charles Munch, who died this year, was recognised as one of the leading conductors of the type of music presented here, comprising: Bolero (Ravel)—La Valse (Ravel)—Prelude a L'Après Midi d'un Faun Debussy—Escales (Ibert). This is a satisfyingly varied program, ranging from the almost hypnotic orchestral tissues of the "Bolero" through the ironic swirlings of "La Valse" and the languor of Debussy's erotic tone poem to the exciting vistas of Ibert's musical travelogue (called in its English title "Ports Of Call"). I can find little to fault in the performance, my only complaint being that in the Bolero, Munch hits his climax too early for my taste, so that for the last five minutes the orchestra is going flat out to sustain the excitement. Otherwise, this is a most satisfying disc, and a fine bargain at its low price of \$2.50.

Although a pre-Dynagroove recording, the sound quality is very good. (H.A.T.)

★ ★ ★

**LIGHT ORCHESTRA FAVOURITES**  
played by The Queen's Hall Light Orchestra, Sidney Torch and his Orchestra, and Charles Williams and his Concert Orchestra. Encore (E.M.I.) mono OEX 9464.

Interest: Light Music.  
Performance: Satisfactory.  
Quality: Poor sound.

There is some very pleasing music in this selection, but the tracks all appear to have been re-processed from 78. r.p.m. discs, to judge from the sound quality and the residual noise. This suspicion is confirmed by the fact that the Queen's Hall was destroyed during the London blitz, and I cannot imagine the orchestra surviving for too long after this event. Sidney Torch was a popular band leader in the 1940s, but I cannot recall having heard of him for many years now. The tracks are: Rustle of Spring — Dusk — Runaway Rocking Horse — Jamaican Rumba — The Boulevardier — Shooting Star — Dance of an Ostracised Imp — Dream of Olwen — Incidental Music "While I live" — La Paloma — Jumping Bean — Beachcomber — High Heels. Nice music, well performed, and good value at \$2.50, despite the below-standard sound. (H.A.T.)

★ ★ ★

**KARAJAN CONDUCTS OVERTURES.** The Berlin Philharmonic Orchestra conducted by Herbert von Karajan, World Record Club Stereo S/4444.

Interest: Middle-brow classics.  
Performance: Virtually faultless.  
Quality: Excellent.  
Stereo: Good spread.

Three of the five pieces on this disc



# Vocal and Humour . . .

are more worthy of the name of tone poem than overture. The titles are: Overture to *Der Freischutz* (Weber), —Overture to "The Flying Dutchman" (Wagner)—Prelude to Act 1 of *Lohengrin* (Wagner)—Overture to *The Merry Wives of Windsor* (Nikolai)—*Hebrides Overture* — Fingal's Cave (Mendelssohn). Although I exclude the Weber and Nikolai overtures from the tone poem bracket, both have some very evocative moments. The playing throughout of the Berlin Philharmonic is of a very high standard, but I particularly emphasise the merits of the performance of the "Lohengrin" prelude. The shimmering beauty of the strings at the opening of this piece is sheer magic and the build up to the great crescendo near the end is controlled in masterly fashion by Karajan. I must also mention the fine performance of the "Hebrides" overture, a particular favourite of mine, which here leaves no room for criticism. Originally released by Decca, the engineering of the disc is of high standard. Highly recommended. (H.A.T.)

\* \* \*

**THE BEST OF THE HOLLYWOOD BOWL SYMPHONY ORCHESTRA.** Album 2. Conducted by Felix Slatkin. Stereo, Capitol (E.M.I.) SP-8679.

Interest: Prom. concert favourites.  
Performance: Generous.  
Quality: First class.  
Stereo: Nicely spread.

The fact that Felix Slatkin died in 1963 dates this album by quite a few years but there is certainly nothing dated about the sound or the quality.

## The electronic Bach

**SWITCHED ON BACH.** Electronic realisations by Walter Carlos, C.B.S. (Australian Record Company). Stereo SBR 235297.

Interest: "Moog" music.  
Performance: Fascinating.  
Quality: Outstanding.  
Stereo: Very well done.

The notation under "Interest" above, is not a misprint. The music recorded here was made with a Moog synthesiser, an electronic device for reproducing music with the aid of a keyboard. The pieces so treated are all Bach compositions, and many of them are what might be called "popular Bach." Thus we have *Sinfonia to Cantata No. 29* —Air on the G String—*Jesu Joy of Man's Desiring* —Chorale Prelude "Wachet Auf." The rest of the program comprises equally well known but perhaps less "popular," pieces: Two Part Inventions in F Major, B Flat Major and D Minor — Preludes and Fugues No. 7 in E Flat Major and No. 2 in C Minor from "The Well Tempered Clavier, Book 1"—Brandenburg Concerto No. 3 in G Major.

It is impossible to describe the sounds with which these pieces are realised, but I doubt whether Bach lovers will find fault with either the sound or the performance, which in

Generous in proportion, well played and cleanly recorded, the album can readily be recommended to any with an ear for popular concert items: Light Cavalry Overture (Suppe)—España Waltz (Waldteufel) — Scherzo "A Midsummer Night's Dream" (Mendelssohn) — Pizzicato Polka (Delibes) — Pavane For A Dead Princess (Ravel) —The Comedians-Galop (Kabalevsky) — Vienna Life (Strauss) — Nocturne (Borodin) — Triana (Albeniz)—Grand Canyon Suite, On The Trail (Grofe).

A good record for listening situations where heavier and less familiar fare might be inappropriate, it is also good hi-fi material. Playing time, by the way, is about 50 minutes. (W.N.W.)

\* \* \*

**ROMA OGGI (Rome Today).** Tony Mottola, guitar, with orchestra. Project 3 Stereo SPJL933, 154. Available in Mono.

Interest: More "Roman Guitar."  
Performance: Outstanding.  
Quality: Excellent.  
Stereo: Well spread.

Some four or five years ago, when he was recording on Enoch Light's Command label, Tony Mottola made "Roman Guitar," still one of the best discs he has made. Now that he has transferred his allegiance to the new Enoch Light Project 3 label, he attempts to repeat his success with a similar formula. The results are completely satisfying. It includes some of the best tunes to come out of Italy in the past few years, with the inevitable "Volare," one of the first and still one

some tracks is absolutely breathtaking in speed and clarity. The sounds which Walter Carlos has created have for the most part a distinctly baroque quality which is entirely appropriate to the music. All the pieces are played "straight" and only in the second movement of the Brandenburg Concerto are there any noises which sound at all out of place—and these are very weird noises indeed. What is particularly noticeable is the clarity of the parts and their spacing in the stereo spread is quite remarkable.

The question remains, "Are we to treat this as serious music or not?" This is likely to be a source of controversy wherever groups gather to listen to this and any subsequent discs. For my parts, I would answer "Yes." If we apply the test of musical enjoyment I maintain that one can listen to these performances and appreciate them in the same manner that we can enjoy any other transcription. For this reason, I suggest that this music has a valid claim to be taken seriously. Still, in the final analysis, this is a matter which each individual must decide for himself. If you have any doubts, and can persuade your record dealer to let you hear a track or two, I suggest you go for the last movement of the "Brandenburg Concerto" and the "Two Part Inventions." (H.A.T.)

## "INNERBOND"

(Regd.)

# BONDED ACETATE FIBRES

FOR PACKING IN

## SPEAKER ENCLOSURES

A new resilient Bonded Wadding made from ultra fine Cellulose Acetate Fibres that gives high efficiency for Sound Absorption.

"INNERBOND" is light, clean, dust-free and easy to handle. Because all the fibres are bonded "INNERBOND" will hang as a "curtain" and will not fracture or break down due to vibration.

"INNERBOND" is odourless, highly resistant to attack by bacteria or fungus and is vermin repellent; "INNERBOND" at 16oz sq. yd. has a normal thickness of 1" and at this density is recommended as a packing in Speaker Enclosures for Sound Absorption.

### STOCKISTS:

**SYDNEY:** Arrow Electronics Pty. Ltd. 342 Kent St.; Broadway Electronics (Sales) Pty. Ltd., 32 Glebe Point Rd. GLEBE; Convooy International Pty. Ltd., 449 Kent St.; Encel Electronics Pty. Ltd., 257 Clarence St.; Kent Hi-Fi, 432 Kent St.; Mastersound Sales Pty. Ltd., 400 Kent St.; Radio Despatch Service, 869 George St.; Stereo Music Systems, 193 Clarence St.; Circuit Components (A/sia) Pty. Ltd., 460 Bexley Rd., BEXLEY; Classic Radio, 245 Parramatta Rd., HABERFIELD; Dyna Stereo Pty. Ltd., 331 Prince's Hwy., ST. PETERS; Albert Wright Radio Service, 795 New Canterbury Road, HURLSTONE PARK.

**NEWCASTLE:** Martin de Launay Pty. Ltd., King and Darby Streets; Dynamic Sound 587 Hunter Street.

**WOLLONGONG:** Electricon Parts Pty. Ltd., 82 Keira Street; Martin de Launay Pty. Ltd., 270 Keira Street.

**MELBOURNE:** J. H. Magrath & Co. Pty. Ltd., 208 Little Lonsdale Street.

**BRISBANE:** A. E. Harrold Pty. Ltd., 123 Charlotte Street; Brisbane Agencies, 78 Wickham Street, Fortitude Valley.

**ADELAIDE:** Duncan Agencies, 57 Woodville Road, Woodville; General Accessories, 81 Flinders Street. Truscott Electronics, 62-64 Hindmarsh Sq.

**PERTH:** Atkins (W.A.) Ltd., 894 Hay Street; Carlyle & Co. Pty. Ltd., 1 Milligan Street; General Accessories, 46 Milligan Street.

**HOBART:** Homecrafts-Tasmania, 199 Collins Street.

If unobtainable

For 1 sq. yd. as above send \$2.00  
For 2 sq. yds. as above send \$3.75  
For 4 sq. yds. as above send \$6.50

Postage paid in Australia and Territories to the manufacturers

## WONDER WOOL

PTY. LTD.

87 JAMES STREET, LEICHHARDT.  
N.S.W., 2040.  
Box 548 — G.P.O., Sydney. 2001.  
Phone: 56-2780.

# WORLD'S BEST HI-FI EQUIPMENT FOR THE CHEAPEST PRICES IN AUSTRALIA FROM RECORDED MUSIC SALON

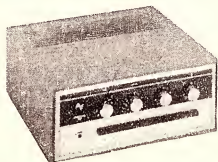

**Technical Specifications:**  
Power Output, continuous sine wave:  
25 watts per channel, 8 ohms  
Power bandwidth: 20—25,000 Hz  
Frequency response: 20—20,000 Hz  
plus/minus 1dB  
Harmonic distortion: less than 0.5% at  
1kHz, measured at 25 watts output  
plus/minus 1dB  
Crosstalk: better than 40 dB.

## THIS MONTH'S SPECIAL OFFERS:

**UNIT 1:** The latest Armstrong Model 521, illustrated and described above, England's most perfect stereo integrated fully transistorised amplifier. P.E. 34 turntable, belt-driven hydraulic controlled lowering device, Empire 808 cartridge, frequency response from 10 to 20,000 cycles, 2 Goodmans 10-inch Twinaxlette loudspeakers.

**Total Price . . . . . \$382.00**  
The same with the Armstrong 426 fully transistorised tuner/amplifier, 15-watt RMS per channel, frequency response from 20—20,000 cycles plus/minus 1 dB less than 1% distortion on the full 15-watt RMS \$80



**UNIT 2:** Schaub-Lorenz (associated with ITT) Model 4000 tuner/amplifier made in Germany, 25-watt per channel is

the most beautiful looking tuner/amplifier available on the world market (sole agents for Australia — Recorded Music Salon). Dual 1019 turntable, Empire 888E cartridge, frequency response from 10—30,000 cycles, 2 Heco fully imported speaker systems in boxes, separate bass and tweeter. **Total Price . . . . . \$540.00**  
The same with Jordan Watts loudspeakers, frequency range on axis: 30—17,000 Hz plus/minus 3 dB, 25—20,000 Hz plus/minus 6 dB (also on axis) 30 degree off axis: 30—17,000 Hz plus/minus 6 dB, with cabinets. **Less . . . . . \$40.00**

**UNIT 3:** Sansul 222 stereo amplifier complete with Garrard 50 Mk 11 4-speed turntable and cartridge, plus 2 Goodmans 10in Twinaxlette loudspeakers.

**Total Price, \$237.00.**  
The same with Kenwood TK150U amplifier, less \$20.00.

**UNIT 4:** Armstrong 127 integrated tuner-amplifier. P.E. 36 turntable complete with base and plastic cover, cartridge included, 2 Wharfedale 8in RSDD loudspeakers.

**Total Price, \$218**  
The same with the Armstrong 227 tuner-amplifier 10-watt RMS per channel, frequency response from 30-20,000 cycles plus/minus 1 dB less than 1% distortion measured at 8-watts RMS. **Add \$30.00.**

**UNIT 5:** Ampex Model 753 tape deck combines magnificent 4-track stereo sound, unmatched Ampex engineering quality and versatile new recording features, sound on sound, tape monitor, sound with sound, echo chamber complete with Armstrong 421, 15-watt per channel RMS fully transistorised stereo amplifier, frequency response from 20-20,000 cycles plus/minus 1 dB less than 1% distortion on the full 15-watt RMS (Ampex recommends Armstrong amplifiers to be used with their tape decks or tape recorders), 2 Jordan Watts loudspeakers.

**Total Price, \$646.00.**

**Unit 6:** Harmon Kardon Model 210 tuner/amplifier 50-watt output, most advanced integrated stereo tuner/amplifier from the U.S.A., frequency response plus/minus 1 dB: 8-25,000 Hz at 1 watt (normal listening level); 10 — 23,000 Hz at full rated power, 2 Empire Model 2000 loudspeakers, frequency response from 30 — 18,000 Hz. Components: 10-inch high-compliance woofer with 2in voice coil, Mid-range/tweeter, direct radiator, less than one foot square and 16 1/2 inches high. Power handling capacity: 60 watts undistorted, world's most compact speaker system from the U.S.A., ERA Mk 3 turntable, Empire 888E cartridge, frequency response from 6 — 32,000 cycles.

**Total Price . . . . . \$1,350.00**

**Unit 7:** Empire Model 9000M Grenadier loudspeakers, frequency response from 20 to 20,000 Hz. Components: 15-inch high-compliance woofer, Mid-range direct radiator and ultrasonic domed tweeter, both coupled to Empire's wide-angle acoustic lens. Maximum Power Handling Capacity: 100 watts, undistorted. Impedance 8 ohms, Schaub-Lorenz Model 4000 tuner/amplifier 25-watt per channel, ERA Mk 3 turntable, Empire 888VE cartridge, frequency response from 6 to 32,000 cycles.

**Total Price . . . . . \$2,000.00**

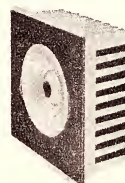

on axis) 30 deg. off axis: 30—17,000 Hz plus/minus 6 dB. **Plus . . . . . \$100.00**

**Unit 8 :** P.E. 2020 turntable with Empire diamond magnetic cartridge Model 808, frequency response from 10 — 20,000 cycles, Sansul 220 stereo transistorised amplifier. **Total Price, . . . \$251.00**  
Plus 2 Jordan Watts loudspeakers, frequency range on axis: 30 — 17,000 Hz plus/minus 3 dB, 25—20,000 Hz plus/minus 6 dB (also on axis) 30 degree off axis: 30—17,000 Hz plus/minus 6 dB. **Plus . . . . . \$100.00**

Trade and wholesale Enquiries welcome — we forward goods to any part of Australia.

## The Best Stereo Equipment must have an Empire Cartridge. With a small outlay of money you can improve your Stereo Equipment with the Empire Cartridges

### MODEL 2000

For Homemakers who want the finest in sound but are short on space. Less than one foot square and 16 1/2 inches high. Frequency response: 30 to 18,000 cycles. Components: 10-inch high compliance woofer with 2in voice coil. Mid-range/tweeter direct radiator. Minimum Power Requirements: 20 watts. Maximum Power Requirements: 60 watts, undistorted. Impedance: 8 ohms. Controls: 3-position treble response switch.

### SPEAKERS



### MODEL 9000M ROYAL GRENADE LLOUDSPEAKER

Irresistible beauty from any position classically designed, elegantly styled. Let the majic of this wide angle speaker system invade your presence with its majestic sound and richness of tone. Truly, one of the world's greatest speaker systems. Frequency response: 20-20,000 cycles. Power Handling Capacity: Maximum undistorted 100 watts music Mid range Direct Radiator and Ultra Sonic Domed Tweeter couple to Die Cast Acoustic Lens. Infinite Baffle System. Imported marble top.

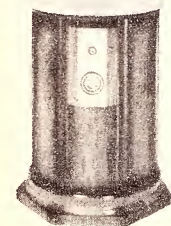

power. 15in woofer. Radiator and Ultra Sonic Domed Tweeter couple to Die Cast Acoustic Lens. Infinite Baffle System. Imported marble top.



### MODEL 888E CART-RIDGE. Deluxe stereo cartridges with patented "Magnetic-Cone Stylus."

for high performance turntables. Frequency response: 6—32,000 cycles. Output voltage: 8.0 mv. per channel. Channel separation: more than 30 db. Terminal Impedance: 47,000 ohms. Compliance: 30 x 10-6 cm/dyne. Tracking force: 1/2 to 2 grams. Stylus: .2 x .7 mil bi-radial elliptical hand-polished diamond. **Price in U.S.A. \$59.95. Price in Australia \$60.**



### EMPIRE PROFESSIONAL 999VE SUPER QUALITY STEREO ELLIPTICAL CARTRIDGE

— for high performance record playback systems only. Will track 30 cm/sec. at less than 1 gram. Patented 4-pole, 4-coil, 3-magnetic design. Frequency Response: 6—35,000 Hz. Output voltage: 5.0 millivolt per channel. Channel separation: more than 30dB. Tracking force 1/2 to 1 1/2 grams. Tracking angle: 15 degree. Stylus: .2 x .7 mil. elliptical hand polished diamond. **Price in U.S.A. \$74.95. Price in Australia \$75.**

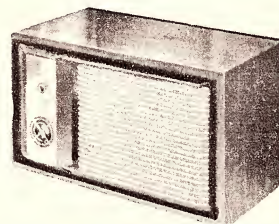

### MODEL 8200 IMPERIAL GRENADE LLOUDSPEAKER

Frequency response: 30-20,000 cycles. Power Handling Capacity: 100 watts. Sine Wave Power: 25-450 cycles . . . . . 60 watts 450-5000 cycles . . . . . 40 watts 5000-20,000 cycles . . . . . 20 watts 12in woofer, Mid Range-Direct Radiator. Tweeter-Ultra Sonic Domed Tweeter. Satin Walnut finish. Overall dimensions 24 1/2in W x 14in H x 12 1/8in D.

## RECORDED MUSIC SALON

23 Collins St., MELBOURNE, 3000.

TRUE FIDELITY,

C. Pinczewski. Tel. 63-6257.

of the best Italian song hits. Also included are: Help Yourself—A Man Without Love — Begin to Love — Semplicissimo — Mala Femmena — Como Prima — Vacanze — Forget Domani — Amore — Scusami — You and Only You — Sentimental Guitar.

Mottola always seems to be most at home with the music of his ancestral country, and is in particularly fine form here. The group of supporting musicians includes such outstanding performers as Dom Cortese on accordion, Phil Bodner on flute and piccolo, Dick Hyman on piano, harpsicord and organ, Bucky Pizzarelli on rhythm guitar, Bib Haggart on bass, Phil Kraus, vibes, and Bill Lavorgna, drums. The Project 3 sound is brilliantly clear and lifelike, with no discernible distortion and quiet surfaces. Recommended. (H.A.T.)

\* \* \*

**MAGIC FOUNTAINS.** Manuel and the Music of the Mountains. Stereo, Studio 2 Columbia SCXO-7885.

Interest: Popular favourites.  
Performance: Big, lush.  
Quality: Clean.  
Stereo: Well spread.

Lots of strings providing the melodic line from the left and centre, a touch of Brazil and strong rhythm from the right channel is the Manuel formula — a kind of extroverted Mantovani. Those who like the big, lush sound will enjoy it no end as Manuel and his orchestra line up a dozen popular themes: Stardust — Tangerine — Corcovado — Lonely Cloud — The Story Of A Starry Night — You And The Night And The Music — Symphony — A Man And A Woman — Estrellita — Magic Fountains — By The Fountains Of Rome — Stella By Starlight.

The sound is completely clean and at a generous level such that surface noise wouldn't have a look in — even if there was any, which there isn't! (W.N.W.)

\* \* \*

**THE ROMANTIC HARP.** Junko Nobata (harp) with orchestra. Calendar (Festival) Stereo SR66-9575.

Interest: Popular hits.  
Performance: Pleasing style.  
Quality: Varies somewhat.  
Stereo: Good spread.

Other discs from the same group that have come my way have been very pleasant listening and I was glad to get this one on its re-issue on the Calendar label, as I missed it first time round. The instrumental group plays very well, with the harp giving it that unusual touch which adds interest. However, I definitely did not like the female voice choir which "ahs" its wordless way through long segments of nearly every track. Not only is this distracting, but it has been badly recorded, so that distortion is quite noticeable, whereas the instrumental side has been very well recorded. If the company could be persuaded to re-cut the master and leave out the voice channel the disc would be a beauty, but for me it is spoiled by the voices in this present recording.

The tunes are: Flamingo — Over the Rainbow — You Don't Have to

Say You Love Me — Solenzara — Song of the Pearl Fisher — Ebb Tide — Fly Me to the Moon — Some Enchanted Evening — More — Strangers in the Night — Michelle — Misty. (H.A.T.)

\* \* \*

**LAND OF A THOUSAND GUITARS.** Buddy Merrill with orchestra. Crescendo (Festival) Stereo SGNPL-933,103. Available in Mono.

Interest: Current hits.  
Performance: Routine.  
Quality: Good standard.  
Stereo: Normal.

A routine performance of the current hits, with Buddy Merrill playing lead guitar and assisted by no less than 13 other guitarists as well as a fair-sized band. Pleasant enough of its type, but not the sort of disc you can get enthusiastic about. The tunes are: Do You Know the Way to San Jose? — Escondido — Love is Blue — When the Worm Turns — Ode to Billie Joe — When the Saints Go Marching In — MacArthur Park — Hushabye Mountain — Impossible Dream — Gentle on My Mind — Crack-Up — Street Corner. If this particular selection appeals, the disc could well please. Sound and stereo are up to standard. (H.A.T.)

\* \* \*

**INTERMEZZO.** Giuseppe Patane conducting the orchestra of the Bavarian State Opera. Capitol (E.M.I.) Stereo SP 8671.

Interest: Light classics.  
Performance: Good atmosphere.  
Quality: Excellent.  
Stereo: Normal.

Giuseppe Patane was a boy prodigy, conducting a full orchestra when other children of his age were still learning the rudiments of letters and numbers. Now in his thirties, he has developed

into a fine conductor with a style not unlike that of von Karajan, except that he tends to over-sentimentalise such items as the Intermezzo from "Cavalleria Rusticana" which forms part of this program, something Karajan would never do. The orchestra he conducts here is a much better one than the title might suggest, and all in all I found this a most pleasing performance.

Despite the title, it is only the second side which has intermezzi. On side one there is: Overture to "Norma" (Bellini) — Dance of the Moorish Slaves and Ballet Music from "Aida" (Verdi) — Overture to "Nabucco" (Verdi). The intermezzi on side 2 are from I Pagliacci (Leoncavallo) — Cavalleria Rusticana (Mascagni) — L'Amico Fritz (Mascagni) — Manon Lescaut (Puccini) — Suor Angelica (Puccini). In this expressive music, Patane obviously tries to convey maximum atmosphere, which ranges here from high excitement to gentle sentiment and stark tragedy. Provided you do not object to the rather sugary treatment of the sentimental numbers, the performances should prove to be enjoyable listening. (H.A.T.)

\* \* \*

**THE DANCING YEARS.** June Bronhill and the Saville Theatre Company. RCA Victor Stereo SL101841.

Interest: Prewar musical.  
Performance: High standard.  
Quality: Good.  
Stereo: Normal.

Presumably, this is an off-stage recording by the cast used for the London revival of the prewar Ivor Novello musical. The success of such revivals in London are possibly due to a nostalgic longing for the "Good Old Days" when Britain was the world's leading power, and such sentiments are not necessarily valid here.

## NEWS FROM SOUTHERN SOUND!!

### Sean (Mick) Spillane has joined Southern Sound

SOUTHERN SOUND announce the addition to its already extensive range of HI-FI equipment BOSE Unique Speaker systems, A.R. Speaker Systems, MONARCH Amplifiers and Speaker Systems, TELEFUNKEN Tape Recorders.

This world-renowned equipment is on continuous demonstration throughout May.

Sean's experience and the incomparable range of equipment coupled with the most competitive prices which are now all available from SOUTHERN SOUND assure you of complete satisfaction.

Phone, write or call SOUTHERN SOUND for the best audio sales service available in Australia.

"Prompt attention to mail orders and fast delivery assured."

MAY SPECIALS: Philips Cassette Stereo System — With Speakers — \$159.00. ROLLS Executant TSA1/10 \$399.00 (With Trade-In) TOSHIBA Stereo Complete \$155.00.

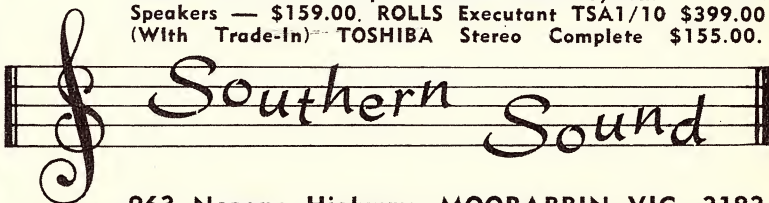

963 Nepean Highway, MOORABBIN VIC. 3183

# Check all systems -

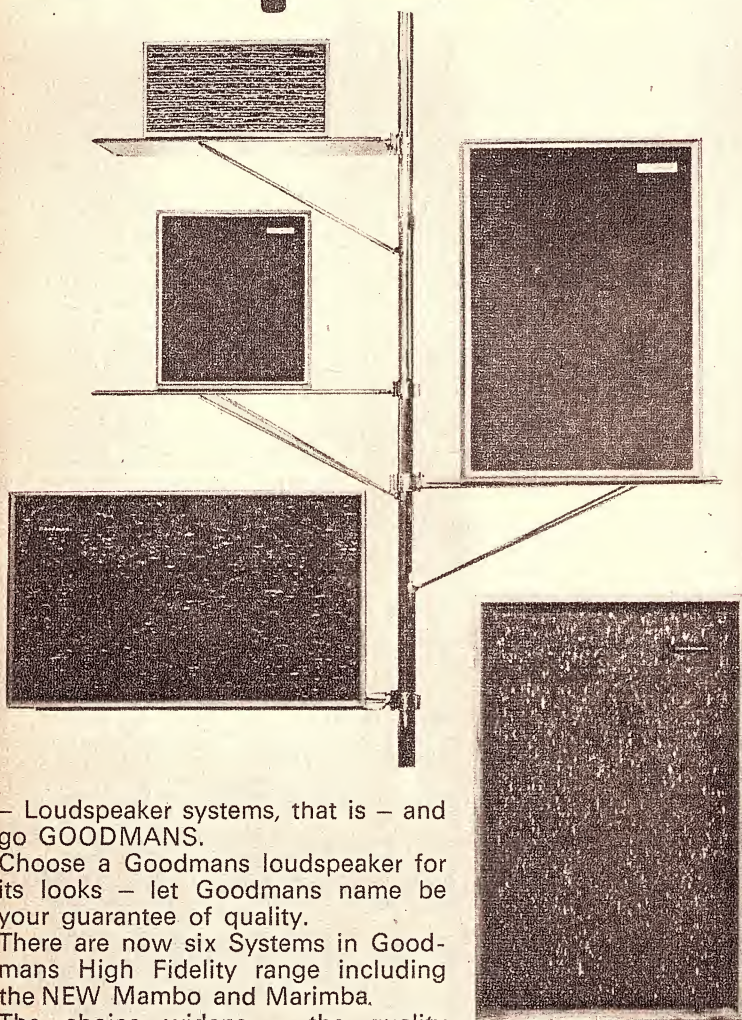

— Loudspeaker systems, that is — and go GOODMAN'S.

Choose a Goodmans loudspeaker for its looks — let Goodmans name be your guarantee of quality.

There are now six Systems in Goodmans High Fidelity range including the NEW Mambo and Marimba.

The choice widens — the quality remains the same. All offer the finest High Fidelity reproduction anywhere. Check for yourself — at your Goodmans dealer.

- 1 NEW! MAMBO\* 10½" x 8½" x 8" deep.
- 2 MAXIM Mini-system. 10½" x 5½" x 7½" deep.
- 3 NEW! MARIMBA\* For wall mounting. 19" x 13" x 5½" deep.
- 4 MEZZO 11 Flush fitted attenuator. 19½" x 12" x 9" deep.
- 5 MAGNUM-K. 3 speakers. 2 attenuators. 24" x 15" x 11½" deep.

All finished in Teak or Walnut to order.  
\*Sold in ready matched pairs.

## Goodmans for High Fidelity

For full particulars, write to the Sole Australian Agent:

**BRITISH MERCHANDISING PTY. LTD.**

Shaw House, 49-51 York St., Sydney. Telephone 29.1571 (3 lines)

Nevertheless, Novello's music is lilting and charming, and includes some of his finest melodies, including "Waltz of My Heart" and "I Will Give You the Starlight."

I doubt whether a more competent singer than Miss Bronhill has ever sung the role of Maria on stage but, to my mind, her rather hard soprano tone lacks the warmth required for this part. Apart from this, her singing is way above the standard of the rest of the cast, who are not particularly distinguished. The recording is of good quality, and the principals can be heard without difficulty, but the chorus suffers from poor diction so that it is virtually impossible to follow what they are singing without a libretto. If you are interested in a version of this musical, I suggest you should try to hear this one yourself before making a decision. (H.A.T.)

★ ★ ★

**SINCERELY YOURS.** Liberace at the piano with the Warner Bros. Symphony Orchestra. Music from the film "Sincerely Yours." Harmony (Australian Record Company) Stereo HAS 143.

Interest: Classics and evergreens.

Performance: Slick.

Quality: Dated.

Stereo: Electronic rechannelling.

Behind all his clowning, Liberace is basically a skilful pianist with a solid background of musical training and disciplined technique. This stands him in good stead when he is playing a program of classical music, as in this selection from the film "Sincerely Yours." Unfortunately, the exigencies of show business require that no piece shall be longer than a few minutes' duration, so the longer classics are all severely abbreviated. The worst example of this here is a ruthlessly truncated but otherwise charming performance on harpsichord of Mozart's famous "Turkish March."

The complete selection comprises: Cornish Rhapsody — Traumerei (Schumann) — Chopsticks — Liebestraum (Liszt) — Gershwin Medley — Turkish March (Mozart) — Concerto No. 1 (Tchaikowsky) excerpt — Rhapsody in Blue (Gershwin) excerpt — Sincerely Yours — El Cumbanchero — Minuet in G (Paderewski) — Tea for Two — Polonaise in A flat — Beer Barrel Polka. I hardly feel it necessary to add that this is a disc strictly for those who are not normally listeners to the classics, but like light classical melodies with a sprinkling of evergreens. In this context, the disc should give a good deal of pleasure. (H.A.T.)

★ ★ ★

**A STEREO SOUND SPECTACULAR.** T. Miyama with his New Herd Orchestra, featuring H. Yamamoto and K. Yokoyama playing shakuhachi, and T. Sawai, koto. King Records, Japan, released in Australia by Festival Records, Stereo SFL 933104.

Interest: Bossa Nova from Japan.

Performance: Good standard.

Quality: Excellent.

Stereo: Wide and smooth.

Having now thoroughly absorbed Western style music and shown that they can perform at least as well as



"Yes, she's away - but she left some nagging for me on tape!"  
("TV Times")

Western bands, Japanese performers appear to be taking an interest in bringing some of the traditional Japanese instruments into their combos. Thus, in this disc, the fairly large and conventional instrument line-up is supplemented by two shakuhachis (traditional five-hole bamboo flutes) and a koto, a harp-like instrument with 13 silk strings. A casual listener would probably not detect any great difference in this performance of ten numbers, all in bossa nova style. However, the flutes seem to be rather richer in harmonics than the Western variety, and presumably have a more limited range. The koto sound, when one becomes aware of it, is unlike that of any Western stringed instrument, being rather sharp and non-resonant.

In general, the band sounds like a very competent group playing popular tunes with skill and taste, but the unvarying bossa nova rhythm starts to become tedious by the time one has heard the disc all through. Taken a bit at a time, though, it is pleasing enough. The sound quality is excellent throughout, full and rich with no evidence of distortion. The selection comprises: Adieu Tristesse — The Look of Love — Sunny — Il Bacio — Mas Que Nada — Constant Rain — Vivre pour Vivre — Un Homme et une Femme — Agua de Beber — The Girl from Ipanema. H.A.T.)

★ ★ ★

**GREAT CATHEDRAL ORGAN SERIES—WORCESTER CATHEDRAL.** Christopher Robinson, organist. His Master's Voice (E.M.I.) Stereo OCSD 3646.

Interest: See title.  
Performance: Competent but un-enterprising.  
Quality: Good standard.  
Stereo: Normal.

Continuing their series of cathedral organ discs, E.M.I. in U.K. has recorded this recital in Worcester Cathedral. Although Worcester is a fairly modest county town in the English Midlands, and the cathedral is by no means large, the organ it possesses is fairly massive. The present organ was built by Robert Hope-Jones in 1896 and was restored and enlarged, with some revoicing, by Harrison and Harrison, in 1925. Further voices were added in 1967. The present arrangement is as follows: Pedal Organ, 13 stops with four couplers; Choir organ, 10 stops, four couplers; Great organ, 15 stops,

10 couplers; swell organ, 17 stops, tremulant and two couplers; solo organ, six stops, two couplers. This gives 61 speaking stops and 23 couplers, a total of 84 drawstops. The manual compass is CC to C, 61 notes, and the pedal CCC to F, 30 notes.

Wind pressures are: Pedal flue-work 5in, diapophones 17in, reeds 17in and 20in; choir 3in; great flue-work 5in and 10in, reeds 15in; swell 5in and 10in; solo, enclosed, 20in, tuba 17in and 20in; action 12in. The action is electro-pneumatic.

The resident cathedral organist is Christopher Robinson, a competent, rather than exciting player. The program he has selected does little to show the resources he has at his command here, and for much of the recital he plays very quietly, so that at first one is led to believe that he has been recorded at low level. However, in some passages where he plays forte it becomes apparent that this is not the case. The program comprises: Prelude and fugue in C major, BWV 547 (J. S. Bach) — Sonata No. 3 in A. Op.65, No. 3 (Mendelssohn) — Chorale Preludes, "O Gott, due Frommer Gott and Nun Ruhen Alle Walder (Peeters) — Piece Heroique (Franck) — Partita (Mathias). Not an enterprising program, but certainly a pleasing one. Unless you have some particular reason for wanting this particular disc, I suggest there are others, some of them in this same series, which are more attractive. (H.A.T.)

★ ★ ★

**KENNETH MCKELLAR IN CONCERT.** Kenneth McKellar, with orchestra conducted by Robert Sharples, or accompanied by Denis Woolform, piano. A Decca recording released exclusively in Australia by World Record Club. Stereo S.4400.

Interest: Classical songs and arias.  
Performance: Some shortcomings.  
Quality: First rate.  
Stereo: Normal.

Kenneth McKellar will be better known as an entertainer singing ballads than as an interpreter of classical songs, but here he turns to rather more substantial fare: Caro Mio Ben (Giordani) — Die Forelle (Schubert) — Ich Liebe Dich (Grieg) — Santa Lucia (Cleather-De Meglio) — Serenade from "The Fair Maid of Perth" (Bizet) — Sea Fever (Ireland) — Torna a Surriento (de Curtis) — Nessun Dorma from Turandot (Puccini) — The Roadside Fire (Vaughan Williams) — Dream Song from "Manon" (Massenet) — Elegie (Berlioz) — Plaisir D'Amour (Martini) — Mattinata (Leoncavallo).

Mr McKellar sings many of these songs very well, and taken as fairly light entertainment there is much to enjoy. However, he is not entirely successful with some numbers. His rendering of "Die Forelle" is too stiff, and this fatal to successful lieder singing. He is more at home in the Italian songs, and his performances of the operatic numbers, although not of the kind which brings audiences to their feet in opera houses, are a very good effort. Not a disc for the experienced concert goer, but pleasant enough for lighter listening. The technical side of the disc leaves nothing to be desired. (H.A.T.)

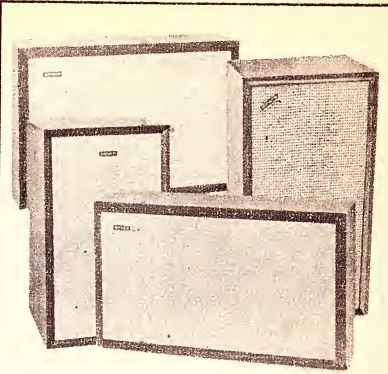

**ADD A SONICS SPEAKER SYSTEM**

Several models are now available . . . priced from \$22.50 to \$68. Write for details of these fine, teak/walnut enclosures.

**KENWOOD AMPLIFIERS NOW AVAILABLE!**

Save more at Encel's . . . write or call for your Kenwood price. Ask for a trade-in valuation on your old equipment; often the allowance made for working units will reduce your outlay considerably. All Kenwood models available.



**NEW MICRO VF-3100 SERIES STEREO CARTRIDGES PROVE MOST POPULAR EVER!**

With a frequency response of 20-28,000 Hz. and channel separation of 28 dB, the Micro VF-3100 series cartridges have already established new performance standards for lower priced magnetic cartridges. Two models are available, the VF-3100/E with elliptical diamond stylus and the VF-3100/5 with a conical diamond stylus. Stylus for both cartridges are replaceable; both track effectively at 1½ grams.

**SAVE ON SANSUI AMPS & SPEAKERS**

All popular Sansui models are in stock . . . amplifiers and speaker systems. Write for your EMQ or call at your nearest Encel Stereo Centre.

**CONNOISSEUR STEREO CARTRIDGE — ONLY \$12.50**

Designed to effectively load any amplifier or tape recorder, the Connoisseur Model SCU-1 ceramic stereo cartridge has an extremely wide frequency response and is fitted with a diamond stylus. Ask for copies of reviews **\$12.50**

**DUAL 1019 TURNTABLES ON SPECIAL OFFER!**

Write or call now for a very special Encel proposition — we're not at liberty to advertise the low Encel price.



**SAVE YOUR RECORDS . . . USE THE UNIVERSAL NIKKA-LUSTRE TONE ARM LIFT!**

This beautifully finished and functional universal tone arm lift will fit all tone arms . . . the lowering action is pneumatically dampened and extremely smooth. Risk of record damage may now be eliminated. **\$8.50**  
Including Sales Tax

**Encel ELECTRONICS (STEREO) PTY. LTD.**

Head Office:  
431 Bridge Rd., Richmond, Victoria 3121.  
Tel. 42 3762.  
Sydney Store: Ground Floor, 2SM Building,  
257 Clarence Street, Sydney, N.S.W. 2000.  
Tel. 29 4563, 29 4564.

\*Wholesalers \*Trade-ins accepted

Australia's Greatest Hi-Fi Centre

# Radiography certifies tiny electronic parts on Telstar

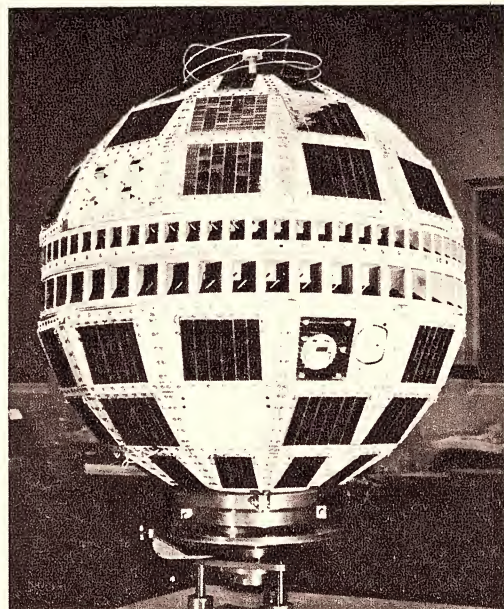
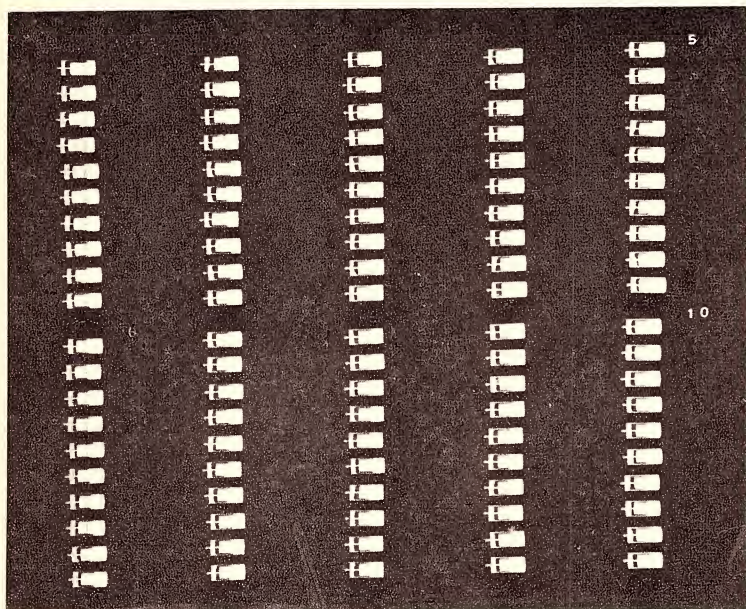

The thousands of parts in Telstar must perform perfectly, including solid tantalum capacitors shown in the radiograph reproduced here. These capacitors were radiographed on Kodak film to show whether their anodes were positioned and plotted properly, and to search for stray solder globules.

The uses of radiography in industry are practically endless. Castings and welds can be inspected for soundness. Even sealed internal assemblies can be inspected. For quality control of the smallest capacitor or largest transformer radiography can save you time and money and help you build a reputation for quality.

Kodak's outstanding range of industrial x-ray films includes general-purpose films; fine-grain films for highest quality production radiography, as well as for extra critical radiography; also single-coated films for maximum detail under high magnification.

Ask your Kodak technical sales representative for further information or write to:

## Kodak

Radiography Markets Division,  
KODAK (Australasia) PTY. LTD.  
Branches in all States.

K. 1986

**SONGS MADE FAMOUS BY NAT COLE** — Earl Grant. Universal Record Club U938.

Interest: Grant's vocals and organ.  
Performance: Polished.  
Quality: Well recorded.

I have always disliked and rather resented the basic principle of albums which are recorded as tributes to artists who have died. This album makes me feel even more uncomfortable than usual, since Earl Grant has always sounded remarkably like the late Nat King Cole. There are, too, some moments of doubtful taste on the album.

But Earl Grant is a remarkably popular artist in Australia and he can be an exciting and versatile performer, particularly in nightclubs. On this album, he plays piano, organ and sings on 12 compositions, most of which were sizable hits for Nat Cole. They include "Sweet Lorraine," "Nature Boy," "Straighten Up And Fly Right," "Ramblin' Rose" and "Mona Lisa." It must be said that Grant handles the songs with his usual professionalism.

Earl Grant enthusiasts will undoubtedly wish to add this to their collections, particularly at the cheap club piece. Other readers may perhaps prefer to listen to the original versions of the songs by Nat King Cole. The playing time, incidentally, is 36 minutes. (T.F.C.)

**SPANISH ALBUM. The Sandpipers.** Universal Record Club Stereo U-956.

Interest: Latin American.  
Performance: Pleasing style.  
Quality: See review.  
Stereo: Normal.

As previously noted in these columns, the Sandpipers are very pleasant to listen to. Although an all-male singing trio, their performances have an unusual coloration by virtue of the soprano voice of one of the members. I take this release from Universal Record Club as a re-issue of their first L.P., as it features their first big hit, "Guantanamera." It was perhaps not a good idea to sing all the songs (even those which had original English lyrics) in Spanish. My experience is that most people prefer their own language. The titles are: Guantanamera—La Bamba — Etranos en la Noche — Llevame a la Luna — Cancion de Amor — Louie, Louie — Cuando Sali de Cuba — Ayer — Michelle — Y la Quiero — Enamorado — Ojos Espanoles. Original an A. & M. release, the disc has good quality sound, but due to a recording fault the sibilants are overemphasised—an unfortunate occurrence, in view of the prevalence of these sounds in Spanish. The lightweight accompaniment consists of only guitar, bass and percussion. (H.A.T.)

**SEAN AND SONJA.** Harmony (Australian Record Company) Electronic Stereo HAS 145.

Interest: Sydney Folksingers.  
Performance: Lacks polish.  
Quality: Below standard.  
Stereo: Rechannelled electronically.

Sean and Sonja showed promise of becoming an accomplished folk singing duo a few years ago, but they seem to have disappeared from the entertainment scene — at least, I cannot recall having seen or heard them in the

past two years. I believe this was their first L.P. release, and C.B.S. have now made it available on their economy Harmony label. I missed this when it first came out, but I did obtain the couple's second release. At that time I commented on certain weaknesses of style, and not surprisingly the same weaknesses are evident here also — a certain amount of unsteadiness and uncertain phrasing. Despite this, they are pleasant enough on the ear, particularly if one is not listening too critically, and they present an interesting and unhackneyed program here: Springtime it Brings on the Shearing — Old Man — Derry Down — The Crow on the Cradle — Jabbin, Jabbin—Mingulay Boat Song — Devilish Mary — Van Diemens Land — Which of My Daughters — Out of Noonkah — Two Maids — Turn Around.

The sound is below what we now regard as a good standard, and there is a peculiar hiss BEFORE each rebalance in the vocals. The electronics rechannelled stereo is not too obviously artificial, but I do not think it does much for the disc. (H.A.T.)

**LOVIN' MOOD—Freddie Paris.** RCA Dynagroove Stereo LSP 4064 (also in mono).

Interest: Mainly ballads.  
Performance: Accomplished.  
Quality: First-rate recording.  
Stereo: Evenly spread.

The back of the sleeve to this record announces in large letters that this is "a memorable first album for a memorable singer." Freddie Paris is without doubt a capable and professional artist (and very popular in Sydney Clubs), but the main feature of these tracks is that most of them are completely ordinary.

This is, after all, a highly competitive field and a singer requires more than a pleasant voice to register strongly on a 12in L.P. However, the 11 tracks are easy listening and, in particular, I enjoyed "We'll Be Together Again," "My Foolish Heart," "Trust In Me," and "What's New?" Most of the tracks, indeed, are ballads.

The arrangements by Don Costa are, as usual, beautifully scored and performed. The playing time of this pleasant, unambitious album is 36½ minutes. (T.F.C.)

**WHAT'S AN UGGAMS? — Leslie Uggams.** Atlantic (Festival). Stereo SAL 933073 (also in mono).

Interest: Young Broadway star.  
Performance: Dull material.  
Quality: Superb.  
Stereo: Well balanced.

Leslie Uggams has come a very long way since she started her career on the Mitch Miller Show. She now appears in the best nightclubs; she had her first Broadway starring role in 1967 in the smash success, "Hallelujah, Baby"; and she recently played the much-coveted part of Cleopatra in "Her First Roman," the Broadway musical version of "Caesar and Cleopatra."

This young singer-dancer-actress obviously has a great deal of talent but her voice on record lacks the communication and personality of artists like Dionne Warwick and Barbra Streisand.

A major part of the trouble in this case is the disappointingly anonymous

**JØRGEN Specialist Hi-Fi Equipment**

The most technically advanced sound equipment in the popular price category.

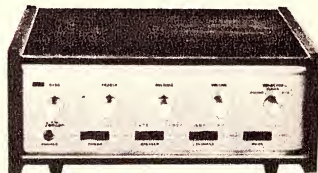

**Jorgen Model A303 solid state stereo amplifier.**

**Specifications:**

- 19 transistors, 8 diodes.
- Music power 30 watts total at 8 Ohms.
- Frequency response 30-20,000 cps ± 2db.
- Complete in attractive polished wooden case.
- Stereo headphone jack on front panel.
- Exclusive loudness control (Good Bass at Low Volume).
- Harmonic distortion less than 1%.
- Hum and noise level on magnetic phono — 50db.
- Sensitivity — magnetic inout 3mv, tuner or auxiliary 250mv.
- Plug in tape recorder facilities.

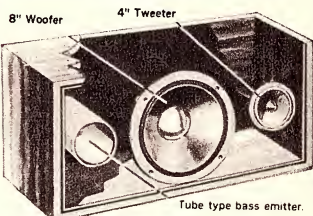

**Jorgen SE50 true 2 way book shelf speaker system.**

**Specifications:**

- 8" Woofer and 4" tweeter high quality hi-fi speakers.
- Tuned enclosure with tube-type Bass Emitter.
- Overall response of 35-18,500 cycles.
- 3,000 CPS electrical crossover.
- 20 watts power handling capacity.
- Front cloth — choice of light (No. 6) or dark (No. 9).
- Polished wood cabinet.

**Retail Enquiries**

**Brashes**

Hi-Fi Centre  
108 Elizabeth St.,  
Melbourne. 63 6701  
Edels Pty. Ltd.,  
88 King St., Sydney.

**Wholesale Enquiries**

**AUSTRALIAN MUSICAL INDUSTRIES**

155 Gladstone Street,  
Sth. Melbourne. 69 7281  
108 Elizabeth Street,  
Melbourne 63 2601

WB431

# Here is

# LEAK HIFI

# Craftmanship & Quality

A COMBINATION OF TALENTED DESIGNERS  
AND THE FINEST TECHNICAL MINDS.



**LEAK 'STEREO  
70' AMPLIFIER**

**\$298.00**

The 'Stereo 70' is full of latent power — up to 35 watts r.m.s. per channel. Distortion is a mere 0.1% at 1,000 Hz for all power outputs up to 25 watts r.m.s. per channel. In addition, this extra output enables a pair of loudspeakers to be connected apart from the two in the main listening room. Elegantly finished in black and silver, or an attractive teak case is also available for shelf mounting. Other brand new features are a head-phone socket for those who prefer to listen to stereo that way, and a DIN record/replay socket on the front panel for a portable tape recorder together with the standard inputs at the back of the amplifier.

All this, backed by the famous LEAK craftsmanship and reliability, makes the Stereo 70 the most technically advanced amplifier available.

**LEAK 'STEREO 30' AMPLIFIER**

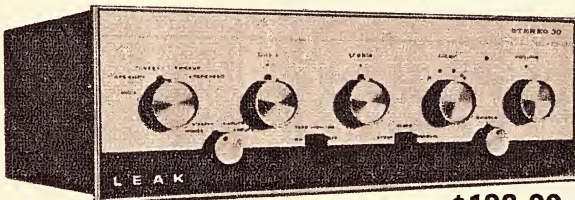

**\$198.00**

The 'Stereo 30' solid-state amplifier offers the discriminating music lover studio-quality sound reproduction, advanced audio engineering and pleasing aesthetic design. The performance of the LEAK 'Stereo 30' represents the highest standards available. Each LEAK instrument is individually crafted and has the same high quality performance as LEAK instruments supplied to broadcasting and television companies throughout the world.

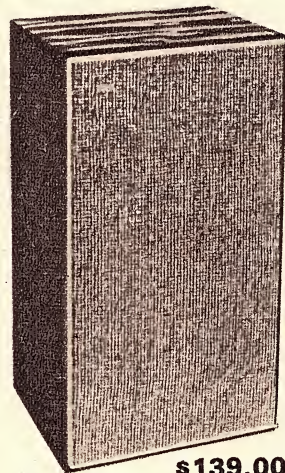

**LEAK  
SANDWICH MK. II  
SPEAKER SYSTEM**

**\$139.00**

The Sandwich cones comprise stiff aluminium skins for the outer surfaces where stresses are greatest, bonded to a thick core of featherweight, expanded plastic where stresses are lowest.

Use of this material provides immense stiffness and rigid piston action over more than six octaves and results in a remarkably smooth response free from violent peaks and troughs over a very wide frequency range. Available in mahogany, teak and walnut, this beautifully finished enclosure is still the only compact speaker system offering substantially linear frequency response. Size: 26" x 15" x 12".



**LEAK MINI-SANDWICH  
SPEAKER SYSTEM**

**\$99.00**

For music lovers who cannot spare space for a full-size LEAK Sandwich, the new Mini-Sandwich provides almost identical performance, with the exception of the very lowest octave. This superlative small speaker system is designed and made exactly as its larger companion. Size: 18½" x 11" x 7". Available in mahogany, teak and walnut.

**LEAK HIFI**

H. J. LEAK (AUST.) PTY. LTD.

P.O. BOX 14, FRENCH'S FOREST, N.S.W. 2086.

FACTORY: 1 CAMPBELL PARADE, MANLY VALE, N.S.W. TELEPHONE: 94 4902.

CABLES: LECTRON, SYDNEY.

Professional equipment enquiries to Simon Gray offices or Representatives in all states



materials, despite the inclusion of four Bacharach/David compositions. Most of the songs would probably be more effective on stage. Six of the arrangements were written by Pat Williams and they, too, are rather commonplace.

Overall, the 32½ minutes of this album fail to do Miss Uggams complete justice. With better production, more appropriate material and stronger arrangements, we can, I hope, look forward to a more impressive and significant album next time. (T.F.C.)

\* \* \*

**I STARTED OUT AS A CHILD.** Bill Cosby. Stereo, Warner Bros. WS-1567.

Interest: More Cosbyisms.  
Performance: As always.  
Quality: Good.  
Stereo: Unimportant.

I don't mind at all listening to Bill Cosby. He's always good for laughs, earned by ability and an excellent sense of timing. The problem is to find something to say about the album, different from what one has said before about others.

The 15 tracks which vary in duration from less than a minute to nearly four minutes are snippets from longer performances before an obviously enthusiastic audience. In the first few tracks, Cosby resurrects childhood memories and situations, progressing through more adult situations, to a crack at Seattle . . . where it rains so much that they're afraid of the sun!

It's different material from that on other albums which I've reviewed so, if you're collecting Cosby humour, here's another album full. (W.N.W.)

\* \* \*

**WHERE IS LOVE.** Jack Jones. RCA Dynagroove Stereo LSP-4048.

Interest: Popular ballads.  
Performance: Polished entertainment.  
Quality: Good standard.  
Stereo: Normal.

The situation of Jack Jones at present reminds me of the down-and-out entertainer on the park bench explaining to another similarly situated how he used

to be very rich — until he started to sing good tunes and sensible lyrics. Jack Jones always sings good tunes and sensible lyrics, but it has not got him very far. Certainly not on the hit charts as yet. He has a fine natural voice (inherited from his famous father, Alan Jones), a sound musical training, and a large measure of integrity. In the current situation, the latter must be rated, commercially at any rate, as a disadvantage. However, as long as he continues to sing as well as he does here, there will always be a minority to appreciate his qualities. His selection here consists of: Where is Love — Light My Fire — Suzanne — Lonely Afternoon — Round the Bend — I Really Want to Know — Good Times — Valley of the Dolls — It's Nice to be With You — Dreams Are All I Have — Old Man River.

As I said, all good tunes with sensible lyrics. The arrangements are good, the orchestra plays very well and the technical side of the disc is excellent. A very pleasant disc. (H.A.T.)

\* \* \*

**BOBBY GENTRY AND GLEN CAMPBELL.** Capitol (E.M.I.) Stereo ST 2928.

Interest: Folk/C. & W. duets.  
Performance: Entirely successful.  
Quality: Very good.  
Stereo: Normal.

Individually, Bobby Gentry and Glen Campbell have a relaxed charm in their performances which cloaks the expertise they both possess. Together, these qualities are compounded, and for an act which appears to have teamed up almost spontaneously, the combination is an outstanding success. In a most satisfying performance, the two voices blend wonderfully, in the kind of simple harmony which is perfect for the unsophisticated music they offer here. Included are Gentry's own "Mornin' Glory" and Campbell's "Less of Me." The other tracks are: Little Green Apples—Gentle on My Mind—Heart to Heart Talk—My Elusive Dream—Imagination—Terrible Tangled Web—Sunday Mornin'—Let It Be Me—Scarborough Fair. A disc which C. & W. and folk song enthusiasts cannot fail to enjoy. (H.A.T.)

## Popular Jazz

**"GREATEST HITS"**—Duke Ellington. C.B.S. Stereo SBP 233,620.

Interest: Varied Ellington 1947-1960.  
Performance: Useful for new collectors.  
Quality: Generally sub-standard.  
Stereo: Some tracks "re-channelled."

This re-issue album is a rather haphazard selection of Ellington's best-known compositions, apparently chosen quite irrespective of the individual performance. It is, in fact, aimed not at the genuine Ellington collector but at a much wider market and this is substantiated by the regretful absence of discographical information.

The ten tracks, in fact, come from the period November, 1947-May, 1960. The best tracks on the album (dating from 1957) are "Prelude to a Kiss," featuring Johnny Hodges; "Solitude" which is mainly a feature for Ellington's piano; and "Mood Indigo" with a beautiful trumpet solo by Harold Baker.

The other tracks are, frankly, not vintage Ellington. On two tracks, the 1959 version of "C Jam Blues" and the 1952 "A Train" with Betty Roche, savage tape-editing has cut minutes off the original playing times. On other tracks (like the two 1947 Al Hibbler vocals, "Don't Get Around" and "Do Nothing"), the real personality of the Ellington Orchestra is somehow missing.

I think we would all agree that for the last 43 years, Duke Ellington has led the finest jazz orchestra in the world. This album may serve as a useful introduction to the band of the 1950's for the new collector.—T.F.C.

\* \* \*

**THE ORIGINAL DIXIELAND JAZZ BAND.** RCA Vintage Series LPV-547.

Interest: Historically important.  
Performance: Six classic tracks.  
Quality: Expertly transferred.

The Original Dixieland Jazz Band (henceforth, the ODJB) was of course the first to record in the jazz idiom.

**WE SPECIALISE IN TAPE RECORDERS EXPERT REPAIRS**

To all brands by German technicians in modern equipped workshop.

Contact

**REKLA**

KLAPP ELECTRONICS PTY. LTD.,  
224 CHAPEL STREET, PRAHRAN, VICTORIA.  
TELEPHONE: 51-4653.

## NEW EQUIPMENT CABINETS

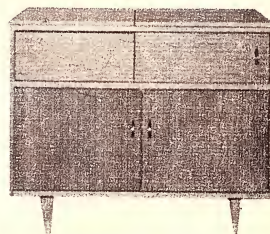

MODEL 154

With lift-up lid over player. Sliding door in front of amplifier compartment. Large storage space with four separators. Size: 36in wide, 17½in deep, 31in high.

Price

Made and polished (maple, walnut or teak) ..	\$63.50
Packing .. .. .	\$2.20
Kit of Parts .. .. .	\$36.00
Packing .. .. .	\$1.40
Teak extra (Kits only) .. .. .	\$6.50

New Player Platform model 175 is 16in x 14in x 3½in. Price \$7.50 for maple or walnut. Kit of parts \$4.00. Teak, 50c extra. Perspex cover, 3½in or 5½in high, \$8.20 and \$1.50 extra if required hinged. Please specify cutout required.

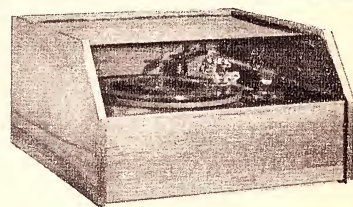

MODEL 186

New Player Cabinet model 186 is 9½in high, 16in wide, 16½in deep and 5½in above shelf. Finished with attractive hinged, tinted perspex top. Price: \$21.00 for maple or walnut or teak.

Kit of Parts: \$13.50.

Teak: \$1.00 extra (Kits only).

Height of this model can be increased to take various amplifiers. Tailored cut out. Ask for quotation.

Free on rail.

Packing charge \$1 per order.

Write for Catalogue and Player Guide

## H. B. RADIO SALES

Manufacturers of Quality Radio and Radio Furniture for 37 years  
103-105 CATHERINE STREET,  
LEICHHARDT, SYDNEY.  
TELEPHONE 56-5580.

# FREE!

## Bonus Offer ... FREE NEEDLE

Diamond or sapphire

Buy one Astatic stylus and receive a free duplicate or other selected Astatic needle of equivalent value

- Write for Free 57-page catalogue.

A SAMPLE OF THE ASTATIC RANGE

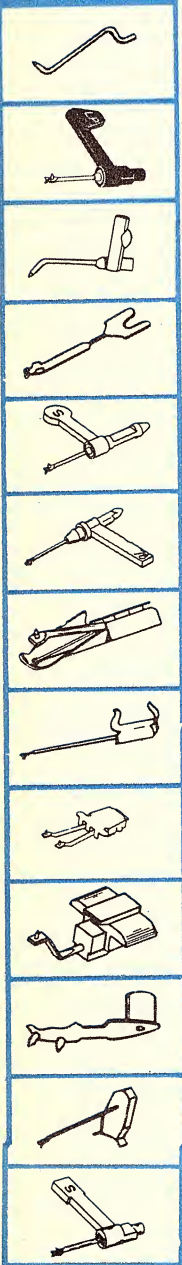

**Compare these prices Now!**  
Just a small selection from the mighty Astatic range.

ASTATIC NEEDLE No.	ASTATIC LIST	OTHER MAKES	CARTRIDGE TYPE
N8-7s	\$1.75	\$1.95	BSR-TC8
N8-7d	4.50	5.00	BSR-TC8
N101-1d	4.95	5.00	Acos
N160s	3.50	3.60	BSR-C1
N160sd	5.95	7.00	BSR-SX series
N601-1s	1.75	1.75	Ronette 105-6
N601-7d	4.50	5.00	Ronette 105
N649-7d	16.60	19.00	Shure M7-M8

s = Sapphire                      d = Diamond



Only our huge buying enables us to make this unbeatable offer on world famous U.S.A. manufactured replacement styli.

World's largest manufacturer of styli pick-up cartridges and microphones. All Astatic styli are factory packed in sealed containers and supplied with full fitting instructions.

The U.S.A.-made Astatic range (over 1,000 different needles for every type of pick-up) has been hand-crafted for over 40 years with a precision equalling that of Swiss watchmakers. Every needle is "Shadowgraph" enlarged and examined for perfect symmetry and alignment—precisely right for brilliant response.

### FREE EXAMINATION

Your local Astatic dealer or the Green Corporation Ltd. will examine your old needle and give you a full report. This service is free.

### CARTRIDGES!

Ask for our special price and Free comprehensive catalogue.

### TRADE ENQUIRIES

Welcomed . . . .

### SOLE AUSTRALIAN DISTRIBUTORS

Green Corporation Ltd.  
88 King Street, Sydney 2000  
Phone 25 1989

**Green Corporation Ltd.**  
88 King Street, Sydney 2000

Please send me the following comprehensive catalogues.

Tick preference

- Needle Catalogue
- Cartridge Catalogue

Tick here  if you have included your old needle for a free examination.

Name.....

Address.....

.....Code.....

GN48

The jazz which the ODJB played was a complicated blend of ragtime, march music and early dance music. The band's real strength was in its collective improvisation and finely integrated ensemble — tighter and much less relaxed than the Negro jazz of the period. The cohesion the ODJB displayed has never really been matched in the Dixieland idiom.

The 16 tracks on this album can be grouped under three main headings. The first six were recorded in 1917-18, by far the ODJB's most creative years and, of these, the two 1917 tracks, "Livery Stable Blues" and "Dixie Jazz Band One-Step" are undoubtedly classics of jazz history.

Four of the tracks, including "Margie" and "Broadway Rose," which the ODJB recorded after their return from London in 1920, are also featured but, even allowing for the inclusion of Benny Krueger's dreadful alto, the music is little more than second-rate and very commercial dance music.

The 46½ minutes of the album are completed by six tracks which the reunited ODJB made in 1936. The recording quality and the musicianship were superior but the creative spark and the sheer excitement of 20 years before were missing. These tracks do, however, confirm that Larry Shields was one of the great clarinetists of jazz.

With six really outstanding tracks from their vintage days and most of the other 10 tracks having at least historical interest, this album should be of considerable interest to readers who take their jazz at all seriously. (T.F.C.)

★ ★ ★

**THE BEST OF PEE WEE HUNT,**  
Capitol Encore Series (E.M.I.)  
Mono ENC 9423.

Interest: Party Dixieland.

Performance: Lightweight but competent.

Quality: Adequate sound.

This album may or may not represent "the best of" Pee Wee Hunt's many recordings over the years. However, it does include "Twelfth Street Rag," one of his biggest commercial successes of some 20 years ago. Although the format of his band is decidedly Dixieland at its most banal, it may perhaps be kinder to judge the results as party or dance music.

On this criterion, Pee Wee Hunt undoubtedly has his admirers, who may enjoy tunes like "Sheik of Araby," "Miss Otis Regrets" and "Charleston." For the rest, the material was unfamiliar to me and, I regret, completely forgettable. Even his loyal fans, however, may resent the playing-time of 29 minutes, despite the budget-price of \$2.50. (T.F.C.)

★ ★ ★

**SKETCHES OF SPAIN—Miles Davis and the Gil Evans Orchestra.**  
CBS Stereo KLLS 1645.

Interest: Orchestral jazz.

Performance: Outstanding collaboration.

Quality: Well recorded but some surface.

Stereo: A great advantage.

This album, the third by Miles Davis and Gil Evans, was recorded in November, 1959 and March, 1960 and was available in Australia some years ago. In view of its importance, the reissue of "Sketches of Spain" is extremely welcome and encouraging.

The abilities of the principals, trumpeter Miles Davis and arranger/composer Gil Evans, are beyond dispute. In their respective ways, both have made crucial contributions to the development of jazz over the past 20 years.

Miles Davis had previously demonstrated his natural affinity with Spanish music on "Flamenco Sketches" (from the classic album "Kind of Blue") and "Blues for Pablo" from the "Miles Ahead" L.P. which he made with Gil Evans.

Side 1 includes Joaquin Rodrigo's "Concierto De Aranjuez" (the outstanding track) and Manuel de Falla's "Will O' the Wisp," while Side 2 features three compositions by Gil Evans, which are convincingly in the traditional Spanish idiom.

The orchestrations and their execution are quite superb, intense, colourful and a perfect blend of jazz voicings and Spanish atmosphere. The trumpet solo work of Miles Davis, particularly in the lower register, is equally remarkable, at once sad and proud, dramatic and delicate but above all haunting and overwhelmingly memorable.

This album must be regarded as essential listening for anyone who enjoys the trumpet playing of Miles Davis, or, indeed, has the slightest interest in contemporary jazz or Spanish music. (T.F.C.)

★ ★ ★

**THE VERITABLE MR BILK — Acker Bilk and his Paramount Jazz Band. EMI Lansdowne Series. Stereo SCXO 6241.**

Interest: Bilk "live" and studio.

Performance: One poor and one good side.

Quality: Disappointing sound.

Stereo: Poorly balanced.

For some reason, EMI have been releasing Acker Bilk L.P.s — both in a jazz and strings setting — with monotonous regularity over the past few months.

Side one of his album contains three tracks recorded by the Paramount Jazz Band during their tour of New Zealand in 1966. Unfortunately, it is quite the worst Bilk that I have heard for a long time. The recording quality is primitive and the music is rough and untidy.

On "Tiger Rag" and "Bugle Call Rag," for example, the band is clearly playing very much to the audience. The results are not impressive — even on "Undecided," by far the best track on this side.

Fortunately, Side two is a much different proposition. These tracks were recorded at the Lansdowne Studios in London and the Bilk Band was augmented, for the occasion, by the great baritone saxophonist Ronnie Ross.

The material, too, is much more interesting. On the classic mainstream tune, "Huckle Buck," for example, Bruce Turner (alto), Stan Greig (piano), Al Fairweather (trumpet), Ross and Bilk turn in first-rate solos. But throughout this side, there is a more relaxed feeling, good solos and some constructive riffing.

Despite the relatively high quality of the second side, I cannot imagine that this L.P. would have more than passing appeal to the record-buying public. (T.F.C.)

# The HI-FI experts

Have expert advice on your choice of a stereo system. Come to Kent Hi-Fi and choose from our complete range of imported, world-famous brand Turntables, Amplifiers and Speakers. We'll advise you on latest trends and on the best value system for your price. Our personal six months' guarantee covers every unit sold, delivered and installed free of charge.

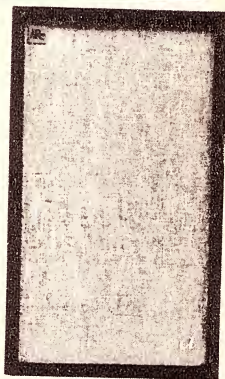

AR



If you want a high performance Stereo System, consider the famous American Acoustic Research. A & R Equipment is designed to reproduce a musically natural sound — not one that is distorted or "pepped-up" — but one which, as the term "hi-fi" implies, produces the highest possible degree of fidelity to the original. A & R turntables, amplifiers and speakers are now available from Sydney's top "Hi-Fi" Shop!

## KENT HI-FI

432 Kent Street, Sydney. 29 2743

(20 yards from Druiitt Street)

# 1967

# ALL WAVE

# 3-4-5-6-7

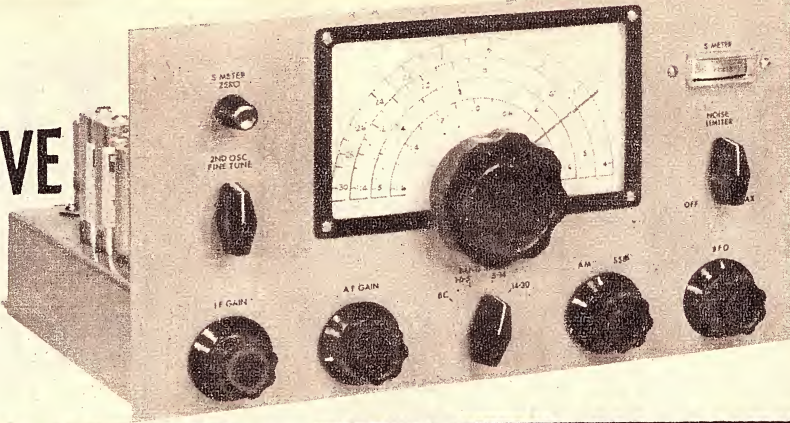

ANY PART  
FROM A  
SINGLE  
RESISTOR  
TO THE  
FULL KIT

## POPULAR KITS - TOP QUALITY - LOWEST PRICES

### INSTRUMENTS C.R.O.

1. 5in wide range.
2. 1963. 3in cal.
3. Audio.
4. 1966. 3in.
5. 1968—Audio.
6. Electronic SW.
7. W/band Preamp.

### MULTIMETERS and V.T.V.M.'s

8. 20K ohm/Volt protected M/M.
9. Probe for above.
10. Protected D.C. M/M.
11. Meterless V/meter.
12. A.C. Millivoltmeter.
13. A.C. Solid State Millivoltmeter.
14. Solid State A.F. Millivoltmeter.
15. Noise Distortion Millivoltmeter.
16. Standard V.T.V.M.
17. 1966—V.T.V.M.
18. 1968—V.T.V.M.

### BRIDGES

19. Standard R/C.
20. 1966. R/C.
21. 1968 R/C and Signal Injector.

### TV INST.'s.

22. Sweep and marker Generator.
23. Dual sweep Gen.
24. Silicon diode sweep Gen.
25. Silicon diode noise Gen.
26. Pattern Gen.
27. Trans. pattern Gen.
28. Wide range pulse gen.

### AUDIO INST.'S

29. 1960 Audio Osc.
30. 1962 High perf. audio Gen.
31. Crystal locked std.
32. Electronic tuning standard.
33. 1965. Solid State audio osc.
34. Direct reading A.F. meter.
35. Sq. wave Gen.
36. 1967 transistor audio Gen.
37. Additive frequency meter.
38. A.F. tone burst gen.
- 38A. 1968. Solid state A.F. Generator.

### R.F. INST.'s.

39. 6-Band service Oscillator.
40. Trans. wave meter.

- 40A. 1969 Dip Osc. Solid state.

41. G.D.O. wide range.
42. G.D.O. adaptor.
43. Trans. service osc.
44. Simple signal injector.
45. Transistorised signal tracer.
46. Transistorised osc.
47. Basic test osc.
48. Transistor test oscillator.

### MISCELLANEOUS INST., ETC., KITS

49. 1960 Trans. Tester.
50. 1968 Transistor test set.
51. Valve and Transistor tester.
52. Electronic scope. Stetho-scope.
53. Moisture alarm.
54. Electronic Pistol range.
55. Transistor Gelger Counter.
56. Light beam alarm.
57. Burglar alarm.
58. Flasher unit.
59. Transistor alarm.
60. Electronic switch.
61. Photo Timer.
62. Direct reading impedance meter.
63. Electronic anemometer.
64. S.W.R. indicator.
65. Simple proximity alarm unit.
66. Pipe and wiring locator.
67. Electronic metronome.
68. Monophonic organ.
- 68A. Keyless organ.

### BATTERY CHARGERS

69. Universal unit.
70. 1 amp unit.

### REGULATED POWER SUPPLIES

71. Transistor. 9v.
72. Transistor, fully protected supply.
73. 1966 H.T. unit.
74. 1968 lab. type. D-30v. supply
- 74A. Simple Pwr. supply.

### VOLTAGE, CURRENT CONTROL UNITS

75. Vari-watt unit.
76. Vari-tach. motor speed control.
77. 2KW auto-light dimmer.
78. 4KW auto. light dimmer.
79. Model train control unit.

80. Model train control unit with simulated inertia.

81. Above-hi-power.

82. No. 81 with simulated inertia.

### TACHOMETER UNITS

83. 6 or 12v Std.
84. 6 or 12v Mullard.
85. 6 or 12v with dwell angle.
86. Tachometer and dwell angle unit for service stations.

### TRANSISTOR IGNITION

87. Ro-Fo. 6 or 12v.
88. Hi-Fire 6 or 12v. (transformer).

### POWER CONVERTERS

89. D.C.-D.C. 60w.
90. D.C.-D.C. 40w.
91. D.C.-D.C. 40w. 12v—Input.
92. D.C.-D.C. 70w 12v—Input.
93. D.C.-D.C. 100w 12v—Input.
94. D.C.-D.C. 140w. 24v—Input.
95. D.C.-D.C. 225w. 24v—Input.

### HIGH FIDELITY AMPLIFIERS MONO UNITS

96. Hi-Fi 3.
97. Mullard 3.3.
98. Mullard 5-10.
99. Mullard 5-10 transistor.

100. Transistor 20w.
101. Transistor 60w.

### STEREO UNITS

102. Mullard 2-2.
103. Mullard (v) 3-3.
104. Mullard (t) 5-5.
105. Mullard (t) 5-5.
106. Mullard (v) 10-10.
107. Mullard (t) 10-10.
108. Philips Twin 10.
109. S.T.C. 10-10.
110. Wireless world transistor 20-20.
111. Hi-Fi 60-60.
112. Playmaster 2-2.
113. Playmaster 3 plus 3.
114. Playmaster unit 3.
115. Playmaster unit 4.
116. Playmaster 10 plus 10
117. Playmaster 101.
118. Playmaster (t) 105.
119. Playmaster (t) 113.
120. Playmaster (t) 115.
121. Playmaster (v) 118.

### P.A. UNITS

122. 10 watt std.

123. 25 watt std.
124. 35 watt std.
125. 30 watt (t).
126. 100 watt std.
127. stereo P.A.

### GUITAR UNITS

128. 10 watt std.
129. 25 watt std.
130. 35 watt std.
131. 50 watt std.
132. 70 watt (t).
133. Playmaster 102.
134. Playmaster 103.
135. Playmaster 40w. 116.
136. Playmaster 60w 117.
137. Guitar fuzz box.
138. Guitar Waa-Waa.
139. Reverb unit.
140. Guitar preamp.

### STEREOGRAMS

141. Playmaster 105.
142. Playmaster 106.
143. Playmaster 107.

### CONTROL UNITS

144. Playmaster No. 9.
145. Playmaster No. 10.
146. Playmaster No. 104.
147. Playmaster No. 112.
148. Playmaster No. 120.
149. Mullard 2v.
150. Mullard 3v.
151. Philips Miniwatt.
152. Wireless world stereo system unit.

### PREAMP UNITS

153. Transistor—Mono.
154. Transistor—Stereo.
155. Transistor—Silicon mono.
156. Transistor F.E.T. mono.
157. Transistor dyn. mic. mono.
158. Above-Stereo.
159. Playmaster 115 F.E.T. Stereo.
160. Playmaster 118 mag.
161. Sound projector.

### MIXER UNITS

162. Trans. 4 ch. (1966).
163. Trans—4 ch. (1967).
164. Valve—4 ch.

### TUNER UNITS

165. Playmaster u/style.
166. Playmaster No. 11.
167. Playmaster No. 114.
168. Playmaster No. 122.
169. Playmaster No. 123.
170. Philips Miniwatt.
180. Trans.—Long range.

### TAPE UNITS

181. Trans. Preamp.
182. Playmaster 110 (M).
182. Playmaster 110 (S).
183. Power Unit 110.
184. Adaptor 110.
185. Playmaster 119 Adaptor.
186. Transistor V.O.X.
187. Tape Actuated relay.
188. Mullard Trans Tape Amp.

### RECEIVERS

189. Fremodyne 4.
190. Fremodyne 4 R.F. Sock only.
191. Synchrodyne.
192. Communications RX.
193. Deltatet RX.
194. 3 Band Double Change S/het RX.
195. Explorer VHF Transistor RX.
196. Interceptor 5 Semi-Comm. RX.
197. 1967 All-Wave 2
198. 1967 All-Wave 3
199. 1967 All-Wave 5
200. 1967 All-Wave 6
201. 1967 All-Wave 7
202. Transporta 7
203. Transistor 8
204. 3 Band 2V RX.
205. 3 Band 3V RX.
206. Interstate 5
207. Versatile Mantel Set.
208. All-Wave Transistor 3
209. A.B.C. 3
210. 1968 F.E.T. 3

### TRANSMITTERS

211. 144 MHz 50W. Linear Final.
212. 144 MHz 20W.
213. 144 MHz 75W. Crystal Locked.
214. 144 MHz 18W.
215. 144 MHz S.S.B.
216. 3 Band A.M.
217. Basic 3 Band.
218. 5 Band. S.S.B.
219. 1967 S.S.B.

### CONVERTERS

220. 50 MHz.
221. 144. MHz.
222. 50 and 144 MHz Crystal Locked.
223. 1965 S/W.
224. 1965 S/W 2 Band.
225. 1966 3 Band.
226. Basic S/W.

### V.F.O. UNITS

227. Remote Unit.
228. 7, 8 and 9 H.F. and V.H.F.
229. All transistor.

Phone 63-3596

# E. D. & E. (SALES) PTY. LTD.

Phone 63-3596

232 FLINDERS LANE, MELBOURNE, VICTORIA 3000

**K  
I  
T  
S**

Public Address Units — Geiger Counters — Metal Locators — Decade Boxes — Mixers — Battery Chargers — Oscillators — Bridges — Parts Supplied for Projects in Electronics (Aust.), Wireless World, Practical Wireless, Electronics World, Electronics Illustrated, Practical Electronics, etc.

**K  
I  
T  
S**

**MULLARD STEREO 3-3**

Full kit . . . . .

(As per Mullard leaflet).

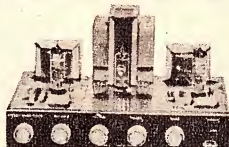

1968 Solid State. V.T.V.M. ELECTRONICS (Aust.), Dec., 1968.

**BATTERY CHARGER 1A**  
ELECTRONICS (Aust.), Feb., 1966

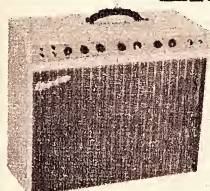

**PLAYMASTER 116 and 117**  
GUITAR AMP.

Electronics Australia  
June 1967 — 40 watt  
July 1967 — 60 watt

**3-BAND SHORT-WAVE CONVERTER**  
ELECTRONICS (Aust.), May, 1966.

**LAB QUALITY**

Regulated Power Supply (0-30v)  
ELECTRONICS (Aust.), Sep-  
tember, 1968.

1966 R/C Bridge  
May, 1966.

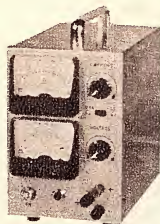

**PUBLIC ADDRESS and**  
**GUITAR AMPLIFIERS**

10, 25, 50 and 100 watt  
units



**3-BAND DOUBLE-CHANGE RECEIVER**  
ELECTRONICS (Aust.), April, 1966.

1966 3<sup>rd</sup> CRO  
ELECTRONICS (Aust.), May, 1966.

Playmaster 122  
Program Source.  
Electronics (Aust.),  
August, 1968.

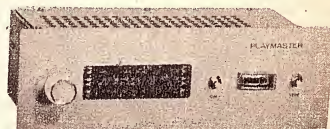

**FOUR-CHANNEL AUDIO MIXER**  
ELECTRONICS (Aust.) Feb., 1966 & 1967

**3-BAND 3-RECEIVER**  
ELECTRONICS (Aust.), Nov., 1966.

**TRANSISTOR MILLIVOLT**  
**METER**

Electronics (Aust.),  
May, 1968.

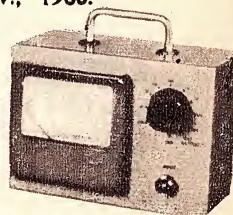

**MAJOR STOCKISTS OF ALL GENERAL RADIO & ELECTRONIC COMPONENT PARTS — YOU NAME IT — WE WILL QUOTE.**

VALVES — TRANSISTORS — ZENER & POWER DIODES — SEMI-CONDUCTORS — DIACS — TRIACS — S.C.R.'S. — I/C'S. SPEAKERS — MICROPHONES — COILS — IFT'S. TRANSFORMERS — INST CASES — METALWORK. PLAYERS & CHANGERS — METERS — RELAYS — CONDENSERS — RESISTORS — BEZELS — STYL II — CARTRIDGES — RECORDING TAPE — PROBES — INSTRUMENTS — POTENTIOMETERS — CRYSTALS — FERRITE BEADS — CORES — BALUNS — TERMINALS — CO-AXIAL PLUGS & SOCKETS — MULTI CONNECTORS — PRINTED CIRCUIT BOARDS — COPPER WINDING WIRE — ETC. — ETC. —

Phone 63-3596

**E. D. & E. (SALES) PTY. LTD.**

Phone 63-3596

232 FLINDERS LANE, MELBOURNE, VICTORIA

# TRADE REVIEWS AND RELEASES

## ADVANCE C.R.O. PERFORMS WELL

A recent addition to the Advance Instruments range is the OS2000 Laboratory Oscilloscope, a fully solid state instrument offering a high standard of performance and reliability at moderate cost. Bandwidth is DC-20MHz or better at 10mV/cm sensitivity.

The OS2000 is constructed on the main frame/plug-in module principle, now fairly standard among high quality oscilloscopes. Available with the basic OS2000 main frame are a comprehensive range of plug-in modules, allowing the user to choose the configuration best suited for his requirements. Pictured in position in the main frame are the Dual Trace Y Amplifier type OS2002Y and the Standard Timebase type OS2003X, with a Single Trace Y Amplifier type OS2001Y alongside. Other modules available include a high-gain differential amplifier and a delayed timebase.

The main frame of the instrument carries the cathode-ray tube, all power supply circuits, the signal delay circuitry, both Y and X deflection output amplifiers and display controls. The frame measures

all at 50Hz. The rear of the main frame provides an intensity modulation or Z axis input, which requires a signal of approximately 30V P-P for full beam modulation.

The Single Trace Y Amplifier module type OS2001Y provides an input sensitivity of 50mV/cm at a rated bandwidth of DC-20MHz. Input impedance is approximately 1M/35pF, and the input attenuator provides nine sensitivity ranges from 50mV-20V in the usual 1-2-5

ally for sweep speeds below 1mS/cm, and alternate-sweep switching for the higher speeds. This provides dual trace facilities over the full bandwidth of the instrument with virtually no sacrifice in either performance or operating convenience. A mode switch allows selection of either Y signal, both together or either the sum or difference between the two, and appropriate trigger selection in each case.

Nineteen basic sweep ranges are provided on the OS2003X Timebase module, spanning from 200mS/cm to 200nS/cm in the usual 1-2-5 sequence. An uncalibrated variable control gives 3:1 interpolation capability, while a 5X gain switch provides magnification and extends the maximum speed to 40nS/cm.

Triggering sensitivity for internal signals is typically 1.5mM trace height, and externally 300mV P-P. Triggering modes selectable include internal, external, power line, TV field, and free run. Trigger slope may be set for either positive or negative polarity, and trigger level may be either set for automatic mean level operation or manual adjustment. There is no front-panel triggering stability control.

The timebase module provides for sweep disabling and external X input, the input sensitivity being 10V (2V in the 5X position), and the rated bandwidth DC-250-KHz. It also provides front-panel sawtooth and step signals, the former for external use and the latter for adjustment of probe compensation.

The plug-in modules of the OS2000 are fitted with a retaining spigot which holds them securely in place during operation. They are also provided with a simple but effective quick-release mechanism to facilitate withdrawal. All signal connections to the modules are by "BNC" coaxial connectors, and a matching cable and probe set, complete with adapters for other types of connector, is available as an optional accessory.

Tested in our laboratory, the sample OS2000 performed extremely well. Sensitivity, bandwidth, stability and control operation all equalled, and in most cases exceeded, the manufacturer's specification. The instrument proved most convenient and straightforward to use, and in short we found it electrically all that one would expect from an instrument of this type.

The only criticism we would make, and it is admittedly a minor one, is in connection with the mechanical aspects of the plug-in modules. The OS2003X timebase module provided for inspection proved to be rather a loose fit in the main frame, and while operation was obviously not prejudiced, the existence of a good 1/16th of an inch of lateral play would seem to us to give the user an unfortunate "first impression" of the instrument finish.

Two further points were that the silk-screened front panel of the sample OS2002Y plug-in was found to be fouling and proud of the "Y2 X10" output connector, preventing its use until the connector was re-positioned; also the panel of the OS2001Y plug-in would appear to be inadequately fastened, particularly in the upper left-hand corner.

Although minor and possibly relevant to the samples only, these points seem all the more disappointing in view of the outstanding electrical performance of the instrument, which otherwise would appear to be excellent value for money. Perhaps like the proverbial "hap'orth of tar," they either have been or can be easily remedied, and I certainly hope that this is so.

Price of the OS2000 is quoted as \$347 for the main frame, \$66.00 for the single trace plug-in, \$157.00 for the dual-trace plug-in, \$110.000 for the standard timebase plug-in, and \$25.00 for the probe and cable kit, in each case exclusive of tax. Enquiries should be directed to the Australian representatives for Advance Instruments, who are Jacoby, Mitchell and Company Pty. Ltd., of 469-475 Kent Street, Sydney, and offices in Victoria, Queensland and South Australia. (J.R.)

The Advance OS2000 with dual-trace vertical pre-amp and standard timebase plug-ins fitted. The single-trace vertical pre-amp is alongside.

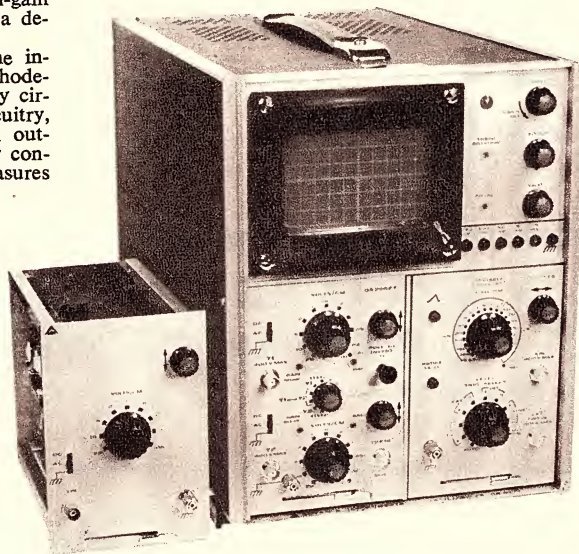

10in x 11½in x 17½in, and weighs a moderate 35lb when complete with two plug-ins. The frame is sturdily constructed from extruded aluminium section and plate, and finished in grey and cream.

The CRT employed is a rectangular flat-face helical PDA (post-deflection acceleration) type providing a display area of 10 x 6cm. The PDA electrode is operated from 4KV, giving sharp focusing and high trace visibility at rapid sweep rates. Variable graticule illumination is provided, together with front-panel preset controls for astigmatism and trace rotation.

The Y signal delay circuitry employs a twin coaxial line to provide approximately 200nS of post-triggering delay. This is sufficient to allow inspection and measurement of the initial portion of almost any type of signal waveform.

Available on the front panel of the main frame are five squarewave calibration signals derived from the power supply circuitry. Amplitudes of these are 250mV, 100mV, 50mV, 5mV and 500µV,

sequence. A switch provides for AC/DC input coupling selection, and also allows the amplifier input to be disconnected from the signal and earthed for DC level calibration, etc. Maximum input rating is ± 400V for DC and LF signals, with derating for RF.

Performance of each channel of the Dual Trace Y Amplifier type OS2002Y is similar to but exceeds that of the single channel module; bandwidth is still DC-20MHz, yet the sensitivity extends down to 10mV/cm. Input impedance, attenuator ranges and maximum sign ratings are unchanged, and in addition each channel is provided with a variable sensitivity control giving a 3:1 uncalibrated gain variation. Provision is made for both channels to be AC coupled in cascade, to give an effective sensitivity of 1mV/cm at a bandwidth of 5Hz — 5MHz.

The OS2002Y module is a beam-switching unit, the CRT being a single beam type. Interlocking with the timebase plug-ins is provided, such that high frequency (100KHz) chopping is selected automati-

# SENCORE FIELD EFFECT VOM

The FE14 Field Effect Volt-Ohm-Milliammeter is a recent addition to the wide range of test instruments manufactured by the American firm of Sencore Inc. It offers higher input impedance than the usual VTVM, combined with the portability and flexibility of a passive "multimeter" or VOM.

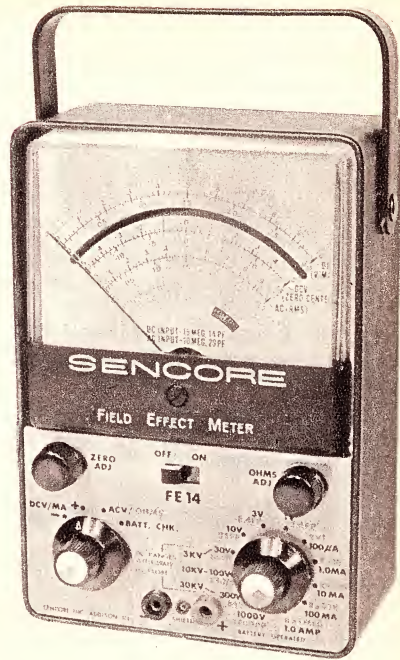

The availability of low-cost junction FETs has recently permitted the design of battery-operated high input impedance voltmeter-ohmmeters which offer virtually all the advantages of the traditional VTVM together with true portability, virtually instant "warm-up," improved stability and the ability to perform "floating" measurements.

With their FE14 meter, Sencore have taken the idea one stage further by adding a set of direct current ranges. While from a design point of view this addition involves only simple passive circuitry and is relatively straightforward, from the user's viewpoint it is very worthwhile because the resultant instrument is capable of making almost any type of amplitude measurement required in servicing and routine development work.

In effect, a meter such as the FE14 combines almost all of the worthwhile features of both a VTVM and a VOM or "multimeter" in the one instrument, while possessing few if any of the drawbacks of either. Because of this it seems likely that this type of instrument may become the "universal test meter" of the future. The FE14 may therefore well qualify for the manufacturer's description of "a revolutionary new concept in test meters," and undoubtedly merits considerable attention.

As may be seen from the illustration, the instrument is of compact construction; it measures 5in x 7-3/16in x 3-1/16in, and weighs a mere 3-1/4lbs without batteries. The meter is a mirror-backed 4 1/2in rectangular type for convenient and accurate reading. The instrument uses two batteries, a miniature 9V type for the FET circuitry and a small 1.5V cell for the resistance ranges. The batteries mount in clamps attached to a small removable back panel on the instrument, and are easily accessible for replacement. The instrument case is of plastic-coated steel, to ensure ruggedness.

Seven basic voltage ranges are provided for both DC and AC, covering the FSD range 1-1000V (2.8-2,800V P-P) in a standard 1-3-10 ratio sequence. The zero-adjust control permits either normal or centre-scale zero setting as required, the meter face being provided with both sets of scales. Input impedance on the DC ranges is 15M shunted by 14pF, and on AC ranges 10M shunted by 29pF. DC voltage accuracy is rated at 3 per cent, with an AC rejection of 30-300 times; rated AC accuracy is 5 per cent, with dB down points at 10Hz and 10MHz. A high voltage probe is available to extend the ranges up to 30KV.

There are five resistance ranges, with centre-scale readings of 10 ohms, 100 ohms, 1000 ohms, 100K and 10M. The resistance ranges read from right to left, as with a conventional VOM, due to the particular measuring configuration employed. Resistance measuring accuracy is rated at  $\pm 2$  degrees arc.

The five direct current ranges cover the FSD range 100uA — 1A in decade ratio steps. The internal voltage drop on these ranges is 200mV, and the rated accuracy 3 per cent. The 3V DC range can be used with an external 3V battery for semiconductor and capacitor leakage tests. An external resistance technique may be used to measure AC current, such tests being safe

because the measuring circuitry is "floating" and isolated from the case.

On the DC voltage and resistance ranges the FET circuitry of the FE14 is connected in a conventional differential DC amplifier configuration. However, for the AC voltage ranges one FET is used as an input source follower, to achieve the unusually high AC input impedance; the second FET is used as a DC source-follower following a peak-to-peak diode detector. The direct current ranges are passive and do not employ the FET circuitry at all.

The sample FE14 unit pictured was tested and used in our laboratory over a period of some weeks, and in that period we found it reliable, accurate, and convenient to use. It appeared to meet in every way the manufacturer's claims, and in fact the only drawback we could find was that it lacks the usual decibel scale or scales. While this omission may not be of much relevance for a majority of normal testing applications, it may be a disadvantage in many development situations.

Apart from this we find the FE14 a well-made and attractive instrument, and one which should be of considerable value

to both service technicians and development engineers as a very high impedance utility meter.

The sample instrument reviewed came from the Australian agents for Sencore, Elmeasco Instruments Pty. Ltd., of 7 Chard Road, Brookvale, N.S.W. 2100, and also at Mt. Waverley, Vic. 3149. Price of the FE14 was quoted as \$86.00 plus sales tax where applicable. (J.R.).

## Australian SSB exports

The U.S. company of Granger Associates is now manufacturing SSB communications equipment in Australia from locally manufactured parts. Some of the equipment is being exported to developing countries, where requirements for communications systems are basically the same as in Australia.



Dr J. V. N. Granger

The chairman of the company, Dr J. V. N. Granger, said in Sydney recently that his company had deliberately set out to establish an engineering effort in Australia and had been prepared to suffer losses to do this. A small factory had been established in 1966 at Brookvale (a Sydney suburb) to assemble small communications equipment, using kits imported from the parent company.

The Australian subsidiary has now reached the stage where its latest models, some incorporating ICs, are being made in Australia from locally obtained parts and to designs modified according to local experience. Such sets have already been exported to New Zealand, the British Solomon Islands, Venezuela, Egypt and Singapore.

Legislation passed by Parliament provides for most users to change over eventually to SSB, including the Flying Doctor Service. Although the legal requirement for the change to SSB is not until 1970, an increasing number of Australian users have already installed SSB equipment.

"Out current operations in Australia are profitable and we anticipate this trend will continue," Dr Granger said. He made

it clear that a number of factors had influenced his company's decision to make Australia a major base for export production.

"In terms of manufacturing costs, there are no advantages," he said. "Labour costs in some areas are lower here than they are in the U.S. but this is offset by much higher materials costs. The real advantage of producing in Australia is that we are making user-oriented equipment. It has to be developed and made close to the markets in which we are going to sell it." Dr Granger added: "In addition, there is the fact that Australian engineers are under-employed as a group, so we decided to take advantage of this."

Granger Associates does not make military equipment (the largest market for SSB equipment in the U.S.A.) but Dr Granger estimates it has between 20 and 25 per cent of the civilian market for this kind of communications equipment in the U.S.A.

The present range of Granger SSB sets cost from \$500 to \$900, compared with \$300 to \$500 for AM sets. However, with the extensive use of solid state components and increasing production, it is expected that initial costs will eventually be lower.

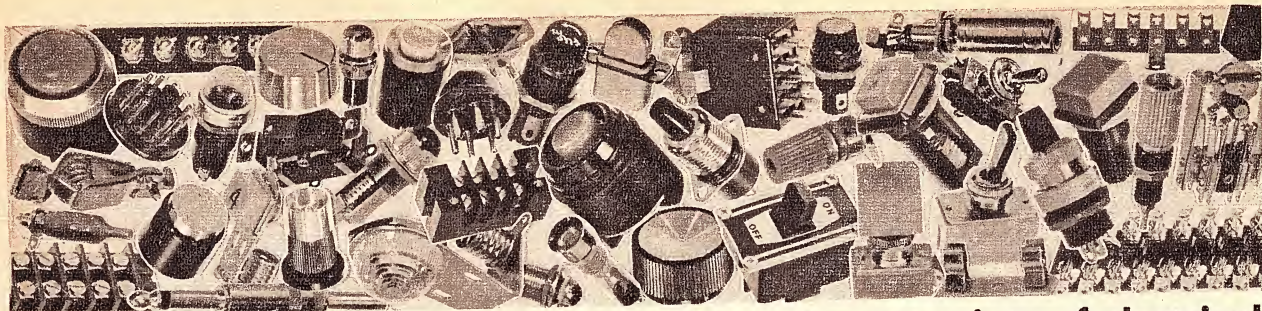

Like being proud of their Kangaroo, Sato's large variety of electrical parts is the favorite choice by Australians. Your inquiries are welcome.

# SATO PARTS

**SATO PARTS CO., LTD.**

HEAD OFFICE: EBISU, SHIBUYA-KU, TOKYO, JAPAN TEL: (442) 8506~8  
BANK ACCOUNT: MITSUBISHI BANK

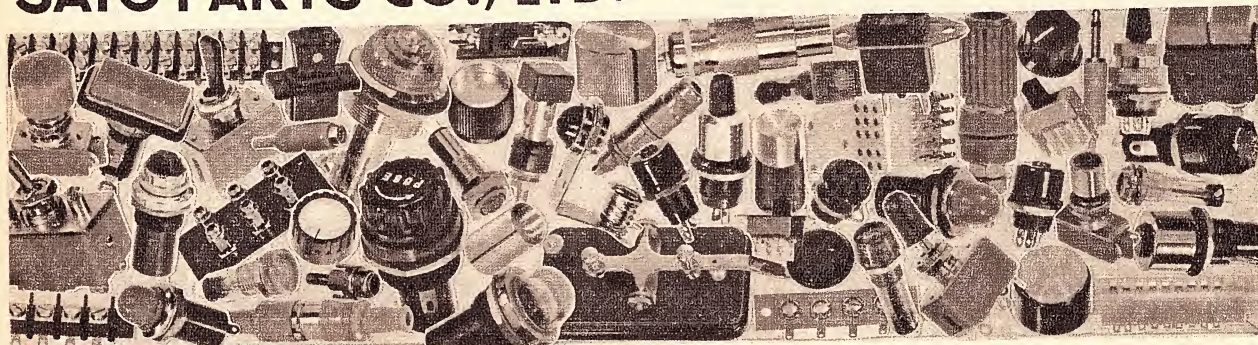

## A vast range of SATO Parts

- For manufacturers
- For TV
- For radio
- For instruments
- For amplifiers
- For kitset builders
- For sound equipment
- For industry
- For stereo equipment
- For educational purposes
- For electronics
- For tape recorders

Distributed by



## GENERAL ACCESSORIES

(A DIVISION OF ELECTRONICS INDUSTRIES)

116-118 CLARENCE STREET, SYDNEY 443 CONCORD ROAD, RHODES — 73-0211  
BOTH STORES OPEN SATURDAY MORNING



# ARMS AND CARTRIDGES FROM NEAT CORPORATION

Pictured is a range of arms and magnetic cartridges which were recently submitted for review by Truscott Electronics, of Adelaide, South Australia. They are made by the Neat Corporation of Japan.

Four arms were submitted, namely the G-30, priced at \$22.50; G-37, priced at \$29.50; G-36 at \$39.50 and the G-32 at \$62.60. These are retail prices, including tax.

All the arms use the same headshell with the standard E.I.A. locking collar, as fitted to Ortofon and S.M.E. arms. The headshells — slightly different from those pictured—have the standard  $\frac{1}{4}$ -inch cartridge mounting centres, the holes being slotted to permit stylus overhang adjustment. Also supplied with all the arms was a mounting template with dimensions marked in millimetres, a connecting lead fitted with standard phono plugs and a lead for earthing the arms if they are not mounted on a metal base-plate.

In general, all the arms were well finished and of good appearance, the connecting lead with plugs fitted to both ends being a particularly good feature. However, in certain cases, the range of height adjustment available is rather limited and/or the setting-up procedure not as simple as it could be.

**G-32 ARM:** At the top of the group, the G-32 has an overall length of 13 inches and an effective length from stylus to pivot of  $9\frac{5}{8}$  inches. The mounting hole required for the base of the arm is only  $\frac{9}{16}$  inches in diameter. Height adjustment is by means of a grub screw in the mounting collar, but the adjustment range of one inch could be insufficient for turntables having a very shallow platter. It is more appropriate to turntables such as the Garrard 401, which has quite a thick platter.

Adjustments are provided for vertical and lateral balance and the stylus tracking weight is adjustable up to 2.0 grams by means of a rotating section of the main counterweight, which has a ratchet action. All adjustments were straightforward and the arm is quite pleasant to use. Bearing friction appeared to be very low and the arm tracked well at a stylus pressure of  $\frac{1}{2}$ -gram. This particular arm is normally supplied with two headshells.

**G-36 ARM:** This arm is unusual in that it has a concealed counterweight system. The balance weight moves inside a tubular section of the arm—moved by a knurled knob on the end of the arm. Two "ring" weights are supplied, for use with unusually heavy or light cartridges. The ring weights are calibrated in half-gram steps but the calibrations and the instructions tend to be somewhat confusing.

Effective length of the G-36 arm is  $9\frac{1}{2}$  inches and the mounting hole diameter  $\frac{7}{8}$  inch. Height adjustment is adequate in this unit. In use, the arm proved to have a very critical balance setting, partly because of the very low bearing friction! It tracked well at the  $\frac{1}{2}$ -gram setting though few cartridges will perform properly at this low setting.

**G-37 ARM:** This tone arm has an overall length of  $12\frac{1}{2}$  inches and an effective length of  $9\frac{1}{2}$  inches. The mounting hole diameter is  $\frac{7}{8}$  inches in diameter and height adjustment is again adequate. The counterweight is split in three sections; one can set the balance easily by moving two of the sections, after which the tracking weight is set by adjusting the third section and using the set of scales

provided. Also fitted is an outrigger weight for lateral balance. This arm tracked quite satisfactorily at around 1 gram.

**G-30 ARM:** The G-30 tone arm has an overall length of  $12\frac{1}{2}$  inches and an effective length from stylus to pivot of  $9\frac{1}{2}$  inches. Height adjustment is by means of a knurled screw on the base of the arm, the range of adjustment being  $\frac{7}{8}$  inch. Again, this cannot be adjusted low enough for shallow turntables, though a small modification by the manufacturer to the base of the arm would eliminate this problem. Mounting hole diameter is  $\frac{9}{16}$  inches.

Balance in the vertical plane is achieved by a large sliding counterweight, fixed in position by a grub screw; the operation would have been so much easier if a knurled set-screw had been provided instead. Stylus tracking weight is adjusted by means of a sliding outrigger weight, secured by a knurled set-screw.

The arm tracked quite satisfactorily at around 1 gram. Slight modifications, as mentioned, would make it an excellent economy arm. It is supplied with a small screwdriver and a set of scales for checking the stylus pressure.

Four cartridges were submitted, namely the V-70, retail \$15.00; V-15, \$19.50; V-60,

\$27.50; and the V-50, \$37.50. The prices include sales tax. All the cartridges are of neat appearance and appear to be well made. All have easily replaceable stylus assemblies, standard  $\frac{1}{4}$ -inch mounting centres and output terminals which are clearly coded. The last three cartridges are available with elliptical stylus for an additional \$5.

**V-50 CARTRIDGE:** The specification shows a recommended tracking weight range of 2.0 to 3.5 grams. This is most unusual for a cartridge in this price range, where one would expect a tracking weight nearer to 1 gram. In general, the performance of this cartridge was poor. Fre-

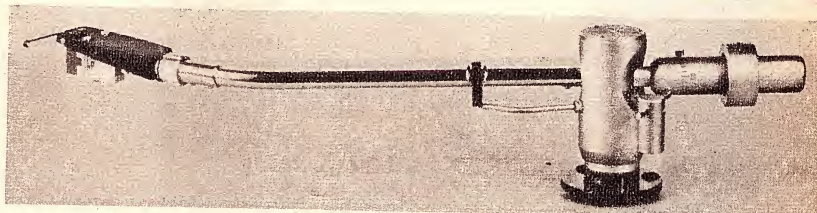

*The Neat G-32 arm shown fitted with the V-50 cartridge.*

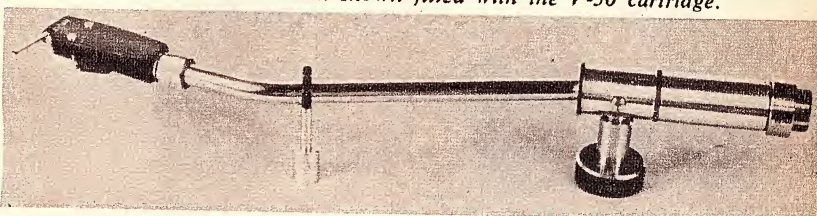

*The G-36 arm fitted with the V-15 cartridge.*



*The G-37 arm fitted with the V-60 cartridge.*

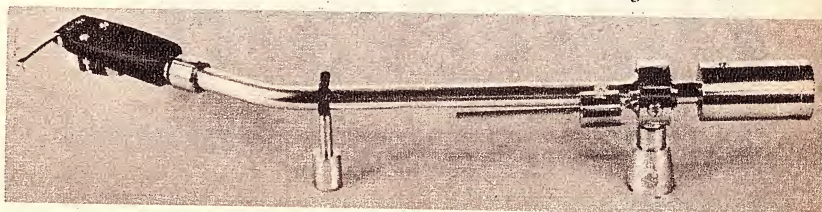

*The G-30 arm fitted with the V-70 cartridge.*

quency response was fairly smooth but severely lacking in treble in one channel. Waveform was good over the whole range. Separation was 26dB at 1KHz and 18dB and 10KHz. Sensitivity was low at 1.3mV at 5cm/sec, a figure which could induce problems with signal-to-noise ratio and hum pick-up. Tracking performance was not good, even at the maximum tracking weight of 3.5 grams.

## CONVOY

### HI-FI AND TAPE RECORDER SERVICE

For all your Hi-Fi and Tape Recorder service requirements, consult the experts at Convoy. We guarantee to offer you the best technical service at an honest price.

You can bring us your problems with the knowledge that you will receive the best attention possible.

449 Kent St., Sydney (nr. Town Hall)  
29-6475



# SPECIALISTS IN HI-FI FURNITURE AND RECORD STORAGE UNITS

Standard range or built to your specifications

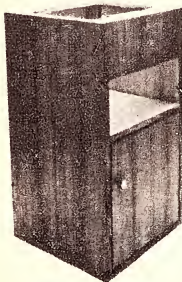

This Hi-Fi Cabinet is a first in every sense of the word. Your turntable, whatever it may be, is cut into the top of the cabinet. Hinged lid in either acrylic or timber as optional extra. Beautifully finished in teak.

Dimensions (approx.) 16 x 16 x 28in high.  
Retail Price . . . . . \$49.00  
Hinged lid extra . . . . . \$10.00  
Other sizes to special order.

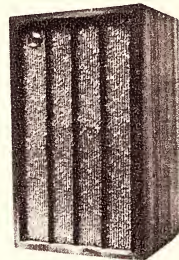

Acrylic covers in neutral shade. Suit most units. Retail price . . . . . \$9.50  
Turntable bases suit Dual and Garrard. Recessed and rebated edges. Teak veneer finish. Retail price . . . . . \$10.00  
Other bases to order.



Wide range of speaker enclosures from \$39.00 pr.

Teak veneer finish. Solid back. Fabric face with Black Timber piping.



*Remember WE specialise and that means we give you personal attention and quality.*

**TRADE ENQUIRIES:**  
MAIL ORDERS ATTENDED  
TO PROMPTLY

**RECAP STORAGE CABINETS**  
69 COLLETT STREET, KENSINGTON, VICTORIA 3031 PHONE 33 3416

# University

## R.L.C. Bridge and Multimeter, Model Uniter-F

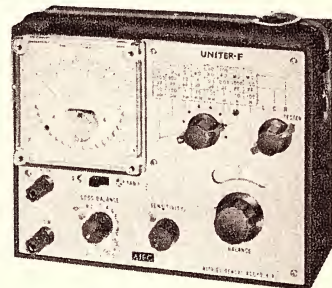

Price \$120 and Sales Tax

### SPECIFICATION

#### 1. L.C.R. BRIDGE SECTION

##### a MEASUREMENT RANGES

Inductance (L) 0.1 $\mu$ H to 110H 8 ranges  
Accuracy  $\pm 1\% \pm 0.5\%$  of the full scale  
Capacitance (C) 1pF to 1100 $\mu$ F 8 ranges  
Accuracy  $\pm 1\% \pm 0.5\%$  of the full scale  
Resistance (R) 0.01 $\Omega$  to 11M  $\Omega$  8 ranges  
Accuracy  $\pm 1\% \pm 0.5\%$  of the full scale  
Residuals (approx.)  
Lo 0.1  $\mu$ H  
Co 0.5 pF  
Ro 0.005 $\Omega$

Q 0 to 10  $\pm 10\% \pm 0.2$   
Tan  $\phi$  (D) 0 to 0.1  $\pm 10\% \pm 0.002$

b BRIDGE ENERGIZING SOURCE: 1kc/s (oscillator)

c POWER SUPPLY : 9V Battery

#### 2. MULTIMETER SECTION

##### Measurement ranges

DC voltage (DCV) 0.25 to 1,000V 6 ranges  
DC current (DCmA) 0.05 to 250mA 5 ranges  
AC voltage (ACV) 2.5 to 1,000V 6 ranges  
DC resistance ( $\Omega$ ) 0 to 50M $\Omega$  4 ranges  
Load current (LI) 20mA, 2mA, 0.2mA  
Load voltage (LV) 0 to 1.5V  
Volume level (dB) -10 to +10, +5 to +36

#### 3. ACCESSORY AC Adaptor

#### 4. DIMENSIONS

4in x 7 $\frac{1}{2}$ in x 6in, 5lb (with case and battery)

### UNIVERSITY GRAHAM INSTRUMENTS PTY. LTD.

106 BELMORE ROAD, RIVERWOOD, N.S.W. 2210.  
Telephone: 53-0644. Cables: Raquip, Sydney.

#### REPRESENTATIVES

N.S.W.: Hunter Engineering QLD.: Keith Percy & Co.  
Sales & Services Pty. Ltd.  
Cnr. Gordon Avenue Waterloo St.,  
and Parry St., Hamilton, NEWSTEAD, Bris.,  
NEWCASTLE, N.S.W. Qld. 4006  
2303. Phone 61-4321. Phone 51-5461.

VIC.: Eastern Instrument & Electronic Service Pty. Ltd.  
Suite 17, 67 Queen's Rd., MELB., Vic. 3000  
Phone: 51-8503.

W.A.: Atkins (W.A.) Ltd.,  
894 Hay St.,  
PERTH, W.A. 6000  
Phone 21-0101.

S.A.: Compar Dist.  
33 Market St.,  
ADELAIDE, S.A. 5000  
Phone 516263.  
TAS.: W. P. Martin & Co.  
202 Argyle St.,  
HOBART, 7000  
Phone 34-2811.  
And 150 Wellington St.,  
LAUNCESTON, TAS  
7250 Phone 22-844

# A.C.I. ENGINEERING SERVICE

Australian Consolidated Industries Ltd, advises that it is able to offer a comprehensive engineering service based on seven engineering plants in the A.C.I. group, equipped with a wide range of modern machine tools and fabrication facilities.

A.C.I. say that the new engineering service will greatly assist the local manufacture of machinery and of parts which till now have had to be imported. It will undertake to build a specific machine to the client's specifications and drawings; take charge of the design and installation as well as the manufacture of the equipment, if required to do so; or act simply as a supplier of precision replacement parts.

A.C.I. has developed its engineering facilities over a number of years, because of the specialised nature of machinery used in its glass manufacture. Since the company did not wish to be dependent on overseas suppliers for equipment and replacement parts, it decided to establish its own engineering facilities. As long ago as 1926, the company was manufacturing enough annealing Lehrs (glass annealing ovens) to equip all glass factories throughout Australia and New Zealand.

Today, A.C.I. has a comprehensive Engineering Division equipped with some of the most modern machine tools in Australia, including numerical control (N.C.) punched tape units. It now has the capacity not only to cater for its own needs, but also to offer a full service to other industries. At the present time, A.C.I. has on order the first Macson N.C. machining centre being made by Macphersons Ltd, at their Victorian machine tool works. This is due for installation in June.

With the recent establishment of its Customer Service Department, A.C.I. engineering service is now fully geared to help clients. The service includes the design of equipment or parts, machine

building or rebuilding, manufacture of replacement parts and special equipment, fabrication of aluminium or sheet, and supply of specialised technical services.

The A.C.I. Engineering Service companies are located at Sydney and Melbourne, and at Eildon, Victoria. They include a Meehanite licensed foundry; a light fabrication shop specialising in stainless steel and aluminium as well as complex mild steel work; and a number of machine shops which also incorporate substantial fitting and assembling departments. In addition there is an extensive technical centre equipped to handle metallurgical and refractory research and development,

process control, electronics, inorganic analysis, and plant design and development. This technical centre, located at Waterloo, N.S.W., has a staff of approximately 250, of whom a quarter are graduates in various scientific and engineering fields.

At one plant, Lane Cove Engineering, on-time delivery is assisted by the use of an IBM computer terminal system. This is used to assist job organisation and supervision and to identify causes of production delays, thus enabling management to keep jobs on schedule.

The IBM data transmission and production control system incorporates a com-

*One of the five IBM 357 input terminals at Lane Cove Engineering. The operator has already entered his identification badge and job specification card and is preparing to enter further information relating to the work he has performed, to up-date the progress report of the job.*

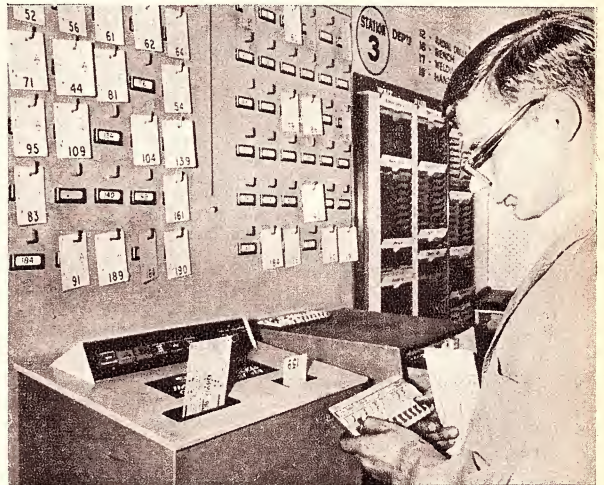

## NEAT ARMS AND CARTRIDGES *continued*

**V-60 CARTRIDGE:** Frequency response of this cartridge is within plus or minus 1dB from 25Hz to 8KHz and from then to 20KHz it is maintained within plus or minus 3dB with respect to the 1KHz reference. Separation between channels was good at better than 27dB at 1KHz in one direction and 21dB in the other direction. Minimum separation was 11dB at 20KHz. Tracking performance was good; it tracked the plus 16dB drum test bands of the W & G 25/2434 at 1.5 grams with only slight embarrassment.

Waveform of the V-60 cartridge was not particularly good in the range from 3 to 8KHz. Fortunately, such distortion is not over-apparent in typical listening conditions, since it consists of higher order harmonics falling in the frequency range where the ear becomes insensitive.

Sensitivity of the cartridge was low at only 1.3mV at 5cm/sec. at 1KHz. This meant that the volume control of the amplifier had to be turned up further than usual, raising the level of noise and hum in the system. This problem aside, overall sound quality on music was quite pleasant.

**V-15 CARTRIDGE:** Frequency response of the V-15 cartridge was substantially flat over the range from 20Hz to 8KHz with some rise in the 8KHz to 10KHz region and a fairly sharp roll-off above 16KHz. Separation between channels was

31dB at 1KHz in one direction and 16dB in the other. Sensitivity was average at 5mV at 5cm/sec at 1KHz and immunity to hum fields good. Tracking performance was acceptable. It handled the plus 12dB drum test band of the W & G 25/2434 test record with only slight embarrassment at 1.5 grams, its maximum advised tracking weight. Overall sound quality of the cartridge was good, with bright treble as could be expected from the frequency response.

**V-70 CARTRIDGE:** Frequency response of the V-70 cartridge was within plus or minus 1dB from 20Hz to 14KHz, tapering slowly thereafter to minus 7dB at 20KHz. Separation between channels was in excess of 35dB at 1KHz in one direction but was poor in the other direction at only 12dB. Fortunately, this characteristic is not particularly noticeable in normal listening. Sensitivity was high at 7mV at 5cm/sec at 1KHz and immunity to hum fields was good. Tracking performance was good as it handled the plus 16dB drum test band of the W & G 25/2434 test record quite comfortably at 2 grams. Indeed, this cartridge appeared to be much the best value for money of the group.

Inquiries regarding these and other components in the Neat range should be directed to Truscott Electronics, 62-64 Hindmarsh Square, Adelaide, South Australia. (L.D.S.)

plex communications network from the shop floor to an IBM System/360 model 30 computer installed at the A.C.I. data processing centre at Waterloo, N.S.W. Five input terminals are located in various departments of the Lane Cove plant. Each station is capable of recognising an identification badge, reading a punched card and receiving manually entered information. The information is collected by the 357 system and punched automatically into a single data processing card.

After checking, the cards from the various stations are collated into a batch and fed into an IBM 1050 communications system, consisting of a printer-keyboard, paper tape punch, paper tape reader and punched card reader.

## YAMAHA LOUSPEAKERS

A discussion of a particular line of Yamaha loudspeakers appeared in our April issue under the heading "Natural Sound Loudspeakers — An Interesting Concept." It was stated that further details could be obtained from the Australian distributors, Rose Music Pty. Ltd., 4-14 Ross St, South Melbourne and from Radio Parts Pty. Ltd.

Unfortunately, the address given for the latter company was incorrect. The correct address is: Radio Parts Pty. Ltd., 562 Spencer St, West Melbourne, 3003. Inquiries may also be directed to Hi-Fi (Stereo) Pty. Ltd., State Savings Bank House, Mezzanine Floor, 157 Elizabeth St, Melbourne 3000.

# SIMPLIFY INTRICATE WORK with



## '1000' RANGE SPECIAL PURPOSE PLIERS

Designed specifically for instrument and electronic technicians to handle fine, precision work, the Elliott-Lucas 4½" size '1000' series is available in Box Joint or Single Joint Tools. All bright finish, in individual Display Packs or in Plastic Tool Roll sets of three or six.

DIAGONAL CUTTING NIPPERS

SNIPER NOSE PLIERS

SNIPER NOSE SIDE CUTTING PLIERS

FLAT NOSE PLIERS

ROUND NOSE PLIERS

END CUTTING NIPPERS

Australian Representatives:

# THOMAS C. BROWN

& CO. PTY. LTD.

Sydney • Melbourne • Adelaide  
Brisbane • Perth

## TRADE RELEASES—in brief

**AUSTRALIAN GENERAL ELECTRIC PTY. LTD.** has added to its line of thyristors with the release of the C122 series rated at 8A RMS. Three voltage grades will be offered initially: 50, 200 and 400V. The main features of this series are: silicon pellet design uses PNPN structure with glass-sealed junctions; no maximum torque limit on mounting screw; round leads to simplify circuit assembly; designed for either printed circuit or chassis mounting compatible with JEDEC TO-66 mounting registration. For further information contact the company at 103 York Street, Sydney, 2000.

**FERRIS BROS. PTY. LTD.** has released the Ferris Model M747 portable car radio and the M747 PC 12-volt power cradle. This is a compact portable receiver in a Cycolac plastic case with chrome plated speaker grille. The dial is all-States calibrated and uses a twin pointer. The seven-transistor printed board is totally shielded in a copper, nickel and chrome plated plastic case to eliminate ignition interference. A ferrite rod aerial is switched into use for normal portable radio reception and completely out of circuit for car radio use. When used with the power cradle, both internal and extension speakers may be used together, or the internal speaker muted for maximum performance from a large external speaker. Inquiries to Ferris Bros. Pty. Ltd., 752 Pittwater Road, Brookvale, N.S.W. 2100.

**W. G. BOOTH PTY. LTD.**, has been formed by Mr W. G. (Bill) Booth, formerly managing director of Painton (Aust.) Pty. Ltd., and has taken over the agency of Bourne Inc., Riverside, California, U.S.A. The new company will import and manufacture a range of products, including trimming and precision potentiometers. The sales office is at 39 Church Street, Hawthorn, Vic., telephone 86-9410. The postal address is P.O. Box 131, Richmond, Vic. 3121.

**FAR NORTHERN TELEVISION LTD.** has appointed Mr N. S. Judd as chief engineer of its studios and facilities at Aumuller Street, Cairns, Qld. Prior to this appointment, Mr Judd was senior technician for the station. He is the holder of appropriate qualifications and is a senior affiliate of the I.R.E.E. Australia.

**STANDARD COMPONENTS PTY. LTD.** has released information on the following equipments.

SWE-Check Volt-Ohm-A FET Meter is

a fully transistorised instrument housed in a robust plastic coated steel case and using a fibreglass printed wiring board. The input impedance is 10M per volt on DC and 1.2M per volt on A.C. It features triple overload protection—spark gap protection for accidental EHT voltages; zener diode protection for FET circuitry; and silicon diode protection for the meter movement on DC current ranges. The ranges are: DC volts, 1, 3, 10, 30, 100V, 1KV, 3KV; AC volts 3, 10, 30, 100, 300V, and 1KV; DC current 300uA, 1, 10, 100mA, 1A; resistance Rx1 (10 ohms centre scale) to Rx1M (10M centre scale) in seven ranges.

Kingray Distribution Amplifier Model D36/500 has a gain of 36dB ±2dB and a frequency response (±2dB) from 40MHz to 200MHz. The maximum output is 500mV into 75 ohms. The input impedance is 75 or 300 ohms, and the output impedance 75 ohms. An input attenuator is switched in five positions from 0 to -16dB.

Further details on these and other equipments from Standard Components Pty. Ltd., 10 Hill Street, Leichhardt N.S.W. 2040.

**ASTATIC CORPORATION**, Conneaut, Ohio, U.S.A., has purchased the audio products line of Sonotone Corporation, a Clevite Corporation subsidiary. The line consists of Sonotone phonograph cartridges, styli and microphone products, and includes all production tools, dies and inventory of finished and semi-finished materials, as well as domestic patent rights. All physical assets involved will be transferred from Sonotone's Elmsford, N.Y., plant to Conneaut. Sonotone's major product lines will continue to be hearing aids and accessories, and rechargeable nickel cadmium batteries. Astatic products are distributed exclusively in Australia by Green Corporation Ltd., 88 King Street, Sydney, 2000.

**RACAL ELECTRONICS PTY. LTD.** has announced a new single-channel HF receiver, the RA1205, said to provide extremely reliable operation on one fixed frequency between 1.6 and 24MHz. It has been specifically designed for applications where continuous monitoring of fixed frequencies is undertaken, or for radio networks which have overlapping or simultaneous traffic schedules on a number of frequencies. It is claimed to save up to two-thirds of capital outlay and require only a quarter of the space needed for current equipments. A complete assembly

## Elma Knobs

**ASSOCIATED CONTROL PTY. LTD.** is stocking a range of Elma knobs and ancillary items which allow users to make up different knob configurations from component parts. All the knobs have collet type fittings which grip the shaft in place of the more usual grub-screw.

The range at present comprises 11 different knob types in the colour range red, grey and black, matching cover plates to cover the collet tightening nut (available in six colours), "arrow disc" indicators (also available in the full colour range), figure dials, stators and bases. Some knobs in the range can be supplied with a white cursor line. Tightening nuts can be hexagonal, with or without slot; or round, with slot. Threaded collars are available for fixing stators to chassis.

Samples of these knobs and accessories submitted for our inspection showed them to be attractive in appearance, and well

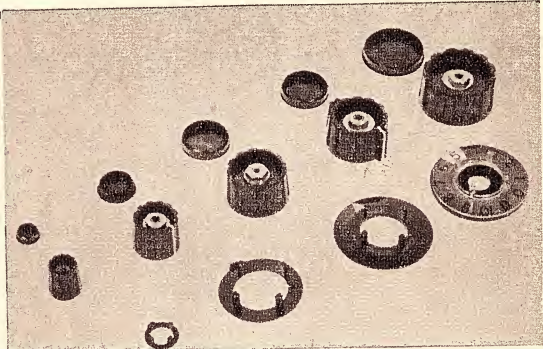

made and finished. We were able to make the components up into a range of different knob configurations, each of which would be applicable to a different purpose. The various components fit easily together to make a good friction fit, tight enough to hold together but not so tight as to be detrimental to easy disassembly.

A brochure with details of the full range of these knobs, and price list, can be obtained from Associated Controls Pty. Ltd., 14 Enterprise Avenue, Padstow, N.S.W. 2211.

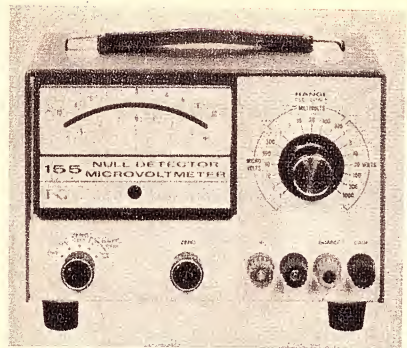

**SAMPLE ELECTRONICS (AUST.) PTH. LTD.**, has released information on the Keithley Model 155 Combination Null Detector-Microvoltmeter with a 150nV resolution. It is a low-cost, completely solid state, battery-operated instrument and can measure voltages from 150nV to 1000V. Immunity to AC interference allows the instrument to detect DC signals in the presence of large AC voltages. The Model 155 can recover from 100V overloads within 5 seconds on the 30uV range. Up to 1200V peak may be applied momentarily on any range without damaging the instrument. Further information from Sample Electronics (Aust.) Pty. Ltd., 100 Chandos Street, Crow's Nest, N.S.W. 2065.

of eight receivers with associated power unit occupies only 7in in a standard 19in rack.

The RA1205 is a double superheterodyne with the oscillator crystals housed in a temperature-controlled oven to maintain a high stability. The 1.6 to 24MHz range is covered in four switched bands, the correct range being selected inside the receiver during setting-up. A selection of filters is available giving suitable bandwidths for DSB, SSB, and FSK modes of operation, while the receiver is always capable of CW reception. For further information contact Rascal Electronics Pty. Ltd., 47 Bennie Street, North Ryde, N.S.W. 2113.

**ROHDE AND SCHWARZ**, Munich, West Germany, has developed two new instruments. One is a UHF Wattmeter and Matching Indicator type NAU, in which the incident and the reflected powers are simultaneously indicated by two meters. The instrument, connected directly into a transmission line, has a VSWR of less than 1.02 to prevent mismatch. It measures power from 50mW to 31.6W in four ranges at frequencies from 25 to 500MHz, the ranges for incident and reflected power being selected separately. Reflection coefficients of 5 p.c. can be easily determined. The indicated RMS power value is also correct for non-sinusoidal voltages, e.g., modulated transmitter waveforms, as the diodes in the instrument are operated in the square-law portion of the characteristic.

The second instrument, RC Generator-Indicator type SUB, can be used to simplify bridge measurements, to facilitate work on standing-wave detectors, and to filter out noisy signals. The generator and the selective detector/amplifier of this instrument are tuned over the entire frequency range (50Hz to 50KHz in three ranges) with only one knob. It has a logarithmic indication over a range of more than 80dB, and voltage changes from 50mV down to 1uV can easily be detected. The RC generator has a source impedance of 600 ohms and delivers continuously adjustable sinewave or square-wave voltages. The EMF in sinewave operation ranges from 3mV to 3V (RMS), and in squarewave operation from 8mV to 8V (peak to peak).

Further details of these instruments may be obtained from the Australian agents, Astronics Australasia Pty. Ltd., 161-173 Sturt Street, South Melbourne, Vic. 3205, or branches in all State capital cities.

# SHURE

*the finest range of high quality tone-arms, microphones and cartridges available.*

V15 Type II . . . . . \$87.50\*  
 M75EJ Type 2 . . . . . \$38.00\*  
 M75E Type 2 . . . . . \$45.00\*  
 M75G Type 2 . . . . . \$35.00\*  
 M75-6 Type 2 . . . . . \$29.50\*



M55E . . . . . \$32.50\*  
 M44E . . . . . \$28.50\*  
 M44-5 . . . . . \$20.00\*  
 M44G . . . . . \$19.50\*  
 M44-7 . . . . . \$19.50\*  
 M44C . . . . . \$18.00\*  
 M31E-EP . . . . . \$25.00\*  
 M32E-EP . . . . . \$25.00\*

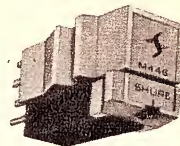

## PRE-MOUNTED CARTRIDGES

M80E-D19 . . . . . \$38.00\*  
 DU10-M75E—Type 2 . . . . . \$48.00\*  
 M75E-D19—Type 2 . . . . . \$50.00\*  
 M75E-95G—Type 2 . . . . . \$50.00\*

## MICROPHONE MIXERS

M62 "Level Loc" . . . . . \$108\*  
 M67-2E (illustrated) . . . . . \$348\*  
 M68FC-2E . . . . . \$164\*  
 PE70RM-2 . . . . . \$185\*

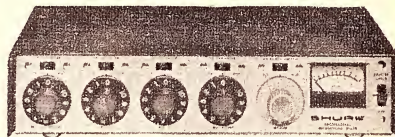

## MICROPHONES:

Model 515SA (illus.) \$47.50\*  
 Model 515SB . . . . . \$42.00\*  
 Model 585SB . . . . . \$69.00\*



Contact your local representative for detailed literature on SHURE quality products.

N.S.W.: Audio Engineers Pty. Ltd., 342 Kent Street, Sydney.  
 W.A.: Athol M. Hill Pty. Ltd., 613-15 Wellington St., Perth.  
 QLD.: Ron Jones Pty. Ltd., 7-9 Merton Rd., Woolloongabba, Brisbane.  
 VIC.: Audio Engineers (Vic.), 2A Hill St., Thornbury.  
 Phone 44-3295.

\* Recommended Resale Price.

# AVAILABLE LOCALLY



WORLDWIDE EXPANSION WITH SINCERITY & DEVELOPMENT

**PALACE**  
ITOKA PRODUCTS CORPORATION  
No. 1-4, 3-chome, Mita, Minato-ku, Tokyo, Japan.

A comprehensive range of products from the ITOKA CORPORATION

- Amplifiers
- Bookshelf speaker systems
- Tape decks.
- Microphones
- Preamplifiers
- Stereo and mono microphone mixers
- Stereo headphones
- Tuners
- Solid state modules
- Phono preamplifiers
- Tape preamplifiers
- Audio power amplifiers
- Code oscillators
- Guitar amplifiers

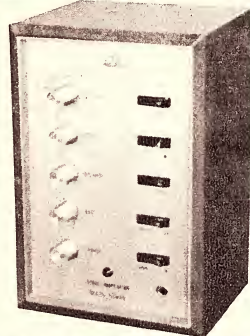

## GENERAL ACCESSORIES

(A DIVISION OF ELECTRONICS INDUSTRIES)

116-118 CLARENCE STREET, SYDNEY 443 CONCORD ROAD, RHODES — 73-0211

BOTH STORES OPEN SATURDAY MORNING

### R.C.S. SPECIALS



**NEW IMPROVED  
30 WATT**  
NOMINAL  
54w MAX.

#### 12v All Transistor P. A. AMPLIFIER

WIRED READY TO OPERATE  
15 ohm output No. 591D ..... \$62  
125, 250, 500 ohm 592D ..... \$62  
Dimensions: 6 1/2 in. w. X 3 1/2 in. h X  
8 1/2 in. d. For 240V op. \$33 extra.

#### 10 WATT P.A.

Inputs 5 MV and 100 MV, 10w R.M.S. at 1%. Frequency 40cy.—30kc. For use with 1.4 ohm, 2.8 ohm or 4.15 ohm speakers in parallel. Same cabinet and dimensions as 30w above.

Wired and tested, No. 485, \$40.  
Freight extra in both cases.

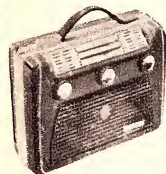

#### R.C.S. COMPLETE DO-IT-YOURSELF KITS

Peak reception, low price. No expensive test equipment. Everything fits. 1964 RF Transports 7.

Complete kit—No. 640 ..... \$43.50  
Portable car radio, identical to 640 above, plus extra switch and car coil etc. No. 642 ..... \$46.00  
(Write for booklet on 640 and 642)  
Postage \$1.

#### NEW TRANSISTOR PREAMP KIT

SIZE 3 x 2 x 1 1/2 in 2 req. for Stereo.  
LOW IMP. Input 2 trans. 672C ..... \$6.50  
Wired ready for use. 672D ..... \$8  
HIGH IMP. 2 tran. 680C ..... \$6.50  
Wired ready for use 680D ..... \$8  
HIGH IMP. silicon 3 tran. 682C ..... \$8  
Wired ready for use. 682D ..... \$9.50  
Postage 10c each. Write for data.

#### HI-FI BROADCAST TUNER UNIT 4 TRANSISTORS — HI SENSITIVITY.



R. F. mixer, I.F., pwr. dectr. stages, adjustable aerial coupling. Complete as illust. Wired and tested with 461 dial, knobs and switch pot. No. 474D, \$31. Postage \$1.  
WHISTLE FILTER for above set for 8Kc band width (can be altered to 9, 10, or 11Kc). No. 128, \$4, Post 10c.

### PRINTED CIRCUITS

For all R. and H., E.A., Mullard, Philips and other designs. Clearly coded. White letters and numbers, easy assembly and service, polished and resined for easy soldering. With blueprint parts list.  
SPECIALS: To your drawing—write for particulars and Drafting aids.

#### New Printed Circuits

Number.	Recent Designs	Price
722	Mullard pre-amp	\$3.00
725	Protected supply	\$2.50
734	E.A. 69 01 gold p. organ	\$5.00
731	E.A. 68 M 12	\$5.50
709	Pre-amp 67-P5	\$2.50
684	Pre-amp 65-P10	\$2.50
685	Pre-amp. 65-P12A	\$2.50
726	3 x 3 or 10 x 10 w stereo 68 A8	\$2.80
736	B C tuner EA 69 T5	\$2.50
727	E & A wide band, tuner 68/8T	\$3.20
728	Audio osc. E.A.	\$8.00
718	Mullard main amp.	\$3.20
		\$2.50

Write for full list. Immediate despatch. Postage 10c.

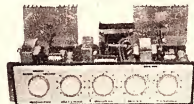

### 10W STEREO

MULLARD 10 x 10  
watts R.M.S.

With output transistor PROTECTION. Frequency response 40cy. to 30Kc. Distortion 0.5%. Treble, bass, boost 20dB. Complete kit of parts No. 480C ..... \$74.00.  
Wired and tested No. 480D ..... \$79.00.  
With hi-fi tuner and whistle filter, \$35 extra. Freight extra. Write for details. For special Saturday demo, ring 59-6550.

#### MAGNETIC STEREO PRE-AMP

In 5Mv out 250Mv. Bass and treble 20D.B. No. 724C \$29.  
Wired ready for use \$31.  
Postage 30c each.



#### TRANSFORMER

Tap 4.6v and 9v D.C. at 100 milliamps.

Filter, condensers, rectifier, resistor, case, etc. \$6.50. Post 10c.

#### PERSONAL PORTABLES 2 TRANSISTORS

Range 30 miles. 200 with short aerial and earth. Earpiece only, no speaker. Wired ready to use. No 666D, \$10.  
Postage 20c.  
Do-it-yourself kit. No. 666C, \$9.00.

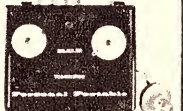

1 TRANSISTOR — 1 DIODE  
593C Do-it-yourself kit, \$5, post 10c.  
593D Wired ready to operate, \$6 post 10c.

#### DIAL KITS

SCALE GOLD WITH WHITE LETTERS. Size 6 3/8 x 2 1/2 in.

• No. 459 to match 300 pf gang. Price ..... \$4.50  
• No. 461 to match 200 pf gang. Price ..... \$4.50  
Post 20c.

#### NEW AUDIO AMPLIFIER



4 transistors. 1/2 or 1 watt. Small size, cabinet 3in x 2in x 1in plastic. Suitable crystal P/up. Inter com. microphone, radio, etc. (9 volt).

DO-IT-YOURSELF KIT 665 \$10 (Post 10c). Wired ready for use 665D \$11.50

#### COILS & IF's 455 Kc

Aer. R.F. OSC. and IF's ..... \$1.80 ea.  
Ferrite Aer. .... \$2  
No. 265 Universal tape OSC Coil, \$6  
Postage 10c. Write for details and price.

R.C.S. Order by Mail Order, Postal Note or Money Order (add post.), direct to—  
RADIO PTY. LTD., 651 FOREST ROAD, BEXLEY, N.S.W., 58-3491, 58-5385

**PLESSEY PACIFIC PTY. LTD.** has advised that Mr Leslie W. Coxon, a senior industrial expert with The Plessey Co. Ltd., U.K., is visiting the company on a two-year assignment. Mr Coxon, F.B.I.M., F.C.W.A., F.C.C.S., F.I.I.A., who will act as a consultant to Plessey in Australia, was until recently the company's chief accountant, but is now engaged on special assignments. He will advise and assist in the rationalisation of management accounting and control procedures.

**EMERSON & CUMING INC.** Canton, Massachusetts, U.S.A., has introduced Eccoshield VY-G, a single component electrically conductive calk and seal. It is designed to finish a shielded room, black box, electronic component or transmission line. Proper calking with Eccoshield VY-G is said to yield insertion losses greater than 100dB over the radio frequency range (including microwaves). Inquiries to the Australian distributors, IRH Components Pty. Ltd., The Crescent, Kingsgrove, N.S.W., 2208.

**ELECTROGRAPHICS DIVISION** of Varian has been formed to develop, produce and market existing and new models of the company's line of multi-channel Statos recorders and other devices using the electrostatic technique. The new division will be located in Palo Alto, California, U.S.A. Information on the products of this division may be obtained from Varian Pty. Ltd., 38 Oxley Street, Crow's Nest, N.S.W., 2065.

**HEWLETT-PACKARD AUSTRALIA PTY. LTD.** has opened an office in Perth to serve Western Australia. The office is located at Suite 13, Casablanca Buildings, 196 Adelaide Terrace, Perth. Manager of the branch is Mr Ron Davis, formerly an engineer in the company's Melbourne and Adelaide branches.

**THE PLESSEY COMPANY LTD.** has been reorganised into two major groupings, covering home-based and overseas-based operations, according to an announcement in London by the company chairman, Lord Harding. The groups, together with the company's central staff, will be directly responsible to the managing director, Mr John Clark. An executive board, under the chairmanship of the managing director, has been created to act as a forum of the company's management for the discussion of major policy issues affecting the company as a whole. Mr Robert Hall, managing director of Plessey Pacific Pty. Ltd. (one of the four overseas Plessey groups), has been appointed to the executive board with the title of executive director. Responsibility for Plessey overseas-based operations will be assumed by Mr W. J. Sinsheimer, president of Plessey Inc. and managing director of the company's North American region.

**NATIONAL SEMICONDUCTOR CORP.**, Santa Clara, California, U.S.A., has introduced the MM510 dual, dynamic 64-bit accumulator/register. It is a high frequency (4MHz), low power (0.8mW/bit/MHz) device designed for use in high-

MM510 dual 64 bit accumulator

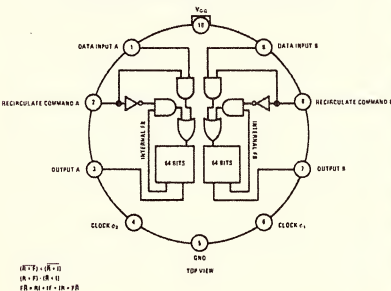

Logic diagram of National MM-510 dual 64-bit accumulator.

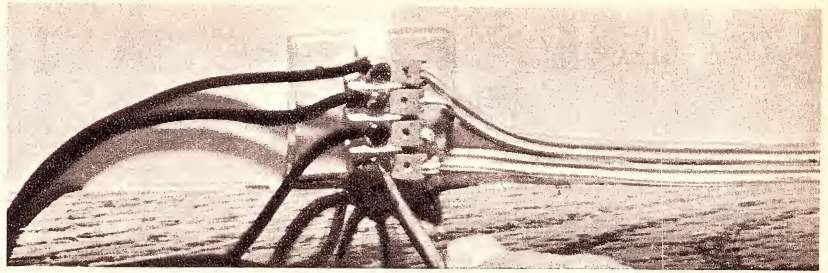

**MINNESOTA MINING AND MANUFACTURING CO.** has developed an improved flat cable system for music, sound, alarms, and low voltage control systems, etc. Called Scotchflex flat cable system No. 500, it can be mounted without nails or screws on almost any smooth, clean surface.

The cable consists of 22AWG stranded wire embedded in a vinyl plastic strip, to which a layer of pressure-sensitive foam adhesive is applied. It is available in two- or three-conductor widths, in rolls of 100 feet. Accessories, of injection molded plastic with foam adhesive backing, in-

*Scotchflex flat cable, laid unobtrusively along a skirting board, is terminated at a distribution point (cover removed). Easily applied, it looks more like a trim than a wiring system.*

clude a barrier strip terminal and a U-grip terminal. Corner covers and self-stripping terminal spades are also available. Scotchflex cable No. 700 is also available, with four solid conductors, for telephone wiring applications. Inquiries to the 3M Company, P.O. Box 99, Pymble, N.S.W. 2073.

speed drum-type memory and high-speed display system applications. Recirculation of data is performed independently of the output drive circuit, to make it insensitive to external loading. A push-pull output stage is used, to increase the maximum frequency and reduce power dissipation. Inquiries to the Australian agents, Rutherford Electronics Pty. Ltd., 833 Doncaster, Vic.

**FAIRCHILD AUSTRALIA PTY. LTD.** has released a dual operational amplifier, type uA739, in a 14-lead dual in-line package containing two identical opera-

tional amplifiers on a single silicon chip. Each amplifier has a differential input and a single-ended output capable of output swings up to 24V peak-to-peak without latch-up. Stable gain is maintained over a supply voltage of 4V to 15V. The device provides high power supply rejection (50uV per V) which reduces supply filter requirements. The input noise is typically 7nV per root Hz and 1pA per root Hz at 1KHz, or about half the level of the uA709. The uA739 also features a high slew rate of 1V per uS, bettering the uA709 by a factor of six.

The uA739 is suitable for a stereo phono

**ADCOLA**

**SOLDERING TOOLS**

## THE VITAL POINT IN PRECISION SOLDERING

*No more guesswork . . . the correct size, the correct temperature for every job.*

See the range of Adcola "M" Series Solder Tools illustrated in Electronics Aust. May, '69, edition or write for illustrated brochure to:

**ADCOLA PRODUCTS PTY. LIMITED**, 22 Birch Street, Doncaster, Vic. 3108. 848-3777.

**ADCOLA PRODUCTS PTY. LTD.**, 17 Burwood Road, Burwood, N.S.W. 747-1606  
Queensland: T. H. Martin Pty. Ltd., 56-74 Edward Street, Brisbane. 2-0555

F. R. Mayfield Pty. Ltd., 11 Halifax Street, Adelaide, S.A. 8-4131  
W. Australia: Everett Agency Pty. Ltd., 17 Northwood St., West Leaderville, 6007  
Phone 84137



# LUX AMPLIFIERS ARE UNEQUALLED FOR VALUE, QUALITY AND PERFORMANCE



## THE NEW LUX SQ-1220 SOLID STEREO AMPLIFIER OVER 100 WATTS R.M.S. TOTAL OUTPUT!

The new and outstanding Lux SQ-1220 is rated at over 50 watts R.M.S. into an 8 ohm speaker load. Distortion is so minute it is difficult to measure even at high outputs. 40 transistors and diodes. Frequency response is 10-50,000 Hz.  $\pm 1$  dB. Provision is made for separate bass and treble controls in each channel, low and high filters, frequency selectors and tape monitoring. Ask for complete and unabridged specifications for this sophisticated Lux amplifier. Performance can only be described as superlative. Encel price (including Sales Tax) ..... **\$350**



## LUX SOLID STATE STEREO AMPLIFIER — THE MODEL SQ-77TW — \$169

Using silicon power transistors the SQ-77TW is rated at 30 watts R.M.S. in each channel with a 4-6 ohm speaker load. Frequency response is 10-50,000 Hz.  $\pm 0$ , minus 3dB. Input sensitivity is 1.8mV for magnetic pickup or tape head, aux. inputs being rated at 200 mV and 800 mV. Controls include stereo volume, stereo balance, mode switch, treble and bass (separate controls for each channel), input selector, head-phone jack and switch, tape monitor switch, rumble and scratch filter switches, etc. (including Sales Tax) ..... **\$169**



## LUX MODEL SQ-606 SOLID STATE STEREO AMPLIFIER

Rated at over 20 watts R.M.S. per channel, the handsome new Lux Model SQ-606 is an all-silicon unit with 27 silicon transistors. Power transistors are designed to withstand temporary short circuits and overloading. Overall frequency response is 10-50,000 Hz.  $\pm 1$  dB. Acoustic performance is quite outstanding. Controls and features include volume, balance, mode selector, treble/bass controls, filters, tape monitor, headphone jack, etc. All in all the SQ-606 is a very fine amplifier, attractively priced. Inc. sales tax ..... **\$219**



## NEW LUX MOVING MAGNET STEREO CARTRIDGE

The Lux T-15-M has been acclaimed as a brilliant performer by discriminating audio enthusiasts — frequency response is conservatively quoted at 20-20,000 Hz. and stylus pressure is from 1 to 2½ grams. Tracking angle is 15°, output is 5 mV. at 1 kHz. Stylus sizes available are 0.7 mil. conical diamond and the new elliptical diamond (T-15-ME). T-15-ME: \$29.50. T-15-M7B (conical diamond stylus) **\$24.50**  
Inc. Sales Tax .....

# ENCEL

**ELECTRONICS (STEREO) PTY. LTD.**

Head Office:  
431 Bridge Rd., Richmond, Victoria 3121. Tel. 42 3762.  
Sydney Store: Ground Floor, 2SM Building,  
257 Clarence Street, Sydney, N.S.W. 2000. Tel. 29 4563, 29 4564.  
Australia's Greatest Hi-Fi Centre \*Wholesalers \*Trade-ins accepted



## EDDYSTONE "EB36" BROADCAST RECEIVER



Price \$190.80 F.O.B.  
(Inc. S.T.)

Also available for  
Export ex Bond.



**Frequency Coverage**  
Range 1 8.5—22.0 MHz  
Range 2 3.5— 8.5 MHz  
Range 3 1.5— 3.5 MHz  
Range 4 550—1500 KHz  
Range 5 150— 350 KHz

**LONG,  
MEDIUM, AND  
SHORT  
WAVES**

**FOR WORLD-WIDE RECEPTION**

The "EB36" is a fully transistorised broadcast model, light, compact, easily transportable and engineered to give the best possible performance. It is a versatile receiver giving coverage of the long, medium and shortwave bands including the marine frequencies used by coastal vessels. Power is derived from U2 type cells housed in a detachable compartment. As the "EB36" is quite suitable as a main domestic receiver, an alternative power supply unit (Cat. No. 924) operating directly from A.C. mains is available if required and is readily interchangeable with the battery unit. A further power supply unit (Cat. No. 945) operating from 12/24 volt DC positive earthed supply is also available for use when mobile operation in small boats, or car, is envisaged.

Comprehensive information from Australian representatives:

**R.H. Cunningham**

608 COLLINS ST., MELBOURNE, VIC., 3000. 61-2464.  
64 ALFRED ST., MILSON'S PT., N.S.W., 2061. 929-8066.  
34 WOLYA WAY, BALGA, W. AUST. 6061. 49-4919.

Queensland Agent:

L. E. BOUGHEN AND CO., 95 CENTRAL AVE, SHERWOOD, QUEENSLAND, 4075. 79-2207.



preamplifier, where it can replace up to 16 devices in discrete designs. Other applications can be found in instrument systems, audio units, telephone systems, process control systems, modulators, digital-to-analog converters, etc. Prices are \$4.85 each for quantities up to 24. Inquiries to the company at 420 Mount Dandenong Road, Croydon, Vic. 3136.

**AUSTRALIAN CONSOLIDATED INDUSTRIES LTD.** has concluded a licensing agreement with American Standard Inc. of New Jersey covering the manufacture and marketing of that company's range of air movement equipment for air conditioning ventilation, heavy duty industrial, general and specialised applications in Australia. With this new licence, A.C.I. is not renewing its previous agreement with Edgar Allen Aerex Ltd. of England, and as a result A.C.I.'s manufacturing unit, Aerex (Australia) Co. has been renamed A.C.I. Industrial Air Company. The new company will take over the manufacture and marketing of Ducon Clean Air equipment carried out under licence from the Ducon Co. Inc. of New York.

**CANNON ELECTRIC (AUSTRALIA) PTY. LTD.** has announced the following appointments: Mr Malcolm L. Carlson (formerly product manager for electronic components) as sales manager; Mr N. Stephenson as marketing manager; Mr T. J. Casey as merchandising manager; and Mr R. Elms as internal sales manager.

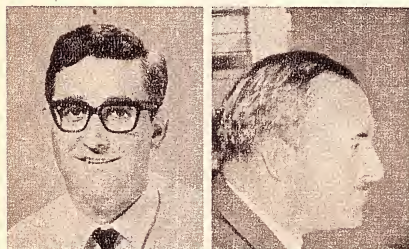

Mr M. L. Carlson Mr J. Broderick

**MARCONI INSTRUMENTS LTD.** Commercial manager, Mr John Broderick, recently undertook a tour of Australia and New Zealand. During his visit, he met executives of Amalgamated Wireless (A'sia) Ltd., the sole representatives of Marconi Instruments in Australia and New Zealand.

**DYNAMCO ELECTRONICS PTY. LTD.**, 90 Alexander Street, Crow's Nest, N.S.W. 2065, has become Australian owned following a recently concluded sale. The company's managing director, Mr Eric Rawlings, is a major shareholder and further capital has been obtained from a leading Australian investment source. To reflect the company's newly independent status, its name has been changed to Datamatic Pty. Ltd. The new name conforms to the company's main interests which have increasingly been in the field of automatic data processing.

## Australian Microcircuits

**PLESSEY PACIFIC** has developed the first Australian - designed metal-oxide semiconductor (MOS) micro-integrated circuits at the company's central research laboratory in Melbourne. The MOS device is a unipolar form of silicon IC as distinct from the bipolar form of IC largely used in microelectronic techniques. The devices had been designed by members of the laboratory's staff, who carried out all the design work, including the preparation of masks for the manufacturing stage. The Plessey Company's micro-electronic production centre at Swindon, in the U.K., processed the masks and made batches of chips from them. The chips were then encapsulated and forwarded to the Plessey Pacific laboratory for checking on a specially prepared test jig.

Two distinct types of MOS device have been covered by the project. One is a time division analog switch for telecommunications applications, and the other a delta modulator suitable for a range of transmission applications. The latter is un-

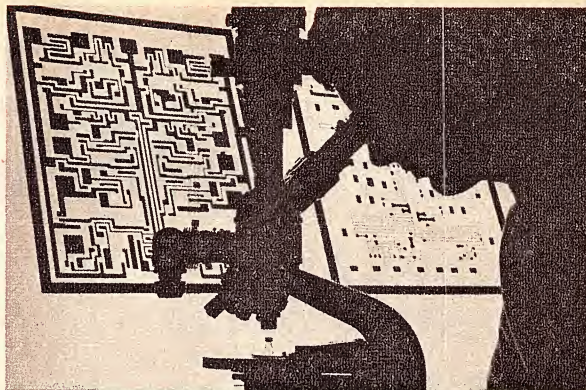

One of the chips in the first batch of Australian-designed MOS ICs is examined through a binocular microscope at the Plessey Pacific research laboratory. At the left of the illuminated table at the rear is one of the masks (250 times the size of the chip) used in the production of the device.

usual in that both analog and digital circuitry are incorporated on the one chip. Other ICs designed by the laboratory staff are currently being processed at the Swindon factory. One of these is a complex bipolar circuit for pulse decoding applications.

Datamatic remains sole Australian and New Zealand distributor for its former parent company, Dynamco Ltd., Chertsey, England, and in addition represents Raytheon Computer, CalComp, Kennedy, and Radio Engineering Laboratories. Mr J. G. Ryan has recently joined the company as manager for CalComp products.

**DATAMATIC PTY. LTD.**, 90 Alexander Street, Crow's Nest, N.S.W. 2065, has introduced the Kennedy model 3100 continuous magnetic recorder which is said to offer the small computer user all the features of big expensive transports but at sensible low prices. Operating at synchronous speeds up to 25ips, it has a high performance single capstan drive matched to the reel servos for fast accurate start/stop. Read/write rates up to 20KHz can be accommodated at 800BPI. Tape motion is bidirectional with no program restrictions. Forward and reverse high-speed search operations can be accommodated at 120 ips. The record mode is NRZI-IBM compatible, seven or nine track.

**CORNING GLASS WORKS** has announced that, effective from April 1, Tecnico Electronics Pty. Ltd. has been appointed stockist distributor for the Corning range of electronic components. Tecnico will assume full responsibility for stock holding, sales, and overseas ordering.

Further details may be obtained from Tecnico Electronics Pty. Ltd., 53 Carrington Road, Marrickville, N.S.W. 2204.

**PLESSEY MICROELECTRONICS** has added two high-performance operational amplifiers to the company range of linear ICs. The devices, types SL703 and SL704, have been developed from the established SL701 device. They offer improved performance with high stability and very low power consumption. The open-loop gain is guaranteed between 68 and 72dB. Both devices are available in TO-5 encapsulation, and the SL704 is also produced in a flat-pack version. Inquiries to the Professional Components Department, Ducon Division, Plessey Components, P.O. Box 2, Villawood, N.S.W., 2163.

**NATIONAL SEMICONDUCTOR CORP.**, Santa Clara, California, U.S.A., has introduced a comprehensive range of N-channel junction FETs. The applications covered by the range of National FETs include UHF/VHF receiver front ends, TV tuners, low noise audio amps, electrometers, DC amps, operational amps, mixers, multiplexers, choppers, gates, etc. Further information and specifications for these devices may be obtained from the Australian agents, Rutherford Electronics Pty. Ltd., 833 Doncaster Road, Doncaster, Vic. 3108.

## PROFESSIONAL LOOKING NAMEPLATES---6 MINUTE PROCESS WITH ALUMINEX

**ALUMINEX** is coloured, anodized aluminium from .003 thru .125 thick with photo sensitive etch resist on one side. Simple exposure in daylight of Aluminex material with a transparent master provides a photographically exact etch resist. Developing and etching dips are entirely non-critical and will produce professional results.

AVAILABLE FROM ALL BETTER KNOWN STOCKISTS for further information contact:

LUNA AGENCIES and DISTRIBUTING COMPANY E. A. WING MANUFACTURING PTY. LTD.,  
259 Jasper Rd., McKinnon, Vic. Tel 97-4111. 43 Anderson Rd., Mortdale, NSW Tel: 57-8739.

# INDUSTRY IS CLAMOURING FOR ELECTRONICS ENGINEERS

*Train now to go straight to the top*

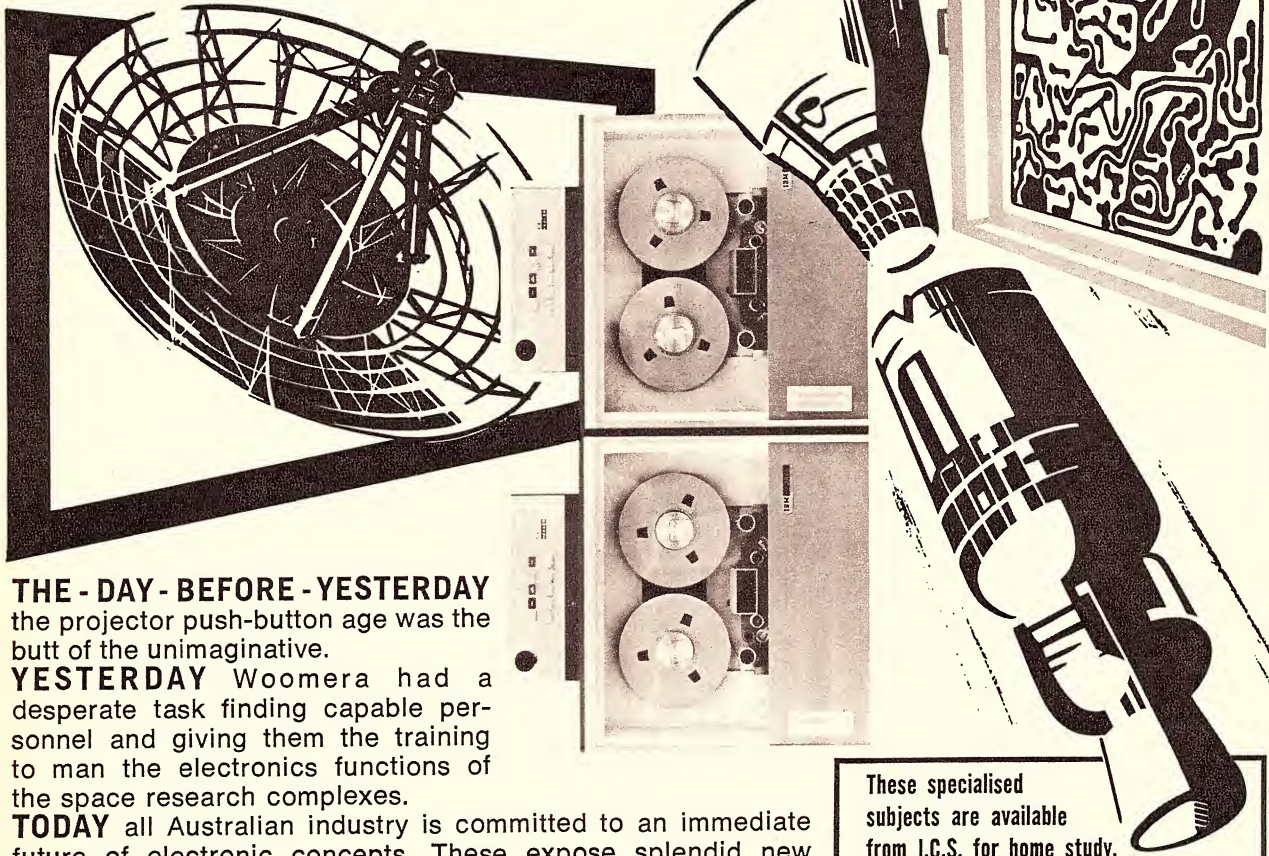

**THE - DAY - BEFORE - YESTERDAY** the projector push-button age was the butt of the unimaginative.

**YESTERDAY** Woomera had a desperate task finding capable personnel and giving them the training to man the electronics functions of the space research complexes.

**TODAY** all Australian industry is committed to an immediate future of electronic concepts. These expose splendid new frontiers of production, of work output in commerce, of living standards. The lack of skilled personnel alone could retard this progression into a totally new world. Eventually the lack will and *must* be overcome. Meantime, Australia will search desperately about the world for the people with electronic skills. Already there is a dearth of them in Australia, *and overseas!* Trained Australians can choose their workplace from the whole world. If you train now with I.C.S., you will be rewarded well. You will reach the top of your profession while many thousands are just beginning to train.

*Make your decision for success now!*

These specialised subjects are available from I.C.S. for home study.

- |  |  |
|--|--|
| <input type="checkbox"/> Audio: Hi-Fi, Stereo          | <input type="checkbox"/> Monochrome and Colour TV                                    |
| <input type="checkbox"/> Automation Electronics        | <input type="checkbox"/> Electronic Drafting   |
| <input type="checkbox"/> Automatic Controls            | <input type="checkbox"/> Printed Circuits, Conventional                              |
| <input type="checkbox"/> Industrial Applications       | <input type="checkbox"/> Printed Circuits, Micro Integrated                          |
| <input type="checkbox"/> Nuclear Instrumentation       | <input type="checkbox"/> Fringe Equipment  |
| <input type="checkbox"/> Digital Techniques            | <input type="checkbox"/> Also Computer Programming for Commerce, Research, Industry. |
| <input type="checkbox"/> Transistors & Semi-Conductors |  |
| <input type="checkbox"/> Communications                |  |

Read the **FREE I.C.S. Illustrated Prospectus**

Send Coupon today!

**International Correspondence Schools,**  
Dpt. 527, Division of Electronics,  
400 Pacific Highway, Crows Nest, N.S.W. 2065.  
Branches in all States and New Zealand.



Please send me **FREE** Prospectus about.....

Name..... Age.....  
(Please print)

Address.....

State.....

Postcode..... Phone..... Dpt. 527

# TECHNICAL BOOKS AND PUBLICATIONS

## Computer monograph—one of a series

**COMPILING TECHNIQUES**, by F. R. A. HOPGOOD. Published by Macdonald and Co. (Publishers) Ltd., London, 1969. Hard covers, 5½ in x 8½ in, 126 pp., diagrams. Price in U.K. 35/.

This book is number eight in a series published under the collective title of Macdonald Computer Monographs, the series being edited by Stanley Gill, M.A., Ph.D., Professor of Computing Science at Imperial College, London. Monographs already published in the series are titled (1) List Processing, (2) A Comparative Study of Programming Languages, (3) Recursive Techniques in Programming, (4) Basic Machine Principles, and (5) Time-Sharing Computer Systems.

"Compiling Techniques" considers the field of techniques currently used in the design and use of compiler systems. For those who are not familiar with compilers, it may be worthwhile to note that they are normally basic utility programs which a computer manufacturer supplies as part of the "software package" accompanying his machine, and whose purpose is effectively to translate into the language of the machine concerned programs which are written in "problem-orientated" languages such as Fortran and Algol.

F. R. A. Hopgood, the author of the present volume, is well qualified as a computer programmer and system designer. Originally in the Applied

Mathematics Group at Harwell, he has since been associated with writing the S2 Fortran Compiler for the IBM 7030 at Aldermaston, and also implemented the Brooker Morris Compiler-Compiler at the Carnegie Institute of Technology. He is presently on the staff of the Atlas Computer Laboratory, where he wrote the initial input phase and general system for the Atlas Algol Compiler.

The content of the book may be judged fairly accurately by the chapter headings: 1—Introduction; 2—Data Structure; 3—Data Structure Mapping; 4—Tables; 5—Language Description; 6—Lexical Analysis; 7—Syntax Analysis; 8—Code Generation for Arithmetic; 9—Expressions; 10—Storage Allocation; 11—Compiler-Compilers. As the foregoing might suggest, the book is intended mainly for use in post-graduate courses and by those intending to become specialist programmers and software designers; a rather advanced reader background is assumed, and the style is concise almost to the point of terseness.

The material and treatment would appear to be well up-to-date, and the book concludes with a comprehensive bibliography. For those to whom it will be of interest, therefore, "Compiling Techniques" should be a very worthwhile acquisition.

The review copy came direct from the publisher, and no information was supplied regarding local price or availability. (J.R.)

## Definitely not recommended

**HAM RADIO PROJECTS For Novice And Technician**, by Bert Simon—W2UUN. Published by TAB Books, Blue Ridge Summit, PA.17214. U.S.A. Stiff paper cover, 190 pages, 8½ x 5½ inches, freely illustrated by circuit diagrams. Our copy direct from the publisher.

The object of this book, according to the preface, is to present a well-rounded collection of circuit ideas for the novice amateur and technician — ideas which can be put into practice with a minimum of expenditure and, in many cases using components salvaged from discarded radio and television receivers. The book contains 104 such ideas, collected under 10 headings ranging from antenna devices, through audio devices to receivers, transmitters and accessories thereto.

The concept isn't unique, but it can result in a quite useful book — provided the ideas and circuits are carefully selected, accurately presented and the necessarily brief text phrased to give maximum guidance in the appli-

cation of the circuits to practical situations. Indeed, the compilation of such an ostensibly simple book calls for a high degree of technical awareness.

How does this particular book match up to these general observations? Well, after a not very convincing start with antenna devices, it gets on to active circuits using transistors and this is where the trouble really begins. The following is a sample of our jottings as we turned from item to item; each identified by a project number.

**5. Transistorised Mic. Booster:** No provision for bias on the base of the transistor. In fact, there would be no DC return for the base with a crystal microphone in circuit.

**6. Four Transistor Self-Powered Modulator:** The battery supply to the power output transistor is reversed.

**7. Transistor Mic. Preamp:** No forward bias on base; envisages feeding a crystal microphone into a load of less than 5K. Supply battery again wrong polarity.

**8. Two-Watt Modulator:** No supply

voltage at all between collector and emitter of the sole transistor. Battery connection either meaningless or wrong.

**12. Effective Audio Filter:** According to the copy, this is "a really effective notch filter" which will "respond only to certain audio frequencies." In fact, it is a primitive, non frequency-conscious diode clipper!

**14. Tuneable Audio Filter:** Using a twin triode valve, this "audio filter" is supposed to increase the sensitivity of a receiver by 18dB, which produces "the same result as boosting the power of the transmitter 60 times." The circuit looks like an RF device but there is no clue as to where "input" and "output" should connect. It uses a 2-gang 365pF variable capacitor and a 350h RF choke, whatever that is!

**15. A One-Tube BFO:** The valve has no grid-leak bias components and there are no instructions as to how to control injection. Yet it is credited with being adequate for SSB and DSB on 6 and 2 "meters."

**16. Heterodyne Eliminator:** A bridged-T network which would probably not be anything like as universally effective as the author would hope. The how-to-connect-it switch diagram is wrong and leaves the audio circuit completely open in the straight-through position.

**24. One-Transistor Grid-Dip Meter:** I would be surprised if a transistor would perform with the base circuit bypassed and returned to ground through a battery, and with the collector bypassed to emitter with a 10uF capacitor.

**31. 50MHz Preamplifier:** Transistor collector supply the wrong way round.

**49. Transistorised Squelch:** With many receivers, this device would simply ground the AVC line through a forward-biased base-emitter junction. Perhaps it should be called "transistorised overload device!"

**50. Ultimate Noise Filter:** Designed to counter noise problems that "cannot be licked using the internal noise limiter," this turns out to be an ordinary line filter. While useful devices in a few special situations, line filters are certainly not the panacea that the text would imply.

## R.S.G.B.

### RADIO COMMUNICATION HANDBOOK

The Fourth Edition of the Handbook published by the Radio Society of Great Britain is the latest and completely revised volume in the series, the first of which appeared thirty years ago. The Handbook deals with the many varied aspects of radio communication and is invaluable not only to the amateur but also to the professional engineer. Theory and practice of the latest techniques have been blended together to form a book essential to both student and constructor.

Price \$10.50, Post 50c.

Available from:

COLLINS BOOK DEPOT PTY. LTD.,  
363 Swanston St, Melb. 3000.  
Phone 663-3787.

Stock Lists available free of charge on any subject of interest to you.

# Electronic Technicians Earn Big Money!

## Why not YOU?

With training through T.T.I., you could qualify for a start in the Electronics Industry as a:

- Radio-television technician • Telecommunications technician • Instrumentation technician • Business machine technician • Automatic control technician • Industrial electronic technician—and many other skilled positions.

### WILL YOU FILL THE BILL WHEN THE TIME COMES?

The "good job" you hold down today may offer less and less opportunity for advancement as Electronics increase their impact on all branches of industry.

**TECHNICAL TRAINING INTERNATIONAL**, a world-wide company with 30 years' experience in the field of specialised technical training, offers the latest Electronics training programmes available in Australia.

**GAIN FULL PRACTICAL EXPERIENCE BY BUILDING YOUR OWN LABORATORY AT HOME.** With T.T.I. training you build over 100 circuit-proving projects. In addition, you actually construct the professional test equipment illustrated here.

IF YOU ARE BETWEEN 18 AND 45 YEARS, AND EARNING LESS THAN \$80 PER WEEK . . . IF YOU ARE SERIOUSLY INTERESTED IN TRAINING FOR A CAREER IN ELECTRONICS, FILL IN THIS COUPON FOR FURTHER INFORMATION, WITHOUT OBLIGATION.



To: Technical Training International Pty. Ltd.  
P.O. Box 328 Chatswood, N.S.W. 2067.

Please tell me more about T.T.I. Electronics Training, without obligation to me.

Name \_\_\_\_\_

Address \_\_\_\_\_

Age \_\_\_\_\_ Present occupation \_\_\_\_\_

T.T.I.—The industry-approved Technical Training Organisation

EA/K

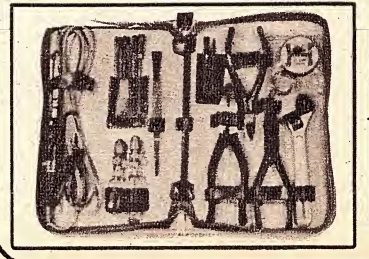
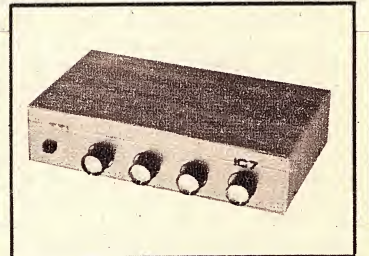
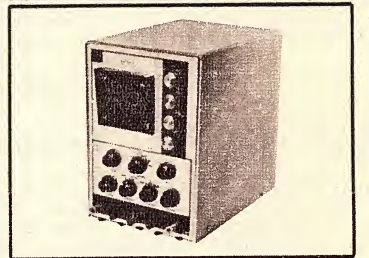
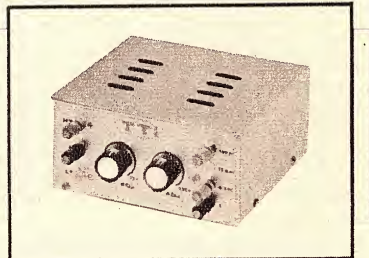
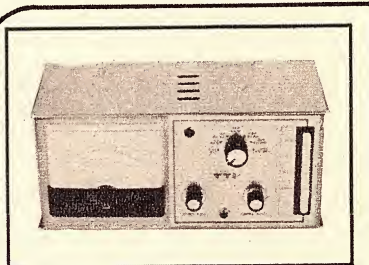

**52. One-Tube Noise Limiter:** Diode clipper circuitry hung on the plate wiring of the last IF tube. Without debating the value of the circuit itself, no warning is given of its likely effect on stability and alignment.

**53. TV "Birdie" Eliminator:** "Blip-like" noises are supposed to come from TV oscillators. Heterodynes and whistles, maybe, but why blips? Could the author be talking about radar pulses? The author's advice as to how to overcome this not clearly defined trouble is surely a gem of technical prose: "Simply solder a 700pF capacitor in series with a 31-ohm resistor and connect the whole mess across your receiver (or transceiver) AC line cord. It may not kill off ALL your birdies, but Napoleon Solo addicts won't be coming at you with their kid's popguns."

What on earth is that supposed to mean?

**63. 80-40 Meter Special:** (Encountered by another staff member while glancing through the book). This is indeed a "special." On transmit, the 12-28V supply is shunted directly to chassis through the output tuning circuit. The collectors of the output transistors go nowhere!

**96: Transistorised Field Strength Meter:** Supply battery, wrong polarity.

Well, I ask you: When a by-no-means exhaustive sampling of contents reveals as many mistakes and shortcomings as this, is it worthwhile to seek any merit in the book at all?

One must surely speculate about the technical standing of the author, whose name appears on the cover.

Did he select each circuit featured and actually write the copy, or was an initial selection of circuits turned over for presentation to not-very-technical copywriters and not-very-technical draughtsmen?

Who checked the manuscript and who checked the drawings before the material went on the presses?

No less important: Have we a right to ask these questions?

Yes, we have. The book was sent to us for review and, we imagine, in the hope that it would receive a favourable write-up. On the contrary, we can only comment that the book must have a strong claim to being the worst that has ever been submitted to us. The kind of misinformation we have quoted can only lead to failure, frustration and, in certain cases, ruined components.

So much for the particular, but it also raises the general case: Too many technical books are appearing on the market, and certainly too many American books, carrying the mark of the "quickie."

They are aimed at specific markets—novice, technician, serviceman, hobbyist, etc. Their title and content is topical, but they may well contain more than their share of error, half-truth, redundancy and omission.

All too obviously, the material has passed from author to layout man, without the vital checking and second-opinion of a technically equipped sub-editor, who can often spot errors, omissions and wrong emphasis far more readily than the original author.

Double-checking of technical manuscripts and drawings is a tedious and

costly business but it is inseparable from the publication of technical books. Neither can it be replaced by an array of titles, an attractive price tag, an imaginative cover or extravagant blurb in the preface.

Whatever the inclinations of his American counterpart, the Australian technical reader is partial to good, old-fashioned accuracy. (W.N.W.)

## TV waveforms

**MODERN TV WAVEFORM ANALYSIS**, by Stan Prentiss. Published by TAB Books, Blue Ridge Summit, Pa., U.S.A. Price in U.S.A., \$4.95.

A further copy of this book has been received from Grenville Publishing Co., the Australian agents for TAB Books. A review was published in the December, 1968, issue.

## Oscilloscopes

**99 WAYS TO USE YOUR OSCILLOSCOPE**, by A. C. W. Saunders. Published by TAB Books, Blue Ridge Summit, Pa., U.S.A., 1968. Paper covers, 5½in x 8in, 192 pp., profusely illustrated. Price in U.S.A., \$4.95.

This recent release by TAB Books presents a collection of some 99 descriptions of techniques and practical setups for making measurements and tests with a service-type oscilloscope. Each technique or setup is described largely by means of a semi-pictorial diagram, accompanied by explanatory notes and also in most cases by one or more photographs of the oscilloscope patterns to be expected.

The broad fields covered by the 99 items include calibration of the oscilloscope itself, frequency measurement, reactance measurement, semiconductor device curve plotting, device testing, amplifier stage checking, power supply testing, use of electronic switches, hysteresis loop plotting, testing colour TV circuitry, monochrome TV servicing, audio amplifier performance, and oscillator and waveform generator testing.

Naturally with such a large number of individual test setups and techniques described, the space available for each is rather limited. This reviewer would like to have seen fewer items treated, with the treatment of each done in a more thorough and satisfying fashion.

However, it would appear that, in general, most items are in fact sufficiently described for the book to be of value, mainly to servicemen and amateurs who already have a reasonable knowledge of oscilloscope operation and use. Notable exceptions to this are the items dealing with electronic switches, amplifier testing and RF and IF alignment, all of which are very sketchily treated indeed.

For those seeking a reference or "guidebook" concerning the use of the oscilloscope in a servicing or amateur environment, a book which may be of limited interest. But it can only be commended with the above qualification.

Two copies of the book were received for review, one direct from the publisher and the other from their Australian agents, Grenville Publica-

tions Ltd. Copies should be available from local bookstores by the time this notice is published. (J.R.)

## TV Servicing

**TV SERVICING GUIDEBOOK, Problems and Solutions.** By Art Margolis. Published 1968 by TAB Books, Blue Ridge Summit, Pa., U.S.A. Hard covers, 5in x 8½in, 176 pages, illustrated by circuits and photographs. Price in Australia \$8.70 hardbound, \$4.95 paperback.

The author, an old hand at the TV service bench, is sufficiently confident to nominate a certain number of "classic" TV trouble symptoms, to give them informal names like "Bleeding," "Worms," "Piecrust" and "Snivets," and suggest how the reader should go about fixing them.

Significantly, although the title simply says "TV Servicing," something like half the book has to do with colour TV with the implication, surely, that colour is now just an everyday part of the U.S. TV scene. At the same time, scanning this material emphasises how much Australian TV ser-

# RADIO ENTHUSIASTS

Learn amateur radio in your spare time.

Whatever your interests are in amateur radio, there's a Stott Radio course for you. Easy to follow. Practical. Modern. Guidance all the way by top-flight radio engineers.

### Radio for amateurs

Learn the exciting skills of building modern radio receivers. Learn about the latest advances in electronics, design, construction and operation.

### Let Stott's show you how. Amateur Operator's Certificate Course:

Broadcasting is fascinating. Stott's offer an entirely new course that enables you to sit for the Amateur Operator's Certificate of Proficiency Examinations with complete confidence.

Get full details now on Stott's Radio Courses.

POST THIS COUPON TODAY

**Stotts** 

TECHNICAL CORRESPONDENCE COLLEGE  
159 Flinders La, Melbourne. 383 George St, Sydney  
290 Adelaide St, Brisbane. 45 Gilles St, Adelaide.  
1130 Hay St, Perth.

Please send me, free and without obligation, full particulars of your courses in Radio for Amateurs.

Mr Mrs Miss.....

Address.....

.....Age.....

No sales representative will call

EA569

# SALE! SALE!

## "Star" Double Conversion Amateur Communications Receiver



SR-550

**SALE PRICE \$159.50** ORIGINAL PRICE \$209.50

The SR-550 is a communications receiver designed specially for SSB, CW and AM reception on amateur bands from 160 to 6 metres. Careful design and construction give good stability and sensitivity. All the most wanted features required for amateur communications are included for ease of operation and first-class results. At its original price of \$209.50 the SR-550 was exceptional value for money; at the low sale price of \$159.50 it is a genuine bargain.

### FEATURES:

- Complete coverage of all seven amateur bands from 160 to 6 metres.
- Direct reading linear type dial with slow tuning rate for ease of tuning SSB.
- Excellent stability through careful overall design and plate tuned oscillator with cathode follower. Voltage regulated power supply.
- Double conversion with first IF of 1650KHz gives excellent image rejection on all bands.
- Second IF of 55KHz for high selectivity. Incorporates four-position bandpass filter, having band widths of .5, 1.2, 2.5 and 4KHz at 6 db down.
- Built-in 3.5MHz crystal calibrator (crystal included) provides check points at the lower end of bands 80 to 10 metres and on 52.5MHz on 6 metres. Zero adjustment control on front panel.
- Product Detector for SSB/CW. Diode Detector for AM.
- Variable BFO. Noise Limiter. S-Meter.
- Power output, 1 watt. Impedance 4 or 8 ohms.
- Power supply, 220 to 240 volts 50 Hz (50 watts).
- Dimensions, 385 mm. wide, 185 mm. high and 255 mm. deep.
- Weight, 8.5 kg.

TUBES: 6BA6 RF Amplifier, 6AU6 1st Mixer, 12AU7 Local Oscillator, 6BE6 2nd Mixer and Oscillator, 2 x 6BA6 IF Amplifiers, 6EA8 Product Detector/BFO, 6AL5 Detector/AVC/ANL, 6BM8 AF Amplifier/Output, VR-105 Voltage Regulator, 6AU6 Crystal Calibrator, Solid State Power Supply.

**STOCKS ARE LIMITED AND WHEN SOLD THIS OFFER  
CANNOT BE REPEATED**

**SEND REMITTANCE WITH ORDER FOR IMMEDIATE DELIVERY  
ANYWHERE.**

### ELECTRON TUBE DISTRIBUTORS PTY. LTD.,

Inc. LAFAYETTE ELECTRONICS DIVISION

15A WELLINGTON STREET, WINDSOR 3181

94 HIGH STREET, ST. KILDA, VIC., 3182. PHONE 94-6036

vicemen will have to pick up in a few years' time—in a rush!

Beginning with colour problems and colour tubes, the author passes on to video troubles, EHT, yokes, oscillators, sync, AGC, sound systems and power supplies.

How to fix TV sets is not a new theme but this book should serve to give local servicemen an authentic bench-eye view of colour problems in particular. Our copy came direct from the publishers but it is understood that supplies will be available from Grenville Publishing Co. Pty. Ltd., 401 Pitt Street, Sydney, 2000. (W.N.W.).

### LITERATURE—in brief

**MULLARD OUTLOOK**, Vol. 12. No. 1, January-February, 1969. Published by Mullard-Australia Pty. Ltd., 35-43 Clarence Street, Sydney, 2000. Contents: Viewpoint with Mullard; Colour Television, part 3—Colour and Colour Reproduction; TAA300 Integrated One-Watt Class B. AF Amplifier; Noise Problems and Interfacing Techniques with Integrated Circuits; New 40A rectifiers in DO-5 Encapsulation; Snap-On Heatsinks; A Three Channel Stereo Mixer. Also included with this issue is the Table of Contents and Product Type Number Index for Vol. 11, 1968.

**TELECOMMUNICATION JOURNAL**, Vol. 36, No. 3, March, 1969. Published by the International Telecommunication Union (I.T.U.), Place des Nations, 1211 Geneva 20, Switzerland. Separate editions are published in English, French and Spanish. Contents: Some Aspects of International Co-operation in Space Telecommunications, by I. Petrov; Colour Videophone, by G. Valensi; Software versus Hardware, by R. A. Cline. The feature "Union Activities" includes a report on the meeting of C.C.I.R. Study Group I last year. Under the heading "Ideas and Achievements" are described the European HEOS-A satellite, the Intelsat III satellites, radar measurements of the Icarus asteroid, and the telecommunications training school at Dieburg. A list of satellites launched in 1968 and the chronological and analytical tables for 1968 are included as two separate supplements.

**MULLARD-AUSTRALIA PTY. LTD.**, 35-43 Clarence Street, Sydney, 2000, has published the following quick reference guides for 1968-69. Inquiries should be on company letterhead.

**Industrial Valves, Tubes and Special Products.** This 52-page guide lists essential data on receiving valves, electron optical devices, photosensitive devices, cold-cathode devices, power devices, transmitting valves, microwave products, vacuum products, particle and radiation detectors, and special products.

**Industrial Semiconductors.** This 52-page guide lists essential data on diodes, transistors, leadless inverted devices, photo-devices, rectifier diodes and stacks, thyristors and stacks, integrated circuits, and details of outline and construction.

**MINIWATT TELEVISION PICTURE TUBE REFERENCE DATA AND REPLACEMENT GUIDE, 1969.** Published by the Miniwatt Electronics Division of Philips Electrical Pty. Ltd., 20 Herbert Street, Artarmon, N.S.W. 2064. This eight-page booklet lists essential data for the range of Miniwatt picture tubes and gives an equivalent for the replacement of older types.

**HEWLETT-PACKARD CO.**, of the U.S.A., has published the following application notes and catalogue. Inquiries, on company letterhead to the Australian associated company, Hewlett-Packard

**INTERNATIONAL ELECTROTECHNICAL COMMISSION (I.E.C.)** has recently issued the following publications, which may be obtained through the Standards Association of Australia.

**IEC 50 (26) International Electrotechnical Vocabulary: Group 26 — Nuclear Power Plants for Electric Energy Generator.** Price \$7.35. This revised edition contains 309 terms and definitions in French and English with equivalent terms in six other languages. The terms are divided into sections on nuclear physics, reactor theory, and reactor technology and operation.

**IEC 268-1 Sound System Equipment — General.** Price \$2.55. This is the first part of a series on sound equipment, from simple general-purpose devices to equipment used in studio techniques, and the parts associated with the systems. It lists the characteristics necessary for the determination of the quality of audio apparatus, for the comparison of these types of apparatus, and for the determination of their proper practical application.

**IEC 283 Methods for the Measurement of Frequency and Equivalent Resistance of Unwanted Resonances of Filter Crystal Units.** Price \$3.15. This describes two methods both based on the use of a measuring bridge in which balancing of the parallel capacitance is performed at a

frequency removed from the main or any unwanted resonance.

**IEC 284 Rules of Behaviour with Respect to Possible Hazards when dealing with Electronic Equipment and Equipment Employing Similar Techniques.** Price \$5.05. This covers factors such as the precautions to be taken against dangerous voltages and currents, high RF voltages, the effects of fields in the vicinity of aerials, explosion hazards, and the risks run by persons working on structures or buildings.

**IEC 289 Reactors.** Price \$6.30. This publication applies to series, shunt and single-phase neutral-earthing reactors, arc-suppression coils, three-phase neutral electromagnetic couplers and earthing transformers. It gives the general requirements and the definitions concerning the reactors as well as the particular requirements of each type of reactor described.

All IEC publications are ordered by the Standards Association as required, and prices are subject to handling charges, details of which may be obtained from sales offices in each State capital city and Newcastle. A complete catalogue of IEC publications current at 31 December, 1968 may be obtained from the Association for 90c. It lists the publications in numerical order with a short summary of each. An alphabetical index is included.

Australia Pty. Ltd., 22-26 Weir Street, Glen Iris, Vic. 3146.

**Frequency Synthesizers, AN96,** describes the principles of operation and applications of fast-switching "direct" frequency synthesizers. It has a section on spectral purity and how to measure it, and a section describing the programmable fast switching capabilities of direct synthesizers and what limitations there are on switching speed.

**Antenna/Radome Boresight Error Measurements, AN110,** describes a simplified but accurate method of measuring radome induced antenna boresight and/or beamshift errors. The method uses a network analyser to detect phase differences in a pair of receiving antennas and is said to give accuracies within 0.1 milliradian.

**Low-Frequency Network Analysis with the 657/676A, AN112-1,** describes how to measure the gain/attenuation and phase response characteristics of networks over a 10KHz to 32MHz swept frequency range. Techniques for obtaining 100dB dynamic range or 0.01dB and 0.01 degree resolution, and for making log-log (Bode) plots are also described.

**Hewlett-Packard 1969 DC Power Supplies Catalogue and Handbook** lists all HP power supplies including a selection guide and condensed listing to help prospective users. The handbook portion discusses power supply circuit principles, operating features, performance measurements, and special application of regulated DC power supplies.

**MARCONI INSTRUMENTATION, Vol. 11, No. 6(A), December, 1968.** Published by Marconi Instruments Ltd., Longacres, St. Albans, Herts., England. Contents: Autotest; Control Systems for Automatic Testing; Control and Recording Instrumentation for an Automatic Test System; Peripheral Instrumentation for an Automatic Test System; Index to Volume 11.

**HEWLETT-PACKARD JOURNAL, Vol. 20, No. 5, January, 1969.** Published by the Hewlett-Packard Co., Palo Alto, California, U.S.A. Inquiries to Hewlett-Packard Australia Pty. Ltd., 22-26 Weir Street, Glen Iris, Victoria 3146. Contents: Broadband Passive Components for Microwave Network Analysis; Measuring

High-Frequency Transistor Parameters; Printed-Circuit Slide Switches Save Panel Space; Recording Data for Computer Analysis.

**SCIENTIFIC EQUIPMENT, No. 6, February, 1969.** Published by Watson Victor Ltd., P.O. Box 100, North Ryde, N.S.W. 2113. Contents: H 1200 Infragraph; Stepless Speed Stirrer; Ultrasonic Thickness Measuring Instrument; Atomic Absorption Spectrophotometer; Thermistor Thermometer; Sound Level Meter; Goerz Multimeter; Portable Viscometer; University Laboratories Lasers; Faxitron 805.

**VARIAN SPECTRUM, Vol. 2, No. 3, February, 1969.** Published by Varian Australia Pty. Ltd., 38 Oxley Street, Crow's Nest, N.S.W. 2065. Contents: M-50 Portable Proton Magnetometer; Digital Recording System; New System E-4 EPR Spectrometer; New High-Frequency Sample Pyrolyzer Model 9425.

**R. H. CUNNINGHAM PTY. LTD., P.O. Box 4533, Melbourne, 3001,** has a number of Geloso 1969 calendars available free of charge to readers on receipt of a 15c stamp to cover postage.

**PLESSEY COMPONENTS, Ducon Division, Box 2 P.O., Villawood, N.S.W. 2163,** has published the following data sheets: TB102 Paper Capacitors, tubular "Highseal 85" series TPB; TB113 Fluorescent Capacitors, types APB and APD; TB 209 Aluminium Electrolytic Capacitors, type EJC/M; TB210 Aluminium Electrolytic Capacitors, type EMG; TB301 Mica Dielectric Capacitors, moulded types MS, SS, SM, M; TB409 type CAA Ceramic RF Power Capacitors; TB610 Metallised Polyester Capacitors, type DMR; Interim data in Epoxy Coated Polyester Dielectric Capacitors, type DMA.

**MINIWATT DIGEST, Vol. 7, No. 8, January/February, 1969.** Published by the Miniwatt Electronics Division of Philips Electrical Pty. Ltd., 20 Herbert Street, Artarmon, N.S.W., 2064. Contents: Transistor Equipped Aerial Amplifiers, Part 2; Miniwatt Thyristor BT100A; Semiconductors — Tentative Data Thyristor BT100A; Additions to Philips Technical Library. □

# PLAN YOUR FUTURE

CHOOSE a career in the field of ELECTRONICS\* — the Nation's most progressive and fastest expanding industry.

✳ Advancement in this modern science demands technical ability; a sound knowledge of basic principles and applications.

YOU can master the subject by training at the MARCONI SCHOOL and be ready to grasp the opportunities that occur in the three fundamental branches of Radio-technology.

# KNOW WHERE YOU'RE GOING

## A = APPLIED SERVICING

Comprehensive training in the maintenance and repair of radio and television receivers offers substantial rewards to competent technicians. Marconi School training covers all aspects of radio and television receiver circuit applications, practical exercises in fault finding and alignment procedures.

## B = BROADCASTING

A thorough and practical grounding is available to students in broadcasting transmitter performance standards and maintenance techniques, with individual instruction in station operation and studio control and testing.

## C = COMMUNICATIONS

Combines all the foregoing, together with radio aids to navigation, mobile telephony, marine service application and international wireless telegraph regulations, qualifying the successful student for the Commonwealth Government Certificate of Proficiency and the Marconi School Diploma in Radiotechnology. Classes are conducted at 21 Pier Street, Sydney (at the foot of Goulburn Street).

Daily: 9.30 a.m. to 4.30 p.m.

Evenings: 6 p.m. to 8.30 p.m.

or by Home-Study Courses (except practical instruction on equipment).

# STUDY NOW

Send for training syllabus. There is no obligation.

NAME.....  
ADDRESS.....

the MARCONI SCHOOL of wireless

G.P.O. Box 2516, Sydney  
A Service of Amalgamated-Wireless (Australasia) Ltd.

# NEW Releases!

**IN HI-FI STEREO EQUIPMENT BY CLASSIC  
BASED ON THE PLAYMASTER 118 AMPLIFIER**

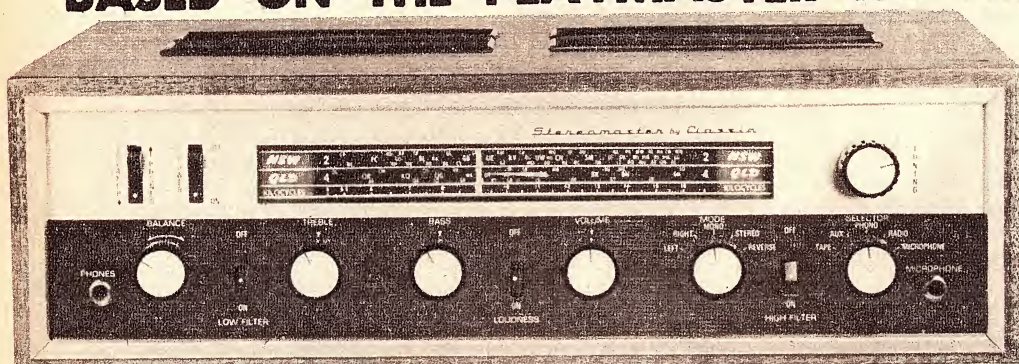

**\$128.00**

**MODEL C 300V**

**FREIGHT EXTRA**  
Dimensions 16½" x 5½" x 11

This amplifier is based on the Playmaster 118 circuit as featured in "Electronics Australia" to which has been added the following features.

- Inbuilt high gain A.M. tuner with a coverage of 530 to 1,600 K.C.
- Loudness control giving bass boost at low volume.
- High and low filters (scratch and rumble filters).
- Provision for tape, record and play-back, with din connector.
- Provision for headphones with headphones-speaker switch.
- Input for microphone with jack on front panel.
- Calibrated dial available for all States.
- EM84 tuning indicator giving accurate tuning with ease.

**POWER OUTPUT:** 9 watts per channel R.M.S. **FREQUENCY RESPONSE:** 20 to 20,000 cycles incorporating Ferguson O.P.412 grain oriented output transformers. **VALVES USED:** 4-6GW8, 12AX7 or 12AU7, 6AN7, 6N8, EM84 and 2 silicon diodes.

**CABINET IN OILED WALNUT OR TEAK WITH METAL TRIM.**

(Cabinet and front panel of valve and transistor amplifiers with tuner are the same)

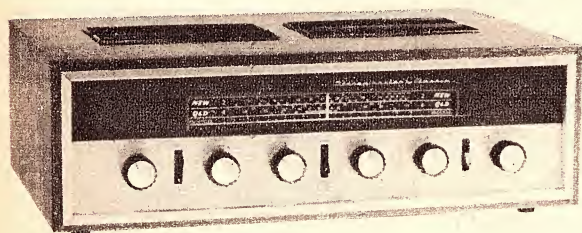

**\$118.00**

**FREIGHT EXTRA**

## MODEL C200V. BASED ON THE PLAYMASTER 118 WITH TUNER

Specifications as C300V but less high and low filters, headphone and microphone jacks.

Dimensions 16½in x 5½in x 11in.

**CABINET IN OILED WALNUT OR TEAK WITH METAL TRIM.**

## NEW AMPLIFIER AND TUNER BASED ON THE PLAYMASTER 107

**107 AMPLIFIER AND  
TUNER  
\$85.00**

**FREIGHT EXTRA**

- 107 AMPLIFIER**
- Output 5 watts per channel (10 watts).
  - Ferguson output transformers with a response of 30 to 20,000 cycles.
  - Valves used: 6AN7, 6N8, 2-12AT7, 2-6BQ5, and 6CA4 rectifier.

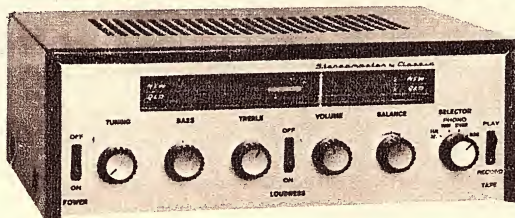

### SPECIFICATIONS

- Inbuilt high-gain tuner with a frequency coverage of 530 to 1,600KC.
- Two-channel tone control stage with separate bass and treble controls.
- Switching facilities for pick-up and stereo or mono tape recorder for record or play-back.
- Loudness control giving bass boost at low volume.
- Chassis plated and mounted in attractive metal case finished in grey with control panel in silver and black with matching knobs and switches.
- Dimensions: 13½in x 5¼in x 11in.
- Fully guaranteed.

The above amplifier supplied with the new Garrard 40 Mk II Changer with Sonatone ceramic cartridge and diamond stylus and two Magnavox 8WR or Rola 8CMX Hi-Fi speakers.

**\$132.00 FREIGHT EXTRA**

# CLASSIC RADIO

245 PARRAMATTA ROAD, HABERFIELD, N.S.W. PHONE 798-7145



# NEW ALL TRANSISTOR STEREO AMPLIFIER ULTIMATE IN DESIGN-LONG DEPENDABILITY USING ALL SILICON TRANSISTORS

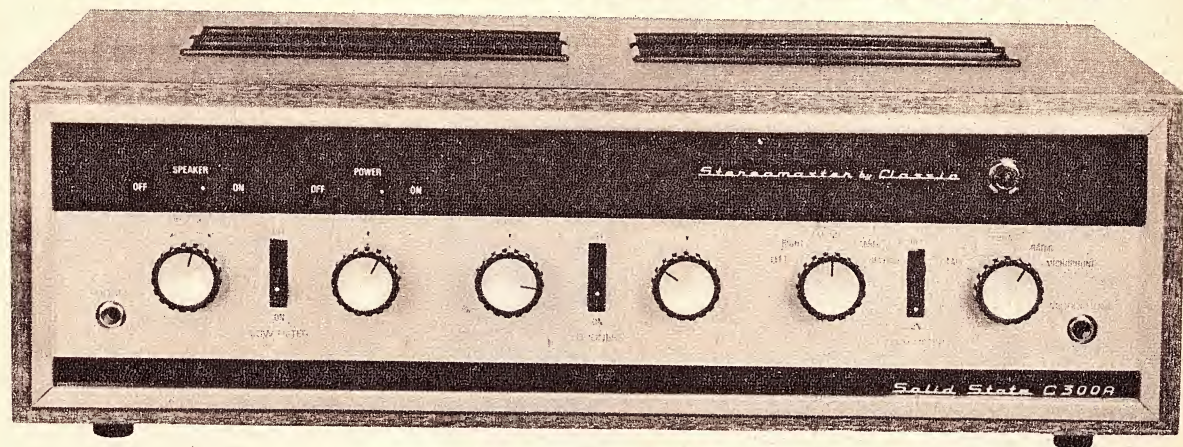

## MODEL C300A

### SPECIFICATIONS:

POWER OUTPUT 20 watts per channel R.M.S. (40 watts total).  
 FREQUENCY RESPONSE: From 20 cycles to 20,000 cycles  $\pm$  1dB.  
 HARMONIC DISTORTION: Less than 1 p.c. at rated output.  
 HUM AND NOISE: Aux. 70dB, Mag. 50dB.  
 INPUT SENSITIVITY: Mag. 3mv. Aux. 150mv. Tuner 150mv.  
 EQUALIZED: Mag. RIAA.  
 TONE CONTROL: Bass 50c/s  $\pm$  12dB. Treble 10kc/s  $\pm$  12dB.

DIMENSIONS: 16½in x 5½in x 11in.

**\$120.00** FREIGHT EXTRA

LOUDNESS CONTROL: 50c/s 10dB.  
 REGULATED and protected power supply.  
 SCRATCH FILTER: (High filter) at 10kc/s 9dB.  
 RUMBLE FILTER: (Low filter) at 50c/s 5dB.  
 PROVISION FOR TAPE RECORDER. RECORD OR PLAY BACK WITH DIN PLUG CONNECTION.  
 PROVISION FOR HEADPHONES WITH SPEAKER — HEADPHONE SWITCH.  
 THE CIRCUIT CONTAINS 26 SILICON TRANSISTORS PLUS 5 DIODES.  
 MOUNTED IN OILED WALNUT OR TEAK CABINET WITH METAL TRIM.

## C300 AMPLIFIER WITH INBUILT TUNER

The above amplifier can be supplied with an inbuilt A.M. tuner as illustrated on opposite page, with dial scale available for all States.

**\$145.00** FREIGHT EXTRA

### MULLARD MAGNAVOX MINI SPEAKERS

These units designed by Mullard and Magnavox engineers compare favourably with imported B/S Speakers costing more than twice the amount and are ideal where space is limited. Incorporates the Magnavox 6WR 6-inch Speaker and the new 3TC Mk. II tweeter frequency response, 50 to 18,000 cycles. Power rating max. 8 watts. Available in 7½ or 15-ohm impedance.

Dimensions: 14in x 8½in x 8½in.

**\$27.00**

Post and Packing: N.S.W. \$1.50. Interstate, \$2.00.

## NEW BOOKSHELF SPEAKER SYSTEMS

### PLAYMASTER .4

Incorporates the new 6in Philips Speaker and Magnavox 3TC tweeter. Frequency response 45 to 18,000 cycles. Power rating 10 watts. Dimensions. 14in x 8in x 8in.

Available in 8 ohms only.

**\$36.00**

Post and Packing: N.S.W. \$1.50. Interstate, \$2.00.

### PLAYMASTER SUPER BOOKSHELF

Using two of the new Magnavox 6WR Speakers and one 3TC tweeter. Dimensions: 19½in x 10in x 8in.

Available in 15 ohms or 8 ohms.

**\$40.00**

Post and Packing: N.S.W. \$2.00. Interstate: \$3.00.

ALL SPEAKER UNITS FINISHED IN OILED WALNUT OR TEAK WITH SILVER TRIM

# CLASSIC RADIO

245 PARRAMATTA ROAD, HABERFIELD, N.S.W. PHONE 798-7145

# PETER SHALLEY ELECTRONICS Pty. Ltd.

127 YORK STREET (Just near Town Hall) 29-7021 29-3767

NEW RELEASE



TOKAI TC502

- 1 watt
- All steel case.
- Ruggedised/ Defence spec.
- Leather case.
- Ext. Aerial con.
- Ext. power con.
- Fully P.M.G. app. as base or hand-held.
- Noise limiter/ squelch.
- Ear plug and Mic. input Options.
- Nick. Cad. Batts.
- Base aerial.
- A.C. adapter. \$132 each.

We've got lots cheaper. None better.



\$49.75 each

TOKAI PT51 100MW

- \* 11 Transistors
- \* All metal
- \* Leather case
- \* Sep. Spkr. and Mic.
- \* Ear piece
- \* Squelch

STATE DISTRIBUTORS  
K. J. KAIREs and CO.,  
4 HILL COURT,  
MACLEOD, VIC. 3085.  
Phone 45-4953.

L. E. BOUGHEN and CO.,  
95 CENTRAL AVENUE,  
SHERWOOD, QLD. 4075.  
Phone 79-2207.

D. K. NORTHOVER and CO.,  
337 WELLINGTON STREET,  
PERTH, W.A. 6000.  
Phone 23-4683.

We have lots of other units, new and used from as little as \$35 each. Repairs, tuning and alignment are our speciality.

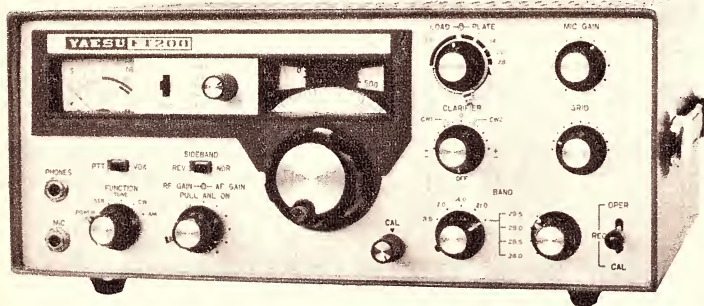

## YAESU-MUSEN AMATEUR SSB TRANSCEIVERS

The largest selection of imported amateur gear in Australia, plenty of stock of all that is advertised, except the YAESU-MUSEN FT-200 transceiver, which will soon arrive in quantity. Here is my list again, all prices net, cash Springwood, sales-tax included, no discounts or terms.  
YAFSU-MUSEN FT-DX-400 transceiver \$550. FV-400 second VFO \$100. FT-DX-100 transceiver \$525. FT-200 transceiver \$375. FL-DX-2000 linear \$250. FL-DX-400 transmitter \$375. FR-DX-400 receiver \$375. SWAN SW 350C transceiver \$525. GALAXY V Mark III transceiver \$525. GALAXY GT550 transceiver \$575. HY-GAIN TH6DXX beam \$200. TH3JR junior beam \$110. BN-86 balun \$17.50. MOSLEY TA33Jr beam \$98. MP-33 senior Mosley beam, expected soon, \$125. HAM-M CDR heavy duty rotator \$180. AR-22 \$60 Ro tator (both with 230V indicator control units.) NEWTRONICS Hustler 4-BTV vertical, 10 to 40 metres, \$55. WEBSTER Bandsanner, all-band mobile whip with swivel-mount and spring, \$55. MARK 40 meter helical whip \$16. MARK tri-band 10-15-20 meter helical whip \$27.50. Swivel mount and spring for the MARK whips \$12.50. ACITRON 12v heavy duty mobile supply, fits all transceivers, \$105.

## SIDEBAND ELECTRONICS ENGINEERING

33 PLATEAU ROAD, P.O. BOX 23, SPRINGWOOD, N.S.W. 2777.

TELEPHONE (STD 047) 511-394

City Office & Showroom, Mondays to Fridays, 9 a.m. to 5 p.m. by appointment with Clive Hutchison  
145a George Street, near Circular Quay, Sydney. Tel. 27-5885/6.



# AMATEUR BAND NEWS AND NOTES

## DX Projects on VHF/UHF Amateur Bands

Over the next 12 months, considerable interest is expected in two projects that could bring a new concept to international amateur communication on the VHF-UHF bands.

by Pierce Healy, VK2APQ\*

Will amateurs have their own repeater station on the moon in 1970?

The answer lies in the result of the work of the MOONRAY project team at Nassau College, Garden City, Long Island, New York, and the assistance given by the National Aeronautics and Space Administration.

The MOONRAY project has been actively pursued since 1967 under the leadership of Nick Marshall, W6OLO, who was technical Director of the OSCAR program during the development of OSCARS I, II and III. It is hoped that arrangements will be made to enable the MOONRAY package to be taken along on the third Apollo Lunar mission in the early 1970s.

In the March, 1969, issue of the American amateur radio magazine "CQ," an article by Kenneth J. Doyle, WA2QMC, gave technical details of the project. Some of the main points have been extracted from the article and may be of interest to Australian UHF/VHF enthusiasts.

The aim is to build a UHF translator to operate in the 432MHz band, capable of relaying all types of signals from amateur stations from any point on earth to another which is in line of sight to the moon. The project will take into consideration such factors as thermal cycling, solar radiation, cosmic rays, meteorites and many others associated with environment on the moon. The aim is to design the MOONRAY unit to have an operating life of at least one year.

The package will weigh 5lb and will be powered by an isotope-fuelled, thermoelectric converter. It is stated that NASA is also interested in the possibility that the MOONRAY unit could be used as a back-up emergency communication package and a site relocation beacon.

It is proposed that frequencies from earth to moon will be near 440MHz and moon to earth near 430MHz. The choice of these frequencies has been made to give the widest possible separation between input and output channels.

The translator will transmit "SS" in Morse code as identification signal, when normal operation is interrupted during the first minute of every ten-minute period.

\* News and notes of Divisional and Club activities submitted for inclusion in these columns should be forwarded direct to Pierce Healy, 69 Taylor St., Bankstown, N.S.W. 2200.

Six to twelve channels of telemetry will time-share with the translator.

A command receiver and decoder operating near 450MHz will be included in the package and will enable the translator to be switched on or off, as desired, by an earth-based control station.

The article points out that while the MOONRAY transmitter virtually will be capable of transmitting any type of emission, the use of CW will give the best results, as a bandwidth of 100Hz or less can be used for CW compared with 2KHz for voice signals.

Based on the use of CW, it has been calculated that an earth station with an effective radiated power of 80 watts could work through the MOONRAY translator very satisfactorily. However, it would be possible under extremely favourable conditions — no QRM — for a station with 5 watts RF power output, a low-noise transistor converter, and a small Yagi antenna to be capable of intelligible long-range line of sight communication.

The calculations given are based on the MOONRAY receiver having a bandwidth of 5KHz. However, it is possible that this will be increased to a bandwidth of 10KHz to minimise the frequency accuracy that would be required by the earth station and to allow more stations to simultaneously work through the translator.

The article contains graphs useful for calculating sensitivity of the complete receiving system and the effective radiated power of a station, as well as the following formula:

The receiving system sensitivity may be calculated thus:—

$$S_r = 10 \log kTB - G_r + NF$$

where  $S_r$  = Receiving system sensitivity.  
 $k$  = Boltzmann's constant  
 $(1.38 \times 10^{-23} \text{ joule / } ^\circ\text{K}).$   
 $T$  = System temperature  
 $(290^\circ\text{K} = \text{room temp.}).$   
 $B$  = Receiver noise bandwidth.  
 $G_r$  = Receiving system antenna gain (in dBi) which is the receiving antenna gain minus line loss.  
 $NF$  = Receiving noise figure in dB over kTB.

For effective Radiated Power:  
 $ERP = 10 \log P_{out} + G_t$   
 where:  $P_{out}$  = Transmitter power output in dBW (dB ref. 1W).  
 $G_t$  = Transmitting antenna system gain in dBW (transmitting antenna gain minus line loss).

The example given shows that a transmitter with a power output of 5 watts and an antenna gain of 12dBi will have an effective radiated power of 19dBW.

Other parameters given for the MOONRAY package are:

MOONRAY receiver: All solid state and integrated circuitry.

Noise figure: 1 to 3dB (estimated).  
 Sensitivity: —164dBW.

Selectivity: 5KHz at 3dB points.  
 Signal acceptance: CW, AM, FM, SSB, FSK, AFSK, MCW, FAX and SSTV.

MOONRAY transmitter: All solid state and integrated circuitry.

Type of modulation: Narrow band FM or PM (hard limiting employed).

Output power: 2.8 Watts (3.8dBW).  
 Telemetry: 6 to 12 channels of data in Morse code.

Command Shutdown: Earth-originated command turn-off and turn-on capability.

MOONRAY antenna: 10ft diameter parabolic dish—aluminised Mylar.

Gain: 17dB at 3dB points.  
 Beamwidth: 16° at 3dB points.  
 Orientation: Fixed, toward earth's centre.

Polarisation: Linear.

MOONRAY Power Supply:  
 Type: Isotope fuel thermoelectric converter.

Voltage (from DC/DC converter): 10VDC  $\pm$  0.5 Volt.

Current: 500mA.

Nominal continuous power output: 5 Watts DC.

Thermal surplus: 200W of heat.

Operating lifetime (isotope half life): 87½ years.

Nominal power supply life (continuous duty): 2 to 5 years.

An invitation is extended to amateurs visiting Long Island to visit the NASTAR facilities where the MOONRAY design and development work is being carried out.

The location is on the Campus of Nassau College, Garden City, Long Island, New York. For additional information, write to NASTAR, P.O. Box T, Syosset, N.Y. 11791.

### VHF Propagation Experiments

Since January 1968, Brian Tideman, VK5TN, an enthusiastic South Australian VHF amateur radio operator, has been attempting to analyse long-range tropospheric propagation on 144MHz across the Great Australian Bight.

This has been done by comparing the surface weather maps, together with the aerological sounding (temperature height chart used to check the magnitude of temperature inversions) available from the Bureau of Meteorology, with the signal strength of the 144MHz amateur radio beacon at Albany, Western Australia, VK6VF/P, transmitting on a frequency of 144.5MHz.

Albany is particularly well situated for the experiments, and in 1969, amateur operators in Albany, Adelaide and in other southern areas of Australia have been noting the signals from VK6VF/P and the South Australian beacon VK5VF, on an average of two days per week. On January 3, 1969, conditions were the best for 12 months, according to

**ALWAYS RELY ON R.D.S.**

**SPECIALS  
FOR MAY**

**R  
D  
S**

- 30 watt PA Amp \$75.10
- Signal Injector SE250B . . . . \$7.13
- Compax transcription turntable comp \$39.50
- 2-stage intercom.. \$7.94
- 3-stage intercom., \$12.88

- CT 500 Meter with mirror scale . . . . . \$14.38
- 200H Meter . . . . . \$11.50
- ST.708 Stereo Amp. 3½ watts per channel . . . . . \$41.25 nett



*The Independent Wholesaler*

**RADIO DESPATCH SERVICE**

Radio and Electrical Distributors  
**869 GEORGE STREET,  
SYDNEY.**

Corner George and Harris Streets  
Telephone 211-0816, 211-0191

**Open Saturday mornings**

Mick McMahon, VK5ZDR, located at Millicent, in south eastern South Australia and Wally Green, VK6WG in Norseman, Western Australia. This was the fourth VK5-VK6 contact on 144MHz since it was first accomplished in 1951 by Clem Tilbrook, VK5GL and Bob Everingham, VK6BO.

Contacts on 144MHz during long-range tropospheric propagation conditions such as existed on January 3, 1969, can usually be predicted a day or so in advance from long-range weather charts. Propagation via the back edge of cold fronts is not so easy to predict.

This fact had been first noted by VK5ZDR as early as 1964 and has recently been revived by Brian Tideman, VK5TN, as a prelude to taking advantage of the large "High" that exists most of the time in the Indian Ocean area.

Predictions for the Indian Ocean region are made possible by the twice-daily weather maps which cover most of the southern hemisphere. These maps are available at the Bureau of Meteorology in each capital city, together with the aerological soundings from places such as capital cities and Carnarvon, Western Australia.

Inspection of the Indian Ocean weather maps since January 1, 1968, has shown that tropospheric propagation should be good between Carnarvon and Tananarive, Malagasy Republic (formerly Madagascar) on about ten days in the period from January to July. Occasionally conditions will improve further south to enable VHF tropospheric propagation between Perth and South Africa, especially in the vicinity of Rhodesia. Propagation as far to the east as South Australia could occasionally occur.

The announcement in the December, 1967, issue of these notes of the establishment of a Memorial Beacon Station ZE1JZA, the availability of information about the excellent long-range tropospheric propagation in January, 1968, and the existence of the southern hemi-

sphere weather maps being realised, has resulted in Brian, VK5TN, commencing a program of investigation to see whether the Indian Ocean could be spanned on UHF/VHF.

This program of investigation has resulted in communications with the Radio Society of Rhodesia, which revealed that the beacon station, ZE1JZA, had been off the air from June, 1968 to February, 1969. At the request from Australia, ZE1JZA has been repaired and put back into operation at its former site, 70 miles from Salisbury, Rhodesia, and the 144MHz transmission has been beamed to Australia from March 1, 1969, 24 hours a day. Continuous beacon operation has been promised up to September, 1969, as requested, after which time the beacon operation may be concluded if there are no positive results.

Amateur radio operators situated within, say, 300 miles of the Indian Ocean, near Carnarvon and Perth, are particularly requested to monitor the beacon frequency of 144.015MHz. The beacon can be identified by an eight-second break in carrier, 36 seconds of carrier, call sign repeated six times in FSK, each taking 18 seconds and 280 seconds of unmodulated carrier. The mark frequency is 600Hz lower than the space frequency of 144.015MHz.

The power output of the transmitter is 60 watts and the 16-element antenna beamed towards Australia has a gain of 15dB over a dipole. It is expected that when a large high-pressure region on the Indian Ocean extends from Africa to the Australian mainland, signals received with a 12dB gain 144MHz antenna should be available at a level of up to 20 microvolts in Western Australia and somewhat less in South Australia.

The extensive FM broadcasting network of stations in South Africa may prove useful as additional more powerful beacons. The frequencies in use extend every 86KHz from channel 1 on 87.740MHz to channel 234 on 107.642MHz (Durban North).

Verification of tropospheric propagation over these long distances — up to 7,000 miles — will provide further evidence to present research being undertaken in various parts of the world in VHF microwave propagation and meteorology.

Brian Tideman, VK5TN, would welcome any inquiries on this experimental program and any reports on VHF signals from Africa. Also, any information about suitable VHF transmissions (preferably close to 144MHz) that may be used in the Malagasy Republic.

For those wishing to communicate with Brian, his address is: 33 Ningans Avenue, Kings Park, South Australia, 5034.

**Amateur Radio Provides a Service**

Late on Friday evening March 13, 1969, Mac Hicks, VK2ADV, a well-known amateur radio operator from Palm Beach near Sydney, received a request for assistance in contacting Noumea, New Caledonia. It was not possible to do so through normal radio and telephone channels which apparently cease operation for the weekend on a Friday afternoon.

The reason for the request was to let a visitor to Noumea know that his mother was ill in Mona Vale Hospital, and had to undergo a serious operation.

On Saturday March 14th at 5.00 p.m. Sydney time, Mac Hicks, VK2ADV, contacted Roul Thomas, FK8AU, in Noumea, on 14MHz and explained the situation.

Despite a severe tropical storm, Roul set out and operating mobile maintained contact with Mac until he eventually learned that the person sought was on a boat cruise and would not be returning until early next morning.

At 6.30 a.m. Sunday morning, March 15, Roul met the boat and delivered the message. He then assisted in arranging an air booking to Sydney.

At 5.00 p.m. Sydney time Sunday afternoon, the visitor to Noumea had returned and was at the bedside of his mother in hospital. The patient is now convalescing

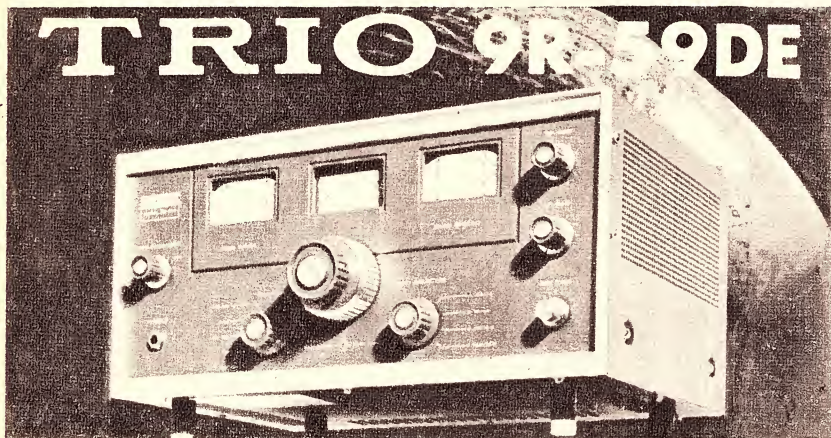

**COMMUNICATIONS RECEIVER**

- 4 BANDS COVERING 540 Kcs. TO 30 Mcs.
- TWO MECHANICAL FILTERS ENSURE MAXIMUM SELECTIVITY.
- PRODUCT DETECTOR FOR S.S.B. RECEPTION.
- AUTOMATIC NOISE LIMITER.
- LARGE TUNING AND BAND-SPREAD DIALS FOR ACCURATE TUNING.
- CALIBRATED ELECTRICAL BANDSPREAD.
- "S" METER AND B.F.O.
- 2 MICROVOLTS SENSITIVITY FOR 10 dB S/N RATIO.

PRICE: FOR/FOA SYDNEY: \$175.00

CONSULT YOUR LOCAL RADIO DEALER, OR

MAIL THIS COUPON *today*

Please forward free illustrated literature and specifications on Trio equipment.

Name.....

Address.....



(A unit of Jacoby Mitchell Holdings Ltd.)

376 EASTERN VALLEY WAY, ROSEVILLE, N.S.W.  
Cables and Telegraphic Address: 'WESTELEC',  
Sydney, Phone: 40 1212

and the hospital staff have said that the speedy return of her son was of great psychological assistance to their patient.

Thanks to Mac and Roul, this is another instance where amateur radio has been of assistance in time of need.

#### VHF Publication

VHF/UHF/microwave enthusiasts will be interested in a new overseas publication, "VHF Communications," published in English text by DJ3QC, in the Federal Republic of Germany. It contains constructional details and photographs of UHF and VHF equipment.

It is actually the English version of "UKW-Berichte," which has been published regularly since 1960. It is to be published quarterly — February, May, August and November. The first English edition, published in February 1969, contained constructional details of a 144MHz FET Converter; Phase Locked Oscillator for transmit and receive mixers; 144MHz/432MHz Transverter; a 144MHz adapter for use with a 28MHz SSB Transceiver as well as other articles.

This publication with up-to-date applications of solid state devices for the VHF operator is available through the Australian representative, Gordon Clarke, VK2ZXD, 2 Beaconview Street, Balgowlah, 2093, New South Wales. Subscription is \$5.50 per year (four issues) airmailed direct from the publisher to the subscriber.

#### DX Note

Until March 16th 1970, Ken Young will be operating under the call sign VK9KY, from Cocos Keeling Island, in the Indian Ocean. Ken is making observations for the Ionospheric Prediction Service and will be operating CW and SSB on the following frequencies:—

7050KHz	14195KHz
14050KHz	21050KHz
14150KHz	21350KHz

Times of operation will be 1100 to 1400GMT and 2300 to 2400GMT.

Ken's QSL manager is Sid Molen VK2SG.

#### Licensing Regulations

During recent months reference has been made in these notes to the use of unlicensed 27MHz walkie-talkie units. Several inquiries have been received regarding the current regulations applying to these units and where a person interested in radio communication can receive advice and guidance. Replying first to the latter question, the secretary of the Wireless Institute of Australia in any of the capital cities will supply the necessary information.

In regard to the current regulations, a copy of the conditions covering the licensing and operation of these units was obtained from the Radio Branch, Postmaster General's Department, and sections of this are reprinted here.

## CONDITIONS GOVERNING THE LICENSING AND OPERATION OF HAND-PHONE MOBILE RADIO SERVICES.

### Purposes for which Licences may be Granted.

1. Licences in accordance with the provisions of the Wireless Telegraphy Act may be granted for the operation of low-powered, short-range mobile radiotelephone transmitting and receiving stations intended for use while being carried by hand, on the person or in such other manner as may be authorised (referred to herein as "hand-phone units"), when required to facilitate industrial, business, or pastoral activities or the conduct of sporting or other group events, and for such other legitimate purposes as the Department considers warrant the grant of licences.

1.1. Licences may also be granted to business enterprises engaged in the sale of hand-phone units to employ such number of the units as may be necessary for demonstrating the equipment to prospective buyers.

### Licence Applications and Fees.

2. Applications for licences should be addressed to the Superintendent, Radio Branch, Postmaster-General's Department, in the capital city of the State in which it is desired to establish the service. Copies of the application forms are obtainable from any office of the Radio Branch.

2.1. If the equipment which it is proposed to employ is of a type which has not been approved by the Department the application must be accompanied by two copies of the electrical and performance specifications and circuit diagrams (indicating component values) of the units. An additional copy of the circuit diagram will be required in respect of each additional State and District Radio Inspector area in which the equipment is to be employed. Inquiries as to the types of hand-phone units already approved by the Department may be made at any of the offices of the Radio Branch.

2.2. A licence fee of \$2 per annum is charged in respect of each unit it is desired to employ. Initial annual fees should accompany applications, cheques or other orders being made payable to the Receiver of Public Moneys.

2.3. An application for a licence for a service required by an unincorporated association of persons (enterprises not registered under a Companies Act or not otherwise constituted as a legal entity) must be made by a nominee of such association who shall state in the application that he is so nominated.

2.4. A licence granted to a person who has applied for it as a nominee of an unincorporated association is subject to a

condition that the licence may be revoked in the event of the association withdrawing its authorisation of that person to act as its nominee.

### Equipment—Technical Requirements.

3. Licences will be granted only in respect of hand-phone units which are of a type approved by the Department (see 2.1 above).

3.1. The input power to the final stage of the transmitter of a hand-phone unit shall not exceed one watt.

3.2. A selected channel within the band 27230 to 27280KHz will be assigned for use by Hand-phone Mobile Services.

3.3. Transmissions by stations in Hand-phone Mobile Services must be maintained within the prescribed tolerances of 50 parts in 10<sup>6</sup> in the case of channels in the band 27230 to 27280KHz.

### Principal Operating Conditions.

4. The stations shall be employed only for the purpose and in the areas indicated in the licences.

4.1. The only antenna which may be used with a hand-phone unit is that which is an integral part of the equipment. This antenna must not be detached from the equipment or extended from it in any manner for use at a separate location.

4.2. No interference shall be caused by operation of the stations to any other radiocommunication service or to the reception of broadcast or television programs.

4.3. Where services of the type referred to herein employing the same operating frequency are used by different licensees in close proximity, licensees must co-operate to ensure that mutual interference is kept at a minimum.

4.4. Employment by operators of appropriate station names or numbers during transmissions for the purpose of service identification may be desirable in the circumstances referred to in 4.3 above.

### General Provisions.

5. Additional hand-phone units must not be included in a service without first obtaining licences as required.

5.1. Stations must be made available for inspection and testing at all reasonable times by an authorised officer.

5.2. Adequate measures must be taken to safeguard against unauthorised use of equipment.

5.6. Except with the consent of the Department in writing, the licensee of an authorised station shall not transfer the licence or assign, sublet, or otherwise dispose of or admit any other persons to participate in any of the benefits of the licence or the powers or authorities there-by granted.

# ELECTROLUBE 2A-X

Registered Trade Mark

IMPROVES ELECTRICAL CONTACTS  
INCREASES RELIABILITY AND  
LOWERS MAINTENANCE COSTS

SAFE ON

POLYSTYRENE, P.V.C. MAKROLON,  
PAINTS, NATURAL AND SYNTHETIC  
RUBBER NON-HAZARDOUS VAPOUR

Write for free Products Summary on the range of electrical and mechanical oils and greases

RFA

RICHARD FOOT (Australia) PTY. LTD.  
63 Hume St., Crows Nest, N.S.W. Tel. 43-0326.

# The NEW MINISCOPE

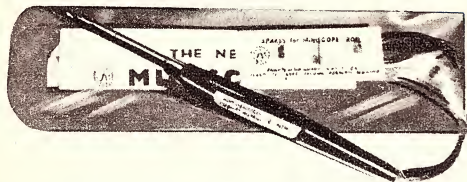

Engineered for the Professionals...

Today's most modern  
soldering tool



Light as a feather . . .  
. . . A finger touch and it's HOT  
. . . that's right!  
. . . from cold to hot in seconds.  
So easy to use at any moment, anywhere.  
. . . Unless you need more heat than even a  
conventional 75 watt iron will give and  
that's very seldom, isn't it?  
Why not meet the mighty MINISCOPE?  
You'll be pleased you did.



AUSTRALIAN & OVERSEAS AGENTS:

**IRH COMPONENTS  
PTY. LIMITED**

THE CRESCENT, KINGSGROVE, N.S.W. 2208. TEL. 50 0111

## WIRELESS INSTITUTE ACTIVITIES

At the time these notes were being compiled, preparations were nearing completion for the Thirty-Third Federal Convention of the Wireless Institute of Australia, the venue being Canberra, A.C.T.

Thirty-five items had been submitted for the agenda covering items of policy, administration, I.A.R.U. Region III, and contests. Decisions arising from the discussions by Federal Councillors representing New South Wales, Victoria, South Australia, Western Australia, Queensland and Tasmania, will become W.I.A. policy of all divisions, to be administered by Federal Executive.

### NEW SOUTH WALES

The Annual General Meeting of the New South Wales Division of the W.I.A. was held at Wireless Institute Centre, 14 Atchison Street, Crows Nest on Friday evening, March 21, 1969.

This year there were 17 nominations for the Divisional Council of seven members. The ballot resulted in a 40 per cent return by members eligible to vote. All retiring councillors who stood for re-election were returned to office.

The seven members elected to council were:

Gordon Clarke, VK2ZXD,  
Bill Foreman, VK2WF,  
Chris Jones, VK2ZDD,  
Don Miller VK2GN  
Gerald Sabin, VK2AGS,  
Chas. Wilkins, VK2ALB,  
Chas. Quin, VK2AWQ.

The retiring president, Don Miller, VK2GN, presented a comprehensive report on the activities of the year. There was an increase of 239 members during the year. Comment was made on the reason for the decision to increase membership fees and that over 70 per cent of members had renewed their membership prior to the end of the financial year.

Reference was also made to the administrative re-organisation that had taken place and which is almost complete; also the success of the A.O.C.P. classes and correspondence provided by the division.

Mention was made and appreciation expressed of the work done by those officers associated with the various sections and groups within the divisional structure as well as the national and international aspects.

The treasurer's report presented by Chas. Quin, VK2AWQ, revealed a sound financial position with total assets of \$86,833. The report gave a resume of various aspects affecting the financial status of the division and provisions made to meet future commitments.

#### Area Officers' Meeting

A meeting of area officers of the division and members of council and the WICEN Group was held on Saturday afternoon March 22nd. The meeting was called to discuss future activities and policies of the division in relation to improved services to country members, WICEN, and drives to increase the number of licensed amateurs as members of the W.I.A.

The first meeting of the newly elected council was held on Friday night, 28th March, and the following officers were appointed:

President, Gordon Clarke, VK2ZXD  
Vice-presidents,  
Don Miller, VK2GN  
Bill Foreman, VK2WF  
Secretary Treasurer,  
Charlie Quin, VK2AWQ  
Minute Secretary,  
Don Miller, VK2GN  
Honorary Solicitor,  
Ben Mills, VK2AJE  
Communications Officer,  
Ian Mackenzie, VK2ZIM

Y.R.S. Supervisor,  
Dave Jeanes, VK2BSJ  
A.O.C.P. Class Manager,  
Cec Bardwell, VK2IR  
QSL Officers,  
Ted Whiting, VK2ACD  
Brian Anderson, VK2AND  
Country Liaison Officer,  
Clive Jackson, VK2TD  
Morse Code Training Broadcasts,  
Doug Courtney, VK2AUC  
Morse Tape Service,  
Ern Hodgkins, VK2EH  
Bulletin Editor,  
Bill Foreman, VK2WF  
Chief Engineer,  
Bill Jenvey, VK2ZO  
VK2WI Grounds,  
Laurie Cartwright, VK2ZJC  
Other appointments will be made at the next meeting of council.

#### Annual Dinner

On Saturday evening, at Windsor Gardens, Chatswood over 80 members with their wives and friends attended the annual dinner of the division. Among the invited guests were John Batrick, VK3OR, Federal President, W.I.A. and Mrs Batrick; Ron Holt and Eric Gaston of the Radio Branch, P.M.G. Department; Charlie Allen of the N.S.W. Civil Defence Organisation and Mrs Allen.

Don Miller, VK2GN, welcomed the guests on behalf of the council and members to which Ron Holt responded and proposed the toast to the W.I.A.

John Batrick replied to the toast and spoke briefly on several aspects of the W.I.A.

#### Annual Convention Field Day

History was made at the Annual Convention Field Day of the New South Wales Division, held at VK2WI, the divisions' Transmitting Station at Quarry Road, Dural. Although the number present was not as large as last year, it was an excellent day.

The historic highlight was the televising via Amateur Television (ATV) of the Sunday morning broadcast of news from VK2WI at 11.00 a.m. This was the first live telecast to be made by ATV of a W.I.A. broadcast to its members.

From an ATV demonstration set-up at VK2WI, by members of the VHF and TV Group which included Vic Barker, VK2ZVV, Horrie Laphorne, Grahame Wilson, VK2ZGW, Ian Mackenzie, VK2ZIM, pictures were transmitted which were received at very good quality by Barry Gerdes, VK2ZAH, located at Hornsby, about five miles away. The input power to the transmitter was 20 watts.

Television transmissions made by Barry Gerdes, VK2ZAH, from his station at Hornsby, were also received at good strength at VK2WI.

Many of those present at the field day saw colour television for the first time, for among the pieces of equipment on display was a colour bar generator, the output of which was fed by closed-circuit to 23in screen. Also during the day, closed circuit TV as well as radiated signals were demonstrated around the grounds of VK2WI.

Trade displays of the latest single side-band equipment, including Swan, Galaxy and Japanese manufactured units, were demonstrated.

A 10,000MHz two way link was also demonstrated by Bruce Carrol, VK2ZIC and Neil Dunn, VK2ZNC. While the path was only across the grounds the demonstration nevertheless created quite a deal of interest.

There was a full program of field events and contests.

#### VHF and TV Group

Over 60 members were present at the Annual Meeting of the VHF and TV Group of the New South Wales Division

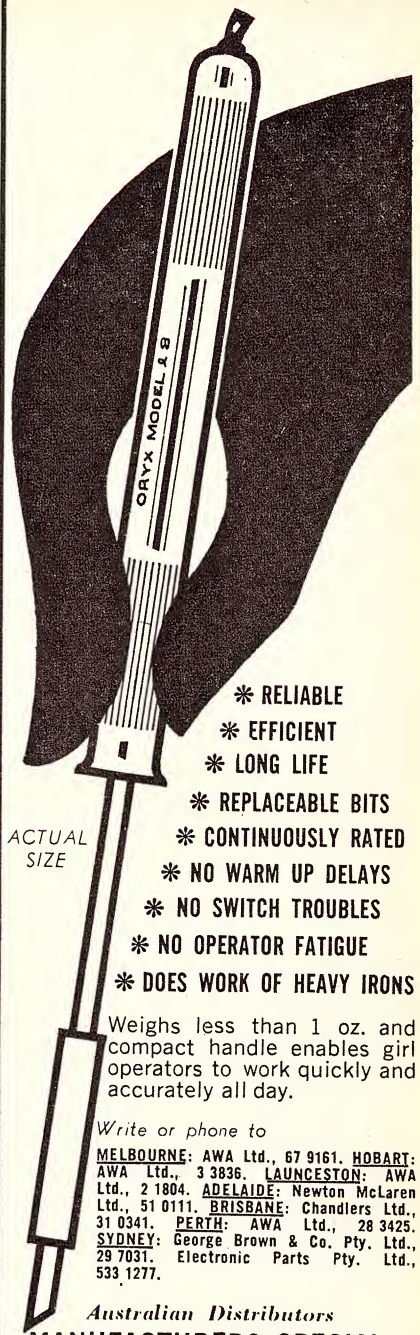

ACTUAL SIZE

- \* RELIABLE
- \* EFFICIENT
- \* LONG LIFE
- \* REPLACEABLE BITS
- \* CONTINUOUSLY RATED
- \* NO WARM UP DELAYS
- \* NO SWITCH TROUBLES
- \* NO OPERATOR FATIGUE
- \* DOES WORK OF HEAVY IRONS

Weighs less than 1 oz. and compact handle enables girl operators to work quickly and accurately all day.

Write or phone to

MELBOURNE: AWA Ltd., 67 9161. HOBART: AWA Ltd., 3 3836. LAUNCESTON: AWA Ltd., 2 1804. ADELAIDE: Newton McLaren Ltd., 51 0111. BRISBANE: Chandlers Ltd., 31 0341. PERTH: AWA Ltd., 28 3425. SYDNEY: George Brown & Co. Pty. Ltd., 29 7031. Electronic Parts Pty. Ltd., 533 1277.

Australian Distributors  
MANUFACTURERS SPECIAL  
PRODUCTS PTY. LTD.

47 York Street, Sydney. 2 0233, Ext. 284

# WANTED

BY ALL  
PRODUCTION ENGINEERS

# ORYX

miniature  
soldering instruments

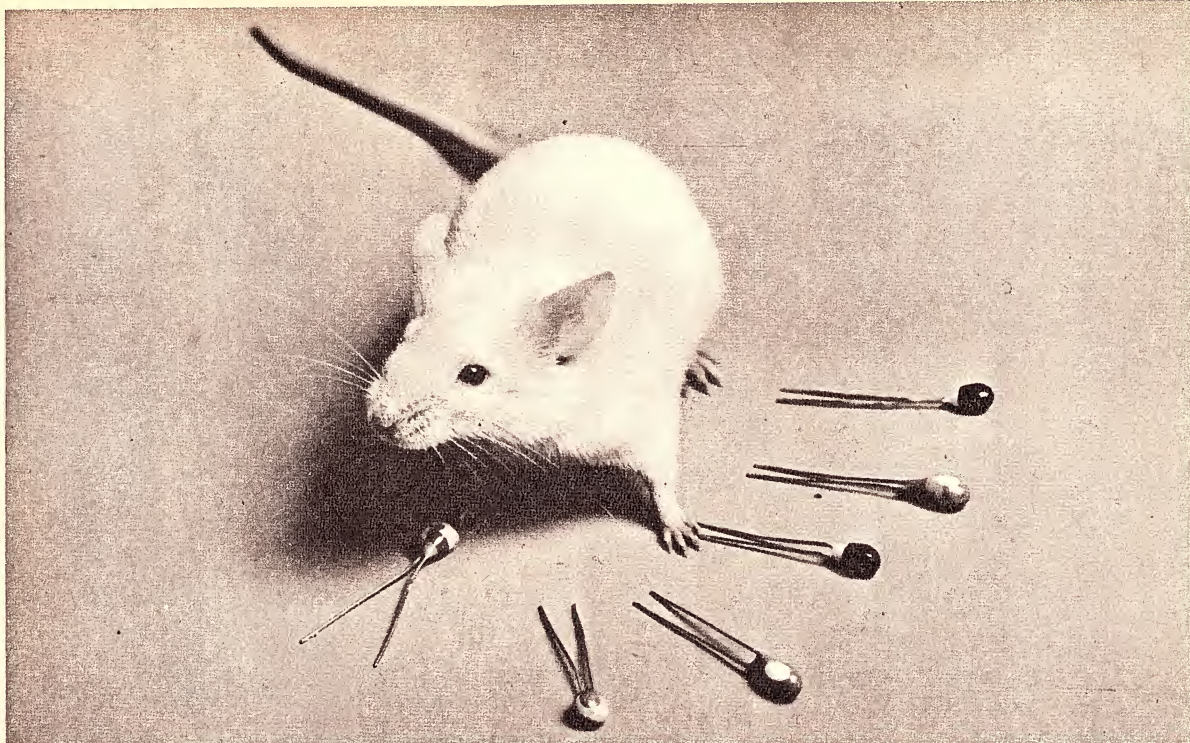

## Do you have a circuit for a 68 $\mu$ F/3V mouse?

Meet Alice. She tried to make history. Tried to polish off one of our new TAG tantalum capacitors. (It would take her weeks to get through a conventional electrolytic capacitor). TAG looked just right. Sort of mouse size. And that's the point: where space is limited, or if miniaturisation is your aim, you'll find one tiny TAG capacitor will do the same job as the normal electrolytic type. Actual size is about the same as

a match head. Just small enough to save you a lot of sweat. And time. And money. We have a free booklet that tells you all about TAG. To get your copy, simply contact: Components Division, **Standard Telephones & Cables Pty. Limited**, Moorebank Ave, Liverpool, N.S.W. 2170. Phone Sydney 602.0333 or phone Melbourne 480.1255, Canberra 49.8667, Brisbane 47.4311, Adelaide 51.3731, Perth 21.6461, Newcastle 61.5172, Wollongong 2.7974.

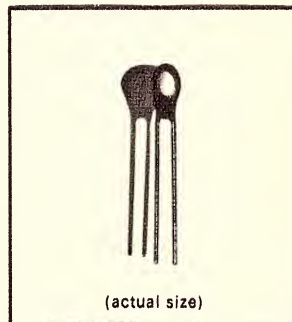

**TAG Tantalum Capacitors**  
3 to 35V., 0.1  $\mu$ F to 100  $\mu$ F,  
.30" to .38",  
-55°C. to +85°C.

AN **ITT**  
ASSOCIATE

world-wide telecommunications and electronics





held on Friday evening, March 7, at Wireless Institute Centre, 14 Atchison Street, Crow's Nest. Retiring chairman Tim Mills, VK2ZTM, presented his report on the Group's activities over the year.

From 15 nominations accepted for election to the committee for the ensuing year, the following were elected on ballot: Chris Jones, VK2ZDD. John Lark, VK2ALK. Peter Carter, VK2ZPC. Vic Barker, VK2ZVV. Bill Quinlan, VK2ZWO. Pierce Healy, VK2APO.

The elected committee held their first meeting on Wednesday night, March 12, and appointed the following office bearers and sub-committees:—

Chairman, Pierce Healy, VK2APO. Vice-chairman, Chris Jones, VK2ZDD. Secretary, Vic Barker, VK2ZVV. Treasurer, John Lark, VK2ALK. Minute Secretary Bill Quinlan, VK2ZWO.

Contests, Peter Carter, VK2ZPC. Sub-committees including co-opted members:—

Technical advisors: Neil Dunn, VK-2ZNC; Barry Gerdes, VK2ZAH; Ian Mackenzie, VK2ZIM.

Amateur TV Advisory Panel: Co-ordinator, Vic Barker, VK2ZVV; Barry Gerdes, VK2ZAH; Grahame Wilson, VK2ZWG.

Lecture Planning: Bill Quinlan, VK-2ZWO; Peter Carter, VK2ZPC.

Contest Committee: Chairman, Peter Carter, VK2ZPC; Dick Norman, VK-2ZCF; Tim Mills, VK2ZTM; VK-2ZBU.

Catering Officer: Stephan Kuhl, VK2ZSK.

Council Liaison: Chris Jones, VK2ZDD. Broadcast Co-ordinator: John Lark, VK2ALK.

Moonbounce Co-ordinator: Gordon Clarke, VK2ZXD.

WICEN Liaison: Pierce Healy, VK2APO.

VHF Project Co-ordinator: John Lark, VK2ALK.

The committee looks forward to the co-operation of members during the year and in turn will endeavour to arrange interesting lectures and contests for members.

The VHF and TV Group meets at the Wireless Institute Centre, 14 Atchison Street, Crow's Nest, on the first Friday of each month at 8 p.m. Visitors are very welcome. Further details may be obtained by writing to the Secretary, VHF and TV Group, at the above address.

### Hunter Branch

Hunter Branch of the N.S.W. Division held its annual meeting at the Newcastle Technical College, Tighes Hill, on Friday evening, March 7, 1969. N.S.W. Division President Don Miller, VK2GN, was guest of the branch and officiated at the election of officers for the forthcoming year. Don also answered questions on policy and future plans for improving the services to members.

Officers elected for 1969-1970 were: President: Gordon Sutherland, VK2ZSG. Vice-presidents: Rodney Prout, VK2CN; Colin Mackie, Assoc.

Patron: Frank Cox, VK2APO. Treasurer: Len Daley, VK2ZFD. Secretary: Ray Leben, Assoc.

Social Secretary: Joe Waugh, VK2IQ. Branch Public Relations Officer: Keith Howard, VK2AKX.

VHF Liaison Officer: Ian Miller, VK2BJT.

QSL Officer: Stan Lloyd, VK2AYL. Broadcast and Publicity Committee:

Neville Threlfo, VK2BTN; Keith Howard, VK2AKX; David Russell, VK2BSC.

Activities Committee: Tony Mullen, VK2ZCT; Stan Lloyd, VK2AYL; Phillip Brown, Assoc.

WICEN Committee: Keith Howard, VK2AKX; Frank Boundy, VK2ZFX; Bruce Morley, VK2ZNB; Rodney Prout, VK2CN.

The Hunter Branch meets on the first Friday of each month in the Clegg Build-

ing, Newcastle Technical College, Tighes Hill, at 8 p.m. Visitors are welcome.

### Central Coast Branch

The Central Coast Branch of the N.S.W. Division held their annual meeting on Friday night, March 21. Retiring president, Lindsay Douglas, VK2ON, commented on the high standard of lectures presented to members, visits to radio and power generating undertakings and the very successful field day held last February. The branch now enters its twelfth year and at the present time has 29 active members. Due to pressure of business, Lindsay declined renomination for the coming year.

The following officers were elected: President: Bill Smith, VK2TS. Vice-presidents: Ern Hodgkins, VK2EH; Frank Jarvis, VK2AFJ; Lindsay Douglas, VK2ON.

Secretary: Dick Maitland, Assoc. Treasurer: Phil Levenspiel, VK2TX. Public Relations: Gordon Proctor, Assoc.

The Central Coast Branch meets on the third Friday of each month at 8 p.m. in the Kariong Hall, Gosford. For visitors to the Gosford area Kariong Hall is located in Woy Woy Road just down the turn off to Woy Woy from the Pacific Highway as you enter Gosford from the south. Visitors are welcome and membership of the club is open to all those interested in amateur radio.

Full details may be obtained from the secretary, R. A. Maitland, 3 Albany Street, Gosford.

## VICTORIA

At the Annual Meeting of the North-Eastern Zone of the Victorian Division the following office bearers were elected: President: L. Hocking, VK3ZYH, Benalla.

Vice-presidents: P. Fawcett, VK3APF, Shepparton; G. Loft, VK3AGM, Echuca.

Secretary-Treasurer J. Meyland VK3AJM, Wangaratta.

The zone hook-up takes place each Friday night at 8 p.m. on the 80-metre band. Secretary-Treasurer J. Meyland, VK3AJM, is the control station. All amateur operators in the zone are invited to join in the net. Details of the zone activities may be obtained from the Secretary, 5 Gayer Avenue, Wangaratta, Victoria 3677.

### "A Prize Possession"

This was the title of an item for thought heard recently on a Sunday morning broadcast from VK3WI.

"We all have possessions of which we are proud, but few are exclusively ours. Some are jointly owned, others are shared other ways.

"In the world's teeming millions there is sure to be someone else with the same name and millions have the same birthday. There is bound to be someone else whose wife's name is Myrtle, or whose dog is named Spot. Someone else could have the same telephone number, car registration or street address.

"But there is one thing that an amateur possesses that belongs to him and no one else on earth, and that is his amateur call sign. A group of letters and figures which precisely identifies just one and only one person.

"Such an exclusive possession deserves the utmost respect from its owner and it should never be tainted by any action or conduct of which its owner is not fully proud.

"Sloppy operating, ungentlemanly conduct, imperfect signals and unsafe gear are the marks of those who, having lost respect for their call signs, have lost respect for themselves."

## SOUTH AUSTRALIA

News from the South Australian VHF Group is that a new amateur television distance record of a distance of 92 miles has been set. Alan Foxwell, VK5ZEF and

# ELECTRONIC DESPATCH

16 SHERIDEN ST., GRANVILLE, N.S.W. 2142.

9-1 Daily and Sat.

MAIL ORDERS WELCOME

(but add for delivery).

P.O. Box 149 Auburn, 2144.

Re. April Ad: Sorry all 100/450 V. Electrocs and QOV03/10 valves sold out.

### COMPUTER BOARDS

10c per TRANSISTOR

5c per DIODE

Resistors, capacitors, tantalum electrolytics, chokes which may also be on board are free. Order by value. Boards have from 2 to 9 Ts and up to 10 diodes.

### TRANSFORMERS

200, 215, 230, 240V. input 50 Hz.  
25V 3A, 10V 1A, 110V 6A output .. \$ 4.00  
240V .115V 8.7A .. \$20.00  
230/240-52V .1KV .. \$ 8.00  
3-phase auto 15KVA 415V-380V.  
22.8A .. \$40.00

### VLF RECEIVER

15-560KHz

Ex P.M.G. .... \$25.00

### INVERTERS

250V, 50Hz at 250 watts (1/3 h.p.)

from 12 volt battery .. \$25.00

### BELL WIRE

Hook-up, etc., 1/036 Copper PVC Fortisan

Lapped coil 440 yds. twisted pair or

880 yds. single \$10 or 1.5c yd. single.

### THERMISTORS

STC bead type for temp measurement or

compensation. G54, 10c.

Rod type CZ12A, 10c.

### ZENER DIODES

Large range up to 8V to select.

9V, 1W, 10c.

RD16C 13.5-18V .3W, \$1.00.

### POWER DIODES etc

1A 800 PIV .. 6c IN 1516 .. 75c

500MA 500V .. 50c IN 1599 .. \$1.50

IN 23 .. \$1.00 CA 152AA .. \$1.50

IN 1124R .. \$1.00 PE 501 .. 20c

High voltage Selenium Tubular:

4,860 PIV 5Ma K860 .. 30c

4,860 PIV 1Ma K370 .. 20c

1,360 PIV 1Ma K320 .. 10c

Signal diodes large range from 5c (GD5, 6, 12, etc.).

### TRANSISTORS

SE 3030 .. \$3.00 2N511A .. \$2.00

2N456A .. \$2.50 \*2N442 .. \$2.00

ADY 22 .. \$1.25

2 SC 139 400 MH3 RF amplifier .. 60c

BFY 22, 23, 30, Pinhead hearing

aid type .. 50c

BC 107 .. 80c BC 108 .. 75c

BC 109 .. \$1.10 BC 148 .. 50c

AC 126 Equivs. (OC308, 2SB110, 11,

12, TS13)

AF 116 .. 65c OC 71 equals .. 50c

BSY 28 .. 50c 2N291 .. 50c

OC 440K .. 50c OC 440 .. 50c

(BCY33) .. 50c OC 445 .. 50c

OC 440 .. 50c (BCY30) .. 50c

(BCY43) .. 50c OC 469 .. 50c

OC 470 .. 50c (BCY34) .. 50c

(BCY34) .. 50c TS3 (AF185) 25c

\*Available in matched pairs.

### RESISTORS

5% 1/4W Phillips full range .. 6c

High stab. IRC most values .. 10c

### ELECTROLYTICS

Added since April Ad.

1000UF/200VW 1500/150 .. \$3.00

15000/55VW .. \$6.00 70,000/13 .. \$5.00

250/85 .. \$2.00 500/50 .. \$2.50

1000/200 .. \$3.00 400/80 .. \$4.00

All new professional quality.

### VALVES

Add to April list:—

CV 57 .. 50c

CV 309 QV04/7 .. \$1.00

455 KC AWA Piwound lfs new, 50c.

Phillips 10-terminal ceramic tag strips, 20c.

RF choke tuneable 6-10mH Q equals 1,

10c. Polar ceramic base trimmers 100pF

60c; 50pF, 40c; 15pF, 30c. Ducon ceramic

trimmer 1-4pF, 10c. Frequency selective

res. for sound actuated devices, 4 types

132-450 Hz range, \$1.00. Xmas tree or display

lights 2.5V flying lead with built-in

flasher, 5c.

### SEND 10c FOR FULL CATALOGUE

On display for personal shoppers we have

a good range of cro's from VTVM's,

GD's, all types test gear, transceiver,

comm. receivers, pan-adaptors, etc. Large

range styroseal, polyfoil mica capacitors

incl. Xmitter types. Block capacitors up to

2uF at 10,000VW. Electrical switch/fuse

gear new-HRC fuses, contactors De ion

C/breakers, blue line switches at low prices.

2,000 sq. ft. of military radio-radar on

display.



# TRIO

## 2 METRE TRANSCEIVER

# TR-2E



### FEATURES:

#### SEPARATE V.F.O. FOR TRANSMITTER AND RECEIVER

- CRYSTAL CONTROL
- SQUELCH
- NUVISTOR FRONT END
- TRIPLE CONVERSION RECEIVER

- NOISE LIMITER
- A.C.-D.C. OPERATION
- INBUILT POWER SUPPLY

### SPECIFICATIONS:

**RECEIVER**  
**Frequency Range:** 144-148 Mc AM  
**Sensitivity:** 1 microvolt for 10dB S/N at 145.5 Mc (0.05 W Audio Output)  
**Image Ratio:** 50 dB at 145.5 Mc  
**IF Frequency:** 1st IF 44-45 Mc  
 2nd IF 10.7 Mc  
 3rd IF 455 Kc  
**Noise Limiting:** Automatic  
**Squelch:** 1 microV-300 microV  
**Selectivity:** 20 dB down at 10Kc  
**Audio Output:** 3W 8 ohms  
**Input Impedance:** 50 ohms (Unbalanced)

**TRANSMITTER**  
**Frequency Range:** 144-148 Mc AM  
**Power Input to Final:** 22 to 26 Watts  
**RF Output Power:** 10W 144-146 Mc  
 AC 240V Operation  
 9W 144-146 Mc  
 DC 12.8V Operation  
 FT-243  
**Crystal Type:** FT-243  
**Crystal Frequency:** 8-8.222 Mc

**VFO Frequency:** 8-8.222 Mc  
**Microphone Input:** High Impedance w/Push to Talk  
**Frequency Response:** -3 dB at 300 and 3,000 c/s  
**Output Impedance:** 50-100 ohms w/Coaxial Connector

**POWER SUPPLY**  
**AC Operation:** 117/230V 60/50 c/s  
 Receive Power Drain 106 VA  
 Transmit Power Drain 146 VA  
**DC Operation:** DC 12.8V (12/14V)  
 Receive Power Drain 90 VA  
 Transmit Power Drain 120 VA

**Tubes and Transistors used:** 16 Tubes  
 1 Nuvistor, 8 Diodes, 4 Power Transistors  
**Dimensions:** H: 6 5/8"; W: 11 7/8"; D: 12 3/4"  
**Weight:** 22.2 lb

F.O.R./F.O.A. SYDNEY \$282.00

CONSULT YOUR LOCAL RADIO DEALER, OR

MAIL THIS COUPON *today*

Please forward free illustrated literature and specifications on Trio equipment.

Name.....

Address.....



(A unit of Jacoby Mitchell Holdings Ltd.)  
 376 EASTERN VALLEY WAY, ROSEVILLE, N.S.W.  
 Cables and Telegraphic Address: 'WESTELEC',  
 Sydney. Phone: 40 1212

Jim Wilcox, VK5ZGV, operated portable at Willunga and running 12 watts of video to a 16-element collinear antenna; while Mait Lane, VK5AO, with Rick Matthews, VK5ZFO, ran 10 watts of video to a 16-element collinear array and a 4-element yagi for sound, at South Hummocks.

Standard TV receivers with 432MHz converters were used by stations. The Australian standard 625 lines was used in the test.

The signals were almost completely snow-free over the 92 mile path.

## YOUTH RADIO SCHEME

With the school-year well under way, Y.R.C.S. activity is increasing. Already several clubs have held examinations and the results indicate that a high standard of passes is being gained by members.

### Maitland Radio Club

A delay in the post prevented notes from this very progressive club appearing in last month's notes. However, some of the news items are included in this issue.

From Wednesday, February 26th until Saturday, March 21st, the Maitland Radio Club conducted an exhibit at the Maitland Show. This was the first display of its kind to be held at the Maitland Show-ground and the first of its kind to be held in the district for many years.

Nine awards were given by the Show Council to projects constructed and displayed by club members. Amateur radio communication was also demonstrated under the club's two call signs, VK2BHV and VK2ZVM, when local and overseas contacts were made.

Visitors to the exhibit included the Director of the United States Information Service, Mr Lewis Lederer, who officially opened the show, and a group study team of Rotary International from Iowa, U.S.A.

President of the Maitland Show Committee, Dr R. H. K. McKerihan, personally congratulated the club committee on the outstanding exhibit.

More than 40 members attended the annual general meeting of the Maitland Radio Club on Friday evening, March 14th, which was chaired by Alderman N. Unicomb of the Maitland City Council, chairman of the Shortland County Council.

Following the election of officers for the ensuing year, five members who were successful in the recent Elementary Certificate examination were presented with their awards. The successful members were: Honours, Miss Linda Tinson, John Gibson, Greg Critchley; Credit, Terry Smith and Neil Gibson.

For his untiring work since he inaugurated the club's activities in 1966, Kev Watson, VK2ZKW, was made a Life Member of the Maitland Radio Club. Kev was also re-elected club president.

The M.R.C. now provides seven training courses in radio theory, Morse code, regulations and workshop practices, including Y.R.C.S. Elementary, Junior and Intermediate Radio Certificate classes. The educational activities are conducted by four instructors: Bill Plant, VK2AMM; Kev Watson, VK2ZKW; Bob Roper. Engineering Officer, Hunter Valley County Council; and Colin Hay.

The office bearers elected for 1969 were:

Patrons: Hon. Allen Fairhall, VK2KB. Minister for Defence; Dr R. H. K. McKerihan.

President: Kev Watson, VK2ZKW.  
 Vice presidents: Bill Plant, VK2AMM; Alan Counsell, VK2ZFH.

Secretary: Margaret Watson.  
 Treasurer, Fred Sams.

Auditor, Allan Matthews.  
 Examinations Supervisor, C. G. Cooke, J.P.

Public Relations Officer, K. Gromley.

(Continued opposite)

# JOHN CLARRICOATES, G6CL - AN APPRECIATION

From England comes the sad news of the death in March of one of the world's best known radio amateurs, John Clarricoates, G6CL, former general secretary of the Radio Society of Great Britain. Here is an appreciation of John Clarricoates by A. O. Milne, G2MI.

To his vast array of friends, in many walks of life and with many differing interests, the knowledge that this human power-house has at last come to rest will be hard to realise.

The loss of a dear friend is always a shock but we can all be thankful that he died in harness and was spared even a short period of lingering existence as an invalid, which he would have found intolerable.

His gifts as a speaker and organiser were outstanding. He had a passion for accuracy and correct procedure with a sense of protocol which, sometimes, could infuriate those of us who dared to argue. Yet events would so often prove what we already know in our hearts, that he would be right in the end.

Not only did he manage to accomplish the tasks of several ordinary men but he had a remarkable aptitude for conscripting assistance from others who would happily remain convinced that they were volunteers. He could lead, inspire and advise at the same time as he, himself, laboured unceasingly.

It was in June 1926 that he became a member of RSGB and immediately things began to happen. He was co-opted on to the Council as Social Manager in July 1928 and became Honorary Secretary in January 1930. In 1932, he became a full-time General Secretary, a courageous decision to take in those dark days of depression, and it was from this post that he retired in December 1963.

Up to the outbreak of war in 1939, it is doubtful if G6CL had a dozen weekends a year at home. Wherever there was a gathering of Radio Amateurs there would be Clarry and on the rare occasions when he was at home, 16 Ashridge Gardens became open house to radio amateurs from far and wide.

During a large part of the war years, the offices of the Society were located at his home and during this period, mainly due to his efforts the membership increased from 2,500 to over 6,000.

This was not all, for, during this time, he also held a commission in the Royal Air Force and was on special duties concerned with the training of personnel for radio communication.

His editorship of the pre-war "Guide to Amateur Radio" and the later Handbook and Supplement laid the foundations of the financial stability of the Society and, just as a side-line, he also

produced several training manuals for service use.

Because of his vast personal knowledge of individuals, stored in that phenomenal memory, many a serving member found himself suddenly removed from his unit and transferred to duties more suited to his specialised radio knowledge. The authorities with a problem just asked Clarry as so many had done before and were to go on doing, in the years to follow.

It was while he was at the I.T.U. Conference in Atlantic City in 1947 that he realised the paramount importance of improving the international image of Amateur Radio and it was his inspiration which brought into being the I.A.R.U. Region I Division, which has played so great a part in the general acceptance of the amateur service and the esteem in which it is held in high places.

He made it his business to know everyone and to bring his persuasive powers to bear to the advantage of amateur radio.

His work for the Region 1 Division alone would be a worthy memorial in itself but this is only one of the fields in which his influence was exerted to leave a permanent mark. His fascinating book "World at their Fingertips" would have satisfied most of us as a bequest to posterity.

Apart from amateur radio, John Clarricoates had another and quite separate life in local government. In 1945 he became a Borough Councillor in his beloved Southgate; he was elevated to Alderman in 1954 and became Mayor in 1955-56.

To his hosts of friends, his admission to the Most Noble Order of the British Empire in January 1955 was a particular pleasure but, although he deeply appreciated this honour, there is little doubt if anything gave him greater personal happiness than his election as an Honorary Member of the Society, of which he was the architect, in December 1963. This is the Society's highest honour and has been conferred on only seventeen people. Of these, which include Sir Oliver Lodge and Signor Marconi, only seven are now living.

In May 1968 he was elected Mayor of the greatly expanded London Borough of Enfield, which now includes Southgate and it was while discharging one of his civic duties that he collapsed and died only a few hours later.

His dedication, wise counsel and sheer hard work will be sadly missed by the I.A.R.U. Region I Division who will be holding their triennial meeting in Brussels in May, the preparatory work for which had been exercising his attention for some time past.

Any tribute to this remarkable man is bound to be inadequate. We can but salute his memory, count ourselves privileged to have been numbered among his friends and be grateful for all that he did for us.

To his wife Cecilia, his son, Professor Peter Clarricoates and his two daughters, Joan and Pamela, we offer our heartfelt condolences.

## BRIGHT STAR CRYSTALS

PREFERRED BY LEADING MANUFACTURERS  
THROUGHOUT THE COUNTRY FOR —

**ACCURACY - STABILITY - ACTIVITY - OUTPUT**

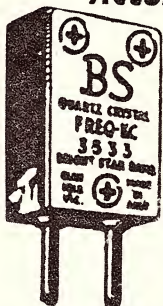

All types of Crystals Available  
Such as DC11, FT 243 HC6U CRA  
B7G, HC18U, ETC.  
TOLERANCES: .0015%, .002%,  
.003%, .005% ETC.

Consult us for Crystals for any Mobile Radio.  
Prices depend on tolerance and frequency  
required.

DISCOUNT FOR QUANTITY ORDERS

Established 36 Years



AMATEUR AIRCRAFT and ULTRASONIC CRYSTALS also AVAILABLE

Our new Factory employing the most modern equipment  
allows us to offer you PROMPT DELIVERY for all your  
CRYSTAL requirements.

DEVOTED EXCLUSIVELY TO THE MANUFACTURE OF

**PIEZO ELECTRIC CRYSTALS**

Contractors to Federal and State Government Departments

REPRESENTATIVES AUSTRALIA AND NEW ZEALAND: Messrs. CARREL & CARREL  
BOX 2102, AUCKLAND.

MESSRS ATKINS (W.A.) LTD.,  
894 Hay Street, PERTH.  
MESSRS. A. E. HAROLD PTY. LTD.,  
123-125 Charlotte Street, BRISBANE.

MESSRS LAWRENCE & HANSEN  
ELECTRICAL (VIC.) PTY. LTD.,  
34 Brisbane Street, HOBART,  
and 29 St. John Street,  
LAUNCESTON, TASMANIA.

**BRIGHT STAR RADIO**

546-5076

LOT 6 EILEEN ROAD, CLAYTON, VICTORIA

546-5076

### YOUTH RADIO SCHEME—cont.

Workshop Supervisor: Colin Hay; Assistant, Phillip Lawrence.

Committee: Ald. Graham Dunkley, Tony Martin, Cecil Cooke, Col Hay, Ken James, Des Cross.

Equipment Officer, Alan Counsell VK2ZFH.

Q.S.L. Officer: Miss Linda Tinson.

Publicity Officers, Kev Watson, VK2-ZKW; Bill Plant, VK2AMM; Bob Thompson; Colin Hay.

Grounds Officer, Bob Thompson.

Canteen Officers: Gary Watson; Terry Smith.

The annual meeting of the ladies committee and the M.R.C. News Publishing Committee will be held later in the year.

Inquiries regarding the activities of the Maitland Radio Club should be directed to the: Secretary, Box 54 P.O., East

(Continued on page 172)





## GUITAR AMPLIFIERS

10-Watt, Two-Channel, with Twin Cone Speaker . . . \$53.55  
 14-Watt, 4 Inputs, Bass and Treble Boost, 2 Twin-Cone Speakers, \$63  
 17-Watt, Four-Channel, Bass and Treble Boost, Two Twin-cone Speakers . . . \$76.25

### 35 WATT

4-Channel, Bass and Treble Boost 4 Twin-Cone Speakers — \$109.05  
 Vibrato with foot control and 2 preset controls for frequency and intensity, \$10.50 extra on above models.

## ELECTRIC GUITAR

Pickup Units . . . \$8.75  
 Accordion Pickup Units . . . \$8.75  
 Harmonica Pickup Units . . . \$1.95  
 Post, N.S.W., 40c; Interstate, 75c.

## FUZZ BOX

FUZZ BOX E. AND A. AUG.  
 WIRED AND TESTED.  
 \$15.  
 Post, 75c.

## REVERB UNIT

COMPLETE with AMPLIFIER  
 E.A. October Issue. Kitset \$39.95.  
 Wired and tested, \$41.95.

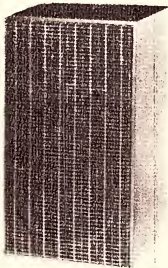

## MULLARD MAGNAVOX

### BOOKSHELF ENCLOSURE

Maple, Teak or Walnut  
 Complete \$24.75

### SUPER BOOKSHELF

\$36.75.

Post: N.S.W. 50c. Interstate \$1.00.

### CABINETS ONLY

R. H. BOOKSHELVES \$11.50

### MULLARD \$10.95

### BOOKSHELF UNITS

6in 8in 10in 12in  
 \$27.75 \$33.50 \$35.50 \$36.50

## PLAYMASTER 106 AND 107

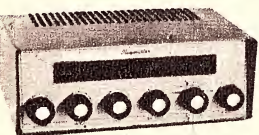

Feb. and March Elect. Aust.

106

WIRED AND TESTED \$94.75

107

WIRED AND TESTED \$83.75

## SOLID STATE VTVM

E.A. Dec.  
 Wired, Tested.  
 \$49.50

## PIGGY BACK GUITAR AMPLIFIER

Excluding Speakers

30 Watt . . . \$79.75  
 45 Watt . . . \$99.75  
 60 Watt . . . \$119.75  
 4 Inputs, Bass and Treble Boost  
 Vibrato if required, \$10.50 extra.

## PIGGY BACK GUITAR AMPLIFIER

Complete with Speakers, Cabinet  
 30 Watt Lead . . . \$138.75  
 30 Watt Bass . . . \$146.75  
 45 Watt Lead . . . \$158.75  
 45 Watt Bass . . . \$166.75  
 50 Watt Lead . . . \$218.00  
 60 Watt Bass . . . \$234.00  
 Vibrato if required . . . \$10.50

## 14 plus 14 WATT

With Reverberation. May be used as 28 Watt or as 14 Watt plus 14 Watt Reverb. Two 9 x 6 Woofer Speakers, Two 9 x 6 Twin-Cone Speakers, 4 Channels, Bass and Treble Boost. Foot Vibrato control included.

\$163.50

## UA 41A - 20-20

SOLID STATE STEREO  
 20 watts per channel. Inputs for tape, magnetic and ceramic P.U. Tuner and aux. Teak cabinet.  
 \$88.00

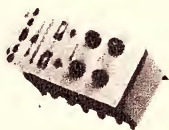

## 119 STEREO TAPE ADAPTER

Suits all Playmaster Stereo amplifiers and others that accept crystal P.U.

Kitset . . . \$79.00  
 Wired and tested . . . \$96.00

## TAPE DECKS B.S.R.

2 Tracks, 3 3/4 I.p.s.  
 \$25.50

4 Track, 3 Speed Stereo.  
 \$41.50



## 240v A.C. POWERED SOLID STATE STEREO

T.S.135  
 18 Transistor, 15-watt per channel. Inputs for Tape, Mag. P.U. Ger. P.U. Radio Aux. Freq. Range 30c to 20KC. Max Sensitivity 3 MV. Speaker matching 4 to 15 ohms.  
 \$78.00



## A.C. STEREO AMPLIFIER

5 WATTS PER CHANNEL.  
 Valve Unit, 240v A.C. Input for Crystal and Ceramic P.U. Radio and Auxiliary. Output for 4, 8, 15 ohms. Cross talk better than -40db. Sensitivity 50 MV.  
 \$47.50

## 11 1/2" FULLY BALANCED PICK-UP ARM.

COMPLETE WITH MAGNETIC Stereo Cartridge . . . \$19.50  
 Arm less cartridge . . . \$11.50  
 Mag. cartridge only . . . \$9.50

## WIDE BAND OSCILLOSCOPES

### SPECIFICATIONS

#### VERTICAL AXIS

Deflection Sensitivity (at 1 kc) 0.1 V p-p/cm.  
 Frequency Characteristics 1.5 cps—1.5 MC.  
 Input Impedance 2 M ohms 25 pF.  
 Calibration Voltage 1V pp-cm.

#### HORIZONTAL AXIS

Deflection Sensitivity 0.9 V p-p cm.  
 Frequency Characteristics 1.5 cps —300 KC.  
 Input Impedance 2 M ohms 20 pF.  
 Sweep Oscillator (5 Range) 10 cps —300 KC.  
 Synchronization Devices Internal (Positive and Negative, External). Power 240V AC 50/60 cps. Cathode Ray Tube 3KF1F.

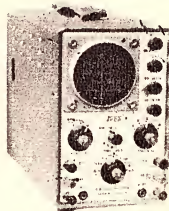

5 Meg Bandwidth Push-Pull vertical and horizontal Amplifiers, 8 Positions, high sensitivity vertical Amplifier Frequency Compensated on all positions. Calibrated .02 to 600 volt Hard time base, 20 cycles to 75K. Latest American R.C.A. circuitry. Complete with probe.

3-inch \$102.75; 5-inch \$118.75

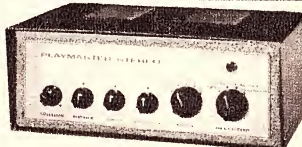

## PLAYMASTER 115

The new solid state Stereo-Amp-ifier. April issue.  
 Wired and tested . . . \$104.00  
 Kit Set . . . \$90.00  
 Pre-amp to suit magnetic Cartridge . . . \$12.00

## 10 + 10 STEREO AMPLIFIER

E.A. November  
 Kit Set . . . \$59.75  
 Wired and tested . . . \$69.75



## AUDIO GENERATOR

De Luxe Model TE-22D.  
 Freq. range, Sine 20 cps—200 KC. SQ. 20 cps—25KC. Output voltage, Sine 7V, sq. TV P-P. Output impedance, 1000 ohms, Acc. 5 per cent. Distortion less than 2 per cent, 4-range attenuation, 1/1, 1/10, 1/100, 1/1K. Printed circuit. 240V A.C.  
 \$42.95

## SIGNAL INJECTOR

Transistorised, Fountain pen-sized Unit for Signal Tracer in Radio, TV and Amplifier Service.  
 \$5.75. Post, 25c

## TRANSISTOR AND DIODE TESTER

E.A. August, '68.  
 Wired and Tested.  
 \$57.00  
 KIT SET \$48.00

## G.D.O. UNITS

Post, N.S.W., 50c; Pstate, 75c.  
 T.E. 15 Transistorised, 7 Band. 360 Kc to 270 Megs.  
 \$35.75

## T.V. BOOSTER

240VAL. Especially designed for fringe area reception. Also up to 3 TV sets can be operated off common aerial for improved signal strength. \$15.95 Post Free.

## NEW GRAMMO MOTORS

240V A.C.  
 3 Speeds, \$2.75.  
 Post, 40c.

## INTER. COM. UNITS

2 Station Transistorised.  
 \$11.95  
 4 Station, including Master.  
 \$20.95

## T.O. 2" OSCILLOSCOPE

IDEAL TV AID  
 240 V-AC 2 BPI CRO Tube  
 Vert. Sen. 10V P-P/CM. 50v P-P/CM.  
 Vert. Input imp. 2 Meg. 25pf.  
 Vert. Freq. 2 cps/1 Meg.-3DB.  
 Sweep Freq. 2 Ranges, 60cps-75KC.  
 \$64.50.

## SIGNAL GENERATOR

Deluxe Model TE-20D.  
 Freq. range 120 KC—500 Mcs. 7 Bands. Accuracy 2 per cent. Output 8V. Provision for Xtal. Suitable for self calibration Marker generator. Printed circuit, 240 T.E.20. \$25.50.  
 V.A.C. \$28.50

## 15-INCH HI-POWER SPEAKER

Imported 30 Watts R.M.S. \$30.00  
 Local 50 Watts R.M.S. \$50.00

## L.S.G. 11 SIGNAL GENERATOR

FREQ. RANGE IN 6 BANDS  
 120KC—130MCS  
 Calibrated Harmonics.  
 120MCS—390MCS.  
 RF output over 100,000UV.  
 120KC-38MC  
 Mod. Freq. 400 and 1000CPS.  
 Crystal Osc. 1-15MCS.  
 AF Output, 3 to 4 Volts.  
 AF Input, 4V approx.  
 240V A.C. Operation.  
 \$31.75. Post 75c.

## T. E. 46 RESISTANCE-CAPACITANCE

Bridge and Analyser.  
 Capacity 20 pf to 2,000 mfd.  
 Resistance 2 ohm to 200 meg.  
 Also tests power factor, leakage, impedance, transformer ratio, insulation resistance to 200 meg. at 600V.  
 Indications by eye and meter.  
 \$49.75

## TRIO W.O.I. SWEEP GENERATOR

TV and F.M.  
 2 to 260 Meg.  
 Sweep 0 to 20 Meg. Ideal for TV Sound and Picture Aligning.  
 \$99.00



# LEADER TEST INSTRUMENTS

## SINE-WAVE / SQUARE WAVE AND COMPLEX

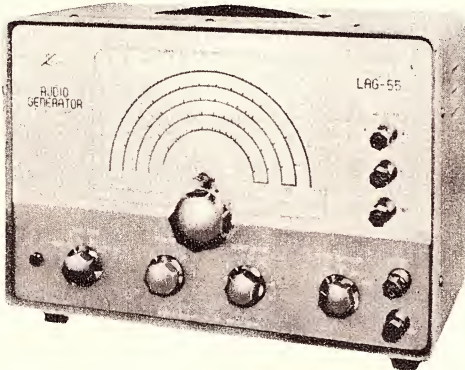

Budget priced unit indispensable for any serious audio measurements.

### Specifications:

Frequency Range 20-200,000Hz in four 10 : 1 bands  
 Calibration Accuracy Within  $\pm 2\% + 2\text{Hz}$   
 Sine Wave Output 20-200,000Hz; level constant within  $\pm 0.5\text{dB}$  below 100kHz; Output 5 V rms below 100kHz  
 Square Wave Output 20-20,000Hz; Output 10 Vp-p  
 Complex Wave Output Above 5,000Hz combined with line frequency  
 Amplitude ratio 4 : 1 (low to high); Output 10Vp-p



## AUDIO SIGNAL GENERATOR WITH METERED OUTPUT AND FREQUENCY METER

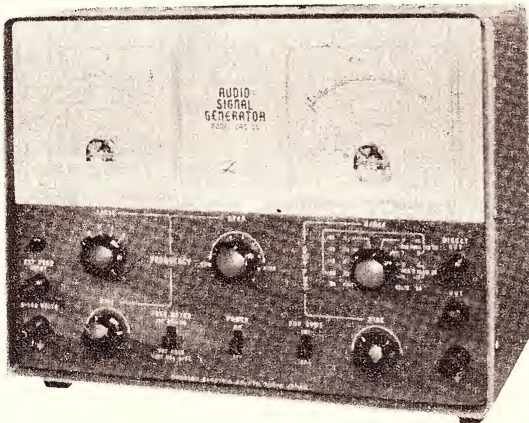

Top quality Leader Unit.

### Specifications:

<b>Generator</b>		<b>Frequency Meter</b>	
Frequency Range	11 to 110,000Hz in 4 bands	Range	10 to 110,000Hz in 4 ranges
Output Voltage	600 Ohms: 0-1V in 6 ranges 10k Ohms: 0-10V in 2 ranges	Input Impedance	200,000 Ohms, approx.
Distortion	Less than 0.3%, 20 to 20,000Hz	Accuracy	$\pm 1.5\%$ , full scale: 10 to 11,000Hz

### FROM ALL GOOD TRADE HOUSES

WHOLESALE ENQUIRIES ONLY TO  
SOLE AUSTRALIAN REPRESENTATIVES:  
ASTRONICS AUSTRALASIA PTY. LTD.,  
ALL STATES.

Maitland 2323; or by telephoning Maitland 33-7286, S.T.D. Area code 049.

Information for the M.R.C. News should be sent to the Editor, M.R.C. News, at the above address.

### Westlakes Radio Club

Over 30 members of the Westlakes Radio Club attended the Annual Field Day of the Central Coast Branch at Gosford. It is reported that the "144MHz Sniffer" designed by club member Tony Mullens, VK2ZCT, proved to be the best available on the day, and was responsible for members gaining two firsts and a second in the hidden transmitter hunt for pedestrians.

During the Field Day, Westlakes Radio Club members gave the first public demonstration of a 146MHz repeater station in operation. Seven members of the Club sat for the recent A.O.C.P. Examination held in Newcastle and at the time these notes were compiled were anxiously awaiting the results.

The "Broadcast Ten" contest among members is proving very popular. This contest requires the competitors to obtain ten QSL cards or letters confirming their reports on reception from local and overseas broadcast stations. A certificate will be awarded to those who present QSL cards or letters confirming reception from the following schedule of stations:

New South Wales: 4 QSLs.

One each from three other States of Australia.

Three QSLs from New Zealand, one from each island, or one from New Zealand and one from Papua/New Guinea and one QSL card for any overseas station not included in the above list.

Another contest is the "Shortwave Ten." This requires the presentation of ten QSL cards from shortwave stations in different countries. Two cards are required from each of the five continents: Europe, Africa, North America, South America and Asia.

### VICTORIA

From Timothy Robinson comes the news that with activities well under way the Camberwell Grammar School Radio Club is emerging as one of the most active Y.R.S. Clubs in Victoria.

At present there are 11 candidates for the Elementary Certificate examination, 14 candidates for the Junior examination, 13 candidates for the Intermediate examination, and three members attempting the Senior Certificate examination. Members of the club hope that the standard of 1968 (between 80 per cent and 100 per cent passes in the various grades) will be maintained this year.

The major project of the Club for 1969 is the establishment of a club station. With one member already holding the call sign VK3ZYY and the prospect that several more will be successful in the near future, it is possible that 1969 is going to be the best year yet.

### SOUTH AUSTRALIA

Bert Hollebon, VK5EQ, who has supplied the notes on Y.R.S. activities in South Australia, is moving to Western Australia. This will be a loss to the Port Pirie Radio Club for whom he has been an instructor for several years. Bert advises that Graham Johnston, VK5ZGJ, will be taking over the job of supplying news from South Australia.

Bert also advises that a Morse code tutor kit is available, consisting of a transistor oscillator in kit form based on a printed-wiring board, part of which carries the code symbols in the form of metal strips. By moving a probe across the strips at constant speed, perfect code can be produced. This means that a person can learn the Morse code without the necessity of a skilled teacher.

A letter Bert received from Mr R. K. Russ of the Electric Components Division of S.T.C., Liverpool, N.S.W., advises that the kit will be made available to Y.R.S. members at a special price of \$5.81 plus 25 per cent Sales Tax.



# LISTENING AROUND THE WORLD

## New Bonaire relay now in service

The Radio Nederlands relay base known as Bonaire Nord is now being used to relay to the Pacific area programs which originate in Hilversum, Holland.

by Arthur Cushen

The two 300KW transmitters of Bonaire Nord are being used to boost the power of Radio Nederlands' signals in the Americas and the Pacific area. The transmitters were officially opened on Thursday, March 6, by the Minister of Traffic and Public Works. The new relay base, which is the first to be used by Radio Nederlands, is expected eventually to provide better world-wide reception. In the past, Radio Nederlands leased time on the Trans World Radio transmitters which are also located on Bonaire. The Bonaire relay is being used for transmissions to Australia and New Zealand as follows:

**English:** 0700-0820 GMT, weekdays, 9715, 11730KHz.

**Dutch:** 0600-0720 GMT, daily, 9715, 11730KHz; 0830-0950 GMT, daily, 9715, 11730KHz.

### RADIO NEDERLANDS.

Radio Nederlands, the Dutch broadcasting system, celebrated its 20th anniversary in 1967. It was on April 15, 1947 that a foundation was set up to define and propagate Holland's voice in international broadcasting. This did not mean that the voice had not previously been heard. On the contrary, towards the end of the twenties Holland had been the first country in the European continent to broadcast on short-wave. The Dutch Philips concern in Eindhoven had been experimenting with the new medium, and succeeded in establishing contact with the then Dutch East Indies (now Indonesia).

World War II and the occupation of the Netherlands called a five-year halt to short-wave broadcasting from that country, but the thread was taken up again at the end of hostilities. After an initial transition period, during which a government agency maintained contact with Dutch nationals overseas, Radio Nederland took on its present form, not as a government agency but as a foundation, the programming being controlled solely by its board of governors. Transmissions soon followed in Indonesian, English, Spanish, Arabic and Afrikaans, as well as Dutch. A West Indies section provides programs in Dutch and the languages of the Netherlands Antilles and Surinam. Transmissions in French are planned to commence in July, 1969.

Serving the interests of specific groups,

or "captive" audiences, has long formed part of Radio Nederland's program policy. One such "directed" item which has gained world-wide recognition is that specially tailored to the needs of the DXers — enthusiasts who have made short-wave listening their hobby. Over the years, Radio Nederland's "DX Juke Box" has become a popular source of technical know-how to listeners all over the world. Radio Nederland's features gained the Merit Award of the National Association of Educational Broadcasters in 1966. The station as a whole has in recent years repeatedly been placed first in various international popularity polls.

Radio Nederlands operates transmitters in Lopik, near Utrecht in Central Holland, (3 of 100KW, 1 of 50KW and 1 of 10KW) and on the island of Bonaire in the Caribbean. Programs were relayed via Trans World Radio's 260KW SW and 525KW MW (broadcast band) transmitters until the end of 1968. From January 1969, Radio Nederland's own relay station in Bonaire, comprising two 300KW transmitters has been used. A second relay station on the island of Madagascar is planned, and is expected to be put into operation in 1971.

### STAFF AND SERVICES

Some 300 people are employed at Radio Nederlands, including some 60 foreign program staff members in various language sections. Written reception reports are welcomed and, if correct, are acknowledged by QSL card. Reports should contain the date and time of the broadcast, the frequency (correct to within

5KHz) and some program details. Illustrated program bulletins and seasonal transmission schedules are obtainable free of charge from Radio Nederlands, P.O. Box 222, Hilversum, Holland.

### LOURENCO MARQUES EXPANSION

Additional services have recently been put into operation by the Radio Club of Mozambique at Lourenco Marques, according to a report in the bulletin of the South Africa DX Club. Services and frequencies now used are as follows:

GMT	KHz
1815-0345	3218
0300-0700, 1500-2200	4855
1630-2100	4925
0415-1745	6050
0430-1800	6115
0630-1400	9620
0300-1845	11780
0430-2100	11820
0600-1600	15295

### COLOGNE CHANGES SCHEDULE

Since March, Radio Deutsche Welle, at Cologne, Germany, has made some time changes in its programs for the Pacific area. The English transmission has been extended to one hour in both the morning and evening reception periods. The German-language program has been reduced to two hours ten minutes, but an additional program has been instituted for later reception.

GMT	English	KHz
0920-1020	17740, 11795, 17845, 21560	
2100-2200	7790, 9760, 15275,	
	German	
0700-0910	9650, 11795, 15205, 21585	
0900-1120	15275, 17705, 21560	

### PARAGUAY VERIFIED

In a recent issue of "Australian DX News," Bob Padula reports a verification from Radio Encarnacion. In our 30 years of listening we have only managed to verify three stations in Paraguay, which is undoubtedly the hardest South American country to hear. The station sent by registered airmail a very friendly letter signed by Antonio E. Carbera.

## ARTHUR CUSHEN ON WORLD TOUR

Our shortwave correspondent Arthur Cushen of Invercargill, New Zealand, and his wife are now on a three-month world tour visiting broadcasters, meeting DXers at conferences and conventions, and learning about radio listening in North America, Europe and Africa.

Arthur is to attend the International DX Parliament at Halmstad in Sweden, at which he will meet many listeners from all over Europe. He is accredited to Radio New Zealand, and will be on a panel of international broadcasters who have DX sessions on short wave for world-wide audiences. These include representatives of the B.B.C. London, Radio Nederlands, Radio Sweden, Radio Denmark and many more European organisations.

Interviews by various broadcasting

organisations are scheduled, including Voice of America, Radio Canada, B.B.C. London, Radio Nederlands, Radio Denmark, Radio Sweden, Radio South Africa etc. As well as attending the DX Parliament and a European DX Council meeting, visits to the Benelux DX Club, Danish SW Club International, and a special convention arranged in Wales by the World DX Club are on the agenda. While in North America, Mr Cushen will be presented with a "Man of the Year" award, for outstanding work in the field of short-wave listening, this honour being conferred on him by the North American Association of Radio Clubs.

Readers of these pages will be kept informed on interesting aspects of listening and reception in various countries, and on interviews with some of the world's best known listeners.

NOTES FROM READERS should be sent to ARTHUR CUSHEN, 212 Earn St., Invercargill, N.Z. All times are GMT. Add 8 hours for Perth, 10 hours for Sydney and 12 hours for Wellington. All frequencies in KHz.



# WARBURTON FRANKI

## SOLID STATE 10 WATT STEREO AMPLIFIER KIT

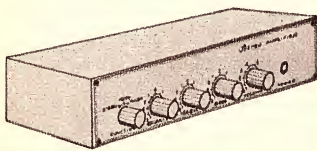

Australian-made by S.T.C. Everything supplied including cabinet and full instructions.

**Specifications:** 10 Watts R.M.S. per channel. Continuous Sine Wave into 4 ohm load.

**Response:**  $\pm 1$ dB 100 Hz — 25 KHz.  $\pm 3$ dB 15 Hz — 50 KHz at 1 watt output.

**Noise and Distortion:**—69dB at 1 watt.

**Channel Separation:** Over 50dB.  
**Output Impedance:** 4 to 16 ohms.  
**Input Sensitivity:** Main Power Amplifier 660mv input for max. undistorted output. Overall sensitivity 7.2mv.

Two Versions Available.

1. For use with ceramic pickup.
2. For use with magnetic pickup.

**\$95.00**

FREIGHT FREE.

## 4 m.m. EARPHONE PLUGS

With 45" twin flex attached  
**12c each**

**Packs of 10 \$1.00**  
including postage.

## "CADET" SPEED CONTROLLED FOR ELECTRIC HAND TOOLS

Varies speed from stop to full speed with no loss of torque. Rated capacity 2 amps. Complete with flex and plug.

**\$11.50**

FREIGHT FREE.

## SPECIAL!! TELEVISION TRANSFORMERS

Well-known Australian brand.

## Clearance at Cost Prices

Write or call for stock list.

## PICO SOLDERING IRON KITS



Handyman's or hobby kit. Includes straight and angle bits, small file, screwdriver, rubbing down brush, resin core solder.

**\$7.95** POST FREE.

## PHILIPS RE2 RADIO ENGINEER KITS

Everything supplied to build a 3 transistor mantel radio including cabinet. The radio may also be used as an amplifier for a record player or microphone.

**\$17.95**

Including batteries and freight.

## SPECIAL CONDENSER POLYPAC No. 20

Contains 25 assorted condensers, including ceramic, electrolytic, metal pack, mica, paper tubular. \$1 plus postage 5c (or 6 for

**\$5.50**

Including postage.

## CRYSTAL LAPEL MICROPHONES

Complete with Cord and Plug.

**\$1.75 each**

or 10 for \$15, inc. post.

## POWER SUPPLY BASIC KIT

Consists of: One Transformer tapped for 9v and 12v at 500 ma. One full wave contact cooled Rectifier. One 1,000 mfd. 15 V.W. Capacitor.

Make your own 9 or 12-volt power pack to supply transistor radios, record players, slot cars, toys, etc. Supplied with wiring diagrams.

**\$3.85**

Post free.



# WARBURTON FRANKI

220 PARK ST., STH. MELB., VIC. Ph. 69-0151 (30 lines)

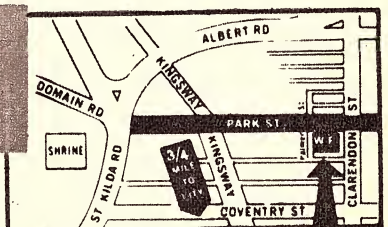



This was received after a delay of nine weeks, and as a result of the third follow-up, for reception in July, 1967, the previous two reports have included mint stamps. The station indicated that previous reports had not been received, and hoped that Bob would be able to write again with details about Melbourne. A verification statement indicated that the report was also of value to the technical department. The report was sent in Spanish, and was for the frequency of 11948KHz.

### TRANSMITTERS USED BY RED CROSS

Over the past few years the bi-monthly tests of the International Committee of the Red Cross with studios in Geneva, have been carried over the transmitters of the Swiss Broadcasting Corporation at Schwarzenburg. Following a request for details on the facilities used by the I.C.R.C. for these broadcasts, the Swiss Broadcasting Corporation informed that the transmitter now used is one located at the site of the Swiss Broadcasting Corporation domestic service, Beromunster, about 100 miles from Berne. Two 250KW short-wave transmitters using an omnidirectional aerial are at this site. They normally relay the Swiss Home Service on 6165 and 9535KHz in German, French, and Italian with some English programs.

The Red Cross sends the announcements for the tests on tape to the transmitter at Beromunster. In Geneva, the Red Cross has studio facilities, and a wide-band line to Berne is used to send contributions to the S.B.C. short-wave programs which originate in Geneva. This line, for high-quality broadcast relay, carries such programs as "Echoes from Switzerland," "Gazette" and other commentaries from Geneva on international affairs.

The tests from the Red Cross on 7210-KHz are scheduled for broadcast for the remainder of the year at 0600-0700, 1130-1230, 1700-1800, and 2300-2400GMT.

The tests will be heard:

May:	19, 21, 23
July:	21, 23, 25
September:	22, 24, 26
November:	24, 26, 28

### CALL CHANGES FOR BRAZIL

According to "Contact," most of the call signs of Brazilian radio stations will be changed in order to conform with the prefixes allocated by the I.T.U. The new calls will consist of three letters followed by one to three digits.

The letters 'ZY' will be followed by a letter giving the station's location:

ZYA Belem  
 ZYD Guanabara  
 ZYG Campo Grande  
 ZYC Salvador  
 ZYB Recife  
 ZYE Sao Paulo  
 ZYH Porto Alegre  
 ZYF Brasilia

As yet no date has been fixed for the proposed change.

### RECEPTION FROM AFRICA

News of the African world this month includes information on new frequencies which have been heard by Bob Padula in Melbourne and from our own observations.

**RHODESIA:** A new frequency in use by the Rhodesian Broadcasting Corporation in Salisbury is 4829KHz. Signals have been received at 2000GMT with a news bulletin, while on Saturdays the program is extended to 2200GMT when a variety musical program is broadcast. Our observations include the reception of the service on 3396KHz with fair signals at 1745GMT. At this time a program of dinner music was presented, followed by a news bulletin in English and weather details. At 1800GMT the station identification is given before the next program. The transmissions originate from Salisbury, but the transmitter is located at Gwelo.

## NEW SCHEDULES OPERATING

### ARGENTINE RADIO

The Argentine National Radio, Buenos Aires, is broadcasting to various parts of the world and uses the slogan RAE (Radio Argentine Exterior).

GMT	KHz	Language	Area
1900-2000	11710, 11780, 6090	Spanish	Europe
2000-2100	11710, 11780	German	Europe
2100-2200	11780	Italian	Europe
2200-2300	11780	French	Europe
2300-2400	11710	English	Europe
0100-0300	9690	Spanish	Eastern North America
0300-0400	9690, 11780, 6090	English	Eastern North America
0400-0600	9690, 11780, 6090	Spanish	Western North America
0600-0700	11780	English	Western North America
0000-0100	9690	Portuguese	Latin America
0100-0300	9690, 11780, 6090	Spanish	Latin America
0400-0600	9690, 11780, 6090	Spanish	Latin America
1900-2000	11710, 11780, 6090	Spanish	Africa - Middle East
2000-2100	11710, 11780, 6090	German	Africa - Middle East
2100-2200	11780	Italian	Africa - Middle East
2200-2300	11780	French	Africa - Middle East
2300-2400	11710	English	Africa - Middle East
0300-0400	9690, 11780, 6090	English	Far East
0900-1000	9690	Japanese	Far East
0400-0600	9690, 11780, 6090	Spanish	North Pacific
0600-0700	9690, 11780, 6090	English	North Pacific
0900-1000	9690	Japanese	North Pacific

### ENGLISH FROM BERLIN

The present schedule from Radio Berlin International includes the following programs in English:

GMT	KHz	Area
0345-0430	11875	Central Africa
0615-0700	9570	West Africa
0645-0730	21465	South East Asia
1115-1200	21540	South East Asia
1200-1245	17880, 21540	South East Asia
1215-1300	21600	Central Africa
1215-1300	21475	West Africa
1315-1400	21450	Central Africa
1315-1400	21475	West Africa
1330-1415	21540	South East Asia
1430-1515	15150	South East Asia
1515-1600	15150	South East Asia
2000-2045	11810	West Africa
0100-0145	9500, 9730	North America
0230-0315	9500, 9730	North America
0330-0415	6080, 9650, 9730	North America

### RADIO MALAYSIA SCHEDULE

According to a verification card from Radio Malaysia at Kuala Lumpur the broadcasts are now on the air according to the following transmission schedule.

GMT	KHz	Language
0625-0855	11900, 15280, 6175	English
0900-1400	11900, 15280, 6175	Indonesian
1400-1600	11900, 15280, 6175	Mandarin

### UNITED NATIONS RADIO

Programs of the United Nations are transmitted over the facilities of ORTF in Paris, RAI in Rome, and Geneva, Switzerland, as well as VOA transmitters. Times and frequencies of U.N. programs are:

GMT	KHz	Day	Language
<b>ORTF Paris</b>			
2000-2015	15160, 11920,	Monday-Friday	Arabic
<b>Rome, Italy</b>			
1920-1930	15400, 11800, 9545	Monday-Friday	Arabic
<b>Geneva, Switzerland</b>			
1830-1840	7443	Monday-Friday	Russian

Reports should be sent to the Radio and Visual Services Division, United Nations, New York, U.S.A.

### IVORY COAST: Reception of the Ivory Coast radio has been possible over its International service from Abidjan using 7213KHz. The station has been observed at 0755GMT in French with fadeout at 0830GMT.

### SOUTH AFRICA: Two internal services of the S.A.B.C. from Johannesburg, are in the 19-metre band. The service, intended for reception in South West Africa, is being received on 15365KHz in Afrikaans and on 15395KHz in English, from 0730 to 0830GMT. The Radio South Africa transmissions are being received at 0445GMT on 17805KHz, with a pro-

### gram in Afrikaans, and at 0625GMT on 15220KHz in Portuguese.

### ANGOLA: The station of Emisora Oficial, at Luanda, is using 7237KHz at 1740-GMT when the program is in Portuguese. In New Zealand reception of the station is best on 4820KHz with sign-on at 0500-GMT.

### EGYPT: Radio Cairo is using 15260-KHz from 2045GMT with a program in Arabic. This new frequency causes considerable interference to B.B.C. London on its World Service relay over the Ascension Island station. The interference

STOP RUST OUTDOORS 2 YEARS--OR MORE!

# Lubricates Penetrates Stops Rust

DRY YOUR ELECTRICAL SYSTEMS  
with **LPS** — the NON-GREASY ONE

**STOPS  
Squeaks!**



LPS is NOT a paint, lacquer or a varnish, and will NOT damage paint, rubber, fabrics, plastics, or finishes.

## Displaces Moisture Fast!

### TECHNICAL INFORMATION

#### Physical Properties:

##### LPS I

Less than .0001 inch non-greasy molecular film with capillary action that spreads evenly and easily to seal out moisture at very low cost. **Rust Inhibitor:** Protects all metals from rust and corrosion.

**Water Displacing Compound:** Dries out mechanical and electrical systems fast.

**Lubricant:** Lubricates even the most delicate mechanisms; non-gummy, non-sticky; does not pick up dust or dirt.

**Penetrant:** Penetrates to loosen frozen parts in seconds.

**Volume Resistivity per ASTM D-257;** Room temperature, ohm/cm;  $1.04 \times 10^{12}$

**Dielectric Constant per ASTM-877:**

**Dielectric Constant 2.11 Dissipation Factor: 0.02**

**Dielectric Strength per ASTM D-150:**

**Breakdown Voltage 0.1 inch gap, 32,000 volts**

**Dielectric Strength volts/inch 320,000 volts**

**Flash Point (Dried Film)**

**Fire Point (Dried Film) 900 degrees F**

**TESTS AND RESULTS: 950 degrees F**

**Lawrence Hydrogen Embrittlement Test for Safety on High Tensile Strength Steels: Passed. Certified safe within limits of Douglas Service Bulletin 13-1 and Boeing D6 17487.**

**Mil Spec. C-16173D-Grade 3**

Passed

**Mil Spec. C-23411**

Passed

**Swiss Federal Government Testing Authority for Industry: Passed 7 Day Rust Test for acid and salt water. Passed Weiland Machine Test for Lubricity as being superior to mineral oil plus additives.**

LPS PRODUCTS CONFORM TO  
FEDERAL MIL SPECS  
C-23411 and/or C-16173D



LPS RESEARCH LABORATORIES, INC.  
2050 COTNER AVE. • LOS ANGELES, CALIF. 90025

(SOLE AGENT)



**ZEPHYR PRODUCTS PTY. LTD.**

70 BATESFORD ROAD, CHADSTONE, VICTORIA—PHONE 56-7231

MANUFACTURERS OF RADIO & ELECTRICAL EQUIPMENT & COMPONENTS

## HOW LPS SAVES YOU TIME AND MONEY

1. LPS PROTECTS all metals from Rust & Corrosion.
2. LPS PENETRATES existing rust — stops it from spreading.
3. LPS DISPLACES moisture on metal—forms fine protective film
4. LPS LUBRICATES even the most delicate mechanisms at extreme temperatures.
5. LPS PENETRATES to free rust frozen parts, nuts, bolts, etc.
6. LPS PREVENTS equipment failures due to moisture (drives it out).
7. LPS LENGTHENS LIFE of electrical & electronic equipment—improves performance.
8. LPS RESTORES equipment damaged by water contamination & corrosion.
9. LPS PENETRATES AND PROTECTS plated and painted metal surfaces.
10. LPS PROTECTS metals from salt atmosphere, acid & caustic vapours.
11. LPS LOOSENS dirt, scale, minor rust spots & cleans metal surfaces.
12. LPS ELIMINATES squeaks where most everything else fails,

is severe on both programs at 2100GMT. Cairo is also being received on 21670-KHz with a program in Thai at 1400-GMT, while on 7375KHz an Arabic program is noted at 2150GMT, and on 7290KHz a further Arabic transmission has been observed at 2230GMT.

#### MEDIUM-WAVE LISTENING

In a recent program from Radio Nederlands some aspects of medium-wave listening and the reasons for signals being heard over such a distance were given in an article prepared by Jim Vastenhoude.

Medium-wave DXing is not dependent on good fortune, but on knowing some of the essentials of medium-wave propagation and using this knowledge when atmospheric conditions permit. We must therefore learn to understand the behaviour of the frequencies between 500 and 1600KHz. This can be a very interesting study in itself.

At these frequencies, ground waves are of limited value only. As they travel over the surface of the earth they become weaker, due mainly to the conductivity of the soil.

Under normal conditions a relatively strong transmitter can be heard up to about 400 miles from the site, but if the wave travels over water the range increases considerably and becomes as much as 600 to 800 miles for the same signal strength. The absorption which causes these limitations has a more severe effect on the high frequencies in the band (towards 1.5MHz) than on the lower frequencies (down to 500KHz), but in both cases one can hardly speak of DXing in the proper sense of the word.

Sky waves offer better opportunities. They are reflected by an ionospheric layer in the sky, and return to the earth. There are several of these ionospheric layers: the D-layer situated at a height of about 40 miles, the E-layer at about 60 miles, the sporadic E-layer—which becomes available under special conditions—at a slightly higher level, and the F-layer, which is at least 150 miles high.

These layers are formed by solar radiation, chiefly in the ultra-violet and X-ray regions. Due to the extreme low density of the air, the radiation is able to ionise atoms, splitting off free electrons. The concentration of free electrons in the D-layer is lower than that of the E-layer, and this in turn is lower than the electron density of the F-layer.

The relationship between the frequency of the signal and the concentration of free electrons in the layer will determine whether the layer acts as a reflector or as an absorbent. This means that E-layer reflection, which is common for the medium-wave frequencies, involves the D-layer acting as an absorbent. As the D-layer is only present during the daytime, E-layer DX becomes possible after sunset, when the ionisation of the D-layer has ceased. Under these conditions, it will be possible to hear medium wave (broadcast band) stations up to distances of about 3,500 miles with a medium field strength of about 10dB over 1 microvolt per metre still available.

It is interesting to note that the propagation characteristics within the medium-wave band are different for higher and lower frequencies. The higher the frequency, the less it suffers from absorption and the further it penetrates into the layer before it is finally bent downwards. The lower the frequency, the worse the effect of absorption and the lower the altitude of reflection will be. This also has its influence on the range of sky-wave propagation via the E-layer for medium-wave frequencies: the higher the frequency, the greater the range. After sunset, the concentration of electrons in the E-layer gradually decreases due to recombination of atoms and the absence of sunlight (which is necessary for new free-electron production.) F-layer propagation becomes possible for the

higher medium-wave frequencies, particularly those between 1 and 1.6MHz.

This F-layer propagation permits a reflection to cover a much greater distance (due to the height of the layer) and real DX becomes possible over distances far beyond the 3,500 miles boundary. This condition is fulfilled during relatively weak E-layer ionisation in the daytime (e.g. in the winter months); during the dark hours; and especially during periods of low sunspot activity, as are expected to prevail again about 1974-1976.

#### ENGLISH FROM KIEV

The English programs from Radio Kiev in the U.S.S.R. are well received in transmissions for Europe and North America.

	To Europe	
GMT	KHz	
1930-2000	5950, 6040, 6050	
2230-2300	5950, 6040, 6050	
	To North America	
0030-0100	7150, 7200, 9660, 9680, 9800, 11760	
0430-0500	7150, 9630, 9650, 9660, 9680, 11890.	

#### HIGHER POWER FOR TAHITI

"Sweden Calling DXers" says the French Government has announced plans to boost the power of the medium- and short-wave stations at Papeete, Tahiti. The plans are for a 25KW transmitter to operate on 730KHz on medium wave, to replace the existing 1400KHz transmitter. On short-wave, the transmitters will be two of 25KW and two of 4KW using the tropical bands of 60 or 90 metres. At present, Tahiti uses two short-wave frequencies, 11825 and 6135KHz. Sign-off is at 0800GMT in French.

#### KUWAIT ON NEW FREQUENCIES.

The Kuwait Broadcasting Station has been received on three new channels during its relay of the Arabic program from sign-on at 0930GMT to after 1800GMT. Our reception has been at 0930GMT on 1524KHz, and in Britain the B.B.C. Monitoring Service at Tisbury reports reception at later times. The station has confirmed our reception with a bright folding card, from the Kuwait Broadcasting Station, P.O. Box 397, Kuwait.

The test transmissions are as follows:

GMT	KHz
0930-1115	15242, 17795, 21780
1445-1600	21710
1600-1700	17795
1700-1800	17795, 15150

## FLASHES FROM EVERYWHERE

### EUROPE

**AUSTRIA:** The Austrian Army Radio Vienna is using 6255KHz, says "Sweden Calling DXers." The station operates in the European evening period and opens at 1630GMT. The station address is: Schulungssender des Osterreichischen Bundesgewehrs, Gussriegelstrasse 45, A-1100, Vienna. The station now uses 10KW and the broadcasts are Monday to Friday 1100-1230, 1630-1900GMT. The station verifies reception report with a special card.

**HUNGARY:** Radio Budapest is conducting a series of monthly contests, the winner each month winning a return trip to Budapest. The letters from listeners will be judged on the best comment on the programs.

### AFRICA

**MOROCCO:** According to a recent schedule, Radiodiffusion Marocaine, Rabat, operates in English 1800 to 1900GMT, on the following frequencies:

KHz	KW
6190	50
7225	10
11735	50
15410	10

**BOTSWANA:** Richard Ginbey, of South Africa, recently visited Radio Botswana, and was informed by the station that they plan to put into operation a 100KW short-wave transmitter. A new 1KW transmitter will be put on the air on 971KHz medium wave replacing the existing outlet. Five 1KW medium wave transmitters are planned at the major population centres. New schedule for daily operation is 0400 to 2100GMT.

### ASIA

**PHILIPPINES:** The Philippines Broadcasting Service is now using 6170KHz, after some weeks of drifting about the frequency. It has been heard well at 1000 GMT, with a news bulletin in English. The transmitter is placed at the disposal of the P.B.S. by the Voice of America. The Far East Broad-

(Continued on page 180)

## TEL-LEIGH-TUBES PTY. LTD.

(SYDNEY and MELBOURNE)

### T.V. PICTURE TUBES AT COMPETITIVE PRICES

#### Two Years Guarantee

We are still buying the following sizes of old TV tubes for cash.

21" 90°	21" 110°	23" 110/114°
\$8.00 ea.	\$5.00 ea.	\$9.00 ea.
		(mono or laminated)

Please send old tubes freight paid to Petersham Station, N.S.W., or Highett Station, Victoria.

TEL-LEIGH-TUBES PTY. LTD.

(Reg'd Office)  
51 REUSS ST., LEICHHARDT.  
N.S.W. 56-8498

TEL-LEIGH-TUBES PTY. LTD.

32-34 GRAHAM RD, HIGHETT VIC.  
95-4086

# NEW RANGE OF RESISTORS, CONDENSERS AND POTENTIOMETERS

WE HAVE JUST PURCHASED THE COMPLETE STOCK OF RESISTORS, CONDENSERS AND POTS. OF A LARGE MANUFACTURER AND CAN OFFER SAME AT LESS THAN 25 PER CENT OF LIST PRICE.

The resistors are mainly I.R.C. and Morganite and are in a wide range of values from 200 ohm. to 3meg. in 1/2, 1 & 2watt also included are I.R.C. 3watt wire wound 2,200 ohm. 3,300 ohm 4,700 ohm. etc.

List price \$9.00 per 100 our price \$2.00 per 100 post & packing 25c extra.

The condensers are in most popular makes and include Polyester, Paper, Mica, Ceramic & Electrolytic in standard values including 4mfd, 8mfd, 16mfd 300V etc.

List price \$11.00 per 100 our price \$2.00 per 100 post & packing 50c extra.

The potentiometers are all current types and include switch pots, dual concentric, 1meg. tandem, 1/2meg switch, tab pots etc.

List price \$12.00 per dozen our price \$2.50 per dozen post & packing 50c extra.

**FREE** With each lot of resistors, condensers or pots, we will supply free one new valve type 6U7G, 6X5GT, 1T4, 6K7G, or 12AT7. Resistors, condensers and pots are in packs of 100 or 12 and we regret we cannot supply to individual Lists of values or types.



## LEADER SIGNAL GENERATOR LS611

240V A.C. operated, 6 band 120KC to 390 Meas. Provision for crystal. Post N.S.W., 75c; Interstate, \$1.25. **\$32.00**

## USED HIGH-SPEED 240V. AC/DC MOTORS

These 240 v. a.c. or d.c. motors are 1/8 H.P. with a speed of 7,000 R.P.M. and are ideal for small drills, grinders, etc. Dimensions: 5 1/2 in x 3 1/2 in, with 5/16 in spindle . . . . . \$3.75.

Post, N.S.W., 50c; Interstate, 85c.

## NEW VALVES AT BARGAIN PRICES

7193	25c
807	\$1.75
1C7G	30c
1D8GT	95c
1K8G	40c
1K7G	49c
1M5G	40c
1P8G	25c
1Q8G	25c

1T4	45c
3Q4	75c
3S4	\$1.00
5V4G	\$1.00
6C8G	80c

6H6G	35c
6K7G	45c
6K8G	68c
6SA7GT	95c
6SJ7	95c

6SS7 equiv. 6SK7	85c
6U7G	45c
6X5GT	75c
7C7	35c
12AT7	\$1.00

1A7GT	75c
1L5G	95c
12SK7	80c
12A6	80c
12K8	50c
12SH7	80c
866	1.80
954	25c
955	25c
EK32	60c

Please add postage on all valves.

## NEW ENGLISH and AMERICAN TRANSISTORS AT 1/4 LIST PRICE

Ideal for the experimenter or service man.

Each package of 12 contains 3 of each of the following types.

Mazda XA101.	Equivalent:	OC45 R.F. Transistor.
Texas 2N1108.	"	OC44 OSC. Transistor.
Texas 2N1111.	"	OC75 General purpose
Texas 2N1110.	"	OC45 R.F. Transistor.

## PACKET OF 12 FOR \$3.00

THESE TRANSISTORS CAN BE SUBSTITUTED FOR MANY OTHER TYPES.

Post and Packaging 20c extra.

## New Electrolytic Condensers

These condensers are miniature pigtail type insulated new stock in packets of 12, each packet containing: 3 16mfd 300 V.W., 2 32 mfd. 300 V.W., 1 25 mfd. 450 V.W. and 6 low voltage electrolytics. \$2.50.

Post and packing 20c extra.

## NEW IMPORTED 4" P.M. SPEAKERS

Available with a 4 or 16 ohm voice coil. \$2.00. Post and packing 30c extra.

## NEW 240V ELECTRIC MOTORS

3300 R.P.M. can be supplied with or without 4-speed reduction mechanism. Size 3 1/2" x 2 1/2" x 3 1/2", including spindle.

**\$2.75**

plus 60c. postage.

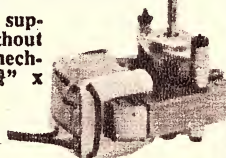
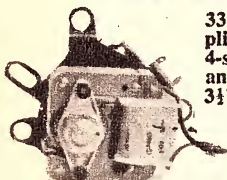

## NEW MINIATURE MOTORS

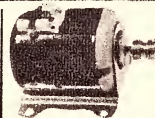

Ideal for models, toys, etc. 1 1/2 to 3 volts. 6,000 r.p.m. 39c each or \$3.50 per doz. Post 10c.

## NEW MIDGET POWER TRANS. \$3.25

40mA prim., 240v. Sec 225 x 225 with 6.3v Fil. Winding. 30mA 240v Prim. Fil. Winding. Postage: N.S.W. 25c; Interstate 45c. 150 x 150v. Sec. with 6.3v. Postage: N.S.W., 35c; Interstate 60c. **\$3.25**

NEW AMERICAN TWIN TELESCOPE TV AERIAL Extends to 36in, each section can be used singly for car or portable . . . . . \$1.50. Post 20c. SINGLE TELESCOPIC Aerial 12in extends to 33in. 60 cents .Post 10 cents.

## NEW B.S.R. TAPE DECKS

These new 3-speed B.S.R. Decks are fitted with a digital counter and will take 7in spools, 2 Track, \$35, 4 Track \$40.

## A PREAMP FOR MAGNETIC PICK-UP OR TAPE HEADS

SUITABLE FOR USE WITH THE COLLARO OR B.S.R. TAPE DECKS

Using 3 silicon transistors as featured in October Electronics Australia complete with kit of parts including transistors mono \$7.50, stereo \$13.00, 240 power supply for above \$7.00. Please specify if required for pick-up or tape heads.



# NATIONAL RADIO SUPPLIES

332 PARRAMATTA ROAD, STANMORE, N.S.W. PHONE 56-7398

# NEW TRANSISTOR 8 KIT SET

SPECIAL PURCHASE ENABLES US TO OFFER THIS KIT SET AT \$24.00



**DIMENSIONS**  
9" x 5" x 3" DEEP

(WIRED AND TESTED \$6.00 EXTRA)

- Complete kit of parts with circuit and full instructions
- Eight transistors.
- Magnavox 5X3 speaker gives excellent fidelity.
- High sensitivity, suitable for city or country use.
- Heavy duty battery for economical operation.
- Modern design, plastic cabinet with gold trim.
- Dial calibrated for all States.
- Available in colours of off-white, red, black or light green.

Post & Packing extra. N.S.W. \$1.25, interstate \$1.75.

## NEW TRANSISTOR CAR RADIO

New transistor six car radios with R.F. stage, of Aust. manufacture using A.W.A. components and transistors.

Available in manual or push-button models with dial calibrated for all Australian States.

Supplied with speaker (5", 6", 5" x 7" OR 6" x 9") and lock-down aerial.

MANUAL MODEL ..... \$43.00  
PUSH-BUTTON MODEL ..... \$48.00  
Post and Packing N.S.W. \$1.50, Interstate \$2.50.

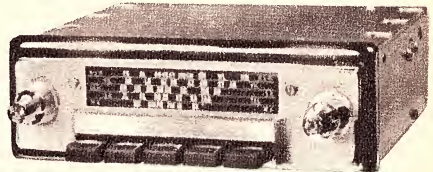

Suitable for 6 or 12 volts for positive or negative earth. Please state type required.

## NEW TRANSISTOR STEREO RECORD PLAYER

This Stereo Record Player is fitted in a durable and attractive vinyl covered case with silver trim and incorporates an 8-transistor Stereo amplifier with two Magnavox 5in x 3in speakers and B.S.R. record player (4-speed) with crystal pick-up. For 240 volt A.C. operation only.

**\$38.00**

DIMENSIONS:— 21" x 10" x 3½" WEIGHT 12lbs

Post and Packing extra N.S.W. .... \$1.50 Interstate ..... \$2.50

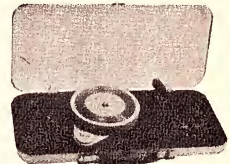

## NEW 25 AND 35 WATT. P. A. AMPLIFIERS

THESE AMPLIFIERS ARE SUITABLE FOR INSTALLATION IN CLUBS, SCHOOLS, RESTAURANTS, HOTELS, FACTORIES, ETC., WHEREVER THE AMPLIFICATION OF SPEECH OR MUSIC IS REQUIRED.

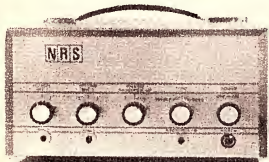

**STANDARD AMPLIFIER**

**25W \$61.00 SPECIFICATIONS 35W \$71.00**

Nominal power 25 or 35 watts. • Inputs two microphone and pick-up or radio with separate controls and mixing facilities. • Tone control. • Microphone sensitivity 6MV. pick-up or radio 150MV. • Frequency response 30 to 18,000 CPS. • Output impedance Line output (100, 166, 250, 500 ohms) or can be supplied with V.C. output (2, 3, 7, 8, 15 ohms). • Dimensions 11in x 6in x 8in. Weight 25W 23lb. 35W 26lb.

**SEPARATE BASS AND TREBLE CONTROLS**

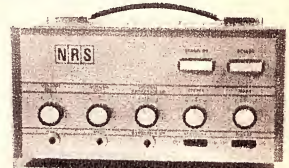

**AMPLIFIER WITH BASS and TREBLE CONTROLS**

All amplifiers can be supplied fitted with a separate tone control stage with separate bass and treble controls and stand-by switch at \$5.00 extra.

All amplifiers are too heavy to be sent by parcel post so can be sent by air freight or rail or road transport.

**FREIGHT EXTRA.**

# NATIONAL RADIO SUPPLIES

332 PARRAMATTA ROAD, STANMORE, N.S.W. PHONE 56-7398

# A FEW DROPS

is  all it takes!



  
Just a few drops to all  
electrical contacts can free you  
of your switching troubles

**SERVISOL** applied to contacting surfaces gives a lasting and protective film, removes loosened deposits almost instantaneously, resulting in, and maintaining, low and noiseless contact resistance.

### SERVISOL HAS NO SUBSTITUTE

It is contained in a distinctive can which has a unique spout stowed internally. Surfaces which otherwise may be awkward to treat physically can be reached using the spout.

**SERVISOL** can be used effectively for:

- Variable capacitors
- Valve holders
- Relay contacts
- Switches
- Turret tuners
- Noisy volume controls and all contacts in the electrical and electronic fields

**SERVISOL** is World Wide . . . used by all leading manufacturers of Radio, Television and Electrical Equipment.

Price: **88c** 1/2 pint tin  
 PLUS SALES TAX IF APPLICABLE

Supplies may be obtained from your  
 Electrical Wholesaler.



Distributed by—

**jacoby, mitchell & co. pty. ltd.**

469-475 kent street, sydney. 26-2651

casting Company, in Manila, is expecting to open a new 100KW transmitter in July. Good signals have been heard on 15380KHz at 2345GMT, and also on 17810 and 15440KHz at 0000GMT. The signals on 21515KHz are being received from 0100GMT with programs beamed to New Zealand.

## THE AMERICAS

**COLOMBIA:** Two new Colombian stations have been reported by contributors to "Sweden Calling DXers," which offer possibilities of reception in our winter months. The first new station has operated on medium wave for some years. It is "Radio Guatapuri" Valledupar, Colombia, using 4905KHz, which has been heard to sign off at 0300GMT. The second station "La Voz del Colombia," at Bogota, is using 6020KHz, and this also has been using medium wave for some years. The President of Colombia recently authorised the Christian Broadcasting Network to establish a radio and television centre in Bogota.

**GREENLAND:** Gronlands Radio is expected to increase its transmitter power output this year from 1KW to 10KW. Transmissions have been reported on 5960 and 5980KHz around 1030GMT.

**ECUADOR:** Radio HCJB, P.O. Box 691, Quito, Ecuador, is offering six new verification cards for reports from listeners this year. Half of the cards will cover technical subjects, and the others will feature Inca art designs. The first of the new series has the form of a slide-rule time converter.

**COSTA RICA:** Our verification from Radio Athenea, San Jose, came in the form of a letter, and gives the schedule as 1200 to 0600, using 6150KHz. The station gives no call letters or power in the verification. The station uses 900KHz for medium-wave operation and 975KHz for 24-hours-a-day operation.

## BROADCAST BAND NEWS

**ROMANIA:** The Romanian Government has placed a contract with The Marconi Company, of U.K., for the supply and installation of two transmitters to expand the country's national broadcasting service. The contractors will equip a 1000KW transmitting station with two 500KW medium-frequency transmitters, equipment to enable them to work in parallel, masts, directional aerials and program input equipment. The company will also design the buildings to house the system. The Marconi Company has previously supplied and installed medium-wave transmitters for the first Romanian broadcasting service in 1929, together with a 100KW long-wave transmitter for Brasov in 1934.

**OFF-SHORE STATIONS:** There continues to be an interest in Britain and on the Continent for off-shore radio stations and, according to "Pirate Radio News," some further stations are planned.

**Radio Nordsee:** According to the latest information Radio Nordsee, which will use the vessel "Galaxy" formerly used by Radio London, is to commence operation off the German coast, despite pending legislation to ban off-shore stations. Six disc-jockeys have already been chosen and other candidates are being tested. Advertising agreements have already been signed. A large amount has been invested by the Swiss agency "Gloria International." The station will operate on 266 metres, 1124KHz.

**Radio Modern:** This is a station proposed to operate off Felixstowe, Suffolk, England, but to date no information on its schedule is known. The frequency the station proposes to use is 259 metres (1157KHz). ■

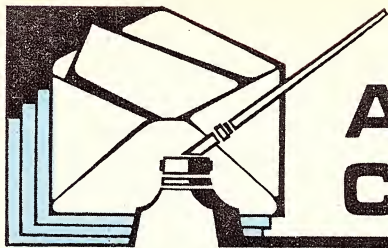

# ANSWERS TO CORRESPONDENTS

**BEGINNER:** I am a beginner in electronics and I am still bewildered by some terms, particularly Hertz. Also, I have a radio operated from two penlight cells of which I buy four at a time. However, the second pair never have full power when they are used. Is there a particular way in which I should store them? My broadcast band crystal set brings in Radio Australia over the local broadcast stations. How can I make a suitable wave trap? What frequency does SSB operate, on and what is a BFO? I have a 2SA100 transistor, would you publish an article describing a short-wave receiver using this transistor? Finally, I would like to join R.F. of Augathello, Qld. and K.L. of Noora, W.A. in asking for 32V equipment, radio receivers in particular. (N.S., Ororoo, S.A.)

• Hertz is the newly adopted nomenclature for the old term "cycles per sec," as discussed in our December, 1968, issue. For better storage life of batteries, we suggest that you keep them in a refrigerator until required. A wave trap usually consists of a parallel resonant circuit, tuned to the unwanted frequency, in series with the aerial input. SSB, or single side band is a mode of transmission which is not confined to any one particular frequency band. Unfortunately the transistor which you have is an unfamiliar type, probably Japanese, and hence we are not able to recommend a circuit specifically for it. With regard to 32V equipment, the situation is that the demand for such equipment is not sufficient to justify special developmental projects. Home lighting plants supplying 32V DC are now much rarer than they were a few years ago.

**"POP" REVIEWS:** I have been reading E.A. since August and, in my view, it is extremely informative. However, I think it would be even better if you included "pop" reviews. This should be done by some person who understands the content of such recordings. Not too much attention should be paid to quality, although many of the new pop records are excellent in this respect. (P.B., Bendigo, Vic.)

• Thanks for the kind comments. Followers of pop records seem to be ganging up on us lately. Some day, maybe, when space can be made available!

**DESIGN CRITERIA:** I have been a keen reader of your magazine since I was a schoolboy in 1961. The knowledge so gained has played its part in securing my present position in applied electronics. I feel that it would be helpful if your articles contained a short note about the criteria for which the transistor is selected in each stage. Other devices should be treated in the same way. Prices vary so much from place to place and time to time that readers on a small budget would be better able to modify designs to suit what is available, if necessary by changing a few resistors and capacitors. (R.C., Auckland, N.Z.)

• Your suggestion is not without merit but we can foresee a problem in setting out the criteria for every key device in each and every project. It would add materially to the work of preparing and checking articles and to the length of the article as finally printed. There is also some doubt in our mind whether readers could interpret the criteria as easily as you believe, remembering that to do so involves having

to hand a fair collection of up-to-date reference material and a knowledge of how to apply it. We are not at all keen on the idea of readers changing a few resistors and capacitors to preserve suitable voltage and current conditions. The spread of transistor parameters is problem enough for specific types and their direct equivalents, without admitting near-equivalent types and circuit changes to adapt them. As we said, the idea has merits but we can also see problems.

**DEFLECTION ANGLE MODIFICATION:** I have a television receiver chassis designed for use with a 110 degree picture tube. I desire to use it with a 90 degree tube. I have obtained a suitable yoke for the job, but when I try the setup, the tube is considerably overscanned. The width and height controls cannot provide sufficient scan reduction to bring the picture in to the correct size. Can you offer any advice? (R.P.V.R., Takapuna, N.Z.)

• Such a modification would strictly involve redesign of most of the sweep output circuitry, R.P.V.R., as you perhaps realise. However, as you are apparently proceeding with care, your present course will probably be satisfactory providing that you ensure that changed circuit conditions do not result in excessive component dissipation.

With regard to the overscan problem, about all we can suggest is that you try reducing the sweep output amplitudes in a way which will not seriously disturb normal operation. With the vertical section this will most likely involve little more than decreasing the value of the oscillator plate load resistor, or alternatively fitting a resistor in series with the coupling capacitor to the output valve grid (forming a voltage divider with the grid resistor). The

horizontal system will not be as straightforward, as one must be careful not to upset either the output valve operating conditions or the various output voltages (EHT, boost, focus, etc.). The approach we would recommend is that of inserting a small series inductor in one of the yoke leads; the inductor might well be a replacement width coil, allowing some adjustment.

We hope this information is of some assistance and thank you for your compliments regarding the magazine.

**CORRESPONDENT WANTED:** The following letter has been received which is self-explanatory:

"I should be very glad to open up writes connections with some yours readers. My name is Pavel Bym, I am 26 years I am working as tests chemist of development department in cars factory SKODA. My interest is jazz/traditional, pop-music and colour slides. I shall be very glad to hear from you if your are in a get acquainted with some yours reader. Thank you very-very much and I am looking forward to your reply at your earliest convenience. Pavel Bym, Bohackova 5/476, Mlada Boleslav, Czechoslovakia.

• We have published your letter. It's now over to our readers.

**SIGNAL INJECTOR:** I wish to build a small signal injector with a number of output frequencies. Could you supply me with a plan or diagram on a suitable project? Also, I am interested in building a direction finder using a rotating loop aerial. Can you tell me the parts required, or give me any information on the subject? (J.L., Bairnsdale, Vic.)

• We published a simple signal injector

## "ELECTRONICS Australia" Information Service

As a service to readers "ELECTRONICS Australia" is able to offer: (1) Photographs, dye-line prints and other filed material to do with constructional projects and (2) A strictly limited degree of personalised assistance by mail or by reply through the columns of the magazine. Details are set out below: **PROJECT REPRINTS:** For a 20c fee, we will supply data, as available from our files. The amount of data available varies but in no case does it include material additional to that already published in the magazine. For complicated projects involving material extracted from more than one issue, an extra fee may be requested. As a rule, requests for project data will be answered more speedily if the projects are positively identified and the request is not complicated by questions requiring the attention of technical personnel. Where articles are not on file, we can usually provide a photostat copy at 20c PER PAGE.

**PHOTOGRAPHS, DYE-LINE PRINTS:** Original photographs are available for most of our projects, from 50c plus 8c postage for a 6in x 8in glossy print. In addition, metalwork dye-line prints are available for most projects for 50c each; these show dimensions and the positions of holes and cut-outs but give no details of wiring.

**BACK NUMBERS:** A fairly good selection is available. On issues up to six months old the cost is the face value, plus 5c surcharge. From seven to 12 months, 10c surcharge; over 12 months, 20c surcharge. Package and postage is 10c extra per issue. Please indicate whether a PROJECT REPRINT may be substituted if the complete issue is not available.

**REPLIES BY POST:** This provision is made primarily to assist readers in matters relating directly to articles and projects published in "ELECTRONICS Australia" within the last 12 months. Note, however, that we cannot provide lengthy answers, undertake special research or modifications to basic designs. A 20c query fee must be enclosed with letters to which a postal reply is required; the inclusion of an extra fee does not entitle correspondents to special consideration.

**OTHER QUERIES:** Technical queries which fall outside the scope of "Replies by Post" may be submitted without fee and may be answered through the columns of the magazine at the discretion of the Editor. Technical queries will not be answered by interview or telephone.

**COMMERCIAL EQUIPMENT:** "ELECTRONICS Australia" does not maintain a directory of commercial equipment, or circuit files of commercial or ex-disposals receivers, amplifiers, etc. We are therefore not in a position to comment on proposed adaptation of such equipment, or on its general design. "ELECTRONICS Australia" does not deal in electronic components. Prices, specifications or other assistance must be sought from the appropriate advertiser or agent.

**REMITTANCES:** These must be in a form negotiable in Australia. Where the charge may be in doubt, an open cheque, endorsed with a limitation, is recommended.

**ADDRESS:** All requests for data and information, as set out above, should be directed to The Assistant Editor, "ELECTRONICS Australia," Box 2728 G.P.O., Sydney, N.S.W. 2001: 5/69

## NEW RH (Radio House) RANGE OF MULTIMETERS

### NEW POCKET SIZE MULTITESTER LIMITED STOCKS

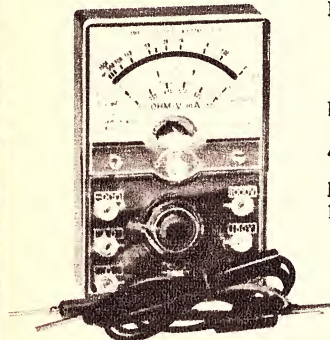

Latest model multitester YT67 now costs only \$8, measures up to 100,000 ohms and continuity.

DC volts 0-15, 0-150, 0-1000.

AC volts 0-15, 0-150, 0-1000.

DC current 150 MA.

1,000 ohms per volt, sensitive and clear scale for accuracy. Posted \$8.50 anywhere, with test leads and internal battery complete, ready to use. Size 3½ in x 2½ in.

### Model RH-80 \$18.00 Postage 50c

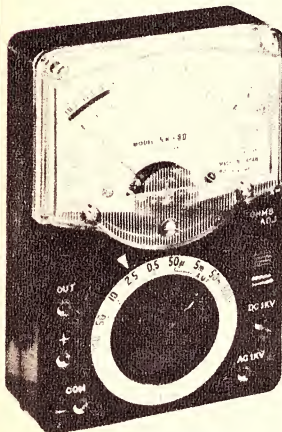

20,000 Ohms per Volt DC  
10,000 Ohms per Volt AC

**Specifications:**  
DC Volts. 0.5, 2.5, 10, 50, 250, 500, 1000 V  
AC Volts. 10, 50, 250, 500, 1000 V  
DC Current: 50uA, 5mA, 50 mA, 500 mA  
Resistance: 5 kΩ, 50kΩ, 500kΩ, 5 MegΩ  
Decibels. -10 + 62 db  
Accuracy. DC ±3%, AC ±4% (of full scale)  
Batteries. Two 1.5V dry cells. Size AA, "Eveready" 915

- Overload-protected by dual silicon diodes.
- Mirror scale.
- Double-jewelled ±2% meter.
- ±1% temperature-stabilized film resistors.

### Model RH-70 \$22.50 Postage 50c

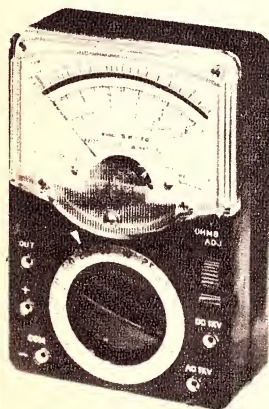

30,000 Ohms per Volt DC  
10,000 Ohms per Volt AC

**Specifications:**  
DC Volts: 0.5, 2.5, 10, 50, 250, 500, 1000 V  
AC Volts: 10, 50, 250, 500, 1000 V  
DC Current. 50 uA, 5 mA, 50 mA, 500mA  
Resistance: 7 kΩ, 70 kΩ, 700 kΩ, 7 MegΩ  
Decibels. -10 +62 db  
Accuracy. DC ±3%, AC ±4% (of full scale)  
Batteries. Two 1.5 V dry cells. Size AA, "Eveready" 915

- Overload-protected by dual silicon diodes.
- Mirror scale.
- Double-jewelled ±2% meter.
- ±1% temperature-stabilized film resistors.

### Model RH-20 \$13.95 Postage 50c

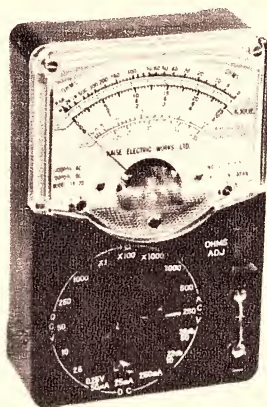

20,000 Ohms per Volt DC  
10,000 Ohms per Volt AC

**Specifications:**  
DC Volts: 0.25, 2.5, 10, 50, 250, 1000 (20,000/V)  
AC Volts: 10, 50, 250, 500, 1000 (10,000/V)  
DC Current. 50 uA, 25mA, 250mA  
Resistance. 7kΩ, 700kΩ, 7MΩ  
Decibels. -10 +22 (at AC/10V) +20 +36 (at AC/50V). Upper frequency limit 7kc.  
Accuracy. DC ±3%, AC ±4% (of full scale)  
Batteries: Two 1.5V dry cells. Size AA, "Eveready" 915

- Overload-protected by dual silicon diodes.
- Double - jewelled ±2% meter.
- ±1% temperature-stabilized film resistors.

### Model RH-55 \$20.00 Postage 50c

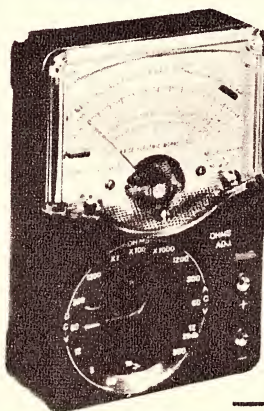

30,000 Ohms per Volt DC  
14,000 Ohms per Volt AC

**SPECIFICATIONS:**  
\*DC Volts: 0.6, 3V, 12V, 60V, 300V, 1200V (30,000 ohms/V).  
\*AC Volts: 12V, 60V, 300V, 1200V (14,000 ohms/V).  
\*DC Current: 60 A, 12mA, 300mA.  
\*Resistance: 10K ohm, 1Meg ohm, 10Meg ohm.  
\*Decibels: -10 db +23 db.  
\*Meter Sensitivity: 23 A.

- Overload-protected by dual silicon diodes.
- Mirror scale.
- Double-jewelled ±2% meter.
- ±1% temperature-stabilized film resistors.

### Model RH-60 \$25.00 Postage 50c

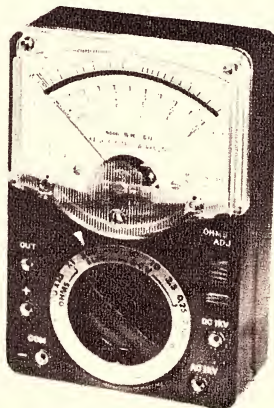

50,000 Ohms per Volt DC  
10,000 Ohms per Volt AC

**Specifications:**  
DC Volts: 0.25, 2.5, 10, 50, 250, 500, 1000 V  
AC Volts. 10, 50, 250, 500, 1000 V  
DC Current. 25 uA, 5 mA, 50 mA, 500 mA  
Resistance: 10 kΩ, 100 kΩ, 1 MegΩ, 10 MegΩ  
Decibels. -10 +62 db  
Accuracy. DC ±3%, AC ±4% (of full scale)  
Batteries. Two 1.5 V dry cells. Size AA, "Eveready" 915

- Overload-protected by dual silicon diodes.
- Mirror scale.
- Double-jewelled ±2% meter.
- ±1% temperature-stabilized film resistors.

#### Features of all models:

High sensitivity, minimises the loading effect to the circuit under test. Wide coverage of measuring ranges. Clear, plastic dial covering for easy and accurate measuring.

# RADIO HOUSE PTY. LTD.

306-308 PITT STREET: 6 ROYAL ARCADE & 760 GEORGE STREET, SYDNEY



# ANSWERS - continued

in February, 1964, which should meet your requirements. Copies of the article are available through the Information Service for 20c each. We have not published a project of a direction finder, nor have we any plans to do so.

**DIGITAL VOLTMETER, CALCULATOR:** Would it be possible for E.A. to describe a small digital voltmeter, one that would ideally be fairly simple, low in cost, and portable? Such an instrument would only need say three display digits at most, but would be of considerable value to serious experimenters and to TV technicians like myself. As a constructional project I think it should also be of interest and educational value to many readers. Another worthwhile project would, I think, be a small desk calculator; again not a big elaborate one, but with say five digits, addition, subtraction, multiplication and division with automatic decimal placing and the "short" keyboard scheme now popular. Any comment? You may also be able to advise regarding a book or articles giving a readable explanation of all the new types—and for that matter, the old types too—of semiconductor device. Does your "Basic Electronics" book cover such devices as the zener diode, the tunnel diode, the "programmable unijunction," and the FET, for example? I have read your "Introduction to Digital Electronics," and it was very informative. (M.J.W., Blackburn, Vic.)

• A really low-cost and simple digital voltmeter is a pretty tall order. M.J.W., but as it happens we are already planning something along those general lines. Just how much it will cost and when it may appear, we aren't able to say at the moment; but we hope to describe a useful instrument in the not-too-distant future.

Unfortunately a small desk calculator is not, as far as we can see, a practical proposition for home construction. Compared with an instrument such as a DVM, a small calculator is still quite complex, and at the moment it seems unlikely that we would be able to describe one in the magazine unless some really radical developments are made in producing low-cost many-function microcircuits.

"Basic Electronics" gives only a very simple explanation of the simple P-N junction diode and the normal bipolar transistor; it does not deal with the more recently developed devices. We have dealt with some aspects of these devices in the "Keeping Up With Semiconductors" series of articles, but to date have not published anything which covers semiconductors as a whole. There are many books on this subject, but to our knowledge none which can be recommended on all aspects.

**PERPETUAL MOTION:** Enclosed is a clipping from the Melbourne Herald reporting that a young Adelaide man had discovered the secret of perpetual motion. He has apparently constructed a transistorised inverter which can deliver enough output power to operate on ordinary mains-operated refrigerator or TV set and have sufficient surplus to meet its own input requirements. Thus having used a battery to initiate the action, the battery can be disconnected and the system will keep going. (R.W., Melbourne.)

• Somebody's leg is being pulled, R.W. Even a theoretically perfect, 100% efficient inverter charger system could do no more than keep itself going. To supply power to an external device would require greater than 100% efficiency and this would be more likely to be a product of Utopia than of Adelaide!

As it would appear that an up-to-date but readable and thorough explanation of semiconductor devices is sorely needed, our Technical Editor has for some time been planning and working on a new series of articles along these lines. The first of these articles appears in this issue, and we hope that they prove to be of value to yourself and the many other readers who have expressed a similar need.

We are glad to hear that you found the Digital Electronics book of value, and thank you for your compliments regarding it and the magazine.

**PUBLICATIONS:** Could you tell me what electronics and computer textbooks you publish? (G.H.J., Port Macquarie, N.S.W.)

• We publish "Basic Electronics" at a cost of \$2 plus postage 20c (this was reviewed in the March, 1969, issue on page 137) and "An Introduction to Digital Electronics" at a cost of \$2 plus postage 20c. Copies of both books may be obtained by writing to the Information Service at the address in the panel on the first page of this section.

**OUT OF TOUCH:** About 20 years ago I built a number of crystal sets and valve radios. Circumstances then obviated the luxury of a hobby but now that I want to take it up again, I find the magazines full of talk about "solid state," whatever that is. I have two or three old battery valve portables and could start with these to bridge the gap so that I can understand transistors, solid state, etc. The younger radio enthusiasts I know tell me to "get with it, man" though at 35, I am not all that ancient. What do you suggest? (P.H., Salisbury, S.A.)

• The scene has changed drastically during the past 20 years and you will certainly have to face a considerable amount of re-orientation. Valve-type battery portables have gone out of use completely and we suggest that you do not spend money or effort trying to resurrect them or re-use the valves. They were notoriously inefficient and unreliable, as well as being costly to power. Efforts should be directed towards regular mains type valve equipment or transistorised equipment. Before becoming involved in a choice of circuits, etc., we suggest you acquire a copy of our book "Basic Electronics," which will help to orientate you in regard to radio theory generally and put some typical small circuits at your disposal. Copies are available from this office at \$2 plus 20c postage.

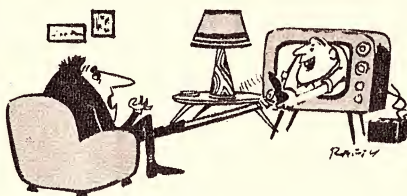

laide! We completely agree with Dr B. Horton's remark (Senior Demonstrator in Physics at the Adelaide University): "Unless everything I have learned over the years is wrong, I'd say it is impossible."



## ALEX ENCEL'S NEWSLETTER

Here at Encel Electronics we are very concerned about amplifier specifications in pamphlets and advertisements. Although amplifier test data seems to be objective, the enthusiast is often relying on figures which can be so inaccurate or so vague as to be meaningless in comparative sense.

Specifications given with an amplifier can fall into one of three different categories —

(i) They are as true and accurate as practically possible (there will always be slight variations in items being made on a production line).

(ii) They appear to be correct but in fact are not so; e.g. power is quoted at 20 watts R.M.S. but when actually measured in considerably less.

(iii) They are worded in such vague terms as to render them virtually useless. (e.g. frequency response may be quoted at 20-20,000 Hz, but no  $\pm$  dB reference given; in some cases this may be stated, but then it is not mentioned whether the measurement was made with an output of 1/10 watt or 20 watts.) Then some manufacturers qualify their measurements by stating the power in I.H.F.M., E.I.A. or peak power, or sometimes don't mention anything!

Often figures quoted have little practical value and little relevance to normal usage. With solid state amplifiers it must also be remembered that the output power is dependent upon the impedance of the speaker being used; figures quoted without stating the impedance at which it was measured cannot be directly compared with any other amplifier. When one manufacturer quotes figures in these vague terms then their competitors often quote in vague terms also so that their products remain attractive to the consumer.

Another question of importance to the purchaser of a new amplifier is whether to buy a valve or a solid state amplifier. There is no definite answer to this question. For instance, in Japan today the expensive, high class valve amplifiers are still popular; in the United States the solid state amplifiers are, by far, the most popular. We advise our customers to listen to the amplifier they are considering purchasing whenever possible as their ear must be the final arbiter.

Several things which are often overlooked when determining the power required are the efficiency of the speaker being used, room size, furnishings and the number of speakers being used.

Output power of an amplifier is an important consideration but not the only factor in determining the performance. Among the other factors to be considered are harmonic distortion, frequency response, signal to noise ratio and input/output sensitivities. There are other factors which are often not mentioned mainly because of the difficulty in measuring in a standardised way. Some of them are transient response, inter-modulation distortion, square wave response and damping factor.

Sincerely,

Alex Encel

## TV CAMERAS AND MONITORS



TV CAMERAS AND MONITORS from \$60.00 each.

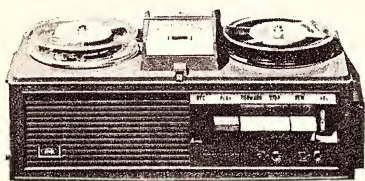

**MODEL RD301 TAPEREORDER** 3in tapes AC 240 operation tape speed 1 7/8 i.p.s. Record Playback time 64 mins. 6 transistor Capstan drive, valued at \$80.00 for only \$30.00 plus postage \$1.00.

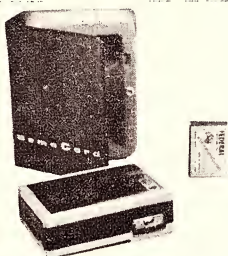

**MEMO CORD**, complete with accessories. Requires some adjustment. Price \$20.00. Post \$1.00

**DYNAMIC MICROPHONES.** High impedance. Suitable for Tape Recorders. Frequency response 60-12000 only \$4.50 each. Post 25 cents.

**PTC TYPE TAB MOUNTED POTENTIOMETER** 25 KC, 100 KC 1 meg C Curve. 25c each or \$2.50 per dozen plus post.

**ASSORTED DIODES AND RECTIFIERS** used for AC adaptors and radio sets. \$1.50 per doz. plus post.

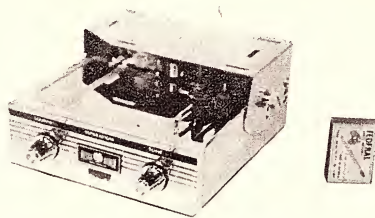

**MECCA 4 TRACK CAR STEREO** 4w per channel with 8 ohm output or 8 w per channel with 4 ohm output. Value \$120 for only \$56.25 plus post \$1.50.

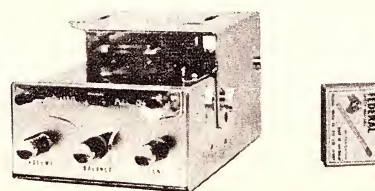

**BELTEK CAR STEREO** 2.5w per channel with ohm value \$90 for only \$40. Plus post \$1.50.

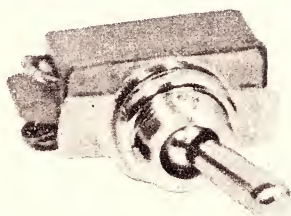

**TOGGLE SWITCHES** with on/off indicator Plates for only 40 cents each or \$4.00 per dozen. Plus post.

**INDICATOR LIGHT** (square type) bracket 25c each or \$2.50 per dozen. Plus post.

**PLUGS** to suit 9-pin valve sockets. Only 40 cents each. Plus post.

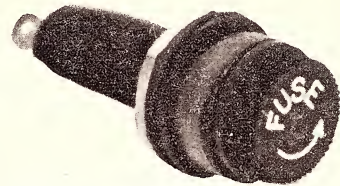

**FUSE HOLDER**, Chassis mounting type for only 25c each or \$2.50 per dozen. Plus post.

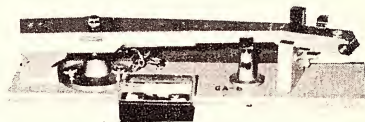

**NEAT STUDIO PICK-UP ARMS** including magnetic cartridges, mono or Stereo. Model GA-4, Model GA-6, Model GA-7, Model GA-11. From \$15.00. Tax included. Plus post.



**HI-TAKE COMPACT CASSETTE TAPE PLAYERS.** Ready to Play. Batteries supplied.

Only \$15.00 each. Post \$1.00

**ELECTROLYTIC CONDENSERS** 500 mfd 20 wv with upright mounting brackets. Height 2 5/8in. Diameter 1 3/8in. \$1.20 each or \$12.00 per dozen. Plus post.

**RESISTORS.** High Stability. Tolerance between 1 p.c. and 5 p.c. 1/4W, 1W, 2W, from 30 to 50K. Bag of 100 only \$5.00. Post 20 cents.

**LUG STRIPS** assorted Bag of 100 5 and 7 connections, 50 of each. \$2.00 each. Plus post.

**RECORD CHANGER COVERS** made from Perspex, grey smoke colour. Usually sold \$17.50. Only \$10.00 each. Plus post.

On a \$100 order we will supply one only Memo cord as a bonus.

# Olims Trading Co. Pty. Limited

A DIVISION OF OLIMS CONSOLIDATED LTD.

26 RICKETTY STREET, MASCOT, N.S.W. 2020

PHONE: 67 6011

# ANSWERS - continued

**SEMICONDUCTOR LASER:** Around two years ago you gave details in Technical Review of a low powered semiconductor laser. Can you tell me whether such devices are now available commercially in Australia? I wish to experiment using such a device in a light-beam communication system similar to that described by Mr Murrell in his excellent and very interesting "A Reader Built It" article in the March, 1969, issue. Incidentally, keep up the good work on the magazine, I think it really fine! (A.W., Geelong, Vic.)

● To the best of our knowledge such devices are not yet available commercially in Australia, A.W., although firms such as A.G.E. and the Ducon Imported Components Division of Plessey have non-lasing semiconductor light emitting diodes. Enquiries to these firms may prove worthwhile. We are glad that you enjoy the magazine, and found the March "Reader Built It" of so much interest.

**VALVE TESTING:** Over the past few years I have collected a number of valves, with no idea which are usable. I am interested in building a simple valve tester or acquiring literature on simple valve testing. Have you published any articles in Electronics Australia on the subject? (I.R.P., Essendon West, Vic.)

● First, we should emphasise that there is no such thing as a "simple" valve tester. It is relatively easy to carry out one or two tests on one specific type of valve, but it requires complex switching arrangements to cater for the vast range of valve pin connections, working voltages, etc. And, having provided this switching, it is then necessary for the home constructor to calibrate his valve tester. In an article which we published in December, 1960, we described the principles of valve testing. This was followed in January, 1961 by an article describing a valve and transistor tester. Copies of these articles are available through the Information Service for 20c each.

**BEGINNERS' MAGAZINE:** I am 12 years old and just started technical school. I get your magazine each month, but find it hard to understand. Would it be possible to publish an easier magazine for beginners? (R.W., and D.D., North Balwyn, Vic.)

● Although we appreciate the situation, it is highly doubtful whether such a publication would be an economic proposition. We try to cater for all levels of readers in "Electronics Australia," including material intended primarily for beginners. If you want assistance in learning the theory, may we recommend our "Basic Electronics." This publication, which costs \$2.20 including postage, was reviewed in our March, 1969 edition and is available through the Information Service.

**THEORY WITHOUT PRACTICE.** I am very interested in electronics, but I am a beginner with some knowledge of theory and no practical experience. My friends are in the same position and we all ask the same question—where do we start?—and how? I should like to know if there are any books on electronic construction, giving information on building with circuit boards, soldering, et cetera, which would start me off in practical electronics. (M.S., Epping, N.S.W.)

● We know of a very good publication which will give you the information you want—"Electronics Australia." We are

## Nero fiddled while Rome burned . . .

I thought you might be interested in an example of bad design which I encountered. A short time ago I removed the two output valves from my stereo amplifier/tuner, to use it as a tuner in conjunction with another amplifier. After running for a couple of hours in this state, a screen bypass capacitor emptied its contents with a resounding bang. I disconnected the capacitor and left the tuner running while I got into the bath. After soaking for a while, I noticed the old familiar "electrolytic" smell. I was just in time to see the rest of the fireworks. Another bypass electrolytic had disgorged, the rectifier tube was displaying "northern lights" and the power supply electros were "oozing." I sat down while the show continued. The dial lights went out, the rectifier internals slowly melted, another electrolytic "left the board" and sundry resistors fired away quietly. Some time later, I figured out the series of events . . . etc. Surely equipment should be designed for "worst-case" conditions, whereas this item was borderline at the best of times. Now I know why it was offered to me cheap. The unit, incidentally, was four years old, new and unmodified, direct from the factory. All that remains to me is to salvage the IF transformers and get the stink out of the room! (L.W., Christchurch, N.Z.)

Well, as we said, Nero Fiddled . . . etc. For reasons of economy, the vast majority of all valve type receivers and amplifiers ever built have used a power supply system with regulation and component ratings sufficient only to cope with normal requirements, normal mains variations and short-term crises brought about by valve failure. To use an old expression, "not even in a fit" would we advise readers simply to remove the output valves and use equipment in that condition for other purposes. We would expect exactly the kind of result that you observed. The fact that it operated for a couple of hours before anything blew up is indication of its tolerance to routine valve failure, etc. In the normal way, this would be more than ample time for the user to realise that something was wrong and to switch the equipment off, pending service. "Good design" in the sense that it would be proof against all conditions is usually also expensive design. One might also argue that "good design" takes cognisance of cost and likely situations. In short, there was nothing unusual about the behaviour of the equipment in question and no reason to think that the vendor saw you coming.

continually publishing articles to assist beginners, including simple projects using printed wiring boards and projects from scrap parts. An article on soldering appeared in June, 1967 issue. We cannot recommend particular books from commercial publishers, but we review a large number of books each year to assist readers in the selection of suitable books. Have you considered joining the Youth Radio Scheme operated by the Wireless Institute of Australia? The address to write to in N.S.W. is The Supervisor, Youth Radio Scheme, Wireless Institute

of Australia, Atcheson Street, Crows Nest, N.S.W. 2065.

**STEREO AMPLIFIER:** Have you published a circuit for a stereo amplifier of 10W or over per channel? (E.N., Abbotsford, Vic.)

● Our most recent design to give 10W per channel is the 10-plus-10 published in November, 1968 and, with protective circuit, in April, 1969. Copies of these circuits are available through the Information Service for the usual 20c each.



## EXPLORATION UNLIMITED

- Telescopes
- Microscopes
- Binoculars
- Astronomical books, charts, atlases
- Build-it-yourself kits
- Celestial globes
- Complete Electronic Weather Stations

**SEEK OUR EXPERT ADVICE  
ENJOY OUR FRIENDLY SERVICE AND  
BIG PRICE SAVINGS**

**UNITRON ELECTRONIC  
WEATHER STATION**

- Electric wind speed generator.
- Instant wind direction indicator.
- Barometer
- Hygrometer
- Thermometer



Prompt mail order service  
All goods fully guaranteed.

**WRITE OR CALL FOR  
OUR FREE CATALOGUE  
NOW**

Become a weather expert

**AMATEUR ASTRONOMERS SUPPLY CO.**  
Dept. E 11A-B Clarke St., Crows Nest,  
Sydney 2065 Phone 43-4360

# HAM

## RADIO SUPPLIERS Mail Order Specialists

323 ELIZABETH STREET,  
(2 Doors from Little Lonsdale Street)  
MELBOURNE, VIC. 3000  
TELEPHONES: 677329, 674286

1B3GT (DY30)	\$1.45
1C7	.50
1D4	.75
1H5	\$1.00
1K5	.50
1K7	.50
1L4	.50
1L5	5 for \$2.00
1LN5	1.50
1M5	.50
1P5	.50
1Q5	.50
1R5	\$1.85
1S2(DL86)	\$1.00
1S4	\$1.00
1S5	\$1.70
1T4	\$1.00
1X2 A/B	\$1.90
2D21	\$1.00
3S4	\$1.00
3V4	\$1.70
5AR4 GZ34	\$2.45
5AS4	\$1.30
5R4GY	\$2.00
5T4	\$1.75
5U4GB	\$1.30
5V4(GZ32)	\$1.50
5Y3GT	\$1.20
5Z3	\$1.50
6A8G	\$2.00
6AB7	\$1.00
6AC7	ea. \$2.50
6AD8	or 5 for \$1.35
6AE8 (X79)	\$3.50
6AG5	.20
6AG7	or 12 for \$2.00
6AJ5	\$1.25
6AK5(EF95)	\$2.55
6AL3	\$1.55
6AL5	.75
6AM5	.75
6AM6	or 3 for \$2.00
6AN7/A	or 3 for \$2.00
6AQ5	1.55
6AR7GT	\$1.30
6AU4GT/A	\$1.80
6AU6	\$1.30
6AV6	\$1.20
6AX4	\$1.50
6B6	\$2.00
6B8	\$3.00
6BA6	\$1.40
6BE6	\$1.40
6BH5	\$1.45
6BK8 (EF86)	\$2.00
6BL8	\$1.50
6BM8	\$1.60
6BQ5 (EL84)	\$1.50
6BO6GTB/	\$2.50
6C07A	\$1.50
6BV7	\$1.35
6BX6	\$1.35
6BY7	\$1.95
6C4	or 5 for \$2.00
6C8	\$1.00
6CA4	\$1.10
6CA7/EL34	\$3.00
6CB6	\$1.40
6CDEG/A	\$4.50
6CG7	\$1.50
6CK5	\$2.00
6CK5	\$2.00
6CK6	\$1.40
6CM5	\$2.20
6CQ6	\$2.20
6CQ8	\$1.40
6CS6	\$1.30
6CW4	\$1.30
(NUVISTA)	\$2.75
6DC6	\$2.40
6DC8	\$1.90
6DQ6A	\$2.20
6DO6B	\$2.65
6E8	\$1.80
6DT6	\$1.80
6DX8	\$1.65
6EA8	\$1.55
6E6	\$1.80
6E8	\$1.80
6F6G	\$2.25
6G8C	\$2.40
6G8	\$1.70
6GW8	\$1.70
6H6GT	.20
6H5	or 12 for \$2.00
6H8	\$1.50
6HS8	\$1.00
6J5GT	\$1.00
6J6	.75
6J7	or 3 for \$2.00
6J8G	or 5 for \$2.00
6K6	\$1.00
6K7	.50
6K8GT	\$1.25
6K8 Metal	\$2.00
6KV8	\$1.75
6L6G	\$2.90
6M5	\$1.50
6M5	\$1.35
6N3	\$1.20
6N7	.30
6N8	or 10 for \$2.00
6O7G	\$1.40
6R3	\$1.55
6S2	\$1.85
6SA7GT	\$2.20
6SC7	.75

6SF5	.75
6SF7	.75
6SH7	.50
6S7	or 5 for \$2.00
6S7	or 3 for \$2.00
6SL7GT	\$1.25
6SN7GT	\$1.00
6SQ7GT	\$2.10
6SS7	.75
6T4GT	\$2.00
6U7G	.75
6U8/A	or 3 for \$2.00
6V4	\$1.55
6V4	\$1.05
6V6GT	\$1.75
6X2	\$1.95
6X4	\$1.00
6X5GT	\$1.50
6Y9	\$1.75
7A8	.35
7A8	8 for \$2
7C5	.50
7E6	.50
7E6	5 for \$2
7H7	.50
7W7	.50
7W7	5 for \$2
9A8	\$1.90
9U8	\$1.90
12A6	.50
12A6	5 for \$2
12AH7	.50
12AT7	.50
12AT7	5 for \$2
12AU6	\$1.50
12AU7	\$1.45
12AV6	.75
12AX7/ECL83	\$1.60
12B6	.75
12BY7/A	\$1.75
12C8	.50
12J5	.50
12SA7GT	\$1.00
12SC7	.50
12SK7	.50
12SK7GT	\$1.00
12SR7	.50
12SR7	5 for \$2
15A8	\$1.00
35L6	\$1.00
19	.50
30	.50
42	\$2.50
57	.50
57	.50
58	.50
78	\$1.00
80	\$1.50
80	\$3.00
100TH	\$3.00
717A	\$1.25
807	\$1.00
808	\$1.00
832A	\$7.00
866A	\$1.00
954	.50
954	5 for \$2
955	.50
956	.50
958A	.50
958A	5 for \$2
1625	5 for \$2
1629	5 for \$2
5636	.50
9006	25c or
9006	10 for \$2
BA50	10c or
BA50	12 for \$1
ECC35	\$2.00
ECH35	\$2.80
EFH/6BK8	\$2.00
EL34 (CA7)	\$3.00
EM84	\$1.50
EY91	.50
KT61	\$3.90
KT66	\$4.75
KT88	\$4.75
RL18	.75
RL18	3 for \$2
UL41	\$1.00
VR150	\$1.00
2D21 (Reg.)	\$1.25
2D21	\$1.20
2E26	\$4.60
2X2/879	.75
6CW4	.75
NUVISTA	\$2.75
6DQ5	\$4.75
75V1	Reg.
75V1	\$2.25
100TH	\$3.00
90C1	Reg.
90C1	\$2.50
108C1	Reg.
108C1	\$2.50
150C4/OA2	Reg.
150C4/OA2	\$1.65
832A	\$7.00
866A/A	Reg. \$1.00
807	\$1.20
884	\$2.85
885	\$2.85
2051	.50
5763	\$2.55
6146A	\$5.95
6146B	\$6.25
OA2/150C4	\$1.50
OB2/108C1	\$1.50
QEO3/10	\$2.55
QEO3/12	\$2.65
QEO3/20	\$3.85
QEO3/40	\$5.95
QVO4/17	\$1.50
QVO4/17	3 for \$3.75

ALSO OTHER  
TYPES AVAILABLE.  
P.O.A.



MODEL OL-64D MULTIMETER, 20,000/OPV, DC Volts: 0-0.25/1/10/50/250/500/1000V at 20K/OPV, 5000 volts at 10K/OPV, AC Volts: 0-10/50/250/1000V at 8K/OPV, DC/A: 50uA/1mA/50mA/500mA/10 amps. RESISTANCE: 0-4K/400K/4M/40Megohm, DB Scale: -20 to plus 36db. Capacitance: 250pF to .02uF, Induct. 0-5000H, size: 5 3/4 x 4 1/8 x 1 3/4 in.  
**PRICE: \$19.50 post 30c.**



MODEL 200H MULTIMETER, 20,000 opv, DC Volts: 0-5/25/50/250/500/2500V (20,000 opv) AC Volts: 0-15/30/100/500/1000V (10,000 opv) DC/Amps: 50uA/2.5mA/250mA, Resistance: 0-60K/6M ohm (scale centre 300 ohm-30K ohm. Capacitance: 10uF to .001uF/.001uF - .1uF, D3 scale 20 db to plus 22 db. Size 4 1/2 x 1 3/4 x 1 1-8.  
**PRICE: \$11.25 post 30c.**



NEW MODEL US-100, Overload protection, Shockproof Movement, polarity switch DC volts: 0.25/1/25/10/50/250/1000V (20K/OPV) AC Volts: 0-2.5, 10/50/250/1000V (5K/OPV), DC/Amps: 1mA/25mA/500mA and 10A. AC/Amps 10A. RESISTANCE: 0-50M/ohms (centre scale 50) R X 1/10/100/1K/10K, db scale -20 to plus 10 plus 22/plus 35/plus 50db.  
**PRICE: \$28.75 post 40c.  
Mirror Scale**



MODEL C-1000 POCKET MULTIMETER, 1000 ohms/per Volt, AC Volts: 0-10/50/250/1000 (1000 opv) DC Volts: 0-10/50/250/1000 (1000 opv), DC Current: 0-100mA, Resistance: 0-150K ohms (3K centre), 2 colour scale, Range Selector Switch, Dimens.: 3 1/2 x 2 1/4 x 1 in.  
**PRICE: \$6.50 post free**



MODEL CT500 MULTIMETER, 20,000/OPV, DC Volts: 0-2.5/10/50/250/500 5000V (20K/OPV) AC Volts: 0-10/50/250/500/1000V (10K/OPV) DC/Amps: 5uA/5mA/50mA/500mA, RESISTANCE: 0-12K/120K/1.2Meg/12Megohms, (scale centre: 60/600/6K/60K, DB scale: -20db to plus 62db (5 ranges). Size: 5 1/2 x 3 5/8 x 1 3/4 in.  
**PRICE: \$14.95 post 30c.**



MODEL CT330 MULTIMETER, 20,000/OPV, DC Volts: 0-6/6/30/120/600/1.2K/3K/6K Volts, AC Volts: 0/6/30/120/600/1.2K Volts (10K/OPV), DC/Amps: (0-0.06/6mA/60mA/600mA), RESISTANCE: 0-6K/600K/6M/60M/600Megohm. (30/3K/30K/300Kohms) centre scale: Capacitance: 30 uf to .01 uf/.001 to 0.2 uf. Decibels: -20 to plus 63db size approx: 5 1/2 x 3 5/8 x 1 3/4.  
**PRICE: \$16.75 post 30c.**

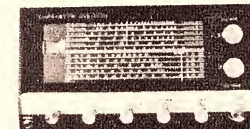

### NEW LAFAYETTE SOLID STATE HAG60 RECEIVER

5 BAND AM/CW/SSB AMATEUR AND SHORT WAVE, 150 Kc/s-400 Kc/s and 550 Kc/s-30 Mc/s, F.E.T. front end • 2 mechanical filters • Huge dial • Product detector • Crystal calibrator • Variable BFO • Noise limiter • S Meter • 24in Bandspeed • 230V A.C./12V DC, neg. earth operation • RF gain control. Size 15in x 9 3/4in, 8 1/4in. Wt. 18lb. S.A.E. for full details.  
**PRICE \$199.50**

### CITIZEN-BAND CRYSTALS

To suit Japanese Walkie-Talkies and Transceivers, P.M.G. approved. Freq. 27.240 Mc. (Tx), 26.785 Mc. (Rx).  
HC8/U Subminiature 1/4in pin spacing, 27.240 or 26.785 Mc. \$3.50 each or \$6.50 a pair.  
HC18/U Miniature 1/4in pin spacing, 27.240 or 26.785 Mc. \$3.50 each or \$6.50 a pair.  
(HC18/U also available with flying leads).  
Postage 10c.

### RECORDING TAPE

WELL KNOWN MAKE SEALED BOXES 3-INCH REELS		BARGAIN PRICED FULLY GUARANTEED 7-INCH REELS	
150ft Acetate	55c	1200ft. Acetate	\$3.00
225ft Acetate	70c	1200ft. Mylar	\$3.75
300ft Mylar	\$1.15	1800ft. Acetate	\$4.50
3/4-INCH REELS		1800ft. Mylar	\$5.00
600ft Mylar	\$1.85	2400ft. Mylar	\$6.25
4-INCH REELS		3600ft. Mylar	\$9.75
400ft Acetate	\$1.40	FILMS TYPE TAPE CASSETTES	
600ft Mylar	\$2.20	C-60 60 min	\$2.65
5-INCH REELS		C-90 90 min	\$3.65
600ft. Acetate	\$1.85	C-120 120 min	\$6.00
900ft. Acetate	\$2.25	EMPTY REELS (UNBOXED)	
900ft. Mylar	\$2.80	3 1/4 inch	35c
1200ft. Mylar	\$3.75	4 inch	40c
1800ft. Mylar	\$5.75	5 inch	40c
5/4-INCH REELS		5 3/4 inch	55c
900ft. Acetate	\$2.40	7 inch	50c
1200ft. Acetate	\$3.40	10c Per Reel Postage	
1200ft. Mylar	\$3.75		
1800ft. Mylar	\$4.75		



### STEREO HEADPHONES

Large rubber earpiece, full audible frequency. 100-15,000 cycles.  
**\$9.00 inc. Tax.**

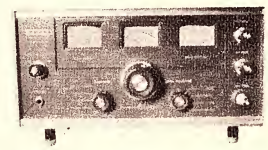

### TRIO COMMUNICATION RECEIVER MODEL 9R-59DE

4 band receiver covering 550 Kc/s to 30 Mc/s, continuous and electrical band-spread on 10, 15, 20, 40 and 80 metres. 8 valve plus 7 diode circuit, 4/8 ohm output and phone jack. SSB-CW. • ANL • Variable BFC • S meter • Sep. band-spread dial • IF 455 Kc/s • Audio output 1.5 W • Variable RF and AF gain controls. 115/250V. A.C. Mains. Beautifully designed. Size: 7 x 15 x 10in. Within instruction manual and service data.  
**PRICE \$175 inc. Sales Tax**  
Speaker to suit type SP5D \$15 inc. tax.

### S.W.R. METERS, MODEL KSW-10

Specifications.—Standing Wave Ratio: 1:1 to 1:10. Accuracies: Plus or minus 3 per cent. scale length, Impedance: 52 ohms and 75 ohms. Meter: 0-100 DC microamperes. Price \$19 inc. tax.

# ANSWERS - continued

**RADAR INTERFERENCE:** I wish to relate an experience concerning radar interference in audio equipment. The interference comes from the nearby airport radar, about one mile away. The amplifier is a home-made unit employing a 12AX7 in the front end, operating from a magnetic cartridge. I have tried various front end valves in an effort to reduce hiss and hum, but the interesting point is that changing from a 12AX7A to a 7025, with no other alterations, reduces the radar interference from quite annoying to barely noticeable. I wonder if you could suggest a reason for this. (K. B. Plympton, S.A.)

● This letter was originally addressed to the "Serviceman" and we have passed it on to him. In the meantime, however, we can only comment that there does not appear to be any obvious reason why this difference should occur. The 7025 is described as being suitable for high fidelity audio amplifier applications critical as to noise and hum. In other respects... similar to 12AX7." This doesn't provide much of a clue, since the "noise" referred to has nothing to do with external interference, only that likely to be generated within the valve itself. It may be that better isolation between heater and cathode could have something to do with it, or that differences in construction (to improve rigidity) may have increased lead inductance by a significant amount for the frequencies involved. However, we are inclined to think that the difference was as much accidental as anything, and would hesitate to suggest it as a standard cure. Incidentally, we published an article on interference in audio circuits in the October, 1968 issue, in the "Audio Topics" section. Readers facing similar troubles would be well advised to consult it. Many thanks for your kind comments about the "Serviceman."

**INTERFERENCE PROBLEM:** I have a push-pull valve amplifier in my hi-fi system, installed in a room in a modern 7-storey building. It has a lift and, as you have guessed, I hear clicks every time the lift is used. A small modern sealed unit refrigerator also causes annoying clicks in the amplifier. I have tried a capacitor across the refrigerator terminals which reduces the click but does not make it unnoticeable. I have played around with earths and a line filter but without any real benefit. The amplifier already has capacitors across its main input lead. Someone suggested a very large capacitor across the power mains and worked out a value of 200uF. S.S. (Parkville, Vic.).

● There is no easy answer to your problem and one of your remarks gets very close to the truth: The proper place to suppress interference is adjacent to the offending appliance and not at the receiver or amplifier—and after the interference has been propagated throughout the building. Unfortunately, it is one thing to say this but quite another to give it expression. Quite apart from finding someone willing to take remedial measures, there is the fact that filtering a heavy-drain device can be difficult and expensive. We published an article on these general problems in the October, 1968 issue and you may find it of some assistance. Although the interference is heard as an audio "plop" it is often caused by a burst of RF energy which will yield to RF filtering. As to the idea of putting a very high value of capacitance across the mains, forget it. It would be cheaper to move and probably more acceptable to the supply authorities,

and several other records. I feel that a lot of small groups would be glad to have this device, as it can be very impressive. The device should be transistorised and could be designed as a companion to, and perhaps share some of the circuitry of one of your fuzz boxes. (D.G.O., Broadview, S.A.)

● We are completely in the dark as to the nature of the device in question. None of our staff has heard any of the

## The optimism of youth

I am trying to obtain plans for an electronic organ. I have written to a couple of other firms, but they are unable to supply me with what I want. I would like plans for a very large organ, about 50 stops, if possible. I am an organist, but don't own an instrument. I am only 12 years of age, but know a fair bit about electronics. I read your book every month and find it interesting and helpful. I already have the casing designed for the instrument. It is to be painted in hippie drawings and flowers. It is to be shaped like a hot dog with big feet, if you know what I mean. (I.S., Guildford, N.S.W.)

● We can only admire your enthusiasm and hope that, one day, you will be able to buy or build the organ of your dreams. But we do wonder whether you have the slightest idea of what would be involved. A 50-stop electronic organ with voices and manuals to go with them would put the instrument into the \$3,000-plus bracket, with months (or years) of spare-time work if you want to build it. No firms that we know of could supply plans for an organ to meet an individual requirement, though one or two firms can arrange complete assembly kits for particular makes and models of organs. Typical are Heathkit organs (styled after Thomas) distributed by Warburton Franki, who advertise in the magazine. There is also a number of Schober kit-organs, available through Schober Organs Aust. at 124 Livingstone Avenue, Pymble, 2073. Either way, you'll discover that a fairly healthy cheque account will be necessary before you can do business! Our advice would be to spend a few dollars on a book on the subject and study it up. Another possibility you may like to consider is to look for a cheap second-hand organ which you could refurbish and perhaps enlarge.

## BUY RECORDING TAPE AT WHOLESALE PRICE

### WILCOX BROS. & BARCLAY

are now offering their line of recording tape direct to the Public at wholesale prices. This is a leading American manufacturer's first-grade line especially packed for us in a plain box. We are not allowed to reveal the maker's name.



TYPE	CODE	LIST PRICE	YOUR Wholesale PRICE
5" 900ft Acetate PVC .....	5R9	\$2.75	\$1.80
5" 1200ft Tensilized Polyester .....	5P12	\$4.45	\$2.95
7" 1800ft Acetate/PVC .....	7R18	\$5.10	\$3.35
7" 2400ft Tensilized Polyester .....	7P24	\$8.35	\$5.50

Wholesale prices allow for 33 1/3 per cent trade discount and cash settlement discount an include sales-tax. Freight free throughout Australia.

### MONEY BACK GUARANTEE

WILCOX BROS. & BARCLAY tape is guaranteed to be first-grade splice free recording tape made in the U.S.A. Your money will be refunded in full on return of goods within fourteen (14) days if you are not fully satisfied with your purchase.

### ORDER FORM (capital letters please)

FROM:  
NAME:  
STREET AND NO.  
CITY OR SUBURB: POSTCODE:

PLEASE SHIP:

..... rolls 5R9 at \$1.80. Total \$ .....

..... rolls 5P12 at \$2.95. Total \$ .....

..... rolls 7R18 at \$3.35. Total \$ .....

..... rolls 7P24 at \$5.50. Total \$ .....

I enclose cheque/pos:al ncte/ Money Order for Total \$ .....

Return this order to:

## Wilcox Bros. & Barclay

WHOLESALE MERCHANTS  
Mail Order Office:  
Room 7, 3rd Fl., 323 Bourke St., Melbourne



**"JET" SOUND.** Will you consider as a project the device that produces the well-known "Jet" sound as used in the recording of "Itchykoo Park" by the Small Faces,

### SOUND PROJECTORS

Cinevox Prefect and Harbour and Heath 16mm in good working order. 240v operated, complete with speaker and amplifier. **from \$90.00**

### CIRCULAR SLIDE RULE

3 3/4in diameter. Will do the same work as the conventional slide rule. Instruction book included.

**\$1.25 each**  
Post 10 cents.

### REFLECTOR GUNSIGHT

Contains these lenses:

1 Lens 1in Focus, 1/2in diam.  
1 Lens 1 1/16in Focus, 1/4in diameter.

1 Air-spaced Lens, 1/4in diam.  
1 Filter Lens, 1 Graticule,  
1 Lampholder. **\$1.85**

Post.: N.S.W. 30c; Interstate: 40c.

### P.M.G. TYPE TELEPHONES

Standard desk type with magneto bell calling device, Range 30 miles. Uses standard batteries at each phone. Any number can be connected together on single line.

**\$23.00**

#### (2 TELEPHONE SETS)

30c cartage to rail. Freight payable at nearest attended railway station.

Please note we are now able to include 1/2 mile of telephone cable **FREE** with each set of Phones.

### BATTERY CHARGERS

240 volt A.C. Input.

Each battery Charger will charge either 6 or 12 volt batteries.

2 amp. without meter, **\$13.75**  
2 amp. with meter, **\$15.75**

Post N.S.W. 70c; Interstate 95c.

### MINIATURE ELECTRIC MOTORS

1/2 to 3 volts D.C. Ideal for model boats, cars, planes, etc. Strong torque. Only **65 cents each** or **10 for \$4.00.** (Post 7c).

### TRANSCEIVER

(2-way radio) R.C.A. America RT 68, 24 volt, operated 10 watt output with 38-54 megacycles F.M. crystal locked. Transmitter and receiver using frequency synthesiser in 100 K/c/s; step 10 channel per meg/cycle with power supply. Leads, mike and headphones **\$90.00.** 60c cartage to rail. Freight payable at nearest attended railway station.

### TRANSCEIVER

(2-way radio) 62 set ideal small ships, Hams, etc. 1.6 to 10 megs. Crystal locked or V.F.O. controlled 5 watt output. Complete with antenna, headphones and mike but not air tested, **\$60.** air tested **\$90.** Not tested incomplete (without accessories **\$25.**) 60c cartage to rail. Freight payable at nearest attended Railway Station.

### HEAD PHONES

Low impedance moving coil fitted with rubber muffler to reduce external noise, fitted with press to talk, dynamic hand microphones. Ideal for use with all types of transceivers. **\$3.50 pair.** Same with black felt muffler, **\$4.50 pair.** Post N.S.W. 25c; Interstate 30c.

### 12 VOLT D.C.

DESYNN INDICATOR AND TRANSMITTER UNIT. Suitable for aerial rotation indicator, etc. 0-360 deg., weatherproof mountings.

**\$5.00 per set.**  
Postage: N.S.W. 95c;  
Interstate **\$1.67.**

### MINIATURE CRYSTAL EARPHONE

With Cord and Plug, **75c.** Post 4c.

### 16" WHIP AERIALS

6-Piece, brand new, **\$5.75.** 60c cartage to rail. Freight payable at nearest attended railway station.

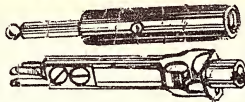

P.M.G. Phone Jack and plugs, 25c each, 45c the pair.  
Post 7c.

### NIFE CELLS

1.2 Volt fully charged, 4in x 3in x 1in 4 AH.

**\$1.00 each**

Post, N.S.W., 25c; interstate 35c.  
1.2 volts 15 AH, 8in x 4in x 2in, **\$3.95**

2.4 volt 10 AH, 6in x 2 1/2in x 2in, **\$2.50.**

Post, N.S.W., 30c; interstate, 40c.

### WALKIE TALKIE TWO-WAY RADIOS

P.M.G. Approved Citizen Band. 9 Transistor, **\$79.00** per set of 2. Post, N.S.W. 50c; interstate, 60c.



P.M.C. TYPE KEY SWITCHES.  
45c each. Post, 15c.



45 x 40 coated Lens with tripod.

**\$10.95**

30 x 30 Power Coated Lens  
Brand new.

**\$3.75**

60 magnification with a 60mm coated objective lens.  
With tripod.

**\$23.00**

As illustrated.

Postage, 95c; Interstate **\$1.20.**

### HIGH STABILITY RESISTORS

I.R.C. brand new 1/4w 1w, 2w, tolerance between 1 and not exceeding 5 per cent including 1K, 15K, 22K, 27K, 100K, 180K, 220K, 560K, 820K, ohms. Usual price 40c each, 50 assorted different values for only

**\$3.75** Post 15c.

### 522 TRANSCEIVERS

100 to 150 m/c/s.

**\$35.00**

### TYPE S POWER SUPPLY

(240 Vac supply for AT 5-ARB) suit most types of Disposal transmitters and receivers outputs 250 volt, 10ma 550 volt 200ma, 300 volt 100ma, **\$30.00**

### TELEPHONE WIRE

21 gauge copper, plastic covered. Ideal telephone or bell wire. 1,320ft coil of twin (equal 1/2 mile) **\$7 per coil.**  
Post, N.S.W. 70c; interstate **\$1.20.**

### SWITCHBOARD FRAMES

Steel ex-P.M.G. Height 45in x 27in x 34in, will make ideal test bench. **\$10.**

**\$1.00** cartage to Rail.

Freight payable at nearest attended railway station.

### SCOOP PURCHASE

Gramo Motors. New. Made in U.S.A. 4-speed 240 volt A.C. 50 cye. Only **\$2.75** each.  
Post, N.S.W. 30c; interstate, 40c.

### CO-AXIAL SWITCH

70 ohms 4 positions, can be motor driven completely waterproof 70 ohms type connectors. Housed in metal case 9in x 8in x 8in **\$5.00** each. Post N.S.W. 70c. Interstate **\$1.20.**

## VALVES BRAND NEW IN CARTONS

Special discount for quantity

807	75c	X61M	\$2.20
65N7GT	95c	CV850	\$1.50
8989	\$1.00	1H6G	30c
12SA7	\$1.25	832	\$5.00
5U4G	95c	6F13	75c
77	\$1.00	6AK5	\$1.50
EF50	35c	6X4	\$1.00
6U7	75c	6F3	75c
V1103	\$1.00	12SK7	50c
VH120	75c	VR1120	50c
IL4	\$1.00	VR118	75c
5Y3	\$1.75	VR65	25c
6C4	50c	VT4C	75c
2 x 2	75c	AUS	\$1.00
6AG5	80c	80	\$1.25
12AU7	\$1.00	6AK5W	\$1.50

### CATHODE RAY TUBES

3FP7	\$2.95	5BP1	\$3.50
3JP1	\$2.95		
V1669 4/1	\$2.95	CY2184	\$2.95

**PLEASE ADD POSTAGE ON ALL ARTICLES**

### TELESCOPES

30 x 40 with Tripod

**\$7.95**

Post N.S.W., 70c; interstate **\$1.20**

### EX ARMY TELESCOPES

4 x 40 Handley **\$6.50**

7 x 40 Otway telescope, **\$9.85.**

Freight payable at nearest attended railway station.

### C.M.A. CABLE

240 volt 3/.036 black, new and perfect, 100yd rolls **\$3.00;** 6 or more.

**\$2.50**

30c cartage to rail. Freight payable at nearest attended railway station.

### MICROMETERS

Brand new Slocombe, 1in-2in, **\$7.85.** Post 32c  
VIBRATORS, 6 volts, 7-pin **75c** each.

UNISELECTORS, 4 BANK, **\$4.00** Post, N.S.W., 25c; interstate, 30c.

INSTRUMENT TRIPODS, sturdy, wooden frame. Telescope. Extended to 4ft 6in . . . . . **\$13.00**

SELVYN MOTORS MAGSLIP Mk. II . . . . . **\$5.25** ea.

No. 19 TWO-WAY RADIOS Sold a sis without power supply, leads, accessories, etc. Only **\$15.** Or complete with above gear, **\$35.**

### BINOCULARS

PRISMATIC. Coated Lenses Brand new. Complete with case.

8 x 30	...	<b>\$18.75</b>
7 x 50	...	<b>\$22.15</b>
10 x 50	...	<b>\$23.07</b>
12 x 5	...	<b>\$23.95</b>
20 x 50	...	<b>\$26.50</b>

Post, N.S.W., 70c; Interstate, **\$1.20**

### 3000 TYPE RELAYS

P.M.G. 200 Ohm — 1,500 Ohm Coils, **\$1.25** each.

### MINE DETECTORS

Ex A.M.F with Instruction Book. Complete in wooden case. Ideal for plumbers, councils for locating buried pipes, etc. Freight payable at nearest attended railway station. **\$39.00**

### 4 DIGIT RELAY COUNTERS

50-volt D.C. suit slot car. Lap counters, etc. **\$1.25** each. Post 13c.

### ALTEC STUDIO MICROPHONES

639B Western Electric, top grade, original cost **\$250,** ideal Broadcast Studio, music recording, Church and play recording, etc. Fraction of original cost. Price on Application.

### 240 VOLT

### 522 POWER SUPPLY

Supplies all necessary voltages to operate 522 transceiver from 240 V.A.C. Complete and ready to plug in **\$30.00.**

SPECIAL lucky dip valve offer. 15 new valves in cartons for only **\$2.00.** We haven't got time to sort them, so you reap the benefit. Post 60c.

### SOLENOIDS

Plunger Type 12V 300M.A. Suit electric camera control, miniature trains, radio, etc.

**\$1.25.** Post. 10c.

200 Mill. amp., 24 volt, 1/8in push movement. **\$1.25.** Post 10c.

### LENSES

TOP GRADE ACHROMATIC 2in DIAMETER, 20in FL ideal as telephoto lens, telescope objectives. **\$13.**

Postage 46c.

### CONDENSER LENS

2 1/2in DIAM, 2in FL. **\$1.50** each or **\$2.50** per pair. Post 21c.

### CONDENSER LENS

1 1/2in diam, 1 1/2FL. **50c** each. Postage, 7c.

### FOUR CHANNEL BRANCHING AMPLIFIER

With 4in Vu, meter GLORAD. Complete with Portable Power Converter, 600 ohm balanced input and output. Ideal for outside broadcasting, etc.

**\$39.50**

### MONITOR SPEAKER UNIT

Ex-A.B.C., consisting of low resistance 8in speaker in Acoustic Labyrinth Baffle Box, complete with 10-watt amplifier, 600 ohms plus 8dbm input, 240 volt A.C. operated.

**\$37.50**

### TEN CHANNELS VHF TRANSCEIVER

Types TR1934 100-125 meg/cys. and TR1935 125-150 meg/cycles. 28 volt DC operated AM single crystal locks both TX and RX on same channel complete with generator.

**\$33.00**

### BENDIX BC221 FREQUENCY METERS

Built-in 240 volt power supply, perfect condition.

**\$90.00**

### RECORDING TAPE EX-GOVERNMENT SURPLUS STOCK

Topgrade, 1200ft on 7in spool, **\$2.25** post 21c. 600ft on 5in spool, **\$1.45,** post 13c. 150ft on 3in spool, **65c,** post 9c.

# Deitch Bros.

70 OXFORD STREET, SYDNEY, 2010

SORRY, NO C.O.D.

# ANSWERS - continued

**POWER SUPPLY RIPPLE:** I have noticed that in many of your published regulated power supply designs you have not chosen the bypassing point of the zener diode biasing resistors to result in minimum ripple through the diode. The correct position for the bypass is at the midpoint of the biasing resistance, as shown by my enclosed proof. I hope you find this of interest. (J.N., Wahroonga, 2076).

● We certainly found it of interest, J.N., and we agree that for the very minimum zener ripple current the bypass should in fact be connected to the midpoint of the biasing resistance. However with many of our power supply designs the attainment of absolute minimum ripple current was neither the sole, nor necessarily the main consideration. There are other considerations, and sometimes less obvious ones, such as the performance of the supply under transient conditions.

It is also true that in practical power supplies, zener ripple often forms only one of the components contributing to the final output ripple level of the supply. In such cases reduction of zener ripple below a certain level may not be worthwhile. To our knowledge none of our published power supply designs has been found to exhibit either high or excessive ripple. However, it may be true that in some cases the ripple might have been even lower had we given this consideration greater weight.

**BUSHFIRE RADIO:** Judging by your reply to J.I. in the March issue, you are not aware of the legal position with regard to VHF receiving equipment, as interpreted by the P.M.G. Radio Branch. As a communications officer of the local fire brigades group, I am very interested in the possibility of using VHF receiving equipment. There is nothing to stop the import, manufacture or sale of VHF receiving equipment but unless it conforms to the 30KHz channel specifications and is licenced, it is an unlicenced receiver and is liable to confiscation; the owner is also liable to prosecution. Strictly speaking, this applies to all other than the 530-1650KHz and the high frequency broadcast

bands but, due to the difficulty of policing HF, nothing is normally done about receivers below 70MHz. (L.O., Beaconsfield, Vic.)

● Looking at the paragraph in retrospect, we possibly should have added something about regulations and licensing, for the sake of readers other than the correspondent concerned. However, he wrote to us as a member of a brigade seeking our opinion on a technical line of approach. This was what was uppermost in the mind of our writer and, on technical grounds, our suggestion was probably a lot more practical than the original one. However, we must agree that there are organisational and legal involvements and it would be up to the particular brigade to say whether its members should have a listening facility and to the P.M.G. Department to say whether they would grant licences and for what class of receiver. As far as tunable H.F. receivers are concerned we have pointed up, in the past, what is a quite anomalous situation. It will probably remain that way until some Government gets around to re-writing the ancient Wireless and Telegraphy Act and all its amendments and addendums.

**CAPACITORS:** I have purchased your magazine for 20 years and while I believe I have not made up a complete featured project, I have profited by many portions or circuits, constructional ideas, components applications, etc. There must be many others like me, whom the periodical keeps up to date in a readable fashion. I am sure many would like to see an article on capacitors, a subject on which composite information is sadly lacking. What I have in mind is an explanation of NPO, N330, N750, NPOK, NPOF, NO50F, etc. Also a discussion of temp. coef. curves and their relationship to ambient. Again, a rundown on the various plastic, ceramic and mica capacitors and their suitability for tuned circuits, etc. These days, if one asks in a store for a capacitor, one can end up with anything from a Redcap to a tubular, from NP0 to N6000. (R.M., Christmas Hills, Vic.)

● You have pointed up what is a genuine and increasing problem for many connected with the electronics industry. If you have a copy of the May, 1965 issue, an article "Fixed Capacitors" by P. S. Redfearn should answer most of your queries. A copy of the article is available through our Information Service for 20c. A few copies of the complete issue remain, at 45c.

**PORTABLE STEREOGRAM.** For some time I have been trying to find a circuit for a portable stereo record player, but without success. I feel that a project of this type would be very popular, especially with the younger hobbyists who cannot afford to commence a major project. A player similar to that described in the

December, 1960, issue would be eminently suitable. An up-to-date circuit would eliminate the output transformers and possibly boost the output. Turntables operating from a 9V battery are available for about \$30. (K.T., Moorabbin, Vic.)

● Thank you for the suggestion. We agree that it is some time since we presented such a project, and that it would lend itself to a completely new approach. Whether we could produce a design which would represent a substantial saving on what is available commercially is something we would have to investigate. We will certainly keep the idea in mind and see what can be done. ■

## COMPUTER BOARDS

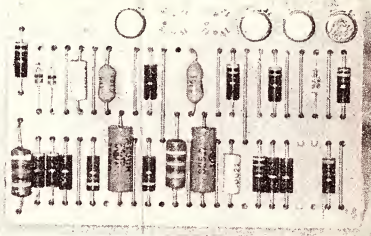

**TRANSISTORS 15c Each.**  
Resistors, Diodes, Capacitors Free.  
8 BOARDS WITH A MINIMUM OF 30 TRANSISTORS \$4.00  
Pack and post 25c  
25 BOARDS WITH A MINIMUM OF 100 TRANS. \$12.00  
Pack and post 50c  
Technical information supplied with goods.  
Minimum order \$1.50.  
Please add Postage.  
**COLSTOK ELECTRONICS**  
Box 178, KELLERBERRIN. 6410

## TRANSISTOR SERVICE

All Japanese and local sets repaired

including . . .

Aristone	Aurora	Belair
Berlin	Crown	Fujiya
General	Hitachi	Kenco
Mariner	Mitsubishi	Nanaola
National	Nivico	Sanyo
Sony	Spica	Standard
Sharp	Toshiba	Yashica

We do not sell spare parts

**PETER G. BROUGHTON**  
211 George Street, Sydney.  
Tel. 27-5831 (3 lines)

## Shared Computer

(Continued from page 18)

ly re-typing drafts of articles and speeches — all sharing the computer simultaneously with over 100 other users on-line to the system.

"From simple arithmetic to capital investment analysis, from sales statistics to production costing, from simultaneous equations to linear programming, Call/360 transmits the answers immediately to the operator via the terminal at 150 words a minute.

"Secondly, the system is fully conversational, in the strict meaning of the term. In other words, the computer can respond to every new instruction entered at a terminal, either confirming, correcting, or refusing to accept the new information. Not only can the user enter data in response to a direct question from the program, he can also enter modifications to the program while it is operating." ■

## NOTES and ERRATA

**LEARNING MORSE** (April, 1969):  
The sound for the letter "L" should be d' dah d' dit and not d' dah d' dah.

## For Reliable Connections

# OTL

## RESIN CORE SOLDERS

**O. T. LEMPRIERE & CO. LIMITED**

Head Office: 27-41 Bowden St., Alexandria, N.S.W., and at Melbourne—Brisbane—Adelaide—Perth—Newcastle.

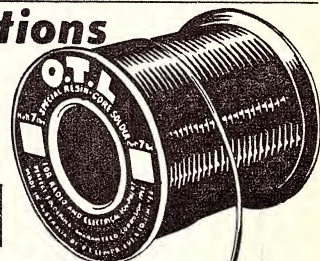



**HI-FI  
STEREO  
SPECIALISTS**

**MANUFACTURE-SALES-SERVICE**

(Props. C. & B. Rener)

731 Centre Road, East Bentleigh, Vic.  
3165.

Telephone 579-1519 A.H. 97-5539

## SECURITY SYSTEMS



Flat security tele-  
phones. \*Ex-  
clusive to S.T.A.  
All brands sold  
and installed  
from \$11.80.



Electronic door  
locks operates on  
AC or DC 3 to  
12 volts. \*Ex-  
clusive to S.T.A.  
\$11.00.



ALARM control  
unit 12 volts all  
SOLID STATE  
no relays. \$19.00



Transistorised 12  
volt relay alarm  
unit ready to  
connect. \$11.00



Photo-electric re-  
lay unit can  
operate up to  
30ft. with speeds  
up to 500 times  
per minute.  
\$27.50.



Reed switches  
and magnets. All  
types available  
ex-stock. From  
\$1.00

Mail Orders, send postal note,  
cheque or money order. Please add  
postage. Inquiries send self-addressed  
stamped envelope.  
Our lay-by is at your service. Hire-  
purchase can also be arranged.

## WAVE TRAP (Continued from page 95)

everything is functioning as it should, signals from all stations, including the local one, should have been either suppressed completely or very substantially reduced in strength. The set should then be connected to an aerial, preferably an outdoor one, clear of the house wiring. The trap should be interposed between the aerial and the aerial terminal, as close to the latter as possible.

A practical trap may be constructed from components similar to those used in the aerial tuned circuit of a receiver, i.e., an aerial coil and single section tuning capacitor. Fairly obviously, the better the Q of the components the better the trap performance. This applies particularly to the coil, where most of the losses normally occur.

Where size is not important there would be some advantage in winding the coil on a large former, say 2in diameter or larger, similar to those recommended for crystal set coils. On the other hand, modern commercial coils using ferrite cores can be made much smaller while still retaining good Q values. This applies particularly to the "standard" size coil, normally housed in a can about 1-3/8in diameter, and these represent an acceptable compromise where size is important. So-called "miniature" coils in square cans would represent a further, and less acceptable, order of compromise.

Regardless of the type of coil used, it should be shielded, and the shield earthed. The trap as a whole, but the coil in particular, being tuned to the unwanted station is quite vulnerable to direct pickup. The use of a commercial coil, as in our model, takes care of this automatically. If a home made coil is used, possibly on a large former, any shield would have to be large enough to allow a clearance of several inches all round between itself and the coil.

Another refinement is to dispense

with the variable tuning capacitor, substituting a fixed capacitor of approximately the correct value and making the final adjustment by means of the adjustable slug in the coil. This arrangement has the advantage of being compact and of stable adjustment. It is most suitable for permanent fitting to standard receivers suffering from cross modulation, and which are to be used by unskilled persons.

When used with simple receivers the wave trap may cause noticeable loss of signal strength for some stations, even though it is not tuned close to the frequency of these stations. It may, therefore, be desirable to remove it from the aerial circuit altogether on some occasions. This can be done either by adding a switch to short out the wave trap or, perhaps more conveniently, by bending one of the rotor plates of the variable capacitor so that it shorts out the wave trap with the plates fully in mesh.

Because a wave trap operates in the aerial circuit the entire network must be "above earth," including the frame of the variable capacitor which normally connects to chassis. For this reason it is usually most convenient to mount the components on an insulating base.

We mounted the tuning capacitor in our prototype wave trap on a piece of particle board. The front panel is of aluminium with a hole to allow the capacitor spindle to pass through without making physical contact. A suitable pointer knob on the spindle allows the trap to be calibrated.

We used a standard broadcast band aerial coil complete with its screening can. It is mounted horizontally, with a suitable U-clamp, alongside the capacitor. The terminals marked "Grid" and "AVC" are used — the others being ignored. The coil tuning slug should be adjusted as necessary to allow the wave trap to tune to any station within the broadcast band. ■

## TIDAL POWER

(Continued from page 29)

schemes, the construction of a major airport, motorways, shipping pool and docks capable of handling the largest ships now forecast.

Paradoxically, the advent of cheap electrical power from nuclear stations could make the tidal scheme more attractive. This is because nuclear power stations, which have a high capital cost compared with fossil fuel stations, need to be operated as near to maximum output as is possible at all times to take advantage of their lower running costs.

Unfortunately consumers are not so obliging as to maintain constant demand for electricity. They generally want very much less at night than at certain periods during the day and so, if nuclear power provides a high proportion of the total system of generation, there will be times when it cannot be operated at full output and the cost of generation will increase.

A tidal scheme such as the one proposed for the Severn estuary could be combined with a pumping scheme so that at periods of high system load the tidal scheme would reinforce generation by nuclear and other power stations,

while at times of low system demand, surplus nuclear generation could be used for pumping, so "storing" energy.

Of course, the success of such a tidal scheme would depend on efficient water turbine-driven generators being available capable of operating over a range of heads which are low compared with most hydro-electric schemes.

Recently the English Electric Co. has entered into a partnership with the Ministry of Technology to design and develop machines for applications where a low head is to be used. Such machines, it is expected, would be suitable for tidal or run-of-river stations where the flow is unidirectional. The machines would run at low speeds, probably about 60 rev/min and would have an output of 50 MW or less so that a large number would be needed for the proposed scheme.

An unusual feature of the proposed machines is that they will be composite units, the generator field system (rotor) being built around the periphery of the turbine. The problems which would have to be solved include ensuring that excessive corrosion would not occur, designing seals to prevent water getting into the electrical components and ensuring that sand would not damage machines. ■



# CLASSIFIED ADVERTISING

## FOR SALE

## FOR SALE

## READER SERVICE

**APE RECORDERS.** Ampex 351 1/2 in. 7 1/2 and 15 ips. \$950. Rola Replay 33C in console form \$350. Victoria 26-3499 week days.

**IMITER** Philips EV 4400 \$1.00. Victoria. 26-3499 week days.

**RECORDING TAPE.** "Universal Electronics." Made in U.S.A. to highest standards and all tensilized. 5 x 90 \$1.95; 7 x 1200 \$2.50; 7 x 1800 \$3.25; 7 x 2400 \$4.95. Aust. made 1/4 x 900 \$1.38; 5 x 1200 \$1.95; 7 x 2400 \$3.40. Cassettes CGO \$1.45. Write for full list. We stock 12 leading brands. Lowest prices for all equipment and accessories. A1MO, Box 15, Footscray, Vic. 3011. Ph. 68-4436.

**DDYSTONE VHF** receiver AM/FM 19-168MHz 6 bands as new, \$100. Meuwissen, 19 Maple Ave, Klemzig, S.A. 5087.

**DIGITAL** voltmeter Dynamco, one year old, transistorised, cheap, Melbourne 277-4408.

**ODEL ENGINEERS** Supplies. Catalogue/Handbook price \$1.50 posted. Bolton, 72 King Street, Sydney, 2001.

**ELECTRONICS** Aust. back issues. Bundles of 30 copies for only \$1. Fair condition — our selection 1952-68. Personal callers only at 56 O'Connor St, Haberfield, N.S.W.

**C108 65c, EC109, 70c, MPF105 \$1.20, Diodes 6A 400 PIV 85c.** All post free. R. M. Electronics, Box 57, P.O., Haberfield, N.S.W.

**TRANSISTORS,** majority PNP, 15c each, on computer boards. Other parts free. Minimum order \$1.50. Add postage. Professional Hi Fi Repairs, 26 Percy St., Newport, Vic. 3015.

**KAI XV** brand new unused. \$300. Phone 31-2917, Sydney.

**AFAYETTE** HA225 communication receiver and speaker. Brand new condition. Offers. Brett, 45 Oakley St., Wandal, Qld. 4700.

**SYCHEDELIC** strobe light complete, transistorised, excites dancers etc. \$20.00. 1 Tolmie St, Toowoomba, Qld.

**CR 400V 3A \$3.10, OA81 \$1.50 resistors** and cond. 75c. Plans wireless mike and transistor \$1. 1 Tolmie St, Toowoomba, Qld.

**EW OC71, 5 for \$2 or 50c ea, OC44, 45, 60c ea, OC72, 84, AC127, 128, OA210, 70c ea, OC171, 2N370, 371, AF116N, 117N, OA211, 90c ea. Power types 2N176, \$1 ea, 2N301 \$1.20 ea, OC28, 29, 35, 36, \$1.50 ea, FET 2N4360 \$1.20 ea, 5C108, 109, 60c ea, BF115, 2N3638, 80c ea, OA81, 85, 91, 95, 30c ea, BA100, 45c ea, UJT 2N2160, \$1.20 ea. No S.A. Sales. Pack and post 15c. Custom Electronics, Box 1452, G.P.O., Adelaide, 5001.**

**ENDIX BC221** frequency meter, 240V power supply, \$46. J. Burns, Graves St, Kadina, 5554.

**B. TRANSCEIVER** 1 watt, \$40. 31 Fairfowl St, Dulwich Hill, 2203.

**LENWOOD TK250U** amplifier, unused in carton, \$150. 5 Thosby Court, Narrabundah, A.C.T.

**MAIL ORDERS:** transistors, FET, kits, meters, PVC capacitors, resistors, transformers, radio sets etc. Very low prices. Free catalogue on request. IEC, P.O. Box K1829, Hong Kong.

**CUSTOM BUILT TRANSFORMERS:** Power, audio, etc. Single or quantity production. Amplifiers, P systems, battery chargers. Rectifiers, electric motors, transistor radios. General engineering, fitting and turning, sheet metal work, etc. Parkinson Transformers, P.O. Box 523, South Brisbane. Telephone 872-033.

**URGULAR ALARMS.** 12V 150uA. Transistor control units. \$12 plus 12 1/2 p.c. s.t. Unit on 4 x 2 plate and case. \$16 plus s.t. 4 1/2 rotary sirens. \$10.50. All above plus 60c p. and post. Foil tape terminals, mats, key switches, bells, reed switches, infra-red ray unit. Complete quote and installation service to Insurance requirements. EDGORE ENTERPRISES, 802 Doncaster Road, Doncaster, Vic.

**COMMUNICATIONS** 10 Receiver, double conversion R&H circuit, Geloso amateur bands 80M to 10M front end. Coils mechanical filter AM upper and lower side band 5 meter in very attractive commercial cabinet, chassis and etched front panel, constructed all new parts.

Transmitter DSB, CW, AM, 5 bands R & H circuit Geloso crystal, VFO with crystals, pair 6DQs in final, also in a very attractive commercial cabinet, chassis and etched front panel.

The complete twin set station. A SNAP. \$250 or best offer, cost more must sell. 122 1/2 V Transceiver, ideal for portable operation, 2 to 8 MHz, with power supply, mic, and leads.

**C.C. CROWE** VK2BEC, 265 Bent Street, South Grafton, 2461.

**MHARFEDALE** Airedale, \$190; Sony 777-4J tapedeck, \$450; Sony TA1120 amp., \$350; SME3012 Shurev-15 16" T/T system, 9 months old. Sydney, 44-6901.

**RECONDITIONED** Channel Master "Telstar" transistorised aerial booster amplifiers. \$25 each. Also Channel Master automatic antenna rotators \$40 ea. Freight free, J. Yalden, 21 Oxford St., Glen Innes, N.S.W., 2370.

**SELL** all back issues "ELECTRONICS AUSTR." In stock at all times. 1939-56 copies 30c; 57-63 40c, 1964 to date 50c Post free. T. Weir, 56 O'Connor St, Haberfield, Sydney, N.S.W., 2045. 798-7569. Wanted to buy copies also.

**TEST** Equipment. Selected reconditioned gear well below new prices. Philips 40KV multi-meters, \$40.00; Philips VTVM's, \$40.00; Heathkit VTVM, \$27.00; Gossen 100V transistorised megger 5 ranges to 50Mohm \$25.00; Gossen 500V generator type 50Mohm, \$25.00; Kovo 500V 50 Mohm generator-type \$25.00. We can supply all types new equipment at best prices. Metropolitan Meter Service, 103 Regent St, Redfern, 2016. Ph. 69-5922.

**BUY PRE-PAK.** Buy Pre-Pak. Buy Pre-Pak. Send \$5.00 for over \$10.00 worth of assorted parts, pots, resistors, capacitors, semi-conductors, etc.), from our extensive range. Pre-Pak Electronics, P.O. Box 131, Kingsgrove, 2208.

**BARGAINS.** Limited quantity available at these prices. SC-40D Triacs, \$4.00; C106F1 SCR, \$1.20; BZV88 zeners 22v, 80c and 3.6v, 66c; 1N914 silicon diodes, 25c; 2N3638, \$1.80 or 75c ea.; 10 OA91, \$2.00 or 26c ea.; 25-uF 25V electrolytics, 10 for \$1.80 or 22c ea.; Ducon linear pots 500K, 1M, 2M 1/2 in long shafts 10 for \$3.50 or 40c ea.; relays 12V 165 ohm miniature Siemens type, \$3.50; magnetic earphones with plug, 50c; All new and guaranteed. Send SAE for free catalogue. Post 10c any order. Pre-Pak Electronics, P.O. Box 131 Kingsgrove, 2208.

**MAGNETIC PRE-AMP** E.A. Aust. Oct., 65. Easy to assemble kit-set supplied with all parts. Mono, \$4.90; Stereo, \$9.00; Mains power supply, \$5.00; Built and tested, \$1.00 ea. Pre-Pak Electronics, P.O. Box 131, Kingsgrove, 2208.

**TRANSISTOR** Radio Parts. We stock a large range of parts for building or repairing transistor radios, etc., and carry a full range of semiconductor at unbeatable prices. Send SAE for free catalogue. Pre-Pak Electronics, P.O. Box 131, Kingsgrove, 2208.

**AKAI X335** auto. professional recorder plus two 550. speakers. As new. Phone Sydney 439-2019.

## READER SERVICE

**PRE-RECORDED TAPES** hired to members of Australian Tape Recording Society. Bi-monthly releases, "The Microphone," newspapers, round robins, sales, service, tape-sponding. Send \$5. 9in x 4in SAE to ATRS, Box 9, P.O. Crow's Nest, N.S.W., 2065 or phone (2) 43-6681, after hours.

**DUP LICATING:** James E. Smith Duplicating Service for photostats, photo copies, electronic stencils, addressing service, extensive duplicating coverage. Customers service, P.O. Box 48, Albion, Qld., 4010. Phone 57-6612.

**FACILITIES** available for electronic equipment include design development, printed circuit and prototype construction, and quantity manufacturing capacity. Transistronics Industries, P.O. Box 7, Ermington, N.S.W., 2115.

**TAPE** to disc service. Take advantage of W. and G. Records' professional experience when next needing a tape to disc service. W. and G. Record Processing Co., 185, A'Beckett Street, Melbourne. Tel.: 329-7255.

**ELECTRONIC** ORGANS. Do not build yourself an organ without first finding out about the superb Schober (U.S.A.), Assemble-it-Yourself Kits. Inquiries to Schober Organs (Australia), 124 Livingstone Ave., Pymble, N.S.W., 2073. (Mail only, please.)

**COILS, CHOKES, RFs, IFs, etc.,** wound to your own specifications or on contract basis. Reply with S.A.E. Paris Radio Electronics, 7a Burton St., Darlinghurst, N.S.W. 31-3273.

**TAPE RECORDING** MAGAZINE, popular English monthly. Free introductory copy, send s.a.e. to 5 Glover Street, Willoughby, N.S.W. 2088.

**FREE** stereo pre-recorded tape, cartridge or cassette, when you join the Rondo Reeg Pre-recorded Tape service. Est. 5 yrs. Save 20 p.c. on all your pre-recorded tape etc., over 25 labels to choose from. Interstate, N.G. and Fiji inquiries welcome, regular new releases posted to all members. Details, Rondo Reeg, Box 162, Rockdale, N.S.W. 2216, Austr.

**TRADE** radio, tape recorder, record player repairs. Large or small quantities catered for, guaranteed work, free pick-up and delivery in Sydney area. Multimeters, panel meters, VTVM's also serviced. Metropolitan Meter Service, 103 Regent St., Redfern, 2016. Ph. 69-5922.

**TAPE** copying, editing. Four-track stereo or mono. John Cain, 17 Powell St, Reservoir, Meib. Vic. 3073. Phone 47-6680.

## WANTED

**NATIONAL** Panasonic RF5000B portable radio serial No. 18377H, 15 Canterbury Street, Moorene Ponds, Victoria, 3039.

**GRAMPIAN** R.A.S disc recording amplifier, or similar. S. Aust. Recording Studios, 202-4 Hindley Street, Adelaide.

**REASONABLY** good disc recorder LP 33-1/3 and 45rpm. Detail, price, address, P.O. Box 50, Nauru, Central Pacific.

## POSITION VACANT

**ASSOCIATED CONTROLS** Pty. Limited require these persons. Supervisor with technical background and quality control knowledge. Technicians with bench experience for manufacture and service. Our equipment is designed for industrial control and is mainly solid state. Ring Sydney 771-3633.

**A FIRM** of electronic engineers has office space available low rental. Suit manufacturer's rep. or agent. Apply in writing to "Electronics," c/o 2 Stirling St, Kew, Vic. 3101.

## MORE GOOD BOOKS

Published by Sams. Highly practical: 10-day money-back Guarantee. These are lowest Australian prices for these books, and they are sent post free!

Diode Circuits Handbook .. \$3.25

Transistor Circuit Manual .. \$5.25

Handbook of (more) Tr. Circuits .. \$5.25

101 Ways to use your VOM/VTVM .. \$2.95

FET: Principles and Projects (including FET Transmitters) \$4.95

**SPECIAL:** Both Transistor Circuit Manuals, over 400 delicious circuits \$10.00

Other books available. Send S.A.E. for Cat.

**AUSTRALIAN ELECTRONICS,**

32 Waterworks Road, Dynynrne,

TASMANIA, 7005.

**1969** Car Coat, \$Aus.3.90  
NYLON COAT, \$Aus.6.30

Including Postage & Insurance.

Direct from Hong Kong save 50%

For free Catalogue & Samples

please write by Airmail to:

**EDITH TRADING CO.,**  
P.O. Box 6881, Kowloon,  
Hong Kong.

On order of 2 coats a string of  
8mm PEARLS will be given to  
you as:

**FREE GIFT!**





# ONLY A FEW MAGNETIC STEREO CARTRIDGES EARN PLACES IN THE SUPERLATIVE BRACKET.

## ORTOFON HEADS THE LIST.

Most reviewers have several favorite cartridges — in most cases, ORTOFON heads the list.

The explanation is a simple one. ORTOFON is the only organization in the world manufacturing professional disc cutting equipment and cartridges for playback. Many of your favorite recordings will be reproductions from ORTOFON cut masters! As reproduction is complementary to recording it naturally follows that ORTOFON should produce the finest arms and cartridges available in the world today.

The ORTOFON moving coil principle is the only recognised transducer system inherently free of non-linear distortion; tracing distortion caused by the differing shapes of cutting styli and reproducing styli has now been eliminated by ORTOFON thanks to the use of exclusive ORTOFON elliptical diamonds. All ORTOFON cartridges feature a 15° tracking angle.

*Technically and musically ORTOFON stereo cartridges are unique and quite superior.*

ORTOFON cartridges have won universal popularity with discerning music lovers and professional engineers; the low distortion moving coil principle is incomparable. Stereo cartridges developed by ORTOFON engineers have always been added in design and construction; the ORTOFON series offers superior sound reproduction and trace the most complex waveforms at 1.5 cm/sec. The S15 is available with an optional built-in transformer and may also be purchased ready mounted in the lightweight metal "G" shell for use with the ORTOFON SMG-212 tone arm.

The exclusive protective device . . . "Protecto-tube" . . . shields the stylus if the cartridge is accidentally subjected to excessive external lateral or vertical pressure. This tube is highly polished and has added protection for the record surface.



### ORTOFON S15 SPECIFICATIONS:

	S15T	S15
Weight of cartridge	18.5 grams.	12.5 grams.
Output impedance	15 Kohm	2 ohm
Output in mV/cm/sec (loaded)	2	0.04
Equivalent mass at stylus point	0.9 mg.	0.9 mg.
Recommended stylus pressure	1-2 gr.	1-2 gr.
Elliptical stylus radius	0.0007" x 0.0003" (both models)	
Spherical diamond radius	0.0006" (both models)	
Tracking angle	15°	15°
Static compliance	20 x 10 <sup>-6</sup> cm/dyne	
Frequency response	15-40,000 Hz.	
Channel separation	20-30 dB	

ORTOFON now introduce the new SL15 lightweight stereo cartridge — a moving coil unit with high compliance and improved frequency response. This superb cartridge is designed for use with inscription tone arms of the highest possible quality.

**ORTOFON TRANSFORMER MODULE** is a transformer module which may be fitted where in the lead between the tone arm and amplifier is now available, complete with plug cables.

Specifications: Input impedance — 2 ohms. Output impedance — 15 Kohm. Load impedance — 2 ohm. Frequency response — 10-40,000 Hz.

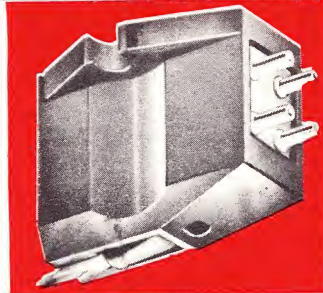

### ORTOFON SL15 SPECIFICATIONS:

Weight of cartridge:	7 grams.
Output impedance:	2 ohms.
Equivalent mass (at stylus point):	0.9 mg
Recommended stylus pressure:	0.75-1.5 grams.
Output:	0.025 mV/cm/sec.
Stylus radius: Spherical diamond—SL15	0.0006"
Stylus radius: Elliptical diamond—	0.0007" x 0.0003"
Tracking angle:	15°.
Static compliance:	25 x 10 <sup>-6</sup> cm/dyne
Channel separation:	20-30 dB.
Frequency response:	10-40,000 Hz.

### NEW ORTOFON TONE ARM MODEL RS-212

The advantage of the outstanding characteristics of the SL15 series cartridge may be taken with the ORTOFON RS-212 arm. A stylus pressure mechanism based on spring tension also incorporates an effective automatic anti-skating adjustment; stylus pressure and anti-skating are correctly related when the stylus pressure is set. Although factory set for ORTOFON cartridges with elliptical styli, a ratio adjustment now permits use of any cartridge. The ORTOFON "Jack" lifting/lowering device is standard equipment with the RS-212 arm.

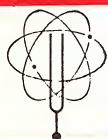
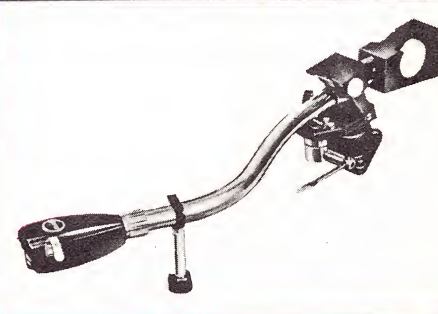
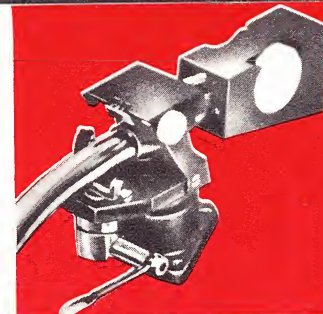

Australian National Distributors:

**Simon Gray Pty. Ltd.**

Head Office: 28 Elizabeth St., Melbourne Vic. Tel. 63 8101\*  
Sydney Office: 22 Ridge St., North Sydney, N.S.W. 929 6816  
Canberra Office: 31-33 London Circuit, Canberra City, A.C.T. Tel. 49 6050

INTERSTATE REPRESENTATIVES:

N.T.: Pfitzner's Music House, Smith Street, Darwin. Tel. 3801  
Q'land: Sydney G. Hughes, 154-158 Arthur St., New Farm, Brisbane. 58 1422  
S.A.: Eilco Sales Pty. Ltd., 7-9 Osmond Terrace, Norwood, S.A. Tel. 63 4844  
Tas.: K. W. McCulloch Pty. Ltd., 57 George Street, Launceston. Tel. 25322  
W.A.: Athol M. Hill, 613-615 Wellington Street, Perth. Tel. 21 7861

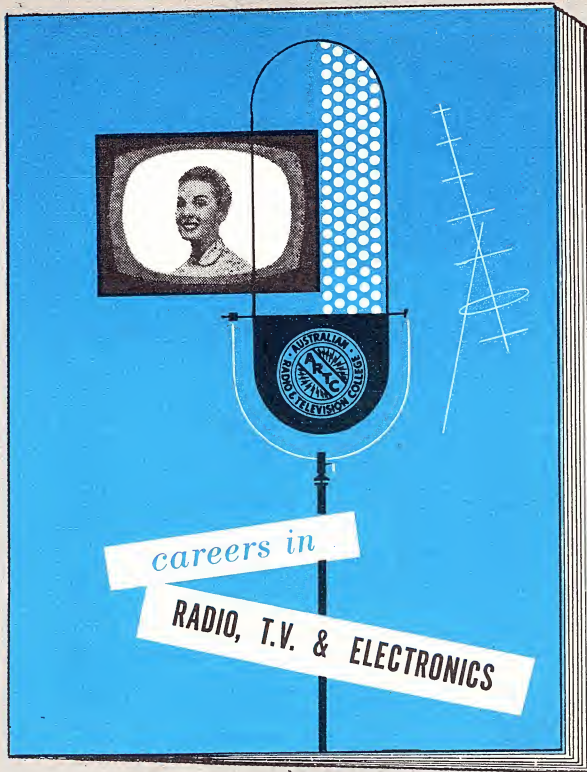

# THIS FREE BOOK COULD BE THE TURNING POINT IN YOUR CAREER

### ASK YOURSELF THESE 3 QUESTIONS

1. Am I in a dead-end job?
2. Can I use my spare time to get ahead?
3. Am I capable of earning more money?

If the answer is yes, there is room for you in radio-television. Does your job really offer security — worthwhile prospects? If not, now is the time to do something about it. Send the coupon below for the free booklet "Careers in Radio, TV & Electronics" which shows you just how A.R.T.C. training can help you to a bright future with good prospects.

### TRAIN AT HOME OR AT THE COLLEGE

With A.R.T.C. you can obtain the training you need at the benches and lecture halls of Australian Radio and Television College or in your own home by correspondence . . . you can be taught every important aspect of radio-television, details of the fundamental principles of Electronics.

### GET INTO ONE OF THESE PROFITABLE CAREERS IN RADIO/TELEVISION

There is a profitable career for you in the many phases of radio-television including manufacturing, radio servicing, television servicing, research, sales, broadcasting and television executive, armed forces. A.R.T.C. can help you gain one of these much-sought-after positions, but remember, it is only the trained men who succeed and A.R.T.C. can give you the complete training which is necessary for success in Electronics.

### Make Spare-Time Money

If you wish, you can make your spare time earn money for you by training at home and many students make extra money after only the first few weeks. However, if it is not convenient for you to train at home, then you may use the modern A.R.T.C. workshops. The course is intensely practical and individual. Safeguard your future . . . mail the coupon today.

### A.R.T.C. CAN TRAIN YOU AS IT HAS THOUSANDS OF OTHERS!

Thousands of ambitious men have realised the benefits offered by A.R.T.C. training and are now making money in radio. You can join the ranks of the skilled men. . . and it costs only pence a day.

### MAIL COUPON NOW

You are invited to mail the coupon below which can be your first step towards securing a job or business of your own with good prospects, security and more money. A.R.T.C. will mail to you, in return, at no obligation to you, the free booklet "Careers in Radio TV & Electronics." This booklet will show you definite steps you can take for a better job . . . how you can succeed in life. Post the coupon, phone or call NOW.

**AUSTRALIAN RADIO  
AND TELEVISION  
COLLEGE  
PTY. LTD.**

**E. S. & A. BANK BUILDING,**

Cnr. Broadway and City Road, Sydney.  
(Opp. Grace Bros.) Phone 211-4244 (3 lines.)

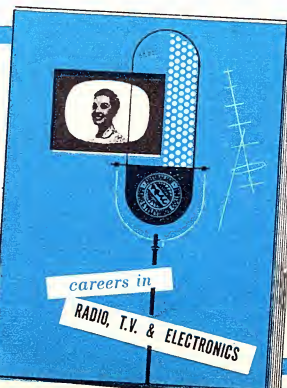

**AUSTRALIAN RADIO & TELEVISION  
COLLEGE PTY. LTD.,**

206 Broadway, Sydney, N.S.W.

Dear Sir,

Please send me, without obligation, your free booklet, "Careers in Radio, TV and Electronics."

NAME .....

ADDRESS .....