

# ELECTRONICS

## Australia

*April, 1969*

Incorporating RADIO, TELEVISION & HOBBIES

Vol. 31 No. 1

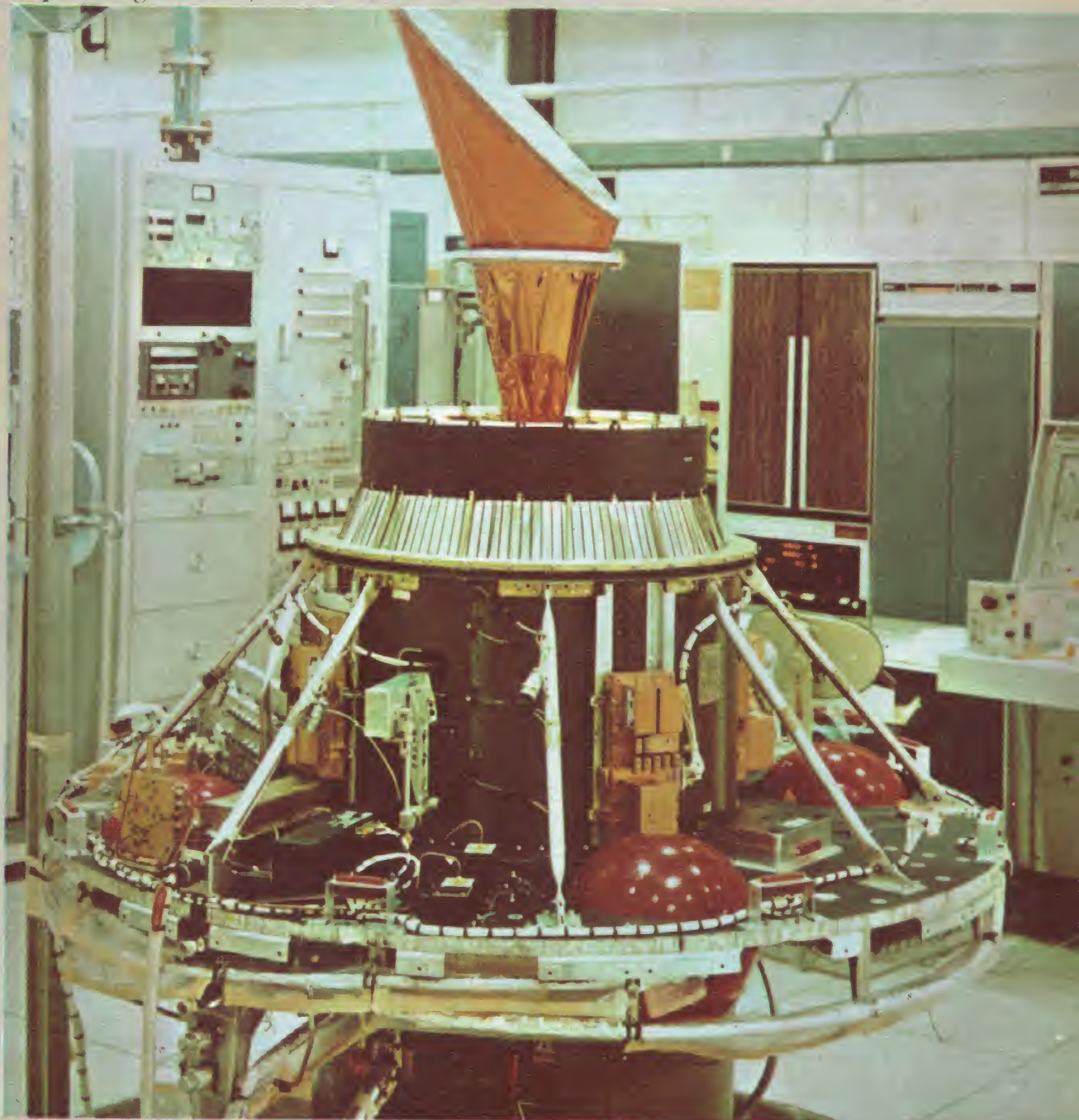

INTELSTAT III FOR THE PACIFIC

**30c**

Electronics in the Concorde • New hi-fi products  
Electron beam TV film • Beginners' set uses I.C.

Registered in Australia for transmission by post as a periodical

# Automatic cassette mini-recorder!

IF IT'S NEW  
IT'S



First with

**IC**

National RQ210S "Mini" cassette recorder. Used by detectives, reporters. Revolutionary I.C. (*integrated circuit*) perfected by National shrinks normal circuit to mini-size, gives amazing performance. Snap-in cassette. Instant action. Auto vol. control. Electronic motor. Remote switch mike. Tie pin mike optional extra.

Size: 6 $\frac{1}{16}$ " x 3 $\frac{3}{4}$ " x 1 $\frac{7}{8}$ "



# NATIONAL

To HACO DISTRIBUTING AGENCIES PTY. LIMITED,  
57-69 Anzac Parade, Kensington, N.S.W. 2033

Please send me further information  
on the RQ210S.



NAME .....

ADDRESS .....

POST CODE .....

# ELECTRONICS Australia

Incorporating "RADIO, TELEVISION and HOBBIES"

Volume 31, No. 1

ABC certified circulation in excess of 47,000.

**Editor:**

NEVILLE WILLIAMS, M.I.R.E.E. (Aust.)  
(VK2XV).

**Assistant Editor:**

PHILIP WATSON, A.M.I.R.E.E. (Aust.)  
(VK2ZPW).

**Technical Editor:**

JAMIESON ROWE, B.A. (Syd.), B.Sc.  
(Technology, N.S.W.), A.M.I.R.E.E.  
(Aust.).

**Technical Staff:**

IAN POGSON (VK2AZN),  
ANTHONY LEO (VK2ZHK),  
HARRY TYRER (VK2ZHH),  
JOHN HORSFIELD,  
ROBERT FLYNN,  
LEO SIMPSON.

**Editorial Office:**

12th Floor, 235-243 Jones Street,  
Broadway, Sydney, Australia. Phone  
20944. Ext. 2531 2525-6-7.

**Postal Address:**

Box 2728, G.P.O., Sydney, 2001, Aus-  
tralia.

**Advertising:**

SELWYN SAYERS, Mgr.  
BILL SUMMONS, Rep., Sydney.  
Offices: 8th Floor, 235-243 Jones Street,  
Broadway, Sydney, Australia. Phone  
2-0944. Ext. 2931, 2508, 2943.  
CLARRIE LEVY, Rep., Melbourne, 392  
Little Collins Street, 3000. Ph. 67-8131.

**Circulation:**

A. Parker, Mgr.  
Offices 9th Floor, 235-243 Jones Street,  
Broadway, Sydney, Australia. Phone  
2-0944. Ext. 2505, 2509.

**Subscription Rates—See back page.**

**Representation:**

Melbourne—John Fairfax & Sons Ltd.,  
392 Little Collins St., 3000. Ph. 67-8131

Brisbane—Sungrave Pty. Ltd., 78  
Elizabeth Street, 4000. Ph. 2-6688.

Adelaide—John Fairfax & Sons Ltd.,  
104 Currie Street, 5000. Ph. 51-3502.

Perth—Sungrave Pty. Ltd., 847 Hay  
Street, 6000. Phone 23-4513.

Newcastle, N.S.W.—Associated News-  
papers Ltd., 22 Bolton Street, 2300.  
Phone 2-3696.

London—John Fairfax & Sons (Aust.)  
Ltd., Reuter Building, 85 Fleet Street.

New York—"The Sydney Morning  
Herald" Ltd., "Times Annex," 229 West  
43rd Street.

**Distribution:**

Distributed in N.S.W. by Sungrave  
Pty. Ltd., Jones St., Broadway, Sydney.  
N.S.W.; in Victoria by Sungrave Pty.  
Ltd., 392 Little Collins Street, Mel-  
bourne; in South Australia by Sun-  
grave Pty. Ltd., 104 Currie Street,  
Adelaide; in Western Australia by  
Western Press; in Queensland by  
Gordon and Gotch (A'sia) Ltd.; in New  
Zealand by Truth (N.Z.), Ltd.; in Tas-  
mania by Davies Bros. Ltd., "Mercury,"  
Hobart.



## Pal colour TV

During the month, the Postmaster-General, Mr Hulme, made the announcement which the electronics industry had more or less anticipated—namely that colour television in Australia would be based on the PAL system. He emphasised, however, that the purpose of the announcement was to provide a firm basis on which the industry could plan and on which television stations, in particular, could most advisedly re-equip. The Government was not prepared to give a firm

date on which colour television would actually begin in Australia.

Since the announcement, there has been a good deal of speculation as to the likely date for commencement and a rash of articles in the Press by non-technical writers attempting—in vain—to explain the PAL system to non-technical readers.

The Government has undertaken to give 18 months' clear notice before the commencement of a colour television service. It would seem logical also that the commencement of such a service should coincide with the start of a peak viewing season. In view of these facts and the possibility that the Government might include colour TV planning in its election policy, the first possible date on which colour programs could be seen would be mid 1971.

An early deadline (if mid 1971 can be described as such) would probably favour the larger commercial stations, as compared with the A.B.C. It might also be to the advantage of Japanese receiver manufacturers who are showing tremendous initiatives in the colour receiver field, and who may well be able to offer stiff competition to local producers, duties notwithstanding.

While these considerations might suggest that mid 1971 would be pushing things too much, I am certainly not convinced that colour television will be delayed as long as others have suggested—till 1974 or even later. Mid 1972 would be my guess.

I am equally not convinced by those who point to events in the U.S.A. and in Britain as indication of the rate at which colour television will be accepted in Australia. Unless there is an unexpected downturn in our national fortunes, we will be in the position of exploiting something that has been proved and popularised overseas, unhampered by the pioneering problems which faced the U.S. and the economic uncertainty which still faces Britain. A more accurate pointer would be the way in which the Australian public bought monochrome television receivers in 1957 at prices, which, on money values, were not very different from those which are expected to apply for colour.

*W. N. Williams*

## April, 1969

Electronics and the Concorde ..	8	The Serviceman .....	80	Variety Fare .....	113
Electron Beam Recorder .....	12	Learning Morse .....	84	Trade Reviews and Releases ..	125
Global Satellite Plan .....	17	Reader Built It .....	87	Technical Publications .....	139
Japan's Broadcasting System ..	18	Audio Topics — Yamaha		Amateur Band News .....	148
Review—Police Communications	23	Loudspeakers .....	94	Listening Around the World ...	161
Review—Liquid Crystals .....	25	Audio Topics — High Power IC		Answers to Correspondents ...	167
Review—Small HV Rectifiers ..	27	Audio Amplifier .....	99	Classified Advertisements ....	175
Scientific and Industrial News	29	Audio Topics — Photoelectric		Classified Advts. Form .....	176
Microcircuit TRF Receiver ....	36	and I.C. Cartridges ....	101	Advertisers' Index .....	176
10-Plus-10 — Amplifier with		Classical Reviews .....	102	Notes and Errata .....	173
Overload Protection .....	46	Documentary Records .....	109		
A Q-Multiplier .....	58				
Audio Power Measurements ..	62				
Dummy Load for Amplifiers ..	67				
What is a Wave Analyser? ....	70				
Forum .....	74				
Next Month .....	77				

*COVER PICTURE: An Intelsat III communications satellite under test. The successful launching of the Intelsat III Pacific Ocean satellite in February has provided Australia with additional international communications circuits with the U.S.A. (initially) and Asian countries (eventually). Further launches later this year will provide circuits between Australia and India, Africa and Europe. (See story, page 17).*

# INSTROL *hi-fi systems . . .*

There's a custom built Instrol hi-fi System to suit every possible purpose. For example, this prestige system, based on the magnificent new Instrol Cabinets "Series One Thousand." We suggest the Kenwood TK250 Amplifier, and Dual 1019 Player (with Shure M75G magnetic cartridge), plus two Wharfedale Super 12 RSDD Speakers all fitted in Instrol Teak Cabinets one Model 1002 and two of enclosure 1001. Built and tested for \$709.50. Many fine combinations can be produced to suit your requirements, with and without tape recorders, in any of the craftsman-made cabinets from the Instrol range. Let us quote you for your choice. You can save more money if you prefer to assemble your own from Instrol Cabinet Kits.



## SPECIAL

Two compact, shelf or table mounting systems — quality at very low cost.

(A) Instrol 20-20 Solid State Amplifier, plus BSR UA70 Player, fitted to Instrol Model 75 Cabinet (Teak) which features hinged perspex top. Add two Instrol-Mullard mini speaker systems. \$229.00

(B) Instrol 20-20 Solid State Amplifier, plus Dual 1010F or Garrard AT60/2 Player, in Model 50 Cabinet, plus two Instrol-Playmaster Bookshelf speaker Systems (all Teak). \$249.00.

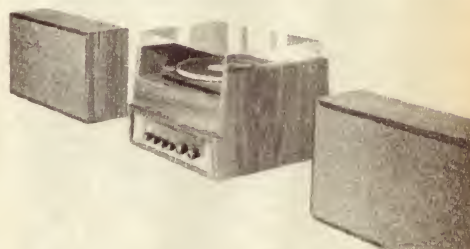

## PERIOD STYLE CABINETS

Just released, new range of Instrol hi-fi cabinets in period styling. Ideally suited for finishing to match cedar, mahogany, etc. Look magnificent when finished in any of the new Estapop Antique colours.

### KITS OR BUILT AND FINISHED

Like all other Instrol designs, Period styles are available as pre-cut kits to build yourself, or ready built and finished. Most economical — the cost is only a trifle more than standard models.

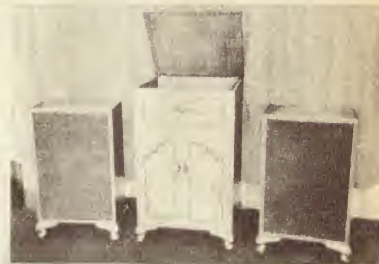

## INSTROL WIDE BAND TUNER Solid State Model T-101

A high quality hi-fi tuner designed to operate with all makes of valve and solid state amplifiers.

- Wide band 530 to 1600KHz
  - Tuning Meter. ● Efficient Noise filter.
  - R.F. Stage.
  - Built-in AC. Power Supply.
  - Major Stations, all States clearly marked on large illuminated scale.
- Housed in smart metal box. Available as Amp/Tuner in combination, with the Instrol 20-20 Amplifier, in attractive Teak cabinet (as illustrated) or less cabinet for panel mounting.



### PRICE DETAILS:

T101 TUNER (in Metal Case) . . . . .	\$72.00
T101 TUNER (without case) . . . . .	\$69.80
20-20 AMP. (in Teak Case) . . . . .	\$99.00
Combined 20-20-T101 in Teak Case . . . . .	\$176.00



Yes, we carry a range of imported Loudspeakers, Players, Amplifiers and Tape Recorders. Please state your requirements and we will gladly quote. All well-known brands stocked.

- |              |               |            |
|--------------|---------------|------------|
| ● INSTROL    | ● A.D.C.      | ● GARRARD  |
| ● FISHER     | ● DECCA       | ● SONY     |
| ● KENWOOD    | ● QUAD        | ● BRENNELL |
| ● SANSUI     | ● LABCRAFT    | ● AKAI     |
| ● WHARFEDALE | ● ALL BALANCE | ● TEMPO    |
| ● GOODMANS   | ● DUAL        | ● LEAK     |
| ● SHURE      | ● ELAC        |            |



# INSTROL cabinet kits . . .

Easy to Assemble

MAKE YOUR OWN HI-FI FURNITURE FOR LITTLE MORE THAN HALF COST . . .

So easy, a child can manage it. The Instrol way—a new simplified method of assembly. A hammer, screwdriver, few hours of your time, and you can make for yourself a complete high quality hi-fi cabinet setting, fully professional in appearance.



Each kit is complete with all necessary timber parts, plus nails, screws, full, easy to follow instructions. Speaker enclosure kits are complete with acoustic Inner-bond lining felt, and acoustic grille cloth. Equipment cabinet kits include hinges, knobs, catches, sliding stays, castors, slides, leg sets, etc. All timber parts precision cut, fit together smoothly . . . panels are best quality veneered in selected Teak or Queensland Maple.

Instrol cabinet designs will cater for virtually any make of speaker, player, amplifier, and tapedeck. If required, all designs are available ready built and polished, but it's highly economical and much more fun to make your own.

## PLAYER STANDS

The Instrol range includes a wide variety of player stands and combination amplifier-player cabinets. High quality perspex covers (clear and tinted) are also available, some hinged, others separate.

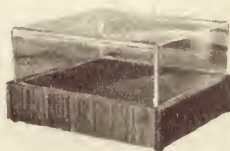

## EQUIPMENT CABINETS

There are more than sixteen Instrol equipment cabinet designs, all available built and polished or as kits of parts to assemble yourself. They range from massive floor units to compact table models, and include cabinets for record storage and wall shelf units.

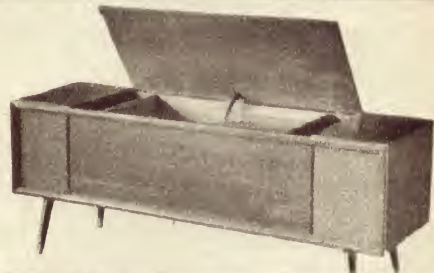

## SPEAKER ENCLOSURES AND SYSTEMS

Name your speaker and Instrol can supply an enclosure to suit. If it's not in the standard range we can quickly produce enclosures to suit speaker manufacturers' specifications. Enclosures only or complete speaker systems are all available built and polished or as kits.

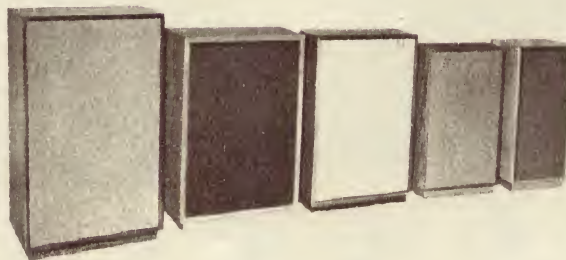

Post coupon, call, or phone for free fully illustrated Instrol hi-fi cabinet brochure. It includes full specifications and down to earth price details of all Instrol cabinet designs. (If writing please include postage stamp.)



**FREE**  
**INSTROL**  
**CABINET**  
**CATALOGUE**

**BROADWAY ELECTRONICS (SALES)**

**PTY. LTD.**

**32 GLEBE PT. ROAD, GLEBE, N.S.W.**

Telephone 660-1171. Only 100 yards from Broadway.

**OPEN SATURDAY MORNINGS.**

Send Coupon for **FREE CATALOGUE.**  
(Please enclose postage stamp.)

NAME .....

ADDRESS .....

.....

.....

Instrol HI-FI  Instrol Cabinets

# A new look at the

The middle power range, roughly that between 40 and 70 watts, has long been neglected by stereo manufacturers in the race to build receivers for the higher power—and price—ranges.

It hasn't been neglected by Sansui, however.

Working on the assumption that the middle power range is the most practical for the average home, Sansui engineers have

developed two of the highest performing solid state receivers ever to enter this field.

Rated at 70 and 46 watts respectively, the new Sansui 800 and 350 bring large receiver performance and refinements within the reach of everyone.

Both incorporate the latest FET circuitry for new standards in FM sensitivity and selectivity. Both offer wider dynamic ranges, lower distortion and higher channel separation figures.



**Sansui 800** Solid State AM/FM Multiplex Stereo Tuner Amplifier. 70 watts. FET & IC circuitry. Bandwidth: 20 to 35,000Hz. Distortion: less than 0.8%.

# middle power range.

Each incorporates a newly developed noise canceler and is capable of handling up to two speaker systems simultaneously. And each features the functional black window design.

For a new look at the middle—or any—power range, see your nearest Sansui dealer soon.

*Sansui*<sup>®</sup>



**Sansui 350** Solid State AM/FM Multiplex Stereo Tuner Amplifier. 46 watts. FET & IC circuitry. Bandwidth: 30 to 20,000Hz. Distortion: less than 1%.

With a BSR X3M  
 'compatible' cartridge,  
 almost any mono  
 record playing  
 equipment can take  
 stereo records  
 (without damaging  
 them)

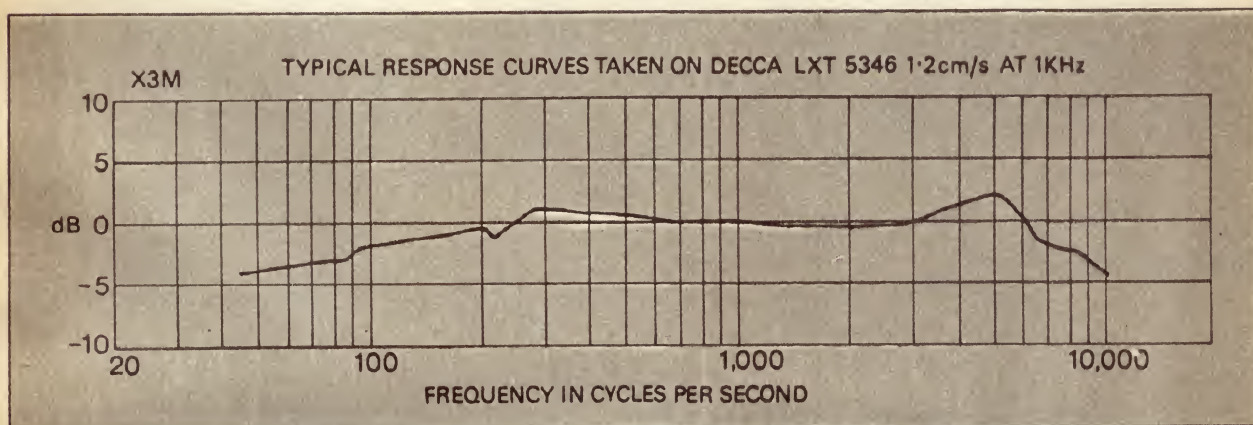
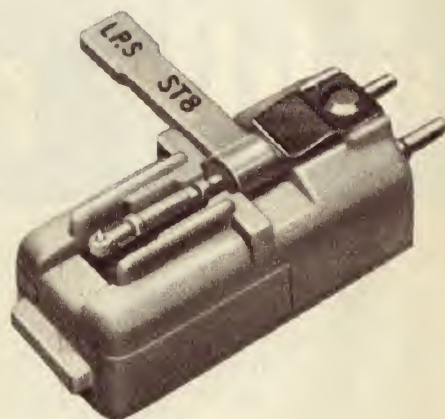

### Why compatible cartridges?

An increasing number of record companies are now making stereo LP records only.

Until now these records could not be played on a mono player without distortion and damage to the records.

When playing stereo records the stylus tip moves vertically and horizontally following groove contours. Mono records have grooves which only move the stylus horizontally so old mono cartridges will not allow vertical movement of the stylus. Playing stereo records with old mono cartridges will damage the vertical component of the groove irrevocably.

The X3M 'compatible' cartridge, designed and perfected by BSR, is the answer to this problem. For a small outlay it allows you to play both stereo and mono records without harming either. Retail price, \$6.00.

### TECHNICAL DATA X3M

Output: 350 mV  $\pm$  2 dB

1 KHz test record Decca  
 LXT 5346 at 1.2 cm/s

Frequency Response: See typical curves above

Dynamic Compliance:

Horizontal  $3.0 \times 10^{-6}$  cm/dyne ( $\pm 20\%$ )  
 Vertical  $1.0 \times 10^{-6}$  cm/dyne ( $\pm 20\%$ )

Equivalent Capacity: 800 pF

Nominal  
 Recommended Loading: 2 M. ohm 100 pF

Stylus Pressure: 4-6 grammes  
 depending on pick-up arm

Measuring Temperature: 20° C 68° F

Colour: Beige



BSR (A/ASIA) PTY. LTD.  
 SOUTHERN SECTION INDUSTRIAL ESTATE  
 ST. MARY'S, N.S.W.  
 PHONE: 623-0375, 623-0376



DISTRIBUTORS:  
 GOLDRING ENGINEERING (A/ASIA) PTY. LTD.  
 443 KENT STREET, SYDNEY, N.S.W.  
 OFFICES IN ALL CAPITAL CITIES.

BSR:P100



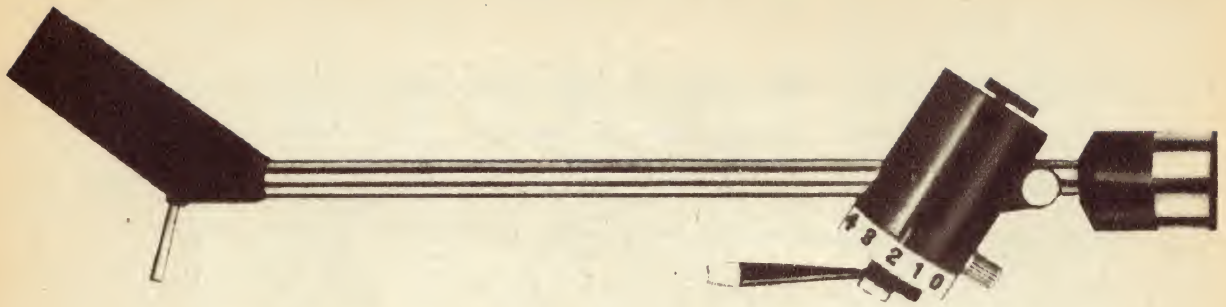

# The BSR MA70 automatic turntable

Probably the most critical way to evaluate the quality of any changer is by closely inspecting the tone arm and its capabilities. Let's examine the tone arm of the BSR MA70 automatic turntable.



This is the resiliently mounted coarse and fine vernier adjustable counterweight. It counterbalances the tone arm both horizontally and vertically and assures sensitive and accurate tracking.

Here you see the micrometer stylus pressure adjustment that permits  $\frac{1}{8}$  gram settings all the way from 0 to 6 grams. This assures perfect stylus pressure in accordance with cartridge specifications.

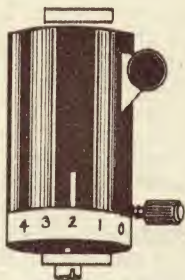

Here's another unique and valuable feature... the cueing and pause control lever that lets you select the exact band on the record, without fear of ever damaging the record or the cartridge. It even permits pausing at any point and then gently floats the tone arm down into the very same groove!



Whenever the turntable is in the "off" position the arm automatically returns and securely locks in this cradle to protect it and keep it from movement.



This is the low-mass tubular aluminium pickup arm... perfectly counterbalanced both horizontally and vertically to make it less susceptible to external shock.

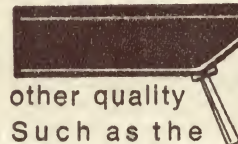

Of course, there are many other quality features on the BSR MA70. Such as the adjustable dynamic anti-skate control — a BSR breakthrough.



## BSR (A'ASIA) PTY LTD

Southern Section Industrial Estate  
St. Marys NSW Tel 623 0375-0376

Wholesale Distribution **GOLDRING ENGINEERING (A'ASIA) PTY LTD**

New South Wales 443 Kent Street Sydney 2000 Telephone 29 5802 Victoria 162 Pelham Street Carlton 3053 Telephone 34 5105  
Queensland 415 Adelaide Street Brisbane 4000 Telephone 2 3247 South Australia Farley & Fahy Pty Ltd 75-77 Wright Street  
Adelaide 5000 Telephone 51 5117 Western Australia 32 Northwood Street Leederville 6007 Telephone 8 4988

# ELECTRONICS AND THE

Electronic systems in the Anglo-French supersonic airliner will account for a substantial proportion of the total cost of each aircraft. This article, from a British source, describes some of the electronic equipment contributed to the enterprise by British manufacturers.

A traveller between, say, London or Paris and New York in a few years' time will, if he flies in a Concorde supersonic airliner, expect to arrive safe and well about three hours after take-off. He will do this by flying twice as high and more than twice as fast as he can in even the most advanced jet airliners in service today.

Such a radical extension of the operational profile for large commercial aircraft has become possible only because completely new problems of performance and safety have been solved by the designers of the Concorde's airframe, engines, and vital ancillary equipment. Speed could not be increased at the expense of safety and, as higher speeds meant less margin for error, safety measures adequate for subsonic aircraft would not do. The onus was, therefore, on equipment designers to provide navigation, control, and aircraft housekeeping systems for Concorde that were not liable to inaccuracy or catastrophic failure.

This underlined a well-known technical dilemma in such cases: the more the safety circuits provided, the more components there are to go wrong and the greater the chance of failure. Taken to its logical conclusion, this means that the addition of safety circuits after a certain point has been reached could result in equipment becoming more rather than less dangerous!

Such considerations as these, with others, resulted in the adoption of a duplicate monitored approach for the electronic systems in Concorde. In other words, two systems are installed instead of only one, although only one system exercises authority over the aircraft at any given time. In addition, each sub-unit of each system is monitored by an electronic and/or mechanical device that simulates the sub-unit it is monitoring. In practice, if in the system that has authority a sub-unit's output does not agree with its monitor, then the authority is automatically passed to the second-complete system. If this subsequently fails, a monitor switches-out the second system before a dangerous condition can develop and authority is passed to the air-

liner's crew. So much, then, for the philosophy behind the provisions, but what about the equipment itself?

All that really needs to be said about the efficiency of the navigation equipment is that Concordes will not carry a human navigator. It was found that vertical gyroscopes were unsuitable for driving instrument displays and for use as a basis for navigation in these aircraft because of the prolonged periods of acceleration and deceleration and other factors that will be peculiar to machines of Concorde's type. Instead, an inertial navigation system is employed. The heart of any inertial system is a platform, carrying gyros and accelerometers, that is stabilised relative to space but with the stabilisation modified in such a way that the platform's vertical axis always points to the centre of the Earth and the X and Y axes point east/west and north/south respectively.

The outputs from the gyros and accelerometers are fed to digital computers. These calculate the correction terms needed to maintain the platform's required position relative to the Earth's surface. They also provide outputs corresponding to aircraft position, speed, drift and heading.

A Ferranti moving chart display provides the pilot/navigation computer interface. This British display unit contains a 35mm colour film that can store en-route charts covering an area of 8,000 by 2,000 nautical miles at a scale of 1:2,000,000 and two areas 1,000 by 2,000 nautical miles at a scale of 1:500,000 for airport terminal areas.

The film is back-projected on to an eight-inch diameter screen occupying an instrument-panel position between the two pilots. The navigation computer ensures that the correct part of the chart is projected and superimposes "present aircraft position" on it. At the pilot's discretion, this position can be either at the screen's centre or at the bottom of the screen so that a greater view ahead can be obtained. Either track-orientation or north-orientation can be selected. With the former, the aircraft's track (that is heading, after

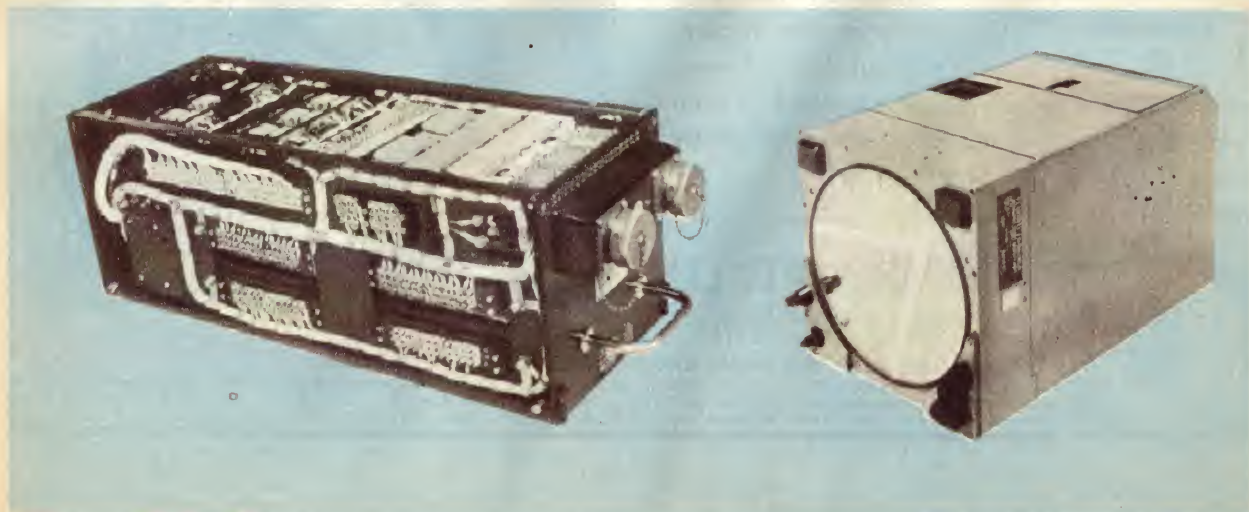

# CONCORDE



By Brian Stanis

allowing for drift) always points to the top of the screen — as the aircraft turns, the chart rotates. With north-orientation, north on the chart is always at the top of the screen and when the aircraft turns a track pointer rotates.

The moving chart indicator is not only a one-way indication device, as it enables the pilot to communicate with the navigation computer. If, for instance, it is necessary to change the flight plan when airborne, to negotiate a storm or for some other reason, a manual control-column is used to drive the chart so as to bring the new destination to the centre of the screen. A button is then pressed and the co-ordinates of the new destination will have been fed to the computer.

The display may also be used to compare the outputs of the two inertial navigators with the VOR/DME (visual omni-directional range/distance measuring equipment) or to display data-sheets, approach charts, check lists, procedures, frequency tables and so on.

Outputs to the automatic pilot are provided by the navigation system so that the aircraft can be flown along a pre-programmed course as updated by the pilot's manipulation of the chart display.

The navigation system, as described, was developed by a consortium formed by Ferranti and a French company, the latter supplying the digital computers. The charts for the display were made by International Aeradio; they measured 16 feet long and 20 inches wide before they were photographed.

The automatic flight systems (AFS) — which include the automatic pilot, flight director, automatic throttle and automatic stabilisers — were also designed by a consortium; this included companies in France and the United States of America and the British firm

Elliott-Automation. The central control panel for the AFS represents a complete departure from conventional aeronautical switching techniques. Push-switches are used instead of rotary switches. Integrated micro-circuit logic, operating in conjunction with the push-buttons, provides a high degree of safety; even if a mode-selector button is jammed in the ON position, it is still possible to lock that mode out.

Facilities offered by the flight control system as a whole are: programmed climb-out; lateral navigation; altitude hold; Mach and airspeed hold; vertical speed hold; altitude capture; automatic approach; automatic landing. The pilot selects the mode he requires on the AFS control panel and then makes a choice between automatic pilot and flight director. If automatic pilot is selected, the required function is carried out automatically; if flight director is selected, the pilot flies the aircraft manually following information presented on the flight director indicator.

In the lateral navigation mode, the flight system responds to the track error and rate-of-change of track error signals with respect to the program stored in the navigational computer. Another program, stored in the climb-out computer, which takes into account local air traffic and noise regulations and details of the aircraft's performance, can be fed into the flight system to control the subsonic climb to cruising altitude after take-off.

An air-data-computer supplies the information to the flight system to enable the aircraft to "lock" on to a selected height, airspeed or Mach number. The automatic throttle provides similar speed "lock-on" facilities — by controlling engine power — by employing the same air-data-computer information as the automatic pilot and an additional longitudinal term from the inertial platforms.

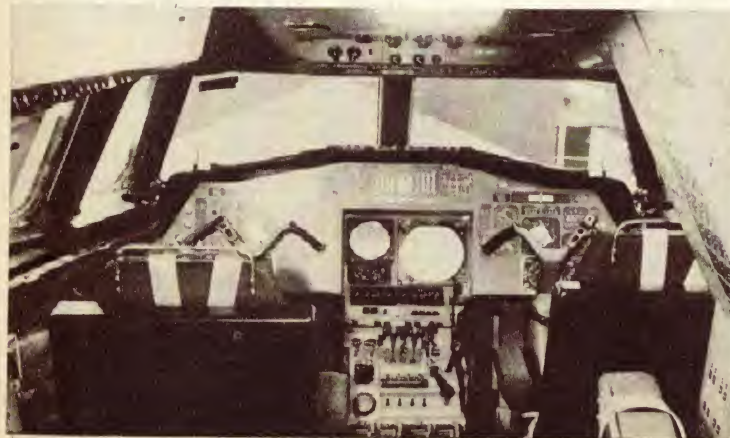

*IMMEDIATE LEFT (this page): Mock-up of the flight deck in the Concorde. The large instrument on the left of the centre panel is the Ekco weather radar and right is the Ferranti moving chart display.*

*FAR LEFT (opposite page): A prototype of one of the computers for engine control in the Concorde. The production unit is considerably smaller than that shown here.*

*CENTRE: The Ferranti moving chart display unit for the Concorde.*

MASS PRODUCTION  
MASS PRODUCTION  
MASS PRODUCTION  
MASS PRODUCTION  
MASS PRODUCTION

## That's how STC make the best rectifier diodes — cheaper

STC make thousands of rectifier diodes every week. Upwards of 200,000 in fact!

Not only do we make them for our own manufacturing divisions but also for 60% of the Australian Electronics Industry. We also export them in volume to major areas round the world. And we make them for you.

**Through mass production we can supply them cheaper and we deliver fast. Instant diodes.**

Available in a complete range of voltages from 50 volts to 1,000 volts, STC EM 400 Series Silicon Rectifier Diodes have a proven reliability record. They are fully accepted by the Australian Post Office and all Government bodies.

Save yourself some money. When you want diodes — any diode — any quantity — always specify STC.

Write now for our free Data sheet or contact Components Division.

### **Standard Telephones & Cables Pty. Limited,**

Moorebank Avenue, Liverpool, N.S.W. 2170. Phone Sydney 602 0333 or Melbourne 480 1255, Brisbane 47 4311, Adelaide 51 3731, Perth 21 6461, Newcastle 61 5172, Wollongong 2 7974.

AN **ITT** world-wide communications and electronics  
ASSOCIATE



N688

Automatic landing is carried out in the normal way, using information from the instrument landing system (ILS), receivers and the radio altimeter. Automatic landings can be carried out in International Civil Aviation Organisation Category IIIc conditions—that is, visibility insufficient to land under manual control, but good enough to steer manually on the runway. Each flight system receives its input information from completely independent sources.

Doppler radar and distance measuring equipment (DME) are supplied by the Marconi Company. The Doppler system provides outputs of ground-speed and drift, which are converted in a mechanical ball resolver to provide, in addition, distance flown along and at right angles to a selected track. This information can be fed into the flight system if required. In order to minimise cross-coupling effects due to the close proximity of the transmitting and receiving aeriels, a frequency modulation technique is employed. This enables the receiver to discriminate between required signals and those due to cross-coupling.

The DME system operates in conjunction with Vortac (VOR tactical) and Tacan (tactical air navigation). Using a time measuring method, it computes the distance between the ground beacon and the aircraft.

A rather interesting warning device is featured in the Ekco Electronics weather radar. It will be appreciated that this kind of equipment only becomes of immediate importance when actually negotiating a storm and is liable to be neglected at other times. To overcome this problem, the equipment is arranged to scan a 20-degree sector 200 nautical miles in front of the aircraft, irrespective of the range to which the equipment is set. If a target is spotted, an "alert" signal is actuated. The weather radar has a maximum range of 360 nautical miles and also employs the duplicated principle.

Aircraft identification, height and other information can be transmitted to a ground station without aircrew participation, using the Cossor secondary radar transponder. The transponder, which employs integrated microcircuits, replies automatically on receipt of a coded signal from a ground station.

Concordes will be fitted with an airborne selective calling unit (Selcal) made by the Marconi Company. Each aircraft will be assigned an individual four-letter code which can be represented by four audio tones. When a ground station wishes to contact a particular aircraft, it will transmit the appropriate code signal; tuned reeds in the Selcal unit will then respond and actuate a warning, thereby relieving the aircraft's crew

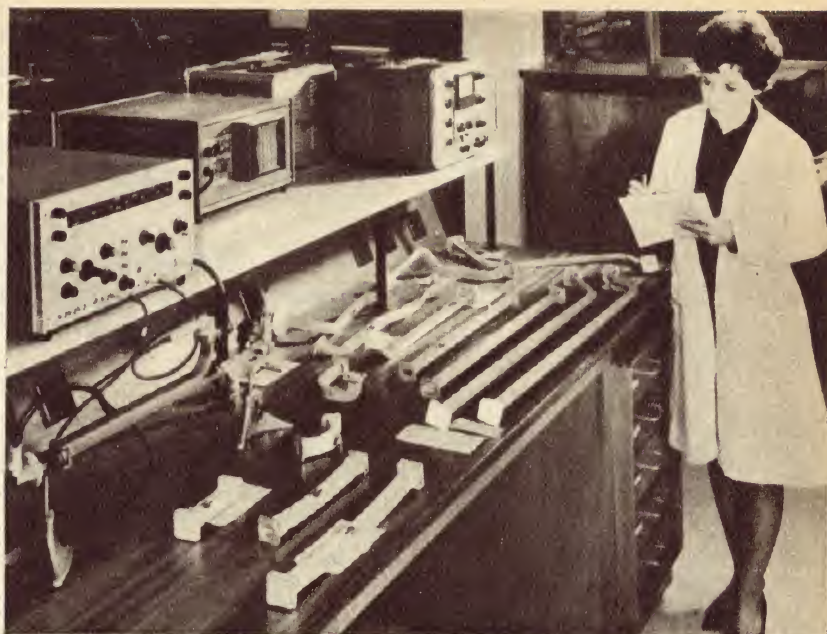

*ABOVE: Waveguides for the weather radar being checked at the Sanders Division of Marconi Instruments Ltd. The main units for the weather radar are being made by Ekco Electronics Ltd.*

*An automatic throttle computer. The two sockets on the front are for test purposes. The testing facilities in the Concorde allow the complete flight system to be checked in 35 minutes*



of the task of continuously monitoring the radio receivers.

Automatic engine controls, supplied by Ultra Electronics, will adjust fuel flow during start-up and re-lighting, engine high-pressure compressor spool speed, idling-fuel flow (to prevent combustion flame-out), throttle settings during acceleration and deceleration, jet pipe temperature, and intake air flow.

Various parts of the aircraft will be monitored during flight and landing by E.M.I. closed-circuit television cameras. One of these will be equipped with a 90-degree, wide-angle lens so that the whole of the underside of the aircraft can be viewed.

Concorde's cruising height will be such that the aircraft will be deprived of the protection normally afforded by the atmosphere from cosmic radiation. A radiation detector, manufactured by S. Davall and Sons, will therefore be fitted, causing an alarm to sound should a dangerous level of radiation be encountered. The aircraft would then descend to a safer altitude.

The mass of electronic equipment in Concorde consumes a considerable amount of power. Main generating equipment for the prototype Concordes was supplied by Electrical

Equipment Division of the Plessey Dynamics Group. Each generation channel consists of an alternator, a voltage regulator and a control panel. The alternator is an oil-cooled brushless type with a continuous output of 62.5KVA at 200V, 400 Hz, three-phase, and it has integral current transformation. To conform with Air Registration Board and Federal Aviation Agency regulations, the alternator's oil system is double-sealed for safety.

Other British equipment for Concorde includes the electrical system, by English Electric; flight recorder and engine instrumentation by Elliott-Automation and Smiths Industries; electric cables by British Insulated Callender's Cables; and notch aeriels by Standard Telephones and Cables. ■

# ELECTRON BEAM RECORDER

## for high-quality television film

The world's first electronic beam recorder for motion picture film was demonstrated in America recently by the makers, Minnesota Mining and Manufacturing Company.

Developed by the 3M Company's Mincom division in Camarillo, California, U.S.A., the device provides the highest quality motion picture films yet attained from a television source. Development of the electron beam recorder has been recognised as a major breakthrough in obtaining picture quality superior to that possible using conventional telerecording systems, where the picture is filmed off the face of a picture tube.

In theory, electron beam recording has long been recognised as the superior recording method. To date, however, the only equipment available has been laboratory constructions and specialised still-frame equipment for military use. The makers claim that its equipment, the EBR-100, provides for the first time to the television industry a tool by which a high resolution, low-noise film can be made from standard television signals, whether originating from a video tape or directly from a television camera.

The 3M Company's recorder appears to be based on similar principles to the recorder developed by C.B.S., of U.S.A., for the production of film cartridges intended for playback through TV receivers. However, C.B.S.

is marketing only playback equipment at present, and has not indicated any intention of making the recording side of the system available. (See "Electronics Australia," December, 1967.)

In its basic concept, electron-beam recording can perhaps best be visualised by imagining a cathode ray tube with the phosphor coated face removed and replaced by photographic film. In this situation, the electron beam strikes the film in place of the phosphor face. It has been found that the reaction of a silver-halide film to an electron beam is much like its reaction to light. Thus, the electron beam striking the film creates a latent image that can subsequently be developed by usual film processing techniques.

An electron beam television recorder accomplishes the same type of conversion (television signal to motion picture film) as a kinescope recorder, but overcomes several of the serious deficiencies. In a kinescope recorder, the limited light output available from a cathode ray tube phosphor necessitates the use of a relatively fast film. To the graininess which results from the use of a fast film is added the graininess which is caused by the par-

ticulate nature of the cathode ray tube phosphor. Uneven shading in the picture is caused by variations in the phosphor thickness. The resulting picture quality is less than ideal. These shortcomings are overcome in the electron beam recorder by eliminating the phosphor and creating the image directly in the photographic emulsion with the electron beam.

In figure 1, a comparison is shown between electron-beam recorded raster lines and raster lines recorded on a conventional kinescope recorder. The large grain size and unevenness typical of the kinescope recording is obvious.

However, electron-beam recording introduces some problems of its own. One of these is that the photographic film must be introduced into a high vacuum system in order to record on it with an electron beam. Another is that the electron beam builds up an electrostatic charge on the film, and this charge tends to deflect the beam from its proper position.

In the EBR-100, these problems are solved by evacuating the whole film magazine and transport system to a modest vacuum of about 15mm pressure. This reduces the requirements on the vacuum seal between the film

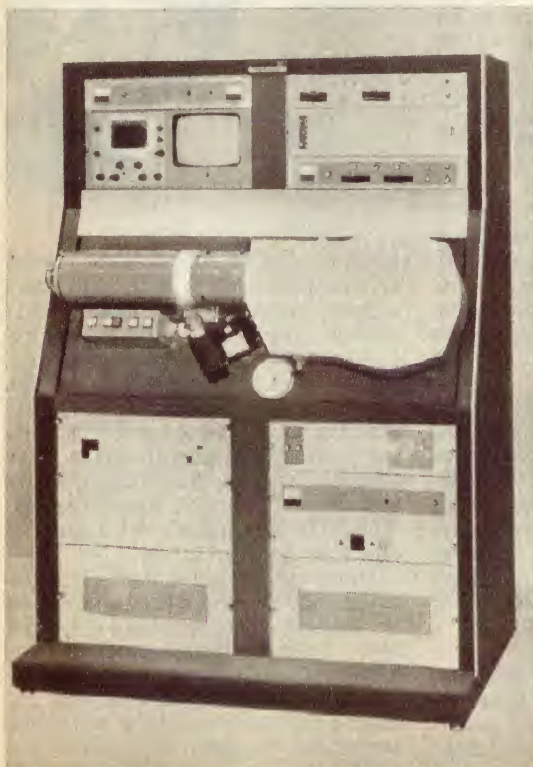

RIGHT: Figure 1, showing raster lines obtained with the EBR-100 (left) and with a kinescope type telerecorder.

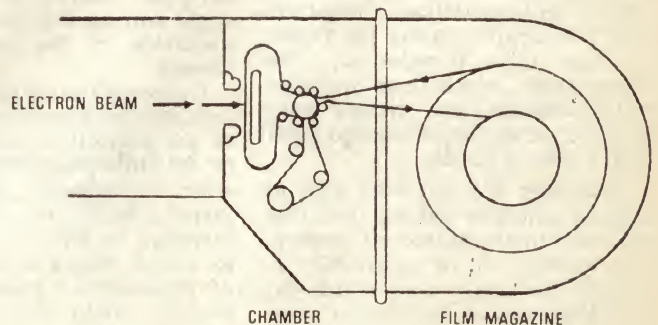
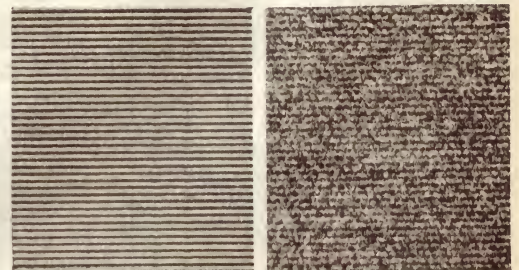

Figure 2. The film transport mechanism of the EBR-100. The gate uses a conventional type intermittent drive. The film magazine has feed and take-up spools mounted co-axially.

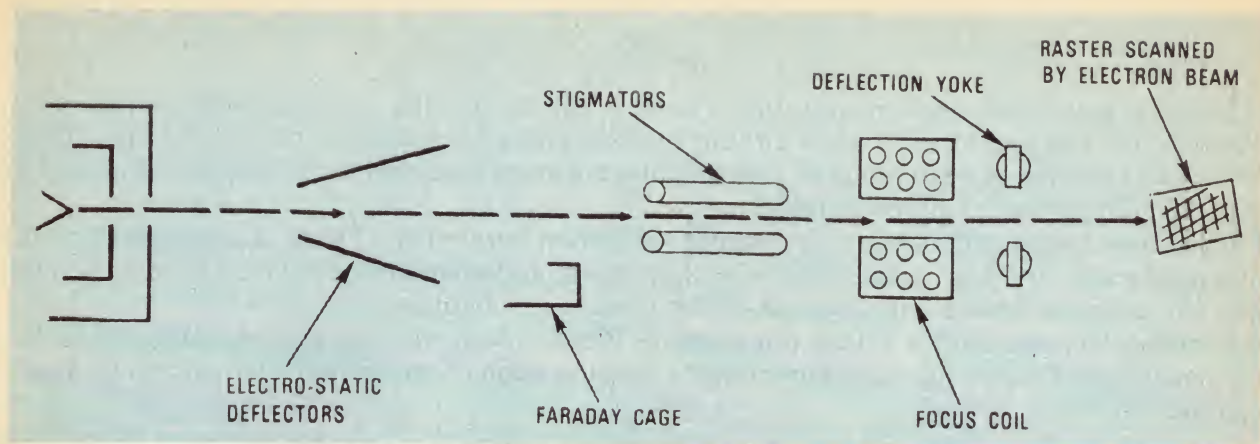

Figure 3. The electron-optical assembly of the EBR-100.

magazine and the electron gun, so that a simple raised land (or border) surrounding an aperture through which the electron beam passes is sufficient to achieve the required high vacuum of about  $10^{-3}$  mm at the recording aperture.

At the same time, by maintaining the pressure in the film magazine at about 15 mm when using a standard commercial positive release stock film, drying out the emulsion is avoided. Since some moisture is retained in the film, the conductivity of the emulsion remains high enough to dissipate the electrical charge built up by the electron beam. Since the film magazine is pumped to only a very modest vacuum, it may be evacuated from atmospheric pressure to the operating pressure in only about 30 seconds.

In recording motion pictures from Australian standard television signals, it is necessary to convert from the 25 frames-second television picture rate to the 24 frames-second required by motion picture standards. This is achieved by a strobing technique which involves discarding a small portion of each television frame.

In figure 2, the frame conversion is illustrated as implemented for American 30-frame standards. The first picture on the film is recorded from the first two fields of video (one frame). Then the top half of the next video field is discarded and the film is advanced to the next frame position during this time. The recording of the next picture on the film starts with the bottom half of a video field, the following interlaced field, and then the top half of the field after that. The film is again advanced and one-half field of video is discarded. This cycle is then repeated. For Australian conditions the problem is different in character, as only one frame in 25 needs to be discarded, and only a small portion of each frame is lost.

The electron-beam television film recorder can be broken down into three general areas: the film transport, the electron-optical system, and the electronics.

The film transport is illustrated in figure 3. A coaxial magazine contains both the supply and take-up reels. Film is pulled from the supply reel by a motor-driven sprocket "servoed" (locked via a feedback system) to vertical sync from the incoming video signal. Film next goes to the gate area where there is a conventional type intermittent drive. Then film goes to the sound drum and to the take-up reel. If sound is to be recorded, a

variable density optical galvanometer is utilized.

At the interface between the film transport and the electron gun, a vacuum seal must be made on the film. This seal must be adequate to reduce the 15 mm pressure in the film chamber to the approximately  $10^{-3}$  mm required at the area where the image is being recorded. A relatively flat plate having an aperture surrounded by raised lands, chrome plated and polished, is used as part of a film gate to accomplish this seal. When the film chamber is being threaded, or in the event of film breakage, a valve closes off the electron gun. This valve may be manually opened or closed, and is closed automatically by an interlock in the event of a vacuum failure.

The electron-optical system uses a single electromagnetic focus coil to image the cross-over spot of the electron gun on to the film (figure 4). A hair-pin tungsten filament is used. In order to achieve good filament life, the gun is pumped by two separate diffusion pumps. The first pump maintains a vacuum of about  $10^{-3}$  at the image plane and the second pump maintains a vacuum of about  $10^{-6}$  at the filament. An octapole stigmator is used to correct astigmatism of the record spot. An electrostatic deflector allows deflection of the electron beam into a Faraday cage for sampling the beam current. Horizontal and vertical sweeps are electromagnetic deflections.

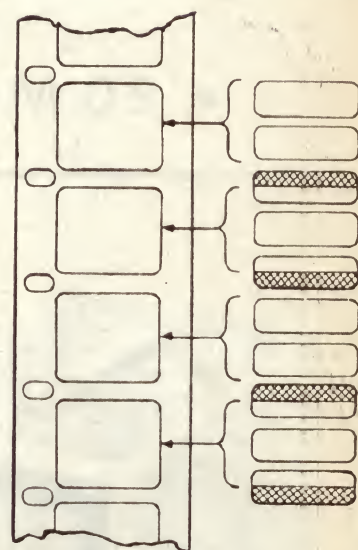
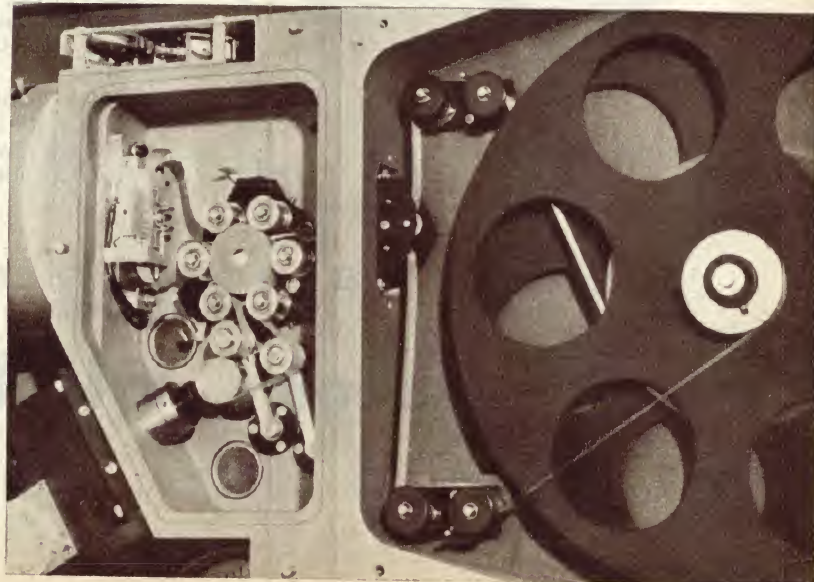

Figure 4. Diagram showing how conversion is made from the 30-frame American television standard to the 24-frame motion picture standard. The shaded portions are discarded. BELOW: The film chamber and shuttle mechanism of the EBR-100 Recorder.



A portable solid state oscilloscope with a band width of 20 MHz at a maximum sensitivity of 10mV/cm. The use of solid state circuitry enables this oscilloscope to be fully operational within 15 seconds of switching on. Supply rails are stabilised against AC supply variations by a VOLSTAT constant voltage transformer.

Plug-in time bases and Y amplifiers ensure maximum versatility. There is a choice of single and dual trace, and high gain differential amplifiers, and standard or delayed time base plug-ins. All plug-ins have a unique quick action release mechanism.

A rectangular tube with a bright trace and a 10cm x 6cm display area, together with 200 nanoseconds of signal delay, ensure that the leading edge of any suitable waveform is clearly visible.

# Solid State Oscilloscope OS2000

• 20 MHz • 200nS • Portable



## BRIEF SPECIFICATION

**MAIN FRAME OS2000 MF:** 5 in. rectangular Cathode ray tube with helical PDA.

**SINGLE TRACE UNIT OS2001 Y:** *Bandwidth* DC to 20 MHz (— 3dB). *Rise time* 17nS. *Sensitivity* 50 mV/cm. *Input impedance* 1MΩ/approx. 35p F.

**DUAL TRACE UNIT OS2002 Y:** *Bandwidth/Sensitivity* (1) DC to 20 MHz (— 3dB) at 10 mV/cm. *Rise time* 17 nS. (2) *Input impedance* 1MΩ/approx. 35 pF.

**STANDARD TIME BASE OS2003 X:** *Sweep speeds* from 200 mS/cm to 0.2 μS/cm.

*Trigger level* (1) Manual. (2) Auto (40 Hz to 20 MHz). *X Gain* Switched X5.

**HIGH GAIN DIFFERENTIAL UNIT OS2004 Y:** Under Development:

*Bandwidth* DC to 200 kHz (— 3dB).

*Sensitivity* 100μV/cm. *Input impedance* 1MΩ shunted by approx. 47 pF each side to earth.

*Common mode rejection* 80dB, DC to 5 kHz up to 100 mV range.

**SWEEP DELAY UNIT OS2005 X:** *Sweep speeds* 19 ranges from 200 mS/cm to 0.2 μS/cm for both A and B time bases.

*Trigger level.* Time base A. (1) Manual. (2) Auto 40 Hz—20MHz. Time base B. Manual only.

*Delay.* Continuously variable 0.2 μS to 2 secs.

*Single shot.* Available in all operating modes. *X Gain.* Switched X5.

**WEIGHT:** 35 lbs.

ADVANCE INSTRUMENTS

Distributed by:

**JACOBY, MITCHELL & CO. PTY. LTD.**

469-475 Kent Street, Sydney. 26-2651



MELBOURNE  
30-2491/2

ADELAIDE  
53-6117

BRISBANE  
2-6467

PERTH  
28-1102

LAUNCESTON  
2-5322

JM17-68



Since the electron beam is imaged to a fine spot, adjacent lines in a recorded raster would not come together. On a direct positive recording, this would leave a clear space between recorded lines thus preventing obtaining the high densities desired for projection. If this image were rescanned for television broadcasting, it would also lead to moire patterns occurring between the lines in the image and the scan lines. To prevent these undesirable effects, while at the same time retaining maximum possible resolution, the electron beam is wobbled vertically at about 30MHz in order to blend adjacent raster lines together.

The electronics in the electron beam recorder provide the following basic functions:

1. Synchronising the film motion to the video input.
2. Counting raster lines to record precisely the right number.
3. Video amplifiers including switchable high frequency boost and gamma correction for recording both direct positive and negative films.

The film synchronising and line counting electronics are shown in block form in figure 5. Switchable high frequency boost is provided so that it may be used or not depending upon whether it improves the subjective quality of the particular material being recorded. High frequency boost gives sharper resolution at the expense of increased high frequency noise. The gamma correction video amplifiers provide adjustable break points to permit adjustment of proper grey scale in the film.

An electron beam intensity control is fitted which makes use of beam samples taken during blanking intervals, when the beam is deflected into the Faraday cage. A reference pulse of approximately one microsecond duration and located in the back porch interval is generated and fed to the gun grid. The resultant pulse amplitude from the Faraday cage is compared with a reference voltage and any error voltage readjusts the gun bias to restore the pulse height to its proper amplitude. The reference pulse and video signal are fed to the grid by the grid drive amplifier as is the composite blanking to establish the minimum exposure.

Monitoring of the Faraday cage output after the preamplifier by an oscilloscope allows a measurement of the reference pulse during horizontal blanking, and of the video signal during the pulldown cycle. With this system, the beam current used for recording can be directly measured.

When the electron beam is scanning a raster at the record aperture, a "loop antenna" surrounding the aperture collects secondary electrons. The signal collected by the antenna is displayed on a television monitor, and thus creates a picture of the object being scanned. For focusing the electron beam, a metal target or screen is placed in front of the beam, or else a leader on the film is coated with graphite paint. By reducing the size of the raster being scanned, the display of the target on the television monitor may be greatly magnified. This permits careful observation of the beam focus and astigmatism. During this focusing, the 30MHz vertical spot wobble is turned off.

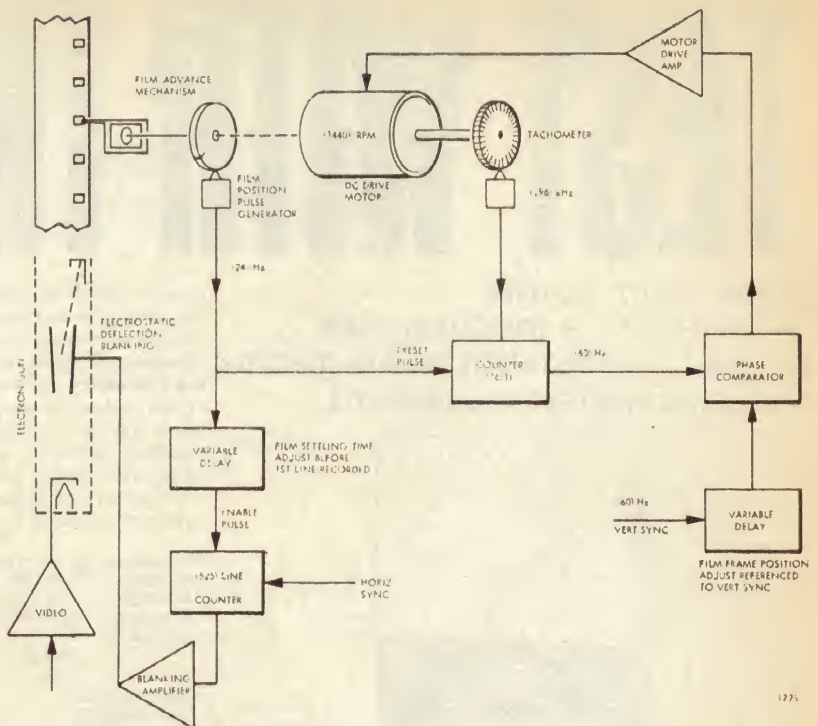

Figure 5. Block schematic of the EBR-100 film synchronising and line counting electronics.

## PLESSEY REMOTE-CONTROL ANSAFONE

A recent addition to the Plessey "Ansafone" range of recording telephones is the Remote Playback Ansafone. A standard Ansafone will answer all telephone calls received at an unattended phone, give a pre-recorded message to the caller and invite the caller to leave a message, which is recorded. The new Remote Playback Ansafone will do all these things, but it will also play back callers' messages when commanded to do so, over the telephone. Thus, the subscriber can dial his own phone and obtain playback of any messages recorded in his absence.

The user can then record new instruction and cause the tape to be rewound. About 60 minutes of tape is then available for further messages.

Playback of recorded messages can only be obtained by use of a pre-

determined code. A person who does not know the code cannot get the Ansafone to play back for him. When the subscriber calls, he hears a series of pips. The subscriber speaks after a certain set of these pips to trigger the playback mechanism. The code can be varied on the machine in a few seconds, to prevent unauthorised persons learning the code by trial and error.

Plessey say that the whole range of Ansafone recording and answering devices is finding wide applications. The equipment has become firmly established as an aid to one-man operations, such as doctors, dentists and architects. Now there is a marked trend towards wider use in large companies and government departments. Many small police stations in country areas of N.S.W. are equipped with Ansafones.

*Before leaving for the day, a secretary programs the Remote Control Ansafone for after-hours callers.*



# TEST WITH THE BEST

New from Sanwa  
**A-303TR<sub>D</sub>**—a medium-size  
 circuit tester with a 44-micro-  
 ampere meter movement.



- Zener effect via silicon diode automatically safeguards the moving coil from burn-out. Also functions against pulse voltage in television circuit checking.
- Solid-state diode rectifier obtains stability measurement extending frequency coverage up to 100kHz for lower ranges.
- High voltage probe is available extra to align television circuits.
- As a Sanwa TR Series multitester, the specific LI and LV scales provided serve to check characteristics of semiconductors by reading current and voltage applied simultaneously with resistance.
- For better insulation and ruggedness, the front panel and rear case are moulded from plastics.

#### Measurement Ranges

DC voltage: 0.3V 1.2V 3V 12V 30V 120V 300V 1.2kV 6kV (20kΩ/V) 25kV (with probe)  
 AC voltage: 6V 30V 120V 300V 1.2kV (8kΩ/V)  
 DC current: 60μA 3mA 30mA 300mA 1.2A (300mV)  
 Resistance: Range · ×1 ×100 ×1K ×10K  
 Midscale · 25Ω 2.5kΩ 25kΩ 250kΩ  
 Maximum · 5kΩ 500kΩ 5MΩ 50MΩ  
 Load current (LI): 60mA 300μA 60μA  
 Load voltage (LV): 1.5V 1.5V 1.5V

Volume level: -10~+17~+63dB

Accuracy: Within ±2.5% for DC range up to 1.2kV.  
 Within ±4% for DC 6kV range.  
 Within ±3% for AC ranges.  
 Within ±2.5% for ohm ranges.

Batteries: 1.5V×1 and 22.5V×1  
 Size: 170×116×59mm

## 430-ES Multitester



- Meter movement of 10 microamperes, doubly protected by silicon diode circuit and spring-backed jewel bearings.
- Common terminals for DC and AC current measurements. Two AC current ranges read on single scale because of equalized characteristics.
- Solid-state germanium diode rectifier.
- Flat frequency response up to 100kHz.

#### Measurement Range.

DC voltage: 0.3V 3V 12V 30V 120V 300V (100kΩ/V)  
 1.2kV 6kV 30kV (with probe) · (16.6kΩ/V)  
 DC current: 12μA 0.3mA 3mA 30mA 300mA 1.2A 12A (300mV)  
 AC voltage: 3V 12V 30V 120V 300V 1.2kV · 5kΩ/V  
 AC current: 1.2A 12A  
 Resistance: Range · X1 X10 X100 X10K  
 Midscale · 40Ω 400Ω 4kΩ 400kΩ  
 Maximum · 5kΩ 50kΩ 500kΩ 50MΩ  
 Volume level: -17~+63dB  
 Accuracy: Within ±2% (10% for 6kV and above) fsd for DC voltage.  
 Within ±2% fsd for DC current.  
 Within ±3% fsd for AC voltage.  
 Within ±2% of scale length for resistance.  
 Frequency coverage: 50Hz-100kHz for AC 30V and below (±3%)  
 10kHz for other AC voltage ranges.  
 Batteries: Four 1.5V (UM-3) and one 1.5V (UM-2) dry cells.  
 Size & weight: 179×133×85mm & 1400 gr

## SH-63TR<sub>D</sub> Multitester



- Protected by silicon diode circuit.
- Stabilized AC voltage reading by solid-state rectifier and frequency coverage extended up to 100kHz.
- Current loss minimized by high input impedance (20k ohms/volt for DC and 8k ohms/volt for AC).
- Standard HV probe of sealed-in 480-megohm resistor

#### Measurement ranges.

DC voltage: 0.25V 1V 2.5V 10V 50V 250V 1000V (20kΩ/V)  
 AC voltage: 1.5V 10V 50V 250V 1000V (8kΩ/V)  
 DC current: 50μA 2.5mA 25mA 250mA (250mV)  
 Resistance: Range · X1 X10 X100 X1000  
 Midscale · 25Ω 2.5kΩ 25kΩ 250kΩ  
 Maximum · 3kΩ 300kΩ 3MΩ 30MΩ  
 Minimum · 0.5Ω 50Ω 500Ω 5kΩ  
 Load voltage: 1.5V 1.5V 1.5V  
 Load current: 60mA 600μA 60μA  
 Volume level: -15~+5dB for AC 1.5V range  
 0~+22dB for AC 10 volt range and up to +62dB  
 Accuracy: ±3% fsd for DC voltage & current  
 ±4% fsd for AC voltage (±6% for 1.5V range)  
 ±3% of scale length for resistance  
 Batteries: One each 1.5V (UM-3) and 22.5V (BL-015) dry cells.  
 Size & weight: 160×103×64 mm & 730 gr approx.

## U-50<sub>D</sub> Multitester



- Meter movement of 35 microamperes safeguarded by a protection circuit.
- Reading error eliminated by battery sheaths.
- Shunt adapter separately available.

#### Measurement Ranges:

DC voltage: 0.1V 0.5V 5V 50V 250V 1000V (20kΩ/V)  
 AC voltage: 2.5V 10V 50V 250V 1000V (8kΩ/V)  
 DC current: 50μA 0.5mA 5mA 50mA 250mA  
 Resistance: Range · X1 X10 X100 X1K  
 Midscale · 50Ω 500Ω 5kΩ 50kΩ  
 Maximum · 5kΩ 50kΩ 500kΩ 5MΩ  
 Volume level: -20~+62dB  
 Accuracy: ±3% for DC and ohm ranges  
 ±4% for AC ranges  
 Batteries: Two 1.5V dry cells (UM-3 or equivalent)  
 Size & weight: 131×89×41mm & 445 gr  
 Accessories available:  
 Shunt adapter High voltage probe  
 Clip adapter Carrying case

For full details contact the Exclusive Sanwa Specialists...



**WARBURTON FRANKI**



**SANWA ELECTRIC  
 INSTRUMENT CO., LTD.**

Dempe Bldg., 2-chome, Sotokanda, Chiyoda-ku, Tokyo, Japan. Cable: "SANWAMETER TOKYO"

# GLOBAL SATELLITE PLAN NEAR COMPLETION

The development of communications satellites, which has brought about a revolution in world communications, has also been responsible for a new era of international co-operation on a hitherto unprecedented scale.

By Kenneth Owens (Technology Correspondent, "The Times")

The successful placing of an Intelsat III satellite over the Pacific Ocean in February this year is the second stage of a global satellite system due to be completed this year.

The Atlantic Intelsat III is already operating, and this will be supplemented by a further launching later this year. The scheme will be completed by an Indian Ocean satellite, also due for launching this year. When the Intelsat III system is fully operational, Australia will have direct communication facilities with the U.S.A., Japan, Hong Kong and other Asian countries via the Pacific satellite; and with India, Africa and Europe via the Indian Ocean satellite.

The Intelsat network will provide Australia with a wide range of international services. Through the earth stations operated by the Overseas Telecommunications Commission (Australia) at Moree, N.S.W., facilities are available for telephone, telex, data transfer, photo-telegraph, television and leased circuit links. The extra channels made available by Intelsat will relieve the overburdened Compac cable system. The Moree station was officially opened in 1968 (See "Electronics Australia" May, 1968) using equipment supplied and installed by Collins Radio Co. (Australasia) Pty. Ltd., a member of the Australian Telecommunications Development Association. Moree began operating with Intelsat III in mid-February. The present Carnarvon, W.A., earth station will operate with the Intelsat satellites when a second station is constructed there for use by N.A.S.A. Another station, at Ceduna, S.A., is currently under construction.

Behind these technological feats (that are already being taken for granted) lies a new internationalism—not only in the actual process of communication but also in the planning and operation of the complicated systems involved and in the manufacture of the spacecraft, ground stations and associated equipment.

No fewer than 61 countries are now members of Intelsat (International Telecommunications Satellite Consortium). Intelsat is concerned only with planning and acquiring the "space segment"—that is, the satellites—leaving individual countries to plan and build, or buy, their own earth stations.

Such is the interest in earth stations at present that more than 50 countries sent delegates recently to a London

conference on the planning and operation of these stations.

Britain's experience in the design and construction of communication satellite earth stations stems from its pioneer work on Manchester University's 250ft diameter radio telescope at Jodrell Bank, Cheshire—which is still the largest fully steerable paraboloid aerial in the world—and on other smaller aerials at Jodrell Bank. Jodrell Bank knowhow went into the Post Office earth station at Goonhilly Downs in Cornwall, south-west England, now expanded to include a second big aerial.

At the opening of the London conference, Britain's Postmaster-General, Roy Mason, was able to report: "Goonhilly has a reputation second to none in the quality and reliability of the service provided. We are proud of its immunity against climatic conditions. This arises directly from the bold decision taken at the outset not to protect the aerial with a radome as was done at all other stations in the original network.

"Not even the notorious English weather can seriously degrade the service offered by the earth station. During three years of operation with Early Bird only once has the received signal been noticeably degraded. The other stations have all suffered loss of service through the effects of moisture on their radomes. In building such an unprotected aerial, the United Kingdom set the pattern for the current generation of earth stations."

On Ascension Island, another British earth station has an exacting and unusual role in the United States space program. It is part of the Atlantic network used to maintain continuous radio contact with the American Apollo spacecraft on its way to and from the moon. Operated by Cable and Wireless Ltd., the station was designed, built, installed and handed over by The Marconi Company in less than 12 months at a cost of just over £1 million.

Other Cable and Wireless stations are being built at Hong Kong and Bahrain, and another is planned for Mount Margaret, Kenya; and a number of military earth stations are in use and being built by Britain's Defence Ministry.

Latest recruits to the earth-station business in Britain are the Crown Agents, well known for civil engineering and project management in many parts of the world. In association with the Post Office, they are now offering



O.T.C.'s earth station at Moree, now working with Intelsat III.

"Crown Communications" — an advisory service covering the selection, design and operation of earth stations anywhere in the world.

Things are moving rapidly in the "space segment," too. "In the future," the British Postmaster-General said at the conference, "satellites will certainly be used to allow computer to speak with computer from one side of the world to the other, just as if they were next door to each other. Based on tests and calculations already made, engineers have evolved schemes enabling aircraft to communicate with their base stations via satellites. Many such developments can be solved technologically as soon as the commercial need is clear."

Although the United States and the Soviet Union have a clear lead in the design and construction of spacecraft, other countries are now becoming involved in this area of technology.

France and Federal Germany are jointly developing a communication satellite known as Symphonie; Europe may develop another tailored to the needs of the Eurovision television network and from now on any spacecraft ordered for the Intelsat consortium will have to be international rather than purely American.

Only recently an ambitious new satellite, 22 feet tall and able to handle 25 times the communications capacity of the famous Early Bird, was proposed by Hughes Aircraft Co., of California, to meet the so-called Intelsat IV requirement for a new generation of satellites for the 1970s.

This would be built by companies in 11 countries. Hughes would be prime contractor, with the British Aircraft Corporation as the major sub-contractor and other sub-contractors in France, Federal Germany, Switzerland, Belgium, Italy, Sweden, Spain, Japan and Canada.

Satellites will not replace cables, but will complement them, adding flexibility over larger areas and opening up new markets. An idea of the traffic involved is given by the capacity of Hughes' proposed Intelsat IV spacecraft. Just one of these satellites will be able to carry 6,000 two-way telephone calls—or 12 colour television programs. The experts are not exaggerating when they talk about a global communications explosion expected in the 1970s. ■



Broadcasting control centre of NHK's five network complex, where TOPICS is installed.

## Japan's Computer-controlled Broadcast Network

The Japan Broadcasting Corporation, in Tokyo, has put into operation a computer complex which both plans and administers the entire production and scheduling operation of two television and three radio networks.

Broadcasting in Japan is organised on roughly similar lines to the Australian system, with a national body operating in competition with commercial organisations.

The Japanese Broadcasting Corporation (known as NHK, from its Japanese name, Nippon Hoso Kyo-kai) is a public service corporation supported by compulsory subscription and operated under the Japanese broadcast laws. It operates two television networks (one of which is educational) two AM broadcast networks, and an FM broadcast network. Its revenues are derived entirely from the subscriptions paid by the public, amounting to slightly less than \$1 per month for television only. There is no charge for sound broadcasting.

NHK broadcasts more than 100 hours of programs each day, entirely without commercial announcements. The main television network is the General Television Service, with 684 stations. This is supplemented by the Educational Television Service with 676 stations. The AM and FM broadcast networks have 307 stations, some of which are used for an Educational Radio Network. These services cover about 95 per cent of Japan's land area, and reach some 20 million households. This large scale operation is now largely under the control of the computer system.

IBM, who supplied the system, call it TOPICS, an acronym meaning Total On-line Program and Information Control System. It consists of a duplicated IBM System 360/Model 50, and an 1800 Data Acquisition control system computer. Peripheral equipment includes 184 visual communications terminals with typewriter type keyboards; and eight graphic display terminals equipped with electronic light

pens. The pens are used to simulate alternative schedules and assignments before the information is fed to the computer.

Despite the advanced equipment used in the system, TOPICS is functionally relatively simple. It has two major parts — one supporting planning and production, the other on-the-air broadcasting of sound and television programs.

Based in Tokyo, the TOPICS network performs the following basic functions:

- Integration of program planning and scheduling.

- Scheduling of production and control of costs.

- Allocation of facilities and equipment, and assignment of personnel.

- Maintenance of inventories of broadcast materials.

- Control of on-the-air operations.

The system will also provide management reports when called upon to do so, and undertake general accounting.

In its planning and production role, TOPICS serves as a central file containing information about NHK's production and broadcasting activities. The information it files is comprehensive. It includes details of what programs are in production, and at what stage of completion; what they are about and when they are scheduled for broadcast; who is directing them, acting in them, building the sets and supplying the props for them; when and where they will be rehearsing, when they will be taped and on which machine; whether they are coming in on schedule or whether reinforcements will be needed to bring them in on time; who worked on them and for how long, and how much they were paid. All this information, which is

the substance of almost all the telephone and memo exchanges in conventional production techniques, as in the files of the IBM System 360/Model 50 computer.

The files serve as a central repository and anyone who needs to know about any detail of production need not get caught up in a tangle of communications: he has only to turn to the computerised file in TOPICS for an answer. Thus, as far as production is concerned, NHK personnel communicate with each other through TOPICS. A director, for example, no longer need compile a schedule, mimeograph it and distribute it. He now compiles it and enters it into the central file. In fact, he compiles it with the help of the file, for it contains all the information he needs in the first place.

Once in TOPICS, the schedule and the personnel and resource assignments included in it are available to anyone. The availability, moreover, is direct: there are no intermediaries between inquirer and computer.

Anyone with a question walks to an IBM 2260, presses a few keys, and is immediately presented with the information he seeks, on a CRT display.

Paperwork is just about eliminated; there is not even the need to copy down a schedule because it can be instantly called up on any of 184 terminals, one of which is within easy reach of any person authorised to use the system.

Changes in schedules and programs are as easily and promptly entered into the system. The display screen is both output and input, presenting to the viewer what is in the system and accepting from him changes to up-date subsequent output. Since schedules and assignments are negotiated through the computer, its files are always up to date.

TOPICS is thus a centralised information bank, collecting and disseminating information.

In addition to mediating in the production of programs, TOPICS, in its

# THE BIG NAME IN IMPORTED AMPLIFIERS!

With specifications that demand attention and most effective quality control in manufacture, it's not surprising that Sound stereo amplifiers command a high proportion of the markets in their respective price ranges. In Australia Encel prices make Sound amplifiers better value than ever. Ask for a trade-in valuation when you write or call!

# SOUND

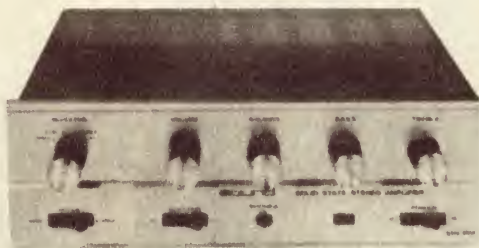

## SOUND MODEL SAQ-505X SOLID STATE STEREO AMPLIFIER

With an output of 50 watts R.M.S. into 8 ohm speaker systems, the 505X represents outstanding value for money. Frequency response is 20-20,000 Hz.  $\pm$  1dB, and extends well beyond this range. Sensitivity is 3 mV. for magnetic cartridges and all desirable control facilities are incorporated. This powerful amplifier is bargain priced by Encel Electronics at only **\$119.50**

\*COMPLETELY SOLID STATE



## SOUND MODEL SAQ-203 SOLID STATE STEREO AMPLIFIER

Frequency response is 30-20,000 Hz. and input sensitivity suits magnetic cartridges at 3 mV. Output is 12 watts R.M.S. or 30 watts E.I.A. peak power. 18 low noise transistors. Headphone jack, all necessary controls, attractive front control panel. Speaker matching for 4, 8 and 16 ohm speakers or speaker systems. An ideal compact amplifier for use with tape recorders or for building into cabinets and bookshelves. Inc. sales tax **\$74.50**

# SONICS

## LOW COST, HIGH PERFORMANCE SPEAKER SYSTEMS

- A** MODEL AS-57. A bookshelf unit measuring only 15 1/2" x 5 1/2" x 8 1/2". Fitted with a wide range oval speaker . . . ideal for use with tape recorders and stereo systems where space is a vital consideration. Hand finished teak/walnut cabinet. Inc. sales tax **\$22.50**
- B** MODEL AS-60E. Although only 18 1/2" x 12 1/2" x 5 1/2" the AS-60E is fitted with a bass/mid-range speaker and a separate high frequency reproducer. An excellent speaker system which has proved very popular with audio enthusiasts. Hand finished teak/walnut cabinet. Inc. sales tax **\$27.50**
- C** MODEL AS-61. A true "Slimline" enclosure with four bass/mid range speakers and a high frequency reproducer. Measures only 4 1/2" in depth; height is 21 1/2" and width is 17 1/2". Finish is teak/walnut and the legs are detachable. Probably the most popular multiple speaker system ever offered at this price in Australia. Inc. sales tax **\$38.50**
- D** MODEL AS-202. A 3 speaker, 3 way speaker system which measures 20 1/2" x 11 1/2" x 11 1/2", the AS-202 is a recent addition to the Encel Sonics range. An 8" woofer and a 6 1/2" mid-range speaker are incorporated — and a high frequency reproducer completes the speaker complement. Will handle 10 watts R.M.S. with ease. Beautiful hand finished teak/walnut cabinet. Inc. sales tax **\$46.50**
- E** MODEL AS-303. A magnificent hand finished teak/walnut speaker system with three speakers and a 3 way crossover network. A 12" woofer with a long throw voice coil provides excellent bass response, a 6 1/2" mid-range speaker cover the middle ranges and a horn type tweeter comes in at 5 kHz. Power handling capacity is over 15 watts R.M.S. Extremely wide frequency response free of coloration. Size: 25" x 14 1/2" x 11 1/2" Inc. sales tax **\$68**

All "Sonics" enclosures are 8 ohms impedance.

### SONICS STEREO 'PHONES—\$12.50

Model HS-304 Sonics stereo headphones are very comfortable and offer fatigue free listening on a personal basis. Wide frequency response and remarkable stereo presence **\$12.50**

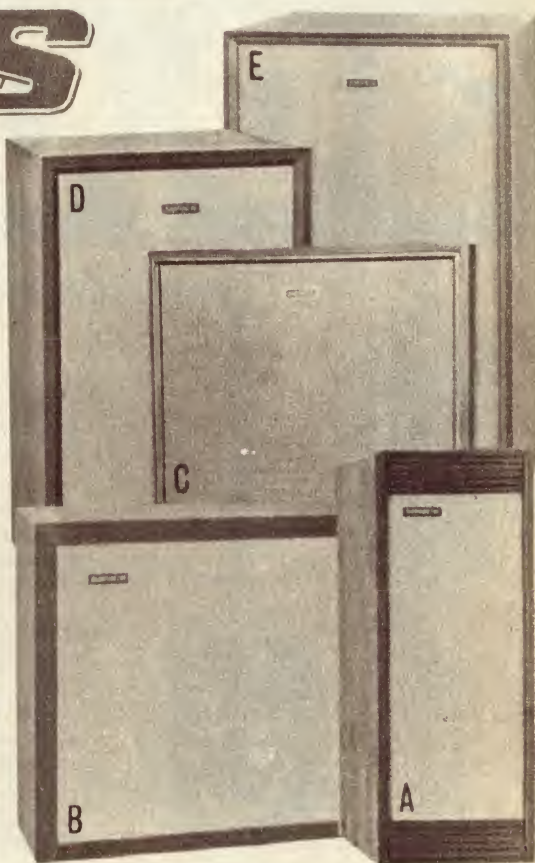

# ENCEL

**ELECTRONICS (STEREO) PTY. LTD.**

Head Office:  
431 Bridge Rd., Richmond, Victoria 3121. Tel. 42 3762.  
Sydney Store: Ground Floor, 25M Building  
257 Clarence Street, Sydney, N.S.W. 2000. Tel. 29 4563, 29 4564.  
Australia's Greatest Hi-Fi Centre \*Wholesalers \*Trade-ins accepted



# you can see

what we mean  
when we say

# Mullard

numerical and character indicators have

# 30,000+

hours of life expectancy

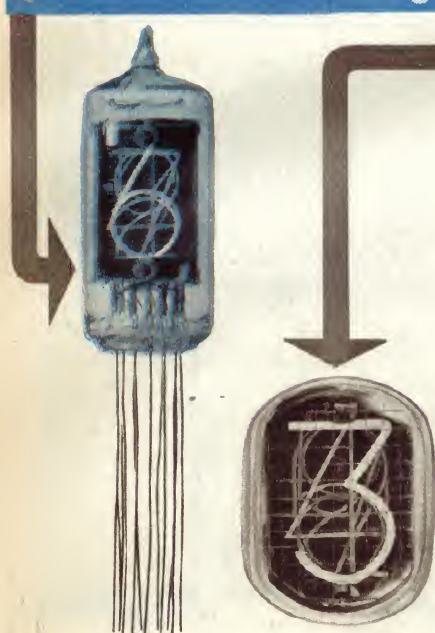

Mullard Numerical and Character Indicator Tubes are gas-filled cold cathode valves which display numerals or characters by means of the glow discharge phenomenon. Symbols are positioned in line within the bulb with only the energized one showing.

All numerical and character indicator tubes exhibit special quality characteristics, and Data Sheets provide details of recommended operating conditions and life expectancy, which may be of the order of 30,000 hours.

Most numerical and character indicator tubes can be obtained in two different versions. In the standard range, the bulb incorporates a tinted filter to improve the contrast of the display. The alternative version is supplied without the tinted filter and is recommended for equipment where a number of tubes are mounted side by side, using a combined filter window.

A leaflet describing the complete range of indicators is available from the Technical Service Department at the addresses below.

**Mullard**

MULLARD-AUSTRALIA PTY. LTD.

35-43 CLARENCE STREET, SYDNEY, N.S.W. 2000. 29 2006. 123 VICTORIA PARADE, COLLINGWOOD, VIC. 3066. 41 6644. MULLARD LIMITED, LONDON



Associated with

M207

# The TOPICS system

Initial plans for programs are laid down by a planning board and registered in an off-line Master Program File with capacity for a year's programs. This file serves as a reservoir, dribbling its contents into the files of the main computer as programs are finished and room becomes available there. Soon after a program plan enters the main systems file, it is called up by a Broadcast Control Centre (BCC) manager on one of the eight Graphic Display Units, and he supplies some details of production. BCC managers also resolve any difficulties that arise. Program directors and other production personnel learn of their assignments made by BCC, by means of Visual Display Terminals. Directors, using these terminals, are assisted by the computer in developing complex production schedules. Performance of the finished program is broadcast or taped. In either case the mechanics are controlled by the Automatic Control System. The line from the "News Centre" to the on-the-air matrix indicates that broadcasts may be interrupted for news flashes.

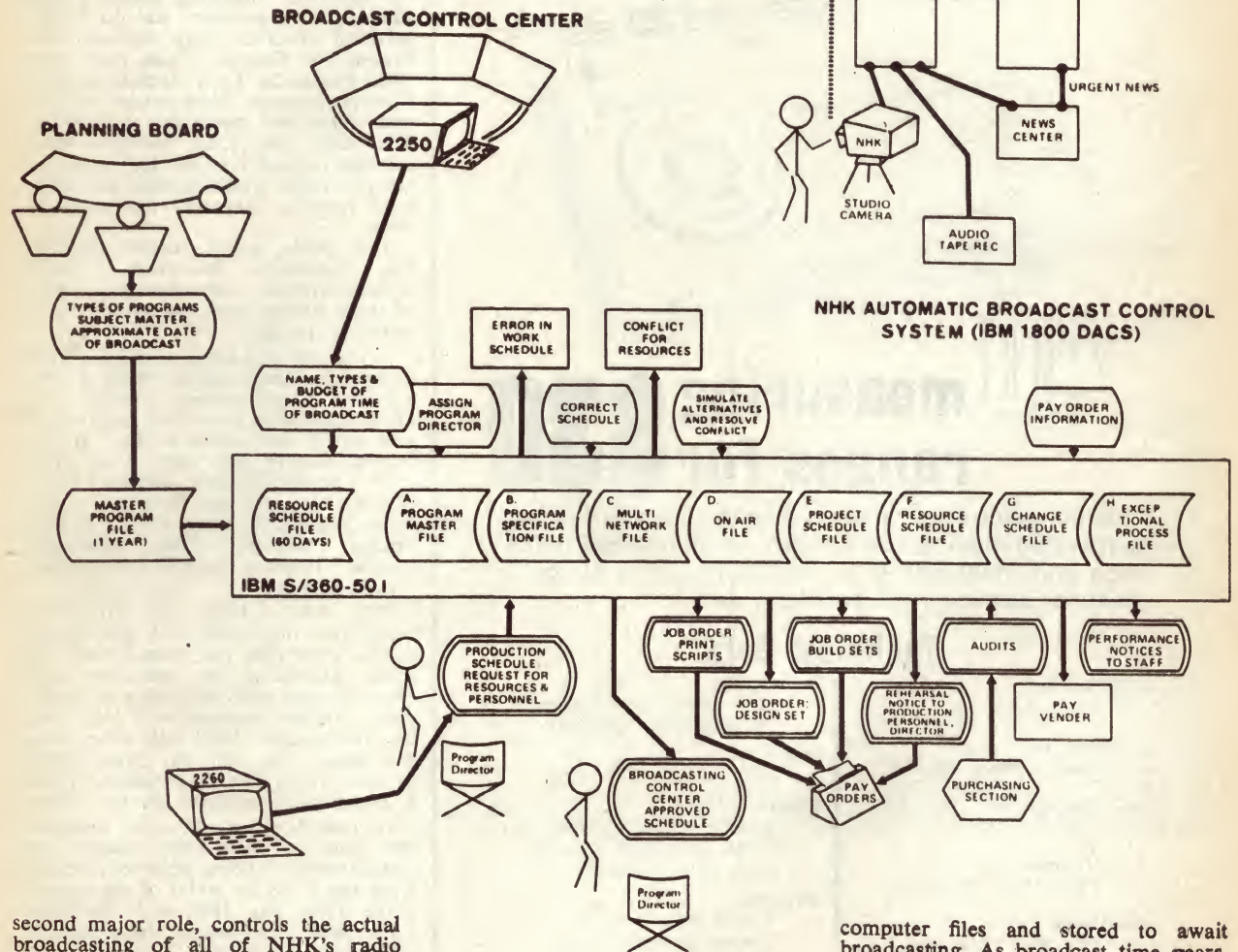

second major role, controls the actual broadcasting of all of NHK's radio and television programs. In its former role, TOPICS deals with information about the real world, with numbers that represent studios, times, people and other resources. As a broadcasting controller, TOPICS deals also with the real world itself—with real tape recorders, kinescopes, and switching matrices. NHK calls that part of TOPICS its ABCS—Automatic Broadcast Control System.

The "centre" of ABCS is the IBM 1800 Data Acquisition and Control System. Every 10 minutes the ABCS receives orders from the System/360 computer to cover the next period of broadcasting and recording activity.

ABCS expands the orders into the longer, more complex routines needed

to translate them into action. Given the order to ready a video tape recorder to receive the output of a specific studio, for example, ABCS finds a path through a complex array of switches, called the preset matrix, thus connecting studio to recorder. ABCS then runs the recorder through a warm-up and check-out routine so that it is ready for recording precisely when the performance is scheduled to begin. It then monitors the recording process, rewinds the tape when recording is finished, and shuts down the recorder.

After the performance, the canned program is registered in TOPICS'

computer files and stored to await broadcasting. As broadcast time nears, the system displays a schedule that alerts an operator to mount the tape on a specified tape recorder.

Twenty minutes before air time, ABCS establishes a path in the preset matrix, checks that the right reel of tape is on the tape recorder, and warms up and checks out the device. Ten seconds before air time, ABCS starts up the recorder. And then 300 milliseconds before air time, it switches the recorder into the on-the-air matrix and sends the program to air.

The two IBM System 360/Model 50 computers used have 512K byte main storage. The two are duplexed, one being on-line; the other, standing by. The standby computer, which can take

# Measure

**Amps, Volts, Ohms,  
Temperature with**

# Normatest



**40** measuring **\$30**  
ranges for

This compact multirange instrument has taut ribbon suspended moving coil system. High internal resistance and measures D.C., and A.C. up to 30 kc/s. Ideal for service work and field use.

## Technical Data

<b>D.C. Current</b> 30 $\mu$ A to 6A	<b>Temperature</b> 20 to 240° C (with accessory Fe—Con.—thermocouple)
<b>D.C. Voltage</b> 12mV to 600V (20,000 $\Omega$ /V)	<b>Level</b> - 20 . . . . 0 . . . . +6dB
<b>A.C. Current</b> 150 $\mu$ A to 6A	<b>Supplied With</b> 1 pair of Measuring Leads 0.75m length with lockable banana plug and prods
<b>A.C. Voltage</b> 1.5 to 600V (4000 $\Omega$ /V)	<b>Optional</b> 1 temp. feeler with Fe— Constantan thermocouple
<b>Resistance</b> 10 to 5M $\Omega$ (2 ranges)	

Further information from—

**jacoby, mitchell**  
**& co. pty. ltd.** **26-2651**  
**469-475 kent street, sydney**

MELBOURNE 30-2491  
ADELAIDE 53-6117  
BRISBANE 2-6467  
PERTH 28-1102  
LAUNGESTON 2-5322



JM/22-68

over primary functions in less than 10 minutes, works while standing by at payroll and conventional computing tasks.

The Model 50s share two IBM 2314 Multi-Disk Storage Units, each with a capacity of more than 200 million bytes, containing the data files and the Operating System programs. Two IBM 2303 Drum Storage Units, also shared, store on-line transmission control and transaction information; they also provide fast response to the terminal communication links.

The central processing unit of each Model 50 is divided into four partitions (MFT), thus enabling it to process four different tasks simultaneously. One partition controls the 2250 Graphic Display Units; a second partition controls the 2260 Display Terminals; a third contains SMART, the pivotal group of programs that serve the networks' manifold planning and administrative activities; and the fourth partition transfers data between the System 360 Computer and dual IBM 1800 Model 2d Data Acquisition and Control Systems. Information can be sent from one partition to another. The 2250 and 2260 partitions also exercise subtask control, for up to 20 separate tasks, which exceeds the traffic load generally expected for any one time.

The 1800s, which control the on-line Automatic Broadcast Control System (ABCS), each have 64K bytes of main storage and two million bytes auxiliary storage.

A sophisticated high-speed Data Link Subsystem, operating at 40.8K bauds, provides communication between the 1800s located in the NHK head office and ABCS equipment located at the Yoyogi facility, five miles away. The IBM Federal Systems Division, FSD, specially designed and built this equipment. The equipment is similar to that linking NASA's Cape Kennedy-Goddard-Houston network for Gemini-Apollo missions.

The ABCS—1800 and DLS—are completely duplicated and are always in dual operation, one being prime, the other paralleling its operation and ready to take over when one is undergoing routine maintenance. Not only can the standby 1800 take over from the prime one, but any components of one ABCS can be switched in for a matching component in the other.

A console, also specially designed and built by IBM-FSD, affords the convenience of being able to monitor from one place the status of the system—the 360's, the 1800 and the Data Link Subsystem—and, if necessary, overriding automatic functions and taking manual control.

The console shows which components of the system—the 360s, the 1800s—are prime, which standby and which are undergoing maintenance. System requirements are the following:  
System life: five years (Sept., 68-Aug., 73).

Operating Hrs. .day: 21, continuous.  
Switchover time: S/360—10 minutes  
1800 DACS—on-air switching, 300 milliseconds, max.

System response: on-line 2260s — 4.5 seconds, max.; on-line 2250s — 4.5 seconds, max. 1800 DACS on-air switching—300 milliseconds, max.

Traffic volume: 20 messages/sec, (2800 characters/sec) peak time. ■





# Technical Review

## U.S. Police Forces Seek Communications Privacy

Scrambling and encoding devices have been tried by some police forces in the U.S.A. to secure privacy of communications, but high costs of really secure devices, and disagreement over methods has led to considerable reluctance in some quarters to install scramblers.

Almost all policemen say they need communications privacy, but there's little agreement on how much is required or the best way to get it. There is some consensus on the main problem. Systems with the desired features cost more than most departments can afford. This difficulty is illustrated by two new products: a device that can operate on as many as 1,024 codes but costs \$2,500 in single units, and a scrambler that costs less than \$300 but is conceded by its maker to be far from ideal.

On most matters, however, even officials in the same city sometimes disagree widely. In Los Angeles, for example, Anthony Gains, chief of the city's electronics division, says the traditional technique of frequency inversion is simple, effective, and reasonably priced. But Noel McQuown, the city's deputy police chief, says, "We have a man who can 'read' scrambled or inverted voice transmissions—without equipment—as well as our officers can understand regular transmissions. Voice inverters are not satisfactory. We're using this technique on one of our frequencies and we're convinced it's not the answer. It's a simple system and can easily be compromised."

And Walter Key, director of communications for the Chicago police, feels the same way: "It doesn't take much to unscramble a frequency-inverted message by someone who puts a little effort into it."

But many manufacturers believe frequency inversion fills the bill for most of today's needs. This adequacy—and the method's low cost—mean that voice-inversion devices are emphasised even though few in industry or public safety believe this technique is the ultimate solution to the eavesdropping problem.

Some authorities doubt the need for voice privacy. Crime studies found "no stated need" for scramblers, says Robert Emerich of the office of law enforcement assistance at the Justice Department. Emerich, one of the men in charge of Federal grants to police departments for testing of new

devices, says that no money has been awarded for scrambler tests and that the department is looking to teleprinters and digital communications to provide security.

When Motorola Inc. introduced a frequency-inversion device at a recent police convention the company stressed that the scrambler wasn't the ultimate answer.

Audio information is received at the microphone terminals of Motorola's equipment and converted into double-sideband suppressed carrier information in a balanced modulator. Low-pass filtering then eliminates the upper sideband, resulting in a scrambled signal that's a frequency-inverted image of the original information.

In the receiver, audio from the discriminator is fed into the scrambler, where an identical frequency conversion occurs, transforming the audio signal to its original makeup. A clear

or code selector switch turns the scrambler on or off. The unit sells for less than \$US300.

The usual echo or "rain barrel" effects encountered with this type of scrambler have been eliminated through the use of fast rise-time computer switching techniques.

A number of police officials have long opted for car teleprinter systems that can automatically record both messages and the output of a computer. And they've sought to increase security even more by getting a system that would route the message to only the car or cars being called.

Motorola, in effect taking both sides of the voice-vs.-printer issue, also showed such a system at the convention. The VP-100, whose price hasn't been disclosed, prints 100 characters a minute. An array of 35 dots in a 5-by-7 matrix forms each character. Impulses bend six piezoelectric ceramic crystals, which deflect the printing bar. The bar forms each character's pattern of dots and spaces on paper containing a self-marking material.

For those who want more privacy than frequency inversion allows, Technical Communications Corp., a small

(Continued on page 173)

## Infra-red telephone gives complete security

One device being tried by police in U.K. to secure communications privacy is this optical telephone, developed by the Telecommunications Group of The

Plessey Company Ltd. It uses infra-red radiation, and provides a speech link, which cannot be tapped. However, it has only very limited range at present—only half a mile in conditions of good visibility.



The optical telephone is only one of many electronic devices currently being tried out by British police. Some squad cars have been fitted with radio facsimile devices made by Muirhead Ltd. The machine can receive pictures (of wanted men, for example) or maps, while the car is in motion and its use does not interrupt use of the speech channel.

# The new MINISCOPE



Engineered for the Professionals...

Today's most modern  
soldering tool



Light as a feather . . .  
. . . A finger touch and it's HOT  
. . . that's right!  
. . . from cold to hot in seconds.  
So easy to use at any moment, anywhere.  
. . . Unless you need more heat than even a  
conventional 75 watt iron will give and  
that's very seldom, isn't it?  
Why not meet the mighty MINISCOPE?  
You'll be pleased you did.



AUSTRALIAN & OVERSEAS AGENTS:

**IRH COMPONENTS  
PTY. LIMITED**

THE CRESCENT, KINGSGROVE, N.S.W. 2208. TEL. 50 0111



# LIQUID CRYSTAL DISPLAYS HAVE PROMISING FUTURE

Liquid crystal displays which reflect light when an electric charge is applied have been developed, and may be the breakthrough that will eventually lead to flat screen television receivers.

The devices employ a new electro-optic effect — "dynamic scattering" — in liquid crystals to display print, pictures, and moving images. Because they reflect light, the displays are easier to read as the ambient light increases and impossible to see in total darkness. The flat, rugged and potentially low-cost displays require very little power and therefore can be driven and addressed by solid-state and integrated circuits.

A number of experimental devices that could lead to important new electronic products have been built at RCA Laboratories. Among them are an all-electronic clock with no moving parts and a high-resolution pattern display. The liquid-crystal displays give promise of becoming practical thin-screen competitors to the CRT used in radar and the Nixie tube used to display changing letters and numbers.

Examples of other potential products include electronic clocks and wrist watches, automobile dashboard displays, scoreboards, stock tickers, and, ultimately, pocket-size TV receivers that could be viewed in bright sunlight. However, it will be some time before there are any liquid-crystal display products on the market as considerable research and development work remains to be done.

The research program that led to the new technology resulted from the application of two discoveries:

1. That certain liquid crystals can be made opalescent and, hence, reflecting by the application of an electric voltage.

2. That the temperature range over which this occurs — originally confined to only a few degrees at high temperature — can be expanded with new materials to cover a wide temperature range from below freezing to the boiling point of water.

Liquid crystals can be defined as organic compounds that look and act like liquids — they can be poured and take the shape of their container — but their molecules tend to form into large, orderly arrays akin to those that make up such solid crystals as mica, quartz, and diamonds.

Liquid crystals are relatively common in nature — approximately one out of every 200 organic compounds is a liquid crystal. They have three forms — nematic, smectic, and cholesteric (figure 1). The RCA displays use nematic liquid crystals; the cholesteric type, which changes colour with temperature, is used in some temperature-indicating devices, while the smectic liquid crystals are of interest to the detergent industry.

When an electric field is applied to certain types of nematic liquid crystals, the field's presence creates ions that travel through the material (figure 2). These travelling ions then produce an effective turbulence that causes a dynamic scattering of light and give the liquid crystal its opalescence — a milky white appearance.

To construct a display, a thin film (1/1,000in thick) of liquid-crystal material is placed between two sheets of thin glass. The inner face of each sheet is coated with an electrode. At least one of the electrodes is trans-

parent so the display can be seen. This electrode is usually a conductive film of tin oxide. The other electrode may also be transparent, or it can be reflective, in which case it is ordinarily an evaporated film of metal, such as nickel or aluminium. In effect, the display is a parallel-plate capacitor with the liquid crystal acting as the dielectric. When a charge is applied to the two glass plates, the sandwich takes on the appearance of frosted glass. The frostiness disappears, however, as soon as the charge is removed.

To display patterns such as letters, symbols, or still images, the coatings are shaped in accordance with the desired pattern. The symbols and letters can be changed merely by applying the electric field to different segments. To display motion, the conductive coatings are laid down in the form of a fine mosaic whose individual elements can be addressed independently in accordance with a scanning signal like that used for facsimile, television, and other electronic displays.

The amount of frostiness can be controlled because liquid-crystal displays have a gray scale that varies with the intensity of the applied voltage, which ranges from 6 to 60 volts. The power required for a reflective display is one milliwatt per square inch and can be either DC or pulsed.

Compared with whiteness of bond paper, the liquid-crystal displays have an efficiency of 50 to 60 per cent. The resolution is 500 lines per inch. The displays can be turned on in 1 to 5 milliseconds, and turned off in about 30 milliseconds. They accept information at a 60-microsecond rate, which happens to be about equal to the time required to scan a single TV line. The contrast of the displays—which is independent of the amount of ambient light—is 15 to one. ("Electronics World," November, 1968).

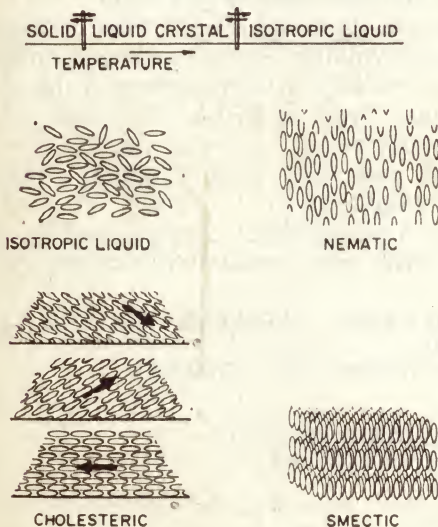

Figure 1

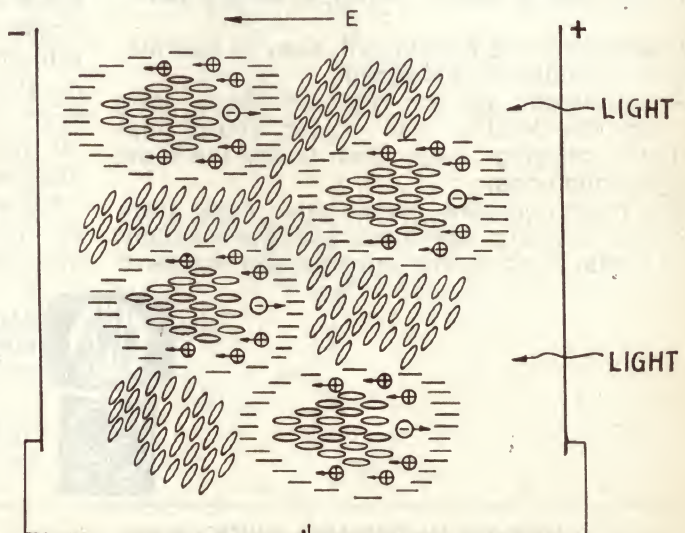
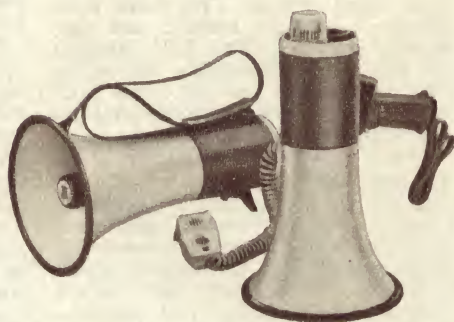

Figure 2



no shouting needed:



# TOA MEGAPHONES

If you've got something to say, if you direct traffic, train a team, fight a fire, direct construction, start a race, make a movie, or simply sound off.

TOA amplifiers are lightweight, easy to operate, rugged and fully transistorised.

TOA equipment delivers high efficiency, long life and the kind of full colour sound that stretches carrying power even under the most difficult conditions.

ER308 hand-operated pistol type. Fully transistorised, battery operated. Maximum output is 16 watts. Special mic construction makes it

feed-back proof. This enables maximum volume. Projects voice up to 1,000 yds. Weight, 3.5 lb.

ER64 shoulder type. Details as ER308.

ER45 shoulder type as ER64. Plus equipped with emergency alarm. Red all over and covered in reflective red tape which glistens in the dark.

ER65 shoulder type as ER64. Maximum output 20 watts (most powerful in the world). Can be installed as stationary type. Projects voice to 1,500 yds. Weight, 6.5 lb.

All models are leakproof and backed by the unrivalled AWA sales and service organisation.



**AMALGAMATED WIRELESS (AUSTRALASIA) LIMITED**

Australia's National Wireless Organisation



**TOA ELECTRIC CO. LTD.**  
Public Address Equipment

**AMALGAMATED WIRELESS (AUSTRALASIA) LIMITED:** Sydney, Newcastle, Canberra, Brisbane, Melbourne, Hobart, Launceston, Adelaide, Perth; and also Chandlers Pty. Ltd., Queensland, and Newton McLaren Ltd., South Australia.



# NEW HIGH-POWER RECTIFIERS ARE SMALLER AND SIMPLER

Until recently, mercury arc rectifier valves used for high-voltage rectification were becoming ever larger. Now much smaller valves have been developed, which are also simpler and cheaper.

The need for such rectifiers has arisen because in many parts of the world, bulk electric power is better transmitted as direct current than as the more conventional AC. Where bulk power must be transmitted either over very long distances by overhead line, or over shorter distances underground or underwater, it is profitable, in technical as well as economic terms, to convert to DC near the generating station and then to convert back to AC for local distribution.

It is well known that the most economical way of transmitting power is at the highest possible voltage. In this way, the current is kept low and the loss of power due to heating of the cable minimised. It follows that where AC to DC conversion is required, the valves must be able to withstand the highest practicable volt-

Figure 1

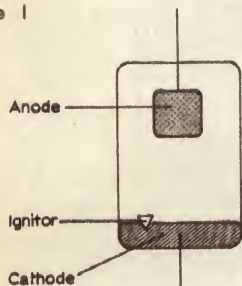

ages. This has led to increases in the physical size of these valves to the point where monsters 15 feet high are in use.

Recent developments have shown the potentialities of a particular type of discharge device, the mercury arc tube, as a rectifier for the very highest voltages and currents. But how does a discharge rectify? In fact, it does not, since a discharge, or plasma, has many of the both-ways properties of a conductor. But it happens that it is much easier to start a discharge to (rather than from) a mercury cathode than to a cathode of almost any other metal. Thus a valve comprising a mercury cathode and a steel or graphite anode, with the discharge (through mercury vapour) between them, makes a tolerable rectifier (see figure 1). A starter electrode, or igniter, is often used to establish the discharge at the mercury pool. It is from this basic principle that the sophisticated modern rectifier for high voltages has been developed. It happens that the same tube can be used to convert back to AC the DC power that has been transmitted.

What considerations determine the

design of a large rectifier valve? Most important is the time taken for mercury vapour that has been conducting to lose its ionisation. It is paramount that residual ionisation left by the current which has passed in the conduction period shall be cleared away before the reverse half-cycle of the alternating voltage appears. The larger the current passed, the longer deionisation takes, and this determines both the current rating and the rate at which a reverse voltage can be applied. In other words, the deionisation rate determines the power that the valve can handle, and development has therefore concentrated heavily upon making deionisation more efficient.

The other crucial parameter is cost. It is clearly not worth converting to DC if the resulting saving in cabling, insulation and so on are outweighed by the high cost of the rectifier and inverter equipment. Not only must the high cost of the valve itself be kept down; the life time and the costs of ancillary equipment and of the installation are important.

The problems involved in developing high-power rectifier valves have been patiently tackled by ASEA of Sweden. The mercury pool rectifier was developed from a small simple valve to a very large and complex unit. This has four parallel anodes and requires extensive ancillary control systems to maintain the appropriate voltage distribution and optimum working temperatures for different parts of the valves.

The general principle adopted was to help deionisation by inserting surfaces into the tube, upon which electrons and ions from the discharge could be absorbed and recombine—rather in the way that cold surfaces are provided in condensers to recover the liquid from the vapour, in, for example, a steam plant. These surfaces take the form of baffles between the anode and cathode,

Figure 2

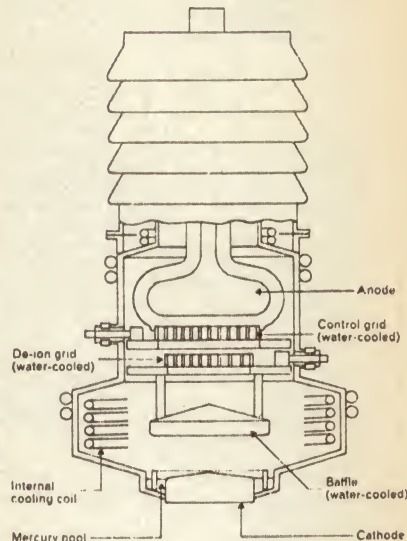
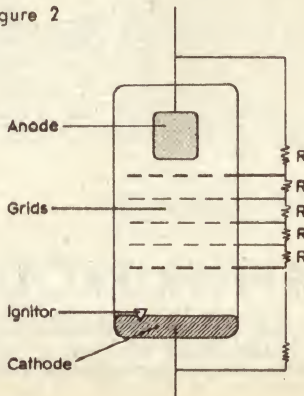

Figure 3

usually referred to as "grids" and made of graphite or other highly refined material which discharges find it difficult to strike (figure 2).

The grids are very important also in "grading" the potential difference across the tube. The very high electric stresses can cause breakdown of the valve in the non-conducting period. Increasing the length of the valve reduces the stresses, but paradoxically the chance of breakdown increases. This happens because there is then more gas between the electrodes to support the ionisation needed for breakdown. If grids are inserted, and maintained at intermediate voltages, then the space between each pair of grids—which act as anode and cathode to each other—contains less gas and the chance of breakdown is reduced.

Development has led to the very large ASEA rectifiers which incorporate no fewer than 24 grids in four separate anode "stacks," side by side. The grids spread the voltage as described, but they also result in heat loss and reduction in current-carrying capacity. This is the reason why four stacks are needed to achieve the required current rating.

That these valves are a technological success cannot be disputed, but their economic viability is more questionable. The drawback is their complexity: there is a need for something simpler.

Significant progress has been made in the past few years by breaking away from the logical, but ad hoc, development process of earlier years and concentrating on a few simple questions which were previously obscured. For instance, what fundamental features of the basic valve were known to contribute to the flow of current in the wrong direction (arc-back)?

By a combination of basic improvements on these principles, a combined

(Continued on page 173)

**D**ESPITE the initial reservations felt by many people, particularly with reference to servicing, the printed circuit is now firmly established in most types of electronic equipment, ranging from the incredibly cheap pocket radios that have flooded the country in recent years, to some of the most sophisticated professional equipment available. Its origins lie in weaponry — a heritage unfortunately common to many good "electronic" ideas, but printed circuitry is, and indeed has been for some time, an attractive system for the amateur who constructs his own equipment, for it solves the mechanical problems of component mounting and eliminates the chores of wiring — as well as facilitating a neat and workmanlike job. For the amateur who has so far shied away from etching his own boards, a new system is now available, which is both economical and easy to use, yet with care, is capable of excellent results. Known as **Cir-kit**, the system utilises bakelite boards, similar to those used commercially, in conjunction with self-adhesive copper strip. This is 1/16in or 1/8in wide — easily cut with scissors or a model knife — and attaches to the boards rather like a piece of Sellotape. The adhesive is very efficient, although the bond is not quite as good as that on pre-laminated boards — which means that care is needed when soldering not to overheat the copper. However, anyone who is competent to solder a transistor or capacitor without causing damage should have no trouble, and the adhesive improves with aging, so that long-term stability is satisfactory. Layouts can normally be planned using the theoretical circuit diagram as a guide, and boards may be pre-punched or drilled according to requirements. With the pre-punched board, the strip can either be laid over the holes, and then punched through with a small drill or a watchmaker's screwdriver, or it can be laid alongside the holes and component leads are inserted through the board, folded over and soldered (see photo). The former method permits a more compact layout.

A few tips on planning layouts. Always be sure that the component spaces you allocate are adequate — it is preferable to purchase the bits before embarking on this task, although capacitors are available in literally dozens of shapes for board mounting and resistors are more or less of standard size, dependent on ratings. Avoid siting adjacently on to your layout components which are in different stages — as this can lead to instability. If instability does occur, of course, **Cir-kit** does permit alterations to be made, although it is as well to investigate the problem before redesigning sections of the board for it may not prove necessary.

The excellence of the system, however, lies in its versatility, for it enables the home constructor to produce a wiring board on a one-off basis for most of the circuits described in this and other journals, and while it will no doubt encourage many to "try their hand," it will also enable many who already build their own equipment to achieve neater, more reliable results with a minimum of fuss.

**AVAILABLE ALL LEADING  
RADIO HOUSES.**

(SOLE AGENT)



**ZEPHYR PRODUCTS PTY. LTD.**

70 BATESFORD ROAD, CHADSTONE, VICTORIA—PHONE 56-7231

**MANUFACTURERS OF RADIO & ELECTRICAL EQUIPMENT & COMPONENTS**

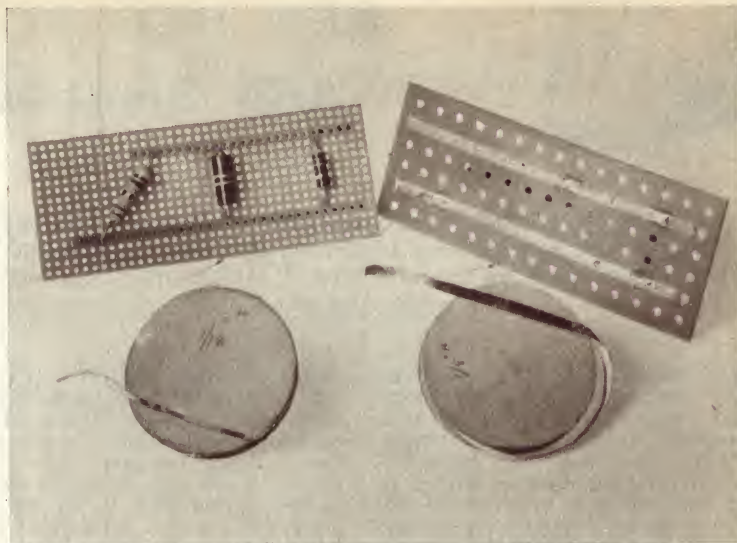

# INSTANT CIRCUITS

**A new method of making component boards using self-adhesive copper strip.**

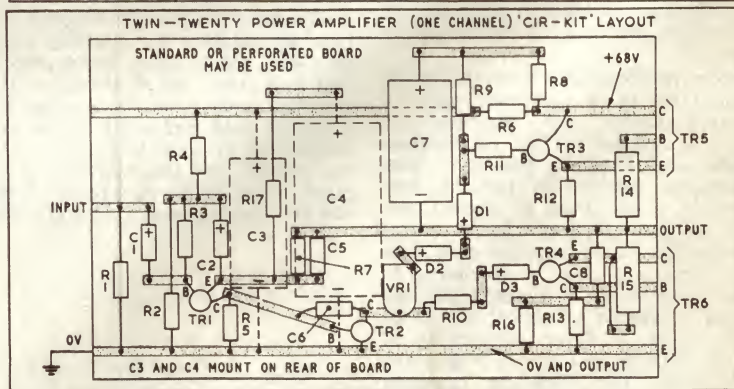
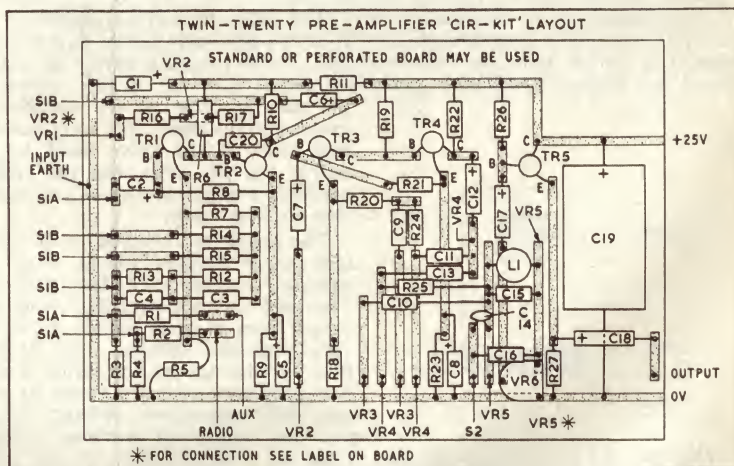

# SCIENTIFIC AND INDUSTRIAL NEWS



## Medal for Dr Gabor

The Rumford Medal, awarded every other year by the Royal Society for scientific contributions in the fields of heat or light in physics, was recently presented to Dr Dennis Gabor for outstanding contributions to optics and for his work on holography. Dr Gabor provided the mathematical basis for holography and coined the word hologram in 1947. In 1948 he used the interference principle to construct a three-dimensional image of an object on a glass plate for the first time. Dr Gabor was born in Budapest, Hungary, and gained his doctorate in Berlin, having studied in both cities. He is now a staff scientist at CBS Laboratories, a division of Columbia Broadcasting System, U.S.A.

## TV standards converter

A technique for converting U.S. colour television pictures to European standards without the picture becoming smaller has been developed by B.B.C. engineers. The converter, first used during the Mexico Olympic Games coverage, produces excellent colour or black-and-white pictures on the British 625-line 50-field PAL system from 525-line 60-field NTSC pictures from the U.S.A. or elsewhere.

The converter redistributes the incoming information in a different and more complex way. An interpolator derives information from the signal which it uses to draw 50 additional lines in each field. To obtain the requisite information, it is necessary to store one input line until the next arrives. Further interpolation is introduced between adjacent lines of a picture, involving the use of ultrasonic stores with a delay time of one field. The interpolator output is passed to the main store where the lines are retimed so that a continuous stream is produced with each U.S. field lengthened by 3-1/30s to occupy the full 200s of a British field.

## Auroral studies

A computer has helped scientists at the Geophysical Institute of the University of Alaska, U.S.A., to prove that auroras seen in the northern and southern hemispheres are almost identical. In a recent experiment, the computer plotted two courses which instrument-laden aircraft flew at the two ends of 80,000-mile-long lines of force in the earth's magnetic field. From the airborne equipment, scientists found that one second after an aurora over Alaska, energised particles created

almost identical auroras over New Zealand. Data from this and other similar experiments is expected to provide new information about the high altitude composition of the atmosphere, the heights to which auroras occur, and to help gain a better understanding of auroral rays.

## Giant laser colour TV

A laser colour television system which projects coloured images onto a 13ft x 10ft screen has been developed by Hitachi Ltd., Tokyo, Japan. The largest system of this type known previously to the company was an experimental unit in the U.S.A. with a 3ft x 2ft screen. The Hitachi system uses a 5W krypton laser emitting red light and two 5W argon lasers which emit blue and green light respectively. The signal-carrying laser beams are scanned by vertical and horizontal revolving scanning mirrors, and projected onto the giant screen to form coloured images. The images on the screen are clearly visible even outside in broad daylight. Hitachi plans to display this system at the 1970 World Exposition in Osaka.

## Fluidic in test rig

The custom design of a fluidic control system by Plessey Components has enabled the rapid installation of a special purpose test rig at the company's factory at Swindon, England. A tapered tooth clutch has been developed with wide potential as an easily operated positive angular lock. A fluidically-controlled life test rig for this locking device was constructed to put the device through repeated cycles, simulating the loads and wear encountered in use. The cycle of operation is repeated several thousand times, simulating over ten years of normal use in one working day. Fluidics was chosen largely because of the ease and speed with which the system could be assembled.

## Editing video signals

A new method of transmitting the video signals of Picturephone calls, which could allow three calls to be made over facilities that normally only carry one, has been developed by the Bell Telephone Laboratories in the U.S.A. The method involves editing the video signals and transmitting only significant differences that occur from frame to frame. In a normal Picturephone conversation the picture changes are only slight, e.g. eye blinking, lip movement. In most videophone systems,

## Lunar light studies

Under contract to NASA, Lockheed Missiles and Space Co. is examining how well astronauts can position Apollo Lunar Surface Experiment Packages (ALSEP) under the lunar sun. Sunlight on the moon, unfiltered and unscattered by atmosphere, presents a difficult visual environment, composed of extremely bright light contrasted with black, impenetrable shadows. The packages must be set at a given distance from each other and aligned relative to the moon and earth. To calculate the alignment, an astronaut must use "sundial-like" guides surrounded by bright aluminised mylar in the middle of each package.

The Lockheed study is being conducted in a sunlight simulator which presents a visual environment similar to the one astronauts face in space and on the moon. The illumination source is a xenon arc lamp reflected by a highly polished parabolic mirror. Light from the lamp is beamed through a filter, which helps to keep the rays parallel, and into a light-trapping chamber which eliminates reflected or back-scattered light. Inside the chamber, on a model of the lunar surface, men in space suits experiment in setting out ALSEP packages.

Apollo astronauts Pete Conrad (left) and Dick Gordon examine a model of the Apollo spacecraft inside the Lockheed solar illumination simulator.



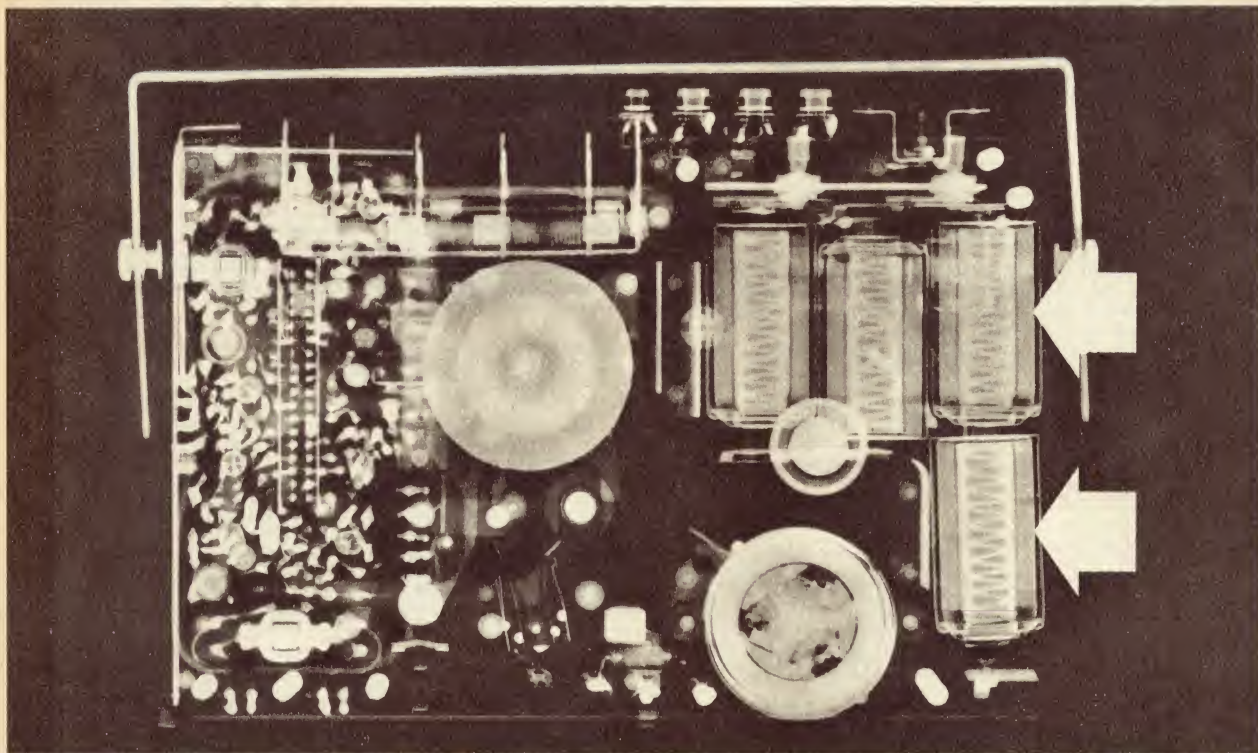

**The more they put into tape recorders**

**the more you need Duracell®**

They put in interlocks to give you sound-on-sound. Automatic shut-offs to save you tape. VU meters, reset counters, automatic level controls—all built-in. Today's portable tape recorders have everything. But it takes heavy-duty batteries to run them. Many manufacturers now recommend Duracell. Duracell, the long distance power cells, pack a maximum of power in a minimum of space.

Inside its steel-jacketed body are almost a dozen patented advances — power cores, special seals and electrolytes. And they all work to stand up to the heavy drains of tape-drive motors. Keep voltage levels high for precise amplifier operation. Hold their power for years. Ask for Duracell—the long distance power cells — wherever batteries are sold.



**DURACELL. THE LONG DISTANCE POWER CELL  
STILL GOING STRONG LONG AFTER ORDINARY BATTERIES ARE DEAD.**

Trade enquiries to Mallory Batteries (Australasia) Pty. Ltd., marketers of Duracell 439 2544

**MALLORY**

® Registered trademark of P. R. Mallory & Co. Inc.

MB2998/68





much of the transmitted information is repeated many times to give what Bell calls frame-to-frame redundancy.

In the Bell system, called conditional replenishment, signals from the camera are converted into electrical pulses which are compared with pulses of a reference picture stored in a memory device. When sufficient differences exist between the new and stored pictures, the stored picture is updated, and the updating information is transmitted. The received picture information similarly updates a stored reference picture which is then decoded to recover the picture information. The new development is not suitable for broadcast television as it is limited by the amount of movement between frames.

### Scottish radar installation



*Nearing completion on Lowther Hill, in Southern Scotland, is this Marconi radar which will give added coverage to busy air routes near Glasgow. Rising above the aerial turning gear is the parabolic reflector, and on the left of the picture is the linear wave-guide feed extending the full 52-foot length of the aerial. The triangular configuration in the background is part of the geodetic radome to give the installation complete weather protection.*

### Two-colour radar display

A marine radar to provide continuously clear and accurate information on possible collision situations has been developed by GEC-AEI (Electronics) Ltd., Stanmore, Mddx., England. The equipment, known as COMPACT (Computer Predicting and Automatic Course Tracking), is said to be the first in the world with a dual electronic presentation system using two colours to convey key navigation information.

One colour presents a conventional radar display of the position of ships and other hazards, while superimposed in the second colour is information predicting the future course of up to a maximum of 12 ships. This prediction is provided by a built-in computer, which also ensures that if any ships are on a collision course with "own" ship, an audible warning note is sounded and a flashing "halo" appears on the display around the radar echo from the other ship involved. A further facility enables a proposed course to be set up on the display; the computer then predicts whether this new course is the optimum to follow, avoiding any new hazards.

Shown here is a COMPACT display installed in the new liner Queen Elizabeth II.

### Concorde direction finders

The Marconi Automatic Direction Finder, type AD370, has been selected for both Concorde prototypes and for the two pre-production models, one to be built in England, and one in France. Dual installations of the solid-state equipment will be fitted in each aircraft. Instantaneous tuning and very high reliability are features claimed for the equipment which will materially assist the extensive trials to be carried out over the next two years. The Marconi Company, Chelmsford, Essex, England, has now supplied some \$A250,000 worth of communications, navigation, and CCTV equipment to main contractors in the Anglo-French project.

### Centenary of I.T.U. Secretariat

The International Telecommunication Union (I.T.U.) celebrates the centenary of the founding of its Secretariat this year. Founded in 1865 in Paris by 20 countries, the International Telegraph Union decided at Vienna in 1868 to set up an "International Bureau of Telegraph Administration." This Bureau was officially opened on January 1, 1869, in Berne, Switzerland. The Bureau, according to the Acts which set it up, was to "centralise information of every kind relating to international telegraphy, draw up tariffs, keep general statistics, carry out useful studies requested of it, and issue a telegraph journal in the French language."

The first issue of the journal was published on November 25, 1869, and, in 1932, when it was decided to rename the union the International Telecommunication Union, it was also decided to change the name of the journal to the "Telecommunication Journal," by which name it is still known.

Having become a specialised agency of the United Nations, the I.T.U. transferred its headquarters to Geneva in 1948. It occupied new offices near the Place des Nations which were inaugurated in 1962 and purchased in 1968. In the next few years the building will be enlarged by an 18-storey tower. Originally there were three officials: a director, a copying clerk and a secretary. Today there is a staff of over 500.

### Second Goonhilly aerial

The British Post Office has brought a new aerial system into service at its Goonhilly earth station to work with the Intelsat III satellite now in synchronous orbit over the Atlantic Ocean. Called Goonhilly II, the 90-foot diameter aerial cost approximately £2 million (sterling). The original aerial, Goonhilly I, is being provided with new equipment to enable it to work with countries to the east of Britain via an Intelsat III satellite to be launched this year and positioned over the Indian Ocean.

### Lead and zinc service formed

The Zinc and Lead International Service (ZALIS) has been formed to provide a technical information service on the uses of lead and zinc in developing areas of the world. ZALIS is financed jointly by the Zinc and Lead Development Associations (London), the Zinc Institute and Lead Industries Association (New York), the Australian Lead and Zinc Development Associations (Melbourne), and the Japan Lead Zinc Development Association (Tokyo). The Indian Lead Zinc Information Centre, established in 1961 as a subsidiary of the British Associations, now becomes part of ZALIS. Further information about ZALIS is available from the Australian Lead and Zinc Development Associations, 95 Collins Street, Melbourne, 3000.





## Introducing . . . the purest . . . clearest music . . . at a budget price

### THE PIONEER SX - 440 TUNER/AMPLIFIER

#### SPECIFICATIONS

Audio Section	40 watts total at 4	Loudness Contour	Switchable to ON-OFF, boost 12 db at 50 Hz, boost 6 db at 10 kHz, with VOLUME control set at .40 db
Music Power	15 watts per channel at 4	FM Section	Front end using "F.E.T."
RMS Power	12 watts per channel at 8	Circuitry	87 - 108 MHz
Harmonic Distortion	Less than 1% (at 1 kHz rated output)	Frequency Range	2.5 V
Frequency Response	3 db, from 20 Hz to 70 kHz	IHF Usable Sensitivity	55 db (at 98 MHz)
Power Bandwidth	30 Hz to 20 kHz (AUX)	Image Rejection	50 db (IHF rating)
Hum & Noise	MAG: better than 75 db	Signal to Noise Ratio	300 ohms (balanced)
(at rated output)	AUX: better than 85 db	Antenna Input	
Inputs and Audio	MAGnetic PHONO: 3 mV	Multiplex Section	Time-switching type de-modulator FM/MONO stereo
	TAPE MONITOR: 130 mV	Circuitry	Automatic Selection
	AUXiliary: 130 mV		35 db (at 1 kHz)
Output Terminals and	Speakers: 4- 16 ohms	Channel Separation	
Jacks	Stereo headphones jack,	AM section	Superheterodyne
	Simultaneous tape recording	Circuitry	525 - 1605 kHz
	jacks, equipped with TAPE	Frequency Range	8 V
	MONITOR switch Tape	IHF Usable Sensitivity	47 db (at 1000 kHz)
	recording/playback jack	Image Rejection	Built-in Ferrite Loopstick
	(DIN standards)	Antenna Input	Antenna
Speaker Switch	A or B speakers		240 volts 50 Hz
Equalization Curves	PHONO: RIAA	Power Supply	
Tone Controls	BASS: boost 13 db, cut 11		
	db (at 50 Hz)		
	TREBLE: boost 9.5 db, cut 10		
	db (at 10 kHz)		

# PIONEER®

THE QUALITY NAME IN HI-FI MUSIC EQUIPMENT

WRITE FOR THE NAME OF YOUR NEAREST PIONEER DEALER.

SOLE AUSTRALIAN REPRESENTATIVES -

ASTRONICS AUSTRALASIA PTY. LTD. P/L. ALL STATES.

DIVISION OF ELECTRONIC INDUSTRIES LTD.

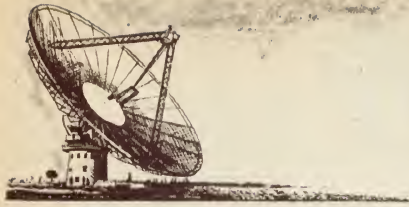

## Gamma-ray research

Later this year physicists of Lockheed Missiles and Space Co., California, U.S.A., propose to fly a new spectrometer (using a lithium-drifted germanium counter) on a high-altitude balloon to search for gamma-ray emissions from the sun and other gamma radiation sources outside our solar system. The results may provide new knowledge of the basic processes occurring in the sun and stellar objects, according to George H. Nakano, L.M.S.C. research scientist. The instrument package, weighing several hundred pounds, will be lifted to an altitude of about 130,000 feet.

## Eurocontrol training centre

A comprehensive radar simulation and data handling system called Instilux to be installed at Eurocontrol's Institute of Air Navigation Services at Luxembourg, is to be supplied by Elliott Space and Weapon Automation Ltd. under a contract worth more than \$A1 million. Instilux will provide standardised training in air traffic control procedures for controllers from all Eurocontrol member countries, and will simulate many types of radar systems from basic primary radar with manual secondary radar to fully automated systems with synthetic displays. The installations will also provide facilities for training Eurocontrol personnel in programming.

## Computer aided design

The Electronic Engineering Association is to organise a Computer Aided Design Exhibition (CADEX '69) to coincide with the international conference on the same subject which is being held at the University of Southampton, England, in April, 1969. Exhibits will embrace all aspects relevant to computer-aided design and design automation including hardware, software, applications and programs, and associated topics arranged to demonstrate the applications of CAD techniques to engineering design problems. Further details may be obtained from the Association's Information Office, Berkeley Square House, Berkeley Square, London, W.1.

## Spanish communications

By early 1970, the Telefonica Company of Spain aims to install a second satellite station at Buitrago for communications

with the Indian Ocean area, including Australia. At present work is going ahead to enlarge the present station in order to establish direct links with the Americas. The next undersea cable to link Europe with the U.S.A., known as Fat-5, will emerge on land at San Fernando, Cadiz, and from this point signals will cross Spanish territory by microwave links to Estepona, on the Costa del Sol, and to Lisbon, Portugal. At Estepona it will join with another cable, the Mat-1, to Italy and other Mediterranean countries.

## Thermionic battery

Isotope-fuelled electric power sources at very low power levels are being developed by the McDonnell Douglas Corporation in Richmond, Washington, U.S.A. The company is working on an integrally fuelled thermionic converter with operating temperatures well below those normally associated with thermionic conversion. Two prototypes have been made, both weighing about five ounces. One uses a low-power density promethium fuel and has an output of 100-600 microwatts, depending on the collector temperature. The other uses higher power density promethium in a single encapsulated emitter structure, and is designed to have an output of four milliwatts.

## Children talk to computer

Psychiatric workers at Stanford University, California, U.S.A., have developed a computer-aided method of encouraging verbal communication in some children who, because of some mental disturbance, are unwilling to speak. The method, reported in the "Archives of General Psychiatry" (December, 1968), uses a display scope and keyboard linked to a computer. By using the keyboard a child can summon from the computer program a series of games displayed in visual, linguistic and other symbols on the screen. At the same time the machine makes a vocal response. In 80 per cent of cases there was an improvement in volunteered intelligible speech.

## Cambridge radio telescope

A new radio telescope is to be built for the Science Research Council at the Radio Astronomy Observatory of Cambridge University in the U.K. at a total cost of some \$4 million. It will consist of eight 42-foot diameter steerable dish aerials spaced out over a distance of about three miles and controlled by a Marconi Myriad 11 computer. Four of the aerials will be fixed with a spacing of 0.7 miles, while the other four will be mounted on bogies to enable them to move along the same straight line (East to West) as the fixed stations. The system will provide a resolution equivalent to a single, steerable dish aerial with a diameter of three miles, and will resolve detail down to a few seconds of arc.

## Close-up zoom lens



*A zoom lens for ultra-close "close-ups" (such as the eye shown here) has been developed by Rank Precision Instruments Ltd., Brentford, Middlesex, England, primarily for colour television. It is claimed to be possible with this lens to place an object actually in contact with the lens and still obtain a perfectly focused picture, magnified many times yet showing the finest detail.*

## New AWA managing director

Mr W. R. Thomas (right) has been appointed managing director of Amalgamated Wireless (A'asia) Ltd. from January 1, 1969. Mr Thomas received his early training with the company in 1920, and was the company's first engineering diplomate. He had charge of many of the company's activities, including the manufacture of flight instruments during the war. Mr Thomas then transferred to an executive position as assistant to the production manager. He was appointed assistant general manager in 1963, and general manager in 1968.



## Faster duct laying

To speed up provision of underground coaxial telephone cables, the British Post Office has started field trials with a new type of moleplough. The machine will be used to install about six miles of quadruple PVC ducting for a new cable between Stoke-on-Trent and Wolverhampton. The moleplough cuts a path for the ducting and draws it into the ground, all in one operation. The cable is later winched through the ducting. A similar method has been used before, but only to lay two ducts at the one time. Previously, a trench had to be dug for multiple ducts, and later filled in. Post Office engineers believe the moleplough may be able to lay about 1000yds of ducting a day, which is about five times faster than the old method.

# University

"University" have produced in the past, meters for use in projects published by "Electronics Australia." We have listed the most popular projects, type and cost of meter and when featured in "Electronics Australia."

All the meters listed are still available direct from our sales office, our agents or any electrical wholesaler.

Project	Date Featured	Model	Price
P/Supply V/meter 0/30V	January 1969	VP-2A (1mA)	\$ 5.10
P/Supply Ammeter 0/1A	January 1969	VP-2A (1mA)	\$ 5.10
Solid State V.T.V.M.	December, 1968	W4-207 (1mA)	\$11.50
Audio Generator	September, 1968	VP-2A (50uA)	\$ 6.00
Transistor Tester	August, 1968	VP-2A (50uA)	\$ 6.00
Transistorised Millivoltmeter	May, 1968	04-86N (100 uA)	\$15.00
20K $\Omega$ /V Multimeter	October, 1965	04-422 (50uA)	\$16.50
Auto Voltmeter	September, 1965	W2-274 (6V or 12V)	\$13.50
Impedance Meter	March, 1965	W4-428 (1mA)	\$11.50
"S" Meter	February, 1965	02-275 (1mA)	\$10.00
Level Meter	June, 1960	W2-18 (0.5mA)	\$10.00

above prices are subject to 15% sales tax if applicable.

## MODEL TM1 500V "UNIMEG" INSULATION TESTER

RANGE .25 to 50 megohms at 500 volts test potential, with centre scale at 1.5 megohms.

One of the most common faults causing the malfunction or failure of electrical equipment is insulation breakdown.

The gradual deterioration of insulation over a period of time can be detected by regular inspection and testing.

A quick and efficient test of electrical equipment, appliances and electrical wiring can be made by using University Graham's "UNIMEG."

This ruggedised portable transistorised insulation tester used regularly will detect failures in their early stages thus preventing expensive breakdowns which could occur at inconvenient times. The unit consists of a stable transistorised oscillator the output voltage of which is then stepped up by a transformer and in turn converted to 500 volts DC by high voltage rectifiers.

The power is supplied by a 9 volt transistor radio battery and by the nature of the unit's intermittent operation and its reserve voltage, long battery life can be expected. The unit has been approved by the Dept. Of Mines (M.D.A.-IS-164)



### THE "UNIMEG" IS QUICK AND SIMPLE TO USE

1. "Short" the test leads, press the push switch, and adjust the potentiometer, to indicate full scale on meter.

Note: (The 500 volt potential is present only when switch is depressed)

2. Connect test leads to circuit under test, and press push switch.
3. Read resistance directly off scale.

Solid leather carrying case, with combined shoulder and hand strap available as an extra.

### UNIVERSITY GRAHAM INSTRUMENTS PTY. LTD.

106 BELMORE ROAD, RIVERWOOD, N.S.W. 2210

Telephones: 53-8758, 53-0644 (5 lines)

Telegrams & Cables: Requip, Sydney

#### REPRESENTATIVES

S.A.: Compar Dist.

33 Market St.,

ADELAIDE, S.A. 5000

QLD.: Keith Percy & Co.

Pty. Ltd.

Waterloo St.,

NEWSTEAD, Bris.,

Qld. 4006

VIC.: Eastern Instrument

& Electronic Service

Pty. Ltd.

Suite 17, 67 Queen's

Rd., MELB., Vic. 3000

Phone: 51-8503 51-8504

TAS.: W.P. Martin &

Company,

202 Argyle St.,

HOBART. 7000

And 150 Wellington

St., LAUNCESTON.

7250

W.A.: Atkins (W.A.) Ltd.,

894 Hay St.,

PERTH, W.A. 6000

**AUSTRALIA'S LEADING MANUFACTURER & IMPORTER OF ELECTRICAL INSTRUMENTS**

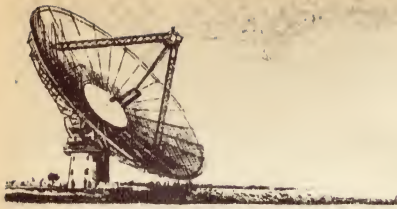

## Extension of TV services

National translator stations are to be established at Nyngan, Cobar and Bourke, all in N.S.W. The station at Bourke will be of higher power than the other two, and will also serve Brewarrina. The three stations will take their programs on relay from the National station at Dubbo, ABQN5. Approval has already been given for the establishment of a commercial television translator station at Cobar. Commercial interests are not prepared at this stage to consider the establishment of commercial services at the other centres because of the high capital expenditure and the relatively small population that would be served.

## Superconducting material

Super-Magloy, a new superconducting material developed by the Plessey Components Group in Britain, is expected to revolutionise high-power magnet technology. It is a niobium-tin compound claimed to have a better performance than any other material. Like other superconductors, Super-Magloy has the property of losing all electrical resistance when its temperature is within a few degrees of absolute zero. It is said to retain its property in magnetic fields nearly twice as strong as those possible with other materials, and to be able to operate at higher temperatures.

## Spanish nuclear power

The first Spanish nuclear power station was inaugurated in December, 1968, at Zorita. By 1975 it will reach an annual output of 4,000 million kilowatt-hours (KWH) a tenth of the present total national output. Work is going ahead at Santa Maria de Garona to finish a reactor due to come into service in 1970 with an annual output of 3000 million KWH. Other Spanish nuclear power stations are planned for Vandellos (to be finished by 1972), Toledo, Bilbao, and Galicia (all due for 1975-80). After 1980, more than half of Spain's electricity will be of atomic origin.

## Sensitive galvanometer

A galvanometer, type 5656, to measure currents from 0.1nA to 0.1uA has been developed by H. Tinsley and Co. Ltd., South Norwood, London, England. An optical amplifier is fitted which gives a scale distance equivalent to 60in. For initial balancing at reduced sensitivity, a small additional light spot appears on the galvanometer scale. The scale is pivoted at its lower edge, and can be adjusted at various angles to the vertical for optimum viewing. It can be fitted with various suspensions having resistances from 3 to 4500 ohms. Dimensions are approximately 6ins x 6ins x 10ins, and it weighs about six pounds.



Tinsley galvanometer type 5656.

## Commercial broadcasting

Licences have been granted to the following companies to operate commercial broadcasting stations: Gladstone District Broadcasting Pty. Ltd. (at Gladstone, Queensland) and Eyre Peninsula Broadcasters Ltd. (at Port Lincoln, South Australia). The grant of the licences to the companies concerned was recommended by the Australian Broadcasting Control Board, following public inquiries into the application.

## Fluidic console

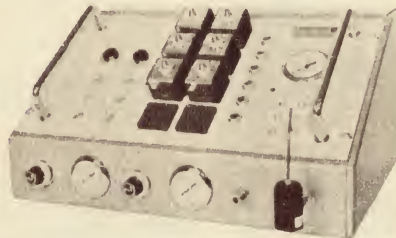

A fluidic control console, type 6SK-910, in which the parts essential to any fluidic system can be rapidly linked in various circuits, has been introduced by C. A. Norrgren Ltd., Shipston-on-Stour, Warwickshire, England. It can be used to work out prototype fluidic systems, as a demonstration device in training colleges, or as part of a laboratory fluidic system.

## CCTV for football pools

An ultra-modern closed-circuit television studio has been supplied by The Marconi Company for Littlewoods Pools Ltd., of Liverpool, the largest firm organising football pools in Britain. The studio has been built specifically to produce video tapes for management training purposes. Another CCTV system, using three cameras and video monitors, is used for the supervision of coupon-checking. The latest order, valued at over \$A20,000, includes two studio cameras, vision mixing equipment, a sound console with eight microphones, a disc reproducer, and a tape recorder.

## Anti-pollution research

The British Leyland Motor Corporation and Shell Research have signed an agreement to co-operate on an intensive research program over the next three years aimed at reducing potentially harmful exhaust emission from petrol engines. Research teams from the two companies will work in close collaboration, with British Leyland developing and supplying experimental engines and equipment for fuel studies by Shell scientists.

# Sale Sale Sale

Stock-taking clearance of Demonstration models, including some of the world's best-known brands. Limited numbers only are offered for sale well below list prices, while stocks last. These are genuine bargains:

### AMPLIFIERS

Fisher X-100-A .....	\$198.00
Sansui Tuner/Amp. SM.34 .....	\$204.00
Pioneer SM.83 .....	\$165.00
Trio 41.V .....	\$107.00
Star SA.30 .....	\$ 90.00
H.M.V. Stereomaster .....	\$120.00
Ilco .....	\$200.00

### CABINETS

8" Speaker Cabinets	\$ 15.00
10" Speaker Cabinets .....	\$ 25.00
12" Speaker Cabinets .....	\$ 40.00
Equipment Cabinets from .....	\$ 40.00

### TURNTABLE BASES

From .....	\$ 7.00
Turntable Covers from .....	\$ 8.00

### TURNTABLES

Garrard LAB.80 .....	\$120.00
Garrard A70 .....	\$ 65.00
Garrard AT60 .....	\$ 54.00
Garrard 3,000 .....	\$ 34.00
Garrard 1,000 .....	\$ 30.00
Elac 40H .....	\$ 70.00

### TAPE DECKS AND ACCESSORIES

While they last, we can make up some complete Hi-Fi systems from the above. First come, first served. Enquire for details. Finance arranged.

# URD

UNITED RADIO  
DISTRIBUTORS PTY. LTD.

Shop 32, Ash Street  
Angel Arcade, Sydney  
Telephones: 28.3718, 28.3926  
OPEN SATURDAY MORNINGS  
Sydney's leading High-Fidelity Specialists

# Our Simplest TRF Receiver--- only 14 transistors & 9 diodes!

Contradictory though the title of this article may seem, it's true. The little radio receiver described herein contains no less than 14 transistors and 9 diodes, and features a high-efficiency RF amplifier, automatic gain control (AGC) and a low-distortion active detector; yet at the same time it is probably the most simply-constructed receiver we have ever described, not counting "crystal" diode sets.

by Jamieson Rowe

The key to the apparent contradiction is that all 14 transistors and 9 diodes used in the basic receiver, together with some 16 associated resistors, are fabricated on a monolithic silicon chip and packaged as a "black box" microcircuit. As a result, for a small TRF radio receiver the components required in addition to the microcircuit are so few that the construction becomes extremely simple and straightforward.

The microcircuit used is the LM372, a low-cost device recently released by the National Semiconductor Corporation of California, and available in Australia from Rutherford Electronics Pty. Ltd. Designated by the manufacturer as a "complete monolithic AM IF strip," the LM372 is in fact a broadband multi-function system consisting of a controlled-gain AGC stage, a high-gain amplifier, and an active AM detector, all of which are designed for full performance between 50KHz and 2MHz. Bandpass response shaping is not included within the device, so that the function of the device as either a TRF receiver or a wide or narrow-band IF system may be defined by external circuitry, in a quite flexible manner.

A block diagram of the LM372 is shown in figure 1, together with the internal circuitry. It should be noted that the capacitors shown on the circuit are not included in the device, but are connected externally to or between the appropriate terminals.

The initial section of the device is the AGC stage, comprising transistors Q2, Q3 and Q4. Q2 is actually the signal-handling element, with a fixed bias voltage applied to the base via Q1; Q3 and Q4 are control elements. As AGC voltage is applied to the base of Q4, this element causes Q3 to conduct, forcing Q2 to draw less emitter current because of the DC feedback across the shared emitter resistor R2. As a result the effective series emitter resistance of Q2 increases, while that of Q3 decreases; both resulting in effective signal attenuation.

From the emitter of Q2 the signals



Front view of the "Micro-Plus" version of the receiver, which drives a loudspeaker. At left is the new LM372 microcircuit, approximately actual size.

are coupled externally to the input of the second section of the device, which is the high-gain amplifier formed by transistors Q6, Q7 and Q8. Direct coupling is used between these elements, with bias stabilisation provided by DC negative feedback through Q5. Regulation of the amplifier transistor supply voltages is performed by Q9 and Q10.

The output from the amplifier section is direct coupled internally to the third and final section of the device, which performs AM signal detection. The detector configuration is an "active" one, consisting essentially of a high-gain feedback amplifier formed by Q11 and Q12, with non-linear feedback provided by emitter-follower Q14. Transistor Q13 is used for regulation of the supply voltage for Q12 and Q14, while diodes D8 and D9 are used for thermal balancing of Q12 against Q11.

It may be noted that all important supply voltages are regulated within the LM372, with reference voltages derived from the forward-biased diode string D1-D7. As a result the performance of the device is virtually unchanged for external supply voltages between 6V and 15V. Total current drain at 6V external supply is typically only 1.7mA, rising to a maximum of about 2.65mA at 15V, equivalent to 40mW dissipation.

Bandpass response shaping may be performed by external filter elements connected in series with the AGC stage input, between the AGC stage output and the amplifier input, or in both positions. The impedance levels in both positions are in the order of 3K, permitting the use of tapped L-C elements, R-C elements, or mechanical filters of either the piezoelectric or magnetostrictive type.

Low-signal gain of the RF/IF section of the LM372 is typically around 2,360 or 67dB, while the active detector has a typical gain of 3 times or 10dB. Hence a 50uV input signal modulated to 80 per cent will typically produce an audio output of around 280mV RMS, or 800mV P-P. The typical AGC control range is 60dB, with a threshold of 50uV; thus the above output level would remain substantially constant if the input signal level were increased from 50uV to 50mV.

Incidentally the quoted price of the LM372 is \$3.75 plus sales tax where applicable, a very reasonable figure in view of the device performance.

From the foregoing it can be seen that the LM372 is quite an elaborate and complex device, and one which is capable of high performance as the heart of the IF-detector section of an up-to-date superhet receiver. And it may well be that in the near future we shall be able to present in Electronics Australia a project using the device in this role. However for the immediate present we thought it might be interesting, and at the same time valuable to readers as a means of gaining practical experience of microcircuit operation, to present the device in a more humble role.

If in fact there are degrees of humility, surely a high (low?) position would be gained for the receiver circuit shown in figure 2, which we have dubbed the "Micro-One." Superficially at least it would seem to correspond closely to the simplest possible "active" receiver, with a tuned circuit at one end, a 'phone or pair of 'phones at the other, and between them nothing more than the microcircuit together with its attendant bypassing and coupling capacitors, and the battery.

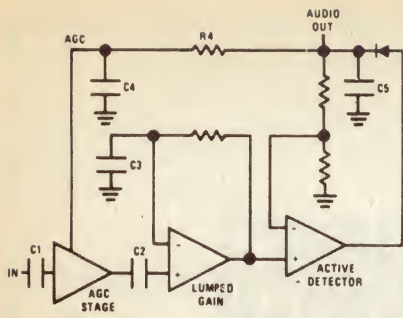

Above and at right are a block diagram and interior circuit for the LM372 microcircuit, showing its complexity. The circuit at lower right uses the device as a simple TRF receiver.

The circuit of figure 2 is deceptively simple, of course, because that innocent-looking triangular "amplifier" symbol in fact represents all the circuitry shown in figure 1. Instead of a simple "amplifier" connected between tuned circuit and 'phones, what we really have is a complex circuit performing controlled amplification and detection.

The point is, however, that as far as the constructor need be concerned the circuit of figure 2 is effectively just as simple as it looks. There are only eleven components to be connected, including the battery and the 'phones.

This illustrates one of the advantages offered by microcircuits: simplification of external circuit connections, despite a high order of functional complexity. Associated with this is an improvement in overall reliability, as a major proportion of the circuit elements and interconnections are within the microcircuit package and protected against moisture, contamination and other potential causes of failure.

But enough of such academic considerations, and on to more practical matters: how does the circuit of figure 2 perform?

Surprisingly well, in fact, for a receiver which has to do without regeneration. The high gain and efficient detection of the LM372 give the little receiver quite a lot of "sting"; with a miniature 2-inch long ferrite rod aerial in the prototype we had no trouble receiving virtually all of the local broadcast stations on the lab. bench, despite the known poor signal levels obtaining as a result of the steel-framed building.

Due to the number of turns on the commercial ferrite rod aerial coil used, it was possible to tune down to around 310KHz with a standard 10-415pF variable capacitor. As a result we were also able to pick up the Sydney Airport beacon on 317KHz, and this also at good volume on the lab. bench. As the efficiency of the 2-inch ferrite rod must be rather poor at this frequency, this seemed quite indicative.

Selectivity of the receiver is understandably limited, in view of the single tuned circuit. Although the high sensitivity of the LM372 allows the use of a high step-down ratio between tuned winding and secondary, resulting in relatively low loading, the "Q" is still relatively modest. Hence although the sensitivity of the receiver is comparable with the more usual "small re-

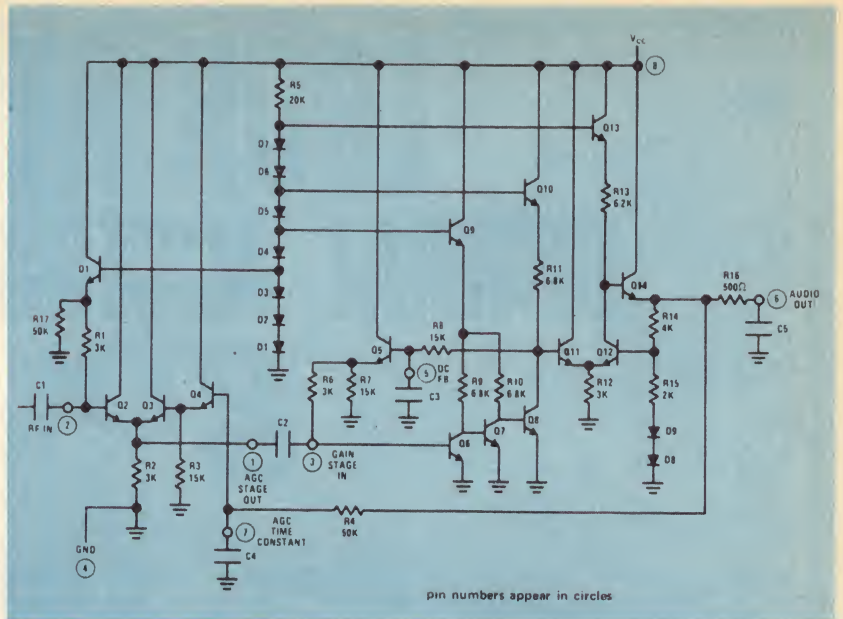

### LM372

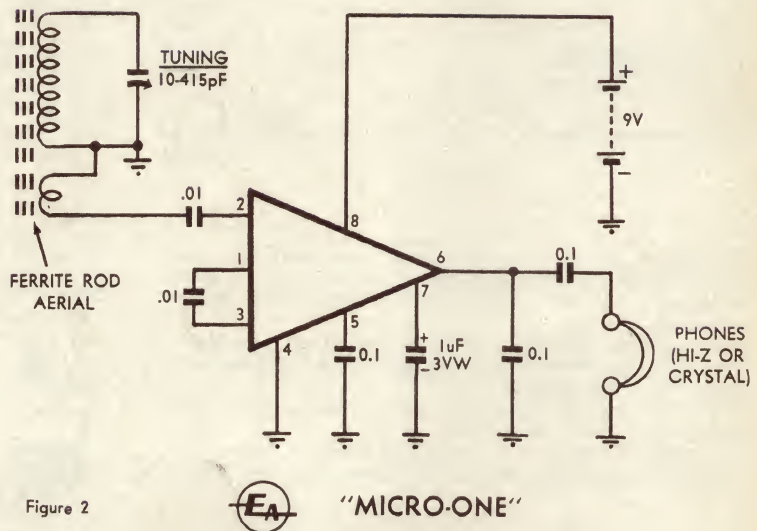

Figure 2

ceiver" employing regeneration, selectivity is not as good. Nevertheless we found it adequate for other than difficult locations.

Although we haven't tried doing so, it should be possible to improve the selectivity by the use of a second tuned circuit coupled to the output of the LM372 AGC section and the input of the amplifier section (pins 1 and 3). A suitable arrangement would be a parallel tuned circuit using a 10-415pF capacitor and a suitable coil, with pins 1 and 3 of the LM372 each connected to a low tap on the coil via separate .01uF capacitors. It would be possible to use a 2-gang capacitor to mechanically couple this tuned circuit to the aerial circuit but, as this would require rather delicate adjustment of the coils to ensure "tracking," two separate capacitors and control knobs may be more practical.

The transistors inside the LM372 are planar silicon types, and are capable of amplifying at very high frequencies. As a result, we found with the prototype that conventional medium-

frequency wiring techniques tended to cause trouble due to excessive lead inductance and capacitance. In particular, the use of even a stout 16-gauge tinned-copper wire "busbar" for common earthing of the various bypass capacitors appeared to leave scope for spurious VHF oscillations.

To obviate such troubles we adopted a "ground plane" technique similar to that used in some VHF equipment, in which a metal plate beneath the circuitry forms a low-inductance earthing path. All bypass capacitors and earth connections are made to the plate, using leads as short as practicable.

As this technique results in very stable operation, we strongly recommend that constructors follow suit. At this stage, in fact, we would suggest it as being essential.

In the prototype the plate consists of a 4in x 3in square of timplite, mounted on a wooden breadboard-type chassis beneath the tuning capacitor and a small section of resistor panel supporting the microcircuit and its associated components. The use of tin-

# LOOK AT GENERAL ACCESSORIES *go*



General Accessories, Melbourne, are really on the move. Products are being eagerly displayed. A hi-fi showroom has been built to suit the most ardent hi-fi specialist.

Stereo units, speakers, microphones, tape recorders and audio accessories of the well known brands are displayed and played.

There is also a department which has meters and testing equipment on display.

Why don't you go to the 'new look' General Accessories and inspect their showrooms now.

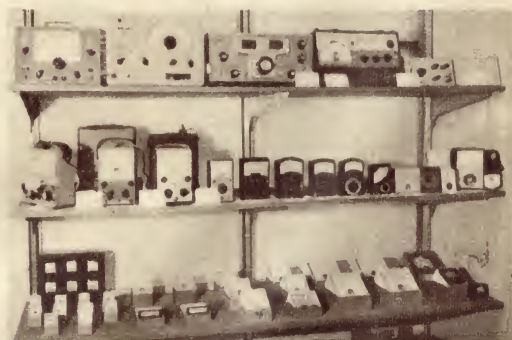

## GENERAL ACCESSORIES

161 STURT STREET, SOUTH MELBOURNE. 'PHONE 69 0300.

BRANCHES IN ALL OTHER STATES



BC108, 2N3565, etc.

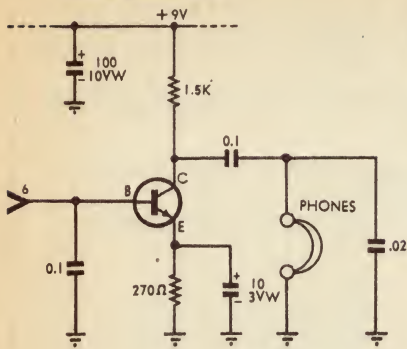

Figure 3

plate ensures convenient soldering of components to the plate at each earthing point.

The commercial 2in ferrite rod aerial used in the prototype had a tuned winding consisting of approximately 100 turns of 30-gauge, or thereabouts, wire, tapped at 12 turns. As mentioned before, this winding permitted tuning from about 1600-310KHz using a standard 10-415pF capacitor. As the 12T tap gave insufficient step-down for adequate selectivity with the 3K input impedance of the LM372, we left it unconnected and wound a new secondary with 6 turns of approximately 30G enamelled wire. The new winding was wound directly over the "cold" or earthy end of the existing winding.

Ferrite rods of larger than 2in length may of course be used, and larger rods will in fact give greater sensitivity. Also there is no reason why the constructor may not wind his own coil, perhaps experimenting with different sizes for the tuned winding (giving appropriate tuning ranges), and different step-down ratios for the microcircuit input.

As a starting point for experiment, typical rods usually require between 50 and 70 turns for the tuned winding to cover the broadcast band alone (more turns to go lower in frequency), while in this circuit a step-down ratio or tapping ratio of 10:1 or more is recommended for adequate selectivity. The idea is to use the greatest step-down ratio which still results in adequate sensitivity, as this will give the lowest tuned circuit loading and hence the highest selectivity.

It would also be quite feasible to use a "normal" aerial coil as an alternative to a ferrite rod aerial, in order to use the set with a conventional capacitive aerial-and-earth system. Either home-wound or commercial coils could be used, and experimentation with size, shape and step-down ratio would again be possible. Note that in the case of commercial aerial coils the tap or secondary windings supplied will probably not give sufficient step-down ratio for adequate selectivity in this circuit, so that a smaller secondary winding may have to be added as before.

Whichever type of aerial and tuned circuit system is used, there is a small point which should be borne in mind regarding positioning and orientation. Due to the high gain and excellent low-frequency response of the LM372, the circuit is capable of blocking oscillation if sufficient coupling is

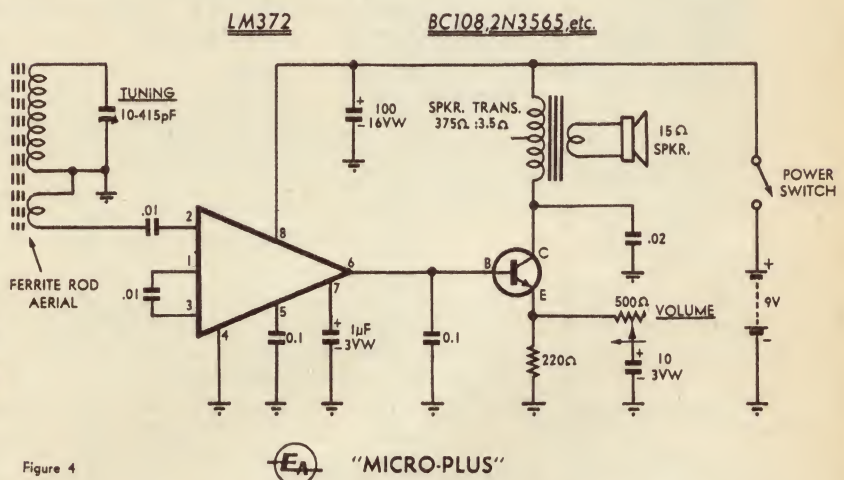
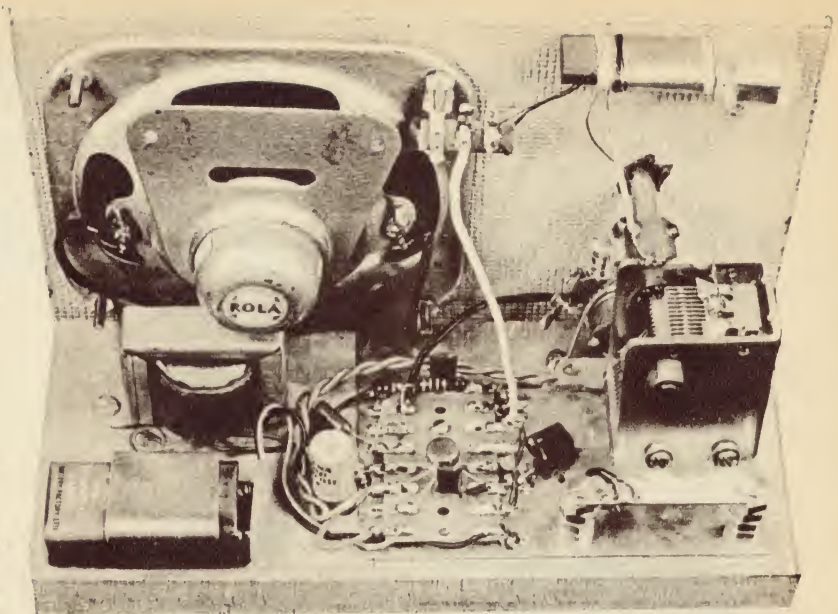

Figure 4

EA "MICRO-PLUS"

Above are the circuit and rear-panel view of the "Micro-Plus" version of the receiver, showing its essential simplicity. At upper left is the transitional circuit for headphone reception.

present — either capacitively or magnetically — between output and input circuitry.

If the ferrite rod aerial or aerial coil is placed too near the output circuitry and components, and/or if its orientation is appropriate, oscillation can thus occur. The remedy is therefore to either move the rod aerial or coil further away, or to try changing its orientation. In a borderline case, it may be alternatively possible to cure oscillation by reversing the connections to the aerial coil secondary winding; but note that this will only work if the coupling responsible is significantly magnetic in nature.

The circuit of figure 1 is intended for use with either high impedance magnetic or crystal earphones; it will not give satisfactory operation with low impedance types. Although the supply is shown as a 9V battery, as mentioned previously the microcircuit will work from any suitable supply delivering from 6V to 15V. It would therefore be quite in order to power the circuit from any suitable power supply or battery capable of delivering a voltage within this range at a current drain

of around 1.5 milliamps.

Due to the AGC action within the LM372 microcircuit the audio output of the circuit of figure 1 tends to be substantially constant, irrespective of the field strength of the received signals. And while the audio output level produced should be found adequate for comfortable earphone reception in quiet conditions, there will no doubt be some constructors for whom it will be insufficient.

For these people, and for those who may simply wish to gain further experience, we show in the diagram of figure 3 a simple way in which to increase the output level. As may be seen it involves a simple add-on amplifier stage using a low cost general-purpose NPN silicon transistor type BC108, TT108, 2N3565 or similar.

The transistor is used as a straightforward class-A amplifier, with forward bias derived from the output electrode of the LM372 microcircuit. A bypassed emitter resistor is used to set the quiescent current level of the transistor to about 6-7mA, at which level it is capable of delivering between

# A REVOLUTIONARY NEW APPROACH TO CIRCUIT TESTING

## the fantastic FE14 FIELD EFFECT VOLT-OHM-MILLIAMETER

- LESS CIRCUIT LOADING THAN A VTVM • ZERO WARM-UP TIME—INSTANT STABILITY • NO BOTHERSOME AC CORDS • USE IT ANYWHERE—ANY TIME
- FULL PROTECTION ON BOTH METER AND INTERNAL CIRCUITS—OVER 100 TIMES AC OVERLOAD PER SCALE.



### DC VOLTS

Ranges: 0 to 1, 3, 10, 30, 100, 300 and 1000 full scale.  
± .5 1.5, 5, 15, 50, 150 and 500 zero centre scales.

Input resistance: 15 megohms shunted by 14 PF.

Accuracy: ± 3% full scale from 32 deg.F to 122 deg.F.

AC rejection: 30 to 300 times.

### AC VOLTS

Ranges RMS: 0 to 1, 3, 10, 30, 100, 300, and 1000 full scale

Ranges peak to peak: 0 to 2.8, 8.4, 28, 84, 280, 840 and 2800 full scale, frequency compensated.

Input impedance: 10 megohms shunted by 29PF

Frequency response: 10 Hz to 10MHz at 3DB points.

Accuracy: ± 5% full scale from 50 deg.F to 100 deg.F.

### OHHMETER

Ranges: 0 to 1000, 10K, 100K ohms and 1000 megohms.

Accuracy: ± 3% linear arc.

### DC CURRENT MEASUREMENTS

Ranges 0 to 100 microamps 1 ma, 10 ma, 100 ma and 1 ampere.

Accuracy: ± 3% full scale.

Internal voltage drop: .2 volts.

### GENERAL

Meter: 4½", 100 microamps ± 2%, diode protected and isolated from input.

Multiplier resistors: 1% precision type.

Ohms battery: 1.5V "C" cell (not supplied).

Power supply battery: 9 volt, Eveready type No. 222 or equivalent (not supplied). Same as used by transistor radios. Battery drain less than 2 ma. Built-in battery checker.

Balanced floating input: To avoid shock hazards. Uses field effect transistors in differential circuit.

Weight: 4lbs. Dimensions: 7½" x 5½" x 3 1/16"

Accessories: High voltage probe 39A19 extends 30 volt DC range to 3KV, 100 volt DC range to 10KV and 300 volt DC range to 30 KV. A must for colour servicing.

**\$86.00 plus Sales Tax**

### DRAKE



### Model W-4 R F Wattmeter

Reads forward and reflected power directly in watts (VSWR from nomogram). Two scales in each direction, 200 and 2,000 watts full scale. Calibration accuracy plus/minus (5% of reading plus 2 watts) on 200 watt scale, plus/minus (5% of reading plus 20 watts) on 2,000 watt scale. Size: 5½in H x 3¾in W x 4in D.

**\$63.00 plus Sales Tax**

### GUEST ELECTRONICS



### Resistor Development Pack

The first of a series, this miniature carbon film resistor development pack has been designed to meet the need for quality resistors in a comprehensive range of ohmic value, at an economic price. It is convenient and clearly labelled and will appeal to the engineers and laboratory staff requiring a range of resistors for prototype work. Each tube contains 25 resistors of the same ohmic value, the complete pack having 1925 resistors. The development pack is also suitable for "select on test" assembly, maintenance and general repair work.

**\$75.00 plus Sales Tax**

### GUEST ELECTRONICS



### Printed Circuit Pack

A unique system for producing prototype printed circuits, designed for engineers working in design departments and development laboratories. The kit is complete, enabling the engineer to translate a circuit diagram into a printed circuit, neatly, simply and economically in the shortest possible time. The contents are designed to allow the greatest flexibility in usage and are ideal not only for original development work, but short production runs, modification to existing circuit boards and use as a training aid in technical colleges.

**\$60.00 plus Sales Tax**

# ELMEASCO INSTRUMENTS PTY. LTD.,

7 Chard Road, Brookvale, N.S.W. 2100 Telephone No. 937944

P.O. BOX 213, MT. WAVERLEY, VICTORIA, 3149.

ten and twenty milliwatts into 'phones of around 1K-2K impedance.

As shown, a 100uF 10VW electrolytic capacitor is added to the power supply line when the add-on stage is used, to ensure audio stability.

The voltage gain of the add-on stage as shown in figure 3 is quite high, and distortion due to either transistor or earphone overload may occur if a high-gain transistor is used with a high-output microcircuit. When evident such distortion may be obviated by reducing the gain of the transistor, by either removing altogether the 10uF emitter bypass capacitor, or by inserting suitable resistors in series with it. The latter scheme permits vernier gain adjustment, and could form the basis for a volume control if the constructor so desires.

The output impedance of the amplifier stage of figure 3 is still fairly high, and will therefore give satisfac-

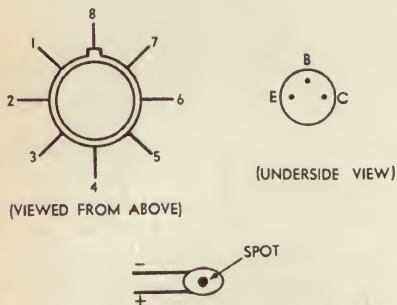

## LIST OF PARTS

- 1 Ferrite rod aerial, or aerial coil (see text).
- 1 LM372 microcircuit.
- 1 10-415pF variable capacitor.
- 2 .01uF LV plastic capacitors.
- 3 0.1uF LV plastic capacitors.
- 1 1.0uF 3VW electrolytic capacitor.
- 9V battery and connector leads, 'phones, wood for baseboard and panel, sheet of tinplate for ground plane, 8-lug section of miniature resistor panel, nuts, bolts, washers, etc.

### ADDITIONAL PARTS FOR "MICRO-PLUS"

- 1 BC108, TT108, 2N3565 or similar transistor.
- 1 375:3.5 ohm transistor output transformer.
- 1 15 ohm speaker (see text).
- 1 220 ohm  $\frac{1}{4}$  watt resistor.
- 1 500 ohm switch potentiometer.
- 1 .02uF LV plastic capacitor.
- 1 10uF 3VW electrolytic.
- 1 100uF 16VW electrolytic.

**Note:** National Semiconductor devices, including the LM372 microcircuit are available in Australia from Rutherford Electronics Pty. Ltd., of P.O. Box 30, North Balwyn, Victoria, 3104.

tory results only with medium to high impedance 'phones. To cater for those wishing to use low impedance 'phones, and also for those who would like to try (inevitably) to operate a loud-speaker from the set, we show in figure 4 a complete circuit of the receiver adapted for such use.

We have dubbed this version of the design the "Micro-Plus," and as it represents to a certain humble extent the end product of an evolution of a

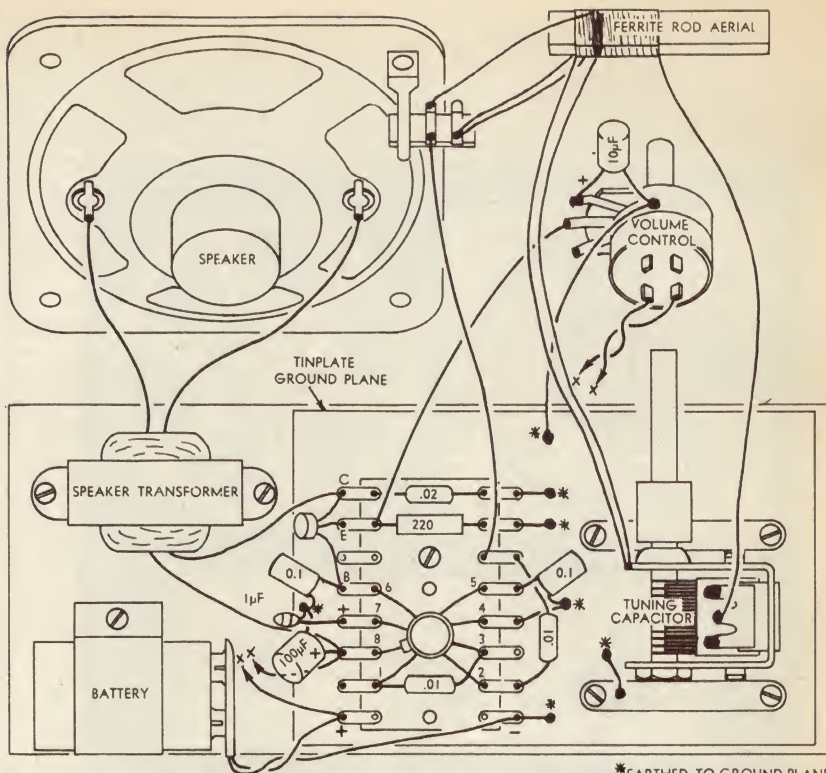

Using the wiring diagram shown above, even inexperienced constructors should encounter few problems in assembling the "Micro-Plus". At left are component connection details, and beneath these the parts lists for both versions of the design.

# ELECTROLUBE FREEZER\*

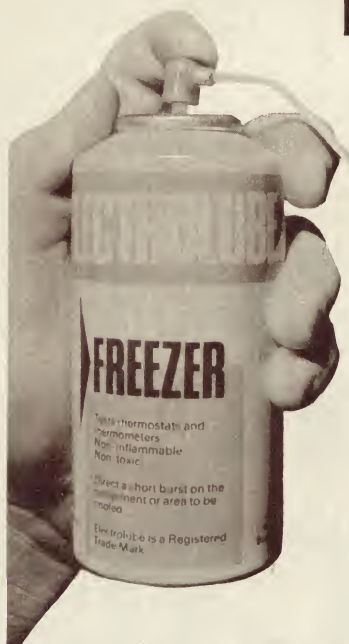

The safer way to faster fault finding

For isolating faults in transistors, diodes and other semi-conductors, finding dry joints and bad contacts. Protecting heat sensitive components whilst soldering. Checking thermostats and thermal cut-outs etc. ELECTROLUBE is NON-TOXIC and will not effect any plastics rubbers or paints.

AVAILABLE FROM LEADING ELECTRICAL WHOLESALERS

**RFA**

**RICHARD FOOT (Australia) PTY. LTD.**  
63 Hume St., Crows Nest, N.S.W. Tel. 43-0326.



Liven up sales meetings, presentations, staff training, etc., with Kodak audio visual aids. One picture is worth a thousand words. Think of the breaths you'll save.

Kodak have all the equipment and "know how" to help you make the most dynamic and memorable presentations ever—using pictures in color or black-and-white. Cameras for making color slides and movies. Slide and movie projectors (including slow-motion models) and screens. Plus the widest range of films, both color and black-and-white. There's a special camera kit for taking close-ups of small objects or printed material from books and maps. Everything you can think of to make it easier for you, and *much* more meaningful and interesting for your audience.

## Kodak

Contact the Kodak branch in your State for details.

Motion Picture & Educational Markets Division KODAK (Australasia) PTY. LTD. Branches in all States.

# Say it in pictures.

K. 1961

simple receiver design based on the LM372, it is this version which we have shown in the photographs.

As before the circuit consists of the basic receiver using the LM372, together with a class-A audio amplifier stage using a general-purpose NPN silicon transistor. Here however the transistor is arranged for transformer coupling to the load, using a small transistor-type output transformer of at type readily obtainable. An emitter-degeneration volume control of the type described earlier has also been added.

The emitter resistor of the transistor has been reduced in value relative to that shown in figure 3, in order to increase the quiescent current level slightly. This gives the stage a potential output power capability of around 28 milliwatts, a figure which while extremely modest is really quite adequate for personal listening. As this potential performance is obtained at a total current level for the receiver of less than 10mA, and with a single low cost transistor, the circuit would seem to represent a happy compromise.

A small but significant increase in potential output power capability may be obtained by increasing the supply voltage. However, it should be noted that on no account should the supply voltage be raised above 15V, both in view of the ratings of the LM372 microcircuit and because at higher supply voltages the transistor dissipation ratings will be exceeded.

Naturally enough, the full output power potential of the circuit will be realised only when the appropriate load is presented at the transistor emitter. With a 9V supply, this will occur with an effective dynamic collector load of around 1K.

Small output transformers designed to present this impedance at the primary are not readily obtainable. However, a readily available 375/3.5 "push-pull" type will reflect an impedance not differing too markedly from this figure if it is used with a nominal 15-ohm loudspeaker instead of the intended 3.5-ohm unit.

Strictly speaking, a transformer intended for "push-pull" operation should not be used in a class-A stage, as it has not been designed to operate with a significant (net) quiescent current level. However, as the quiescent current in the present circuit is very low, such a transformer in fact operates quite satisfactorily. Again, from theory the deliberate impedance mismatch must cause a deterioration in low frequency response; however, in fact, the response is found adequate for a small receiver of this type.

Although the prototype receiver shown in the photographs used a 4-inch loudspeaker for convenience, it would in fact be desirable to use the largest loudspeaker available in order to utilise to the full the modest power output available. This follows because, in general, loudspeakers are relatively efficient in proportion to their size; the larger the loudspeaker, the greater the sound volume produced from a given electrical power input.

If low impedance phones are connected to the circuit of figure 4 in place of the recommended 15-ohm speaker, the power output capability will fall but should still be adequate to produce adequate undistorted volume with typical earphones of around 8 ohms impedance. The same

argument will tend to apply for 8-ohm speakers, although in this case the obtainable undistorted volume may be disappointing.

The use of loudspeakers with 3.5 ohms or 2 ohms nominal impedance is not recommended, as results will in general prove quite inadequate.

The physical layout of the "Micro-Plus" version of the receiver may be seen from the photographs. A very similar scheme may be used for the simpler versions, and this is in fact recommended.

As may be seen most of the components are mounted on an 8-lug section of miniature resistor panel, beneath which and extending also beneath the tuning capacitor and volume control/on-off switch is the tinplate "ground plane." All earthed lugs on the resistor panel are bent down and soldered directly to the tinplate, while the earthy end of all bypass capacitors are connected directly to the plate with leads as short as practicable.

The tuning capacitor is mounted up on spacers (we used groups of large nuts), and its shaft length is extended using a tin shaft coupler so that its control knob is vertically above the volume/on-off knob on the front panel. The loudspeaker is mounted behind a simple cutout on the right-hand side of the panel (viewed from the front), with the output transformer and battery behind it. The battery is clamped to the wooden "breadboard" base using a small bracket fashioned from scrap aluminium.

The small ferrite rod aerial used in the prototype is mounted at the top of the panel rear, above the potentiometer and tuning capacitor spindle. In this position it was found to have minimum coupling, both capacitive and magnetic, to the output circuitry. It is clamped to the composition board panel by means of another small bracket fashioned from scrap aluminium.

It should be carefully noted that the performance of ferrite rod aerials can be seriously impaired if they are significantly coupled to an effective "shorted turn" constituted by surrounding metalwork. Thus when mounting such aerials one must be careful to avoid creating any complete conductive loops formed by brackets, panels and so on.

To assist in the construction of the receivers we have prepared a pictorial wiring diagram, and this should enable the project to be tackled with confidence even by the inexperienced. Although the diagram shows specifically the wiring for the "Micro-Plus," it may be used for the simpler versions by simply omitting the additional components.

There you have it, then: variations on a rather novel small receiver theme not only of interest in their own right but also of potential value as a source of educational "fun with a microcircuit." We hope that the material and ideas presented will be found of interest not only by individual constructors but also by schools and Youth Radio clubs.

As a project it would appear to be rather well suited for club and training purposes, both because of the relatively few components involved, and because it lends itself to convenient construction in a stage-by-stage fashion. There are also many opportunities for experimentation, as we have indicated in the foregoing. □



#### MICRO TONE ARMS OFFER OUTSTANDING VALUE!

Designed to track effortlessly with the most sensitive and delicate cartridges, Micro arms accept SME and ORTOFON head shells without modification. The Micro head shell accepts any standard  $\frac{1}{2}$ " mounting cartridge. Vertical and horizontal movement is almost friction-free — tracking pressure is adjustable from 0.5 grams.

MA77 (14") Inc. sales tax. **\$29.50**

#### NEW MODEL MICRO MAGNETIC STEREO CARTRIDGE

Now Micro have released a new series . . . the Models 3100/5 and the 3100/E (with elliptical diamond stylus). Both cartridges have an extended frequency response (20-25,000 Hz.) and performance is outstanding. Write or call for additional information and prices.

#### LOW PRICED CERAMIC CARTRIDGE FOR BUDGET CONSCIOUS MUSIC LOVERS!

The popular Micro SC-301 cartridge has now been superseded by the new, improved Model SC303D. Only the price remains the same! Frequency response is 20-15,000 Hz. and tracking angle is 15°. With diamond stylus . . . Inc. sales tax . . . **\$6.90**

**MICRO LIFTS AVAILABLE.** Both these arms are available with a tailored lifting/lowering device. Pneumatically dampened action assures record protection. The lift may be purchased separately for . . . **\$8.50**



#### MICRO DUST PICKUPS—\$3.50

An effective automatic record cleaner which removes dust as the record plays. An ideal gift. \$3.50 inc. sales tax.

# Encel

**ELECTRONICS  
(STEREO)PTY. LTD.**

Head Office:

431 Bridge Rd., Richmond, Victoria 3121.

Tel. 42 3762.

Sydney Store: Ground Floor, 25M Building

257 Clarence Street, Sydney, N.S.W. 2000.

Tel. 29 4563, 29 4564.

\*Wholesalers \*Trade-ins accepted

Australia's Greatest Hi-Fi Centre

To guarantee you top performance every **Mini-fi**<sup>®</sup> produced is individually tested to meet the highest specifications for response and power handling

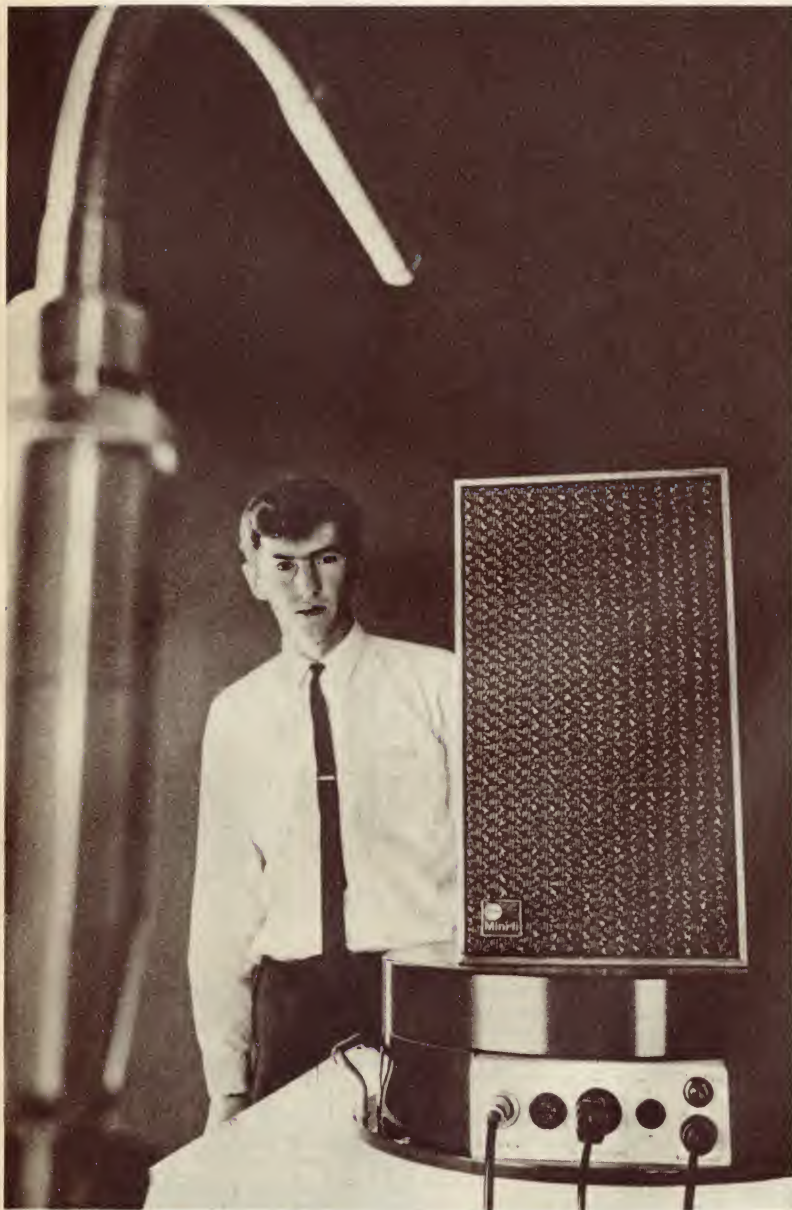

We do it to give you the ultimate performance! Mini-fi is a great miniature speaker system from many points of view. It has the superb wide response, remarkable bass development and brilliant transients to delight the connoisseur of fine sound. It looks distinctive in any situation, and it's small, really small — just 14" x 8" x 8".

Mini-fi's are individually checked as they come off the production line to ensure that each and every one surpasses the published specifications. With a response from 38Hz to 19,000Hz ( $\pm 6$ db) and a power handling capacity of 15 Watts RMS Mini-fi is the ideal miniature system for your most exacting requirements.

Hear a great miniature speaker system in action — listen to Mini-fi at your quality audio dealer. If possible make it today!

® Registered trade mark



## Plessey Components

Rola Division The Boulevard

Richmond Victoria 3121 Telephone 42 3921

NSW Plessey Components Rola Division PO Box 2 Villawood 2163 Telephone 72 0133 AC89

some TV sets aren't marketed now  
...but their components are...

# Rola supply them!



Rola does more than manufacture a wide range of T.V. components for the production of new television sets. They supply components for the older T.V. sets as well — regardless of year, make or model. In fact, since 1956, when television was first introduced into Australia, Rola has supplied more than 2,500,000 electronic components to original equipment

manufacturers and service companies of Australia's television industry. From the earliest Admiral television receivers to the latest Astor, Thorn and General Electric, T.V. manufacturers and suppliers have depended on the reliability and availability of Rola products. These are the reasons why Rola components are an integral part of nearly every brand name

television set made in this country today. Components manufactured by Rola include vertical output and horizontal output transformers, deflection yokes, blocking oscillators, power chokes and many other electronic systems. And, apart from the wide range of standard products available, Rola can tailor make T.V. components to suit your own specifications.

## PLESSEY Components



For additional information please contact:  
Rola Division  
The Boulevard Richmond Victoria 3121  
Telephone 42 3921 Telex 30383  
NSW Plessey Components Rola Division  
PO Box 2 Villawood 2163 Telephone 72 0133

124-AR13

NOW WITH OUTPUT STAGE PROTECTION . . .

# THE 10-PLUS-10 STEREO AMPLIFIER

By LEO SIMPSON

In the few months since November, 1968, when we first presented this amplifier, it has become a popular project. We were, however, conscious of the desirability of protecting the output transistors against destructive overloads and, since then, we have been able to develop suitable circuitry which will add little to the cost of the amplifier. Because we feel that most readers will in the future prefer to assemble the amplifier with protection circuitry incorporated, we are presenting a complete article, so that details of the amended design will be available in the one issue.

Many systems have been suggested for protecting the output stages in an amplifier, some of which were described in the "Audio Topics" article in the December, 1968, issue of "Electronics Australia." For the most part, however, the ideas were not very appropriate for use with an economy stereo amplifier. Since then we have developed a protection circuit which is incorporated into the power supply: It is effective, easily reset after overload — and economical.

lished in "Miniwatt Digest" for June-July, 1967. Four transistors are used in each power amplifier, one silicon type for initial amplification, and three germanium types as the driver stage and output pair. The principle of operation is much the same as in the 3-plus 3 Stereo Amplifier, described earlier.

The input transistor is a silicon NPN type which provides voltage amplification. Negative AC and DC feedback is applied to the emitter from the emitter resistors of the output transistor pair.

The quiescent voltage at the junction of the output transistor emitter resistors should be about half a volt less than half the supply voltage, which it will normally be with standard tolerance components. If need be, it can be set, with the aid of a suitable voltmeter, by varying the 1.5K emitter resistor of the first transistor. Increasing the resistor will increase the voltage and vice versa. When set thus, a sine-wave signal should clip symmetrically at the point of overload, thus resulting in maximum power before the on-



*The prototype amplifier fitted with a brushed aluminium cover. Its compact dimensions and simple appearance belie its high performance. The complete circuit diagram is on the right.*

In operation, if the amplifier is overloaded by a short-circuit or is grossly overdriven, the power supply to the amplifier is automatically disabled. To restore the amplifier to working condition, the cause of the overload is simply removed, the amplifier switched off for ten seconds or so, and then switched on again. Circuit operation will revert to normal.

The main power amplifier for each channel, assembled on the printed wiring board, is based on a design pub-

set of clipping. If the necessary equipment is available, operation can be double-checked by observation of the waveform with an oscilloscope.

The class-A driver stage is a germanium PNP transistor, AC128, operating with a collector current of 50-mA. At this current the usual flag heatsink is insufficient and the flag heatsink must be mounted on an aluminium plate which, in turn, is attached to the printed board.

The output transistors are a comple-

mentary germanium pair AD161/162 operated in the normal push-pull complementary-symmetry mode. These transistors have the advantage of being able to deliver high power with a relatively low supply voltage, because of low IR losses in the transistors themselves. The quiescent current of the output stage is nominally 10mA which, again, will not normally require setting up. If it does prove to be necessary, however, it can be altered by variation of the 68-ohm resistor be-

## SPECIFICATIONS

A transistorised stereo amplifier capable of being fully driven by ceramic cartridges or other "flat" signal source with an output of at least 100mV. Output and regulator transistors are protected against damage.

**Power:** 10 watts music power or 8 watts RMS per channel into 8 ohms, each channel driven separately or both together; 5 watts RMS per channel into 16-ohm loads. 4-ohm speakers may not be used.

**Distortion:** Less than 0.85 per cent THD at 1KHz at 8 watts; less than 0.5 per cent THD at 1 watt at 1KHz.

**Signal-to-noise ratio:** 58dB with respect to 8 watts.

**Separation between channels:**—43dB or better, with respect to 8 watts at any frequency between 100Hz and 10KHz.

**Frequency response at 1 watt:**—3dB points at 25Hz and 17KHz (—4dB at 20KHz).

**Tone Control:** 13dB cut at 10KHz.

**Input impedance:** 1 megohm, all inputs.





# TELEQUIPMENT

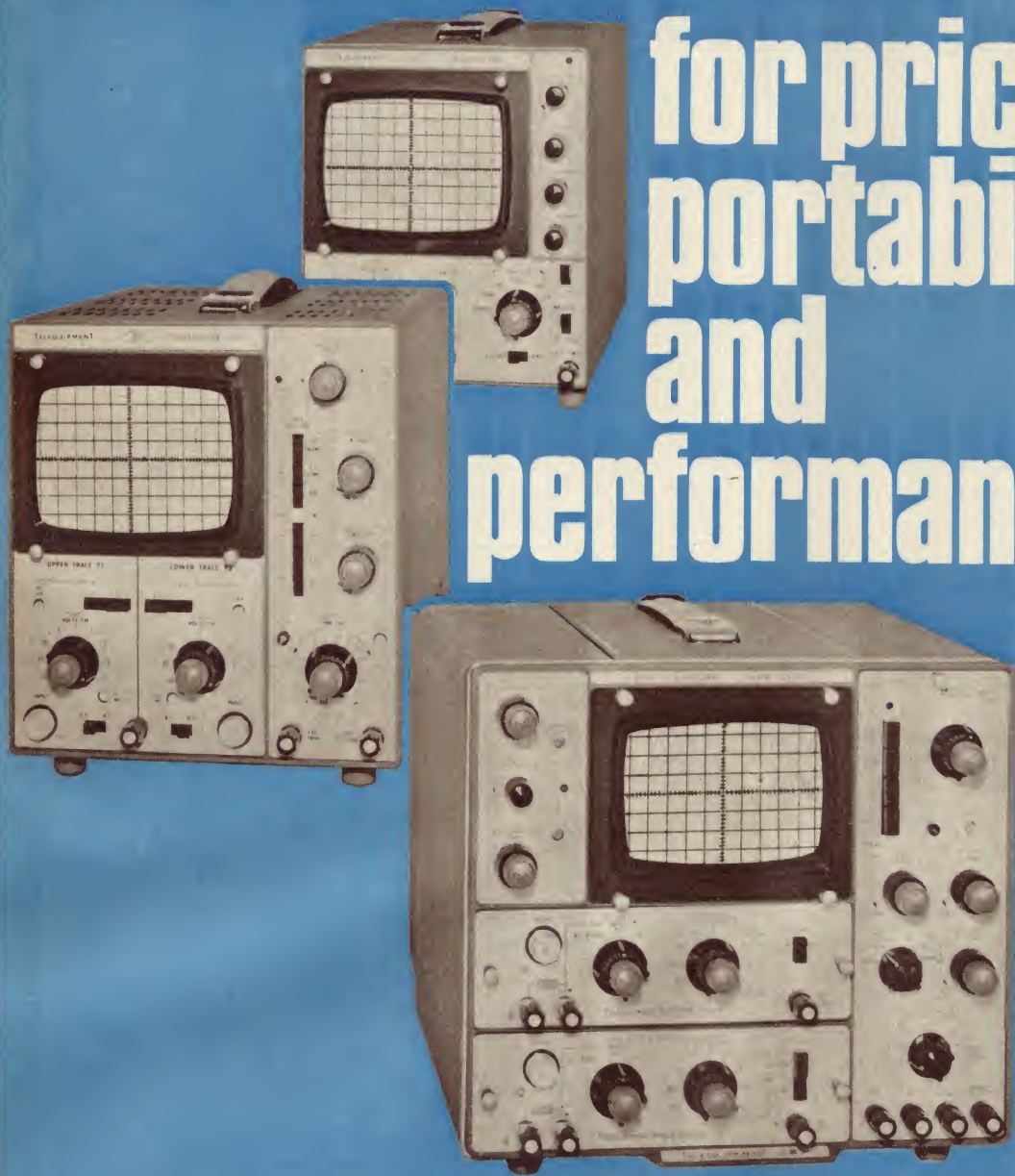

# for price portability and performance

World leaders in low-cost portable oscilloscopes  
—Telequipment offer a scope for every purpose,  
from the Serviscope S51B to the sophisticated  
D53 Oscilloscope for laboratory use. Write or  
phone for details—TODAY.

Distributed by Tektronix Australia Pty. Limited  
N.S.W.: 80 Waterloo Rd., North Ryde 2113. Phone 88 7066  
VIC.: Suite 20, 67 Queens Rd., Melbourne 3004. Phone 51 1592  
S.A.: 128 Gilles St., Adelaide 5000. Phone 23 2811

# TEKTRONIX



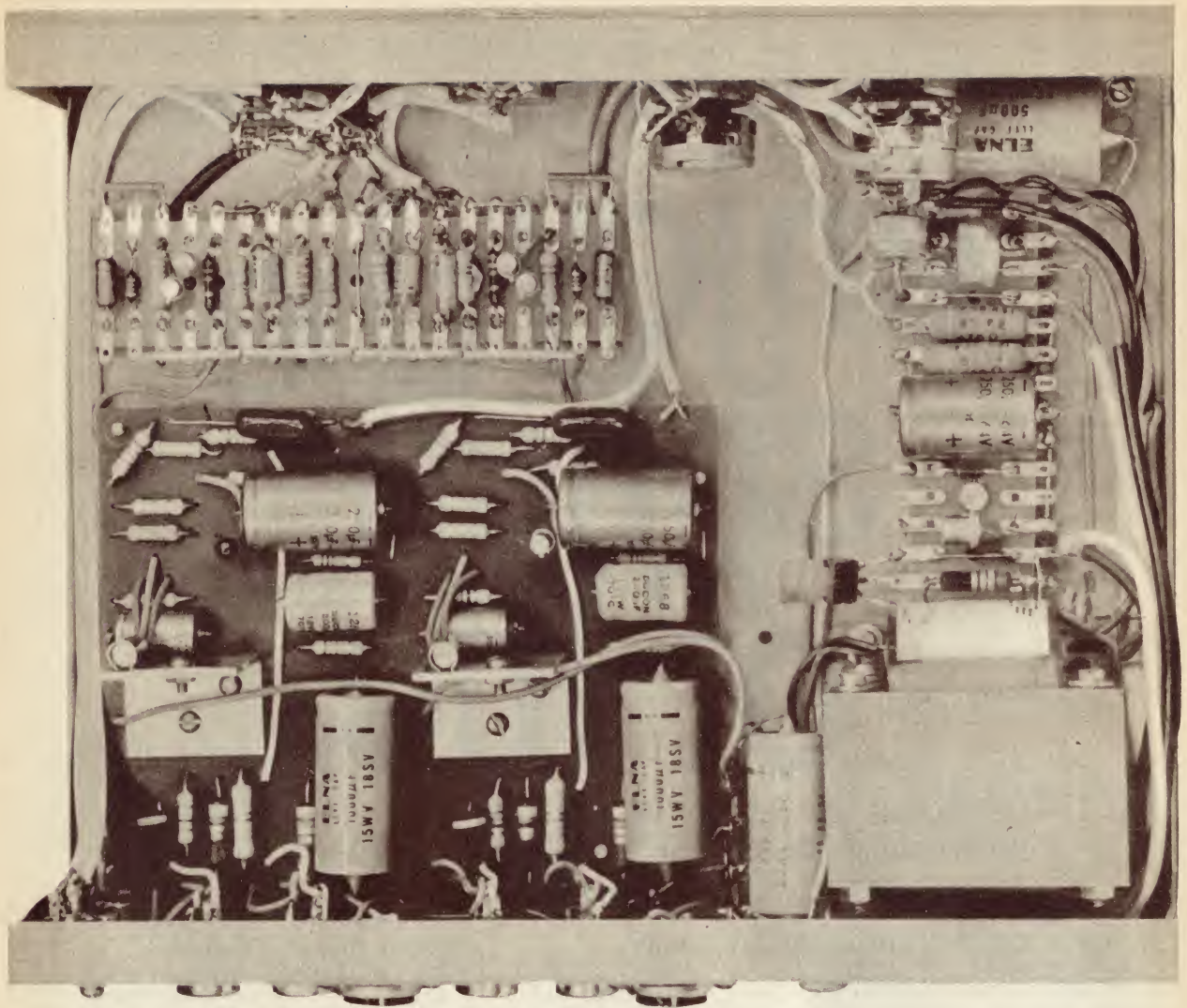

tween the two output transistor bases. Increasing the resistance will increase the current and vice versa.

Note that the quiescent current of the output stage cannot be set unless a load is connected, since the load forms part of the biasing network for the output transistors.

All the above-mentioned circuitry is mounted on the printed wiring board, which uses the same copper pattern as that for the 3-PLUS-3 Stereo Amplifier. However, the sensitivity for full output is of the order of 150mV, with an input impedance of 60K. This means that an extra stage of amplification is required to obtain the necessary sensitivity and high input impedance, to enable the amplifier to be driven to full output by the lower output, higher quality ceramic cartridges which constructors may well wish to use.

The input stage employs two transistors connected as a "Darlington pair." In this mode of operation, the emitter of the first transistor is connected to the base of the second and they share a common collector load. This provides high input impedance, the required gain and a low noise content.

The volume control follows the input stage, coupled to it via a 10uF electrolytic capacitor. The volume control will thus attenuate any noise generated in the input stage at its normal settings, making for lower background noise in typical use.

*An overall view of the interior of the amplifier. The main amplifier board is at bottom left, the preamplifier board above it. The power supply board is to the right. The thyristor is soldered directly into circuit, no heatsink being necessary. All connecting leads should be kept short but arranged in a tidy fashion.*

However, having the volume control in this position means that the input stage may be overloaded if fed with too large a signal. The stage overloads with an input signal of 2 volts RMS (sine wave) and this means it is not directly suitable for high-output crystal cartridges — as opposed to ceramic cartridges which usually have considerably lower output.

If a crystal cartridge must be used it should be connected via a high impedance divider, say 2 megohms and 270K. Alternatively, one can shunt the cartridge with a suitable capacitor (say 0.0047uF) which will reduce the output voltage, while improving the effective bass response. To obtain the best reproduction from the amplifier, however, one of the better quality ceramic cartridges should be used.

The power supply is basically a conventional full-wave rectifier system followed by a series regulator. When both channels of the amplifier are driven to full power, the total current drain is over 1.2 amps, while the current under "no-signal" conditions is of the order of 130 milliamps. This large variation in current drain, plus

the fact that the output transistors have a relatively low collector-emitter voltage rating of 32 volts, means that a regulated power supply is mandatory.

The transformer rectifier combination supplies 40 volts DC to the input of the regulator. Having two separate secondary windings, the transformer can be connected to suit a bridge rectifier or the conventional "centre-tapped winding" rectifier. Instructions on the method of connection are normally packaged with the transformer. We used two BYX21/200 20-amp automotive diodes as rectifiers, these being about the cheapest high current diodes available. Offsetting their economy is the disadvantage that it is necessary to make a soldered connection to the case, which tends to be a little untidy. A suitable bridge rectifier is the silicon type MB1 made by IIT.

The series regulator consists of a silicon NPN power transistor connected in the "emitter-follower" configuration. This takes care of voltage regulation, filtering and overload protection.

A low value resistor in the negative supply line senses the amount of current drawn from the supply. If the

Agfa helps tape editors

# enjoy the splice of life

The only accessory we don't make is a tape recorder. But if you want professional precision in your tape editing — then AGFA has all the accessories you'll ever need.

**ALWAYS KEEP SOME EMPTY SPOOLS**

Mighty handy when you want to run off a short tape or when you've spliced tapes together. AGFA spools run evenly and true. Sizes: 3", 4", 4½", 5", 5½", 7", 8½", 10". From 50c.



**THE COMPLETE, COMPACT SPLICER**

The AGFA Magnetron Splicing set comes with splicing tape, splicing template, and tape cutter. Handy, because it is useful with even the smallest recorder. \$1.15.



**FULL, PROFESSIONAL EDITING KIT**

The AGFA Magnetron editing kit comes with red, green, and white leader tape, with splicing tape, silver stop tape, anti-magnetic scissors, tape clips, and splicing template. It's a complete, 1st class editing kit. \$8.00.



**PROTECTION FOR VALUABLE TAPES**

You can build AGFA plastic spool cases into a neat tape library that protects your valuable recordings. 5", \$1.20; 5½", \$1.50; 7", \$1.72.



**OTHER AGFA TAPE ACCESSORIES**

Leader tape in red and green, 80 ft. \$1.38. Silver stop/Switch tape in rolls of 33 ft. 98c. Special adhesive splicing tape, 33 ft. \$1.12. Neat-fit tape clips in boxes of 25 for \$2.30. Special anti-magnetic splicing scissors \$6.60.

PE31PE31RPE31KPE41PE41RPE41KPE65PE65RPE65K?

Write for FREE leaflet on Agfa Recording tapes and accessories. To AGFA-GEVAERT LIMITED P.O. Box 48, Nunawading, Victoria. 3131

NAME ..... (PLEASE PRINT)

ADDRESS .....

STATE ..... POSTCODE .....



**TAPE RECORDING ACCESSORIES**

\*Registered trademark AGFA-GEVAERT Antwerp/Leverkusen

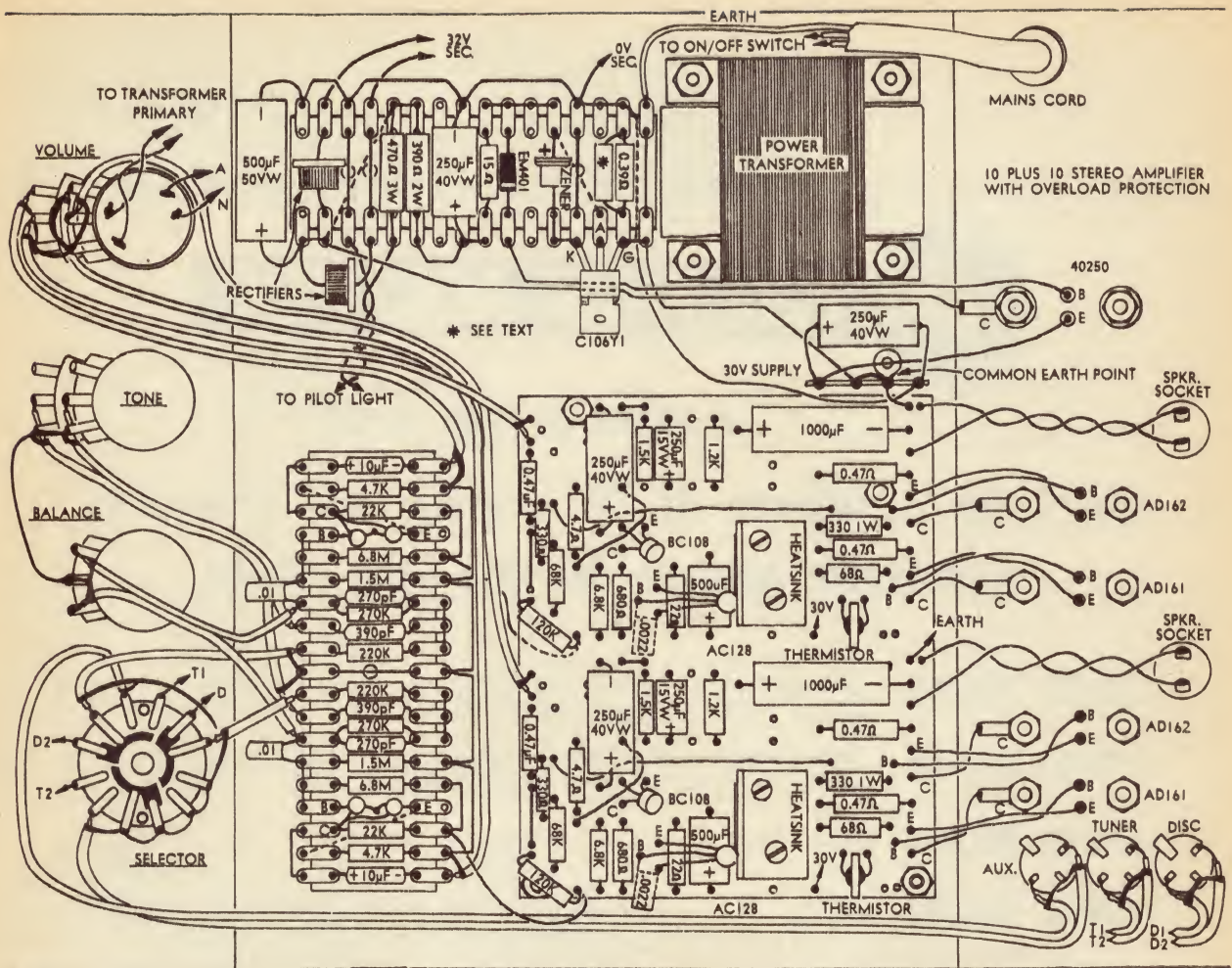

current exceeds a certain value, the voltage developed across the sensing resistor triggers the thyristor (in parallel with the zener diode) into conduction, thereby removing the forward bias from the transistor and interrupting the current drain. The actual "switch-off" time is dependent upon the particular transistor and thyristor but can be expected to be of the order of a couple of micro-seconds. This should provide adequate protection against even the most catastrophic overload.

The value of current at which the thyristor is triggered should lie between the maximum peak current drain of about 1.7 amps and the maximum current rating of the output transistors, which is 3 amps. The optimum current at which the thyristor triggers might thus be nominated as 2 amps. The maximum triggering voltage of the C106Y1 thyristor used is 0.8 volts so that a sensing resistor of 0.39 ohm would seem to be a suitable choice. However, individual C106Y1 thyristors may trigger, in this circuit, at voltages as low as 0.45 volts which would mean premature triggering if a sensing resistor of 0.39 ohms is used. For this reason, we have specified 0.39 ohms but with the proviso that it will have to be shunted down, in most cases, so that the thyristor triggers at about 2 amps.

The value of the shunting resistor can be determined with an ammeter and a load resistor, connected across the supply to draw 2 amps. Alternatively, it may be selected so

*The above wiring diagram and the accompanying photographs will make construction straightforward. Do not forget the mains cord clamp which is not shown above. The amplifier earth returns should be connected to the chassis at the common earth point.*

that the thyristor triggers when both channels are driven to just over full power, i.e., past the onset of clipping. If facilities are not available to measure power output or observe clipping, the shunting resistor can be selected so that the thyristor triggers when the amplifier is driven to loud levels on normal signal.

The power diode connected between the zener diode and the base of the transistor ensures that the transistor is turned completely "off." The thyristor remains in a state of conduction after the transistor is turned off, supplied with current via the 390-ohm and 15-ohm resistors. The only way that normal operation can be restored is to stop the current through the thyristor by switching off the mains supply for about ten seconds, which allows the filter capacitors to discharge. Normal operation can then be restored by switching on again.

The ripple content from the supply, even at maximum current drain, is quite low due to the capacitance amplification of the regulator. However, while the effective capacitance of the supply is very high in terms of filtering, the intrinsic output impedance of the supply is not as low as might be desired, due to the sensing resistor and the dynamic resistance of the collector-emitter junction of the transistor. To reduce the effective out-

put impedance of the supply, a 250µF capacitor has been specified across the output.

It may be thought that the 250µF capacitor could cause damage to the regulator transistor at "switch-on," due to the fact that it would act as a temporary short-circuit and is not included in the loop which is monitored by the sensing resistor. In fact, the time-constant formed by the 390-ohm bias resistor and the 500µF capacitor in the base circuit of the transistor causes it to turn "on" gradually, effectively limiting the surge current. For the same reason, there is no "plop" from the loud-speakers as the amplifier is turned on—an effect which is noticeable with some transistor amplifiers.

**CONSTRUCTION:** The amplifier is assembled in a chassis with overall dimensions of 9½ x 7½ x 3½ inches. It is U-shaped, with a ½-inch flange all round. The prototype was made of 18-gauge aluminium. We would not advise a reduction in the metal thickness, as it would reduce the potential effectiveness of the chassis as a heat-sink for the power transistors.

The four output transistors are mounted on the rear of the chassis, mica washers being used to insulate them electrically from the chassis. If the chassis has been painted, the area to which the transistors are mounted



# CHANNEL MASTER

A SOURCE OF TOTAL SUPPLY

**makes the installation of TV antennas and accessories  
a profitable business for you—the retailer**

- CHANNEL MASTER** Supplies everything but the roof for every type of installation — metropolitan and fringe — indoor and outdoor — single set and MATV.
- CHANNEL MASTER** Has printed technical data to assist you to solve every problem — to bring TV reception to all potential viewers.
- CHANNEL MASTER** Has offices and technical experts in every major city.
- CHANNEL MASTER** Backed by the resources of Channel Master Corporation of America — the name that is synonymous with the best in TV reception in Australia, New Zealand, U.S.A., Canada, Europe and Malaysia.

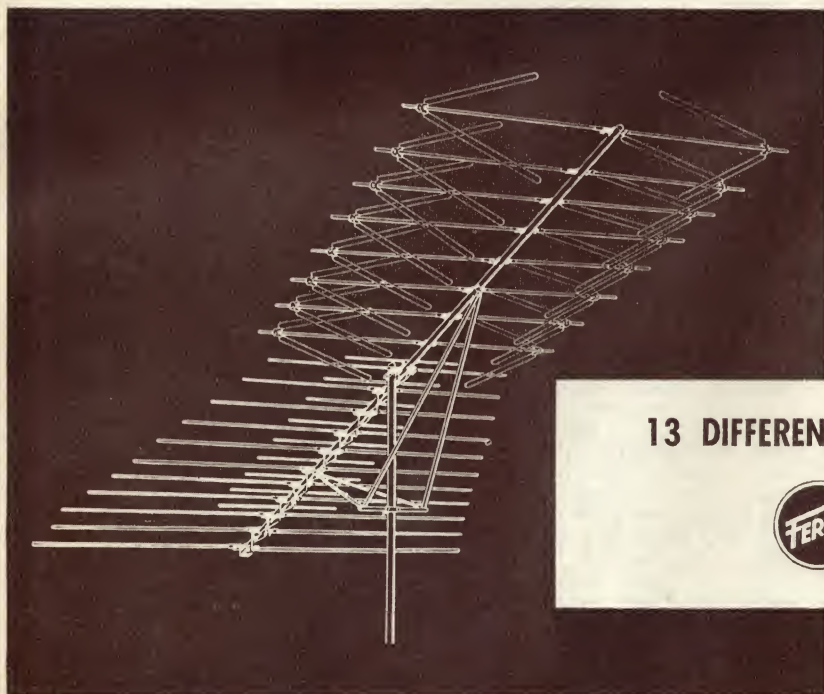

## COLOUR CROSSFIRES

The most powerful, efficient and best-selling antennas in the history of television . . .

with higher and more uniform gain over all channels . . .

fantastic black and white improvement everywhere — ready to meet the demands of colour, too!

Performance like this is why Colour Cross-fire antennas are covered by three U.S. patents, plus one or more of the following: Australian Patent Nos.: 223207, 247716, Pat. Application Nos. 48991/64, 68172/65, New Zealand Patent Nos. 128782, 139216 and Pat. Application No. 143720.

**13 DIFFERENT MODELS - 7 to 28 EL**



**CHANNEL MASTER**

Branches, Distributors and  
Manufacturers' Representatives  
throughout the Commonwealth.

CM 11T/P

must be rubbed back to bare metal to ensure efficient heat transfer.

Actually, under normal "program" conditions, "heatsinking" requirements are not exacting and, even on hot days, the output transistors will be merely warm to the touch. However, we would not advise extended full power testing on hot days, since the chassis — and of course the output transistors — will become rather warm.

If an application is envisaged where the full RMS power of the amplifier is used continuously, a more efficient heatsink for the transistors should really be provided. For normal music reproduction in the home, the chassis itself will be quite adequate, however.

When purchasing the transistors, be sure to obtain the mica washers and nylon bushes, the latter being required to insulate the retaining nuts from the chassis. When mounting the transistors, silicone grease should be lightly applied to both the transistors and the heatsink (chassis). Connection to the collectors of the transistors is made to a solder lug placed under one of the retaining nuts. The same mounting instructions apply for the regulator transistor.

Polarised two-pin sockets are used for loudspeaker connection, since they simplify speaker phasing and are easier and safer to use than terminal lugs. Three 3-pin DIN sockets are provided for the inputs and these are connected to the selector switch via dual shielded cable. The shield for each channel input is connected to the centre pin (pin 2) of the DIN socket but no connection is made to the outer shield of the socket.

All the circuitry for the input stage is mounted on a piece of miniature tagboard.

Similarly, the power supply circuitry, apart from the transistor and 250uF capacitor at the output are mounted on tagboard. The thyristor is soldered directly to the tagboard, no heatsink being necessary. The electrostatic screen of the power transformer and the earth wire of the mains cord are connected directly to the single common earth point on the chassis, via the tagboard. They should not be connected to chassis via the current sensing resistor. The 250uF capacitor is mounted on a four-way tagstrip which also serves as the common earth point to the chassis. The negative connection for this 250uF should not be made directly to earth but via the sensing resistors.

The pilot lamp is supplied from the output of the rectifiers via a 470-ohm 3-watt resistor. This will have to be varied according to the voltage rating and current drain of the lamp. The lamp in the prototype drew about 70 milliamps at 8 volts — it was rated at 12 volts. It is good practice to run these lamps at reduced voltage to obtain longer life and reduce brightness so that it is not obtrusive. A 560-ohm resistor should be suitable for typical 6-volt lamps.

The third pole of the 3-pole selector switch is used for shield terminations. As the circuit and wiring diagrams indicate, only one of the two shields of the dual input cables and the signal cable to the input stage is connected to the third pole of the selector switch, to decrease the possibility of earth loops.

The input wiring shield must not be

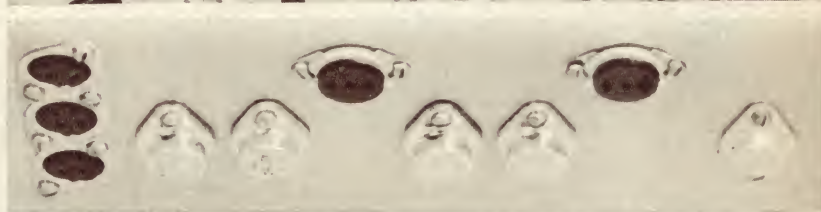
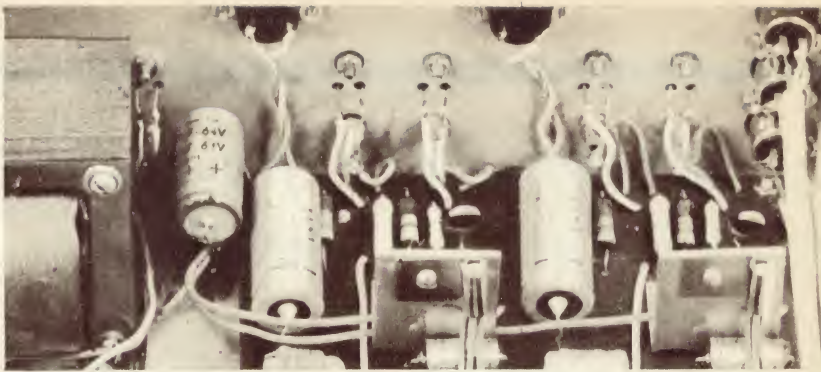

At top is a view showing the location of the power transistors and the input and output sockets. Below this is a view of the control wiring: Particular care needs to be taken with the earth returns. Below this, again, is an oblique view of the rear of the amplifier.

## PARTS LIST

- 1 chassis with overall dimensions  $9\frac{1}{2} \times 7\frac{7}{8} \times 3\frac{1}{2}$  inches made of 18-gauge metal.
- 1 metal cover with dimensions to suit chassis (optional).
- 1 front panel.
- 1 power transformer, 240V to 32V at 2A DC.
- 3 3-pin DIN sockets.
- 2 2-pin polarised sockets.
- 1 printed board, 68/a8.
- Miniature tagboard, 1 19-lug, 1 16-lug.
- 1 3-pole 3-position rotary switch.

### SEMICONDUCTORS

- 2 AD161/162 complementary matched transistor pairs.
- 1 40250 silicon NPN transistor.
- 2 BC109, SE4010 or similar low-noise silicon NPN transistor.
- 4 BC108, 2N3565 or similar silicon NPN transistor.
- 2 AC128 germanium PNP transistor (with flag heatsinks).
- 2 BYX21/200 power diodes or MB1 bridge rectifier.
- 1 EM401, AD100 or similar power diode.
- 1 BZY95-/C30 zener diode.
- 1 C106Y1 thyristor.
- 2 B8-320-01A/10E or E215AB/15E thermistors.

### POTENTIOMETERS

- 1 50K (log) dual ganged, with rotary power switch.
- 1 2M (log) dual ganged.
- 1 5M (lin).

### RESISTORS

- ( $\frac{1}{2}$  or  $\frac{1}{4}$ -watt, 5% tolerance.)
- 2 x 6.8 M, 2 x 1.5M, 2 x 270K,
- 2 x 220K, 2 x 120K, 2 x 68K,
- 2 x 22K, 2 x 6.8K, 2 x 4.7K,
- 2 x 1.5K, 2 x 1.2 K, 2 x 680 ohm,
- 2 x 68 ohm, 2 x 22 ohm, 1 x 15 ohm, 2 x 4.7 ohm.
- ( $\frac{1}{2}$ -watt unless specified.)
- 1 x 470 ohm/3 watt (to suit pilot lamp).
- 1 x 390 ohm/2 watt.
- 4 x 330 ohm (2 x 1 watt, 2 x  $\frac{1}{2}$ -watt).
- 2 x 0.47 ohm, 1 x 0.39 ohm.

### ELECTROLYTIC CAPACITORS

- 2 x 1000uF/15VW, 1 x 500uF/50VW, 4 x 250uF/40VW, 2 x 500uF/2.5VW, 2 x 250uF/15VW, 2 x 10uF/15VW.

### CAPACITORS

- (Low voltage polyester, polystyrene or metallised polyester)
- 2 x 0.47uF, 2 x 0.01uF, 2 x 2200pF, 2 x 390pF, 2 x 270pF.

### SUNDRIES

- 4 turned aluminium knobs, 4 rubber feet, 8 x  $\frac{1}{8}$ in fibre rod spacers, tapped right through for 1/8in Whit. screws, 1 4-terminal tagstrip, mains cord and plug, mains cord clamp, grommet, miniature bezel and lamp, dual shielded cable, hook-up wire, spaghetti sleeving, screws, nuts, silicone grease, solder, etc.

# Move from the problem to the solution

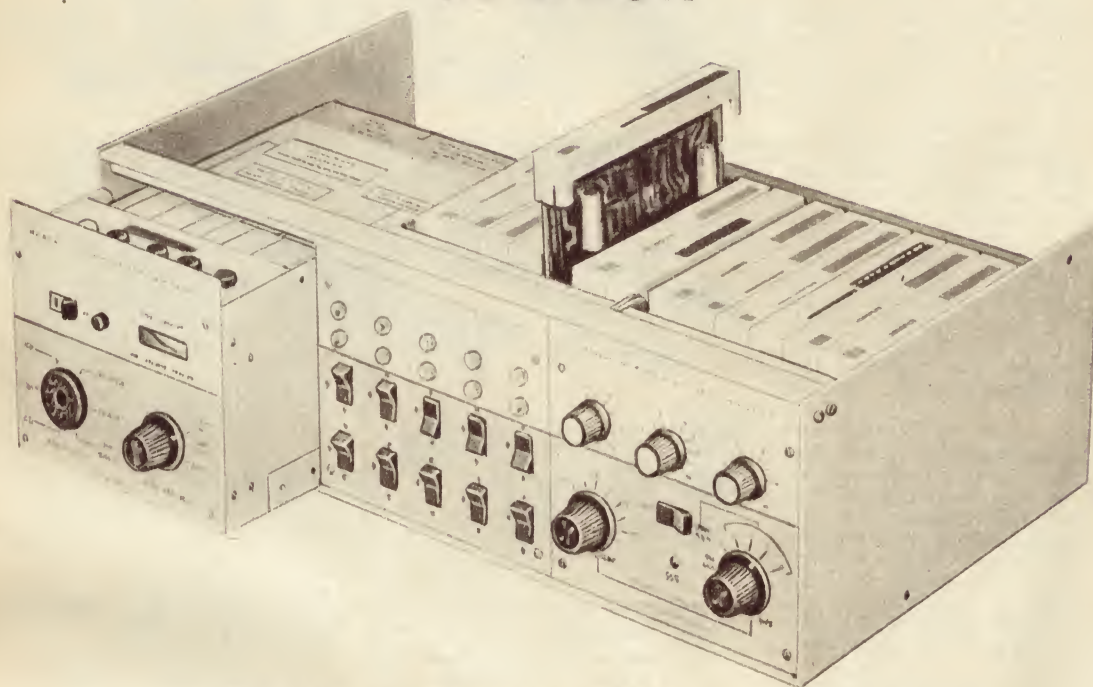

## with Heath Analog Digital Designer

Achieve virtually anything you wish in digital and analog circuitry: design your own Counters, Frequency Meters, DVM, Precision Timers, Frequency Standards, Digital Interfaces . . . and hundreds of other digital Instruments. You can also investigate Counter, Scaling and DVM circuits, Adders, Subtractors, Digital Analog Interfaces and special circuits of your own. All you have to do is plug-in a few circuit cards and connect them . . .

The Heath/Malmstadt-Enke Analog Digital Designer (ADD) EU-801A is a unique method of systems and circuit "breadboarding" for experimentation. The ADD includes three factory-assembled modules (power supply, binary information and digital timing) and 13 factory-assembled cards. Each module may be used individually or connected to the others in the system cabinet. Cards plug into each module . . . power supply connections are automatically made.

High value cards with TTL ICs feature "wire-patch" solderless

connector boards to accept ordinary hookup wire and component leads for simple and rapid assembly of your circuit designs. A color schematic of inputs and outputs is provided on the board.

The ADD may easily be expanded as new modules and new cards are available following the improvement of technology.

The ADD with its Analog Digital Interfaces is able to accept and process external information, thus opening it to the outside world. 10 lamp binary readout is built-in . . . digital readout will be available shortly.

Multiple NAND gate, Dual J-K Flip-flop, Dual monostable, Relay, Comparator/Voltage to Frequency, Dual In-line IC socket, Multiple connector/Blank PC and Operational Amplifier cards are supplied. Just plug-in your design in the ADD . . . optimize it and use the solution directly.

### The ADD's Logical Companion



Many cards from the Heath EU-805 Universal Digital Instrument (UDI) may be used in the ADD, increasing its capabilities. The UDI combines in one package a 12.5 MHz Multi-Purpose Counter/Timer and a 0.05% accuracy Integrating Digital Voltmeter to measure frequency, period, time interval, ratio, count events and perform as a DVM and voltage integrator with unmatched versatility.

For full details of this economical solution to digital and analog problems contact:



## WARBURTON FRANKI

ADELAIDE: 56-7333  
BRISBANE: 51-5121  
HOBART: 2-1841

LAUNCESTON: 2-1318  
MELBOURNE: 69-0151  
MOUNT GAMBIER: 2-3841  
NEWCASTLE WEST: 61-4077

PERTH: 8-4131  
SYDNEY: 29-1111  
WOLLONGONG: 2-5444



connected to the chassis at any point apart from the connection made via the printed boards.

All the above wiring details are shown on the wiring diagram. It is good practice to check your wiring against the circuit diagram. If the details of the wiring layout are not noted and duplicated, instability or, at the very least, failure to obtain the performance of the prototype, may result.

The power transformer used in the prototype was a Ferguson, type PF 2876, which is rated 32 volts at 2 amps DC. Other manufacturers have equip-

be passed through a grommited hole in the rear of the chassis, then between the chassis side flange and the transformer stack and finally terminated at the switchpot. It is anchored by a clamp held by the same screw which retains one of the transformer lugs.

The five power transistors may now be mounted, as detailed earlier. Then install the supply board and make inter-connections to it. Next, install the printed wiring board and 4-terminal tagstrip for the earth and supply connections.

The quiescent current is most easily checked at this stage. It should be be-



Above is the copper pattern of the amplifier board. Actual size of the board is  $5\frac{1}{2} \times 4\frac{1}{2}$  inches.

alent types available. It should be mounted in the way shown in the illustration.

A suitable order of assembly would be as follows: First, wire all the components and connecting wires into the printed board. The 2200pF capacitor connected from base to collector of the driver transistor is wired on the copper side of the board, as is the positive supply connection for the input stages. The heat sinks for the driver transistors are made of 18 gauge metal,  $1\frac{1}{2}$  inches wide by  $2\text{-}3/16$  bent at right-angles  $13/16$  inches from the end, with holes drilled for mounting screws. The two tagboards are also pre-wired as noted previously.

Note that all the boards are mounted on the chassis so that they have at least  $\frac{1}{4}$ -inch clearance of the same. This can be done using fibre rod spacers tapped right through for  $1/8$ in whitworth or, alternatively, using just  $\frac{1}{4}$ -in screws and nuts.

Having wired the boards, attention can be turned to the chassis. The rubber feet are retained with a screw and nut, the nut being held in the foot itself. The potentiometer and selector switch shafts should be cut to suit the knobs. Having installed the controls and input sockets, transformer and rectifier, etc., the appropriate wiring can be installed. The mains cord should

tween 65 and 75 milliamps for each channel. Next, the input stage tagboard can be installed. The "half-supply" voltage at the junction of the emitter resistors of the output transistors may now be checked and adjusted if need be, as described earlier. The final adjustment is that of the sensing resistor which is described above.

Finally, a front panel and knobs can be fitted. The prototype had a panel with a glossy black background and white lettering which contrasts with the turned aluminium knobs.

The amplifier may be installed in a cabinet or used in a free-standing situation, in which case a cover is required. In both cases care must be taken to ensure that air can circulate freely around the rear of the chassis. The cover was made of 18-gauge aluminium, suitably bent and with a slight overhang at front and rear. Ventilation, in the form of a row of holes at top and sides or louvres, must be provided, to allow the interior of the amplifier to remain cool. The transformer was the main source of heat in the prototype, and if this is not allowed to escape the case can become quite warm to the touch.

Used with a high quality ceramic cartridge and good quality speakers, the amplifier is capable of really excellent sound.

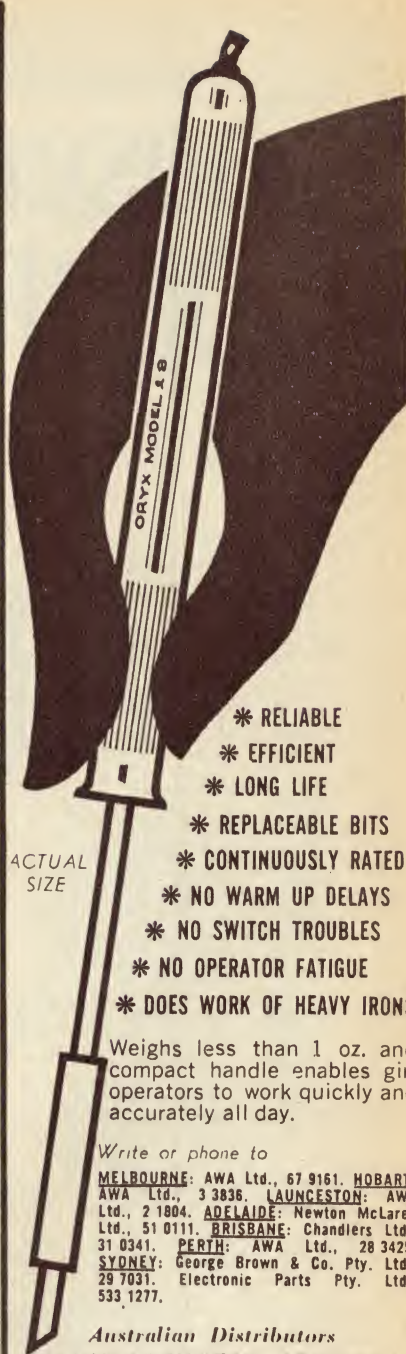

ACTUAL SIZE

- \* RELIABLE
- \* EFFICIENT
- \* LONG LIFE
- \* REPLACEABLE BITS
- \* CONTINUOUSLY RATED
- \* NO WARM UP DELAYS
- \* NO SWITCH TROUBLES
- \* NO OPERATOR FATIGUE
- \* DOES WORK OF HEAVY IRONS

Weights less than 1 oz. and compact handle enables girl operators to work quickly and accurately all day.

Write or phone to

MELBOURNE: AWA Ltd., 67 9161. HOBART: AWA Ltd., 3 3836. LAUNCESTON: AWA Ltd., 2 1804. ADELAIDE: Newton McLaren Ltd., 51 0111. BRISBANE: Chandlers Ltd., 31 0341. PERTH: AWA Ltd., 28 3425. SYDNEY: George Brown & Co. Pty. Ltd., 29 7031. Electronic Parts Pty. Ltd., 533 1277.

Australian Distributors  
MANUFACTURERS SPECIAL  
PRODUCTS PTY. LTD.

47 York Street, Sydney. 2 0233, Ext. 284

# WANTED

BY ALL  
PRODUCTION ENGINEERS

# ORYX

miniature  
soldering instruments

# Chosen by the BBC... GOLDRING '800' SERIES

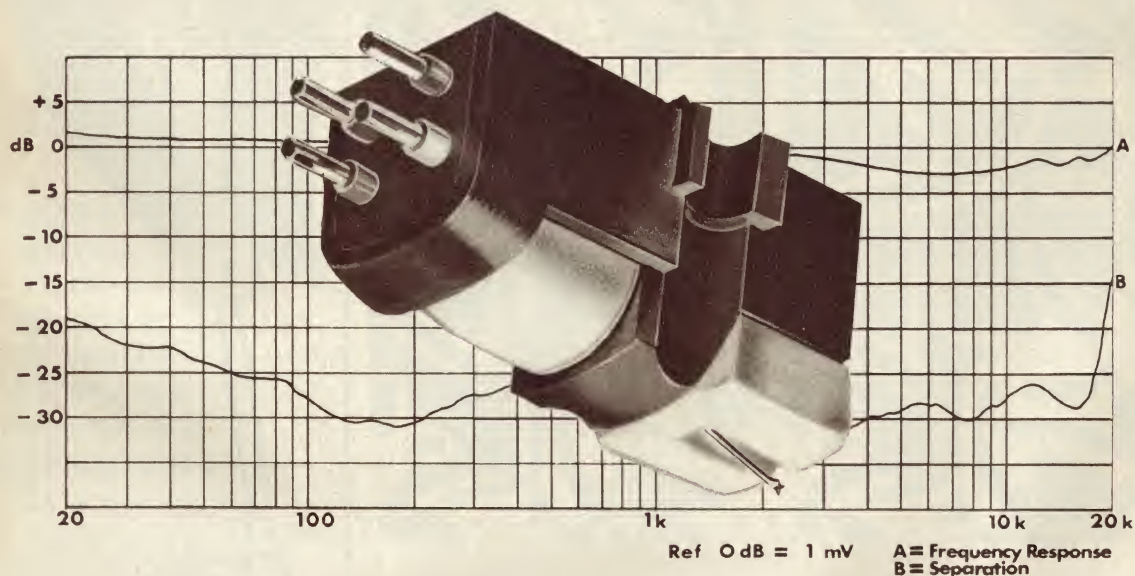

## Goldring '800' and '800E' free field stereo cartridges

With a choice of the finest cartridges anywhere in the world, BBC engineers chose the Goldring '800' series. They recognised the unparalleled advantages of the 'free field' system in re-creating the finer shades of original sound. Read the specifications and you'll agree. In these cartridges a very lightweight tube of magnetic material lies in a 'free field' generated by a fixed source coupled to a low mass diamond point. They feature low mechanical impedance, tracking at 1 to 3 grams (800) and 0.75 to 2 grams (800E), screening from external hum fields, gold-plated contacts. Stylus is replaceable.

### Specifications:

	'800'	'800E'
Type	Magnetic	stereo & mono
Frequency Response	20Hz-20kHz	10Hz-25kHz
Sensitivity	5.5 mV at 5 cm/sec	
Separation	25dB at 1kHz and nowhere less than 15 dB	
Load	100k-47k/ohms	
Compliance	20 x 10 <sup>-5</sup>	30 x 10 <sup>-5</sup>
Static	cm/dyne	cm/dyne
Effective Point		
Mass	1 mg	less than 1 mg
Stylus Point	Conical 0.0005" diamond	Elliptical .0008" x 0.0003" diamond
Tracking Weight	1-3 gm	0.75-2 gm
Head Weight		8 gm
Connections		4 pins
Fixing	Standard 1/2" centres	
Vertical Tracking Angle	15°	
Mu-Metal Shield for hum protection		
Removable Stylus		

## GOLDRING ENGINEERING (A'ASIA) PTY. LTD.

N.S.W. 443 Kent St., Sydney, 2000. Phone 29-5802  
VIC: 162 Pelham St., Carlton, 3053. Phone 34-5105.  
QLD.: 415 Adelaide St., Brisbane, 4000. Phone 23247.

S.A.: Farley & Fahy Pty. Ltd., 75-77 Wright St., Adelaide, 5000. Phone 51-5117.

W.A.: 32 Northwood St., Leederville, 6007. Phone 84988

FROM THE EVER-WIDENING RANGE OF HI-FI EQUIPMENT AVAILABLE FROM GOLDRING.

# There's an AIWA microphone to solve your recording problem.

**AIWA DM.57 DYNAMIC MICROPHONE**—Impedance: 60 and 50K. Frequency Response: 100-13,000 cps. Sensitivity: 75 db's. Dimensions: 7½" x 1½". Weight: 14 ozs. **\$18.50**

**AIWA DM.17 OMNI-DIRECTIONAL DYNAMIC BOOM MICROPHONE**—Impedance: 50K or 50Ω. Frequency Response: 70-14,000 cps. Sensitivity: 75 db's. Dimensions: 5½" x 1½". Weight: 10½ ozs. **\$18.50**

**AIWA DM.51 DYNAMIC MICROPHONE**. Impedance 50Ω or 50KΩ. Frequency Response: 50-15,000 cps. Sensitivity: 55 db's. Dimensions: 10" x 1½". Weight: 29 ozs. **\$27.00**

**AIWA DYNAMIC NON-DIRECTIONAL MICROPHONE DM.13**—Impedance: 50K or 50Ω. Frequency Response: 60 c's-14,000 cps. Sensitivity: 55 db's. Dimensions: Length 10½". Weight: 18½ ozs. **\$29.00**

**AIWA UNI-DIRECTIONAL DYNAMIC MICROPHONE DM.47**—Impedance: 50Ω or 50K. Frequency Response: 40-18,000 cps. Sensitivity: 75 db's. Dimensions: 5½" x 1½". Weight: 18 ozs. with cord. **\$36.00**

**AIWA DM.10 DYNAMIC DESK MICROPHONE**—Impedance: 50KΩ or 50Ω. Frequency Response: 60-13 Kc's. Sensitivity: 75 db's. Dimensions: 7½" x 1½". Weight: 11 ozs. without stand. **\$16.80**

**AIWA DM.14 DYNAMIC MICROPHONE**—Impedance: 50Ω or 50K. Frequency Response: 90 c's-14,000 cps. Sensitivity: 75 db's. Dimensions: 3½" x 1½". Wt. 10 ozs. **\$12.50**

**AIWA DM.67 CARDIOD DYNAMIC MICROPHONE** — Impedance 50Ω or 50 KΩ. Frequency response 100-12000 CPS with 15 dB. Front to rear separation. Sensitivity: 74 dB. Dimensions: 5½" x 2" max. Weight: 8 ozs. **\$33.00**



DM 57



DM 17



DM 51



DM 13

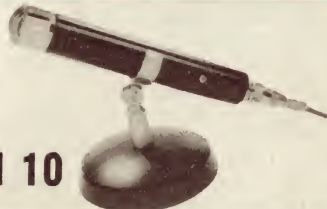

DM 10



DM 47



DM 67



DM 14



*Distributed by:*  
**GOLDRING**  
**ENGINEERING (A'ASIA) PTY. LTD.**

N.S.W.: 443 Kent St., Sydney. 2000. 29-1275.  
VIC.: 162 Telham St., Carlton, Vic. 3053. 67-1197.  
QLD.: 415 Adelaide St., Brisbane, Qld. 4000. 23247.  
W.A.: 32 Northwood St., Perth, W.A. 6007. 84988.  
S.A.: 77 Wright St., Adelaide. 5000. 51-5117.

GE:P345



# How to Construct a Q-Multiplier

by Ian Pogson

This simple little device is easy to build and get going and will be found very useful in stepping up the selectivity of short-wave and other receivers which may be somewhat lacking in this respect. The selectivity can be adjusted from the original broad characteristic of the receiver, to a point where it is very sharp indeed.

Although Q-multipliers have been around for 15 years or more, and there are many receivers which would be better for the use of one of these devices, we have never described one in the pages of this magazine. We are about to make good this omission and describe a simple version.

What is a Q-multiplier, what does it do and how does it work? These are some questions which should be answered at least in part before we proceed with other aspects of the unit.

Basically, a Q-multiplier is an amplifier which is tunable to the frequency required and which has a positive feedback loop, but under conditions where the regeneration is under strict control at all times.

When the output of this amplifier or Q-multiplier is connected across a tuned circuit, such as an IF transformer, the regeneration makes up in a controllable manner, the intrinsic losses of the particular tuned circuit. This results in an apparent increase in the Q of the tuned circuit, with a consequent sharpening of its selectivity.

Alternatively, the arrangement may be looked upon as one tuned circuit in parallel with another. The original tuned circuit is broad but the Q-multiplier circuit is very sharp and consequently has a high dynamic impedance at the centre frequency so letting signal though at this precise frequency. However, as the skirts of the multiplier are very steep, the dynamic impedance falls off sharply and shunts the signals at either side of mid-frequency, so giving the effect of high selectivity.

The circuit of a Q-multiplier often takes the form of a slightly modified Colpitts oscillator. The feedback is obtained via a capacitive voltage divider in the usual way. However, in the case of a grounded cathode configuration, a variable resistor is placed in

the cathode circuit. This is un-bypassed and so adds a certain amount of degeneration to the circuit. The amount of degeneration is controlled by varying the value of the resistor. This should be adjustable over the range from where little regeneration is evident, to the point where the amplifier goes gently into oscillation. It is just before this latter point where the maximum possible selectivity is obtainable.

As we have just implied, early Q-multipliers were designed around valves, quite often a 12AX7 or similar triode. More recently, valves have tended to give place to transistors, the design and circuitry being modified to accommodate the lower impedances and other characteristics of bipolar transistors. The unit which we are now presenting uses a FET (field effect transistor). As these devices have input and output impedances comparable with those of a valve, the circuit once again takes on the more familiar appearance which we knew earlier on.

There is one decided advantage which the field effect transistor has over the valve, namely that no heater supply is required. But, in common with other transistors, it is physically small and requires only a modest supply voltage.

However, while FETs hold excellent promise for the future, they, too, have their problems. As readers may be aware, there are various types of field transistor, some of them very delicate and needing special care in handling. The junction FET, one of which we are using in the Q-multiplier, is reasonably rugged, but often suffers from a wide spread in characteristics. Fortunately, the type which we are using is fairly good in this respect.

The actual shape of the selectivity curve which results from the use of a Q-multiplier must be considered. Due to the nature of the device, the curve is one which comes to a more or less

sharp point—according to its adjustment—and resembles that of a single correctly phased crystal filter. At its sharpest, the selectivity and shape of the curve makes it ideally suited to Morse Code reception. On the other hand, these characteristics make it less suitable for AM reception. Also, for SSB reception, we need a pass-band shape which is ideally flat on top, with steep skirts on each side.

Although the ideal shapes are not obtained with the Q-multiplier for these modes, it is nevertheless still very worthwhile, particularly where improved selectivity is being sought at low cost. As was pointed out earlier, it is possible to control the degree of selectivity with a Q-multiplier. For AM work, adequate selectivity is likely to be obtained without even approaching the maximum limit. With SSB reception it would normally be possible to use a greater amount of the available selectivity, giving quite acceptable results, even though the pass-band shape will not be the best.

Although we have only discussed the possibility of stepping up the selectivity of a receiver with a Q-multiplier, it is actually possible to create quite a different effect. Instead of effectively making the selectivity shape very sharp, we can, by inversion, introduce a sharp, deep notch in the normal pass band of the receiver. This can be very useful, particularly when the notch can be tuned across the pass-band to attenuate an adjacent interfering heterodyne.

The effect is achieved by adding another stage to the system, the extra stage incorporating negative feedback. Instead of the output of the Q-multiplier having some characteristics of a parallel resonant circuit with a very high impedance, it now looks like a series resonant circuit, with a very low impedance and high Q. This cuts a very narrow slice or notch out of the passband.

This feature can be useful where AM reception is the general rule and where trouble is constantly being experienced with heterodynes from adjacent AM transmissions. We have not incorporated it in our unit in the interests of simplicity.

If you take a look at our circuit, you will notice that the Q-multiplier is intended to connect to the output of the mixer of the receiver, via a 15pF capacitor. Most Q-multipliers have a much larger capacitor, something like

.001 $\mu$ F, at the input. This can necessitate the addition of a large adjustable inductor, of the order of 1.5 to 3mH, to tune out the effect of the capacitance of the coaxial cable between the mixer stage in the receiver and the input to the Q-multiplier. In the interests of simplicity, we have used the value of 15pF; it may have a slight effect on the ultimate amount of selectivity attainable but there is adequate available for most purposes.

In fact, the circuit is about as simple as it can be; besides the 2N5459 field effect transistor and the coil, there are only four resistors and six capacitors. As mentioned earlier, the circuit is fundamentally a Colpitts oscillator, the ratio of the two feedback divider capacitors, across the coil, being about three to one. The values which we have chosen suit the inductance of the types of coil which we had in mind.

Suitable coils are either the tuned winding of an aerial or RF coil, as used in a broadcast receiver, originally with a 415pF tuning gang. The one which we used was an old aerial coil, made by Aegis. Resonated at 455KHz, the tuned winding had a Q of 120, which is quite good for coils of this type. However, in many articles describing Q multipliers in the past, the emphasis has been directed towards getting a coil with as high a Q as possible. Although the Q of 120 is satisfactory, it is possible to get much higher Qs by winding your own coil, either on a pot core or a toroidal core.

We wound a coil on a Ducon toroidal former, Q1 material, 23/32in OD x 15/32in ID x 1/4in thick, with 57 turns of 24 gauge enamelled copper wire. Measured on the Q meter, this coil came up with a Q of 240, or double that of the other coil. If you wish to try this type of winding, the number of turns stated can only be a guide, as the inductance will vary with physical variations, such as the actual disposition of the turns on the former. Also, if you use a toroidal coil, make sure you mount it at least 1/4in clear of any metal objects, otherwise the Q may suffer accordingly.

The 50pF variable capacitor, across the 820pF capacitor, may be used to set the tuned circuit precisely to the wanted frequency. In the case of the slug-tuned aerial coil which we used, the variable capacitor may be used in addition to the slug, to adjust to the intermediate frequency, under actual operating conditions. This is a debatable advantage, however, and, where simplicity is paramount, the capacitor may be dispensed with and the coil brought to the IF centre frequency with its own slug.

On the other hand, if you use a toroidal coil, it is difficult to adjust the inductance to a precise value. Under these conditions, the inductance should be brought as close as possible to the wanted value, with the 50pF variable capacitor in its mid-position. The tuned circuit can then be adjusted to the centre of the pass-band with the variable capacitor.

In the source circuit of the FET are a 470 ohm fixed resistor and a 1K potentiometer. The 470 ohm resistor is simply provided to limit the control range of the potentiometer and to give some vernier action to the

selectivity adjustment. More will be said about this later on.

The complete prototype unit was housed in a diecast metal box made by Eddystone and measuring 4-5/8in x 3-5/8in x 2-3/16in. This box gives the finished job a professional appearance but a folded metal box may be substituted, if desired.

The layout of the components is not critical but we will detail how we went about it so you may follow it closely or use it as a guide. The variable capacitor, potentiometer and On-Off switch are mounted on the front panel. The coil assembly is more or less free and can be clamped conveniently at one end of the box and close to the potentiometer. If you use a different size and shape of coil, other methods of fixing will no doubt suggest themselves.

The rest of the components, including the field effect transistor, are mounted on a piece of tag board. The coded diagram of the board should make wiring and assembly an easy matter. As is always the case, care must be taken to make good soldered joints but, at the same time, the components should not be overheated. This applies particularly to the FET.

The completed tag board assembly is held to the front panel with two stand-off pillars, 1-1/4in long. As pillars of this length were not readily available, we used some 1in spacers

which were tapped at each end and then made up the extra 1/4in with another spacer with a clearance hole through it.

You will notice that the tag-board has a few spare tags. We made it a little longer than necessary, so that the spacers were located towards the edges of the panel. This allows more space under the tag-board and makes for a better location of the switch.

Having built the unit up to this point, all that remains is to connect it to the receiver. This is normally done via a short run of low capacitance coaxial cable. A grommited hole is needed in the back of the case, to pass the cable through. A convenient point for connecting the cable is across the .0027 $\mu$ F capacitor.

Just how you connect the other end to the receiver will depend on circumstances. The cable could be taken through the skirt of the chassis, adjacent to the mixer valve or its equivalent. Alternatively, a coaxial socket could be installed at this point on the chassis, with a mating plug on the coaxial cable. In any case, the active conductor must be connected to the plate of the mixer, via the 15pF capacitor connected right at the socket, with a minimum of lead length between capacitor and socket.

We carried out our initial bench tests with the "1967 All Wave Seven"

## More selectivity for existing receivers

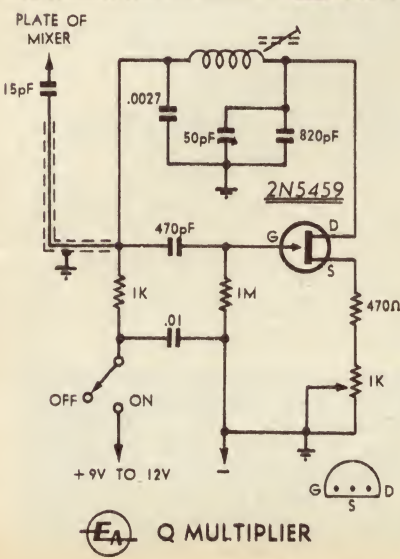
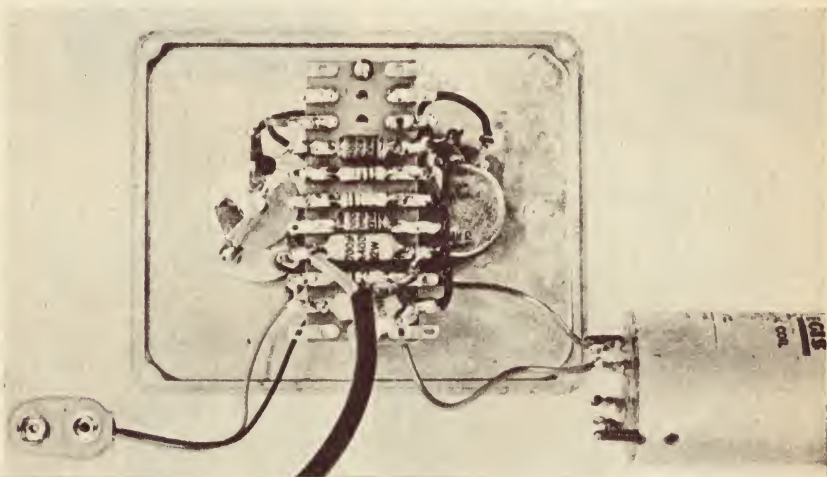

Above is an inside view, with an old aerial coil to the right and a battery connection to the left. At left is the simple circuit diagram. Note the FET connections.

receiver, with connection made to pin 5 of the 6BE6. The earth connection was made to the centre shield of the valve socket. It was found that the coaxial cable was not really necessary in this case and we were able to "get away" with a twisted pair of hookup wires. In most cases it would be wise to use a piece of coaxial cable, no longer than necessary. The piece which we finally used is about 14in long.

Having completed the unit and connected it to the receiver, the next task is to align and make adjustments. Firstly, and before the Q-multiplier is switched on, the IF trans-

IF IT'S  
A  
QUESTION  
OF  
HI-FI

CALL ON

**ARROW ELECTRONICS**

THE KENT STREET  
HI-FI SPECIALISTS

(Established 20 years)

We stock all well known brands of HI-FI equipment. Write for details and your "ARROW QUOTE," or drop in and see for yourself any item illustrated or mentioned below. These items represent just a few of the wide range available to you at ARROW.

### LEAK

The NEW LEAK STEREO 70 will thrill you with the clearest, most exciting sound ever reproduced by an amplifier—35 watts R.M.S. per channel—distortion a mere 0.1% at 1,000 Hz for all power outputs up to 25 watts R.M.S. per channel. Brand new features of the Stereo 70 include—extra output, enabling a pair of loudspeakers to be connected apart from the two in the main listening room—a headphone socket for private listening—a DIN record/replay socket on the front panel for a portable tape recorder. A host of new features, backed by the famous Leak craftsmanship and reliability plus a three year guarantee make the Stereo 70 the most technically advanced amplifier available.



UNBEATABLE  
VALUE AT \$298

### SANSUI MODEL 555

Solid state stereo amplifier continuous power 20 watts per channel — frequency response 20 to 50 000Hz at less than .1 per cent distortion. Sensitivity for magnetic pick-up cartridge 2-MV. Has every desirable control facility including speaker switching and damping factor switch allowing matching amplifier to any speaker system. Top quality at budget price. Send for details and "Arrow Quote." \$278.75



### THE QUAD 33/303

Amazing new QUAD 33/303 control unit and amplifier. One of the very best stereo amplifiers available anywhere in the world. Unconditionally stable with any load. Overall frequency response 20 to 35KHz at 16 ohm load less than .1 per cent variation. Hum and noise an incredible low -100 db below full output. Power output per channel 28 watts into 16 ohm, 45 watts into 8 ohms at less than .1 per cent distortion. A most remarkable unit at its very best. One glance at the inside time and effort that has been lavished on the



amplifier—British electronic engineering of these units will convince you of the NEW Quads. Write for details. \$486.

### KENWOOD TK250U

Solid state stereo amplifier. Continuous power 20 watts per channel — (0.8 per cent T.H.D.) frequency response 20 to 50 KHZ plus or minus 1db. Magnetic pick-up input sensitivity 2 MV. All worthwhile control facilities. Clean appearance and clean sound. A proven amplifier for the Audiophile. Send for details and "Arrow Quote." \$179.00.



### SONY TA1120 AMPLIFIER

Guaranteed incomparable high-performance to satisfy the most exacting audio listeners. An amplifier you must hear to believe. All silicon with incredibly low distortion. Total harmonic distortion: less than .1 per cent at 50 WATTS throughout 30 C/S. — 20,000 C/S. High damping factor of more than 70. Call for a demonstration or phone/write for specification sheets. \$592.



**ARROW ELECTRONICS**

342 KENT ST. SYDNEY, 29-8580

### PARTS LIST

- 1 Diecast box 4-5/8in x 3-5/8in x 2 1/2in.
- 1 50pF miniature variable capacitor.
- 1 Coil (see text).
- 1 Power supply (see text).
- 1 1K linear potentiometer.
- 1 SPST toggle switch.
- 1 Tag-board (11 pairs of tags).
- 2 Spacers, 1in long, tapped 1/8in Whit. each end.
- 2 Spacers, 1/2in long, 1/8in clearance hole.
- 1 2N5459 field effect transistor.
- 1 470 ohm 1/2W resistor.
- 1 1K 1/2W resistor.
- 1 1M 1/2W resistor.
- 1 15pF NPO ceramic capacitor.
- 1 470pF plastic capacitor.
- 1 820pF plastic capacitor.
- 1 .0027uF plastic capacitor.
- 1 .01uF plastic capacitor.
- Coaxial cable, hookup wire, screws, nuts, knobs, solder, grommet, etc.

former following the mixer stage will need to be realigned. If no signal generator is available it can be done by tuning accurately to, say, a broadcast station, which is not fading and which is not too strong. Peak the slugs in each winding of the IF transformer.

Set the potentiometer selectivity control so that the rotor is at the earthy end of the track. If you have wired in a variable capacitor, set it to the mid-point of its travel. Switch on the Q-multiplier and advance the potentiometer. If the tuned circuit is close to the intermediate frequency, a hollow sound will become evident. With further advancement of the potentiometer, a squeal will be heard, indicating that the Q-multiplier has gone into oscillation. Back off the potentiometer until oscillation just ceases. Now adjust the slug in the coil for maximum response. If the coil has no slug, the variable capacitor will be used for this purpose.

This exercise calls for a little juggling, practice and patience, until one gets to understand the nature of the device. You will find that, as the potentiometer selectivity peaking control is advanced, there will be a slight but noticeable shift in frequency. The coil slug or the variable capacitor should be so adjusted that it is correct at the point of maximum selectivity.

The behaviour of the potentiometer can be varied by altering the value of the 470 ohms resistor shown in series with it. If the Q-multiplier goes into oscillation at, say, the mid-point of its travel, the second half of the track is being wasted. Try increasing the 470 ohms resistor to say, 1K, or to that value which allows the multiplier to go into oscillation just before the end of the track is reached. This will give a much better vernier action and easier control. In some cases the control may be further improved by reducing the value of the potentiometer, such that when the rotor is at the earthy end, there is no further reduction in selectivity, compared with when the unit is switched off.

If you go to this bit of extra trouble, the ease of control will be worth the effort. The selectivity characteristic obtained with the Q-multiplier is continuously variable, a feature which is not usually available with other and often more complicated systems.

To sum up the worth of this simple Q-multiplier, we feel that it is a worthwhile addition to any short-wave receiver which is deficient in selectivity. If you desire to get the very best from it, we suggest that you go to the extra trouble of making up a special coil on a ferrite toroid. The Q-multiplier could of course be got going with a more conventional coil and then the toroid could be added later. However, the remarks relating to the potentiometer and its series resistor are important again, as the values will almost certainly have to be changed to suit the new coil.

So far, we have not touched on the subject of providing a power supply for the Q-multiplier. It will operate satisfactorily on voltages between 9 and 12. It is quite easy, of course, to supply it

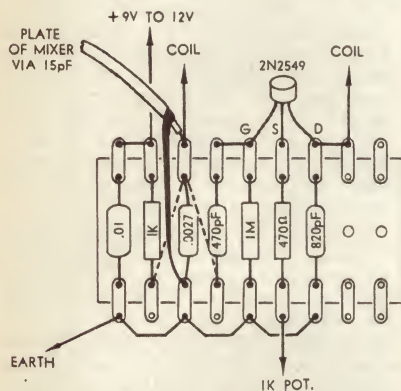

This diagram shows clearly how the board is wired. The reason for the unused lugs is mentioned in the text.

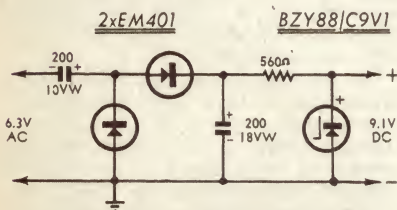

Here is the circuit of a suggested power supply which makes use of a 6.3 volt heater supply, with one side grounded.

from a small 9-volt dry battery and this is what we did when the unit was being tested. There is no reason why this method should not be adopted permanently, except that it is not as economical as it might be. The FET can take anything between about 4 and 10 milliamps. At the higher figure, the battery is not likely to last very long, particularly if the receiver is used for lengthy periods.

Perhaps a more satisfactory idea, in the case of valve receivers, is to make use of the 6.3-volt heater supply. Almost certainly, one side of this supply will be earthed. This being so, we can feed the 6.3 volts into a half-wave

doubler circuit. This will result in about 17 volts DC appearing at the output of the doubler. This can be fed through a dropping resistor to a 9-volt zener diode.

This is all shown on the circuit diagram. The series electrolytic capacitor is a 200uF rated at 10 volts working. The shunt electrolytic is also a 200uF but it is rated at 18 volts working, as it has the doubled voltage across it. At this point, there will be about 17 volts, depending upon the actual value of the nominal 6.3 volts fed into it.

We have to get this 17 volts down to, say, 9 volts nominal, although we could make it anything up to 12 volts if we wished. The 9 volts could be obtained simply by using a dropping resistor of the appropriate value. Herein lies a small problem, however. As mentioned before, the spread in field effect transistors is quite wide. The resistor would have to be calculated on the basis of the particular FET being used. A much better way out of this, although it costs a few cents more, is to install a zener diode with a suitable dropping resistor.

Let us assume a total drain of 12 milliamps from the filter. This means that the series dropping resistor has to cope with 17 - 9 volts, which is a drop of 8 volts. Ohm's law tells us that a resistance of 530 ohms is required. The nearest preferred value is 560 ohms and this will do.

With no drain from the output of the power supply, as when the Q-multiplier is switched off, the total 15 milliamps will flow through the zener diode.

(Continued on page 173)

# \*AEGIS

\*Registered Trade Mark

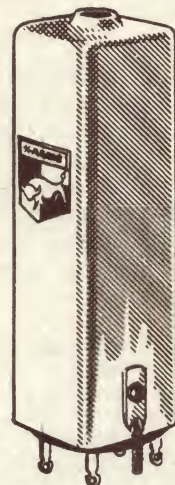

VALVE  
TYPE  
I.F. TRANS-  
FORMERS  
For 50, 85,  
455, 1600  
KHz.  
4 & 10.7  
MHz. TUNING  
COILS  
COVERING  
THE  
RANGE  
500 KHz  
to 30 MHz

455 KHz  
TRANSISTOR  
TYPE I.F.  
TRANSFORMERS  
& TUNING COILS



Available in all radio parts stores

AEGIS PTY. LTD.

347 Darebin Rd., Thornbury  
49-1017 49-6792  
P.O. Box 49—Thornbury, Vic., 3071

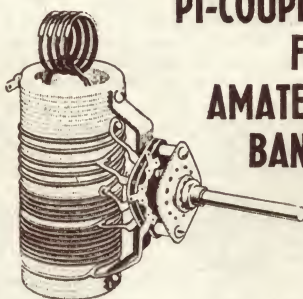

## PI-COUPLER FOR AMATEUR BANDS

### Willis Medium Power Type

For use up to 600 watts p.e.p. Match plate loads of 2,000 to 3,500 ohms (Z) and higher into co-axial cable. Operating Q increases at higher frequencies to increase harmonic suppression, enabling practical values of tuning capacity to be used on 10 and 15 metres and allowing for wiring inductance (L). Incorporates extra switch section for shunting additional capacity (C) if required, or switching other circuits. Switch rated for 10 amps at 2,000 volts with contact resistant (R) of 0.8 milliohms. Price \$8.85.

## "WILLIS" AIR-WOUND INDUCTANCES

Take the hard work out of Coil Winding — use "WILLIS" AIR-WOUND INDUCTANCES

No.	Diam Inch	Turns per inch	L'gth. Inch	B. & W. Equiv.	Price
1-08	1/2	8	3	No. 3002	65c
1-16	1/2	16	3	No. 3003	65c
2-08	5/8	8	3	No. 3006	77c
2-16	5/8	16	3	No. 3007	77c
3-08	3/4	8	3	No. 3010	90c
3-16	3/4	16	3	No. 3011	90c
4-08	1	8	3	No. 3014	\$1.05
4-16	1	16	3	No. 3015	\$1.05
5-08	1 1/4	8	4	No. 3018	\$1.28
5-16	1 1/4	16	4	No. 3019	\$1.28
8-10	2	10	4	No. 3907	\$1.70

Special Antenna All-Band Tuner Inductance (equivalent to B. & W. No. 3907 7in.)

7in length, 2in diameter, 10 turns pr inch, \$3.

References: A.R.R.L. Handbook, 1961;

"QST," March, 1959;

"Amateur Radio," Dec. 1959.

QUANTITY DISCOUNTS AVAILABLE TO INDUSTRY

## WILLIAM WILLIS & CO. PTY. LTD.

ELECTRONIC AND RADIO EQUIPMENT SUPPLIES

430 Elizabeth Street, Melbourne, Vic., 3000

Telephone 34-6539

# MEASURING AUDIO POWER OUTPUT

By  
Philip Watson  
and  
Leo Simpson

Power output measurement is one of the more important tests we should apply to any new amplifier. It is relatively simple, yet can yield a good deal of valuable information about the amplifier's performance. This article discusses the advantages of the measurement, the simple precautions needed to perform it correctly and the British and American standards laid down for testing commercial amplifiers.

One of the most important tests which can be carried out on a new amplifier is that for power output. It will help to establish more certainly than anything else whether the amplifier as a whole, and particularly the output stage, is operating as intended. Failure to reach the specified figure is a clear indication that operating conditions need checking or modifying before proceeding with any other tests.

Yet it is surprising how seldom this test is made or, if it is made, how seldom it achieves a useful degree of accuracy due to the manner in which it is conducted.

This is all the more so since it is a relatively simple test, capable of good accuracy and requiring little in the way of equipment not normally accessible to many audio enthusiasts.

In an amplifier which uses an output transformer there are two ways in which this test may be approached. One is to measure power developed in the primary circuit of the output transformer and the other the power available in the secondary and which is available at the voice coil of the loudspeaker.

Where the circuit does not employ an output transformer, the power at the output socket and available for the voice coil of the loudspeaker is, fairly obviously, the only measurement that has to be made.

Regardless of the approach chosen, both involve the same broad principles, namely feeding the audio power into a load resistor of the appropriate value, measuring the audio volts developed across it at the overload point and, from the figures, calculating the audio power output.

Assuming the use of an output transformer, the measurement of primary power is useful mainly in developmental work, as when it might be desired to establish the correct load for a set of unpublished operating conditions. Its main advantage is that it is largely independent of losses or variables in the output transformer which might otherwise confuse the issue.

Secondary power is a more useful figure when we wish to know just how many watts are available to drive the loudspeaker. It is less decisive as a measure of the output stage operating conditions. However, if a reasonable estimate can be made of the output transformer losses it never-

theless provides a useful guide to the amplifier's performance.

It is most useful where, a design having been worked out and accepted, it is desired to establish that any individual amplifier made to it does in fact approach the output claimed and is therefore unlikely to contain any major faults.

In the case of a transformerless output stage there are no consequent losses to cloud the issue, so that a power output measurement provides, at one and the same time, an indication that the output stage is functioning as intended, and a figure which can be quoted as the output power available to drive the loudspeaker or other load.

Inasmuch as the main purpose of an amplifier is to deliver a specified amount of power to an appropriate load, one would expect that this would be the natural measurement an enthusiast would look forward to making when he had tightened the last nut and bolt and deposited the last blob of solder. Yet so many seem content to simply give the system a listening test, and, providing it sounds "good and loud," accept it as OK.

And even when results are disappointing, and they seek someone's advice, it is seldom that they can quote precise figures to support their claim that it is not delivering the power it should. They are usually content to mentally compare it with some other amplifier, rated at so many watts, then pluck a figure out of the air to suit their own unit, depending on whether it sounds louder, the same, or weaker.

In the case of high-power PA amplifiers and guitar amplifiers, which may be rated as high as 100W, or even some domestic equipment which may run as high as 30W, measurement — rather than subjective reaction — is even more important. It is virtually impossible to run such amplifiers "full bore" into a loud speaker load on the bench, or to assess anything worthwhile from such a test should it be attempted.

It should also be appreciated that other vital amplifier characteristics (sensitivity is one example) are normally quoted on the basis of maximum power output, so we must be able to measure power output before these other characteristics can be assessed. On the other hand if, when a power output measurement is made, we can also measure (for example) the level

of signal being fed into the amplifier, the test will yield both power output and sensitivity figures.

Having thus made a case for this test, let us take a closer look at what is required to perform it. First, the load resistor, or "dummy load" as it is usually called. This is to replace the loudspeaker, which cannot be used for several reasons, the main one being that it simply is not accurate enough, in terms of impedance, for the purpose.

Impedance values quoted for speaker voice coils are purely nominal and are quoted for one frequency only. The actual value likely to be presented in a typical test set-up could vary by two to one from the nominal.

In its place we substitute a resistor. Ideally, this should be a non-inductive, close-tolerance unit, capable of dissipating the anticipated power without damaging heat rise or change of value. In practice, we can tolerate the small amount of inductance inherent in a simple wire-wound unit, and a resistance tolerance of 5 per cent would be adequate in most cases.

In regard to power handling ability, it should be appreciated that resistors are normally rated on a "free air" basis and should be down rated if they are enclosed in any way. Except for intermittent use a good rule-of-thumb is to half the wattage rating when the resistors are to be enclosed in a metal instrument case, provided with reasonable ventilation.

The value of the load resistor will depend entirely on the particular job to be done. It could range from (typically) 10,000 ohms for a primary measurement of a valve type amplifier, down to (typically) 8 ohms for a voice coil measurement.

In practice, it is most convenient to make up a load box containing a representative group of heavy-duty resistors, complete with the necessary switching, terminals, etc., to make for greatest convenience. A typical unit is described elsewhere in this issue.

Where the load is to be substituted directly for the voice coil the arrangement is so straightforward as to warrant little comment. The primary measurement is, however, somewhat different. Because there is both AC and DC present in the primary circuit, we must provide circuits for each. Simply substituting a resistor for the transformer primary would result in an intolerable voltage drop and failure of the output stage to function correctly.

The transformer is therefore left in circuit, but with all secondary load removed. It thus acts as a high impedance choke, and has little effect on the load as seen by the output stage. On the other hand it continues to function as a low resistance path for the DC supply. The dummy load — equal in value to the required primary impedance — is then connected in parallel with the primary winding, where it



is seen by the output stage exactly as if it had been reflected from the low impedance secondary circuit.

Next, the voltmeter. This needs to be a good quality AC instrument, with a suitable selection of ranges. In addition, a DC blocking capacitor will be needed whenever measurements are to be made on the primary side of a transformer. Even if the meter is connected directly across a transformer primary, there may be a small DC voltage present, due to the resistance of the primary winding. There is no such problem when measurements are made in secondary circuit and the normal AC ranges may then be used.

For measurements at voice coil impedance, the sensitivity of the meter is not particularly critical. Anything above about 100 ohms per volt should be perfectly satisfactory. For higher impedance measurements, such as those encountered in the primary circuit of valve amplifiers, the meter impedance should be at least 1000 ohms per volt, and even this value can introduce errors in some cases.

For example, a 10,000 ohm load resistor shunted by a 50,000 ohm meter (1,000 ohms volt, 50 volt scale) will be reduced to 8,300 ohms approximately, a significant error.

To produce a true 10,000 ohm load in such circumstances it would be necessary to start with a resistor of about 12,500 ohms.

Voltmeter accuracy is the most important factor, since the voltage figure is squared in the formula, and even minor errors will be aggravated. For example, a reading of 9 volts instead of 10 (a 10 per cent error) will result in a figure of 81 being found in the formula in place of the correct figure of 100 — an error of 19 per cent!

Valve or solid-state voltmeters can be used, and these would automatically solve any problems concerning

able the audio output from a conventional signal generator may be used. This usually is about 400Hz and anything between this figure and, say, 1,500Hz should be quite satisfactory.

Most audio oscillators are capable of generating a reasonably good waveform but anything exhibiting either an obvious peakiness or squared-wave characteristics should be avoided.

A useful refinement to any such audio generator is the provision of a calibrated output. This will enable a sensitivity measurement to be made at the same time as the power input is determined. Together, these two figures give a very clear picture of an amplifier's behaviour.

Finally the CRO. Not a great deal need be said about this since almost any instrument worthy of the name should be suitable. Its job is to indicate the overload point of the amplifier, as shown by just perceptible flattening or other irregularity of one or both halves of the sine wave. Connected across the load, or between the "hot" side and chassis, it will reveal the first signs of overload or clipping, and the need to reduce the signal level or gain to preserve a non-distorted waveform.

When all these items have been connected to the amplifier in the appropriate manner the amplifier is driven up to the overload point, backed off slightly, and the AC voltage developed across the load resistor measured as accurately as possible. From voltage and resistance the power may be calculated according to the following formula:

$$W = E^2 / R$$

Where:

W is the power in watts.

E is the RMS audio output volts, and

R is the load resistance in ohms.

The foregoing is directed mainly at

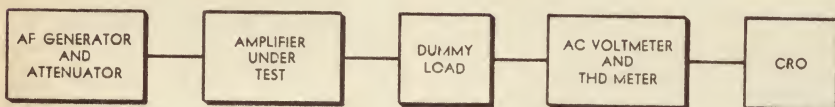

Figure 1

Figure 1. Block diagram showing the set-up for measuring "Continuous Power Output" or "Rated Power Output".

sensitivity. However, where a unit is mains operated, with the possibility that one side of the input may be "earthy," due care must be taken to see that this does not conflict with any other "earths" inherent in the amplifier or associated test equipment.

In our own laboratory, we have access to a digital voltmeter and there is no doubt that this makes the job a good deal simpler. Not only is the direct readout free from possible ambiguity, but the inherent high accuracy of these instruments eliminates all doubts as the validity of the final calculations.

Next, we require a test signal. The requirements are not unduly stringent. A frequency of 1000Hz is usually chosen, and the waveform should be a reasonably good sine wave. If a regular audio oscillator is not avail-

those who build or design amplifiers and who wish to confirm that an individual unit comes up to the predicted performance figure.

However, there is another situation involving power output measurement; the need to test a commercial amplifier to confirm that it comes up to the manufacturer's specifications. This is a situation which confronts us regularly in our own laboratory when we are required to check equipment submitted by advertisers for our Trade Review columns. And, while the approach is broadly similar, there are a number of additional factors which have to be taken into account.

These involve such things as the total harmonic distortion for which power output is quoted, the method of rating used by the manufacturer, and

# TEAC

sound reproduction equipment in the upper end of the Hi-Fi market

— a legend in its own time.

Just two models from the extensive TEAC range.

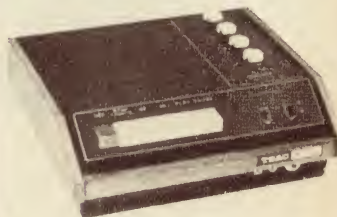

TEAC A-20 Stereo Cassette Tape Deck. SPECIFICATIONS:

HEADS — Two, erase & Record Playback, WOW & FLUTTER — Less than 0.2%. F.R. — 60 to 10,000 Hz. TRACKS — Four CHANNELS — Two. SIZE 9 3/4" x 10" x 4 1/4" etc., etc.

Full size tape deck Hi-Fi, with cassette convenience.



TEAC 4010 Tape Deck. SPECIFICATIONS:

4 Track Stereo. 3 Motor System. F.R. — 30 to 20,000 Hz at 7 1/2 cps. SPEEDS — Two. REMOTE CONTROL OPERATION AVAILABLE. TOUCH BUTTON CONTROL SYSTEM. AUTOMATIC REVERSE, etc., etc.

Professional quality machine with unique features.

Wholesale Enquiries:

AUSTRALIAN MUSICAL INDUSTRIES  
SOLE AUSTRALIAN DISTRIBUTORS  
108 ELIZABETH ST., MELB. VIC.

Retail Enquiries:

BRASH'S HI-FI  
CENTRE - 108 Eliz. St.  
Melb. Vic. Phone 63 6701

SUTTONS SOUND CENTRE  
105 Elizabeth St., Melb., Vic.  
Phone 60 1201

STEREO SOUND SYSTEMS  
304 Chapel St., Prahran.  
Phone 51 3998

WB411

# Excellence in Sound and Appearance from



## BEOCORD 2000 DE LUXE

The finest taperecorder you can buy: All solid state circuitry, true Hi-Fi with professional specification. Built-in 4-channel mixer section with twin faders, 4 heads, 3 speeds multiplayback, synchroplayback, echo button working on mono and stereo. Professional swing arms take up tape slack, ensure absolutely smooth running. Built-in push-pull transformerless output amplifier with 2 x 8 watts R M S and electronic overload protection.

## BEOVOX SPEAKERS

Seven types are available. All are pressure chamber systems providing excellent sound over their entire frequency range. The smallest, the Beovox 500, measures only 11" x 5 7/8" x 9 3/4", the biggest, which will satisfy the most fastidious audio-ophile, is the Beovox 5000 with seven speaker modules, frequency response 30 Hz - 18 kHz, 60 watts music power. Of special appeal is the 2400 with 3 speakers, frequency response 40 Hz - 18 kHz.



## BEOGRAM 1500

A compact stereo unit consisting of a 3-speed belt driven turntable with the ST/L low mass arm, built-in anti-skate and SP 7 or SP 9 magnetic cartridge, hydraulic arm lift and solid state 2 x 8 watts R M S amplifier with external tape and radio connections. The quality of reproduction is excellent, particularly when used with a pair of Beovox speakers. A transparent dust cover comes with the unit.

## HYPERTONE MODULE

By using a Hypertone Titanium hyperbolic radiating element an extremely high standard of definition and wide frequency range, combined with the lowest distortion figures in a single speaker has been achieved. The module will deliver powerful smooth bass down to 30 Hz in an enclosure of only 3/4 cub. ft. A massive 6lb. ceramic magnet enables the unit to handle 15 watts comfortably.



## BEOMASTER 1400 K

A solid state multiple band - including FM 87.5 - 104 MHz - Hi-Fi tuner and extra high quality amplifier of 2 x 15 watts continuous. Frequency range is 30 - 25,000 Hz  $\pm$  1 db. Model K (illustrated) has 2 built-in wide range pressure chamber speakers. Also available Model M without speakers.



## BEOLAB 5000

The best money can buy! Tightly packed in this perfectly designed stereo amplifier are 2 x 60 watts R M S with less than 0.6% distortion over the frequency range from 20 - 20,000 Hz. DIN and RCA sockets; inputs for high and low impedances; phono, tuner, mic., tape and aux. Calibrated unique slide controls for volume, balance, bass and treble. Electronic overload protection. Teak or rosewood.



## PEERLESS SPEAKERS

Danish quality speakers for every application. A wide range from 2" Tweeters to 15" Woofers, mid-range speakers and crossover networks are available, also wide range twin-cone speakers, circular or elliptical. Several enclosures with excellent reproduction qualities for 2, 3, or 4 speakers have been designed by Peerless and data for such are supplied with the speakers. Complete systems from book-shelf types to floor units are also available. Choice of timber is teak or palisander.



Above selection represents only a small part of our extensive range of quality Hi-Fi equipment. Come and see us for your requirements

# Danish Hi-Fi Pty. Ltd.

941 BURKE ROAD, CAMBERWELL 3124, PHONE 82 4839

so on. Fortunately, quite precise industrial standards have been laid down which provide guidelines for amplifier power measurement.

There are two which are generally recognised. The first and most stringent is that by the American Institute of High Fidelity Manufacturers; the IHF Standard of Measurement for Amplifiers, IHF-A-201, which was published in late 1965. The other standard is the British Standard 3860: 1965.

Other organisations besides the I.H.F.M. have sought to set up standards for the measurement of amplifiers but these have not been as stringent as the above two specifications and the organisations themselves have

the specified harmonic distortion). An individual unit could deliver the same value, but none should deliver less.

In simple terms, the difference be-

termining continuous power output is shown in figure 1.

Another definition often encountered is "Music Power Rating." This

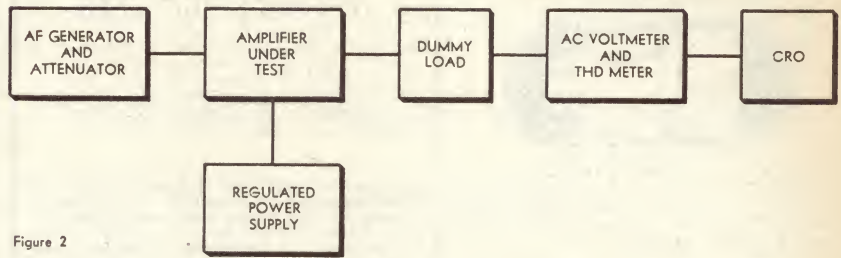

Figure 2

Figure 2. An early method used to measure "Music Power". It had many limitations and is seldom used.

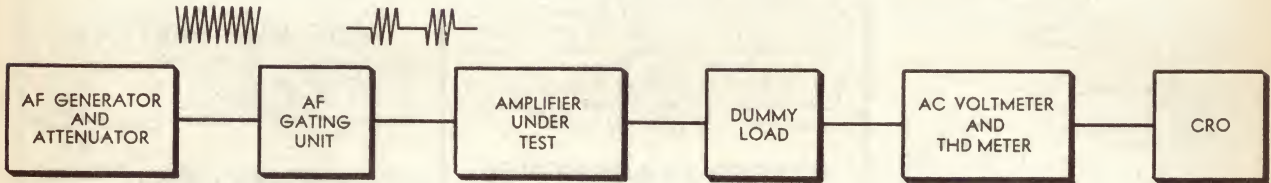

Figure 3

Figure 3. The tone burst method of measuring "Music Power". While better than the system shown in figure 2, it still has some limitations.

not gained the same recognition as the I.H.F.M.

The method of testing which we have detailed in the first part of the article is similar to, but less stringent than, that described in the American standards under the definition "Continuous Power Output" and in the British standards as "Maximum Power Output." The main difference is that these standards require that the manufacturer specify a value of total harmonic distortion at which the power is measured, and that the test set-up includes a distortion meter to measure this. (Typical distortion limits are 1 per cent for average high fidelity applications and 0.1 per cent for very high quality amplifiers.) Other terms used in place of "Continuous Power Output" are "Sine Wave Power," "RMS Power," and "Continuous Tone Power."

More precisely, the British Standard defines "Maximum Power Output" as follows:

"The maximum measured output power that the amplifier can deliver continuously to a stated load resistance at a frequency of 1000 c/s without exceeding a specified value of (total) harmonic distortion." As explained elsewhere in the standard specifications, "continuous" implies a test of not less than 30 seconds' duration.

A similar definition, and one which has caused some confusion by reason of its similarity, is quoted for the term "Rated Power Output." The difference between these two is mainly one involving the normal spread of tolerances in commercial components, and which results in no two amplifiers, nominally the same, being absolutely identical.

For this reason amplifier manufacturers normally quote a "Rated Power Output" for their products, and this is meant to imply that the figure quoted is the guaranteed minimum power output which any individual amplifier will deliver. If the manufacturer values his reputation, most units would deliver something more than this value (for

tween the two terms is the safety margin the manufacturer allows himself in order to compensate for component tolerances.

A block diagram of the equipment used for verifying rated power and de-

termining continuous power output is shown in figure 1. Another definition often encountered is "Music Power Rating." This

(Continued on page 174)

## BUY RECORDING TAPE AT WHOLESALE PRICE

### WILCOX BROS. & BARCLAY

are now offering their line of recording tape direct to the Public at wholesale prices. This is a leading American manufacturer's first-grade line especially packed for us in a plain box. We are not allowed to reveal the maker's name.



TYPE	CODE	LIST PRICE	YOUR Wholesale PRICE
5" 900ft Acetate PVC .....	5R9	\$2.75	\$1.80
5" 1200ft Tensilized Polyester .....	5P12	\$4.45	\$2.95
7" 1800ft Acetate/PVC .....	7R18	\$5.10	\$3.35
7" 2400ft Tensilized Polyester .....	7P24	\$8.35	\$5.50

Wholesale prices allow for 33 1/3 per cent trade discount and cash settlement discount and include sales-tax. Freight free throughout Australia.

### MONEY BACK GUARANTEE

WILCOX BROS. & BARCLAY tape is guaranteed to be first-grade splice free recording tape made in the U.S.A. Your money will be refunded in full on return of goods within fourteen (14) days if you are not fully satisfied with your purchase.

### ORDER FORM (capital letters please)

FROM:  
NAME:  
STREET AND NO.  
CITY OR SUBURB: POSTCODE:

PLEASE SHIP:

..... rolls 5R9 at \$1.80. Total \$ .....

..... rolls 5P12 at \$2.95. Total \$ .....

..... rolls 7R18 at \$3.35. Total \$ .....

..... rolls 7P24 at \$5.50. Total \$ .....

I enclose cheque/pos:al ncte/ Money Order for Total \$ .....

Return this order to:

Wilcox Bros. & Barclay

WHOLESALE MERCHANTS

Mail Order Office:  
Room 7, 3rd Fl., 823 Bourke St., Melbourne



**NEAT man—That's the way to enjoy Hi-Fi Music**  
**CARTRIDGES**



**V70 MOVING MAGNET CARTRIDGE.**  
\* Review from Hi Fi News available.  
The V70 is a top performance—high quality magnetic cartridge that out-performs many more expensive cartridges.

Specifications—Output voltage: 5mV 1,000 c/s 5 cm/sec. Frequency range: 20-20,000 c/s. Channel balance:  $\pm 0.5$  db 1,000 c/s. Channel isolation: 30 db 1,000 c/s. Compliance:  $5.0 \times 10^{-6}$  cm/dyne. D.C. resistance: 800  $\Omega$ . Load resistance: 50K  $\Omega$ . Playing weight: 1.5 gr. 3 gr. Stylus: 0.5 mil diamond.

**V60 Induced Magnet Cartridge.**  
Specifications — Output voltage: 4 mV. Freq. range: 5-30,000 c/s. Channel isolation: 30 db. Compliance:  $6 \times 10^{-6}$  cm/dyne. Stylus: 0.7 mil. diamond. 0.2 x 0.8 mil. for Model V-60E.

**V15 "Dynamagnet" Cartridge.**  
Specifications — Output voltage: 5 mV. Freq. range: 20-21,000 cps. Cross talk: 30db at 1,000 cps. Stylus: 0.7 mil. diamond. 0.2 x 0.8 mil. for Model V-15E.

**NEAT TONE ARMS**



G-32 "Gyrostat" Professional Tone Arm.

This professional Tone Arm is a beautifully engineered instrument featuring the revolutionary "GYROSTAT" rotary mechanism. Designed for milligram tracking and as for all NEAT tone arms, will accept all standard 1/2 in mounting cartridges, including Ortophon and SME headshells without modification.



G-30 Static Balance Tone Arm  
\* Review from "GRAMAPHONE" available.

The NEAT G30 Static Balance Tone Arm is a high quality—low priced Hi-Fi tone arm, of which the conception, construction and finish are equal to many tone arms selling at considerably higher prices. When used with the NEAT V70 cartridge, an excellent low cost combination can be obtained.

Other outstanding NEAT tone arms available are the G37 Static balance tone arm, and the G36 Professional tone arm.

**NEAT HI-FI EQUIPMENT**

Sole Australian Distributors:  
Truscott Electronics, Adelaide

Interstate outlets:  
N.S.W.—W. C. Wedderspoon Pty. Ltd.  
193 Clarence Street, Sydney  
VIC.—Australian Hi Fi Electronics  
265 Lygon Street, Carlton  
And all leading HI-FI Houses.

**TAPE RECORDER & HI-FI SERVICE CENTRE**

For service on your Tape Recorder, Amplifier, Turn-Table, Mikes, etc., come to the experts. All work is undertaken by fully trained professionals and is guaranteed.

**TRUSCOTT ELECTRONICS**  
**THE TAPE RECORDER & HI-FI SPECIALISTS**

Stockists of all leading brands including — SONY — AKAI — NEAT — ADC — TRIO — DUAL — WHARFEDALE — DECCA — LABCRAFT — ALL BALANCE — LEAK — B&O — GELOSO — SENNHEISER — PHILIPS — NATIONAL — TANDBERG — KENWOOD — MONARCH — TESLA — JH — THORN.

Equipment stocked includes: **Tape Recorders — Video Recorders — Amplifiers — Turntables — Tone Arms — Cartridges — Speakers — Cabinets — Acoustical Speaker Cloth — Radios — Dictation Machines — Telephone Answering Machines — P.A. Equipment** — and all accessories including **Inner Bond — Bonded Cortel — Magnetic Tape — Pre-recorded Mono and Stereo Tapes, etc.**  
and all general electronic components including resistors, capacitors, plugs and sockets, solder, scope irons and spares, hook-up cables, valves, terminals, tag strips, matrix board, cambric spaghetti, fuses, chassis, grommets, solder lugs, alligator clips, valve sockets, D.I.N. connectors, T.V. connectors, battery savers, and also a large range of semi conductors for all Japanese makes.

**STEREO HEADPHONES**

*High Fidelity Stereo Phones at Budget Prices.*  
A wide range of Stereo headphones is now available including the new model ELEGA DR65C at only \$11.00 and the fantastic ASHIDAVOX ST11 at only \$19.50.

**SPEEDY MAIL ORDER SERVICE**

When ordering please give your full address printed in BLOCK LETTERS. All Truscott Equipment is brand new and fully guaranteed. Sales tax is included in all quoted prices. All orders are dispatched promptly.  
**Available Cash, Terms or Lay-by.**  
*All prices quoted are Net.  
Postage and freight extra.*

**NOTE:**  
**T.M.Q. = Truscott Mail.  
Order Quote**

**SLEEP LEARNING EQUIPMENT**

All requirements for sleep learning equipment available, including Pillow Phones at \$4.50—Endless Tapes at \$8.86 and Time Clocks at \$25.00.

**TAPE RECORDER BELTS**

Belts available to suit most models of Telefunken, Uher, Philips, Cossor, Stella, Grundig, B.S.R. Ferguson, Walter and Korting recorders. When ordering, it is most essential to state the correct make and model of recorder.

**TAPE RECORDERS —ask for a T.M.Q.**

Stock now includes Akai X360, M9, X1800, X5, 1710, X150D, 4000D—Sony TC660, 560, 540, 230, 105, 355, 255, and AC/DC portables—National RQ790S, 776S, 761S, 760S, 766US, 706S, 503S and portables—Grundig TS340, TK247, 245, 2200—Philips 4408, 4308, 3312 and Cassette portables—Tandberg Series 12 and 64X—Julicorder DA999, 301—Geloso 681, 651 — Tesla 4, 44, 45, 43A, 46 — Thorn 3214, 3226, 3224 and many more.  
Remember, you'll save much more at Truscott Electronics.

**SENNHEISER STUDIO MICROPHONES**

A full range of these famous Sennheiser Studio Microphones for amateur or professional use are now available. Send now for specifications and prices.

**CASSETTE RECORDERS**

A full range of cassette recorders and players is available—write or call for a T.M.Q.

**CAR RADIO SPECIAL SOUNDMASTER 8**

The new super sensitive push button all transistor car radio, featuring 8 trans.—3 W. output—push button tuning—built-in noise suppression—high quality speaker—suit any car—Truscott's price only **\$55**  
If aerial required add **\$4.00.**

**220S MULTIMETERS**

D.C. Volts 5, 25, 125, 500, 2,500.  
A.C. Volts 10, 50, 250, 1000.  
Current: 250mA, 250mA.  
Resistance: 0-10K, 0.1 Meg. **\$7.95**

**SAVE YOUR RECORDS . . . USE THE UNIVERSAL LUSTRE TONE ARM LIFT!**

This beautifully finished and functional universal tone arm lift will fit all tone arms . . . the lowering action is pneumatically dampened and extremely smooth. Risk of record damage may now be eliminated.

Truscott's price only **\$8.50**

**ACOUSTIC SPEAKER CLOTH**

Over 30 top-grade cloths to select from. Send for samples and prices.

**HI-FI COMBINATIONS**

Select your Hi-Fi Combination from the following recommended equipment, then write or call for a T.M.Q. Combination Special—you'll be amazed at how much you can save.

**AMPLIFIERS**

Akai AA5000 — Leak Stereo 30 and 70 — Grundig SV40, SV80 — Monarch SA616, SA500, SAT260X, SAT460X — Sony TA1120 — Trio Kenwood TK150U, TK250U, TK400T, TK20U, TK40U, TK88U, etc.

**TURNTABLES**

JH — Labcraft 655, 605L, 643 — Neat NR101, NU101, P100 — Dual 1019, 1009F, 1015F, 1010F, etc.

**TONE ARMS**

All Balance — Neat G30, G37, G36, G32 — Miniconic Euphonics, etc.

**CARTRIDGES**

ADC, B. & O., Decca, Dual, Goldring, Neat, Ronette, Sonotone, Philips, etc.

**SPEAKER & SPEAKER SYSTEMS**

Philips, Tesla, Wharfedale, Rola, Kenwood, B. & O., Akai, Leak, Soundmaster, etc.

**HI-FI TRANSCRIPTION TURNTABLE COMBINATION**

Consists the one and only JH turntable, Neat G30, static balance tone arm, Neat V70, magnetic cartridge, Lustre Tone arm lift, and hand finished oiled Teak wooden base. Truscott's price only \$79.00. If assembly required—add \$6.00



**TRUSCOTT ELECTRONICS**

AUSTRALIA'S GREATEST TAPE RECORDER & HI-FI CENTRE

62-64 HINDMARSH SQ. ADELAIDE, 5000 Phone: 233024 233278

# Dummy Load & Speaker Switching System

Following the discussion of power output measurement in the previous pages, here is a description of a practical load box suitable for high power stereo amplifiers. It also provides facilities for simple and rapid switching between speaker systems, as required for comparative tests.

Until now, we have used a variety of load boxes described in past issues and which, in their way, served the purpose well enough. However, it was becoming increasingly obvious that changing amplifier fashions served to emphasise the limitations of these units, and that the time had come to produce something more suitable.

To name just two factors which were most obvious there is (1) the fact that almost all amplifiers these days are stereo, and therefore require two load resistors, and (2) the fact that amplifier ratings can be a good deal higher than would have been considered likely, even 10 years ago.

As an example of this latter aspect, load resistors can typically be called upon to dissipate power in excess of 60 watts. This figure is not unusual as the per-channel rating of some high-powered stereophonic amplifiers. Similarly, it is not unusual to encounter guitar amplifiers with rated powers of the order of 100 watts.

And, having decided to construct a new unit, we considered what other features we could incorporate which would make it as versatile and con-

venient to use as possible. The end result is something which, while being relatively simple and inexpensive, should appeal to anyone who has a regular need to measure amplifier power.

venient to use as possible. The end result is something which, while being relatively simple and inexpensive, should appeal to anyone who has a regular need to measure amplifier power.

First, we had to consider how many values of load resistor we should provide, and what these should be, while keeping in mind the need to use readily available switches and other components. While it is easy to evolve

"smart" switching systems which provide great variety of resistance values, there is a very real risk that this will call for switches and resistors which are too expensive, hard to obtain, or both.

We finally settled for four load values; 2, 4, 8 and 16 ohms, as being sufficient to cope with most practical situations. While it is true that there may be minor differences between these and the values specified by some manufacturers—i.e., 15 ohms rather than 16, or 3.75 rather than 4—these are not likely to cause any serious problems. Provided we know the value of the load, and base our power calculations on it, the error introduced by presenting a slightly different load to the amplifier will be small.

These four values are selected by means of a 2-pole, 7-position switch. (We will discuss the purpose of the other three positions in a moment.) The method of connection and the values of resistors chosen are such that two resistors are required to make up any value. This means that the wattage which can be dissipated will be twice that of the rating of the individual

## PARTS LIST

- 1 metal case, 9in x 6-5/8 x 5-5/8in.
- 1 front panel to suit.
- 1 carrying handle.
- 4 8-ohm resistors (5pc or better).
- 4 4-ohm resistors (5pc or better).
- 2 2-pole, seven-position switches.
- 1 2-pole, two-position switch, with "make-after-break" contacts.
- 9 red terminals.
- 9 black terminals.
- 3 pointer knobs.
- 4 rubber feet, screws, nuts, hook-up wire, solder, etc.

resistors. Thus if 50-watt resistors are used throughout, the unit could handle 100W in each channel. In a special case, where only a single channel was involved, the right and left hand loads could be connected in series or parallel to provide a 200 watt rating.

While we used 50 watt resistors in the unit we built, such large ratings may not be justifiable in every case, and this will be for the individual constructor to decide. Fifty watt resistors, at 5pc tolerance, are quite expensive, and many builders may be content to settle for 20 watt units

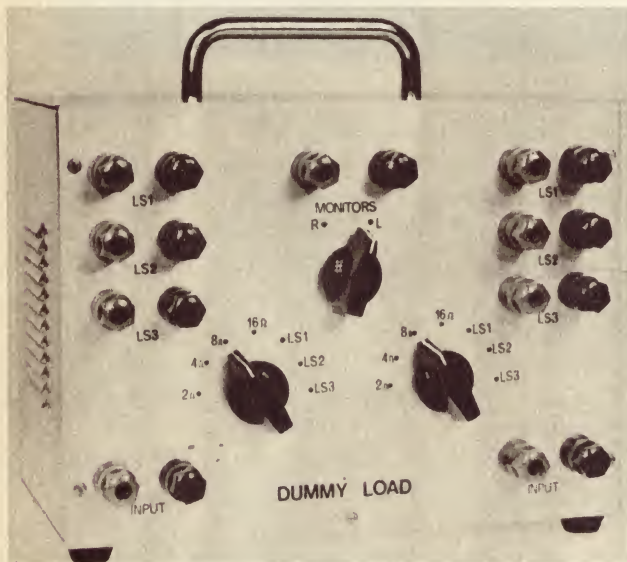

Above: The complete unit built in a standard instrument case. Right: Rear view showing resistor mounting and switch and wire layout.

# look the new **LEAK** Stereo 70

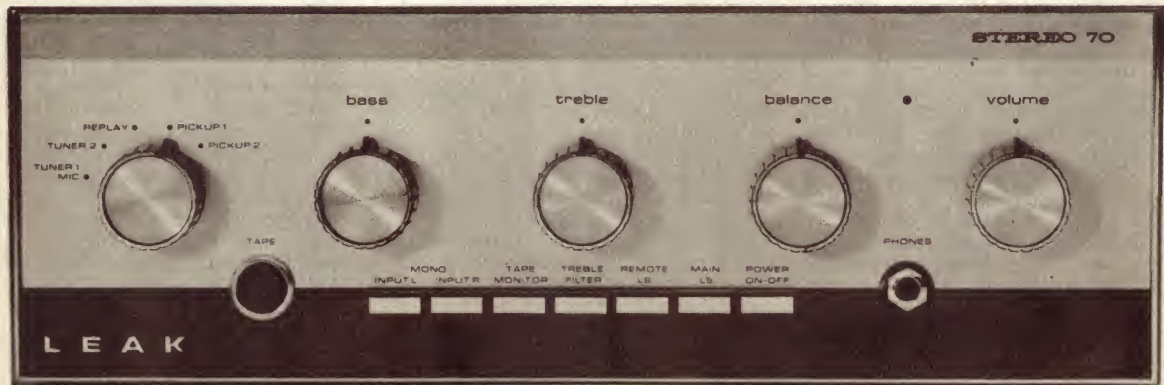

**\$298.00**  
**RETAIL NET**  
**INC. SALES TAX**

The Leak Stereo 70 will thrill you with the clearest, most exciting sound ever reproduced by an amplifier.

It is full of latent power—up to 35 watts r.m.s. per channel. Distortion is a mere 0.1% at 1000 Hz for all power outputs up to 25 watts r.m.s. per channel.

In addition, this extra output enables a pair of loudspeakers to be connected apart from the two in the main listening room.

The Stereo 70 follows the elegant styling of other Leak units. It is finished in black and silver. An attractive teak

case is available for shelf mounting.

Other brand new features are a head-phone socket for those who prefer to listen to stereo that way, and a DIN record/replay socket on the front panel for a portable tape recorder together with the standard inputs at the back of the amplifier.

All this, backed by the famous Leak craftsmanship and reliability, makes the Stereo 70 the most technically advanced amplifier available.

**LEAK** HI-FI

**H. J. LEAK (AUST.) PTY. LTD.**

P.O. BOX 14, FRENCH'S FOREST, N.S.W. 2086.

FACTORY: 1 CAMPBELL PARADE, MANLY VALE, N.S.W. TELEPHONE: 94 4902.

CABLES: LECTRON, SYDNEY.

\*Professional Equipment enquiries to Simon Gray offices or representatives in all States.

(40W total), or 10 watt units (20W total).

The resistors were vertically mounted in a standard equipment case measuring 9 x 6 5/8 x 5 5/8 inches deep. Ventilation was provided in the form of louvres in the sides and two rows of 3/4-inch diameter holes along the back panel. This is necessary to keep the temperature rise of the resistors within acceptable limits.

Both sides of the loads are isolated from the case to reduce to a minimum the possibilities of shorts and instability. Care must be taken with all connections to ensure low residual resistance. No special layout is necessary but the wiring for each channel should be kept separate to facilitate assembly.

The further three positions on the load selector switch are brought out to terminals on the front panel of the unit. These can be used for connecting capacitors across the output of the amplifier for stability tests or for connecting various speaker systems. The latter facility is very useful when it is desired to make a subjective comparison between speaker systems, by switching rapidly from one to the other.

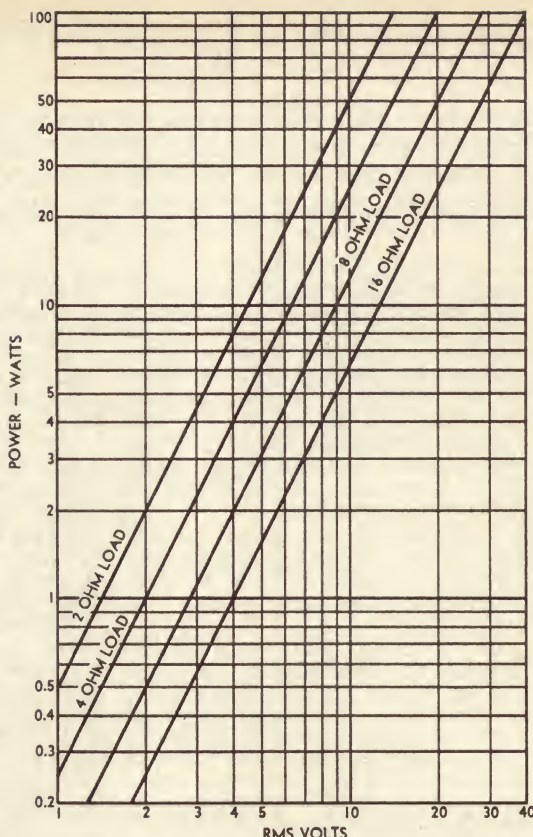

This graph will simplify power output calculations.

In regard to stability tests, current standards require that they be made with no load across the output, other

than the nominated values of capacitor. The load box thus satisfies this requirement.

Another facility is a pair of monitor terminals. These can be switched to either channel and permit the easy connection of a CRO, voltmeter or other measuring device to the channel under test. The switch is a two-pole, two-position unit with "make-after-break" contacts. A switch with "make-before-break" contacts must not be used because both channels of the amplifier would be connected in parallel at switch-over. In many amplifiers this is a sure formula for destruction.

The unit in its final form is suitable for all normal amplifier tests such as power output, frequency response, cross-talk, and stability. Damping factor measurements can be made easily by disconnecting the load.

One point to be kept in mind when using the dummy load is that the loads should not be switched when operating at a high power level. This is to avoid damage to the switches and also to the amplifier. This precaution is not necessary when making comparison tests of speakers because these tests are made at a relatively low power level.

### MAKE TO \$100 A WEEK

Work at home, be self-employed full or part time. All ages, all localities. No machines or kits to buy. Splendid PREMIUM to early comers. FREE details from

Dept. R.H.45.  
Box 5070 G.P.O. Sydney  
(Send stamp for quick reply.)

### ALWAYS RELY ON R.D.S.

### SPECIALS FOR MARCH

- R** 30 watt PA Amp **\$75.10**
- D** Signal injector SE250B **\$7.13**
- S** Compax transcription turntable comp. **\$39.50**
- 2-stage intercom. **\$7.94**
- 3-stage intercom. **\$12.88**
- CT 500 Meter with mirror scale **\$13.23**
- 200H Meter . . . . . **\$11.50**
- Small Dynamic Microphones . **69c**
- ST.708 Stereo Amp. 3 1/2 watts per channel . . . . . **\$41.25 nett**
- 8in Twin speed personal fan **\$10.18**

★

The Independent Wholesaler  
**RADIO DESPATCH SERVICE,**  
Radio and Electrical distributors,  
**869 GEORGE STREET, SYDNEY.**  
Cnr. George and Harris Streets.

Phone 211-0816, 211-0191.  
Open Saturday mornings.

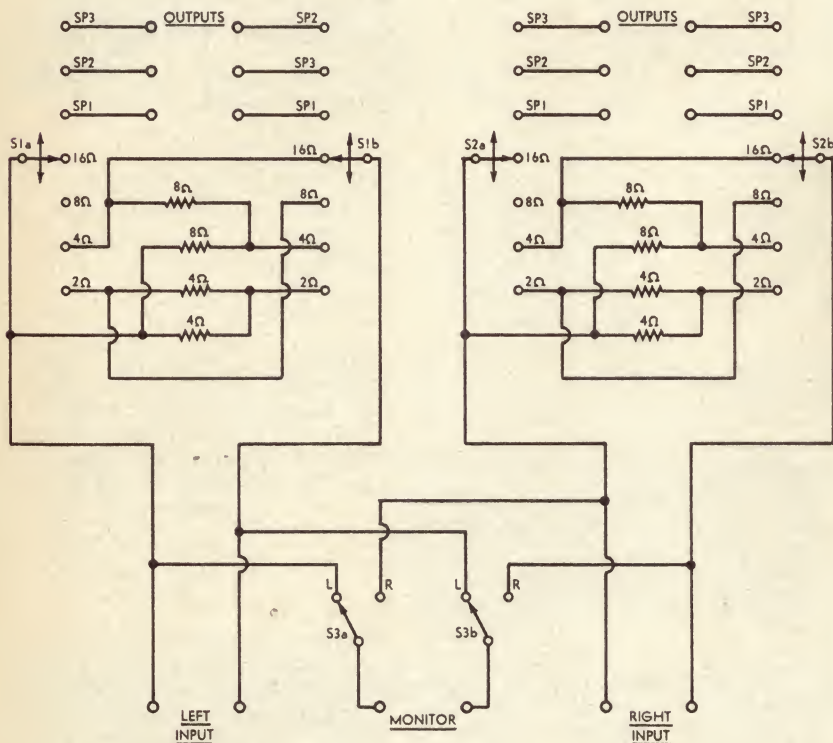

**DUMMY LOAD (AUDIO)**

Main feature of the circuit is the use of two resistors for all load values, thus doubling the wattage rating. Switching facilities between speakers is also provided. Wiring is relatively simple.

# WHAT IS A WAVE ANALYSER?

Basically, a wave analyser is a tunable voltmeter and its function is to permit a detailed examination of complex waveforms. The following discussion not only gives a more detailed description of these devices, but also discusses the need for them, and their application.

In general terms, all practical electronic equipment suffers from the inherent defect of non-linearity, which gives rise to distortion. The aim of designers of electronic devices is to keep this distortion within acceptable limits by means of careful basic design and the use of negative feedback. What is acceptable varies widely with different situations. Moreover, what would have been regarded as acceptable 10 or 20 years ago may not still be so regarded. Many of our readers will be aware of the progress which has been made in the design of audio amplifiers, pickups and loudspeakers, for example, even in the ten years or so since the introduction of stereo discs.

The effect of non-linearity in audio equipment is to create harmonics of the original signal frequencies, the harmonics being multiples of the original signals. For example, the harmonics of an original signal of 500Hz are 100Hz (second harmonic), 1500Hz (third harmonic), 2000Hz (fourth harmonic), and so on.

If it is desired to measure the **total distortion** in an audio system, a so-called distortion factor meter is normally employed. With this instrument, a sine wave test signal as nearly pure as possible is fed into the equipment under test, and the output (usually from the amplifier) is fed to the distortion factor meter. The circuitry of the distortion meter incorporates a filter which can be sharply tuned to the frequency of the original sine wave, thus removing this component of the signal. What is left is the total distortion (and noise) introduced by the amplifier system under test. A sensitive audio millivoltmeter indicates the level of this residual noise and distortion relative to that of the total signal.

This lumped measurement of distortion is sufficient for most purposes; for example, audio amplifier specifica-

tions usually quote THD (total harmonic distortion) as a percentage of total output. However, an equipment designer may require to have a more detailed analysis of the total distortion present when testing a prototype, since he may regard the level of distortion as unacceptable, and wish to seek means of minimising it. To do this, he will require to know the exact nature of the distortion, so as to determine the best means of reducing it.

Again he may be required to meet more critical specifications which may set separate limits on harmonic components, random noise content and mains hum.

In effect, wave analysers are highly accurate frequency-selective voltmeters that can be tuned to select and measure the amplitude of a single frequency or a frequency component of a complex signal. Originally, wave analysers were designed and used to measure audio signal distortion by determining the amplitude and frequency of each harmonic distortion product, one at a time. More recently, they have found wide use in frequency-domain analyses of complex waveforms, modulated waveforms, vibration waveforms, noise, and many other phenomena. They are also widely used as selective voltmeters for analysing the performance

of carrier and radio communications systems.

In addition, wave analysers are useful as sensitive AC microvoltmeters and null detectors. This is because most of the noise and distortion accompanying a signal is removed by the very narrowband filters. A residual noise level of less than 0.3uV in the latest types makes it possible to measure AC signals smaller than 1uV.

The instrument uses the heterodyne principle—in fact it is basically a sensitive, narrowband superheterodyne receiver, as shown in the accompanying block diagram. The input frequency is heterodyned with a local oscillator signal to derive a higher frequency for application to the narrowband IF (Intermediate Frequency) channel. By tuning the local oscillator, any input signal component within the range of the instrument can be converted to the IF. Its amplitude is then indicated on the meter. Signal components outside the passband are rejected. Just as in superheterodyne radio receivers, this technique allows the instrument to be tunable while the filtering circuits remain fixed tuned.

The input to the wave analyser is via an attenuator which is variable to allow the level of signal of the fundamental to be set at a convenient

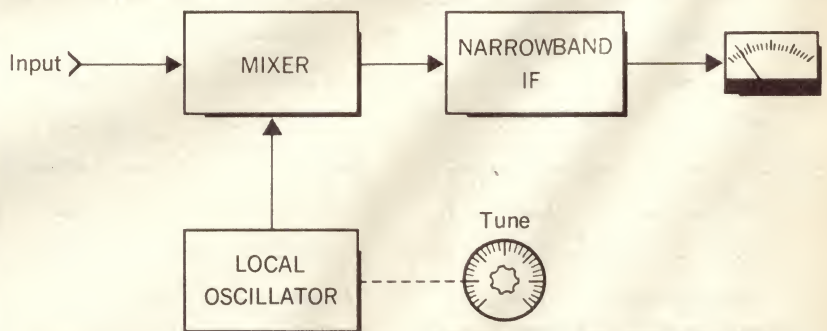

Figure 1. Simplified block schematic showing the basic arrangement of a wave analyser. Note that basically the arrangement is identical with that of the superheterodyne radio receiver.

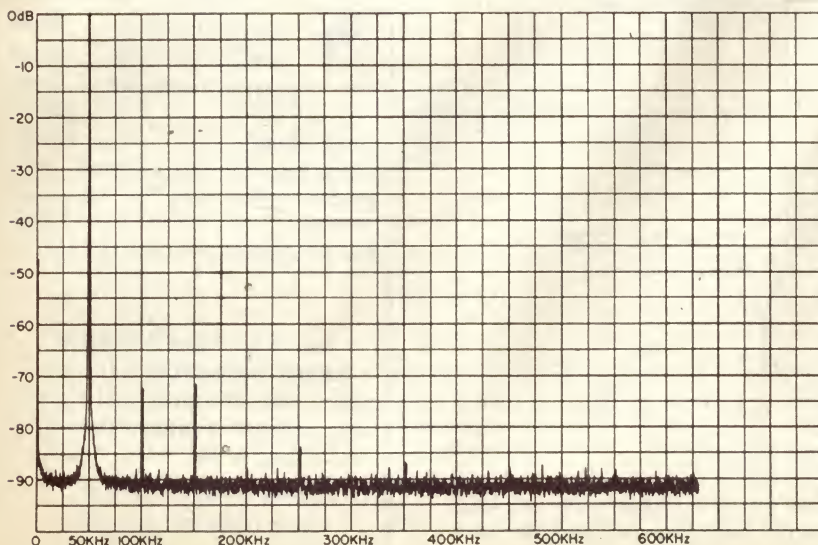
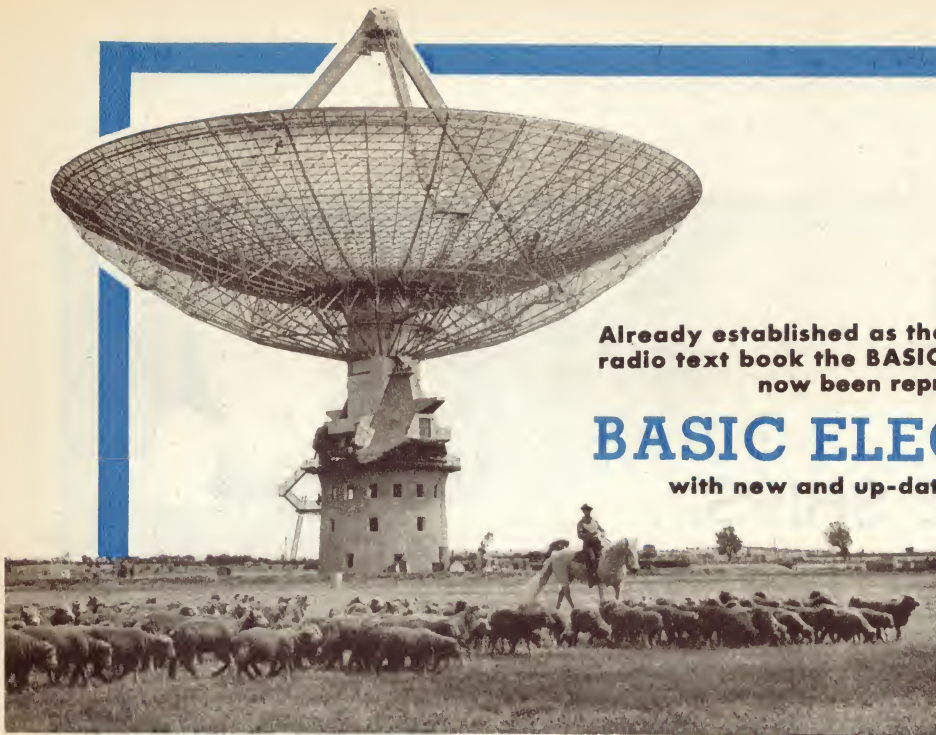

Figure 2. A graph obtained with a waveform analyser. The fundamental frequency is 50Hz, and the amplitude of this has been set at 0dB. The second harmonic (100Hz) has minus 72dB, the third harmonic (150Hz) has minus 71dB, while most other harmonics have negligible amplitude.





Already established as the most popular basic radio text book the **BASIC RADIO COURSE** has now been reprinted as

# BASIC ELECTRONICS

with new and up-dated information.

**Out now, only \$2.00**

This 128-page text book is packed with diagrams and useful information about radio, hi-fi and electronics.

An ideal gift for either student or enthusiast.

An invaluable source of information for those who are curious to know **HOW** and **WHY** the many electronically based devices of today's world work.

It is written so you can understand it.

For a comprehensive review please see page 137 of the March '69 issue.

You can buy your copy of **BASIC ELECTRONICS** by calling personally at any of the offices of John Fairfax & Sons — **Sydney:** Sun-Herald Building, 235-243 Jones Street, or 26 Hunter Street; **Melbourne:** 392 Little Collins Street; **Newcastle:** 22 Bolton Street; **Adelaide:** 104 Currie Street; **Perth:** 847 Hay Street and **Brisbane:** 78 Elizabeth Street.



**To: ELECTRONICS AUSTRALIA:  
Box 2728, G.P.O., Sydney, N.S.W. 2001.**

Please send me ..... copies of **BASIC ELECTRONICS** at \$2.20 posted within Australia. \$2.00 plus postage to overseas buyers (plus estimated for 11 oz. posted weight). Please enclose only a cheque, money order, Australian Postal Order, etc., **NOT CASH.**

NAME .....

ADDRESS .....

STATE .....

**A SPECIAL 10% DISCOUNT** is available on single-copy rate for bulk buyers of not less than 25 copies to radio clubs, youth groups. Please enclose remittance with order including estimated parcel postage or freight.

FROM  
TOYS...  
TO  
SPACE SHIPS...

# HAMLIN MAGNETIC REED SWITCHES



Proximity switches, thermostats, remote readouts, appliances, toys, float switches, space ships—the list of applications which could incorporate Hamlin Magnetic Reed switches is as unlimited as Man's ingenuity in devising ways of using them. Dependent only on a magnetic field for their operation, and isolated from the harmful effects of environment, reed switches have an exceptionally long life (in excess of 100 million operations) and are ideally suited for high speed switching (operating time less than 1 millisecond). The package density of reed switches is of course less than solid state devices but because of the simplicity of the reed switch in comparison with transistorized logic circuitry, the switching cost could be much less.

Hamlin Reed switches have met every conceivable test in a broad range of environmental and electrical applications. As the pioneer in the development of dry-reed switches, Hamlin offers the widest selection and is the industry's largest producer of magnetic reed switches.

They are available with contacts of gold, silver, tungsten, or rhodium for switching various load types. Mercury wetted contacts are used to eliminate contact bounce. Nitrogen or hydrogen, at various pressures, offer inert atmosphere for clean operation, while evacuated switches are used for high voltages.

There are dozens of reed switches designed for specific load requirements, such as low-level dry circuit loads, or high voltage loads. Various switch configurations in different sizes, ranging from the standard through to micro miniature (Grain of Wheat), are available in single pole throw or single pole double throw. Also with contacts mercury wetted, biased, polarized, or spring loaded. All Hamlin switches are further classified in close tolerances according to magnetic sensitivity. Depending on switch design, these ranges are from 20 AT to 150 AT for pull-in and 10 AT to 100 AT for drop-out.

**HAMLIN** MAGNETIC REED SWITCHES  
FIRST AND FINEST IN THE FIELD

**IRH COMPONENTS PTY. LIMITED**

(A subsidiary of International Resistance Holdings Ltd.)

THE CRESCENT, KINGSGROVE, N.S.W. PHONE 50 0111

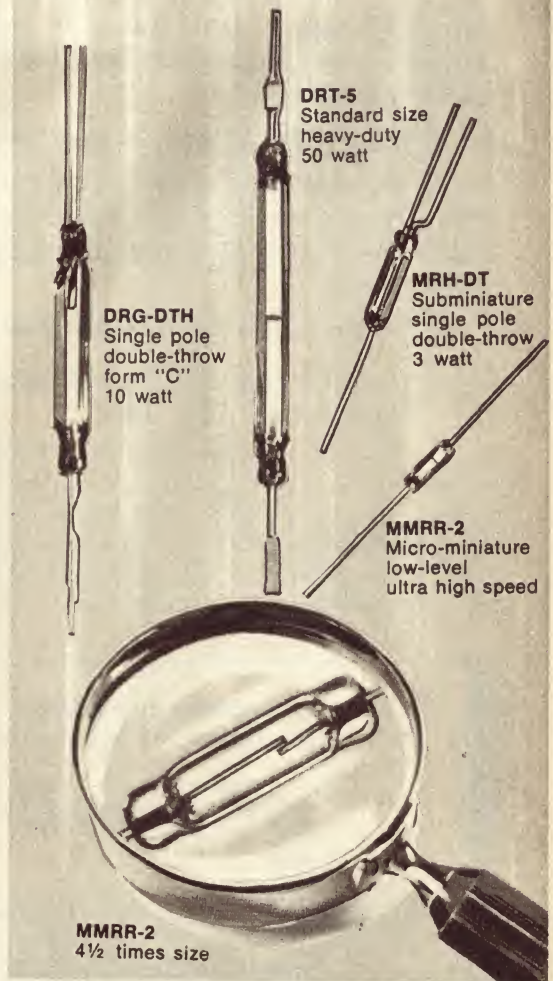

level, usually designated as 0db on the meter scale. To avoid undue loading on the observed stage of the equipment under test, an input amplifier with a high input impedance acts as a buffer stage before the mixer. The gain of the input amplifier may be fixed, or variable as part of the attenuator function.

Practical wave analysers include other refinements not apparent from the block diagram. One refinement of particular importance concerns the stability of the local oscillator. The local oscillator must have excellent short term stability, so that a signal component does not drift out of the narrow passband during a measurement, and it should have good long term stability so that the user can have confidence in the frequency calibration of the instrument. To assure long term stability, critical components in the local oscillator circuit of the higher quality instruments are pre-aged. For both long- and short-term stability, the entire circuit may be contained within an oven that maintains a constant operating temperature for the oscillator.

The equipment to be investigated is supplied with a sine wave signal with an inherently low distortion content (not more than 10 per cent of the anticipated level of measured distortion is usually regarded as satisfactory) and the output fed to the analyser. With the simpler types of wave analyser, the instrument is then tuned to the fundamental frequency and the input attenuator adjusted until the meter reads 0dB. Harmonic distortion can then be determined by retuning the analyser to the frequencies of the second, third and higher harmonics of the fundamental, and reading off the level of each component in dBs below the fundamental.

More advanced types of wave analyser have provision for sweeping a range of frequencies to avoid the need for individual setting to the harmonics, the results being charted on an XY recorder. (See figure 2.)

Variable air capacitors have been used to tune a wave analyser's local oscillator, but this requires cumbersome mechanical drives to obtain sweep frequency tuning. Now, modern-day solid-state varactors can be used to tune local oscillators with the requisite high stability. Suitable shaping of the controlling voltage obtains the requisite linearity. The resulting electrical control of oscillator tuning simplifies sweep frequency tuning arrangements and also allows external electrical control of the wave analyser's tuning. The ultimate sensitivity of the instrument is determined by the input amplifier's noise level and the bandwidth. The difference between the noise level and the amplifier's maximum undistorted signal output determines the dynamic range.

The selectivity of a wave analyser is determined by the passband of the IF circuits, just as in a superheterodyne receiver. Crystal filters have commonly been used to establish the passband, but even better passband shaping has been achieved with active filters. In some models the IF is translated down to a zero carrier frequency where audio-frequency active filters can be used to obtain the flat top and steep skirts desired in the filter response. After filtering, the IF signal is translated back up to the IF, and rectified to drive the meter. ■

## A Modern High-quality Wave Analyser

Pictured below is a new wave analyser which incorporates all of the desirable features mentioned in the accompanying article and has in addition some unique features.



The analyser, Hewlett-Packard Model 3590A, measures the frequency components of simple or complex signals over an extremely wide dynamic range of more than 85dB without manual range switching. Automatic ranging makes successive measurements of all signal components quick and easy. It also gives the instrument the ability to make recordings over the full dynamic range. No time is lost in making range changes usually required for signal components with widely differing amplitudes. The analyser has a wide frequency range, covering from 20Hz to 620KHz in two overlapping ranges.

The local oscillator output, suitably buffered, is also supplied to a front panel connector where it is available for slaving another wave analyser. Logarithmic and linear DC outputs are available to drive the X and Y axes of recorders. With the logarithmic X and Y outputs, wide range frequency response measurements can be made on semi-log paper (linear vs log of frequency) enabling Bode plots of amplifier or filter frequency response to be made directly. Recordings can be made with any combination of linear and logarithmic axes.

Plug in modules allow digital readout of frequency, including instantaneous reading of frequency during sweeping. Tuning is simplified by automatic frequency control (AFC). It is only necessary to approach the correct tuning and the AFC circuit "pulls in" the selected component. Frequency sweeping is simplified by electronic tuning. Space does not permit a full summary of the instrument's features, but further details can be obtained from Hewlett-Packard Australia Pty. Ltd, 22-26 Weir Street, Glen Iris, Victoria, 3146. ■

### TEL-LEIGH-TUBES PTY. LTD.

(SYDNEY and MELBOURNE)

### ARE BUYING OLD TV TUBES FOR CASH

21" 90° \$8 23" 110°-114° \$9 23" Laminated \$9

*These prices are for tubes under vacuum*

Broken tubes with 3" neck are purchased at \$5.00 each subject to inspection.

ALL TUBES TO BE FREE OF ION-BURNS

Send freight paid to HIGHETT STATION, VIC., or PETERSHAM STATION, N.S.W.

TEL-LEIGH-TUBES PTY. LTD.

32/34 Graham Rd., Highett, Vic. 95-4086.

51 Reuss Street, Leichhardt, N.S.W. 56-8498.



# Forum

## The case for novice transmitting licences

Two correspondents in our February issue opposed the idea of a "novice" amateur type licence, suggested by Mr Rex Black in December. Not surprisingly, their letters have sparked a rejoinder from some of the lads in the relevant age group as well as from Mr Black who, incidentally, played a very large part in getting the Wireless Institute of Australia's Youth Radio Scheme under way.

### Conducted by the Editor

**NO CLUB:** "In February issue (page 60) T.L. of Gordon opposed the suggestion that novice transmitting licences should be made available to radio hobbyists in Australia. Like T.L. I am a schoolboy interested in radio but, unfortunately, one who cannot afford to pay for a correspondence course from the Wireless Institute.

"It seems to me that T.L.'s only argument against novice licences is that HE would rather do the A.O.C.P. straight off. I assume that his contemptuous reference to a 'small radio station' indicates that he intends to get on the air with a high-powered transmitter when he completes the remaining two-thirds of his A.O.C.P. course.

"Personally, I should be very grateful for the opportunity to operate a small radio station, even if the conditions for the novice licence did restrict the power and, perhaps, the bands on which I could operate.

"Getting on the air at a stage earlier — and easier — than the A.O.C.P. would appeal to a great number of school students like myself. Most of us would not find the time to undertake a course of one year, as T.L. is doing, as the Wyndham Scheme with its six subjects in fifth and sixth form requires a great deal of time and study. We could, I think, manage to handle a shorter course such as a novice licence would require. Also, this radio work would help us with the parts of the school course dealing

with electronics in the Senior Physics syllabus.

"Unfortunately, we do not have a radio club at the school which I attend, so I have no association with the Y.R.S., about which I have read a lot in 'Electronics Australia.' However, I do live close to an amateur who would certainly help me get a novice licence, if this form of licence could be introduced. Also, he would help me build and test my transmitter and would make sure that I knew how it worked.

"I cannot see any sense in T.L.'s comments about beginners who are not really interested in radio but who know enough of the basic principles to get their novice licences. I cannot imagine anyone not interested in amateur radio worrying about getting a novice licence. Even if they did, surely some arrangement could be made to make sure that they did not use illicit transmitting equipment?

"T.L. thinks that there should be other ways in which the Y.R.S. could help young radio enthusiasts without giving them a novice licence. From the reports I have read in your columns it seems that the Y.R.S. is really encouraging young people. Novice licences would make it possible for the Y.R.S. to encourage them even more effectively.

"However, I agree with T.L. that there should be some way in which novice licences could be earned by people other than Y.R.S. members. I

feel sure that Mr Black in his letter in December issue did not intend that only Y.R.S. Club members should be entitled to this form of licence."(D.S.)

**GRATEFUL, BUT . . . :** "I have read with interest the correspondence started by Mr Black on the subject of novice licences and wish to add my support to the proposal.

"As a member of a Y.R.S.-type of school radio club, I have managed over a considerable period to acquire a range of Y.R.S. proficiency certificates from elementary to senior and I feel that my interest in radio shown by gaining these awards has helped me considerably in being selected for training as a radio technician in the D.C.A. Radio School.

"I am grateful for the assistance and encouragement given by the Youth Radio Scheme and for the prizes which were made available to me by the O.T.C. and other supporters of the Y.R.S. However, I do feel that even greater interest would be aroused if school radio club members could obtain transmitting permits — call them novice licences if you like — to enable them to contact members of other clubs, on a restricted basis if it has to be so.

"Perhaps we really do not need as liberal and as unsupervised a novice system as the Americans seem to enjoy.

"However, I do think that High School students following a higher school certificate course in science would benefit greatly by being allowed to engage in licensed transmitting after receiving instruction in the construction, installation, checking and theory of simple equipment. This sort of activity would serve to arouse interest in electronics and would lead, as in my case, to a career in this type of work. It should also encourage more enthusiasts to follow through to A.O.C.P. qualifications.

"I think that there is ample room in the scheme of things for both methods of reaching full amateur status: (a) Through the W.I.A. courses followed by your correspondent T.L. of Gordon and (2) through the Y.R.S. and a well-conducted novice licence system.

"Your correspondent T.L. seems to fear that his interests as a future amateur will be prejudiced by making novice operation available. I would point out that one advantage that will result will be increased use of the amateur bands which are by no means fully occupied by Australian amateurs. He should realise that only partially used bands are going to be lost to the amateur service in time, owing to pressure from other interests. He and his fellow correspondent, P.W., of Eltham, should keep this in mind and give good support to any move that will fill the bands and ensure their re-

attention for the amateur service — even if they have to swallow their objections to the novice proposition!" (G.D.)

**MEMBER OF Y.R.S.** "I am a member of a radio club associated with the Wireless Institute's Youth Radio Scheme and consider that the introduction of a novice licence for members of such clubs as mine would add greatly to the interest of the hobby.

"I admit that the Y.R.S. certificates and prizes do give us encouragement to follow the courses and tests but I think that the extra interest that would be aroused by getting on the air with our own low-powered transmitting stations would be terrific.

"One hears of people getting on the air on illegal frequencies and of raids by P.M.G. officers but I feel that this is largely due to the difficulty of the present amateur licence requirements. An easier form of licence would, perhaps, remove the urge for unlawful operation—on or outside the amateur bands." (P.C.)

**IN THE U.S.A.:** "The suggestion appeals to me greatly that the radio authorities in Australia should introduce a novice licence something like what is available to Americans. I have often read in their magazines that young American schoolboys, and schoolgirls enjoy amateur radio transmitting and I have regretted that similar licence conditions do not apply in Australia. I have found out recently that similar licences exist in other countries also, including Japan, Russia, India and Israel. There may be others as well. What justification can there be for denying such opportunities to young Australian radio enthusiasts?" (L.W.)

**ELECTRONICS CAREER:** "I am a student in fifth year and hope to do electronics engineering next year, probably under my own steam. This will mean working through holidays to obtain enough money to pay my way through the Institute of Technology.

"When I was in second year at school, I read a book from the library entitled 'There's Adventure in Electronics.' This book was centred around a young boy who became interested in electronics through amateur radio and it was the novice licence which led this young man eventually to make up his mind to become an electronics engineer.

"It was the idea of a novice licence which also pushed me toward amateur radio and I was very disappointed when an amateur friend (who is in favour of novice licences) told me that they were not available in Australia. If only they were, they would definitely encourage young people to become electronics technicians and engineers.

"However, I do not feel that there should be an age limit. The licence should assist all those who are not immediately able to qualify for a regular amateur licence. An example would be those who have retired, but who are still keen on radio.

"As regards irresponsibility, I feel that it would not be a problem if an amateur was to visit the novices at particular times to make sure that they are not transmitting illegally. I am definitely in favour of novice licences." (R.N.)

**COMMENT:** So much for the viewpoint of lads in the age group most

## YOUTH RADIO CLUB IN ZAMBIA

Dear Sir,

Due to the kindness of a contact in Victoria, I receive "Electronics Australia" regularly. I run a radio club for boys at this school and a single copy gets passed around the members of the club until it literally drops to pieces.

Your excellent technical reviews and general articles provide a never ending source of discussion topics at the club meetings.

Our members are very poor and can barely afford shoes, let alone radio books or magazines. Components are very expensive here, when they are available — which is rarely — so we have to make do with what we can salvage from broken radios that are given to us.

I only wish we had something similar to the W.I.A. Youth Radio Scheme. I believe that the development of an interest in radio and amateur radio in particular is essential if amateur radio is to retain its frequency allocations under the strong pressure at Geneva for frequencies by the developing countries.

Congratulations and thank you for a first-class magazine.

B. Otter,  
(Chalimbana Secondary School Radio Club,  
Private Bag E.1,  
Lusaka, REP. OF ZAMBIA).

affected by the proposition for a novice licence. It is refreshing to note the attitude that novice licences should not be restricted to teenagers.

Among our more mature readers, we would expect to find a significant number who might be inclined to sit for a limited level examination, with a view to gaining the momentum and experience necessary to qualify within a specified time period for a limited or a full A.O.C.P. licence.

And, in this technological age, there may well be an increasing number of people reaching retirement who could join the ranks of the amateurs—if the path thereto was made a little easier. Or do we believe that they would be better occupied fretting in idleness?

Replying to his critics, Rex Black has this to say:

"I read with interest the letters of your correspondents, P.W. and T.L., in February issue, both voicing opposition to the suggestion that there should be a novice-type transmitting licence available to Australian radio enthusiasts.

"My letter in the December issue in favour of a novice-type licence was not supposed to present a complete and detailed scheme, so perhaps P.W. may forgive me for not specifying age limits, qualifications and technical requirements.

"I realise that the Australian authorities have lowered the A.O.C.P. examination age to 14 and the Morse speed to 10 words per minute, but I am not at all convinced that these concessions will make for any significant increase in the number of licensed

### IT IS WISE TO CONTACT

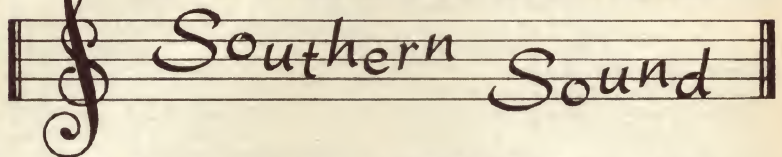

963 Nepean Highway, MOORABBIN VIC. 3183

**AMPLIFIERS:** B. and O., Dynaco, Kenwood, Lux, Leak, Peak, Pioneer, Rapar, Sansui, Sound, Sony, etc. **CARTRIDGES:** A.D.C., Audio Technica, B. and O., Lux, Micro, Ortofon, Shure, etc. **SPEAKERS:** Beovox, Celestion, Leak, Peak, Pioneer, Sonics, Wharfedale, etc. **TONE ARMS:** A.D.C., All Balance, Audio Technica, B. and O., Grace, Micro, Nikka, Ortofon, S.M.E. **TURNABLES:** Compax, Dual, Goldring, Labcraft, Orpheus Silex, P.E., Thorens. **TAPE RECORDERS:** Ampex, Beocord, Grundig, National, Revox, Sony, Tanberg, Teac, Toshiba.

#### APRIL SPECIALS

National RS776S — 4 track Auto Reverse Tape recorder . . . \$295  
National RS760S — 4 track Tape recorder . . . \$229  
Sharp RD708 — 4 track Tape recorder . . . \$179  
Turntable (mounted) Connoisseur Craftsman 111 with Micro M88 tone arm and Ortofon SL15 cartridge with transformer . . . \$129  
Complete Stereo System: Sound 10 x 10 watt amp. Compax A.R. Auto-return T/table mounted in cabinet with hinged Plexiglass cover, and 2 10-watt 40-20,000 Hz speakers . . . \$179

**WHILE STOCKS LAST.**

ALSO: Modular Systems: Rolls, Jorgen, Rhapsody, National, Toshiba., etc.

**MAIL ORDER: Special MAIL ORDER Dept. will give prompt attention to all enquiries.**

Address enquiries to; SOUTHERN SOUND P.O. Box 204 MOORABBIN VIC. 3189

# TRIO

## COMMUNICATIONS RECEIVER

### 9R-59DE



- 4 BANDS COVERING 540 Kcs. TO 30 Mcs.
- TWO MECHANICAL FILTERS ENSURE MAXIMUM SELECTIVITY.
- PRODUCT DETECTOR FOR S.S.B. RECEPTION.
- AUTOMATIC NOISE LIMITER.
- LARGE TUNING AND BAND-SPREAD DIALS FOR ACCURATE TUNING.
- CALIBRATED ELECTRICAL BANDSPREAD.
- "S" METER AND B.F.O.
- 2 MICROVOLTS SENSITIVITY FOR 10 dB S/N RATIO.

#### SPECIFICATIONS:

Frequency Range: Band A—550-1600 Kcs.  
Band B—1.6-4.8 Mcs.  
Band C—4.8-14.5 Mcs.  
Band D—10.5-30 Mcs.

#### Calibrated Electrical Bandspread:

80 and 40 metres—5 Kcs. per division.  
20 and 15 metres—20 Kcs. per division.  
10 metres—50 Kcs. per division.

Antenna Input: 50-400 ohms impedance.

Audio Power Output: 1.5 watts.

Sensitivity: 2  $\mu$ V for 10 dB S/N Ratio (at 10 Mcs.).

Selectivity:  $\pm 5$  Kcs. at  $-60$  dB ( $\pm 1.3$  Kcs. at  $-6$  dB).

When using the Mechanical Filter.

BFO Frequency: 455 Kcs.  $\pm 2.5$  Kcs.

Speaker Output: 4 or 8 ohms.

Headphone Output: Low impedance.  
Power Consumption: 45 VA at 115/230 volts  
A.C. 50/60 Cps.

Tube Complement: V1—6BA6 RF Amplifier.  
V2—6BE6 Mixer.  
V3—6AQ8 HF Oscillator.  
V4—6BA6 1st IF Amplifier.  
V5—6BA6 2nd IF Amplifier.  
V6—6BE6 Product Detector.  
V7a—6AQ8 Beat Frequency Oscillator.  
V7b—6AQ8 1st AF Amplifier.  
V8—6AQ5 Audio Output.  
IN60—AF Detector.  
IN60, SW-05S—AVC.  
SW-05S—ANL.  
SW-05S x 2—Rectifiers.

Dimensions: 7" High, 15" Wide, 10" Deep.  
Weight: 19 lbs.

PRICE: FOR/FOA SYDNEY: \$175.00

CONSULT YOUR LOCAL RADIO DEALER, OR

MAIL THIS COUPON *today*

Please forward free illustrated literature and specifications on Trio equipment.

Name.....

Address.....



(A unit of Jacoby Mitchell Holdings Ltd.)

376 EASTERN VALLEY WAY, ROSEVILLE, N.S.W.

Cables and Telegraphic Address: 'WESTELEC',  
Sydney. Phone: 40 1212

amateurs and in the Wireless Institute's membership. There may be, perhaps, an easier transition from A.O.L.C.P. to A.O.C.P. status, but more radical measures are needed if Australia is to gain parity on a pro rata population basis with American amateur totals. We should have an amateur population here of about 13,000, whereas 5,000 would be closer to the current figure. Obviously, the amateur service in this country needs a real boost from somewhere.

"P.W. states that under the present system Australian amateurs have the advantage of being equal in operating privileges. However, we do have distinctions between A.O.C.P. and A.O.L.C.P. operators together with other very obvious inequalities due to varying incomes and wide variations in technical knowledge. Some licensees use high-powered black boxes of astronomical values; others operate simple equipments of minimal cost; some possess minimal A.O.C.P. standards of knowledge; others have impressive professional qualifications. The equality argument just does not hold water.

"The leading nations in the field of electronics are undoubtedly America, the Soviet Union, Japan and Great Britain. In the first three countries novice-type licensing has been operative for a long time. Great Britain is in the throes of working out a beginner licensing system. This does not leave much room for P.W. to argue against an Australian lower-level licence system.

"Some amateurs stress the need for all users of the bands to have a sound theoretical knowledge of the equipments they operate. The introduction of a novice or other sub-AOCP licence, they claim, would undermine the high standards traditional within the amateur service.

"While I do not suggest that a novice licensee should be ignorant about what happens inside his equipment, I do feel that a person operating a novice type outfit with CW facility only would not need to know at that stage about the intricacies of FM and SSB. A simpler examination to ensure sufficient knowledge of low-powered transmitters together with guarantees of continued training through W.I.A. or other agencies to ultimate A.O.C.P. standard should serve to allay undue fears.

"At the same time, close supervision by approved Radio Club instructors and Institute agencies might serve the Australian scene far better than the American-type novice licensing scheme, whereby a candidate completes a simple written examination with multiple-choice questions and a Code test at 6 w.p.m. My concept of an Australian system envisages close control and supervision, construction of novice-type transmitters under Club instructors, elimination of TVI and BCI before installation and operation only within club networks in the early stages, with gradual extension of privileges to parallel further stages in both practical and theoretical training.

"The Australian novice licence should not be an end in itself, but a means of getting interested and responsible candidates on to the air as part of their progression towards the full Amateur licence.

"I suggest that P.W. and T.L. should

examine the Articles of Association of the Wireless Institute and the aims of the Youth Radio Scheme and, in doing so, appreciate the responsibilities of the Institute towards those who wish to gain an insight into the art of Electronics.

"My own wish is to see the Wireless Institute grow in membership, to extend its influence in the community, and to eliminate from its ranks those whose aim is to keep the amateur service a closed circle, talking to itself about itself." (R. C. Black, VK2YA)

**COMMENT:** While Rex Black's pre-occupation with the Youth Radio Scheme is understandable, it would appear to have circumscribed his thinking in regard to the novice licence so that it emerges virtually as a privilege extended to Y.R.S. proteges.

While "Electronics Australia" has supported in principle the Wireless Institute and its Youth Radio Scheme, we can hardly support the idea that one would have to be a member of either or both to hold a particular form of amateur licence. And why Morse only in an era when the code is about as appropriate as a horse and buggy?

Common sense may dictate a variety of limitations and sponsorship and/or supervision by a responsible amateur, commercial "ticket" holder, I.R.E.E. member, or such other technically oriented person as the authorities may see fit to define and accept.

But the sole right of W.I.A. proteges, no!

So much for our own comment. Finally here is a letter from a reader who sees possibilities in the novice licence which have not hitherto been mentioned:

**CODE PRACTICE:** "Following discussions in the December and February issues concerning novice licences, and the publication of the proposed basis for this in the February issue, I would like to have my sixpennyworth of say-so.

"I am not a teenager. I am a mature person working in the electronics industry. I have a Limited A.O.C.P. but, due to many factors — mainly lack of time — I have never managed to get on the air or progress to a full licence.

"It would seem that the novice licence would suit me down to the ground. Assuming that my present licence would exempt me from a further examination, the granting of such a licence would enable me to build and use the relatively simple equipment needed for low power crystal locked CW on 3.5MHz. Such a set-up should provide ample incentive and an ideal environment to practice the code and thus qualify for a full licence. I suspect there may be many more "Z" licensees who would also welcome such an opportunity.

"As for the broader concept of the novice licence, i.e., to encourage young people to seek a full licence I think it is an excellent idea. As proposed, it would seem to offer the necessary encouragement while retaining the necessary safeguards to ensure that it functions simply as a means to an end; not an end in itself." (G.W.)

# ELECTRONICS Australia . . .

Australia's national electronics journal

*Next month —*

## A COURSE IN SEMICONDUCTORS

In next month's issue will appear the first of a brand-new series of articles written by our Technical Editor to provide a thorough, modern and especially **readable** explanation of both the operation and uses of diodes, transistors and the many other exciting solid state devices which have revolutionised modern electronics. The title of the series is **Fundamentals of Solid State**, and the first chapter starts right from the beginning by looking at modern atomic theory. For a clear insight into semiconductors, don't miss it next month — or any of its successors!

*Next month —*

## A SOLID-STATE STEREOGRAM



This attractive solid-state stereogram is a combination of the popular 3-plus-3 amplifier and the tuner described in May, 1968.

*Almost ready —*

## CLOCK CRYSTAL DRIVE UNIT

A device in which many readers have expressed a keen interest. A fully solid-state system divides the output from a 100KHz crystal to drive a standard 50Hz clock.

*On the way —*

## 50W SOLID-STATE GUITAR AMP.

The Playmaster 60-watt valve-type guitar amplifier has been both popular and successful. We are now developing a 50-watt solid-state equivalent, which we hope will be even more popular and versatile.

The cost of producing a technical journal as comprehensive as "Electronics Australia" and as tightly packed with information has risen steeply in recent years. Rather than impose economies, which would react on content and accuracy alike, we have opted for the only possible alternative and increased the cover price by 10c per copy. Existing subscriptions will be honoured for their full currency without price increase.

40c

# EVERYTHING FOR THE HOBBYIST and

## 40 Watt & 60 Watt Instrol-Playmaster GUITAR AMPLIFIERS

All parts now available

Like all Instrol-Playmaster kits, the 116 and 117 Guitar Amplifier Kits are complete in every detail, down to the last nut and bolt, and precisely to "Electronics Australia" specifications. Chassis is ready drilled, cadmium plated and finally passivated to avoid fingermarking. The front label is beautifully finished with black lettering on silver-white background. Kits for both the 116 and 117 include extras such as 3 inputs (circuit included), vibrato and extra treble pull switches, and foot switch complete with chrome housing.

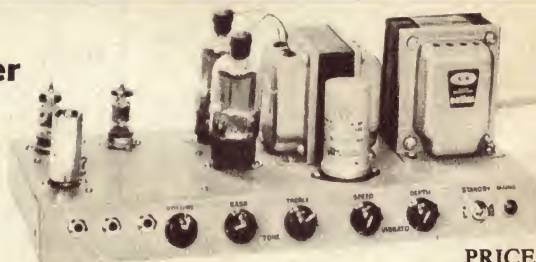

	<b>PRICE</b>
40 Watt complete kit of parts . . . . .	<b>\$84.36</b>
40 Watt built and tested . . . . .	<b>\$91.49</b>
60 Watt complete kit of parts . . . . .	<b>\$92.31</b>
60 Watt built and tested . . . . .	<b>\$98.83</b>
(Freight extra)	

All parts available separately if required.  
 Chassis only . . . . . **\$4.70** (plus 85c postage)  
 Front Label . . . . . **\$2.80** (plus 20c postage)  
 Fuzz Box Kit . . . **\$12.95** (plus 75c postage).



**KEYLESS ORGAN**  
 (Electronics Aust. January 1969)

A useful novelty instrument which can be used successfully by a single entertainer or in conjunction with a group. Includes sharps and flats, built-in vibrato and has a high level of acoustic output.

Kits of Parts .. \$35.10. Postage extra.



**INSTROL-PLAYMASTER 106 AMP/TUNER** ("RTV and H," Dec., 1963).  
 A high-quality amplifier/tuner with all stations clearly marked on dial. Amplifier 10 watts per channel.  
 Kit of Parts . . . . . **\$96.50**  
 Postage Extra.



The new **INSTROL-PLAYMASTER 115 SOLID STATE STEREO AMPLIFIER** ("Electronics Aust.," April-May, 1967).

A fully transistorised 10 Watt Stereo Amplifier using the latest F.E.T. high-efficiency transistors.

Crystal/Ceramic Kit . . . . . **\$95.00**  
 Magnetic kit extra . . . . . **\$10.50**  
 Postage Extra.

### INSTROL-PLAYMASTER 123 PROGRAM SOURCE



("ELECTRONICS AUSTRALIA" Oct. 68)

A high quality wide band solid state unit, fitted in free-standing metal case, featuring meter tuning and large illuminated dial.

Kit of Parts — with Ceramic Filter . . . . . **\$91.20**

Kit of Parts—without Ceramic Filter . . . . . **\$77.50**  
 (Postage extra)



**THE 10-PLUS-10 STEREO AMPLIFIER**

("Electronics Australia," November, 1968)

A high quality solid-state 10 watt amplifier. Suitable for crystal or ceramic cartridges.

KIT OF PARTS . . . . . **\$60.50**  
 (Postage Extra.)



**THE 3-PLUS-3-STEREO AMPLIFIER,**

("Electronics Australia," August, 1968).

A small, modern, 3-watt solid-state audio amplifier.

Kit of parts . . . . . **\$43.50**  
 (Postage extra.)

Tick catalogue required, and please include stamps for postage.

- |  |  |
|--|--|
| <input type="checkbox"/> Playmaster        | <input type="checkbox"/> Test Equip Kits       |
| <input type="checkbox"/> Toolkit           | <input type="checkbox"/> Tape Recorder Instrol |
| <input type="checkbox"/> Cannon Connectors | <input type="checkbox"/> Microphone            |

Name .....

Address .....

Post Coupon for Free Catalogue.

### OTHER PLAYMASTER KITS

	Price	Add Post
111 Tuner . . . . .	\$39.00	\$1.20
114 Tuner . . . . .	\$47.00	\$1.20
107 Amp/Tuner . . . . .	\$81.80	\$2.00
108 Amp/Tuner . . . . .	\$69.80	\$2.00
101 Amp . . . . .	\$61.00	\$2.00
No. 3 Amp . . . . .	\$57.80	\$2.00
10W U/L Amp . . . . .	\$85.80	\$2.00
No. 10 Control Unit	\$39.00	\$1.20
113 Amp . . . . .	\$64.00	\$2.00
119 Tape Adapter . . . . .	\$86.70	\$1.20
No. 4 Amp . . . . .	\$73.00	\$2.00

Most Playmaster Designs are also available Completely Built and Tested.

### INSTROL PRINTED CIRCUIT BOARDS

High-quality, pre-fluxed boards to suit the 115 Amp. Clearly printed on reverse side with component location map. Easy to assemble.



**PRICE**  
 Crystal Pre-Amp . . . . . **\$2.00 ea.**  
 Main Amp (2 required) . . . **\$1.60 ea.**  
 Magnetic Pre-Amp . . . . . **\$1.60 ea.**  
 (Add 15c for postage)

# BROADWAY ELECTRONICS



# TECHNICIAN...

## INSTROL EDUCATIONAL ELECTRONIC KIT

In this Electronic Age, every person should have some knowledge, however elementary, of "how it works." The new Instrol 20 in 1 electronic kit will enable you to understand in an absorbing, simple manner the basic principles underlying computers, satellite communications, industrial electronic devices, etc., etc. You make 20 different experimental circuits, including 10 working radio transistor operated radio circuits. Audio Amplifier circuits, home intercom, testing circuits including Audio Frequency Oscillator and Signal Tracer, Morse Code practice set and telegraph transmitter, etc. You use and learn about the amazing SOLAR CELL.



**NO TOOLS OR SOLDERING IRON REQUIRED**

All components pre-wired, ready for clip-on assembly. 50 page Instruction Manual supplied.

**ONLY . . . \$16.90**

(Plus 85c for Registered Post)

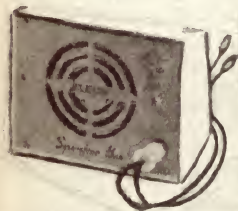

To allow others to hear the results you achieve, why not obtain the Instrol SPI Speaker box. Completely assembled, includes transistorised audio frequency amplifier, dynamic speaker and leads, housed in an attractive plastic box, and ready to plug-in at any appropriate stage of your experiments with the Instrol 20 in 1 Electronic Kit.

**INSTROL SPEAKER BOX. PRICE \$6 plus 10 cents Postage.**



## ELECTRONIC TOOL KIT

**For Hobbyists Students and Servicemen**

An inexpensive, yet most comprehensive, pocket-sized tool kit. Ideal for the Student, Hobbyist and Practising Service Technician. The Soldering Iron is an Australian made high efficiency 30 Watt 240 Volt type. All the other hand tools are imported, high grade steel. The complete kit fits snugly into a strong attractive zip-fastening carrying satchet.

### COMPONENTS

- 1—Soldering Iron with 3-pin plug 30 Watts 240V
- 1—Set 3 Spanners.
- 1—Coil Resin Cored Solder
- 1—Pair Pliers standard
- 1—Pair Long Nose Pliers
- 1—Pair Side Cutters
- 1—Pair Tweezers
- 1—Screwdriver Set complete with handle and chuck, comprising
  - 2—Screwdriver bits
  - 1—Philips driver bit
  - 1—Pointed awl
  - 1—Spintite for 1/4in nuts

**PRICE \$12.50. Plus Regd. Postage \$1.00**

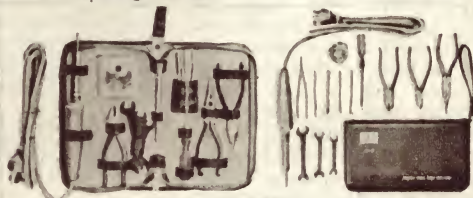

**V.T.V.M. (Feb., '66)**



**SOLID STATE AUDIO MILLIVOLTMETER**

(May, '68)



**TRANSISTORISED AUDIO OSCILLATOR (Dec., '67)**



**AF TONE BURST GATE (April, '68)**



**R.C. BRIDGE (MAY, '66)**

### TEST EQUIPMENT KITS

**PRICE**

- V.T.V.M. . . . . Feb. 66 \$57.51
  - Solid State Audio Millivoltmeter
  - May 68 . . . . . \$60.63
  - Audio Oscillator . . Dec. 67 \$44.30
  - AF Tone Burst Gate, April 68 \$61.00
  - R.C. Bridge . . . . May 66 \$40.99
- Postage extra on all kits.

# PTY. LTD.

**E. S. & A. BANK BUILDING  
CNR. BROADWAY & CITY ROAD, SYDNEY  
(OPP. GRACE BROS.) Phone: 211-4224, 211-4244, 411-4213**



# The Serviceman



## TIME TO STUDY TRANSISTORS

The winds of change are blowing for servicemen and it won't be long before the trickle of transistorised equipment calling for attention becomes a flood. A mixed metaphor, maybe, but that shouldn't prevent you from getting the message — while there is still time!

To date, the average serviceman has not had to deal with overmuch transistorised equipment. His daily round is still largely occupied, as it has been for the past 10 years, correcting faults in valve-type television receivers, valve-type radios and valve-type stereograms. Transistor portables and the occasional transistor TV set, which look at all difficult, can still be shunted back to the shop specialists, who have the circuits, the spare parts and the know-how to cope with them.

But this procedure shouldn't be allowed to become routine, otherwise a lot of servicemen are going to find themselves acting as pickup and delivery men, while somebody else solves the technical problems—and both paid accordingly! The wise serviceman should, I think, be burning some midnight oil in the face of this changing situation, finding out a few things about transistors and the equipment in which they are being used.

And what better way of backing up such study than by tackling a few repair jobs—not with the idea of being paid on a per-hour basis, but simply with a view to gaining experience.

As you have no doubt guessed, these thoughts were prompted by an actual situation encountered, not by myself as it happens, but by a friend who is also in the servicing game. He is on the service staff of a large organisation which sells and services a wide range of electronic and electrical goods, including a few electronic organs, imported musicians' amplifiers and so on.

My friend's activities are normally confined to television sets and stereograms but a staff crisis, a few weeks back, projected him into the situation where he had to handle a couple of urgent jobs in the music field—if he could! His superiors happened to know that he was a proficient pianist and this, with his knowledge of electronics, made him the most likely recruit to fill the empty shoes.

The first job involved a guitar-cum-microphone amplifier that belonged to a professional musician. My friend picked it up in the course of his normal "television" rounds and took it home to work on that night—preferring to work quietly in his own time rather than display to the client his lack of experience with the particular equip-

ment. The complaint was very bad noise on the microphone channel.

My friend soon established that the noise depended on the microphone volume setting, so that it was apparently in the microphone preamplifier stage. So, rather painstakingly, he traced out the circuitry on the wiring board, identified the collector, base and emitter components and, of course, the transistor itself. A check with ohmmeter and voltmeter showed nothing obviously amiss and led him to the idea that the transistor itself might have been the source of the noise.

The question was how to prove it.

With no circuit and no clear marking on the transistor, he could only assume that it was a PNP type, probably germanium, operating from a negative supply line. It so happened that he had a few such transistors among oddments in a screw-top jar

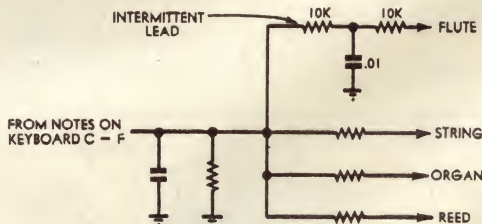

*An intermittent 10K resistor silenced one of the basic voices in an electronic organ.*

and, without further ado, he carefully removed the suspect transistor from the amplifier and wired in one of his own oddments.

Result? Plenty of gain and no noise to speak of.

Rather encouraged by how easily it had worked out, he returned the amplifier next morning, promising to return at the first opportunity with an "official" replacement transistor. In the meantime . . . "The one I put in will see you through. . ." (Here the client is supposed to express grateful thanks).

What I've recounted to this point I pieced together from a conversation when my friend rang me one evening in anything but a happy frame of mind. His next job had turned out to be much more sticky and this was the real reason for his pessimistic note — and his call!

It involved an electronic organ which

exhibited a very strange fault. It would be behaving quite normally when, for no apparent reason, every B-flat note on the manual would sound an octave above normal.

And here's where my friend's musical background did, in fact, help. He could play the organ, he did verify that every B-flat was affected and he confirmed that the notes were perfectly on pitch, though an octave high. Since it had (mercifully) been late in the day, he explained to the client that he would prefer not to get too deeply involved just then. Having heard the trouble for himself he would see if he could rectify it. . . "probably tomorrow."

What he did, in fact, was to go home and ring yours truly, having recalled that I had exhibited some interest in electronic organs through the years. I might even be able to suggest where to begin looking for such a crazy fault!

I probably didn't sound too helpful at first. I knew nothing at all about the particular brand of organ — a Japanese make — and while the one book I had contained a few details of American designs, it had been written long before the Japanese entered the field on the present scale.

However, I was able to explain to him that most electronic organs had a set of twelve master oscillators providing signals for the topmost octave on the keyboards, or even an octave above that again. The frequencies provided by these master oscillators were passed through a series of 2:1 dividers, so that each oscillator, with its train of dividers, would provide signals for all notes of a particular name.

Since the trouble had to do with the B-flats in the organ, it would obviously be in the oscillator-divider chain providing these notes.

And, since the pitch of the notes remained true, I didn't think that the oscillator would be at fault. But, since all the notes jumped an octave, I felt that the trouble would be in the first

divider. For some reason or other it was apparently intermittent; sometimes it did the right thing and divided the oscillator frequency by two at other times it was apparently passing on the same number of pulses that the oscillator was feeding to it. This caused it to produce twice its normal output frequency, the other dividers fed from it doing likewise.

"Why would it do this?" my friend asked. Not being an expert in transistor dividers, I could only hazard a guess that one of the components in the stage was intermittent or, perhaps, the transistor itself. It would be up to my friend to find which; but first he had to locate the suspect stage in a completely unfamiliar and apparently rather complex instrument.

As it turned out, knowing what to look for, he located the twelve master oscillators readily enough, and the sets of frequency dividers (or flip-flops)

associated with each. Then, with the organ switched on but not being played, he went over the twelve first dividers taking comparative voltage readings at corresponding points in the circuit assembly.

In his own words: "I checked them several ways and each time it was that B-flat divider that turned out to be the odd one out." This much established he switched off and tested the components as best he could, without finding anything amiss.

Could it be the transistor?

Once again, the screw-top jar yielded a transistor which seemed like a reasonable substitute for the original one and this was duly installed "pro tem" — which is a flash way of saying "until he could get the right one."

In fact, the substitute transistor worked perfectly and the organ showed no further inclination to switch octaves — which is always an advantage!

As they used to say when I was a boy: Another redskin had "bit the dust!"

The next story comes almost as a postscript and, in fact, was related to me by the same budding organ serviceman, just after I had finished writing up the other two. It concerned a fault in a single manual Japanese organ, which had the nasty habit of dropping completely the top six notes—C to F inclusive—when using the "Flute" voice.

Emboldened—and enlightened — by his previous experience, my friend worked out that, since the Flute voice only was affected, the trouble would not be in the oscillator or divider systems. It would almost certainly be in the signal distribution system — the control tabs, key contacts or the associated wiring.

Aided, on this occasion, by a circuit in the owner's manual, he found that the five suspect notes were passed as a group through a simple filter system, the Flute filter being two 10K resistors in series with the junction bypassed to chassis through a .01uF capacitor, as shown in the accompanying circuit. Since the String, Organ and Reed voices were not subject to the fault, the trouble more or less had to be in this Flute network.

A little manipulation with pointed pliers quickly revealed that the circuit through the first 10K resistor was intermittent, although the exact reason was not clear. However, once the resistor had been removed from the assembly board, it was apparent that the lead wire was floating loose in the resistor body. Whoever had bent the leads for insertion into the board had been more willing than wise!

It was only a few minutes' work to locate and instal another 10K resistor and to assure the owner that the trouble had been positively located and positively fixed.

If there is a moral to these stories it surely must be that, whether in radio or TV sets, guitar amplifiers, organs or other items of electronic equipment, the failure pattern of components is a fairly routine one. Servicemen proficient with one class of equipment should not find it too difficult to adapt to another—given some re-training and the willingness to burn a little midnight oil!

Having had so much to say about solid-state devices, it may be appropriate to squeeze in a couple of items which involved me personally.

The first one had to do with a transistor receiver which was being used by a patient in a hospital. His wife rang to say that he had accidentally knocked the set off his locker and that it didn't seem to go very well any more. She explained:

"It only gets the stations weakly, and they sound harsh. And there's a knob thing that doesn't seem to work."

Could she drop it in next day for me to have a look at?

I'm afraid I had a mental picture of some of the wrecked receivers I have seen in the past—receivers that have literally had to be brought in in a plastic bag; bits of moulded case, bits of dial, batteries and other gadgetry hanging at the end of wires and so on. I pointed out to the lady involved that I might have to send the receiver back to the distributor, if sections of it were broken for which only the distributor would have replacements.

What could be worse, if parts were not available, it might not be practical to repair it economically.

When the set was finally put on my counter, I was rather surprised to find that it was of local manufacture, secure in a protective leather case and free from any visible signs of damage. The sound from it was weak and distorted, to be sure, but I recognised immediately that the "knob thing that doesn't seem to work" was a fine tune roller intended to operate on the short-wave band only.

At the first opportunity I checked the batteries and found them to be about as flat as any I've ever taken from a "still working" set. New batteries restored it to normal operation on broadcast and short-wave bands alike. In fact, there was just nothing wrong with the set.

Fairly obviously, the owner had been using it for long periods in the hospital but at very low volume, to avoid annoying other patients. This being so, he was quite unaware that the batteries had run right down to the point where they would have been quite unable to run the set at normal volume.

When he dropped the set, the owner naturally feared the worst and when, by way of test, he tried vainly to play all the stations at normal volume, his fears seemed to be well founded. Hence the report that the set was quite okay until it was dropped.

As for the fine-tune knob, my tip is that the owner either never knew or had forgotten what it was for and, when it didn't have any effect on the broadcast stations, he assumed that it, too, was broken.

Naturally, it was a very relieved wife who learned next day that the set was back to its old self, for little more than the cost of new batteries.

Another "I dropped it" tale which followed hard on the heels of this one concerned an imported battery-operated cassette type tape recorder. After being dropped, it still seemed to replay normally but would not record.

Again, I had to explain to the owner about special components that might have been damaged in the fall—internal projections from the case, printed wiring boards, integral switching levers and so on. However, I promised to have a look at it, in case it turned

## up to ten times longer life



MAXELL Alkaline Dry Cell — this unique new design concept features high capacity and durability that surpasses the performance of the world's top dry cell batteries. The construction of the Maxell Alkaline Dry Cell differs greatly from conventional types of carbon ZINC cells. However, the Maxell Alkaline cells can be used where you normally use a carbon ZINC cell. MAXELL ALKALINE CELLS are especially suitable where there is a demand for increased current, combined with durability and little voltage drop. Even near the end of the cell life the discharge capacity is large and stabilized.

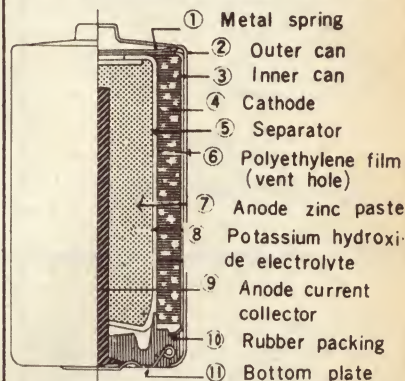

Exclusive new construction minimises leakage. Double cans are used and rubber sealing with the unique spring safety device. (see diagram)

Interior drying is prevented by hermetic sealing, therefore long storage periods are possible (over two years). Even then Maxell Alkaline cells are in the same condition as when they left the production line. These cells will withstand severe temperature changes. Rigid tests have shown extremely stabilized capacities from the low temperature of -4F to the high temperature of 150F at which temperatures dry cells would fail to operate satisfactorily.

### Prices:

AM1 ..... 75c  
AM2 ..... 50c  
AM3 ..... 40c

Trade enquiries to  
TASMANEX PTY. LTD.  
17 Parker Street SYDNEY 2000

# Now low cost, power rectification to 25 amps!\*

with "Miniwatt" BYX21L

Series Silicon Power Diodes made in Australia

BYX21L/200  
BYX21L/200R † 100 Piv

BYX21L/400  
BYX21L/400R † 200 Piv

25 AMP

(† Reverse Polarity Version)

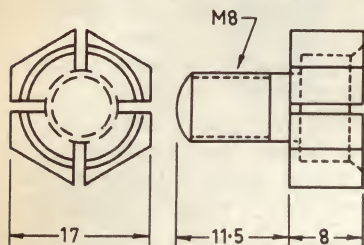
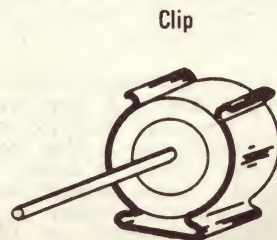
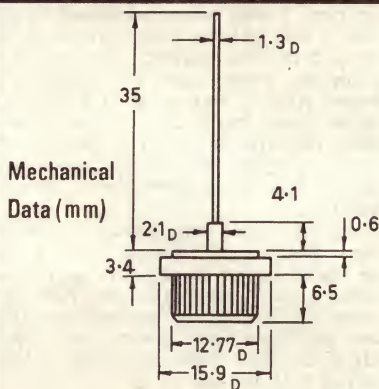

MTG Adaptor



Press

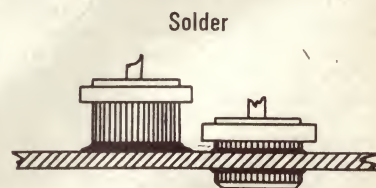

\* WITH SUITABLE HEATSINK

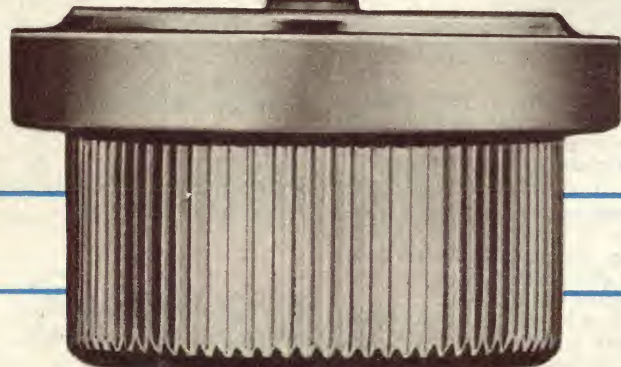

*"Miniwatt"*



ELECTRONICS DIVISION OF  
PHILIPS ELECTRICAL PTY. LIMITED.

Sydney, Melbourne, Brisbane, Adelaide,  
Perth, Hobart, Newcastle, Canberra.

38.2448

out to be something that could be fixed simply.

Later, on gaining access to the "works," it was immediately apparent that the printed wiring board, on which most of the circuitry was mounted, was quite loose. It certainly did look as though it had been torn adrift from its mountings by the fall.

As a next step, I manipulated the switches on the front panel while peering under the board to see what they did—or were supposed to do. A couple of minutes of peering and pushing were sufficient to establish that the "Record" switch did not work because a small nylon collet was out of position. Once having spotted the trouble, it was only a matter of seconds to re-engage it.

It further became apparent that the collet had disengaged when the board jumped out of position — apparently when the recorder hit the floor. But how was I going to hold the board firmly to its mounting again?

Very simply — by tightening the mounting screws!

Nothing was broken; none of them was stripped.

In fact, the board had apparently been loose on its mountings for a long time; it may never have been tightened before it left the factory!

As long as the recorder was treated with the care that a proud owner lavishes on something new, all was well. But a drop to the floor was a different matter.

If the screws had been tight, the drop would almost certainly not have affected the recorder and the owner would have had not more than a few moments of dismay. As it was, he had to wait till he phoned me next day to learn that everything was "jake"—again at the cost of a modest service fee.

And now some comments regarding a couple of points raised in the January and March articles. First, the matter of incorrect polarity markings on batteries. One reader writes:

Dear Sir,

In response to your request for experience concerning incorrectly marked batteries, I would like to record a recent case. It was a (brand) type (number) cell, with the label upside down.

A simple, and what should be a very obvious fault like this can cause a surprising amount of trouble. In this case, the cell was purchased along with three others by a young lady who was quite inexperienced in electrical matters. She fitted the cells to her Japanese portable radio herself.

When the set (almost new) performed poorly, she took it to a serviceman, who reported there was nothing wrong with it, and who returned it, no charge.

I saw the set a week or two later and confirmed that its performance was down. I had the poor volume and high distortion characteristic of low batteries. I did what the serviceman had probably done—checked each cell for voltage, and then checked them under load. They were all O.K., so I turned to the set itself. It operated perfectly from a power supply, so, puzzled, I replaced the batteries. They were replaced according to the shape of the cells rather than according to label. It was then obvious that one cell was "upside down," and a second look showed that the label on the cell was indeed reversed.

I thought at the time that such a fault must be very rare, mentally kicked myself for not noticing it immediately, and promptly forgot about it.

If your reader from Orange has had two examples, it is possible that it is not so uncommon. I expect there have been quite a few who, like me, have had the experience, and let it go at that. I would be very interested to see the response to your request for similar experiences. Yours faithfully,

K. E. H. (Cremorne, N.S.W.).

The interesting point about this letter, I feel, is not so much that it reports another battery wrongly marked, but rather that it describes, as an actual happening, the kind of inconvenience which this kind of thing can cause. On the other hand, with typical production running into millions of cells per year, the number of cases reported so far can only be regarded as a negligible percentage.

The second comment concerns the story in the January issue about the premature demise of a couple of portable radios while in the vicinity of an amateur transmitter. Our correspondent is a radio operator who gives his address as one of the coastal vessels operating off Western Australia. He writes:

Dear Sir,

Reference your correspondent's story about mobile transmissions doing in the front end of transistorised noise producers. This tallies with what I used to think what would happen, but experience has shown otherwise, in my case anyway.

I am a marine radio op., and since transistor radios became common

nearly every crew member has his own in his cabin and, in non-Pantenna equipped ships, every one has his own aerial. (Observe the display of wire on most Australian ships.)

On this vessel there are six crew aeriels on the bridge alone, each about 40ft vertical length, approx, parallel to my main aerial and emergency aerial down leads, within 10-15ft of them. My Transmissions range from 410KHz to 22MHz on spot frequencies at approx 300 watts up the spout.

I used to warn people not to put aeriels anywhere near my gear (to keep them clear of DF loops, and to protect the front end of their radios). However experience has shown them it doesn't matter, as far as damage to their noise boxes goes, and so every ship is cluttered up with bits and lengths of wire close to transmitting gear. I think the only way to permanently mute these sets is to hook the main transmitter on to their aeriels.

In fact, I have usually one or two of these boxes in the radio shack for repair, etc, and they are usually within 10 feet of my transmitter aerial leads (copper tubing on stand-off insulators). I use the transmitter as required, and the only effect, I can detect, is to mute them, or splatter their output, or produce Morse only interference, depending on mode (CW, MCW or R-T) and frequency in use. They recover almost immediately on transmission ceasing. I had put it down to AVC-AGC action, on overload,

This should start some argument.

Best regards, W.B.

Well, so much for that reader's observation. Any comments? □

**FOR WAYS OUT SOUND**

FOR WAYS OUT SOUND

Controlled **BOOSTING** of Treble and Volume

**FOR PRESTIGE SOUND SEE CLAYBRIDGE SOUND**

Secure your **FREE COLOURED CATALOGUE** of our products & services.

**Claybridge SOUND** 163 CLAYTON RD. CLAYTON VIC. 3168 OR RING 544 6171 (CNR. DANDENONG RD.) (ALL HOURS)

# LEARNING MORSE IS NOT SO DIFFICULT

This article, written from the viewpoint of practical experience, will help you master the Morse Code, and open up a new language for you. You must pass a test in Morse when you sit the P.M.G.'s examination for your Amateur Operator's Certificate of Proficiency.

The Morse code is essentially a sound language, therefore the only way to learn it is by sound. It follows, therefore, that the "opposites" method and others of a similar type are not the best. By their use, the student learns to "see" Morse symbols as they are heard, and pictures so many dots and dashes on paper, instead of relying on the rhythmical sound of each symbol. He is then faced with the necessity of converting his visual picture into a sound picture before he can achieve any real speed. The logical thing, therefore, is to concentrate on sound right from the start.

Before attempting to "take" Morse or send it, the student must first memorise the code. Printed herewith is a copy of the Morse code. It will be observed that the letter itself is written after the actual sound. The student should learn that "d' dah" means "a" and not that "a" is "d' dah."

The first step is to memorise the code by singing each letter—then say the letter, e.g.:

"d' dah (pause) a"  
"dah d' d' dit (pause) b"  
"dah d' dah dit (pause) c"

Dashes are called "dah," and dots are called either "d" or "dit," depending on their relative position in the symbol, e.g., if a symbol ends in a dot, the dot is called "dit." If the dot precedes a dah or another dot, it is called "d."

Generally speaking, the rules for spacing are as follows:

The "dit" is the unit upon which the spacing is made.

1. Dah=3 dits.
2. Space between any two elements of a letter=1 dit.
3. Space between any two letters or figures forming one group=3 dits.
4. Space between groups or words = 5 dits.

The whole code should be sung through, slowly at first, and, then, as each symbol "sticks" in the memory, speed will automatically increase. By this method, it is possible to learn how each symbol would sound on a buzzer or oscillator, even though the student has never heard one.

When the student has memorised the code, even at a slow speed, he will have passed the most difficult stage. It does not require much work. A quarter of an hour each day will embed it in the memory, but the person who really wants to learn the code as quickly as possible would put more time into it—and learn much faster.

The ideal method of carrying on from here is to get some operator to send to you at a rate equivalent to 20 words a minute, but with a long break between each letter. By taking this

type of Morse, even though some of it will be missed, the beginner will hear each symbol at its correct speed, and in its correct rhythm.

The Wireless Institute of Australia currently provides code practice for beginners in two ways; code practice sessions over the air, and a library of pre-recorded tapes available for a nominal charge.

The code practice sessions are broadcast seven nights a week on two frequencies, 3550KHz and 144.5MHz. The transmissions emanate from various sites, normally the home station of the volunteer operator chosen for the particular night. Most of these are located within a 50-mile radius of Sydney. The 3550KHz session runs from 7.30 p.m. to 8 p.m. and the 144.5MHz session from 8 p.m. to 8.30 p.m. The call sign is VK2BWI.

The code practice tapes are available to all prospective amateurs, whether members of the W.I.A. or not. There is a charge of 30c to cover outwards postage, etc., while the student is required to pay the return postage. The loan period allowed is one month. Tapes are graded according to the speed which the user has reached, and when asking for tapes, the sending speed required should be indicated.

Inquiries regarding tapes should be addressed to:

Mr E. Hodgkins (VK2EH),  
Mangrove Road,  
Narara,  
N.S.W. 2251.

In the early stages of training the

student should try as far as possible to receive code groups in preference to plain language. The reason for this procedure is that with reception of plain language the beginner involuntarily starts to "journalise" and the system is defeated.

To illustrate the point: If the sentence, "He went away," is being sent, he would receive, "He went aw . . ." and before the "ay" was sent the student would have written it down.

Other traps for the beginner are such words as "formed-forming" and "stayed-staying," where "ed" has been written down before the final part of the word is sent, and often the wrong suffix is added.

Code groups are groups of five letters with five dots' space between them. By using these for practice, the student does not know which letter is coming next. Later on, these groups may also contain figures, but it is advisable for the student to master the letter groups first.

At the bottom of the alphabet are shown the 10 primary figures used in Morse. These are not as hard to master as at first may appear. To begin with, the 26 letters of the alphabet are made up of from one to four units. The figures all have five units and to determine from figure 1 to figure 5 merely count the dits. That will be the number. The balance of the five units is made up of "dahs," so that the figure 2 has 2 "dits," followed by the three "dahs" necessary to make the units up to five.

From 6 to 0 is exactly the opposite. By counting the number of "dahs" appearing, we have either 6, 7, 8, 9, or 0. The balance here is made up of dits.

For example, if "dah dah d' d' dit" was sent, merely say: "Six, seven d' d' dit" (to yourself), and write down 7.

After mastering the alphabet and the figures, the student may now

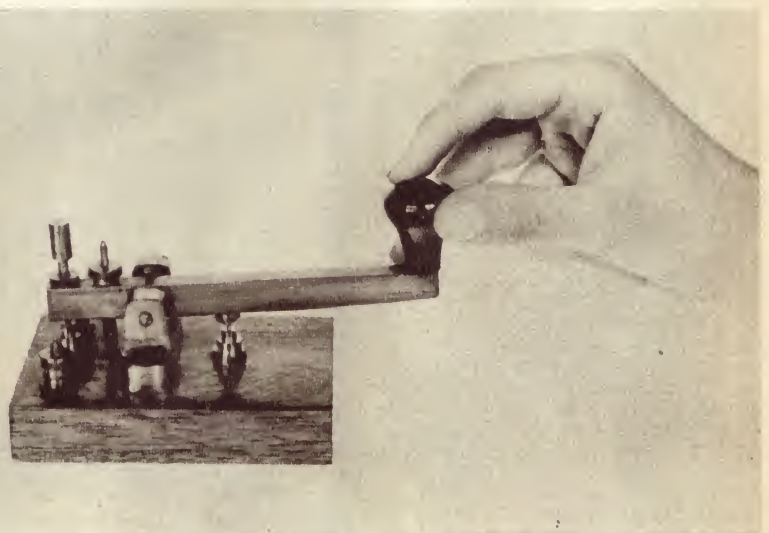

Good keying habits should be established from the start. Shown above is the correct way to hold the key for the method recommended in this article.

spend some time on plain language. This is done in ordinary handwriting, but care must be taken to ensure clear, legible characters in the early stages, so that when speed does come the student will not tend to scrawl.

After some practice it will be possible to keep one letter behind the sender, so that if the word "coming" is being sent the student will be writing "c" as the "o" is being sent and at the end of the word, while the operator is pausing before the next word, the student will be writing the "g."

Experienced operators are able to write several letters behind the transmitting operator and even work three or more words behind without being troubled.

Once the student has mastered the rhythm of Morse signals by receiving practice, he may take the key. But it is useless for him to try and send unless he knows how each symbol should sound.

The good Morse operator sits upright in his chair, with both feet flat on the floor. The left hand is placed comfortably on the table in readiness for turning a page.

There are many different methods of keying, but one of the most successful is that which was adopted by the RAAF. The method was to hold the key between the ball of the thumb and the forefinger. The second finger was placed on the right of the key towards the bottom.

Then, instead of pressing down with either the fingers or the whole arm, the wrist was held horizontal and dropped whenever a symbol was made. The upward and downward movement of the wrist was the method of keying.

This method is recommended because it reduces "arm fatigue" over long periods of operating.

The tendency is, however, to stray from this method and attempt to "nerve send." The student is advised to pay particular attention that this does not happen and that slovenly habits do not creep on him and ruin his operating.

Many people will argue that the "wrist-movement" method is cumbersome and that it is impossible to reach any high speeds. Countless operators have disproved this theory by passing the 30-wpm rate by "wrist" action alone.

Of course, as speed increases, the wrist action becomes less noticeable, but the beginner should allow his wrist to drop the full distance while sending at low speeds. By "following through," even though contact is made by the first movement of the wrist, greater key control is obtained.

The key chosen for practice should be a good quality one, particularly if it is likely to become a standard item in the ham shack after a licence is granted. Keys do not appear to be in very good supply at the moment, although some dealers have indicated that some good quality imported types may be available later. In the meantime, the disposals sources may have a few to offer.

Electrical contact is made by the front stop of the key and its anvil. The distance between these two points is called the "GAP," and should be equal to the thickness of a sheet of notepaper folded once. The spring tension is supplied by the spring at the back of the key, and should be just tight

## THE MORSE ALPHABET

SOUND	MEANING	SOUND	MEANING
d' dah . . . . .	A	dah dit . . . . .	N
dah d' d' dit . . . . .	B	dah dah dah . . . . .	O
dah d' dah dit . . . . .	C	d' dah dah dit . . . . .	P
dah d' dit . . . . .	D	dah dah d' dah . . . . .	Q
dit . . . . .	E	d' dah dit . . . . .	R
d' d' dah dit . . . . .	F	d' d' dit . . . . .	S
dah dah dit . . . . .	G	dah . . . . .	T
d' d' d' dit . . . . .	H	d' d' dah . . . . .	U
d' dit . . . . .	I	d' d' d' dah . . . . .	V
d' dah dah dah . . . . .	J	d' dah dah . . . . .	W
dah d' dah . . . . .	K	dah d' d' dah . . . . .	X
d' dah d' dah . . . . .	L	dah d' dah dah . . . . .	Y
dah dah . . . . .	M	dah dah d' dit . . . . .	Z

## MORSE FIGURES

SOUND	MEANING	SOUND	MEANING
d' dah dah dah dah . . . . .	1	dah dah d' d' dit . . . . .	7
d' d' dah dah dah . . . . .	2	dah dah dah d' dit . . . . .	8
d' d' d' dah dah . . . . .	3	dah dah dah dah dit . . . . .	9
d' d' d' d' dah . . . . .	4	dah dah dah dah dah . . . . .	0
d' d' d' d' dit . . . . .	5	d' dah d' dah d' dah . . . . .	dot
dah d' d' d' dit . . . . .	6	dah dah d' d' dah dah . . . . .	comma
		d' dah d' dah dit . . . . .	end

## PRACTICE GROUPS

APR6Y	R5KYQ	N3UGL	4BGUZ	LMO9Y
LYQG7	F6CQS	AXN3O	B9HMY	PUXX8
DX2VO	P8UA4	SOF4U	9COGF	HNU3Z
OPLMI	MY6QS	TOQMO	PKU7N	BRG6L
QP3BY	CD5HM	R4BWD	IN8FS	YE2GJ
IUOTZ	V9LP4	XF7UB	Z5GTO	TUDIZ
IY7JP	LIRPV	LP2LD	6LUPY	AC8FB
K4KVB	NU3RX	A8FYK	PDQRV	DOYBG
UF9LQ	P8GYD	GU3FB	2LUXN	G4QFS
Y6YUT	SK3RM	SRIOK	P8BRG	Z7GUT

Here are some difficult groups. Correct spacing is essential otherwise the result of your sending will be meaningless.

686BD	SHIEH	TOMMO	GOOGD	B6LAI
FINDT	LREB6	5HH54	JAMIE	TUTU
JYQYQ	LPPFQ	6B5HL	FLYPQ	XPANY
ZMIZG	YKTNM	WATEM	JWTAM	GTNME

enough to cause the key to return to the open position after the key is pressed, but not too tight to cause actual operating fatigue.

When operating, keep the fingers arched and the muscles loose.

The beginner should sing through the alphabet and lower his wrist to keep in time with the units.

Some common faults with beginners are:

1. Slurred characters.
2. Clipped dashes.
3. Bad spacing.
4. Running words together.
5. Sending too fast.

From this stage on, all that is needed is practice and more practice. A little each day is worth more than a lot once a week. Handbooks on Morse will carry the student further on in the subject but, if he is prepared to work, the data given in this article will put him in the speed category in the matter of a few weeks.

Taken on an average, the hardest letters for the beginner to memorize are:

DBFGWLQYKRPIX.

The practice chart shown here has been compiled to place emphasis on these letters. Send the groups from left to right, and then, for variation, read downwards in columns.

Remember that practice makes perfect. Make up your own chart, stressing the letters that YOU find most difficult. Keep at it until you have mastered them.

We would stress again the importance of listening to the code at every opportunity. Get yourself a short wave receiver, and look round the short waves for commercial stations sending at a reasonable speed. You can often strike such stations sending code groups at often less than 20 words per minute, frequently repeating each group after it has been sent. This is good practice, because you have an opportunity to check on your first attempt.

As you progress, you can pick out a station sending at a higher speed. Do not develop the complex of despair if you find yourself receiving only portion of what you hear. Take this philosophically, trying to develop an attitude of mind which refuses to be "rattled."

# Sinclair products for the electronic constructor—

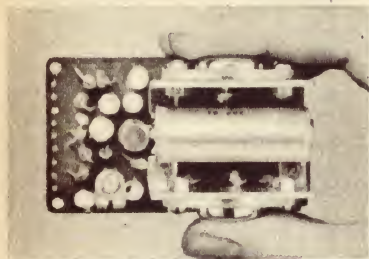

## Z.12 INTEGRATED 12-WATT HIGH FIDELITY AMPLIFIER

### Technical specification

Output: Class B, ultra-linear, with generous negative feedback.

Output Power: 12 watts R.M.S. continuous sine wave (24 watts peak); 15 watts R.M.S. music power (30 watts peak).

Frequency Response: 15 to 50,000 c/s,  $\pm 1$ dB.

Input Sensitivity: 2 mV K $\Omega$ .

Signal to Noise Ratio: Better than 60dB.

Output Impedance: Suitable for 3, 7.5 and 15 ohm loudspeakers. Two 3 ohm speakers may be used in parallel.

Power Requirements: 6 to 20 volts D.C. or Sinclair PZ.4 Mains Power Supply Unit.

Quiescent Current Consumption: 15mA. Size: 3in x 1 $\frac{1}{2}$ in x 1 $\frac{1}{2}$ in (7.6 x 4.45 x 3.2cm).

Weight: 3oz (85gm.).

Ready Built and Tested with Manual, \$13.60, plus sales tax.

Z12 Power Supply, Ready Built, \$13.60, plus sales tax.



## IC.10 INTEGRATED CIRCUIT 10-WATT AMPLIFIER

### Specifications

Output: Class AB. 10 watts peak, 5 watts RMS.

Frequency response: 5Hz to 100kHz  $\pm 1$ dB. Total harmonic distortion less than 1% at full output.

Power gain: 110dB (100,000,000,000 times) total.

Supply voltage: 8-18 volts.

Sensitivity: 5mV. Input impedance adjustable externally up to 2.5m $\Omega$  for above sensitivity. Size: 1in x 0.4in x 0.2in.

Circuitry: 3 transistors in pre-amp; 10 (including two power output) in power amplifier. Both sections are d.c. coupled, and a high level of negative feedback is applied over all. With a transistor cut-off greater than 500MHz, the pre-amp can be used as an RF or IF transformer and the whole IC.10 used as a radio receiver without the need to add further transistors.

Price, including application manual, \$9, plus sales tax.



## MICROMATIC WORLD'S SMALLEST RADIO

### Technical specification

Size: 1 13-16in x 1 7-16in x  $\frac{1}{2}$ in (46 x 33 x 13mm).

Weight including batteries: 1oz (28.35 gms) approx.

Transistors: High gain silicon types.

Circuit: Five stage reflex.

Aerial: Self-contained ferrite rod.

Earpiece: High-fidelity magnetic type for best possible quality.

Battery requirements: Two Mallory Mercury Cells, type RM 675, giving extra long working life.

Complete Kit with Instructions.

\$7 plus sales tax.



## STEREO 25 PRE-AMPLIFIER

### Technical specification

Performance figures obtained from using the Sinclair Stereo 25, two Z.12's and a Z12 Power Supply Unit. Sensitivity for 10 watts into 1.5 ohms load per channel. Mic.: 2mV into 50 K ohms. Pick up: 3 mV into 50 K ohms. Radio: 20 mV into 10 K ohms. Frequency Response (Mic. and Radio): 25 c/s to 30 kc/s  $\pm 1$ dB extending to 100 kc/s  $\pm 3$ dB.

Equalisation for P.U.: Correct to within  $\pm 1$ dB on RIAA curve from 50 c/s to 20 kc/s.

Tone Controls: Treble + 12dB to -10dB at 10 kc/s. Bass +15dB to -12dB at 100 c/s.

Size: 6 $\frac{1}{2}$ in x 2 $\frac{1}{2}$ in x 2 $\frac{1}{2}$ in (14.5 x 6.3 x 6.3cm) overall, plus knobs.

Finish: Front panel in brushed and polished solid aluminium with solid aluminium knobs. Black figuring on front panel.

Ready Built and Tested with Manual, \$29.80, plus sales tax.



## Q.14 HIGH FIDELITY LOUDSPEAKER

### New Design Principles New Materials

Construction: The seamless sound, or pressure chamber and mounting baffle are of special high-density ultra-low resonance materials made possible by modern bonding and processing techniques to ensure freedom from spurious coloration.

Loading: The Sinclair Q.14 has in input impedance of 8 ohms and will comfortably accept loading in excess of 14 watts, far greater than that required for average listening requirements.

Frequency response: As the independently made test curve shows, remarkably smooth response is maintained between 60 and 15,000 Hz.

Driver unit: This is a specially designed unit having exceptionally high compliance due to the method of cone suspension employed. It has a massive ceramic magnet of 11,000 gauss and aluminium speech coil, with the cone treated to ensure a brilliant transient response.

Contoured pressure chamber: The shape of the sealed chamber has been determined mathematically to ensure forward sounding presence and freedom from directional effect. Connections at rear are marked for correct phasing.

Size and styling: The Sinclair Q.14 measures 9 $\frac{1}{2}$ in square on its front face by 4 $\frac{1}{2}$ in deep from front to back. A separate base for free standing position is provided as well as a template for wall or flush mounting. A neat solid aluminium bar inset is used to embellish the front.

Price \$29.80, plus sales tax.

### R.T.C. Recording Tapes

High quality British product. Send for price list. All reel sizes available. In single, long, double and triple play.

### OTHER SINCLAIR PRODUCTS

X20 P.W.M. 20 watt amplifier and pre-amp Built and Tested, \$20.00, plus sales tax.

X20 Power Supply, \$12.60, plus sales tax.

Sole Australian Agents:

# CENTRAL IMPORTS PTY. LTD.

196 ADELAIDE TERRACE, PERTH, W.A.  
Manufacturer and distributor

PHONE 23-5103  
Enquiries welcomed





# A READER BUILT IT!

Circuits and devices which we have not actually tested in our laboratory but published for the general interest of beginners and experimenters.

## Low-voltage solid-state regulated power supply

The design for a simple low-voltage regulated power supply has been submitted by Mr J. Goding, 15 Yarrabee Court, Mount Waverly, Vic. 3149.

In the amateur journals and in electronic textbooks, there are many circuits for transistor-regulated power supplies. Most of these, however, are unsuitable for the delivery of output voltages below about six volts. Those circuits capable of giving low output voltages are almost always rather complex—often requiring a separate negative supply—or do not give very good regulation.

While there is nothing original in the circuit presented, it employs a couple of ideas that may not be widely

sented to the series regulating transistors Q2 and Q3—in a Darlington configuration—in such a way that the “error” is corrected.

In conventional supplies, NPN transistors are often used throughout with the zener voltage less than the output voltage. Since zener diodes are not very satisfactory below about 6V (they are also hard to get), another approach is needed. In order to use a 6V zener diode, a PNP transistor is used for Q1 and NPN transistors for Q2 and Q3. The collector of Q1 is at about

plied with its operating voltage from a regulated source.

Another unusual idea incorporated into the supply is the use of a field effect transistor Q4 in series with the zener diode. Q4 acts as a “constant-current diode” and supplies a constant current of about 5mA to the zener diode regardless of supply voltage variations. Since the zener voltage of a particular diode depends primarily on the current through it, the zener voltage is held more constant than is usually possible with a resistive feed from an unregulated source.

Because of production spreads in the 2N4360 FET, it may be necessary to alter the source resistor somewhat in order to set the current through the zener diode at about 5mA. The current

This low-voltage supply uses both NPN and PNP transistors to allow the use of a 6V zener diode for the reference voltage.

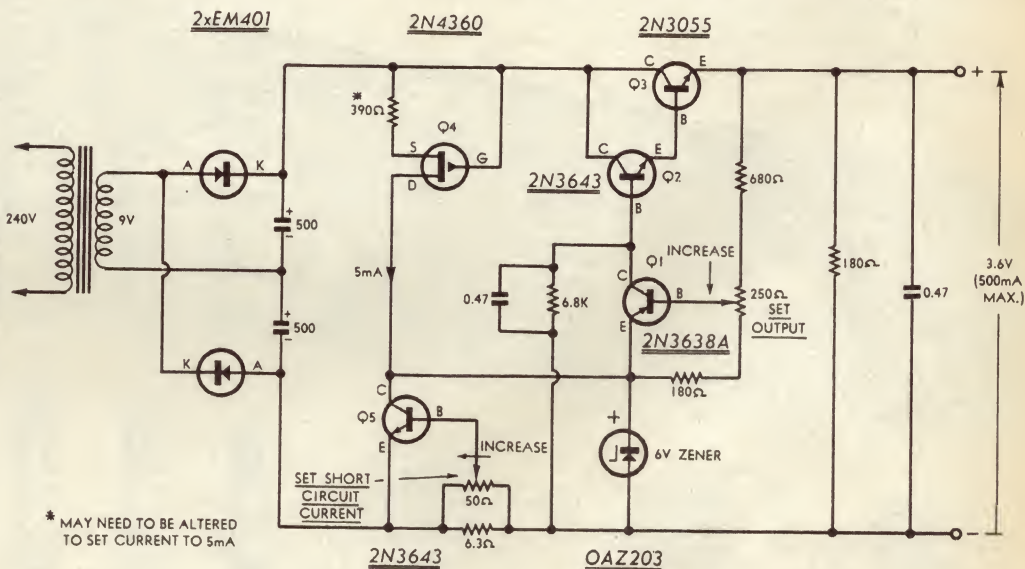

\* MAY NEED TO BE ALTERED TO SET CURRENT TO 5mA

known. The circuit is simple, uses readily available parts, and is capable of quite good performance. The output voltage drops less than 30mV for a full 500mA load. Hum and noise are well below 20mV. The supply is protected against overload or accidental short circuit of the output. The output voltage may be varied between about 2 and 4 volts, making the supply very suitable for Fairchild microcircuits which require  $3.6V \pm 10\text{pc}$ .

As in all regulated supplies, the output voltage is sampled, and compared with a reference voltage (the voltage of the 6V zener diode.) Any difference, or “error,” between the two is amplified by transistor Q1 and pre-

3.8V and its emitter at 6V. Hence the collector is 2.2V negative with respect to its emitter. The base of Q1 is set at about 0.6V negative with respect to the emitter. Thus Q1 amplifies in a perfectly normal way.

The base current for Q2 is derived from the collector of Q1. With no load on the output of the supply, the entire collector current of Q1 passes through the 6.8K resistor. As current is drawn from the supply, more collector current passes into the base of Q2—this is in addition to the constant current through the 6.8K resistor. This system is capable of good regulation because the comparator amplifier Q1 is sup-

WE SPECIALISE IN TAPE RECORDERS EXPERT REPAIRS

To all brands by German technicians in modern equipped workshop.

Contact

REKLA

KLAPP ELECTRONICS PTY. LTD.,  
224 CHAPEL STREET, PRAHRAN, VICTORIA.  
TELEPHONE: 51-4653.

# KENWOOD's TK-20U Priceless Precision At Reasonable Cost

You can't afford not having the TK-20U (A\$219) solid state stereo receiver. Powered by silicon transistors, it's in the same class as the more expensive models. A highlight is its 30 watts of total music power, F.E.T. (Field Effect Transistor), 3 gang tuning condenser, 5 IF stages with a top-tone bass and clean treble sound. For more power, KENWOOD has other amplifiers.

## ▼ TK-20U

- \* F.E.T. (Field Effect Transistor) 3 Gang Tuning Condenser frontend for superior sensitivity, image rejection and cross modulation ratio.
- \* 5 IF stages with 3 limiters and wideband ratio detector have been incorporated to provide 40 dB alternate channel selectivity and freedom from noise and interference.
- \* 4-position program source selector permits AM, FM AUTO, PHONO and AUX.
- \* USABLE SENSITIVITY: FM: 2.5 microvolts (IHF Standard), AM: 10 microvolts (IHF Standard)
- \* TOTAL MUSIC POWER: 32 watts (IHF Standard at 4 ohms), 30 watts (IHF Standard at 8 ohms)
- \* FREQUENCY RESPONSE: 25Hz-40,000Hz
- \* DIMENSIONS: 14 1/8" (W), 4 3/4" (H), 11 1/4" (D)

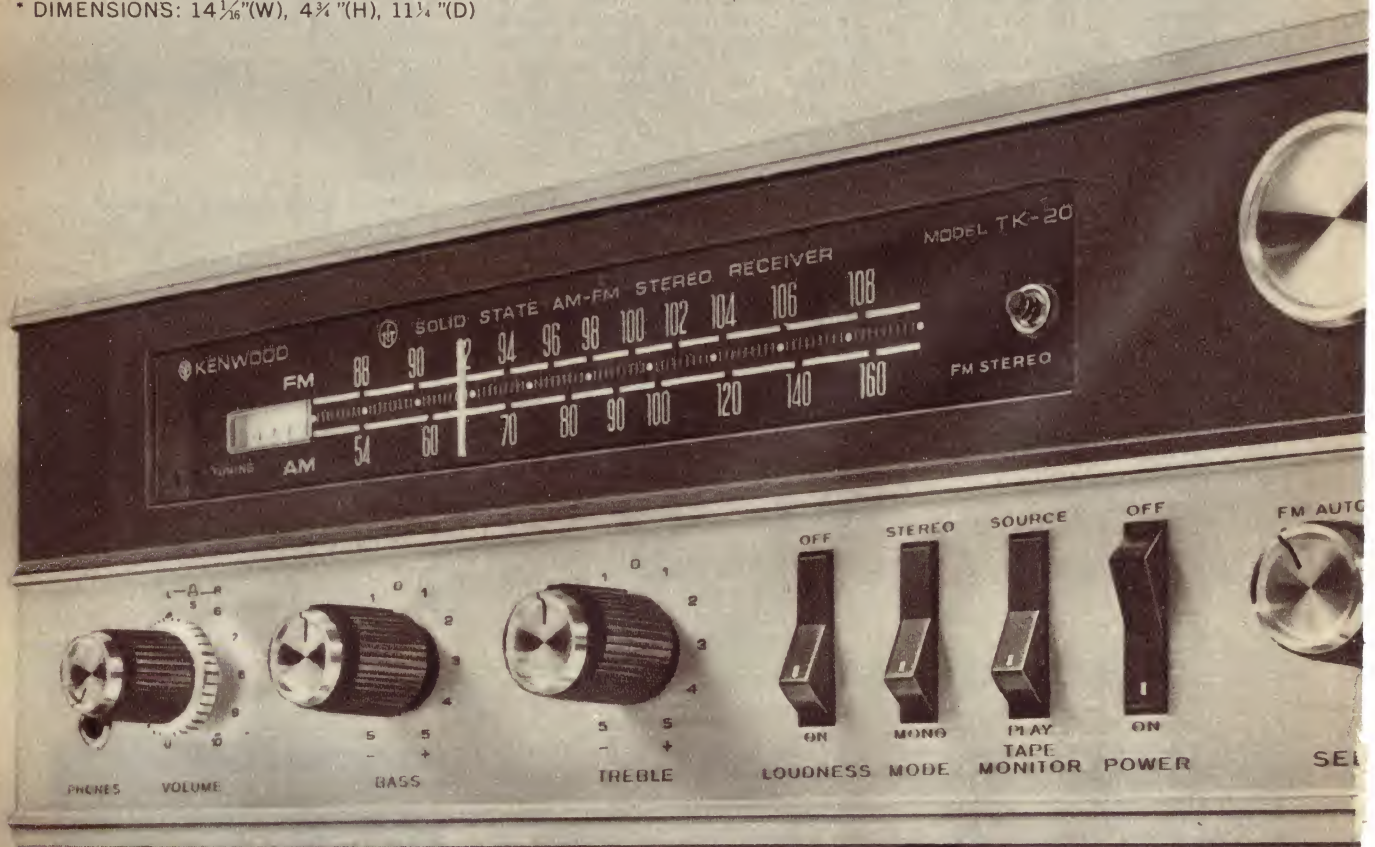

**30 WATT FET SOLID STATE AM/FM STEREO RECEIVER TK-20U**

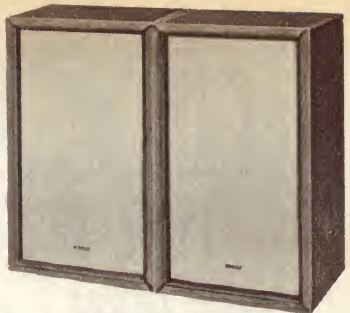

**BOOKSHELF TYPE 4-WAY  
5 SPEAKER SYSTEM KL-60**

- Mounted speakers: 12-inch, free-edge woofer × 1 (Bass)
- 6½ inch cone squawker × 1 (lower midrange)
- 4 inch cone squawker × 1 (higher midrange)
- Horn-type tweeter × 2 (Trebble)
- Dimensions: 15" (W), 25½" (H), 11⅝" (D)



**40 WATT  
SOLID STATE STEREO  
AMPLIFIER TK-150U**

- 5 pairs of input terminals for MAG, AUX 1, AUX 2, TAPE REC and TAPE PLAY.
- Damping factor: 40 (at 16 ohms), 20 (at 8 ohms)
- Dimensions: 10¼" (W), 4⅞" (H), 9⅜" (D).



**60 WATT  
SOLID STATE STEREO  
AMPLIFIER TK-250U**

- 2 sets of stereo speaker terminal and front panel speaker selector switch.
- Dimensions: 13" (W), 4⅞" (H), 9⅝" (D).



**NEW MODEL  
180 WATT SOLID STATE STEREO  
AMPLIFIER KA-6000**

- The wide power bandwidth of 10Hz to 50,000Hz with very low IM distortion.
- Dimensions: (not including control knobs)  
16⅝" (W), 5⅝" (H), 11⅜" (D)

Ask for a catalogue or demonstration by your nearest dealer.

To: Jacoby Mitchell & Co., Pty., Ltd. EA  
469-475 Kent St., Sydney.

Send me information on KENWOOD RECEIVER, AMPLIFIERS, SPEAKERS & name of nearest KENWOOD retailer,

NAME \_\_\_\_\_ AGE: \_\_\_\_\_

ADDRESS: \_\_\_\_\_

*the sound approach to quality*



# MAGRATH'S

## FOR INSTROL HI-FI CABINET KITS

BUY DIRECT FROM THE VICTORIAN DISTRIBUTORS

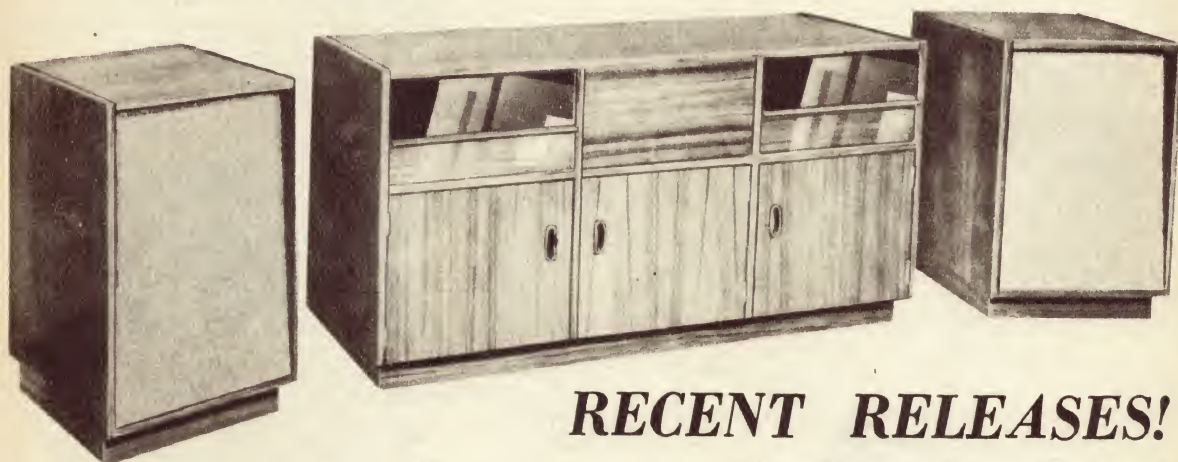

### RECENT RELEASES!

**Built and polished  
or Easy-to-assemble INSTROL cabinets.**

SPEAKER ENCLOSURE . . . MODEL 1001  
TWO SECTION EQUIPMENT CABINET  
MODEL 1002  
THREE SECTION EQUIPMENT CABINET  
MODEL 1003

These Instrol Cabinets are modular in design, and when your 3 cabinet setting is compacted an imposing sweep of quality cabinet-work results. Fundamentally, Model 1002 makes provision for amplifier and player, with record storage below. Model 1003 adds provision for tape deck or recorder, plus tape storage below. Player and Tape Recorder compartments are slide-out, running on heavy duty slides with nylon bearings for smooth long life. Compartment fronts are smartly finished in polished perspex which gives full visibility to record playing and tape recording equipment. Amplifier, player and tape compartments are generous in size and can accommodate even the largest equipment. The amplifier compartment may be cut to accommodate any type of amplifier, either panel or shelf mounting. Doors are smooth fitting with recessed handles cut from solid teak. It also is acoustically designed on the vented enclosure principle, and provides ample space for multiple speaker networks.



"INSTROL" products are made, serviced and guaranteed by  
BROADWAY ELECTRONICS PTY. LTD., Broadway, N.S.W.

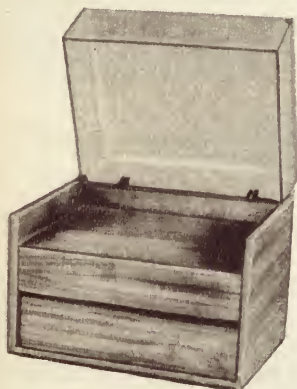

**SPEAKER ENCLOSURE KITS available as below in either  
Maple or Teak finishes.**

	SIZE
PLAYMASTER BOOKSHELF	19½" x 11½" x 6 1/8"
8" SLIMLINE	25½" x 14" x 6"
10" or 12" SLIMLINE	27½" x 17½" x 7½"
8" MAGNAVOX WR	27½" x 17½" x 7½"
8" DP	23½" x 11" x 10½"
10" or 12" DP	30" x 18" x 12"
8" or 10" VENTED ENCLOSURE	27½" x 17-7/8" x 10"
1001 (as illustrated above)	28¾" x 18" x 8"

**EQUIPMENT CABINET KITS — Magrath's carry the full  
INSTROL range. Send for illustrated CATALOGUE AND  
PRICE LIST.**

Magrath's carry the full range of INSTROL metal work for "Electronics  
Australia" projects.

Also just released. Combination  
amplifier/player cabinet. Model 75.  
Complete with friction stay-up per-  
spex cover. Available in Kit form or  
built and polished.

**J. H. MAGRATH & CO. PTY. LTD.**  
208 LT. LONSDALE STREET, MELBOURNE, VICTORIA, PHONE 663 3731

## A READER BUILT IT—continued

must not be too large, or Q4 may overheat.

The protection circuit employs only one transistor, one resistor and one potentiometer. In view of its simplicity and usefulness, it should not be omitted. As the current drawn from the supply increases, the voltage developed across the 6.3-ohm resistor increases. The base-emitter voltage of transistor Q5 also increases. When the base-emitter voltage of Q5 reaches about 0.6V, the transistor starts to conduct and progressively shunts the zener

diode. This reduces the reference voltage and hence the output voltage.

As the output current increases above the threshold of protection—set by the 50-ohm potentiometer—the output voltage falls, eventually reaching zero. If the control is set to give a threshold of 500mA, the short circuit current is less than 600mA.

Editorial note: It should be possible to use a normal bi-polar transistor instead of the field effect transistor as a constant-current device. The production spread will be less, and the design more economical.

## A Simple Noughts and Crosses Machine

A circuit submitted by Mr Martyn Sayers, 18 Young Street, Mount Kuring-Gai, N.S.W. 2080, is an attempt to design an unbeatable noughts and crosses machine.

Mr Sayers claims that the machine cannot be beaten, but will always win or draw against logical play. The chief disadvantage is that the machine must always go first, taking the bottom left-hand square. The game is played on a piece of paper with the pattern drawn in the usual way and with an X (for the machine) in the bottom left-hand corner. After each move by the opposing player, the machine indicates the move to be recorded on its behalf by

a lamp lighting in the appropriate square.

With the machine already occupying square 7 in the bottom left corner, the player makes his first move by writing a nought (O) in the square he selects. He then sets switches S2 to S5 according to the combination adjacent to the lamp on the panel in the chosen square. For example, if the player wanted to place his O in the top right-hand corner (square 3), he

would set S2 to 1, S3 to 1, S4 to 2, and S5 to 0, although the position of S5 is of no account in this example. The player then rotates switch S1 one position, the lamp in square 7 (indicating the machine's initial move) goes out, and another lamp will light to indicate the machine's next move. This is written (X) on the written diagram on the paper.

The player makes his next and succeeding moves writing a nought in the appropriate square and operating the equivalent toggle on the panel of toggle switches. Switches are fitted in positions 4, 5, 6 and 8 with dummy switches in the other positions. After making his second move by depressing the toggle switch corresponding to the selected square, the player rotates switch S1 another position to discover the machine's next move. This procedure is repeated using the toggle switches on this panel until the game is completed. While some of the toggles are dummies, the guest player need not know this.

Editor's Note: Although the machine always wins or draws against logical play, it is unable to cope with illogical moves by the player. The "program" assumes that in every case the player will make the obvious move to prevent a row of Xs. If the player does not make this move by oversight or by deliberate tactics, the machine is not capable of sensing the possible alternative "win" pattern. Following the choice of certain initial blocking moves by the player, the machine will always play for a draw oblivious of any winning opportunities which may occur. If a player makes one specific initial move followed by one of two illogical moves ignoring a threat of a row of Xs, the machine will allow the player to complete a row of Os because it cannot foresee such an action by the player! As soon as the way to beat the machine is discovered, its amusement value will decrease rapidly. More sophisticated designs which really are infallible have been developed and may typically be seen at fetes, etc. Perhaps one of our readers may be able to work out a more proficient machine without getting into circuitry which is too forbidding.

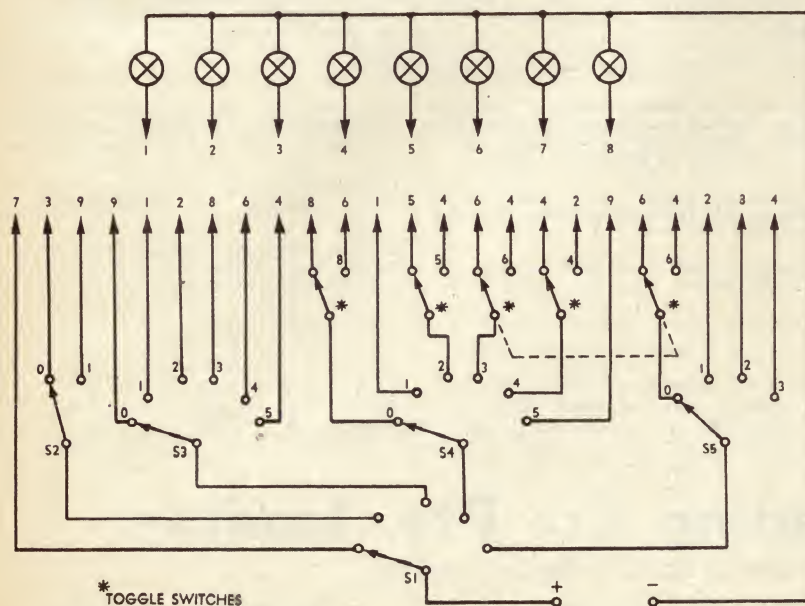
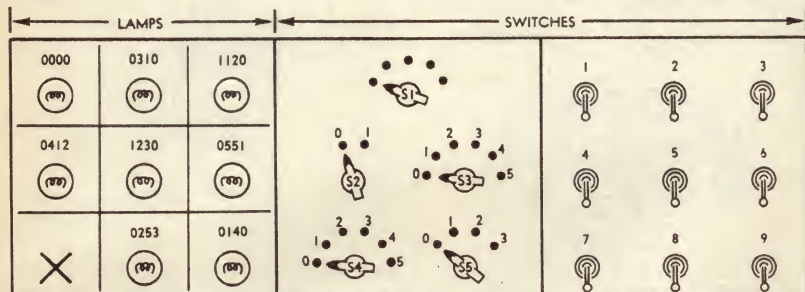

TOP: A possible panel arrangement for the noughts and crosses machine. BOTTOM: The circuit of this simple device.

### COMPUTER BOARDS

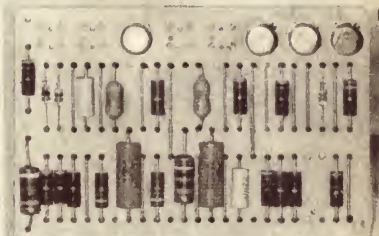

**TRANSISTORS 15c Each.**  
Resistors, Diodes, Capacitors Free.

8 BOARDS WITH A MINIMUM  
OF 30 TRANSISTORS \$4.00  
Pack and post 25c

25 BOARDS WITH A MINIMUM  
OF 100 TRANS. \$12.00  
Pack and post 50c

Technical information supplied with goods.  
Minimum order \$1.50.  
Please add Postage.

**COLSTOK ELECTRONICS**  
Box 178, KELLERBERRIN. 6410

# stocktaking clearance

## TV CAMERAS AND MONITORS



TV CAMERAS AND MONITORS from \$120.00 each.

## TAPE RECORDERS



TRANSISTOR TAPE RECORDERS clearing from \$12.00 each, plus postage \$1.00.



MEMO CORD, complete with accessories. Requires some adjustment. Price \$20.00. Post \$1.00

DYNAMIC MICROPHONES. High Impedance. Suitable for Tape Recorders. Frequency response 60-12000 only \$5.00 each. Post 25 cents.



MECCA 4 TRACK CAR STEREO, 4 watts per channel with 4 ohm output. Brand new. Price \$65.00. Post \$1.50



BELTEK CAR STEREO, 4 track. Brand new. 2.5W per channel. Price \$45.00. Post \$1.50



TOGGLE SWITCHES with on/off indicator Plates for only 40 cents each or \$4.00 per dozen.

BUILD YOUR OWN RADIO . . . Transistor Radio Cabinets with 4-band Dial Scale. Many other Cabinets of all sizes available. Prices from \$2.50 plus Postage.

INDICATOR LIGHT (square type) bracket. 25c each or \$2.50 dozen. Colours: Red, Yellow, Blue and Green.

PLUGS to suit 9-pin valve sockets. Only 40 cents each.



FUSE HOLDER, Chassis mounting type for only 25c each or \$2.50 per dozen.



NEAT STUDIO PICK-UP ARMS including magnetic cartridges, mono or Stereo. Model GA-4, Model GA-6, Model GA-7, Model GA-11. From \$20.00. Tax included.



HI-TAKE COMPACT CASSETTE TAPE PLAYERS. Ready to Play. Batteries supplied. Only \$15.00 each. Post \$1.00

ELECTROLYTIC CONDENSERS, 5000 mfd, 20wv with mounting brackets. Upright mounting. Height, 2 1/2 in, diameter 1 3/8 in for only \$1.80 each. Tax Included. OR \$18.00 per dozen.

RESISTORS. High Stability. Tolerance between 1 p.c. and 5 p.c. 1/2W, 1W, 2W, from 30 to 50K. Bag of 100 only \$6.00. Post 20 cents.

LUG STRIPS. Bag of 100 Assorted. 7, 5, 4, 3 lugs. \$2.00.

RECORD CHANGER COVERS made from Perspex, grey smoke colour. Usually sold \$17.50. Only \$10.00 each.

We have large stocks of Spare Parts for all makes of Japanese Transistor Radios, Tape Recorders, Amplifiers etc. If special parts are required for Servicing any Japanese make of Transistor Radio, please send us a sample of the faulty part and we will supply the part or an equal substitute. We also repair all makes of Radios, Tape Recorders, Hi-Fi equipment, Transceivers, Transistorised TVs, etc.

## Olims Trading Co. Pty. Limited

A DIVISION OF OLIMS CONSOLIDATED LTD.

26 RICKETTY STREET, MASCOT, N.S.W. 2020

PHONE: 67 6011

## FURTHER NOTES ON BROADCAST-BAND FRAME AERIAL

Mr J. H. Wheller, 29 Budwood Terrace, Auchenflower, Qld. 4066, submitted an idea for a frame-type broadcast-band aerial which was published in these columns in the February, 1969 issue.

Since then, Mr Wheller has been deluged with letters seeking further information. He is unable to cope with all this mail and has therefore asked that the following be published to answer most of the queries he has received.

The aerial is on a 4ft x 4ft square frame made of 1in x 1½in pine screwed together and with one diagonal bracing strut. The frame is mounted on a 10ft pole so that it can be firmly fastened in the desired position. The feed to the receiver should preferably be of TV twin lead-in wire, or otherwise of a lightly twisted pair of wires.

Unsolder the earthy-end of the receiver input coil from earth or chassis, and attach a wire long enough to reach outside the case. Join one wire of the feeder to this lead; the other wire is

then taken to the aerial terminal of the receiver. To ascertain the value of tuning capacitor required, use a variable capacitor initially to find the optimum value, and then substitute fixed capacitors to give the same capacitance.

For the foil use clean shiny foil from cigarette cartons. Cut this into 1in strips and wind round the horizontal members of the frame in spiral form, numbering the strips. The odds go shiny side up and the evens shiny side down, all with an overlap. Join top and bottom at the centres, and tape with PVC sticky tape. The aerial consists of three turns of 16 gauge insulated wire or one turn of tri-core (the cores being soldered so as to be in series).

If the aerial is not in a straight line with two stations, the system will discriminate between the two signals. The null is only two degrees wide.

Mr Wheller comments: I am at present working on a tuneable filter to insert in the mains lead to stop unwanted RF signals entering the receiver via this lead. I am also working on a larger aerial to increase the signal strength of wanted stations."

## AID FOR SERVICING PRINTED BOARDS

A simple device to help in servicing transistor radios has been submitted by Mr A. D. Fuller, 406 Pennant Hills Road, Pennant Hills, N.S.W., 2120.

Some readers, including servicemen, may have the job of finding a fault in a transistor radio without a copy of the circuit or the printed wiring layout. There are so many different models that even servicemen seem to

to a glass plate to give sharp shadows of components, etc. placed on it. The transistor radio is placed on the glass plate, first with the printed wiring side down, and then with the parts side down. A sketch is made in each case of the area of interest. It is then a fairly simple matter to draw out the circuit and trace the fault.

Basically, the device consists of a

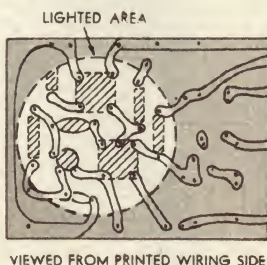
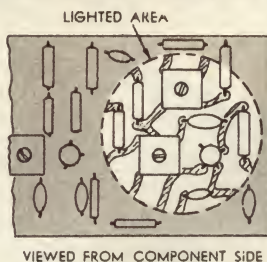
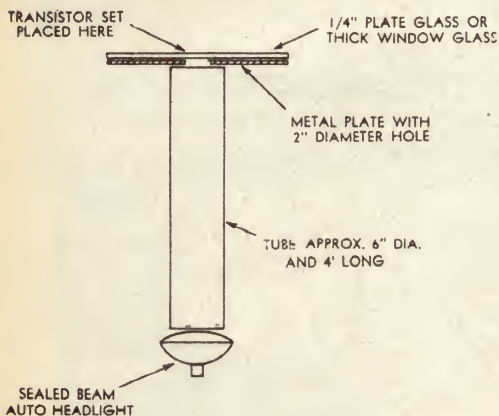

have diagrams in only a few cases. It can be an exasperating job trying to trace out the circuit of a section suspected to be faulty. I have found it is almost impossible to relate the printed wiring to the parts on the other side of the board without assistance from the device I have produced.

The idea behind the device is to send a near parallel beam of light up

suitable tube about 4ft long by 6in diameter with a sealed beam car headlight at one end. The tube is mounted vertically with the lamp at the bottom, and the top end covered with a metal plate with a 2in diameter hole in it and a glass plate over the hole. If a diffused light is required for any reason, opal or ground glass can be used.

HI-FI  
**STA** STEREO  
ELECTRONICS SPECIALISTS

## ELECTRONICS

731 CENTRE ROAD,  
EAST BENTLEIGH 3165

Props. C. and B. RENER  
Phone 579-1519

- L.D.R. Electronic light beam relay unit with light source, 240v operation. New Year Special .. \$27.50 Post 20c.
- 15" Bass speaker 852 .... \$30.00 Post 90c.
- Slimline enclosures teak or walnut complete with speaker \$39.50 Post \$1.00.
- Ohden 2 station intercom with battery and 50ft wire .... \$11.50 Post 20c.
- 6W per channel transistorized amplifier .. . \$59.00. Post 50c.
- 10W per channel transistorized amplifier .. . \$55.00. Post 50c.
- Hi-Fi stereo headphones, 8 omhs .. . \$9.00. Post 20c.
- Toyo DS 2-way speakers . \$35.00 Post 90c.
- Tubular extension speakers \$4.95 Post 20c.
- Onkyo concert family stereo set .. . \$175.00. Post \$1.00.
- Lockdown car radio aerial LO3 .. . \$4.25. Post 20c.

### ALL YOUR REQUIREMENTS FOR SLEEP LEARNING

- Pillow Phones \$ 4.95 10c Post
- Endless Tapes \$ 9.80 20c
- Timers \$29.95 40c

Nikka 14 transistor 1 watt transceivers long range boost circuit buzzer call system 2 channel squelch control R.F. stage all metal construction .. \$175.00 Post 50c.

Electronic and general musical instruments, guitar amplifiers, fuzz boxes, pep boxes, cry babies, verb units, etc.

Stocks include a large range of accessories and spare parts to suit electronic home projects and amateurs requirements. Specialising in unusual and hard-to-get parts.

MAIL ORDERS. SEND POSTAL NOTE, CHEQUE OR MONEY ORDER. PLEASE ADD POSTAGE. INQUIRIES SEND SELF-ADDRESSED, STAMPED ENVELOPE. OUR LAY-BY IT AT YOUR SERVICE. HIRE PURCHASE CAN ALSO BE ARRANGED.

# AUDIO TOPICS

## "NATURAL SOUND" LOUDSPEAKERS—AN INTERESTING CONCEPT

Though submitted originally for review in our "Trade" columns, the Yamaha NS-10 and NS-15 loudspeakers are sufficiently unusual to warrant different and more extensive discussion. Manufactured by Nippon Gakki Co. Ltd. of Hamamatsu, Japan, they dispense with normal enclosure concepts and rely on an unusually large diaphragm to reproduce the lower frequencies.

Attention was first drawn to this type of loudspeaker by their use in a Yamaha electronic organ where the diaphragm occupied a large proportion of the frontal area of the console. The diaphragm and support were irregularly shaped and it was doubtless no coincidence that the irregularity was of the right shape and in the right position to clear the expression pedal.

The loudspeakers which have since been released for general hi-fi use bear a strong family resemblance to their parent, the rather more regular shape still providing a handy spot for mounting the accompanying high frequency tweeter.

The description "Natural Sound Speaker" and references in Yamaha literature to a piano sounding board are not surprising, in view of the fact that the parent company is claimed to be the world's largest manufacturer of pianos. A publicity department attuned to selling musical instruments may understandably allow the related thinking and terminology to carry over into another selling area.

But it is rather surprising to read that Yamaha engineers followed "an epoch-making concept for the development of a loudspeaker that did not merely reproduce sound, but rather produced sound."

Whatever value this statement may have for purposes of sales promotion, it is skating on very thin ice in the technical sense. So also, in fact, is the idea of drawing a parallel between the role of a high fidelity loudspeaker and the sounding board of a musical instrument.

The designers of a musical instrument may provide it with a sounding board (or other mechano-acoustic fittings) having certain deliberate formant qualities. Their purpose is to shape the frequency response and tone structure to what is considered appropriate and desirable for the particular instrument.

Against this, a loudspeaker in a hi-fi system, intended to reproduce any kind of program material, should have no formant qualities at all. It should exhibit no tendency to "colour" the sound issuing from it.

The loudspeaker used in an electronic musical instrument is a special case because it is an integral part of a system which is producing original sound. The designer may deliberately and legitimately choose a loudspeaker with strong formant characteristics—if it helps to create the kind of sound which he is seeking.

An electronic organ may have a "round" tone because the loudspeaker rolls off the higher order harmonics above 5KHz. A smoothly contoured prominence above 100Hz may, to some ears, give it a nice "woody" bass. Loudspeakers for electric lead

guitars must be able to produce plenty of "thump" in the region above 70Hz. And so on.

None of these characteristics can be regarded as desirable or appropriate for good quality reproduction of general program material. A high fidelity loudspeaker system has to be considered on its merits for this application alone, divorced from other matters which are really irrelevant.

Conventional loudspeakers use a cone structure which is free to move as a whole, having a compliant suspension near the apex and around the periphery. They are mounted on a baffle board or in an enclosure which is supposed to isolate or suppress radiation from the rear of the cone and prevent it from cancelling frontal radiation, particularly at the low frequencies. The "bass reflex" system goes a step further and seeks to reverse the phase of the rear radiation so that it actually reinforces that from the front of the cone.

Either way the baffle or enclosure

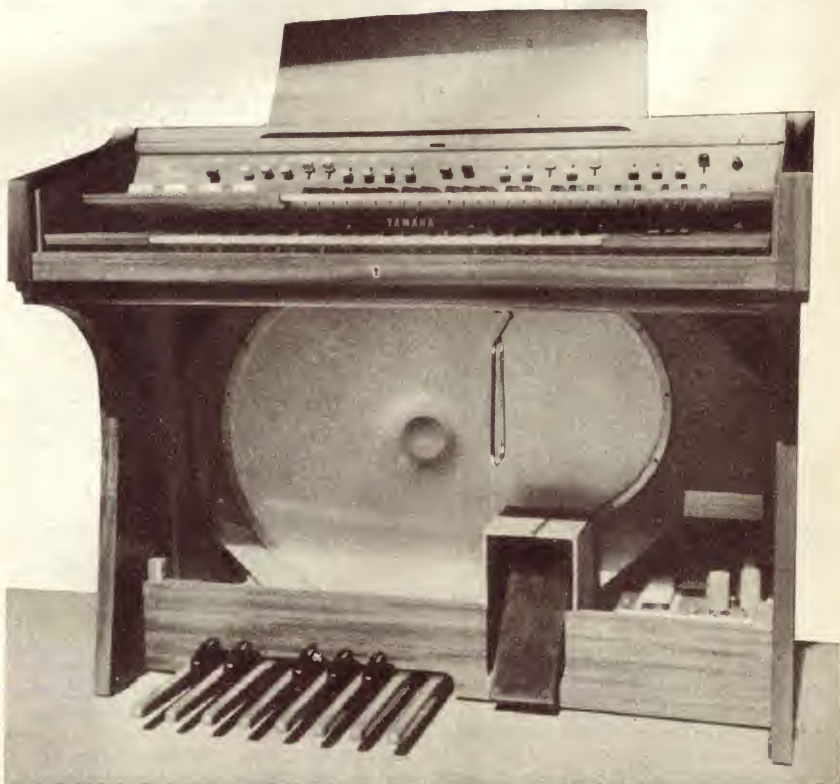

A king-sized loudspeaker in the console of a Yamaha electronic organ. The NS-20 and NS-30, both larger than the NS-15 discussed in the article, are available in Australia ex-stock.



is an essential part of the loudspeaker system, particularly in respect to its ability to propagate low frequency energy into the listening area.

The philosophy behind the new line of Yamaha loudspeakers is apparently that, if the cone is made large enough, it will be able to move enough air and develop an acceptable bass response by sheer virtue of its frontal area. It will be less dependent on external baffling.

This kind of thinking is not, in itself, new. Most enthusiasts have observed that, if signal is fed to either of two loudspeakers, one very large and one very small, lying unbaffled on the bench, the large unit will produce more apparent bass. This is due partly to cone area and partly to the system resonance occurring lower down in the range.

In effect, the designers of the new Yamaha loudspeakers start off with "enclosures" of certain representative and marketable sizes and, instead of using a smaller loudspeaker and controlling the rear radiation, they "fill" the enclosure front with diaphragm and let the back wave behave as it will in any given environment.

In the case of the NS-15, the sides of the cabinet are slotted and the back is an acoustically open fret, giving a minimum air path from front to back of the cone of no more than a dozen inches.

Another unusual feature of the loudspeakers is that the cone is moulded from polystyrene and is fixed rigidly to the periphery of the metal housing. For the loudspeaker to work at all, the cone must flex and, in practice, the regions where it flexes are likely to be different for each individual frequency. The flexing region is further randomised by the irregular shape of the cone.

The manufacturers see this distributed pattern of behaviour as a virtue but their explanation of it in the sales literature is something of an all-time howler: "The movements effected on the vibrating portions of the diaphragm are reflected by means of the rigidly fixed edge, so that they do not become standing waves. . . ."

Be that as it may, the impedance curve of the NS-15 stays within an ohm of two of the rated 8-ohms from about 70Hz to 5000Hz, above which it tapers to something less than 4 ohms at 10KHz as the tweeter takes over —this with the tweeter fully on.

At the bass end, it shows a very sharp rise to a peak of 25 ohms at 48Hz. This itself is an interesting figure because, while one is accustomed to impedance peaks in loudspeakers of conventional design, it was hard to venture a guess as to the nature of the peak, if any, which would be exhibited by a self-flexing cone, rigidly supported around the edge.

A peak there surely is, no less evident than in a conventional system and in a fairly customary spot, just below 50Hz!

In this vital region, the effective area of the cone must be markedly less than that within the confines of the rigid frame and it would be an interesting exercise to determine approximately what the true active cone area is, allowing for the zones that move very little.

From inspection, it would appear that the true piston area would be

somewhat greater than that of a nominal 15-inch round unit.

This, coupled with the resonance figure just mentioned, is indication enough as to why the "enclosure" can be nothing more than an open box. Any attempt to confine the back wave would react on the resonance, exactly as for a conventional 15-inch loudspeaker, setting rather bulky minimums on the size of such an enclosure.

13 x 17 inches across its minimum and maximum dimensions. It is driven by a 2½ dia., 8-ohm voice coil and carries a continuous maximum power rating of 15 watts.

The manufacturers state that the enclosure should not be placed close to a hard-surfaced wall, and this would presumably prevent it being used as a bookshelf unit, at least if the space is restricted. They prefer that the units



The Yamaha NS-10 (left) and NS-15 loudspeakers, with front fret removed. The 2-inch tweeters are visible in each case at the top right-hand corner.

Have Yamaha engineers managed to circumvent the basic acoustic laws which have directed so much attention, in recent years, to methods of loudspeaker baffling?

No they haven't. The velocity and wavelength of sound waves, the tendency for front and rear radiation to interact, and all the other acoustic laws apply just as much for Yamaha products as they do for Rola, Goodmans or J. B. Lansing!

What has happened is that, for this particular line of loudspeakers, Yamaha engineers have pushed familiar design compromises to an extreme opposed to the current trend. They have elected to:

1. Move air with a big cone and smaller travel, rather than a small cone with larger travel.
2. Rely on cone area reinforced by controlled system resonance to sustain bass response, rather than on enclosure design.
3. Allow the back wave to bounce around the listening area rather than control or suppress it.
4. By basic design and lack of damping to seek a higher acoustic efficiency than is normally available from other compact systems.

Looking at the NS-15 as a consumer product, the cabinet work measures 23½ x 16½ x 7½ inches and is finished on 4 sides in American walnut. The front grille, easily removable, is a dark open-weave plastic cloth, while the back is a simple grille of composition board, backed with black cloth to limit dust penetration. The main moulded cone measures approximately

be free-standing and positioned where they sound best. While this is clearly a characteristic and a limitation of the open-backed design, the manufacturers claim that the sound reflected from the rear of the system broadens the



### FOUR CHANNEL AUDIO MIXER

E.A. Feb., '66.

Fully transistorised. It offers outstanding performance together with compact size and economy of operation. Provision for two Microphone channels plus two P.U. channels.

#### Specifications:

Two Microphone channels: 11K or 50K input, Gain 750 or 250, noise minus 54 dB, response 30 cps to 40KC. Adaptable for lower impedance Microphones.

Two Crystal/Ceramic P.U. channels.

Noise minus 60 dB, Unity gain, Response 20 cps to 40KC.

Wired and Tested . . . . . Price \$35.00

240 AC/18 DC Power supply for above.

Price . . . . . \$14.95

Pack and Post add 50 cents.

PRE AMPS also available for: Tape Heads, Electric Guitars, Magnetic cartridges.

### BEECH ELECTRONICS

P.O. Box 160 Kogarah, 2217

N.S.W. Telephone 605-2307.

# Now, The Most Complete Model, X-360!

- **Magnetic Brake:** Developed to bring the tape to an immediate stop in a split second, without making it saggy or too taut.
- **Automatic Volume Control (Comput-O-matic):** Developed to automatically adjust the sound level for perfect high fidelity recording. The operator is relieved of the burden to manipulate the volume control watching the VU meters, as the occasion warrants.
- **Automatic Dust Minder:** Developed to indicate the dust deposits on the heads. Such deposits account for 90% of the failures in most tape recorders. Clean the heads as dictated by the indication of the lamp.
- **Three Speed Motor For Capstan Drive:** Developed 3 tape speeds ( $7\frac{1}{2}$ ,  $3\frac{3}{4}$  and  $1\frac{7}{8}$  ips), which can be determined by the electrical selection of the motor speed. The 15 ips tape speed is made possible by the capstan and pinch wheel unit.
- **Cross Field Head:** Developed to permit low tape speeds with amazing frequency response and perfect high fidelity recording.
- **4 track stereo/monaural recording and playback**
- **50 watt solid state amplifier**
- **Automatic continuous reverse (Reverse -O-matic)**

X-360D tape deck is also available.

There are others too, all making for perfection in sounds for your maximum enjoyment.



**AKAI**  
AKAI ELECTRIC CO., LTD.  
HIGASHIKOJIYACHO OHTA-KU TOKYO JAPAN

N.S.W.: Magnecord Australasia Pty., Ltd. 210 Clarence St., Sydney CANBERRA AND A.C.T.: Homecrafts, Petrie St., Civic Centre  
VICTORIA: Magnecord Sales & Service, 146 Burwood Rd., Hawthorn 3122 QUEENSLAND: Magnecord Sales & Service 399 Montague  
Bd., West End; Brisbane: S.A.: Magnecord Sales & Service, 8 Arthur St., Unley W.A.: Magnecord Sales & Service 579 Murray  
St., Perth

apparent sound source and enhances its listener appeal.

A two-inch tweeter is fitted in the top right-hand corner, fed through a conventional half-section cross-over network, and provided with a level control to set the balance of treble against bass.

On listening tests in a fairly live room of average dimensions, output was quite strong in the region 100 to 300Hz. This is primarily responsible for the impression of substantial bass output and for the impression that bass boost is unnecessary on ordinary pro-

more effective provision for baffling.

The NS-10 is the smallest loudspeaker in the "Natural Sound" range. The enclosure is styled in a similar manner to the NS-15 and measures 20 x 14 x 7 inches. The main loudspeaker has a moulded diaphragm measuring 11 x 15 inches across its minimum and maximum dimensions, and rigidly mounted around the periphery to a pressed steel frame. The system incorporates a tweeter but no tweeter level control.

On listening tests, performance level was markedly below that of the NS-15.

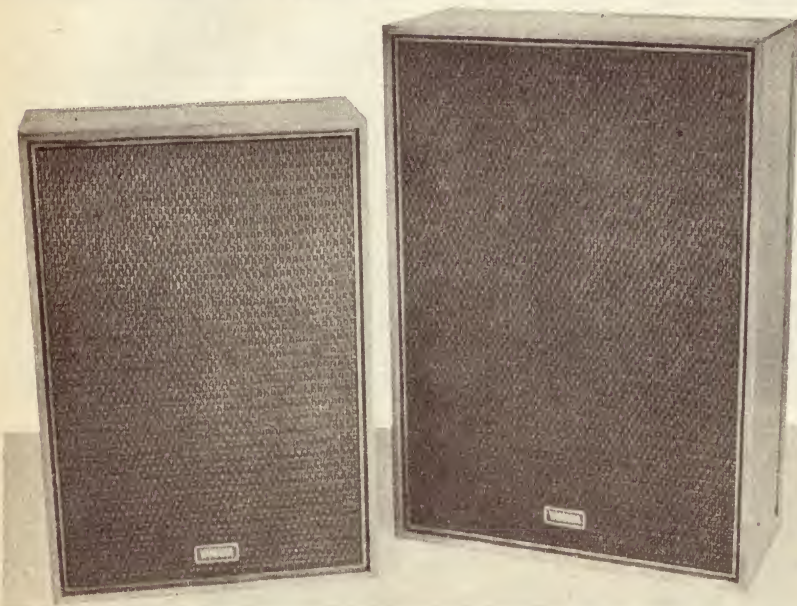

*The NS-10 and NS-15 loudspeakers in normal dress. Finished in straight-grained American walnut, they have plenty of eye appeal.*

gram material. Not surprisingly, in view of the lack of baffling, the response tapers below this but is aided somewhat by a system resonance in the vicinity of 50Hz, as already mentioned.

Output is also noticeably above reference in the 1 to 2KHz region, giving so-called "presence," while the tweeter control gave a range from adequate treble balance at full-on to a sharp roll-off above about 7KHz at full-off.

The NS-15 lives up to its maker's claim of being sensitive, pleasant to listen to, and capable of being used without bass boost. In fact, if boost is used, it would have to be applied sparingly, because of the already existing plateau above 200Hz, and the risk of over-driving the unbaffled cone at 50Hz or thereabouts.

Compared with competitive systems, the NS-15 would probably show up to best advantage with amplifiers of good quality but tending to be light-on in terms of power output and bass boost facility. This assumes, of course, that the furnishing situation does not prevent them from being placed as the manufacturers stipulate.

Where the amplifier system has a surplus of power output and bass boost, and particularly where the owner is keen on producing heavy fundamental bass, as from grand organ recordings, the NS-15 would have to be more critically evaluated against conventional designs with — possibly —

Response was strong in the region above 100Hz but both listening and oscilloscopic tests with input energy in the lower bass register showed a tendency to frequency multiply up into the plateau area. Bass therefore tended to be strong but "woody" in its colouration.

At the high end, response rolled quite noticeably above about 5KHz, although still audible over the whole range. On direct A-B tests, top response of the NS-10 was only a little above that of the NS-15 with the latter's tweeter turned right down. Although the avowed intention of the manufacturers has been to present loudspeakers which appeal to the ear rather than to the eye (per medium of response curves) one cannot but wonder why they have so noticeably limited the top response of the (somewhat) smaller unit. It must surely limit its appeal to hi-fi-conscious listeners.

Price of the NS-15 is quoted as \$112, including tax, while that of the NS-10 is \$90, including tax.

The NS-20 is quoted as \$225.00 and the NS-30 as \$337.00, all systems being available immediately in Australia.

Further information regarding these and other speakers in the "Natural Sound" range can be obtained from the Australian distributors, Rose Music Pty. Ltd., 4-14 Ross Street, South Melbourne and Radio Parts Pty. Ltd., 289 Elizabeth Street, Melbourne, Victoria. ■

## TRADE ENQUIRIES INVITED!

- ✧ COMPAX III TURNTABLES
- ✧ COMPAX AMPLIFIERS
- ✧ LUSTRE TONE ARMS
- ✧ MICRO CARTRIDGES
- ✧ PML MICROPHONES
- ✧ LONDON MICROPHONES
- ✧ CELESTION GUITAR SPEAKERS
- ✧ PRL TANGENTIAL FANS
- ✧ MICRO DUST PICKUPS
- ✧ PLANET P.A. AMPLIFIERS

Trade supplies only available from:

**INTERNATIONAL DYNAMICS (AGENCIES) PTY. LTD.**

361 Bridge Rd., Richmond,  
Vic. 3121  
Tel. 42 4403

# The "Out-Crowd Pleaser."



Some people will never be "in." Their fancies run high and they are fanatically loyal to logic, imported beer and aged cheese. The out-crowder is long-haired, bald, herring-bone suited, and clad in dungarees with turtleneck sweater.

The conversation is endless. Probing the profound, he will discourse on drugs, Stendahl, the Kennedys, De Gaulle, Art, Love and Be-Ins.

His taste in music can run the gamut of Beatle fad, Bach fugue and Ravi Shankar.

The one thing that is most common is a demand for great performance. His ear is attuned to the subtleties of delicate instrumentation.

When the conversation becomes subdued and the mood softens to a "listen," THE CARTRIDGE USED IS THE ADC-10E/II.

Top-rated, this mini-cartridge is almost human in its instinct. It brings out the brilliance, from the lowest bass to the highest treble. Its channel separation, supreme, as it feels and caresses every groove, bringing out each little nuance of the recording.

Using the unique and patented "INDUCED MAGNET PRINCIPLE", it reduces the mass of the moving system to a minimal value and significantly increases stylus compliance. This allows the stylus to accurately follow the intricate modulation of the record groove.

There is less distortion and minimum record wear.

The miniscule, geometrically designed, elliptical diamond (lateral radius of .7 mil and contact radius of .3 mil) contributes to a more superior tracking ability.

These elements, carefully opinionated features, result in a genuine, effortless reproduction that carries the listener to the edge of his seat.

Hi-Fi Stereo Review in an independent survey made these claims, ". . . its ability to trace highly modulated grooves at only 1 gram is a feat achieved by few cartridges in our experience." And, ". . . it would track the HF/SR test record at 0.5 gram, lower than any other cartridge tested."

The cost is high . . . \$80. But understandably so. The appeal is to a small "out" crowd.

## J. H. REPRODUCERS PTY. LTD.

293 HUNTINGDALE ROAD, CHADSTONE, VICTORIA. 3148

TELEPHONE 277-3066

Exclusive Australian Representatives of ADC, U.S.A. and KEF, U.K., and Makers of the J.H. Synchronous Turntable.

## HIGH POWER IC AUDIO AMPLIFIER

The Sony Corporation of Japan, through their Australian representatives, Jacoby Mitchell and Co., Pty., Ltd., have announced the development of a new technique for making IC's which makes possible very much higher power ratings than formerly. One of the units they have produced should be of considerable interest to audio enthusiasts.

The makers claim that this is the highest powered IC yet produced, and we must agree that we have not heard of anything which approaches the performance figures quoted. Unfortunately, the descriptive matter issued by Sony appears to have suffered somewhat in translation from the Japanese, but the following would seem to be the salient points of the device.

The complete IC represents a single-ended push-pull amplifier consisting of two NPN power transistors, four smaller transistors—two NPN, two PNP—one diode, and six resistors. It is designed to work into a load of 8 ohms, delivers 18W RMS power for an input of 50mV RMS, and incorporates 30dB of negative feedback. It appears to be designed for 12V operation with a 40V maximum rating. Circuit efficiency is quoted at 67pc for the 18W rating.

A figure of 26W "linear power" is also quoted, and this presumably means music power. In any case, the 18W rating may have to be qualified slightly, since it is quoted on the basis of "less than" 10pc harmonic distortion. This would be much too high for most audio applications, but an alternative rating of 15W RMS at 0.4pc harmonic distortion appears very attractive indeed.

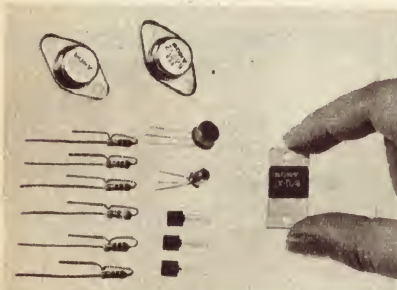

The complete IC, compared with the discrete components it replaces. Note its small size, compared with the hand.

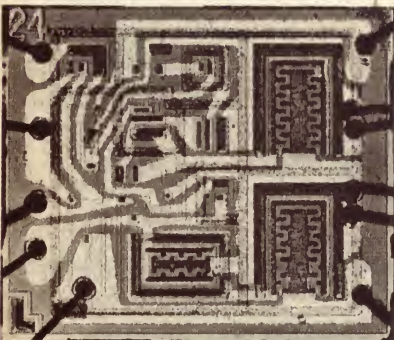

The IC pellet, very much enlarged. It measures 1.5mm x 1.75mm or .059in x .069in.

Physically, it consists of the IC pellet proper which measures 1.5mm x 1.75mm (.059in x .069in) mounted in either a flat package or a TO5 housing. Some idea of the size of the complete flat package can be obtained from the photograph. The full impact of this is realised when one considers that two such units would provide a substantial part of the electronic requirements for a domestic stereogram with more than adequate power output.

Similarly, a single unit could provide the complete audio system for radio receivers, TV receivers, tape recorders and similar applications, while the manufacturers also envisage its use as a TV vertical deflection amplifier. However, this particular circuit is only one of many which are now being developed to take advantage of the new high power IC technology.

The technology itself is regarded as a major breakthrough by the Sony organisation, and was developed by a team of Sony engineers in charge of Mr Isamu Kobayashi and led by Mr Kinji Wakamiya.

Jacoby, Mitchell and Co. specifically ask us to point out that they cannot at this stage provide any further information, either to trade or private inquirers.

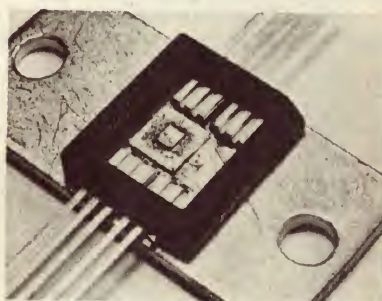

The pellet mounted in a flat package. Presumably, a heat sink would need to be added, but no details are given.

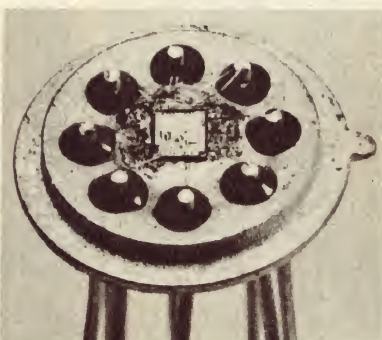

The pellet prepared for installation in a TO5 case. Again no heat sink details are given.

## If you want STEREO EQUIPMENT

You'll deal better with  
**H. B. RADIO SALES**  
**APRIL SPECIALS**

**KENWOOD TK250 AMPLIFIER/** 2 Wharfedale Golden 10 speakers in R2 teak cabinets—Dual 1009F player with Shure magnetic cartridge on platform, **\$386.00.**

With Sansui 555 amp, \$20.00 extra. **KENWOOD 150 AMP, 2 Magnavox 10in speaker systems in Teak. Garrard AT60 with Shure M44G on Platform, \$275.00.**

**TOKAI AMP.** 2 Magnavox 8in speakers, Garrard 1000 Players on Platform, **\$98.50.**

**MAGNAVOX or ROLA design** slimline cabinet with 8 W.R. (V.C. 15, 8 or 3 ohms) or 8 CMX speaker fitted . . . . . **\$29.00**  
Cabinet Kit only . . . . . **\$10.50**

**MAGNAVOX 10 W.R. and 3 T.C.** Tweeter with Crossover network in 2 C.F. cabinet  $\frac{3}{4}$ " material **\$41.00**  
12 W.R. in 3 cubic ft. cabinets **\$43.00**

**GOODMANS design 3 CF Cabinet** and Twin-axiom 10 speaker,  $\frac{3}{4}$ " material . . . . . **\$56.00**  
Cabinet Kit and Speaker . . . **\$44.20**

**WHARFEDALE design, 3 CF** cabinet (R3)  $\frac{3}{4}$ " material and Golden 10 speaker . . . . . **\$60.00**  
Cabinet Kit and Golden 10 Speaker . . . . . **\$47.50**

Special quotes for other Wharfedale or Goodmans speakers.

Available in Maple, Walnut or Rosewood colours. Teak veneer \$1 extra for Slimline and Bookshelf models. \$2.00 extra for others.

**PLAYMASTER Bookshelf Speaker System, Complete, \$31.00**  
Cabinet kit only \$7.

All other parts, including speakers, innerbond, etc., \$16.00.

**POINT 4. BOOKSHELF UNIT,** complete kit of parts, cabinet, speaker, innerbond, etc., \$25.00.  
Complete. Price \$35.00.

**PLAYMASTER Super Bookshelf System, Complete, \$43.00.**  
Cabinet kit only \$10.50.

All other parts, including speakers, innerbond, etc., \$25.00.  
Teak, \$1.00 extra.

Wharfedale Unit 3. Complete kit of parts, cabinet size, 14in x 9in, 8 $\frac{1}{2}$ in ( $\frac{1}{2}$ in)—\$41.25 (made \$49).  
Cabinet size 11 $\frac{1}{2}$ , 21in 9 $\frac{1}{2}$ in ( $\frac{1}{2}$ in)—\$45.50 (made \$54).

Packing charge \$1 per order.  
Postage, N.S.W., \$1.00; Qld., Vic., Tas., \$1.40; other States, \$2.00.

Send for Stereo Catalogue

**H. B. RADIO SALES**

Manufacturers of Quality Radio and Radio Furniture for 36 years

103-105 Catherine Street,

LEICHHARDT, SYDNEY

Telephone 56-5580

# ONLY A FEW MAGNETIC STEREO CARTRIDGES EARN PLACES IN THE SUPERLATIVE BRACKET. **ORTOFON** HEADS THE LIST.

Most reviewers have several favorite cartridges — *in most cases, ORTOFON heads the list.*

The explanation is a simple one. ORTOFON is the only organization in the world manufacturing professional disc cutting equipment and cartridges for playback. Many of your favorite recordings will be reproductions from ORTOFON cut masters! As reproduction is complementary to recording it naturally follows that ORTOFON should produce the finest arms and cartridges available in the world today.

The ORTOFON moving coil principle is the only recognised transducer system inherently free of non-linear distortion; tracing distortion caused by the differing shapes of cutting styli and reproducing styli has now been eliminated by ORTOFON thanks to the use of exclusive ORTOFON elliptical diamonds. All ORTOFON cartridges feature a 15° tracking angle.

*Technically and musically ORTOFON stereo cartridges are unique and quite superior.*

ORTOFON cartridges have won universal popularity with discerning music lovers and professional users; the low distortion moving coil principle is quite incomparable. Stereo cartridges developed by ORTOFON engineers have always been advanced in design and construction; the ORTOFON S15 series offers superior sound reproduction and will trace the most complex waveforms at 1.5 grams. The S15 is available with an optional built-in transformer and may also be purchased ready mounted in the lightweight metal "G" shell for use with the ORTOFON SMG-212 tone arm.

\*An exclusive protective device . . . "Protecto-Skate" . . . shields the stylus if the cartridge is accidentally subjected to excessive external lateral, or vertical pressure. This tube is highly polished to afford added protection for the record surface itself.



#### ORTOFON S15 SPECIFICATIONS:

	S15T	S15
Weight of cartridge	18.5 grams.	12.5 grams.
Output impedance	15 Kohm	2 ohm
Output in mV/cm/sec (loaded)	2	0.04
Equivalent mass at stylus point	0.9 mg.	0.9 mg.
Recommended stylus pressure	1-2 gr.	1-2 gr.
Elliptical stylus radius	0.0007" x 0.0003" (both models)	
Spherical diamond radius	0.0006" (both models)	
Tracking angle	15°	15°
Static compliance	20 x 10 cm/dyne	
Frequency response	15-40,000 Hz.	
Channel separation	20-30 dB	

ORTOFON now introduce the new SL15 lightweight stereo cartridge — a moving coil unit with very high compliance and improved frequency response. This superb cartridge is designed for use in transcription tone arms of the highest possible calibre.

#### ORTOFON TRANSFORMER MODULE

A twin transformer module which may be fitted anywhere in the lead between the tone arm and the amplifier is now available, complete with plugs and cables.

Specifications: Input impedance — 2 ohms. Output impedance — 15 Kohm. Load impedance — 47 Kohm. Frequency response — 10-40,000 Hz.

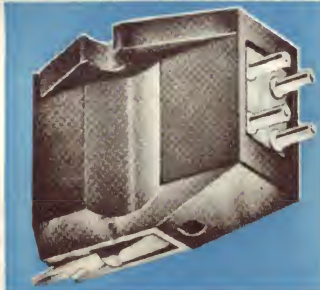

#### ORTOFON SL15 SPECIFICATIONS:

Weight of cartridge:	7 grams.
Output impedance:	2 ohms.
Equivalent mass (at stylus point):	0.9 mg
Recommended stylus pressure:	0.75-1.5 grams.
Output:	0.025 mV/cm/sec.
Stylus radius: Spherical diamond—	SL15 0.0006"
Stylus radius: Elliptical diamond—	0.0007" x 0.0003"
Tracking angle:	15°.
Static compliance:	25 x 10 cm/dyne
Channel separation:	20-30 dB.
Frequency response:	10-40,000 Hz.

#### THE NEW ORTOFON TONE ARM MODEL RS-212

Full advantage of the outstanding characteristics of the SL15 series cartridge may be taken with the new ORTOFON RS-212 arm. A stylus pressure mechanism based on spring tension also incorporates an effective automatic anti-skating arrangement; stylus pressure and anti-skating force are correctly related when the stylus pressure is set. Although factory set for ORTOFON cartridges with elliptical styli, a ratio adjustment screw permits use of any cartridge. The ORTOFON "Hi-Jack" lifting/lowering device is standard equipment with the RS-212 arm.

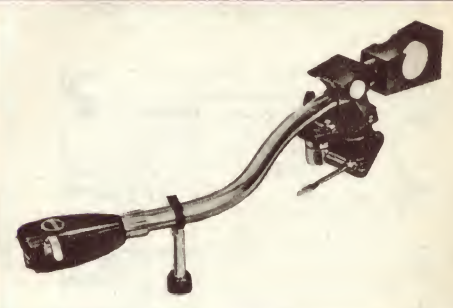

Australian National Distributors:

**Simon Gray Pty. Ltd.**

Head Office: 28 Elizabeth St., Melbourne Vic. Tel. 63 8101\*  
Sydney Office: 22 Ridge St., North Sydney, N.S.W. 929 6816  
Canberra Office: 31-33 London Circuit, Canberra City. A.C.T. Tel. 49 6050

INTERSTATE REPRESENTATIVES:

N.T.: Pfitzner's Music House, Smith Street, Darwin. Tel. 3801  
Q'land: Sydney G. Hughes, 154-158 Arthur St., New Farm, Brisbane. 58 1422  
S.A.: Elico Sales Pty. Ltd., 7-9 Osmond Terrace, Norwood, S.A. Tel. 63 4844  
Tas.: K. W. McCulloch Pty. Ltd., 57 George Street, Launceston. Tel. 25322  
W.A.: Athol M. Hill, 613-615 Wellington Street, Perth. Tel. 21 7861

## PHOTOELECTRIC PICKUPS ANNOUNCED

New developments in gramophone pick-up design announced recently in Japan are two types of photoelectric cartridge and an integrated circuit cartridge.

Almost simultaneously, Trio Corporation and Tokyo Shibaura Electric Company (Toshiba) announced availability of photoelectric cartridges, representing a radical development in pick-up design. Both appear to use the same basic principles, and vary only in detail. This principle is illustrated in the diagram, which is from the Trio Corporation literature for their Supreme 20 cartridge.

The two photoelectric diodes are illuminated by a small lamp. Between the lamp and the diodes is a tiny screen, attached to the cantilever arm of the stylus. When the stylus is tracking a groove, the screen moves in response to the groove modulations, transmitted via the stylus arm. The movement of the screen between the lamp and the photoelectric diodes modulates the light reaching the diodes, and thereby varies their conductivity. The associated pre-amplifier, supplied with the cartridge in both cases, uses this characteristic to produce the left and right channel signal voltages.

A slightly different arrangement appears to be used in the Toshiba cartridge. In this unit, the light reaches the photosensitive elements through small slits in the screen.

The makers both claim superior performance for the new cartridge. The specification for the Trio Supreme 20 is certainly impressive:

Frequency Response: 20-20,000Hz  
Compliance: 25 $\mu$ cm/dyne  
Crosstalk: -30dB at 1000Hz  
Sensitivity: 500mV (5cm/sec.)  
Tip mass: 0.55 milligram  
Playing weight: 1 to 2 grams

No figure is given in the specification for distortion, but we understand it is of a very low order.

We have not seen a full specification for the Toshiba cartridge, but a description of the device from the company gives frequency response as 20-40,000Hz (no dB reference or tolerance quoted), compliance as 30 $\mu$ cm/dyne, and distortion as a mere 0.65 per cent (1KHz, 5cm/sec.). Playing weight is quoted as 1 to 1.5 grams. The cartridge will be marketed with a matching preamp unit which features a unique electrical playing-force indica-



The Trio Supreme 20 cartridge is encased in an integral head shell as illustrated.

tor to permit the user to adjust the cartridge for minimum distortion.

While the specifications are undoubtedly impressive, they do not appear to be better than those of many good quality magnetic cartridges, some of which are available at considerably lower prices than are currently being asked for the photoelectric types. The Trio unit is on sale in the U.K. for \$160 approximately, while the Toshiba device is said to be available in Japan for around \$78. If present price differentials are any guide, this unit also will sell for around the \$120-150 mark in overseas markets.

The second innovation from Toshiba is described as the C-300F "Mini" integrated circuit cartridge. This is said to be a piezoelectric type of cartridge but with the performance of the best moving coil types. Literature from Toshiba says that the company's scientists have developed a "super-miniaturised" element, and have also overcome the problems of placing an impedance converter near the generating element. The miniaturisation of the element has resulted in extended high frequency response, and the impedance converter overcomes the problem of transmission line losses at high frequencies. Again, only an abridged specification is quoted, and this shows frequency response as 20-20,000Hz, distortion as less than 1 p.c. and compliance as 20 $\mu$ cm/dyne. The cartridge, which is very much smaller than conventional types, will not be sold as a separate component, but only as part of a complete stereo record player. ■

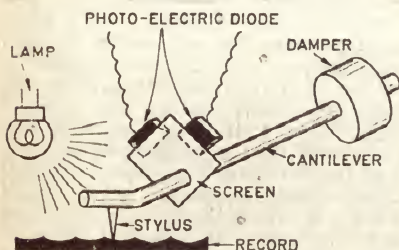

This diagram illustrates the operating principle of the Trio photoelectric cartridge.

## COMPLETE HI-FI RADIOGRAM-TAPE RECORDER ALL IN ONE

MODEL TR9



### AS AN AMPLIFIER . . .

- Frequency response, 20-20000 cps.
- 7 Watts RMS. output per channel.
- Distortion less than .25%
- Separate treble and bass controls.

### AS A RADIO . . .

- Being fully transistorised, can be switched on all day at full output without heat problems. Program can be recorded on tape without any external connections.

### AS A TAPE RECORDER . . .

- Freq. response 30-18000 cps.
- 3 speeds. Meter level indicator.
- Push button operation.
- Superimposing.

### PRICES:

2 track mono, \$159.00  
4 track mono, \$169.00  
4 track stereo, \$230.00

RADIO TUNER CAN BE FITTED TO ANY OF THE ABOVE MODELS FOR \$28 EXTRA.

### TAPE DECKS

for the home constructor.

COLLARO (Magnavox) tape decks complete with record/play and speed change switch wafers fitted . . .

2 tracks, \$48. 4 tracks, \$55.  
SPECIAL LOW IMPEDANCE HEADS for transistorised tape amplifier circuits. (Mullard) available.

### CLASSIC TAPE RECORDERS

93B LIVERPOOL ROAD,  
SUMMER HILL, N.S.W.  
Telephone 79-2618



# Classical reviews

By JULIAN RUSSELL

## Grumiaux in contemporary concertos

**STRAVINSKY** — Violin Concerto in D Major. Arthur Grumiaux and the Concertgebouw Orchestra conducted by Ernest Bour.

**BERG** — Violin Concerto. Arthur Grumiaux and the Concertgebouw Orchestra conducted by Igor Markevitch. Philips Stereo 802785LY.

I can imagine no two works in the modern style which make greater demands on a solo violinist than these. To be successful he must display breadth of interest, interpretative perception, and vast versatility, to say nothing of a dazzling technique, that would deter all but a very few contemporary violinists. I can state categorically that Grumiaux is spectacularly successful in both these concertos, each of which remains unchallenged in this century's literature for the instrument. To these I must, of course, add the Bartok. I am probably repeating what you already know when I write that Alban Berg, though one of the first to use atonal and sometimes serial methods of composition, was a romantic at heart — admittedly a hazy description but one which, for want of a better, is fashionable to use. And Grumiaux's is the only recorded performance I have ever heard — and I am not unmindful of the excellence of some of his rivals' — which does not overstate this aspect of Berg's music — an aspect which the composer himself would surely have deplored. I read somewhere that, despite the complexity of both the solo and orchestral parts, Grumiaux claims to be able to write out the full score from memory. His performance here supports this claim and moreover adds a dimension to the music that is missing in all the other performances, both live and recorded, that I have heard. He injects into the score a sweetness that is far removed from romantic extravagancies. And in the final apotheosis, where Berg introduces a Bach chorale, he achieves an ethereal quality that I found utterly compelling.

As to Grumiaux's technical accomplishments, these are in evidence from the very first bars. The orchestral part under Markevitch matches the soloist's moods in every detail and if some of the inside writing does not always emerge as clearly as Berg's marking of the score demands, I doubt if a more sympathetic reading exists. This last perhaps churlish criticism of mine does not accuse the engineer of clumsy recording but is due to the soloist being marginally loud enough to come between himself and the orchestra.

In the Stravinsky, when the orchestra is under the direction of Ernest Bour, no such problems exist —

or if they do, they have been solved so brilliantly that the balance between soloist and orchestra, and the internal orchestral balance, are always in perfect equilibrium. Stravinsky's wonderfully limpid scoring does much to make this much easier to achieve than in the more richly scored Berg. Every facet of Stravinsky's gem-like writing shines with its own internal light. And I can only describe the brilliance of Grumiaux's playing, articulated with well-nigh incredible accuracy and speed, as breath-taking. Yet every note receives its true value, not a single passage is slurred over, and the end result is a quite wonderful contrast to the Berg.

★ ★ ★  
**MAHLER** — Symphony No. 4 in G Major. Elsie Morison (soprano) and the Bavarian Radio Orchestra conducted by Rafael Kubelik. DGG Stereo 139339.

The year before last I wrote with considerable enthusiasm about Szelli's recording of this work with the Cleveland. I thought it unlikely that a competitor as successful as this one under review would turn up so soon. But it has and I find it difficult to recommend the one in favour of the other. All I can do is to describe briefly the differences you will find in the two performances. Not unexpectedly, Kubelik's interpretation is ever so slightly more genial than Szelli's without, however, degenerating into flippancy, even in the last movement, where the soprano sings of childish fantasies.

Engineering-wise, DGG have provided a slightly warmer acoustic than did CBS with a consequent enrichment of the sound. But here again I must stress that there is no bar in the Szelli version that sounds too cold or cerebral. Both orchestras play with complete dedication to and understanding of the composer's style. And both conductors are in complete sympathy with what is undoubtedly the happiest symphony Mahler ever wrote. For it was composed during one of the rare periods when he was happy in his work and health.

When I write that I enjoyed the Kubelik version by ever such a narrow margin better than the Szelli in the first three movements you might well think otherwise — with plenty of valid reasons. However when the Finale is reached I have no difficulty at all in preferring the DGG to the CBS. Elsie Morison sings beautifully and expressively for Kubelik. But compared to the shining innocence of Judith Raskin's singing for Szelli Miss Morison sounds ever so slightly too

sophisticated, too conscious of the childhood chatter Mahler has set so deliciously to music that is truly artless yet never arch. However I cannot imagine anyone going very far wrong by acquiring either, and for an example of two absolutely convincing but different readings by two great conductors both can be compared with profit by even the best informed musicians.

★ ★ ★  
**TCHAIKOVSKY** — Suite No. 4 for Orchestra ("Mozartiana").

**ROSSINI-RESPIGHI** — Suite ("Rossiniana"). Swiss Romande Orchestra with Ruggiero Ricci (violin) conducted by Ernest Ansermet. Decca Stereo SXL6312.

After Rossini ceased to write operas at a comparatively early age, and could afford to live very comfortably indeed on what they had earned him, he wrote many short pieces, most of them for pianoforte, and most of them undiscovered till after his death. Even today scholars are not sure how many of them still exist, guessing between hundreds and thousands. Respighi used a few in the phenomenally successful Diaghileff ballet "La Boutique Fantasque" in which he dressed them up in orchestral garb using the resources of a modern band and techniques. One of the Sitwells (I think it was Sacheverell) described — with arguable accuracy — the trumpet notes in the cheeky little Can-Can as the first example of modern writing. In any case it is an entirely enchanting suite.

In this new suite, "Rossiniana," Respighi followed much the same lines, but, as the sleeve-notes point out, it is "a more adventurous and colourful score, making use of a full orchestra with lavish percussion." The tunes are delightfully simple though ingeniously treated and the whole score has considerable allure. It is well played by the Swiss orchestra and the sound is first rate even by Decca's characteristically high standards.

I am much less keen on the Tchaikovsky which is not very good Mozart and does not represent Tchaikovsky at his best either. Its best feature is Ricci's contribution to a set of Brahms-like variations at the end. However, it is better than bearable and you might well find enough to charm you in the Respighi to influence you in favour of the disc.

★ ★ ★  
**BERLIOZ**—Requiem. Peter Schreier (tenor) with the Chorus and Orchestra of the Bavarian Radio conducted by Charles Munch. DGG Stereo 104-4969/70.

Berlioz's great "Requiem" must pose more problems for solution by recording engineers than any other work I can recall in the whole repertoire of symphonic music. Berlioz uses a very large orchestra throughout much of the work, and this is augmented in the Dies Irae by four brass bands—which should ideally be placed at the four corners of the orchestra—and, in this same movement, 16 timpani. There is also a chorus and, in the Sanctus, a tenor soloist. For a perfect performance it needs an auditorium the size of the Albert Hall in London, though even there the notorious echo proves a



considerable nuisance. The Sydney Stadium would be no better, in fact not nearly so good. To perform the work in the Sydney Town Hall would be so difficult that the project, although often considered, has been rejected.

But don't get the idea from these remarks that the whole work is just sound and fury. Indeed in only two of the movements does Berlioz deploy vast resources—the Dies Irae and the Lachrymosa. Elsewhere the scoring is of ravishing delicacy and sensitivity. I think DGG have done all that is possible even with the most modern and skilfully used recording techniques to produce a most impressive surge of sound from the speakers in the two movements mentioned above. It has both breadth and depth and in this way corresponds to Munch's reading, which has improved greatly since his 1960 recording of the work with the Boston Symphony.

The fact that he uses German singers and a German orchestra in no way handicaps his performance since he was (he died only a few weeks ago) Alsatian born, which means that he was brought up to enjoy the best of both French and German cultures. In any case, the text is in Latin so that there is no language difficulty to quibble about. In a work of this length it would be a miracle if every movement met with universal approval and I do not propose to carp at an occasional bar when the performance of the work as a whole is so rewarding. I must mention, however, that the tenor in the Sanctus, Peter Schreier, does not quite reach the general standard of excellence of the other performers. He has an oratorio-type voice often heard in English concerts where the standard is not of the highest.

Otherwise I can strongly recommend this new recording with one proviso. It is that Philips have plans to record all Berlioz' works this year under the direction of the very great English conductor of Berlioz, Colin Davis. Just when his recording of the "Requiem" will be issued no one can say at present. But it might be borne in mind if you wish to hear it first before committing yourself to the Munch.

★ ★ ★

**SCHONBERG**—Verklarte Nacht.

**WAGNER**—Siegfried Idyll.

**HINDEMITH**—Trauermusik.

English Chamber Orchestra conducted by Daniel Barenboim. EMI Stereo, OASD2346.

Barenboim's reputation as one of the best, if not the best, of the younger pianists is now secure. His recordings, whether they be of Mozart, Beethoven or Brahms are way up among the best available today and can be compared favourably to performances of the same works by pianists twice his age. Recently he has started to develop the same enviable reputation as a conductor and can be heard here in an excellent example of his skill in this field. In the "Siegfried Idyll" Barenboim enriches the original small Wagnerian orchestra by adding more strings — profitably to my mind. The resultant sound is very beautiful indeed and prompts one to speculate that Wagner himself would have approved. The work, you may recall, was specially written by Wagner as a present to



#### International Arm

The design features include, MAGNETIC BIAS COMPENSATION, MAGNETIC SUSPENSION, INVERTED JEWELLED UNI-PIVOT, OPTIONAL LATERAL and VERTICAL DAMPING PIVOT. The result of painstaking design and the incorporation of the very latest techniques has, we believe produced a pick-up far ahead of any available and one which is unsurpassed in its versatility and precision.

DECCA  
SPECIAL  
PRODUCTS

DECCA the world's  
leading manufacturer  
of records and the means  
of playing them

Other outstanding  
pick-ups include



Anti-Rumble  
Integrated  
pick-up arm

#### The Decca ffss Mk.4 cartridge

Cartridge with elliptical stylus for use in head shells fitted to arms other than the Decca ffss range



#### Magnetic Bias

An ingenious method of applying an anti-skating force to all current Decca pick-ups i.e. *Professional*, *Mk. 1*, *ARI* arms.



#### Stylus Cleaner

A soft-hair wheel cleans the stylus when the pick-up is in its rest position. Adjustable height for most pick-up arms. A must for all conscientious record collectors.



#### Microlift

Protect your records with this simple operation microlift which positions at any point. Easy to fit and adjust for most pick-up arms, not suitable for auto-changers.



DECCA

Sole Australian Agent:

**BRITISH MERCHANDISING PTY. LTD.**

Shaw House, 49-51 York St., Sydney. Telephone 29.1571 (3 lines)

# SONY-O-MATIC TC-210

**Take Everywhere!**



**Tape Everywhere!**

## SONY-O-MATIC TC-210 FEATURES

This new take everywhere . . . tape everywhere model is a dual track, dual speed, solid-state tape recorder for quality recording and reproduction. Refined styling with an elegant two-tone panel of black and silver make it a pleasure to use for home, business, on-the-spot recording, etc.

The SONY-O-MATIC system automatically adjusts the incoming signal to optimum recording level without any manual control . . . may be used by the 'inexperienced' with assured results.

This take everywhere . . . tape everywhere recorder is a ready-to-go portable—battery operated, lightweight, built-in carrying handle, full 5-inch tape reel capacity with lid closed. SONY-O-MATIC TC-210 will expand your enjoyment in tape recording.

Take everywhere . . . tape everywhere operates also on A.C. house current without external adaptor unit.

Remote control operation is provided by a convenient start/stop switch on the cardioid dynamic microphone. Take everywhere . . . tape everywhere . . . with the new, easy-to-operate SONY-O-MATIC TC-210.

## SPECIFICATIONS

Recording System: 2-track monaural. Power Requirements: D.C.: 6 V. A.C.: 110, 120, 220 & 240 V., 50/60 Hz. Reels: 5" or smaller. Tape Speeds: 3 $\frac{1}{2}$  i.p.s., 1 $\frac{1}{2}$  i.p.s. Recording Time: 1.5 hours in total at 3 $\frac{1}{2}$  i.p.s. (with 900' tape, 3 hours in total at 1 $\frac{1}{2}$  i.p.s.). Frequency Response: 100-7,500 Hz. at 3 $\frac{1}{2}$  i.p.s. Bias Frequency: Approx. 32 kHz. Power Output: 1 watt. Inputs: Microphone (1) Sensitivity: 0.195 mV. Impedance: 400 ohms. Line (1) Sensitivity: 0.0615 V. Impedance Approx. 150 kohms. Outputs: Monitor (1) Standard output level 0.775 V. (load impedance 100 kohms). Motor: D-006G. Speaker: 3 $\frac{1}{4}$ " x 6 $\frac{1}{2}$ " PM dynamic. Transistors: 7. Diodes: 5. Power Consumption: A.C. 5.4 W. Battery Life: 10 hours in continuous recording (with supplied batteries). Dimensions: 11 $\frac{1}{2}$ " (W) x 4 $\frac{3}{8}$ " (H) x 11 $\frac{1}{4}$ " (D). Weight: 8 lbs. 13 oz. without batteries. Standard Accessories: Microphone (F-25S), 5" demonstration tape, 5" empty reel, head cleaning ribbon, super batteries, power supply cord (DK-16). Optional Accessories: Battery pack (BP-8), telephone pick-up (TP-4S), earphone (ME-20 or CE-3), microphone mixer (MX-600M), foot switch (FS-5), microphone extension cord (EC-5R), carrying case (LC-2).

Also available  
**SONY-O-MATIC**  
**TC-505**

TAKE EVERYWHERE



TAPE EVERYWHERE

## FEATURES

- **Auto tape reverse**
- Accurate servo-controlled tape speed
- Automatic record level
- A.C./D.C. operation
- Simple and convenient take everywhere . . . tape everywhere operation.

# SONY®

Distributed by:

**jacoby, mitchell & co. pty. ltd.**

469-475 Kent Street, Sydney. 26 2651

Melbourne  
30 2491/2

Adelaide  
53 6117

Brisbane  
2 6467

To: Jacoby, Mitchell & Co. Pty. Ltd., 469-475 Kent Street, Sydney, 2000.

Please send me information on Sony Tape Recorders and nearest Sony retailer.

NAME.....

ADDRESS.....

JMS/3-69/EA469

his wife, Cosima, after the birth of their son, Siegfried, and was performed by a handful of musicians — the trumpet player was the great conductor Richter — under the window of their villa in Switzerland.

The Schonberg work was also originally composed for string quartet and it was the composer himself who elaborated it afterwards into the version played here. Its relationship to the Wagnerian school is patent at first hearing and Schonberg kept the scoring of the Tristan-like chromaticism beautifully limpid without any tendency to the thickening he seemed unable to avoid in most of his later works. This, too, is a performance at once ardent yet unselfish with the stamp of inspired youth all over it.

Readers may have noticed that I find it difficult to enthuse over much of Hindemith's music, but his "Trauermusik" here is an exception. It has great dignity, is superbly evocative, and the performance is enhanced by the playing of a lofty viola solo by Cecil Aronowitz. The whole recital makes a disc that lovers of this kind of music should treasure for many years.

★ ★ ★

**MOZART—Clarinet Concerto in A Major. (K622).**

**WEBER—Clarinet Concerto in F Minor, Op. 73. Karl Leister and the Berlin Philharmonic Orchestra conducted by Rafael Kubelik. DGG Stereo 136550.**

I am not exaggerating when I write that I listened entranced to every bar of this delicious record. Leister has the gift of being able to produce an almost human tone on his instrument. His technique is impeccable and his phrasing always perfectly natural. The great Berlin Philharmonic, though its contribution is a modest one, plays exquisitely for Kubelik. The balance is faultless and the engineering absolutely faithful. What else is there to say about so perfect a disc? It is easy to point out the faults in a recording, much more difficult to write anything but superlatives when you come across one as good as this. All I can do is to urge you to listen to it, when I hope you will enjoy it as much as I did.

★ ★ ★

**MOZART — Piano Concertos (Complete). With the Concert Rondos in D (K382), and A (K386), the Double Concerto for Two Pianos (K.365), and the Concerto for Three Pianos (K.242). The London Symphony Orchestra conducted by Colin Davis, Alceo Gallera, and Witold Rowicki. Ingrid Haebler, solo pianist with, in the double concerto, Ludwig Hoffman; and, in the treble concerto, Ludwig Hoffman and Sas Bunge. Phillips Stereo S-C75AX200. (Twelve records).**

This is a massive issue because it contains, in the same very large box, not only every one of Mozart's 21 Piano Concertos but also the Concert Rondos in D and A, the Concerto for Two Pianos and the one for Three Pianos. Ingrid Haebler plays all the solo Piano Concertos with the London Symphony and the conducting is

shared between Colin Davis, Alceo Gallera and Witold Rowicki. In the double concerto she is joined by Ludwig Hoffman, and in the Triple by Hoffman again and Sas Bunge. Many of these concertos have been issued in integral recordings on previous occasions, but never before in so compendious a form.

Miss Haebler's Mozart playing is nowadays well known to most Australian concert-goers — she has made two tours here for the A.B.C. — and to record buyers. I admire her style enormously. While never pugnacious she is never too reticent and uses her facile technique at the service of the music rather than for personal advertisement. Moreover she restricts her dynamic range to make Mozart, played on a modern concert grand, sound as much as possible like the narrower dynamic band of the instruments of Mozart's day. Her touch is limpid, her articulation fluent, her phrasing inflected to match the proportions of the various concertos. Importantly, she also uses her left hand with as much scrupulous attention to phrasing and dynamic inflections as her right — a point which many other otherwise admirable Mozart players forget.

In acquiring this set, most collectors will, of course, find that they already own performances of some of the concertos played by other fine pianists, some of whose readings they might even prefer to Miss Haebler's. It would be impossible to present such a vast oeuvre without some of the contributions having their disappointing bars, or even movements. But, to me, Miss Haebler's playing is of a consistently high standard throughout this marathon effort.

Orchestrally, too, the playing is admirable. And though all three conductors provide excellent accompaniments I ever so slightly prefer those of Colin Davis, who seems to have the knack of persuading Miss Haebler to give a little more to him than she does to the other two. But this is not to be taken as disparaging the readings of the other two. They are also fine. But Davis is just marginally better.

What does the owner do with a box containing 12 discs. To sit down and

play them through at one, two or even three sittings would be impossible. But to have them all there whenever one wants them must always be a boon, and I had no difficulty at all in listening to three or four of the concertos at a sitting, with no more than a few minutes interval between each. Another point — even the knowledgeable record buyers might find some of the concertos new to them.

★ ★ ★

**LEONTYNE PRICE — Prima Donna. Vol. 1. Arias by Purcell, Mozart, Verdi, Meyerbeer, Massenet, Cilea, Charpentier and Barber. RCA Stereo LSC8007.**

**Vol. 2. Arias by Handel, Mozart, Weber, Verdi, Boito, Debussy, Giordana, Zandonai and Puccini. RCA Stereo LSC80018.**

You can enjoy much lovely singing in both these recitals, each of which is on a single disc in a box with English and original language texts of the different items. All but one of the songs in the first recital will be well known to almost all classes of music lovers and all are deliciously sung. There is only one novelty, "Do Not Utter A Word" from the opera "Vanessa" by the American composer, Samuel Barber. Purcell is represented by "When I Am Laid To Earth" from "Dido and Aeneas"; Mozart by "Dove Sono" from "The Marriage of Figaro"; Verdi by "Addio del Passato" from "La Traviata" and the "Willow Song" from "Otello"; Meyerbeer by "On My Knees, Son of the Sun"; Massenet by the "Table" aria from "Manon"; Cilea by an aria from his "Adrienne Lecouvreur" and Charpentier by "Depuis le Jour."

This last I found the only slightly disappointing contribution to the recital.

Unusual items in the second recital are "L'Altra Notte in Fondo al Mare" from Boito's "Mephistofele" and Zandonai's "Paolo, Datemi Pace" from "Francesca da Rimini." The other pieces, though better known, are all delivered with a freshness that will compensate for what might be overexposure.

(Continued on page 108)

### "FIRST FOR QUALITY IN HI-FIDELITY"

We stock and recommend "TEAC" amplifiers, loudspeakers and tape recorders. In addition we stock a wide range of the world's highest quality audio components — Leak, K.E.F., A.D.C., Wharfedale, Goodmans, Kenwood Sansui, Labcraft, J.H., Sony, Peak, Goldring, Shure, Revox, Tandberg, etc.

**STEREO SOUND SYSTEMS**

PTY. LTD.

304 CHAPEL STREET,  
PRAHRAN, VIC. 3181.  
51-3998.

To STEREO SOUND SYSTEMS PTY. LTD.  
Please forward information and prices on the following items.

Name .....

Address .....

AMPLIFIERS — PREAMPLIFIERS — TUNERS — CONTROL UNITS —  
GUITAR UNITS — INSTRUMENTS — INVERTERS — CONVERTERS —  
RECEIVERS — TRANSMITTERS — REGULATED POWER SUPPLY —  
TRANSISTOR AND VALVE TYPES.

MAJOR STOCKISTS OF ALL GENERAL RADIO &  
ELECTRONIC COMPONENT PARTS — YOU NAME  
IT — WE WILL QUOTE.

## POPULAR KITS - TOP QUALITY - LOWEST PRICES

### INSTRUMENTS C.R.O.

1. 5in wide range.
2. 1963. 3in cal.
3. Audio.
4. 1966. 3in.
5. 1968—Audio.
6. Electronic SW.
7. W/band Preamp.

### MULTIMETERS and V.T.V.M.'s

8. 20K ohm/Volt protected M/M.
9. Probe for above.
10. Protected D.C. M/M.
11. Meterless V/meter.
12. A.C. Millivoltmeter.
13. A.C. Solid State Millivoltmeter.
14. Solid State A.F. Millivoltmeter.
15. Noise Distortion Millivoltmeter.
16. Standard V.T.V.M.
17. 1966—V.T.V.M.
18. 1968—V.T.V.M.

### BRIDGES

19. Standard R/C.
20. 1966. R/C.
21. 1968 R/C and Signal Injector.

### TV INST.'s

22. Sweep and marker Generator.
23. Dual sweep Gen.
24. Silicon diode sweep Gen.
25. Silicon diode noise Gen.
26. Pattern Gen.
27. Trans. pattern Gen.
28. Wide range pulse gen.

### AUDIO INST.'S

29. 1960 Audio Osc.
30. 1962 High perf. audio Gen.
31. Crystal locked std.
32. Electronic tuning standard.
33. 1965. Solid State audio osc.
34. Direct reading A.F. meter.
35. Sq. wave Gen.
36. 1967 transistor audio Gen.
37. Additive frequency meter.
38. A.F. tone burst gen.
- 38A. 1968. Solid state A.F. Generator.

### R.F. INST.'s

39. 6-band service oscillator.
40. Trans. wave meter.

### 40A 1969 Dip Osc. Solid state.

41. G.D.O. wide range.
42. G.D.O. adaptor.
43. Trans. service osc.
44. Simple signal injector.
45. Transistorised signal tracer.
46. Transistorised osc.
47. Basic test osc.
48. Transistor test oscillator.

### MISCELLANEOUS INST., ETC., KITS

49. 1960 Trans. Tester.
50. 1968 Transistor test set.
51. Valve and Transistor tester.
52. Electronic Stethoscope.
53. Moisture alarm.
54. Electronic Pistol range.
55. Transistor Gelger Counter.
56. Light beam alarm.
57. Burglar alarm.
58. Flasher unit.
59. Transistor alarm.
60. Electronic switch.
61. Photo Timer.
62. Direct reading impedance meter.
63. Electronic anemometer.
64. S.W.R. indicator.
65. Simple proximity alarm unit.
66. Pipe and wiring locator.
67. Electronic metronome.
68. Monophonic organ.
- 68A Keyless organ.

### BATTERY CHARGERS

69. Universal unit.
70. 1 amp unit.

### REGULATED POWER SUPPLIES

71. Transistor, 9v.
72. Transistor, fully protected supply.
73. 1966 H.T. unit.
74. 1968 lab. type, D-30v. supply
- 74A Simple Pwr. supply.

### VOLTAGE CURRENT CONTROL UNITS

75. Vari-watt unit.
76. Vari-tach. motor speed control.
77. 2KW auto-light dimmer.
78. 4KW auto. light dimmer.
79. Model train control unit.

### 80. Model train control unit with simulated inertia.

81. Above-hi-power.
82. No. 81 with simulated Inertia.

### TACHOMETER UNITS

83. 6 or 12v Std.
84. 6 or 12v Mullard.
85. 6 or 12v with dwell angle.
86. Tachometer and dwell angle unit for service stations.

### TRANSISTOR IGNITION

87. Ro-Fo. 6 or 12v.
88. Hi-Fire 6 or 12v. (transformer).

### POWER CONVERTERS

89. D.C.-D.C. 60w.
90. D.C.-D.C. 40w.
91. D.C.-D.C. 40w. 12v—input.
92. D.C.-D.C. 70w 12v—input.
93. D.C.-D.C. 100w 12v—input.
94. D.C.-D.C. 140w. 24v—input.
95. D.C.-D.C. 225w. 24v—input.

### HIGH FIDELITY AMPLIFIERS MONO UNITS

96. HI-FI 3.
97. Mullard 3.3.
98. Mullard 5-10.
99. Mullard 5-10 transistor.
100. Transistor 20w.
101. Transistor 60w.

### STEREO UNITS

102. Mullard 2-2.
103. Mullard (v) 3-3.
104. Mullard (t) 5-5.
105. Mullard (t) 5-5.
106. Mullard (v) 10-10.
107. Mullard (t) 10-10.
108. Philips Twin 10.
109. S.T.C. 10-10.
110. Wireless world transistor 20-20.
111. HI-FI 60-60.
112. Playmaster 2-2.
113. Playmaster 3 plus 3.
114. Playmaster unit 3.
115. Playmaster unit 4.
116. Playmaster 10 plus 10
117. Playmaster 101.
118. Playmaster (t) 105.
119. Playmaster (t) 113.
120. Playmaster (t) 115.
121. Playmaster (v) 118.

### P.A. UNITS

122. 10 watt std.

123. 25 watt std.
124. 35 watt std.
125. 30 watt (t).
126. 100 watt std.
127. stereo P.A.

### GUITAR UNITS

128. 10 watt std.
129. 25 watt std.
130. 35 watt std.
131. 50 watt std.
132. 70 watt (t).
133. Playmaster 102.
134. Playmaster 103.
135. Playmaster 40w. 116.
136. Playmaster 60w 117.
137. Guitar fuzz box.
138. Guitar Waa-Waa.
139. Reverb unit.
140. Guitar preamp.

### STEREOGRAMS

141. Playmaster 105.
142. Playmaster 106.
143. Playmaster 107.

### CONTROL UNITS

144. Playmaster No. 9.
145. Playmaster No. 10.
146. Playmaster No. 104.
147. Playmaster No. 112.
148. Playmaster No. 120.
149. Mullard 2v.
150. Mullard 3v.
151. Philips Miniwatt.
152. Wireless world stereo system unit.

### PREAMP UNITS

153. Transistor—Mono.
154. Transistor—Stereo.
155. Transistor—Silicon mono.
156. Transistor F.E.T. mono.
157. Transistor dyn. mic. mono.
158. Above-Stereo.
159. Playmaster 115 F.E.T. Stereo.
160. Playmaster 118 mag.
161. Sound projector.

### MIXER UNITS

162. Trans. 4 ch. (1966).
163. Trans—4 ch. (1967).
164. Valve—4 ch.

### TUNER UNITS

165. Playmaster u/style.
166. Playmaster No. 11.
167. Playmaster No. 114.
168. Playmaster No. 122.
169. Playmaster No. 123.
170. Philips Miniwatt.
180. Trans.—Long range.

### TAPE UNITS

181. Trans. Preamp.
182. Playmaster 110 (M).
182. Playmaster 110 (S).
183. Power Unit 110.
184. Adaptor 110.
185. Playmaster 119 Adaptor.
186. Transistor V.O.X.
187. Tape Actuated relay.
188. Mullard Trans Tape Amp.

### RECEIVERS

189. Fremodyne 4.
190. Fremodyne 4 R.F. Sock only.
191. Synchrodyne.
192. Communications RX.
193. Deltahet RX.
194. 3 Band Double Change S/het RX.
195. Explorer VHF Transistor RX.
196. Interceptor 5 Semi-Comm. RX.
197. 1967 All-Wave 2
198. 1967 All-Wave 3
199. 1967 All-Wave 5
200. 1967 All-Wave 6
201. 1967 All-Wave 7
202. Transpota 7
203. Transistor 3 Band.
204. 3 Band 2V RX.
205. 3 Band 3V RX.
206. Interstate 5
207. Versatile Mantel Set.
208. All-Wave Transistor 3
209. A.B.C. 3
210. 1968 F.E.T. 3

### TRANSMITTERS

211. 144 MHZ 50W. Linear Final.
212. 144 MHZ 20W.
213. 144 MHZ 75W.
214. 144 MHZ 18W.
215. 144 MHZ S.S.B.
216. 3 Band A.M.
217. Basic 3 Band.
218. 5 Band. S.S.B.
219. 1967 S.S.B.

### CONVERTERS

220. 50 MHZ.
221. 144. MHZ.
222. 50 and 144 MHZ Crystal Locked.
223. 1965 S/W.
224. 1965 S/W 2 Band.
225. 1966 3 Band.
226. Basic S/W.

### V.F.O. UNITS

227. Remote Unit.
228. 7, 8 and 9 H.F. and V.H.F.
229. All transistor.

Phone 63-3596

**E. D. & E. (SALES) PTY. LTD.**  
232 FLINDERS LANE, MELBOURNE, VICTORIA

Phone 63-3596

**K  
I  
T  
S**

Public Address Units — Geiger Counters — Metal Locators — Decade Boxes — Mixers — Battery Chargers — Oscillators — Bridges — Parts Supplied for Projects in Electronics (Aust.), Wireless World, Practical Wireless, Electronics World, Electronics Illustrated, Practical Electronics, etc.

**K  
I  
T  
S**

**SOLID STATE DIP OSCILLATOR**  
FEB., 1969



**SOLID STATE V.O.M.**  
DEC., 1968



**ELECTRONIC ORGAN**  
JAN., 1969

**MULLARD STEREO 3-3**

Full kit . . . . .

(As per Mullard leaflet).

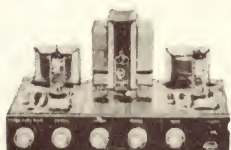

1968 Solid State. V.T.V.M.  
ELECTRONICS (Aust.), Dec., 1968.

**BATTERY CHARGER 1A**  
ELECTRONICS (Aust.), Feb., 1966

**PLAYMASTER 116 and 117**  
GUITAR AMP.

Electronics Australia  
June 1967 — 40 watt  
July 1967 — 60 watt



**3-BAND SHORT-WAVE CONVERTER**  
ELECTRONICS (Aust.), May, 1966.

**LAB QUALITY**

Regulated Power Supply (0-30v)  
ELECTRONICS (Aust.), Sep-  
tember, 1968.

1966 R/C Bridge  
May, 1966.



**PUBLIC ADDRESS and**  
**GUITAR AMPLIFIERS**

10, 25, 50 and 100 watt  
units



**3-BAND DOUBLE-CHANGE RECEIVER**  
ELECTRONICS (Aust.), April, 1966.

1966 3in CRO  
ELECTRONICS (Aust.), May, 1966.

Playmaster 122  
Program Source.  
Electronics (Aust.),  
August, 1968.



**FOUR-CHANNEL AUDIO MIXER**  
ELECTRONICS (Aust.) Feb., 1966 & 1967

**3-BAND 3-RECEIVER**  
ELECTRONICS (Aust.), Nov., 1966.

**TRANSISTOR MILLIVOLT**  
**METER**

Electronics (Aust.),  
May, 1968.



Excellent frequency response. Low distortion figure. High input sensitivity. All controls self-contained. 10 watts per channel.



**Enjoy your**  
**leisure time**  
**and build**

Phone 63-3596

**E. D. & E. (SALES) PTY. LTD.**

Phone 63-3596

232 FLINDERS LANE, MELBOURNE, VICTORIA



**SHURE S M E**

## the best pick-up arm in the world

SHURE S.M.E. Precision Pick-up Arms offer all these features: • Choice of arms length Model 3009 (9") or Model 3012 (12") for still lower tracking error — of special importance with elliptical stylis • Low inertia • High precision ball races and knife-edge bearings for minimum pivot friction • Linear offset chosen for lowest distortion • Automatic slow-descent with hydraulic control • Bias adjuster, calibrated for tracking force • Exact overhang adjustment with alignment protractor • Precise tracking force from 1/5 grams applied without a gauge • Shielded output socket • Low capacity 4' connecting cable with quality plugs • Lightweight shell • Camera finish in satin-chrome gun-black and anodised alloy.

**MODEL 3009/S2 \$80.00\***

**MODEL 3012/S2 \$85.00\***

Contact your local Hi-Fi dealer or any of the following for more information:

N.S.W.: Audio Engineers, 342 Kent Street, Sydney.

W.A.: Athol M. Hill Pty. Ltd., 613-15 Wellington Street, Perth.

QLD.: Ron Jones Pty. Ltd., 7-9 Merton Road, Wolloongabba, Brisbane.

VIC.: Audio Engineers (Vic.), 2A Hill Street, Thornbury, 44-3295.

\*Recommended Resale Price.

**GORDON CROSSE — Concerto da Camera.**

**HUGH WOOD — Three Piano Pieces.**

**HARRISON BIRTWHISTLE — Tragoedia.** Edward Downes conducting Concerto da Camera. Lawrence Foster conducting Tragoedia. Record Society Stereo S/6287.

I must apologise for leaving my review of this interesting disc till so long after its first appearance in November last. Quite simply it got put on to the wrong shelf and was overlooked. It is Volume 7 of the World Record Club's "Music Today" series and features works by British composers. Of the three works offered, my favourite is Birtwhistle's "Tragoedia" written for flute, oboe, clarinet, bassoon, violin, viola, cello and harp. I found it a strange and fascinating exercise in chamber music composition. Birtwhistle combines his instruments to produce some novel sounds which can be enjoyed entirely on their own merits if one ignores claims in the sleeve notes that the music is aimed at "bridging the gap between absolute music and theatre music" whatever that might mean.

The work grows on one with every repetition though I must warn that it is unlikely to appeal to any but the most experienced listeners to avant garde music.

Easier to grasp are Wood's "Three Piano Pieces," especially when played so intelligently as by Susan McGaw here. In these pieces Wood exposes two chief allegiances, most importantly to Schonberg's Opus 11, and to a lesser degree the piano writing of Messiaen.

Even more accessible is Crosse's "Concerto da Camera," though it is perhaps the least original of the three. Crosse understands very well the instruments he is writing for — wind, percussion and solo violin — and places his music well within their normal registers. He composed the concerto when he was only 25 so that he might, since then, have developed a more personal style.

The engineering is first class and the disc should prove valuable to all interested in avant garde music.

★ ★ ★

**CHOPIN — 24 Preludes, Op. 28.**  
Prelude in C Sharp Minor, Op. 45.  
Prelude in A Flat Major, Op. Posth. Rafael Orozco. HMV Stereo HQS1125.

This new young pianist — he is 22 — has made a brilliant recording debut in this Chopin recital. Information on the sleeve tells that he was born at Cordoba, Spain, and was the 1st prize winner in the Leeds International Pianoforte Competition in 1966. Although he rocks his rhythms lightly with rubatos he pays unremitting attention to the purity of his music line. This means that though his playing lacks nothing of poetry it is never overburdened by languorous stretching of the tempos. His touch is clean rather than pearly though not without its own individual — and charming — characteristics. His technique is sufficiently assured to encompass everything he tackles in this recital with ease. But its primary charm to me was its delicious freshness, together with a recording which is the last word in fidelity.

# DOCUMENTARY

Drama and The Spoken Word  
Reviewed by Glen Menzies

**THE BALLAD OF JOHN AXON:** By Ewan MacColl and Charles Parker. Music by Peggy Seeger. Recorded in association with the B.B.C. The story of John Axon, G.C., and of the tradition of railway service for which he stands, told by his widow and his workmates and set into song by Ewan MacColl. ARGO Mono LP RG474.

Some time ago on this page I found much to praise in a Radio Ballad called "Singing the Fishing" which was a moving account of the lives of the herring fishermen in a remote part of northern Scotland. The MacColl and Parker team has made eight Radio Ballads altogether and interestingly enough "The Ballad of John Axon" was the first of them from as far back as 1958.

It was in the autumn of 1957 that the team was commissioned by the B.B.C. to prepare a documentary radio program about the life and death of driver John Axon who was posthumously awarded the George Cross for devotion to duty in a tragic railway crash earlier in that year. Obviously the team could not make a standard memorial tribute after such a time had elapsed, and so out of this assignment arose a new documentary form, the Radio Ballad. Even a decade later this is a most exacting form, dispensing as it does with the conventional narrator's voice and allowing the story to be told only in the words of the actual participants as recorded in real life. The songs which are heard throughout are closely integrated with these actuality recordings and are written in the folk song mode.

The story of how the form evolved is worth dwelling on for a moment. The producers originally journeyed to Stockton, where John Axon had lived and worked, to record conversations with his widow and work-mates, mainly as a background for a script and to provide a dash of local colour here and there in the program. They soon found, however, that the kind of material they were getting deserved to be used in an entirely different way. John Axon's neighbour, an engine-driver himself for 20 years, told them: "... the oild railwaymen—it was a tradition. It was part of your life, it went through—railways went through the back of your spine like Blackpool went through rock."

Then there is Mrs Axon telling of how she met and married John Axon. Also the men in the railway sheds and the wonderful real life background of highly authentic speech recorded on the footplate of the engine. This kind of authenticity was something that could never have been attained in a studio with actors reading a script.

The program was completely recast to become not only a tribute to one

man's devotion to duty, but also a tribute to a whole group of men and a way of life devoted to driving the great steam locomotives on the iron way. "Engine driving's got to be in your blood for a start. If it's not in your blood to stand the erratic hours you'll never stand the pace. The railway life, to my mind—to the proper railwayman—always comes first. it's in his blood."

Train watchers and steam locomotive fans will be particularly interested in the excellent booklet supplied, which apart from outlining the history of the making of the radio ballad also prints extracts and diagrams from the Ministry of Transport's report on the collision.

"The Ballad of John Axon" is a warmly human documentary with none of the usual earmarks of a first attempt, neither has it dated at all in the decade since its creation.

\* \* \*

**GREAT MEN OF SCIENCE: BENJAMIN FRANKLIN.** By Professor Julius Sumner Miller. A Disneyland Recording released in Australia through the World Record Club. Mono LP ME/2139.

Ever since his first "Why Is It So?" TV series in 1962, and right up to the present time, Professor Julius Sumner Miller has been a huge success with the children of Australia and more than a few adults too. This volatile, exciting, and at the same time, irascible American physicist is a communicator of the first order who has quite succeeded in his professed aim to "re-awaken scientific curiosity and the desire for scientific knowledge."

His demonstration experiments have made him internationally famous because of his fine sense of presentation, contagious enthusiasm and sense of drama guaranteed to "get in" even the most unscientific among us.

All very well with television cameras to help, but does it work in sound alone? Well, Professor Miller comes across on record with all his customary sparkle and at just the right speed, with the pauses well placed to allow important pieces of information to sink in.

This is a bright and stimulating profile of the life and times of a great man of science, Benjamin Franklin. Young listeners are told of the first lightning conductor on a house, the invention of bifocal spectacles, the experiments with the Leyden jar and the young Franklin as a printer. The little human touches are not forgotten either, including the vast array of aphorisms which appeared in his famous almanac. Who else but Sumner Miller could, in reciting some of these, make them sound so fresh

and new: "Never leave till tomorrow that which you can do today," "Early to bed and early to rise makes you healthy, wealthy and wise," "It is hard for an empty sack to stand upright."

Technically the voice recording is excellent, and the surfaces are the silent kind that we have come to expect from the World Record Club.

\* \* \*

**ROMEO AND JULIET:** Leonard Whiting as Romeo and Olivia Hussey as Juliet. Dialogue Highlights with Original Score Composed and Conducted by Nino Rota. Production by Franco Zeffirelli for Paramount Pictures. Original Soundtrack Recording. Capitol Stereo ST2993.

Producer-director Franco Zeffirelli after his successful screen adaptation of "The Taming of the Shrew" goes a step further in bringing Shakespeare to the multitudes with this film version of Romeo and Juliet. His most revolutionary step was in casting two real teenagers as the star-crossed lovers of the Shakespeare classic. As the cover note states; "... to challenge for all time the procession of fat Juliets and wrinkled Romeos." That seems to me to be something of an overstatement: I can think of plenty of attractive and appealing actors and actresses a few years older but with greater dramatic experience and better schooled in the Shakespearean language, who could have played the parts more convincingly. Listening to this album, of course, one is not so much concerned about how the players look, as how they sound, and Olivia Hussey and Leonard Whiting do sound young and ardent but lacking in vocal technique. The drastically close miking has made every breath larger than life, as well as exposing the voices far too much.

Side 1 of the album includes the Meeting of Romeo and Juliet (Act 1, Sc. 5) and The Balcony Scene (Act 2, Sc. 2). The young players do not make much of the "word-music" of Shakespeare's dialogue but nevertheless the urgency of their love and the tragedy of family quarrels is clearly delineated. As Franco Zeffirelli himself says; "They are like teenagers today. They don't want to be, but are involved in adult hates and wars."

About one thing there is no doubt, that is the quality of Nino Rota's musical score which, in many places, has a chamber music-like delicacy. The sound in the album is of the wide screen kind with many good stereophonic effects. □

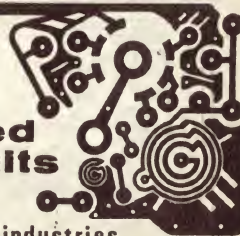

printed  
circuits

for all  
electronic industries

**PHOTRONIC**

515 PITTWATER RD. BROOKVALE N.S.W. phone 93 7664

# NEW Releases!

## IN HI-FI STEREO EQUIPMENT BY CLASSIC BASED ON THE PLAYMASTER 118 AMPLIFIER

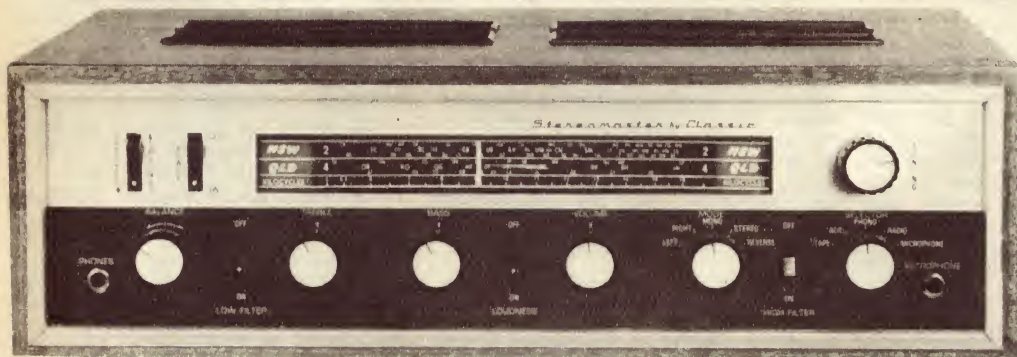

**MODEL C 300V**

**\$128.00**

FREIGHT EXTRA  
Dimensions 16½" x 5½" x 11"

This amplifier is based on the Playmaster 118 circuit as featured in "Electronics Australia" to which has been added the following features.

- Inbuilt high gain A.M. tuner with a coverage of 530 to 1,600 K.C.
- Loudness control giving bass boost at low volume.
- High and low filters (scratch and rumble filters).
- Provision for tape, record and play-back, with din connector.
- Provision for headphones with headphones-speaker switch.
- Input for microphone with jack on front panel.
- Calibrated dial available for all States.
- EM84 tuning indicator giving accurate tuning with ease.

POWER OUTPUT: 9 watts per channel R.M.S. FREQUENCY RESPONSE: 20 to 20,000 cycles incorporating Ferguson O.P.412 grain oriented output transformers. VALVES USED: 4-6GW8, 12AX7 or 12AU7, 6AN7, 6N8, EM84 and 2 silicon diodes.

CABINET IN OILED WALNUT OR TEAK WITH METAL TRIM.

(Cabinet and front panel of valve and transistor amplifiers with tuner are the same)

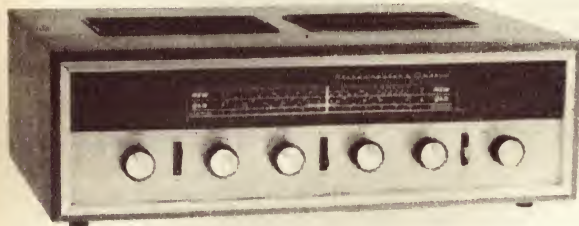

### MODEL C200V. BASED ON THE PLAYMASTER 118 WITH TUNER

Specifications as C300V but less high and low filters, headphone and microphone jacks.

Dimensions 16½in x 5½in x 11in.

CABINET IN OILED WALNUT OR TEAK WITH METAL TRIM.

**\$118.00**

FREIGHT EXTRA

## NEW AMPLIFIER AND TUNER BASED ON THE PLAYMASTER 107

107 AMPLIFIER AND  
TUNER  
**\$85.00**

FREIGHT EXTRA

- 107 AMPLIFIER
- Output 5 watts per channel (10 watts). Ferguson output transformers with a response of 30 to 20,000 cycles.
  - Valves used: 6AN7, 6N8, 2-12AT7, 2-6BQ5, and 6CA4 rectifier.



#### SPECIFICATIONS

- Inbuilt high-gain tuner with a frequency coverage of 530 to 1,600K.C.
- Two-channel tone control stage with separate bass and treble controls.
- Switching facilities for pick-up and stereo or mono tape recorder for record or play-back.
- Loudness control giving bass boost at low volume.
- Chassis plated and mounted in attractive metal case finished in grey with control panel in silver and black with matching knobs and switches.
- Dimensions: 13½in x 5¼in x 11in.
- Fully guaranteed.

The above amplifier supplied with the new Garrard 40 Mk II Changer with Sonatone ceramic cartridge and diamond stylus and two Magnavox 8WR or Rola 8CMX Hi-Fi speakers.

**\$132.00** FREIGHT EXTRA

# CLASSIC RADIO

245 PARRAMATTA ROAD, HABERFIELD, N.S.W. PHONE 798-7145



# NEW ALL TRANSISTOR STEREO AMPLIFIER ULTIMATE IN DESIGN-LONG DEPENDABILITY USING ALL SILICON TRANSISTORS



**MODEL C300A**

## SPECIFICATIONS

POWER OUTPUT: 12 watts per channel R.M.S. (24 watts total).  
 FREQUENCY RESPONSE: From 20 cycles to 20,000 cycles  $\pm$  1dB.  
 HARMONIC DISTORTION: Less than 1%.  
 HUM AND NOISE: Aux. 70dB, Mag. 50dB.  
 INPUT SENSITIVITY: Mag. 3mv. Aux. 150mv. Tuner 150mv.  
 EQUALIZED: Mag. RIAA.  
 TONE CONTROL: Bass 50c/s  $\pm$  12dB. Treble 10kc/s  $\pm$  12dB.  
 LOUDNESS CONTROL: 50c/s 10dB.

DIMENSIONS: 16 $\frac{1}{2}$ in x 5 $\frac{1}{2}$ in x 11in.

**\$110.00** FREIGHT EXTRA

SCRATCH FILTER: (High filter) at 10kc/s 9dB.  
 RUMBLE FILTER: (Low filter) at 50c/s 5dB.  
 PROVISION FOR TAPE RECORDER. RECORD OR PLAY BACK WITH DIN PLUG CONNECTION.  
 PROVISION FOR HEADPHONES WITH SPEAKER — HEADPHONE SWITCH.  
 INPUT FOR MICROPHONE WITH JACK ON FRONT PANEL.  
 THE CIRCUIT CONTAINS 24 SILICON TRANSISTORS PLUS 4 DIODES.  
 MOUNTED IN OILED WALNUT OR TEAK CABINET WITH METAL TRIM.

## C300 AMPLIFIER WITH INBUILT TUNER

The above amplifier can be supplied with an inbuilt A.M. tuner as illustrated on opposite page, with dial scale available for all States.

**\$130.00** FREIGHT EXTRA

### MULLARD MAGNAVOX MINI SPEAKERS

These units designed by Mullard and Magnavox engineers compare favourably with imported B/S Speakers costing more than twice the amount and are ideal where space is limited. Incorporates the Magnavox 6WR 6-inch Speaker and the new 3TC Mk. II tweeter frequency response, 50 to 18,000 cycles. Power rating max. 8 watts. Available in 7 $\frac{1}{2}$  or 15-ohm impedance.

Dimensions: 14in x 8 $\frac{1}{2}$ in x 8 $\frac{1}{2}$ in.

**\$27.00**

Post and Packing: N.S.W. \$1.50, Interstate, \$2.00.

## NEW BOOKSHELF SPEAKER SYSTEMS

### PLAYMASTER .4

Incorporates the new 6in Philips Speaker and Magnavox 3TC tweeter. Frequency response 45 to 18,000 cycles. Power rating 10 watts. Dimensions. 14in x 8in x 8in.

Available in 8 ohms only.

**\$36.00**

Post and Packing: N.S.W. \$1.50, Interstate, \$2.00.

### PLAYMASTER SUPER BOOKSHELF

Using two of the new Magnavox 6WR Speakers and one 3TC tweeter. Dimensions: 19 $\frac{1}{2}$ in x 10in x 8in.

Available in 15 ohms or 8 ohms.

**\$40.00**

Post and Packing: N.S.W. \$2.00, Interstate: \$3.00.

ALL SPEAKER UNITS FINISHED IN OILED WALNUT OR TEAK WITH SILVER TRIM

# CLASSIC RADIO

245 PARRAMATTA ROAD, HABERFIELD, N.S.W. PHONE 798-7145

# can you afford to buy anything less than SANSUI?

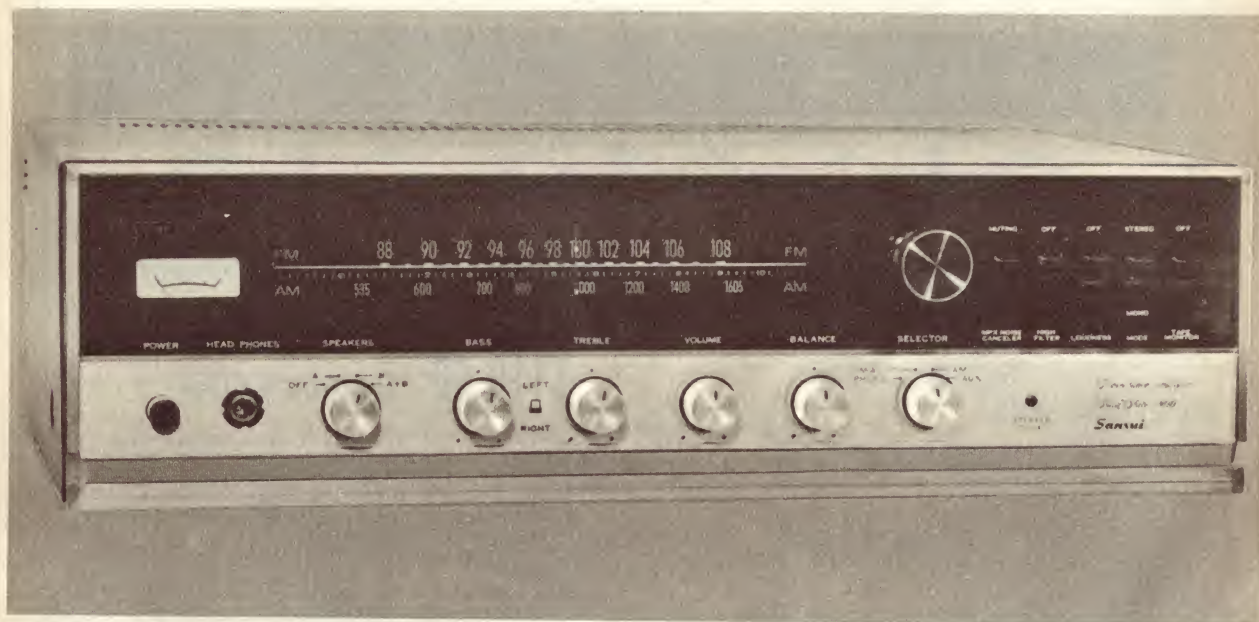

Illustrated this month: The new Sansui Model 800 Tuner/Amplifier. 70 watts music power.

Twelve months from now you will have forgotten precisely how much you paid for your Sansui Amplifier. Price will have become irrelevant. The only important factor in your mind will be how satisfied you are — how glad you paid that little bit more for the first class workmanship that has been put into your Sansui.

On the other hand, if you bought something that was a "bargain" and maybe only bought it because it was cheap, you will most likely regret it for ages. Measure it this way: Over a ten year period of enjoyment and complete satisfaction with your amplifier, is it worth jeopardizing all this to save a few dollars?

## 12 models to choose from

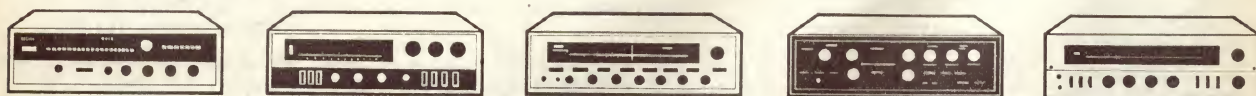

... and appearance wise they look what they are ... top performance combined with smart styling.

# SANSUI

Imported direct from Japan by: Magnecord International Pty. Ltd., Chapman House, 210 Clarence St., Sydney 2000. Tokyo Office: Tokyo Ginza Building 5-6 Chome, Ginza. Tokyo.

# VARIETY FARE

Reviews by: Neville Williams  
Harry Tyrer Forbes Cameron

## Devotional

**CHRIST THE LORD IS RISEN.** Sixteen different groups. Stereo, Word WST-8441-LP. (Distributed through Sacred Productions Aust. in all capitals.)

Interest: Easter themes.  
Performances: Good.  
Quality: Excellent.  
Stereo: Normal.

I have often wondered why record companies do not issue more albums like this one—based on a theme but performed by a number of different artists and/or groups. It can be listened to as a program without the tedium that sometimes builds up when listening to 10 or more tracks by the one performer.

In this imported American album there are 16 tracks, all to do with the Easter season, all well known and adding up to just over 37 minutes of playing time. Rather than list the titles in this case, it may be better to list the performers: Beth Farnum—Korean Orphan Choir—Jim Roberts, Norma Zimmer—Old Fashioned Revival Hour Quartet—Ethel Waters—Fague Springman—Scottish Festivals Of Male Voice Praise—Orchestra conducted by Hugh Ross—Crusader Men—White Sisters—MBI Glee Club—Ralph Carmichael Singers—J. T. Adams and Men Of Texas—Lutheran Hour Choir—Abilene Christian College Choir.

A sampler? In a sense it is, because all the artists are featured separately on the Word label. However, the performances are all first rate and are bound together by a common theme, making this an excellent choice for Easter family listening. Recommended. (W.N.W.)

★ ★ ★

**CLIFF BARROWS** Directs The Gospel Choristers. Songs from The Cliff Barrows Choir Book. Mono, Pilgrim JLP-142. (From Southwell Supplies, 176 Geelong Road, Footscray, Vic. 3001).

Interest: Radio choir.  
Performance: Smooth, unassuming.  
Quality: Good.

The name of Cliff Barrows is so commonly associated with massive Crusade choirs, or ebullient youth groups that it comes almost as a surprise to find him conducting a choir that is neither massive nor obviously youthful. It is, in fact, a radio-style choir featured frequently in the "Hour of Decision" broadcasts and, as such, will probably be well known to those who listen regularly to the particular program.

The hymns, all from Cliff Barrows' own choir book, are well known in evangelical circles; they are sung well

but simply, and with due attention to clarity of diction: All Glory To Jesus—Burdens Are Lifted At Calvary—That Day At Calvary—There's Room At The Cross—Turn Your Eyes Upon Jesus—So Send I You—Sooner Or Later—Heaven Came Down—Balm In Gilead—Surely Goodness And Mercy—Jesus Led Me All The Way—Jesus Is Coming Again.

In short, a straightforward, pleasant disc which should appeal particularly to those familiar with "Hour Of Decision" programs. (W.N.W.)

★ ★ ★

**SING PRAISES, Volume 2. Carols and Songs of Praise from The Cambridge Hymnal. Choir of King's College, Cambridge, conducted by David Wilcox. Stereo, World Record Club W.R.C.-S/4497.**

Interest: Settings new and old.  
Performance: Very capable.  
Quality: Good.  
Stereo: Normal.

Volume 1 of "Sing Praises" was reviewed in these columns in the March issue. Volume 2 uses the same cover design and the same credits but it does not, in fact, feature the Choir of King's College, as mentioned on the jacket and used for Volume 1.

While the music is apparently taken from the Cambridge Hymnal, it is presented by a number of different choral groups.

Side 1, devoted to festive music, features the Scottish Festival Chorus of the Edinburgh Festival, a finely trained group of Scotland's best male amateur singers, 340 in number and recorded in Episcopal Cathedral of St. Mary, Edinburgh. The titles: The Queen's Hymn—Twelfth Night Song

—Wondrous Love—He Shall The Broken Heart Repair—My Shepherd Shall Supply My Need—Experience Does Me So Inspire—Alleluia—Tallis' Ordinal.

Side 2 is entitled "Settings New and Old." It contains 10 bands but some of them are very brief. The Baccholian Singers (a group attached to King's College, Cambridge) present two American folk songs: "Sing, All Men" and "Poor Little Jesus." Other items on this side are "Sweet Day," "Simple Gifts" and "Never Weather-Beaten Sail," all by the Benenden School Choir.

"Alleluia," "A New Year Carol," "Deo Gratias" and "Chanticleer's Carol," are by A London Schoolboy's Choir, based on The Royal Opera House, Covent Garden. Finally, "The Water Stood Like Walls Of Brass" is sung by the Choir of Coventry Cathedral.

Like Volume 1, the album will appeal to those who have a broad interest in the development and variety of church music, as distinct from the performance of familiar anthems, hymns and songs. (W.N.W.)

★ ★ ★

**STORIES WITH A MESSAGE.** Rev. Roger Bush. Mono, Calendar (Festival) R66-567.

Interest: Stories For Children.  
Performance: Sincere.  
Quality: Well recorded.

Originally reviewed in the August, 1967, issue, this record has now been re-released on the economy Calendar label, suitably timed for the Easter season.

Well known in the Sydney area, Rev. Roger Bush recounts the story of the Passion, Crucifixion and Resurrection in terms which closely parallel the Bible record. This occupies the whole of side 1.

Side 2 is devoted to seven stories for children, in character resembling legends of fairy-tales, but each with a scriptural moral; hence the title of the album.

The narration is straightforward and sincere and, as I remarked on the previous occasion, "in a sympathetic home situation the children could well come to regard this as their record." (W.N.W.)

## ACOS

### REPLACEMENT CRYSTAL CARTRIDGES

Acos 90 Series — a brand new family of four pick-up cartridges, covering all the main types needed to-day, each fitted with Diamond Stylus at no extra cost.

GP91-1 Replaces GP67-1G MONO CRYSTAL	\$5.95
GP91-2 Replaces GP67-2G HIGH OUTPUT MONO CRYSTAL	\$5.95
GP92 MONO CERAMIC	\$6.55
GP93 Replaces GP73-2A STEREO CRYSTAL	\$7.55
GP94-1 Replaces GP81 STEREO CERAMIC	\$7.95
GP94-5 STEREO CERAMIC FOR TRANSISTOR AMPLIFIERS	\$8.95

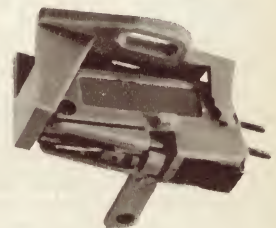

fitted with  
**DIAMOND**  
Stylus at no extra cost.

TECHNICAL DATA SHEETS SENT FREE ON REQUEST

Sole Australian Agents:

**AMPLION (A'SIA) PTY. LTD.**

29 Majors Bay Rd., Concord,  
Sydney, N.S.W. Phone 73 1227

# HIGH FIDELITY

THE name is

# GOODMANS



**MAXAMP 30** is a fully transistorised stereophonic High Fidelity Amplifier using Silicon Transistors throughout. It is precision engineered and fullest use is made of printed circuits. It will deliver continuously up to 15 watts of power on each channel and it looks as good as it is. Its polished wood cabinet with 'Danish Silver' scratchgrain control panel blends with any decor.



**MAXIM.** The ORIGINAL and unequalled High Fidelity Loudspeaker mini-system. Complete full-range Hi-Fi reproduction (45-20,000 c/s)—yet within shoe-box size and handling 8 watts. Meticulously finished enclosure in hand rubbed Teak or Walnut. 10½" x 5½" x 7¼"

## FULL RANGE SINGLE UNIT LOUDSPEAKERS

8 inch



**AXIETTE 8**  
8"—6 watt

**TWIN AXIETTE 8**  
8"—6 watt



9½ inch

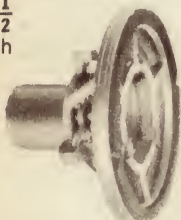

**AXIOM 80**  
9½"—6 watt

**AXIOM 10**  
10"—10 watt



10 inch

12 inch

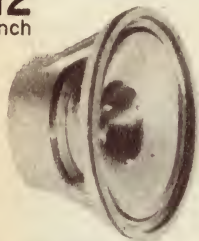

**AXIOM 201**  
12"—15 watt

**AXIOM 301**  
12"—20 watt

**TRIAxiOM 1220c**  
12"—20 watt

**TRIAxiOM 212c**  
12"—15 watt

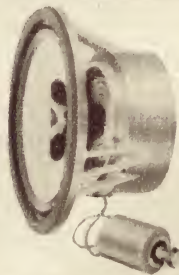

## BASS UNITS

12 inch



**AUDIOM 51 BASS**  
12"—15 watt

**AUDIOM 61 BASS**  
12"—20 watt

15 inch



**AUDIOM 81 BASS**  
15"—25 watt

18 inch

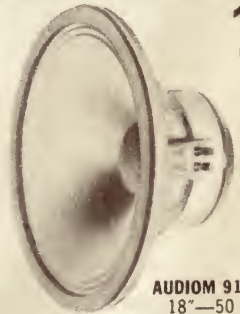

**AUDIOM 91 BASS**  
18"—50 watt

Standard Versions of all Audiom speakers are available for Public Address work and Musical Instrument amplification (Electric guitars etc.)

## GOODMANS MULTIPLE SPEAKER HIGH FIDELITY SYSTEMS

For a very low distortion, high sensitivity loudspeaker system choose a Goodmans 3-way system, employing an Audiom Bass unit, and pressure-driven horn-loaded Midax mid-range and Trebax high frequency units, with crossover network and attenuators.



**TREBAX 100**  
Range:  
2,500-20,000 c/s  
25 watt

**TREBAX 5K/20XL**  
Complete  
with XO and  
attenuator.  
Range:  
2,500-20,000 c/s.  
20 watt

**MIDAX 650**  
Range:  
650-8,000 c/s.  
25 watt.

**XO/950/5000**  
Crossover  
frequencies:  
950 and  
5,000 c/s.

**XO/950**  
Crossover  
frequency:  
950 c/s.

**XO/5000**  
Crossover  
frequency:  
5,000 c/s.

**ATTENUATOR**  
8-step

● Impedance of each speaker is 15-16 ohms, unless otherwise stated.

Each of the six loudspeakers in this range covers the full audible frequency range, and mounted in an enclosure of the correct design each is a complete High Fidelity system. There is a unit to suit every requirement—amplifier output, room size, pocket and personal taste—from the economical Axiette 8 and TwinAxiette 8, through the more powerful Axiom 10 and Axiom 201, the Axiom 301, the world's most advanced twin cone 12" speaker, to the connoisseur quality hand-built Axiom 80 transducer and the triple element Triaxiom 1220c and 212c with built-in Treble control.

If you choose an Axiom 201, 301 or 10, the unit's performance can be further enhanced, if desired, by the later addition of Trebax High Frequency and Midax Mid-range units.

## GOODMANS LOUDSPEAKERS LTD

AXIOM WORKS · WEMBLEY · MIDDLESEX · ENGLAND

Sole Australian Agents: **BRITISH MERCHANDISING PTY., LTD** · 49-51 York St · Sydney · N.S.W. Telephone: 29 1571

**A MIGHTY FORTRESS.** Mahalia Jackson. Arranged and conducted by Marty Paich. Stereo, CBS SBP-233559. Also in mono, BP-233559.

Interest: Famous Gospel Singer.  
Performance: Negro style.  
Quality: Good.  
Stereo: Normal.

Mahalia Jackson has a tremendous reputation as a Gospel singer but that doesn't mean that she will have an automatic appeal to all those who like hymns and Gospel songs. As a Negress, she interprets the numbers with all the emotion and passion of her race, and with the mannerisms that characterise such interpretations.

The first two numbers, "A Mighty Fortress" and "Be Still My Soul,"

come nearest to being straight presentations. These are followed by an up-tempo "Power In The Blood" and then by the slowest interpretation I have ever heard of "I'd Rather Have Jesus." "Roll, Jordan, Roll" is as one would expect.

Side 2 opens with an emotion-charged "Sweet Hour Of Prayer," followed by "Good News, The Chariot's Coming" and "All Is Well." Track 4 is "It Is Well With My Soul" also sung very slowly. Track 5 reverts to the opening style, a fairly straight presentation of "All Hail The Power Of Jesus' Name," with orchestral backing.

There is no doubting Miss Jackson's sincerity and interpretive skill. It's all a question of idiom. Some will enjoy the performance; others will dislike it just as deeply. (W.N.W.)

## Instrumental, Vocal & Humour

**A TREASURY OF VIENNESE OPERETTA.** Highlights of four operettas (four L.P.s). World Record Club Stereo S-4449/52.

Interest: As per title.  
Performance: High standard.  
Quality: Excellent.  
Stereo: Normal.

The four operettas represented in this four-disc set are: Gipsy Princess (Kalmann)—Countess Maritza (Kalmann)—Gipsy Love (Lehar)—The Czarevich (Lehar). These have perhaps declined in popularity in recent times, and I think most people would agree with me that they are not to be compared with Lehar's "Merry Widow" or Strauss' "Fledermaus" whose popularity is still unimpaired. Nevertheless, they contain a wealth of charming melodies, and when sung by a top-ranking cast, as here, they are very pleasant listening.

The cast is basically the same as is to be found in the World Record Club releases of the "Merry Widow" and "Fledermaus," with soprano Margit Schramm in the leading role in each work, supported by Dorothea Chryst, Rudolf Schock, Ferry Gruber, Renate Holm, Klaus Lang, with the chorus of the German Opera, Berlin, the Gunther Arndt Choir and the Berlin Symphony Orchestra, conducted by Robert Stolz. This very strong and experienced cast present eminently satisfactory performances in each case, and has been very well recorded. The set comes in a strong box with a single-fold leaflet, giving a synopsis of the plots. The operettas are sung throughout in the original German, but because of copyright problems it has not been possible to provide English translations of the librettos. (H.A.T.)

★ ★ ★

**ROMANTIC OVERTURES.** The Vienna Philharmonic Orchestra conducted by Karl Munchinger. Decca (E.M.I.) Stereo SXL 6320.

Interest: Lesser known overtures.  
Performance: Delightful.  
Quality: First class.  
Stereo: Well spread.

One becomes so used to seeing the same overtures coming up time and again in discs of this sort that it is a welcome relief to find some of the lesser known ones in this selection:

Preciosa (Weber)—Genoveva (Schumann)—Overture in D (Schubert)—Anacreon (Cherubini)—Calm Sea and Prosperous Voyage (Mendelssohn). Of these, only the Mendelssohn has been recorded at all consistently and I am willing to bet that for many people this will be first hearing of the others. They are all delightful works, easy on the ear and replete with fine melodies, and they are splendidly played by the fine Vienna Philharmonic Orchestra. The strings of this orchestra are particularly good to hear and they have many fine moments where they can demonstrate their precision and tonal quality. A very pleasant disc. (H.A.T.)

★ ★ ★

**HELLO, DOLLY!** — New Broadway Cast with Pearl Bailey. RCA Stereo LSO-1147 (also in mono).

Interest: New recording of popular show.  
Performance: Enjoyable.  
Quality: Adequate recording.  
Stereo: Adds little.

In the autumn of 1967, David Merrick presented a new edition of "Hello, Dolly" on Broadway. This followed the highly successful production starring Carol Channing which had run from 1963. Dolly's music and lyrics were written by Jerry Herman and the show was directed and choreographed by Gower Champion.

This new all-coloured cast included Pearl Bailey as Mrs Dolly Gallagher Levi, Cab Calloway as Horace Vandergelder and the very talented young jazz singer, Emily Yancy, as Irene Malloy.

Pearl Bailey and Cab Calloway are, of course, two of the most distinguished names in show business with a string of Broadway shows, films, television shows and major club appearances to their credit. Pearl Bailey, indeed, dominates most of the numbers on the album, particularly on the two big hits from the show, "So Long Dearie" and "Dolly" itself.

I have not yet seen "Hello, Dolly!" on stage, nor have I heard the original L.P. with Carol Channing. But I would be surprised if this version does not compare favourably with the original cast.

The playing time is 46 minutes. (T.F.C.)

**OLIVER!** Lionel Bart. Original soundtrack recording from the Columbia Pictures film. Arranged and conducted by John Green. Stereo, RCA Victor COS-5501.

Interest: Music from the film.  
Performance: Top Line.  
Quality: Excellent.  
Stereo: Normal.

Undoubtedly the greatest incentive to buy an album like this is to repeat the pleasure of a show that one has enjoyed. And logically, the album one is most likely to enjoy is the original cast or soundtrack version, as the case may be. That is, provided it has no

## NEW EQUIPMENT CABINETS



MODEL 154

With lift-up lid over player. Sliding door in front of amplifier compartment. Large storage space with four separators. Size: 36in wide, 17½in deep, 31in high.

	Price
Made and polished . . . . .	\$57.00
Packing . . . . .	\$2.20
Kit of Parts . . . . .	\$35.50
Packing . . . . .	\$1.40
Teak . . . . .	Extra \$6.50

New Player Platform model 175 is 16in x 14in x 3½in. Price \$7.50 for maple or walnut. Kit of parts \$4.00. Teak 50c extra. Perspex cover, 5in high, \$8.20 and \$1.50 extra if required hinged. Please specify cutout required.



MODEL 186

New Player Cabinet model 186 is 9in high, 17in wide, 16½ deep and 5½in above shelf. Finished with attractive hinged, tinted perspex top. Price: \$20.00 for maple or walnut.

Kit of parts: \$13.50.

Teak: \$1.00 extra.

Height of this model can be increased to take various amplifiers. Tailored cut out. Ask for quotation. Free on rail.

Packing charge \$1 per order.

Write for Catalogue and Player Guide.

## H. B. RADIO SALES

Manufacturers of Quality Radio and Radio Furniture for 36 years.

103-105 Catherine Street, LEICHHARDT, SYDNEY.

Telephone 56-5580.

# SONY® FROM MELBOURNE'S

## LEADING TAPE RECORDER SPECIALIST



**Sony's** LATEST 4-TRACK STEREO RECORDER TC530



**SONY  
RESEARCH  
MAKES THE  
DIFFERENCE**



*JUST RELEASED! TWO SENSATIONAL ADVANCED TAPE-DECK MODELS!*

**FEATURES:** 4-track, 2-channel stereophonic and monophonic recording and playback • Newly developed precision solid-state circuitry using all silicon transistors • Wide range frequency response • Simple tape threading procedure with retractable pinch roller • Horizontal or vertical operation • 3 tape speeds, 7" reel capacity, dual VU meter for recording control, and automatic shut-off switch • Stereo headphone jack.

**FEATURES:** 4-track, 2-channel stereo/mono recording and playback • Professional three head system • True high fidelity due to high bias frequency and noise-free, low-distortion amplifier • Greatly extended frequency range (20-25000 Hz at 7½ ips) • Retractable pinch roller for trouble-free tape threading • Noise suppressor, vibrator-proof motor automatic shut-off switch • Stereo headphone jack.

*Check our amazingly low discount prices on the entire range of SONY*

# DOUGLAS TRADING P/L

Inc. City Hi Fi — Tape Recorders (Vic.) — BJD Electronics  
191 BOURKE STREET, MELBOURNE 3000—PHONE 63-9321

evident shortcomings and does not lose too obviously by comparison with other versions.

There need be no such fear about this particular recording.

It has any amount of atmosphere, adequate diction and generous orchestral support. The quality, too, is excellent.

On the two sides are fourteen tracks: Overture — Food, Glorious Food — Boy For Sale — Where Is Love? — You've Got To Pick A Pocket Or Two — Consider Yourself — I'd Do Anything — Be Back Soon — As Long As He Needs Me — Who Will Buy? — It's A Fine Life — Reviewing The Situation — Omm-Pah-Pah — Finale.

The album is packaged in a handsomely printed 4-page booklet-cum-jacket carrying scenes from the film in full colour, notes on the musical itself and, of course, track titles and cast. For those who have seen the film it will have sure-fire appeal but it should make good listening also for those who have not.

Recommended. (W.N.W.)

★ ★ ★

**THE WORLD'S GREATEST LOVE SONGS.** John Cacavas and his orchestra. Universal Record Club Stereo U-954.

Interest: Tunes from classics.  
Performance: Pleasing style.  
Quality: Good sound, some noise.  
Stereo: Normal.

The ten tunes in this selection all have their origins in the classics or the semi-classics of the Palm Court type repertoire. Several of these have fallen victim to Tin Pan Alley, and were provided with maudlin lyrics to become popular songs. However, most of them have escaped this fate, and for this reason, the title of this disc is misleading. In any case, they are presented here in straightforward Palm Court arrangements, without vocals, and I must say I much prefer them this way. In total, the disc is very pleasant to listen to, and can be recommended to those with a liking for light classics played by a smallish orchestra.

Included here are: Melody in F (Rubinstein) — Romeo and Juliet, Love Theme (Tchaikowsky) — Liebestraum (Liszt) — Theme from 5th Symphony (Tchaikowsky) — Moonlight Sonata, first movement (Beethoven) — La Paloma (Yradier) — Nocturne in E Flat (Chopin) — Polovtsian Dances, excerpt (Borodin) — Estrellita (Ponce) — Valse Bluette (Drigo). The orchestra plays these very competently, and the sound quality is very good, but there is a residue of tape hiss which is noticeable in quiet passages. Also, the review copy had some surface noise. In summary, a disc which buyers of light classics will enjoy, but not one for the more serious listener. (H.A.T.)

★ ★ ★

**TRUST IN ME.** Soul Flutes. A and M Records (Festival). Stereo SAML 932920 (also in mono).

Interest: For late-night listening.  
Performance: Pleasant but unexciting.  
Quality: Good clean sound.  
Stereo: Adds little.

This album features a new assemblage called Soul Flutes, with a soloist who, for some reason, is identified

only as The Fluteman. This must, I think, be Herbie Mann.

He and the other four flautists in Soul Flutes are accompanied by the usual highly competent A and M session men, including Herbie Hancock (piano), Eric Gale (guitar), Ron Carter (bass) and Grady Tate (drums).

The overall mood of this album is ideal for late-night listening and most of the tracks are gentle ballads like "Trust in Me," "Try a Little Tenderness," "Scarborough Fair," "In The Wee Small Hours" and Ralph Burns' beautiful composition "Early Autumn." Indeed, some contrasting material would have been welcome to break the monotony.

If you enjoy Herbie Mann's flute playing, particularly on ballads, you'll certainly enjoy this album. For other collectors, this is one album that could, I think, be ignored. (T.F.C.)

★ ★ ★

**THE PROMISE OF A FUTURE—**

Hugh Masekela. Festival Stereo SFL 933013 (also in mono).

Interest: African pop-jazz.  
Performance: Monotonous.  
Quality: Adequate recording.  
Stereo: Adds little.

Over the past two years or so, the 30-year-old South African trumpeter, Hugh Masekela, has become increasingly popular in America. (Perhaps to some readers, he will be better remembered as the former husband of the singer, Miriam Makeba.)

This album was released to feature and capitalise on Masekela's single of "Grazing In The Grass," which enjoyed huge success all over the world.

But, personally, I found that Masekela's trumpet playing and the unimaginative sound of his quintet became remarkably dull after a few tracks. Most of the eight numbers are curious hybrids of native African music and early 1960s modern jazz—for example, the music of the Adderley Quintet.

Masekela wrote three of the eight compositions and Miriam Makeba one other. The material, to my ears, is quite uninspiring, although someone more familiar with native African forms may appreciate some hidden subtleties in the music.

Hugh Masekela is a competent enough, if limited, trumpeter, but his group—and particularly the rhythm section—lacks shape and personality.

I would find it difficult to recommend this album to the general public but potential buyers should be warned that the playing-time is just over 30 minutes. (T.F.C.)

★ ★ ★

**BURNISHED BRASS.** The B.M.C.

Concert Band, conducted by Harry Mortimer. His Master's Voice (E.M.I.) Stereo OCS3650.

Interest: Brass band.  
Performance: Polished.  
Quality: Some distortion.  
Stereo: Normal.

"Burnished" is a synonym for polished, and that latter term is very appropriate to the playing of the B.M.C. Concert Band in this recording. Perhaps this is not surprising, as the band has a long history, having been formed in 1924, and since then has made numerous broadcasts, won innumerable contests and have undertaken many concert tours. Precision is



## A BREAKTHROUGH

IN ECONOMICAL, HIGH POWERED, PUBLIC ADDRESS AMPLIFICATION EQUIPMENT

Fully Transistorised. ——— 50 to 800 RMS Watts.

**FOR PRESTIGE SOUND SEE CLAYBRIDGE SOUND**

Secure your FREE, COLOURED CATALOGUE of our products & services.

**Claybridge**  
SOUND

163 CLAYTON RD. CLAYTON VIC. 3168 OR RING 544 6171

(CNR. DANDENONG RD.)

(ALL HOURS)

# RELIABLE

# RENDAR

## ELECTRONIC COMPONENTS

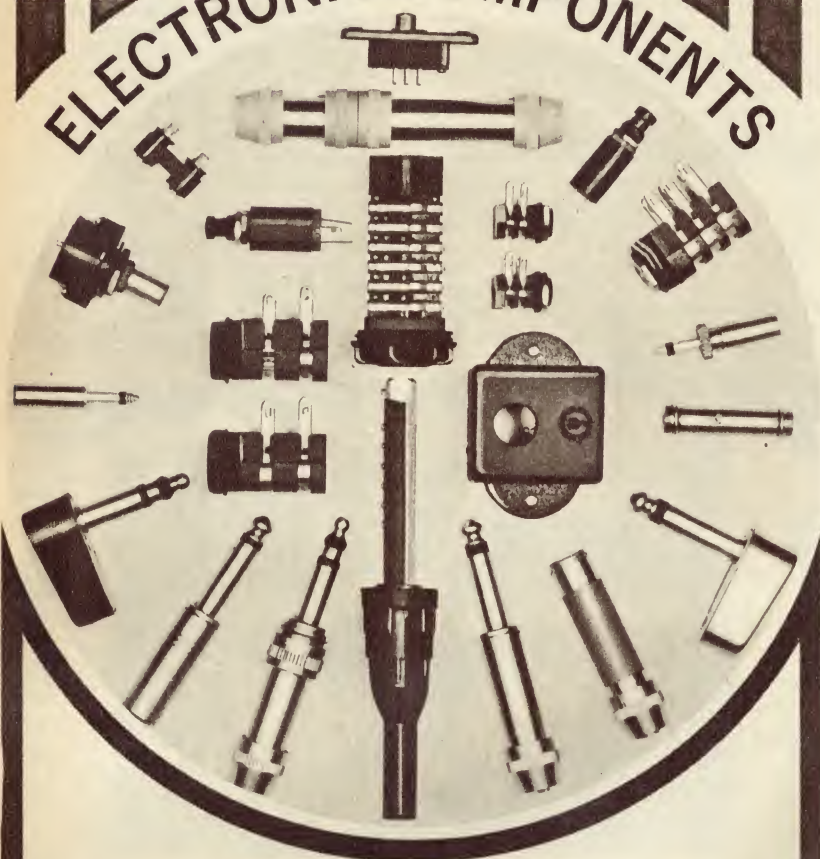

All Rendar electronic components can be relied upon to perform their function perfectly. And to prove this Audio-Lec guarantee them for a lifetime. Find out about the full range. Send for our catalogue of technical specifications and price list.



**OF AUSTRALIA PTY. LTD.**

**VICTORIA:**

33 Bridge Road, Eltham. 3095. Ph. 439 9415

**S. AUST.:**

TRUSCOTT ELECTRONICS

64 Hindmarsh Square, Adelaide. 5000. Ph. 23 3024

**N.S.W.:**

GEORGE BROWN & CO. P/L

267 Clarence Street, Sydney. 2000. Ph. 20 7031

CH381

a feature of their ensemble work, and the skill of their soloists is outstanding, as is amply demonstrated in the showpieces for the various instruments in this selection: Overture on Famous English Airs—Three Dale Dances—Hailstorm—Red Musketeer—Overture "The Bronze Horse" (Auber)—Rondo from Horn Concerto No. 3 (Mozart)—Fanfare Polka—Cornet Feature, "High Spirits"—Paperchase—The Padstow Lifeboat (Malcolm Arnold).

Individual feats of virtuosity which should be mentioned are the euphonium solo by Gareth Morgan in "Hailstorm"; the tenor horn solo by David Williams in the Mozart piece, and the work of a quartet of cornets in "High Spirits." The recording has captured a full, rich tone, and the stereo spread has been effectively used, but there is noticeable distortion on peaks in some tracks which may worry some people with high quality equipment. (H.A.T.)

★ ★ ★

**THE NESA CONCERT BAND**, conducted by Poul Ivan Moller. His Master's Voice Stereo OCS D 7671.

Interest: Salon music.

Performance: Competent.

Quality: Good.

Stereo: Normal.

Although the musicians playing here are all amateur, their performance is very competent, and is certainly of a high enough standard for the type of light fare offered. The selection of tunes is attractive enough, too, but the question arises "Who is going to pay \$5.75 for this disc, when for the same price they can get any of the world's great orchestras?" Frankly, I suggest not many. However, if the particular selection appeals, there is nothing wrong with either the performance or the technical side. The titles are: Entry of the Boyards—Manhattan Tower Overture—Tambou—Swedish Rhapsody—Jealousy—Reeds in Front—Brass woodwind Clique—Trumpet Holiday—Tango Americano—Hoopla—Alla Marci from "Karelia" (Sibelius)—Concerto for Trombone and Orchestra (Rimsky Korsakov). (H.A.T.)

★ ★ ★

**THE BEST OF FRANCIS LAI**, United Artists (Festival). Stereo SUAI 932911 (also in mono).

Interest: Film music.

Performance: Good themes, well played.

Quality: Superbly recorded.

Stereo: Well balanced.

Francis Lai is the exciting young French composer who scored the background music for the award-winning films, "A Man and a Woman" and "Live for Life." This album features some of the well-known themes from these two films and the anonymous studio orchestra interprets Lai's compositions and arrangements with great feeling and vigour.

Some of the tracks include the haunting "Man and a Woman," "Stronger Than Us" (with a very fine trumpet solo) and the powerful and exciting "Today It's You."

If you saw these two films and enjoy the dynamic and contemporary writing of Francis Lai, this album can safely be recommended. Unfortunately, the playing-time is only 28 minutes. (T.F.C.)



## Reader's Digest Album

**MAGICAL MELODIES FOR LISTENING, DANCING, RELAXING AND DINING.** Ten-record boxed set (plus bonus record in the review set) complete with normal jacket notes, brochure and slide-type program selector. **Reader's Digest/RCA Dynagroove. Stereo and mono.**

Interest: Top quality, top value.  
Performances: All excellent.  
Quality: Virtually flawless.  
Stereo: Generous, effective.

With eleven good quality L.P. discs in the one handsome box, this might almost qualify for the description "instant record library." There's certainly a lot of music on the 22 sides and for the collector who is interested in sound rather than specific performances, it represents very good value indeed.

Noted among the credits were the RCA Victor Symphony Orchestra, the London "Pops" Orchestra and a variety of other specialist orchestras and combos too numerous to list. There are duo-pianists, vocalists and harpists Marie Goossens and David Snell.

With an advertised "133 beautiful melodies" the titles are also far too numerous to list but the moods which have guided the choice and arrangement of numbers can be set out briefly: Dining by Candlelight — Just You, Just Me — Serenade for a Summer Evening — Cocktails for Two — In a Small Cafe — Soft Lights, Sweet Music — Piano for Dining and Dancing — Gipsy Violins — Tropical Nights — Lightly Latin — That Old Feeling — Manhattan Serenade — A Lovely Way to Spend an Evening — Goodnight Sweetheart — Cocktail Piano Time — Champagne Waltzes — Dinner Dancing — South of the Border.

The bonus record "In a Mellow Mood" features melodic guitars on the one side, mellow trombones on the other.

**YOU CAN'T SEE ROUND CORNERS.** Original soundtrack music, composed and conducted by Thomas Tycho. Festival Stereo SFL-933,141.

Interest: Local film music.  
Performance: Competent.  
Quality: Routine.  
Stereo: Normal.

Representing Thomas Tycho's most ambitious project to date, the musical score for the all-Australian film "You Can't See Round Corners" is most competently scored, with flashes of real inspiration. However, as with all film scores, much of the music has little meaning out of its film context. Nine of the thirteen tracks in this disc come into this category, leaving only four of genuine musical interest, namely the main theme which we are sure to hear many times on the radio in the weeks ahead; also "Marge's Theme," "Myra's Theme" and "Disco Theme" The last-named is a riotous rock number which will no doubt become a firm favourite with the younger set. The rest of the tracks, written to specific scenes in the film, will have more meaning to those who have seen it, but otherwise generate only mild interest.

Presumably the orchestra is made up of Australian musicians, and their



A novel enclosure with the album is a slide-type programmer made from cardboard. The listener nominates the occasion and pushed the card along until the appropriate definition appears in the window; it may be "easy listening," "perfect for dancing," "a continental dinner" or any one of a couple of dozen settings. Below the window appears two suggested programs, one of about 35-40 minutes' duration, the other twice as long, or more. It's a good idea, saving feats of memory, and putting to full use the varied potential of the twenty sides.

The overall pattern of the sound and arrangements follows the expected "Reader's Digest" middle-of-the-road formula, likely to fall easy on the ears of the greatest number of potential listeners.

Technically, it must be given top marks. I certainly didn't listen to all the tracks but it would not be exaggerating to say that in a fairly generous sampling, I did not detect one distorted note or one extraneous sound that might have indicated a pressing fault.

For a generous helping of pleasant, varied, middle-of-the-road music, recommended. (W.N.W.)

work here is of excellent standard. The sound is only of fair quality, with a certain amount of distortion in evidence, and only a restricted stereo spread. (H.A.T.)

★ ★ ★

**BOB RALSTON Playing The Great Movie Themes. Presented by Lawrence Welk. Stereo, Ranwood Records Inc. (Festival) SFL-933-123.**

Interest: Soft lights and sweet organ.

Performance: Smooth, pleasant.  
Quality: Normal.  
Stereo: Normal.

According to Bob Ralston, he chose the Thomas Electra organ for the weekly Lawrence Welk show because its sound most closely resembled that of the once popular "mighty Wurlitzer." In fact, for this album, Bob Ralston makes little attempt to demonstrate any such quality. Nevertheless, with well judged changes in registration, nice phrasing and beautifully blended support from a small rhythm group, he plays a dozen popular movie themes:

A Man And A Woman — When I Look In Your Eyes — Theme From Exodus — If Ever I Would Leave You — Born Free — Somewhere My Love

**LEADER  
TEST INSTRUMENTS**

## LBO-52B 5" OSCILLOSCOPE

### FEATURES

- \* Wide bandwidth with high sensitivity, DC-10MHz at 10mVp-p/cm.
- \* DC amplifiers for vertical and horizontal inputs.
- \* Highly linear wide sweep range with automatic synchronization.
- \* Vector pattern display for color TV circuits.

*New*



### SPECIFICATIONS

#### Vertical Axis

Deflection sensitivity  
10mVp-p/cm or better.  
Bandwidth, at -3dB.  
DC: DC to 10MHz.  
AC: 2Hz to 10MHz.

#### Horizontal Axis

Deflection sensitivity  
300mVp-p/cm or better.  
Bandwidth, at -3dB.  
DC: DC to 500kHz.  
AC: 2Hz to 500kHz.

#### Sweep Circuit

Frequency  
1Hz to 200kHz in six steps:  
H-TV at 15.75kHz/2.

#### Synchronization

INT + & -, EXT and LINE.

#### Size and Weight

10 1/2" x 8" x 16 1/2"; 24 lbs.

WHOLESALE ENQUIRIES ONLY  
TO SOLE AUSTRALIAN REPRESENTATIVE:

ASTRONICS AUSTRALASIA  
PTY. LTD.  
ALL STATES

# MASTERSOUND SOUND CELLAR

*Sydney's most popular Music Lovers' Meeting Place*

The Hi-Fi enthusiast is assured of a better choice of up to date equipment, reliable service and better prices. If you think of Hi-Fi or good tape recorders, think of MASTERSOUND.

## TAKE A LOOK AT THESE BARGAINS:

### AMPEX FULL TAPE RECORDER MODEL 800

Fully transistorised 3-speed tape recorder with 6 watts R.M.S. output per channel and big 4 track stereo. Another bargain at \$320.00 (speaker extra).

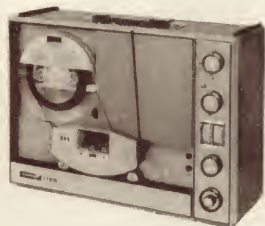

**MODEL 800**

**\$320**

**MODEL 1100**

**\$400**

### AMPEX FULL TAPE RECORDER MODEL 1100

A fully transistorised 4 track tape-recorder complete with speakers, bi-directional play back, 3 speeds, automatic reverse and automatic threading. A beautiful unit. List price \$545.00 but from MASTERSOUND our special cash price is only \$400.00.

### KENWOOD COMPACT MINOR

The amazing Kenwood 150 amplifier with Dual 1015 automatic record changer and famous Shure Magnetic Cartridge, \$240.00. YOU CHOOSE YOUR OWN SPEAKERS!



### KENWOOD COMPACT MAJOR

A Kenwood 250 amplifier, Dual 1009 player and Shure Magnetic Cartridge all housed in an attractive teak cabinet with cover. Plus the new Wharfedale "Denton" speaker system. A magnificent combination for only \$499.00. Or if you prefer team one of our many other speaker systems with this unit.

### GRILLE CLOTH

If your thinking of making your own speaker enclosure or just re-modelling your present set then see MASTERSOUND'S wide range of grille cloth patterns. B.A.F. wadding is also available.

**MASTERSOUND SALES PTY. LTD.,**

**400 Kent Street, SYDNEY. 29-1527.**

— The Sound Of Music — Watch What Happens — Somewhere — The Impossible Dream.

In short, twenty-three minutes of thoroughly pleasant organ mood music — a sound, a style and an instrument that I tip will sell more albums than this one. (W.N.W.)

★ ★ ★

**TOMMY GARRETT AND HIS 50 GUITARS, Universal Record Club Stereo U950.**

Interest: Guitars en masse.  
Performance: Relaxed.  
Quality: Very good.  
Stereo: Well spread.

Tommy Garrett and his 50 guitars have been featured on many releases in the past few months, and in general they have not made much impression on me. However, I found much to enjoy in this release through Universal Record Club. In the first place, the performers sound much more relaxed than in other discs, and the arrangements are not so aggressive. One is aware of this from the first track, where they present a most pleasing account of "Lara's Theme." This is followed by: Spanish Eyes — Cu-Cu-Rru-Cu-Cu Paloma — What Now My Love — Courtin' — Guantanamera — Anna — Michelle — Sway — If You Go Away. The recording is of high quality and in general the only complaint is the short playing time afforded by the 10 tracks—about 15 minutes each side. A good one for club members. (H.A.T.)

★ ★ ★

**THE OMSK RUSSIAN ENSEMBLE, CBS (Australian Record company) Stereo, SBP 233610.**

Interest: Siberian folk group.  
Performance: Unexciting.  
Quality: Poor.  
Stereo: Normal.

Recorded while the Omsk group was touring U.K., this disc will presumably appeal to those who saw the group perform during their Australian tour a few years ago, despite the loss of interest inevitable when a group relies largely on its visual effect on stage. The material is all Siberian folk music and it is pretty and effective, but to my mind not sufficiently so to hold its own in an L.P., unless you have a particular fondness for this type of material. Unfortunately it has not been particularly well recorded, and there is evident distortion in some passages. This is particularly noticeable in the inner tracks, which are cut very close to the label, to accommodate the long program (17 tracks in all, making a very generous playing time of around 50 minutes).

Except for a few minor interpolations in halting English, the Russian language is used throughout, and translations of only three of the lyrics are given on the sleeve. This must be accounted a drawback, since, in my experience, most people like to know what the songs are about when sung in a foreign language: The titles are: Intro, Act 1 — Malania — Sunset — Volga, Volga — How Could I — The Grass of Love — The Song of the Coachman — Green Fields — Moonshine — Intro, Act 2 — The Great Baikal Sea — My Hut — The Troika — Ryubinskinka — Willow Tree — My Husband — Omsk Polka. Of limited appeal. (H.A.T.)

**THE REAL PEARL — Pearl Bailey.**  
Project 3 Records (Festival).  
Stereo SPJL 932980 (also in mono).

Interest: The great Pearl Bailey — 1968.

Performance: Magnificent.  
Quality: Superbly recorded.  
Stereo: Perfectly balanced.

It is difficult to believe that Pearl Bailey is now 51. She has appeared in several Broadway shows including "St. Louis Woman" in 1946, "House of Flowers" in 1954-55 and recently "Hello, Dolly!"; films like "Carmen Jones," "St. Louis Blues" and "Porgy and Bess"; and on numerous TV shows and all the leading clubs in America and overseas.

Pearl Bailey is completely and intensely professional in all that she does and her voice is tigerish and implacably tough. Even at her most commercial — for she is primarily an entertainer — there is, I think, a great deal of the jazz singer in her.

In short, she is a great artist.

This album, which was recorded last year, provides a very good showcase for her remarkable personality. Her material includes standards like "Poor Butterfly," vaudeville numbers like "Ukulele Talk" and "I'm Gonna Keep on Doin'," and typical Pearl Bailey numbers like "He's Gone" and "Nobody."

Indeed, the only poor track on this thoroughly enjoyable album is "Tower of Strength," but for the remainder of the 33 minutes, she is on top form. The backing of her husband, Louis Bellson, is sympathetic and, as usual with Project 3 albums, the sound is quite remarkable. (T.F.C.)

★ ★ ★

**TIME, TIME.** Ed Ames. RCA Dynagroove. Stereo LSP-3834. Available in mono.

Interest: Popular vocals.  
Performance: Polished.  
Quality: Excellent.  
Stereo: Good spread.

The deep masculine voice of Ed Ames is allied with the polished technique of a veteran entertainer. Ed's choice of material is mainly the songs which were up the top of the charts a year ago, but those which could be destined to become evergreens. At any rate, they are all excellent tunes which make for very pleasant listening, particularly when sung as well as they are here, and backed by a fine studio orchestra. The tunes are: Time, Time — Michelle — Pretend — Somethin' Stupid — Here With You — Cabaret — One Little Girl at a Time — Wish Me a Rainbow — Love That Lasts Forever — Sunrise, Sunset — What the World Needs Now is Love. A record one can relax with in the evening. (H.A.T.)

★ ★ ★

**LANA!** — Lana Cantrell. RCA Dynagroove. Stereo LSP 4026 (also in mono).

Interest: Cantrell's fourth album.  
Performance: Her best so far.  
Quality: First-rate recording.  
Stereo: Good, even spread.

This is Lana Cantrell's fourth album for RCA and the third which I have reviewed in these pages within the space of a year. Regular readers will therefore know that I am not among

Miss Cantrell's more ardent admirers. On this album I still find her voice basically unappealing for reasons which I have detailed previously.

But it is, I think, her most impressive album to date, due mainly to superior material. Apart from the inclusion of "Honey" (the most nauseating composition of 1968 or any other year), the tracks include Paul Simon's "Sound of Silence," the Foundations' hit "Baby, Now That I've Found You," "The Fool On the Hill," by Lennon and McCartney, and some lesser-known but attractive songs like "Gentle on My Mind" and "The Music Played."

Once again, I enjoyed Chuck Sagle's dramatic and sympathetic arrangements but Miss Cantrell may do well to find some new writers for her next album before her backings become typecast. If Lana Cantrell's singing means anything at all to you, then this album can safely be recommended. The playing time is 35 minutes. (T.F.C.)

★ ★ ★

**HEATHER MCKEAN SINGS PATSY CLINE.** Festival Stereo SFL-933-061. Available in mono.

Few people would dispute Heather McKean's pre-eminence as Australia's leading female country and western singer and, judged purely on its merits, this disc is a very good effort. If this disc had been entitled something more general, such as "Heather McKean sings Country and Western," I think the tone of this review would have been one of general approbation. However, the coupling of the singer's name with that of Patsy Cline inevitably calls for comparisons, and good as Heather is, she cannot claim to be in the same class as the late and very much lamented Miss Cline. Heather has undoubtedly studied Patsy Cline's style closely before making this disc, and has achieved a fairly close imitation, including a quite unnecessary American accent. But the question is, why should anybody pay \$5.75 for this, when the real Miss Cline is readily available on discs, some of which are less than half the price.

If you can resolve this question to your satisfaction, and are still interested, the sound quality is of reasonable standard, if not outstanding, and the instrumental backing is good, although a little too prominent for my taste. The songs included are: Poor Man's Roses — Who Can I Count On — Heartaches — Walkin' After Midnight — Back In Baby's Arms — Crazy — Tra Le La Le La Triangle — I Fall to Pieces — You're Stronger Than Me — Three Cigarettes — I Don't Wanna — Faded Love. (H.A.T.)

★ ★ ★

**200 M.P.H.** Bill Cosby. Stereo, Warner Bros. WS-1757.

Interest: Popular comedian.  
Performance: Obviously went over.  
Quality: Good.  
Stereo: Not important.

Bill Cosby's particular brand of humour should be known to most by now. He just relaxes on stage with a microphone and chats about characters and situations that are common to a large cross section of an adult audience. Cosby has a good sense of timing and a flair for vocal sound effects but it is mainly his choice of

## LEADER TEST INSTRUMENTS

### LBO-31M 3" PRIMA-SCOPE

The PRIMA-SCOPE is a compact oscilloscope designed for all-around service. Its small and handy size will appeal to experimenters, servicemen and plant technicians who desire maximum performance with minimum space requirements.

*New*



#### SPECIFICATIONS

##### Vertical Channel

Sensitivity: 80mVp-p/cm, at 1kHz.

Response: -3dB. 3Hz to 1MHz.

##### Horizontal Channel

Sensitivity: 2.5Vp-p/cm.

Response: -3dB. 3Hz to 400kHz.  
(at max GAIN)

Sweep Frequency: 10Hz to 100kHz  
in 4 steps.

##### Size and Weight:

7" x 4" x 12"; 11 lbs.

WHOLESALE ENQUIRIES ONLY  
TO SOLE AUSTRALIAN REPRESENTATIVE:

ASTRONICS AUSTRALASIA  
PTY. LTD.  
ALL STATES

**LUX SOLID STATE STEREO AMPLIFIER — THE MODEL SQ-77TW — \$169**

Using silicon power transistors the SQ-77TW is rated at 30 watts R.M.S. in each channel with a 4-6 ohm speaker load. Frequency response is 10-50,000 Hz. plus 0, minus 3dB. Input sensitivity is 1.8mV for magnetic pickup or tape head, aux. Inputs being rated at 200 mV and 800 mV. Controls include stereo volume, stereo balance, mode switch, treble and bass (separate controls for each channel), input selector, headphone jack and switch, tape monitor switch, rumble and scratch filter switches, etc. **\$169**

**LUX MODEL SQ-505 SOLID STATE STEREO AMPLIFIER**

Rated at 30 watts R.M.S. per channel, the all new Lux Model 505 is a silicon transistor unit. Power transistors are designed to withstand temporary short circuits and overloading — overall frequency response is 10-50,000 Hz. plus or minus 1dB in the power amplifier and 20-50,000 Hz. plus or minus 2dB in the pre-amplifier. Controls and features include volume, balance, mode selector, treble/bass controls, filters, tape monitor, headphone jack, exclusive A/B speaker systems selector, etc. All in all the Lux SQ-505 is a very fine amplifier **\$259**

**THE NEW LUX SQ-1220 SOLID STEREO AMPLIFIER OVER 100 WATTS R.M.S. TOTAL OUTPUT**

The new and outstanding Lux SQ-1220 is rated at over 50 watts R.M.S. into an 8 ohm speaker load. Distortion is so minute it is difficult to measure even at high outputs. 40 transistors and diodes. Frequency response is 10-50,000 Hz. ± 1 dB. Provision is made for separate bass and treble controls in each channel, low and high filters, frequency selectors and tape monitoring. Ask for complete and unabridged specifications for this sophisticated Lux amplifier. Performance can only be described as superlative. Encel price (including Sales Tax) **\$350**

**NEW LUX MOVING MAGNET STEREO CARTRIDGE**

The Lux T-15-M has been acclaimed as a brilliant performer by discriminating audio enthusiasts — frequency response is conservatively quoted at 20-20,000 Hz. and stylus pressure is from 1 to 2½ grams. Tracking angle is 15°, output is 5 mV. at 1 kHz. Stylus sizes available are 0.7 mil. conical diamond and the new elliptical diamond (T-15-ME). T-15-ME: \$29.50. T-15-M7B (conical diamond stylus) Inc. Sales Tax **\$24.50**

**BUY YOUR NEW PHILIPS STEREO RECORDER FROM ENCEL ELECTRONICS**

You'll save more when you buy your new Philips recorder from Encel's. Models currently in stock include EL3302, EL3312, N4308 and the new model N4408. The latter is one of the most effective stereo recorders ever available, and extremely good value at the low Encel price. It features 3 speeds, 4 tracks, 2 VU meters, stereo speakers and it is completely solid state. It takes 7" reels, frequency response at 7½ i.p.s. is 40-18,000 Hz. ± 3 dB. The fast forward and fast rewind rate is 1800" within 200 seconds. An automatic selector enables the operator to find sections of the tape accurately and quickly. Encel's prices cannot be advertised because of agreements with manufacturers. Write or call for your trade-in valuation or an EMQ

**PE TURNTABLES MODELS PE34 & PE2020**

Perpetuum-Ebner turntables are probably the most popular in their price categories . . . and the low Encel price adds further value to these fine German products. Write for Encel prices (EMQ's) or call for your PE proposition. Stocks are limited, although more are on the water. Contact Encel's now!

**SEE THE CELESTION RANGE!**

Both models of the Celestion 12" co-axial loudspeakers (the CX-1512 at \$44.50 and the CX-2012 at \$64.50) are very popular with audio enthusiasts. If you're looking for a compact speaker system be sure to hear the Celestion "Ditton 10" (\$59) and the "Ditton 15" (\$89). All Encel prices include sales tax.

**SAVE MORE ON ALL LEADING MAKES OF TAPE RECORDER**

Encel Stereo Centres stock all the best makes . . . Akai, Sony, National, Toshiba, Philips, Revox, Tandberg, Nivico and many more. You'll be wise to secure an Encel price before you commit yourself elsewhere. Save at Encel's!

**CONNOISSEUR STEREO CARTRIDGE — ONLY \$10.80!**

Designed to load any amplifier or tape recorder, the Model SCU-1 is regarded as the finest ceramic stereo cartridge ever produced. Ask for copies of reviews. **\$10.80**

**JUNCTION BOXES FOR STEREO HEADPHONES**

If your amplifier is not fitted with a headphone jack socket a junction box is easily attached to the amplifier outputs. (Inc. Sales Tax) **\$4.50**

**FOUR TOP VALUE COMPLETE STEREO SYSTEMS FROM ENCEL ELECTRONICS!**

1. Sound Model SAQ203 solid state stereo amplifier with an output of 12 watts R.M.S., BSR Model UA70 turntable, Shure Model M44-7 magnetic stereo cartridge with diamond stylus, two wide range Stentorian Model 812 speakers. Inc. sales tax **\$159**  
If you would prefer the Cosmos model SW-30C stereo amplifier in place of the SAQ203 the price becomes \$164.

2. Sound Model SAQ505 solid state stereo amplifier with an output of 25 watts R.M.S. per channel, Compaq III belt driven turntable, the popular Lustrum Model ST510 tone arm, Micro Model 3100/5 magnetic stereo cartridge with diamond stylus, a matched pair of teak/walnut Sonics Model AS61 speaker systems. Each enclosure houses 5 loud speakers. Inc. sales tax **\$269**

3. Special low priced complete unit. Sound Model SAQ203 solid state stereo amplifier (12 watts R.M.S.), Compaq Model AR turntable complete with ceramic stereo cartridge and diamond stylus, a matched pair of Sonics Model AS-60E wide range speaker systems, an oiled base for the turntable. Inc. sales tax **\$189**

4. The connoisseur's choice. Lux Model SQ1220 solid state stereo amplifier (100 watts R.M.S.), a Goldring Model G99 transcription turntable, the proven Grace Model G540L tone arm complete with lifting/lowering device, your choice of the Shure Model V15E Mk. II or the ADC 10E Mk. II stereo cartridges complete with diamond stylus, a matched pair of the fabulous Janszen Model Z600 electrostatic speaker systems. Complete with oiled base for the turntable and perspex dust-proof cover; wired and tested ready for your pleasure. Inc. sales tax **\$899**

**SPECIAL SLASHED PRICES ON SHURE CARTRIDGES**

If you're waiting to buy a new Shure cartridge be sure to get Encel's bargain basement price before you make your purchase. We are not at liberty to advertise our new low prices.

**WORN STYLII**

Worn stylus wreck records. A worn stylus in your cartridge can ruin your favourite records quite quickly. Regular inspection is a must. Encel's now have a stock of stylus inspectors which are priced at only (incl. sales tax) **\$1.80**

**AKAI RECORDERS**

All AKAI models are now in stock . . . M9, XV, 4000D, X150D, X360, X300, 1710W and the X1800SD. Ask for your Encel price or a trade-in valuation. Sorry . . . we cannot advertise the low Encel prices!

**GRACE TONE ARMS . . . FOR THE PERFECTIONIST!**

Two models of this sophisticated arm are available . . . the 12" G-540L and the 14" G-560L. A gimbal type gyroscopic bearing is used — and the Grace arm will track suitable cartridges down to 1 gram with ease. A super light-weight head shell is supplied. Since this arm became available at Encel Stereo Centres many fastidious enthusiasts have traded much more expensive arms of Continental origin. Write for detailed specifications and prices.

**NEW LIFT RELEASED BY GRACE — \$11.50**

This beautifully designed lifting/lowering device fits all types of tone arm. Action is velvet-smooth . . . and the lift is a fitting companion to the high quality precision Grace arms.

**NEW GRACE CARTRIDGE!**

With an output of 7mV. the superb new Grace stereo cartridge Model F-8M provides outstanding results. Frequency response is 5-35,000 Hz. Stylus pressures recommended are ½ to 2½ grams. Ask for details!



**NOW . . . A NEW 8" CO-AXIAL SPEAKER WITH UNIQUE PERFORMANCE AND SIX POWERFUL MAGNETS . . . ONLY \$34.50!**

Can any 8" speaker be worth \$34.50? Easily . . . when you see and hear the remarkable CX-20D. Here at last is a total-performance 8" co-axial speaker with six magnets, a horn type tweeter, an electrical crossover, high compliance and unusually robust ribbed construction. Total weight is almost 8 lbs. and frequency response is 35-20,000 Hz. The response curve is substantially flat; from an engineering viewpoint the CX-20D is superb in design and construction. The matching enclosure is easy to make and any handyman can make it from readily available materials. We want you to hear the CX-20D and make your own appraisal. It's tremendous value for money! Inc sales tax **\$34.50**

**FROM THE UNITED STATES . . . JANSZEN SPEAKER SYSTEMS WITH ELECTROSTATIC ELEMENTS**

The Janszen Z600 speaker system is revolutionary in design and construction and provides a magnificent "transparent" sound. Response is 30 to beyond 30,000 Hz. The natural treble response results from the use of Series 130 Janszen mid/high range radiators — electrostatic units with 176 push-pull sheathed conductors. The bass reproducer is the Janszen Model 350B dynamic. Impedance is 8 ohms only. Encel price is \$178 for the Z600 . . . and a variety of finishes is available. Truly an audiophile's delight. Ask for copies of elated reviews. Encel price (including Sales Tax) **\$178**

**TRADE-IN AND TRADE-UP!**

When purchasing equipment from Encel Electronics, be sure to ask for a trade-in valuation on your old equipment. If your old equipment is in good working order, the cost of your current purchase can be reduced considerably. Bring in your amplifier, tape recorder, tone arm, etc. . . . and save more than ever at Encel Stereo Centres!

**TAPE SPLICERS . . . ONLY \$2.50!**

We've just made a special purchase of tape splicers . . . and while the stock lasts this easy-to-use unit is priced at only \$2.50. Save time and fidgeting — and frayed nerves; order now!

**SEE A COMPLETE AUDIO RANGE AT ENCEL STEREO CENTRES!**

Apart from the many exclusive Encel lines, you'll find a vast range of high quality equipment at Encel stores in both Sydney and Melbourne. Here are a few of the manufacturers represented: Trio-Kenwood, KEF, Sony, ADC, Wharfedale, Ortofon, National, Toshiba, Shure, Akai, Sansui, Philips, Nivico, BSR, Garrard, and many, many more. Be sure to get an Encel EMQ (Encel Mail Quote) . . . you'll save much more at Encel Electronics!

**LOOKING FOR LOWTHER LOUDSPEAKERS?**

Models PM6 and PM7 are now in stock at Encel Electronics. Both are fine performers — and cabinet specifications are available to suit both speakers. Encel's low prices cannot be advertised — call for your personal Lowther price!

**CP3 TONE ARMS IN STOCK AGAIN**

Because of the popularity of the CP3 arm, we've been obliged to re-order. Price has been reduced to only \$17.50, or \$22.50 with the lifting/lowering device. Order now! Limited stocks. Inc. sales tax **\$17.50**

**DUAL 1019 & 1010F TURNTABLES NOW ON SPECIAL OFFER!**

Looking for a Dual Turntable? Write or call now for a very special Encel proposition. You'll save more at Encel Electronics . . . but we're not at liberty to advertise the low Encel prices.

**ENCCEL**  
**ELECTRONICS (STEREO)**  
**PTY. LTD.**

Head Office:

431 Bridge Rd., Richmond, Victoria 3121. Tel. 42 3762.

Sydney Store: Ground Floor, 2SM Building

257 Clarence Street, Sydney, N.S.W. 2000. Tel. 29 4563, 29 4564.

Australia's Greatest Hi-Fi Centre \*Wholesalers \*Trade-ins accepted

material that evokes the response that he gets.

On side 1 he chats about "Mothers and Fathers," "The Wife," "The Grandfather" and "Dogs and Cats."

Side 2 is a single monologue about cars — the first part of it at the expense of Volkswagen owners, the rest at his own expense as he tells of his fascination for hot cars—until he got one that scared the daylight out of him

I still prefer his earlier album "Wonderfulness" but, if you want another one in similar style, this one could be it. (W.N.W.).

## Popular Jazz

**MR JELLY LORD—Jelly Roll Morton, RCA Vintage Series mono LPV 546.**

Interest. Variety of groups, 1926-1930.

Performance: Mainly for Morton collectors.

Quality: Beautifully transferred.

The music on this fourth Morton RCA Vintage collection is a curious mixture, ranging in quality from poor to superb.

The outstanding — indeed classic — tracks include his 1927 trio performances of "Mr Jelly Lord" and "Wolverine Blues" with the Dodds Brothers. (We get, incidentally, two — and quite different — takes of "Wolverine," the second of which had not previously been issued.) The 1928 recording of "Deep Creek," with a remarkable clarinet solo by Russell Procope and the 1929 "Burnin' The Iceberg" with an eleven-piece group are also highly desirable reissues.

Of the remaining eleven tracks, three are decidedly poor. Two feature the grotesque clarinet of Wilton Crawley, while "When They Get Lovin'" finds Morton providing a solo piano accompaniment for Billie Young, an honest but rather undistinguished singer.

The remaining tracks, which include "Fussy Mabel," "Load of Coal," "Red Hot Pepper" and "Courthouse Bump" are about average-quality Morton. But all have an unmistakable feeling of nostalgia for his earlier triumphs. They appeared to be attempts to recapture the magic of the past rather than to progress. Still, there are truly excellent piano solos by Morton on most of these tracks.

This is really an album for Morton collectors and, with a playing-time of 51 minutes, it represents exceptional value for them. (T.F.C.)

★ ★ ★

**CALL ME MISTER — Acker Bilk and his Paramount Jazz Band, Lansdowne (EMI) Encore Series, Stereo SOEX 9163 (also in mono).**

Interest: English trad jazz (1963).  
Performance: Spirited and enjoyable.

Quality: Rather muddy sound.  
Stereo: Not much benefit.

Despite its remarkable popularity and success, the Acker Bilk Band was far from being the most accomplished group produced by the English trad boom of the early 1960s. Nevertheless his band could, at its peak, turn in some fairly solid and enjoyable

music and the personnel on this album certainly represented one of Acker's best groups.

The tracks were recorded in January, 1963, and include traditional jazz workhorses like "South" and "Climax Rag," popular standards including "Sunny Side of the Street" and "Home" (both with characteristic vocals by the leader) and some original compositions by trumpeter Colin Smith and Acker Bilk.

Smith, in fact, was the most accomplished soloist in the band but he receives solid support from the rhythm section led by the excellent pianist Stan Greig.

Most people who would be interested in buying this album will know pretty well what to expect. All that need be added is that with a playing time of 38 minutes and a price of only \$2.50, it represents distinctly good value for those who enjoyed the old Bilk Band. (T.F.C.)

★ ★ ★

**MONGO SANTAMARIA EXPLODES AT THE VILLAGE GATE, C.B.S. Stereo SBP 233551 (also in mono.)**

Interest: Afro-Cuban jazz.

Performance: Spirited and enjoyable.

Quality: Very good for "live" recording.

Stereo: Well balanced.

I enjoy the rhythmic excitement of Afro-Cuban jazz in moderate quantities and the group led by Mongo Santamaria on conga and bongos is one of the best and most popular in the field. Santamaria is a 47-year-old Cuban percussionist, who worked with leaders like Perez Prado and Cal Tjader before forming his own group in 1961. His most successful recording was "Watermelon Man."

This album was recorded "live" at New York's Village Gate and his seven-piece band was clearly in cracking form that evening on numbers like "Afro Blue," "Philadelphia," "Springtime" and "Elephant Pants."

The rhythm section drives along tightly and relentlessly and there is plenty of depth and variety in the ensemble, with the strong lead trumpet of Ray Maldonado and the saxophones and flutes of Hubert Laws and Bobby Porcelli. Laws is the most interesting and creative soloist in the group and his remarkable piccolo solo on "Afro Blue" is particularly impressive.

This album, which plays for a generous 43 minutes, can safely be recommended to any readers who enjoy Latin or Afro-Cuban music. (T.F.C.)

★ ★ ★

**ISRAEL — Kai Winding and J. J. Johnson, A and M Records (Festival), Stereo SAML 932957 (also in mono).**

Interest: Reunion of two great trombonists.

Performance: Patchy.

Quality: Well recorded.

Stereo: Good separation and balance.

The two-trombone quintet led by Danish-born Kai Winding and J. J. Johnson, the greatest trombone player in modern jazz, was one of the most popular groups of the mid-1950s. After their break-up in 1956, the two trombonists reunited only twice before they recorded this new album, once for a

"INNERBOND"

(Regd.)

# BONDED ACETATE FIBRES

FOR PACKING IN

## SPEAKER ENCLOSURES

A new resilient Bonded Wadding made from ultra fine Cellulose Acetate Fibres that gives high efficiency for Sound Absorption.

"INNERBOND" is light, clean, dust-free and easy to handle. Because all the fibres are bonded "INNERBOND" will hang as a "curtain" and will not fracture or break down due to vibration.

"INNERBOND" is odourless, highly resistant to attack by bacteria or fungus and is vermin repellent; "INNERBOND" at 16oz sq. yd. has a normal thickness of 1" and at this density is recommended as a packing in Speaker Enclosures for Sound Absorption.

### STOCKISTS:

**SYDNEY:** Arrow Electronics Pty. Ltd., 342 Kent St.; Broadway Electronics (Sales) Pty. Ltd., 52 Glebe Point Rd.  
**GLEBE:** Convoys International Pty. Ltd., 449 Kent St.; Ence Electronics Pty. Ltd., 257 Clarence St.; Kent Hi-Fi, 432 Kent St.; Mastersound Sales Pty. Ltd., 400 Kent St.; Radio Dispatch Service, 869 George St.; Stereo Music Systems, 193 Clarence St.; Circuit Components (A/asia) Pty. Ltd., 460 Bexley Rd., BEXLEY; Classic Radio, 245 Parramatta Rd., HABERFIELD; Dyna Stereo Pty. Ltd., 331 Prince's Hwy., ST. PETERS; Albert Wright Radio Service, 795 New Canterbury Road, HURLSTONE PARK.

**NEWCASTLE:** Martin de Launay Pty. Ltd., King and Darby Streets; Dynamic Sound, 587 Hunter Street.

**WOLLONGONG:** Electricon Parts Pty. Ltd., 82 Keira Street; Martin de Launay Pty. Ltd., 270 Keira Street.

**MELBOURNE:** J. H. Magrath & Co. Pty. Ltd., 208 Little Lonsdale Street.

**BRISBANE:** A. E. Harrold Pty. Ltd., 123 Charlotte Street; Brisbane Agencies, 78 Wickham Street, Fortitude Valley.

**ADELAIDE:** Duncan Agencies, 57 Woodville Road, Woodville; General Accessories, 81 Flinders Street.  
Truscott Electronics, 62-64 Hindmarsh Sq.

**PERTH:** Atkins (W.A.) Ltd., 894 Hay Street; Carlyle & Co. Pty. Ltd., 1 Milligan Street; General Accessories, 48 Milligan Street.

**HOBART:** Homecrafts-Tasmania, 199 Collins Street.

If unobtainable

For 1 sq. yd. as above send \$2.00  
For 2 sq. yds. as above send \$3.75  
For 4 sq. yds. as above send \$6.50

Postage paid in Australia and Territories to the manufacturers

## WONDER WOOL PTY. LTD.

87 JAMES STREET, LEICHHARDT, N.S.W., 2040.  
Box 548 — G.P.O., Sydney, 2001.  
Phone: 56-2780.

Peter Clark invites  
you to visit his new  
hi-fidelity centre at  
Magnetic Sound.  
Sydney's most  
comprehensive range of



**HI-FI**



Discover the thrill of

## HI-FI STEREO SOUND

from **\$169.95**

Three piece set includes S.A. 616 20 watt amplifier Garrard 3000 record player 2 M.S.I. G.T. 100 speakers

**\$2.50 weekly**

The best sound in the world comes only from Hi-Fi Stereo. From our Junior Executive 3-piece 20-watt system priced at **\$169.95** or **\$2.50 weekly**—to the Senior Executive system at **\$2,000**. Match up your own system with exciting imported names such as Fisher, Leak, Lansing, Sansui, Sony, Sanyo, Trio and Titan. Over 2,000 different combinations to explore.

**OUR TAPE RECORDER AND HI-FI PRICES ARE LOWER THAN ANY DISCOUNT STORE**



Only Australia's Top Recorder Specialist can offer you these outstanding buys.

**NATIONAL RS 780** automatic reverse tape recorder, 16 watts, list price \$495, our price **\$335.95**.

**NATIONAL RQ 706** twin speaker mono machine, list price \$176.95, our price **\$133.95**.

**NATIONAL 205** cassette machine, list price \$69.75, our price **\$52.95**.

**PHILIPS 4408** stereo, list price \$450, our price **\$338.95**.

**SANYO** stereo, list \$499, our price **\$335.95**.

**AKAI 1710** stereo, teak case, list \$341, our price **\$239.95**.

**AKAI M9** stereo, list \$664, our price **\$395**.

**SANYO 915** stereo, list \$275, our price **\$199.95**.

*Magnetic Sound*

**INDUSTRIES**

**387 GEORGE ST., SYDNEY** I door **29-3371**  
from Kodak  
Parramatta Branch, 20 Macquarie St., 635-0830 opp. Astra Theatre.

tour of Europe in 1958 and again for an impulse recording session in 1961.

Much of the appeal of Kai and Jay Jay was the free-wheeling interchange of ideas between the two trombonists — Johnson with his exemplary control, bland assurance and immaculate technique and Winding with his similar ideas, but gruffer and more virile tone.

On this album, they never really let themselves go and part of the reason is undoubtedly Don Sebesky's rather unimaginative writing for more than half the tracks, which feature a sizable accompaniment of strings and woodwinds. This sugar-coating, for which producer Creed Taylor is now infamous, was, I think, totally unnecessary and particularly inappropriate on tunes like "St. James Infirmary," John Lewis' "Django" and "Try To Remember."

The only tracks on which the old magic if Jay and Kai is recaptured are John Carisi's beautiful composition "Israel" and "Saturday Night Is The Loneliest Night of the Week." On these tracks, the rhythm section of Herbie Hancock (piano), Ron Carter (bass) and Grady Tate (drums) stimulates Kai and Jay to some exciting and satisfying solos.

Ira Gitler's sleeve note suggests that this is the first of a series of albums by Jay and Kai. Their many admirers would be well advised to wait for a less commercial and more relaxed album than this. (T.F.C.)

★ ★ ★

**WIVES AND LOVERS**, George Golla  
Festival Stereo SFL 933125 (also  
in mono.)

Interest: Modern Australian guitarist.

Performance: Superb musicianship.

Quality: Bright recording.

Stereo: Balance a little suspect.

This is the second album by the Sydney musician, George Golla, who undoubtedly ranks among the world's leading contemporary guitarists at the present time. It should be said that this is not strictly a jazz album, but rather a kaleidoscope of George Golla — the musician and the man; a reflection of all the different kinds of music which he has played and which have influenced him in his career as a professional musician.

The collective personnel on "Wives and Lovers" includes the cream of Sydney's musicians in Graeme Lyall, John Sangster, Don Burrows, Errol Buddle, Peter Haslam, George Thompson, Ed Gaston and Derek Fairbrass. As one would expect, the musicianship on all twelve tracks is impeccable and George Golla's arrangements are extremely competent.

The material ranges from jazz standards like "Bye Bye Blues"; an original by Golla called "Waltz to Adelaide"; two Lennon/McCartney compositions in "Fool On The Hill" and "Day Tripper"; ballads like "The More I See You" and "Dream A Little Dream Of Me"; and bossa nova tunes like "Berimbau" and "How Insensitive."

The musical spectrum on this album is wide-ranging but all the tracks have their own distinctive appeal and character. I would regard this very enjoyable album as essential listening for anyone with the slightest interest in contemporary guitar. (T.F.C.)

# TRADE REVIEWS AND RELEASES

## REVOX A77 STEREO TAPE RECORDER

The Revox A77 supersedes the earlier G36 valve model—a machine which had a high reputation for its performance and conservative ratings. The new A77 incorporates most of the features of the old machine but easily passes it in performance.

The A77 model we tested is a three-motor, two-track, two-speed recorder without power amplifiers. Other models are available with 4 tracks and with or without power amplifiers. All models, except a portable version which includes speakers, use the same chassis and case which is considerably lighter and more compact than for the previous model.

The control layout of the deck is very simple, yet enables a high degree of flexibility. Five push-buttons on the left control the tape transport via solenoids.

ine will not operate unless the tape is threaded correctly. A lamp and light-dependent resistor stops the tape transport in the event of tape breakage or the end of a reel.

Also concealed by the tape path cover is a switch to disconnect the speakers, in those models which have power amplifiers, and a switch to stop the reel motors for editing purposes. A neat feature is the metal flap which snaps over the replay head during recording and replay to reduce hum.



*Pictured is the new Revox recorder, which can be used with the deck horizontal or vertical. The array of controls is simple, but provides a high degree of flexibility.*

Below these push-buttons are two knobs backed by concentric switches which control the playback facilities, while a similar set of knobs on the right control recording. Also on the right are the two calibrated VU meters and the five-position switch which controls power, speed, equalisation and tape tension. In the centre of the control panel are jacks for two microphones and stereo headphones. The deck can be used either horizontally or vertically.

Apart from the three jacks just mentioned, all input and output sockets are accommodated on a recessed panel behind the carrying handle. One small complaint we have here is that some of the sockets were too close for easy manipulation of plugs.

The tape path is concealed under a drop-down chrome-plated plastic cover. Tape threading is a little more "fiddly" than would at first appear and the mach-

The machine is built around a very rigid, cast alloy frame chassis. All the circuitry is accommodated on plug-in printed boards to facilitate servicing. The three motors make for a very simple and reliable transport, there being only one belt-drive in the whole mechanism—that for the rev. counter.

At the base of the chassis are seven plug-in boards which accommodate the basic tape-recorder electronics. These provide input amplification, speed equalisation for record and replay, drive for the VU meters and the necessary bias and erase voltages at a frequency of 120KHz.

The two spooling motors are Papst while the capstan motor is made by Revox. It is an eddy-current motor that delivers a high torque free of the pulsations normally occurring with a motor having a pole structure. The rotating outer section of the motor has a band of machined slots around it and these

are read by a transducer not unlike a tape replay head to obtain a signal for electronic control of the motor speed.

In fact, this system maintains the speed of the motor so accurately and smoothly that the capstan is directly driven from the motor shaft via a flexible coupling instead of the more usual belt-driven fly-wheel arrangement. This feature, plus the regulated power supply means that the machine is not affected by mains voltage or frequency variations, and can be used on 50Hz or 60Hz supplies without alteration.

In operation, the machine is very pleasant to use. The tape transport is very smooth and quiet and spill-free due to the solenoid controls. The fast wind facility is truly that, taking less than 70 seconds to rewind a 1200 feet reel of tape. It is possible to go from fast forward to fast reverse without an intermediate stop—very smooth. The tape transport is foolproof to the point that even disconnection of the mains supply will not cause spillage of tape. It merely brakes to a smooth stop.

As mentioned earlier, the record and replay controls give a high degree of flexibility. One can monitor the difference in quality between the input signal and that recorded on the tape just at the flick of a switch. Dubbing from track-to-track, adding echo and many other operations can be done very easily. One feature which could be a drawback is that the volume control for the replay amplifiers also controls the signal level of the 600-ohm outputs.

One feature that we did miss was the pause facility which comes in handy when recording. It eliminates the "click" or "bong" which is recorded on the tape when restarting. This was available on the superseded G36 model and is, of course, available when using this machine in the remote control mode.

It was in performance that the machine excelled itself. The frequency response was measured with high-quality virgin tape at 20dB below 0dB recording level. At 7½ inches per second it was within plus or minus 2dB from 15Hz to 20KHz while at 3½ inches per second it was within plus or minus 2dB from 15Hz to 16KHz and only 6dB down at 18KHz. This is well within the specifications, and from memory is the best response that we have obtained from any tape recorder yet.

Signal-to-noise ratio and cross-talk between channels are specifications which are harder to verify. Cross-talk at 1KHz was specified at 45dB in the stereo mode but this would depend on what reference level was used and the method of measurement. We measured in excess of 40dB with respect to 0dB recording level which is good. Signal-to-noise ratio was specified at better than 58dB weighted at 7½ inches per second but this would depend to a large extent on the quality of tape used. We were able to measure in excess of 45dB with respect to 0dB recording level. These figures could be significantly improved if a higher recording level was used as reference. This could be done, since the distortion at 0dB recording level was below 1 per cent and a higher level would be quite practical.

In all aspects the machine gives a good account of itself. We have no hesitation in recommending it to those readers who are looking for a machine in this price range, as it is more than competitive. Price of the two and four-track decks is \$550 including tax, while the two and four track models with integral power amplifiers are \$650 including tax.

Further information regarding the Revox tape recorder range can be obtained from the Australian distributors, Amalgamated Wireless (Australia) Ltd., Engineering Products Division, 422 Lane Cove Rd., North Ryde, N.S.W. or normal retail outlets. (L.D.S.)

# Convoy ELECTRONICS TECHNOCENTRE

FOR SOUND SATISFACTION

Specifications, Systems, Service, Friendly Advice

Whatever your problem may be in the field of electronic music, tape recording, microphones or electronic equipment Convoy offers you the complete service.

## Famous Convoy-Peerless 3 way

This outstanding speaker system is either in 12" or 10" configuration with crisp balanced sound from 30 cycles to 20K. These systems are either 2 or 3 1/2 cu. ft. in top quality teak enclosures specially sealed and tuned for the speakers used. Crossover at 750 cycles and 4K. The new Peerless MT225HFC sealed Tweeter now included with new standards of power and quality of reproduction. In the \$200 per pair range this is the outstanding speaker value in Australia today.

## AKG Microphone and Head-set specials

A comprehensive range available from stock, including professional mike stands with boom and shock absorber bases—a must for serious microphone users. We have a full range of AKG accessories. Hear the famous Model D200, and self-contained reverb Model DXII.

There is an AKG microphone for every use priced from \$20.00 to \$600.00. Our consultants will advise you on the best model for your use. AKG headsets are outstanding in the field of sound reproduction. Full stocks, demonstrations of all models, boom microphone units available, too.

Come, see our top quality trade-in units. Our service department is on the premises. Bring in your equipment for consultation.

## See, hear, and take home REVOXI

The new Revox 77A solid state, tape deck, or full recorder with 4 speakers and 10 watt RMS amplifier is here.

This unit allows you to tape from existing tapes with hardly detectable difference between source and playback. You duplicate tape libraries without appreciable loss of quality. Frequency stabilised capstan makes it ideal for outback power supplies. 10" reels doubles 7" playing times. Rewind and forward at speed without any tape stretch or damage. Hand sound editing with fixed tape cutting slot between heads. Professional machine quality at consumer prices. Hear the superb Revox deck sourcing a QUAD 303 amplifier, into Richard Allen 15in. 3-way Speaker System for a sound that is unequalled in Australia.



## Special Value Month!

Call and hear the famous name amplifiers, tape-decks, recorders, speakers, etc. In new condition but at rock bottom costs. Own a luxury system at a budget price.

CONVOY INTERNATIONAL Pty. Ltd., 449 Kent St., Sydney (nr. Town Hall) 29-6475

## R.G.S. SPECIALS



**NEW IMPROVED  
30 WATT  
NOMINAL  
54w MAX.**

### 12v All Transistor P. A. AMPLIFIER

Complete kit of parts. No. 591C \$60  
WIRED READY TO OPERATE:  
15 ohm output No. 591D \$62  
125, 250, 500 ohm output. . . \$62  
No. 592D . . . \$62  
All metal work, panel and knobs only.  
No. 597 . . . \$10.50  
All dimensions: 6 1/2in w. x 3 1/2in h. x  
8 1/2in d.  
For 240V operation. \$33 extra.  
Freight extra. Write for details.



### R.G.S. COMPLETE DO-IT-YOURSELF KITS

Peak reception, low price. No expensive test equipment. Everything fits. 1964 RF Transports 7.  
Complete kit—No. 640 \$43.50  
Portable car radio, identical to 640 above, plus extra switch and car coil etc. No. 642 \$46.00  
(Write for booklet on 640 and 642)  
Postage \$1.

### NEW TRANSISTOR PREAMP KIT

SIZE 3 x 2 x 1 1/2 in 2 req. for Stereo.  
LOW IMP. Input 2 trans. 672C \$6.50  
Wired ready for use. 672D \$8  
HIGH IMP. 2 tran. 680C \$6.50  
Wired ready for use 680D \$8  
HIGH IMP. silicon 3 tran. 682C \$8  
Wired ready for use. 682D \$9.50  
Postage 10c each. Write for data.

## HI-FI BROADCAST TUNER UNIT 4 TRANSISTORS — HI SENSITIVITY.



R. F. mixer, I.F. pwr. dectr. stages, adjustable aerial coupling. Complete as illust., wired and tested with 461 dial, knobs and switch pot. No. 474D. \$31. Postage \$1.  
WHISTLE FILTER for above set for 8Kc band width (can be altered to 9, 10, or 11Kc). No. 128. \$4. Post 10c.

## PRINTED CIRCUITS

For all R. and H. E.A., Mullard, Philips and other designs. Clearly coded. White letters and numbers, easy assembly and service, polished and resined for easy soldering. With blueprint parts list.

SPECIALS: To your drawing—write for particulars and Drafting aids.  
**New Printed Circuits**

Part	No	Recent	Designs
726 3 x 3 w. stereo	68/A8	731 E.A.	69 01 gold p. organ
	\$2.80	731 E.A.	68 M 12 \$2.50
727 E & A wide band.	709	Pre-amp	67-P5 \$2.50
728 Audio osc. E.A.	68-09	684	Pre-amp 65-P10 \$2.50
	\$3.20	685	Pre-amp. 65-P12A \$2.50
718 Mullard main amp.	\$2.50	686	Pre-amp. 65-P12B \$2.50
722 Mullard pre-amp	\$3.00	723	B/c tuner EA68-5T \$2.50
725 Protected supply	\$2.50		

Write for full list. Immediate despatch. Postage 10c.



## 10W STEREO

MULLARD 10 x 10  
watts R.M.S.

With output transistor PROTECTION. Frequency response 40cy. to 30Kc. Distortion 0.5%. Treble, bass, boost 20dB. Complete kit of parts No. 480C \$74.00.  
Wired and tested No. 480D \$79.00.  
With hi-fi tuner and whistle filter, \$35 extra. Freight extra. Write for details.

## MAGNETIC STEREO PRE-AMP

In 5Mv. out 500Mv. Bass and treble 18 D.B. No. 700C. \$29. Wired ready for use \$31. Postage 30c.



## TRANSFORMER

Tap 4 6v and 9v D.C. at 100 millamps.

Filter, condensers, rectifier, resistor, case, etc. \$6.50. Post 10c.

## PERSONAL PORTABLES 2 TRANSISTORS

Range 30 miles. 200 with short aerial and earth. Earpiece only, no speaker. Wired ready to use. No. 665D. \$10.



Postage 20c.  
Do-it-yourself kit. No. 666C. \$9.00.  
1 TRANSISTOR — 1 DIODE  
593C Do-it-yourself kit, \$8. post 10c.  
593D Wired ready to operate. \$6 post 10c.

## DIAL KITS SCALE GOLD WITH WHITE LETTERS.

● No. 459 to match 300 pf gang. Price \$4.50  
● No. 461 to match 200 pf gang. Price \$4.50  
Post 20c.

## NEW AUDIO AMPLIFIER

4 transistors. 15 or 1 watt. Small size, cabinet 3in x 2in x 1in plastic. Suitable crystal P/up. Inter com., microphone, radio, etc. (9 volt).  
DO-IT-YOURSELF KIT 665, \$10 (Post 10c). Wired ready for use 665D \$11.50

## COILS & IF's 455 Kc

Aer. R.F. OSC. and IF's \$1.60 ea. Ferrite Aer. \$2  
No. 265 Universal Type OSC. Coil. \$6  
Postage 10c. Write for details and price.

R.C.S. Order by Mail Order, Postal Note or Money Order (add post.), direct to—  
RADIO PTY. LTD., 651 FOREST ROAD, BEXLEY, N.S.W., 58-3491, 58-5385



# Contactless push-button switches

A range of electronic contactless push-button switches, developed in West Germany by Raimund Finsterholz (Rafi), is now available in Australia.

The Rafi contactless push-button switch is an electronic unit which resembles a conventional mechanical unit in its outward appearance. The electrical functioning of the unit, however, is basically different. Operation is effected by a permanent magnet, the position of which is changed relative to a "Fieldplate." ("Fieldplates" are magnetically controllable solid-state resistors made of indium antimonide). When a magnetic field passes through a "Fieldplate," its ohmic resistance changes. The resistance change is available at the output terminals, or (depending on the switch design) triggers a transistor circuit built into the unit.

The advantages of the contactless push-button switch are claimed to be bounce-free contact operation, long life, stable contact resistance, contact system independent of mains voltage and fluctuations, no oscillator frequency, and unaffected by environment, vibration and humidity.

The unit can be directly connected into electronic equipment such as calculating machines, computers, etc., where switches of conventional design have previously been used. The switch is said to be of most value where frequent operation and a high degree of safety are required. It is claimed to be particularly suitable for areas of explosion hazard, as the contactless principle avoids sparking. The contactless switch can be built into equipment subjected to shock and vibration as the unit can be actuated only by depressing the push button.

The basic contactless push-button switch contains a magnetic system with a maximum of two fieldplates which are directly connected to the output. On actuation, the resistance at the output changes in a ratio not less than 5 to 1 — 40 ohms at rest, and 200 ohms when operated. This function can also be reversed. This change of resistance can be used to trigger electronic switching circuits.

A power output form of contactless switch incorporates a transistor in addition to the basic switching components. The transistor has maximum ratings of 80mA and 12V, and can be used to operate relays, etc. A Schmitt trigger form of the switch is similar to the basic switch but includes an IC to give a square pulse of very fast rise and fall at two outputs which are 180 degrees out of phase. This

is particularly useful for manual feeding of data into electronic equipment.

Two forms of waterproof switches are available including a built-in membrane for sealing purposes. These switches are described as being particularly suitable for the machine-tool industry. The units can be supplied in the basic, power output or Schmitt trigger forms.

Contactless illuminated push-button switches can be supplied with two miniature lamps built into the button. The connections of the lamps are brought out separately. Using the contactless switches, it is possible to build electronically interlocked push-button switches. In the absence of all mechanical linkages, the buttons can be mounted at any place on a switchboard. Coupling is effected by wire connections using an exchangeable program-block.

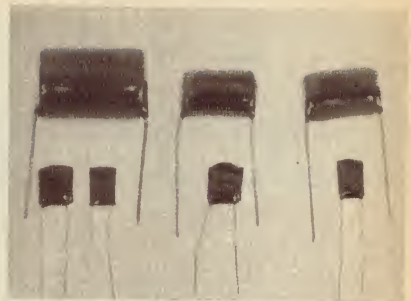

SOANAR ELECTRONICS PTY. LTD. is now stocking a full range of Alna Elna polyester film capacitors. These are high quality sub-miniature capacitors, suited to transistorised circuits and other low-medium voltage applications. The range covers .001 to 0.22uF 100VW, and 0.33 to 2uF 200VW.

Further information on these and other Rafi products may be obtained from the Australian agents who are E. S. Rubin and Co. Pty. Ltd., 73 Whiting Street, Artarmon, N.S.W. 2064.

## Light Probe Checks Logic Circuits

A hand-held probe, the Logic Probe model 1052A, has been introduced by Hewlett-Packard to check the performance of logic circuits by showing when pulses occur or when logic levels are in the "0" or "1" states. Logic level indication is by a light close to the probe tip. Probe operation is automatic, no triggering or threshold adjustments are required, high overload voltages can be tolerated, and the probe can be used by untrained personnel.

Designed for use with IC logic circuits, the new probe is compatible with TTL and DTL 5-volt logic schemes. Threshold level is the standard +1.4V — above this level, the light is on; below, it is off.

Positive pulses as short as 30nS cause the light to flash for 1/10 second, clearly indicating that a pulse has occurred. When used with negative logic systems, the light (normally on) is momentarily extinguished by negative-going pulses. Although easily seen with the logic probe, single short pulses are difficult to detect by other means. Pulse trains cause the lamp to glow at intermediate brightness.

The probe is protected against accidental overload up to 200V. Input impedance



is 10K, sufficiently high to prevent disturbing IC logic circuits. Power for the probe is supplied through a cable with adapters for connection to a lab power supply or the supply of the circuits being checked. It consumes 75mA at 5V, and operates within a temperature range between 0 and 55 degrees C. Further information may be obtained from Hewlett-Packard Australia Pty. Ltd., 22-26 Weir Street, Glen Iris, Vic. 3146.

## Jacoby, Mitchell Open Night

Jacoby, Mitchell and Co. Pty. Ltd. put on display a wide range of electronic equipment, including the latest in testing equipment for communications systems, at an "Open Night" held in Sydney on Tuesday, February 25. During the evening, Mr Ted Cowcher, manager of GEC-AEI Electronics Division gave an interesting talk on the P.M.G.'s broadband link between Perth and Port Pirie, which completed the trans-Australia broadband system and will enable subscribers in all States to use STD facilities. Pictured are Mr John Hibbert, managing director of Jacoby, Mitchell (left) with Mr Cowcher, of GEC-AEI.



# PETER SHALLEY ELECTRONICS Pty. Ltd.

127 YORK STREET (Just near Town Hall) 29-7021 29-3767



TOKAI TC502

- 1 watt
- All steel case.
- Ruggedised/ Defence spec.
- Leather case.
- Ext. Aerial con.
- Ext. power con.
- Fully P.M.G. app. as base or hand-held.
- Noise limiter/ squelch.
- Ear plug and Mic. input Options.
- Nick. Cad. Batts.
- Base aerial.
- A.C. adapter. \$132 each.

We've got lots cheaper. None better.

## NEW RELEASE



\$49.75 each

TOKAI PT51 100MW

- \* 11 Transistors
- \* All metal
- \* Leather case
- \* Sep. Spkr. and Mic.
- \* Ear piece
- \* Squelch

### STATE DISTRIBUTORS

K. J. KAIREs and CO.,  
4 HILL COURT,  
MACLEOD, VIC. 3085.  
Phone 45-4953.

L. E. BOUGHEN and CO.,  
95 CENTRAL AVENUE,  
SHERWOOD, QLD. 4075.  
Phone 79-2207.

D. K. NORTHOVER and CO.,  
337 WELLINGTON STREET,  
PERTH, W.A. 6000.  
Phone 23-4683.

We have lots of other units, new and used from as little as \$35 each. Repairs, tuning and alignment are our speciality.

## AVAILABLE LOCALLY



WORLDWIDE EXPANSION WITH SINCERITY & DEVELOPMENT

**PALACE**  
ITOKA PRODUCTS CORPORATION  
No. 1-4, 3-chome, Mita, Minato-ku, Tokyo, Japan.

A comprehensive range of products from the ITOKA CORPORATION

- Amplifiers
- Bookshelf speaker systems
- Tape decks.
- Microphones
- Preamplifiers
- Stereo and mono microphone mixers
- Stereo headphones
- Tuners
- Solid state modules
- Phono preamplifiers
- Tape preamplifiers
- Audio power amplifiers
- Code oscillators
- Guitar amplifiers



## GENERAL ACCESSORIES

(A DIVISION OF ELECTRONICS INDUSTRIES)

116-118 CLARENCE STREET, SYDNEY 443 CONCORD ROAD, RHODES — 73-0211  
BOTH STORES OPEN SATURDAY MORNING

# NEW CARTRIDGES FROM AUDIO-TECHNICA

Audio-Technica Corporation, of Japan, have added two new models to their range of magnetic pickups. Samples of these have been made available for evaluation by the Australian distributors, Jacoby, Mitchell and Company Pty. Ltd., 469-475 Kent Street, Sydney, 2000.

The two cartridges are designated the AT-35, a medium-priced unit selling for \$30.95 retail; and the AT-21, a low-price unit, retail price being \$11.50. Despite the difference in price, the claimed performance is remarkably similar and, in fact, the manufacturers quote a superior compliance for the AT-21. Literature supplied with the cartridges give the following specifications:

#### AT-35

Frequency response: 10Hz to 25KHz  $\pm 2$ dB.

Channel separation: More than 30dB at 1KHz.

Output voltage: 3mV at 1KHz (5cm/sec.)

Channel balance: 0.5dB at 1KHz.

Compliance: 23 $\mu$ cm/dyne.

Tracking force: 0.5 to 2.5 grams.

#### AT-21

Frequency response: 10Hz to 25KHz  $\pm 2$ dB.

Channel separation: More than 30dB at 1KHz.

Output voltage: 4mV at 1KHz (5cm/sec.)

Channel balance: 0.5dB at 1KHz.

Compliance: 30 $\mu$ cm/dyne.

Tracking force: 0.5 to 2 grams.

Both cartridges appear to be well made and finished, with the AT-35 looking rather more sleek. Both use the moving magnet form of construction, with the coils and pole pieces contained in the moulded plastic body, and the moving magnet mounted at the end of the cantilever stylus assembly. Stylus changeover is extremely simple in both cases.

The design of the AT-35 stylus assembly has an unusual feature in that there are two tiny magnets mounted at the end of the stylus cantilever in a "V" formation, but otherwise the moving magnet principle is preserved. Advantages claimed for the V-magnet configuration are good channel separation and low distortion.

Before proceeding to other measurements we checked the stylus force required by the cartridges for playing difficult passages. These observations suggested that the range of stylus force given by manufacturers was optimistic at the low end, and although the cartridges may indeed track most passages satisfactorily at  $\frac{1}{2}$  gram pressure, they could not cope with heavily modulated passages under these conditions. For tracking tests we used the W & G Professional Test Record (WG 25/2434) which has drum beats recorded at 4, 8, 12 and 16dB above standard recording level. We regard it as essential for good tracking to be obtained at the plus 12dB level and, for this, the AT-35 required 2.5 grams, while the AT-21 tracked it at 1.5 grams. In view of the superior compliance of the AT-21, this result is not surprising.

Under these conditions we carried out subjective music tests, and the AT-35 made a very good impression here, sounding very clean and smooth. On frequency response tests, feeding the output of the cartridge directly into a Hewlett-Packard distortion analyser across the recommended load, the AT-35 showed an almost ideal result, being within  $\pm 2$ dB over the entire range of measurement possible with the test record (C.B.S. Stereophonic Frequency Test Record, STR 100). Channel balance was within 1dB over the tested range, and channel separation was 30dB at 1KHz, with a minimum of 13dB at 20KHz. Observations of sine waves obtained on the oscilloscope during the frequency response tests showed that

there was no significant distortion over the entire tested range.

The performance of the AT-21 was found to be only marginally below that of the more expensive AT-35. Our frequency response measurements did not quite confirm the maker's claims, but we found output to be substantially flat from 20Hz to 16KHz, where roll-off began, with response 5dB down at 18KHz and 10dB down at 20KHz. While this did not quite meet the specification, it is an excellent result from such a low-price car-



The Audio-Technica AT-35 (left) and the cheaper AT-21.

## Hewlett-Packard Flying Showroom in Australia

A DC6B aircraft fitted out as a "flying showroom" with a wide range of electronic equipment visited Australia in February as part of a 110-day trip around the world. More than 100 different products, ranging from computers and calculators to medical and analytical instruments, electronic equipment and microwave equipment were carried aboard the aircraft. The object of the tour is to bring demonstrations of the latest technical developments in the fields of electronic testing, measuring and computing to scientists, engineers and doctors in many parts of the world.

The staff of Hewlett-Packard Australia Pty. Ltd. assisted engineering experts from the U.S.A. laboratories and factories in explaining to visitors the operation and uses of all instruments aboard the aircraft. The exhibit will have been seen at airports in 46 cities in 24 countries in Australasia, Asia, Africa and Latin America at the conclusion of the tour. From California, the aircraft's route has taken it via Honolulu to New Zealand, Australia, Japan, Taiwan, Philip-

tride. We found the AT-21 a very pleasant cartridge to listen with, capable of high quality reproduction. Oscilloscope observations showed only very slight irregularities around the 6 to 8KHz region, but elsewhere clean waveforms were obtained.

Separation was 33dB at 1KHz, and thus well within the claimed performance. A good order of separation was maintained over most of the range of frequencies tested, rising to a minimum at 16KHz (8dB). Channel balance was also very good, being within 1dB over most of the measured range, and never exceeding 2dB.

To summarise, the AT-35 is regarded as a very good performer capable of high quality reproduction, but the AT-21, at considerably less than half the price, is regarded as better value, since its response is only slightly below that of the more expensive unit, and its tracking ability is superior.

Both types are supplied as standard with an 0.5mil spherical diamond stylus. Alternative versions fitted with 0.3 x 0.7 mil elliptical styli are available as follows: AT-35X, \$41.50; AT-21X, \$23.65.

It is worth noting that all Audio-Technica cartridges are extremely well packaged, with a moulded plastic inner container encased in foam plastic and a stout cardboard case. A small package of accessories, comprising lead weight, terminal lugs and fixing screws is provided with each cartridge. (H.A.T.)

ines, Singapore, Malaysia, Thailand, India, Pakistan, Iran, Lebanon, Kenya, South Africa, Angola, Brazil, Uruguay, Argentina, Chile, Peru, Colombia, Puerto Rico and Mexico.

The four-engined aircraft was purchased from Pacific Airmotive Corporation in Santa Monica, which converted it from passenger accommodation to a flying electronic showroom.

The picture shows the cabin of the specially converted DC6B. The main cabin has been divided into two areas, one 48ft long with electronic, medical and analytical equipment; and a second, 17ft long, containing computers and calculators.

The exhibition requires a large amount of power, and this is provided by three Onan generating sets with a total capacity of 30KW. The generating sets are carried in the cargo hold when the aircraft is in flight, and are lowered to the ground and run out some distance from the aircraft at each stopping place. Mufflers on flexible pipes are fitted to minimise noise nuisance.



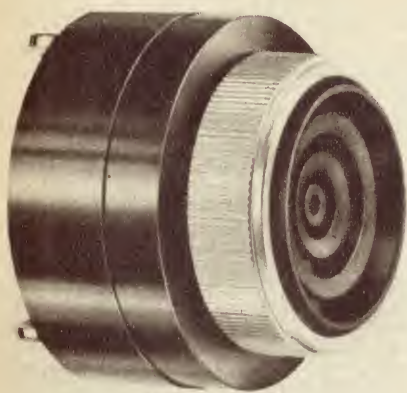

# Sonalert<sup>®</sup>

## electronic audible signal

- Automotive, Marine & Aircraft warning systems
- Intrusion & burglar alarms • Swimming pool splash alarms
- Code practice oscillators • Pressure & temperature sensing
- Operation with photocells • Liquid level indicators
- Voltage variation warnings • Industrial applications

### SIGNAL PRINCIPLES

The Sonalert electronic audible signal is a solid-state device which emits a compelling sound on a minimum current. The standard model is the SC628. This model operates on as little as 6 volts DC but accepts 28 volts DC. Current requirements range from 3 to 14 ma. depending on input voltage. Sound output is proportional to input voltage and ranges from 68

db @ 6 VDC to 80 db @ 28 VDC. Frequency of the SC628 unit is 2800 Hz  $\pm$  300 Hz which corresponds to the resonant frequency in the piezoelectric transducer used in the Sonalert. This frequency is generated by a transistorised circuit which is an integral part of the unit and cannot be altered by external means.

® "Sonalert" is a registered trademark and is manufactured by P. R. Mallory & Co. Inc., U.S.A.

**PLESSEY**  
**Components**



Ducon Division  
Plessey Components  
Box 2 PO Villawood NSW 2163  
Telephone 72 0133

Melbourne 42 3921  
Brisbane 2 3287  
Adelaide 76 3434  
Perth 21 4821/21 7867

AD3

## HEAR the — FANTASTIC reproduction with a magnetic cartridge "RAPAR" SOLID STATE STEREO AMPLIFIER



### SPECIFICATIONS

**TRANSISTORS:** 20 Transistors. 2 Power Diodes.  
**OUTPUT POWER:** 24 Watts (4 ohm), each channel 12 Watts.  
**AUDIO SENSITIVITY:** 16 Watts (4 ohm) continuous sine wave. 8 Watts per channel.  
**FREQUENCY RESPONSE:** 30c/s. 25 Kc/s plus over minus 1 db.  
**HUM and NOISE:** AUX. or TUNER: 60 db at 8 ohm SPKR Max. Vol. Flat Tone.  
TAPE or MAG: 50 db at 8 ohm SPKR Max. Vol. Flat Tone

### MODEL RP242

**AUDIO DISTORTION:** (AUX) Max. Output 1/10 Output  
100 c/s . . . . . 0.7% 0.52%  
1 Kc/s . . . . . 0.55% 0.55%  
10 Kc/s . . . . . 1.70% 0.6%  
**CONTROLS and SWITCHES:** Selectors: Phono: Tape Head, Aux. Tuner.  
Made: Stereo. Mono.  
**TERMINALS:** Bass: Treble, Volume, Balance, Power.  
Input: Mag, Tape Head, Tuner, Aux.  
Output: 4 16 ohm SPKR.  
**AMBIENT TEMPERATURE:** Below 45 deg. C.  
**POWER SUPPLY:** 240V, AC, 50/60c/s. 90VA at Non Signal.  
**DIMENSION:** 13 1/2 in (W) x 4 1/2 in (H) x 8 3/4 in (D).  
**WEIGHT:** 7 1/2 lb.

FEATURING IMPORTED "RAPAR" EQUIPMENT

WRITE FOR PARTICULARS ON ANY COMBINATION YOU DESIRE

**HI-FI (STEREO) PTY. LTD.**

STATE SAVINGS BANK HOUSE, Mezzanine Floor, 157 Elizabeth Street, Melbourne, Vic. 3000 — 67-3263.

# GOLAY CELL POWER SUPPLY

A power supply for Golay Cell infrared detectors has been released by AIM Electronics, Cambridge, England.

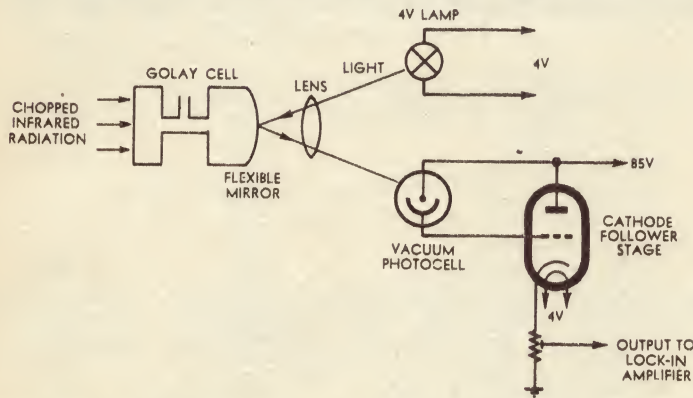

The AIM Golay Cell Power Supply, model GPS 213, is a self-contained mains-powered module which can be used with AIM lock-in amplifiers for the measurement of infrared radiation. The supply provides a highly stable 4V DC output for the optical exciter lamp and the valve heater. Thus the lamp brightness is independent of any external variations such as mains voltage fluctuations. Also provided is a stable 85V DC output to operate the low noise valve and vacuum photocell which are part of a Golay Cell.

In a Golay Cell, an alternating infrared signal, produced by chopping the incident radiation with a rotating vane, falls on an absorbing membrane. This causes a gas to heat and expand, resulting in the bulging of a flexible mirror at the end of the gas chamber. The chamber has a leak to a ballasting reservoir so that changes in ambient temperature do not affect the detector. The mirror forms part of a very sensitive optical lever system, and movement of the mirror causes a change in the intensity of light falling on a photocell. The sensitivity of the optical system is such that it can detect the motion of the gas molecules at ambient temperatures.

For the device to operate at its most

sensitive, the total noise generated in the detection system must be less than the noise from thermal movement. To reduce noise, a vacuum photocell followed by a low-noise valve are usually used. The valve is operated in the cathode-follower mode to provide a low impedance output to an amplifier. The exciter lamp in the optical system requires a low voltage supply with a stability of better than 1 part in 100,000.

Further information may be obtained from the Australian agents for AIM Electronics, who are Rutherford Electronics Pty. Ltd., 833 Doncaster Road, Doncaster, Vic. 3108.

# Metal Protector

A corrosion preventive compound manufactured by LPS Research Laboratories, Los Angeles, California, U.S.A., is said to protect all metals against rust and corrosion, to displace moisture on metals by forming a fine protective film, and to lubricate delicate mechanisms at extreme temperatures. It is available for dip application or as an aerosol spray.

The LPS compound is not a silicone and is claimed to be non-toxic and to be harmless to paint, rubber, fabrics, plastics or other finishes.

Three different grades of the compound are produced. LPS No. 1, regular, forms a fine .0001in non-greasy, non-sticky transparent film said to protect all sheltered metals from rust and corrosion for a year or more. LPS No. 2 is similar and used where a heavier coating is needed. LPS No. 3 forms a coating .0002in thick and is said to protect all metals from rust and corrosion for two years or more under severe outdoor conditions. In a test quoted in the literature, three panels dipped in LPS No. 3 showed only a slight amount of red dust after 135 hours of 5 per cent concentrate salt spray test.

Full details of the LPS metal protector may be obtained from the sole agent: Zephyr Products Pty. Ltd., 70 Batesford Road, Chadstone, Vic. 3148.



## Note on the Beogram 1500

The Beogram 1500 turntable with integral amplifier was reviewed in these pages in the January, 1969, issue. In this review we found the frequency response of the basic amplifier was within plus or minus 3dB from 50Hz to 30KHz with the tone controls adjusted for the best response. A check of the equalisation for the magnetic cartridge was difficult to do without making internal connections and was consequently carried out using the CBS STR 100 test record. This revealed a substantial deviation from the ideal response curve.

The Australian distributors, G.R.D. Instruments Pty. Ltd., agree with the above findings and have advised us that the apparent deviation from flat response is due to an automatic loudness compensation circuit contained in the amplifier. They also advise that they propose to offer an alternative model with a switch to cut out this loudness compensation circuit so the amplifier as a whole will have a flat response. The user can then use the amplifier with or without loudness compensation, depending on his listening requirements.

Further information on this and other features of the Beogram 1500 can be obtained from G.R.D. Instruments Pty. Ltd., 6 Railway Walk, Camberwell, Vic. 3124.

THE VITAL GRIP  
IN PRECISION SOLDERING



**FINE BALANCE AND LIGHTNESS  
PRECISE FINGERTIP CONTROL  
NO SWITCH TO DISTRACT**

See the range of Adcola "M" series soldering tools illustrated in **ELECTRONICS** Australia January edition or write for a brochure to

**ADCOLA PRODUCTS PTY. LIMITED,**  
22 Firth St., Doncaster, Vic. 3108. 848-3777.  
**ADCOLA PRODUCTS PTY. LIMITED,**  
17 Burwood Rd., Burwood, N.S.W. 747-1606.

**T. H. Martin Pty. Ltd.,** 56-74 Edward St., Brisbane. 2-0555.  
**Everett Agency Pty. Ltd.,** 17 Northwood Street, West Leederville. 6007. W.A. Phone 84 137.  
**F. R. Mayhew Pty. Ltd.,** 11 Halifax St., Adelaide. S.A., 8-4131.

**ADCOLA**

SELECTED AS  
**Good Design**  
FOR  
AUSTRALIAN  
DESIGN INDEX  
INDUSTRIAL  
DESIGN COUNCIL  
OF AUSTRALIA



# STOCK TRANSFORMERS for Popular Projects!

PUBLICATION	PROJECT	A. & R. TRANSFORMER TYPE
ELEC. AUST. FEB. 1969	Solid State V.O. Meter	PT6474
ELEC. AUST. FEB. 1969	Probe, Pre-Amp C.R.O.s and V.T.M.s	PT6474
ELEC. AUST. JAN. 1969	Low cost Transistor Power Supply	PT2155
ELEC. AUST. JAN. 1969	Timer and Sequencer for Slide Projectors	PT6474
ELEC. AUST. DEC. 1968	Tape Replay Pre-Amp.	PT6474
ELEC. AUST. NOV. 1968	Acoustic Signal Unit	T01
ELEC. AUST. OCT. 1968	Playmaster 123 Program Source	PT5679
ELEC. AUST. OCT. 1968	Power Supply for Transistors in Valve Equip.	PT5579 or PT6474
ELEC. AUST. SEPT. 1968	Electronic Thermometer	PT6474
ELEC. AUST. SEPT. 1968	Solid State A.F. Signal Generator	PT5990
MULLARD OUTLOOK SEPT.-OCT. 1968	Stabilised Power Supply	PT6557
ELEC. AUST. AUG. 1968	3- Plus -3 Stereo Amplifier	PT2155
ELEC. AUST. AUG. 1968	Playmaster 122 Program Source	PT5579
ELEC. AUST. AUG. 1968	D.C.-A.C. Inverter for Fluorescent Lamps	PT2155
ELEC. AUST. JUNE 1968	P.A. Amplifier Power Supply	PT5990
ELEC. AUST. MAY 1968	Solid State A.F. Millivolt Meter	PT6474
ELEC. AUST. APRIL 1968	Synchronous Unit Gating	PT6474
ELEC. AUST. MARCH 1968	Transistor R.F. Test Oscillator	PT6474
OUTLOOK JAN. FEB. 1968	Stereo 10-10 Transistor Power Amp.	PT6413
ELEC. AUST. AUG. DEC. 1967	All Wave Receivers 3, 4, 5, 6 and 7	PT2062, E7/V.C.
ELEC. AUST. AUG. 1967	60 Watt Guitar Amplifier	PT5893, OT2842
ELEC. AUST. JUNE 1967	40 Watt Guitar Amplifier	PT5892, OT2843
ELEC. AUST. APRIL 1967	Logic and Counting Demonstrator	PT2150 or 2 x PT5579
ELEC. AUST. APRIL 1967	Optical and Magnetic Preamp. for Sound Projectors	PT1992
ELEC. AUST. APRIL 1967	All Silicone Playmaster Amplifier	PT6232, Z3252
ELEC. AUST. NOV. 1966	Stereo Public Address Amplifier	PT5891, Z3239, OT4005 (2 req'd)
ELEC. AUST. OCT. 1966	3 Band Receiver with Switched Coils	PT1992 Suitable Speaker Trans. from A. & R. Range
MINIWATT DIGEST AUG.-SEPT. 1966	Electronic Photo Cell Circuits	PT5991
OUTLOOK MAY-JUNE 1966	3 Watt Transistor Stereo Amp.	PT5990
ELEC. AUST. JUNE 1966	Regulated Power Supply	PT1940
ELECT. AUST. JUNE 1966	Basic Stereo Amplifier	PT1889, Z3040, K5/15 (2 Reg'd.)
ELEC. AUST. MAY 1966	A Battery Charger for your Car	PT5786

Available from all leading Stockists!

A & R TRANSFORMERS PTY. LTD. 42-46 Lexton Rd., Box Hill, Vic. (Box Hill P.O. Box 170) Phone 89 0238



## THIS IS THE LONG PLAYING CARTRIDGE

1,000-play test proves it keeps your records new . . . indefinitely.

The Empire 999VE is the only cartridge that gives you laboratory-test proof that even 1,000 playbacks produce no audible sign of record wear.

With virtually weightless playback, only the 999VE gives your total record protection. High frequencies stay clean and perfect: even a 20K Hz tone is only -3 db after 1,000 plays. Distortion is below audibility: 0.1% at a groove velocity of 14 cm—sec. after a full 1,000 plays.

If you value your record collection, ask your dealer for the EMPIRE 999VE.

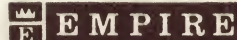

Summary of review in the November, 1968, edition of the "Gramophone" magazine: "The 999VE cartridge is one of the best we have tested, we unhesitatingly put it in the top echelon. It can confidently be recommended to those who want the best, irrespective of price."

MADE IN U.S.A. SOLE AGENTS FOR AUSTRALIA: RECORDED MUSIC SALON.

THE BEST STEREO EQUIPMENT MUST HAVE AN ARMSTRONG.

A NEW SHIPMENT OF RECENTLY RELEASED ARMSTRONG SERIES 500 AMPLIFIERS HAS JUST ARRIVED.



### Specifications:

Power output, continuous sine wave	25 watts per channel, 8 ohms
Power bandwidth	20—25,000 Hz
Frequency response	20—20,000 Hz plus minus 1 dB
Harmonic distortion	Less than 0.5% at 1 kHz measured at 25 watts output plus minus 1 dB
Loudspeaker matching	Between 4 and 16 ohms
Crosstalk	Better than 40 dB
Channel matching	Plus or minus 1 dB
Bass control	Plus or minus 10 dB at 70Hz
Treble control	Plus or minus 10 dB at 10 kHz
Balance control	Maximum to zero each channel
Rumble filter	Minus 1 dB at 30 kHz increasing at lower frequencies.
Treble filters	1.65 kHz minus 3 dB, 10 kHz minus 25 dB
Loudness	2.45 kHz minus 3 dB, 9 kHz minus 40 dB
	At 1 kHz reference (minus 20 dB).
	70 Hz plus 10 db, 10 kHz plus 5 dB
Tape recording	400mV low impedance
Output	Suitable for all stereo phones
Headphone output	
Inputs	Sensitivity Hum & Noise (reference 25W)
Tape playback	400 mV minus 70 dB :
Radio (421 only)	100 mV minus 60 dB
Pickup 1 ceramic	60 mV minus 55 dB
Pickup 2 magnetic	3.5 mV minus 55 dB

Made in England. Sole Agents for Australia.

**RECORDED MUSIC SALON**  
C. PINCZEWSKI

TRUE FIDELITY

23 COLLINS STREET,  
MELBOURNE 3000  
Telephone 63-6257

## TRADE RELEASES—in brief

**THERMALLOY** has developed a new type of insulating washer for power semi-conductors. Known as "Therma-film," these washers use a special plastic film material, which is said to have the thermal conductivity, low cost and dielectric strength of mica washers, but will not puncture, fracture or peel. The breakdown voltage is 7000V per mil and the temperature range—269 to +400°C. The washers are initially offered 2 mils thick in 14 popular Jedec styles. Complete specifications are available from the Australian agents, Cannon Electric Aust. Pty. Ltd., 58 Cluden Street, Brighton, Vic. 3187.

**AUSTRALIAN GENERAL ELECTRIC PTY. LTD.** offers the 8A Junior Mini-bridge manufactured by Electronic Devices Inc. of the U.S.A. This miniature single phase full wave bridge is designed to replace larger bridges in power supplies, etc. Features include: 50 to 1000V peak inverse rating; peak one-cycle surge (at 60Hz) of 100A maximum; peak recurrent forward current of 20A maximum. Further information is available from Australian General Electric Pty. Ltd., 103 York Street Sydney, 2000.

**PERKIN-ELMER PTY. LTD.** has appointed agents to handle Australian sales for its laser equipment range. Wild (Australia) Pty. Ltd (Sydney and Melbourne) will handle the agency in all States except Queensland, where the agent will be Instrument Engineering Pty. Ltd. of Woolongabba. Most laser equipment sales by Perkin-Elmer are in the construction and surveying fields in which the two new agents specialise.

**CAMBRIDGE SYSTEMS INC.**, of the U.S.A., has developed a low-cost, precision water-vapour gas analyser, the model 880 Dew Point Hygrometer. It has a modified version of the sensor used in the higher-priced Cambridge instruments, a thermo-electrically cooled mirror optically maintained at the dew point. Proportional



cooling control allows the mirror temperature to be independently measured with an aged precision thermistor. The dew point temperature is displayed directly on a taut band, mirrored scale with a dual span of -40° to +125°F and -40° to +50°C. Recorder output and remote thermistor readout are standard features. Inquiries to Auriema (A'asia) Pty. Ltd., 443 Kent Street, Sydney, 2000.

**PLESSEY** has announced the following appointments within the Plessey Group in Australia:

Mr Robert Long has been appointed divisional manager of the Telephone and Electrical Industries (T.E.I.) division of Plessey Telecommunications in succession to Mr Fred Baker. Previously, Mr Long was deputy divisional manager (engineering and production).

Mr Daryl Hooper has been appointed to the new position of research manager at the Plessey Pacific central research laboratory in Melbourne. Prior to his new ap-

## Management for Singapore company

Philips Industries Ltd., of Sydney, has agreed to undertake the full management responsibility for the newly formed company Singapore Electronic and Engineering (Private) Ltd., which is wholly owned by the Singapore Government, and to provide the senior management personnel from Australia. The executives appointed are:

Mr K. A. Middleton (previously Philips Industries export manager) as managing director (top picture);

Mr B. T. Nolte (previously manager of Commonwealth Electronics Pty. Ltd., a wholly owned Philips subsidiary) as technical manager (centre);

Mr C. S. Sulan (previously chief purchasing officer at Philips' manufacturing centre at Hendon, S.A.) as administrative manager (bottom).

Singapore Electronic and Engineering (Private) Ltd., S.E.E.L., was formed to take over and operate on a commercial basis that section of the British Naval Dockyard at Singapore engaged in the installation and servicing of electronic equipment and weapons systems.

As a commercial enterprise, S.E.E.L. will be able to service the defence forces of all countries (including remaining British forces in the area), and extend its activities to other Government and commercial undertakings. The company's activities will be concerned fundamentally with system design, installation and servicing of radar systems, telecommunication equipment, computers, servo mechanisms including gyros, optical equipment and electronic test equipment.



pointment, Mr Hooper was in charge of a design team at the laboratory specialising in the development of integrated circuits.

Mr Jack Stringer has been appointed to the new position of marketing manager of the Plessey Components Division, which comprises the Ducon, Rola and Garrard subsidiaries. Previously he was marketing manager of the Ducon unit.

Other appointments include: Mr Robert Iveson to production manager, T.E.I. Division; Mr Colin Fleming to commercial manager, Telecommunications Division; Mr W. E. K. Selkton to divisional controller, Components Division; Mr Mauri Smith to general sales manager, Rola subsidiary in Melbourne.

**AUSTRALIAN GENERAL ELECTRIC PTY. LTD.** has introduced a 5W monolithic IC amplifier, claimed to be the first available in the world. The PA246 is a general purpose driver for use in consumer and industrial systems. It incorporates a PA237 IC chip in a package containing two heatsink tabs and eight leads in a staggered configuration based on the present GE dual-in-line package. The device operates from a wide range of supply voltages up to 37V, and can drive loads with up to 1.25A peak. The 5W rating is based on a 34V supply and a 16-ohm load. For further information contact the company at 103 York Street, Sydney, 2000.

## NEW ELECTRONIC WEATHER STATION

Become a  
Weather  
Expert

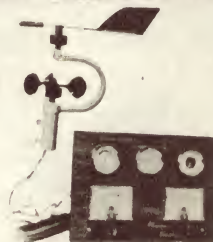

Complete with:

- Generator type-accurate wind speed indicator.
- Rheostat controlled wind vane. Operates by torch cell.
- Barometer.
- Hygrometer
- Thermometer.

Attractive panel for in-door installation. Transmitter may be mounted on the roof.

You will be amazed at our large spectacular range and our big price savings. All goods fully guaranteed.

- BINOCULARS
- OPTICAL ACCESSORIES
- CELESTIAL GLOBES
- TELESCOPES ● MICROSCOPES
- BOOKS, CHARTS, ATLASES
- BUILD-IT-YOURSELF KITS

Special attention given to all mail order clients.

**AMATEUR ASTRONOMERS  
SUPPLY CO.**

11b Clarke St., Crow's Nest,  
SYDNEY, 2065. Phone 43-4360

WRITE OR CALL FOR OUR FREE CATALOGUE NOW!

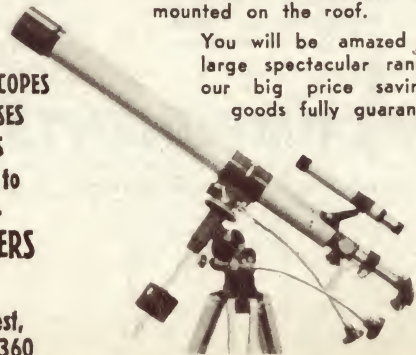

**Sony replaced IFT in this  
4-band transistor radio**

**with the new Murata  
ceramic filter SF-455D.**

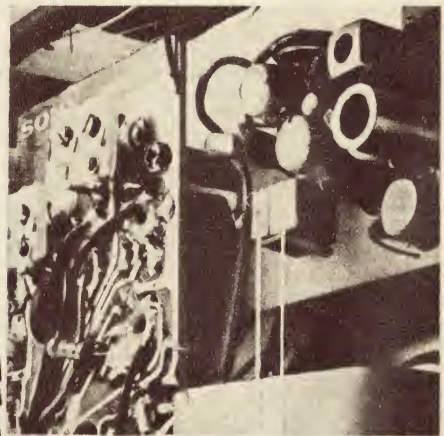

BF-455A J L SF-455D

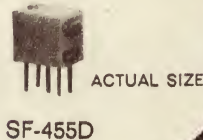

Throughout the world electronic design engineers have begun to realise the many benefits offered by Murata Ceramic Filters. These include high gain, low spurious response, negligible ageing characteristics (0.4% over 10 years) and, since no alignment is necessary, considerable cost saving in production. Sony engineers have taken advantage of these benefits and have incorporated two Murata Ceramic Filters

SF-455D and BF-455A in the quality model TR-1000 4-band transistor radio.

Combining excellent overall response and selectivity characteristics with space saving and production economy, the Murata Ceramic Filters are proving superior to conventional IF transformers.

Include Murata Ceramic Filters in **your** next design.



**MODEL BF-455A** improves the selectivity of transistor radios when used as an emitter by-pass in transistor IF Stages.

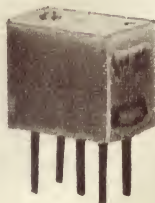

**SERIES TYPE (Model SF-455)** is a resonance type filter of 455 KHz. It replaces the transistor radio's IFT or can be used in combination with IFT's.



**LADDER TYPE** Ceramic Filters CF-455 and CF-455P (Popular Type) are ideal for IF stages of high quality communication receivers.

**IRH COMPONENTS PTY. LIMITED**

*A subsidiary of International Resistance Holdings Limited*

THE CRESCENT, KINGSGROVE, N.S.W. 2208. TEL. 50 0111

**muRata**

MAKES THE MOST OF CERAMICS

IRH. M.I.



## CETIA 1970 Exhibition

Melbourne is to be the venue for the next CETIA Exhibition to be held from February 23 to 27, 1970. The title of the exhibition, CETIA, is derived from the fields it is designed to cover—Control, Electronics, Telecommunications, Instruments and Automation. The exhibition is staged under the technical direction and sponsorship of the Institute of Instrumentation and Control Australia. The Melbourne exhibition will be staged in the new Western Annexe, an extension to the city's established exhibition building. The administration and control of the exhibition will be conducted from the organisers' head office in Sydney.

The exhibition was last staged in Sydney in 1968, in conjunction with symposia at which papers of technical interest were presented. Over 1,300 products were officially listed for the 1968 exhibition, and the organisers expect a considerable increase on this figure for the Melbourne exhibition. Visitors will have the opportunity to attend the various technical conferences held in conjunction with the exhibition.

Further details about the exhibition can be obtained from the organisers by writing to CETIA 1970, Box 3269, G.P.O., Sydney, N.S.W. 2001.

**AUSTRAL STANDARD CABLES PTY. LTD.** announces that Mr A. T. Deegan has been appointed a director of the company. Mr Deegan is also deputy managing director of Standard Telephones and Cables Pty. Ltd.

**FAIRCHILD AUSTRALIA PTY. LTD.** has reduced the price of the following counting micrologic integrated circuits (prices for 1-24 units): CuL 9958 decade counter \$9.75; CuL 9959 4-bit buffer-storage element \$9.00; CuL 9960 decoder display driver \$12.75. Further details may be obtained from the company at 420 Mount Dandenong Road, Croydon, Vic. 3136.

**FRAZAR & HANSEN LTD.,** of U.S.A., has signed an agreement with the Instrumentation Division of Microdot Inc., South Pasadena, California, for the marketing of electronic products in Australia. Microdot manufactures telemetry transmitters, high power VHF and UHF transmitters, RF power sources and amplifiers, and other industrial products. Frazar & Hansen plans to set up its marketing and sales activities in Australia, and is seeking to broaden its representation throughout the country. Inquiries to Frazar & Hansen Ltd., 150 California Street, San Francisco, California 94111, U.S.A.

**RACAL ELECTRONICS PTY. LTD.,** the Australian associate of the recently formed data communications company, Racal-Milgo Ltd., has announced a new megabit data modem. The model 1000 data modem can be supplied operating at any data rate between 10,000 and 1 million bits per second. It is designed primarily for rapid data transfer between computer terminals in concentrated areas. Each unit is a synchronous, differential two-phase full duplex data set. Further information is available from Racal Electronics Pty. Ltd., 47 Bennie Street, North Ryde, N.S.W. 2113.

**MOTOROLA Semiconductor Products Division** has announced the availability of a linear integrated circuit design kit. The kit includes two of each of 12 different circuit types covering nearly all linear applications. In addition the kit provides a complete library on everything in the company's linear IC line. Motorola say that the devices included in the kit have a retail value of \$388 but the kit will sell for under \$105. For further information write on company letterhead to the Australian distributors, Cannon Electric Aust. Pty. Ltd., 58 Cluden Street, Brighton East, Vic.

**PLESSEY DYNAMICS DIVISION** has developed a new range of airfield lighting equipment. The range includes air field lights, beacons, floodlights and associated control gear and standby power systems. All equipment meets existing ICAO and BS requirements, and also has provision for modification to meet more rigid lighting requirements already contemplated for aircraft operation using

a lower weather minimum. Each system is constructed from a comprehensive range of standardised interchangeable lights and multi-purpose controls. Further information is available from Plessey Dynamics Division, 15 Coongie Avenue, Edwardstown, South Australia.

**LEL DIVISION** of Varian Associates has announced the new series ITM-3 miniature low noise solid state amplifiers. These are primarily intended for use in applications where low noise and high gain are needed. The design is claimed to feature the lowest practical noise figure commensurate with high input and output power handling capability, in order to provide low intermodulation and harmonic distortion. Solid state components are used throughout for high reliability. The centre frequency is 30 or 60MHz with a bandwidth of 10MHz minimum, and a minimum gain of 90dB. Inquiries to the Australian associated company, Varian Pty. Ltd., 38 Oxley Street, Crow's Nest, N.S.W. 2065.

**ICIENZ Films Division** informs that Melinex type 226 polyester film has been re-graded as a class B insulating material following the successful completion of a series of independently conducted tests. The tests were carried out by the Physikalisch-Technische Bundesanstalt Institut, Berlin, and covered the effects of heat ageing on dielectric strength, tensile strength, and elongation at break. The film can now be used with compatible resins in the construction of fully impregnated rotating electrical machinery designed to operate at temperatures up to 130 degrees C. Previously, Melinex type 226 had a grading as Class E material with a maximum working temperature of 120°C. It is marketed in Australia by ICIENZ Films Division, 1 Nicholson Street, Melbourne.

**RAYTHEON** has added the Raytheon 706 to its family of computers. Its full cycle time of 900ns permits data acquisition at rates up to 2.2 million bytes per second, and a standard automatic priority interrupt response time of 2.7µs. The 16-bit computer has both word and byte instructions and memory organisation for maximum programming and storage efficiency with character as well as word data. The basic system sells for \$19,000 and includes 4,096-word memory, systems cabinet, console, one level automatic priority interrupt, hardware bootstrap, ASR-33 and training in both programming and maintenance. Inquiries to the Australian agents, Dynamco Electronics Pty. Ltd., 90 Alexander Street, Crow's Nest, N.S.W. 2065.

**CANNON ELECTRIC AUSTRALIA PTY. LTD.** announces the appointment to the company's board of directors of Mr A. T. Deegan, deputy managing director of Standard Telephones and Cables Pty. Ltd., and Mr R. T. Johnson, the controller of S.T.C. Cannon Electric is jointly owned by I.T.T., Cannon Electric of the U.S.A., and Overseas Corporation (Aust.) Ltd.

## UNITED TRADE SALES

PTY. LTD.

### SPECIAL

6 only Marconi Video osc. spec. in Jan. 69 Electronics. \$90 plus freight.

### MILLER TRANSISTORISED IF STRIPS

455 Kc Selectivity 5 Kc at 6db down. Power 6 Volts 2mA gain 50db. Price: \$9.70.

### EMI REGULATED POWER SUPPLIES

Input 200-240 v.a.c. 50-500c/s. Output 300 v d.c. at 500 mA. Fully Regulated. Also 6.3 v.a.c. at 4.8 Amp. Output Metered. Uses 3X 5R4 Rectifiers in Parallel 3X 12EI Regulators in Parallel. Mounted on Chassis with 19in Panel. PRICE \$40.00.

Due to excess weight, approx. 50lb, these units will be sent Freight Forward.

### LOW VOLTAGE REGULATED POWER SUPPLIES

230 v.a.c. 50-250c/s Input. 12 v.d.c. (Nominal) 10Amp. Output. Variable over the range of 11-13 Volts. Automatic Overload Protection. 16 Power Transistors in Parallel. Each Transistor 2N257 Rated at 3 Amps. "C" Core Transformer. PRICE: \$35.00.

FREIGHT FORWARD. Weight Approx. 30lb.

### NEW PIANO KEY SWITCHES

5 KEY, Special at \$1.00 each.

### CAPACITORS

80 for \$2 in Poly Packed Bags. Mixed values only.

### VALVES

6Jc 30c ea. 815 70c ea. 807 70c ea. 6AC7 20c ea. or 12 for \$2: 6C4 50c ea. 1K7 20c ea. or 3 for \$2. 6AM6, 50c each.

QS150/15 50c ea. VR150/30 75c ea. or 3 for \$2.

QB2/250 Philips (813). New in sealed cartons.

Current manufacture, \$7 ea.

### COMPLETE RANGE OF METERS.

P25's 24sq  
100uA .. \$6.95 1mA .. \$4.50  
500uA .. \$5.25 50mA .. \$4.50  
10mA .. \$4.50 S'meter .. \$5.25

**MULTIMETERS.** 200H, 20K ohms per volt. \$11.25, inc. tax. CT 500 20K ohms per volt, \$15 inc. tax. CT 330 20,000 ohms per volt, \$17.25.

**RESISTORS.** Mixed Values only in Bags: \$2 per 100, or 50 for \$1. 3,000 Type Relays. New stocks. 50c each. Plus postage.

**TRANSISTOR V.H.F. CONVERTER** Tunable 108-136 Mhz Aircraft Band 1F-600Kc to 1,000Kc. No connecting wires needed, 9V Battery, self-contained, just place alongside broadcast radio. Price only \$14.40 plus 45c postage.

### WANTED BUY:

RECEIVERS, TRANSMITTERS, TEST EQUIPMENT.

All prices subject to alteration without notice.

All items PLUS POSTAGE.

## UNITED TRADE SALES

PTY. LTD.

280 LONSDALE STREET,  
Melbourne. Phone 663-3815  
Opposite Myers

# TUDOR RADIO

L. E. CHAPMAN  
ESTABLISHED 1940

103 ENMORE ROAD, ENMORE, N.S.W.

PHONE 51-1011

PHONE 51-1011

Knobs long shaft, push on. Dozen \$1.20  
Knobs for concentric shaft. Dozen \$1.20  
250 mixed screws. BA, Whit., self-tapper  
bolts, nuts, etc. \$1 bag plus 25c post.  
Crystal microphones, good quality, ideal  
tape recorders, etc. \$2.80.  
Transistor speaker transformers, single  
ended, 5 watt. \$1.50.  
Pick up shielded Wire—15 cents yard.

## SPEAKERS

MSP 8-inch dual cone . . . . . \$5.80  
MSP 12-inch dual cone . . . . . \$7.50  
MSP 7 x 5 15 ohm . . . . . \$3.50  
MSP 3½-inch 3 ohm . . . . . \$2.00  
Rola 6 x 4 15 ohm . . . . . \$3.00  
Rola 5 x 3 15 or 27 ohm . . . . . \$2.00  
Rola 5B 3 ohm . . . . . \$2.00  
MSP 6 x 9 15 ohm . . . . . \$5.00  
3-inch single cone 15 ohm . . . . . \$4.20  
6 x 4 33 ohm . . . . . \$3.00  
MSP 20 Watt . . . . . \$19.75  
MSP 12-inch 8 ohm . . . . . \$7.00  
MSP 2-inch 15 ohm . . . . . \$2.00  
MSP 8-inch dual cone, 8 ohm . . . . . \$5.80  
MSP 12-inch 3.5 ohm . . . . . \$6.00  
MSP 4-inch large magnet 8 ohm . . . . . \$2.50  
MSP 3-inch 150 ohm . . . . . \$3.00  
National 8-inch built-in tweeter  
and crossover network . . . . . \$14.75  
MSP Electro Dynamic, 8in, \$4, or 6 x 9.  
MSP 6 x 2 15 ohm, \$3.  
MSP 6 x 4 15 ohm \$3.50.  
Peck 6a7 16cm Hi-Fi  
Dual Tone 6in . . . . . \$7.50  
MSP 20watt radial beam 12pqab \$21.50



RADIOGRAM CHASSIS 4 valve including valves and speaker, \$15.50. Size 10½ x 3 x 5.



## SMALL 2-GANG TUNING CONDENSERS

Complete with direct drive scale. \$1.75  
TV IF STRIPS . . . . . \$5 each.  
ENGLISH PANEL LAMP with toggle switch 75 cents.



English push-button on/off switches, 75c each. Pack and post 10c.  
Vinyl insulating tubing, 13MM wall thickness .030, 25 yards . . . \$1  
Mini cable, 4 strand shielded, lots of uses, including microphone cable, extension speakers etc. . . . . 10c yard  
Radio knobs, push on . . . . . 50c doz.

Miniature valve sockets 7 and 9 pin 15 cents each.  
Speaker Crossover net work Condensers 2 MFD — 60 cents.  
Phillips IFT's 455KC . . . . . 75c each  
Aerial and oscillator coils . . . . . 50c each  
Scope soldering iron, standard; mini scope. Scope De Luxe. Vibra scope; National scope transformer.

Transistor IFs, medium size, 75c each  
Record Changers, Garrard 3000. \$35

RECORD CHANGERS, B.S.R. UA70. \$37.50.

PORTABLE RADIOGRAM CASES. NEW, SHOPSOILED . . . . . \$4  
Pack and Post, 50 cents.

Transistor speaker and drive transformers, large and midget type . . . \$1.00  
Speaker transformers 15,000 and 25,000 to 3 ohms 6 watts . . . \$1.50 each  
5,000 to 3 and 15 ohms . . \$1.25 each  
Transistor speaker chokes . . \$1.50 each  
Here's value in pots.

Pots, single log and linear:  
3K, 7½K, 10K, W.W., 20K, 25K, 50K, 100K, 200K, 250K, 500K, 1 Meg, 2 Meg. Dual Concentric Switch Pot \$1.25

Pots 25,000 dual gauged switch pots, \$1.25  
1.5 Meg. Dual Concentric . . \$1.00  
Pots dual gauged 10K, 50c. 1 Meg. \$1.25

Pots concentric. 100K + 50K, 100K + 2½K, 100K + 10K, 250K + 250K, 500K + 500K, 1 Meg + 1 Meg, 1 Meg. + 500K. Various others 2 Meg . . . . . 50c each  
TV power Transformers 300 mill 225v a side, suit amplifiers up to 50 watts voltage doublers available, \$8.00 each  
TV safety glass per sheet . . . \$3.50  
Garrard plug in stereo heads . . . \$4.00  
TV masks, 17, 21, 23in . . . \$1.50 each  
Tuning condensers 2 and 3 gang, \$1.00



## STEREO AMPLIFIER KIT SETS

TU 10, 3.5 watt per channel . . . \$19  
TU 11, 3.5 watt per channel, has facilities for tape and microphone channels . . . . . \$23  
TU 12, 5 watt per channel . . . \$22.00  
TU 13, 5 watt per channel, with TU 11 facilities . . . . . \$27  
Each kit set includes valves and all components. Front face plate, if required, \$1 extra.

Single stage amplifier kit set:  
5 watt per channel . . . . . \$22.00  
Transistor ear plugs . . . 3 for \$1.00  
Tag strips, mixed types . . Dozen, 60c  
Switches, oak 4 position . . 50c each  
2 position . . . . . 40c each

½ and ¼ AMP. FUSES \$3.50 100.  
Din Plugs, 3 or 5 pin . . . 50c each.  
Ceiling Speaker Baffle, suit 5in or 6in Speaker . . . . . \$2.50  
Utilux H168 Double contact Holders . . . . . 20c each  
Elip Sal. 2-pin, 10 amp, 240 volt plug sockets . . . . . 25c each

## ELECTROS:

50	3 in one	415
8	250	415
10	350	415
	350	415
	75 cents each.	

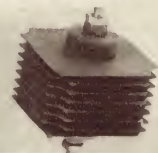

Metal Rectifier . . . . . \$1 each

## TV AERIALS

Famous Make  
All types \$3.50 to \$20.00 plus post.  
TV aerial lead in . . . . . 10c yard  
Tuning Condensers, 2 gang or 3 gang —\$1 each.

2 amp fuses . . . . . \$3.50 per 100  
Special, 12in speaker, 2 ohm Rola, \$6.00 pack and post, 75c.  
Transistor plastic outer case, 50c each  
Transistor carrying straps . . 20c each  
Stereo pick-up arms, with Xtal, \$6.00 ea.  
Metal rectifiers for battery and electric portables . . . . . 50c each, post. 10c  
Pilot lamp holders . . . . . 60c per doz.  
TV or cabinet castors . . . . 4 for \$1.00  
100 Mixed Knobs including TV channel changers . . . . . \$10.00  
240v AC Record Changers, stereo \$21.50, Mono \$20.00. Pack and post, N.S.W. \$1.50, interstate \$2.50.  
Gramophone motor and pick-up, 240v AC \$11.50. Pack and post, N.S.W. \$1.00, interstate \$1.50.

OA 70 diodes . . . . . 40c each  
Morganite and IRC resistors. At least 33 values. Suit transistors, radios, TV, etc., \$2.00 per 100. Pack and post, 25c.  
3, 5, and 10 Watt IRC wire wound resistors. Many values.  
20c each, 12 for \$2.00  
100 mixed condensers, micas, ceramics, tubular. Fresh stock.  
\$2.00. Pack and post 25c.  
50 + 24, 350 vw + 100 mf 25vw, 75c each  
30, 30mf 300 vw 350vp . . 75c each  
Many others. Invaluable for service.

SHEPHERD CASTORS, \$3.00 set of 4.  
SMALL AMPLIFIER OR TUNER CHASSIS, \$1.50 each. Pack and post 25c.

ALPHA 200VAC ¼ amp push-on switches, 30c each. Ideal for fridges.  
90 deg. PICTURE TUBE SOCKETS 25c each. 152 valve sockets, 25c each.  
Transistors AC127, 2N384, 2N217, 2N218, OC71, OC75.  
\$1.00 each. Post and pack 5c.

THREE WATT AMPLIFIERS, complete with speaker.  
NEW. \$10.00

Electros 1.8 x 0.9 MF — 20c each

AUDIO TRANSFORMERS  
18-4294, 28-4536 . . . . . 75 cents each.

PILOT LIGHTS, Plug in . . 10 cents

SWITCH WAFERS  
20 Cents each.

R.C.A. plastic Tape Reels, 7 inch type  
EPR-7 — 85 cents each.

NEW GRAMOPHONE MOTORS,  
For 4-speed Turntables . . \$2.50 each.

## NEW VALVES

12AU7 . . . \$1.25	6AU4 . . . \$1.25
6SA7 . . . \$1.25	6U9 . . . \$1.25
6BU8 . . . \$1.25	6Y9 . . . \$1.25
6M5 . . . \$1.25	6X9 . . . \$1.25
6BM8 . . . \$1.50	6AQ5 . . . \$1.25
1S5 . . . \$1.00	1B3 . . . \$1.50
1T4 . . . .50	1S2 . . . \$1.50
6CJ6 . . . \$1.50	5AS4 . . . \$1.25
6L18 . . . \$1.00	6DQ6 . . . \$1.50
ECL85 . . \$1.25	12AT7 . . \$1.25
SP61 . . . \$1.00	12AX7 . . \$1.75
UU9 . . . \$1.00	6B8 . . . \$1.25
12BE6 . . \$1.00	



TV IF Coils, ideal for Coil Formers  
..... \$1 dozen.



**SPEAKER CABINETS**

- 13 x 6 1/2 ..... \$5.00
- 10 x 6 1/2 x 4 1/2 ..... \$3.50
- 12 1/2 x 8 1/2 x 6 ..... \$5.00

Dial drums 5 inch, 3 1/2, 3 3/4 .. 50c each

National speakers 8 inch built-in  
Tweeter, Crossover net work \$14.75  
10 inch Bass, mid range  
Tweeter combined. \$32

Fuse holders ..... 50 cents doz.  
Octal valve sockets ..... 50 cents dozen  
Chokes 18 Henry 30 mil. .... \$1.50

ELECTROS 20 MFD 200 PV — 20c

RESIN CORE SOLDER 5 yards 75c

M.S.P. 6in SPEAKERS, 3 or  
15ohm ..... \$4.00

6 VOLT PILOT LIGHT, screw-  
in ..... ea. 10c

TRANSISTOR speaker and Case Plastic  
5-inch speaker with plug and lead, \$4  
each, Pack and Post 25 cents.

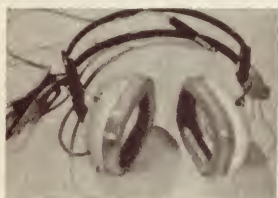

Stereo Head Phones, good quality —  
\$9.75.



TV Portable voltage doubler power  
trans. C. Core. 240 volt 77V 1 amp. 6.3  
Volts 8 amps, \$6.



TV POWER TRANSFORMER, \$8.  
300 mil. Two 6.3 windings. 200 volt sec-  
ondary for Bridge Type Rectifier.



AMPLIFIER, 3-watt, complete with  
speaker. Size 10 1/2 x 3 x 5. \$11.  
Pack and post, 75c.



VOLTAGE DOUBLER POWER  
TRANSFORMER. 200 mil 240 volt x  
105-110 secondary 6. 3V 15 amp. \$8.



BATTERY SAVER. 6 or 9 volt DC  
100MA, \$8.50; 300 MA, \$100.



SPEAKER ENCLOSURE, complete  
with 8in M.S.P. dual-cone speaker,  
8 or 15 ohm, \$15.80.  
Cabinet without speaker, \$10.  
Cabinet size 16 x 10 x 8.

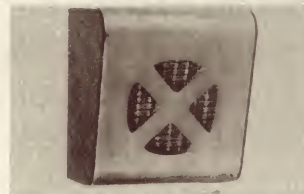

TRANSISTOR IN EXTENSION  
SPEAKER. 5in cabinet, \$3.50.

Tape Spools and Cassettes, American  
Tapes, 7/1800 — \$4.40.  
R.C.C. 5 1/2 1800 — \$5.60.  
R.C.A. 5 1/2 1200 — \$5.25.  
R.C.A. 5 1/2 900J — \$2.80.  
HANIMEX 3/225 — \$1.20.  
HANIMEX C60 Cassettes — \$3.40.  
HANIMEX C90 Cassettes — \$4.75.

- BASF 5/900 — \$6.14.
- SONY 7/1200 — \$3.25.
- BASF 5 1/2 2400 — \$12.45.

NEW RADIOGRAM, chassis, mono,  
complete, valves, speaker .. \$13.50

**POTS**

- 1 meg. Dual Ganged Log. . . . \$1.25
- 1 meg. Dual Ganged Lin. . . . \$1.25
- 1/2 meg. Switch Pot double pole  
log . . . . . 75c
- 2 meg. Lin. Pots . . . . . 50c

GARRARD, 32 volt, 3 speed record  
changer . . . . . \$15

**TRANSISTOR 8 RADIOGRAM  
CHASSIS**

Complete except pots and Ferrite  
Aerial. Famous make. . . . . \$18

STEREO SPEAKER LEAD, 8 Cents yd.

GARRARD MAGAZINE TAPE DECK  
1/2 Per Second, 2 Track, Left to Right  
\$25.



Speaker box unpolished suit 8 inch  
speaker \$3.75. Pack and post 50 cents.

2N 1108, 2N 1110, 2N 1111, Transistors  
50 Cents each.

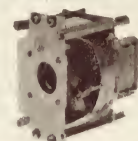

RCA VIBRATING CAPACITOR.  
98601 . . . . . \$2

Dial scales, 5in 1 1/2 x 6, 10 1/2, 3 1/2,  
9 1/2 x 1/2 . . . . . 50c

Pots 50 ohm switch, . . . . 50 cents each.

American or Japanese 2 pin power plugs  
rubber complete with 2 1/2 yards flex 50  
cents, Pack and post 10 cents.

Microphones magnetic or crystal \$1.75.  
Pack and post 10 cents.

Speaker Cabinet, 16 x 10 x 8, complete  
with 6 inch MSP dual cone Speaker  
tweeter, 3 inch and Crossover net  
work — \$18.75.

Magnavox 8 WR, 10 WR,  
12 WR. Tweeter 3, 4 or 5 inch

Speaker Plugs, 4 pin . . . . . 15 cents  
Speaker Sockets . . . . . 15 cents

PUSH PULL AUDIO TRANSFORM-  
ERS 10,000 CT 3.5 ohm . . . \$3.00 each

STEREO HEADPHONES, \$10 pair.  
Pack and post 25 cents.

TRANSISTOR DRIVE and OUTPUT  
TRANSFORMER 23 to 15 ohm. 75  
cents a pair.

MSP 6 inch dual  
cone — \$5.50 each.  
M.P.S. 3 inch.  
tweeter — \$3.75.

Mullard Bookshelf Speaker Cabinets  
\$10 each.

STEREOGRAM CHASSIS, 5 watt per  
channel, complete except speakers.  
\$35

NEW POSTAGE RATES  
PLEASE ADD EXTRA

# Electronic Technicians Earn Big Money!

## Why not YOU?

With training through T.T.I., you could qualify for a start in the Electronics Industry as a:

- Radio-television technician • Telecommunications technician • Instrumentation technician • Business machine technician • Automatic control technician • Industrial electronic technician—and many other skilled positions.

### WILL YOU FILL THE BILL WHEN THE TIME COMES?

The "good job" you hold down today may offer less and less opportunity for advancement as Electronics increase their impact on all branches of industry.

**TECHNICAL TRAINING INTERNATIONAL**, a world-wide company with 30 years' experience in the field of specialised technical training, offers the latest Electronics training programmes available in Australia.

**GAIN FULL PRACTICAL EXPERIENCE BY BUILDING YOUR OWN LABORATORY AT HOME.** With T.T.I. training you build over 100 circuit-proving projects. In addition, you actually construct the professional test equipment illustrated here.

IF YOU ARE BETWEEN 18 AND 45 YEARS, AND EARNING LESS THAN \$80 PER WEEK . . . IF YOU ARE SERIOUSLY INTERESTED IN TRAINING FOR A CAREER IN ELECTRONICS, FILL IN THIS COUPON FOR FURTHER INFORMATION, WITHOUT OBLIGATION.



To: Technical Training International Pty. Ltd.  
P.O. Box 328 Chatswood, N.S.W. 2067.

Please tell me more about T.T.I. Electronics Training, without obligation to me.

Name \_\_\_\_\_

Address \_\_\_\_\_

Age \_\_\_\_\_ Present occupation \_\_\_\_\_

T.T.I.—The Industry-approved Technical Training Organisation

EA/K

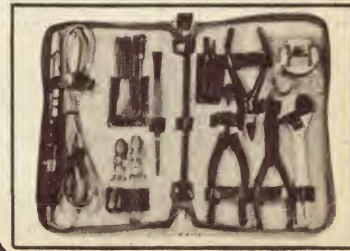
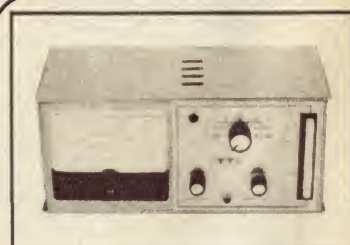

# TECHNICAL BOOKS AND PUBLICATIONS

## Amplifying devices.. "Impressive book"

**AMPLIFYING DEVICES AND LOW-PASS AMPLIFIER DESIGN**, by E. M. Cherry and D. E. Hooper. Published by John Wiley and Sons, Inc., New York, 1968. Hard covers, 6in x 9½in, 1036 pp., numerous circuits and diagrams. Price in Australia \$31.45.

An electronics engineering text intended for university students and practising engineers, this book is written by two well-known Australian engineer-lecturers. Dr Cherry is a senior lecturer at Monash University in Melbourne, and Mr Hooper is now in industry after spending some 10 years lecturing the electrical engineering and the University of Melbourne. Both have gained wide overseas experience at research institutions such as Bell Telephone Labs and the U.K. Atomic Energy Authority at Harwell.

The book is an impressive one, and not the least reason for this is its size. More importantly, it represents the outcome of considerable effort spent by the authors with the aim of producing an engineering text explicitly orientated towards practical and realistic designing. It is the authors' belief that the current and developing tendency of engineering education to concentrate on the fundamental or purely scientific aspects, while understandable and largely justified, tends to turn out engineers with very limited ability to perform the actual tasks expected by industry of them: design of practical equipment.

With this in mind, their aim has been to provide in this book not only a development of the theoretical analysis of device and circuit operation, but also a detailed and interleaved discussion of the many practical considerations which dictate the efficient use of such analysis in practical design work. The authors' success in this aim seems to the present reviewer to be considerable, and such that the book must surely deserve, and is likely to become as much a "classic" technical work as is possible in this rapidly moving era.

There is much more that could be said, because there are many aspects of the book worthy of comment. However, it will perhaps suffice to say that it seems to this reviewer to be comprehensive, thorough, and concise, with its material presented in a particularly logical and helpful development. While concise the text is quite readable, and is well served by illustrations. Also the content would appear to be very much up-to-date—an important point when one is considering any text, in particular one of this size and cost.

Some idea of the scope and development of the book may be gained by the following list of chapter headings: 1—Introduction to Amplifiers; 2—Characteristics of Amplifying Devices I; 3—Characteristics of Amplifying Devices II; 4—Characteristics of Amplifying Devices III; 5—Small Signal Mid-band Circuit Theory of Elementary Amplifiers; 6—Biasing Circuits; 7—Simple Practical Amplifiers I, Small signal dynamic response; 8—Simple Practical Amplifiers II, Noise; 9—Simple Practical Amplifiers III, Nonlinearity and Distortion; 10—Introduction to Negative Feedback Theory; 11—Amplifiers with Single-Stage Feedback; 12—Low Frequency Compensation of Amplifiers; 13—High Frequency Compensation; 14—Multi-stage Feedback; 15

—Differential and DC Amplifiers; 16—Large Signal Amplifiers; 17—Components, Construction and Reliability.

In short, then, a book which can be thoroughly commended to both university students and practising engineers, and one which should be of considerable value to anyone involved in the design of low-pass amplifiers and similar equipment.

Our copy came from the local office of the publisher, who advises that copies are in stock at all major bookstores. (J.R.)

## Better reception

**BETTER RADIO RECEPTION**. Published by Eddystone Radio Ltd., Birmingham, England. Paper covers, 5½ x 8½in, 23 pages, 14 line illustrations. Price in Australia 20c including postage.

The 20c price tag on this modest little book may induce some people to question its value, but it should be understood that it has been published by the well known British receiver manufacturer, Eddystone Radio Ltd., as a public relations exercise. The advice given is of a general nature intended to help listeners obtain best results from their radio receivers, whether Eddystone or not. Some suggestions can be carried out by the user alone, but others may need the assistance of a friend.

The size of the book has imposed limitations on the author, but nevertheless a surprising amount of ground has been

covered, as the section headings show: Propagation effects—Use of an earth—Frequency versus wavelength—Broadcast transmissions—Amateur transmissions—The time factor—Fading—Jamming—Aerials—Special aerials—Wide band reception—Folded dipole aerials—Directional effects—All round reception—Aerials on board ship—Small boats—Protection from lightning and static discharges—Mains connections—Loudspeakers and telephones—Causes of interference—Methods of reducing interference.

The information presented, while of necessity rather brief, should prove of interest to the listener with little technical background but who is interested in the best performance from his receiver. At its give-away price, it should also be of considerable interest for youngsters just starting in radio.

Our review copy was supplied by R. H. Cunningham Pty. Ltd., from whom copies may be purchased at either 608 Collins Street, Melbourne, 3000, or 64 Alfred Street, Milsons Point, Sydney, N.S.W., 2061. (J.H.)

## Electric soldering

**ABC'S OF ELECTRIC SOLDERING**, by Louis M. Dezettel. Published by W. Foulsham and Co. Ltd., Slough, Bucks, England, 1968. Hard covers, 5½in x 8½in, 128 pages, many illustrations. Price in Australia \$3.05.

The author's aim has been to cover both the science and the skill of soldering for three classes of readers; the beginner, the technician, and the manufacturer. For the beginner, the book attempts to instill good soldering habits. For the technician it presents the theory which he may not have fully appreciated. For the would-be manufacturer, an outline is given of soldering on a larger scale. More than a third of the space available is given over to illustrations.

The material is well presented and easy to follow. The first five chapters are devoted to the theory of soldering, the contents being as follows: 1—What Soldering is and does; 2—The Solder Alloy,

## Weather satellite receivers

**CONSTRUCTING INEXPENSIVE AUTOMATIC PICTURE-TRANSMISSION GROUND STATIONS**, by Charles H. Vermillion. A Technology Utilisation Report published by the National Aeronautics and Space Administration, Washington, D.C. (Code SP-5079), 1968. Paper covers, 8in x 10½in, 64 pp., many illustrations. Price in U.S.A. \$0.50.

This report has been published by N.A.S.A. to serve as a guide for individuals and organisations wishing to construct (relatively) inexpensive ground stations for reception of the "weather pictures" transmitted by the NIMBUS and ESSA weather satellites. Such satellite transmissions are expected to be made using the present systems until at least 1972 so that the type of ground station described should be useful until at least that time, and possibly longer.

The idea of constructing a ground station to receive the satellite-taken pictures of the Earth and its weather patterns is an attractive one to many scientifically inclined individuals; such pictures will also tend to be of considerable value to meteorologists, astronomers and other scientists, both professional and amateur. However, lest anyone imagine that such a station can be constructed in a weekend or two and with an outlay of but a few dollars, it should perhaps be mentioned that at its simplest such a station still tends to be a "major project" from an individual constructor's point of view.

The cost estimate given in the summary of this guide quotes a figure of "under \$500" if a significant proportion of the components are obtained from (American) disposals sources, and a figure of \$5,000 as representative of the purchase cost of a complete ready-built station.

The station equipment described includes a special antenna and preamplifier system, a 136MHz FM receiver, and a facsimile unit comprising an oscilloscope, sweeping generators, and scan starting and phasing trigger circuitry. The electronic complexity of the station is probably comparable with that of a standard monochrome TV receiver, while the mechanical complexity—particularly that associated with the antenna system—would appear to be somewhat greater. The background assumed of the reader is that of a fairly advanced amateur or technician.

In short, construction of such a station would be quite a challenging project. For those capable of accepting such a challenge, this would no doubt add further to the reward and satisfaction when one received one's first pictures.

Copies of the report may be purchased from the Clearinghouse for Federal Scientific and Technical Information, Springfield, Virginia 22151. (J.R.)

# Let The World University Of Postal Education **TRAIN YOU FOR A KEY JOB**



## BRANCHES THROUGHOUT THE WORLD

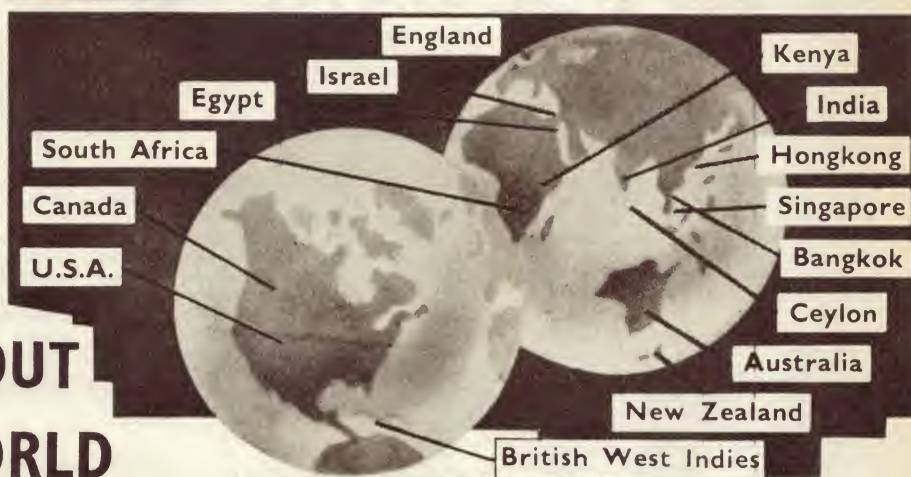

**TODAY** there are wonderful Opportunities for the forward-looking man and woman. However, the best jobs go to those who have the foresight to prepare themselves by proper Training. British Institutes have already trained some 300,000

men and women who have reached the top of the ladder. Therefore, it is up to **YOU** to make something of yourself. Don't delay, act **NOW**. Remember that an enquiry places you under no obligation but could be the turning point in **YOUR** career.

### OVER 500 COURSES

Courses offered by British Institutes include:—

#### TECHNICAL

Aero Engines  
Aeronautical Eng.  
Air Conditioning  
Arch. Drwg. & Design  
Automation  
Auto Elec. Equipment  
Automobile Eng.  
Automobile Repairs  
Building (General)  
Carpentry & Joinery  
Chemical Engineering  
Civil Engineering  
Computers  
Die & Press Tools  
Diesel Engines

Draughtsmanship  
Electrical Engineering  
Elec. Installations  
Elec. Measurements  
Electrical Power  
Electricity Supply  
Electronics  
Foundry Practice  
Garage Management  
Gas Turbines  
Geology  
Hydraulics  
Illuminating Eng.  
Industrial Chemistry  
Jig & Tool Design  
Mach. Drwg. & Design  
Maintenance Eng.

Management  
Marine Engineering  
Mechanical Eng.  
Metallurgy  
Municipal Engineering  
Naval Architecture  
Painting & Decorating  
Patternmaking  
Petroleum Technology  
Plastics  
Production Eng.  
Radar Technology  
Radio Engineering  
Radio Servicing  
Refrigeration  
Reinforced Concrete  
Road Engineering

Rubber Technology  
Sanitary Engineering  
Structural Eng.  
Surveying  
Telecommunications  
Television  
Television Servicing  
Timber Technology  
Tracing  
Welding Technology

#### COMMERCIAL

Accounting  
Advertising  
Auditing  
Book-keeping

Business M'gement  
Commercial Art  
Commercial Law  
Company Law  
Costing  
Economics  
Fiction Writing  
Journalism  
Secretaryship  
Selling

#### GENERAL

English  
European Languages  
Mathematics  
Shorthand  
Typewriting

*And many other Subjects.*

Details of Engineering and Commercial Exams., Certs. of Competency, Matriculation, etc.

### CHECK THESE FEATURES:

- Modern streamlined methods . . . you learn the fast way and make rapid progress.
- Courses based on STANDARD TEXT-BOOKS . . . Lessons and Model Answers written and planned by experts.
- We provide all necessary text-books which remain your own property.
- Moderate fees payable by small monthly sums. Written guarantee.
- Courses can be "tailored" to individual requirements.

### SECURE ONE OF THESE BOOKS



### POST COUPON NOW!

#### BRITISH INSTITUTE OF CAREERS

College House, 113 Pacific Highway, North Sydney, 2060

I am interested in . . . . .  
Please send me the appropriate Career-Book.

NAME (PLEASE PRINT) . . . . .

ADDRESS . . . . .

E.L.-W-9 . . . . .

Occupation . . . . . Age . . . . .



## BRITISH INSTITUTE OF CAREERS

In association with  
British Institute of  
Engineering Technology

**THE B.I.C. GROUP LEADS THE WORLD IN POSTAL TRAINING**

including solder additives; 3—Fluxes, including flux cores and non-flux soldering; 4—Soldering Irons, including construction, pencil-type irons, transformer isolated irons, heat control and tips; 5—Instant-Heat Guns.

Chapter 6—How to Solder—is all about soldering with a soldering iron including the following sections: right iron and tip; pretinning leads; soldering for beginners; experienced solderers; printed-circuit boards; semiconductors; cable connectors; shielded cables; wire splices; inspection; soldering aids. Chapter 7—Production Soldering—gives a simple account of soldering for manufacturing processes, including these sections: hand soldering; voltage leakage; soldering-iron details; resistance soldering; the soldering pot; dip soldering; wave soldering; solderability tests; stands.

The concluding chapters are: 8—Miscellaneous Soldering and Connecting Methods, including the bottled-gas torch, the friction wheel, and solderless connections; 9—How to Make Solder Repairs, including point-to-point wiring repairs, special desoldering tips, and vacuum desoldering irons; 10—Burns and their Treatment, including precautions.

One drawback from the point of view of the Australian reader is that the examples of soldering equipment quoted are all of American equipment. In this edition there is a specially written chapter for an English reader which lists some British alternative types, some of which will be available in this country. It will be necessary for readers to scan the pages of magazines such as "Electronics Australia" to see what is to be obtained.

The author has certainly achieved his aim of a comprehensive cover of the subject. Anyone interested in soldering in all its aspects will find this book of value.

Our review copy came from Grenville Publishing Co. Pty. Ltd., 401 Pitt Street, Sydney, 2000. Copies should be available from most booksellers. (J.H.)

## The troposphere

**VHF RADIO WAVE PROPAGATION IN THE TROPOSPHERE**, by W. G. Burrows. Published by International Textbook Co., Ltd., London, 1968. Hard covers, 5-5/8in x 8 1/2in, 130pp., many diagrams. Price in Australia \$6.05.

A monograph for undergraduate and graduate radio communications degree students, written with the aim of providing under one cover an introductory discussion of VHF propagation in the troposphere, a survey of the current hypotheses and experimental work on the subject, and a useful bibliography. The author is on the academic staff of the Department of Electrical Engineering at Imperial College, London, and is currently involved in research in this field.

The book begins with a general introduction, followed by a discussion of the characteristics of tropospheric transmissions. Then follows a considered examination of the troposphere itself, with reference made both to the effect of meteorological phenomena and to the relationships between the troposphere and the higher atmospheric layers and regions.

With the foregoing as background, the author then develops an analysis of wave propagation in the idealised medium, and considers the complications involved when one deals with the actual atmosphere. A final section describes current experimental studies, draws conclusions and makes a number of suggestions regarding the directions which could be taken by future research work. The book then ends with data and mathematical appendices, a bibliography and an index.

The text of the book would appear to

be clearly and concisely written and is well served by illustration. It would thus seem likely that the book will be of considerable value to anyone seeking an up-to-date monograph on the subject, particularly those interested in taking up research in the field.

Our copy came from the local office of the publisher, who advises that stocks are held by all major bookstores. (J.R.)

## Applied maths.

**WORKED EXAMPLES IN APPLIED MATHEMATICS**, by B. A. L. Hart, B.Sc. Published by Iliffe Books Ltd., London, 1968. Soft covers, 8 1/2in x 5 1/2in, 275pp., many diagrams. Price in U.K. 21/..

A book written as a companion for the engineering and science student who finds himself regularly frustrated in reading analytical and applied mathematics texts, by statements in the text such as "...thus it will be obvious that..." "...hence the student can obviously see..." "...from this it is easily shown that..." and so on.

The author provides carefully and thoroughly worked examples on such topics as vector theory, hydrodynamics, elementary field theory, particle motion, plane, impulsive and vibrational motion, and structure statics. In each section he includes brief statements of the relevant laws, expressions and equations, and also a set of reader exercises (answers not given). The level at which the book is pitched is roughly that of an undergraduate university or college student, being in fact written specifically for students working for the external General Degree of the University of London.

The material presented is naturally quite applicable to courses in local institutions, and in view of the care with which the book would appear to have been prepared, it would seem to this reviewer to have considerable potential value to most engineering and science students.

Our copy came direct from the publisher, and no information was given regarding local price or availability. (J.R.)

## Colour TV

**ON THE COLOUR TV SERVICE BENCH**, by Jay Shane. Published by TAB Books, Blue Ridge Summit, Pa. 17214, U.S.A. 1968. Size 8 1/2 x 5 1/2 inches, 192 pages, illustrated by circuits and diagrams. Australian price \$8.70 hard cover, \$6.15 paper cover.

This book is somewhat ahead of its time in Australia but it may be useful for anyone who wishes to gain a preview of servicing colour television receivers.

By an author who is apparently involved in colour TV servicing, the book has, as its motivating theme, the idea that a serviceman familiar with monochrome receivers can retain and enlarge upon his techniques to service colour.

The result is not a textbook for students but rather a look at various major sections of a TV receiver, with observations about the differences between monochrome and colour designs, some explanations about circuits which are more or less peculiar to the latter and, by way of illustration, case histories of faults in typical American receivers. One would assume that these are reprinted from the service columns of an electronics periodical.

Major topics include brightness, horizontal deflection and oscillators, EHT regulation, feedback type EHT regulators, vertical problems, video and chroma amps, colour sync. and demodulation, alignment and miscellaneous hints.

Stocks of the book are on order by Grenville Publishing Co., 401 Pitt Street, Sydney, 2000. (W.N.W.)

**WORLD RADIO-TV HANDBOOK, 23rd edition, 1969.** Published by the World Radio-Television Handbook Co. Ltd., Hellerup, Denmark. Soft covers, 360 pages, 9in x 6in. Price in Australia \$5.40 plus postage.

This book was reviewed in our February, 1969, issue by our short-wave correspondent Arthur Cushen. We have been advised by Technical Book and Magazine Company Pty. Ltd., 289-299 Swanston Street, Melbourne, Victoria, 3000, that they now hold stocks.

**104 EASY TRANSISTOR PROJECTS YOU CAN BUILD**, by Robert M. Brown. Published by Tab Books, Blue Ridge Summit, Pa., U.S.A. Soft covers, 5 1/2 x 8 1/2in, 223 pages, illustrated with numerous circuit diagrams. Price in Australia, \$4.95 (hard covers \$8.70).

This book was reviewed in our January, 1969, issue, page 109. We have been informed that copies are available from Grenville Publishing Co., 401 Pitt Street, Sydney, 2000.

**TRANSISTOR CIRCUIT GUIDEBOOK**, by Byron Wels. Published by Tab Books, Blue Ridge Summit, Pa., U.S.A. Soft covers, 5 1/2 x 8 1/2in, 219 pages, illustrated with numerous circuit diagrams. Price in Australia, \$6.15 (hard covers \$8.70).

This book was reviewed in our January, 1969, issue, on page 109. We have been informed that copies are available from Grenville Publishing Co., 401 Pitt Street, Sydney, 2000.

# RADIO ENTHUSIASTS

Learn amateur radio in your spare time.

Whatever your interests are in amateur radio, there's a Stott Radio course for you. Easy to follow. Practical. Modern. Guidance all the way by top-flight radio engineers.

**Radio for amateurs**  
Learn the exciting skills of building modern radio receivers. Learn about the latest advances in electronics, design, construction and operation. Let Stott's show you how.

**Amateur Operator's Certificate Course:**  
Broadcasting is fascinating. Stott's offer an entirely new course that enables you to sit for the Amateur Operator's Certificate of Proficiency Examinations with complete confidence.

Get full details now on Stott's Radio Courses.

POST THIS COUPON TODAY

**Stotts**



TECHNICAL CORRESPONDENCE COLLEGE

159 Flinders La, Melbourne. 383 George St, Sydney  
290 Adelaide St, Brisbane. 45 Gilles St, Adelaide.  
1130 Hay St, Perth.

Please send me, free and without obligation, full particulars of your courses in Radio for Amateurs.

Mr Mrs Miss.....

Address.....

Age.....

No sales representative will call

EA469

# RADIO HOUSE PTY. LTD.

306-308 PITT STREET, 6 ROYAL ARCADE & 760 GEORGE STREET, SYDNEY

## NEW FROM GERMANY



**THE OXFORD  
CORDLESS  
ELECTRIC RAZOR**  
Battery Operated

Twin blades rotary cutting head, spare batteries. 15c Size 5 1/4 x 1 1/4 in.

**Posted  
\$8.75**



Actual Size

**"KEYLITE" \$3.95**

Free. One spare mercury cell.

With fob keyring, attractive gold finish case. Simply squeeze. Illuminates car and house locks, etc.

**\$4.00 Posted anywhere**

## CHROME VAN

German screwdriver and pocket tester.

1. 6-12 volt model auto test.
2. Sparkplug tester.
3. 110-380 volt mains tester.

**\$1.25 each**

Cordless battery-operated Electric scissors cut most materials fast and clean. 1 torch cell fits in handle, complete posted. **\$4.95**

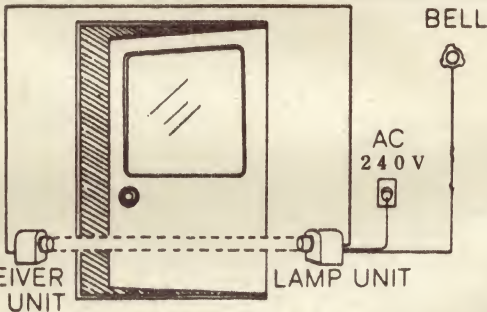

Photo-electric Alarm operates when beam of light across entrance, 20-50 ft., maximum, is broken by intruder. No wires or moving parts. This magic eye can be connected to a bell or light to announce the entrance of visitors, etc. 240 V. mains required.

**\$39.00 or \$40.00 posted.**

## MULTIMETER TESTERS

### Model RH-50

Modern Design, 33 Micro-Amp Meter. 30,000 Ohms per Volt D.C. 13,000 Ohms per Volt A.C. 1 p.c. Multipliers and Shunts used. Printed circuit. Clear Scale, rugged moulded case.

#### SPECIFICATIONS:

DC VOLTAGES: 0-0.25-1-2.5  
-10-25-100-250-500-1,000 V  
at 30,000 ohms per volt.  
AC VOLTAGES: 0-2.5-10-25-  
100-250-500-1,000 V at  
15,000 ohms per volt.  
DC CURRENTS: 0.05-5-50-  
500 mA, 0-12 A.

Resistance: 0-60K-6M-60M  
(350, 35K, 350K at mid-scale).

Decibels: Minus 20 to plus 56  
dB (0 dB equals 1 mW, 600  
Ohms).

Audio Out: Capacitor in series  
with AC Volt ranges.

Short Test: Internal buzzer.

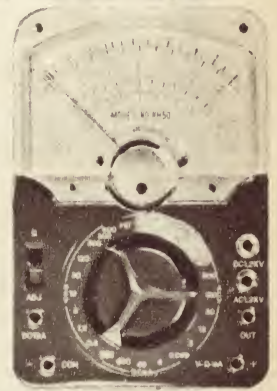

**Price \$31**

With leather case, **\$38.00.**  
Posted 50c to \$1 extra.

Accessory: 1 pr. heavy test leads.

Batteries: 1 (1.5V), 1 (15V).  
Size: 3 5/16" x 6 5/16" x 2 3/8"

Weight: 1.4lb approx.

## NEW POCKET SIZE MULTITESTER LIMITED STOCKS



Latest model multitester YT67 now costs only **\$8**, measures up to 100,000 ohms and continuity.

DC volts 0-15, 0-150, 0-1000.

AC volts 0-15, 0-150, 0-1000.

DC current 150mA.

1,000 ohms per volt, sensitive and clear scale for accuracy. Posted **\$8.50** anywhere, with test leads and internal battery complete, ready to use. Size 3 1/4 in x 2 1/4 in.

"RIAM" Swiss-made battery-operated Vibratory Massager comes complete with two batteries, three applicators and instruction sheet.

**\$8.50 or \$9.00 posted.**

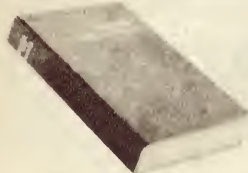

**EASTER SPECIAL**

**\$19.95**

### BOOK TYPE

The latest model portable Tape-recorder. 4 transistor, 3in Reels, 2 track. Instruction manual. Size 10 1/2 in x 7 in x 1 1/4 in.

Just open the book and record. Supplied complete with tape, microphone and batteries. Special discount price:

**\$19.95 posted anywhere.**



"CONION" transistorised SIREN ALARM can be used for personal protection or as a burglar alarm. Loud siren sounds for 20 minutes when cord is disturbed. Pocket size, easily concealed.

**\$11.75 complete. Posted, \$12.00.**

### PORTABLE PLAYS

33 x 45  
**RECORDS**



**ALL TRANSISTOR RADIO**  
Phonograph. Complete  
**\$45.00**

SIZE  
9 1/4" x 5 1/4"



# TEACHING SYSTEMS FROM A.G.E.

Stark Electronic Instruments Ltd., of Ajax, Ontario, in Canada, manufacture a range of electronic and physics teaching systems which are available in Australia through their agents, Australian General Electric Pty. Ltd.

The Stark electronic teaching systems are designed to demonstrate in a practical manner the basic principles of electricity and electronics by allowing the student to build circuits from a schematic. There are several sets of components for a series of experiments in elementary electricity. Typical experiments include: electrostatics; production of EMF; Ohm's Law; series and parallel circuits; meters; magnetism; electromagnetism capacitors. Other sets introduce diodes, triodes and transistors in a number of simple experiments. One set includes experiments on the use of various items of test equipment.

Components are mounted on high impact polystyrene bases, with metal mounting feet which plug into inter-connectable mounting boards, also made of polystyrene. Connections are made by patented crimp-type connectors. All components are packed in trays which slide into sturdy metal cabinets. A rugged power supply provides all the necessary voltages to perform experiments in basic electricity and electronics courses. It has been designed to tolerate "normal" overloads associated with use by inexperienced students.

Typical of the sets listed in the Stark catalogue are the following:

**Model 10—Electricity, electronics.** This set is designed for basic experiments in electricity and electronics to meet the higher grades of an industrial arts program. It consists of the complete set of components, stored in rugged plastic trays with printed tracks for identification; and two metal cabinets. The set correlates with the text "Electricity and Electronics" by Kirchner, Buban and Schmitt, although other texts may be used. A manual of experiments is provided.

**Model G 12—Electronic mechanics.** This set is designed for a dual purpose course, to give students a working knowledge of both the theory and practice of electronics. One set is sufficient for two students. In addition to printed wiring boards and components, it includes two sets of tools, two printed wiring board holders and two basic soldering boards with adjustable vice. The student has to complete a harness wiring board which is later used in the construction of a superhet receiver.

**Model 700—Industrial electronics.** This set provides facilities for control device and system experiments. The student learns the characteristics of thyratrons, phototubes, time delay circuits, phototransistors, saturable reactors and three-phase rectifiers. This leads to motor control experiments, including basic circuits, power supply regulation, radio and tone signalling control systems; and computer experiments, including adders, triggers, counters and transistor computer circuits.

**Model 800—Transistors.** A set designed to introduce students to the basic principles of transistors, and their

application to the most widely encountered circuits, including industrial applications.

**Model 70 — Digital computer trainer.** Designed to teach digital computer fundamentals, this set uses all solid-state circuitry. Students set up the experiments on the patch board face of the trainer, which includes AND, OR, NAND, NOR and NOT gates, a variety of flip-flops, and assorted signal source and display facilities.

**Model 600 — Communications.** Although listed as a communications set, this is really a basic television course. Sections of a TV receiver are individually studied, and the effect of each section on picture and/or sound is noted. Experiments dealing with vertical and horizontal amplifiers and oscillators, multivibrators, sync circuits and automatic gain control can be

undertaken. The course is designed to develop circuit understanding, analytical thinking, time saving in fault finding and the use of the correct test instruments for checking circuits.

**Model X-300 — Microwave Technology.** Intended as a 40-hour course for technician training, this requires only basic electronics as a prerequisite, and instructors need no special knowledge of microwaves. Students measure characteristics of microwave equipment in the frequency range 8.2 to 12.4GHz. Hardware and instruments allow experiments concerning frequency, impedance, VSWR, attenuation, and power.

In addition to the electronics sets, Stark produces a range of equipment for physics students, comprising individual items for student use and demonstration models for the use of instructors. Typical of the items listed in the physics catalogue are the following:

**C-6261 and C-6256—Student team sets.** These include a wide selection of apparatus for high school and similar physics course, and each kit provides sufficient equipment for teams of four students to do comprehensive courses in experimental physics.

**C-10 — Physical Measurement set:**  
**C-20—Optics and waves set:** C-30 —

## Be Paid What You are REALLY WORTH!



Develop your aptitudes at your own pace, for recognition that brings HIGHER PAY. Begin YOUR Progress Today! Select the course you want and which will benefit you most. ICS will send YOU promptly — a FREE illustrated BOOK, giving FULL DETAILS.

### GENERAL

Journalism — Short Stories  
Writing for Radio & TV  
Interior Decorating  
Etiquette & Entertaining  
Textiles  
Photography  
Mathematics  
General Education  
Dressmaking

### DRAUGHTSMANSHIP

Architectural  
Builders' Plan Drawing  
Mechanical Structural  
Surveying & Mapping

### ILLUSTRATING

Still Life—Landscape  
Caricature & Cartoons  
Oil & Water Colour.  
Fashion Drawing  
Showcards & Tickets  
Signwriting

### COMMERCIAL

Accountancy  
Cost Accountancy  
General Bookkeeping  
Salesmanship  
Shorthand Typing

Retail Management  
Commercial Management  
Small Business Owners  
Hotel-Motel Management  
Club Administration  
Window Dressing  
Business Letters

### BUILDING

Architecture  
Building Contracting  
Carpentry, Joinery  
Structural Engineering  
Concrete Engineering  
Estimate & Quantities  
Roofing, Steel Square  
Timber Home Building

### INDUSTRIAL

All Mechanical Eng.  
Fitting & Turning  
Soft Drink Manufacture  
Air Conditioning  
Gas or Elect. Welding  
Chemistry, Plastics  
Electronics  
Electrical Mechanics  
Radio Eng. or Service  
Television  
Refrigeration  
Diesel Engines

Auto Mechanics  
Civil Engineer  
Production Management  
Industrial Management  
Executive Training  
Modern Supervision

### SPECIAL EXAMINATION COACHING COURSES

Account'cy: All Exams  
Institute of Secretaries  
Inst. Cost Accountants  
Inst. Sales & Marketing  
Metric. or Leav. Cert.  
Intermediate Certificate  
Senior or Junior Public  
C'wealth Clerical Exams  
Police Entrance Exam  
Nurses' Entrance Exam  
Steam Certificate  
Refrigeration Certificate  
Radio Examinations  
Inst. Auto. Mech. Engrs.  
Inst. Diesel Engineers  
Shire Overseers' Exam  
Engineers' Institutions.

### ADVERTISING

Copywriting  
Commercial Art  
Advertis'g Inst. Aust.

## TO INTERNATIONAL CORRESPONDENCE

Dept. 526 **SCHOOLS.**

**SYDNEY:** 400 Pacific H'way, Crow's Nest. Tele.: 43-2121.

**MELBOURNE:** 234 Collins Street. Tele.: 63-7327.

**BRISBANE:** Heindorff House, 171 Queen St., Brisbane. Tele.: 2-6125.

**ADELAIDE:** T. & G. Building, King William St. Tele.: W-4148.

**PERTH:** C'wealth Bank Building, 55 William St. Tele.: 21-7268.

**NEW ZEALAND:** Wellington, 182 Wakefield St. Tele.: 53-109.

Please send Free Book on .....

NAME (Mr, Mrs, Miss) ..... AGE .....

ADDRESS .....

..... STATE ..... Dept. 526

OCCUPATION ..... PHONE .....

EA.4.69

# LAFAYETTE Transistor Radios

## For Aircraft and VHF FM

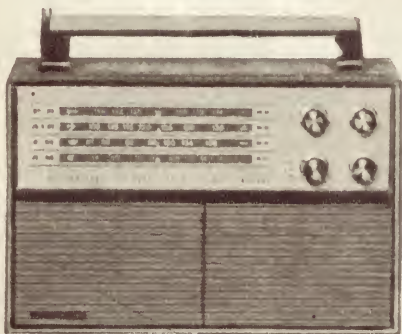

**DE LUXE LAFAYETTE  
18-TRANSISTOR 4-BAND  
AM, FM, AIRCRAFT, VHF**

- Broadcast Band 550-1.600 KHz.
- FM 88-108 MHz.
- Aircraft Band 108-136 MHz AM.
- VHF Band 147-174 MHz FM.
- Inbuilt Batteries or 117 VAC.

Stock No. 99-3550, \$119.50



**LAFAYETTE "AIR MASTER"  
10-TRANSISTOR AM  
AND VHF AIRCRAFT  
RADIO**

- Broadcast Band 550-1.600 KHz.
- Aircraft Band 108-136 MHz AM.
- Telescopic Antenna.
- Slide Rule Dial.
- Logging Scale.
- Inbuilt Batteries.

Stock No. 99-3523, \$71.50



**LAFAYETTE "GUARDIAN  
II" AM BROADCAST  
BAND AND HIGH BAND  
VHF FM**

- Broadcast Band 550-1600 KHz.
- VHF Band 147-174 MHz FM.
- Ferrite Rod AM Antenna.
- Telescopic VHF Antenna.
- Earphone Jack.
- Inbuilt Batteries.

Stock No. 99-3522, \$71.50



**LAFAYETTE HAND-HELD  
VHF FM RECEIVER  
TUNEABLE 146-175 MHz**

- 10-Transistor Superhet Receiver.
- Size 6in x 2in x 1 5/8in.
- Swivel Telescopic Antenna.
- Provision for External Antenna.
- Inbuilt Batteries.

Stock No. 99-3531, \$61.50

SEND REMITTANCE WITH ORDER FOR IMMEDIATE  
DELIVERY ANYWHERE

## LAFAYETTE ELECTRONICS

Division of Electron Tube  
Distributors Pty. Ltd.

All mail enquiries and orders to:

**VICTORIAN SALES CENTRE  
AND HEAD OFFICE,**

**94 HIGH STREET, ST. KILDA,  
VIC., 3182. Ph. 94-6036.**

LAFAYETTE Communications receivers are  
also available from:

**RADIO HOUSE PTY. LTD.,** 306 Pitt Street,  
6 Royal Arcade, 760 George Street,  
Sydney, N.S.W. 2000.

**TISCO AGENCIES,** Overend and Hampton  
Streets, Woolloongabba, Q'land 4102.

Mechanics set: C-40—Electrical set.  
These are smaller sets for conducting  
limited experiments in the fields listed.  
Each set has sufficient equipment for  
a team of four students.

The range of demonstration apparatus  
includes the following items:

C-6790 — Motor stroboscope. This  
consists of a synchronous motor stro-  
boscope plus a variable speed DC  
motor with a rotating fibre disc. The  
two rotating discs can be used in con-  
junction for "stop motion" experiments.

C-6750 — Diffusion cloud chamber.  
This simple model of a cloud chamber  
allows ionised particle tracks to be ob-  
served. When brightly illuminated, the  
viewing chamber will show cosmic  
ray tracks.

Other equipment in the physics  
teaching range includes an electromag-  
netic induction set, to show the re-  
lationship between the rate of change  
of magnetic flux in a coil and the in-  
duced voltage and current; cast alumin-  
ium pucks for demonstrating uniform  
motion in the absence of net force, by  
supporting them with pressurised car-  
bon dioxide; "G" apparatus which con-  
tains all the equipment necessary to  
measure the force of gravity by the  
Cavendish method; a distance measur-  
ing instrument which can be used as  
a rangefinder, a parallax viewer or an  
optical micrometer; sensitive micro-  
balances of the soda straw type  
which enable students to measure small  
masses of the order of 1 to 5 grams;  
and a spectrum analysis apparatus to  
show that atoms of a strongly heated  
element produce colour bands char-  
acteristic of that element.

Items intended for demonstration  
aids for the use of teachers include  
GEDAC (Gaint Electronic Demon-  
strator of Activated Circuits) which has  
modules furnished with magnets which  
can be attached to a steel demonstra-  
tion board, and stretch cables for inter-  
connections, which makes the wiring  
look like a schematic; large scale de-  
monstration meter displays with scales  
measuring 36 x 48in, printed with 2-  
cycle logarithmic and 10-division linear  
scales, and provided with VTVM and  
VOM overlays; and a 21in demonstra-  
tion oscilloscope which presents bright,  
clear waveforms for class demonstra-  
tions.

Catalogues giving more detailed de-  
scriptions of the items listed above, and  
many more, are available on applica-  
tion by education and training organisa-  
tions from Australian General Electric  
Pty. Ltd., 103 Kent Street, Sydney,  
2000.

## LITERATURE—in brief

**1968 TECHNICAL HIGHLIGHTS OF  
THE NATIONAL BUREAU OF STANDARDS.**  
NBS special publication 308,  
issued November, 1968; 211 pages; price  
\$U.S.1.00 plus postage. Inquiries to U.S.  
Government Printing Office, Washington,  
D.C. 20402, U.S.A. This is a survey of the  
activities of the NBS from July 1, 1967  
to June 30, 1968 and covers the Bureau's  
research activities, its relations with other  
U.S. Government agencies, industry and  
science, and its participation in inter-  
national efforts to co-ordinate and ad-  
vance physical measurements and stan-  
dards. Two key programs, the National  
Standard Reference Data System and the  
Standard Reference Materials Program, are  
the subjects of a special feature. The main  
body of the report deals with significant  
scientific and technical accomplishments  
during the year.

### CONNECTOR SELECTION GUIDE.

Published by Cannon Electric, Los Angeles, California, U.S.A. Inquiries on company letterhead should be addressed to Cannon Electric (Aust.) Pty. Ltd., 58 Cluden Street, East Brighton, Vic. 3187. The guide covers the complete Cannon range including rectangular rack and panel, circular, microminiature and special application connectors.

### TELECOMMUNICATION JOURNAL

Vol. 36, No. 2, February, 1969. Published by the International Telecommunication Union (ITU), Place des Nations, 1211 Geneva 20, Switzerland. Separate editions in English, French and Spanish. Contents include: "The Dioscures project—system of telecommunications, air traffic control and navigation by satellites," by B. Manu-ali; "The European broadcaster's attitude toward satellite technology," by O. Rydbeck and E. W. Ploman; "Western Union International — pioneers in computerised telex operation," by P. J. Klein.

The feature "Union Activities" includes reports of the meetings of two ITU Study Groups, one dealing with radio-relay systems, and the other with television transmission. Under the heading of "Ideas and Achievements" are described the Orbiting Astronomical Observatory (OAO) satellite; a large cylindrical radio telescope in India; and the Pioneer D satellite.

**NEW DEVELOPMENTS**, issue B041, February, 1969. Published by Jacoby, Mitchell and Co. Pty. Ltd., 469-475 Kent Street, Sydney 2000. Contents: Sanders microwave signal sources; CEC solids moisture analyser; Weinschel motorised step attenuators; Electronic Switchgear conductivity meter; Telonic pass band filters; Comark electronic thermometers; TRW laser IC trimmer; Siliconix low-noise FETs; Colvern potentiometers; Lionmount low pass active filter; Wilstron phase meter; Gossen temperature measuring meters.

**MULLARD OUTLOOK**, Vol. 11, No. 6, November-December, 1968. Published by Mullard-Australia Pty. Ltd., 35-43 Clarence Street, Sydney, 2000. Contents: Viewpoint with Mullard; Electronics in Domestic Appliances, part 1; Mullard Numerical Indicator Tubes Incorporate Decimal Point; Transistors for Transmitters; New Industrial Magnetron YJ1280; The Mullard Range of Memory Products; Mullard Transistors for Transmitters.

**ATHOM NEWS**, Vol. 7, No. 2, December, 1968. Published by Andrew Thom Ltd., 261 Broadway, Sydney, N.S.W. 2007. Contents: A New and Useful Galvanometer-Extraordinary; Electric Surface Heating in the Laboratory; An Instrument System for the Chemical Laboratory; Areatron; Thermal Analysis in Vapour Atmospheres; Industrial Gel Filtration with Sephadex; Blood Measuring Systems; Low Velocity Anemometer; Improved Small Optical Two Circle Goniometer; GISECA; Sephadex LH-20; An Outstanding pH Meter; Introduction to Microcalorimetry; New Cell Washing Centrifuge; Problem — Simple-Mindedness Succeeds Sometimes.

**NATIONAL SEMICONDUCTOR CORPORATION**, Santa Clara, California, U.S.A., has published a transistor and dice specification guide. It contains electrical specifications, dice geometries, substitution recommendations and carrier information on the company's line of silicon planar epitaxial unencapsulated transistors. Trade inquiries to the Australian agents, Rutherford Electronics Pty. Ltd., 833 Doncaster Road, Doncaster, Vic. 3108.

**VARIAN BOMAC DIVISION** has published an application engineering bulletin, No. AEB-28, entitled "Injection locking of voltage tunable magnetrons." It points out that a voltage tunable magnetron can be forced to oscillate at the frequency of a low-level, stable "locking" signal without elaborate circuitry. The method of injection locking, frequency modulation, and

### Motorola FET guide



**FIELD EFFECT TRANSISTORS.** Published by Motorola Semiconductor Products Inc., Phoenix, Arizona, U.S.A. Inquiries on company letterhead to Cannon Electric (Aust.) Pty. Ltd., 58 Cluden Street, Brighton East, Vic. 3187. A 6-page selector guide and cross reference chart covering Motorola's complete line of field effect transistors. More than 100 JFET and MOSFET types are categorised by application. A list of application notes describing FETs and their uses is also included. A summary of Motorola's new silicon nitride passivation process to produce highly stable MOSFETs is in the introduction.

noise reduction are also discussed in the bulletin. Inquiries to Varian Pty. Ltd., 38 Oxley Street, Crow's Nest, N.S.W. 2065.

**INSIDE INFORMATION**, No. 2, December, 1968. Published by the Service Division, Marconi Instruments Ltd., St Albans, Herts, England. Contents: Servicing Guide to AM Signal Generators Type TF 801D and Series; Modification Kits—TF 801D/3Mi; Repair Notes 1, TF 801 series, Reduction of Hum Level; Repair Notes 2, Extension Board for TF 2330; Change Notes, Oscilloscopes types TF 2203, 2200A/1, and 2201.

**1969 INTEGRATED CIRCUIT SHORT FORM CATALOG.** Published by National Semiconductor Corporation, Santa Clara, California, U.S.A. Trade inquiries to the Australian agents, Rutherford Electronics Pty. Ltd., 833 Doncaster Road, Doncaster, Vic. 3108. The 24-page catalogue contains reference data for operational amplifiers, voltage regulators and comparators, communication circuits, shift registers, analog switches, logic elements, flip-flops and gates. The catalogue also lists application notes and technical papers published by National Semiconductor.

**NBS INTERAGENCY TRANSDUCER PROJECT**, by Paul S. Lederer. National Bureau of Standards Technical Note 469, issued October, 1968; 21 pages; price 30c U.S. plus postage. Order from the Superintendent of Documents, U.S. Government Printing Office, Washington, D.C. 20402, U.S.A. This report describes briefly the background and history of the project to study the performance of transducers (primarily those used in telemetry), the objectives, some specialised facilities developed and used and some publications issued.

**MODERN EMI MEASUREMENTS**, Hewlett-Packard Application Note 63E, Published by Hewlett-Packard Co., Palo Alto, California, U.S.A. Inquiries to Hewlett-Packard Australia Pty. Ltd., 22-26 Weir Street, Glen Iris, Vic. 3146. This 26-page note discusses the principles of electromagnetic interference (EMI) measurements, and describes how modern calibrated spectrum analysers can be used as tuned RF microvoltmeters with visual display to make these measurements with substantial savings in time.

# PLAN YOUR FUTURE

CHOOSE a career in the field of ELECTRONICS\* — the Nation's most progressive and fastest expanding industry.



Advancement in this modern science demands technical ability, a sound knowledge of basic principles and applications.

YOU can master the subject by training at the MARCONI SCHOOL and be ready to grasp the opportunities that occur in the three fundamental branches of Radio-technology.

# KNOW WHERE YOU'RE GOING

## A = APPLIED SERVICING

Comprehensive training in the maintenance and repair of radio and television receivers offers substantial rewards to competent technicians. Marconi School training covers all aspects of radio and television receiver circuit applications, practical exercises in fault finding and alignment procedures.

## B = BROADCASTING

A thorough and practical grounding is available to students in broadcasting transmitter performance standards and maintenance techniques, with individual instruction in station operation and studio control and testing.

## C = COMMUNICATIONS

Combines all the foregoing, together with radio aids to navigation, mobile telephony, marine service application and international wireless telegraph regulations, qualifying the successful student for the Commonwealth Government Certificate of Proficiency and the Marconi School Diploma in Radiotechnology.

Classes are conducted at 21 Pier Street, Sydney (at the foot of Goulburn Street).  
Daily: 9.30 a.m. to 4.30 p.m.  
Evenings: 6 p.m. to 8.30 p.m.  
or by Home-Study Courses (except practical instruction on equipment).

# STUDY NOW

Send for training syllabus. There is no obligation.

NAME.....  
ADDRESS.....

the MARCONI SCHOOL of wireless

G.P.O. Box 2516, Sydney  
A Service of Amalgamated Wireless (Australasia) Ltd.





## GUITAR AMPLIFIERS

10-Watt, Two-Channel, with Twin Cone Speaker . . . . . \$53.55  
 14-Watt, 4 Inputs, Bass and Treble Boost, 2 Twin-Cone Speakers, \$63  
 17-Watt, Four-Channel, Bass and Treble Boost, Two Twin-cone Speakers . . . . . \$76.25

### 35 WATT

4-Channel, Bass and Treble Boost, 4 Twin-Cone Speakers . . . \$109.05  
 Vibrato with foot control and 2 preset controls for frequency and intensity, \$10.50 extra on above models.

## ELECTRIC GUITAR

Pickup Units . . . . . \$8.75  
 Accordion Pickup Units . . \$8.75  
 Harmonica Pickup Units . . \$1.95  
 Post., N.S.W. 40c; Interstate, 75c.

## FUZZ BOX

FUZZ BOX E. AND A. AUG. WIRED AND TESTED. \$15.  
 Post., 75c.

## REVERB UNIT

COMPLETE WITH AMPLIFIER. E.A. October Issue. Kitset \$39.95. Wired and tested, \$41.95.



## MULLARD MAGNAVOX

### BOOKSHELF ENCLOSURE

Maple, Teak or Walnut Complete \$24.75

### SUPER BOOKSHELF \$36.75.

Post: N.S.W. 50c, Interstate \$1.00. CABINETS ONLY

R. H. BOOKSHELVES \$11.50

MULLARD \$10.95

### BOOKSHELF UNITS

6in 8in 10in 12in \$27.75 \$33.50 \$35.50 \$36.50

## PLAYMASTER 106 AND 107



Feb. and March Elect. Aust.

106

WIRED AND TESTED \$94.75

107

WIRED AND TESTED \$83.75

## PIGGY BACK GUITAR AMPLIFIER

Excluding Speakers

30 Watt . . . . . \$79.75  
 45 Watt . . . . . \$99.75  
 60 Watt . . . . . \$119.75  
 4 Inputs, Bass and Treble Boost. Vibrato if required, \$10.50 extra.

## PIGGY BACK GUITAR AMPLIFIER

Complete with Speakers, Cabinet  
 30 Watt Lead . . . . . \$138.75  
 30 Watt Bass . . . . . \$146.75  
 45 Watt Lead . . . . . \$158.75  
 45 Watt Bass . . . . . \$166.75  
 50 Watt Lead . . . . . \$218.00  
 60 Watt Bass . . . . . \$234.00  
 Vibrato if required . . . \$10.50

### 14 plus 14 WATT

With Reverberation. May be used as 28 Watt or as 14 Watt plus 14 Watt Reverb. Two 9 x 6 Woofer Speakers. Two 9 x 6 Twin-Cone Speakers. 4 Channels. Bass and Treble Boost. Foot Vibrato control included.

\$163.50

## 15-INCH HI-POWER SPEAKER

Imported 30 Watts R.M.S. \$30.00  
 Local 50 Watts R.M.S. \$50.00.



## 119 STEREO TAPE ADAPTER

Suits all Playmaster Stereo amplifiers and others that accept crystal P.U.

Kitset . . . . . \$79.00  
 Wired and tested . . . . \$96.00

## TAPE DECKS B.S.R.

2 Track, 3 1/4 l.p.s.

\$25.50

4 Track, 3 Speed Stereo.

\$41.50



## 240v A.C. POWERED SOLID STATE STEREO

T.S.135

18 Transistor, 15-watt per channel. Inputs for Tape, Mag. P.U. Ger. P.U. Radio Aux. Freq. Range 30c to 20KC. Max Sensitivity 3 MV. Speaker matching 4 to 15 ohms.

\$78.00



## A.Z.C. STEREO AMPLIFIER

5 WATTS PER CHANNEL.

Valve Unit, 240v A.C.

Input for Crystal and Ceramic P.U. Radio and Auxiliary. Output for 4, 8, 15 ohms. Cross talk better than -40db. Sensitivity 50 MV.

\$47.50

## WIDE BAND OSCILLOSCOPES

### SPECIFICATIONS

#### VERTICAL AXIS

Deflection Sensitivity (at 1 kc) 0.1 V p-p/cm.  
 Frequency Characteristics 1.5 cps—1.5 MC.  
 Input Impedance 2 M ohms 25 pF.  
 Calibration Voltage 1V pp-cm.

#### HORIZONTAL AXIS

Deflection Sensitivity 0.9 V p-p cm.  
 Frequency Characteristics 1.5 cps—300 KC.  
 Input Impedance 2 M ohms 20 pF.  
 Sweep Oscillator (5 Range) 10 cps—300 KC.  
 Synchronization Devices Internal (Positive and Negative, External). Power 240V AC 50/60 cps. Cathode Ray Tube 3KF1F.



5 Meg. Bandwidth Push-pull vertical and horizontal Amplifiers. 8 positions, high sensitivity vertical Amplifier Frequency Compensated on all positions. Calibrated .02 to 600 volt. Hard time base, 20 cycles to 75K. Latest American R.C.A. circuitry. Complete with probe.

**3-inch \$102.75; 5-inch \$118.75**



## PLAYMASTER 115

The new solid state Stereo-Amplifier. April Issue. Wired and tested . . . . \$104.00  
 Kit Set . . . . . \$90.00  
 Pre-amp to suit magnetic cartridge . . . . . 12.00



## 10 + 10 STEREO AMPLIFIER

E.A. November.

Kit Set . . . . . \$59.75  
 Wired and tested . . . . \$69.75



## AUDIO GENERATOR

De Luxe Model TE-22D. Freq. range, Sine 20 cps—200 KC. SQ. 20 cps—25KC. Output voltage, Sine 7V. SQ. TV P-P. Output impedance 1000 ohms. Acc. 5 per cent. Distortion less than 2 per cent. 4-range attenuation, 1/1, 1/10, 1/100, 1/1K. Printed circuit. 240V A.C.

\$42.95

## SIGNAL INJECTOR

Transistorised. Fountain pen-sized Unit for Signal Tracer in Radio, TV and Amplifier Service.

\$5.75.

Post, 25c.

## TRANSISTOR AND DIODE TESTER

E.A. August, '68. Wired and Tested.

\$57.00

KIT SET \$48.00

## G.D.O. UNITS

Post., N.S.W., 50c; Pstate, 75c. T.E. 15 Transistorised, 7 Band, 360 Kc to 270 Megs.

\$35.75

## SOLID STATE VTVM

E.A., Dec. Wired, Tested.

\$49.50

## UA 41A - 20-20

### SOLID STATE STEREO

20 watts per channel. Inputs for tape, magnetic and ceramic P.U. Tuner and aux. Teak cabinet.

\$88.00

## T.O. 2" OSCILLOSCOPE

### IDEAL TV AID

240 V-AC 2 BPI CRO Tube  
 Vert. Sen. 10V P-P/CM. 50v P-P/CM.  
 Vert. Input imp. 2 Meg. 25pf.  
 Vert. Freq. 2 cps/1 Meg.-3DB.  
 Sweep Freq. 2 Ranges. 60cps-75KC.  
 \$64.50.

## SIGNAL GENERATOR

### Deluxe Model TE-20D.

Freq. range 120 KC—500 Mcs. 7 Bands. Accuracy 2 per cent. Output 8V. Provision for Xtal. Suitable for self calibration Marker generator. Printed circuit. 240 T.E.30 \$25.50. \$28.50 V.A.C.

## INTER. COM. UNITS

2 Station Transistorised

\$11.95

4 Station, including Master

\$20.95

## L.S.G. 11

## SIGNAL GENERATOR

FREQ. RANGE IN 6 BANDS

120KC—130MCS.

Calibrated Harmonics

120MCS—390MCS

RF output over 100,000UV.

120KC—38MC.

Mod. Freq 400 and 1000CPS.

Crystal Osc. 1-15MCS.

AF Output, 3 to 4 Volts.

AF Input, 4V approx.

240V AC Operation.

\$31.75, Post 75c.

## T. E. 46

## RESISTANCE-CAPACITANCE

Bridge and Analyser.

Capacity 20 pf to 2,000 mfd.

Resistance 2 ohm to 200 megs.

Also tests power factor, leakage.

Impedance, transformer ratio. Insulation resistance to 200 megs. at 600V.

Indications by eye and meter.

\$49.75

# AMATEUR BAND NEWS AND NOTES

## Amateur Radio — Are Changes Necessary?

All too often, one hears people complaining about the state of amateur radio in Australia, but when they are asked to specify the changes they would like to see, no satisfactory replies are received. This article discusses the grounds for discontent and suggests possible solutions.

By Pierce Healy, VK2APQ\*

Whether there is anything wrong with amateur radio depends very much on your viewpoint. As far as members of the Wireless Institute of Australia are concerned, grievances can be aired at the monthly meetings of the branches. Members have already agreed that the present Federal constitution of the W.I.A. needs changing, and after lengthy discussions, agreement was reached on a new constitution. Unfortunately, certain legal difficulties in connection with some of the new clauses proposed for the constitution have arisen, and the subject will have to be reviewed.

That many members of the W.I.A. feel that changes are necessary, not only in regard to domestic policy matters, but also in regard to P.M.G. regulations, is clear from the often controversial questions asked by members at meetings, from which the following are fair samples:

"Does the fact that some divisions are much larger in numbers than others, due to the distribution of the population throughout Australia, have a detrimental effect on the overall organisation of amateur radio? Should there be more divisions?"

"Should the current divisional concept be changed?"

"Do some or all of the policies con-

cerning the organisation and structure of the W.I.A. need to be changed?"

"Does the appointment of Federal Executive need to be reviewed?"

"Should there be a headquarters division? If so, how should it be determined?"

"Should there be a limit on the assets that a division should acquire?"

These are really domestic matters relating to the organisation of the W.I.A. Any changes arising from such matters will result from discussions held at Institute meetings and conventions. It is therefore in the interests of any amateur interested in such matters to be active in the affairs of the W.I.A., to attend the meetings and make his views known in discussions.

The regulations applying to amateur radio as laid down by the P.M.G.'s Department also come into question, and have evoked such questions as:

"Should the power limitation on amateur transmitters be raised?"

"Should phone patch operation be permitted?"

"Should the Morse code requirement for the A.O.C.P. amateur licence be deleted?"

"Should a form of novice licence be introduced?"

"Should certain specified facets of amateur licensing be delegated to the W.I.A. or a similar body?"

"Would an examination system similar to that of the City and Guilds of London Institute, in operation in England, encourage more interested persons to attempt to gain their amateur licence?"

In regard to P.M.G. regulations, it should be recorded that the current "Handbook for Operators of Radio Stations in the Amateur Service" was revised in 1967 and was the joint effort of officers of the P.M.G.'s Department and representatives of the W.I.A.

None of the foregoing questions reflects any great desire for radical overall changes in the operation of amateur radio in Australia. However, discussions often provoke new thoughts, and it is probably correct to assume that a more active and less apathetic outlook among the main body of members could result in some organisational changes.

No doubt there are some people unable or unwilling to meet P.M.G. regulations who would like to see the regulations relaxed to allow some kind of hobby activity by unlicensed operators. However, the law is quite specific, and such people would do well to reflect on the definitions of amateurs and the amateur service as laid down in the P.M.G.'s "Handbook for Operators of Radio Stations in the Amateur Service." "Amateur Service" means a service of self-training, intercommunication and technical investigations carried on by amateurs; that is, duly qualified persons interested in radio technique solely with a personal aim and without pecuniary interest."

Naturally, licensed amateurs resent any unauthorised transmissions, not only because they are illegal, but also because the persons attempting such transmissions are loosely described by newspapers as "amateurs." The W.I.A. has, for some years, been urging on the P.M.G.'s Department a scheme for novice licences which would allow persons with a lower technical knowledge than is required for the full amateur licence to operate on some amateur bands. Anybody who has any interest in such a scheme would be well advised to join the W.I.A. and make their views known at the monthly meetings, as well as voting on the issues involved.

It should be noted that membership of the W.I.A. is open to any persons, whether they are licensed amateurs or not, and regardless of age or sex.

In general, the only thing really wrong with amateur radio in Australia appears to be the apathy or lack of interest of licensed amateurs, who either do not support the W.I.A., the organisation whose sole purpose is to protect their interest, or if they are members of the W.I.A., do not attend the monthly meetings. In the past, the W.I.A. has done a great deal to represent the case of the amateur in official circles and is ever watchful to safeguard the privileges it has won for all amateurs, whether they are members of the W.I.A. or not.

At this point, and notwithstanding any dissatisfaction among amateurs, it is perhaps appropriate to point out that the W.I.A. has a very successful record of achievement, and that the privileges enjoyed by the amateur service in Australia compare more than favourably with those in some other countries. To quote one instance: mobile operation—so popular in Australia—is not permitted in Italy, nor are amateur television transmissions allowed.

It should also be borne in mind that

\* News and notes of Divisional and Club activities submitted for inclusion in these columns should be forwarded direct to Pierce Healy, 69 Taylor St., Bankstown, N.S.W., 2200.

**CHAN NEL LOCK** Little Champ PRECISION PLIERS

DIAGONAL CUTTER 41G



PLASTIC GRIPS

Finest quality precision pliers for delicate bench work. Handy gripping tools for work in electronics, model making and watch repair. Polished steel finish with blue, plastic grips.

Complete range 41G to 49G inclusive available from wholesalers all States.

Sole Australian Distributor.

SC/11/2/69

Selectronic Components

29 MARTIN PLACE,  
GLEN WAVERLEY, VIC.  
Phone 232-4883

the W.I.A. has been in existence for nearly 60 years, and has the honour of being the oldest amateur radio organisation in the world, having been formed in 1910, three years before the second oldest group, the Radio Society of Great Britain. It is also the only amateur radio organisation in Australia, and is recognised by the Postmaster-General's Department as being the body able to speak for the amateur cause. The W.I.A. has therefore been able to present the amateur case to successive Governments of Australia, and has also represented the Australian amateurs at numerous international conferences. It took the initiative in the formation of the Region III group established last year as an international body for Asia and Australasia.

All amateurs would do well to consider the problems of shortage of frequencies, and how this will affect the amateur bands. The International Telecommunication Union's Space Frequency Conference will be held in 1970-71, and it seems likely that the outcome of this will in some way affect amateur radio (particularly in the VHF and UHF frequency bands). It is therefore desirable that all amateur bodies should be as strong as possible, to present the most effective case for the amateur service. Now then, you licensed radio amateurs, what are your views on the state of amateur radio in Australia?

#### Special "VK" Callsigns

The Postmaster-General's Department has decided to set aside a special block of call letters from which allocations may be made to amateur licensees who are subject to frequent interstate transfers in their work and desire to retain the basic call letters by which they are known throughout the amateur community.

It will, of course, be necessary for the numeral denoting the particular State to be changed when such transfers are effected and application must be made to the superintendent in the State in which the station is to be established before removing it to another address, in accordance with the provisions of paragraph 87 of the "Handbook for Operators of Radio Stations in the Amateur Service."

Call signs reserved for use in the various States are as follows:—

New South Wales: VK2CAA-VK2CBZ.  
Victoria: VK3CCA-VK3CDZ.  
Queensland: VK4CEA-VK4CFZ.  
South Australia: VK5CGA-VK5CHZ.  
Western Australia: VK6CIA-VK6CJZ.  
Tasmania: VK7CKA-VK7CKZ.

An applicant for a call sign from the abovementioned series will be required to furnish satisfactory evidence that his employment is likely to result in his being transferred interstate at some future date.

The abovementioned arrangement is being introduced on a trial basis for three years and will apply to the holders of the full Amateur Operators' Certificate of Proficiency only.

#### Callsign Reservation

The controller, radio branch, Postmaster-General's Department, Mr C. Carroll, has pointed out that where a licensee has died, it is the policy of the department not to reissue his callsign for five years, except in special circumstances. Also, where special circumstances exist, callsigns may not be reissued for a period of 10 years.

In the event of unexpired callsigns, these are reserved for two years where no special reasons are given. Consideration will be given, however, to the reservation of callsigns for longer periods, for example, if a licensee is transferred interstate or overseas, but intends to return to his original call area.

#### Corrigendum

In the item on W.I.A. policy on Novice Licence in last month's notes, reference to P.M.G. regulations was omitted. A knowledge of the P.M.G. regulations to A.O.C.P. standard is recommended.



## NKK switches

The best the World can offer

"A selected few from the large range available"

TYPE	MODEL	CIRCUIT	CAPACITY	CIRCUIT ARRANGEMENT
Toggle Switch	S-1051Y	SPST	1.5A 250V A/C	ON-OFF
	S-114	DPST	2A 250V A/C	ON-OFF
	S-116	DPDT	2A 250V A/C	ON-ON
	S-2B	SPDT	5A 250V A/C	ON-ON
	S-305	SPDT	6A 250V A/C	ON-MOM ON
	S-6A	DPDT	10A 250V A/C	ON-ON
Push Button Switch	SB-265	SPST	3A 250V A/C	PUSH-ON-PUSH OFF
	SB-61A	DPDT	5A 250V A/C	ON-MOM ON
	SB-25	DPDT	9A 250V A/C	PUSH ON-PUSH ON
See Saw Switch	SW-3511	SPST	1.5A 250V A/C	ON-OFF
	SW-3116	DPDT	2A 250V A/C	ON-ON
	SW-3006	DPDT	10A 250V A/C	ON-ON
Lamp-lighted† Switches	CLB-2085	DPDT	3A 250V A/C	PUSH ON-PUSH ON
	CLB-2011	SPDT	2A 250V A/C	ON-MOM ON
	MLB-2085	DPDT	3A 250V A/C	PUSH ON-PUSH ON
Push Button‡	SCB/1	ROUND TYPE		
Switch Button‡	SCB/2	RECTANGULAR TYPE		

†These style of push buttons are for panel mounting and feature a range of dual colours, the push button being a different colour to its panel surround.

PLEASE ENQUIRE AS TO THE COLOURS AVAILABLE WHEN ORDERING.

‡The CLB and MLB lamp-lighted switches are available in the following range of lamp voltages 6V, 12V, 18V and 24V and red, green and clear colours. The lens buttons are available in red, green and transparent. Please specify when ordering.

## IRH COMPONENTS PTY. LIMITED

(A subsidiary of International Resistance Holdings Ltd.)

THE CRESCENT, KINGSGROVE, N.S.W. 2208. TEL. 50 0111

**POST TODAY**

Please supply Sub-Miniature and Standard switch catalogue.



NAME.....

ADDRESS.....

# Yaesu-Musen SSB Amateur Transceivers



**SIDEBAND ELECTRONICS ENGINEERING** continues to offer you the largest stock and selection of imported amateur equipment in Australia. The licensed and prospective licensed amateurs are the only customers we cater for. All units advertised below are in stock in quantity, except for the Yeasu-Musen FT-200 transceivers, which will continue to be in short supply for some time to come. All prices quoted, subject to prior change without notice, are net, cash Springwood, N.S.W., sales tax included, no discounts for trade or otherwise, sorry no terms either. Quality commercial units are accepted as trade-in.

Certain transceivers will soon be kept in bond for buyers outside the Australian Continent, New Guinea and New Zealand residents, please apply for details; payments, however, must be made in Australian currency.

Apart from new equipment, there is usually a stock of second-hand Galaxy, Drake, Swan or Collins equipment, reconditioned where necessary and sold under 90 days' warranty; just send an S.A.E. for the latest list.

YAESU-MUSEN FT-DX-400 transceiver, with FV-400 external second VFO, **\$650**. FT-DX-100 transceiver, **\$525**. FT-DX-200 transceivers, **\$375**. FL-DX-2000 linear, **\$250**. FL-DX-400 transmitter, **\$375**. FR-DX-400 receiver, **\$375**.

SWAN SW 350C transceiver, **\$525**. SW 500C deluxe transceiver, **\$650**.

GALAXY V Mark III transceiver, **\$525**.

HY-GAIN TH6DXX beam, **\$200**. TH3JR junior beam, **\$110**. BN-86 balun, **\$17.50**.

MOSLEY TA33Jr beam, **\$98**. MP-33 senior Mosley beam, expected soon, **\$125**.

HAM-M-CDR heavy duty rotator, **\$180**. AR-22 rotator, **\$60**, both with 230V indicator control units.

NEWTRONICS Hustler 4-BTV vertical, 10 to 40 metres, **\$55**.

WEBSTER Bandspanner, all-band mobile whip, with swivel-mount and spring, **\$55**.

MARK 40 metre helical whip, **\$16**. MARK triband 10-15-20 metre helical whip, **\$27.50**. Swivel mount and spring for the MARK whips, **\$12.50**.

GERMAN W-3-DZZ all-band inverted V dipole, set of traps and balun, **\$25**.

ACITRON 12V heavy-duty mobile supply, fits all transceivers, **\$105**.

## USED EQUIPMENT

SWAN SW 350, 3 years old, with CAL. and VOX and AC-supply-speaker units . . . . .	<b>\$450</b>
GALAXY V Mark II, one year old, with AC-supply-speaker unit . . . . .	<b>425</b>
DRAKE TR-3, 4 years old, with DRAKE external VFO plus AC supply . . . . .	<b>500</b>
COLLINS 30-L-1 spotless linear amplifier . . . . .	<b>500</b>
GALAXY V, 3 years old, with GALAXY external VFO and AC-supply . . . . .	<b>450</b>

## **SIDEBAND ELECTRONICS ENGINEERING**

33 PLATEAU ROAD, POSTBOX 23 SPRINGWOOD, N.S.W. 2777.

TELEPHONE (STD 047) 511-394

City Office & Showroom, Mondays to Fridays, 9 a.m. to 5 p.m. by appointment ONLY, 145A George Street, near Circular Quay, Sydney. Tel. 27-5885/6.



# WIRELESS INSTITUTE ACTIVITIES

During February, the Postmaster-General's Department advised the Federal Executive of the W.I.A. of an extension of the Australian callign series for amateur operators. Full details of these series for each Australian State are given in these notes.

## WICEN EXERCISE

A very successful Wireless Institute Civil Emergency Net exercise was held on Sunday 26th, and Monday 27th, February, 1969, by members of the North-West Zone in Victoria. The exercise provided VHF communication links for the 37½-mile Marathon Swim down the Murray River to Mildura.

The purpose of the Marathon Swim was to raise money for the Mildura Apex Club's Geriatrics Fund. The starting point was Mindook Station, 37½ miles upstream from Mildura. The map shown illustrates the course and the location of the communication units.

The problem of providing reliable VHF communication was accentuated by the fact that the actual river level is much lower than the surrounding country. In places there are high cliffs and heavily timbered areas. Channel 'B' 146MHz was used throughout, and the equipments used were all converted MR3A units.

A houseboat which accompanied the 11 swimmers was equipped with a ground-plane antenna. From the start of the race at 1100EST Sunday to 1730EST Sunday, communication to the Mildura base was through a portable station located on the cliffs at Mindook Station, approximately 17 miles airline from Mildura.

At 1730EST on Sunday a mobile station was brought into use to provide the link with the houseboat, while the portable station was moved from Mindook Station to Monak. The portable station at Monak was required for only a short period, as direct communication was made with the houseboat from the Mildura Base station.

Unexpected propagation conditions were experienced at times during the operation. Early on Sunday morning, 26th January, it was necessary for the portable station at Mindook Station to work through a station at Cardross to the base station at Mildura, as signals dropped from solid readability level down into the noise level. This condition lasted for about 30 minutes.

Operation from the maritime/mobile station ceased at 0600EST on Monday morning when the first swimmer arrived at the finishing point at Mildura. From that time until the arrival of the last swimmer at 2300EST Monday, mobile stations were used to pass information regarding the swimmers' locations to the Mildura Base station.

The first swimmer to finish was Des Renford and only two others of the 11 starters completed the course.

Over 100 formal messages were handled during the course of the operation, many of which were telephoned from the base to their destination. The messages included reporting the positions of the various swimmers, request for transport facilities at specified points, reports on overloading on the houseboat, personal messages from the swimmers' handlers to relatives, one message reporting a missing girl and a request for medical supplies for one of the swimmers. The network control station was manned and operated continually for 36 hours 20 minutes.

Special thanks were extended to Max Tulloch, VK3AKT, who prepared the maps for the exercise; to Graeme Zimmer, VK3ZZX, who constructed a skeleton slot antenna for use during the operation; and

to Peter Mortiz for the work done in preparation for the exercise.

Full credit must also go to the 12 operators for the successful completion of the exercise.

The operators during the exercise were:  
 Max Tulloch, VK3AKT  
 Graeme Zimmer, VK3ZZX  
 Michael Alsop, VK3ZYB  
 Jim Brown-Sarre, VK3ZVJ  
 Noel Ferguson, VK3AGF

Assistant Operators:  
 Michael Adnams, Ian Beulky  
 Russell Zimmer, Bob Foreman  
 Graeme Lock, Bill Smith  
 Peter Moritz

## VHF Repeaters

News to hand on the work being carried out in the various States in regard to setting up VHF repeater installations indicate that considerable progress is being made. In many cases repeater frequencies have been determined and approval is awaited from the Postmaster-General's Department for installation permits. As at the end of February, details of repeater frequencies and proposed locations were:—

### New South Wales

Sydney: Location — VK2WI, Quarry Road, Dural.

Frequencies — Transmit 145.9MHz; Receive 146.4MHz (Channel 4). Deviation 15KHz maximum.

Awaiting approval from PMG's Department. Operation expected end of April.  
 Newcastle: Location—site tests being

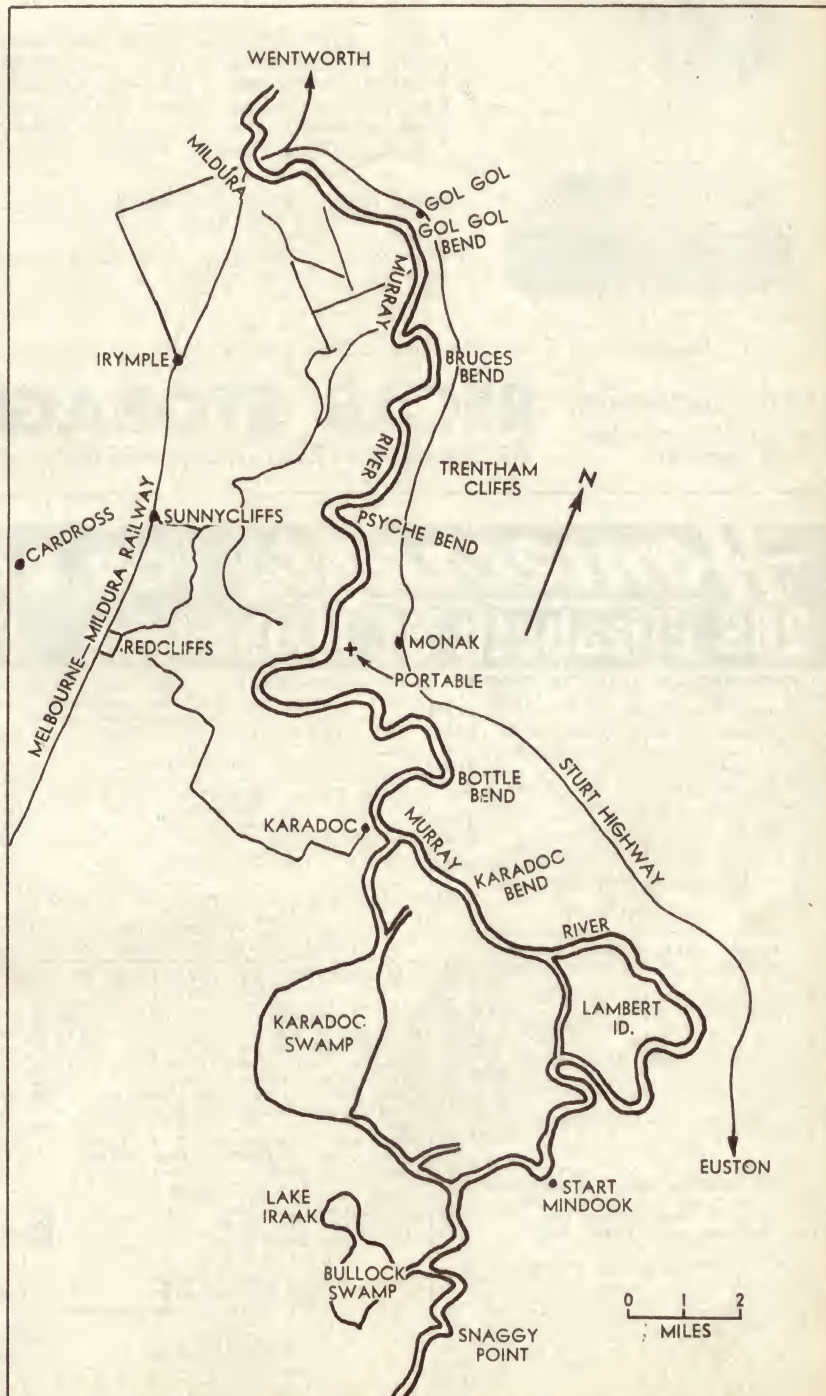

A map of the Murray River from Mindook to Mildura showing communication points used by WICEN during the marathon swim.



# SPECIALISTS IN HI-FI FURNITURE AND RECORD STORAGE UNITS

Standard range or built to your specifications

This Hi-Fi Cabinet is a first in every sense of the word. Your turntable, whatever it may be, is cut into the top of the cabinet. Hinged lid in either acrylic or timber as optional extra. Beautifully finished in teak.

Dimensions (approx.) 16 x 16 x 28in high.  
Retail Price . . . . . \$49.00  
Hinged lid extra . . . . . \$10.00  
Other sizes to special order.



Acrylic covers in neutral shade. Suit most units. Retail price . . . . . \$9.50  
Turntable bases suit Dual and Garrard. Recessed and rebated edges. Teak veneer finish. Retail price . . . . . \$10.00  
Other bases to order.



Wide range of speaker enclosures from \$39.00 pr.

Teak veneer finish. Solid back. Fabric face with Black Timber piping.



Remember WE specialise and that means we give you personal attention and quality.

TRADE ENQUIRIES:  
MAIL ORDERS ATTENDED  
TO PROMPTLY

## RECAP STORAGE CABINETS

69 COLLETT STREET, KENSINGTON, VICTORIA 3031 PHONE 33 3416

# Homecrafts FOR RADIO PARTS

289 Elizabeth St. Melbourne. Phone 60 1442

<p><b>PIEZO PICK-UP AND CARTRIDGES</b> PU-86 Pickup LP/78 T/O Crystal cartridge. Length 240mm . . . . . Ea. \$2.95 Y700 Ceramic Cartridge. Mon. LP/78 . . \$2.50 PU-86 Pick-up Ster-LP/78. T/O Cartridge. Length 204mm . . . . . Ea. \$4.00 Y200 Ceramic Cartridge. ST LP/78 . . \$3.40 PU-54 Pick-up LP/45 only. Length 1.25mm . . . . . Ea. \$2.10 Y400 Crystal Cartridge. LP/45 . . . . \$1.20 Y130 Crystal Cartridge. T/O Type Ster/LP . . . . . Ea. \$2.70 Sapphire Replacement Styli. Each Ster/LP . . . . . Plus postage 15c. 60c</p>	<p>12-Pin Wafer Sockets. . . . . 20c ea. 12-Pin Plugs . 25 ea. Plus postage 10c.</p> <p><b>OCTAL PLUG AND CORD</b> Ext. Socket. 45c pr. Plus postage 10c.</p> <p><b>ALL TYPES AMPHENOL PLUGS AND SOCKETS</b> Carried in stock. Plugs 27c ea. Sockets 30c ea. Meall Covers for same 27c ea. Plus postage 10c.</p> <p><b>HALF-INCH MINIATURE PLUGS AND SOCKETS</b> 2, 3, 4 and 5-Pin Plugs 10c ea. Sockets 10c ea. Plus postage 10c.</p> <p><b>ELECTROLYTIC CAPACITORS IN METAL CANS</b> 16 + 16 450 VW . . . . . 95c ea. 32 + 32 450 VW . . . . . \$1.30 ea. 50 + 50 450 VW . . . . . \$1.85 ea. 50 + 50 + 50 350 VW . . . . . \$1.90 ea. 100 MFD P.V.C. Cover . . . . . \$1.15 ea. Jacks. 2.5 and 3.5mm . . . . . 20c 3.5mm Plug and Cord Ext. Jack Pair . . 50c Metal Co-axial Plugs and Line Sockets Pr. . . . . 65c "Din" and "Hirschmann," 2, 3, 4 and 5-pin Plugs, Chassis and Line Sockets, carried ex stock. Prices on application. P.M.G. type Plugs from . . . . . 50c P.M.G. type Jacks from . . . . . 35c P.M.G. Line Jacks from . . . . . 55c Plus postage 15c.</p>	<p>Capacitor Substitution Box. 1,000 VW . . \$5.00 Resistor Substitution Box. 1 Watt. Plus Post. 20c. . . . . \$4.50</p> <p><b>TRANSISTOR AERIALS</b> 5in extends to 39in . . . . . \$1.70 5in extends to 39in . . . . . \$1.70 6in extends to 43in . . . . . \$1.70 6in extends to 32in . . . . . \$1.00 6in extends to 28in . . . . . \$1.00 7in extends to 39in . . . . . \$1.20 9in extends to 39in . . . . . \$1.90 6in extends to 4ft 6in . . . . . \$1.00 7in extends to 5ft 8in . . . . . \$3.70 Plus Post 15c.</p> <p><b>CRYSTAL SET BUILDERS</b> Coils . . . . . 80c Diodes . . . . . 35c Headphones . . . \$2.90 Tuning Conds. . \$2.00 Terms . . . . . Ea. 12c Plus Postage.</p>
<p><b>PIEZO MICROPHONE INSERTS</b> MC-3 Crystal, 50-7K, 35 x 25 x 8mm. -57 DB . . . . . \$1.00 ea. MC-7 Crystal, 100-7K, 39mm Round x 11mm. -56 DB . . . . . \$1.00 ea. MC-8 Crystal, 50-8K, 48mm Round x 17mm. -50 DB . . . . . \$1.00 ea. MC-9 Crystal, 50-8K, 25mm Round x 9mm. -68 DB . . . . . \$1.80 ea. MC-33 Crystal, 50-10K, 33mm Round x 9mm. -60 DB . . . . . \$1.30 ea. MD-5 Dynamic, 100-15K, 33mm Round x 14mm. -55 DB . . . . . \$1.80 ea. Plus postage 20c.</p>	<p><b>TRANSISTOR SET ACCESSORIES</b> Magnetic Earpiece with 3.5mm Plug . . 75c Crystal Earpiece with 2.5mm Plug . . 75c Crystal Earpiece with 3.5mm Plug . . 75c</p> <p><b>LAPEL TYPE CRYSTAL MICROPHONE</b> With 3.5mm Plug . . . . . \$1.00 ea. Plus postage 15c. Fuses for Japanese equipment 1A, 3A, 5A 3c ea. OR \$2.00 per 100. Plus postage 10c.</p> <p>Michigan/Collard—Twin Track Rec/Play Heads . . . . . \$8.50 Michigan/Collard—Twin Track Erase Heads \$3.00 Michigan/Collard—Four Track Erase Heads \$8.50</p>	<p><b>TAPE RECORDER ACCESSORIES</b> 2 1/2in Spools . . 30c 3in Spools . . . 35c 5in Spools . . . 40c 5 3/4in Spools . . 70c 7in Spools . . . 50c 2 1/2in x 100ft Tape . . . . . 60c 2 1/2in x 300ft Tape . . . . . \$1.40 Plus postage 20c. See us for Tape Recorder Patch Cords, Adaptors, etc.</p> <p><b>NIBBLING TOOL CUTTERS</b> \$3.50 ea. Plus postage 20c.</p> <p><b>STEREO PLUGS AND JACKS</b> Metal Plugs . . . 95c Bakelite ext. sockets . . . 70c Chassis Jacks . . 65c Plus postage 10c.</p>

## MAIL ORDER SPECIALISTS

carried out by Keith Howard, VK2AKX, and David Russell, VK2BSC.

Frequencies — Transmit 145.9MHz; Receive 146.4MHz (Channel 4).

Orange: Location—Mount Canobolas.

Frequencies: — Transmit 145.854MHz, will be changed to 145.6MHz; Receive 146.1MHz (Channel 1).

Awaiting approval from PMG's Department.

Wagga and Wollongong: Location—site tests being carried out.

Frequencies — Transmit 145.6MHz; Receive 146.1MHz (Channel 1).

Application for approval being prepared.

Albury: Location — site tests being carried out.

Frequencies — Transmit 145.9MHz; Receive 146.4MHz (Channel 4).

Application for approval being prepared.

#### Victoria

Melbourne: Location—site tests being carried out.

Frequencies — Transmit 145.9MHz; Receiver 146.4MHz (Channel 4).

Tests are also being carried out in south-east Victoria where a site is being investigated that will allow about 30 amateurs in the Latrobe Valley to contact each other via the repeater. Discussions are due to take place on the proposal during the Zone Convention on April 19 and 20.

Various locations in the Wangaratta and Shepparton area are being investigated as possible sites for a repeater installation.

#### Tasmania

North-eastern area. Location — Mount Burrow.

Frequencies — Transmit 145.9MHz; Receive 146.4MHz (Channel 4).

Awaiting approval from the PMG's Department. It is also hoped to set up a link with the mainland, probably to south-eastern Victoria.

Hobart: Location—Mount Wellington. Frequencies—No final decision.

#### A.C.T. and S.A.

Tests being carried out for suitable sites.

#### Queensland and W.A.

Various proposals are being considered. The co-ordination committee of the W.I.A., Chris Jones, VK2ZZD, Tim Mills, VK2ZTM, and Ian Mackenzie, VK2ZIM has advised that interest in the use of VHF repeaters has exceeded expectations. They invite any amateur radio operator interested in the subject to contact them for further information. Letters should be addressed to:—VHF Repeater Committee Wireless Institute Centre, 14 Atchison Street, Crow's Nest, N.S.W. 2065.

## NEW SOUTH WALES

At the February monthly meeting of the New South Wales Division, a record number of 41 applications for membership were accepted. The meeting also coincided with the closing date for nominations for council for the coming year and it appeared that a record number of nominations were submitted. It had been previously indicated that several of the 1968-69 council would not be able to accept nomination for the forthcoming election.

#### Gosford Field Day

On Sunday, February 23, 1969, the Annual Field Day of the Central Coast Branch of the New South Wales Division of the Wireless Institute of Australia was held at the Gosford Showground. Under ideal weather conditions, the program as planned went off very smoothly and the organisers were congratulated on their efficiency.

The attendance again exceeded that of previous years, there being 214 men, 68 ladies and 70 children present. Of the total of 352 persons, 160 were licenced amateurs. Among the visitors were Institute members from Sydney, Newcastle, Hunter Valley, Forbes, Bathurst and the Blue Mountains.

Many old acquaintances were renewed and a number of new friends made with a general feeling of good fellowship prevailing throughout the day.

The catering, which included morning and afternoon tea and a hot mid-day meal, was again carried out by the small group of ever-willing ladies, to whom the thanks of all present was extended for a job well done.

In addition to the keenly contested field events, the ever intriguing sale of disposal equipment, and the de-hydration of the proverbial 809s, there was a glittering display of the latest commercial amateur communication equipment by Ron Richardson, VK2ALR—W.F.S. Co.; Fred Bail, VK3YS and Sandy Bruce-Smith VK2AD — Bail Electronics; and Arie Bless, VK2AVA—Sideband Electronics.

The organising committee of the Central Coast Branch has expressed its sincere thanks to the trade houses who generously donated excellent prizes for various competitive events. Among those included were: George Brown and Co.; R. H. Cunningham Pty. Ltd.; Mullard-Australia Pty. Ltd.; Amalgamated Wireless Valve Co. Pty. Ltd.; Radio Despatch Service; M.S.P. Ltd.; Technical Book Co.; Electronic Parts Pty. Ltd.; Pye Pty. Ltd.; Plessey Components; Ducon Condenser Pty. Ltd.; Kit Sets Aust.; Anodeon Sales; Philips Miniwatt Division; Sideband Electronics and Bail Electronics.

At the final gathering of all present prior to the presentation of prizes, a past president of the Central Coast Branch, Major Collett, VK2RU, was presented with his Life Membership badge of the W.I.A., the presentation being made by Pierce Healy, VK2APQ, Federal Councillor for the N.S.W. Division.

The prize winners for the various events held were:—

7MHz Mobile Scramble:  
1st Dennis Wheaton VK2AWW  
2nd Charlie Wilkins VK2ALB

144MHz Mobile Scramble:  
1st J. C. Bennett VK2ZGB  
2nd G. I. Post VK2BGP

7MHz Hidden Transmitter Hunt:  
1st Dave Andrews VK2AWZ  
2nd Dick Norman VK2ZCF  
3rd Bob Lear VK2ASZ

1st 144MHz Hidden Transmitter Hunt for Pedestrians:

1st Tony Mullen VK2ZCT  
2nd B. A. Jones VK2ZKF  
3rd Ken Young Assoc.

2nd 144MHz Hidden Transmitter Hunt for Pedestrians:

1st B. A. Jones VK2ZKF  
2nd D. A. Friend VK2ZZI  
3rd D. R. Ashton VK2ZWY

1st 144MHz Hidden Transmitter Hunt for Mobiles:

1st Bob Lear VK2ASZ  
2nd Dave Andrews VK2AWZ

2nd 144MHz Hidden Transmitter Hunt for Mobiles:

1st Dave Andrews VK2AWZ  
2nd Paul Jackson VK2BPJ  
3rd Bob Lear VK2ASZ

Mens Quiz Competition: Tony Mullen VK2ZCT.

Ladies Quiz Competition: Mrs Henderson.

Ladies Scavenger Hunt: Mrs Patricia Skeers Mrs Val Laws.

During the afternoon there was a coach tour around the Central Coast Scenic Spots and a boat trip on the Brisbane Water for those not participating in the field events.

#### Nepean and District Amateur Radio Club

The annual general meeting of the Nepean and District Amateur Radio Club was set down for March 19. The agenda for the meeting included the election of officers for the ensuing year and a discussion on the club's activities.

It had already been proposed that the club commence a series of lectures and practical classes to assist those wishing to sit for the P.M.G.'s Amateur Operators' Certificate of Proficiency examination.

An invitation is extended to persons living in the St. Marys/Penrith area who would like to attend meetings or participate in the club's activities to contact the club secretary, G. Drew, Cnr. Station

# ELECTRONIC DESPATCH

16 SHERIDEN ST., GRANVILLE, N.S.W. 2142.

Mail Order — Direct Sale  
9-1 Daily and Sat.

#### VALVE SPECIALS

6AM4 .. .. \$2.00	6AK6 .. .. \$1.00
6AM5 .. .. \$1.30	6AL5 (6058)* \$1.00
6AK5 .. .. \$1.50	6BA6 (5749)* \$0.90
6AL5 .. .. \$0.80	12AX7 (6057)* \$1.25

All new in cartons.  
\* Premium quality.

#### TRANSMITTING VALVES

QOV0Z-6 .. \$4.00	832A .. .. \$1.00
QVZ-250C .. \$20.00	5B22M (807) .. \$1.00
QOV03-10 .. \$2.00	12E14 .. .. \$1.50
TDO3/10 .. \$12.50	CVS7 .. .. \$1.00
RR3-250 .. \$5.00	

1" CRO Monitor Tube VLS492AB .. \$5.00
V 230A/1K Velocity Mod. Oscillator .. \$2.00

#### NEW LISTS EACH MONTH

##### VACUUM CONDENSERS

10 pF Fixed 32KV .. .. \$5.00
25-500 pF Variable 15KV .. \$50.00
Temperature controlled crystal AWA 710 KC .. .. \$25.00

#### SEMICONDUCTORS

TS3 (AF 185) .. .. \$0.50	2N3563 .. .. \$0.50
audio .. .. 25c	2N442 150w .. \$2.00
TS13 (AC 126) .. 50c	2N511A 50w .. \$1.50
2N456A .. .. \$2.50	GD5 GE Diode .. 5c
513B .. .. \$4.00	GD12GE .. .. 5c
2N3564 .. .. \$0.60	Diode .. .. 5c

#### RELAYS, Etc.

3000 type new, all functions .. .. 75c
Others ex-equipment .. .. 35c
P.M.G. Jack Plug, single, each .. 15c
Double .. .. 40c
Key Switch, New .. .. 80c. Used .. 25c
4 Digit Counters .. .. 75c

#### RESISTORS, Etc.

European brand, professional quality cracked carbon, 1/2W, 5% full range, always in stock, ea. .. 6c
IRC Histab 1, 2 or 5%, 50 values, ea. 10c
Wire wound, 3 watt, 50 values, ea. 12c
1 watt carbon, 200, 320, 600 20K. 10 for .. .. 20c
Power rheostat, IRC, 25W, 5K, new \$1.50
"Wireless World" non inductive available
Carbon pots .. .. 20c
Wire wound pots .. .. 30c

#### ELECTROLYTICS

28,000 MFD .. .. \$4.00	100 MFD 450 VP, ea. .. 65c
10VW .. .. \$1.50	160/64 .. .. 25c
15,000/10 .. \$3.00	150/150AC .. \$1.50
4000/80 .. .. \$4.00	100/10 .. .. 10c
3300/100 .. \$4.00	68/15 .. .. 30c
500/50 .. .. \$2.00	25/100 .. .. 10c
50/12 .. .. 10c	25/6 .. .. 10c
400/10 .. .. 10c	24/450 .. .. 15c
250/85 .. .. \$2.00	20/3 .. .. 10c
250/12 .. .. 30c	16/500 .. .. 15c
200/25 .. .. 20c	5/70 .. .. 10c
200/3 .. .. 20c	1/50 .. .. 6c

Send SAE for FULL LIST OF PARTS  
PLEASE ALLOW FOR PACKING AND POST, ETC.

#### 240V MAINS VOLTAGE STABILIZERS

"Claud Lyons" new, 10 amps, plus, minus 5% .. .. \$25.00
Stabilac, new, 3 amps .. .. \$35.00

#### NEW TEST GEAR

PV58 VTVM .. .. \$30.00
SE200 MINILAB .. .. \$15.00
SE250 SIG. INJECTOR .. .. \$4.50
SC2 TRANSISTOR CHECKER .. \$30.00
TE18 GRID DIP METER .. .. \$34.00
HM50 RF FIELD METER .. .. \$8.00
HM55 RF FIELD FREQ. METER .. \$8.00

COUNTRY SHOW VISITORS  
WELCOME TO INSPECT OUR STOCK

NOTE TRADING HOURS ABOVE



# BATTERY SAVER - A/C ADAPTOR

Permits A/C Mains operation of Transistors and other 6-9V Battery Powered Equipment

*- at Negligible Power Cost!*



- 6 or 9 Volt (Nominal Voltage) selected by external switch
- Double insulated for absolute safety.
- Handsome cabinet complete with 3 pin power point plug, and radio lead with plug.
- Measures a compact 3½ ins. x 2½ ins. x 2 ins.
- Suitable for any 6 or 9 Volt Battery Operated Transistor Equipment.

**APPROVED BY ELEC. SUPPLY AUTHORITIES**

**PS 64 Specially for Tape Recorders**  
**PS 82 Specially for Transistor Radios**

Manufactured by:

**A & R ELECTRONIC EQUIPMENT CO. PTY. LTD.**  
 42-46 Lexton Rd., Box Hill, Vic. 3128.

Phone: 89 0238

REPRESENTATIVES IN ALL STATES

S.A. SCOTT THOMPSON P/L, 93 Gilles St., Adelaide 23 2261 N.S.W. SOANAR ELECTRONICS P/L, 82 Carlton Cres., Summer Hill 798 6999  
 W.A. EVERETT AGENCY P/L, 17 Northwood St., W. Leederville 8 4137 Q'LAND. R. A. VENN P/L, 71-73 Doggett St., Valley, Brisbane 51 5421

## Eddystone

### 990 R

#### VHF COMMUNICATIONS RECEIVER



AVAILABLE NOW EX-STOCK  
 OR BOND STORE.

**Intermediate Frequency**

10.7 MHz. Output of up to 50 millivolts is available at low impedance from B.N.C. co-axial socket.

Range 1 . . . . 127—240 MHz.

Range 2 . . . . 75—127 MHz.

Range 3 . . . . 46—75 MHz.

Range 4 . . . . 27—46 MHz.

**IF Bandwidth**

30 kHz and 200 kHz.

The Eddystone model "990R" is a fully transistorised single conversion receiver for reception of CW, AM and FM signals in the range of 27-240. The full tuning range is covered in four switched bands, with the R.F. unit having three gang-tuned signal circuits prior to the mixer. Local oscillator arrangements permit operation with crystal control from any one of eight switched frequencies in addition to manual tuning.

An intermediate frequency of 10.7 M/Hz is used and bandwidths of 30 kHz and 200 kHz are provided as standard, the former employing a crystal filter, alternative filters being available to order.

Separate wide and narrow bandwidth outputs are available at the intermediate frequency. The former is a low level output intended for driving the companion Panoramic Display Unit (Model ER17R) via an external converter, bandwidth being of the order of 1 MHz at the higher frequencies. Video output is available on both AM and FM.



608 COLLINS ST., MELBOURNE, VIC., 3000. 61-2464.

64 ALFRED ST., MILSON'S PT., N.S.W., 2061. 929-8066.

L. E. BOUGHEN & CO., 95 CENTRAL AVE., SHERWOOD, QLD., 4075. 79-2207.

Street and Western Highway, Mount Druitt, 2770.

Members of the club are very active in the Wireless Institute Civil Emergency Net and work very closely with the St. Marys/Penrith section of the New South Wales Civil Defence Organisation. Roland Grevas, VK2AQX, was recently elected WICEN co-ordinator for the Nepean district.

Monthly meetings of the club are held on the third Wednesday of each month in the C.D.O. headquarters building at the Industrial Area, St Marys.

#### Urunga Convention

The details of the 21st Urunga Convention came to hand too late for inclusion in last month's notes. As this very popular event was held over the Easter Holiday weekend, 4-5-6th April, it will be over when these notes are read. Any inconvenience to those who were awaiting details is regretted.

## Reports from Abroad

### R.N.A.R.S.

At the annual general meeting of the Royal Navy Amateur Radio Society held last October it was decided that Associate Membership of the R.N.A.R.S. should be extended to members of the Merchant Navy and foreign navies. The first members accepted under the new rule were GM5AHS and ON50J.

### QRP

A report on really low power contacts between England and Australia appeared in the December issue of the Radio Society of Great Britain journal "Radio Communication." Congratulations were expressed to G6XN on his achievement of maintaining daily schedules, while on holiday in Mull, with VK3IP and VK2NN between October 20 and 25, 1968, on 14MHz single side band and only missing making contact on one day.

G6XN was only running 1 watt output into an inverted vee antenna which was sloping steeply in the direction of Australia via the long path (over Central America). His signal in Australia was strength seven at its best. In addition to these contacts he worked VK5BB on 21MHz this time via the short path.

During the same period contacts were also made with American and European stations.

### Great Britain

The British Postmaster-General announced in U.K. recently licensing changes which affect both amateur sound and amateur television licences. These changes became effective on November 1, 1968.

The four-metre amateur band limits have been amended to read 70.025MHz to 70.7MHz. These changes affect the holders of amateur sound licences both fixed station and mobile.

The other licencing changes affect the 70cm band. The frequency allocation has been amended to read 425MHz to 429MHz and 432MHz to 450MHz. This change will affect the holders of sound licences A, B, C and D and all mobile licences.

The frequency limits for holders of amateur television licences has been amended to read 425MHz to 429MHz and 432MHz to 445MHz.

### New Bill

A bill has been introduced in the British Parliament that will change the status of the Post Office from that of a Government department to that of a nationalised corporation. The powers of the Postmaster General to licence radio stations, to control frequency usage and co-ordinate the use of radio apparatus for transmitting and receiving will be transferred to the new Minister of Posts and Telecommunications, who will be responsible for the oversight of the new Post Office.

The bill is a very large document, having 224 pages. It repeals some 500 Acts of Parliament.

## AUSTRALIAN VHF CENTURY CLUB AWARD

### Objects:

- 1.1 This award has been created in order to stimulate interest in the VHF bands in Australia, and to give successful applicants some tangible recognition of their achievement.
- 1.2 This award to be known as the VHF Century Club Award will be issued to any Australian amateur who satisfies the following conditions.
- 1.3 Certificates of the Award will be issued to the applicants who show proof of having made 100 contacts on the VHF bands, and will be endorsed as necessary, for contacts made using only one type of emission.
- 2.1 Contacts must be made in the VHF band (band 8) which extends from 30MHz to 300MHz, but such contacts must only be made in the authorised Amateur Bands in Band 8.
- 2.2 In the case of the authorised bands between 30MHz and 100MHz, verifications are required from 100 different stations at least 70 of which must be Australian. The amateur bands 50MHz to 54MHz and 56MHz to 60MHz will be counted as one band for the purposes of the Award.
- 2.3 In the case of the authorised amateur band between 100MHz and 200MHz, and any authorised band between 200MHz and 300MHz, verifications from 100 different stations for each band is required.
- 2.4 It is possible under these rules for one applicant to receive three certificates, one for each of the authorised amateur bands mentioned in Rules 2.2 and 2.3.
- 2.5 The commencing date for the Award is June 1, 1948. Any contacts made on or after this date may be included.

### Operation:

- 3.1 All contacts must be two-way contacts on the same band, and cross band contacts will not be allowed.
- 3.2 Contacts may be made using any authorised type of emission for the band concerned.
- 3.3 Fixed stations may contact portable/mobile stations and vice versa, but portable/mobile station applicants must make their contacts from within the same call area.
- 3.4 Applicants, when operating either portable/mobile or fixed, may contact the same station licensee, but may not include both contacts for the same type of endorsement.
- 3.5 Applicants may only count one contact for a station worked as a limited licensee with a 'Z' call sign who is subsequently contacted as a full A.O.C.P. holder.
- 3.6 All stations must be contacted from the same call area by the applicant, although if the applicants' call signals subsequently

changed, contacts will be allowed under the new call sign providing the applicant is still in the same call area.

- 3.7 All contacts must be made when operating in accordance with the regulations laid down in the "Handbook for Operators of Radio Stations in the Amateur Service," or its successor.
- Verifications:
  - 4.1 It will be necessary for the applicant to produce verifications in the form of QSL cards or other written evidence showing that two-way contacts have taken place.
  - 4.2 Each verification submitted must be exactly as received from the station contacted, and altered or forged verifications will be grounds for disqualification of the applicant.
  - 4.3 Each verification submitted must show the date and time of contact, type of emissions and frequency band used, the report and the location or address of the station at the time of the contact.
  - 4.4 A check list must accompany every application setting out the following details:
    - 4.4.1 Applicants name and call sign, and whether a member of the W.I.A. or not.
    - 4.4.2 Band for which application is made, and whether special endorsement is involved.
    - 4.4.3 Where applicable, the date of change of call sign and previous call sign.
    - 4.4.5 The applicant's location at the time of each contact if portable/mobile operation is involved.
    - 4.4.6 Any relevant details of any contact about which some doubt might exist.
- Applications:
  - 5.1 Applications for membership shall be addressed to the Federal Awards Manager, Box 2611W, G.P.O. Melbourne, Victoria, 3001, accompanied by the verifications and the check list with sufficient postage enclosed for their return to the applicant, registration being included if desired.
  - 5.2 A nominal charge of 25c. which shall also be forwarded with the application, will be made for the issue of the certificate to successful applicants who are non-members of the Wireless Institute of Australia.
  - 5.3 Successful applicants will be listed periodically in "Amateur Radio," Members of the V.H.F.C.C. wishing to have their verified totals, over and above 100 necessary for membership, listed will notify these totals to the Federal Awards Manager.
  - 5.4 In all cases of dispute, the decision of the Federal Executive of the W.I.A. on the interpretation and application of these Rules shall be final and binding.
  - 5.5 Notwithstanding anything to the contrary in these Rules, the Federal Council of the W.I.A. reserves the right to amend them when necessary.



## COMMUNICATIONS RECEIVER

- 4 BANDS COVERING 540 Kcs. TO 30 Mcs.
- TWO MECHANICAL FILTERS ENSURE MAXIMUM SELECTIVITY.
- PRODUCT DETECTOR FOR S.S.B. RECEPTION.
- AUTOMATIC NOISE LIMITER.
- LARGE TUNING AND BAND-SPREAD DIALS FOR ACCURATE TUNING.
- CALIBRATED ELECTRICAL BANDSPREAD.
- "S" METER AND B.F.O.
- 2 MICROVOLTS SENSITIVITY FOR 10 dB S/N RATIO.

PRICE: FOR/FOA SYDNEY: \$175.00

CONSULT YOUR LOCAL RADIO DEALER, OR

MAIL THIS COUPON *today*

Please forward free illustrated literature and specifications on Trio equipment.

Name.....

Address.....



(A unit of Jacoby Mitchell Holdings Ltd.)  
376 EASTERN VALLEY WAY, ROSEVILLE, N.S.W.  
Cables and Telegraphic Address: 'WESTELEC',  
Sydney, Phone: 40 1212

# SATO PARTS

Millions of our various electric parts are being exported to many countries of the world. Free catalogues are available upon your request to the manufacturer or through trading companies.

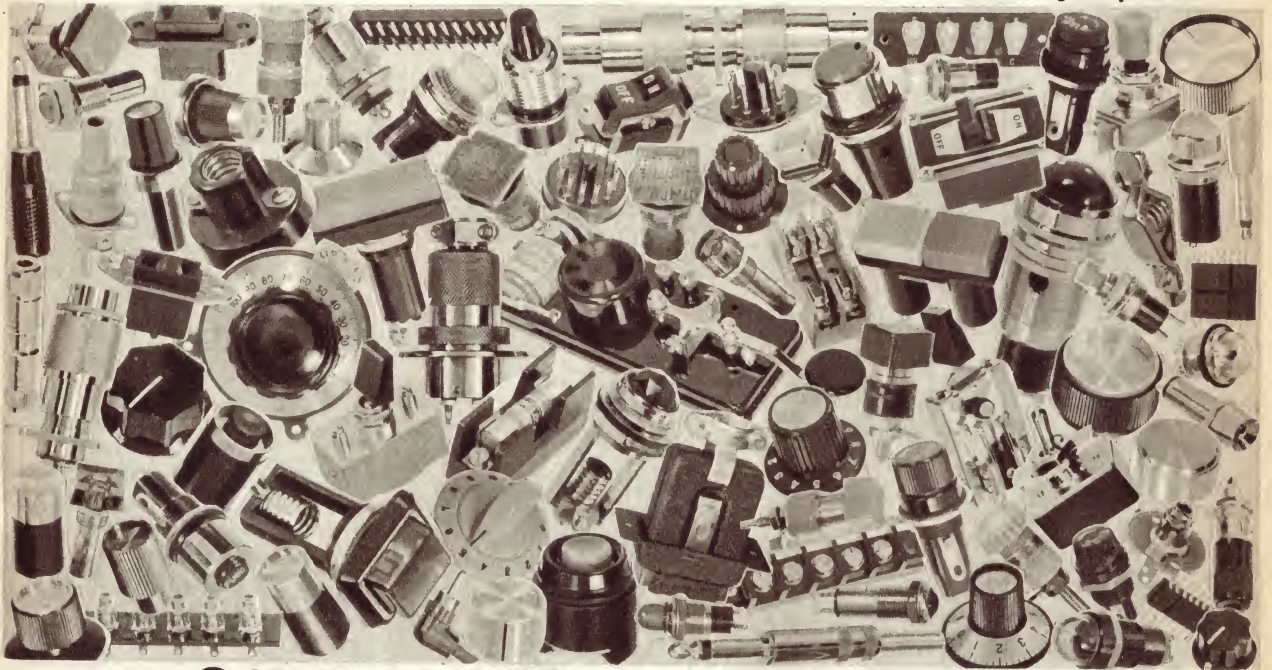

**SATO PARTS** CO., LTD.

HEAD OFFICE: 2-12 EBISU, SHIBUYA-KU, TOKYO, JAPAN  
TEL. 442-8505-8  
BANK ACCOUNT: MITSUBISHI BANK EBISU BRANCH

## A vast range of SATO Parts

- For manufacturers
- For TV
- For radio
- For instruments
- For amplifiers
- For kitset builders
- For sound equipment
- For industry
- For stereo equipment
- For educational purposes
- For electronics
- For tape recorders

Distributed by

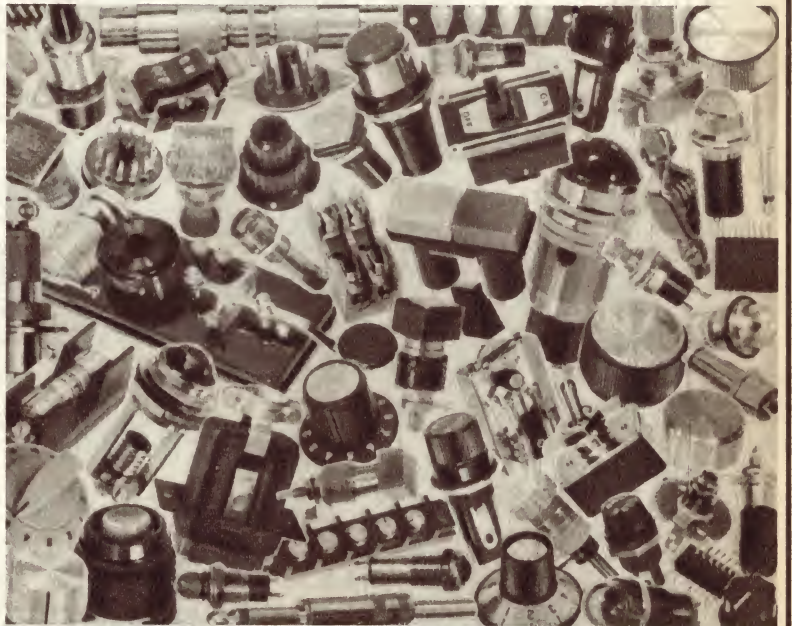

## GENERAL ACCESSORIES

(A DIVISION OF ELECTRONICS INDUSTRIES)

116-118 CLARENCE STREET, SYDNEY 443 CONCORD ROAD, RHODES — 73-0211  
BOTH STORES OPEN SATURDAY MORNING

# YOUTH RADIO SCHEME

## NEW SOUTH WALES

Some excellent passes have been recorded by members of Y.R.S. Clubs in the Elementary Certificate examinations. Sydney Technical High School:

Neil Wilks Honours  
William Rannard Honours  
Greg Wooten Credit

Murwillumbah High School:

C. Preston Honours  
C. Coles Honours  
J. Dashwood Honours  
K. Allard Credit  
C. Kiess Credit  
L. Greenhalgh Pass

Normanhurst High School:

Graham Harvey Honours  
Martin Price Honours  
Peter Bladwell Honours  
Robert Tregaa Honours  
Grant Maguire Credit

Arthur Phillip High School:

P. Cheetham Credit  
K. Conning Credit  
M. Latta Credit  
P. Tsambos Credit  
I. Story Pass  
W. Byrnes Pass  
L. Aanens Pass



Two members of the Port Augusta Youth Radio Club. Dietmar Lindner (left) checks a receiver with a multimeter, and Robert Kaleish uses a club-made RC bridge.

## VICTORIA

### Camberwell Grammar School Radio Club

Present indications are that 1969 is going to be a particularly good year for the Camberwell Grammar School Radio Club. In 1968 three members of the club gained Intermediate Certificates, 10 gained Junior Certificates and eight gained Elementary Certificates in the Youth Radio Club Scheme examinations. Two members were successful in the P.M.G.'s examination for the Amateur Operators Limited Certificate of Proficiency and have been allocated the call signs VK3ZYF and VK3ZYY.

Under the guidance of Mr Trean, Senior Geography and Geology Master, two members are studying for the Senior Y.R.S. certificates. Some members who were successful last year are now preparing for the higher grades.

## SOUTH AUSTRALIA

### Port Augusta Youth Radio Club

The Port Augusta club re-opened for 1969 during February. Membership was slightly down compared with 1968. This was due mainly to annual holidays. One of the first activities of the year was a tour of the Electricity Trust's power station at Port Augusta. Special emphasis was laid on the radio and electronics aspect of the station and club members learned something on the subjects of Carrier Protection and Communication Networks within the power system.

### Elizabeth Amateur Radio Club

The Elizabeth Club commenced its activities in 1969 with 30 members. Officers of the club concerned with Youth Radio activities this year are:—

Youth Radio Officer, Steve Johnston.  
Elementary and Junior Classes:—  
Chief Theory Instructor, Trevor Mell.  
Chief Practical Instructor, Steve Johnston.

Practical Assistants, Norm Worthington, Kym Prendergast.  
Intermediate — Senior — Advanced Classes:—

Theory Instructor, John Dennis.  
Regulations Instructor, Allen Dunn.

### Port Pirie Youth Radio Club

Classes resumed at the Port Pirie Club on February 21st with 25 members. Instructors for 1969 are:—

Elementary Certificate, Graham Johnston, Jim McDonald.

Junior and Intermediate Certificate.  
Harry Johnston, Bert Hollebon.

A second classroom has been made available to the Club by the Port Pirie City Council at the local aerodrome building. This additional facility will now allow simultaneous lectures in two grades to be conducted.

## WESTERN AUSTRALIA

Bob Trepp, VK6BT, has been co-opted by the Western Australian Divisional Council as Y.R.S. Superintendent to fill the vacancy caused through the transfer of Rev. Bro. Jack Morgan, VK6RT, to Victoria.

# BRIGHT STAR CRYSTALS

PREFERRED BY LEADING MANUFACTURERS  
THROUGHOUT THE COUNTRY FOR —

**ACCURACY - STABILITY - ACTIVITY - OUTPUT**



All types of Crystals Available  
Such as DC11, FT 243 HC6U CRA  
B7G, HC18U, ETC.  
TOLERANCES: .0015%, .002%,  
.003%, .005% ETC.

Consult us for Crystals for any Mobile Radio.  
Prices depend on tolerance and frequency  
required.

DISCOUNT FOR QUANTITY ORDERS

Established 36 Years



AMATEUR AIRCRAFT and ULTRASONIC CRYSTALS also AVAILABLE

Our new Factory employing the most modern equipment  
allows us to offer you PROMPT DELIVERY for all your  
CRYSTAL requirements.

DEVOTED EXCLUSIVELY TO THE MANUFACTURE OF

## PIEZO ELECTRIC CRYSTALS

Contractors to Federal and State Government Departments

REPRESENTATIVES AUSTRALIA AND NEW ZEALAND: Messrs. CARREL & CARREL  
BOX 2102, AUCKLAND.

MESSRS ATKINS (W.A.) LTD.,

894 Hay Street, PERTH.

MESSRS. A. E. HAROLD PTY. LTD.,  
123-125 Charlotte Street, BRISBANE.

MESSRS LAWRENCE & HANSEN  
ELECTRICAL (VIC.) PTY. LTD.,

34 Brisbane Street, HOBART,  
and 29 St. John Street,  
LAUNCESTON, TASMANIA.

# BRIGHT STAR RADIO

546-5076

LOT 6 EILEEN ROAD, CLAYTON, VICTORIA

546-5076

# NEW RANGE OF RESISTORS, CONDENSERS AND POTENTIOMETERS

WE HAVE JUST PURCHASED THE COMPLETE STOCK OF RESISTORS, CONDENSERS AND POTS. OF A LARGE MANUFACTURER AND CAN OFFER SAME AT LESS THAN 25 PER CENT OF LIST PRICE.

The resistors are mainly I.R.C. and Morganite and are in a wide range of values from 200 ohm. to 3meg. in  $\frac{1}{2}$ , 1 & 2watt also included are I.R.C. 3watt wire wound 2,200 ohm. 3,300 ohm 4,700 ohm. etc.

List price \$9.00 per 100 our price \$2.00 per 100 post & packing 25c extra.

The condensers are in most popular makes and include Polyester, Paper, Mica, Ceramic & Electrolytic in standard values including 4mfd, 8mfd, 16mfd 300V etc.

List price \$11.00 per 100 our price \$2.00 per 100 post & packing 50c extra.

The potentiometers are all current types and include switch pots, dual concentric, 1meg. tandem,  $\frac{1}{2}$  meg switch, tab pots etc.

List price \$12.00 per dozen our price \$2.50 per dozen post & packing 50c extra.

**FREE** With each lot of resistors, condensers or pots, we will supply free one new valve type 6U7G, 6X5GT, 1T4, 6K7G, or 12AT7. Resistors, condensers and pots are in packs of 100 or 12 and we regret we cannot supply to individual Lists of values or types.



## LEADER SIGNAL GENERATOR LSG11

240V A.C. operated, 6 band 120KC to 390 Mags.  
Provision for crystal.  
Post N.S.W., 75c; Interstate, \$1.25. **\$32.00**

## USED HIGH-SPEED 240V. AC/DC MOTORS

These 240 v. a.c. or d.c. motors are 1/8 H.P. with a speed of 7,000 R.P.M. and are ideal for small drills, grinders, etc. Dimensions:  $5\frac{1}{2}$ in x  $3\frac{1}{2}$ in, with  $5/16$ in spindle . . . . . \$3.75.  
Post, N.S.W., 50c; Interstate, 85c.

## NEW VALVES AT BARGAIN PRICES

7193 . . . . . 25c	1T4 . . . . . 45c	6H6G . . . . . 35c	6SS7 equiv. 6SK7 . . . . . 85c	1A7GT . . . . . 75c
807 . . . . . \$1.75	3Q4 . . . . . 75c	6K7G . . . . . 45c	6U7G . . . . . 45c	1L8G . . . . . 95c
1C7G . . . . . 30c	3S4 . . . . . \$1.00	6K8G . . . . . 68c	6X5GT . . . . . 78c	12SK7 . . . . . 60c
1D8GT . . . . . 95c	5V4G . . . . . \$1.00	6SA7GT . . . . . 95c	7C7 . . . . . 35c	12A6 . . . . . 80c
1K6G . . . . . 48c	6C6G . . . . . 80c	6S17 . . . . . 95c	12AT7 . . . . . \$1.00	12K8 . . . . . 50c
1K7G . . . . . 49c				12SH7 . . . . . 80c
1M6G . . . . . 40c				866 . . . . . 1.80
1P6G . . . . . 28c				954 . . . . . 23c
1Q6G . . . . . 25c				985 . . . . . 28c
				EK33 . . . . . 68c

Please add postage on all valves.

## NEW ENGLISH and AMERICAN TRANSISTORS AT 1/4 LIST PRICE

Ideal for the experimenter or service man.  
Each package of 12 contains 3 of each of the following types.

**PACKET OF 12 FOR \$3.00**

Mazda XA101.	Equivalent:	OC45 R.F. Transistor.
Texas 2N1108.	"	OC44 OSC. Transistor.
Texas 2N1111.	"	OC75 General purpose
Texas 2N1110.	"	OC45 R.F. Transistor.

THESE TRANSISTORS  
CAN BE SUBSTITUTED  
FOR MANY OTHER  
TYPES.

Post and Packaging 20c  
extra.

## New Electrolytic Condensers

These condensers are miniature pigtail type insulated new stock in packets of 12, each packet containing: 3 16mfd 300 V.W., 2 32 mfd. 300 V.W., 1 25 mfd. 450 V.W. and 6 low voltage electrolytics. \$2.50.

Post and packing 20c extra.

## NEW IMPORTED 4" P.M. SPEAKERS

Available with a 4 or 16 ohm voice coil. \$2.00.  
Post and packing 30c extra.

## NEW 240V ELECTRIC MOTORS



3300 R.P.M. can be supplied with or without 4-speed reduction mechanism. Size  $3\frac{1}{2}$ " x  $2\frac{1}{2}$ " x  $3\frac{1}{2}$ ", including spindle.

**\$2.75**

plus 60c. postage.



## NEW MINIATURE MOTORS



Ideal for models, toys, etc.  $1\frac{1}{2}$  to 3 volts. 6,000 r.p.m. 39c each or \$3.50 per doz. Post 10c.

## NEW MIDGET POWER TRANS. \$3.25

40mA prim., 240v. Sec 225 x 225 with 6.3v Fil. Winding. 30mA 240v Prim. Fil. Winding. Postage: N.S.W. 25c;

Interstate 45c.

150 x 150v. Sec. with 6.3v. Postage: N.S.W., 35c, Interstate 60c. **\$3.25**

NEW AMERICAN TWIN TELESCOPE TV AERIAL  
Extends to 36in, each section can be used singly for car or portable . . . . . \$1.50. Post 20c.  
SINGLE TELESCOPIC Aerial 12in extends to 33in. 60 cents .Post 10 cents.

## NEW B.S.R. TAPE DECKS

These new 3-speed B.S.R. Decks are fitted with a digital counter and will take 7in spools, 2 Track, \$35, 4 Track \$40.

## A PREAMP FOR MAGNETIC PICK-UP OR TAPE HEADS

SUITABLE FOR USE WITH THE COLLARO OR B.S.R. TAPE DECKS

Using 3 silicon transistors as featured in October Electronics Australia complete with kit of parts including transistors mono \$7.50, stereo \$13.00, 240 power supply for above \$7.00.  
Please specify if required for pick-up or tape heads.



# NATIONAL RADIO SUPPLIES

332 PARRAMATTA ROAD, STANMORE, N.S.W. PHONE 56-7398



# NEW TRANSISTOR 8 KIT SET

SPECIAL PURCHASE ENABLES US TO OFFER THIS KIT SET AT \$24.00



**DIMENSIONS**  
9" x 5" x 3" DEEP

(WIRED AND TESTED \$6.00 EXTRA)

- Complete kit of parts with circuit and full instructions
  - Eight transistors.
  - Magnavox 5X3 speaker gives excellent fidelity.
  - High sensitivity, suitable for city or country use.
  - Heavy duty battery for economical operation.
  - Modern design, plastic cabinet with gold trim.
  - Dial calibrated for all States.
  - Available in colours of off-white, red, black or light green.
- Post & Packing extra. N.S.W. \$1.25, Interstate \$1.75.

## NEW TRANSISTOR CAR RADIO

New transistor six car radios with R.F. stage, of Aust. manufacture using A.W.A. components and transistors. Available in manual or push-button models with dial calibrated for all Australian States. Supplied with speaker (5", 6", 5" x 7" OR 6" x 9") and lock-down aerial.



MANUAL MODEL ..... \$43.00  
PUSH-BUTTON MODEL ..... \$48.00  
Post and Packing N.S.W. \$1.50, Interstate \$2.50.

Suitable for 6 or 12 volts for positive or negative earth. Please state type required.

## NEW TRANSISTOR STEREO RECORD PLAYER

This Stereo Record Player is fitted in a durable and attractive vinyl covered case with silver trim and incorporates an 8-transistor Stereo amplifier with two Magnavox 5in x 3in speakers and B.S.R. record player (4-speed) with crystal pick-up. For 240 volt A.C. operation only.

**\$38.00**



DIMENSIONS:— 21" x 10" x 3½" WEIGHT 12lbs

Post and Packing extra N.S.W. .... \$1.50 Interstate ..... \$2.50

## NEW 25 AND 35 WATT. P. A. AMPLIFIERS

THESE AMPLIFIERS ARE SUITABLE FOR INSTALLATION IN CLUBS, SCHOOLS, RESTAURANTS, HOTELS, FACTORIES, ETC., WHEREVER THE AMPLIFICATION OF SPEECH OR MUSIC IS REQUIRED.



**STANDARD AMPLIFIER**

**25W \$61.00 SPECIFICATIONS 35W \$71.00**

Nominal power 25 or 35 watts. • Inputs two microphone and pick-up or radio with separate controls and mixing facilities. • Tone control. • Microphone sensitivity 6MV. pick-up or radio 150MV. • Frequency response 30 to 18,000 CPS. • Output impedance Line output (100, 166, 250, 500 ohms) or can be supplied with V.C. output (2, 3, 7, 8, 15 ohms). • Dimensions 11in x 6in x 8in. Weight 25W 23lb. 35W 26lb.

**SEPARATE BASS AND TREBLE CONTROLS**



**AMPLIFIER WITH BASS and TREBLE CONTROLS**

All amplifiers can be supplied fitted with a separate tone control stage with separate bass and treble controls and stand-by switch at \$5.00 extra.

All amplifiers are too heavy to be sent by parcel post so can be sent by air freight or rail or road transport.

**FREIGHT EXTRA.**

# NATIONAL RADIO SUPPLIES

332 PARRAMATTA ROAD, STANMORE, N.S.W. PHONE 56-7398

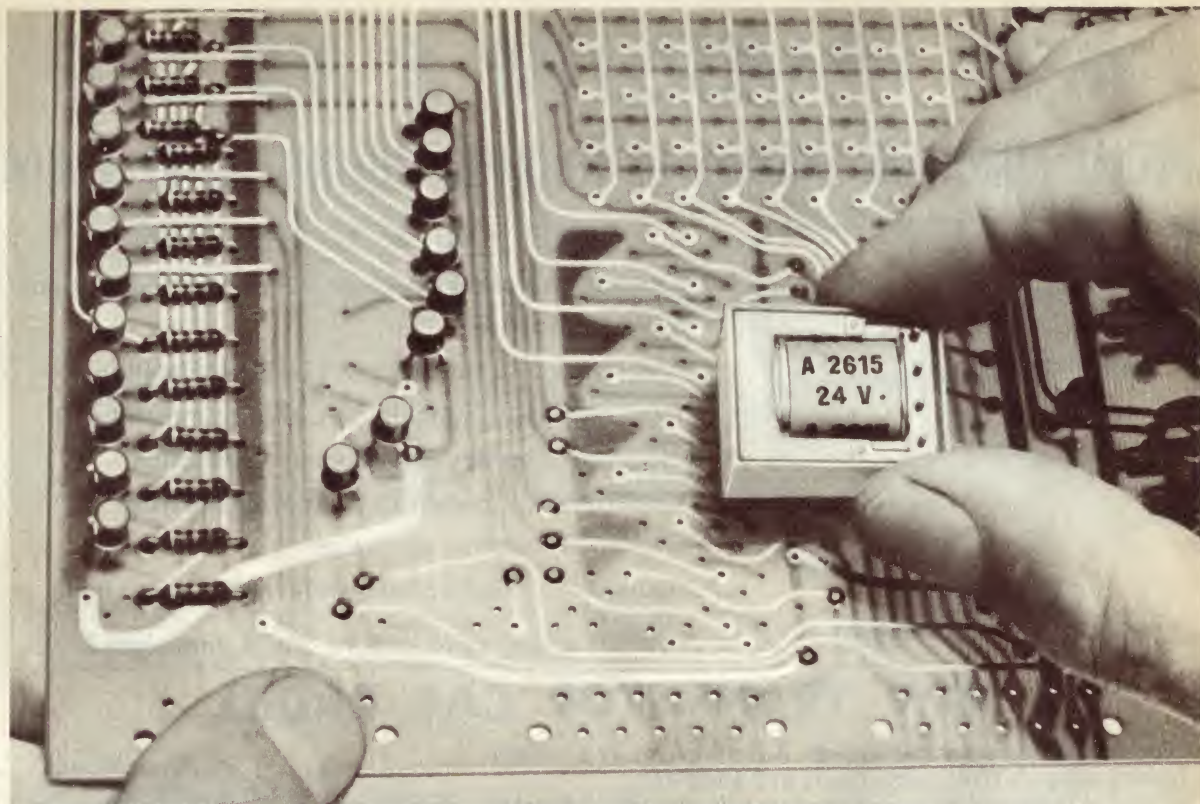

## STC PZ Miniature Relays have a giant advantage

You can direct-mount them.

With STC PZ miniature relays the need for a separate socket has been eliminated. They can be directly mounted onto printed circuit boards for simpler assembly and more compact layout.

This makes for efficiency and savings all the way round.

STC PZ miniature relays are available with four (PZ4) or six (PZ6) changeover twin contacts rated at .2A AC/DC, 100v DC, 6 to

48v DC coil, operating at .5w minimum. You'll like the immediate delivery and they come at a price that matches their size. Only \$2.36 for PZ4 and \$3.14 for PZ6 (100 up OEM).

For further details contact **Standard Telephones and Cables Pty. Ltd.**, Electronic Components Division, Moorebank Avenue, Liverpool, N.S.W. Phone 602 0333. Melbourne 480 1255. Canberra 49 8667. Brisbane 47 4311. Adelaide 51 3731. Perth 21 6461. Launceston 31 2511.

AN

**ITT**  
ASSOCIATE

worldwide telecommunications and electronics





# LISTENING AROUND THE WORLD

Art Cushen's monthly report on long-distance short-wave, television and broadcast band reception.

## Radio New Zealand's Birthday Competition

To celebrate its twenty-first anniversary in September, Radio New Zealand is running an essay contest for listeners outside New Zealand.

The competition will be for the best radio talk up to 400 words in length on New Zealand. The subject may be tackled from any angle: "How I see New Zealand," "What I know of New Zealand," "New Zealand's place in the Pacific," "Was the colonisation of New Zealand by the British in 1840 justified?" "New Zealand in sport," "New Zealand as a holiday resort," or any angle they wish, whether what they write is based on fact or just on their own image of the country.

The competition will be judged in three sections: For the English speaking; for the non-English speaking, except Pacific Islanders; and for Pacific Islanders. The essays will not be judged on literary style. What is required is an easy, everyday style of speech, suitable for radio presentation. NZBC does not seek flattery, nor does it seek abuse, but if either is justified, they will be judged with impartiality. There are no age restrictions.

The station will provide translation for foreign entrants, but English is preferred. Allowances will be made for faulty English in essays received from non-English speaking entrants.

Entries should reach NZBC before August 15, 1969, and should be sent to: 21st Anniversary Contest, Radio New Zealand, P.O. Box 2396, Wellington, New Zealand.

The first prize for each section will be a volume of New Zealand scenes, beautifully illustrated by one of New Zealand's leading artists. All entrants will receive a certificate and a New Zealand souvenir. The first two prize-winning essays in each section will be broadcast.

### SOMETHING FOR NOTHING

According to T. G. Brock, Maroubra, N.S.W., a free list of all radio stations operating in Australia and the Australian Territories is obtainable from the Australian Broadcasting Control Board, 373 Elizabeth St, Melbourne. The list contains details on Australian stations, with call-sign, location, frequency and power, as well as the names and addresses of companies operating commercial stations.

### MONTREAL USING 9630KHz

Radio Canada in Montreal has made a slight frequency change in its service to Australia and New Zealand, at 0830-0930GMT daily. The frequency of 9625KHz has been replaced by 9630KHz. The change is due to interference in the November-March period on 9625KHz from Radio Sweden. The C.B.C. continues to use 5970KHz as an alternative frequency.

The interference from Radio Sweden Stockholm, over the past few months has been severe in New Zealand. The transmissions from Stockholm were omnidirectional and intended for Europe with

programs in Russian at 0830 and in Spanish at 0900. The latest information from Radio Sweden is that a budget cut may cancel some programs and the bulletin issued for "Sweden Calling DXers" has been discontinued.

### RADIO NEW ZEALAND SERVICE

The rescheduling of some frequencies by Radio New Zealand has resulted in new times for Pacific Island reception. A shift in frequency for the evening service to the same area is also announced.

#### To the Pacific Islands

GMT	KHz.
1700-1815	6080
1830-1945	11705
1700-1945	9755
2000-0545	15110
0600-0845	9540, 6080

#### To Australia

2000-0545	17770
0900-1145	9520, 11705

#### To Antarctic (Sunday only)

0815-0845	6080
-----------	------

Listeners' mail is answered at 0730GMT on Friday. The DX session, "Arthur Cushen's DX World," is broadcast on the first Wednesday of each month at 0645 and 1030GMT, and on the following Saturday at 2345GMT.

### KUWAIT VERIFIES

Radio Kuwait has confirmed our reception with a new folding card which shows a map of the area and, inside, verification details. Details on the Kuwait State are also given in the folder, and some reproductions of stamps. The present schedule of the station has English 0400-0600 and 1600-1900GMT.

Frequencies in operation, with transmitter powers, are:

KHz	KW
1133	1
4967	10
1345	200
9520	50

Experimental transmissions are on 6055-KHz, 250W, 11920KHz, 250KW, 15150-KHz, 250KW, 17750KHz, 250KW, 21525KHz, 250KW.

### VERIFICATIONS RECEIVED

From time to time, we have given details of interesting verifications which we have received or which have been reported to use by our readers. Here is a further list.

**RHODESIA:** The Rhodesian Broadcasting Corporation has confirmed our reception on 3396KHz with a card signed by E. McKenzie. The card has a colour picture of an African animal and a photo of Broadcasting House, Salisbury.

**COLOMBIA:** Radio Colossal, which operates on the frequency of 4945KHz, during the past Latin season provided one of the strongest signals on the 60 metre band, according to a report in "Australian

DX News." Verifications from this station, are, however, very rare and until recently no reports of QSLs have been heard of in Australia. Roger Adams recently reported this station in English and enclosed one IRC. In five weeks, back came a letter in Spanish and a pennant verifying his reception. This station may still be heard at around 1000GMT.

La Voz del Llano, on 6115KHz, verified with a personal letter signed by the Sub-Gerente, Bernardo Otero Lafauria, reports Bob Padula, of Victoria. Detailed information was included on the geographical attractions, industries, and occupations of the peoples of Colombia, additionally the station informed that they believed they would receive many reports, but that many listeners did not understand Spanish. The station said that reports had been received from Norway, Honolulu, Switzerland, Finland, U.S.A. and Canada. The report was sent in Spanish, and was sent with four IRCs, as well as a coloured postcard of Melbourne. The reply was by airmail, but a delay of some 4½ months was experienced before the reply was mailed. The QSL text was in Spanish.

**GREECE:** NHBI now issues a card instead of a letter. A QSL card for 17745KHz was recently received by airmail in 3 weeks. The report was sent in English and one IRC was included, reports Robert Shepard in "Australian DX News."

**CANARY ISLAND:** The RNE relay sent a Madrid card showing the interior view of a transmitter hall, reports Bob Padula. The signature was by Juan de Rojas. The station was reported in Spanish without IRCs. The reply was received by sea-mail, the total time elapsing being 83 days. The report was sent for the frequency of 15365KHz with 45 minutes of program detail itemised.

### ENGLISH FROM SEOUL

The programs of the Voice of Free Korea, carried on the transmitters of the Korean Broadcasting System, operate to the following schedule:

#### General Service

GMT	KHz
0500-0530	9640
1000-1100	9640
2100-2130	9640

#### To South Asian

0800-0830	6035, 9640
1430-1500	15430

#### To North America

0300-0400	15430
-----------	-------

#### To Europe

0600-0700	15130
-----------	-------

### VIENNA EXPANDS SERVICES

Radio Vienna in Austria has extended its schedule of broadcasts to Australia and New Zealand to cover every day of the month. In the past, the transmissions to Australia and New Zealand have been carried only on the odd dates of each month. Four transmitters of 1000KW are now in operation with a total air time of 74 hours a day. Changes planned will introduce news bulletins in German and English, and an overseas service. Details of new programs for Europe and overseas, and language courses in English, French, Spanish, Arabic, Russian and Czech, are to be included in future broadcasts. The station is planning a DX session, possibly in English, and is interested in receiving suggestions from its listeners about this

STOP RUST OUTDOORS 2 YEARS--OR MORE!

# Lubricates Penetrates Stops Rust

DRY YOUR ELECTRICAL SYSTEMS  
with LPS — the NON-GREASY ONE

**STOPS  
Squeaks!**



LPS is NOT a paint, lacquer or a varnish, and will NOT damage paint, rubber, fabrics, plastics, or finishes.

## Displaces Moisture Fast!

### TECHNICAL INFORMATION

#### Physical Properties:

##### LPS I

Less than .0001 inch non-greasy molecular film with capillary action that spreads evenly and easily to seal out moisture at very low cost.  
**Rust Inhibitor:** Protects all metals from rust and corrosion.

**Water Displacing Compound:** Dries out mechanical and electrical systems fast.

**Lubricant:** Lubricates even the most delicate mechanisms; non-gummy, non-sticky; does not pick up dust or dirt.

**Penetrant:** Penetrates to loosen frozen parts in seconds.

**Volume Resistivity per ASTM D-257:** Room temperature, ohm/cm;  $1.04 \times 10^{12}$

**Dielectric Constant per ASTM-877:**

**Dielectric Constant 2.11 Dissipation Factor: 0.02**

**Dielectric Strength per ASTM D-150:**

**Breakdown Voltage 0.1 inch gap. 32,000 volts**

**Dielectric Strength volts/inch 320,000 volts**

**Flash Point (Dried Film)**

**Fire Point (Dried Film) 900 degrees F**

**TESTS AND RESULTS: 950 degrees F**

**Lawrence Hydrogen Embrittlement Test for Safety on High Tensile Strength Steels: Passed.** Certified safe within limits of Douglas Service Bulletin 13-1 and Boeing D6 17487.

**Mil Spec. C-16173D-Grade 3**

Passed

**Mil Spec. C-23411**

Passed

**Swiss Federal Government Testing Authority for Industry: Passed 7 Day Rust Test for acid and salt water. Passed Weiland Machine Test for Lubricity as being superior to mineral oil plus additives.**

LPS PRODUCTS CONFORM TO  
FEDERAL MIL SPECS  
C-23411 and/or C-16173D



LPS RESEARCH LABORATORIES, INC.  
2050 COTNER AVE. • LOS ANGELES, CALIF. 90025

## HOW LPS SAVES YOU TIME AND MONEY

1. LPS PROTECTS all metals from Rust & Corrosion.
2. LPS PENETRATES existing rust — stops it from spreading.
3. LPS DISPLACES moisture on metal—forms fine protective film
4. LPS LUBRICATES even the most delicate mechanisms at extreme temperatures.
5. LPS PENETRATES to free rust frozen parts, nuts, bolts, etc.
6. LPS PREVENTS equipment failures due to moisture (drives it out).
7. LPS LENGTHENS LIFE of electrical & electronic equipment—improves performance.
8. LPS RESTORES equipment damaged by water contamination & corrosion.
9. LPS PENETRATES AND PROTECTS plated and painted metal surfaces.
10. LPS PROTECTS metals from salt atmosphere, acid & caustic vapours.
11. LPS LOOSENS dirt, scale, minor rust spots & cleans metal surfaces.
12. LPS ELIMINATES squeaks where most everything else fails.

(SOLE AGENT)



**ZEPHYR PRODUCTS PTY. LTD.**

70 BATESFORD ROAD, CHADSTONE, VICTORIA—PHONE 56-7231

MANUFACTURERS OF RADIO & ELECTRICAL EQUIPMENT & COMPONENTS

new venture. The address is Austrian Radio, Shortwave Service, P.O. Box 700 A-1041, Vienna, Austria.

### RADIO NEW YORK WORLD WIDE

The only private commercial shortwave station in the United States is station WNYW (New York World Wide) in New York. This station can be traced back to WIXAL in Boston and then to WRUL before the station shifted to New York.

WNYW is an international shortwave radio station broadcasting to Western Europe, Africa, the Caribbean and the Americas from the United States. With studios and offices in New York City, Radio New York World Wide uses high-powered transmitters and directional antennas to beam programs to listeners in more than 100 countries. WNYW is a privately owned, independent station, financially supported by commercial advertisers, and is not supported in any way by the U.S. Government.

WNYW broadcasts the sounds of the best on the U.S. musical scene, with U.S. and world news from the ABC, CBS and NBC networks. It offers the fastest and most complete source of financial news for the international businessman. WNYW provides its audience with commentary, news analysis and live stock market reports from the floors of the New York and other American-Exchanges.

This includes reports from United Press International, Associated Press, United Press Latin America (English and Spanish), U.P.I. Audio, United Nations News Service, and correspondents throughout Latin America and the Organisation of American States.

WNYW has two 100KW, two 50KW and one 20KW shortwave transmitters located near Boston, Mass. Studios and offices are at 485 Madison Avenue, New York City.

WNYW New York this winter is operating according to the following schedule:

GMT	KHz
<b>To Europe</b>	
1600-1815	21525
1600-1930	17760
1830-1945	15440
1940-2145	11970
2000-2145	9690
<b>To Africa</b>	
1600-1900	21725
1900-2145	21525
<b>To Latin America</b>	
1600-1815	15440
1600-1900	17840
1830-2145	21715
1900-0000	17835
2200-0000	17760, 15440, 21525, 15130
0000-0200	11855 15370
0100-0330	15355
0100-0400	5985
0100-0500	9615
200-0500	11740, 11855
0330-0500	9575

### VOICE OF FREE CHINA

Radio VOFC at Taipei, Taiwan, now promises a souvenir to all who report their signals. The present English transmissions are:

GMT	KHz
0200-0350	7130, 11925, 15125, 15345, 17710, 17780, 17890
1700-1900	9685, 9765, 11825, 15125, 17720, 17890.
1030-1130	7130, 9575, 9685, 11825, 15370, 17890.

The program at 1030GMT is the Dragon Show, best received in the South Pacific on 11825KHz.

### POWER BOOST FOR VOA

The West Coast relay transmitters of the Voice of America, located at Dixon and Delano, California, have recently increased in power. Both sites now have

## NEW SCHEDULES OPERATING

The operating schedule of ORTF in Paris is as follows:

GMT	KHz	Language
0000-0030	11920, 15120, 17730, 21580	Portuguese, Spanish
0030-0100	11920, 15120, 17730, 21580	Portuguese, Spanish
0230-0300	11920, 15120, 15200, 17730, 17725, 21580	Spanish
0500-0615	9700, 11975	French, English
0515-0630	9700, 11975	French, English
0600-0730	5960, 9585, 9620, 18845, 17765, 21620	French
0800-1000	7160	French
1100-1115	15160, 21650, 6175	English, Portuguese, French
1115-1130	15160, 21650, 6175	English, Portuguese, French
1130-1145	15160, 21650, 6175	English, Portuguese, French
1100-2200	6175, 21650, 6175	English, Portuguese, French
1215-1245	15160, 17875, 21620	Greek, French
1245-1900	15160, 17875, 21620	Greek, French
1330-1400	15245, 17735, 21525, 21580	French
1515-1530	11920, 15155, 15160, 21450	French
1545-1730	11920, 15155, 15160, 21450	French
1630-1700	5955, 7260, 9520, 11845	Bulgarian
1700-1730	5995, 7260, 9520, 11845	Romanian
1730-1740	5995, 7260, 9520, 11845	Slovak
1730-1900	11920, 15160	Arabic
1740-1810	5955, 7260, 9520, 11845	Serbo-Croat
1810-1845	5995, 7260, 9520, 11845	Hungarian
1845-1945	5995, 7260, 9520, 11845	Russian
1845-1900	15280, 21580	Portuguese
1900-1915	15280, 21580, 15120, 21580	French
1900-2000	17850	French
1900-2000	11920, 15160	French
1900-1930	15185	French
1900-1915	7280, 9585	Kabyle
1915-2200	7280, 9585	Arabic
1915-1930	15830, 21680	English
1945-2015	9560, 11775	Portuguese
1945-2000	5955, 7255, 9520, 11845	Czech
2010-2020	5955, 7255, 9520, 11845	Slovak
2020-2110	5955, 7255, 9520, 11845	Polish

### PROGRAMS FROM OSLO

Broadcasts from Oslo, Norway, include a 30-minute program in English on Sundays. This is heard at the conclusion of the Norwegian program, which occupies the first hour. The present transmission schedule of Radio Norway is as follows:

GMT	KHz	Area Served
0730-0830	15175, 21730, 25730, 21655, 25900.	Australia and New Zealand
1100-1230	21730, 25900, 21655, 25730	Australia and New Zealand
1300-1430	25730, 25900, 17825, 21730, 21655.	India
1500-1630	21655, 25730, 25900, 21730, 17825.	Africa
1700-1830	21655, 21730, 25730, 17825	Africa
1900-2030	11735, 17825, 21730, 25730, 21655.	Africa
2100-2230	21655, 17825, 15175, 15345	America
2300-0030	15175, 11735, 11850	America
0100-0230	11850, 11735, 11860	America
0300-0430	11735, 9645, 11860.	America

### ENGLISH FROM PYONGYANG

The North Korean Radio is notable for its use of off-band frequencies for its transmissions. Its services to South Asia are well received in our area. The present operating schedule and frequencies in use are as follows:

GMT	KHz	Area
1900-2000	6540, 7580	Europe
0200-0300	6540, 7580	Europe
0800-0900	6540, 15520	South-East Asia
1100-1200	6480, 7580	South-East Asia
1400-1500	6480, 7580	South-East Asia

### ENGLISH FROM ISRAEL

The Kol Israel station in Jerusalem has extended its English language programs and now has a broadcast directed to North America.

GMT	KHz	Area Served
2015-2030	9009	Africa
2015-2030	9725	Europe, United Kingdom
2030-2045	9725	Europe, United Kingdom
2045-2100	9725	Europe, United Kingdom
2045-2100	9009	Europe, United Kingdom
0400-0415	9009	U.S.A., Canada

in operation three 250KW, two 100KW and one 200KW transmitters. Programs include the relays of the Voice of America, United Nations Radio and Armed Forces programs. The old 50KW transmitters at Delano and Dixon have been withdrawn.

The Voice of America is using these transmitters for its programs to Australia and New Zealand, and operates:

GMT	KHz	KW
2200-0000	17820	250
2200-0000	21610	100
0130-0200 (Mon Fri)	17885	250
0130-0200 (UN Radio)	21610	250
0845-0900		
0900-4100	5955	100
0900-1400	9735	100

## CHEST OF DRAWERS

Three types of Galvanised Chests measuring 17½in x 6¾in x 11½in, containing 16 drawers, each measuring 6¾ x 3¾in x 2½in.

- TYPE C.D.1. With 16 undivided drawers, \$7.00.
- TYPE C.D.2. With 16 triple compartment drawers, \$8.00.
- TYPE C.D.3. With 8 triple compartment drawers, and 8 undivided drawers, \$8.00.

The Chests are finished in blue hammertone stoving enamel, are complete with identification cards and packed in strong corrugated cartons. Provision is made for all units to be bolted together in tiers.

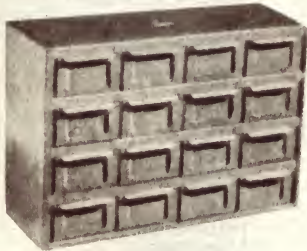

## CHEST OF DRAWERS TYPE C.D.4.

A 17½in x 6¾in x 11½in Galvanised Chest containing 4 full-length drawers each measuring 15¼in x 6¾in x 2½in. Finished in blue hammertone stoving enamel, \$7.00.

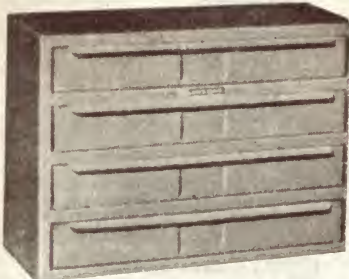

WRITE FOR FREE CATALOGUE AND PRICE LIST OF TOOL BOXES AND CHESTS OF DRAWERS.

## MODEL M6 FOUR CHANNEL TRANSISTORISED MICROPHONE MIXER



All four inputs accept standard two circuit Phone Plugs, while the output jack accepts a standard circuit Phone Pin Plug.

### SPECIFICATIONS:

- Input Impedance: "Hi" Impedance for Crystal Microphone, etc.
- Gain: Approximately 6 db.
- Maximum Input Signal: 1.5 volts.
- Maximum Output Signal: 2.5 volts.
- Output for Minimum Distortion: 2 volts.
- Hum: 0.
- Battery: 9 volts.

**Mono \$6.75 Stereo \$9.75**

## BELLPHONE



Pick up the receiver and dial push number desired.

**Retail Price \$10.12 per pair**

## KALTRO SVC TV-RADIO REMOTE CONTROL LISTENER



This TV-Radio Remote Control Listener is a combination of an extension speaker and a remote control station to regulate the sound of both the TV, Radio, Phono, or Hi-Fi set and the speaker incorporated in the Listener itself. In addition, up to two earphones can be attached for listening to the sound of the TV, Radio, Phono, or Hi-Fi set without disturbing others around you. Unwanted commercials can be easily cut off by merely turning down the control of the TV-Radio Remote Control Listener. A modern designed plastic cabinet with easily adjustable fingertip controls ideal for use in home, office and business. Complete with earphone, 20ft of lead wire and installation instructions.

**Retail Price \$8.75**



## "PIPGRAS" HOLE PUNCHES

"PIPGRAS" Hole Punches are made from Alloy Tool Steel, and cut clean and accurate holes in sheet metal. They make a smooth, perfect hole without reaming or filing.

## SCREW TYPE, ROUND

Supplied with "UNBRAKO" High Tensile Socket Screws and Wrenches. Cut holes in sheet metal up to 18 gauge.

Type No.	Nominal Size	Actual Size (I.D.)	Water Pipe Drill Size	Pilot Size	Price Each
32.S	¼in	0.507in	—	¼in	\$2.17
40.S	⅜in	0.618in	¼in	5/16in	\$2.17
48.S	½in	0.742in	⅜in	5/16in	\$2.80
56.S	⅝in	0.884in	½in	⅝in	\$3.80
64.S	1in	1.008in	—	¾in	\$4.10
72.S	1¼in	1.133in	¾in	¾in	\$4.53
76.S	1 7/16in	1.172in	—	¾in	\$4.53
80.S	1½in	1.258in	—	¾in	\$4.97
88.S	1¾in	1.382in	1in	7/16in	\$5.97

With Heat Treated, High Tensile Steel Hex. Head Bolt and Nut.

Cut holes in sheet metal up to 16 gauge.

96.S	1½in	1.512in	—	9/16in	\$6.68
112.S	1¾in	1.762in	1¼in	9/16in	\$7.68
128.S	2in	2.014in	1½in	9/16in	\$8.33

## THIS MONTH'S SPECIALS

- PK.633 Transistorised Tuners, 9 volt \$10.25
- PK.544 5 Transistor Miniature Push Pull Audio Amplifiers, 9 volt \$8.50
- Palace MD200 Audio Amplifier Module Imp. 5000 Ohm, Output. 8-16 Ohm, 9 volt. \$5.50
- D X Switches. \$3.00
- Megapet Loud Hailers Transistorised \$7.00
- Stylouue. \$1.50

## 8 WATT STEREO AMPLIFIER MODEL SA-80S OPERATING MANUAL



### SPECIFICATIONS

Output Power: 8 Watt, 4 Watts per channel.  
 Frequency Response: 60 to 15,000 cps. plus or minus 1 db  
 Harmonic Distortion: Less than 3%.  
 Hum and Noise: 52 db below rated output.  
 Sensitivity: Phone (Crystal) 100mV 250K ohm.  
 Tuner 100mV.  
 Tube Complements: 12AX7x1, 30A5x2, 1S315x1 (Silicon Rectifier).  
 Dimensions: 5.1lb. 9¾in x 6¾in x 3in.

**Retail Price \$43.00**

## "PALACE" SOLID STATE STEREO AMPLIFIER Model AM-320



Power Output: 16W (8W per channel).  
 Frequency Response: 80-10,000 cps plus or minus 1dB 1W; 50-20,000 cps plus or minus 2dB 1W.  
 Harmonic Distortion: Less than 2% at 3W; less than 4% at 5W; less than 4.5% at 8W.  
 Tone Control: Bass plus or minus 10dB at 50 cps. Treble plus or minus 10dB at 10,000 cps.  
 Loudness Control: Plus 6dB at 50 cps; plus 4dB at 10,000 cps.  
 Input: Tape head 3.5mV; Mag. 3.5mV; Cer. 100mV; Tun. Aux. 150mV.  
 S/N Ratio: Minus 45dB.  
 Transistor complement: 2SB347 x 2, 2SB345 x 8, 2SB481 x 4.  
 Power Supply: 117V AC 50/60 cps.  
 Dimensions: 10¾in (W) x 3½in (H) x 8¾in (D).

**Retail Price \$116.00**

AM-V32 Upright \$133.

## BOOK SHELF TYPE SPEAKER SYSTEM MODEL SP-4S



Speaker: 4in, 8 ohms.  
 Frequency Response: 70-13,000 cps.  
 Sensitivity: 93dB.  
 Power Input: 8W (Music Power).  
 Cabinet Size: 9¾in (H) x 6¾in (W) x 5¾in (D).

Finish: Walnut lacquer.

**Retail Price \$16.00**

# GENERAL ACCESSORIES

(A DIVISION OF ELECTRONICS INDUSTRIES)

116-118 CLARENCE STREET, SYDNEY 4 43 CONCORD ROAD, RHODES — 73-0211

BOTH STORES OPEN SATURDAY MORNING

# FLASHES FROM EVERYWHERE

## EUROPE

**BELGIUM:** The Belgian National Radio is scheduled to put a new 50KW short-wave transmitter on the air this month. This will increase the short-wave service to two 100KW, one 50KW and one 20KW transmitters.

**GREECE:** The Voice of America is building a new relay station, reports Sweden Calling DXers. This will comprise some 10 short-wave transmitters, each of 250KW. At present the Voice of America operates on medium and short-wave from transmitting sites at Thessaloniki and Rhodes.

**CZECHOSLOVAKIA:** Radio Prague has altered the timing of its service to North America. The transmissions in English are broadcast.

GMT	KHz
0100-0200	5930, 7345, 9540, 9630, 11990
0300-0400	5930, 7345, 9540, 9630, 11990.

**SPAIN:** Radio Liberty, has recently put into operation a new frequency, 7145KHz. The transmitter on this channel is located at Playa de Pais, Spain. The frequency is in use from 1800 to 2130GMT with programs in Russian.

Reception in Melbourne has been at 2100GMT, but with severe jamming, reports Bob Padula, of Melbourne.

**YUGOSLAVIA:** Radio Belgrade in Yugoslavia has in use five frequencies for its foreign broadcasts: 6100, 7200, 9620, 11735 and 15240KHz. The home program is now carried on 9505KHz from 1400 to 2400GMT.

**FRANCE:** It has been announced by the ORTF that plans are underway to construct a high power station to broadcast to the Americas from the Antilles. The recent action of the French Government in giving ORTF more independence from Government control is expected to lead to expansion of its services. ORTF has recently introduced a program in Russian for Siberia, and this is on the air 1000-1030GMT, using 11920, 15155, 17850 and 21500KHz.

**ALBANIA:** Radio Tuirana in Albania has broadcasts in English to Europe 0630, 1620, 1830, 2030, and 2200GMT, using 7065 and 9500KHz; and to North America at 0030, 0130, 0230, 0330GMT on 6200 and 7300KHz. The frequency of 9500KHz is also used in the 0130GMT session.

## AFRICA

**SUDAN:** The Voice of Sudan at Khartoum, has been received on the new frequency of 15100KHz, and reception has been as early as 1700GMT. Programs are in Arabic, but the frequency suffers from severe interference.

**MALAWI:** The Malawi Broadcasting Corporation plans to open 20KW and 100KW short-wave transmitters, to be in operation by July, 1969. Two transmitters on medium wave, both of 1KW, are due to open shortly, one at Mzimba using 674KHz, and the other at Nkhotakota on 908KHz. A further 1KW transmitter is located at Bangula, using 1277KHz.

**TANZANIA:** Radio Tanzania at Dar es Salaam, has its International Service on 15435KHz. The station opens transmission at 1700GMT, with announcement in English, then has African language programs from 1715GMT. At 1800GMT, English programs are again scheduled with a news bulletin at this time. The station has also been observed on 15395-KHz with transmissions of the same programs.

**BOTSWANA:** Radio Botswana has started to use the ex-B.B.C. 10KW transmitter which formerly operated from Francistown. The station is using 4386-KHz from 0400 to 0530GMT and 1530 to 1900GMT. The frequencies of 9590 and 9565, are operating Thursday, Friday

and Saturday 1320-1400. Richard Ginby, of South Africa, reports that the transmitter is also used for extended schedules during school broadcasts.

**MOZAMBIQUE:** Radio Lourenco Marques, has altered its transmissions, as follows:

GMT	KHz
0300-0700, 1500-2200	4855
0630-1400	9620
0330-1900	11780

The power of the transmitter on 9620-KHz is now 7.5 or 10KW.

## ASIA

**IRAQ:** Radio Baghdad is using two frequencies for the English transmission at 1930-2020 GMT, and in German at 2020-2110GMT, and French at 2110-2200GMT. The reception is on 6030 and 6095KHz, both channels giving fair signals in New Zealand.

**SINGAPORE:** Radio Singapore has, according to its program schedule, a service in English 2230-1630GMT daily on 11940, medium-wave. For the period 1445-1630GMT the medium wave channel of 790KHz is also used.

**SOUTH VIETNAM:** "The Voice of Freedom" can be heard in the Asian area 0000-0030GMT. The program is in English on 9670KHz. The station announcement indicated that a medium wave station on 650KHz was also carrying the program.

**IRAN:** Radio Teheran is using a new schedule with a program in an Asian language from 0730 to after 0900GMT. The frequency in use is 15135KHz, and this causes interference to Radio Japan, which is also using this frequency in its service to Europe.

The service to Europe from Teheran was noted at 1930GMT with a program in French, while a program in German was observed at 1900-1930GMT. English has been received at our listening post at 2000GMT on the new frequency of 11700KHz, which carries the same program at 15135KHz.

**NEPAL:** According to a verification Radio Nepal, in Katmandu, is now operating

GMT	KHz
0200-0420	7105, 11970
0720-0920	7165
1220-1502	7165, 11970
1220-1620	4795.

The station is also reported to be heard with a news bulletin in English at 0300-0325GMT and best reception is on 11970KHz.

**TAIWAN:** The Police Broadcasting Station in Taiwan is on the air 2115 to 1700GMT except on Saturday when transmission is 0100-0200. Transmissions are carried on 5960KHz. The station is printing new verification cards.

## THE AMERICAS

**EL SALVADOR:** Radio YSV "La Voz de Comercio" Santa Ana, on 9576KHz, is a new station to short-wave.

The station is heard at 1310GMT in California with commercials and typical programs in Spanish.

**COSTA RICA:** Radio Antenea, San Jose, is using 6150KHz and is now verifying correct reports with a letter and sticker. The signals have been heard in New Zealand around 0700GMT during the period when the transmitter was testing.

**GUATEMALA:** Radio Cultural, TGNB, Guatemala City, uses 9668KHz and a power of 5KW. The signals in New Zealand can be heard at 0400GMT when it concludes a program in English of gospel music.

## SUPPLY DEPARTMENT VICTORIA DEFENCE STANDARDS LABORATORIES TECHNICAL SECTION MARIBYRNONG

**Draftsman Grade 1**

**SALARY: \$3,553 - \$4,553.**

**DUTIES:** Position No. 162—Undertake independent design and prepare layout and detail drawings of electro-mechanical and electronic laboratory equipment.

**QUALIFICATIONS:** Qualifications at the level of an approved Certificate from a Technical College or Institute of Technology or its equivalent or such other qualifications as the Board considers appropriate. Applications will, however, be accepted from persons not possessing acceptable qualifications providing they have a minimum of six years' relevant experience including at least three years' experience on drafting. If the selected applicant does not possess acceptable qualifications he will be required to pass a test of knowledge and competence to establish his eligibility for nomination to the position.

**APPLICATIONS:** On forms available from the Regional Director's Office, Department of Supply, in each capital city should be lodged with:—

**The Chief Superintendent,  
Defence Standards Laboratories,  
Box 50, P.O.,  
ASCOT VALE.**

By: April 21, 1969.

The OS25 has set new standards for a low-cost, dual-trace oscilloscope. It is rugged, simple to operate and maintain and is attractively styled. Triggering facilities are unusually comprehensive for a low-cost instrument of this type and include internal triggering from either channel.

This oscilloscope has a vertical amplifier bandwidth from DC to 5 MHz with a maximum sensitivity of 100 mV/cm on each channel. The time base gives sweep speeds from 1 sec/cm to 0.5  $\mu$ S/cm using switched and fine controls. The operating mode best suited to the time base speed is automatically selected by the time base range switch; beam switching for the two slowest speeds and alternate sweep for the four highest speeds.

A bright clear display is obtained on a 5-inch helical PDA tube operating at a potential of 3 kV overall.

## 5 MHz Dual-Trace Oscilloscope OS25



**\$225**  
plus Sales Tax  
as applicable

Exclusive Australian Distributors for...

**ADVANCE INSTRUMENTS**

**jacoby, mitchell**  
& co. pty. ltd. **26-2651**  
**469-475 kent street, sydney**

MELBOURNE 30-2491  
ADELAIDE 53-6117  
BRISBANE 2-6467  
PERTH 28-1102  
LAUNCESTON 2-5322



Radio TGQB, Quetzaltenango, is now using the new frequency of 11706KHz. The station has been heard in the United States around 0030GMT and again at 1400GMT. The signal can usually be recognized by its marimba music, which is popular with all Guatemalan stations.

ECUADOR: A new station, "Emisora Luzu Vida Loja," has been heard at 1100GMT on 4712KHz. The station opens with a religious program, and at 1130GMT has a session of Ecuadorian music.

MEXICO: Radio XEBR, Hermosillo, is again on the air, but seems to be irregular. The station uses 11820KHz and has been heard at 0400GMT. Another station, XEMP, using 11740KHz, has been observed in the United States at 0130GMT.

BOLIVIA: Radio San Rafael is on 5055KHz, and is now verifying reports with a letter and pennant. The station has been heard around 0300GMT in North America and should be heard here in our winter months. The "World Radio Handbook" lists sign-on time as 1000GMT.

NOTES FROM READERS should be sent to ARTHUR CUSHEN, 212 Earn St., Invercargill, N.Z. All times are GMT. Add 8 hours for Perth, 10 hours for Sydney and 12 hours for Wellington. All frequencies in KHz.

### BROADCAST BAND NEWS

Information on new stations and increased power of many transmitters which has appeared in the "New Zealand DX Times," "Australian Radio DX News" and the "Bulletin of the National Radio Club of America," is summarised below:

TAHITI: Radio Tahiti at Papeete is scheduled to increase power to 25KW and change frequency from 1400KHz to 730KHz.

MIDDLE EAST: Radio Sharjah, Trucial State, has moved to 737-KHz from 1250KHz. Radio Amman, Jordan, has moved from 870KHz to 854KHz. Radio Damman, Saudi Arabia, on 890KHz is now in operation with 100KW, while the other transmitter formerly on 647 has moved to 652KHz. Radio Omdurman, Sudan, is now on 764KHz. Turkey has plans for 300KW transmitters on 629 and 1061KHz, 1200KW on 1016, and 600KW on a frequency which has not yet been decided.

NORFOLK ISLANDS: Radio VL2NI on 1570KHz using 50W, has increased its schedule and now broadcasts on Mondays 0830-1030GMT. The station continues to operate on the first Tuesday of each month with a relay of the local Council meeting.

INDIA: All India Radio is currently installing a 1000KW MW transmitter, to be on the air in April. It is intended mainly for night broadcasts to South East Asia. AIR is also installing a 1000KW transmitter at Rajkot and four 100KW transmitters in other towns.

MALAYSIA: Radio Malaysia is to install three 50KW transmitters at Johore Bahru which will become operational this year.

TRUST TERRITORY OF THE PACIFIC: Radio WSZD at Ponape, Caroline Islands, has confirmed our reception with a prepared card signed by Elias H. Thomas, Station Manager. The station operates 1450KHz with 1KW and is on the air 1700-1100GMT (6 a.m. to 12 p.m. Ponape time). According to the card, sign-on is at 1800GMT, though the official time zone for Eastern Carolines is 11 hours ahead of GMT.

YAP ISLAND: A report in "Australian Radio DX News" from Ron Knight in New Guinea lists a verification from WSZA on 1480KHz with 1KW. The letter was on the official letterhead of the Trust Territory Government and was signed by Wilfred Mark Gorongfel, announcer of WSZA. The station broadcasts in three languages, English, Yapese, and Ulithian, and broadcasts 200-1400GMT. ■



# ANSWERS TO CORRESPONDENTS

When writing to us:—

- Please give your name and full postal address, including the State and Postcode.
- Write the above information clearly or, for preference, print it in block letters. Your co-operation will facilitate delivery of replies by mail, where such are called for.

**CLOCK AND ASTRONOMY:** I am pleased with Electronics Australia as it keeps one abreast of the times in electronic and scientific advancement. Like many others, I am looking forward to the publication of the crystal clock. What sort of accuracy could be expected from it? Articles on astronomical equipment, particularly reflector telescopes would be appreciated. (A.F.L., H.M.A.S. Duchess).

• Thank you for your remarks about the magazine and we are pleased that you like it. The crystal clock has attracted considerable interest and it is still undergoing observation and testing. No firm figure for its accuracy can be given at this stage but we could expect an accuracy of a fraction of a second per day. Thank you also for your suggestions relating to the articles on astronomical equipment but the construction of substantially "mechanical" projects is outside the present scope of the journal.

**BOOKS WANTED:** Can you tell me where I could get a book with plans of guitar pickups and devices used to make an organ sound from a guitar, also an organ and a tonebender? (M.T., Preston, Victoria).

• Because of the work involved, we cannot undertake to search out and recommend books for individual readers interested in a particular subject. We review books in our Technical Publications columns, and readers must then decide whether any of these suit their requirements. You should also consult your nearest technical bookseller, who should have lists from publishers on what is available. A visit to your local library may also pay dividends.

**AMATEUR TRANSCEIVER:** I should like to suggest a project suitable for your amateur readers. This is a small portable low-power two-metre transistorised FM transceiver, running about 2W or more, using integrated circuits as IF amps, discriminator and audio amp. The General Electric PA189, PA237 series would be ideal, with Fairchild AY1119 as drivers. Provision for three channels (channels A B and C, using the recognised frequencies) with one channel crystal-controlled would be sufficient to start with. (A.R.M., Toowoomba, Qld.)

• Thank you for your suggestion. We receive many requests along similar lines, but the amount of staff time we can devote to such projects is strictly limited, and a set as you described would require a great deal of time in design and development. At this stage we can see little prospect of being able to prepare such a circuit.

**BATTERY CHARGER:** I want to build my own battery charger. When did you publish details for such a project? (J.R., Balgownie, N.S.W.)

• In the February, 1963, issue we published details of a universal battery charger, suitable for either 12 or 6 volt accumulators and having a charging capacity of up to 5 amps. Copies of this

article are available through the Information Service. Incidentally, J.R., you forgot to include your postal address, otherwise we could have forwarded a copy of the article immediately for your 20c enclosure.

**TRANSCEIVER:** Have you published circuits of a transceiver in past editions of your excellent magazine, either incorporating valves or being solid state. If not, have you considered the publication of such in the near future? (W.R.H., Cheltenham, Vic.)

• We have published a few transceiver designs in past issues, but most of them would now be obsolete. However, your request is far too vague for us to offer much in the way of advice. In fact, there is little place on the air these days for home-made transmitting equipment, except for use by licensed amateur operators in their own bands.

**KIT OF PARTS:** In the January, 1969, edition of "Electronics Australia" is the description of a keyless organ. Could you inform me of any company which offers a complete set of parts for the organ, or a list of companies offering the various parts, and also the cost involved. (P.A.M., Cairns, Qld.)

• We are not in a position to recommend any company or companies in preference to others, nor are we in a position to quote the cost of any project. Each issue of our magazine carries a number of advertisements offering kits of parts for our various projects; we can only suggest that you examine these advertisements and

write to one of the kit suppliers asking about the project in question if it is not actually featured.

**BOUQUETS, BRICKBATS:** I think that E.A. is just about ideal in terms of its contents. However, I have noticed some inconsistency in regard to abbreviations. Some time ago, you changed to "Hertz" but still retain the term Centigrade. Why not "Celsius"? Your answers to correspondence deal heavily with projects that have been featured in the past. It might save a lot of time and trouble if designs described over the past 10 years were tabulated and listed in the back of each issue. Are you going to up-date the G.D.O.? Also why are radio signals always stronger when the wind direction is from the receiver to transmitter? (K.V., Cooma North, N.S.W.)

• Abbreviations can be a problem to any journal but can be particularly so to one like ours, which is produced in a printing facility which also produces daily newspapers, trade and other news-sheets, and general-reading magazines. "House" styles which make sense for general readers may be at variance with technical practice and vice versa. We have to try to work to compromises which will not send typesetters and proof readers too far round the bend! A number of new terms have appeared over the horizon but let's absorb Hertz first. The others can follow as usage and necessity dictates. By this time you will have seen the solid-state dip oscillator in the February issue. We are not aware that radio signals are as sensitive to wind conditions as you suggest. If they react that way in your area, it is probably because winds from a particular direction are symptomatic of other ionospheric and climatic conditions which do have an effect on radio propagation. We have considered publishing occasional lists of past projects but it could not possibly be done on a monthly basis. You would be amazed at the number of projects in our files which have to be regarded as still "active."

## "ELECTRONICS Australia" Information Service

As a service to readers "ELECTRONICS Australia" is able to offer: (1) Photographs, dye-line prints and other filed material to do with constructional projects and (2) A strictly limited degree of personal assistance by mail or by reply through the columns of the magazine. Details are set out below:

**REPRINTS:** For a 20c fee, we will supply circuit data, as available from our files. The amount of data available varies but in no case does it include material additional to that already published in the magazine. For complicated projects involving material extracted from more than one issue, an extra fee may be requested. As a rule, requests for circuit data will be answered more speedily if the circuits are positively identified and the request is not complicated by questions requiring the attention of technical personnel. Where articles are not on file, we can usually provide a photostat copy at 20c PER PAGE.

**PHOTOGRAPHS, DYE-LINE PRINTS:** Original photographs are available for most of our projects, from 50c plus 8c postage for a 6in x 8in glossy print. In addition, metalwork dye-line prints are available for most projects for 50c each; these show dimensions and the positions of holes and cut-outs but give no details of wiring.

**BACK NUMBERS:** A fairly good selection is available. On issues up to 6 months old there is a surcharge of 5c. On issues from seven to 12 months old the surcharge is 10c. Over 12 months, it is 20c. Package and postage is 10c extra in all cases.

**REPLIES BY POST:** This provision is made primarily to assist readers in matters relating directly to articles and projects published in "ELECTRONICS Australia" within the last 12 months. Note, however, that we cannot provide lengthy answers, undertake special research or modifications to basic designs. A 20c query fee must be enclosed with letters to which a postal reply is required; the inclusion of an extra fee does not entitle correspondents to special consideration.

**OTHER QUERIES:** Technical queries which fall outside the scope of "Replies by Post" may be submitted without fee and may be answered through the columns of the magazine at the discretion of the Editor. Technical queries will not be answered by telephone.

**COMMERCIAL EQUIPMENT:** "ELECTRONICS Australia" does not maintain a directory of commercial equipment, or circuit files of commercial or ex-disposals receivers, amplifiers, etc. We are therefore not in a position to comment on proposed adaptation of such equipment, or on its general design. "ELECTRONICS Australia" does not deal in electronic components. Prices, specifications or other assistance must be sought from the appropriate advertiser or agent.

**REMITTANCES:** These must be in a form negotiable in Australia. Where the charge may be in doubt, an open cheque, endorsed with a limitation, is recommended.

**ADDRESS:** All requests for data and information, as set out above, should be directed to The Assistant Editor, "ELECTRONICS Australia," Box 2728 G.P.O., Sydney, N.S.W., 2001. Other correspondence should be directed to The Editor.

9/67



# WARBURTON FRANKI

## NEW

**SOLID STATE 10 WATT  
STEREO  
AMPLIFIER KIT**

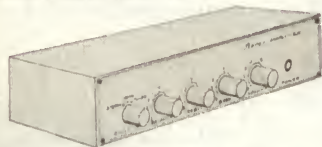

*Australian made by S.T.C.  
Everything supplied including  
cabinet and full instructions.*

**Specifications:** 10 Watts R.M.S.  
per channel. Continuous Sine  
Wave into 4 ohm load.

**Response:**  $\pm 1$ dB 100 Hz—25KHz.  
 $\pm 3$ dB 15Hz—50KHz at 1 watt  
output.

**Noise and Distortion:** —69dB at  
1 watt.

**Channel Separation:** Over 50dB.

**Output Impedance:** 4 to 16 ohms.

**Input Sensitivity:** Main Power Amplifier  
660mv input for max. un-  
distorted output. Overall sensi-  
tivity 7.2mv.

**Two Versions Available**

1. For use with ceramic pickup.
2. For use with magnetic pickup.

**\$95.00**

Freight free.

## NEW

**SOLID STATE AUDIO  
SIGNAL GENERATOR  
MODEL 100**



- 15Hz to 1.5MHz in 5 bands.
- 0-800mv (0 to 2.5v p-p) with  
both stepped and fine controls.
- Less than 2% distortion.
- 9-volt battery-operated.
- Australian made.

**\$48.50**

Freight Free

## NEW

**INSTRUMENT CASES**

As used for above signal gener-  
ator. Size: 7 $\frac{1}{2}$ in x 4 $\frac{1}{2}$ in x 4 $\frac{1}{2}$ in.  
Tough plastic case with aluminium  
panel. May be used for instru-  
ments, intercoms, extension speak-  
ers, etc.

**\$3.75**

Freight Free

## BINOCULARS

**Superopto Brand**

- Coated lenses.
- Centre focusing—with separate  
right eye adjustment.
- Precision manufacture.
- Complete with leather case and  
straps.

**8 x 30 \$17.50**

**7 x 50 \$19.50**

Freight Free

## NEW

**"CADET"  
SPEED CONTROLLER FOR  
ELECTRIC HAND TOOLS**

Varies speed from stop to full  
speed with no loss of torque.  
Rated capacity 2 amps. Complete  
with flex and plug.

**\$11.50**

Freight Free

## NEW

**A.W.A. SOLID STATE  
TAPE RECORDER  
MODEL T225UA**



- 2-track, 2-speed.
- Takes 5in reels.
- Microphone — Dynamic with  
switch.
- Push-button operation.
- Powered by A.C. mains or in-  
ternal batteries.

**\$95.00**

Freight Free

## PHILIPS RE2 RADIO ENGINEER KITS

Everything supplied to build a 3 transistor mantel  
radio including cabinet. The radio may also be used  
as an amplifier for a record player or microphone.  
Price while they last, including batteries and freight.

**\$17.95**

## POWER SUPPLY BASIC KIT

Consists of: One Transformer tapped for 9v and 12v  
at 500 ma. One full wave contact cooled Rectifier.  
One 1,000 mfd 15 V.W. Capacitor.

Make your own 9 or 12-volt power pack to supply  
transistor radios, record players, slot cars, toys, etc.

Supplied with wiring diagrams. **\$3.85** Post free.



# WARBURTON FRANKI

220 PARK ST., STH. MELB., VIC. Ph. 69-0151 (30 lines)

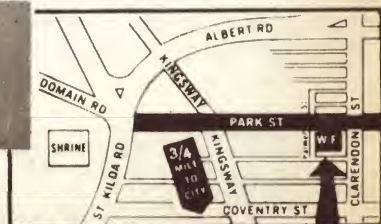

## ANSWERS TO CORRESPONDENTS—continued

**MODEL CONTROL:** In the December, 1965, and January, 1966, editions of your fine magazine you published two consecutive articles on Radio Model Control. Both the transmitter and receiver use a valve in one stage or another. This needs both space and high voltage batteries, as well as the liability of valve failure at a crucial moment. Can you tell me if these have been revised to solid state or if another design using only solid state devices has been published? (R.J., St. Lucia, Qld.)

• We have not revised the designs, nor published a solid state design, nor have we any plans to develop such a design in the immediate future. Unfortunately, we cannot suggest an alternative source for such information.

**SHORTED TURNS TESTER:** Have you ever described, or thought of describing, a "shorted turns tester"? I have examined and tried a number of commercial instruments of this type, and while most can detect a fault in a high-inductance winding such as a TV line-output transformer, they cannot be relied upon when testing low inductance windings. (T.J.R., Manly West, Qld.)

• Sorry, T.J.R., but to date we have not been able to describe an instrument of this type. As you have perhaps deduced from your experience with commercial testers, it is not easy to produce an instrument capable of giving unequivocal and reliable readings on small inductors. An instrument capable of doing the job tends to become both costly and complex in operation.

When writing, please make sure your address is complete, including the POSTCODE. Addition of the latter will ensure minimum delay in handling your letter. Also make sure that your address is legibly written or, for preference, PRINTED. A significant number of letters are returned to us each month because the original address was incomplete or illegible.

**TRANSISTOR TV BOOK:** Can you advise of a book explaining the operation of transistorised TV receivers? I have a number of books on valve-type TV receivers, etc., but have been unable to find one dealing with transistor circuitry. (W.R., Emmaville, N.S.W.)

• The best idea would be for you to pay a visit to one of the larger comprehensive or technical bookstores, W.R., as there are a number of recent books dealing with this subject. However if this presents a problem, one book which we might commend to you is "Transistor Television Receivers" by T. D. Towers, published by Iliffe Books. It should be obtainable via mail order from many of the larger stores. Other books dealing with transistor circuits have been mentioned recently in our book review pages.

**RECEIVERS:** I like the standard of the magazine and I particularly like to read the "Serviceman." Unfortunately, there seems to be less than ever for the radio amateur. Some of my friends and I have decided that the "ideal" receiver which we would like to see described would have the following: 1uV sensitivity for 10dB S/N ratio; stability comparable with the Deltahet, but using the Eddystone method of conversion; FETs up to the detector; 12 volt supply; price about \$200; copper shielded modules for vital stages; free-running BFO; temperature-compensated VFO; 30KHz per turn of 2 1/2 in dia. tuning knob. By the way, the FET voltmeter is a "beauty." I would also like to see some

of the better pop records reviewed in with other record reviews. (G. K. C. Lindfield, N.S.W.)

• We are pleased that you like the magazine and particularly the "Serviceman." We are not able to provide an article of specifically amateur interest in every issue. However, in the past, we have described many valuable items for amateurs, most of which are still current and available through the Information Service. Also, there are a number of projects which we hope to publish in the near future of interest to amateurs. Thank you for your list of receiver requirements. Most of these are fair enough but we are puzzled by others. It may be worth while to calculate respective costs of the Eddystone system of conversion, compared with that used in the Deltahet. Also, FETs are not a magic cure-all for the possible shortcomings which transistors sometimes exhibit. In short, we feel that you would not get much change from your \$200! We are pleased that the FET voltmeter has given you such satisfaction. We are unable to see our way clear at present to provide pop record reviews, especially as they are often covered elsewhere.

**AERIAL LEADS AND SPEAKERS:** Can you explain why, when I wish to receive Channel 0 in Melbourne, it is usually necessary to disconnect one of the feeder leads? Sometimes it is necessary to experiment with the leads and terminals. Most other stations are received fairly well. Is the quoted loudspeaker impedance just the ohmic resistance of the winding, or the phasor sum of the resistance and reactance at some particular frequency? Could I increase the sound output from my portable radio by replacing the loudspeaker with a larger one of the same impedance? (P.J.C., Traralgon, Vic.)

• When it is necessary to remove one of the aerial feedline leads from the TV receiver, it usually indicates an impedance mismatch. This is likely to be due to the aerial not being designed to provide for the particular channel. The only way around this is to have an aerial installed which will suit the wanted channel. The loudspeaker voice coil impedance is generally quoted at 400Hz, except possibly for very small units. The impedance at this frequency is normally just a little above the DC resistance of the winding, as measured on an ohmmeter. Below this frequency, there is a steep rise, due to resonance effects. Above 400Hz, the actual impedance rises gradually, due to increasing reactance with rising frequency. Loudspeakers installed in portable receivers are generally small and the sound output can normally be increased by replacing them with a larger and, more often than not, a much more efficient loudspeaker.

**TUNERS:** I am building the 3-plus-3 stereo amplifier and would like to build the Instrol 123 program source at the same time. Has the article plans and specifications that the home builder can follow? Also, if you have plans for a short wave tuner, would you let me know the cost of the article. (G. K., Adamstown, N.S.W.)

• The article describing the original Playmaster 123 program source contains the usual circuit and constructional information. Most constructors who wish to add short-wave listening to their hobbies build a completely separate short-wave receiver such as our series of all-wave receivers published in 1967. The last tuner we described which gave a short-wave facility was the dual-wave tuner of July, 1959. We can supply the circuit and essential diagrams for this tuner for the usual 20c fee.



### THE NEW LUSTRE MODEL ST-510 TONE ARM . . . TRACKS AT LESS THAN 1/2 GRAM . . . AND COSTS ONLY \$19!

Orders for the new Nikka-Lustre Model ST-510 tone arm can now be filled immediately. Miniature ball races are used throughout, the head shell accepts all standard 1/2" mounting cartridges, finish is satin chrome and anodised aluminium. An outrigger bias adjustment is fitted and stylus pressure is adjusted with the counter balance weight. The Model ST-510 is fitted with a lifting/lowering device and costs \$24.50. The Model ST-510 (without lift), inc. sales tax is priced at . . . **\$19**

### RAPIER SOLID STATE TUNERS

A high quality AM tuner, the Rapier represents outstanding value. Output suits all amplifiers and tape recorders. The external teak finish case is optional. Price with case is \$46.50 inc. sales tax. Encel price without case is only . . . **\$43.60**



### NEW SHIPMENT OF HIGH QUALITY, LOW PRICED COSMOS STEREO AMPLIFIERS

Once more the popular Cosmos Model SW-30C stereo amplifiers are in stock. Output is 8 watts R.M.S. or 15 watts I.H.F.M. in each channel, all necessary control facilities are included and the price is only \$79.50. (IMPOR-TANT: The sensitivity of the Cosmos suits magnetic cartridges at 5 mV.) Provision is made for use of stereo headphones and a DIN socket permits connection of tape recorders. The pre-amplifier is fully transistorised. Speaker outputs allow for use of 4, 8 and 16 ohm. speakers or speaker systems. The Cosmos is ideal for use with tape recorders and tape decks. When used with high quality stereo pick-ups and wide range speaker systems, results are very satisfying. Encel price, inc. sales tax . . . **\$79.50**

## Encel ELECTRONICS (STEREO) PTY. LTD.

Head Office:

431 Bridge Rd., Richmond, Victoria 3121.

Tel. 42 3762.

Sydney Store: Ground Floor, 25M Building

257 Clarence Street, Sydney, N.S.W. 2000.

Tel. 29 4563, 29 4564.

\*Wholesalers

\*Trade-ins accepted

Australia's Greatest Hi-Fi Centre

# HAM

# RADIO SUPPLIERS

323 ELIZABETH ST., MELBOURNE, VIC., 3000. Phone: 67-4286  
2 DOORS FROM LITTLE LONSDALE STREET

ESTABLISHED 1947



## "KEW" KYORITSU MO 65 METERS, NEW

Size: 3 1/4 inch, mounting hole 2 1/2 inch, 1 1/2 inch deep.

All plus Postage 20c.  
1 mA, 5 mA, 10 mA, 25 mA, 50 mA, 100 mA, 150 mA, 250 mA, 500 mA.

**\$4.50**

1 amp DC .. \$4.50  
5 amp DC .. \$4.50  
10 amp DC .. \$4.50  
30-0-30 amp DC .. \$5.25  
15v DC, 30v DC, 300v DC .. \$4.50  
300 volts AC .. \$5.50

## CLEAR PLASTIC PANEL METERS

MR1P, 1 1/4 inch square, clear plastic, 1 inch round mounting hole, 1 1/4 inch deep.  
1 milliamperes (mA) .. \$3.50  
500 microamperes (uA) .. \$3.75  
5 amperes (A) .. \$4.75

### ALSO OTHER TYPES AVAILABLE.

MR2P, 1 3/4 inch square, clear plastic face, 1 1/2 inch round mounting hole, 1 1/2 inch deep.

50 uA .. \$5.50 5, 10, 25, 50  
50-0-50 uA .. \$5.75 100, 250, 500  
100 uA .. \$5.40 1, 5, 10 uA .. \$3.75  
100-0-100 uA .. \$5.50 15, 30A .. \$4.50  
500 uA .. \$4.00 15 volt d.c. .. \$3.75  
1 mA .. \$3.75 30 volt d.c. .. \$3.75  
1-0-1 mA .. \$4.00 1000 V a.c. .. \$4.50

"S" Meter (1 mA, f.s.d.) cal. 0-9 (with additional scale in 10 db. steps over S9).  
**\$5.25.**

"VU" Meter, scale minus 20 to plus 3. VU (0 to plus 3 VU in bold red arc). Accuracy: within plus or minus 0.5 db, at 0 VU.  
**\$5.00**

Stereo Balance Meter (1-0-1 mA f.s.d.)  
**\$4.50**

Also other types available.

MR3P 3 3/8 inch square, clear plastic face, 2 3/4 inch round mounting hole, 1 1/2 inch deep:

50 uA .. \$7.00 50-0-50 uA .. \$5.75  
100 uA .. \$6.75 15 volts d.c. .. \$5.75  
500 uA .. \$6.50 25 volts d.c. .. \$5.75  
1, 5, 10, 25, 50 30 volts a.c. .. \$5.75  
100, 250 and 500 mA .. \$5.75 "VU" Meter .. \$8.25

P25 2 1/4 inch square, clear plastic face, 2 1/8 inch mounting hole, 3/4 inch deep.

50 uA .. \$5.75 15 volts d.c. .. \$5.50  
100 uA .. \$5.75 25 volts d.c. .. \$5.50  
500uA .. \$5.25 500 volts a.c. .. \$5.50  
1, 5, 10, 20, 50 250 and 500 "S" Meter .. \$5.75  
mA .. \$5.00 "VU" Meter .. \$6.50

## INSTRUMENT CASE

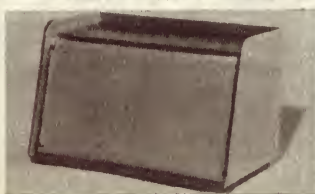

Sloping Front Panel.  
Plastic case, metal front panel.  
7 1/4" x 4 1/4" x 5 in.  
Suitable radio, test equipment, projects, etc.  
**Price \$3.50 inc. Tax**  
Post 10c

## "NIKKA" 1 WATT TRANSCEIVERS

P.M.G. APPROVED. SOLID STATE 14 Transistor Circuit inc. R.F. Stage. 27.240 Mc (Provision for 2 Channels). Range Boost Circuit. Up to 10 miles in open country or water. Buzzer Type Call System. Squelch Control. Complete with leather carrying case.  
**\$175.00 PAIR**

## DISCOUNT SPECIAL BUY BULK AND SAVE

New Brand Name Recording Tapes and Accessories

LGTH.	BASE REEL	REELS PER PACK	PRICE
150ft	Acetate .3in	4 for	\$1.75
225ft	Acetate .3in	3 for	\$1.75
300ft	Mylar .3in	2 for	\$1.75
600ft	Acetate .5in	2 for	\$3.25
900ft	Acetate .5in	2 for	\$3.75
1200ft	Acetate .7in	2 for	\$5.20
1800ft	Acetate .7in	2 for	\$6.50
1800ft	Mylar .7in	2 for	\$8.50
2400ft	Mylar .7in	2 for	\$9.25
3600ft	Mylar .7in	2 for	\$13.50

## TAPE ACCESSORIES

Head Alignment Tape, 100ft on 2 1/2in Reel .. \$1.50  
Tape Clips Packet of 75 .. \$1.35  
Book "Tape Editing and Splicing" .45  
Reel Holders, Pair .. \$1.00  
Tape Jockey Cloths, Pkt. Of 3 .. \$1.00  
Head-Kleen Tape, 225ft on 3in Reel .. \$1.75  
"Tape-Clean," Cloth Tape, 3in Reel .. \$1.75  
Head and Guide Cleaner and Lub Kit .. \$1.90  
Address Cards, 2 Sided, Pkt. Of 30 .. \$1.40  
Replacement Pressure Pad Kit .. \$1.00  
Sensing and Cuing Patches, Aluminium, Pkt. Of 50 .. \$1.95  
Splicing Tape, 1/4in Wide, 300in .. \$1.00  
Coloured Leader Tape, 5in x 2 1/2in Reels, 100ft, Each .. \$4.50  
Available Separately, All Colours  
Per Reel .. \$1.00  
Splicing Tape, 1/4in x 100in .. \$1.00  
Head Cleaner .. \$1.50  
Head and Guide Lubricant .. \$1.00  
Recorder and Phono Drive Oil .. .75  
Non-Slip For Tape and Phono Drives .. \$1.00

## PHONO ACCESSORIES

3 - Hi-Fi Stereo Record Cleaning Cloths .. \$1.15  
Record Jockey Cloth .. .75  
Record Cleaning Kit .. \$2.50  
Stylus Microscope .. \$3.00  
Gauge Stylus Pressure .. \$150

## DISPOSALS SPECIALS

TV TUNERS, M.S.P., Incremental, BRAND NEW, COMPLETE WITH VALVES. 6ES8 and 6U8.

PRICE: \$5.50.  
100 Assorted, 1/4 and 1/2 watt Carbon, Resistors, Good Selection, AL POPULAR TYPES. \$1.75 PKT.

PACK OF MICA Washers and Grommets. 25c

50 ceramic, Disc, Ceramic, Paper, Mica and Polyester Capacitors. \$1.75 PKT.

## AUDIO TRANSFORMERS, A. AND R. TYPES

Primary 8000 C.T., Ultra Linear, 43 p.c. TAPS, 10 WATTS. Secondary 2, 8, 16 ohms. \$7.50.

6600 ohm/4500 ohms. Push-Pull, 40 WATTS. Secondary 500, 250, 125, 50 ohm. PRICE: \$10.00.

Primary 10,000 Ohms/8000 ohms, Push-Pull. Secondary: 2, 4, 8, 15 ohms, 15 WATTS. \$5.50.

2558 Primary 10,000 ohms, single Ended, Secondary 2, 3.5, 8, 15 ohms. 5 WATTS \$4.00.

## RECORDING TAPE SPECIALS

Unboxed SCOTCH Brand, NEW GUARANTEED.

2 REELS, 900FT, 5 inch, Polyester base, \$3.95.

2 REELS, 1800FT, 7 inch, Polyester base, \$7.75.

## TRANSISTOR DRIVER TRANSFORMERS.

Type AMT-208, Primary Impedance, 5000 ohms. Secondary Impedance: 1500 ohms X2 75c or 3 for \$2.

BARGAIN PRICED NEW VALVES.



## MULTIMETERS

### Model OL.64

20,000 ohms per volt DC 8,000 ohms per volt.

Measuring range—volt AC.

DC Voltage: 0-0, 3 1 10 50 250 500 1000

5000V at 30Kohm/V.

AC Voltage: 0-10 50 250 1000V at 8Kohm/V

DC Current: 0-30uA 1 50 500mA 10A.

Resistance: 0-5 500Kohm 550Mohm.

Decibels: -20 to +22dB, plus 20 to plus 36dB.

Capacitance: 250pF-0.02 uF.

Inductance: 0-500 H.

Load Current: 0-0.06 0.6 60mA.

Self Contained Batteries: 22.5V (BL-015) x 1.

1.5V (UM-3) x 2.

Size and Weight: 6in x 4-1/5in x 2in.

650g.

Meter Movement Fundamental Sensitivity: 30uA FSD.

Meter Movement Internal Resistance: 3,100-ohm +3 p.c.

Allowance: For DC Voltage range +3 p.c. of specified value.

For DC Current range +3 p.c. of specified value.

For AC Voltage range +4 p.c. of specified value.

For Resistance range +3 p.c. of scale length.

For Decibel Range +4 p.c. of specified value.

**PRICE: \$19.75**

## TRIO COMMUNICATIONS RECEIVERS

Trio Model 9R59DE, four bands covering 540Kc to 30Mc, two mechanical filters for maximum selectivity. Product Detector for SSB reception. Large tuning and bandsread dials for accurate tuning. Automatic noise limiter, calibrated electrical bandsread, S meter and BFO. 2 microvolts sensitivity for 10 db S-N ratio.

**\$175.00**

## TRADE-IN ACCEPTED

### MAGNETIC CARTRIDGES

CM500 Magnetic Stereo Diamond, 4 mv at 1 KHZ, 20-20,000 c/s 3 grams

tracing weight .. \$8.25

Spare Stylus .. \$5.00

MC/Magnetic Stereo, .7 mil. Diamond

6 mv at 1 KHZ, 20-21,000 c/s, 2

grams Tracking Weight .. \$9.50

Spare Stylus .. \$6.20



## CLOSED CIRCUIT TV SYSTEM

CAMERA Type CA-6V, including Standard 25mm lens and 10 yards of Video Cable with Connectors.

SPECIAL PRICE: \$285 inc. Tax.

VIDEO MONITOR 8 inch Type PM81V, \$124 inc. Tax.

VIDEO MONITOR 12 inch Type PM 121-V INCLUDING AUDIO STAGE \$150 inc. Tax.

VIDEO MONITOR 16 inch Type PM-162-VA. \$145 inc. Tax.

## ANSWERS TO CORRESPONDENTS - continued

**LIKES "THE SERVICEMAN":** I would like to congratulate you on a fine magazine which I have been reading now for 8 years. As a practising serviceman, I appreciate the article by "The Serviceman." Keeping up to date with circuits and modifications is a real problem and I wonder whether "Electronics Australia" could help by publishing this kind of information each month. B. M. (Nth. Richmond, S.A.)

• Many years ago, we decided not to become involved in this activity because of the problem, in those days, of getting copies of new circuits in a form suitable for re-blocking to our size and format. We must confess that we have not looked closely at it since. However, we would point out that Westley Contractors Pty. Ltd., publish a series of service manuals which are kept up to date with additional circuits. These manuals are available from Radio Parts Pty. Ltd., 562 Spencer Street, Melbourne, 3003, or from General Accessories in all capital cities.

**DYNAMIC SPEAKER:** I have a 9in electromagnetic dynamic speaker from an old radio. Is there any way this can be converted to a permanent magnet speaker suitable for inserting in the speaker jack of a tape recorder or radio? (B.C.L., Tamworth, N.S.W.)

• Briefly, no. An electrodynamic speaker needs a source of current to energise the coils and, unless provision is made for this, the speaker is useless.

**STATIONS LIST.** I was very interested in the Australian TV and Broadcast Stations lists in the January, 1969, issue. They are better arranged than in the 1968 issue. In the same issue I noticed the item in "Answers to Correspondents" under the heading "Why Push-Pull?" In your answer you stated that among the advantages of push-pull circuits is included cancellation of ODD harmonic distortion. I suppose this should have read EVEN harmonics. (Z.A.C., Liverpool, N.S.W.)

• Thank you for your expressions of appreciation for our annual stations list. We too feel that the changes made this year are worth while. You are quite right about the error in the answer on push-pull circuits. Despite a fair amount of vigilance, errors of this kind unfortunately creep in from time to time.

**TRANSISTOR RECEIVERS:** In November, 1966 you published a four-transistor receiver which has given me marvellous results. Nevertheless it has its limitations and I would like to extend it to six transistors. Could you tell me how to extend this radio or how to build a new set? Also can you tell me where I can get some books explaining the principle of radio, including servicing? (R.J., Ingham, Qld.)

• In general, it is not practicable to add transistors to an existing receiver without completely re-working the design, both electrical and physical. If you particularly want a receiver with more transistors, we have published a number of designs using from five to eight transistors, the latest being the "Transporta Seven" of December, 1963. Copies of this article are available through the Information Service for 20c. We can recommend our own "Basic Electronics" as a good book from which to learn the principles of radio, television, etc. It includes an introduction to servicing techniques.

**SIGNAL TRACER:** As I am going to build the signal injector described in the May, 1968 issue, I would like to know if you have published a compact signal tracer with probe input and speaker output. (L. McE., Ryde, N.S.W.)

• We have published several signal tracers in the past, the one most suited to your purpose being described in March,

1964. Another more recent unit using oddment parts was described in July, 1966.

**RCA AMPLIFIER:** I would be grateful if you would answer some questions about an amplifier design in the RCA handbook. I have not received a reply from the company, after several letters. (A.V., Patea, N.Z.)

• The fact that you have not received a reply is perhaps not altogether surprising. Circuits published in a book tend to generate queries and the publishers may simply not be set up to answer individual technical questions. "Electronics Australia" has a closer link with readers than would be the case with publishers of a textbook but even we have to draw a heavy line between what we can and can't do in the way of answering individual queries. One of the stipulations is that we cannot become involved in discussions of circuit design other than what we have ourselves published and we therefore cannot help you much in your particular problems. In general, mica capacitors have been displaced for general circuit use by ceramic and plastic dielectric types. You could use either of these, provided they have the appropriate voltage and capacitance ratings. We imagine that a potentiometer branded "audio taper" would be broadly equivalent to "C-taper" or "logarithmic." If an amplifier oscillates, it may be due to a circuit error, or to bad layout. Alternatively, if negative feedback is derived from the output transformer secondary, you may have to reverse the phase of the winding. Earth the end which is at present active and derive the feedback from the end which at present is earthed. Grid or screen stoppers can contribute to stability but, if your amplifier is oscillating at an audible frequency, it is likely to be something

more basic, as already suggested. A voltage of 330 on the plates of 6V6 valves sounds a lot too high. Using an indirectly heated rectifier instead of the directly heated one would make the situation worse because it would deliver higher voltage.

**COMPONENT PRICES:** May I endorse the remarks of R.S. about advertisers who omit to price their goods. Despite your defence of such practices, I usually assume that the product must be unreasonably expensive. Unless it has something very special about it, I try to make a choice from others which do give the information. After all, if price were really good, you can't convince me that an advertiser would not make every effort to highlight it, instead of using idiotic phrases like "attractively priced," etc. (R.F., New Town, Tas.)

• Hold hard there! We may have advanced reasons why advertisers sometimes adopt the attitude they do. An explanation, yes, but scarcely a defence. We certainly think that it is a good idea to quote prices wherever possible, and we're all for it. We also agree that, if an advertiser withholds price, perhaps for a very good reason, he runs the risk of his action being misinterpreted.

**KEYLESS ORGAN:** Before I start to build the keyless organ, published in January, 1969, could you please advise me what the total cost of the parts would amount to? Also, are all the components readily available at the moment? (D.F., Armidale, N.S.W.)

• As we have stated many times in these columns, we prefer not to quote the cost of projects. If you examine our advertising pages, you will probably find several companies offering kits or parts who would be prepared to do so. At the time of publication, parts for this project were available readily enough.

RANGE  
OF  
GUITAR  
AMPS.  
  
**TRANSISTORISED**



50 TO 800 RMS.WATTS.

**PREMIUM**

ABOVE  
ALL IN  
PERFORMANCE  
AND STYLE.



**FOR PRESTIGE SOUND SEE CLAYBRIDGE SOUND**

Secure your FREE, COLOURED CATALOGUE of our products & services.



**Claybridge**  
SOUND

163 CLAYTON RD. CLAYTON VIC. 3168 OR RING 544 6171  
(CNR. DANDENONG RD.)

(ALL HOURS)

### SOUND PROJECTORS

Cinevox Prefect and Harmour and Heath 16mm in good working order, 240v operated, complete with speaker and amplifier.  
**from \$90.00**

### CIRCULAR SLIDE RULE

3 3/4 in diameter. Will do the same work as the conventional slide rule. Instruction book included.

**\$1.25 each**  
Post 10 cents.

### REFLECTOR GUNSIGHT

Contains these lenses:

1 Lens 1 1/2 in Focus, 1 1/2 in diam.  
1 Lens 1 11/16 in Focus, 1 1/4 in diameter.  
1 Air-spaced Lens, 1 1/4 in diam.  
1 Filter Lens, 1 Graticule.  
1 Lampholder. **\$1.85**  
Post.: N.S.W. 30c; Interstate: 40c.

### P.M.G. TYPE TELEPHONES

Standard desk type with magneto bell calling device. Range 30 miles. Uses standard batteries at each phone. Any number can be connected together on single line.  
**\$23.00**

### (2 TELEPHONE SETS)

30c cartage to rail. Freight payable at nearest attended railway station.

Please note we are now able to include 1/2 mile of telephone cable FREE with each set of Phones.

### BATTERY CHARGERS

240 volt A.C. Input. Each battery charger will charge either 6 or 12 volt batteries.  
2 amp. without meter, **\$13.75**  
2 amp. with meter, **\$15.75**  
Post N.S.W. 70c; Interstate 95c.

### MINIATURE ELECTRIC MOTORS

1 1/2 to 3 volts D.C. Ideal for model boats, cars, planes, etc. Strong torque. Only **65 cents each or 10 for \$4.00.** (Post 7c).

### TRANSCEIVER

(2-way radio) R.C.A. America RT 68, 24 volt, operated 10 watt output 38-54 megacycles F.M. crystal locked. Transmitter and receiver using frequency synthesiser in 100 K/c/s; step 10 channel per meg/cycle with power supply. Leads, mike and headphones **\$90.00**, 60c cartage to rail. Freight payable at nearest attended railway station.

### TRANSCEIVER

(2-way radio) 62 set ideal small ships, Hams, etc. 1.6 to 10 megs. Crystal locked or V.F.O. controlled 5 watt output. Complete with antenna, headphones and mike but not air tested, \$60, air tested \$90. Not tested incomplete (without accessories \$25), 60c cartage to rail. Freight payable at nearest attended Railway Station.

### HEAD PHONES

Low impedance moving coil fitted with rubber muffler to reduce external noise, fitted with press to talk, dynamic hand microphones. Ideal for use with all types of transceivers, \$3.50 pair. Same with black felt muffler, \$4.50 pair. Post N.S.W. 25c; Interstate 30c.

### 12 VOLT D.C.

DESYNN INDICATOR AND TRANSMITTER UNIT. Suitable for aerial rotation indicator, etc. 0-360 deg., weatherproof mountings.

**\$5.00 per set.**  
Postage: N.S.W., 95c;  
Interstate \$1.67.

### MINIATURE CRYSTAL EARPHONE

With Cord and Plug, 75c. Post 4c.

### 16'6" WHIP AERIALS

6-Piece, brand new, \$5.75. 60c cartage to rail. Freight payable at nearest attended railway station.



P.M.G. Phone Jack and plugs, 25c each, 45c the pair.  
Post 7c.

### NIFE CELLS

1.2 Volt fully charged, 4in x 3in x 1in 4 AH. **\$1.00 each**  
Post. N.S.W., 25c; interstate 35c.  
1.2 volts 15 AH, 8in x 4in x 2in. **\$3.95**  
2.4 volt 10 AH, 6in x 2 1/2 in x 2in. **\$2.50**  
Post. N.S.W., 30c; interstate, 40c.

### WALKIE TALKIE TWO-WAY RADIOS

P.M.G. Approved Citizen Band. 9 Transistor. **\$79.00 per set of 2.**  
Post. N.S.W. 50c; interstate, 60c.

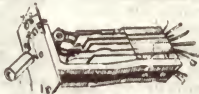

P.M.G. TYPE KEY SWITCHES.  
45c each. Post, 15c.



45 x 40 coated Lens with tripod. **\$10.95**

30 x 30 Power Coated Lens Brand new. **\$3.75**

60 magnification with a 60mm coated objective lens. With tripod. **\$23.00**

As illustrated.

Postage, 95c; Interstate \$1.20.

### HIGH STABILITY RESISTORS

I.R.C. brand new 1/2w 1w, 2w, tolerance between 1 and not exceeding 5 per cent including 1K 15K, 22K, 27K, 100K, 180K, 220K, 560K, 820K, ohms. Usual price 40c each, 50 assorted different values for only **\$3.75** Post 15c.

**522 TRANSCEIVERS**  
100 to 150 m/c.s.  
**\$35.00**

### TYPE S POWER SUPPLY

(240 Vac supply for AT 5-ARB) suit most types of Disposal transmitters and receivers outputs 250 volt, 10ma 550 volt 200ma, 300 volt 100ma, **\$30.00**

### TELEPHONE WIRE

21 gauge copper, plastic covered. Ideal telephone or bell wire. 1,320ft coil of twin (equal 1/2 mile) \$7 per coil.  
Post. N.S.W. 70c; Interstate \$1.20.

### SWITCHBOARD FRAMES

Steel ex-P.M.G. Height 4 1/2 in x 27in x 3 1/4 in, will make ideal test bench, \$10.  
**\$1.00 cartage to Rail.**  
Freight payable at nearest attended railway station.

### SCOOP PURCHASE

Gramo Motors. New. Made in U.S.A. 4-speed 240 volt A.C. 50 c/c. Only **\$2.75 each.**  
Post. N.S.W. 30c; Interstate, 40c.

### CO-AXIAL SWITCH

70 ohms 4 positions, can be motor driven completely waterproof 70 ohms type connectors. Housed in metal case 9in x 8in x 8in \$5.00 each. Post N.S.W 70c. Interstate \$1.20.

## VALVES BRAND NEW IN CARTONS

Special discount for quantity

807	75c	X61M	\$2.20
65N7GT	95c	CV850	\$1.50
8989	\$1.00	1H6G	30c
12SA7	\$1.25	832	\$5.00
5U4G	95c	6F13	75c
77	\$1.00	6AK5	\$1.50
EF50	35c	6X4	\$1.00
6U7	75c	6F3	75c
V1103	\$1.00	12SK7	50c
VH120	75c	VR1120	50c
1L4	\$1.00	VR118	75c
5Y3	\$1.75	VR65	25c
6C4	50c	VT4C	75c
2 x 2	75c	AU5	\$1.00
6AG5	80c	80	\$1.25
12AU7	\$1.00	6AK5W	\$1.50

### CATHODE RAY TUBES

3FP7	\$2.95	5BP1	\$3.50
3JP1	\$2.95		
V1669 4/1	\$2.95	CY2184	\$2.95

PLEASE ADD POSTAGE ON ALL ARTICLES

### TELESCOPES

30 x 40 with Tripod **\$7.95**

Post N.S.W., 70c; interstate \$1.20

### EX ARMY TELESCOPES

4 x 40 Handley **\$6.50**  
7 x 40 Otway telescope, **\$9.85.**  
Freight payable at nearest attended railway station.

### C.M.A. CABLE

240 volt 3/.036 black, new and perfect, 100yd rolls **\$3.00**; 6 or more.

**\$2.50**

30c cartage to rail. Freight payable at nearest attended railway station.

### MICROMETERS

Brand new Slocombe, 1in-2in, 87.85. Post 32c  
VIBRATORS, 6 volts, 7-pin 75c each.

UNISELECTORS, 4 BANK, \$4.00  
Post. N.S.W., 25c; interstate, 30c.

INSTRUMENT TRIPODS, sturdy, wooden frame, Telescope. Extend to 4ft 6in . . . . . **\$13.00**

SELVYN MOTORS MAGSLIP Mk. II . . . . . **\$5.25 ea.**

No. 19 TWO-WAY RADIOS Sold a sis without power supply, leads, accessories, etc. Only \$15. Or complete with above gear, \$35.

### BINOCULARS

PRISMATIC. Coated Lenses Brand new. Complete with case.  
8 x 30 . . . . . **\$18.75**  
7 x 50 . . . . . **\$22.15**  
10 x 50 . . . . . **\$23.07**  
12 x 5 . . . . . **\$23.95**  
20 x 50 . . . . . **\$26.50**  
Post. N.S.W., 70c; Interstate, \$1.20

### 3000 TYPE RELAYS

P.M.G. 200 Ohm — 1,500 Ohm Coils, **\$1.25 each.**

### MINE DETECTORS

Ex A.M.F with Instruction Book. Complete in wooden case. Ideal for plumbers, councils for locating buried pipes, etc. Freight payable at nearest attended railway station. **\$39.00**

### 4 DIGIT RELAY COUNTERS

50-volt D.C. suit slot car. Lap counters, etc.  
**\$1.25 each.** Post 13c.

### ALTEC STUDIO MICROPHONES

639B Western Electric, top grade, original cost \$250, ideal Broadcast Studio, music recording, Church and play recording, etc. Fraction of original cost. Price on Application.

### 240 VOLT

### 522 POWER SUPPLY

Supplies all necessary voltages to operate 522 transceiver from 240 V A.C. Complete and ready to plug in **\$30.00.**

SPECIAL lucky dip valve offer. 15 new valves in cartons for only **\$2.00.** We haven't got time to sort them, so you reap the benefit. Post 60c.

### SOLENOIDS

Plunger Type 12V 300M.A. Suit electric camera control, miniature trains, radio, etc. **\$1.25.** Post. 10c.  
200 Mill. amp., 24 volt, 1/8in push movement. **\$1.25.** Post 10c.

### LENSES

TOP GRADE ACHROMATIC 2in DIAMETER, 20in FL. Ideal as telephoto lens, telescope objectives. **\$13.**  
Postage 46c.

### CONDENSER LENS

2 1/2 in DIAM. 2in FL. **\$1.50 each** or **\$2.50 per pair.** Post 21c.

### CONDENSER LENS

1 1/2 in diam. 1 1/2 in FL. **50c each.**  
Postage, 17c.

### FOUR CHANNEL BRANCHING AMPLIFIER

With 4in Vu, meter GLORAD. Complete with Portable Power Converter. 600 ohm balanced input and output. Ideal for outside broadcasting, etc.

**\$39.50**

### MONITOR SPEAKER UNIT

Ex-A.B.C., consisting of low resistance 8in speaker in Acoustic Labyrinth Baffle Box, complete with 10-watt amplifier, 600 ohms plus 8dbm input, 240 volt A.C. operated.

**\$37.50**

### TEN CHANNELS VHF TRANSCEIVER

Types TR1934 100-125 meg/cys. and TR1935 125-150 meg/cycles. 28 volt DC operated AM single crystal locks both TX and RX on same channel complete with generator.

**\$33.00**

### BENDIX BC221 FREQUENCY METERS

Built-in 240 volt power supply, perfect condition.

**\$90.00**

### RECORDING TAPE

EX-GOVERNMENT SURPLUS STOCK. Topgrade, 1200ft on 7in spool, \$2.25, post 21c. 600ft on 5in spool, \$1.45, post 13c. 150ft on 3in spool, 65c, post 9c.

# Deitch Bros.

70 OXFORD STREET, SYDNEY, 2010

SORRY, NO C.O.D.

# ANSWERS TO CORRESPONDENTS—continued

**NO NAME OR ADDRESS:** We are holding an order for a copy of "Basic Electronics," which does not carry any name or address. It was accompanied by a postal order issued at Ivanhoe, Victoria. The postal order was for \$2.00 which, incidentally, is 20c short of the correct amount. Will the person concerned please contact us.

**RF AMPLIFIER:** I have built many of your projects with very good results. Recently, I built the 1967 All Wave Seven receiver, which performs very well. However I feel that the performance could be improved by the addition of an outboard RF amplifier, with switched coils to cover the various ranges. (S.H., Bankstown, N.S.W.)

● We are pleased that you have had such success with your projects and that the 1967 All Wave Seven receiver has worked so well. Thank you for your suggestion regarding the RF amplifier. We have it in mind to describe such an amplifier in the not too distant future. More than likely, it will use a field effect transistor, rather than a valve as you suggested.

## Q-Multiplier

(Continued from page 61)

This amounts to a dissipation of 135 milliwatts, which is well within the maximum permissible rating of 340 milliwatts. The result of this little design exercise is a regulated power supply of a nominal 9.1 volts and capable of accommodating the current spreads likely to be encountered with any FET likely to be used in the Q-multiplier.

If you should need a power supply like this one for some other purpose and where the current drain is likely to be up to 30 milliamps or so, it is possible to do this simply by reducing the 560-ohm resistor to one of 270 ohms. This will bring the zener diode close to its maximum permissible dissipation rating, when there is no current being drawn from the supply. Whatever current is drawn from the output is subtracted from the current flowing through the zener diode and the dissipation is reduced accordingly.

## Communications Privacy

(Continued from page 23)

Lexington, Mass., company, has developed a voice device whose codes can be changed at any time by resetting one or more of 10 switches; the number of possible code combinations is so large that the chances of timely deciphering are remote.

"The device gives you safety in numbers," says Arnold M. McCalmont, president of the company. "The likelihood of a stolen unit being set to the correct code is close to zero." Units can be equipped to operate on any one of 128, 256, or even 1,024 codes.

The method of encoding, McCalmont says, "is a hybrid technique, part digital, part analog. This keeps the price down to under \$US800 in quantity." The \$800 price is for orders between 100 and 1,000; a single unit costs \$2,500. ("Electronics," 2/9/68.)

**24-HOUR CLOCK:** In June, 1968, you published an article describing a 24-hour universal clock using a Telechron movement. As I now have a Telechron movement, I would like to know if you still have a dial showing the times in different parts of the world to fit to the clock. I will also need a copy of the article. Could you tell me how much the dial and article will cost? (P.J.F., Clayton, Vic.)

● Copies of the article are available at 20c each, while photographic prints of the dial (in either of two sizes) can be supplied for 50c. All inquiries should be addressed to the Information Service as in the panel on the first page of this section.

## Notes and Errata

**PLAYMASTER 118 STEREO AMPLIFIER** (July, 1967): If the 6GW8 output valves show any tendency to overheat, the value of the bias resistors can be increased from 100 to 130 ohms.

**TRANSISTOR TEST SET** (August 1968): The circuit on p. 37 contains a small error. The lead from the "BV" lug of the switch connected to the cathode lug of the diode socket should connect to the "diode" lug of the topmost section of S1, not to the "PNP" lug as shown. The parts list on p. 41 should show the voltage rating of the 2uF electrolytic capacitor as "200VW"; also the 8uF 300VW capacitor listed is not required, and should be removed from the list.

## Smaller Rectifiers

(Continued from page 27)

team from the General Electric Company (U.K.) and the Central Electricity Generating Board has been able to return to a relatively simple type of valve in which the number of de-ionising and voltage control grids has been reduced to one. It is a small valve, by established standards, being just over three feet high, and its simplicity holds out the promise of cheapness and ease of maintenance. It is illustrated in Figure 3.

Inevitably, one wonders if the mercury arc valve will be superseded by solid-state semiconductor rectifiers. However, the trend towards more compact and simple valves, together with the priceless advantage of ruggedness in the face of accidental overloads possessed by the mercury pool device, suggests that valves will remain in the forefront for many years to come.

## NEXT MONTH

We plan to describe a new RF PREAMPLIFIER which uses a junction FET. The frequency coverage is from 1.5MHz to 30MHz in four ranges, and the broadcast band could be covered as an optional extra. The preamplifier will effect a remarkable improvement in sensitivity and signal-to-noise ratio, where receivers are deficient in these respects.

### TRANSISTOR SPECIALS! SEMI-CONDUCTOR PACKS BRAND NEW & TESTED

#### SILICON AND GERMANIUM TYPES

- SILICON TRANSISTORS**
- 10—RF Type, similar BF115, AT325, AY101 \$2.95
  - 10—Audio type, similar AT326, BC108 \$2.95
  - 10—Audio Output Type, Matched Pairs \$3.25
  - 1—NPN Hi Power Output, 2N3055 \$2.20
  - 1—PNP RF 1F Type, similar AF116, each 60c or 10, \$5.00
  - 1—PNP Power Output, similar 2N301, 2N2148 \$1.80

- SILICON RECTIFIERS**
- 50V, 40c, 400V, 60c
  - 100V, 45c, 800V, \$1.00
  - 200V, 50c, 1000V, \$1.30

- GERMANIUM DIODES**
- OA 90 Type 30c
  - OA 91 Type, 30c
  - AN1102, BA100, 30c

### RECORDING TAPE POPULAR MAKE AT WHOLESALE PRICES

In	150ft	.60
..	225ft	.72
..	300ft	.99
..	600ft	\$1.80
..	900ft	2.55
..	1,200ft	3.50
..	900ft	2.65
..	1,200ft	3.25
..	1,200ft	3.00
..	1,800ft	4.00
..	2,400ft	4.97
..	3,600ft	6.65

- PHILIPS TYPE CASSETTS**
- C60, 60min 1.95
  - C90, 90min 2.75
  - C120, 120min 3.50

### GUITAR AMP KIT All Solid State

70W RMS Bass and Treble, etc. \$102 plus tax. Also available modules for reverb, tremolo, etc. Fuzz, etc. Plus Playmaster amps.

### TUNERS

Based on Playmaster design. Ceramic Filters, Tuning meter, Whistle Filters, etc. \$52 Plus tax. Teak Cabinet, \$6. Extra Unit 10—with RF stage and power supply, 8KCs bandwidth, \$31. Plus tax.



Peak 7W Stereo Amplifier, 50-20,000 Hz, in oiled timber cabinet, \$34.50, complete. Palace 8 watt Stereo Amplifier, Freq. range 50-15,000 Kcs. \$32.50 complete.

### AMPLIFIER KIT

STC 20W RMS STEREO AMPLIFIER  
Complete to last nut and bolt. Plus full instructions. \$72 plus 25 p.c. sales tax.

### TAPE RECORDER KITS

Unit 14. Tape pre-amplifier unit. Unit 15, 60-90 Kc's. Push-pull trans. Bias erase oscillator module. Unit 16, transistor tape recording amplifier module. Used with unit 14.

### TAPE DECKS

With or without pre amps. VAN DER MOLEN

## S. E. WILLIS TRADING CO.

38 Riversdale Road, Camberwell Junction, Vic., 3124. Phone 82-5787, Please include Freight Sorry No C.O.D.

### NEW 1969 TRANSISTOR RADIO KIT



6 Silicon Transistors and complete with Instruction Book, carrying case and earphone. Special price, \$11.25  
Wired, \$13.50  
Post and Pack, 75c.



### BOYS' CRYSTAL SET KIT

Complete with plastic cabinet, earphone and instructions. \$2.20  
Illustration Unit 2.



Transistor Modules  
Unit 1, 25W RMS Amplifier.  
Unit 2, 10W Amplifier.  
Unit 3, 10W RMS Amplifier.  
Unit 4, Pre-amp tone Control Stage.  
Unit 11, 65W Hi-Fi Amplifier.  
**TRANSISTORS AND DIODES AT SPECIAL PRICES, ALSO ALL COMPONENTS, TAPE, FILM, etc.**  
SEND S.A.E. FOR DETAILS AND LIST.

# The HI-FI experts

Have expert advice on your choice of a stereo system. Come to Kent Hi-Fi and choose from our complete range of imported, world-famous brand Turntables, Amplifiers and Speakers. We'll advise you on latest trends and on the best value system for your price. Our personal six months' guarantee covers every unit sold, delivered and installed free of charge.



If you want a high performance Stereo System, consider the famous American Acoustic Research. A & R Equipment is designed to reproduce a musically natural sound — not one that is distorted or "pepped-up" — but one which, as the term "hi-fi" implies, produces the highest possible degree of fidelity to the original. A & R turntables, amplifiers and speakers are now available from Sydney's top "Hi-Fi" Shop!

**KENT HI-FI**  
432 Kent Street, Sydney. 29 2743  
(20 yards from Druiit Street)

## POWER OUTPUT

(Continued from page 65)

the regulation of the power supply and the fact that the average level of music is considerably lower than the maximum or peak level.

Originally, the I.H.F.M. sought to measure music power with an external regulated supply connected to the amplifier. (Figure 2.) This maintained the supply voltages at the quiescent (no-signal) level regardless of the current drain. The power measurement was made at the reference distortion, in the same way as continuous power measurement. While this method did give an approximate idea of the amplifier's performance on music signals, it is unrealistic and impractical for several reasons. For one, the dissipation rating of output transistors can be exceeded at the higher power levels permitted by the external supply.

Further, there is no ripple superimposed on the regulated supply to add distortion to the waveform near the clipping level, or to add hum to the input signal. Also, apart from such criticisms, there is the inconvenience involved in connecting a regulated supply to an amplifier for testing purposes.

For these reasons a new test was introduced by the I.H.F.M. to give a more realistic approximation of the short term power capability of an amplifier. The test involves applying gated sine waves in bursts of 10mS duration at a low repetition rate. (Figure 3.)

(See Electronics Australia, April 1968, "A Synchronous Gating Unit For Tone Burst Testing.")

The so-called "Tone Burst" test has also been called the "Transient Distortion" test by the I.H.F.M. and the resulting parameter is called the "Dynamic Power" rating. While this test certainly does give a better indication of the short-term power capability of an amplifier it should be realised that an amplifier cannot always deliver this power on the peaks of typical music signals. The actual "music power" of an amplifier at any instant will vary and depends on the immediately preceding amplifier conditions.

In normal conditions the amplifier is not operating at zero output conditions as it does in the tone burst test. For every musical transient that follows a quiet passage there are many which follow moderately loud passages and on these latter transients the amplifier could not deliver the same level of power that it might on the transient following the quiet passage. Thus, an amplifier's music power will lie between the "Dynamic Power" and the "Continuous Power" ratings.

The "Dynamic Power" test has another flaw in that it is intended to indicate the power developed at the same total harmonic distortion as that specified for the rated power output. Distortion measurements on pulsed sine waves are difficult to perform, to say the least, so this forms another region of uncertainty.

In most cases, "Dynamic Power" will be higher by about 20 per cent than the "Continuous Power Output." If it is any higher it indicates a poorly re-

gulated supply. Amplifiers with an electronically regulated supply will give the same power output on "Dynamic Power" and "Continuous Power" tests.

The "Peak Power" rating is one much-favoured by advertising departments in the past but now, fortunately, it is falling into disuse. The people who used it sought to justify it on the basis that the power on a sine waveform is not constant.

The "peak power" figure is arrived at by multiplying the peak voltage (1.4 times the RMS voltage) by the peak current (1.4 times again) to produce a figure twice that which would be produced by using RMS values. The process is about as valid as rating a 100W lamp at 200W peak power. Use of the term "Peak power" has led to the term "RMS power" being coined to distinguish the RMS derived figure from the peak derived figure. However, the term "RMS power" is mathematically incorrect.

We at Electronics Australia consider the "Continuous Power" test to give the best indication of the quality and capability of an amplifier.

Having explained the various power ratings we can describe the points which must be considered when verifying the manufacturers' specifications of an amplifier. Firstly, as mentioned above, the oscillator used in the test must generate a pure sinewave. For accurate distortion measurements the total harmonic distortion should be less than one-fifth of the anticipated distortion of the amplifier under test.

The most important point as far as the actual power measurement is concerned is the accuracy of the voltmeter. While routine checks can be carried out with a multimeter of average accuracy, verification of amplifier performance specifications really requires a voltmeter with an accuracy of 1 per cent of F.S.D.

According to the British standard, the load used for the amplifier should not vary from its nominal value by more than 5 per cent, while dissipating any power up to the amplifier's maximum. The I.H.F.M. standard recommends that it should not vary from its nominal value by more than 1 per cent while dissipating the maximum output of the amplifier, and also that its reactance will not be more than 10 per cent at any frequency up to five times the highest test frequency. This is an expensive requirement.

While the resistors used for the load must be accurate, care must also be taken to ensure that contact resistance is low in the various connections between amplifier and load. This is particularly important when measuring power into 4-ohm or 2-ohm loads.

The mains supply should be within 2 per cent of the mean of the supply range specified by the manufacturer. The British specification further states that tests should be carried out to determine the effect of supply variations over certain limits.

The final stipulation made by the British specification is that all amplifiers should be in use for at least 1 hour before measurements are recorded and that solid state amplifiers should be in use for at least two hours before measurements, to ensure that conditions in the amplifier have stabilised.



# CLASSIFIED ADVERTISING

## FOR SALE

**FLASH TUBES and TRIGGER TRANSFORMERS.** Photo or strobe. 4 to 200 joules. All ex stock. Circuit Components (A/asia) Pty. Ltd., 460 Bexley Road Bexley, N.S.W. 2207. Phone 59-6550.

**AUDIO EQUIPMENT.** Mullard 10/10 amps., tuners, kitsets or assembled, speakers, enclosures, etc. Open Saturday morning. Circuit Components (A/asia) Pty. Ltd., 460 Bexley Road, Bexley, N.S.W. 2207. Phone: 59-6550.

**REED SWITCHES** available from stock. Circuit Components (A/asia) Pty. Ltd., 460 Bexley Road, Bexley, N.S.W., 2207. Ph.: 59-6550.

**SELL** all back issues "Electronics Aust." in stock at all times. 1939-56 copies 30c, 57-63 40c, 1964 to date 50c. Post free. T. Weir, 56 O'Connor St. Haberfeld, N.S.W. 2045. Sydney, 798-7569. Wanted to buy copies also.

**BURGLAR ALARMS.** 12V 150uA. Transistor control units. \$12 plus 12½ p.c. s.t. Unit on 4 x 2 plate and case. \$16 plus s.t. 4½V rotary sirens \$10.50. All above plus 60c p. and post. Foil tape terminals, mats, key switches bells, reed switches, infra-red ray unit. Complete quote and installation service to insurance requirements.

**EDDRE ENTERPRISES.**  
802 Doncaster Road, Doncaster, Vic.

**RECONDITIONED** Channel Master "Telstar" transistorised aerial booster amplifiers. \$25 ea. Also Channel Master automatic antenna rotators \$40 ea. Freight free. J. Yalden, 21 Oxford St., Glen Innes, N.S.W., 2370.

**FOR SALE OR HIRE.** complete set of top quality hi-hi P.A. equipment, suitable for large areas. Excellent fidelity. Offers, Melb. 69-7731, business hours.

**FOR SALE OR HIRE.** National closed-circuit TV camera tripod and video amplifier, with 25mm 1.8 lens and 90mm 1:1 telephoto zoom lens. Total price \$377. Excellent condition, Melb. 69-7731, business hours.

**CUSTOM-BUILT TRANSFORMERS:** Power audio etc. Single or quantity production. Amplifiers, P.A. systems, battery chargers, rectifiers, electric motors, transistor radios, general engineering, fitting and turning, sheetmetal work, etc. Parkinson Transformers, P.O. Box 523, South Brisbane. Telephone 87-2033.

**EDDYSTONE "940."** Brand-new condition. 100MHz to 1000KHz. AM SSB. \$320. 484 Barrenloey Road, Avalon, Sydney. Phone 918-3835.

**RECORDING TAPE,** made in U.S.A. to highest standards, yet the lowest priced (tensitized tape imported into Australia. 5 x 900 \$1.95, 7 x 1,200 \$2.50, 7 x 1,800 \$3.25, 7 x 2,400 \$4.95. Australian-made tapes: 3 x 600 \$1, 5 x 1,200 1.95, 7 x 4,800 \$9 (and all other sizes in between). Write for full list of 12 different brands. All accessories and tape-recorder bargains. A1 Mail Orders, Box 15, Footscray, Vic. 3011. Ph. 68-4436.

**FIVE VOLUMES.** Applied Radio Television Manual, \$20. C.G.C., Box 2, Broken Hill South N.S.W. 2880.

**EDDYSTONE EC10** fully transistorised communication receiver, covering 30MHz-500KHz in five bands SSB-CW-AM. An extremely sensitive stable receiver for someone requiring the ultimate. Brand-new in original carton with instruction manual. Bargain at \$175. Roth Jones, 1 Albert Rd., Melbourne. 3004. 26-6911.

**EMPIRE 808** cartridge with extra new stylus \$29 or offer, 18 Kennealy St., Surrey Hills, Vic. 83-5735.

**HI-FI CABINETS,** craftsman-built to your design enquiries welcome, trade supplied, Robert N. Smallwood, 205 Brisbane Rd., Booval, Qld. 4304. Phone: 82-1550.

**UNIUNION** transistors, Texas TIS43A silicon uniunions, complete with data and applications sheets. \$1.50 ea. 4/92 Station Street, West Ryde, N.S.W. 2114.

**BC108, 65c; BC109, 70c; MPF 165, \$1.20.** Post-free. T and M Electronics, Box 57, P.O. Haberfeld, N.S.W. 2045.

**MODEL ENGINEERING** Supplies, Castings, blue prints, Bolton, 70 King Street Sydney. 2001. Illustrated catalogue now \$1.50.

**STUDIO** tape-recorders. Two only Reflectograph (British) mono ½-track professional machines, 7½ and 3½, three motors, three heads, variable speed, fast wind. Brand-new, never used. Sacrifice, \$250 each. Send S.A.E. for details, photos. Vista Recording Studios, 78 Robert St., Wickham, N.S.W. 61-4908.

## FOR SALE

**STUDIO** microphones. PML BCK condenser mic three patterns, c/w power supply and cables, as new. \$120. RCA 440X velocity mic. \$60. Vista Recording Studios, 78 Robert St., Wickham, N.S.W. 61-4908.

**CYLDEN** turret Astor video strip, \$40 pair, or will separate. W. Hurrey, 2 Merton Close, Cheltenham, Melb. Phone 93-7593.

**POTS,** new, linear 1K, 2.5K, 5K, 10K, 25K, 50K, 100K, 500K. Standard 2in shaft, 35c each. Plus 10c post., pack any order. Kitsets Aust., Box 176, P.O., Dee Why, N.S.W. 2099.

**RESISTORS,** new, top-grade all 5 pc tolerance. ¼W, 4c each or \$3 per 100; ½W, 5c each or \$4 per 100; 1W, 8c each or \$6.50 per 100. Quantities may be made up of any value between 1 ohm and 10 meg. We supply to your list. Pack and post, 10c any order. Prompt service. Kitsets Aust., Box 176, P.O., Dee Why, N.S.W. 2099.

**ELECTROLYTICS,** 25VW. Miniature type, top grade. 2,000uF, 95c; 1,000uF, 60c; 500uF, 40c; 200uF, 29c; 100uF, 25c; 50uF, 21c; 25uF, 20c; 10uF, 18c; 5uF, 16c.

**ELECTROLYTICS,** 10VW. 1,000uF, 49c; 500uF, 33c; 200uF, 25c; 100uF, 19c; 50uF, 17c; 30uF, 15c; 2uF, 14c; 10uF, 13c; 5uF, 12c. Pack and post, 10c any order. Kitsets Aust., Box 176, P.O., Dee Why N.S.W. 2099.

**BARGAINS:** Bulk buying saves money. 10 OA91 diodes \$2.50 or 28c ea. 10 silicon rect. 100 PIV 1A, \$2.50 or 28c ea. 400 PIV 1A \$3.20 or 36c ea. 3 2N 3638 trans. \$2.20 or 80c ea. 5 2N4121 trans. \$1.50 or 40c ea. 4 BC108 or BC109 trans. \$2.40 or 70c ea. 5 25uF 25VW elect. capacitors. \$1.00 or 23c ea. 10 5uF 10V \$1.00 or 12c ea. 10 30uF 10V \$1.30 or 16c ea. 10 100uF 10V \$1.50 or 19c ea. All tested and guaranteed. Post any order 10c. Send S.A.E. for free catalogue. Pre-Pak Electronics, Box 131, P.O., Kingsgrove 2208.

**AUDIO MIXER,** four channel E.A. Feb. 66. Excellent performance, all transistor. Two low impedance mic. channels, two P.U. \$35. With four mic. channels \$55. 240V AC power supply, \$14.95. Beech Electronics, P.O. Box 160, Kogarah, N.S.W. Phone 605-2307.

## READER SERVICE

**ELECTRONIC ORGANS.** Do not build yourself an organ without first finding out about the superb Schober (U.S.A.) Assemble-It-Yourself Kits. Inquiries to Schober Organs (Australia), 124 Livingstone Ave., Pymble, N.S.W., 2073 (mail only, please).

**TRANSFORMERS** wound. Output or mains and specials to order. Paris Radio Electronics, 7a Burton St., Darlinghurst N.S.W. 31-3273.

**TAPE** to disc service. Take advantage of W. and G. Records' professional experience when next needing a tape to disc service. W. and G. Record Processing Co., 185 A'Beckett Street, Melbourne. Tel.: 329-7255.

**PRE-RECORDED TAPES** hired to members of Australian Tape Recording Society. Bi-monthly releases. "The Microphone," newspapers, round robins, sales, service, tape-spooling. Send 5c 9in x 4in SAE to ATRS, Box 9, P.O. Grows, Nes., N.S.W., 2065 or phone (2) 43-6681, after hours.

**DUPICATING:** James E. Smith Duplicating Service for photostats, photo copies, electronic stencils, addressing service, extensive duplicating coverage. Customers wanted. P.O. Box 48, Albion, Qld., 4010. Phone 57-6612.

**FOR SERVICE** to all instrument and electronic equipment. Excellent service, work guaranteed. Eric C. Thomas, 16 Jonathan Ave., E. Burwood, Vic. Phone 232-5511.

## AWA MICROELECTRONICS

### Further opportunities for ELECTRONIC TECHNICIANS

are now available in the fascinating field of integrated circuits with the only Australian I.C. facility.

Write or phone Staff Office,

**AMALGAMATED WIRELESS VALVE COMPANY PTY. LTD.,**

348 Victoria Road,

RYDALMERE, N.S.W. 2116.

Phone 638-0411.

## READER SERVICE

**FACILITIES** available for electronic equipment include design development, printed circuit and prototype construction, and quantity manufacturing capacity. Transistronics Industries, P.O. Box 7, Ermington, N.S.W. 2115.

**COILS, CHOKES, RFS, IFs, etc.,** wound to your own specifications or on contract basis. Reply with S.A.E. Paris Radio Electronics, 7a Burton St. Darlinghurst, N.S.W. 31-3273.

## WANTED

**L.P. RECORDS WANTED.** Any quantity. Highest prices paid. Will call with cash within 30 minutes. Castle Records, 323 Church Street, Parramatta, 635-8621; after hours 86-1422.

**EXCHANGE** two beautiful radio-control model boats, valued \$6,000 for "ham" rig. Write VK2AMI, 142 Seville St., Fairfield, N.S.W. 2165.

**SIGNALLING** lamps, Army type, small Stromberg. Carlson, Lucas, Sydney 86-7695.

**DISC RECORDING LATHE.** M.S.S. or similar type. In good order. J. E. Fox 14 Helen Street, Mt. Gambler, S.A. 5290.

## POSITIONS VACANT

**TUTOR** in Melbourne area for 2nd class P.M.G. Certificate student. Write Dewhurst, C/O Bank Of N.S.W., 325 Collins St., Melbourne. 3000.

## PROBLEMS?

The scientifically endorsed potential of **THOUGHT-POWER**, opens doors, solves problems, ensures success, brings peace of mind. Free informative, large book, containing pages of letter-extracts, explains how simple, proven, uncostly methods fulfil your needs. Send 17c stamp to

Mr BENN, 44 VICTORY LANE, LEURA, N.S.W. 2781.

## SERVICE

**BILL TURNBULL** offers you service on Hi Fidelity equipment tape Recorders, Communication Receivers and Electronic Test Equipment.

25 years experience  
All work guaranteed

## BILL TURNBULL

11 ELLALONG ROAD,  
CREMORNE, N.S.W. 90 4825

## GOOD BOOKS

Published by U.S. Government. Clear, detailed, cheap (in spite of outrageous postal costs). Big pages, many diagrams, comprehensive, but negligible maths. Basic Electricity . . . . . \$4.00 Introduction to Electronics . . . . . 1.15 Basic Theory/Application Transistors 1.75 Theory/Use Electronic Test Eqpt. 1.30 Troubleshooting/Repair Radio Eqpt. 2.65 Selected Semiconductor Circuits Hbk. 3.25 Also Available: Some good books by Sams, Techpress, Motorola, G.E., S.A.E. for catalogue. Money Back Guarantee (10 days)! But to see these books is to love them. All post free.

**AUSTRALIAN ELECTRONICS,**  
32 Waterworks Road,  
Dyynryne, Tasmania, 7005.

# ADVERTISING INDEX

A & R Electronic Equipmt. Co. Ltd.	154
A & R Transformers Pty. Ltd.	132
A.C.E. Radio	147
Adcola Products Pty. Ltd.	131
Aegis Pty. Ltd.	61
Alfa-Gevaert Ltd.	96
Akal Electric Co. Ltd.	175
Amalgamated Wireless (A'sia) Ltd.	26
Amateur Astronomers Supply Co.	133
Amplion (A'sia) Pty. Ltd.	113
Arrow Electronics Pty. Ltd.	60
Astronics Australasia Pty. Ltd.	32, 119, 121
Audio Engineers Pty. Ltd.	108
Australian Electronics	175
Aust. Radio and TV College Pty. Ltd.	Outside Back Cover
Basic Electronics	71
Beech Electronics	95
Brush Hi-Fi Centre	63
Bright Star Radio	157
British Institute of Careers	140
Broadway Electronics Pty. Ltd.	78, 79
Broadway Electronics (Sales) Pty. Ltd.	2, 3
Central Imports Pty. Ltd.	86
Chapman, Maurice and Co. Pty. Ltd.	112
Charmal Pty. Ltd.	111
Classic Radio Service	110, 111
Classic Tape Recorders	101
Classified Advertisements	175
Claybridge Sound	83, 117, 171
Coistock Electronics	91
Convoy International Pty. Ltd.	126
Cunningham, R. H. Pty. Ltd.	154
Danish Hi-Fi Pty. Ltd.	64
Decca	135
Deltch Bros.	172
Dept. of Supply	165
Douglas Trading Pty. Ltd.	116
E. D. and E. (Sales) Pty. Ltd.	106, 107
Electronic Despatch	153
Elmeasco Instruments Pty. Ltd.	40
Encel Electronics (Stereo) Pty. Ltd.	19, 43, 122, 169
Ferris Bros. Pty. Ltd.	52
Foot, Richard (Aust.) Pty. Ltd.	41
General Accessories Ltd.	38, 128, 156, 164
Goldring Eng. (A'sia) Pty. Ltd.	6, 7, 56, 57
Goodmans Loudspeakers Ltd.	114
Gray, Simon Pty. Ltd.	100, Inside Back Cover
Haco Distributing Agencies Pty. Ltd.	Inside Front Cover
Ham Radio Suppliers	170
H.B. Radio Sales	99, 115
Hi Fi (Stereo) Pty. Ltd.	130
Homecrafts Pty. Ltd.	152
International Correspondence Schools	143
International Dynamics (Ag.) Pty. Ltd.	97
IRH Components Pty. Ltd.	24, 72, 134, 149
Jacoby Mitchell and Co. Pty. Ltd.	14, 22, 166
J.H. Reproducers Pty. Ltd.	98
Kent Hi-Fi	174
Klapp Electronics Pty. Ltd.	87
Kodak (Australasia) Pty. Ltd.	42
Lafayette Electronics	144
Leak, H. J. (Aust.) Pty. Ltd.	68
Magnetic Sound Industries	124
Magrath, J. H. and Co. Pty. Ltd.	90
Mallory Batteries (A'sia) Pty. Ltd.	30
Manufacturers Spec. Prod. Pty. Ltd.	55
Marconi School of Wireless	145
Mastersound Sales Pty. Ltd.	120
Miniwatt Electronics Division	82
Mullard-Australia Pty. Ltd.	20
National Radio Supplies	158, 159
Oilms Trading Co. Pty. Ltd.	92
O'Rourke Enterprises (Reg.)	69
Photronic	109
Plessey Pacific Ducon Division	130
Plessey Pacific Rola Division	44, 45
Radio Despatch Service	69
Radio House Pty. Ltd.	12
R.C.S. Radio Pty. Ltd.	126
Recab Storage Cabinets	152
Recorded Music Salon	132
Sansul Electric Co. Ltd.	4, 5
Sanwa Electric Inst. Co. Ltd.	16
Sato Parts Co. Ltd.	156
Selectronic Components	148
Shalley, Peter Electronics Pty. Ltd.	128
Sideband Electronics Engineering	150
Sony Corporation	104
Southern Sound	75
STA Electronics	93
Standard Telephones and Cables Pty. Ltd.	10, 160
Stereo Sound Systems	141
Stott's Tech. Correspondence College	141
Tasmanex Pty. Ltd.	81
Technical Training Int. Pty. Ltd.	138
Tektronix Australia Pty. Ltd.	48
Tei-Leigh-Tubes Pty. Ltd.	73
"Thought Power"	175
Trlo Corporation	88, 89
Truscott Electronics	66
Tudor Radio	136, 137
Turnbull, Bill	175
United Radio Distributors Pty. Ltd.	35
United Trade Sales Pty. Ltd.	135
University Graham Inst. Pty. Ltd.	34
Warburton Frankl Ltd.	54, 168
Weston Electronics Pty. Ltd.	76, 155
Wilcox Bros. & Barclay	65
Willis, S. E. Trading Co.	173
Willis, William and Co. Pty. Ltd.	61
Wonder Wool Pty. Ltd.	123
Zephyr Products Pty. Ltd.	28, 162

## CLASSIFIED ADVERTISERS ELECTRONICS Australia Classified Columns

USE THIS FORM FOR YOUR NEXT ADVERTISEMENT TO APPEAR IN THE

To the Advertising Manager,  
ELECTRONICS Australia,  
Box 2728 G.P.O.,  
Sydney, 2001

• Please insert the following advertisement in the \_\_\_\_\_ issue

FOR SALE     WANTED     READER SERVICE     POSITION VACANT

• I enclose P. Note/Cheque for \$ \_\_\_\_\_ being full payment for \_\_\_\_\_ lines at \$0.60 per line.

Endorsement \_\_\_\_\_  
Residential Address \_\_\_\_\_  
State \_\_\_\_\_

Please write in block letters with ink or ball-point pen. Number of insertions \_\_\_\_\_

## "ELECTRONICS Australia" SPECIAL ORDER FORM

Guarantee yourself a complete set of issues for your library with no copies missing.

### SUBSCRIPTION RATES

Australia, New Guinea, Fiji, New Zealand    PER YEAR \$5.00  
Elsewhere    PER YEAR \$7.00

### POST THIS COUPON TO:-

The Circulation Manager, ELECTRONICS Australia,  
Box 2728, G.P.O., Sydney, 2001, Australia.

Name \_\_\_\_\_  
Address \_\_\_\_\_  
Enclosed is \$ \_\_\_\_\_ for \_\_\_\_\_ years. Start with \_\_\_\_\_  
(Please use cheque, money order, etc. Do not enclose cash)

# proven wharfedale high fidelity sound from two low priced compact speaker systems!

Several years of intensive research have resulted in the release of two new compact speaker systems by Rank Wharfedale Ltd. The problems associated with small speaker enclosures have finally been solved; until now these limiting factors have been restricted frequency response and lack of musical quality.

The "Denton" measures only 9¾" x 15" x 9" . . . the "Super Linton" is 19" x 10" x 10". Both systems feature a new type of bass/mid-range 8" drive unit with an exclusive Wharfedale Flexiprene surround, an extra-long throw voice coil and a new-type ceramic magnet. A specially designed paper cone is employed as laboratory tests reveal that a well-designed paper cone is far more sensitive to musical sound than those made from plastics or man-made fibres. Lower registers are reproduced without restraint or collapse.

Treble response is smooth, clean and satisfying; a new H.F. pressure unit incorporated in both enclosures features an "Acoustiprene" dome — the lightest material ever used in speaker manufacture.

Frequency response of the "Denton" is conservatively quoted at 65-17,000 Hz. Response of the "Super Linton" is 40-17,000 Hz. Impedance is 4-8 ohms.

Cabinets are finished in selected oiled teak or polished walnut veneers and have been designed to match both modern and period decor. Both "Dentons" and "Super Lintons" are supplied in acoustically matched pairs for optimum stereophonic performance.

When first you listen to these compact Wharfedale multiple speaker systems you will find it hard to believe; after several weeks you will still wonder how Wharfedale succeeded in putting high fidelity Wharfedale sound into extremely compact enclosures.

## the new Wharfedale Denton



**\$61.40**

ea. inc.  
sales tax.

## the new Wharfedale Super Linton



**\$78.**

ea. inc.  
sales tax.

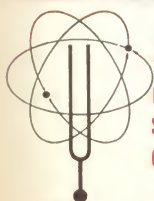

Australian National Distributors:

**Simon Gray Pty. Ltd.**

Head Office: 28 Elizabeth St., Melbourne, Vic. Tel. 63 8101\*

Sydney Office: 22 Ridge St., North Sydney, N.S.W. Tel. 929 6816

Canberra Office: 31-33 London Circuit, Canberra City, A.C.T.  
Tel. 49 6050

INTERSTATE REPRESENTATIVES:

N.T.: Pfitzner's Music House, Smith Street, Darwin. Tel. 3801

Q'land: Sydney G. Hughes, 154-158 Arthur St., New Farm, Brisbane. Tel. 58 1422

S.A.: Eilco Sales Pty. Ltd., 7-9 Osmond Terrace, Norwood, S.A. Tel. 63 4844

Tas.: K. W. McCulloch Pty. Ltd., 57 George Street, Launceston. Tel. 2 5322

W.A.: Athol M. Hill, 613-615 Wellington Street, Perth. Tel. 21 7861

SGW7/68



# YOU CAN EARN BIG MONEY IN RADIO- TELEVISION

## ASK YOURSELF THESE 3 QUESTIONS!

1. Am I in a dead-end job? 2. Could I earn more by learning more? 3. Could I use my spare time to get ahead?

If the answer is yes, there is room for you in radio/television/electronics.

## NOW IS THE TIME TO TRAIN!

Does your job offer good prospects — real security? Does it hold your interest? If not, now is the time to do something about it. Television is expanding daily. It's the most exciting subject you can study. The sky's the limit for the **trained man** . . . but only the trained man. Radio and television technicians are in huge demand. Train for success now, in Australia's fastest-growing industry! **Join the ranks of skilled men** . . . the Australian Radio and Television College can train you for a bright future with unlimited prospects. Send for the free booklet "Careers in Radio, TV & Electronics" and find out how A.R.T.C. can bring you success—in your own business or as well-paid technical staff!

## A.R.T.C. CAN TRAIN YOU AS IT HAS THOUSANDS OF OTHERS

For nearly 40 years A.R.T.C. has successfully trained thousands of progressive Australians who realised how much the training could mean to

them. Now they're making big money in radio and television. Training can bring you success, too.

## FOR A FEW PENCE PER DAY YOU CAN STUDY THE A.R.T.C. WAY

. . . in your spare time, you can equip yourself for a rewarding career in radio/television. **The future belongs to the trained.**

The A.R.T.C. "Service Engineering Course" teaches you from the ground up . . . step by step . . . at your own pace. Remember, opportunity is always knocking for the trained man!

## PRACTICAL UP-TO-DATE LESSONS

At the work benches and lecture halls of A.R.T.C. — or in your own home by correspondence — you can learn every necessary aspect of radio and television, every application of fundamental principles. The Course gives you both basic and advanced instruction.



No previous experience or high educational standard required . . . only enthusiasm and normal intelligence. A.R.T.C. will give you

all the instruction you need. Each lesson is made easy to understand by numerous illustrations and diagrams. The Course adapts itself to your requirements, your speed. It's up to you! Instruction is individual and intensely practical.

## THOUSANDS OF SUCCESSFUL STUDENTS HAVE PROVED THIS

Make your spare time earn money for you while training at home.

Many students make extra money after only a few weeks' tuition. Train at the modern A.R.T.C. workshops, if more convenient.

## GET INTO ONE OF THESE PROFITABLE CAREERS IN RADIO/TELEVISION

There is a career for you in one of the many phases of radio/television, including manufacture, servicing, research, sales, executive positions, armed forces, audio, etc., etc.

A.R.T.C. can help you gain one of these sought-after careers. Remember, it's the trained man who wins, every time!

## MAIL COUPON NOW!

Safeguard your future! You are invited to send in the coupon below. A.R.T.C. will mail you by return their big free and post-free booklet, "Careers in Radio, TV and Electronics." This exciting book shows you definite steps you can take towards a big future—how you can succeed in life and find satisfaction in doing a worthwhile job well.

# AUSTRALIAN RADIO AND TELEVISION COLLEGE PTY. LTD.

E. S. & A. BANK BUILDING,  
Cnr. Broadway and City Road, Sydney.  
(Opp. Grace Bros.) Phone 211-4244 (3 lines.)

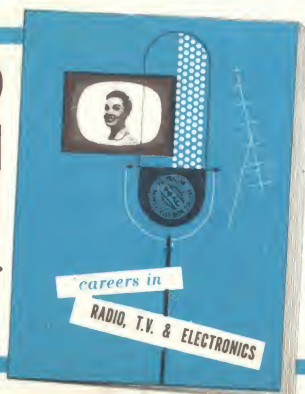

## AUSTRALIAN RADIO & TELEVISION COLLEGE PTY. LTD.

206 Broadway, Sydney, N.S.W.

Dear Sir,

Please send me, without obligation, your free booklet "Careers in Radio TV and Electronics."

NAME .....

ADDRESS .....

.....